

January 2010

US \$ 7.95 - Canada \$ 7.95

M.A.H

eLektor

www.elektor.com



**There's More
to Life than just USB!**

USB Magic Eye

Put a Stop to Throwawayism!

Buses beyond USB and I²C

**Fourier Analysis using
LTspice & Excel**

**ATM18
Logic Analyzer**

Dimmer with a Micro

My First AVR-USB





**NO MATTER WHAT THE IDEA
YOUR PCB PROTOTYPES SHOULD BE THE EASY PART**

QUOTE & ORDER PCBs ONLINE AT WWW.SUNSTONE.COM OR CALL 1-800-228-8198



THE EASIEST PCB COMPANY TO DO BUSINESS WITH



ValueProto™



PCBexpress®



Full Feature

Sunstone Circuits® pioneered the online ordering of printed circuit boards and is the leading PCB solutions provider with more than 35 years of experience in delivering quality prototypes and engineering software. With this knowledge and experience, Sunstone is dedicated to improving the PCB prototyping process from quote to delivery (Q2D®).

Did You Know? Sunstone Offers:

- Controlled impedance testing
- Free 25-point design review
- Online Quote & Order
- Over 99% on-time or early delivery
- Fine lines and spacing [.003]
- Free shipping & no NRE's
- PCB123® design software
- Best PCBs in the industry
- RoHS compliant finishes
- Flex / Rigid Flex Boards
- RF / Exotic Materials
- Live customer support 24/7/365

WIRELESS MADE SIMPLE[®]

QUICKLY AND COST-EFFECTIVELY MAKE YOUR PRODUCT WIRELESS

RF MODULES

LOW COST • LONG RANGE



**TRANSMITTERS • RECEIVERS
• TRANSCEIVERS**

INTEGRATED CIRCUITS

ENCODERS • DECODERS • TRANSCODERS



**COMMAND • CONTROL
• KEYLESS ENTRY**

OEM PRODUCTS

EASILY CUSTOMIZED



ANTENNAS

FROM WHIPS TO CHIPS



Featured Products:

GPS Modules

GPS MADE SIMPLE™

- RXM-GPS-SR
- RXM-GPS-SG

- High Performance
- High Sensitivity
- Low Cost
- Easy Serial Interface
- Ultra Compact
- Low Power Consumption

These easily applied GPS modules blend high performance, low power and cost effectiveness into a single, compact, SMD package. The SiRFstar III low-power chipset minimizes power consumption and provides exceptional sensitivity. The receivers feature an on-board LNA and SAW filter with a choice of an integrated or external antenna. No other RF components are needed and the module's standard NMEA data output makes integration easy.



Development Systems

THE FAST TRACK TO WIRELESS SUCCESS

Linx development systems contain everything needed to evaluate the Linx product of your choice and implement it in record time.



LINX
TECHNOLOGIES

WIRELESS MADE SIMPLE

800-736-6677

159 Ort Lane
Merlin, OR 97532

linxtechnologies.com

Big Deal *Elektor & Circuit Cellar*

In 2011 it will 50 years ago when a Dutchman called Bob van der Horst launched his magazine *Electronica wereld* (Electronics world). A bit later the use of the title started to present problems and Bob's periodical continued under the name *Elektuur* in 1964. Bob did not fail to see the cross-border potential of the publication, especially for Germany. Before long, *Elektor* — as all non-Dutch editions were called — also appeared in English and French, followed by numerous licensed editions for lesser language areas like Italian and Spanish, and the publication as a whole grew massively. Now, 50 years on, *Elektor* is poised to cross the Atlantic and enter the US market. Keen readers will object that a localized edition of *Elektor* has been on publication the US and Canada since January 2009, so what's the big deal? The answer is: we've added US publication *Circuit Cellar* to the *Elektor* portfolio.

Circuit Cellar equates to Steve Ciarcia, the resident author of the famous 'Circuit Cellar' section in (equally famous) *Byte Magazine*. While *Byte* drowned in the tidal wave called online publishing, Steve strengthened and expanded *Circuit Cellar*. Over the years 'CC' became a leading periodical on embedded electronics, graced by readers in all corners of the globe.

Circuit Cellar and *Elektor* are complementary to a large extent, *Elektor* throwing in its long and varied history, in-house laboratory, prototyping-for-repeatability, multi-lingual culture and an author network spanning the globe. *Circuit Cellar*, the younger magazine, adds a strong focus on PC and embedded applications, plus its proven ability to mobilize hoards of programmers by means of design competitions.

As I write this we're recovering from a highly successful *Elektor Live!* day in Eindhoven, The Netherlands, which attracted some 1,200 visitors — all enthusiastic about electronics. By uniting the forces of *Elektor* and *Circuit Cellar* our community of electronics experts is considerably widened and enthusiasm is sure to grow all along.

Wisse Hettinga

elektor

- 6 Colophon**
Corporate information on *Elektor* magazine.

- 8 News & New Products**
A monthly roundup of all the latest in electronics land.

- 12 And the Winners are...**
Elektor Foundation Award 2009.

- 13 Burning Amp Festival 2009**
A report by Jan Didden.

- 14 There's More to Life than just USB!**
How to connect your micro to a PC.

- 20 My First AVR-USB**
An annotated guide to the Atmel AT90USBKey.

- 26 PCB-DIY All the Way**
Elektor's new SMT stencil machine and pick & place tool.

- 28 On the Buses**
What if you do decide not to use USB or I²C?

- 32 USB Magic Eye**
Vintage technology in a PC environment — no problem.

- 38 Router & Wireless Doorbell = Alarm System!**
Inspired electronic recycling truly rings the bell.

- 43 USB is cool/sucks* (cross out as applicable)**
Ten questions about USB answered by Elektor Labs.

- 45 Elektor CO₂ Meter Mk. 2**
How the original design was upgraded for asthma sufferers.

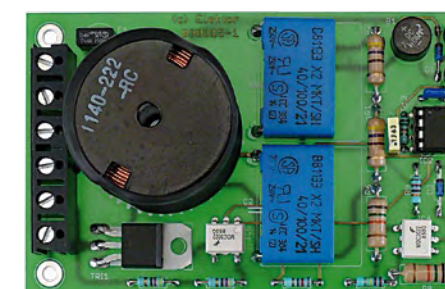
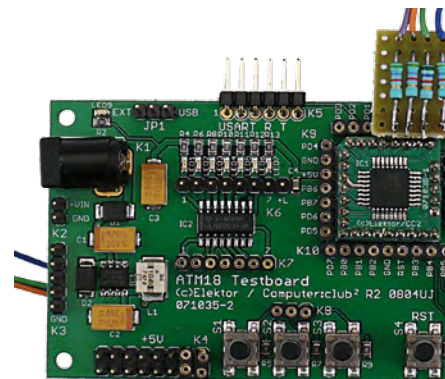
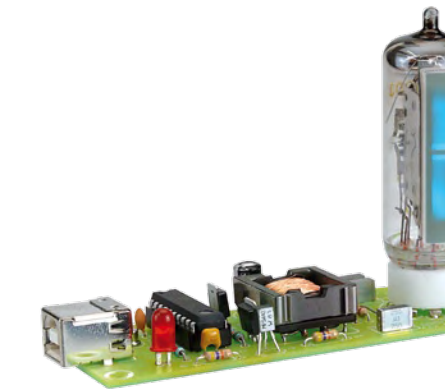

CONTENTS

Volume 2
January 2010
no. 13

20 My First AVR-USB

Sure, countless microcontroller boards featuring a USB connection have made it to the Projects and News pages of Elektor. However, the AVR-USB hardware stack wasn't covered till now. A 30-dollar board and free software utilities to play with are going to change that as you meet the USB-AVR family.

32 USB Magic Eye

A green glowing indicator tube as a CPU activity meter? Sure, with power and control both provided by the USB port. A simpler variant on the circuit, using a moving-coil meter, is also described.

48 ATM18 Logic Analyzer

If it is logic levels rather than pulse shapes that matter, a software-based logic analyzer like the one described here can offer a very powerful alternative solution.

68 Dimmer with a Micro

The idea for this design came about because the author wanted to replace a double switch with a switch/dimmer combination that wasn't available off the shelf. The existing double switch was retained and the dimmer circuit described in this article was built into the light fitting in the ceiling.

46 Linux Symposium

If only to confirm that Linux for embedded applications is hot.

48 ATM18 Logic Analyzer

This month the Elektor ATM18 is used for test & measurement.

52 Fourier Analysis using LTspice and Excel

A straightforward guide to frequency and time domain analysis.

56 All-Analog Design Tips

LEDs double as photosensors
Incandescent lamp flasher
Communication with a laser
How low can it go?
Low voltage indicator

60 Vacuum Pump

A tool to improve the quality of your homebrew PCBs.

64 MIAC for Home Automation

The CAN bus is not just for vehicles!

68 Dimmer with a Micro

For incandescent and halogen lamps up to 300 watts.

72 Gerard's Columns

DBA

74 Hexadoku

Our monthly puzzle with an electronics touch.

75 Retronics: Put a Stop to Throwawayism!

Regular feature on electronics 'odd & ancient'.

84 Coming Attractions

Next month in Elektor magazine.

Elektor International Media provides a multimedia and interactive platform for everyone interested in electronics. From professionals passionate about their work to enthusiasts with professional ambitions. From beginner to diehard, from student to lecturer. Information, education, inspiration and entertainment. Analog and digital; practical and theoretical; software and hardware.



No. 1, JANUARY 2010

ISSN 1947-3753

Elektor aims at inspiring people to master electronics at any personal level by presenting construction projects and spotting developments in electronics and information technology.

Elektor (ISSN 1947-3753) is published monthly (except for one issue in July/August) at \$39.95 per year, Canada add \$11.00 per year; by Elektor International Media LLC, 4 Park Street, Vernon, CT 06066, USA. Phone: 860-875-2199, Fax: 860-871-0411. www.elektor-usa.com

Elektor is also published in French, Spanish, German and Dutch. Together with franchised editions the magazine is on circulation in more than 50 countries.

International Editor:
Wisse Hettinga (w.hettinga@elektor.com)

Editor: Jan Buiting (editor@elektor-usa.com)

International editorial staff: Harry Baggen, Thijs Beckers, Eduardo Corral, Ernst Krempelsauer, Jens Nickel, Clemens Valens

Design staff: Antoine Authier (Head), Ton Giesberts, Luc Lemmens, Daniel Rodrigues, Jan Visser, Christian Vossen

Graphic design / DTP: Giel Dols, Mart Schroijen

Publisher: Hugo Van haecke
(h.vanhaecke@elektor.com)

Marketing: Carlo van Nistelrooy

Customer Services: sales@elektor-usa.com

Subscriptions:
Elektor US, 4 Park Street, Vernon, CT 06066, USA.
Phone: 860-875-2199, Fax: 860-871-0411
Internet: www.elektor-usa.com
E-mail: custservus@elektor.com

Elektor Personal Organizer 2010

NEW!



Complete with a free pen and SMD-tool

The Elektor Personal Organizer 2010 makes planning your appointments a real pleasure, and you always have ready access to have handy information that everyone who works with electronics needs to know.



elektor

In addition to the usual features such as an appointments calendar, address book and notes pages, this organizer has around 40 pages packed with useful information for you as an electronics specialist, both professionally and in your leisure time. For example, there is an extensive collection of formulas and tables for calculating current and voltage, component descriptions, physical constants, connector pin assignments, and much more.

The Organizer at a glance:

- 2010 calendar (two pages per week)
- Appointments calendar (with corner perforations) in six languages
- 40 pages of technical information on electronics
- Seven sections, separated by tab sheets
- Alphabetic address and telephone book
- Handy monthly planner
- Lined pages for your notes
- Five credit-card pockets and a pocket for business cards
- Push-button closure
- Six-ring binder mechanism (diameter 25 mm)
- Luxurious grey imitation-leather binding

ISBN 978-90-5381-247-1 • \$40.20

Further information and ordering at
www.elektor.com/organizer

Head Office:

Elektor International Media b.v.
PO Box 11 NL-6114-ZG Susteren The Netherlands
Telephone: (+31) 46 4389444. Fax: (+31) 46 4370161

US Advertising:

Strategic Media Marketing, Peter Wostrel,
1187 Washington St., Gloucester MA 01930 USA.
Phone: 978-281-7708, Fax: 978-281-7706
E-mail: peter@smmarketing.us
Advertising rates and terms available on request.

Copyright Notice

The circuits described in this magazine are for domestic use only. All drawings, photographs, printed circuit board layouts, programmed integrated circuits, disks, CD-ROMs, software carriers and article texts published in our books and magazines (other than third-party advertisements) are copyright Elektor International Media b.v. and may not be reproduced or transmitted in any form or by any means, including photocopying, scanning or recording, in whole or in part without prior written permission from the Publisher. Such written permission must also be obtained before any part of this publication is stored in a retrieval system of any nature. Patent protection may exist in respect of circuits, devices, components etc. described in this magazine. The Publisher does

not accept responsibility for failing to identify such patent(s) or other protection. The submission of designs or articles implies permission to the Publisher to alter the text and design, and to use the contents in other Elektor International Media publications and activities. The Publisher cannot guarantee to return any material submitted.

Disclaimer

Prices and descriptions of publication-related items subject to change. Errors and omissions excluded.

© Elektor International Media b.v. 2010 Printed in the USA

Real-time operating system cohabits with Windows on PC platforms

The TenAsys INtime real-time operating system allows embedded system developers to run multiple instances of the OS alongside Windows on the same multi-core processor platform. Release 4.0 allows supports this advanced functionality.

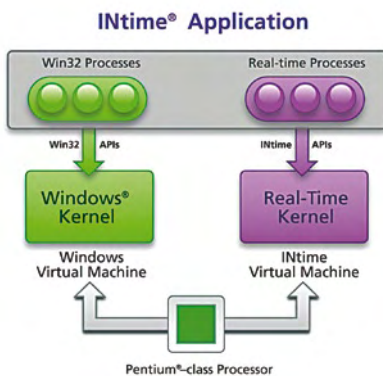

INtime software combines deterministic, hard real-time control with standard Windows operating systems, including Windows Vista, Windows XP, Windows XP Embedded, Windows 2000 and Windows Server 2003, without requiring additional hardware. INtime is specifically designed to take advantage of the powerful capabilities of the x86 processor architecture, so that real-time and non-real-time applications can run in separate virtual machines on a single computer to provide cost-effective, reliable control that is easy to develop and maintain.

Previously, embedded systems requiring multiple real-time OSs and Windows needed to employ multiple independent processor platforms. By consolidating multiple operating environments into one platform, embedded system suppliers can save cost and increase the scalability of processing power.

With INtime 4.0, developers don't have to worry about mutual interference between several high-priority real-time processes. Time-critical processes can be configured to run on dedicated cores of a multi-core processor, fostering modular design of real-time systems without the burden of resolving priorities between deterministic processes. If processes running on separate cores need to signal one another, INtime 4.0 provides a reliable, deterministic way to do this with shared memory.

Back-illuminated CCD sensor targets low-light applications

In conventional back-illuminated CCD imaging sensors, the silicon substrate thickness is reduced to just a few dozen microns. As a result, infrared light is more likely to pass through the substrate, decreasing the quantum efficiency of the sensor in the infrared region. A thicker silicon substrate increases the quantum efficiency in the near-IR region, but it reduces the resolution due to charge spreading. Hamamatsu Photonics has now developed fully depleted CCD sensors using a unique thick silicon substrate that has no neutral region when a bias voltage is applied, which enables them to deliver relatively high quantum efficiency in the near-IR region while avoiding any significant loss of spatial resolution. This improved near-IR sensitivity makes these back illuminated CCD devices well suited to astronomy applications.

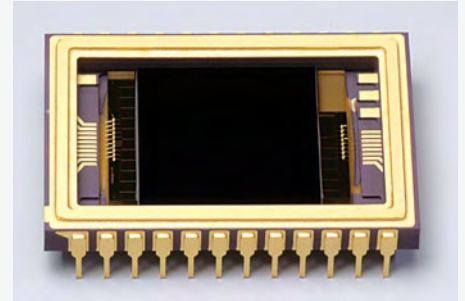

The new Hamamatsu S10747-0909 fully depleted CCD imaging sensor is specifically designed for operation at low light levels and is available with a resolution of 512 by 512 pixels at a pixel size of $24 \times 24 \mu\text{m}$. It has an outstanding spectral response range from 300 to 1200 nm, with a peak quantum efficiency greater than 90%. Typical CCD sensors have very low sensitivity at 1000 nm, but the new S10747-0909 exhibits a quantum efficiency of 70% at this wavelength. In fact, the quantum efficiency is significantly improved over the entire range from 400 nm to 1200 nm in comparison with a typical back-thinned CCD image sensors. This makes the S10747-0909 suitable for a wide range of applications, in particular as a detector for near-IR imaging of astronomical objects. Hamamatsu can also produce devices in this technology that can be butted on all four edges to create 100-megapixel imaging sensors with areas of 288 cm^2 or larger by tiling individual devices in an array.

www.sales.hamamatsu.com

(090951-I)

INtime 4.0 is a free upgrade for all INtime for Windows customers that are covered by an active TenAsys support contract. Requests for a fully functional evaluation copy of the INtime RTOS for Windows can be submitted on the TenAsys website.

www.tenasys.com/intime

(090951-II)

Chronos is designed to give users all the hardware and software they need to start developing wireless networking applications, regardless of their programming expertise. It has sensors for measurement and motion-based control and can serve as

Development environment brings wireless networking to sports watches

Texas Instruments has announced eZ430-Chronos, which it claims to be first customizable development environment for sports watches. It enhances the popular line of eZ430 development tools to help developers utilize the integration, ultra-low power and wireless features of the TI's CC430 microcontroller (MCU).



\$51^{For 3} PCBs
FREE Layout Software!
FREE Schematic Software!

Advertisement

a central hub for nearby wireless sensors to give users remote access to real-time data from devices such as pedometers and heart rate monitors.

Chronos also includes a USB RF access point for wireless set-up and PC connectivity, as well as several production-ready open source projects to foster evaluation, design and community collaboration.

The key benefits of eZ430-Chronos include a wearable form factor to support development in remote locations, support for three frequency bands (915, 868 and 433 MHz) to enable worldwide use, and an integrated three-axis accelerometer for motion sensitive control, along with sensors for measuring parameters such as altitude, temperature and battery voltage.

Other features include an eZ430 emulator for simplified programming and debugging on a base software framework and RF functions, internal CC430 memory for data storage, a large 96 segment LCD display driven directly by the CC430, and a USB RF access point for PC communication and automation.

<http://focus.ti.com/docs/toolsw/folders/print/eZ430-chronos.html>
 (090951-III)

Chameleon AVR 8-bit and Chameleon PIC 16-bit development boards

Chameleon™ from Nurve Networks is an evolutionary step in high performance, small footprint application development boards. Similar in concept to the BASIC Stamp™ and Arduino™, Chameleon takes these products to the next level with substantial increased processing power and I/O capability. Simply put, Chameleon is a computer with a credit-card form factor that features two processors, nine processing cores, 1 MB of on-board flash, 64 KB of EEPROM, and more than 180 MIPS of processing power. The Chameleon's numerous I/O interfaces include composite video for NTSC/PAL generation, VGA, audio out, and PS/2 for a keyboard and mouse. The Chameleon also has several digital I/O ports and analog inputs, making it ideal for industrial controllers, experimentation, education, wearable computing, and hobbyist use.

The Chameleon comes in two flavors: AVR 8-bit and PIC 16-bit. The AVR version uses the Atmel AVR328P 8-bit microcontroller, while

the PIC version uses the Microchip PIC24 16-bit microcontroller as the main master processor (client), along with the Parallax multi-core Propeller chip as the media processor (server). Instead of tasking a single processor system with everything, the Chameleon offloads the heavy lifting to the mul-

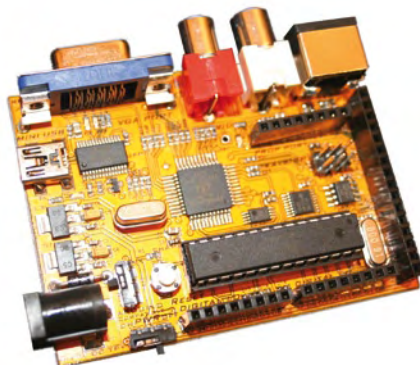

ticore Propeller chip, which has 8 processing cores to perform tasks such as video and audio output, keyboards and mouse input, and so on. The AVR or PIC MCU simply sends commands to the Propeller chip over a high speed SPI interface to have the Propeller execute various operations, using a simple API that usually consists of a just few lines of code for any task. This makes AVR or PIC programming very easy, and with simple APIs you can develop very complex, rich media applications that leverage the powerful Propeller chip's media rendering capabilities and huge software library. It takes only a few lines of code to generate TV and VGA signals and read inputs from a keyboard and mouse.

The AVR and PIC versions are both designed to have Arduino I/O header compatibility as much as possible, but the AVR version is also fully software compatible, so the Arduino

- 01 DOWNLOAD our free CAD software
- 02 DESIGN your two or four layer PC board
- 03 SEND us your design with just a click
- 04 RECEIVE top quality boards in just days

expresspcb.com

NEWS & NEW PRODUCTS

environment (as well as AVRStudio) can be used to develop software for the AVR version. The PIC version works with MPLab as well as a stand-alone 'Arduino-like' tool chain developed by Nurve Networks that uses a boot loader. Both versions thus have a boot loader hosted development environment where all you need is a text editor and a USB port – no programming tools are necessary.

The Chameleon is a complete AVR/PIC application development board as well as a Propeller development board. Both processors can be programmed and used independently. Additionally, the AVR/PIC and Propeller have their own digital I/O ports, so in principle you can run two different applications on the Chameleon or use the processors together via the SPI link. In addition, the Propeller subsystem is compatible with most Propeller development boards and the HYDRA™ system, which means that the Chameleon can run most of these applications with little or no modification.

www.xgamestation.com/browse_products.php?category=9
(090951-IV)

NXP launches low-cost 32-bit MCU family



With unit prices starting at just 65 cents, the LPC1100 flash-based microcontroller family has the potential to displace 8-bit and 16-bit MCUs. Designers can now get 32-bit performance at power levels and prices usually associated with devices offering much lower performance.

Initially announced with 15 members, the LPC1100 family is based on the ARM Cortex-M0 IP core. It offers a seamless entry point for designers currently using 8-bit and 16-bit MCUs who want to introduce the scalable

ARM architecture across their entire product development range. With this family, designers can take advantage of modern ARM-based design tools and techniques for low-power devices.

According to NXP, the 50-MHz LPC1100 offers more than 45 DMIPS of performance, considerably more than what can be achieved by 8-bit MCUs (typically under 1 DMIPS) or 16-bit MCUs (typically 3 to 5 DMIPS). In addition to executing basic control tasks, the LPC1100 can handle sophisticated algorithms. Reduced task execution time also translates into lower power consumption. With extensive power optimization features, the MCU can operate at less than 10 mA.

The key features of the NXP LPC1100 family of microcontrollers include 32 vectored interrupts, four priority levels, and dedicated interrupts from up to 13 GPIOs; a UART, two 16-bit and two 32-bit timers; power-on-reset and multi-level brown-out-detection; and an eight-channel, 10-bit ADC.

The LPC1100 family is supported by development tools from IAR, Keil, Hitex, and Code Red. NXP plans to offer an easy to use, comprehensive development tool platform at less than \$30. Pricing (in 10,000-piece quantities) for family members in the 33-pin package ranges from \$0.65 to \$0.95, with flash memory capacities of 8 to 32 KB. For socketed applications, 48-pin LPQFP and PLCC44 packages will also be available. All the devices are scheduled to be available in early December.

www.standardics.nxp.com/products/lpc1000/lpc11xx/
(090951-VII)

Silicon-air batteries boast unlimited shelf life

Researchers at Technion (Israel Institute of Technology) have developed an environmentally friendly silicon-air battery that can supply non-stop power for thousands of hours without needing to be replaced.

Utilizing oxygen and silicon – the second most plentiful element in the earth's crust – this battery technology has the advantages of light weight, unlimited shelf life, and high tolerance to both humid and extremely dry conditions. Potential uses include medical applications such as powering diabetic pumps or hearing aids, sensors, and micro-electronics devices.

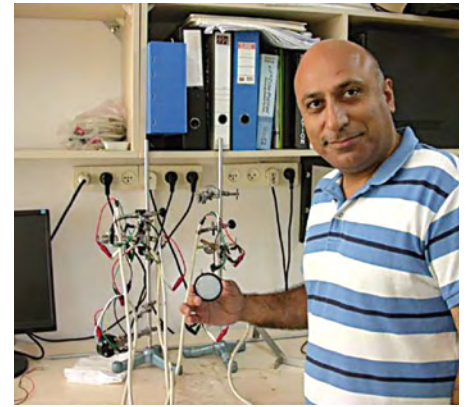

According to lead researcher Yair Ein-Eli in the Materials Engineering department, silicon-air batteries can be used in the same way as existing batteries, but as a safe, non-toxic, stable and readily available material, silicon enables the development of very lightweight batteries with infinite shelf life and high energy capacity.

Silicon-air batteries could provide significant savings in cost and weight because they eliminate the need for the cathode structure of conventional batteries. The cathode of a silicon-air or metal-air battery is formed by the oxygen taken from the air through a membrane.

Ein-Eli estimates that in three to four years, silicon-air batteries could be made more powerful as well as rechargeable. In ten years, he says, it may be possible to produce silicon-based electric car batteries that can would turn back into sand that could be recycled to make new batteries.

According to Ein-Eli, lightweight, long-lasting metal-air batteries are already used in hearing aids. There have also been some attempts to upgrade this battery technology for use in electric cars and portable electronic devices, with increased interest in this topic sparked recently when Toyota and Panasonic began joint efforts to adapt zinc-air battery technology for use in future electric cars.

<http://pard.technion.ac.il/press/PressrelE.asp#>
(090951-VIII)

Tiny isolated voltage/current detectors come in stretched SO-8 package

Avago Technologies has announced two new miniature voltage/current threshold detection optocouplers for use in a wide

range of industrial control applications. The ACPL-K370 and K376 optocouplers are designed to detect AC/DC voltages and convert the voltage to a logic signal across an optical coupling barrier that provides safe isolation in the electronically noisy environments found in industrial applications. Applications include limit switch sensors, low voltage detectors, relay contact monitors, relay coil voltage monitors, and current sensors.

The ACPL-K370/K376 series uses threshold sensing input buffer ICs that allow the threshold level to be set over a wide range of input voltages up to $1140 V_{pk}$ using a single external resistor.

The key features of the optocoupler series include a small stretched SO-8 (SSO-8) package that meets 8-mm clearance and creepage requirements and needs thirty percent less PCB space than a dual inline package (DIP-8). In addition, the optocoupler input buffer provides several features

that enhance threshold sensing, such as hysteresis for extra noise and switching immunity, a diode bridge for easy use with AC input signals, and internal clamping diodes to protect the buffer and LED against overvoltage and overcurrent transients.

With the ACPL-K370/K376 series, Avago now offers an SSO-8 package option in addition to existing DIP packages for optocoupler devices used in high voltage industrial applications. The ACPL-K376 is a low-current version of the ACPL-K370. To reduce the operating current, the ACPL-K376 has a high-efficiency aluminum gallium arsenide LED that provides more light output with less drive current.

Additional features include $\pm 5\%$ voltage detection accuracy, user configurable single/dual detection levels, built-in hysteresis, 1.32 mA threshold current (ACPL-K376), logic-compatible output, 2 V to 18 V supply voltage range, and an operating temperature range of -40 to +105°C.

www.avagotech.com

(090951-X)

JOULE™ LED lighting systems shine with Evonik Cyro ACRYLITE® SuPure® acrylic polymer



When OSRAM Sylvania unveiled its JOULE™ LED lighting system in 2003, its goal was to provide OEM designers with a reliable, industry-standard LED light source that simplifies the design process. They pioneered LED standardization with the JOULE system, allowing OEMs to offer customers a high quality, standardized automotive LED system without the complexity or cost of a custom assembly. The JOULE system was first installed in the 2006 Mercury Mountaineer and the 2008 Chevrolet Malibu LTZ. Five years after product inception, OSRAM wanted to revamp their product to better serve the market they created and stay ahead of their competitors. In essence, they needed to keep their innovative product innovative.

During the redesign process, one aspect of the JOULE LED lighting system that needed an overhaul was the light pipe. The job of the light pipe is to transfer light from the LED source to the output without losing any luminosity in the process. This requires pinpoint accuracy in the light pipe design and high optical clarity in a dimensionally stable clear acrylic polymer – properties that are generally difficult and expensive to achieve together.

OSRAM called on DTI Molding Technologies (Illinois) to assist in part design and selection for the newest generation of the JOULE system. The new design required some very complicated molds, and they needed to find an acrylic material that could achieve a high level of optical clarity but not damage the mold cores during processing. After evaluating five acrylic polymers they selected Evonik Cyro's ACRYLITE® SuPure acrylic polymer, which is ideal for light pipes and light engines. It is designed to deliver extreme clarity for product applications in which no defects can be detected by the naked eye under varying light conditions. This enables maximum light transmission efficiency with minimal loss.

Another improvement achieved with the new acrylic polymer was green design. The automotive industry sees a growing demand for environmentally friendly manufacturing. More and more cars are attaining higher fuel efficiency with lower overall emissions, but other areas can be also be improved. Lighting is one of them, specifically in terms of optical material selection for LED-based applications.

ACRYLITE SuPure's clarity provides high light transmission at 92%, complementing the brilliant LED source used in the OSRAM JOULE system. The result is a high efficiency system that delivers bright illumination while consuming less power.

ACRYLITE SuPure acrylic also provides other environmental benefits. It's lighter than glass optics, which helps reduce the overall vehicle weight to improve fuel efficiency. It also eliminates the need for coatings and lasts longer than glass alternatives, thereby reducing waste.

www.cyro.com/methacrylates/us/products/molding_compounds/products/acrylitesupurepolymers/
www.osram.com/osram_com/Professionals/Automotive_Lighting/Products/JOULE_LED_Systems/index.html

(090951-V)



And the Winners are...

Elektor Foundation Award 2009 prizes for people with a passion



Don Akkermans
Managing Director, Elektor International Media



Ingrid Mulder – Chairman, Elektor Foundation

As part of the Elektor Live! event staged on November 21, 2009 in Eindhoven, The Netherlands, prizes were awarded for the first edition of the Elektor Foundation Award.

Over the past months, members of Elektor's international editorial team examined their local markets and nominated people and companies for the Award. The selection was based not just on erudition in the field, but also on the candidates' very own ways of using electronics, now and in the past, to make a contribution to society that matters. This criterion was found back in all winners:

- Mr Hossfeld from Holland for rigging up an emergency 80m transmitter during the great flood of 1953;
- the DigitalSTROM organization from Switzerland for applying chip technology to rigorously reduce the power consumption of household appliances;



Mr P. Hossfeld receives his Award

tion of household appliances;

- Mrs Fatma Zeynep Köksal from Turkey for her network and activities to promote electronics and other technologies in her country;

- Bart Huyskens from Belgium for his tireless effort in working with robots with a view to stimulate young people, and now awarded with rising student numbers for his school.

The registered aim of the Elektor Foundation is

“to generate, on a global scale, free publicity and goodwill for projects and people who have accomplished extraordinary achievements towards technology and electronics”.



Flowers for the spouses, sure!



“this prize awarding is such a nice job”.
Ingrid Mulder and Wisse Hettinga



Bart Huyskens rewarded for his efforts.

Further information:
www.elektorfoundation.org

Burning Amp Festival 2009

The third edition of the Burning Amplifier Festival started off on a crisp October 18, 2009 morning at the Sausalito Yacht Club at San Francisco Bay. Jan Didden reports.

The BAF event is organized by the Editor of www.diyaudio.com. With generous support by Audio Amateur Inc., Elektor USA and NHT, BAFog had a full smorgasbord of listening sessions, presentations and great ad-hoc discussions. But first things first... breakfast was served by Natasja, compliments of Elektor (**photo 1**).



BAFog breakfast sponsored by Elektor and served by Natasja from Denmark; she's in the US on a one-year sponsored PhD program in Medical Biology.

Jack Hidley of Audio Consulting Services (**Photo 2**) gave a presentation on the design considerations at the lower crossover point in 3-way speaker systems. That point is typically between 80–150 Hz which can be problematic as driver impedances can vary wildly in this frequency range and passive crossovers don't work well with varying load impedances. Jack showed that if you carefully match the crossover to the driver and the enclosure mechanical roll off you can get a satisfactory solution.

Nelson Pass (**Photo 3**) showed an extremely simple power amplifier that 'even a lawyer could build' as someone remarked: just one depletion mode power MOSFET (an IXYS IXTH20N50), see <http://www.diyaudio.com/forums/pass-labs/153832-pass-delite-amp-baf.html>.

Linear Integrated Systems (LS) presented very low noise JFET devices replacing those popular Toshiba devices from way back (N-channel LSK170, P-channel LSJ74 dual N-channel LSK389). They also demoed an all-FET power amplifier with all Linear Systems devices right up to the output which used vintage 2SJ60 V-FETs.

The bulk of the show was of course designs and projects by diy-ers; from the very pro-

fessional looking units by Ti Kan (AMB audio) and the wood retro looking stuff by Carpenter, to 'steam-punk' designs (**Photo 4**). Audio equipment engineering as an art form, a synthesis between the music flowing from DACs and amps and speakers as well as the visually stimulating look of the realizations.



Jack Hidley previously with NHT, now with Audio Consulting services talked about crossover issues.



stages (metal can of course) to the LME49811 power amp Vas and driver

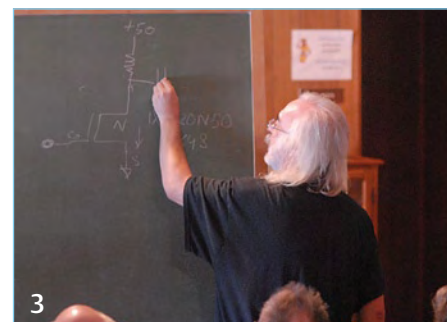

Nelson Pass explaining the one-FET amp 'that even lawyers can build'...

The range of technologies used was diverse: Mark Brasfield (audioman54) demoed a system almost entirely built with National analog products, from LME49600's and 49710's in the DAC power supply regulators, via the LME49713's in the amplifier input



'Steam punk' by the ocean.

stages. At the other end of the spectrum were Jack (Electraprint) Elliano's creation with type 211 transmitting tubes in SE class A2 mode, outputting 45 watts in (gasp!) grid current mode.

In the Technical Creativity department, David Gravereaux ('davygrvy') dismantled a radar speed gun and pointed the beam at his speaker's cone. Connecting the demodulated output of the radar unit to a scope showed him a wave form representing the cone excursion. A sort of poor man's Klippel system that can help you operate your drivers in their linear region.

The participation of accomplished designers like Nelson Pass from Pass Labs, John Curl of Parasound fame and Siegfried Linkwitz of Linkwitz Lab made it clear that even amateurs can contribute to the state of the art. Audio amateurs and DIY-ers spend lots of money and time to realize their vision with great enthusiasm and persistence, and the reward is a great sounding and great looking piece of equipment or speaker. I am looking forward to next year's edition. Be there and be counted at www.burningamp.com!

All photos by Dana Brock.

(090959-1)

There's More to Life than just USB!

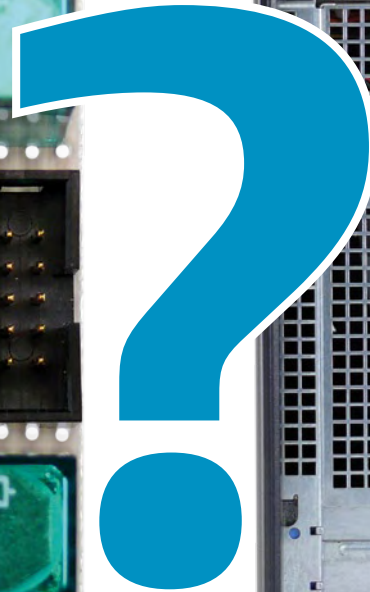
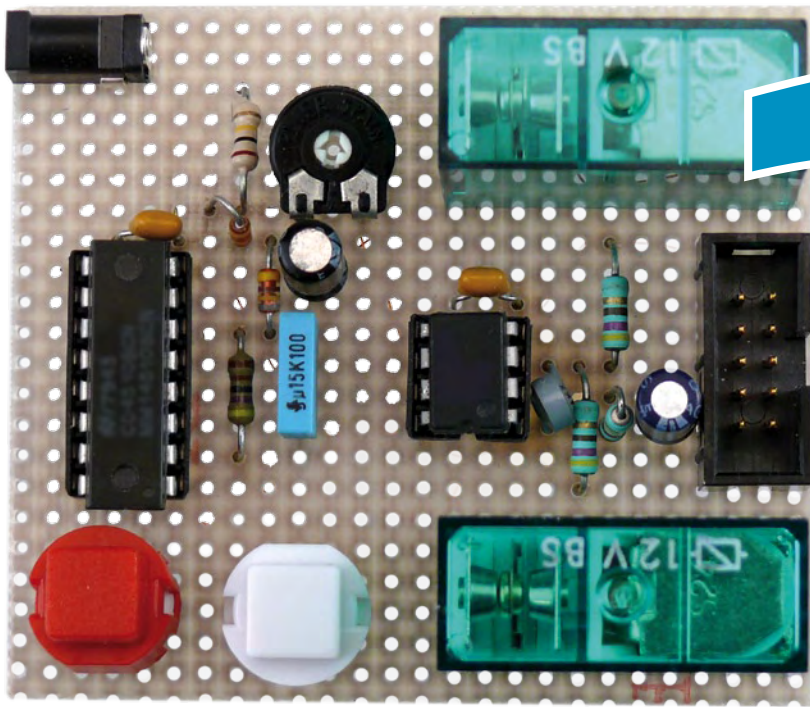

how to connect your own project to a PC

By Clemens Valens (Elektor France Editorial)

Lots of projects use the office computer or a laptop as the 'brain' – for example, for saving data, as a powerful controller, or for accessing the Internet. The serial or parallel ports that once used to provide this link have been replaced by USB connections. So, now what do we do?

There are a number of solutions for connecting a peripheral to a computer – you only have to take a look round the computer to see that. For example, the laptop on which I'm writing this article has an S/PDIF output, two audio inputs (microphone and line), four USB ports, an Ethernet port, and a modem socket. This model doesn't have FireWire. The computer also supports Wifi and Bluetooth, but

not IrDA. On older computers, we find other ports like PS/2, RS-232 (COM ports), and the parallel port. All these ports are readily accessible, without needing to open up the computer.

Each port has its advantages and disadvantages, and you need to choose the one that suits the project concerned. The choice

of the computer's expansion or communications port not only affects the hardware complexity of the interface to be created between the computer and the project, but also has a bearing on the complexity of the software. These two dimensions are proportional to the amount of data to be transferred and the transmission speed you want.

This article is not going to tackle computer expansion cards, as these days it really isn't easy to build your own expansion cards. It's much easier just to buy this sort of card ready made, complete with drivers.

Asynchronous serial ports...

...are probably the easiest ports to use when you want to drive a project. Serial ports (let's leave off the 'asynchronous' to keep it short) are well integrated into operating systems and usually only need three wires. There are lots of software tools, free or paying, for serial ports, there is plenty of documentation, and the communication protocol is easy to understand. What's more, many microcontrollers have one or more compatible asynchronous serial interfaces (UARTs), and even if there isn't one, it's easy enough to create in software.

The older serial ports are virtually nonexistent on computers these days, but there are alternatives. First of all, the serial/USB port. This is a little circuit that converts a USB port into a serial port. To the operating system (OS), the USB serial port appears like a conventional port that can be used in the way we are used to.

This solution is simple to use: all you have to do is add a serial/USB chip to your project. The commonest ones are the PL2303 from Prolific^[1], the CP210x family from Silicon Labs^[2] and the FTDI devices^[3] (**Figure 1**). The OS drivers are supplied by the chip manufacturers. For the user, it's almost like a conventional serial port, though it is sometimes a bit slow. Remember to set the driver latency (whatever's that?) to minimum if possible.

Another possibility is to use an Ethernet serial link. There are lots of commercially-available serial/Ethernet converters (also called serial servers). Using the driver from the convertor manufacturer, you can add one or more virtual serial ports to the computer's operating system. These ports can be accessed just like conventional ports. Serial/Ethernet ports (**Figure 2**) are more expensive than serial/USB ports, but they do offer electrical isolation, the possibility of having several in the same package, different interface standards (RS-232, RS-485, etc.), wireless (WiFi), long distances, and a user-friendly configuration interface via the Internet browser, which sometimes also lets you drive a number of non-serial inputs/outputs.

A third solution is the Bluetooth serial port. Here, we go up a notch in complexity, as you also have the Bluetooth link to deal with. Like the serial/USB converters, Bluetooth chips often include a serial port to make it easy to produce a wireless link. The advantage of this type of connection is the wireless system's inherent signal isolation. If the computer doesn't have built-in Bluetooth, for a few dol-

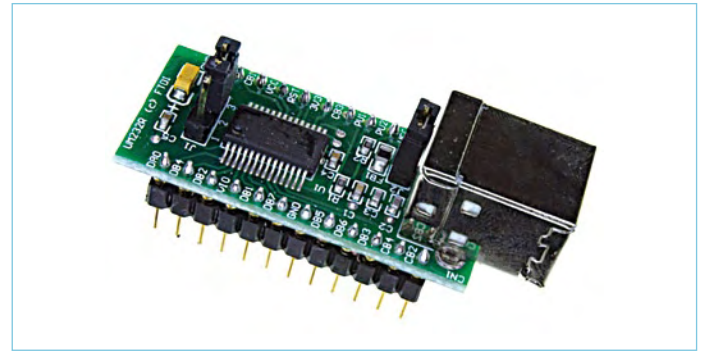

Figure 1. The UM232R module from FTDI is a serial/USB interface that's easy to incorporate into an existing project.

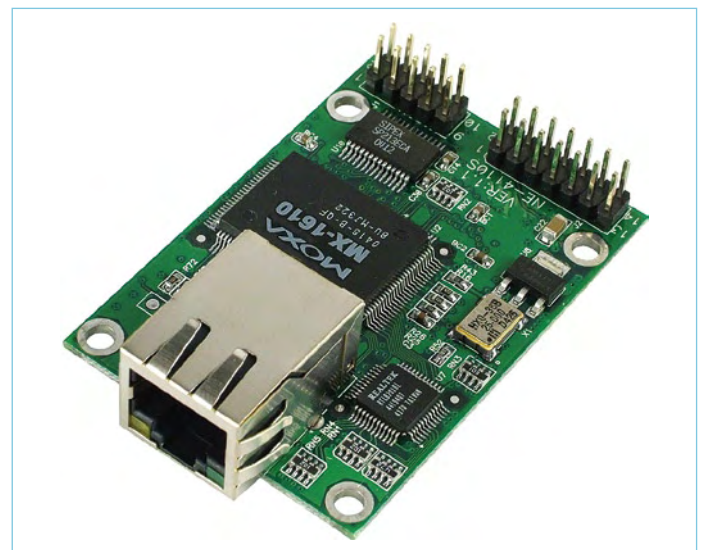

Figure 2. Here's the NE-4110, a bridge between serial port (RS-485/RS-422) and Ethernet, sold by Moxa.

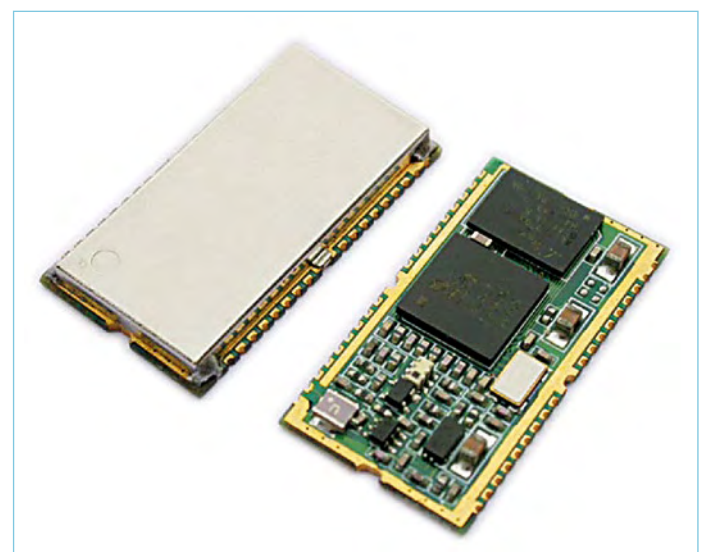

Figure 3. The BTM222 module from Rayson measures 28 × 15 mm and offers a wireless Bluetooth serial link.



Figure 4. Still being sold, now in the A version, the Crystal LAN CS8900A Ethernet controller.



Figure 5. The WIZ 830MJ module comprises not only an Ethernet controller, but also a hardware TCP/IP stack.

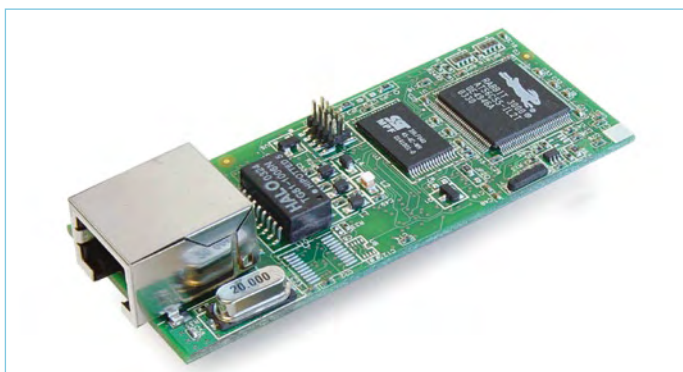

Figure 6. The RCM3700 module from Rabbit makes it easy to add an Ethernet port with processor to a home-built project.

lars you can add a Bluetooth USB key. So in this case, you have a serial/Bluetooth/USB convertor. On the project, you just add a small Bluetooth module to the microcontroller's serial port (Figure 3). On the software side of things, it's a bit more complicated, as the Bluetooth connection, with its PIN codes and other commands, requires extra programming.

So serial ports are still easy to use, even if you have to do so via a USB or other port. The big drawback of serial ports is their 'slowness'. If all you need to do is now and again send a command or read some data, this port is very suitable, but when the transfer rate goes up, you'd best look for another way.

The parallel port?

No, not the parallel port, since just like serial ports, parallel ports don't exist any more. But, unlike the serial port ones, parallel port/USB convertors have never become very popular. Laptop computer port extensions do exist that allow you to add a Centronics printer, but it's not the same as the old bidirectional parallel port with its EPP/ECP options. What's more, it's tricky to communicate with this type of interface, as there's not a lot of documentation around.

When there's a lot of data to be transferred, it's better to use a USB, Ethernet, or FireWire port, or even the sound card. If there are no other solutions, you can always add a PCI or other expansion card. The advantage of going via a FireWire or USB port is that operating systems already include the drivers for defined types of data. For example, USB uses classes that allow the OS to load the appropriate driver. In this way, the application can access the port in a standard way, which simplifies programming, since everything is documented and examples are readily available on the Internet. All the same, you do need to choose the class for USB peripheral carefully, as this determines the bandwidth the OS must allocate to the peripheral (e.g. 64 Kb/s for a 'full speed' HID peripheral) — though that idea is now becoming rather theoretical thanks to the 'super speed' USB. As for the peripheral, that too is more complicated, as the USB class must be respected. So now it's not enough to just add a serial/USB chip to the board, you'll need to go for a microcontroller with built-in USB port. There'll also be more programming to be done.

FireWire is even more complicated, as there don't seem to be any devices around that let you easily add a FireWire port to a home-built project. Besides, isn't the word out the FireWire is finished?

To be continued...

A good alternative to FireWire or USB is Ethernet. We can't repeat it often enough: it's not hard to fit an Ethernet port to a home-built project. There are a number of integrated Ethernet controllers that are fairly simple to implement (e.g. from Realtek^[4] or National Semiconductor^[5], or the well-known CS8900A from Cirrus Logic^[6] (Figure 4), or the ENC28J60 from Microchip^[7]). It's even possible to 'do Ethernet' without a dedicated controller, if the processor is fast enough^[8].

True, Ethernet does require a microcontroller with quite a lot of resources, especially RAM, and programming is more complicated – but on the Internet you can find masses of libraries that can limit the amount of work you’ll have to do.

For many people, Ethernet and Internet are synonymous, but there’s really no need to go via a TCP/IP stack in order to use an Ethernet network. Particularly when a direct connection between the computer and the peripheral is involved, it can be very advantageous to not use a TCP/IP stack at all.

Of course, a TCP/IP stack offers huge advantages (all routers and other Ethernet peripherals operate primarily with TCP/IP), but it increases loading for the user application. For this, ‘founding father’ WIZnet^[9] offers chips that include not only an Ethernet controller, but also a hardware TCP/IP stack (**Figure 5**). Their latest offering, the W7100, also includes an 8051-compatible processor. These chips can be driven via an SPI bus or, if you need to go faster, via a parallel bus. There are also small modules that let you add an Ethernet port to any application (e.g. Rabbit^[10], **Figure 6**). They usually include a processor, which can be used by the application, avoiding the need to add another processor. There are even small modules that are really powerful, capable of running Linux (Lantronix^[11], Digi^[12], **Figure 7**).

The Ethernet network is very well integrated into modern operating systems and it’s easy to send or receive data at high speed. There is no issue with peripheral class or other complications – all you have to do is open the port to be able to use it.

Sound card

Everyone knows that the sound card can be used to turn a computer into an oscilloscope or function generator. SDR (Software Defined Radio) also makes use of the sound card. But this interface is capable of doing a great deal more. Not only does it allow full-duplex communication, it also has several channels: 2 (stereo) or 6 (5+1), if not more.

The big advantage of the sound card compared with the other ports lies in its analogue outputs, which make it possible to drive circuits by voltage. The sound card can drive a small circuit that doesn’t include a microcontroller. It’s actually very easy to send it a sound file containing control voltages. For a little more flexibility, you’ll need to embark on programming the sound card. This subject is well covered by a great many websites.

The sound card can also emulate serial protocols. Using a 96 kHz sampling frequency, you can achieve acceptable communication speeds.

The sound card inputs let you read voltages, even quite small ones if you use the microphone input.

One disadvantage with the sound card is the low level of the output signals, typically 1 V_{pp} — you’ll probably need amplifiers in order to be able to make use of the signals.



Figure 7. Difficult to believe, but this simple module contains a small computer capable of running Linux.



Figure 8. An IrDA USB key of unknown make (source Wikipedia)



Figure 9. The FOX LX832 card by Acme Systems; This card measuring 66 × 72 mm has an Ethernet port, two USB 1.1 ports, digital I/Os, an I²C port, serial and parallel ports, operates under Linux and costs around \$200.

MMI tip

While you're using a TCP/IP stack, you might as well give your project a graphical interface via your computer's web browser. By adding a (small) HTTP server to the microcontroller's software, the project becomes capable of generating HTML files that the browser can display. In this way, the project can be controlled using the computer mouse. Note that a TCP/IP stack works just as well via an RS-232-style serial link as over Ethernet – it's only a communication protocol.

Note, too, that sound cards are not usually able to handle DC voltages, because of the series capacitors on their inputs and outputs. It's also a good idea to find out about the minimum and maximum frequencies the sound card can handle.

The PS/2 port...

...is a synchronous serial port. PS/2 ports are bidirectional, so they can be used to drive something, as well as to receive data. Normally, these ports are used to connect a keyboard and a mouse to the computer. The communication protocol is very simple and consists of a data line and a clock line for synchronization. The levels are between 0 and +5 V. Every microcontroller with an SPI port can do it, but it's entirely feasible to implement it purely in software using bit banging.

By default, the computer's operating system treats the data received on its PS/2 ports as keyboard and mouse data. Hence by getting your project to send the right information, you can write directly into a file or move the mouse cursor. Using keyboard shortcuts, you can execute all sorts of commands. Perhaps more interesting is to divert certain well-defined data so as to then recover them in a personal application. This requires a bit more programming on the computer side – but it's not rocket science!

IrDA

This infrared port, fairly popular in the late 90s, allows a laptop computer to communicate with a cell phone, for example, but has now been replaced by Bluetooth or wireless USB. Despite this, there are still plenty of 'old' laptops around with an IrDA port. What's more, IrDA is coming back into the fray with the new IrSimple protocol that allows markedly higher transfer rates, up to 4 Mb/s. Faster still is the Giga-IR for rates of 1 Gb/s! For computers without an IrDA port, there are of course IrDA USB keys (**Figure 8**).

The IrDA (Infrared Data Association) port is not a basic serial port, but in fact uses quite sophisticated communication protocols,

precluding its use with small microcontrollers. The proof: Microchip, the manufacturer of small (and large) microcontrollers gives away (yes, it's free) an IrDA communication stack for its 16-bit (and above) controllers.

The advantages of IrDA are the reliability of the communication and the signal isolation; the disadvantage is the need for a line-of-sight between the computer and the peripheral. Moreover, an IrDA link is only half-duplex, as the receiver is blinded by the transmitter housed in the same package. To implement IrDA, all you have to do is fit your project with a fast enough infrared transmitter/receiver (like the TFDU6301 from Vishay^[13] – a purely random choice) and produce the communication stack.

And finally...

In this article, I have mainly spoken about ways of connecting a home-built project to a computer. But there is another solution, mentioned briefly when we were talking about Ethernet: to make the project itself powerful enough that it doesn't need a computer. There are in fact hundreds of small processor cards around capable of running Linux or Windows CE, which have been made solely for driving something. The I/Os are integrated, as are the serial, Ethernet, and USB ports. They can be found under the acronym SBC (Single Board Computer), and are usually compatible with computer based on Intel or AMD processors, but also some boards with MIPS, ARM, or Coldfire processors with plenty of RAM and Flash memory (**Figure 9**).

Why spend hours struggling to cram a TCP/IP stack into the memory of a small 8-bit microcontroller instead of doing the same thing in five minutes under Linux on a 32-bit card that's hardly any more expensive? Think of that next time you start a microcontroller project!

(090772-1)

Internet links

- [1] www.prolific.com.tw
- [2] www.silabs.com
- [3] www.ftdichip.com
- [4] www.realtek.com.tw
- [5] www.national.com/analog/interface/ethernet
- [6] www.cirrus.com/en/products/pro/detail/P46.html
- [7] www.microchip.com
- [8] www.cesko.host.sk/IgorPlugUDP/IgorPlug-UDP%20%28AVR%29_eng.htm
- [9] www.wiznet.co.kr
- [10] www.rabbit.com
- [11] www.lantronix.com/device-networking/embedded-device-servers/xport-pro.html
- [12] www.digi.com/products/embeddedolutions/digiconnect-me9210.jsp#overview
- [13] www.vishay.com/ir-transceivers/list/product-84668/
- [14] www.elektor.com/090772

NEW TOOL REQUIRES LESS TIME AND MONEY

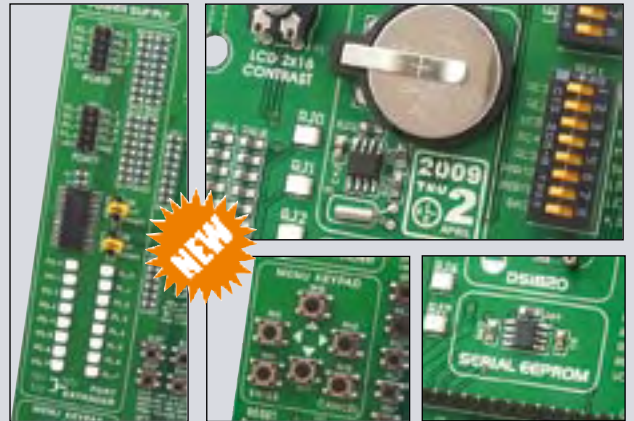

Complete PIC development solution

Speed up your prototype development with the BIGPIC6 Development System. The BIGPIC6 comes packed with examples that makes your PIC development fast and easy.

BIGPIC6 is a development system for **64-pin and 80-pin PIC** microcontroller applications development and testing. The **mikroICD** (Hardware In-circuit Debugger) enables very efficient step by step debugging. Examples in **C**, **BASIC** and **Pascal** are provided with the board.

BIGPIC6 MCU Cards support PIC microcontrollers in **64-pin and 80-pin** package. Cards can be easily switched, so you can continue working in the same development environment but with a different MCU. Also, these cards can be easily used as part of your prototype device. Each microcontroller pin is connected via **double-sided contact** which insures proper connection with the development system. MCU card contains **2.54mm pitch pads** which can be used for easier connection with external circuits.



99.3% of customers plan to purchase development tools from mikroElektronika again.

Hardware In-Circuit Debugger for step by step debugging at hardware level

Port Expander provides easy I/O expansion (2 additional ports) using serial interface

Full-featured and user-friendly development board for PIC microcontrollers

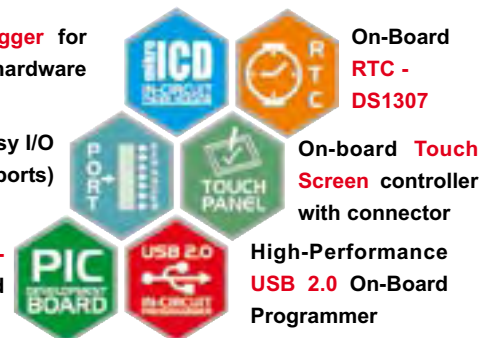

On-Board RTC - DS1307

On-board Touch Screen controller with connector

High-Performance USB 2.0 On-Board Programmer

Get your new BIGPIC6 Development System right now and enjoy creating your electronic devices immediately!

MikroElektronika
DEVELOPMENT TOOLS | COMPILERS | BOOKS

...making it simple

BIGPIC6 DEVELOPMENT SYSTEM

For more information, visit our Web site at

www.mikroe.com

My First AVR-USB

Low cost and step by step

By Antoine Authier (Elektor Labs)

This article is a quick guide to building firmware that will unleash the capabilities of Atmel's advanced AVR-USB chip and especially its USB features, which are fairly easy to deploy. Join the fun if you have a basic knowledge of USB and 30 dollars to invest.

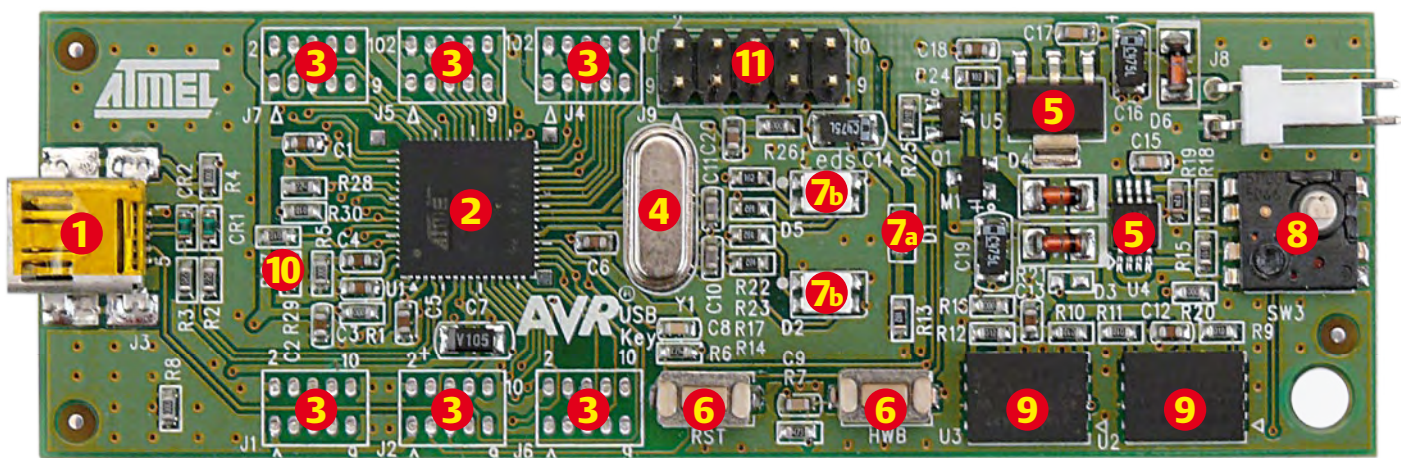

Figure 1. The AT90USBKey board and the main components on it. Item descriptions may be found under the section heading 'Hardware'.

Sure, countless microcontroller boards featuring a USB connection have made it to the Projects and News pages of Elektor. You've seen solutions based on so-called bridges (Prolific, FTDI), USB nodes (National) or USB hardware stacks (Microchip, Cypress, TI, Atmel ARM) and even software emulated stacks (V-USB for ATM18/CC²). However, the AVR-USB hardware stack wasn't covered till now. A low-cost board and free software utilities to play with are going to change that as you meet the USB-AVR family^[1].

Caveats

USB (universal serial bus) has become commonplace if not a phenomenon, the majority of modern computers using it to communicate with peripherals like the keyboard, mouse and even an external hard drive — all with 'hot-plug' capability and sometimes advertised as easy enough for lawyers to use it. Not so for USB product development, so be warned that the programs described in this article might be harmful when not operated correctly. Also, your intention being to gain experience you might expect failures, setbacks and the odd surprise. Remember, every start is difficult and the computer may have to be restarted from time to time with some data loss... be prepared, you're on a steep learning curve.

Hardware

In terms of hardware we're talking about the **AT90USBKey**^[2], a low cost development board from Atmel featuring their beefiest USB-AVR

microcontroller called **AT90USB1287**. The (unexciting) board schematics are reproduced in sections in the Hardware User Guide. The board supports all standard USB modes, however within the scope of the article we only look at the USB Device implementation, leaving aside the ability to act as a USB Master and support USB On-the-go (OTG). The dev board is available from all the big guns out there like Mouser, DigiKey and Farnell and will set you back about US\$30.00 (or the equivalent in local money) plus tax and shipping.

Let's quickly list some of the AT90USBKey's main features and comment on them. The numbers refer to the photograph of the board in **Figure 1**.

1. A (tiny) USB mini A-B receptacle connector (use a USB mini B cable for Device mode only; USB mini A is for Host mode).
2. An AT90USB1287 microcontroller
3. GPIO connectivity brought out to external connector footprints. The (annoyingly) small lead pitch is obviously required to be able to call the thing a Key.
4. The MCU is clocked by an 8 MHz crystal.
5. A power supply section supplying both 5 V and 3.3 V^[7,8]. Sure, the board can be powered over the USB connector when acting in Device mode. Within the scope and intent of this article you should not plug anything onto J8.
6. Two tactile-feedback switches (one is the Reset button).
7. A red power indicator LED, and two bi-color LEDs under control

of the MCU.

8. A four-direction joystick with a central switch, i.e. five pushbuttons.
9. 16 MBytes of serial (SPI 66 MHz) data-flash memory ^[6].
10. An NTC (negative temperature coefficient) thermistor ^[9] as a temperature sensor, connected to analog channel 0.
11. JTAG connector (not used right now).

The board comes with a piece of Atmel firmware loaded that enacts a USB Composite Device comprising mouse emulation and a Mass Storage device. Before doing anything ‘really educational’, make a backup of the complete Key contents. All singing & dancing you can already play with the mini joystick on the board, see the mouse cursor move on your computer screen and use it to browse the serial dataflash content using any explorer(-like) software... all within the AVR-USB environment Atmel has created for you. However you’re reading Elektor so there’s more to discover, learn and chuckle over.

Source code, firmware, software

There are different firmware-based approaches to program this application and some other classes of the USB specification and sure, all the main USB profiles can be demonstrated using this board. You can of course take a look at the source code from Atmel and a small army of application notes on the AT90USBKey web page that will prove instructive in many ways. For this article, in good Elektor tradition we will use other freely available solutions. There are quite a few around and it was decided to focus on the two most impressive: the LUFA (Lightweight USB Framework for AVRs) ^[3] from Dean Camera and the HID implementation of the Teensy project ^[4]. Here it’s also worth mentioning the work of Dr. Stefan Salewski available at ^[5] — now that’s what we call compact and straightforward.

Toolchains

Before getting started you need to know about the software tools that will help you develop code without too much pain.

All tests were done using WinAVR version 20090313 featuring the C compiler avr-gcc v4.3.2, the binary manipulation tools binutils v2.19, and the lightweight IDE “Programmer Notepad v2.0.8”. AVR Studio is not required but can be used too; you can also use the command line tool if you like.

All software tinkering was tested under Linux too, running Ubuntu release 9.04 and the AVR GCC v4.4.1 cross compiler with binutils v2.19.1.

Programming the device with FLIP

Although the AT90USB1287 comes with a JTAG interface that will enable you to debug and program the MCU with an appropriate JTAG tool, we would rather use a much simpler method: by way of the bootloader. Note that you can also use the standard ISP.

The bootloader can be activated by pushing the RST and HWB buttons while the board is connected and then releasing the RST button first. A new device will be enumerated called “AT90USB128 DFU”. The first time you plug it in under Microsoft Windows you will have to install the driver; it comes with Atmel’s own utility called FLIP ^[11]

Features

- Low-cost (\$30) Atmel AT90USBKey demo board fwith on-board mini joystick
- MCU: AT90USB1287 with DFU bootloader
- Easy introduction to USB for AVR embedded technology, including USB hardware controller
- Introduction to designing USB HIDs and Composite Devices
- Lots of freeware utilities around (FLIP, LUFA)
- Largely Linux compatible
- Easily accepts software ported from other projects (e.g. Teensy)

in the usb subfolder of the installed files.

FLIP is the utility used to program the AT90USB1287 by way of the bootloader — but you have to install it first. We suggest downloading the version that includes Java, if you are not sure if you have it already or not.

Note that **prior to writing the program to the flash memory you have to erase it**. If not, the MCU is locked in a protected mode. When using FLIP you can simply set up the sequence in the ‘operation flow’ frame by selecting Erase, Program and Verify. Then load the hex file with CTRL+L and click on “Run” to flash the program. One last thing: to exit the bootloader mode click on “Start Application” (the yellow button) and press the RST button on the board. A screendump of FLIP in use is shown in **Figure 2**.

Under Linux, [dfu-programmer] ^[10] is required to program the device. We used v0.5.1... and here are the three main command lines used:

```
# dfu-programmer at90usb1287 erase
```

```
# dfu-programmer at90usb1287 flash example.hex
```

```
# dfu-programmer at90usb1287 start
```

LUFA

Now it’s time to get your hands dirty! Download the latest LUFA source code from ^[3]. At the time of writing LUFA was at version #090924 and that’s not an Elektor production number. Unzip it and fix this section:

```
./Demos/Host/ClassDriver/KeyboardHostWithParser/  
KeyboardHostWithParser.c line 264  
./Demos/Host/ClassDriver/MouseHostWithParser/  
MouseHostWithParser.c line 264  
./Demos/Host/LowLevel/MouseHostWithParser/  
HIDReport.c line 89
```

by adding ‘;’ at the end of each line — doing so will save a few errors popping up if you compile the whole thing.

Open the project file [LUFA.pnproj] at the root of the source code and then take a look at how it’s structured. The LUFA library and demonstration program are (by default) tuned to work on the USB-AVR board, but in case you are not sure simply check the makefile. These variables should be configured as:

```
MCU = at90usb1287  
BOARD = USBKEY  
F_CPU = 8000000
```

key, it is, well, echoed on your PC screen. You have established your own traffic flow on the bridge called USB!

Teensy USB HID implementation

To demonstrate the HID (Human Interface Device) class we propose to use the Teensy USB project source code. This project does not natively support the AT90USBkey hardware and needs to be tweaked.

First get the source code of [USB Raw HID, Version 1.1], it's in the Code Library of [4]. Depending on your operating you may also need one of the RawHid Test files, so choose one. Uncompress this archive and take a close look at what's inside [USB Raw HID]. We need to tinker with it. In the `makefile`, comment out all 'MCU' lines and add a new one for our MCU:

```
MCU = at90usb1287      # AT90USBKey
```

then change the `F_CPU` value to match the 8 MHz crystal.

```
F_CPU = 8000000
```

Now look at the string `__AVR_AT90USB1286__` in `[usb_rawhid.h]` and add the following case before the `#endif`.

```
#elif defined(__AVR_AT90USB1287__)
#define HW_CONFIG() (UHWCON = 0x81)
#define PLL_CONFIG() (PLLCSR = 0x0E)
#define USB_CONFIG() (USBCON =
                    ((1<<USBE) | (1<<OTGPADE)))
#define USB_FREEZE() (USBCON =
                    ((1<<USBE) | (1<<FRZCLK)))
```

Notice the `PLLCSR` value is changed to `0x0E` because of the crystal frequency used on the Teensy board (16 MHz).

Open `[analog.c]` and search again for `__AVR_AT90USB1286__` then append `" || defined(__AVR_AT90USB1287__)"` to the line

Advertisement



Sensor SAVVY

We've got it! Parallax stocks sensors for acceleration and tilt, temperature, humidity, compass and GPS position, rotation, distance, color and light, pressure, motion, gases, sound, and more. **Get some for your project.**

Discover **Parallax Sensors** at www.parallax.com
 Order online or call our Sales Department toll-free: 888-512-1024 (Monday - Friday, 7 a.m. - 5 p.m., PT).

Prices subject to change without notice. Parallax and the Parallax logo are trademarks of Parallax Inc.

PARALLAX
www.parallax.com
 Friendly microcontrollers, legendary resources.™

```
#elif defined(__AVR_AT90USB646__)
    || defined(__AVR_AT90USB1286__)
    || defined(__AVR_AT90USB1287__)
```

Another detail to make it more amusing, in [example.c] change the line

```
PORTD = (PORTD & 0xF0) | (buffer[0] & 0x0F);
```

into

```
PORTD = ((buffer[0] << 4) & 0xF0) |
        (PORTD & 0x0F);
```

so you can quickly (and dirtily) control the board LEDs by pressing numbers on the numeric keypad...

You are now ready for the test: compile by running a make-all in the project folder using the Command Line Tool. Then flash the hex file to the target.

Launch the application at the computer side and you will see a bunch of data displayed on the screen. The first line corresponds to the value of the ADC scanned, which means you can make the value change by heating the NTC with your finger, for instance. Press a number on the computer's numpad (except 0) and you will actually light or extinguish one of the LEDs. Tell your friends! Show it to the boss!

Now we kindly suggest to take a look at the Teensy USB Mouse example, change the makefile and usb_mouse.h to make the project ready for your board... compile, flash and reset and enjoy the erratic dance of the mouse, which becomes really irritating if you try to put a window over the mouse. As a prank you can now program your own USB keyboard that RanDOMly turns on the CapsLock FeATUrE — study the keyboard implementation of the LUFA, or Google a bit...

Conclusion

While playing around with this little board you should have picked up the basics of USB applications with the specific AT90USB core. If you would like revert the AT90USBkey to its original configuration you can simply flash the original firmware you have backed up

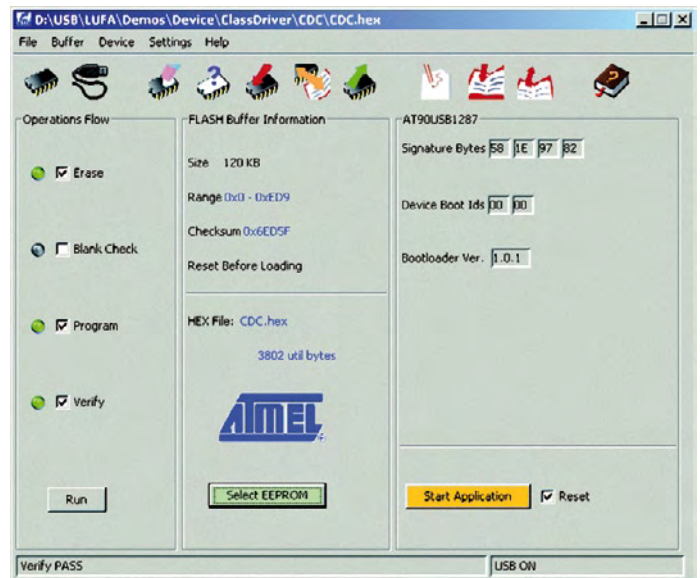

Figure 2. Atmel FLIP is used to program the AVR micro by way of the bootloader.

earlier, this is the file called [FIRMWARE.HEX] that was at the root directory of the AT90USBkey. If you have tried some more examples and ruined the dataflash content you may have to format the new USB stick device. Format to FAT16 then copy back the backup done earlier.

Developing embedded stuff around the USB bus may require some extra tools to make your life easier. Hardware tools can provide deep debugging information but are unfortunately very expensive. Nowadays they can be replaced by some hacking and tracing software that will also spawn useful information when it comes to reverse-engineering certain protocols. For example, take a look at USBview — originally Microsoft software that seems to have disappeared from the distributions — it which gives a nice tree view of your computer's USB bus. A version is available for Linux that uses GTK. To trace USB packets you may look for Snoopy and USBtrace under Windows, or WireShark under Linux.

The USB on the Go and USB Master features that can also be achieved with this board (once self powered), may be covered another time.

(090767-1)

Internet Links

- [1] www.atmel.com/dyn/products/devices.asp?family_id=607#1761
- [2] www.atmel.com/dyn/products/tools_card.asp?tool_id=3879
- [3] www.fourwalledcubicle.com/LUFA.php
- [4] www.pjrc.com/teensy/
- [5] www.ssalewski.de/AT90USB_firmware.html.en
- [6] www.atmel.com/dyn/products/product_card.asp?part_id=3777

- [7] www.national.com/mpf/LP/LP3982.html
- [8] www.national.com/mpf/LM/LM340.html
- [9] http://search.murata.co.jp/Ceramy/CatalogAction.do?sHinnm=NTH5G16P42B104J07TH&sNHinnm=NCP18WF104J03RB&sNhin_key=NCP18WF104J03RB&sLang=en&sParam=NCP
- [10] <http://dfu-programmer.sourceforge.net/>
- [11] www.atmel.com/dyn/products/tools_card.asp?tool_id=3886

Are you up for a challenge?

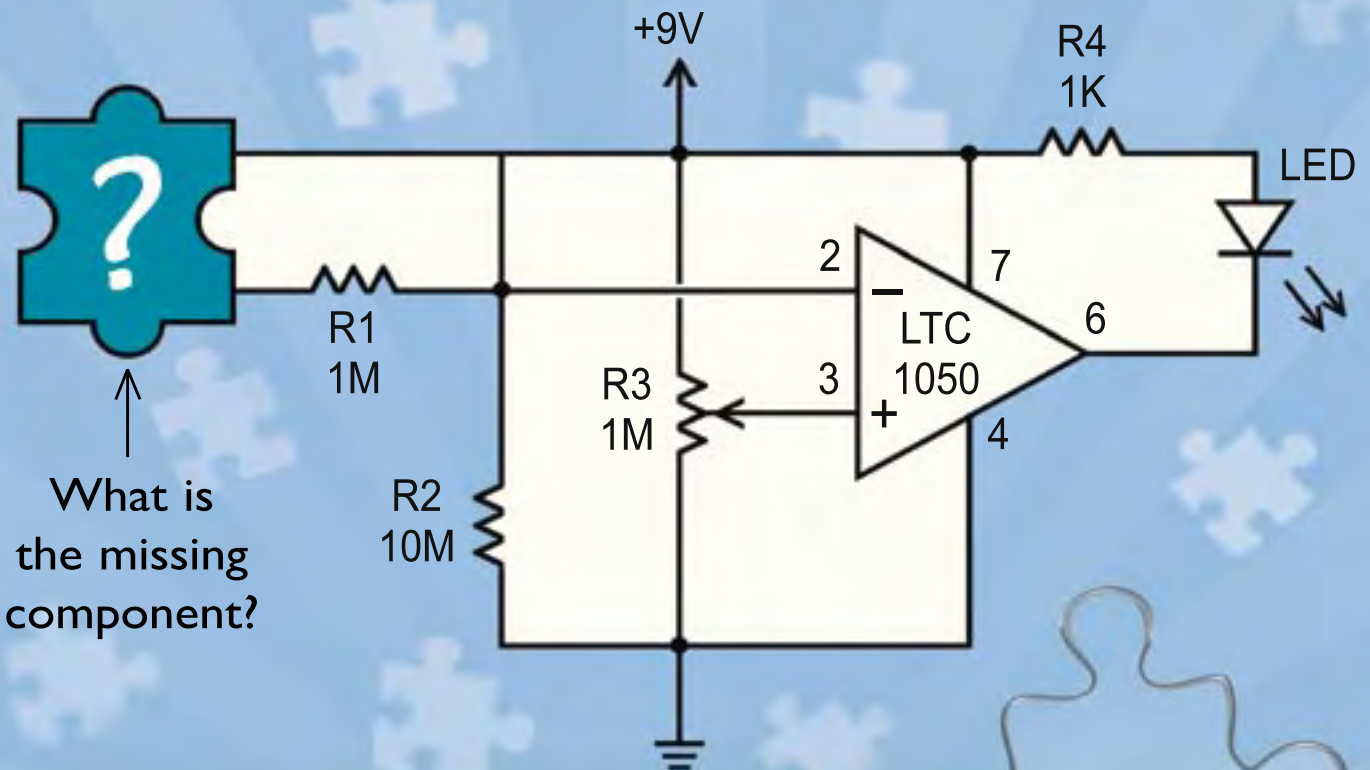

What is the missing component?

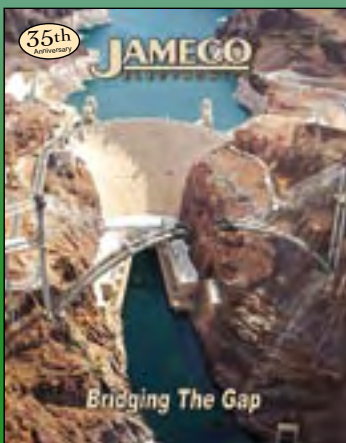

Industry guru Forrest M. Mims III has created yet another stumper. The Ultra Simple Sensors Company assigned its engineering staff to design a circuit that would trigger an LED when a few millimeters of water is present in a basement or boat. What is the water sensor behind the puzzle piece? Go to www.jameco.com/unwrap to see if you are correct and while you are there, sign-up for our free full color catalog.

JAMECO[®]
ELECTRONICS

1-800-831-4242

PCB-DIY All the Way

It all started with color-banded resistors and those quaint codes printed on capacitors – then SMD components arrived and suddenly our eyes were too weak and our fingers chubby. Worse, the trusted solder iron suddenly turned out unwieldy and too powerful to achieve a decent soldering job.

Stencil Machine

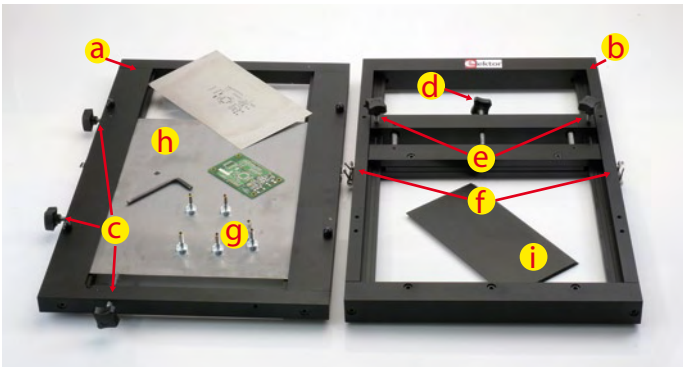

The PCB stencil machine is composed of: bottom frame (b) and top frame (a), PCB fine adjustment knobs (c), tension knob (d), vertical knobs (e), clips (f), magnetic supports (g) and a sliding base (h).

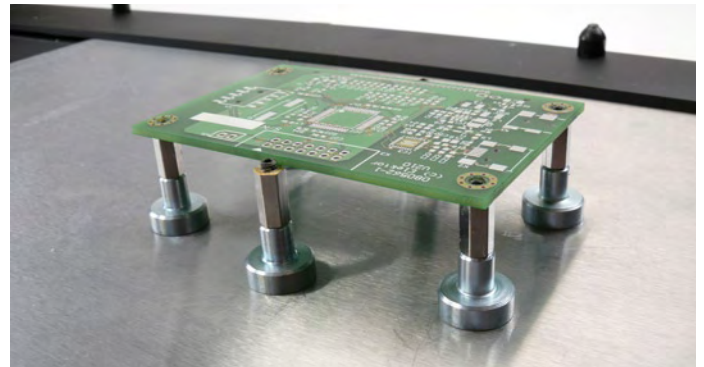

Secure the PCB on the magnetic standoff supports and place the top frame over the bottom one.



Position the stencil on the rails striving to align it with the PCB to the best of your ability. To stiffen the stencil, tighten the 6 screws using a hexagonal key. Now, close the lateral clips.

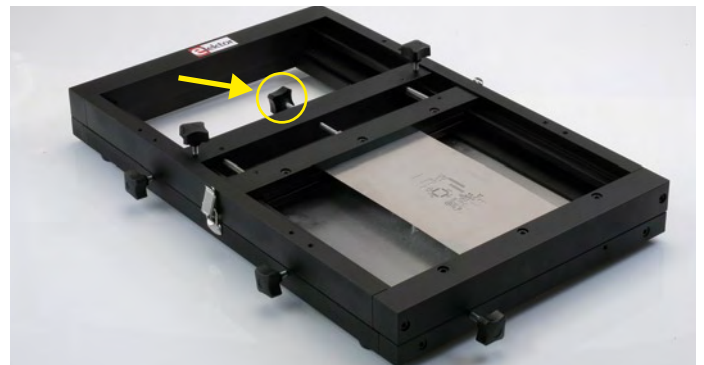

Rotate the tension knob clockwise to apply tension to the springs, then tighten the vertical knobs and release the tension knob. At this point the stencil should be completely flat over the PCB.

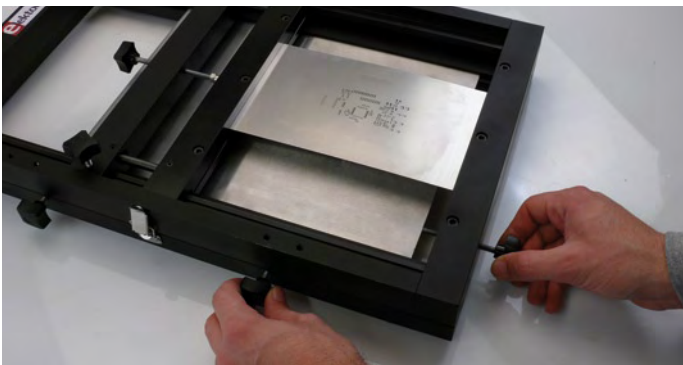

Although the stencil is over the PCB and you did your best to match it with the PCB's pads earlier, it will be necessary in most cases to adjust the knobs 'c' for fine tuning the alignment.

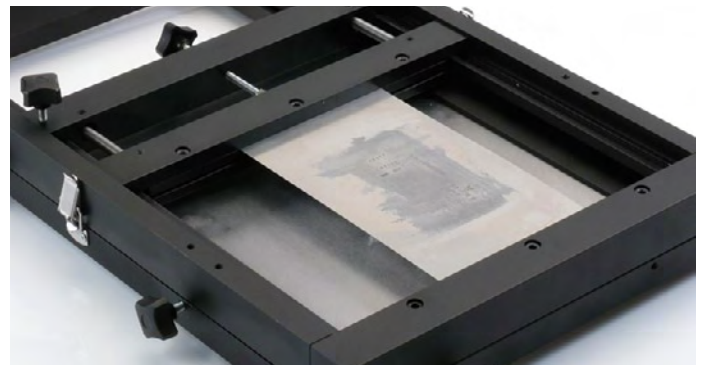

Apply solder paste on the stencil's side and spread it homogeneously using the squeegee (i). Make sure there's no excess paste across the surface.

Does this mean PCB production and SMD component stuffing is now beyond the reach of the home worker? Hardly, but it's clear a good set of tools is required for the job.

The Elektor SMT Oven was an initial step to enable DIY component populating of circuit boards. Based on the success of the

oven we thought we'd collect a number of add-ons that allow the skilled enthusiast to produce small series of stuffed boards. Assuming your favorite PCB supplier is doing the actual board manufacturing we now offer these tools: a stencil machine to get the solder paste accurately positioned, and a pick & place device to gingerly land

those tiny SMT parts on their solder pads. All ready for popping into the oven!

And now, step by step ...

Pick&Place Tool

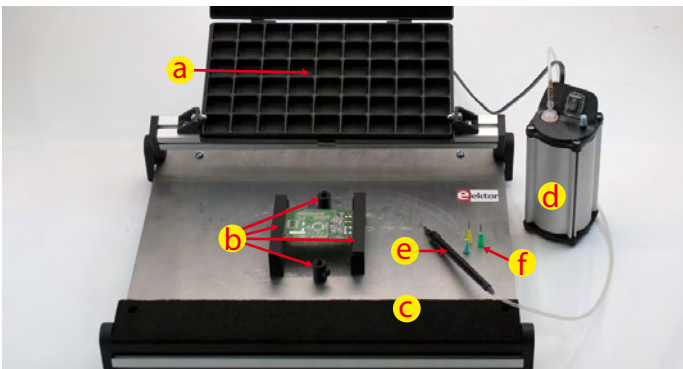

The pick & place tool is composed of: component tray (a), magnetic board supports (b), arm rest (c), vacuum pump (d), pickup holder (e) and pickup needles (f).

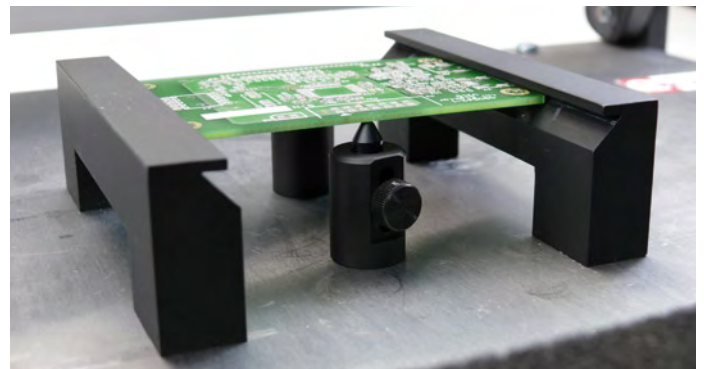

Use the magnetic board supports to secure the PCB. The standoff posts can be used underneath larger PCBs.



The pickup needles have different diameters to suit the size of the components handled. Connect a pickup needle to the pickup holder's nozzle and turn the pump on.



To pick and hold a component, just attach the pickup needle to the component's surface and turn on vacuum by putting your finger top on the pickup holder's side hole.

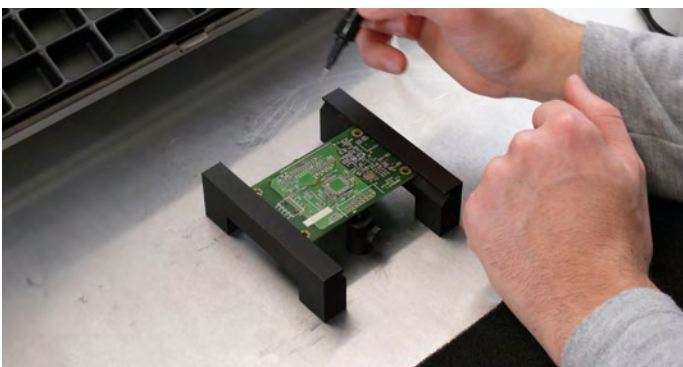

Use the arm rest (c) for your comfort and optimum accuracy of component placement.



Carefully place each component on its PCB pads. To release the component, turn off the vacuum by removing your finger from the side hole.

On the Buses

Alternatives to USB and I²C

By Rolf Blijleven (The Netherlands)

If you want to have an intelligent circuit communicate with its companions, the standard approach is to use the omnipresent USB port or an I²C link. But is this the ideal solution? A survey of various industrial areas shows that there are other alternatives, ranging from the well known to the obscure. Here we provide a capsule summary for your information and inspiration.

Photo: Siemens



Communication between individual circuits is more than just a special discipline – it's a science in its own right. The simplest solution at the lowest cost is usually the best option, and price-conscious electronics enthusiasts usually end up with USB, I²C or RS-232. The underlying rationale is the same in industry, but the magnitude of the problems encountered there puts them in a different league and makes other solutions necessary. Although most of our readers do not have access to the hefty budgets of industrial projects, it seems worthwhile to us to examine how things are done there. This stirs the creative juices, and it's always nice to take a look over the fence.

Here we present a brief overview of the category 'industrial buses'. A full summary would fill several books, so we have restricted our selection to 'out of the box' solutions — this is not the place to look for an explanation of how your video card communicates with the motherboard. We start off in the automotive industry, pass through the realm of process engineering, and finish up with wireless technology. On the way we provide references to websites where you can find more information.

Why use a bus?

The answer to this question is short and succinct: because cable harnesses cause too many problems. In a circuit with only a handful of functions, it is silly to use a bus, but if you have a sensor or an actuator in a more or less intelligent module, the situation is different. If you have dozens of such modules demanding attention, a bus is the appropriate solution.

For several decades already, buses have conformed to the OSI model. Put briefly, this means that communication between modules is divided into layers, and each layer has its own task (**Figure 1**). The OSI model is not a standard, but instead a reference model. A key aspect of the OSI model is that the receiving layer always reports

back to the sending layer whether a message was received correctly or incorrectly ^[1, 11].

CAN and kin

Modern cars are jam-packed with electronics. A car can have up to 70 or so engine control units (ECUs), which can collectively generate around 2500 different signals ^[9, 13]. In this situation, a bus is indispensable. The basis for the industrial bus with the highest worldwide usage was fashioned in the 1980s by Robert Bosch GmbH in the form of the Controller Area Network (**CAN**). CAN is proven technology: there are hundreds of millions of CAN nodes in the world, and CAN is now specified by ISO standards (11898 and 11519) that have been made mandatory for the diagnosis of petrol and diesel vehicles manufactured after 2004. The CAN documentation is unusually good and readily accessible, and just about every self-respecting IC vendor can supply ICs for the CAN bus. If you want to know more after reading the following description, a good starting point is interfacebus.com ^[2].

The CAN bus uses a differential signal line, which means it has two signal leads in the form of a shielded or unshielded twisted pair with a maximum length of 1000 metres (3,000 ft), terminated in 120 ohms at each end (**Figure 2**). CAN supports diverse data rates, but every device must be able to handle 20 kbit/s. Relatively low data rates are used for tasks such as window and seat operation, while relatively high data rates are used for engine and brake control.

In practice, the maximum number of nodes on a bus is around 110, but there are variants such as J1939 that support 253 bus addresses. CAN is inherently vendor independent; modules from any vendor can communicate with modules from any other vendor. It's clearly evident that CAN has become the head of a large family, with branches extending far beyond the automotive sector. This has led

to a large number of variants and intermediate forms, of which a small sample are listed in the table.

Nme	Date rate (b/s)	Medium
MOST	45 M	Plastic optical fiber
FlexRay/bytflight	10 M	STP or UTP
TTCAN	1 M	STP or UTP
CAN	10 k to 1 M	STP or UTP
LIN	19,200 baud	Single-wire

At the lower end of the transmission rate scale we find **LIN** (Local Interconnect Network). LIN is cheaper and simpler than CAN. It operates over a single-wire link with a maximum length of 40 metres at a maximum data rate of 92,600 baud, with a single bus master and several slaves. Congestion does not occur because only one message at a time is allowed on the bus. There are good dozen manufacturers of ICs for LIN, including NXP and Infineon (formerly the semiconductor divisions of Philips and Siemens, respectively).

Moving up the data rate scale, we see variations on a theme, many of which represent the response of one manufacturer to an innovation by another manufacturer. Here we can mention Time-Triggered CAN (**TTCAN**), which is also based on an ISO standard, as well as its faster brother **FlexRay** and finally, at the top of the scale, **MOST**. Although CAN probably won't be your first choice for your next design, it's nice to learn something about its operating principles. Traditional CAN is essentially event triggered, which means that a specific event initiates a sequence of bus traffic. For example, a particular sensor may indicate 'collision' at exactly the same time as another sensor indicates 'petrol tank nearly empty'. With an event-triggered system, in this situation it's necessary to determine which sensor has priority for access to the bus. This is called bus arbitration, and it takes time. In addition, the designer must have a good idea in advance of which priority a particular event may have. After all, you don't want to have airbag inflation wait until the 'petrol low' indicator has lit up.

In a time-triggered system, each device is polled at least once per cycle. The total duration of the cycle is known, so you know the maximum elapsed time before an event is followed up. TTCAN is actually a mixed form of event-triggered and time-triggered, based on the idea that there are always enough devices that do not need to be handled so urgently.

With TTCAN and **FlexRay**, we are clearly in a domain with lots of money. FlexRay operates at 10 MB/s, which opens up futuristic perspectives such as steer-by-wire, where the steering wheel is simply a control device that could just as easily be replaced by a joystick, perhaps with better results (see **Figure 3**). The fastest progeny of CAN is **MOST**, which was developed by BMW. The acronym stands for 'Media Oriented Systems Transport', and as the name suggests, it is intended to be used for tasks such as integrating the navigation system, mobile telephone, radio, and DVD player (with passenger viewing screens front and rear). **Figure 4** shows a complete example of how these three systems can be used in a car.

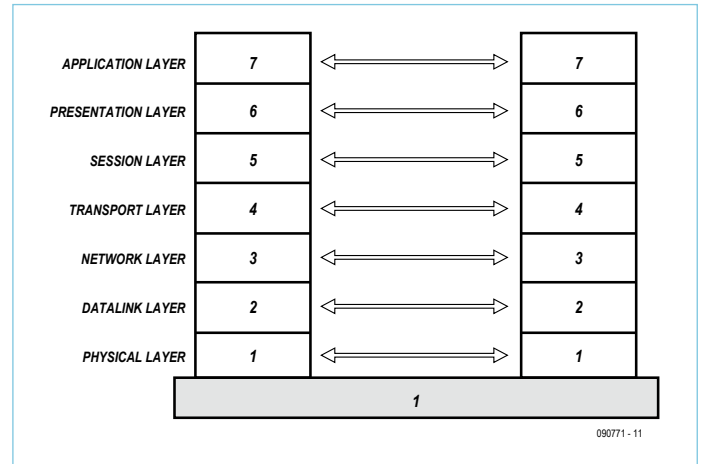

Figure 1. Open systems interconnection: the OSI reference model.

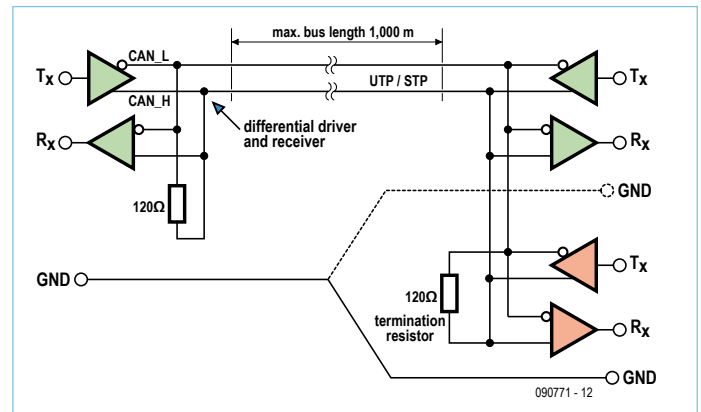

Figure 2. The CAN physical link.



Figure 3. FlexRay: why not use a joystick to drive a car? After all, it's good enough for fighter pilots. (photo: Mercedes Benz)

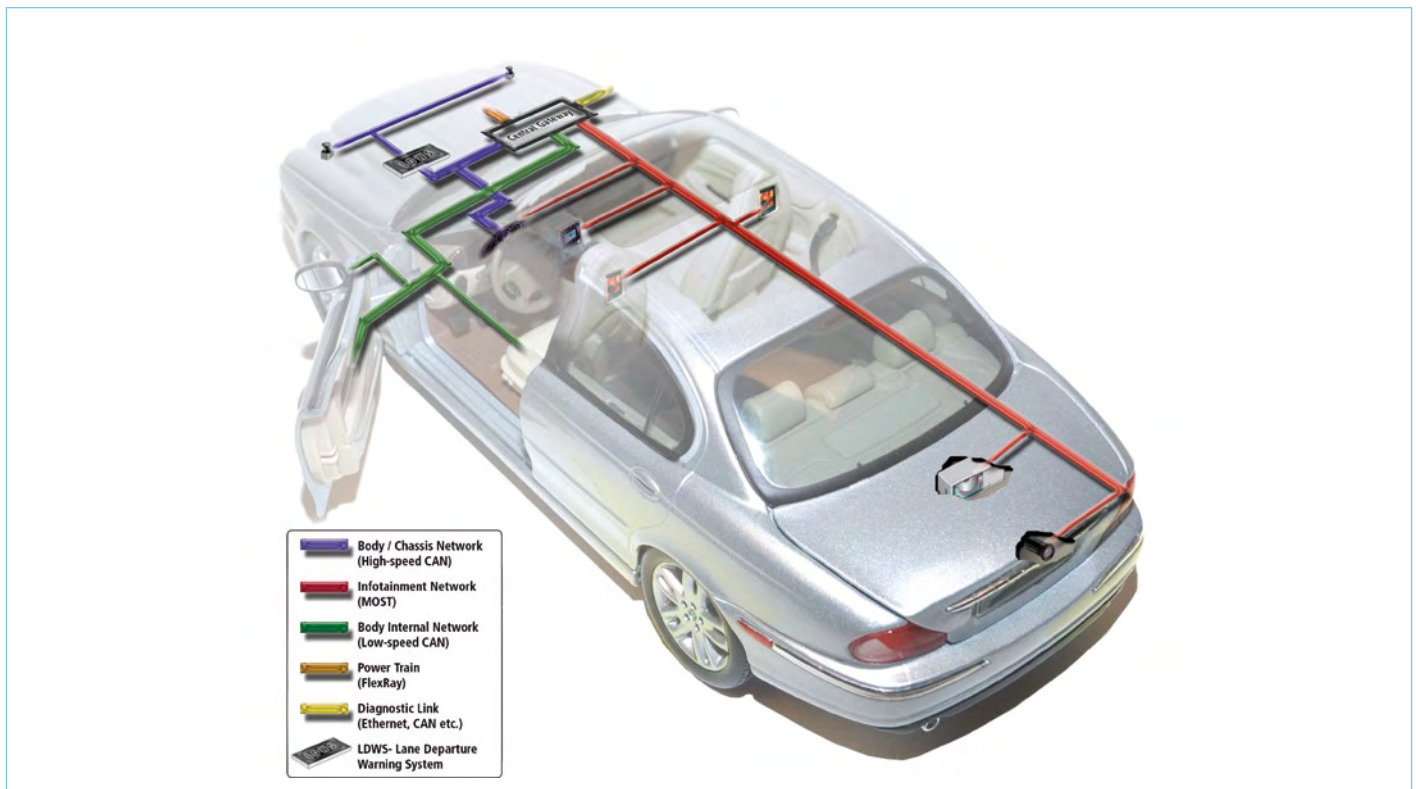

Figure 4. LIN, CAN and MOST together in a car (illustration: Xilinx [3])

Fieldbus and Profibus

A tour of industrial buses is not complete without a glimpse into the world of process and factory automation, which covers a wide range of industries from petrochemical to sauce makers and much more. The sums involved are also considerable. The first modules in this area appeared in the 1980s, with microprocessors, intelligent controllers, valves, encoders, analysers and the like — all of which are called ‘field devices’. Where there’s a lot of money to be made, fierce competition arises, and although the need for standardisation was recognised quite early on, compatible products were few and far between and even the ISA and IEC standardisation organisations could not reach an agreement.

Still, cooperation is better than cutthroat competition. Groups of manufacturers, customers and scientists gradually got together, and they eventually merged to form the two largest camps at present: the **Fieldbus Foundation** in the USA and Japan, and **PROFIBUS** in Europe. It’s a rather complicated story. For example, Siemens collaborated with Yokogawa on Fieldbus for a while, but they also collaborated with Robert Bosch GmbH on Profibus, which in addition has French ingredients ^[10, 12].

Profibus was later handed over a users organisation called the Profibus Nutzer (User) Organization. This organisation now has more than 1300 members worldwide, with more than 30 million nodes in use. Its customers include Shell and CERN, of particle accelerator fame.

Fieldbus and Profibus both define only layers 1, 2 and 7 of the OSI model. There is at least worldwide agreement on at one thing: the three versions of the physical layer, which are specified in IEC 61158 and IEC 61784. In a nutshell, they are:

- glass fibre for distances up to 100 km, with data rates of 9.6 kbit/s to 12 Mbit/s;

- RS-485 or EIA-485 over differential UTP or STP with a data rate of 35 Mbit/s up to 10 m or 100 kbit/s up to 1200 m. CAN and several other protocols, such as DMX512 for theatre lighting and the like, fall in this category;

- MBP-IS (Manchester Bus Powered Intrinsically Safe) is used in areas subject to explosion hazard, such as in refineries above liquid storage tanks containing gas. A low current flows through the wiring at all times, so no sparks can occur when something is connected or disconnected. The data rate is limited to 32.25 kbit/s over STP, with 10 to 32 stations per segment at distances up to 1900 m (approx. 6,000 ft).

If you want to learn more about these topics, we can recommend the websites of PROFIBUS International ^[7] and the Fieldbus Foundation ^[8], but you would do well to have a large company look after the costs of training and the necessary material.

What about wireless?

Let’s return to our original problem: the cable harness. Why not simply replace it with wireless technology? This was the task that the Swedish company Ericsson set itself in 1994. The aim was to develop an open, vendor-independent, affordable and international standard, and they succeeded. **Bluetooth** operates in the 2.45-GHz band and uses little power, so it can easily be employed in battery-powered equipment: 30 μ A in hold mode or 8 to 30 mA with an active link. There are three range classes: 1, 10, and 100 metres. A single device can serve several companion devices (point-to-many operation). A link between two devices is called a piconet. Each piconet can support up to 127 devices, with up to eight of them active at the same time. Bluetooth is a developing technology — version 3, which appeared only recently in April 2009, utilizes the WiFi protocol to

enable data rates up to 24 Mbit/s. Bluetooth is an open standard, and documentation is readily available via the Internet [4]. Like CAN, the Bluetooth system has already more than proven its merits. Originally conceived for linking personal devices together, it has also made its way into industrial applications, in particular in areas where wireless communication is simply much more convenient, such as automated warehouses and robotic systems. Along the development trend is toward higher and higher data rates, a need has also developed for a trend in the opposite direction, since there are a multitude of less demanding applications.

The counterpart of LIN for CAN is **ZigBee** for Bluetooth. The ZigBee Alliance was founded by a number of major players including Motorola and Samsung, and the standard has since been adopted by more than 150 manufacturers. ZigBee is a developing technology. It already supports automation and energy management for office and factory buildings as well as residential buildings. Efforts are currently underway to develop support for telecommunication and health care applications.

ZigBee consumes even less power than Bluetooth, which makes it possible to develop equipment that can be worn in the same way as a wristwatch or a brooch. Incidentally, you should take the term 'simple' with more than a pinch of salt here. The ZigBee physical layer consists of two frequency bands: 869 MHz (Europe) or 915 MHz (USA and Australia) and 2.4 GHz (worldwide), which support data rates up to 20, 40 and 250 kbit/s (respectively). The range is 10 to 70 metres (30 to 200 ft), and each ZigBee client has a unique 16-bit address, which means that a maximum of 65,535 (2^{16}) nodes are possible in a single personal area network (PAN).

There are three types of ZigBee devices in a network: a coordinator (ZC), one or more routers (ZRs), and end devices (ZEDs). The coordinator is the bus master. It determines the name of the network, holds the encryption keys, and can link to other networks (bridging). Routers serve specific applications, but they can also forward data from other devices. A ZigBee end device can only communicate with its parent node.

ZigBee has several very clever properties. Devices can switch from sleep mode to active mode within 15 ms. This is intentional, since ZEDs sleep most of the time to enable very long battery life (the

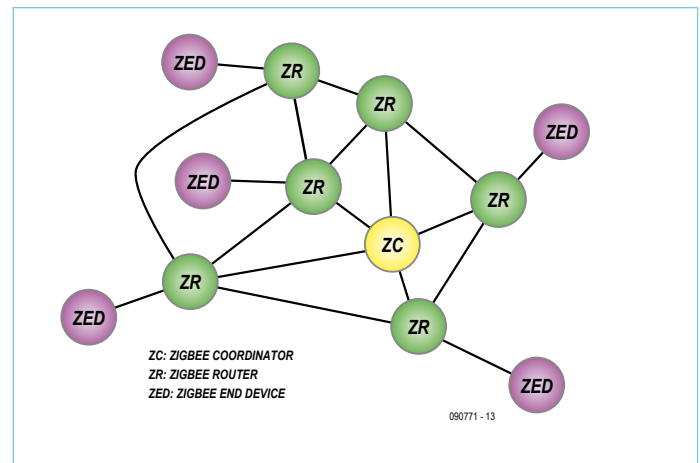

Figure 5. ZigBee grid topology with end devices, routers and a coordinator.

standard specifies two years). Routers and coordinators usually draw considerably more power. For example, a lighting fixture is always connected to the AC mains, so it can serve as a router or a coordinator. The light switch is a ZED. If you press its button, it wakes up, sends a command, waits until it receives an acknowledgement, and then goes back to sleep.

Routers are another clever idea. They extend the range of the network without consuming extra power, but what's more important is that make it possible to implement a grid topology similar to that of the Internet. Routers know which nodes are heavily loaded and route traffic over paths with lighter loading (see **Figure 5**).

ZigBee is an open standard [5]. If you want to use it for a personal project, you can obtain the specifications free of charge but you have to pay for the hardware and the development tools, although there are also initiatives for implementing the ZigBee stack in open-source software [6]. If you want to market a commercial ZigBee product, you are required to join the ZigBee Alliance and pay a membership fee.

Conclusion

As already mentioned, we have limited ourselves to a small selection of the hundreds of communication standards that have been developed in the electronics world. If you think we have overlooked something essential, you are cordially invited to let us know.

(090771-1)

Internet Links

- [1] http://en.wikipedia.org/wiki/OSI_model
- [2] www.interfacebus.com/Design_Connector_CAN.html
- [3] www.xilinx.com/bvdocs/ipcenter/product_brief/Auto_ECU_sellsheet.pdf
- [4] www.bluetooth.com/Bluetooth/Technology/
- [5] www.zigbee.org
- [6] <http://freaklabs.org/>
- [7] www.profibus.com
- [8] www.fieldbus.org
- [9] www.semiconductors.bosch.de/pdf/embedded_world_04_albert.pdf

- [10] www.imc.org.nz/fieldbus.html

Other sources:

- [11] OSI Reference Model - The ISO Model of Architecture for Open Systems Interconnection, H. Zimmermann, *IEEE Transactions on Communications*, Vol. COM-28, No. 4, April 1980
- [12] Overview and Geographic Impact of Current Process Fieldbus Technologies, Larry O'Brien, Institute of Measurement & Control NZ [10]
- [13] Comparison of Event-Triggered and Time-Triggered Concepts with Regard to Distributed Control Systems, A. Albert, Robert Bosch GmbH, *Embedded World*, 2004, Nürnberg [9]

USB Magic Eye

Tube indicates CPU load

By Martin Ossmann (Germany)

The author's son is a keen PC modder. Having constructed a number of USB-controlled LED displays, he decided it would be a good idea to have an indicator of CPU load. The author himself is a fan of retro electronics, and so the idea emerged of using a green glowing tube as a CPU meter. Power and control are both provided by the USB port. A simpler variant on the circuit, using a moving-coil meter, is also described.

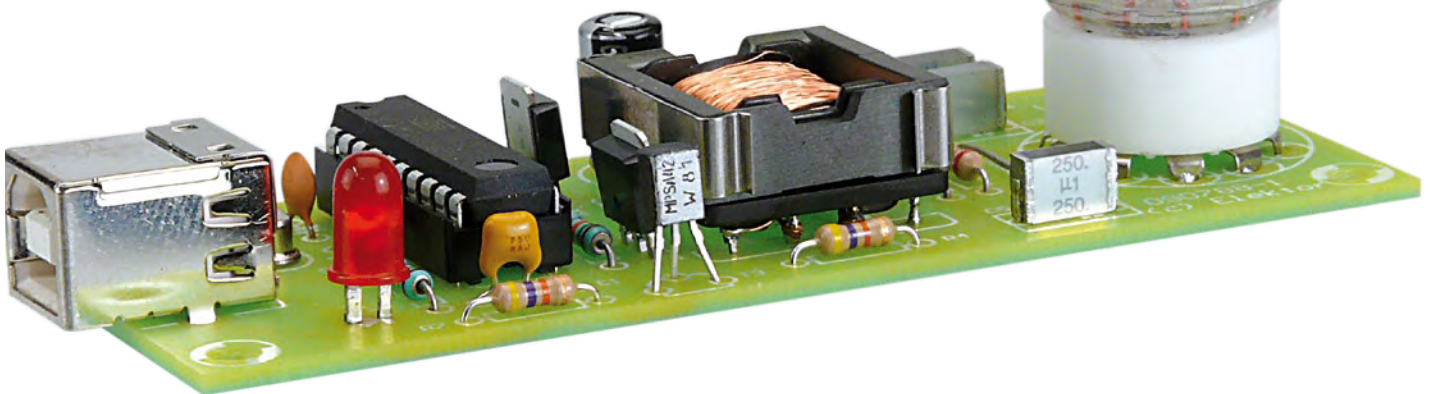

In fact it was the idea for the moving-coil meter that came first: the prototype is shown in **Figure 1**. With the aim of using off-the-shelf components as far as possible, a USB interface implemented in software in an Atmel microcontroller was chosen.

There are several alternative stacks available, including AVR309^[1], V-USB^[2] and avrcdc^[3]. For the CPU meter we chose the USB stack described in application note AVR309 by Igor Cesko.

First circuit

As **Figure 2** shows, the resulting circuit is very simple and can easily be constructed on a small piece of perforated prototyping board. The red LED drops the 5 V USB supply to the 3 V level required by the AVR microcontroller. A 12 MHz crystal is used

to ensure that the USB clock frequency is closely matched.

The microcontroller can be programmed using any of the multitudinous AVR programming adaptors available. The software running in the ATtiny2313, described in a separate section, is available for free download from the Elektor website^[4].

The analog value that drives the meter itself is created using pulsewidth modulation (PWM). Software running on the PC sends out the CPU load as a percentage (i.e., as an integer from 0 to 100). The AVR multiplies this number by 2 and writes the result to the PWM control register. The PWM signal is output on pin OC0B (PD5). At 100 % CPU load the average voltage on the PWM output is thus $2 \times 100 / 255 \times 3.3 \text{ V} = 2.6 \text{ V}$.

Potentiometer P1 allows the circuit to be adapted to use different types of moving-coil instrument. Any instrument with a full-scale deflection of at most 10 mA or 2 V is suitable. Before first connecting the circuit to the PC it is worth checking that the USB connections are correct, as otherwise damage may be caused to the PC by a short or reversal of polarity.

Magic Eye

Hardened retro fans will be much happier having their CPU load indicated by a 'magic eye' tube. Back in the day (until the mid-1960s, in fact), 'magic eye' tubes were used as tuning indicators on radio receivers and as signal level indicators on tape recorders. For the magic eye CPU meter we use a type EM84 (6FG6) tube (**Figure 3**). Unused stock is still available from some suppliers, and a new

Features

- display of CPU load as a percentage (0 to 100)
- power and control over USB
- ATtiny microcontroller with software USB interface
- two variants with the same firmware
- display using moving-coil meter or EM84 'magic eye' tube
- very low component count
- low-cost, readily-available indicator valve
- current consumption (moving-coil version): less than 100 mA
- current consumption (magic eye version): less than 500 mA
- freely downloadable PC software and microcontroller firmware, with source code

version is in production in China, priced from about 20 dollars. The Chinese part number is 6E2P. Sources are suggested at [5].

Second circuit

The tube requires a heater voltage of 6.3 V and an anode voltage of around 200 V. A small, unregulated, push-pull converter is used to generate these voltages from the 5 V supply provided by the USB port. The output voltages of the converter are determined by the turns ratio of the transformer in the circuit (Figure 4). In this case 10 turns are driven on the primary side at 5 V, giving 0.5 V per turn. The heater voltage is taken from taps on the primary winding twelve turns apart, giving 6 V. The winding of the transformer is described in the text box. With a heater current of 0.21 A we have a total heater power of 1.3 W. The anode supply requires 2 mA at 200 V for a power of 0.4 W. The total current consumption at 5 V is thus

$$I = (1.3 \text{ W} + 0.4 \text{ W}) / 5 \text{ V} = 0.34 \text{ A}$$

which is more than the 100 mA that a standard USB socket can supply directly. A further difficulty is that the heater has a low resistance when cold, and if it is suddenly switched on, a sharp spike of current will be drawn from the USB supply.

These problems are solved as follows. When power is applied the push-pull converter is first run at a low duty cycle. This means that the current supplied (and hence the current drawn) will be low while the heater gradually warms up. Then, under control of the PC, the heater power and the anode voltage are gradually raised. The current consumption is kept below 500 mA, which tests show is in practice within the capability of most USB ports.

Driving the push-pull transistor arrangement requires a second PWM generator, producing two non-overlapping pulses to the gates of the FETs. The anode voltage is produced with the help of a voltage doubler circuit in the interests of reducing the number of turns required on the transformer. The output of the transformer is $220 \times 0.5 \text{ V} = 110 \text{ V}$ which, after doubling, gives the required voltage. Transistor T3,

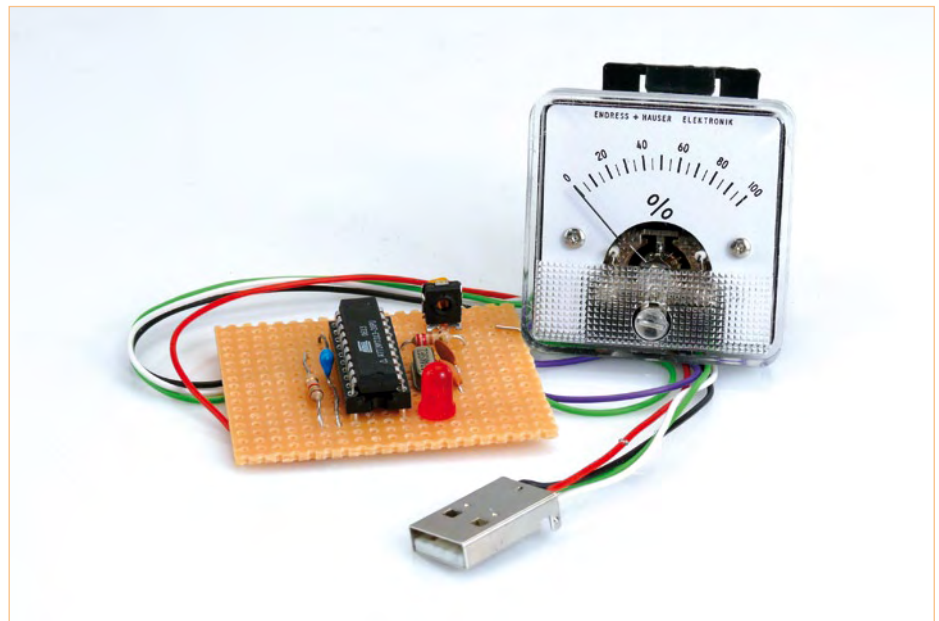

Figure 1. Moving-coil version of the CPU meter.

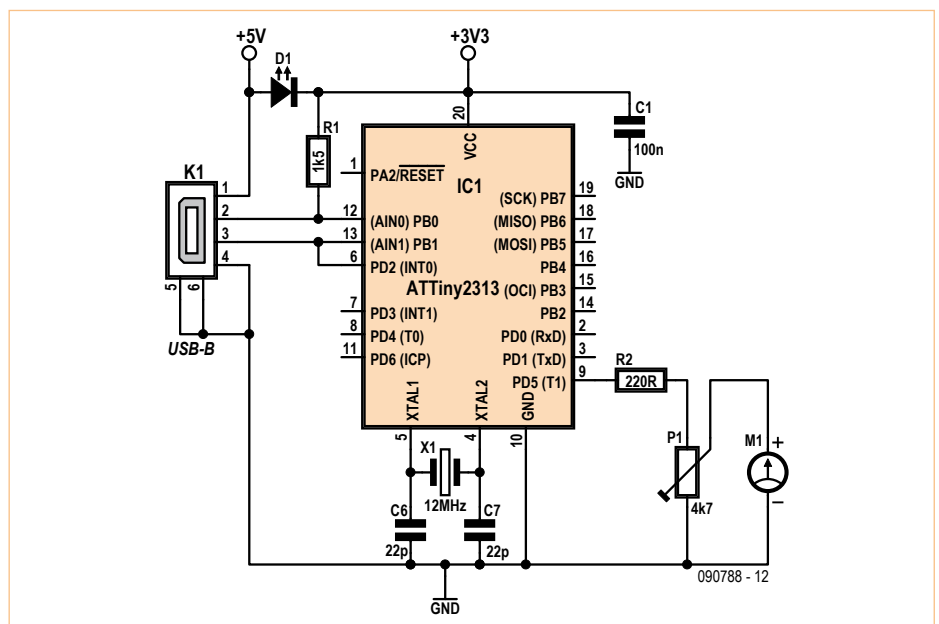

Figure 2. Circuit diagram of the moving-coil CPU meter.

Winding the transformer

Winding transformer L1 should present no great difficulty. First make the secondary winding. This consists of 220 turns of 0.1 mm (AWG #38) enamelled copper wire, running between pins 4 and 5 of the former. Pin 1 of the former can be identified by the chamfered corner, and the other pins can be identified using the datasheet (for example, from EPCOS). If 0.1 mm (AWG #38) diameter wire is not available, 0.15 mm (AWG #34) diameter wire can be used instead for the secondary.

A layer of insulating tape is used over the secondary winding to isolate the primary side from the high voltage present on it. Next make the primary windings in two parts, each with a tap. Enamelled copper wire with a diameter of 0.3 mm (AWG #28) or 0.4 mm (AWG #26) should be used for the primary winding. Each of the four parts of the primary winding should be



Former with secondary winding

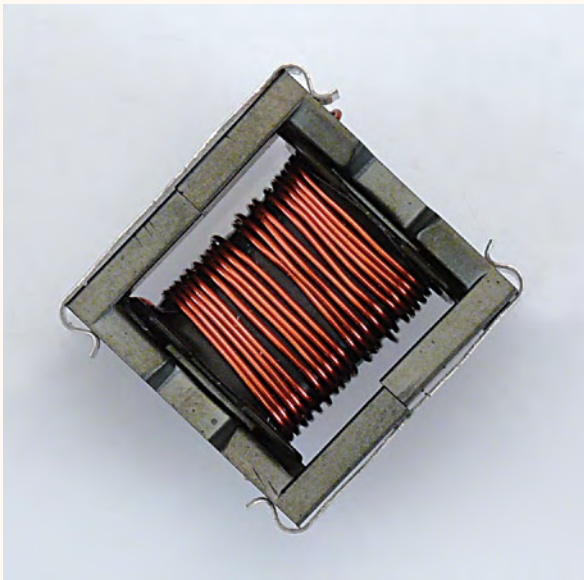

The completed transformer

wound in the same direction on the former (see the dots marked on the circuit diagram). Start at pin 1 and wind four turns; then make a tap at pin 2. Then wind six more turns in the same direction to pin 3, where this winding ends. Start a new winding at pin 6, again with six turns and again in the same direction, before the tap at pin 7. From there wind four more turns in the same direction to end at pin 8.

The final step is to fit the two halves of the core (without an air gap) and fix them with the clips provided. Alternatively, insulating tape or glue can be used. If using glue, take care to ensure that it does not flow between the halves of the core and create an air gap.

and then use that directory for manual USB installation. A tool such as USBview can be used to check whether the PC can 'see' the CPU meter: simply look down the list of recognized devices and see if the CPU meter (with ID AVR30USB) is present.

PC software

A C program was written (using Visual C version 6) to send the CPU load information to the AVR. The load is determined using the technique described in [6], and routines in the AVR309 library are used to carry out communication with the AVR.

The program can be used with either version of the CPU meter circuit. If the program is run without any parameters, it first gradually increases the switching supply duty cycle. Then, every tenth of a second, it

Listing 1

```

mov    temp0,ACC    ; fetch USB value
andi  temp0,0x80   ; check MSB
breq  SMPSpwm      ; if = 0 we have a SMPS set
CPUload: mov    temp0,ACC    ; fetch USB value again
lsl   temp0       ; multiply *2, range now 0..200
out   OCR0B,temp0 ; control instrument PWM
ret   ; and done
SMPSpwm: mov    temp0,ACC    ; fetch USB value again,
                        ; must be <50
out   OCR1AL,temp0 ; set SMPS-PWM output A
ldi   temp0,100   ; compute 100-value
sub   temp0,ACC
out   OCR1BL,temp0 ; and set SMPS-PWM output B
ret

```

COMPONENT LIST

Resistors

R1 = 1.5k Ω
 R5, R6 = 15k Ω
 R2 = 22k Ω
 R4, R7 = 47k Ω
 R3 = 330k Ω

Capacitors

C1, C3, C4, C5 = 100nF 250V
 C2 = 100 μ F 25V
 C6, C7 = 22pF

Inductor

L1 = transformer; coil former #
 B66418WL008D1 with clip # B66418B2000
 and core # EFD20 B66417GX187

Semiconductors

D1 = LED, red, 20mA
 D2, D3 = BY448
 T1, T2 = IRLU014
 T3 = MPSA42

IC1 = ATtiny2313-20PU, programmed,
 Elektor Shop # 090788-41

socket
 PCB, Elektor Shop # 090788-1

Miscellaneous

X1 = 12MHz quartz crystal
 K1 = USB socket Type B
 V1 = EM84 (6FG6) and 9-way (noval) tube

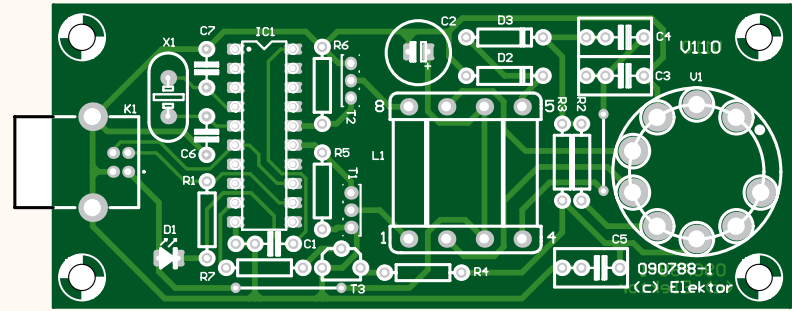

Figure 5. Printed circuit board for the EM84-based CPU meter, designed in the Elektor labs.

determines the CPU load value and sends it to the AVR as a percentage. The PWM duty cycle needs to be controlled over a certain range for use with the magic eye version of the circuit, and this range can be specified by passing two parameters to the program. If just one parameter is given a fixed duty cycle is output. This allows for test and calibration: for example, to calibrate the 100 % point, run the program as

```
CPUshow 100 <return>
```

and then adjust potentiometer P1 to obtain a full-scale deflection on the meter.

The circuit we have described illustrates what is possible today using relatively modest means. The quick-eyed reader will

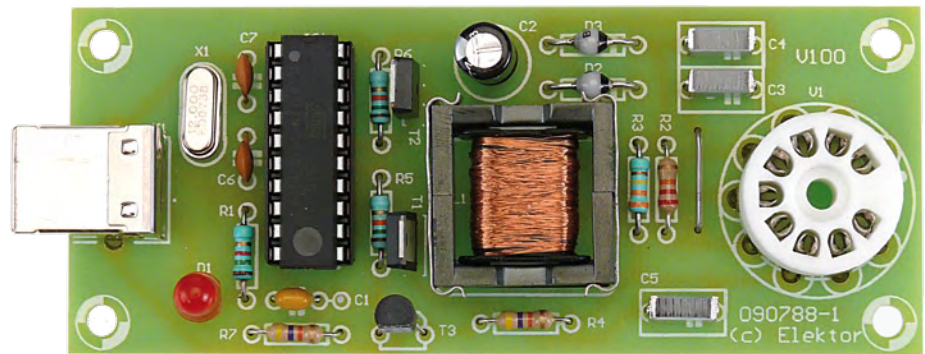

Figure 6. The assembled prototype.

have noticed that all the ideas we needed in designing the circuit were available on the world wide web, and that by simply combin-

ing these ideas in a new way we can make an interesting and novel project.

(090788)

Software notes

Microcontroller software

Compiler: WINAVR
 Source code: CPUshow.asm
 Hex file: CPUshow.hex

Programming of ATtiny2313:

```
; fuses:  
; brownout at 1.8 V  
; external crystal 65 ms startup  
CKSEL=1111 SUT=11
```

USB driver

AVR309.zip from the Atmel website

AVR309.dll

AVR309.inf

AVR309.sys

Use these files when installing the USB driver.

PC Software

Compiler: Microsoft Visual C version 6
 CPUshow.cpp
 CPUshow.exe

Files are included in the Elektor download [4].

Sources and Internet Links

- [1] [www.cesko.host.sk/IgorPlugUSB/IgorPlug-USB%20\(AVR\)_eng.htm](http://www.cesko.host.sk/IgorPlugUSB/IgorPlug-USB%20(AVR)_eng.htm)
- [2] www.obdev.at/products/avrusb/index.html
- [3] www.recursion.jp/avrcdc
- [4] www.elektor.com/090788
- [5] www.btb-elektronik.de/en/index.html, www.die-wuestens.de/eindex.htm, www.conrad.com
- [6] [http://en.literateprograms.org/CPU_usage_\(C,_Windows_XP\)](http://en.literateprograms.org/CPU_usage_(C,_Windows_XP))

310 Circuits

 Creative solutions for all areas of electronics

The 30x series of Summer Circuit compilation books have been bestsellers for many years. The 11th volume is available now! 310 circuits, tips and design ideas in one book form a treasure trove for every area of electronics: audio and video, hobby and modelling, RF techniques, home and garden, test and measurement, microcontrollers, computer hardware and software, power supplies and chargers – plus of course everything else that does not seem to belong in any of these categories. 310 Circuits for the first time has a section exclusively on robots and robotics. This book contains many complete solutions as well as useful starting points for your own projects. Both categories and anything in between represent a veritable fountain of inspiration for cultivating your own ideas and learning about electronics.

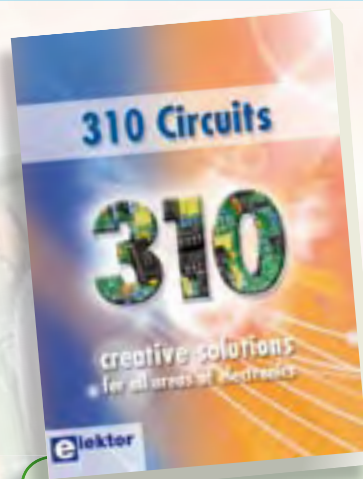

544 pages • ISBN 978-0-905705-78-1
\$48.30

Elektor US
4 Park Street
Vernon CT 06066
USA
Phone: 860-875-2199
Fax: 860-871-0411
E-mail: sales@elektor.com

Further information and ordering at www.elektor.com/shop

Saelig

UNIQUE PRODUCTS + FREE SUPPORT!

www.saelig.com 888-75SAELIG info@saelig.com

We have the testgear you need!

Call us for technical advice!

<p>60 - 300MHz DSOs</p> <p>SALE!</p>  <p>60/100/200/300MHz 2 ch, 2GS/s DSO 2000 wfm/s refresh rate. High quality, ultra Compact Design with small footprint. Totally new price.</p> <p>DS1052E \$595 Free Case! \$495 •• thru •• DS1302A \$495 \$495</p>	<p>Scope + Analyzer</p> <p>SALE!</p>  <p>50/100MHz 2-ch/16 logic scope and analyzer. 2000 wfm/s refresh rate. See wfms and logic data simultaneously. Trigger on data or signal edge.</p> <p>DS1052D \$4195 Free Case! \$4195 DS1102D \$4395 \$4395</p>	<p>Mixed -Signal PC Oscilloscope</p>  <p>100 MHz Scope and Logic Analyzer lets you do complex triggering to find hard-to-get-at glitches, spikes, etc. Huge 4 or 8 MS buffer for deep data drilling and zooming. Optional built-in swept signal generator. 2 Analog channels x 10, 12, 14 bit with more than 60 dB dynamic range. 8 digital inputs for mixed signal display/trigger.</p> <p>CS328A-4 (4MS Buffer) \$1259 CS328A-8 (8MS Buffer) \$1474 CS700A (signal generator) \$299</p>	<p>LCD Scopes</p> <p>BEST SELLER!</p>  <p>Owon - 25 or 60MHz color LCD 2-ch bench scope OR 20MHz handheld scope/meter. USB interface for printouts. Includes scope probes! Battery versions available.</p> <p>PDS5022S / 6062T \$315 / \$499 HDS1022MN / 2062MN \$593 / \$699</p>	
<p>USB Bus Analyzers</p>  <p>Packet-Master™ - best value USB1.1/2.0 USB analyzers and generators. Identify USB problems fast, fine-tune performance, easily view Host commands, emulate host/device sequences, etc.</p> <p>USB12 (USB1.1) \$699 USB480+ (USB1.1/2.0) \$1199 USB500AG (USB1.1/2.0/Gen) \$1399</p>	<p>7 in 1 USB Scope</p> <p>NEW!</p>  <p>2-ch 10-bit 2MHz scope/spectrum-analyzer, 3MHz 8-bit wfm gen; 16 x I/O; Network Analyzer; Noise Generator; PWM. Windows/Linux/Mac compatible! USB-powered, great for toolbox, education, etc.</p> <p>CGR-101™ \$180</p>	<p>EMC Spectrum Analyzer</p>  <p>EMC RF & EMF Spectrum - Analyzer 1Hz to 7GHz for measuring transmissions from radar, radio/tv towers, WLAN, WiFi, WiMAX, Bluetooth, microwave ovens, etc.</p> <p>from \$299 / \$1990</p>	<p>microCAM</p>  <p>Compact compressed-serial output camera module for any host system. JPEG OmniVision™ CMOS VGA color camera for embedded imaging.</p> <p>uCAM TTL or 232 \$58</p>	<p>Sound Module</p>  <p>14-pin Tiny Audio-Sound Module plays back pre-stored audio files (voice and music) from micro-SD card - ideal for embedded audio output.</p> <p>SOMO-14D \$25</p>
<p>RF Modules</p>  <p>RF TX/RX Modules - simultaneously transmit composite video and stereo audio signals. 2.4 GHz ISM band. 4-ch RF, 5V operation.</p> <p>AWM630TX \$16 AWM634RX \$27</p>	<p>Wireless Data Loggers</p>  <p>Log and display temperature, humidity, voltage, event-time or pulse-counting data up to 100 meters away from base station.</p> <p>RTR-50 modules from \$170 RTR-57U base \$401</p>	<p>USB Logger</p>  <p>EL-USB-1 - Standalone USB temp data logger (-25°C to +80°C). \$49 EL-USB-2 (+ humidity) \$79 EL-USB-3 (voltage) \$69 EL-USB-4 (current loop) \$69 EL-USB-CO (Carbon Monoxide) \$89</p>	<p>RF Testing/EMI Tents</p>  <p>Economical, portable RF test enclosures, for initial compliance testing. from \$1295</p> <p>Shielding Tents with external frame, instant up/down for emissions-free room. from \$3500</p>	<p>I started Saelig as an engineer - for engineers! Saelig is an olde English word means 'happy, prosperous, blessed'</p> <p>Check our website for lots of neat stuff! Alan Lowne • Saelig CEO</p> 

Router + Wireless Doorbell = Alarm system!

Inspired electronic recycling truly rings the bell

By Enrico Müller (Germany)

Once again our workshop project is a true blue recycling project – turning an old telephone router and a wireless front door bell into a wirefree alarm system. Apart from a handful of cent components, an LCD readout and a scrap of breadboard no additional parts are necessary.

Have you noticed how short the lifespan of consumer electronics gadgets is becoming? The fabulous gizmo that you carried home with pride last year is already out of date and you find yourself the owner of a growing pile of ‘electronic scrap’ that you nevertheless feel reluctant to dump. All the same, recycling this stuff for reusable components is often tricky, as either you need special tools or else the custom chips are too specialized or mysterious to do anything useful with. The introduction of multilayer PCBs and unhelpful labeling of components make identification of circuitry and individual parts extremely difficult. It’s a rare pleasure when you discover an opportunity to breathe new life into an outdated appliance that had been condemned to oblivion.

Conception

For more than two years a Least Cost Router (LCR) for a multi-line ISDN telephone installation had been kicking around in my loft. Every time I went up there it annoyed me to see the box of this ‘useless’ device. Finally in mid-2006 I opened the cardboard box to see if there was anything useful I could do with the contents. At first glance I found a ‘wall wart’ AC power unit, an ISDN cable, a case and a circuit board that was almost entirely covered in surface-mount devices. Disenchanted I put it to one side.

A few weeks later I examined the PCB (see **Figure 1**) a second time more closely. Rapidly it became clear that I hadn’t wasted good beer money after all. It was very apparent that the designers at Teles (the manufacturer) had separated each functional block of the circuitry both conceptually and physically on the board. On one side lay the ISDN functionality and on the other the processor section, next to the voltage stabilizer. The second pleasant surprise was the ‘classically’ laid out data section: an 8051 derivative operated in textbook fashion! An 80C32 microprocessor, 32 KB of scratchpad memory (RAM), 64 KB program memory (ROM) and even a serial EEPROM were all provided. After studying the data sheets [1] [2] there was more good news. The ROM module used was made up from a sort

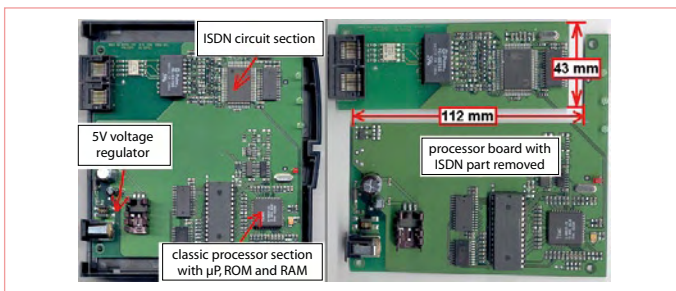

Figure 1. Neat and tidy: each functional block of the Router is completely compartmentalized.

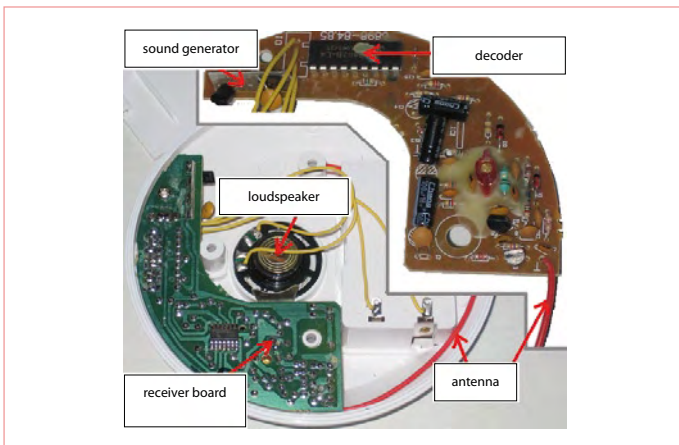

Figure 2. Practise your surgical skills on the doorbell corpse.

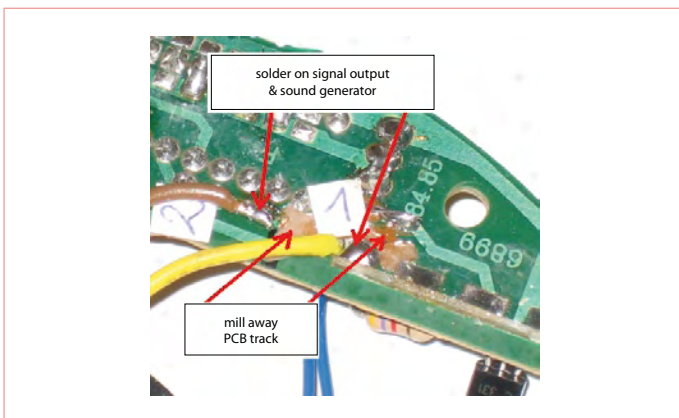
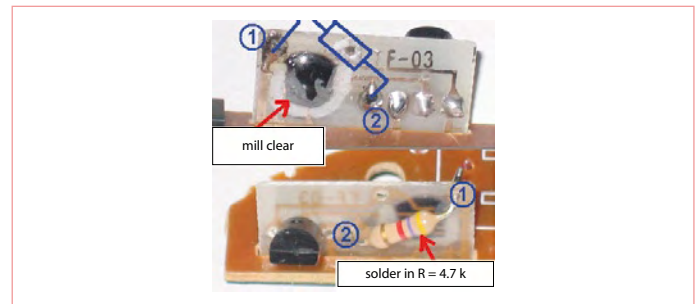

Figure 3. This is where we dig in, between the signal output and the sounder.

Figure 4. The audio chip is removed, as you can make our own noise!



of hybrid of Flash and OTP EPROM. An MTP-EPROM (multi-time programmable EPROM) can be reprogrammed afresh up to 100 times. With this at the back of my mind, albeit without any firm ideas, I bundled away everything for further thought.

As 2006 closed a 'golden moment' finally gave me the opportunity to have a proper play with the board. Dismantling the ISDN circuitry turned out taking longer than expected. This involved equipping myself with a junior hacksaw, after which I took some measurements and sawed out the complete ISDN section without major difficulty (see **Figure 1**). On the PCB I found four LEDs that begged me to power them up. A simple multimeter was all I needed to identify the relevant Portpins on the 80C32 that illuminated them. With a small program written in machine code I was finally able to fulfil the wish of these little lamplings.

Troubled birth

In the early summer of 2007 our neighborhood was suffering a series of domestic break-ins. I had a brainwave. How about a simple alarm system? The idea of installing cables that would snake all over the property was an unattractive proposition, so a wirefree solution came under consideration. Leafing through some catalogs soon made it clear that systems of this kind cost a three-figure sum! My researches were interrupted by the ringing of the telephone. An acquaintance wanted to let me know that an electronic doorbell that I had ordered for him had stopped working. It was then that it hit me: this was the moment of conception for 'Project Wirefree Alarm System'!

Things moved rapidly now. Repeating what I did with the LCR box, I split the doorbell system into its component parts (see **Figure 2**) and once more I was pleasantly surprised. Despite the low purchase price of \$ 7.50 or so the product employed a proper coding system, albeit a simple one. I isolated the signal output of the decoder circuit. This output was connected direct to a small audio signal generator, meaning I had only to cut the circuit track in question and attach a piece of wire about 15 cm (6 inches) long to the track on either side (**Figure 3**).

These two wires were now hooked up to the processor board of the router at the very same locations where two LEDs were located previously. A small 'bell push detection' program was now written, enabling the first practical test to be take place. After fitting batteries into the bell push I pressed the button full of expectation. A red LED lit up on the bell push itself but that was all; the

Figure 7. This is where you make the ten connections of the user interface.

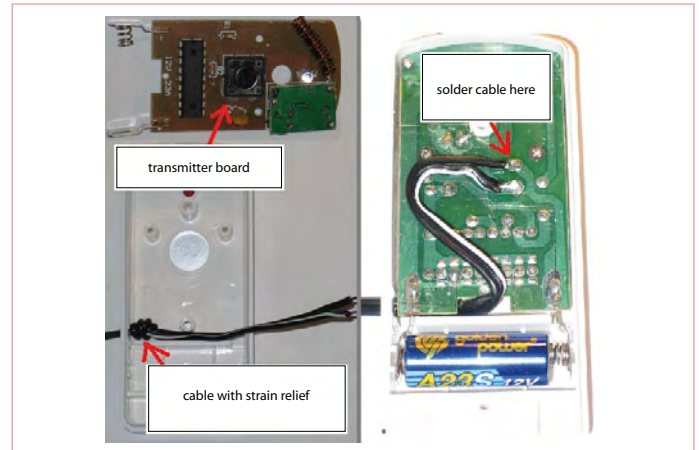

Figure 5. A cable leads from a reed contact to the transmitter board. The wireless sensor unit is now complete!

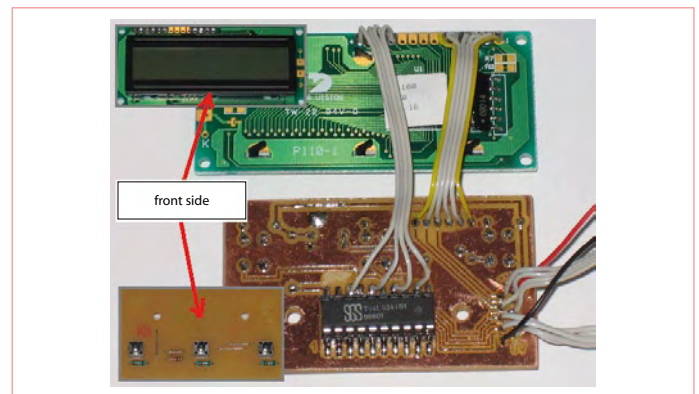
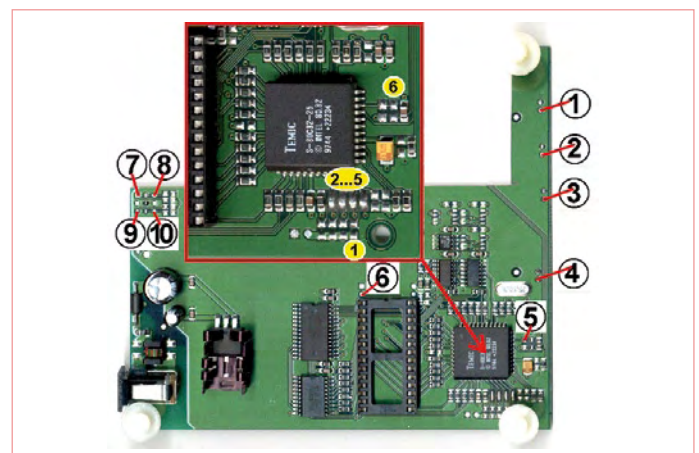

Figure 6. An LCD display and three pushbuttons form the user interface.



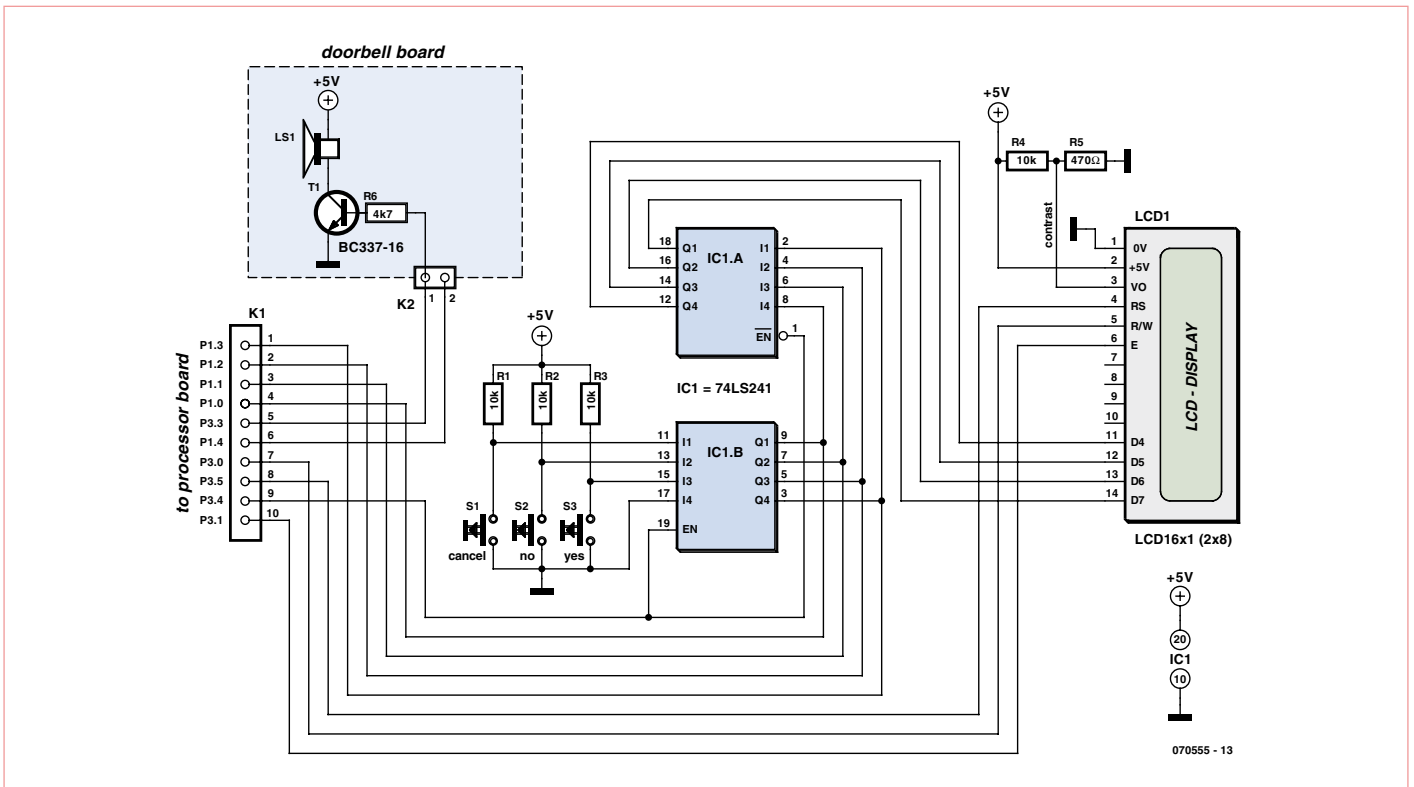

Figure 8. Thanks to the logic unit we need just four port pins for the display and buttons.

Components

At the heart of this project is a product from the firm Teles sold under the title ‘Teles.iLCR Box’ as a Least Cost Router (LCR) device for multi-line ISDN installations. If you look around you can find it cheaply — we entered “Teles.iLCR Box” into Google and found one for 10 bucks at http://www.oppermann-electronic.de/html/body_mai_2006.html. The dealer <http://www.telefonino.de/isdn.htm> has them currently for 10 euro and there was also one on offer for 10 euro on the German auction site <http://www.hood.de/> Check out electronics swapmeets too, as the product may appear under different brand names but do not confuse it with the S0-Box, 250-Box etc. from Teles. If you get really stuck e-mail the author (u881emr@habmalnefrage.de).

The second ingredient is the wireless doorbell setup. This consists of a transmitter (bell push) and a combined receiver and sounder. Of course you can substitute any similar product for the one used here. As these are so cheap now (under \$10) you are best off buying this new at a DIY shop or from an electronics surplus dealer.

Beyond a handful of simple components (see parts list), an LCD display and a piece of breadboard (Vector Board, perf board) no additional parts are needed. The whole lot should not cost more than about \$40 in material costs. The printed circuit board is single-sided and can be made at home to save money. Details and measurements are in the Zip file that you can download gratis from the project page (070555) on the Elektor website. No special workshop tools are required but you will need access to an EPROM burner with the ability to erase and write MTP-EPROMs. At a stretch simpler

models will handle this task if they can write to a 27C512. In this case as well as two 27C512 EPROMs you will need a UV eraser too.



COMPONENT LIST

Resistors

R1-R4 = 10kΩ (0.25 W)
 R5 = 470 Ohm (0.25 W)
 R6 = 4kΩ7 (0.25 W)

Semiconductors

IC1 = 74LS241
 T1 = included

Miscellaneous

S1, S2, S3 = low-profile pushbuttons (6x 4 mm, 9 mm tall)
 LCD1 = LCD display 1x16 (8x8)
 Breadboard
 20-pin socket for IC
 various support pillars 5 mm
 various screws (15 mm long) and nuts M3-M3.5

tips and testing

To separate the processor board you are best off using a junior hacksaw equipped with a steel blade. Having sawn it out, smooth off all the edges with fine sandpaper and check with a magnifying glass for any unwanted contact between individual tracks or the +5 V and Ground lines. After this, remove SMD resistors 1 and 6 (yellow) illustrated in **Figure 7**. In the download file [1] is a simple diagnostic program by the name of TEST1.HEX, with which you can check out the function of the circuit board (the way this works is shown in the flow diagram). Connection 5 should permanently indicate a level of around +2.5 V. Further details can be found in the source text TEST1.ASM. If everything works properly you can now remove all the LEDs (white connections 1-4) and substitute wire bridges for SMD resistors 2-5 (yellow).

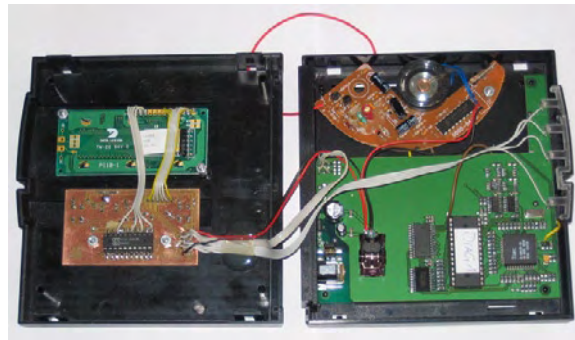

drips out you can fix a small piece of paper or tape temporarily on the outside of the case in the appropriate position.

Now remove the processor block from the lower half of the housing. Connect the data lines of the display and control panel (you will need eight data lines and two power feeds of around 20 to 30 cm length) and also the receiver board to the processor board. To find out which wire con-

nect to which examine the table (for numbering see **Figure 7**). The power supply wires are not included in the list. It is well worth twisting the power supply cables with one another (+5 V to +5 V, Ground to Ground) and soldering them direct to the wires from the voltage regulator. Take care to avoid short circuits.

The download file contains a further diagnostic program called TEST2.HEX that can check out your hook-up wiring. If everything tests correct the display will read “Warten auf Taste” (Waiting for key press). After any press button is pressed (S1-S3) the message “Taste X gedrückt” (Key X pressed) is displayed. If the sounder has been silenced you need to reset it for “Alarm-Signal EIN” (Alarm signal ON). In the latter case a tone signal is also heard on the loudspeaker. Each of the press buttons plus the alarm can be operated in any order you wish and as often as desired. If all this functions correctly it’s time to convert the project into a working wirefree alarm system by programming it with FUA51.HEX (see download file). Very lastly you need to label the press buttons from left to right as follows: ‘Cancel’, ‘No’ and ‘Yes’ (see header illustration).

On the doorbell receiver board (see **Figure 2**) the existing power feeds should be swapped for pieces of wire about 15 cm long and the board then offered up and mounted in an unoccupied area of the lower half of the router casing (see illustration in panel). Fixing is by means of a screw through a 5-mm standoff spacer direct to the case. When doing this make sure the projections of the upper half of the case still mate properly with the openings in lower half. A hot glue gun is a convenient way of fixing the small loudspeaker between the board and the lower half of the case. To ensure no glue

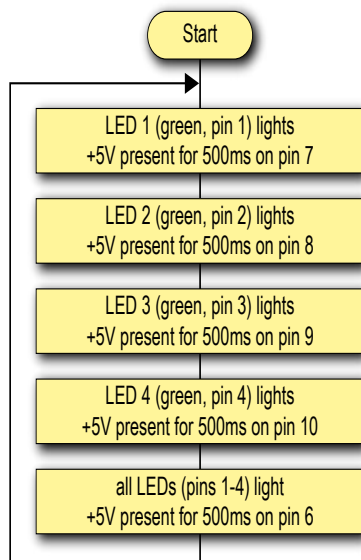

Connection	Port	Function
01	P1.3	D7
02	P1.2	D6
03	P1.1	D5
04	P1.0	D4
05	P3.3	Sounder
06	P1.4	Signal input
07	P3.0	R/W
08	P3.5	RS
09	P3.4	Control input/output
10	P3.1	E

trial did absolutely nothing otherwise. I put my trusty multimeter to work once more to monitor the output level of the decoder when the bell push was pressed. This looked perfectly adequate. What’s more the signal was reaching the processor. It was then that I accidentally dislodged the test probes and short-circuited two adjacent Portpins. Immediately the sounder did its business and the red LED on the

processor board began to blink. The connection in question measured 0 volts. Very strange: surely the alarm would be canceled with a logic 1 signal? Then it occurred to me that when I connected the meter I had forgotten to adjust the ‘set zero’ function. After correcting my error the circuit functioned as expected.

The first prototype of my system was now fully functional.

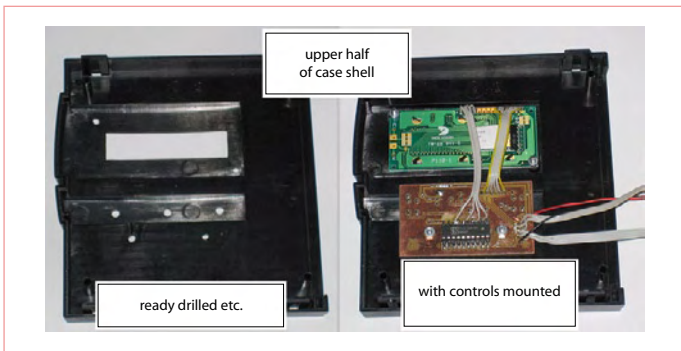

Figure 9. The case requires a bit of ‘surgery’ too.

First in-service test

Over the next few days I added a reset button to the test set-up. The audio sounder board needed a bit of tickling as well. The control chip was chopped out completely and the driver transistor for the loudspeaker provided with a 4.7k base resistor to its base connection (see **Figure 4**). Now it could sound an alarm. I removed the receiver board and the loudspeaker from the case of the doorbell unit at last and fixed them in space that had become free inside the LCR unit case. At the same time I connected the power supply direct onto the processor board. So as not to shorten the lifespan of the components by over-voltage, the receiver board supply was reduced by inserting two series-connected diodes. After adapting the control program I treated the bell push to a cable with a built-in reed contact (see **Figure 5**). For test purposes I fixed this contact with a magnet and the transmitter to my letter box. Now the system alerted me whenever the postman raised the flap to deliver mail.

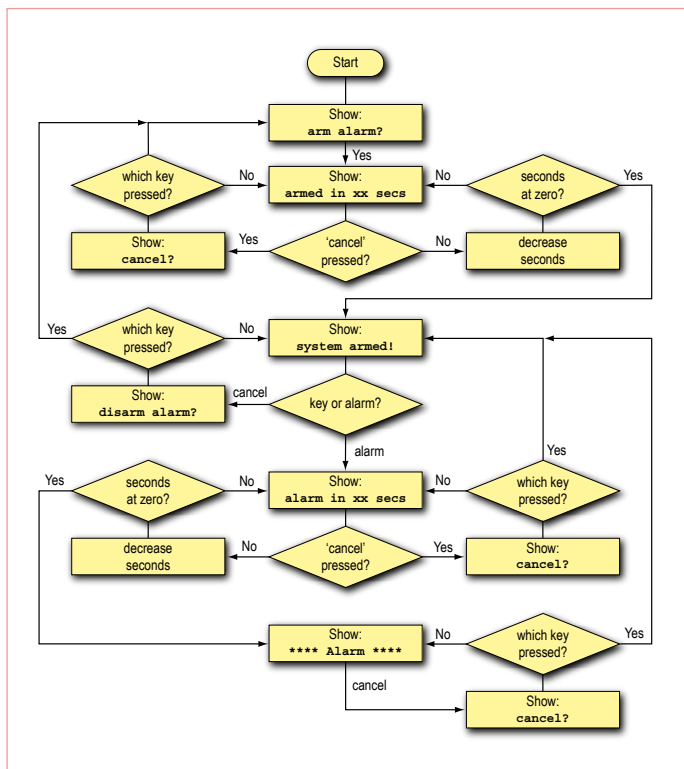

Figure 10. The firmware has been kept as simple as possible.

Let’s get started...

Although my first proper trial worked well, something was annoying me. The alarm LED mounted up on the wall was either hard to see or totally out of sight. For this reason I decided to enhance the project with an LCD read-out and a small operating panel. Conveniently I was able to find an elderly 1x16 LCD display in my junk box (**Figure 6**). To simplify operation as far as possible I decided to restrict the number of press buttons to just three. All functions could now be catered for by Yes, No and Cancel decisions. The ‘wish list’ was now finalized.

Operating an HD44780-compatible LCD module calls for a minimum of seven Portpins (in 4-bit mode). Three are needed for the press buttons and one each for signal acquisition and output. Altogether this chalks up a requirement for 12 unassigned connections on the processor board. Nevertheless we can manage with just ten Portpins (see **Figure 7**). This is achieved by utilizing connections twice over. I decided to transfer the four data bits of the LCD module (D7-D4) and the three input press buttons by corresponding logic to the four Portpins of the processor (see **Figure 8**). This is how the need arises for a total of ten wires, including the connections to transfer the four Portpins used together from input and output and vice versa.

The operating panel has components on both sides. All press buttons, resistors and bridge loops are on the ‘top’ or ‘component’ side, with a 74LS241 (fitted in a socket) and the ‘wiring’ fitted to the ‘bottom’ or track side.

... and finish the job!

All that’s left now is to drill the upper half of the case and make the necessary openings (**Figure 9**). All sizes and locations were simply measured off the LCD display and the already populated PCB of the operational unit.

I deliberately kept the firmware very simple. As you can see in **Figure 10**, the system has a start-up delay, set at 60 seconds, and an alarm delay, preset at 30 seconds. The sounder is silenced after two minutes.

To replicate my design you will find a layout plan of the components on the board, a PCB layout and software in ASM and HEX files ready to download on [4]. The components needed and conversion details are set out in panels included with this article.

Naturally everybody is free to make alterations to meet their individual needs. There is plenty of unused RAM and EEPROM capacity to spare on the processor board of the LCR!

(070555-1)

Web links

- [1] www.alldatasheet.com/view.jsp?Searchword=80C32
- [2] www.alldatasheet.com/view.jsp?Searchword=MX26C512A
- [3] http://www.oppermann-electronic.de/assets/applets/installation_teles_router (Teles iLCR Box technical manual)
- [4] www.elektor.com/070555

USB is cool/sucks*

* cross out as applicable

By Jerry Jacobs and Chris Vossen (Elektor Labs) and Jens Nickel (Elektor Germany Editorial)

USB is 'state of the art' when it comes to connecting electronics to a computer — and in some cases it's the only option, too. It goes without saying that many of the recent Elektor circuits that require an interface to download, upload or store data on a PC, also have a USB Interface. After all, USB is fast, flexible and has this nice hot-plug-and-play-feature (sorely missed if you didn't have it, believe u us!). But when it comes to making things easy for end users, it's getting increasingly difficult for developers. Some of our readers may have come across non-recognized USB Devices, USB timing problems and some other time-consuming quirk or nastiness of the 'universal serial bus'. For those — and all other readers — we compiled this USB FAQ!

1. I really like building Elektor circuits from time to time. But with the good old RS232 port the whole thing seemed so much easier. Will you stick to USB to connect your circuits with a PC in the future?

One of the first Elektor articles dealing with this bus was the USB interface in September 2000 (www.elektor.com/000079) using an IC from Cypress. This was a great success! Meanwhile, we have gained a lot of experience with this interface.

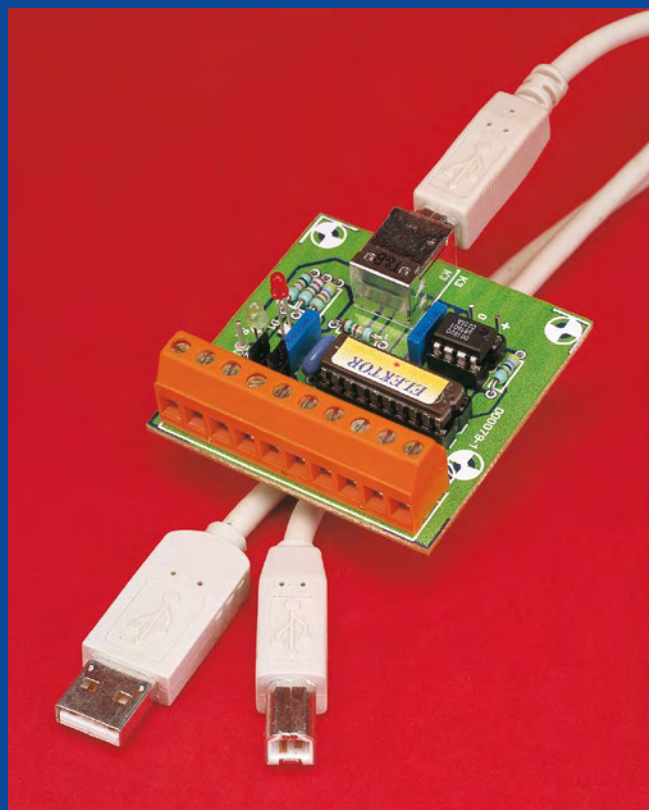

As far as possible, we won't use the good old MAX232 in the Elektor circuits any more, but a USB chip like the FT232R(L) from FTDI (the L version is a QFN package and a little more difficult to

solder). For circuits where such a chip is too expensive, a simple TTL pinout is an option. On this connector you can find the data lines, handshake lines and power-supply — as you may remember it from the old times. To connect with a PC, you can use a TTL-USB Cable (see www.elektor.com/080213), which is quite easy to handle.

2. For some older circuits, I can use existing RS232-USB converters. But there are timing problems occasionally. Where can I get information about this problem?

Our resident author Burkhard Kainka wrote an article in Elektor about such problems, see www.elektor.com/050071. You can also find good information about RS232-USB conversion on the Internet, for example at www.lammertbies.nl/comm/info/RS-232-usb.html.

3. Where do I get started when I want to make my own USB project?

There are various manufacturers of microcontrollers that have built-in USB, for example Atmel's AT90USB series. The ARM cored Philips LPC(1/2/3)000 devices also have USB. A third example is the PIC18 and PIC24 series from Microchip.

4. If I want to use an AVR micro with USB, can you point me in the right direction?

Here are three recommendations from Jerry Jacobs, who is trainee in our lab: The Teensy project (<http://pjrc.com/teensy>) has lightweight examples that should help you understand the actual bit manipulations governing USB on an AVR controller.

On the websites www.ssalewski.de/AT90USB_firmware.html and www.fourwalledcubicle.com/LUFA.php you can find more advanced examples.

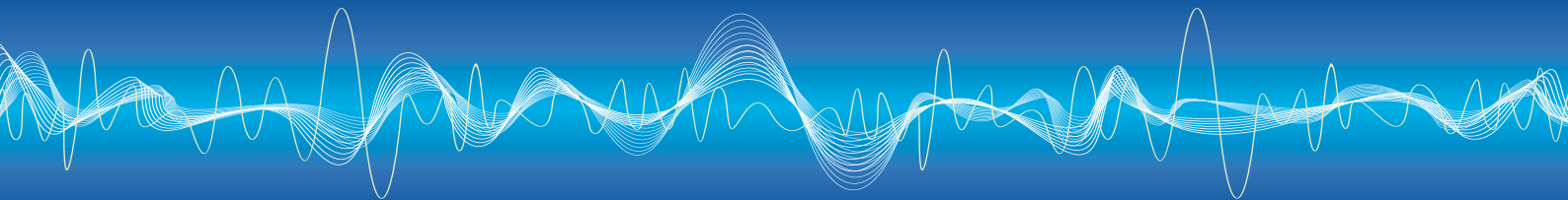

5. USB is cool, but one often has problems with non-recognized devices. Is there a bag of tricks to avoid such problems?

Always make sure you have the driver that belongs to the product and software you're using. For example: Atmel's avrispmk2 ISP programmer needs the Atmel driver if you use AVR Studio for in-circuit programming. If you want to use avrdude then you need to install the correct libusb driver. AVR Studio won't recognize your programmer if the libusb driver is installed. Furthermore, it's useful to have a good understanding how the so-called enumeration works and what it does. This is the most important part of device recognition. It enables the computer to ask which device it is, in which class it belongs, how much current it draws and how many endpoints it has. You can find a lot of information on the Internet, for example at www.lvr.com/usbceenum.htm.

6. When nothing seems to work, are there software tools around I can use to check or solve the problem?

Under Linux you can just fetch the kernel messages by running `dmesg` in the console. Unfortunately, you can't see kernel messages under Windows (there are some utilities from Intel but you should use it only with an English Windows XP SP2 installed!).

Here are some handy utilities for Windows that may prove helpful

- www.usb.org/developers/tools
- www.ftdichip.com/Resources/Utilities/usbview.zip
- www.nirsoft.net/utis/usb_devices_view.html
- <http://sourceforge.net/projects/usbsnoop>

Under Linux you can use the tools called `usbview` (www.kroah.com/linux-usb) and `lsusb` (<http://sourceforge.net/projects/linux-usb>).

Furthermore, there's a good commercial program by SYSnucleus (www.sysnucleus.com). USBtrace is a software spy for USB that also features a protocol analyzer.

7. I heard devices can draw up to 500 mA over USB, but some people say it's just 100 mA. What's the secret behind it?

There's theory and there's real life. The specification says that you can only draw 100 mA by default. If you need more, the device should 'order' the excess amount from the Host (the configuration can be set in steps of 2 mA) at the time of enumeration. Maximum is 500 mA.

In practice, almost all PC USB ports are designed and built to supply 500 mA by default.

8. What happens if my circuit draws too many milliamps?

Most of the computer's USB hubs are overcurrent-protected and will disconnect offending devices automatically, sending a message back to the operating system that can pop-up a message box in the user (space) interface.

If you are unlucky, the USB port is not protected. Instead of a fuse, in some cases only a resistor is integrated, and when you see smoke, it's too late. So we strongly recommend to make sure that your circuit won't draw too much current.

If you work with high voltage on the target device, there's an interesting chip from Analog devices, called 'iCoupler USB Port Isolator', see <http://www.analog.com/en/interface/digital-isolators/adum4160/products/product.html>.

9. Do you have any experience with the mechanical sturdiness of USB connectors?

If everything is soldered correctly, there shouldn't be any problems. In the Elektor lab, we haven't had any broken connectors so far. Especially the micro connectors are very robust. The designers of the connectors did a good job. The construction of the connector ensures that the metallic sheath (which is connected to ground) first makes contact, then the pins follow. This prevents damage from electrostatic charges.



10. What do you think about USB 3.0?

We already had an article in Elektor about USB 3.0 (www.elektor.com/080880). You can rest assured there will be Elektor circuits using that interface in the future! Such an interface is downwards compatible, so you can use it with USB-2.0 cables and a PC-USB 2.0 Port, too.

(090768-1)

Elektor CO₂ Meter Mk. 2

by Jens Nickel (Elektor Germany Editorial)

Too much carbon dioxide (CO₂) is harmful not only for the environment but also for our own health. But as Michael Caine would say, not a lot of people know that. In just two hours of a meeting or classroom presentation the normal concentration of this gas can rise tenfold. The build-up of CO₂ in the blood prevents the unfortunate participants from absorbing enough oxygen, with giddiness, nausea and even breathlessness a worst-case outcome. This was reason enough for Elektor to make a CO₂ meter its cover project in January 2008 [1]. The core of this design was a CO₂ measurement module from the Japanese manufacturer Figaro combining not just a built-in sensor but also the control system and even a microcontroller. The latter looked after evaluation of the sensor signals: one pin of the module's interface produced a DC voltage directly proportional to the concentration of CO₂. Also included was

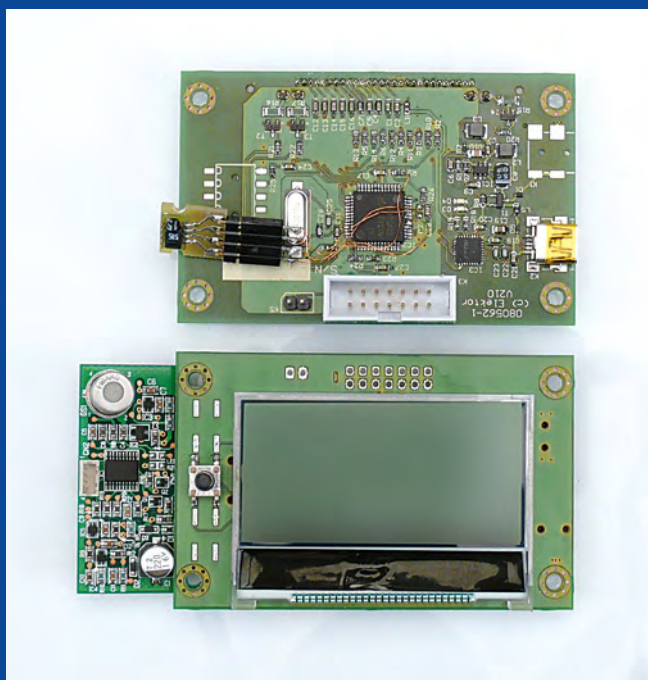
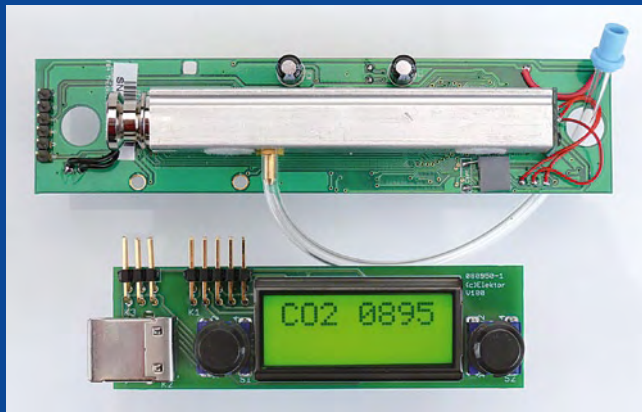

a switching output that went high when a user-settable threshold was reached.

This intelligent module — remarkably compact in the surface-mount version CDM4116A — made the schematic of our CO₂ meter delightfully simple to follow. An ISP-programmable ATtiny was used for A/D conversion of the signal measured and for driving the alphanumeric LCD display. Throw in the power supply plus a switching output using a transistor and a relay and they you have the essential elements in their entirety.

The simplicity of the circuitry and the ready availability of a kit from Elektor comprising a PCB, a pre-programmed microcontroller and the sensor module encouraged many readers to build their own CO₂ meter and almost 200 of these kits were ordered (now all sold — sorry!). We received feedback too: readers all over the world got in touch by letter and e-mail, as did the Dutch Asthma

Foundation, for a very good reason.

Asthma sufferers are particularly susceptible to the harmful effect of excessive concentrations of carbon dioxide. Because the lungs and bronchial passages of asthmatics are damaged these people are inclined to hyperventilate, in other words they have to breathe rapidly, in fact too rapidly. As a result the lung tissues of severe asthmatics can become so damaged that the CO₂ in the blood can no longer be eliminated easily by respiration.

Elektor was delighted to make a modest contribution to the relief of this problem. Chris Vossen from Elektor Labs was assigned the task of improving the design of the CO₂ meter, with the goal of creating for sufferers a handy portable device with simple 3-button operation and a convenient readout using a graphical LCD display. Bonus nice-to-have features included a USB connection for transferring measurements to a computer for storing long-term measurements. Of course a temperature and humidity sensor would be useful too, as sufferers' woes increase in excessively dry atmospheres (to compensate for dry air, lungs increase mucus production that then blocks the airways).

After some deliberation Chris decided to make an entirely fresh start. Satisfactory experience with the R8C from Renesas on various projects inclined him to employ this handy little 16-bit machine in the new CO₂ meter. The E8a debugger used in the labs made an



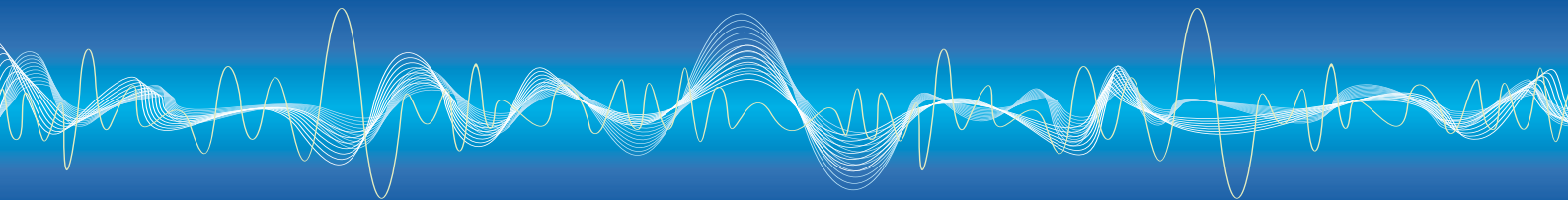

excellent development tool, so provision was included on the board for a suitable connector for this. Since the R8C has no USB interface Chris enhanced the little controller with an FT232 chip from FTDI. The combination of this UART and the R8C would now take care of all USB connectivity. Another convenient touch included is automatic switching to take volts either from a USB connection or from an external plug-in power supply; we can hardly expect end users to fiddle around changing jumper plugs!

So far the printed circuit board has developed to the stage that you can see in the photo. There is still some way to go, as the connection to the surface-mount humidity sensor from Sensirion (this must be familiar to many Elektor readers) is still a bit 'provisional'.

When it came to the packaging the final choice was for a design made of cardboard that when opened can be laid on a table. In its flat (unopened) form the device can also be hung on a wall, enabling users to keep a constant eye on the readings for CO₂ and humidity. On the cardboard case it would be easy to print all manner of instructive information on the subject of CO₂. In this connection our meter will prove handy not just for taking measurements but also for educational purposes, for instance in schools. Here it is a positive advantage to have all the electronics and the sensor visible on display, rather than hidden inside a plastic case. A feature that's both useful and attractive is the RGB-LED background illumination of the readout display. Using the colors green, orange or red we can

alert users at a glance whether the CO₂ concentration is acceptable, becoming significantly elevated or has already reached a critical value. Red means it's vital to let some fresh air in!

Some way off in the future are plans for a transportable CO₂ sensor to use inside cars. Since the Figaro sensor requires start-up calibration with unstressed air for about two hours, by its nature it would not look a good choice. But there's nothing engineers enjoy more than a challenge and so Chris ordered from one of the large electronic suppliers a portable CO₂ sensor that made a plus point of having a short initialisation time. Some 'reverse engineering' revealed a completely different looking sensor module. Instead of the so-called Nernst Cell used in the Figaro device, this alternative device makes use of an infrared spectroscopic technique, which also enforces a somewhat larger form factor. This sensor provides an SPI interface delivering the CO₂ concentration in digital format. It was handy that Chris already had the small Minimod18 on the bench, the Minimod18 being a new processor board for the CC2 project, which conveniently has not only an SPI interface but also a display already... A small program for the ATmega used with this project was soon written, meaning there's nothing to stop testing the new CO₂ sensor now (see photo)!

(090603-1)

[1] www.elektor.com/070802

Linux Symposium

Around 80 engineers and project managers were attracted to a Linux symposium organised by the German distributor GLYN [1] together with Toshiba who were showcasing their latest 32-bit microcontroller. The two-day event took place in the middle of November in Düsseldorf. With a total of around 12 presentations we were introduced to the nuts and bolts of an (Embedded) Linux system and also to a microcontroller that would be an ideal platform for it. Toshiba's new 32-bit microcontroller type TMPA900 was the star of the show featuring an ARM9 compatible core with MMU, instruction pipeline, cache and integrated LCD graphics controller (including LCD accelerator) USB host/device interface plus a few other useful features. This is clearly a capable beast with enough power on tap to comfortably run a mature operating system such as Linux in an embedded environment. It could form the basis of a compact mobile device with a sophisticated graphical user interface without too much additional hardware. On the second day it was described how embedded graphics run under Linux. From the software engineers point of view the frame buffer looks like a file in the /dev folder (true to the Linux motto: 'everything is a file'). Linux uses the single instruction mmap to map the whole of the hardware video frame buffer therefore the application gets an array pointer to the frame buffer memory so that changes made to the memory area are then immediately represented on the display. The controller MMU simplifies the developer's job. The file system used by Linux is quite innovative and deserved a special slot in the two day timetable. Also interesting for software developers were the compiler and debugger demonstration in the Linux Tool Chain (running on a virtual machine but which can also be installed on a Windows platform). A collection of all the necessary software was distributed to all participants by bplan GmbH [2].

Many participants raised the question of the licence rights of Linux. The Linux operating system is an Open Source program so that the

source code is available for anyone to read and the program is free to download and use. In contrast to Public Domain Software (which has no copyright protection and can be used by anyone for any purpose) the use of Open Source software is controlled by the conditions of a licence. The best known Open

Source licence is GPL (General Public License). A GPL ensures that any new program derived as a result of modifying or adding-to the original program must also have a GPL (also known as Copyleft, so named to distance it from the age-old concept of Copyright). GPL states also that any program which uses static linking to a GPL library is also derivative and must therefore have GPL rights. At the time of writing there is some dispute amongst the experts whether dynamic linking also produces derivative software. Less strict licences are LGPL (Lesser GPL) and BSD (Berkeley Software Distribution). LGPL allows the use of open-source libraries in closed-source software with the proviso that any modifications must be documented in the library. BSD licences have very few restrictions allowing unlimited redistribution for any purpose providing certain copyright acknowledgements are maintained in the source code.

Chris Vossen from Elektor took part in this event in Düsseldorf and came back full of ideas and suggestions; he is in no doubt that in the coming year we will see more of these high performance ARM controllers running embedded Linux in all sorts of applications.

(090770-1)

[1] www.glyn.de

[2] www.bplan-gmbh.de/output.php?PAGE_ID=209



FRONT PANELS & ENCLOSURES

Customized front panels can be easily designed with our free software
Front Panel Designer

- Cost-effective prototypes and production runs
- Wide range of materials or customization of provided material
- Automatic price calculation
- Fabrication in 1, 3 or 7 days

Sample price:
\$43.78 plus S&H



FRONT PANEL
EXPRESS

www.frontpanelexpress.com
(206) 768-0602

Build Your Own:
SYNTHESIZER

FREE KIT!
www.pala.com/elektor

FatMan
Analog MIDI Synth

PAIA paia.com Music/Tutorials/Kits
Analog Synthesizers
Guitar Effects
Tube Electronics
Studio Gear

Makers since 1959

PIC Cookbook for Virtual Instrumentation

➔ Several case studies included

The software simulation of gauges, control-knobs, meters and indicators which behave just like real hardware components on a PC's screen is known as virtual instrumentation. In this book, the Delphi program is used to create these mimics and PIC based external sensors are connected via a USB/RS232 converter communication link to a PC. Several case studies of virtual instruments are detailed including a compass, an oscilloscope, a digital and analogue thermometer, a FFT-based Frequency analyser, a joystick, mouse-control panels and virtual displays for cars and aircraft. Full source code examples are provided both for several different PIC's, both in assembler and C, together with the Pascal code for the Delphi programs which use different 3rd party Delphi virtual components.

elektor

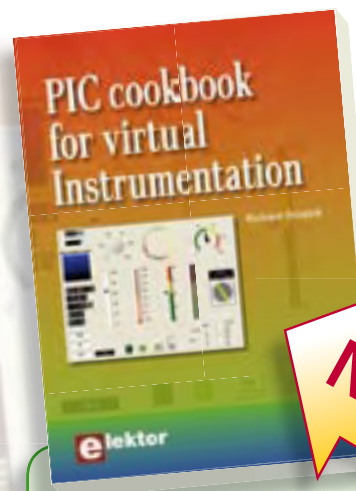

NEW!

Approx. 264 pages • ISBN 978-0-905705-84-2
\$46.00

Elektor US
4 Park Street
Vernon CT 06066
USA
Phone: 860-875-2199
Fax: 860-871-0411
E-mail: sales@elektor.com

Further information and ordering at www.elektor.com/shop

ATM18 Logic Analyzer for deft data acquisition

By Wolfgang Rudolph and Burkhard Kainka (Germany)

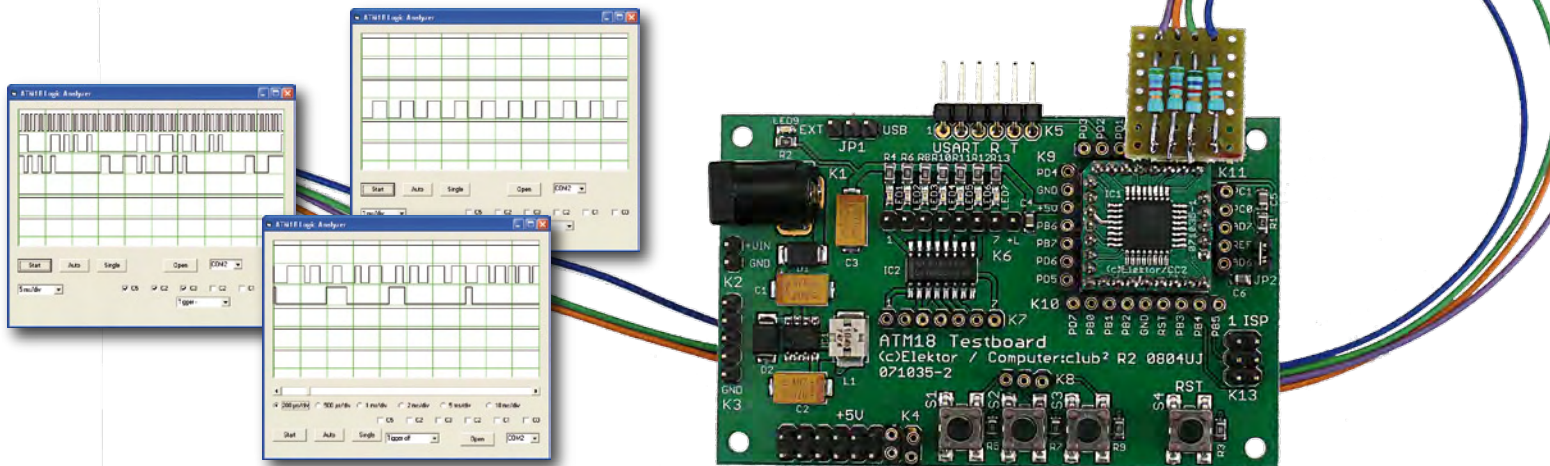

The oscilloscope is a fine tool for showing the evolution of a signal in time, but when it comes to digital signals it soon shows its limitations. Few oscilloscopes can clearly show more than four signals at once, and setting up complex trigger conditions can be messy. If it is logic levels rather than pulse shapes that matter, a software-based logic analyzer like the one described here can offer a very powerful alternative solution.

A logic analyzer is an instrument for monitoring how signals in a digital circuit change with time. This can of course also be done using an analog or a digital oscilloscope, but these devices tend to be limited in the number of channels that they can simultaneously process and display, and it can be difficult to set up the wanted triggering conditions. However, they are useful for measuring certain properties of signals, such as pulse width, rise and fall times and signal period. Glitches, however, can generally only be observed if they happen to occur at the right time and have sufficiently long duration.

The earliest logic analyzers appeared on the market in the 1970s, and rapidly became valuable tools for engineers working in the then rapidly-growing field of digital electronics. These early examples featured a maximum of eight input channels and were relatively hard to use. In comparison to oscilloscopes, modern logic analyzers have considerably more

inputs: even the simplest units have sixteen inputs and top-end models aimed at analyzing complex digital circuits have up to 512 inputs. The y-axis of the analyzer's display is only capable of displaying logic levels, '0', '1', or 'undefined'. There is no provision for direct measurement of the voltage on an input as on an oscilloscope. However, the unit can store a very complex series of events for each of its digital inputs. With the right add-on module, a good analyzer can follow the execution of a computer program in real time, disassembling and displaying instructions as it goes, by simply connecting it to the address and data buses of the microprocessor under test.

Even though many modern microcontrollers feature diagnostic interfaces and built-in hardware support for software debugging, the logic analyzer is still a valuable troubleshooting weapon in the engineer's arsenal of test equipment, allowing a rapid overview of what is happening on all input channels and the ability to scroll rapidly backwards

and forwards through a series of events: a kind of time machine for digital signals. Unfortunately, as you might expect, these instruments are not cheap.

Analysis using an oscilloscope

Suppose you want to examine the signals on a serial port, a job which is actually more complicated than it first appears. An ordinary analog oscilloscope will clearly show you the signal levels and the duration of each bit, but the data actually being sent are still shrouded in mystery: what is being sent in the reverse direction, and what is happening on the handshake and other control lines? What should we use as a trigger signal? As soon as a signal has been detected, it disappears again. Although analysis using an oscilloscope may be practical at 300 baud, at higher speeds it becomes very difficult indeed.

A storage oscilloscope is a better proposition in these circumstances, since it allows you to examine a portion of a signal at your

leisure. However, you will need several channels as well as independent triggering for each channel. And, of course, more channels translates into higher cost.

ATM18 as logic analyzer

Previous articles have shown that our ATM18 processor board is a very flexible piece of hardware. As we shall see below, with the right software it can even be pressed into service as a logic analyzer. There are six free input ports that we can use as inputs, and the processing required is well within the capability of the processor. All we need to do is monitor whether the voltage at each input is above or below a set threshold:

- if the voltage is above the threshold, a logic 'high' is displayed;
- if the voltage is below the threshold, a logic 'low' is displayed.

The resulting stored values are then transferred to a host PC, where they are displayed as greatly simplified oscilloscope traces with a vertical resolution of just one bit. The ATM18 thus offers a cheap and cheerful solution. The project as described here offers simultaneous acquisition over the six input channels, and there are two versions of the firmware to choose from, offering different features.

Digital inputs

The essence of the operation of a logic analyzer is simple: values are read from an entire port in rapid succession and then stored to memory. Then the values are transferred to a program running on a PC, where they are separated out into individual bits. The process is highly reminiscent of the storage oscilloscope article 'Scoping with the ATM18' that we published in the April 2009 issue of *Elektor*^[1]. The case here is somewhat simpler as we simply need to read a value directly from a port rather than from a multi-channel analog-to-digital converter. The six digital inputs used are pins PC0 to PC5 of port C, the only external circuitry required being a set of series 4k7 resistors to protect the inputs. The software

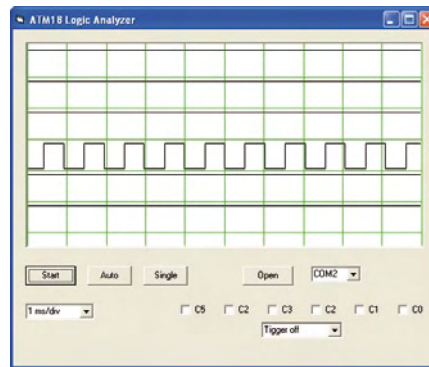

Figure 1. Acquisition of six digital inputs.

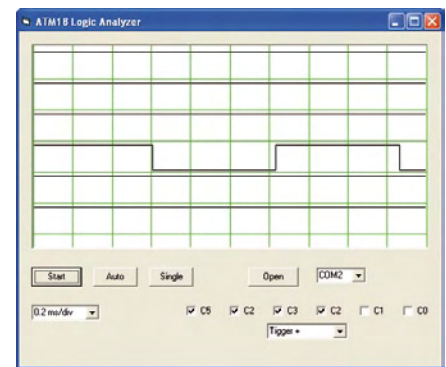

Figure 2. Triggered acquisition.

is based on that used in the oscilloscope project, with the timebase and triggering code, for example, being very similar.

Listing 1 shows an excerpt from the BASCOM program *Logic1.bas*. The data acquisition itself is done using a timer interrupt. Taking one sample per interrupt gives a maximum sample rate of 10 kHz and a displayed timebase of 1 ms per division. To obtain faster sampling (up to 50 kHz, or 0.2 ms per division) we have to avoid paying the penalty of interrupt latency. If the highest sample rates are selected, therefore, the processor will acquire all 501 samples in a single loop, without leaving the interrupt service routine.

All six digital inputs have a pull-up resistor enabled. This means that in the quiescent state they will all read as 'high' (see **Figure 1**). The traces only change when signals are applied to one or more channels.

Triggering

The trigger function implemented in the software allows acquisition to start at a defined point in time. It is necessary to specify what levels are required on which channels to initiate the process. The levels on inputs PC0 to PC5 are combined into a single binary value for this purpose. **Figure 2** shows the result of an acquisition triggered by a rising edge on input PC2. The other inputs are not connected in this example and therefore are read as high: this must also be reflected in the bits of the trigger value corresponding to PC3 to PC5. The resulting value in this case is binary 111100 (decimal 60). The unit will begin acquisition when this value is first seen on the input port.

Figure 3 shows an example acquisition using four channels, in this case connected to an Atmel STK500 programmer while it

is programming an ATmega8 device. To observe the process it is best to set the ISP clock rate to its lowest value of 1.2 kHz. From top to bottom the signals are SCK, MISO, MOSI and Reset. As can be seen, Reset is held low during the programming process. The programmer generates the

Listing 1

Storing digital data (BASCOM program *Logic1.bas*)

```

Tim1_isr:
  If Timebase > -30 Then
    For Adr = 0 To 501
      D = Pinc
      Ram(adr) = D
    Next Adr
  Else
    Timer1 = Timebase
    Portb.0 = 1
    D = Pinc
    If Saveram = 1 Then
      Ram(adr) = D
      Adr = Adr + 1
    Else
      Put #1 , D
    End If
  End If

  If Adr > 501 Then
    For Adr = 1 To 501
      D = Ram(adr)
      Put #1 , D
    Next Adr
    Adr = 1
    If Oneshot = 1 Then
      Stop Timer1
    End If
  End If
  Portb.0 = 0
Return

```

TEST & MEASUREMENT

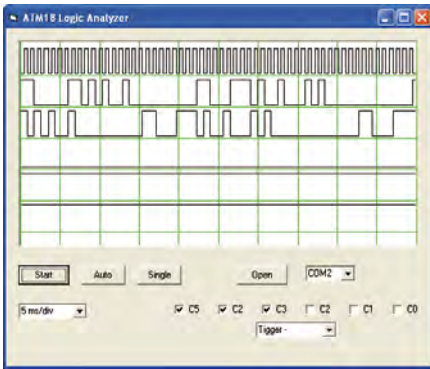

Figure 3. A four-channel acquisition.

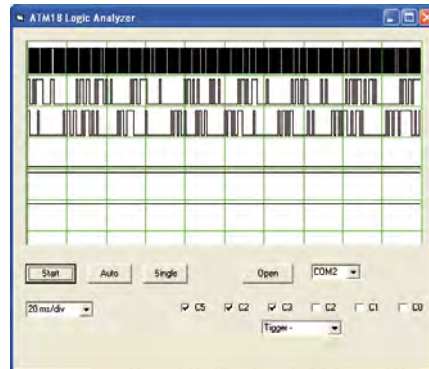

Figure 4. An acquisition lasting 200 ms.

clock signal and outputs the data to be programmed one byte at a time on MOSI.

After a delay of exactly eight clocks the data values reappear on MISO, giving an indica-

tion of whether they have been correctly received by the target processor.

This example demonstrates the benefit of having multiple digital channels available, but also a weakness of the software: it would be highly desirable to have a longer data buffer to allow acquisition over a longer time period, but retaining the ability to zoom in to details of the signal behavior. If we slow the timebase down to, for example, 20 ms per division (**Figure 4**) then it is

Listing 2

Display of six bits (Visual Basic program ATM18Logic1.vbp)

```

For n = 1 To 498
  X1 = n
  X2 = n + 1
  Y1 = 240 - 32 * (Ch1(n) And 1)
  Y2 = 240 - 32 * (Ch1(n + 1) And 1)
  Picture1.Line (X1, Y1)-(X2, Y1), &H0&
  Picture1.Line (X2, Y1)-(X2, Y2), &H0&
  Y1 = 200 - 16 * (Ch1(n) And 2)
  Y2 = 200 - 16 * (Ch1(n + 1) And 2)
  Picture1.Line (X1, Y1)-(X2, Y1), &H0&
  Picture1.Line (X2, Y1)-(X2, Y2), &H0&
  Y1 = 160 - 8 * (Ch1(n) And 4)
  Y2 = 160 - 8 * (Ch1(n + 1) And 4)

```

```

Picture1.Line (X1, Y1)-(X2, Y1), &H0&
Picture1.Line (X2, Y1)-(X2, Y2), &H0&
Y1 = 120 - 4 * (Ch1(n) And 8)
Y2 = 120 - 4 * (Ch1(n + 1) And 8)
Picture1.Line (X1, Y1)-(X2, Y1), &H0&
Picture1.Line (X2, Y1)-(X2, Y2), &H0&
Y1 = 80 - 2 * (Ch1(n) And 16)
Y2 = 80 - 2 * (Ch1(n + 1) And 16)
Picture1.Line (X1, Y1)-(X2, Y1), &H0&
Picture1.Line (X2, Y1)-(X2, Y2), &H0&
Y1 = 40 - 1 * (Ch1(n) And 32)
Y2 = 40 - 1 * (Ch1(n + 1) And 32)
Picture1.Line (X1, Y1)-(X2, Y1), &H0&
Picture1.Line (X2, Y1)-(X2, Y2), &H0&
Next n

```

Listing 3

Use of timestamps (BASCOM program Logic2.bas)

```

Sub Logger
  Timer1 = 0
  ADR = 1
  Dold = 255
  Do
    Timestamp = Timer1
    D = Pinc
    Portb.0 = 1
    If D <> Dold Then
      Ram(adr) = D
      ADR = ADR + 1
      A = High(timestamp)
      Ram(adr) = A
      ADR = ADR + 1
      A = Timestamp
      Ram(adr) = A
      ADR = ADR + 1
      Dold = D
    End If
  Loop Until ADR > 500
  Portb.0 = 0
  Loop Until ADR > 500
  For ADR = 1 To 501
    D = Ram(adr)
    Put #1, D
  Next ADR
End Sub

```

```

End If
If Timestamp > 60000 Then
  Do
    Ram(adr) = D
    ADR = ADR + 1
    A = High(timestamp)
    Ram(adr) = A
    ADR = ADR + 1
    A = Timestamp
    Ram(adr) = A
    ADR = ADR + 1
  Loop Until ADR > 500
End If
Portb.0 = 0
Loop Until ADR > 500
For ADR = 1 To 501
  D = Ram(adr)
  Put #1, D
Next ADR
End Sub

```

possible to see a longer record covering the programming of around ten bytes, but the details of the clock signal and its time relationship to the data signal are lost. A record length of 500 samples is not enough to give a full overview of the process.

Timestamps

The underlying problem is that digital signals can include both very brief and very long pulses. We would like to have a much larger memory buffer (and, ideally, a correspondingly larger monitor on which to view the results). Both, unfortunately, are expensive.

There is, however, a solution. In the examples we have looked at there have been long periods where the state of a signal does not change, which is rather wasteful of memory. If, instead of storing values at regular intervals of time, we store values only when they change, we can save on memory. The cost is that each sample now needs to be accompanied by a timestamp. The timestamp might take the form of a 16-bit quantity, measured to a resolution of 4 μ s using Timer 1 (see Listing 3). A total of three bytes are now required for each sample, and we can fit 167 state changes in the memory buffer. This is fewer than before, but we can now mix short and long pulses at will. Listing 4 shows how the timestamps are converted into x-coordinates in the Visual Basic program running on the PC.

The implementation includes a further compromise, in that if 60000 time units (240 ms) pass and the buffer has not been

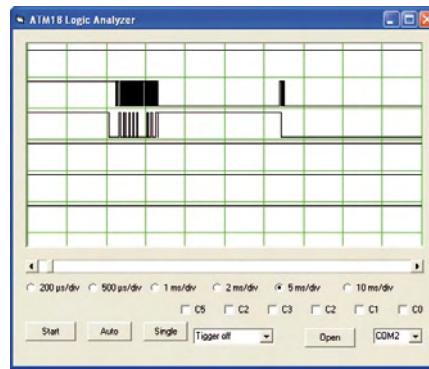

Figure 5. Signals on an I²C bus.

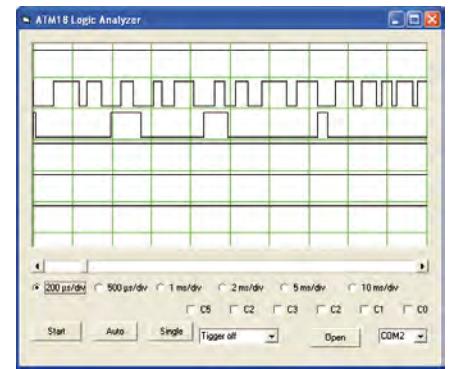

Figure 6. I²C bus signals under the magnifying glass.

filled, the last state will be repeated until the buffer is full. This gets around the problem that if fewer than 167 state changes occur the system would wait for ever without displaying any results to the user, the timeout ensuring that even constant signals are displayed. The total acquisition time now depends on the signal being observed: with constant or very slowly changing input the total time will reach its maximum of 240 ms, while the shortest possible total acquisition time is just 2 ms, a ratio of 120 to 1. The maximum sample rate is approximately 200 kHz.

The decisive advantage of this technique is that it is possible to display the results from a single acquisition and analyse them at various timebases at your leisure. You can scroll through the data to look for significant events. For example, you can set the timebase to 10 ms per division to get an overview of the situation and then zoom in for a closer look. Figure 5 shows some activity on an I²C bus: you can see that there is a gap of around 30 ms between the individual data packets. Figure 6 shows a close-up displaying a part of the transaction in greater detail.

In conclusion

This project has again demonstrated the potential of modern microcontrollers and the versatility of the ATM18 board, which has been turned into a logic analyzer with very little effort. By converting the software [2] into C or assembler it would be possible to achieve higher time resolution, and the PC program that displays the results also has plenty of scope for expansion. One possibility would be to automatically analyse the bit patterns that have been acquired from a serial port and convert them into ASCII characters to be displayed alongside the waveforms. Although our little logic analyzer lacks the performance and some of the features of its professional cousins, the basic principles are much the same: we have learned a lot more and spent a lot less!

(080949-1)

Internet Links

[1] www.elektor.com/080944

[2] www.elektor.com/080949

Listing 4

Converting timestamps into x-coordinates
(Visual Basic program ATM18Logic2.vbp)

```

X1 = 0
For n = 0 To 497 Step 3
    X2 = (Ch1(n + 5) + 256 * Ch1(n + 4))
    X2 = X2 - Pos * 80
    X2 = X2 / zoom
    If X2 < 0 Then X2 = 0
    If X2 > 500 Then Pos2 = 500
    Y1 = 240 - 32 * (Ch1(n) And 1)
    Y2 = 240 - 32 * (Ch1(n + 3) And 1)
    Picture1.Line (X1, Y1)-(X2, Y1), &H0&
    Picture1.Line (X2, Y1)-(X2, Y2), &H0&
    Y1 = 200 - 16 * (Ch1(n) And 2)
    Y2 = 200 - 16 * (Ch1(n + 3) And 2)
    Picture1.Line (X1, Y1)-(X2, Y1), &H0&
    Picture1.Line (X2, Y1)-(X2, Y2), &H0&
    ...
    ...
    X1 = X2
Next n
End Sub
    
```

Fourier Analysis Using LTspice & Excel

Frequency & time domain analysis made easy

By Jeremy Clark, VE3PKC (Canada)

LTspice is a circuit analysis program with many powerful functions, including a spectral analysis tool. It is freely downloadable and has an active user group. Together with Microsoft’s well-known Excel tool and three free spreadsheets from the Elektor website, Fourier analysis can be performed on many common waveforms found in electronics.

Let’s start with the analysis of the rectangular pulse train. This waveform as depicted in **Figure 1** can be used to represent many basic signals such as a timing sequence, a trigger signal or a data signal. The Fourier series for a rectangular pulse train as shown is:

$$f(t) = a_0 / 2 + \sum_{n=1}^{\infty} a_n \cos(n\omega t)$$

$$a_n = 2Ad \frac{\sin(n\pi d)}{(n\pi d)}$$

This represents a DC value plus an infinite series of harmonic cosine waves. The components can be calculated using the Excel spreadsheet called *fourier.xls* supplied free of charge at [1]. If you run it, you’ll see that the component values are shown in dBm as would be seen on a spectrum analyzer (**Figure 2**).

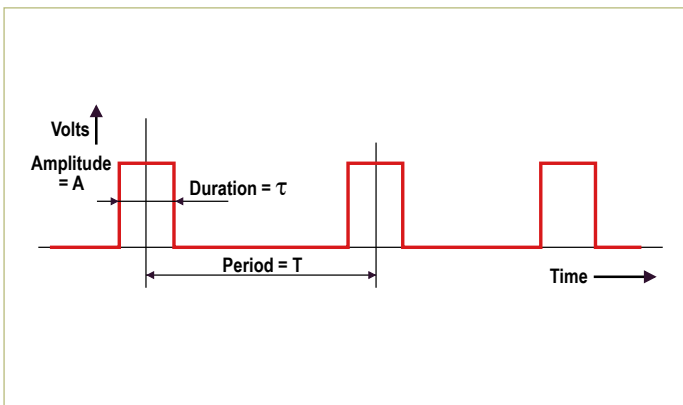

Figure 1. Definitions of a rectangular pulse train.

Note for the example shown, the parameters are:

- Pulse Amplitude = 1 volt
- Duty Cycle = Pulse Duration/Period = $\tau/T = 0.2$
- Impedance = 50 ohms
- Fundamental = +1.5 dBm
- Second Harmonic = -0.4 dBm
- Third Harmonic = -3.9 dBm
- Fourth Harmonic = -10.6 dBm
- Fifth Harmonic = $-\infty$ dBm; spectral null

Now use LTspice

We can now verify these harmonic components using LTspice, a free program from Linear Technology [2]. The circuit in **Figure 3** can be used to generate a rectangular pulse train. We will start off with the following settings:

- Amplitude = 1 volt
- Impedance = 50 ohms

Rectangular Pulse Train Cn=2Ad[sin(n*pi*d)]/(n*pi*d)										
Enter the waveform p2p amplitude = A volts										
Enter the waveform duty cycle = d (decimal)										
Enter the circuit impedance = R ohms										
A=	1									
d=	0.2									
R=	50									
n	2*A*d	n*pi*d	sin(n*pi*d)	(sin(n*pi*d))/n*pi*d	Cn volts	Cn volts rms	Cn watts	Cn milliwatts	Cn dBm	
1	0.40	0.63	5.88E-01	9.35E-01	3.74E-01	2.65E-01	1.40E-03	1.40E+00	1.5	
2	0.40	1.26	9.51E-01	7.57E-01	3.03E-01	2.14E-01	9.17E-04	9.17E-01	-0.4	
3	0.40	1.88	9.51E-01	5.05E-01	2.02E-01	1.43E-01	4.07E-04	4.07E-01	-3.9	
4	0.40	2.51	5.88E-01	2.34E-01	9.35E-02	6.62E-02	8.75E-05	8.75E-02	-10.6	
5	0.40	3.14	2.65E-08	8.45E-07	3.38E-07	2.39E-07	1.14E-15	1.14E-12	-119.4	
6	0.40	3.77	-5.88E-01	-1.56E-01	-6.24E-02	-4.41E-02	3.89E-05	3.89E-02	-14.1	
7	0.40	4.40	-9.51E-01	-2.16E-01	-8.65E-02	-6.12E-02	7.48E-05	7.48E-02	-11.3	
8	0.40	5.03	-9.51E-01	-1.89E-01	-7.57E-02	-5.35E-02	5.73E-05	5.73E-02	-12.4	
9	0.40	5.65	-5.88E-01	-1.04E-01	-4.16E-02	-2.94E-02	1.73E-05	1.73E-02	-17.6	
10	0.40	6.28	-5.31E-06	-8.45E-07	-3.38E-07	-2.39E-07	1.14E-15	1.14E-12	-119.4	
11	0.40	6.91	5.88E-01	8.50E-02	3.40E-02	2.41E-02	1.16E-05	1.16E-02	-19.4	
12	0.40	7.54	9.51E-01	1.26E-01	5.05E-02	3.67E-02	2.55E-05	2.55E-02	-15.9	

Note:
The log of a very small number is increasingly negative, so the log(0) is -infinity. For practical purposes -125dBm is a very small signal.

Figure 2. The “fourier.xls” spreadsheet program used to calculate Fourier components.

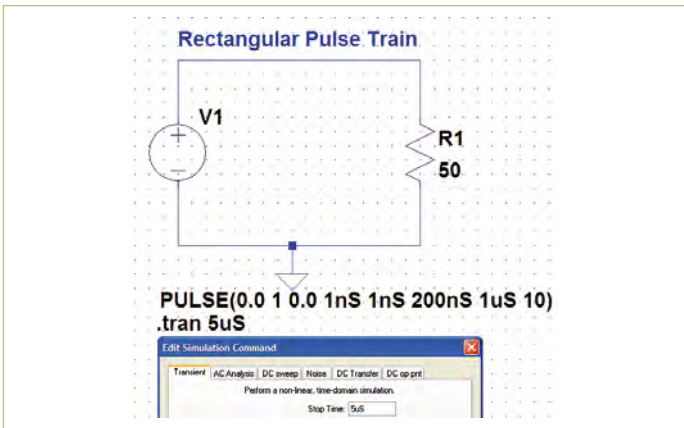

Figure 3. The 'schematic' of the pulse generator as drawn in LTSpice. Note the Stop time setting under the 'Transient' tab

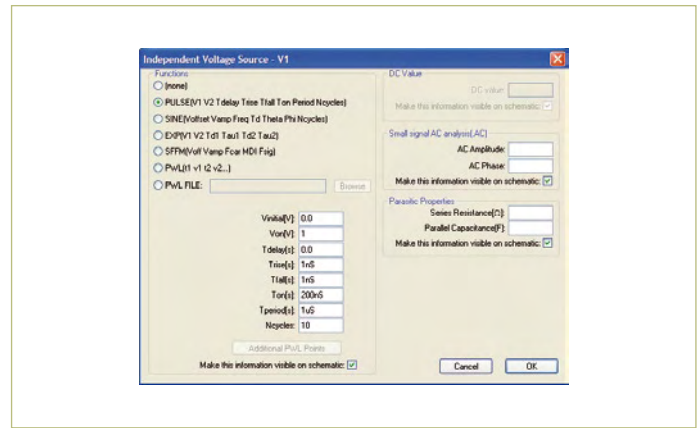

Figure 4. LTSpice settings for voltage V1.

- Duty Cycle = 0.2
- Period = 1 μsec
- Pulse d = 200 ns

Figure 4 will help you get LTSpice to do what you want.

Figure 5 depicts the waveform as you would see it on an oscilloscope.

The spectrum of the waveform can be seen by using the FFT function, see Figure 6.

Note the decreasing power of the harmonics with spectral nulls at the fifth, tenth, etc. harmonics. The spectrum has the so-called sinc^2/x shape.

We can compare the spectral powers as measured in LTSpice vs. the theoretical values given by the Excel spreadsheet. First however we must calibrate the FFT display.

Enter dbm.xls

In LTSpice it can be shown that a cosine wave of amplitude = 1.414 volts gives 0 dB on the FFT display. This means that 0 dB in LTSpice = +13 dBm. The calculation goes like this:

$$\begin{aligned} \text{Power}(W) &= V_{\text{rms}}^2 / R \\ \text{Power}(mW) &= \text{Power}(W) * 1000 \\ \text{dBm} &= 10 \log_{10}(mW) \end{aligned}$$

Table 1. LTSpice and theoretical results compared.			
Component	LTSpice level [dB]	LTSpice [dB] (0 dB = +13 dBm)	Theory (Excel) [dBm]
F1 = 1MHz	-11.2	+1.8	+1.5
F2 = 2MHz	-13.2	-0.2	-0.4
F3 = 3MHz	-16.8	-3.8	-3.9
F4 = 4MHz	-23.7	-10.7	-10.6
F5 = 5MHz	-56.8	-43.8	-Infinity

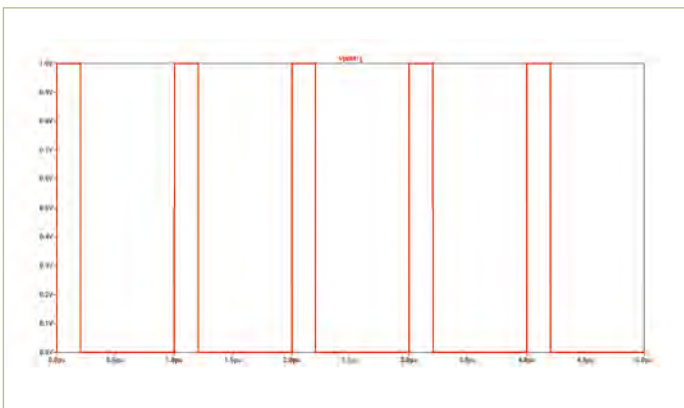

Figure 5. Rectangular pulse train with Period = 1 μs and Pulse Duration = 200 ns.

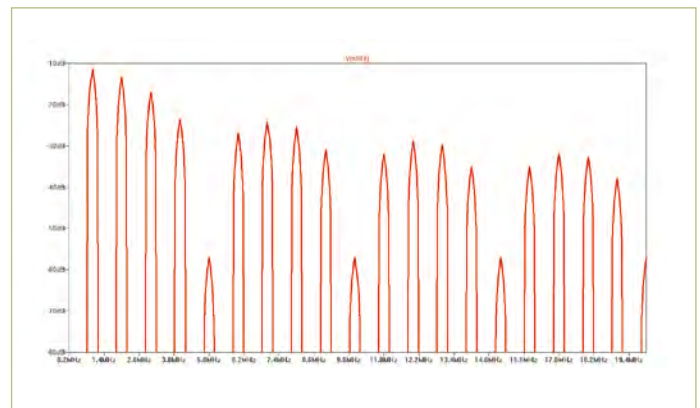

Figure 6. Rectangular pulse train spectrum. Fundamental at 1 MHz, 1st null at 5 MHz.

CIRCUIT ANALYSIS

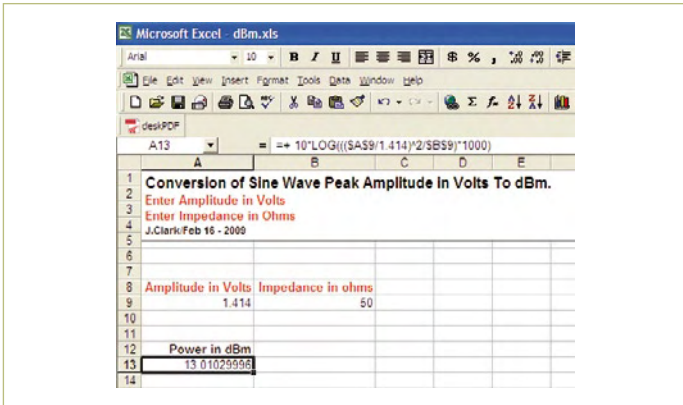

Figure 7. The “dbm.xls” spreadsheet in action.

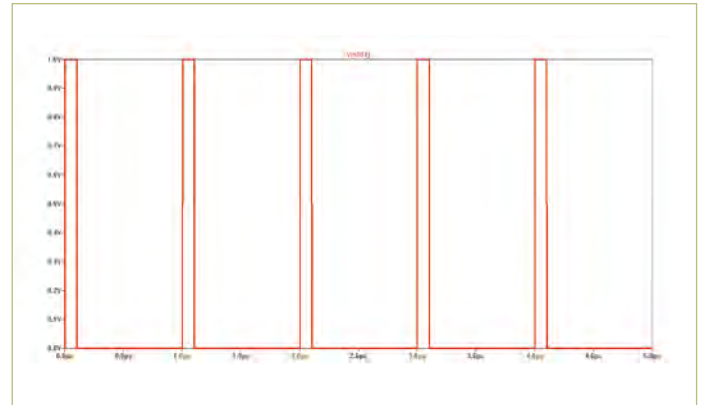

Figure 8. Rectangular pulse with Period = 1 μ sec and Pulse Duration = 100 ns.

Running *dBm.xls* (also from ^[1]) you should see a spreadsheet like the one in **Figure 7**. Looking at **Table 1** you can see that the LTspice FFT components match the theoretical values very closely except at the null points where they are not infinitely small.

It is instructive to see what happens to the spectrum of the rectangular pulse train as we decrease the pulse duration keeping the

period constant. Consider the following modified settings:

- Amplitude = 1 volt
- Impedance = 50 ohms
- Duty Cycle = 0.1
- Period = 1 μ sec
- Pulse d = 100 ns

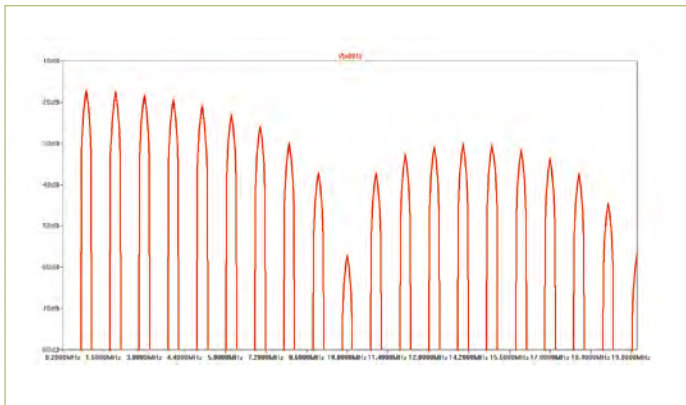

Figure 9. Rectangular pulse train spectrum. Fundamental at 1 MHz, 1st null at 10 MHz.

and view the result for yourself (**Figure 8**). Note that the first spectral null has now moved out from 5 MHz to 10 MHz. In the limit as the pulse duration becomes very small, the nulls move out to infinity giving a flat spectrum of harmonics, see **Figure 9**.

Now, let’s modify the settings one more time. This time we will lengthen the period, keeping the other settings the same:

- Amplitude = 1 volt
- Impedance = 50 ohms
- Duty Cycle = 0.1
- Period = 10 μ s
- Pulse d = 100 ns

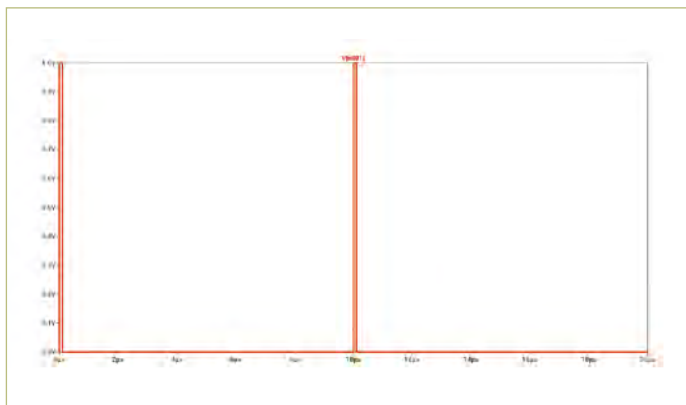

Figure 10. Rectangular pulse train with Period = 10 μ sec and Pulse Duration = 100 ns.

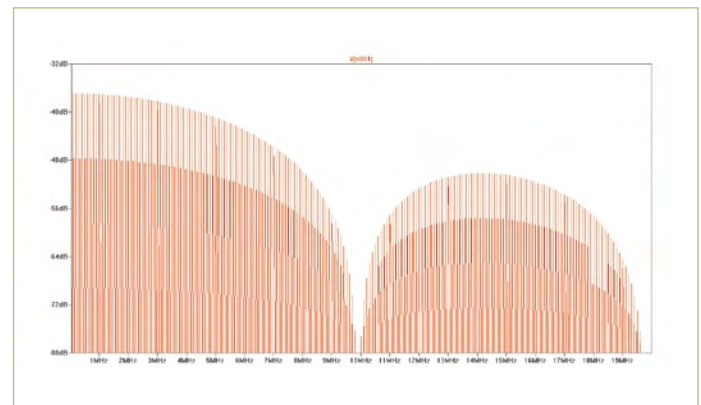

Figure 11. Rectangular pulse train spectrum. Fundamental at 100 kHz, 1st null at 10 MHz.

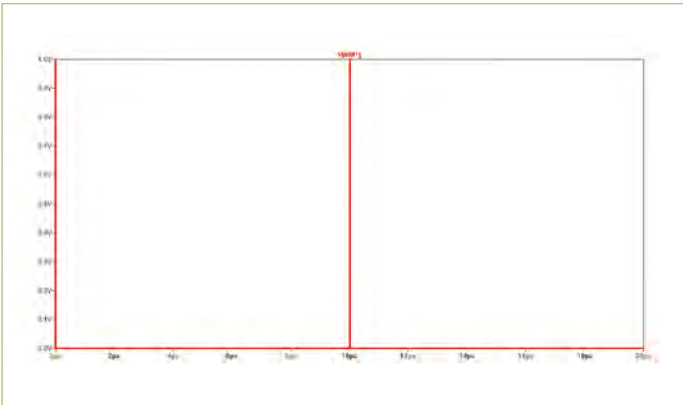

Figure 12. Rectangular pulse train with Period = 10 μsec and Pulse Duration 10 ns.

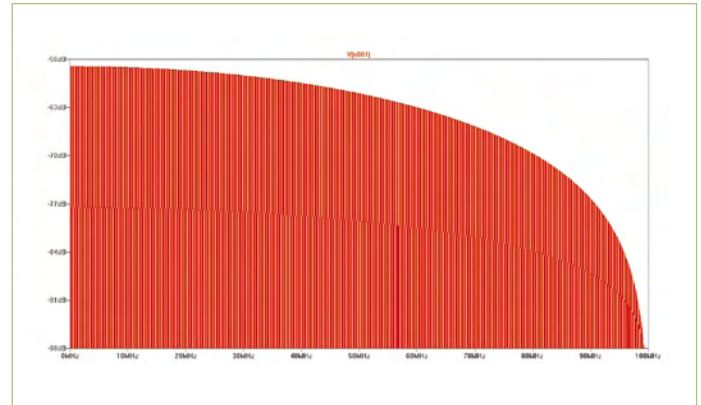

Figure 13. Rectangular pulse train spectrum. Fundamental at 100 kHz, 1st null at 100 MHz.

Look at the virtual ‘scope and the FFT display in **Figures 10 and 11** respectively — the spectrum looks denser now.

Finally in the limit, as we decrease the pulse duration and increase the period we generate the so-called impulse function. This is a single extremely narrow pulse, see **Figure 12**.

We can see that it would have a flat spectrum extending out to infinity as in **Figure 13**. For purists, strictly speaking an impulse function $\delta(t)$ has a unit area. You can adjust the amplitude in LTspice to reflect this as you shrink the duration and increase the period. Here are some properties of the Impulse (Dirac Delta) function:

$$\int_{-\infty}^{+\infty} \delta(t) dt = 1$$

Where area under the curve of $\delta(t) = 1$ unit.

$$\int_{-\infty}^{+\infty} \delta(t) e^{-j\omega t} dt = 1$$

Where Fourier Transform or frequency spectrum = 1 unit.

Time Domain Behaviour

Now that we have examined the Fourier series in the frequency domain, let’s examine the time domain. We can use the Excel spreadsheet “fourier_rpt.xls” from [1] to generate the rectangular pulse train waveform based on the Fourier components given by the mathematics formula listed earlier on. For simplicity, the period is set at 1 second vs. 1 μsecond. The duty cycle is kept at 0.2. The first 40 Fourier coefficients are calculated to use in the sum. As shown in **Figure 14**, time interval is established from –1 to 1 second and the sums calculated and graph plotted, shown separately in **Figure 15**. Note the result conforms to a rectangular pulse train. More accuracy could be obtained by using a finer interval in time and more components.

(090245-1)

Internet Links

[1] www.elektor.com/090245

[2] www.linear.com/designtools/software/

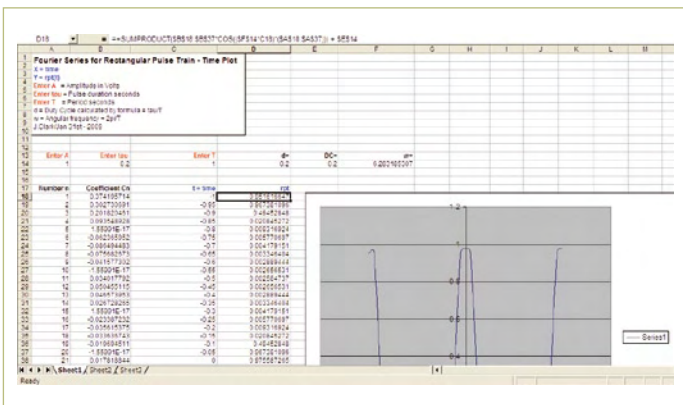

Figure 14. Fourier series calculated and plotted for the time domain.

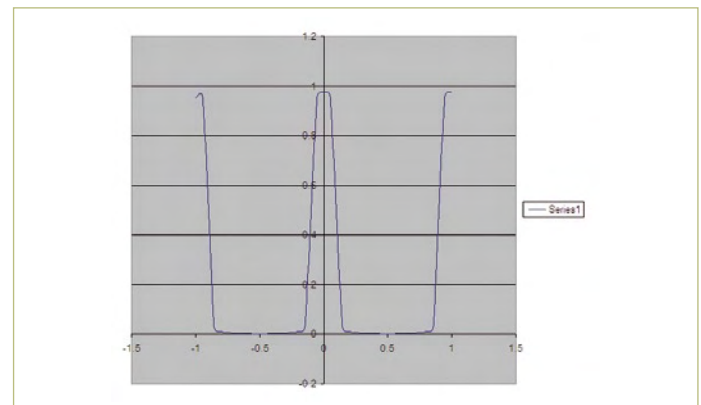
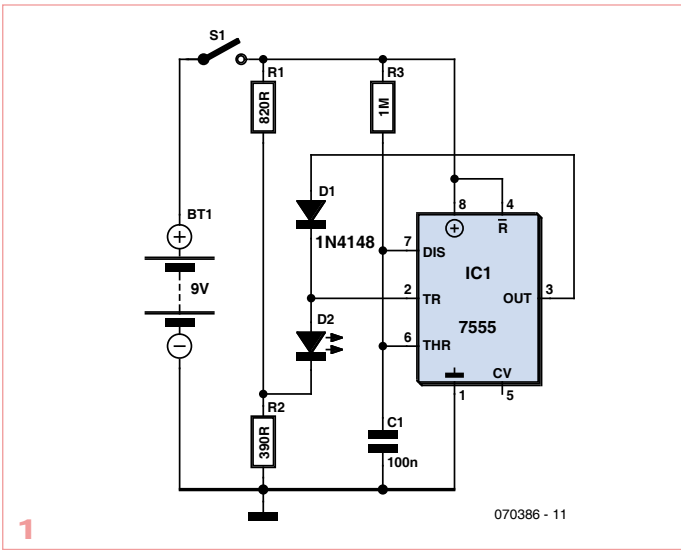

Figure 15. The time domain plot as a separate graph.



LEDs double as photosensors

By Geoff Nicholls (Germany)

Ordinary red LEDs are normally used as light emitters but they can also be used as photosensors. A single LED can even function as both a light emitter and a light detector in the same circuit!

The basic idea is to flash the LED, using the 'on' time to light it and the 'off' time to sense the photovoltaic current generated by the ambient light 'seen' by the LED.

The two circuits presented here use a few low-cost components to demonstrate how one LED can function as both a sensor and an indicator.

The circuit in **Figure 1** functions as a 'night-light' — the LED stays off in normal light and turns on when the ambient light level drops below a certain level. The 7555 CMOS timer is configured for monostable operation and triggers when the pin 2 voltage is less than 1/3 of the supply voltage. R1 and R2 form a voltage divider which keeps the cathode of the LED just below the trigger voltage. When

the ambient light level is bright enough the LED will develop several hundred millivolts, which adds to the R1/R2 junction voltage and keeps pin 2 above the 1/3 trigger level.

In this state the pin 3 output of the 7555 will be near zero and the 1N4148 diode will be reverse biased, allowing the LED photovoltaic current to flow into the pin 2 trigger input.

When the ambient light level drops low enough the LED voltage will fall and pin 2 will be below the trigger level. The 7555 will then generate a one-shot pulse, the 1N4148 will be forward biased and the LED will light up. At the end of the timing period set by R3 and C1 the monostable will reset and discharge C1, ready for another cycle. The LED will be turned off briefly during this time which allows it to sense the ambient light again.

The circuit shown in **Figure 2** functions as a 'day-light', the LED flashes in bright light and stays off in low ambient light. Here the 7555 is configured for astable operation and flashes the LED slowly via the 1N4148 diode as long as the pin 4 RESET input is held above 600 mV, roughly. If the ambient light is too low the LED will not generate enough voltage at pin 4 and the 7555 output will stay near zero, keeping the LED from turning on.

The LED operates as a light emitter when the pin 3 output is High and as a sensor when the output is Low.

The first circuit could be used to indicate the position of light switches, door keyholes etc. at night.

The second circuit would be ideal for a simple game as a target 'hit' indicator, the target LED would light up when 'hit' by the light from a laser pointer etc. C1 could be increased to 10 µF or so to extend the time the LED is on.

Both circuits could be used as touch switches in a bright room; covering the LED with a finger will change the state of the 7555 output.

The timer IC must be a CMOS type because the circuit design requires very low input currents to operate correctly. Intersil ICM7555 devices were used in the prototypes.

(070386-1)

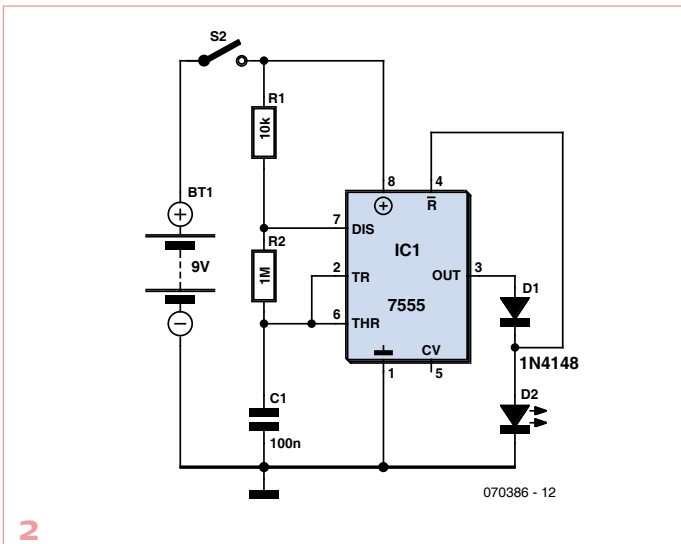

Incandescent lamp flasher

By D. Prabakaran (India)

In this circuit two IRF511 MOSFETs are configured as a simple astable multivibrator to alternately switch two incandescent lamps on and off. The resistor and capacitor C values given set the flash rate to about 0.33 Hz. By varying either the resistor or capacitor values almost any flash rate can be obtained. Increase either C1 and C2, or R1 and R2, and the flash rate decreases. Decrease the values and the flash rate goes up.

Unlike most semiconductor devices, the power MOSFETs can be par-

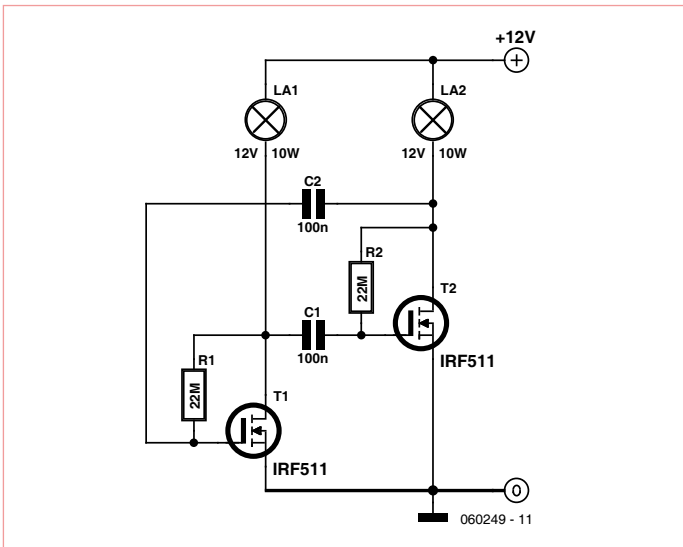

alleled, without special current sharing components, with a view to controlling larger load currents. That can be an important feature when the circuit is used to turn on a pair of high power incandescent lamps, because the lamp's resistance is initially much lower than at the normal operating temperature. A typical 12 to 14 volt lamp measures about 6 ohms in the 'cold' state. When 12 volts is applied, the initial current drawn is of the order of 2 amps. The same lamp, once operating at 12 volts, requires only about 200 mA. The 'hot' resistance typically works out at about 60 ohms, or ten times the 'cold' resistance. This constraint should be considered when picking any semiconductor device to control an incandescent lamp.

(060249-1)

Communication with a laser

By Raj. K. Gorkhali (Nepal)

Communicating with laser is not a novelty. You may be familiar with fibre optic cables that carry our telephone signals around the globe. The laser beam is then used as a carrier, which is modulated by the signal to be transmitted. At the receiver end, the desired signal is recovered by separating it from the carrier.

This Design Tip describes a wireless laser link that could be used to transmit information across a line of sight link between two stations. The basic principle of operation of the wireless link is identical to that applied for fibre optics. Wireless laser communication links are very popular in space applications for providing inter-satellite

communication.

The system is composed of a transmitter and a receiver section, **Figures 1 and 2** respectively.

The transmitter circuit basically comprises of an astable multivibrator, IC1, generating a pulse train, which serves as modulation input for the laser diode circuit. The output wave form appearing at pin 3 of the NE555 has a High time given by

$$0.69 \times (R1+P2) \times C2 [s]$$

and a Low time expressed as

$$0.69 \times P1 \times C2 [s]$$

The frequency of this pulse train can be set to around 1 kHz. Potential divider R2-R3-P3 reduces the peak amplitude of the pulse train from about 8 V to 3 V. Op amp IC2, transistor T1 and associated components constitute the driver circuit for laser diode D3. The laser diode current is switched between zero and about 90 mA. The upper current level in this configuration is given by the voltage at pin 3 of IC2, which due to the virtual earth phenomenon of the operational amplifier, also appears at pin 2 (divided down by R4).

The receiver is basically a current-to-voltage converter followed by a non-inverting amplifier built around IC3, whose gain is calculated

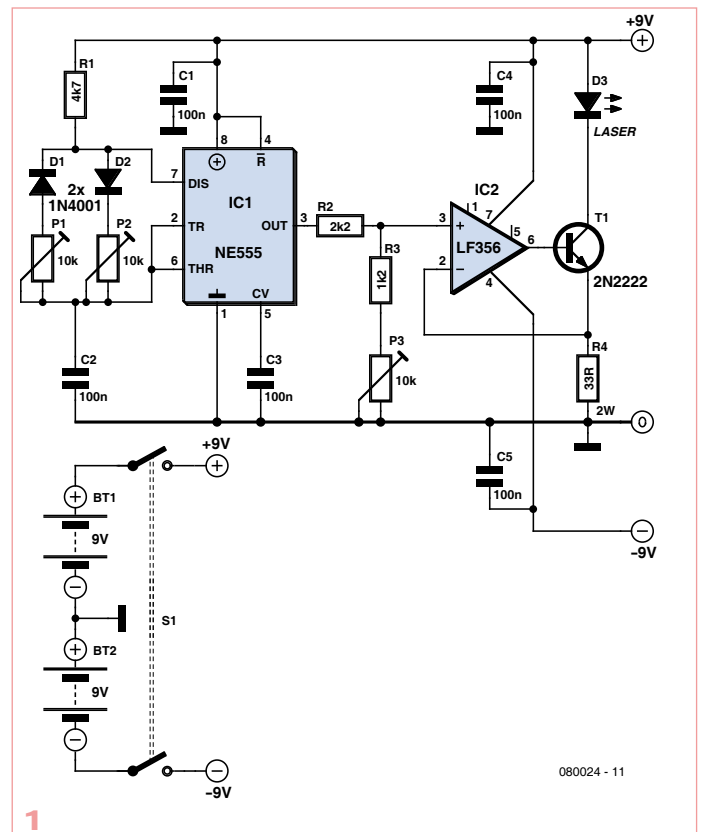

1

080024 - 11

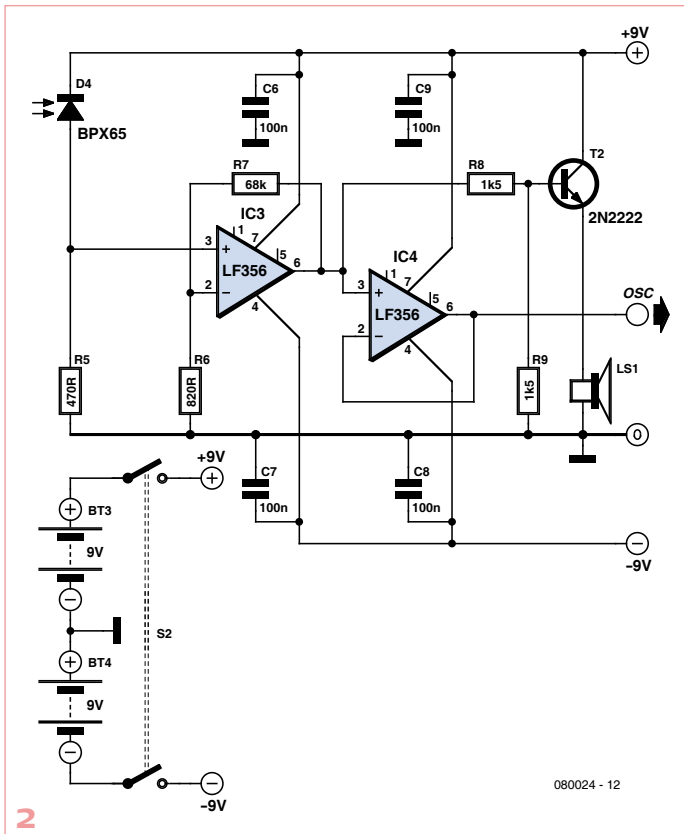

How low can it go?

By Vladimir Mitrovic (Croatia)

Once you're no longer baffled by the supply voltages at which modern computer processors and memories work, it's a challenge to check how far a supply voltage of an all-analogue electronic circuit can be lowered with the circuit remaining operational.

The circuit under test, shown here, is an ordinary astable multivibrator built from a pair of PNP transistors and a piezo beeper to signal that the electronics is still working. The operation of the circuit is checked with an oscilloscope as well, because at low supply voltages the beeper is likely to produce a very low sound level.

The circuit has been tested and the response noted. For your own experiments, follow this sequence.

1. Apply a supply voltage of -1 V and observe if the circuit starts to oscillate.
2. Slowly lower the supply voltage (yes, towards 0 V) until the circuit stops oscillating.
3. Repeatedly switch the supply voltage off and on, each time at a slightly higher voltage, until the circuit starts to operate again.

from

$$(R6+R7) \times R6$$

The gain for this stage can be chosen so as to get sufficient signal amplitude at its output. The output drives a mini loudspeaker through emitter follower T2. The unity gain buffer stage built around IC4 allows the received signal to be viewed on an oscilloscope if so desired.

Both the transmitter and the receiver are powered by two 9 V batteries to provide ±9 V symmetrical supplies. The two circuits are simple enough to be assembled on breadboards or prototyping boards.

To set up the system,

1. Adjust preset P1 and P2 to get a pulse signal of approximately 1 kHz at pin 3 of the NE555.
2. Adjust P3 to ensure that the desired value of current flows through the laser diode. Do not exceed the manufacturer's specifications!
3. Align the transmitter and receiver cards to ensure that the laser light falls on the photodiode.
4. Check the signal amplitude at the output of IC3 (pin 6). The pulse amplitude should be in the range of 3–5 V.
5. All working you should hear the 1 kHz tone from the loudspeaker.
6. Experiment with the line of sight range of the system — this will be dependent on laser power and any optics used.

(080024-1)

Caution

Never look directly into a laser beam. Observe all safety precautions issued by the manufacturer of the emitting device.

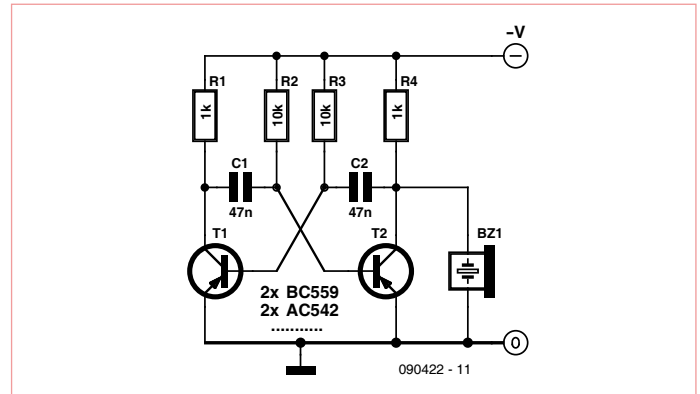

Two pairs of transistors have been tested — types BC559B and AC542. The results are shown in **Table 1**. A circuit that is operational at just 130 mV. Amazing, isn't it? Will Intel move to germanium soon?

Obviously, your experiments will require an appropriate adjustable low-voltage source with good control in the 0–1 volt range. Lacking such an instrument, a high-current potential divider supplied at, say, 5 volts with a 1-volt tap should prove an adequate alternative.

(090422-1)

transistor	switch off voltage	switch on voltage
BC559B	470 mV	520 mV
AC542	130 mV	190 mV

Low voltage indicator

By Lars Nås (Sweden)

This circuit is a very simple low voltage monitoring device for +5 V V_{CC} supply lines. It can be used to monitor battery voltage by indicating when the supply level drops below a predefined value. The output of the circuit can interface directly to digital logic (for example, TTL), reset a microcontroller or turn off your application before it goes haywire (CEO-speak: "into an undefined state") owing to a too low supply voltage.

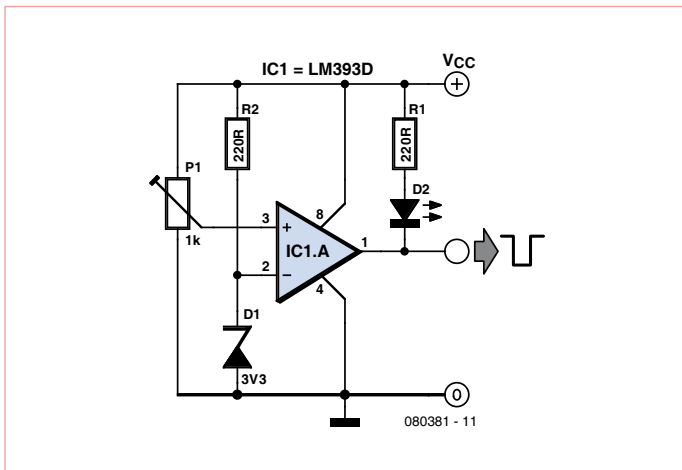

The circuit uses only one comparator from the LM393D package. Alternatively, feel free to use the LM339.

The LM393D compares two voltages, V_1 at the inverting (-) input and V_2 at the inverting (+) input. When $V_2 < V_1$, the comparator output is pulled Low, i.e. to GND (well, almost). When $V_2 > V_1$, the output is driven High, i.e. to (nearly) the positive supply voltage.

A 3.3 V zener diode, D1, and a 220 Ω resistor, R3, form a shunt voltage regulator used to set up a reference voltage (V_1) of 3.3V at the inverting input. R3 limits the current through zener diode D1 to at least 6 mA, causing the diode to remain reverse biased and conduct even when battery voltage drops to 4.65V.

Preset potentiometer R2 enables V_2 at the non inverting input to be set above the 3.3 V threshold when the supply voltage V_{CC} is above 4.65 V. The output of the comparator will then be driven High since the output transistor is off. Consequently the LED is turned off also.

When V_{CC} drops below 4.65 V, V_2 goes below the level of V_1 . This causes the comparator output to be driven to the negative supply voltage (GND). The current flow through R1 causes the LED to light up. R1 is calculated to limit the current through the LED to about 15 mA.

(080381-1)

Pololu

Robotics & Electronics

Robot Kits

Line followers

Mini-sumos

Robot arms

Save 10%
With coupon code
ELEKTOR3PI9

3pi Robot

Item #975: **\$99.95**

High-performance, C-programmable, ATmega328P-based robot (with Arduino support).

Mechanical Components

Motors, servos, wheels, ball casters, chassis, & more!

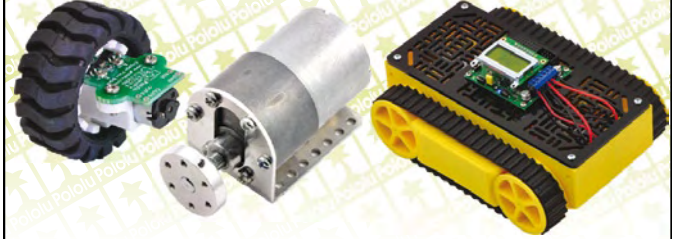

Controllers and Sensors

Jrk USB
motor controller
with Feedback

\$49.95

Baby Orangutan
robot controller

\$24.95

QTR reflectance
sensors **\$3.49**

Solder Paste Stencils & Laser Cutting

Both starting at \$25!

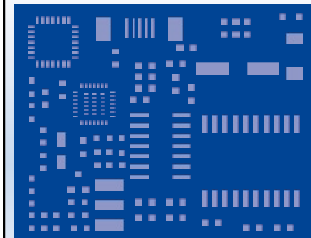

Use our low-cost plastic solder paste stencils to quickly assemble your surface-mount designs.

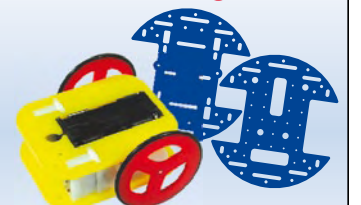

Laser-cut your own custom chassis, front panels, and more!

1-877-7-POLOLU
www.pololu.com

3095 E. Patrick Ln. #12, Las Vegas, NV, 89120

Vacuum Pump

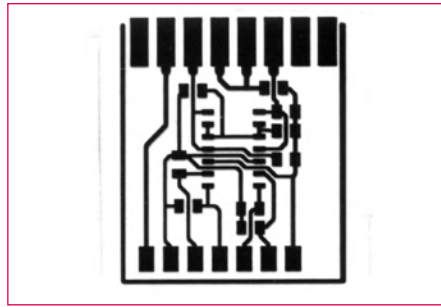

Figure 1. The perfectly satisfactory original negative.

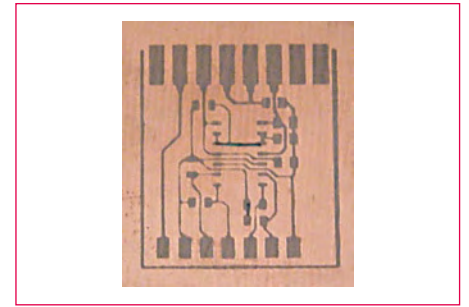

Figure 2. The rather unsuccessful exposed board.

improve the quality of your homebrew PCBs

By Yves Masquelier (France)

If like me you have been confronted with mediocre results when making certain PCBs, and if you're not put off by a little bit of DIY, then this is certainly going to be the solution for you.

I have sometimes ended up with poor PCBs, for reasons which I didn't really understand, since the photoresist was of good quality, from a reliable source, and wasn't out of date, and the photo-sensitive coating appeared evenly spread. The exposure equipment was a standard PVC case type fitted with four 8 W actinic tubes, with a sheet of plastic foam to exert pressure over the whole of the area. Even though this pressure was only light, and the foam somewhat followed the slight curvature of the lid, I did check that it held a document the thickness of a PCB negative properly, and so should be even better with the thickness of the board itself added.

Larger-size boards were sometimes spoiled in the middle, where the tracks were thinner than they should have been, so much so that sometimes they broke up altogether — and this, regardless of where I positioned my board to be exposed on the illuminated surface. So it wasn't being caused by the curvature of the cover. Smaller boards were always OK when exposed singly, but sometimes exhibited the same defects on the middle ones when I tried grouping together several small negatives to expose one board to be cut up after etching. To give you an idea, **Figures 1** and **2** show a negative and a central section of a board exposed in the traditional way. I tried doing a bit of retouching

by hand, before deciding to start again with a fresh exposure.

I ended up having some doubts about the mechanical characteristics of the boards themselves, rather confirmed by a number of problems I encountered when trying to mill boards, where here too the middle sections of the boards had problems, with milling that was less deep than near the edges.

A simple check using an engineer's rule, which is pretty perfectly straight, showed me that the boards were sometimes significantly curved, with a central hollow on the copper side — probably due to the different dimensional variations between the different materials the boards are made of.

When the negative is not in perfect contact with the photo-sensitive coating, 'semi-shadow areas' are formed around the tracks, because of the light rays coming from the tubes further away. A quick calculation shows that this area can undermine the tracks by as much as 2 mm if the space between the negative and the board is just 0.5 mm. Even though the exposure is less than that from the closest actinic tube, it's enough to severely compromise the final quality.

A point source would not have produced this effect, but the UV tubes give off a diffuse light, and of course, there is more than

one source. Since an epoxy board is quite stiff, the pressure of the plastic foam wasn't enough to flatten it out. I couldn't quite see myself ironing my boards to flatten them out, so all that was left for me to do was to make the negative press firmly against the photo-sensitive surface.

I had seen a few experiments where the board and negative were in a hermetically-sealed plastic bag and a vacuum was created in it using a vacuum-cleaner ^[1]. The idea seemed like a good one, but I didn't think my wife would appreciate my hijacking domestic appliances for experimental use (maybe there were already some unpleasant memories...?), and above all, I felt the degree of suction was excessive — not to mention the power consumption, in these energy-conscious days.

So I started out by working on the part that would keep the negative in contact with the photo-resist, thinking that by the time I'd finished this stage, I would have found an idea for replacing the vacuum-cleaner — otherwise I'd have to open diplomatic negotiations!

I started off using a zip-up freezer bag, in a way quite similar to that described on the 'Net, until I noticed that an open bag stays sealed closed anyway as soon as the suction brings the two walls tightly together.

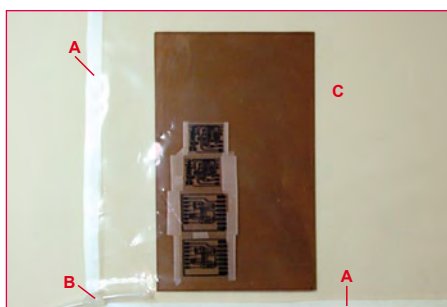

Figure 3. Everything is in place, but suction hasn't started yet. Note the adhesive tape (A) and the hot-melt glue or sealant (B). The pocket cam remain unsealed (C) once the board has been inserted.

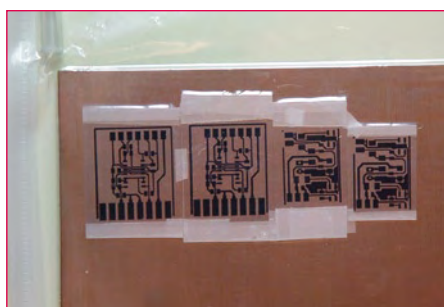

Figure 4. With suction on, the negatives are held perfectly against the board. There's no longer any risk of the width of the tracks being reduced by the light diffusing between the negative and the board because it isn't flat enough.

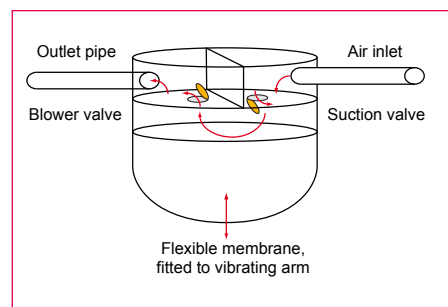

Figure 5. Operation of a pump commonly used for aquaria.

My own system

I abstemiously removed just two of the central 'pockets' from a plastic-leaved document binder that was not full. They come in sizes of 20, 40 leaves etc., but you can probably scrounge one off your kids.

As the welding was only 'dotted', I made the pockets' welded seams airtight by folding some adhesive tape over the edges.

I cut off one corner of the pocket so as to be able to slip in a length of tubing as used in aquaria (*Eureka*, I've just found the solution for my vacuum pump! But we'll see about that later...) and also for our PCB etcher.

I used a length of tubing long enough to thread one end out through the hole from inside the pocket, and still keep the other end outside the pocket (even if you have to thread a metre through, you want to avoid creating cut-off pieces that you'll only have to re-do later). I applied some hot-melt glue at about 1–2 cm from this end, then threaded it out carefully, to avoid leaving traces of glue on the walls of the pocket, till the ring of glue reached the hole.

I doubled up with some more glue on the outside, to make sure it was airtight. It's still easier doing it this way round — I think I'd have had some trouble trying to use a glue-gun inside the pocket! If like me you use hot-melt glue, be careful: it can give you a nasty burn! I prefer to give you detailed instructions, to save you time and make things more accurate — and to avoid your calling me all the names under the sun! But of course you can use other methods (sealant, another type of glue, etc.) The final result is shown in **Figure 3**.

In use, all you have to do is position the board close to the end of the tube, so that the walls of the pocket don't collapse onto one another between the suction hole and the board, and turn on the suction. If the

tube opening is in an area where there is not exposure, you'll need to create an 'air channel' from the suction hole to the board using a length of sleeving or 2–3 mm diameter wire. In this way, a natural airway is formed around the board, allowing it to take full advantage of the vacuum (see **Figure 4**). The airway doesn't necessarily need to be hollow, as the air will pass between this cylinder and the walls of the pocket.

Vacuum pump

You noticed that the solution came to me when I mentioned the tubing used for aquaria and PCB etching. I thought of the air supply pump, since for it to be able to blow, it inevitably must also suck, QED.

Figure 5 shows how a pump currently used to oxygenate the air in an aquarium, or in electronics to agitate the ferric chloride in a PCB etching bath. It can be seen that it performs two functions — sucking and blowing — but only the latter is used. The pumps on the market don't have a suction tube, just a simple opening to the air, usually via a filter underneath the casing.

My suggestion is to make use of all the possibilities of this tool, and so, besides using it to agitate the etching fluid, I'm going to call upon it to act as a vacuum pump to improve the graphical quality of my boards.

I used an ordinary pump that's easy to find in any self-respecting electronics shop and, for those hermits who live a long way from this type of shop and don't want to pay postage (probably as much as the cost of the pump itself), it's also readily available in pet shops, which are a bit more widespread than our own favourite shops. Ideally, choose one where the base can be unscrewed rather than one that can't be taken apart — although the casing can be 'vandalized' without affecting the success-

ful outcome of the project. Take care, the pump is AC powered, so I always make sure I unplug it before working on it!

I removed the bottom of the casing, held in place by four screws (anyone unlucky enough to have picked one that doesn't come apart will just have to get by). Once the bottom has been removed, I ended up with what you can see in **Figure 6**. You can make out the electromagnet, the arm that vibrates at the mains frequency, and the pump body with the 'bellows', consisting of a rubber membrane with its top attached to the vibrating arm.

The modification involves the pump body, which you'll now need to remove from the case. To do this, I detached the 'bellows' from the pump body (it just slips on and is held in place by a groove that stops it slipping off with the vibrations), and then I removed the screw that holds the pump body into the case. There's a rubber gasket between the case and the pump body, it will stay on the inside wall of the case and make it airtight once everything is refitted. If there isn't a gasket, it's easy enough to make one from a piece of inner-tube or some other material of the same type.

You can make out the two opposite parts of the pump body with the exchange section on the flexible membrane side and the two inlet and outlet chambers on the other side. **Figures 7** and **8** respectively show the two sides after the modification (sorry, I didn't take the time to photograph it beforehand).

I used hot-melt glue to block up the original air inlet, which is just an opening adjacent to the junction with the bottom gasket. After it had set, I filed the edge flat to make sure it would be properly airtight.

I drilled a hole in the pump body in the wall of the inlet chamber to suit the diameter of

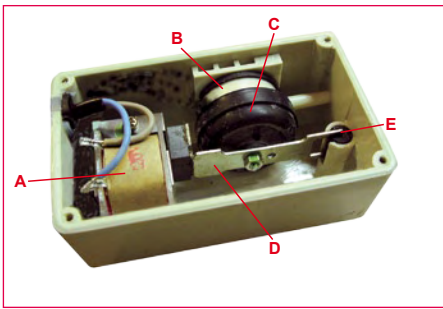

Figure 6. The interior of the aquarium pump: electromagnet (A), pump body (B), flexible membrane (C), vibrating arm (D), and flexible pivot (E).

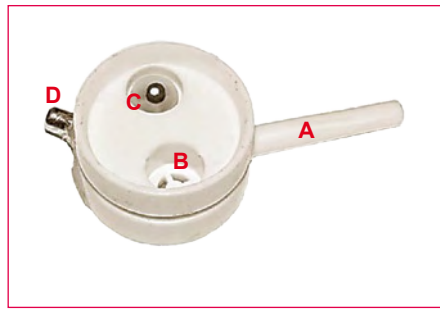

Figure 7. The modified pump body, seen from the membrane side. Outlet pipe (A), blower valve (B), suction valve (C), suction inlet nozzle (D), and original air inlet (E), blocked off using hot-melt glue.

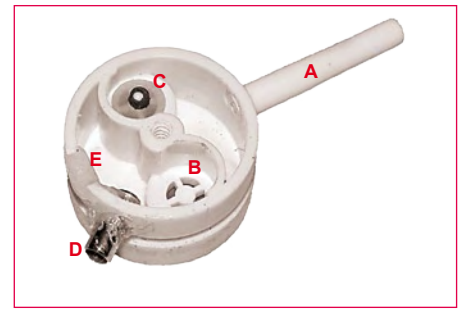

Figure 8. The modified pump body, seen from the inlet/outlet chamber side. Outlet pipe (A), blower valve (B), suction valve (C), suction inlet nozzle (D), and original air inlet (E), blocked off using hot-melt glue.

the suction nozzle to be ‘grafted on’. This should have an outside diameter of 4 mm so that it is a ‘force fit’ into the plastic tubing. If the original air inlet was already a hole, you can re-use it just by correcting its diameter. My graft was cut from a suitably-sized piece of a discarded telescopic aerial. You’ll need to work out the correct length so that you can fit it from the inside of the inlet chamber. This will make future operations easier.

I applied some hot-melt glue to this suction nozzle and, using a small pair of pliers, inserted it into the previously-drilled hole, from the inside towards the outside. To make it airtight, I applied some more glue to the outer part of the tube, where it comes out of the pump. It’s easier to get to the outer part than the inner part once the tube is in place, this is why I used the same trick above that I used for the vacuum bag. Then I made a hole in the outer wall of the pump case, threaded through a piece of flexible tubing (the same as used for the plastic pocket), and connected this tube up to the newly-created suction nozzle. I led it round a circuitous route to reduce the mechanical strain (see Figure 9). After testing and refitting the bottom of the

case, I connected this suction/blower pump to the vacuum bag using another piece of 4 mm diameter tube (from the same source) and the result is perfect.

Summary of materials used

Pocket

- adhesive tape
- 1 m of plastic tubing for aquarium aerator (you’ll need at least 20 cm, but it’s often sold by the metre only)
- 1 plastic document protector
- 2-component resin or hot-melt glue and gun.

Pump and connections

- the remainder of the aquarium tubing (you’ll need about 50 cm to leave you a degree of freedom of movement)
- 2 pieces of tubing with an external diameter to suit the internal diameter of the flexible tubing (in theory, 4 mm)
- hot-melt glue and gun.

I measured the suction with the pump in the working set-up. It came out at 120 g/cm². Not a lot, you say! Well, extrapolating

that to a 160 × 100 mm ‘Euro’ format board will show us that the negative is pressed against the board with the equivalent of a weight of over 19 kg. The other advantage with this system is that the force is evenly distributed.

The blower output can still be used, either by removing the suction pipe, or by fitting a 3-way valve where the unused function is vented to the open air. I’ll develop that another time, for those who have the opportunity to have a permanent laboratory set-up.

If you have any doubts about whether it’s worth bothering, take a look at my website [2] and the comparisons of results obtained under the same exposure conditions, where the only variable is the way the negative was held against the board.

(081073-1)

Internet Links

- [1] www.abcelectronique.com/acquier/Insoleuse.html
- [2] www.ymasquelier.net



Figure 9. Pump with suction tube fitted.



Figure 10. The exposure unit with the pump in operating position.



Figure 11. Detail of the way the suction tube is led out.

Take out a free subscription to E-weekly now

Do you want to stay up to date with electronics and computer technology? Always looking for useful hints, tips and interesting offers? Subscribe now to E-weekly, the free Elektor Newsletter.

Your benefits:

- The latest news on electronics in your own mailbox each Friday
- Free access to the News Archive on the Elektor website
- You're authorized to post replies and new topics in our forum



Register today on www.elektor.com/newsletter

USB Add USB to your next project. It's easier than you might think!

DLP-USB1232H: USB 2.0 UART/FIFO

HIGH-SPEED 480Mb/s



Only \$28.95!

- Multipurpose: 7 interfaces
- Royalty-free, robust USB drivers
- No in-depth knowledge of USB required
- Standard 18-pin DIP interface; 0.6x1.26-inch footprint

DLP-IO8-G 8-Channel Data Acquisition



Only \$29.95!

- 8 I/Os: Digital I/O
Analog In
Temperature
- USB Port Powered
- Single-Byte Commands

DLP-IOR4 4-Channel Relay Cable

DLP-TH1b Temp/Humidity Cable

DLP-RFID1 HF RFID Reader/Writer

DLP-FPGA USB-to-Xilinx FPGA Module



www.dlpdesign.com

ElektorWheelie

Elektor's DIY self-balancing vehicle

Everyone agrees that the internal combustion engine is coming to the end of its life cycle. However, you don't need to go to the expense of a Prius or Tesla to experience the future of transportation devices. If you would prefer something more personal (and don't mind turning a few heads), why not build the astonishing ElektorWheelie? First take two electric motors, two rechargeable batteries and two sensors, then add two micro-controllers, and the ElektorWheelie is ready to transport you in style to your destination.

Demo video on www.elektor.com/wheelie



Characteristics

- Two 500 W DC drive motors
- Two 12 V lead-acid AGM batteries, 9 Ah
- Two sixteen-inch wheels with pneumatic tyres
- H-bridge PWM motor control up to 25 A
- Automatic power off on dismount
- Maximum speed approx. 11 mph (18 km/h)
- Range approx. 5 miles (8 km)
- Weight approx. 35 kg

The kit comprises two 500-watt DC drive motors, two 12-V lead-acid AGM batteries, two 16-inch ABS wheels, casing, control lever and assembled and tested control board with sensor board fitted on top.

Art.# 090248-71 • \$2275.00*

* Prices include tax, exclude shipping and handling.

Elektor US
4 Park Street
Vernon CT 06066
USA
Phone: 860-875-2199
Fax: 860-871-0411
E-mail: sales@elektor.com

Further information and ordering at www.elektor.com/wheelie

MIAC for Home Automation

The CAN bus at home

By Bert van Dam (The Netherlands)

The MIAC is a PLC which is easy to use with Flowcode and can be used to design and build an electronic control system. In this article we use three MIACs for the implementation of a simple home automation system with an alarm.



A MIAC (Matrix Industrial Automotive Controller) is an industrial programmable logic controller (PLC) that can be used in a wide variety of electronic systems. Internally it has a powerful 18F4455 PIC microcontroller which is connected directly to a USB port. As a result it can be easily programmed using either Flowcode, C or assembly. An LCD, push buttons, four relay outputs, four transistor outputs, eight inputs – selectable analog or digital – and a CAN connection complete the system. Because the main purpose for the MIAC is industrial applications, its power supply is 12 V instead of the PIC's more usual 5 V. In this project we design a basic home automation system using three MIACs, where the MIACs are connected to each other via the CAN bus. This makes the home automation system very flexible and easily expandable.

Installation

To be able to use the MIAC you need to use the latest version of Flowcode V3 (3.6.11.53 or higher) or V4. These versions have the MIAC component integrated so that a whole range of macros are available to control the inputs, LCD and outputs. To use the CAN bus you need to add the CAN bus component. This must be set up with the parameters as shown in **Figure 1**.

The CAN bus, chip select and the interrupt are not on the same port, even though you just entered that. It actually works because the CAN bus component recognizes that you are using a MIAC and therefore controls the correct ports anyway. Note: you can therefore not use the MIAC CAN bus unless you also include the MIAC component in your program.

A CAN bus system

The CAN bus (Controller Area Network) was designed in 1986 by Bosch as a solution to the ever increasing number of wires in cars and the large number of different protocols. CAN is extraordinarily robust and relatively insensitive to noise, so as a consequence it was

also quickly adopted by industry.

In our system we send messages over the CAN bus. Every message comprises a unique 11-bit ID number and a maximum of eight data bytes. CAN operates with 'broadcast' messages: messages are not sent to a particular receiver but are just transmitted on the bus. Every device on the bus can therefore receive every message. This makes the system very flexible. If one of the receivers fails or is removed then this does not affect the operation of the bus. On the downside, the sender has no idea whether the message has been received by anyone.

A CAN bus is built with a twisted-pair connection. At the beginning and end of the series of CAN bus devices is a termination resistor. For the MIACs this means that all the H and L terminals of all the devices need to be connected together. The termination resistor is built in and can be activated with a wire link from TA to TB (**Figure 2**).

We position the units as follows: Unit 1 which functions as the alarm on/off and TV timer in the master bedroom; Unit 2 which operates the garden lighting and functions as alarm downstairs and near the rear of the house; Unit 3 which functions as the door bell with night mode and alarm on/off (with code lock) downstairs near the front door (**Figures 3, 4 and 5**). Three different messages are used. Each unit can send one message, see **Table 1**. Unit 2, for example, sends a message with ID 20. The contents of this message consists of eight bytes of which only two are used, bytes 0 and 1. There is, therefore, the option of future expansion. For the values of these bytes we use 0, 1 and 2, where 1 and 2 are an actual instruction. Value 0 stands for 'no action'. In this way Unit 2 can, for example, send a message to display text on the LCD, without mentioning anything about the security of the back yard.

In the Flowcode CAN component, buffer 0 is associated with the ID of the CAN message. As a consequence, making and sending a message comprises only two steps: place the appropriate information in buffer 0 and send the buffer. The message will then automatically be given the correct ID number.

In the CAN component we indicate that the received messages must end up in buffer 1. We therefore only have to look at the contents of buffer 1. However, we still have to check whether the message has the desired ID.

The ID has 11 bits, which unfortunately are rather awkwardly spread across two bytes (see Figure 6). The two bytes are received separately and have to be combined into one integer using the formula:

$$\text{MessageID} = (\text{HighByte} * 0x08) + (\text{LowByte} / 0x20).$$

The challenges of the CAN bus

When programming applications for the MIAC we always have to keep in mind that CAN bus messages can arrive at any time and that new messages can overwrite older ones. There is, after all, space for only one message in the buffer. We solve this by checking very frequently whether there is a message in the buffer. We may also not send messages one after the other too quickly. In this way MIACs can be added and removed and any individual MIACs can have their software changed without having to redesign everything.

‘Checking very frequently’ means that the software checks every 10 ms whether there is a CAN bus message. This does, however, cause other problems. No part of the program may delay the wait loop too much. We solve this by using counters. In the source code ^[1] you will find the Flowcode flow diagrams that make this clear.

Example applications

The following circuits are intended as examples of the capabilities of the MIAC. It would be too much to explain these circuits in detail, so only the most important aspects are discussed. For further details you can read the source code, which is available as a free download ^[1].

Alarm circuit

This circuit is used to turn the alarm function on and off. Once it is turned on, all units will energise relay Q1 and the corresponding LED turns on. Q1 is intended, for example, to turn on indicator lamps or spe-

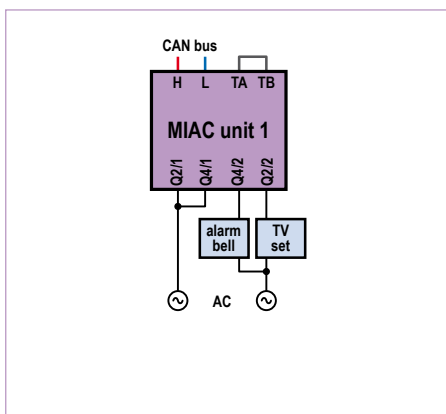

Figure 3. The MIAC in the bedroom (Unit 1) has to be connected according to this schematic, ...

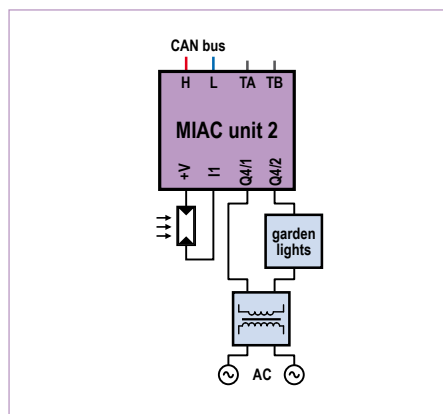

Figure 4. ... this is how the MIAC near the back of the house (Unit 2) needs to be wired up...

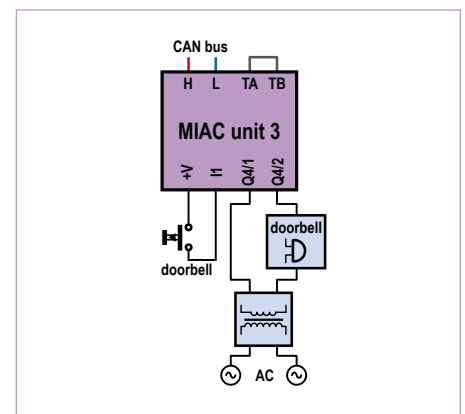

Figure 5. ... and this connection diagram belongs with the MIAC at the front of the house (Unit 3).

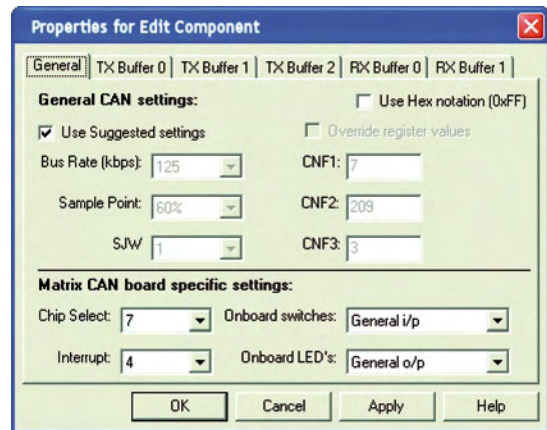

Figure 1. CAN bus settings for the CAN bus component.

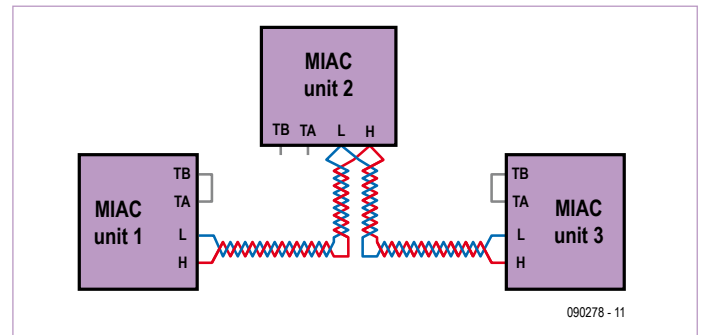
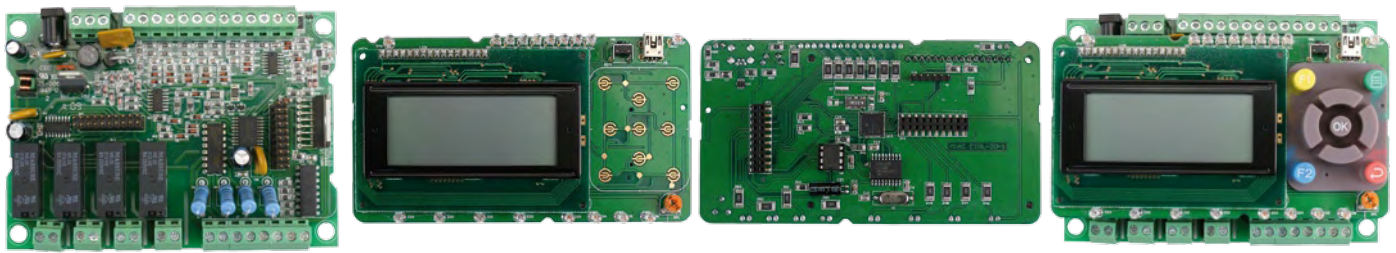

Figure 2. A simple CAN bus network using MIACs.

cial sensors. The circuit comprises three parts. On Unit 1 (bedroom) the alarm can be turned on and off with the red and green pushbuttons. The second part of this circuit is in Unit 3 (front door). Turning the alarm on is the same as for Unit 1, this is, using the green button, but for disarming a four digit code is required. A remarkable feature of this part of the program is that the LCD only shows the number



of the button that has just been pressed. The number of digits in the correct code and whether enough digits have been entered already or whether too many digits have been entered, is not indicated. This makes it much more difficult for an unauthorized person to find the correct code. The program continually checks the last four digits entered. When these are all correct the alarm is turned off. In addition every unit checks whether there is a message from Unit 1, which indicates that the alarm is turned on.

Night bell

This part runs on Unit 3 and its function is that at night only acquaintances can ring the bell. When the alarm is off, the signal from the bell push button goes via the MIAC to the bell. When the alarm is turned on, this connection is interrupted. The only way to ring the bell is to push the button in a special way: short-short-long-short. When the MIAC recognizes this code it will ring the door bell briefly.

Garden lighting and alarm

This circuit too has a dual function. When the alarm is off, the garden lights turn on as soon as it becomes dark at night and turn off when it becomes light again in the morning. However, when the alarm is on, you are either in bed or you are not at home and therefore the garden lights can be turned off. If in this situation the amount of light on the sensor changes suddenly, then this light is from a torch or from a person who blocks the incoming light from, for example, the moon. In both cases this is sufficient reason to trigger the alarm.

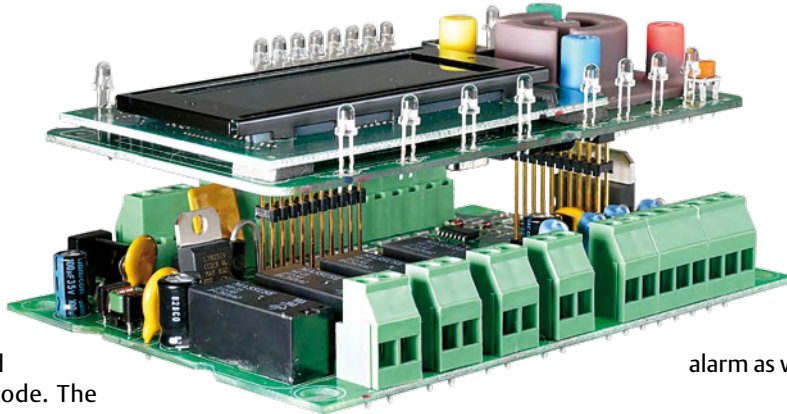

This is the only example that can actually trigger the alarm. This uses byte 1 in message ID 20. By looking at the source code for Unit 2 (the sender) and Unit 1 (the receiver) you can easily create other situations that can trigger the alarm as well.

TV timer

Finally a project with a long delay loop. When the alarm is off, the yellow and blue pushbuttons of Unit 1 are used to turn the TV on and off. However, when the alarm is on the TV will be turned off after about 20 minutes.

Software

The software discussed in the article (including the firmware for the alarm with code, the night bell, the garden lighting with alarm and the TV timer) can be download free as source code and HEX files from the Elektor website [1]. The MIAC is available through the Elektor Shop as item # 090278-91.

(090278-1)

Internet Link

[1] www.elektor.com/090278

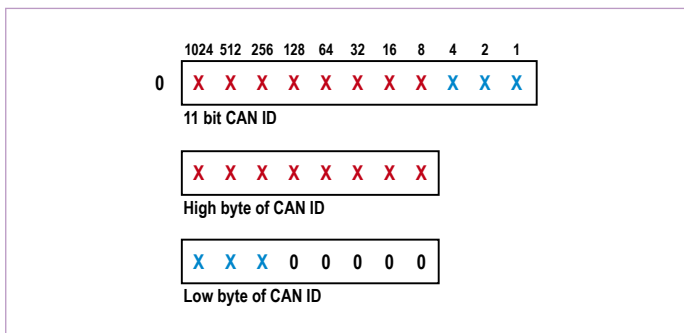

Figure 6. the CAN bus ID is spread across two bytes.

Table 1. Contents of the messages			
Unit	Byte	Values	Description
1 - ID 10	0	0, 1, 2	0 = no action 1 = relay Q1 on 2 = relay Q1 off
	1-7	spare	
2 - ID 20	0	0,1,2	0 = no action 1 = clear LCD 2 = "Hello" on LCD
	1	0,1,2	0 = no action 1 = burglar in back yard 2 = no alerts
	2-7	spare	
3 - ID 30	0	0,1,2	0 = no action 1 = alarm on 2 = alarm off
	1-7	spare	



Things of the past

Elektor is now & tomorrow

Secure a head start in electronics with a subscription!

Advantages to subscribers



11 Issues including the summer double issue for just \$39.95*

- Cheaper than 11 issues from the newsstand: **Save 57%** off the cover price of \$92.45
- With every issue subscribers get up to **40% discount** on selected Elektor products
- No lines, traveling, parking fees or 'sold out'; Elektor is mailed to you every month
- Always up to date – read your copy before everyone else

* Offer available in US and Canada only. Canada add \$11 per year.

www.elektor.com/subs

Or use the subscription order form near the end of the magazine.

elektor
electronics worldwide

Dimmer with a Micro

For incandescent and halogen lamps up to 300 watts

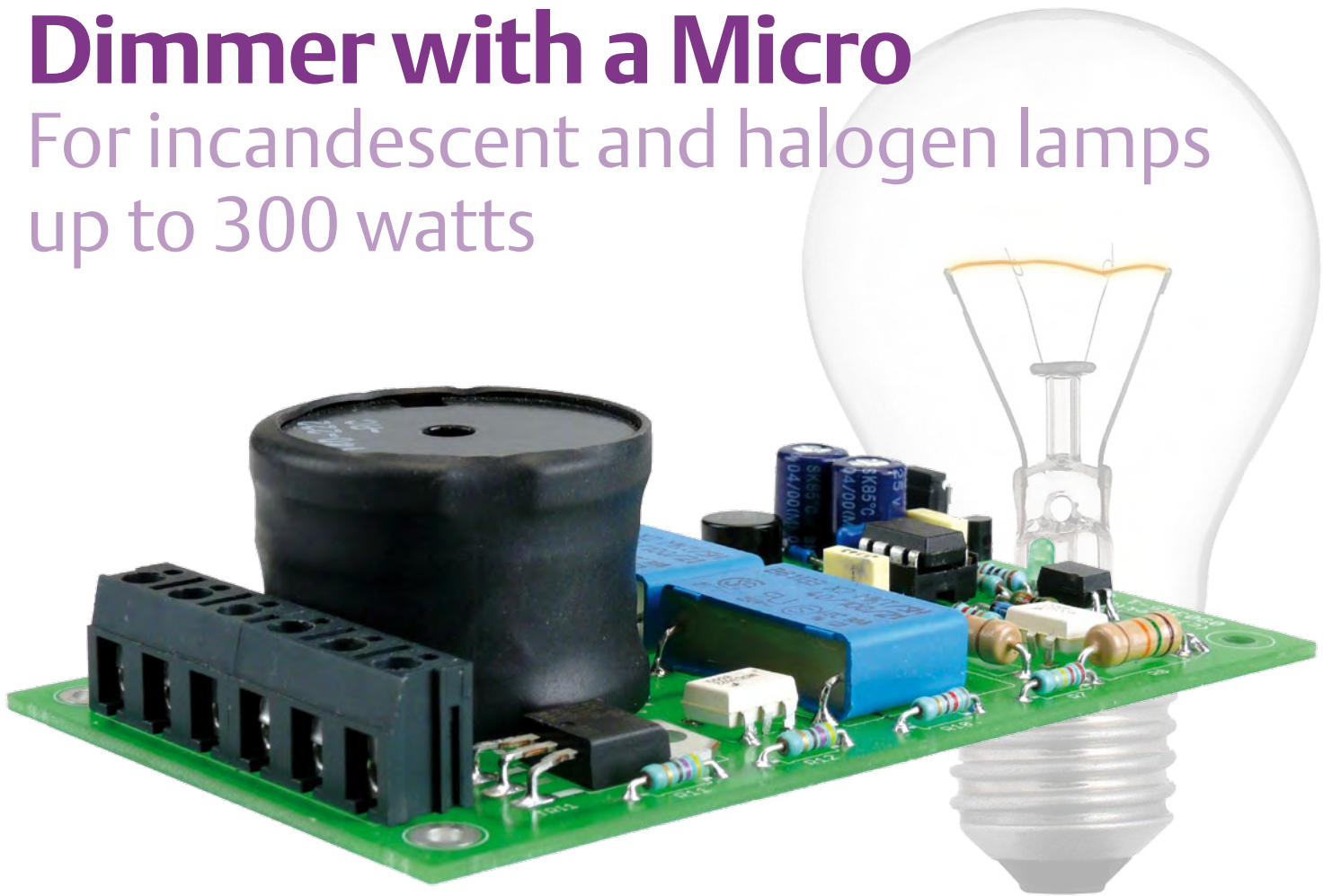

By Goswin Visschers (The Netherlands)

Dimmers come in many varieties — you'd think. Still, the author did not find what he wanted. So it was back to the drawing board to design a dimmer circuit with the exact personal requirements. The result is a project that's easy to add to the existing electrical installation as well as simple to operated using existing light switches. The design is for 230 V, 50 Hz AC power lines and our US and Canadian readers are expressly invited to rework it to 110/115 VAC, 60 Hz.

The idea for this design came about because the author wanted to replace a double switch with a switch/dimmer combination that wasn't available of the shelf. The existing double switch was retained and the dimmer circuit described in this article was built into the light fitting in the ceiling. This is now used to control four 50-watt halogen lamps. The circuit is also suitable to allow the lights to be dimmed when connected to a two-way switch circuit (staircase configuration), using either switch.

The schematic

The microcontroller controlled dimmer dims the lights using phase control. It is therefore no surprise that triac TRI1 has to do all the heavy work. But before the triac 'knows' when to turn on, a few things have to be measured first.

Starting at the beginning: the AC power line voltage (see **Figure 1**). Coil L1 and capacitor C2 form a classic dimmer filter which prevents the noise that is generated by the phase control circuit from creating interfer-

ence on the AC power lines. Fuse F1 is a miniature fuse rated 1.6 A (slow blow). Components R1, R2, C1, B1 and D1 convert the 230 VAC power line voltage into a suitable power supply voltage for IC1, a 78L05 voltage regulator. To prevent electrical breakdown across the resistors, two 470 Ω resistors are used, instead of a single 1 k Ω resistor. By connecting the two resistors of 470 Ω (R1 and R2) in series the risk of electrical breakdown is much smaller because the voltage dropped across each resistor is halved.

Main Features

- Dimmer function using phase angle control
- Simple to set
(can also be permanently set)
- Suitable for two-way switch circuits (staircase circuit)
- Very low profile construction (20 mm)
- Transformerless

The power supply voltage of about 16 volts is normally a bit high for a 78L05. However, in order to have a buffer that stores as much charge in C3 and C4 as possible we chose the highest possible voltage. The energy stored in C3 and C4 has to power the microcontroller during the time required to activate the 'setting mode' of the microcontroller. This mode is activated by briefly switching the lamp (and the circuit) off using the AC power switch and then turning it back on again (see further down for the complete operating instructions for the circuit).

Space constraints

Because the author had to build the circuit board into a housing which was only 2 centimetres high it was decided not to

mount C1 and C2 vertically as is the norm, but to fit them horizontally by laying them on their side (see photo). For the same reason the buffer of the power supply voltage uses two smaller electrolytic capacitors (C3 and C4) instead of using one big capacitor. If you have more than two centimeters of height available then all this is not really necessary, although there is only very little room for the vertical mounting of C1 and C2 because of L1.

A disadvantage of the type of power supply used here is that the microcontroller is directly connected to the potentially lethal AC power line voltage. Detecting the zero-crossing of the AC power line voltage cannot be done using only the low voltage part of the circuit either. A transformer, however,

would have been too big to fit in the enclosure and that is why this type of power supply was chosen.

Incidentally, the prototype in the photo uses a coil from DigiKey. To reduce the height requirement it is better if you use the coil from Conrad Electronics, which is also specified in the component list. This is made with a toroid and is considerably lower.

Heart of the circuit

The core of the circuit is formed by a PIC12F629 microcontroller. A zero-crossing detector is built around IC3. At the zero-

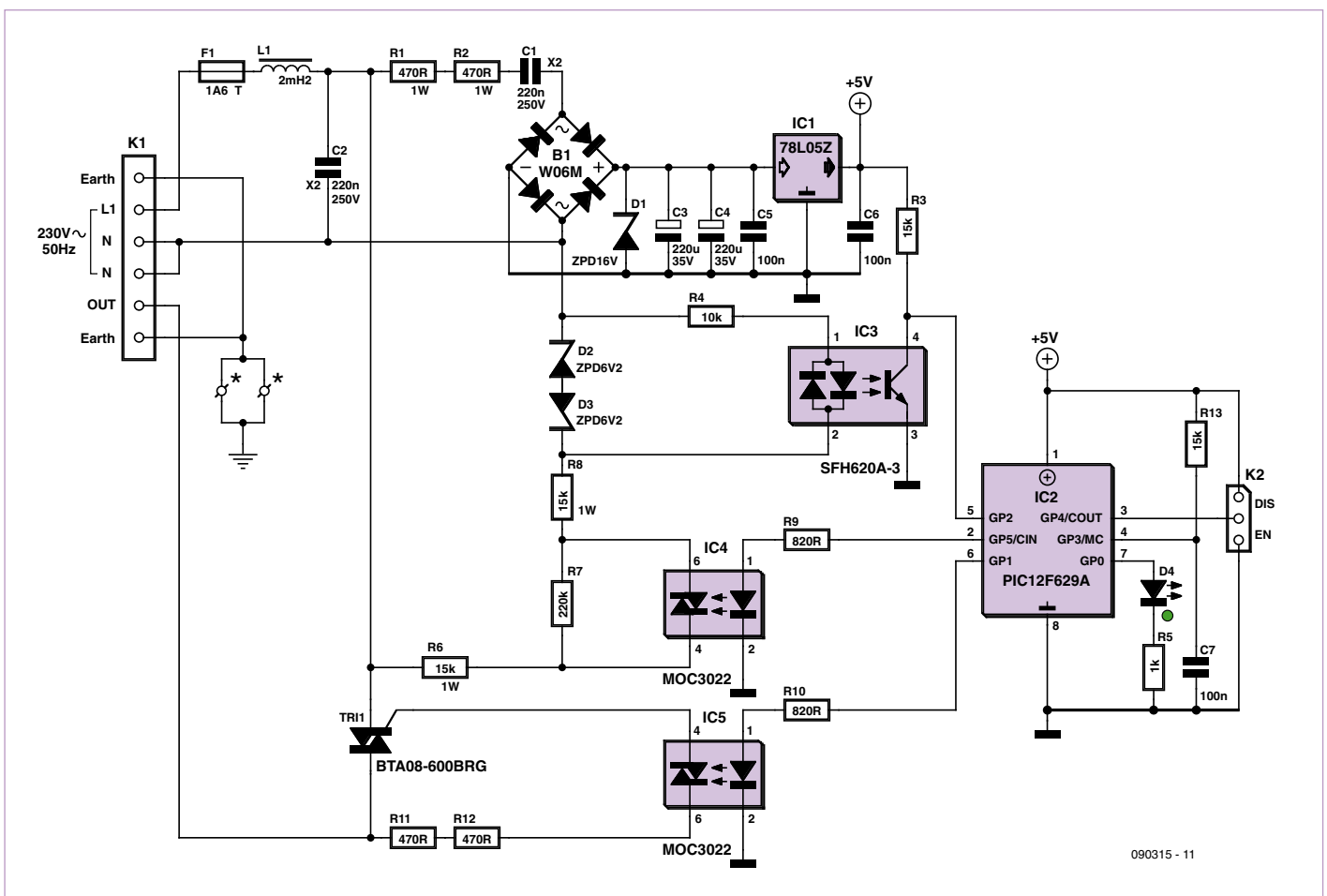

090315 - 11

Figure 1. From the schematic we can see that the circuit is not electrically isolated from the AC power lines. To prevent a shock hazard when using a metal enclosure it is possible to earth this using K1 and two of the mounting holes that have earth pads.

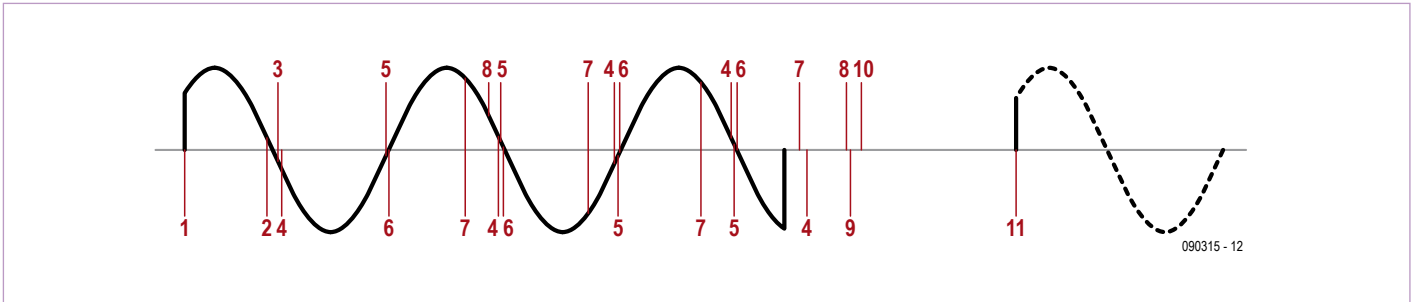

Figure 2. The diagram shows the positions in the AC voltage cycle that are essential to the software.

crossing the voltage across the output of IC3 is higher than 2.5 volts for a duration of about 2 ms. D2 and D3 limit the voltage across the LEDs in IC3. Using the voltage pulse from IC3, the microcontroller knows when the AC voltage sine wave passes through zero and therefore when the triac should be turned on to slice a predetermined amount – corresponding to the dimmer position – from the sine wave.

Resistor R3 acts as a pull-up. We could have used the internal pull-up resistors that are inside the PIC microcontroller, but to reduce the current consumption these are not activated. That is because the pull-up resistors in the microcontroller cannot be activated individually. By using a single external pull-up resistor the amount of time that the circuit continues to operate can be longer (important when setting the dimmer position).

D4 turns on when the setting mode is activated. It is not actually necessary to fit this LED, together with R5. By omitting both D4 and R5 the amount of time that the circuit continues to work without AC power line voltage is extended even further. This is because electrolytic capacitors C3 and C4 are discharged at a slower rate: no charge disappears into D4.

Heat

R8 and R6 would be quite hot, if they had to deal with the full AC power line voltage. That is why, with the aid of IC4, R7 and R9, current is only allowed to flow through R8 and R6 just before the zero-crossing. In this way the exact zero-crossing can still be determined accurately while at the same time the current through R6 and R8 is mini-

mized. If there had been enough space in the enclosure to cope with the heat dissipation of R6 and R8 then IC4, R7 and R9 could have been left out (pin 2 of IC2 directly connected to the node between R6 and R8). R6 and R8 would however dissipate 0.9 W each, which is below their 1 W rating. But because of the small enclosure they would become so hot as to be a fire hazard. With the help of IC4 this heat generation is kept nicely within limits.

After IC2 has detected the first zero-crossing, the controller turns the current through R6 to R8 off via IC4 until the next zero crossing is nearly reached. Just before the new zero-crossing is expected, the triac in IC4 is turned on again. As a result of this solution resistors R6 and R8 stay nice and cool as already mentioned. R7 ensures that the triac IC4 turns off after the zero-crossing. Finally, IC5 takes care of the interface between the microcontroller and triac TRI1. The design for this circuit board does not use a standard TO-220 footprint for TRI1. The reason for this is the small distance between the pads of a normal footprint. Here, the pads of the legs are 1.25 mm further apart, in order to prevent electrical breakdown.

Printed circuit board

This schematic was used to design a double-sided printed circuit board, the artwork of which can be downloaded from the Elektor website ^[1]. The construction is not at all difficult; no SMD parts are used. As usual, start by fitting the smallest (lowest) parts such as resistors and diodes followed by the larger (taller) components.

When connecting the board, extra attention needs to be paid to the wires connecting to K1. For C1 and C2 use capacitors with an X2 rating, these are safer to use at high voltages.

If a metal enclosure is used then this can be earthed with the aid of the two earthed mounting holes in the board.

The software

The program is divided into three parts. The first part contains the main dimmer program, the second (middle) part contains the code which is necessary for the setting mode and the last part contains routines for reading and writing of the EEPROM.

After turning the AC power on, the registers are reset and the dimmer value is read from the EEPROM. The microcontroller waits for two zero-crossings (step 4) so that it is not affected by any contact bounce of the switch or switches. The steps shown below correspond with the numbers shown in the sine wave of **Figure 2** and the routines in the code:

1. Switching the AC power on; the PIC microcontroller starts up.
2. Pretest0; the PIC waits for the zero-crossing.
3. Pretest1; the PIC waits for the zero-crossing to pass, pin 5 is low again.
4. Main; wait for the next zero-crossing or until the AC power is turned off.
5. MainWaitToSwitchTriacOnSetup; Reset the internal timer.
6. MainWaitToSwitchTriacOn; Wait until the timer has reached the desired value to trigger the triac.

COMPONENT LIST

Resistors

R1,R2 = 470 Ω 1W
 R3, R13 = 15k Ω
 R4 = 10k Ω
 R5 = 1k Ω
 R6,R8 = 15k Ω 1W
 R7 = 220k Ω
 R9,R10 = 820 Ω
 R11,R12 = 470 Ω

Capacitors

C1,C2 = 220nF 250V, polypropylene, X2 class
 C3,C4 = 220 μ F 35V, radial, lead pitch 3.5mm
 C5,C6,C7 = 100nF, ceramic, lead pitch 5mm

Semiconductors

B1 = W06M, bridge rectifier, 1.5A, 600Vpiv,
 (e.g. Farnell # 1621776)
 D1 = 16V 0.5W zener diode
 D2,D3 = 6.2V 0.5W zener diode
 D4 = LED, low-current, green, 3mm
 IC1 = 78L05 (TO-92 case)
 IC2 = PIC12F629A (Microchip), DIL8 case, pro-
 grammed, Elektor Shop # 090315-41
 IC3 = SFH620A-3 optocoupler (e.g. Farnell #
 1469594)
 IC4,IC5 = MOC3022 optocoupler (e.g. Farnell
 # 1021366)
 TRI1 = BTA08-600BRG, triac, 8A, 600V, TO-
 220AB case (e.g. Farnell # 1057269)

Miscellaneous

F1 = 1.6 A (slow blow) subminiature, (e.g.
 DigiKey # 507-1178-ND)
 K1 = AK110/6wp, 6-way terminal block, lead
 pitch 7.5mm
 K2 = 3-pin SIL header lead pitch 2.54mm, with
 jumper
 L1 = 2.2mH suppressor coil, (e.g. DigiKey
 # M8383-ND or Conrad Electronics #
 534358-89)
 2 pcs DIL6 IC socket
 PCB # 090315-1, ordering information at [1]

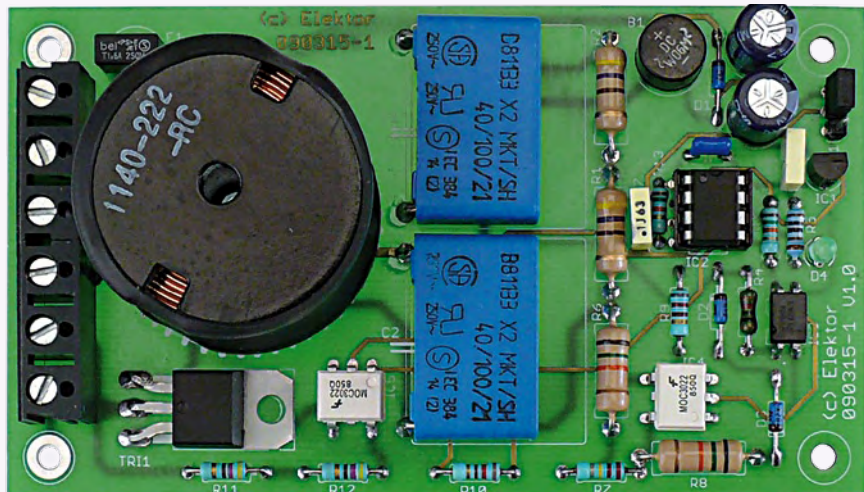
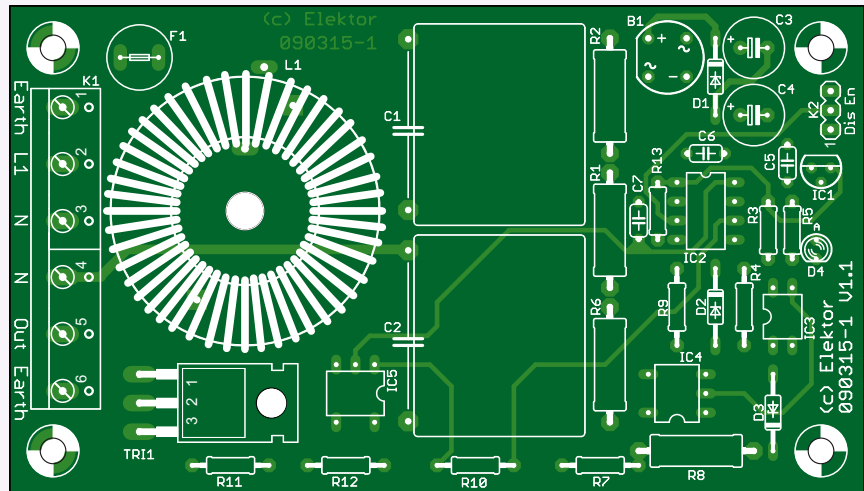

7. Triac is triggered, pin 6 of the PIC goes briefly high.
8. MainWaitToSwitchOnZCrossDetect; the zero-crossing detector is activated because pin 2 goes briefly high. The program now jumps back to step 4.
9. Program; the PIC enters setting mode and checks the position of the jumper. Depending on the position of the jumper the PIC either continues or jumps back to step 1.
10. ShowProgramMode; the LED lights up and the triac turns on.
11. Based on the previous description you can easily determine the operation of the program while in the setting mode. The reading and writing of the EEPROM is taken directly from the datasheet from Microchip.

Operation

The microcontroller-driven dimmer can be 'operated' in the setting mode. This mode is activated by turning the lamp on and then briefly turning it off and then on again (within 1 second, while the LED is still on). The lamp will initially turn on at full brightness for about 1 second and subsequently the brightness is adjusted in steps from 0 to 100%. After 100% is reached the cycle repeats again starting from 0%. As soon as the desired brightness has been reached you need to turn the switch off for more than two seconds (or until the LED turns off) to store this brightness setting. When the switch is turned on again the lamp will turn on at the brightness just selected. With header K2 the setting mode can be disabled, so that the dimmer will remain at

the last brightness set. To do this, connect pin 3 of the microcontroller with the jumper to +5 V. The setting mode is enabled when pin 3 is connected to ground.

If you find the on-off-on periods too long then you can reduce the values of C3 and C4 down to 100 μ F. On the other hand, if the times are too short then C3 and C4 can be replaced with higher capacitance types.
 (090315-1)

Internet Link

[1] www.elektor.com/090315

DBA (doing business as)

By Gerard Fonte (USA)

Starting your own business, or 'Doing Business As' (DBA) has a number of benefits for hobbyists which are generally overlooked. Writing a letter on your company letterhead (very easy with today's ink-jet and laser printers) immediately confers credibility. Bob from Dyno-Dyne is much more likely to be taken seriously than Joe from Idaho. Many hard-copy technical magazines are available free with a business address (*Electronic Engineering Times*, *EDN*, *Electronic Products* and lots of others). And once you get on the list they often offer other free journals. Some shipping companies charge slightly less for deliveries to a business address, even if it's a home business. And one of the best perks is that you can often get free samples directly from the manufacturer. Sometimes they even pay for shipping.

What's in a Name

Fundamentally, a DBA is a legal alias. It connects a real person with a company name. This means that the company has the ability set up bank accounts, own property and so forth. Note that this is not a requirement for the company, rather it is permission. You are not required to have separate bank accounts. But if you want to have a check with Dyno-Dyne on it, or deposit checks made out to Dyno-Dyne, the bank will require a 'business account' and a copy of your DBA.

In most cases, setting up a DBA is very simple. It usually requires a trip to the County Hall to fill out a short form (there may be an age requirement). You choose a name you want and look through their listings to be sure no one else is using that name. There is generally a small processing fee. Then you're in business! A note on names. The county only cares about local companies and their names. They do not list every company in the state, USA or the world. It is doubtful that they register Microsoft or General Electric. So, unless you like spending quality time with angry corporate lawyers, a quick Google of your name of choice can keep you out of trouble.

You next have to decide what position within your company you want to have. Many call themselves *owner* or *president*. I prefer a more descriptive title, like *Principal Engineer*. In that way, people immediately know your job and area of expertise. Additionally, there is the subtle implication that there are more people in the company besides yourself. Obviously, a company that is perceived to be bigger than one person is a plus.

Taxman

One of the options you have as a business is to be 'Tax Exempt'. This means that you do not have to pay tax on things you buy *for sale to others*. Obviously this initially seems very appealing. No tax! Of course, it's not that simple. If you go tax exempt, you get a tax ID number that you use for your purchases. Naturally, these purchases are recorded and sent to the proper authorities. So if you don't re-

sell these items, you must still pay tax on them. And if you do sell them, *you must collect the taxes* and pass them on. Worst of all, you have to file tax reports every three months (usually). The government is very protective of its revenue stream. TANSTAAFL! ("There ain't no such thing as a free lunch," Robert Heinlein.) For the hobbyist/entrepreneur, there is no real up-side to being tax-exempt. I have found that the less I am involved with the government, the better off I am.

If you have a home business you are allowed to write off a percentage of household expenses on your yearly income tax. This includes things like house payment/rent, electricity, cable, etc. Again, this initially sounds great. But the fine print is that your business must make money in the long run or else the government will declare it a 'hobby' and disallow the deductions.



Business or Pleasure

This brings us to an important point. Are you in business as a hobbyist or as a businessperson? It's fairly obvious that if you want to make money, you will need to set up a real company and do a lot of work. Starting a new business from the ground up

is not a project for the faint of heart. You can expect 60 to 80 hour work weeks. And for the first year or so, eating will be a milestone and sleep will be an indulgence. However building something new provides a great satisfaction. Seeing all your effort grow into something substantial is a success that few others will know. You might even get rich!

However, a real business isn't necessary. The trappings of commerce are helpful in themselves. Using company letterhead is like wearing a suit and tie. It tends to make you more aware of professionalism. It certainly makes you look better to others. Learning how companies operate, at any scale, is useful practical knowledge. And even though it takes little time and effort to obtain a DBA, you will become a member of a different group. This makes it likely that you will become more conscious of things related to business. This is also very useful.

So setting up a virtual company as 'practice' can provide a fundamental education that you can't get anywhere else. Furthermore, if you later choose to make it real, you already have the infrastructure in place. This makes the transition easy.

Making Money

Most small businesses fail within a year. About 80% of these failures are because of poor management. They fail to manage money properly. They fail to market the product well. They fail to put in the needed effort. Basically, it is a failure of understanding business. Only rarely is the failure because of a bad product or idea. So, if you think that some day you will want to have your own company, start now. Get a DBA and learn what business is all about. Give yourself an edge that others won't have. You don't actually have to do business to Do Business As.

(090995)

JOIN THE WORLD'S LEADING PLATFORM FOR ELECTRONICS ENGINEERS

160,000 MEMBERS!

**On Top of Electronics and
Information Technology**

www.elektor.com/newsletter

The latest on electronics for free in your
mailbox each Friday!

The world leading platform for electronics engineers



www.elektor.com | .de | .es | .fr | .nl | .it | .cn

elektor

Hexadoku

Puzzle with an electronics touch

And here's your first puzzle for the new year 2010. We sincerely hope you'll enjoy Hexadoku as much as you did last year. Fine prizes are available for which you can qualify by solving the puzzle. Send hexadecimal numbers in the grey boxes to Elektor and you may win an E-blocks Starter Kit Professional or an Elektor Shop vouchers. Have fun!

The instructions for this puzzle are straightforward. In the diagram composed of 16 × 16 boxes, enter numbers such that **all** hexadecimal numbers 0 through F (that's 0-9 and A-F) occur once only in each row, once in each column and in each of the 4×4 boxes (marked by the thicker black lines). A number of clues are given in the puzzle

and these determine the start situation.

All correct entries received for each month's puzzle go into a draw for a main prize and three lesser prizes. All you need to do is send us the numbers in the grey boxes. The puzzle is also available as a **free download** from the Elektor website.

Solve Hexadoku and win!

Correct solutions received from the entire Elektor readership automatically enter a prize draw for an

E-blocks Starter Kit Professional worth US\$425.00 and

three **Elektor Electronics SHOP Vouchers** worth US\$55.00. each

We believe these prizes should encourage all our readers to participate!

Participate!

Please send your solution (the numbers in the grey boxes) by email to hexadoku@elektor.com – Subject: **hexadoku 01-2010** (please copy exactly). Include with your solution: full name and street address.

Alternatively, by fax or post to:

Elektor Hexadoku, 4 Park Street, Vernon, CT 06066, USA.

Fax 860-871-0411.

The closing date is 1 February 2010.

Prize winners

The solution of the November 2009 Hexadoku is: A5F32.

The E-blocks Starter Kit Professional goes to: Eduard Kalinowski (Germany).

An Elektor SHOP voucher goes to: Tatjana Bulgak (Germany), René Niel (France), Olli Hakala (Finland).

Congratulations everybody!

4		E						2	5			B			6	
1	5			9	4	A						F	E		3	
6		0	3			1	7	C		9	8				A	
8	B		F	D	2						6	9		4		
		C		F	6	3	E	D		5		8	A	2	1	
B						8		A					C	D		
7	8			5			A		E	F	C	4	B	9		
					7		B	4	9	8	0				F	5
	0		4					C	F	8	E		D			
										3	9		1			8
	3	7		E		0							A			
E	F	1		7		D	8		C	0			3	9		
		6		0	C		D	3	2		1	5		8	9	
	2			A	B	7	5	8		4						3
3	E			2			1	5	F					4		B
		4						9	0		B	2				

(c) PZZL.com

9	F	D	C	1	2	5	E	4	A	0	6	3	7	B	8
6	B	2	1	0	A	4	D	3	C	7	8	5	E	9	F
E	A	8	4	C	7	3	B	5	1	F	9	0	D	6	2
0	5	7	3	9	8	F	6	2	D	B	E	4	1	A	C
1	0	E	9	4	F	7	3	6	2	5	D	C	A	8	B
7	8	F	A	6	5	E	1	9	B	C	3	D	2	4	0
4	6	3	B	A	C	D	2	E	8	1	0	7	5	F	9
2	D	C	5	8	0	B	9	A	7	4	F	E	3	1	6
D	3	9	E	2	6	8	C	B	0	A	4	1	F	7	5
A	2	5	F	B	4	9	7	C	E	8	1	6	0	D	3
B	4	6	0	D	1	A	5	F	3	2	7	8	9	C	E
8	C	1	7	E	3	0	F	D	9	6	5	A	B	2	4
F	7	0	2	5	E	1	4	8	6	9	A	B	C	3	D
C	E	4	8	7	D	2	0	1	F	3	B	9	6	5	A
5	1	B	6	3	9	C	A	0	4	D	2	F	8	E	7
3	9	A	D	F	B	6	8	7	5	E	C	2	4	0	1

Notice: the competition is not open to employees of Elektor International Media, its business partners and/or associated publishing houses.

Put a Stop to Throwawayism!

A visit to Helmut Singer Elektronik

By Jan Didden (The Netherlands) and Jan Buiting (Elektor UK & US Editorial)

When we talk about vintage radios, amplifiers, transmitters etc, we often forget the test equipment that was necessary to develop and maintain that equipment. Technology advances have changed test equipment into high performance, computer-driven analysis systems, but what happens with the old gear? We asked Helmut Singer, an authority in Europe when it comes to used and refurbished test equipment for electronics pro's and enthusiasts alike to drool over.

After the Second World War massive amounts of military surplus goods and gear came to the market. In a weak economic climate many electronics enthusiasts did not have the money to buy new gear, so this was really a market waiting to be opened up. Roughly a decade later, when the Cold War again prompted large investments in weapon systems and associated equipment, a steady stream of ex-military equipment was established. Companies and institutes too tried to keep up with the latest and greatest and got rid of their test equipment long before it became technically obsolete. After the turn of the century, the decline in military spending and increasing restructuring and outsourcing in companies resulted

in increasing volumes of ex-government and ex-high-end-company equipment coming on the market.

Helmut Singer started his business in the mid 1970's and has been expanding his Aachen (Germany) warehouse steadily ^[1]. As the pictures show, anybody interested in test equipment would find himself in Paradise! Although there is still a sizeable number of quite old, tube-equipped gear, lots of relatively modern, automated oscilloscopes, spectrum analyzers and network analyzers, switch-mode supplies, signal generators and multimeters line the shelves. In a warehouse this size, it is not uncommon to find sections of 20 or more identical high-perfor-

mance oscilloscopes from HP or Tektronix side by side.

Helmut Singer's customers span a wide range of interested parties. There are fewer enthusiasts nowadays who buy an old scope to take it apart or modify it, but anyone interested in electronics can now afford and buy very high-performance equipment that wasn't even available to laboratories 30 years ago. Also, many companies that have a development project that (CEO sez) "runs out of budget" come to Singer Electronic for refurbished test gear for a fraction of the original price.

When you are in this trade, you have to add



Seriously, you don't have to get on 164.8500 MHz VHF simplex to talk to Helmut Singer in his warehouse.



Equipment from a time when it was bulky and even daily operation required skills and knowledge.



Three decades of office automation "junked" and the value now expressed in gold weight.

RETRONICS XL



A whole family of Tektronix oscilloscope plug-in units.



Found them (1) ... a variety of AVO multimeters.



Rare and ultra-vintage, this DC milliammeter from The Sensitive Research instrument Corporation (La Rochelle, NY). Last calibration signed October 11, 1960.

value to what you sell. Singer has a staff of experienced technicians who test each and every piece and repair or recalibrate it before it reaches the customer. Repair does not just mean replacement of failed parts, but if necessary also replace bits inside hybrid circuits and replace the bond wires (!). In-house curve tracers are used to find replacements for obsolete transistors and diodes. Even for proprietary chips it is often possible to find replacements, second sourced or commercial alternatives. Many companies have a habit of rebranding ICs with their own 'xyz/smk-scrn' part number when in fact it's just a standard chip. Singer's technicians have accumulated a lot of experience and they always find a solution! Sometimes they are asked to repair vintage test equipment not because a replacement is not available, but because it is part of a large test suite designed around equipment available at the time. But, as Herr Singer told us, that repair gets more and more difficult because the more recent equipment sim-

ply is no longer designed to be repaired but for replacement of modules, and these are often difficult to find or unavailable. Also, with the decline of interest in this equipment, it's getting difficult to find technicians that have the expertise and interest to locate and study a schematic diagram of a failed piece of equipment and do fault-finding and repair. Mr. Singer currently has a job opportunity for someone with good fault-finding, repair and calibration skills. So far he's been unable find a suitable candidate. One young applicant, a student from the local Technical University, insisted that a faulty linear power supply placed in front of him could be repaired by writing a DLL for it on his laptop PC and then debugging the "thing" under Linux using the latest simulation software and of course a blog site — totally unaware of the burnt out transformer (and the awful smell).

How about service manuals for the equipment? Mr. Singer provides manuals or copies with his equipment, helped by the lat-

est trend to digitize service manuals. Many companies have produced pdf versions of their manuals, also for older and obsolete equipment, and these are made available for free or a small fee through online outfits ^[2,3]. But for newer equipment, designed for repair-by-replacement, component-level manuals are simply no longer produced. Also, after 9/11 some technical information that previously was freely available suddenly became classified which makes repair more difficult.

There is also tons of equipment that's beyond economical repair of course, and this is scrapped locally, if possible, or sold to specialized scrapping companies. Sometimes equipment is deliberately damaged: in one part of the warehouse we saw a stack of 12 mil-spec HP8640B RF signal generators. These came from a support unit for a decommissioned weapon system. Instructions from UpThere stated that all weapon system components be 'permanently disabled' before they could be sold as scrap.

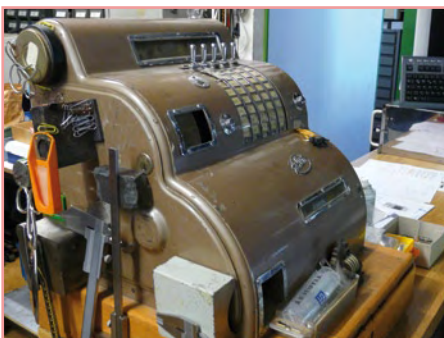

Checkout with lots of 'period elements' carefully preserved strictly without Government funding.

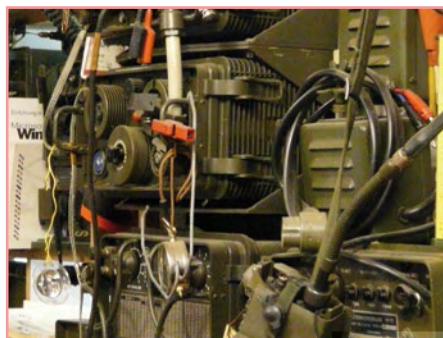

The inevitable military radio equipment which has its staunch supporters.



Vertical storage to suit shelf space: test equipment spanning roughly 40 years of electronics.



Jan Buiting is always more than comfortable with HP test gear around.



Jan Didden has rescued a gem from one of the electronics-allsorts boxes at the shop entrance.

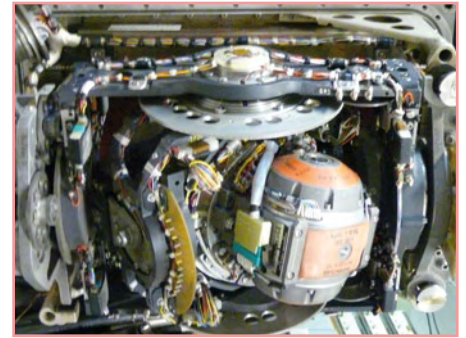

Never ask Mr. Singer about the weirdest piece of gear in his shop – this is it, basically! You have to come over to the shop in Aachen; seeing is believing.

Somebody must have taken that very literally because all HP8640B's that arrived at Singer's had their faceplate smashed by blows with a Mil-Std. #xyz hammer, no doubt about that!

Speaking of scrap, Singer took us to a newly acquired industrial yard opposite his shop and showed us huge crates brimful with parts and PCBs (mostly ex-networking) ready for recycling, i.e. recovery of precious metals and valuable minerals. Gold, platinum and palladium of course, but also metals like rhodium, which is used in relays and switches and is recycled into parts for reuse in catalytic converters for cars – full marks to Mr. Singer for saving the environment while preserving our electronics heritage. Gold plating in modern equipment is often very thin, wearing from the connectors after just a few insertions and extractions. Older (mil-spec) PC boards however

have massive gold plating on edge connectors and even gold plated solder posts and IC sockets. Despite the cost of shipping these boards by the containerload halfway around the world, recycling by specialized companies is lucrative.

Despite equipment there's a good dose of engineers' and electronics humor waiting to be discovered in Mr. Singer's warehouse, some very selective and for the initiated only. One example is an enormous coil selector unit at least 50x50x50 cms in size dangling from the ceiling. It is made from ceramic materials and silver-plated solid tubing at least 10 mm thick. It is drily labeled "wave range switch from 100 mW QRP transceiver". If you do not get the joke, you are not RF savvy. Indeed Helmut himself is the kind of person you can rely on to keep you amused for an hour or so but still in a technically informed way while your fam-

ily is out shopping and eating 'printen' in the Aachen city centre. Most Saturdays are 'cash & carry' days at Singer's — see [1] for opening hours.

Today the serious electronics enthusiasts can afford equipment that was state-of-the-art yesterday with almost the same capabilities as the latest units, albeit with less automation, which in many cases is nothing to be sad about. Companies strapped for cash in today's economic downturn can save considerably on test equipment by buying refurbished gear. And Mother Earth will thank you for recycling!

[1] <http://www.helmut-singer.de/>

[2] www.artekmedia.com

[3] <http://bama.sbc.edu/>

(090287-1)

Retronics is a monthly column covering vintage electronics including legendary Elektor designs. Contributions, suggestions and requests are welcomed; please send an email to editor@elektor.com

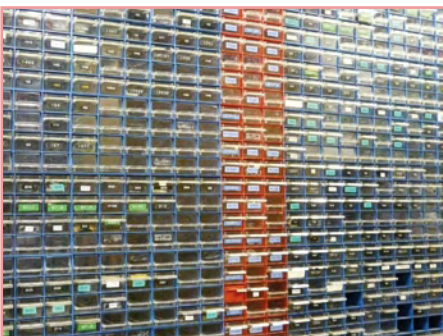

Half a mile of drawers filled with obsolete and hard to find components.



Found them (2) ... a variety of RF wattmeter adjuncts from Bird, the established market leader.



New times, new opportunities: thousands of PC cards crated for shipping to a materials recycling company.

ELEKTOR SHOWCASE

To book your showcase space contact Strategic Media Marketing Inc.

Tel. 1-978-281-7708

Fax 1-978-281-7706

Email ElektorUSA@smmarketing.us

HAMEG® Instruments

A Rohde & Schwarz Company

- ✓ Oscilloscopes
- ✓ Power Supplies
- ✓ Radio Frequency
- Measuring Instruments
- ✓ Programmable
- Measuring Instruments

Great Value in
Test & Measurement

www.hameg.com

MICROENGINEERING LABS, INC.

www.melabs.com

PICBASIC PRO™ Compiler
for PIC® MCUs

Development tools for
PIC® microcontrollers,
including Software, Device
Programmers, Prototyping
Boards, Experimenter
Boards, Serial Displays, and Books.



MICROENGINEERING LABS, INC.

www.melabs.com

Serial Displays

Software and hardware
products for embedded
development, including
BASIC Compilers for
PIC® MCUs, Experimenter Boards, Device
Programmers, Books, and other resources.



Build Your Own:

THEREMIN

Theremax
The Ultimate Theremin

pala.com

MAIA
Makers since 1959

Music/Tutorials/Kim
Analog Synthesizers
Guitar Effects
Tube Electronics
Studio Gear

Pololu Robotics & Electronics

Save 10%
on motor controllers
with coupon code
ELEKTORMC23

Electronics
Controllers & sensors
Cables & batteries
Discrete components
Jrk 21v3 USB Motor Controller
with Feedback, item #1392: **\$44.95**

Mechanical parts
Wheels & casters
Motors & servos
Robot chassis
RP5 Tracked Chassis Yellow
item #1059: **\$49.95**

www.pololu.com

7 in 1 Scope !

CircuitGear CGR-101™ is a
unique new, low-cost PC-based
instrument which provides the
features of seven devices in
one USB-powered compact box:
2-ch 10-bit 20MS/sec 2MHz
oscilloscope, 2-ch spectrum-
analyzer, 3MHz 8-bit arbitrary-waveform/standard-
function generator with 8 digital I/O lines. It also
functions as a Network Analyzer, a Noise Generator
and a PWM Output source. What's more – its
open-source software runs with Windows, Linux
and Mac OS's!

Only **\$180**

Saelig
Unique Electronics

1-888-7SAELIG
info@saelig.com
www.saelig.com

SchmartBOARD™ www.schmartboard.com

\$15 PIC Development Board

bob

basic overlay board for NTSC & PAL

Automatic text scroll & crawl · 'TTL-232' & SPI control ports
Any size for custom fonts · Vector & bitmap graphics

DECADE ENGINEERING
www.decadenet.com

PCB PROTOTYPES

BY SUNSTONE CIRCUITS®
www.sunstone.com

Sunstone Circuits is dedicated to
improving the PCB prototyping process
from quote to delivery (Q2D®) and
provides "live" customer support every
day of the year (24/7/365). For more
information or to quote and order PCBs
online, visit www.sunstone.com

PCBexpress®, PCB123™, ValueProto™, Sunstone
ECOSystem(SM), and Q2D® are trademarked by
Sunstone Circuits.

AVIT RESEARCH

www.avitresearch.co.uk

USB has never been so simple...
with our USB to Microcontroller Interface cable.
Appears just like a serial port to both PC and
Microcontroller, for really easy USB connection to
your projects, or replacement of existing RS232
interfaces.



See our webpage for more
details.

BLACK ROBOTICS

www.blackrobotics.com

Robot platforms and brains for
research, hobby and education.



- Make your robot talk!
- TalkBotBrain is open-source
- Free robot speech software
- Robot humanisation technology
- Mandibot Gripper Robot

ByVac

www.byvac.com

- PIC32 With BASIC
- ARM With Forth
- USB to I2C
- Serial Devices
- VT100 LCD Displays



DECIBIT CO.LTD.

www.decibit.com

- Development Kit 2.4 GHz
- Transceiver nRF24L01
- AVR MCU ATmega168



products and services directory

SHOWCASE YOUR COMPANY HERE

Elektor Electronics has a feature to help customers promote their business, Showcase - a permanent feature of the magazine where you will be able to showcase your products and services.

- For just \$385.00 + VAT (\$35.00 per issue for eleven issues) Elektor will publish your company name, website address and a 30-word description
- For \$550.00 + VAT for the year (\$50.00 per issue for eleven issues) we will publish the above plus run a 3cm deep full colour

image - e.g. a product shot, a screen shot from your site, a company logo - your choice

Places are limited and spaces will go on a strictly first come, first served basis. So-please fax back your order today!

I wish to promote my company, please book my space:

- Text insertion only for \$385.00 + VAT
- Text and photo for \$550.00 + VAT

NAME: ORGANISATION:

JOB TITLE:

ADDRESS:

..... TEL:

PLEASE COMPLETE COUPON BELOW AND FAX BACK TO 1-978-281-7706

COMPANY NAME

WEB ADDRESS

30-WORD DESCRIPTION

.....

.....

.....

.....

INDEX OF ADVERTISERS

Avit Research, Showcase www.avitresearch.co.uk	78	MikroElektronika www.mikroe.com	19
Beta Layout www.pcb-pool.com	87	Paia Electronics, Showcase www.paia.com	47, 78
Black Robotics, Showcase www.blackrobotics.com	78	Parallax www.parallax.com	23
ByVac, Showcase www.byvac.com	78	Pololu Corporation, Showcase www.pololu.com	59, 78
Decade Engineering, Showcase www.decadenet.com	78	Saelig, Showcase www.saelig.com	37, 78
Decibit Co. Ltd, Showcase www.decibit.com	78	Schmartboard, Showcase www.schmartboard.com	78
DLP Design www.dlpdesign.com	63	SparkFun Electronics www.sparkfun.com	88
ExpressPCB www.expresspcb.com	9	Sunstone Circuits, Showcase www.sunstone.com	2, 78
Front Panel Express www.frontpanelexpress.com	47	Showcase	78, 79
Hameg Instruments, Showcase www.hameg.com	78		
Jameco www.jameco.com/unwrap	25		
Linx Technologies www.linxtechnologies.com	3		
Microengineering Labs, Inc., Showcase www.melabs.com	78		

Advertising space for the issue of 11 February 2010 may be reserved not later than 19 January 2010
 with Strategic Media Marketing, Inc. - 2 Main Street - Gloucester, MA 01930 - USA - Telephone 1.978.281.7708 - Fax 1.978.281.7706 - e-mail: ElektorUSA@smmarketing.us to whom all correspondence, copy instructions and artwork should be addressed.

Going Strong

A world of electronics
from a single shop!

NEW!

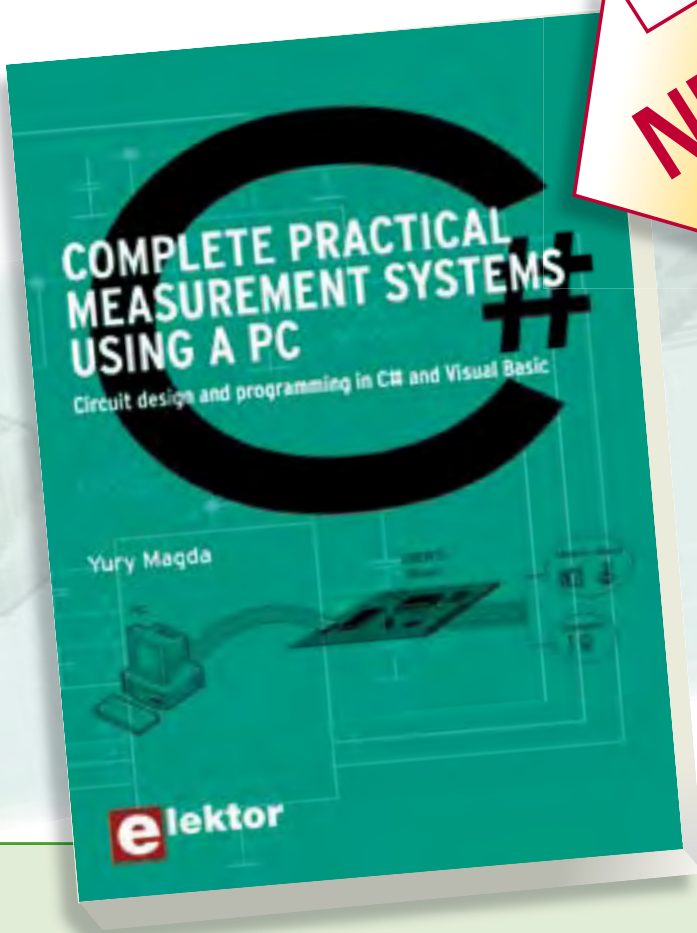

Circuit design and programming in C# and Visual Basic

Complete practical measurement systems using a PC

This is a highly-practical guide for Hobbyists, Engineers and Scientists wishing to build measurement and control systems to be used in conjunction with a local or even remote Personal Computer. The book covers both hardware and software aspects of designing typical embedded systems based on personal computers running the Windows operating system. It's use of modern techniques in detailed, numerous examples has been designed to show clearly how straightforward it can be to create the interfaces between digital and analog electronics, programming and Web-design. Hardware developers will discover how use of latest high-level language constructs overcomes the need for specialist programming skills. Software developers will appreciate how a better understanding of circuits will enable them to optimize related programs, including drivers. There is no need to buy special equipment or expensive software tools in order to create embedded projects covered in this book

292 pages • ISBN 978-0-905705-79-8 • \$46.00



Learn by doing

C Programming for Embedded Micro-controllers

If you would like to learn the C Programming language to program microcontrollers, then this book is for you. No programming experience is necessary! You'll start learning to program from the very first chapter with simple programs and slowly build from there. Initially, you program on the PC only, so no need for dedicated hardware. This book uses only free or open source software and sample programs and exercises can be downloaded from the Internet.

324 pages • ISBN 978-0-905705-80-4 • \$52.50



Learn more about C# programming and .NET

C# 2008 and .NET programming

This book is aimed at Engineers and Scientists who want to learn about the .NET environment and C# programming or who have an interest in interfacing hardware to a PC. The book covers the Visual Studio 2008 development environment, the .NET framework and C# programming language from data types and program flow to more advanced concepts including object oriented programming.

240 pages • ISBN 978-0-905705-81-1 • \$47.60

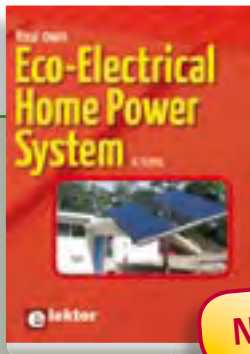

New!

Home electric power

Your own Eco-Electrical Home Power System

This book provides the semi-technical, power-conscious homeowner a place to begin in the quest for home electric power. Both the essential principles and detailed information on how to build or maintain a home electric system off the utility grid are presented in an easy-going style. This booklet will help you to safeguard or develop your own home electricity supply. It contains step-by-step calculations, practical details, examples, electric system problems with remedies and much more.

96 pages • ISBN 978-0-905705-82-8 • \$26.70



Silent alarm, poetry box, night buzzer and more

PIC Microcontrollers

This hands-on book covers a series of exciting and fun projects with PIC microcontrollers. You can build more than 50 projects for your own use. The clear explanations, schematics, and pictures of each project on a breadboard make this a fun activity. The technical background information in each project explains why the project is set up the way it is, including the use of datasheets. Even after you've built all the projects it will still be a valuable reference guide to keep next to your PC.

446 pages • ISBN 978-0-905705-70-5 • \$45.10



Bestseller!

Look into the electronics of eco-power

Practical Eco-Electrical Home Power Electronics

This book is a sequel to *Your own Eco-Electrical Home Power System* and goes deeper into the electronics of photovoltaic and thermal solar technologies, wind power conversion, inverter circuits, and loads such as electronic lighting. Power electronics circuit theory is presented while analyzing commercial circuits, including little-known converters and subtleties such as snubbers and leakage inductance. The book also offers in-depth coverage of power system strategizing for optimal efficiency and utility, including a 170 V DC bus, commercial solar charger design with detailed circuit explanations, wind generator electric machine electromechanical theory, wind converter design requirements and the series-L zero-current-switching converter and power supplies found inside loads connected to home power systems and their potential problems and consequences for inverters.

192 pages • ISBN 978-0-905705-83-5 • \$40.20

More information on the
Elektor Website:

www.elektor.com

Elektor US

4 Park Street

Vernon CT 06066

USA

Phone: 860-875-2199

Fax: 860-871-0411

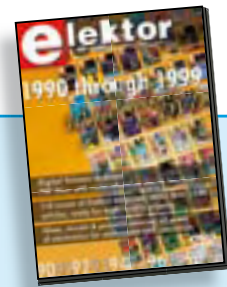
E-mail: sales@elektor.com

110 issues, more than 2,100 articles

DVD Elektor 1990 through 1999

This DVD-ROM contains the full range of 1990-1999 volumes (all 110 issues) of Elektor Electronics magazine (PDF). The more than 2,100 separate articles have been classified chronologically by their dates of publication (month/year), but are also listed alphabetically by topic. A comprehensive index enables you to search the entire DVD. The DVD also contains (free of charge) the entire 'The Elektor Datasheet Collection 1...5' CD-ROM series, with the original full datasheets of semiconductors, memory ICs, microcontrollers, and much more.

ISBN 978-0-905705-76-7 • \$111.30

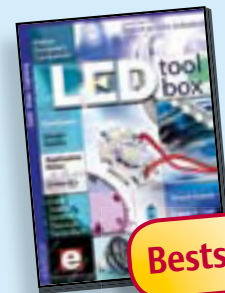

Bestseller!

See the light on Solid State Lighting

DVD LED Toolbox

This DVD-ROM contains carefully-sorted comprehensive technical documentation about and around LEDs. For standard models, and for a selection of LED modules, this Toolbox gathers together data sheets from all the manufacturers, application notes, design guides, white papers and so on. It offers several hundred drivers for powering and controlling LEDs in different configurations, along with ready-to-use modules (power supply units, DMX controllers, dimmers, etc.). In addition to optical systems, light detectors, hardware, etc., this DVD also addresses the main shortcoming of power LEDs: heating. Of course, this DVD contains several Elektor articles (more than 100) on the subject of LEDs.

ISBN 978-90-5381-245-7 • \$46.00



Embedded USB Know How
USB Toolbox

This CD-ROM contains all the essential information a designer needs to start working with the USB interface. It includes a large collection of data sheets for specific USB components from a wide range of manufacturers. USB Toolbox provides information on all ICs suitable for different applications. A subdivision has been made in controllers, hubs, microcontrollers and others. What is perhaps more interesting for many designers however, is the extremely extensive software collection which contains drivers, tools and components for Windows, Delphi and various microcontroller families. Of course, none of the Elektor articles on the subject of USB are missing on this CD-ROM.

ISBN 978-90-5381-212-9 • \$32.10



Completely updated
Elektor's Components Database 5

The program package consists of eight databanks covering ICs, germanium and silicon transistors, FETs, diodes, thyristors, triacs and optocouplers. A further eleven applications cover the calculation of, for example, LED series droppers, zener diode series resistors, voltage regulators and AMVs. A colour band decoder is included for determining resistor and inductor values. ECD 5 gives instant access to data on more than 69,000 components. All databank applications are fully interactive, allowing the user to add, edit and complete component data. This CD-ROM is a must-have for all electronics enthusiasts.

ISBN 978-90-5381-159-7 • \$40.20



New!

Preselector for Elektor SDR

Elektor's Software Defined Radio (SDR) is deservedly popular. The performance of a receiver depends to a large extent on its input filters. A selective input circuit improves antenna matching and immunity to interference from other strong signals. This preselector allows the use of up to four filters, tuned under software control using varicap diodes. A tuned loop antenna is also described that lets you use our SDR without an outdoor antenna.

Kit of parts, contains partly populated board, coil formers, ferrite rod with coils

Art.# 090615-71 • \$75.90

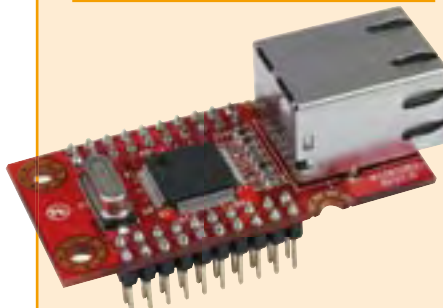

R32C Web Server

The R32C microcontroller goes Internet! A small add-on module for the application board from our September 2009 issue combines a TCP/IP chip plus Ethernet interface, a network connection with built-in transformer and status LEDs. This handy combination makes it child's play to implement a web server and many other Internet applications without getting involved in complexities such as TCP/IP protocols. Free downloads of an Open Source driver, a short web server program and other sample software complete this attractive proposition.

PCB, populated and tested WIZ812MJ module with W5100 chip

Art.# 090607-91 • \$29.10



OBD2 Analyser NG

The compact OBD2 Analyzer in the June 2007 issue was an enormous success — not surprising for an affordable handheld on-board diagnostics device with automatic protocol recognition and error codes explained in plain language. Now enhanced with a graphical display, Cortex M3 processor and an Open Source user interface, the next generation of Elektor's standalone analyser sets new standards for a DIY OBD2 project. The key advantage of the OBD2 Analyser NG is that it's self-contained and can plug into any OBD diagnostic port.

Kit of parts including DXM Module, PCB SMD-prefitted, case, mounting materials and cable

Art.# 090451-71 • \$135.50



Bestseller!

R32C Application Board

This R32C Application Board sports push-buttons, LEDs, an I2C interface, an OLED panel, an SD card interface and a socket for an Ethernet module. There is plenty of space on the board for further expansion.

Kit of parts incl. application board with SMD parts prefitted, plus all other components

Art.# 080082-710 • \$200.90

January 2010 (No. 13) \$

+ + + Product Shortlist January: See www.elektor.com + + +

December 2009 (No. 12)

Preselector for Elektor SDR

090615-71 ...Kit of parts, contains partly populated board, coil formers, ferrite rod with coils75.90

Top-of-the-Bill Lights Sequencer

090125-1PCB, bare (master module)17.50

090125-2PCB, bare (lamp module)3.80

090125-41 ...Controller (PIC18F2550) for main PCB, programmed.....23.40

090125-42 ...Controller (PIC12F508-I/SN) for lamp unit, programmed..... 3.80

The Vikings Are Coming!

080948-71 ...Kit of parts: bare PCB and bluetooth module BTM22238.30

Minimalistic Time Switch

090823-41 ...PIC12F683-I/SN, programmed.....10.50

November 2009 (No. 11)

Solder Station 'Plus'

090022-41 ...PIC18F4520, programmed18.60

AVR-Max Chess Computer

081101-1Printed circuit board20.90

081101-41 ...Programmed controller ATmega8818.60

081101-71 ...Kit of parts incl. PCB, programmed controller and components48.30

R32C Web Server

080082-71 ...Application Board with SMD parts prefitted, plus all other components200.90

080928-91 ...R32C Starter Kit: processor board populated and tested, Toolchain on CD.....43.60

090607-91 ...PCB, populated and tested WIZ812MJ module with W5100 chip29.10

October 2009 (No. 10)

Pocket Preamp

080278-71 ...Kit of parts104.90

Digital Barometric Altimeter

080444-41 ...PIC18F2423, programmed24.20

September 2009 (No. 9)

R32C Application Board

080082-71 ...Kit of parts Application Board with SMD parts prefitted, plus all other components200.90

080928-91 ...R32C Starterkit: Processor board populated and tested, Toolchain on CD.....43.60

OBD Analyser NG

090451-71 ...Kit of parts including DXM Module, PCB SMD-prefitted, case, mounting materials and cable135.50

Battery Monitor

030451-72 ...LC display17.80

080824-1Printed circuit board20.90

080824-41 ...Programmed controller LPC210326.70

July/August 2009 (No. 7/8)

Luxeon Logic

081159-41 ...Programmed controller ATtiny2510.40

Programmable Nokia RTTTL Player

090243-41 ...Programmed Attiny1310.40

Breadboard/Perfboard Combo

080937-1Printed circuit board41.20

Annoy-a-Tron

090084-41 ...Programmed controller ATtiny1310.40

Fan Speed Controller

070579-41 ...Programmed controller ATtiny1312.50

Bestsellers

Books	1	↻	Practical Eco-Electrical Home Power Electronics ISBN 978-0-905705-83-5 \$40.20
	2	➡	Elektor Personal Organizer 2010 ISBN 978-90-5381-247-1 \$40.20
	3	➡	Your own Eco-Electrical Home Power System ISBN 978-0-905705-82-8 \$26.70
	4	➡	C# 2008 and .NET programming ISBN 978-0-905705-81-1 \$47.60
	5	➡	310 Circuits ISBN 978-0-905705-78-1 \$48.30
CD/DVD-ROMs	1	➡	DVD LED Toolbox ISBN 978-90-5381-245-7 \$46.00
	2	➡	DVD Elektor 1990 through 1999 ISBN 978-0-905705-76-7 \$111.30
	3	↻	USB Toolbox ISBN 978-90-5381-212-9 \$32.10
	4	➡	ECD 5 ISBN 978-90-5381-159-7 \$40.20
	5	⬆	Home Automation ISBN 978-90-5381-195-5 \$22.50
Kits & Modules	1	↻	R32C Application Board Art. # 080082-71 \$200.90
	2	⬆	R32C/111 Starterkit Art. # 080928-91 \$43.60
	3	↻	OBD2 Analyser NG Art. # 090451-71 \$135.50
	4	⬆	R32C Webserver Art. # 080082-71 \$29.10
	5	↻	Software Defined Radio Art. # 070039-91 \$139.60

Order quickly and securely through
www.elektor.com/shop
 or use the Order Form near the end
 of the magazine!



Elektor US
 4 Park Street
 Vernon CT 06066
 USA
 Phone: 860-875-2199
 Fax: 860-871-0411
 E-mail: sales@elektor.com

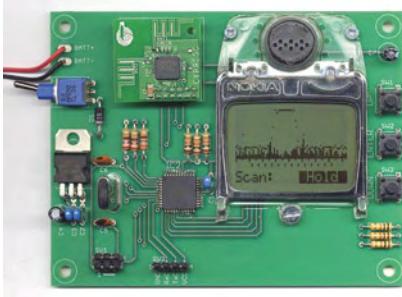

Portable 2.4 GHz WiFi Scanner

Lots of consumer electronics gear employs the 2.4 GHz ISM band, like WiFi LAN, Bluetooth and cordless peripherals for the computer. Unfortunately, noise sources like microwave ovens work on adjacent frequencies. Our portable 2.4-GHz RF scanner allows you to view frequency occupancy in your area. An ATmega microcontroller scours the entire 2.4-GHz band and displays activity on a graphic LCD.

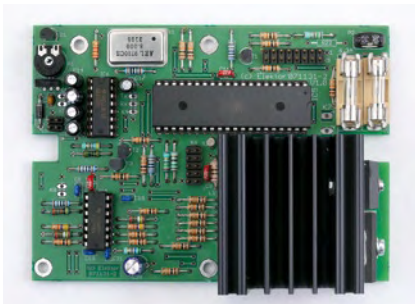

Battery Check

Every battery pack is only as strong as the weakest link, which translates into the worst cell inside. No exceptions and no matter if you're dealing with an RC model battery pack or one for flash photography.

Our intelligent battery tester allows the capacity of individual cells to be measured to identify the ones best suited to building a pack. The circuit not only measures capacity, but also internal resistance to enable cells to be matched accurately.

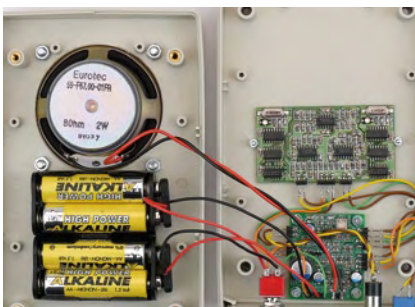

Mini Public Address

For lecturing or addressing a small gathering it's often useful to have some electronic amplification available on the spot, if only to prevent a sore throat. For the recently held ElektorLive! event our lab designed a compact portable public address (PA) box for use by those doing demos, workshops and lectures. The box has a built-in feedback suppressor, a digital power stage and a loudspeaker. The unit is battery powered and weighs less than 1,000 grams. Very handy to stretch your voice by a few yards!

*Article titles and magazine contents subject to change, please check 'Magazine' on www.elektor.com
The February 2010 issue of Elektor USA is published on Thursday, January 14, 2010.
Elektor is available on subscription or from selected Borders and Barnes & Noble bookshops in the USA and Canada.*

www.elektor.com www.elektor.com www.elektor.com www.elektor.com www.elektor.com www.elektor.com

Elektor on the web

All magazine articles back to volume 2000 (UK edition) are available online in pdf format. The article summary and parts list (if applicable) can be instantly viewed to help you positively identify an article. Article related items are also shown, including software downloads, circuit boards, programmed ICs and corrections and updates if applicable. Complete magazine issues may also be downloaded.

In the Elektor Shop you'll find all other products sold by the publishers, like CD-ROMs, kits and books. A powerful search function allows you to search for items and references across the entire website.

Also on the Elektor website:

- Electronics news and Elektor announcements
- Readers Forum
- PCB, software and e-magazine downloads
- Surveys and polls
- FAQ, Author Guidelines and Contact

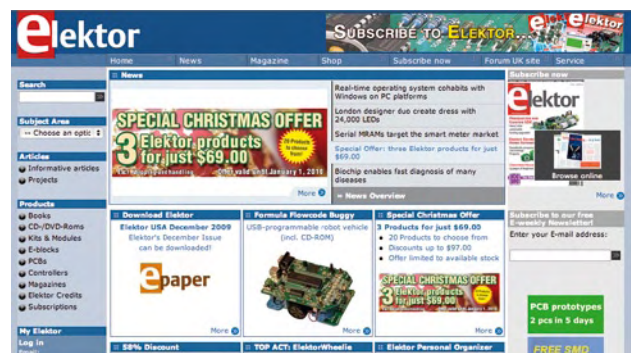

Are you an Elektor subscriber? Then send us your email address (and subscription number) and secure a subscription to Elektor Weekly, the free online newsletter published by the makers of Elektor magazine. sales@elektor.com

Order Form

01-2010

Description	Price each	Qty.	Total	Order Code
PIC Cookbook for Virtual Instrumentation	NEW \$46.00			
Complete practical measurement systems using a PC	NEW \$46.00			
Practical Eco-Electrical Home Power Electronics	\$40.20			
Your own Eco-Electrical Home Power System	\$26.70			
Elektor Personal Organizer 2010	\$40.20			
<hr/>				
	Sub-total			
Prices and item descriptions subject to change. The publishers reserve the right to change prices without prior notification. Prices and item descriptions shown here supersede those in previous issues. E. & O.E.	Shipping & Handling <i>(Airmail from Europe)</i>	\$	20.00	
	Total paid			

METHOD OF PAYMENT

Remit in US \$ drawn on a US bank. Please see next page for ordering information.

- Check or Money Order
- Mastercard
- VISA
- Discover
- American Express

XXXXXXXXXXXXXXXXXXXX

Expiry date: _____

Verification code: _____

Send order form to:

Elektor US
4 Park Street
Vernon CT 06066
USA

Phone: 860-875-2199

Fax: 860-871-0411

E-mail: sales@elektor.com

www.elektor.com



Name/Company _____

Street & No. _____

City/State/Zip _____ Country _____

Tel _____ E-mail _____

EL01 Date - - Signature _____

Order Form

01-2010

Subscription

Yes, I want to subscribe to Elektor US for 1 year*

I would like:

- Standard Subscription for \$39.95 (11 issues)
 - Plus Subscription for \$54.95 (11 issues plus the Elektor Volume 2009 DVD-ROM)
- As a special limited period offer I also receive the Volume 2008 on DVD-ROM. Free of charge!

* Offer available in US & Canada only. Canada please add \$11.00 per year for postage.

METHOD OF PAYMENT

Remit in US \$ drawn on a US bank. Please see next page for ordering information.

- Check or Money Order
- Mastercard
- VISA
- Discover
- American Express

XXXXXXXXXXXXXXXXXXXX

Expiry date: _____

Verification code: _____

Send order form to:

Elektor US
4 Park Street
Vernon CT 06066
USA

Phone: 860-875-2199

Fax: 860-871-0411

E-mail: sales@elektor.com

www.elektor.com

Name/Company _____

Street & No. _____

City/State/Zip _____ Country _____

Tel _____ E-mail _____

EL01 Date - - Signature _____

ORDERING INFORMATION

To order contact customer service:

Phone: 860-875-2199
Fax: 860-871-0411
Mail: Elektor US
4 Park Street
Vernon CT 06066
USA
E-mail: sales@elektor.com
On-line at www.elektor.com

Customer service hours: 8:00 AM–4:30 PM Monday–Thursday. Voice mail available at other times.
When leaving a message please be sure to leave a daytime telephone number where we can return your call.

PLEASE NOTE: While we strive to provide the best possible information in this issue, pricing and availability are subject to change without notice. To find out about current pricing and stock, please call or email customer service.

COMPONENTS

Components for projects appearing in Elektor are usually available from certain advertisers in the magazine. If difficulties in obtaining components are suspected, a source will normally be identified in the article. Please note, however, that the source(s) given is (are) not exclusive.

PAYMENT

Orders must be prepaid. We accept checks or money orders (in US \$ drawn on a US bank only), VISA, Mastercard, Discover, and American Express credit cards. We do not accept C.O.D. orders.
We also accept wire transfers. Add \$20 to cover fees charged for these transfers.

TERMS OF BUSINESS

Shipping Note: All orders will be shipped from Europe. Please allow 3–4 weeks for delivery. Shipping and handling via airmail: US \$20.00 per order. **Returns** Damaged or miss-shipped goods may be returned for replacement or refund. All returns must have an RA #. Call or email customer service to receive an RA# before returning the merchandise and be sure to put the RA# on the outside of the package. Please save shipping materials for possible carrier inspection. Requests for RA# must be received 30 days from invoice. **Patents** Patent protection may exist with respect to circuits, devices, components, and items described in our books and magazines. Elektor accepts no responsibility or liability for failing to identify such patent or other protection. **Copyright** All drawing, photographs, articles, printed circuit boards, programmed integrated circuits, diskettes, and software carriers published in our books and magazines (other than in third-party advertisements) are copyrighted and may not be reproduced (or stored in any sort of retrieval system) without written permission from Elektor. Notwithstanding, printed circuit boards may be produced for private and personal use without prior permission. **Limitation of liability** Elektor shall not be liable in contract, tort, or otherwise, for any loss or damage suffered by the purchaser whatsoever or howsoever arising out of, or in connection with, the supply of goods or services by Elektor other than to supply goods as described or, at the option of Elektor, to refund the purchaser any money paid with respect to the goods.

SUBSCRIPTIONS (US & CANADA ONLY)

Subscription rates (1 Yr.)

Standard Subscription: \$39.95
Plus Subscription: \$54.95

Canada add \$11 per year for postage

All subscriptions begin with the current issue. Expect 3–4 weeks for receipt of the first issue. Subscriptions, renewals, and change of address should be sent to:

Elektor US
4 Park Street
Vernon CT 06066
USA

E-mail: sales@elektor.com

Order subscriptions on-line at www.elektor.com/subs

Subscriptions may be paid for by check or money order (in US \$ drawn on a US bank only). We accept Mastercard, VISA, Discover and American Express credit cards.

For gift subscriptions, please include gift recipient's name and address as well as your own, with remittance. A gift card will be sent on request.
Subscriptions may be cancelled at any time for a refund of all unmailed issues.

Does your subscription expire soon?

Renew it online at www.elektor.com/renew

THE ORIGINAL SINCE 1994

PCB-POOL[®]

Beta LAYOUT

Servicing your complete PCB prototype needs:

- **Low Cost - High Quality**
PCB Prototypes

- **Easy Online Ordering**

- **Full DRC included**

- **Lead-times**
from 8hrs

NEW !

- **1mm Prototyping**
service

NEW !

- **Optional**
Chemical Tin finish
no extra cost

NEW !

FREE
LASER STENCIL
WITH ALL
PROTOTYPE
PCB-ORDERS

Email: sales@pcb-pool.com
Toll Free USA: 1877 390851
www.pcb-pool.com



Beta
LAYOUT

Simply send your files & order **ONLINE**



Let your geek shine.

Meet Steven Kennedy, SparkFun customer and high school teacher. In one of his classes, Steven helps his students discover the world of physical computing by encouraging them to explore all the facets of engineering – whether it is electrical, mechanical, or aeronautical. Using SparkFun products, Steven's class has created projects ranging from a homemade pick-and-place machine to a robotic arm.

Whether you're looking for tutorials to get started in electronics, or a way to inspire your students, the tools are out there. Create an environment of invention, and let your geek shine too.



Sharing Ingenuity
WWW.SPARKFUN.COM

©2010 SparkFun Electronics, Inc. All rights reserved. All other trademarks contained herein are the property of their respective owners. For more information about Steven's class and projects, please visit www.youtube.com/user/OPHSTech or www.opschools.org.