



elektor

electronics worldwide

SD Card Data Logger

Have memory, will log 4 u



Software builds hardware C-2-H, compilers & FPGAs

- ✓ **Projects** – PC Spy, Cylon Voice, Pimped Shoes, PLC, LED Projector
- ✓ **Organic Electronics** – in all shapes and sizes!
- ✓ **Embedded** – Linux, Open Source, RTOS, ARM



Great Kits for Electronics Enthusiasts

NEW KIT

New Jaycar Kits

Fast Ni-MH Battery Charger Kit

KC-5453 £11.75 + postage & packing

A truly versatile charger, capable of handling up to 15 of the same type of Ni-MH or Ni-Cd cells. Build it to suit any size cells or cell capacity and set your own fast or trickle charge rate. It also has overcharge protection including temperature sensing. Ideal for R/C enthusiasts who burn through a lot of batteries. Kit includes PCB and all specified electronic components. Case, heatsink & battery holder not included.

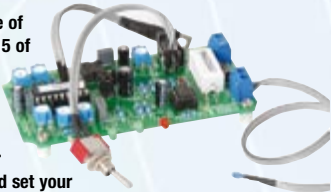

PIR Controlled Mains Power Switch

KC-5455 £23.25 + postage & packing

You've seen those lights fitted with PIR detectors that turn on when someone approaches. Well now you can do the same thing with just about any mains-powered device you like including security systems, decorative lighting, fountain pumps or even commercial advertising etc. The system uses a standard PIR to safely turn on 240VAC mains device(s) for an adjustable pre-set period. Kit supplied with case, screen printed PCB, and all electronic components.



Remote Controlled Mains Switch

KC-5462 £29.00 + postage & packing

Commercial remote control mains switches are available but these are generally limited to a range of less than 20m. This UHF system will operate up to 200m and is perfect for remote power control systems etc. The switch can be activated using the included hand held controller or our KC-5461 water tank level sensor base station. Kit supplied with case, screen printed PCB, RF modules and all electronic components.



12V Emergency Lighting Controller

KC-5456 £20.50 + postage & packing

This easy-to-build project is designed to automatically supply power for 12V emergency lighting during a blackout. The system has provision for its own 7.5Ah SLA battery, which is maintained via an external smart charger. The system includes a manual override switch & automatic protection to prevent over-discharge of the battery. Kit supplied with all electronic components, screen printed PCB, front panel and case. Charger and SLA battery available separately.



Clockwatchers' Clock Kit - It's Hypnotic

It consists of an AVR driven clock circuit that drives an 8 segment 12 or 24H display. The segments are 48mm high and consist of 3mm high brightness - but diffuse - LEDs. Additionally, around the PCB diameter are 3mm high brightness LEDs on a 60 second circle (every 5 seconds is a 5mm LED). When the clock is running the "seconds" are kept by a chase-LED running anti-clockwise from 12 noon back to the relevant "seconds" position. It takes exactly one second and this position remains illuminated. When the entire face has filled up one minute has elapsed, the digital clock increments by one and the whole process starts again. Trust us, the visual effect is mesmerising!! The kit comprises of 188mm diameter double sided plated-thru PCB with overlay and all board components. A special clock housing is included.

- With red LEDs KC-5404 £41.75 + postage & packing
- With blue LEDs KC-5416 £55.25 + postage & packing



Blue Version:
Cat. KC-5416

Red Version:
Cat. KC-5404

Build-It-Yourself Electronic Project Kits

Checkout Jaycar's extensive range. We have kits & electronic projects for use in:

- Audio & Video
- Car & Automotive
- Computer
- Learning & Educational
- Lighting
- Power
- Test & Meters
- General Electronics Projects - just for fun!



Post and Packing Charges

Order Value	Cost	Order Value	Cost
£10 - £49.99	£5	£200 - £499.99	£30
£50 - £99.99	£10	£500+	£40
£100 - £199.99	£20		

Max weight 12lb (5kg). Heavier parcels POA. Minimum order £10.

Note: Products are despatched from Australia, so local customs duty and taxes may apply.

How to order:

Phone: Call Australian Eastern Standard Time Mon-Fri on 0800 032 7241. Fax: +61 28832 3119
Email: techstore@jaycarelectronics.co.uk
Post: 320 Victoria Rd, Rydalmere NSW 2116 Australia
Expect 10-14 days for air parcel delivery



- ORDER ON-LINE
- ALL PRICING IN POUND STERLING
- MINIMUM ORDER ONLY £10

Handy Tools

Digital Multimeter Kit

KG-9250 £6.00 + postage & packing

Learn everything there is to know about component recognition and basic electronics with this comprehensive kit. From test leads to solder, everything you need for the construction of this meter is included. All you'll need is a soldering iron!

- Meter dimensions: 67(W) x 123(H) x 25(D)mm



PIC Logic Probe Kit

KC-5457 £4.50 + postage & packing

Most logic probes are designed to operate on the 5V rails that have been around in logic circuits for years.

This design operates on a wide voltage range down to 2.8V so it's suitable for use on the most modern circuits. It's also extremely compact with SMT devices on a PCB only 5mm wide, so it will fit inside a very slim case. It's capable of picking up a pulse only 50ms long and will also detect and hold infrequent pulses when in latch mode. Kit includes PCB and all specified electronic components including pre-programmed PIC. You'll need to add your own case and probe - a clear ballpoint pen.



CAT III Autoranging Pocket DMM

QM-1542 £14.00 + postage & packing

An advanced pocket sized DMM that is suitable for serious work. It features detachable leads, capacitance and frequency ranges as well as a CATIII 1000V rating and non-contact voltage detection.

- AC & DC voltage: 600V
- AC & DC current: 200mA
- Resistance: 40 MOhms
- Capacitance: 100µF
- Frequency: 100kHz
- Diode test
- Dimensions: 120(L) x 55(W) x 40(D)mm



NEW

Check out the Jaycar range in your FREE Catalogue - logon to

www.jaycarelectronics.co.uk/elektor

or check out the range at

www.jaycarelectronics.co.uk

0800 032 7241

(Monday - Friday 09.00 to 17.30 GMT + 10 hours only)

For those who want to write: 320 Victoria Rd, Rydalmere NSW 2116 AUSTRALIA

Jaycar
Electronics

BitScope PC Oscilloscopes & Analyzers

DSO Test Instrument Software for BitScope Mixed Signal Oscilloscopes

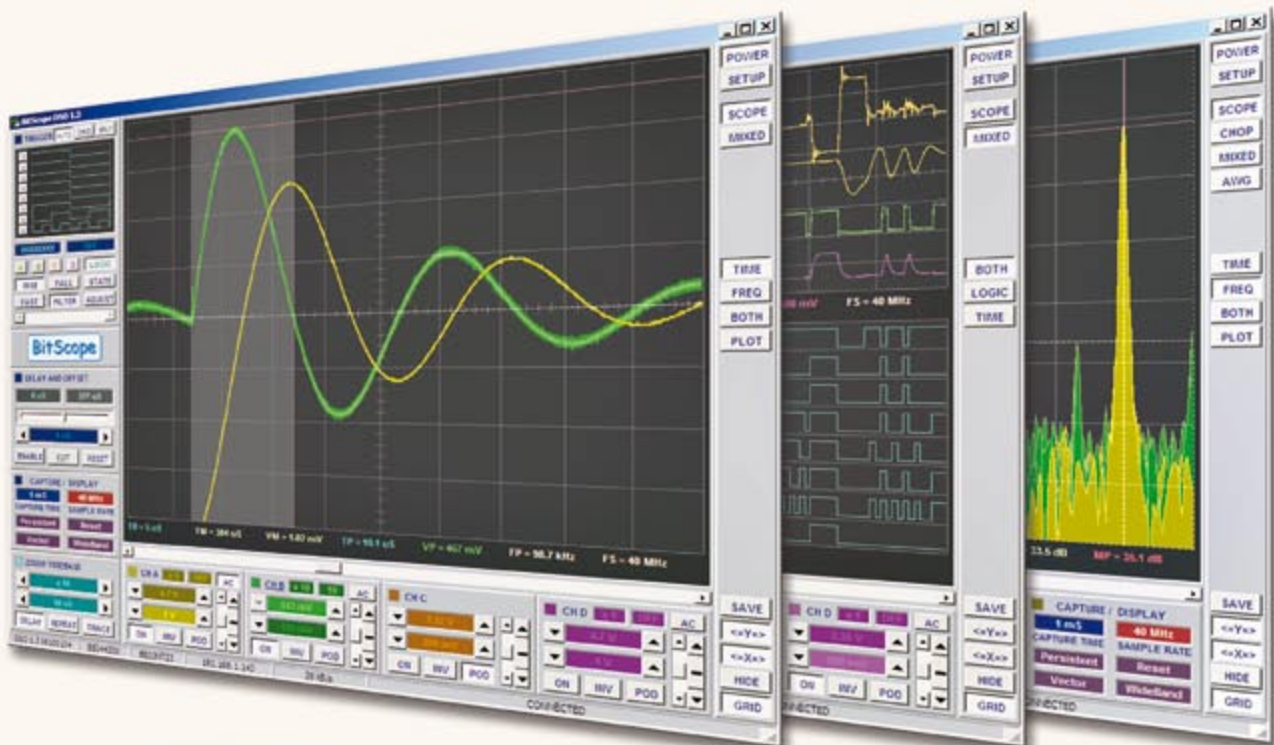

4 Channel BitScope



2 Channel BitScope



Pocket Analyzer

Digital Storage Oscilloscope

- ✓ Up to 4 analog channels using industry standard probes or POD connected analog inputs.

Mixed Signal Oscilloscope

- ✓ Capture and display up to 4 analog and 8 logic channels with sophisticated cross-triggers.

Spectrum Analyzer

- ✓ Integrated real-time spectrum analyzer for each analog channel with concurrent waveform display.

Logic Analyzer

- ✓ 8 logic, External Trigger and special purpose inputs to capture digital signals down to 25nS.

Data Recorder

- ✓ Record anything DSO can capture. Supports live data replay and display export.

Networking

- ✓ Flexible network connectivity supporting multi-scope operation, remote monitoring and data acquisition.

Data Export

- ✓ Export data with DSO using portable CSV files or use libraries to build custom BitScope solutions.

BitScope DSO Software for Windows and Linux

BitScope DSO is fast and intuitive multi-channel test and measurement software for your PC or notebook. Whether it's a digital scope, spectrum analyzer, mixed signal scope, logic analyzer, waveform generator or data recorder, BitScope DSO supports them all.

Capture deep buffer one-shots or display waveforms live just like an analog scope. Comprehensive test instrument integration means you can view the same data in different ways simultaneously at the click of a button.

DSO may even be used stand-alone to share data with colleagues, students or customers. Waveforms may be exported as portable image files or live captures replayed on other PCs as if a BitScope was locally connected.

BitScope DSO supports all current BitScope models, auto-configures when it connects and can manage multiple BitScopes concurrently. No manual setup is normally required. Data export is available for use with third party software tools and BitScope's networked data acquisition capabilities are fully supported.



www.bitscope.com

CU at Embedded 2008

If you look at the contents of Elektor over the past few years then it's conspicuous that our March issues are crammed with articles on microcontrollers, or 'embedded systems' to use the trendy expression.

In March 2006, the Elektor FPGA system was prominently featured on the front cover; in 2007, our AVR/USB development board. Both fared extremely well. Two years ago our articles on FPGAs, consisting of a course and a hardware platform, first required convincing our international editor of the sheer potential of these devices and the fact that none of our competitors had the wherewithal to even mention FPGA technology to "enthusiasts". A hard struggle it was for Elektor designer Paul Goossens, as his articles were expected to "capture only a small audience of very advanced enthusiast with industrial connections here and there". Wrong, and happy to say so! To everyone's amazement the Elektor FPGA development board and the associated FPGA module sold in the hundreds and in its wake created an enthusiastic community. The community members, I am always amazed to observe, are too modest about the results they get from our articles and kits and I would politely urge them to write just the odd line of text on their project so we can consider publishing it. For example, I heard of readers having cast vintage microprocessors like the 6502 and Z80 into the Elektor FPGA and cheerfully run emulations at speeds unheard of when the 'real DIP things' were available some 25 years ago. Ditto for old arcade-style games like Donkey Kong and Pacman.

The reason for focusing on microcontrollers in the March issue is simple and goes by the name of Embedded World, Nuremberg, Germany. This year the show is held on 26, 27 and 28 February. At Embedded World, trends in microcontroller land are defined, discovered, vapourised and talked about in two languages mainly: English and German. What better opportunity for Europe's largest magazine on electronics to present itself (in a modest way) and arrange meetings with industry leaders and their representatives (preferably well Elektorised) to see how we can work together on projects that make a difference?

cordially inviting to Booth 10-213,

Jan Buiting
Editor

Datalogger 26 "deLuxe"

Elektor has a long history when it comes to publishing data acquisition systems and loggers. The data logger we are proposing here is unique due to its simplicity and compact size; a microcontroller and a handful of common components are all it takes for hardware.

32 The Secrets of I²C

The I²C bus analyser described in this article connects to the I²C bus of an application, extracting its start, stop, address, data and acknowledge signals for the purpose of examination. It can be used to troubleshoot a reluctant proprietary circuit or to 'reverse engineer' existing applications.

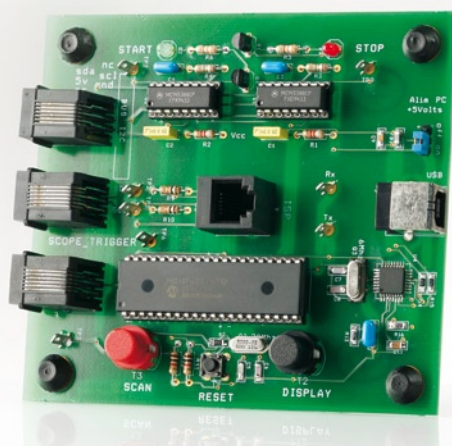

ProcessingThread

Begin

Forever Do

Wait for message

Read values from message

Process values

EndDo

End

tADCValue adcVal;

```

-;
avixPipe Read(pipeADC, (unsigned char*)adcVal,
sizeof(adcVal));

```

ADCThread

Begin

Forever Do

Wait for 1ms timer

Read ADC values

Put ADC values in message

Send message to ProcessingThread

EndDo

End

44 Real-Time Computing

By using a Real Time Operating System (RTOS) the structure of the software and the timing characteristics of the microcontroller can be significantly improved. Here we describe the operation and specific characteristics of such an RTOS.

CONTENTS

Volume 34
March 2008
no. 375

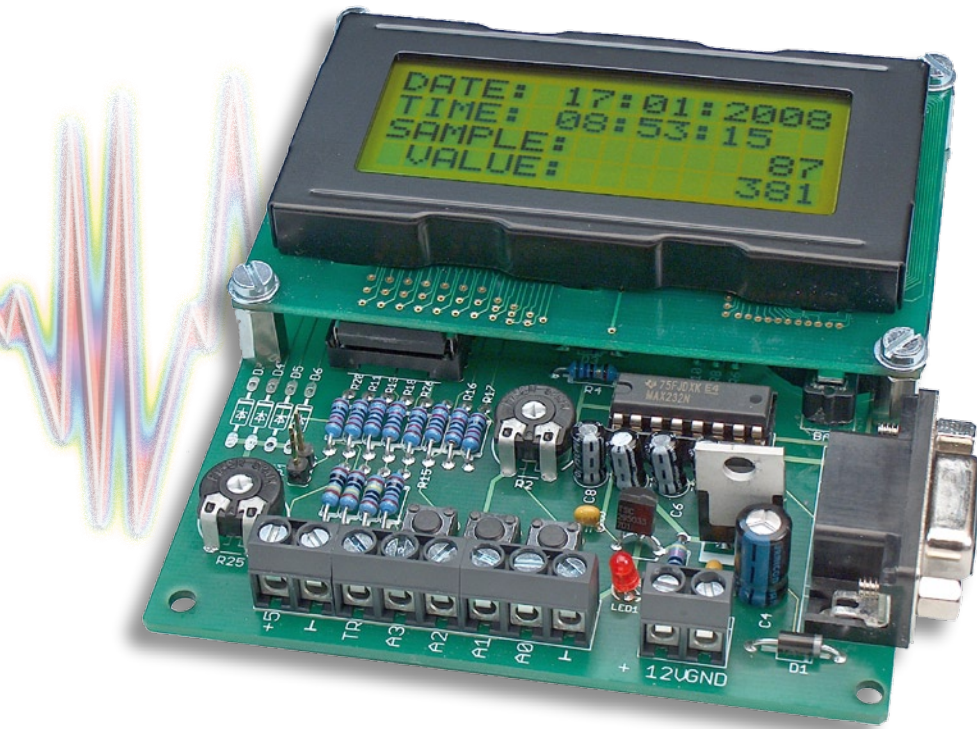

projects

- 26** Data Logger "deluxe"
- 32** The Secrets of I²C
- 40** Cylon Voice
- 44** Real-Time Computing
- 54** 'LAOS' for ARMee
- 58** DIY LED Projector
- 64** ECIO PLC
- 70** Pimp your Shoes
- 75** Design Tips:
XOR frequency multiplier
Swap button cell for a Goldcap

technology

- 22** Plastics Replace Silicon
- 48** From C to Hardware



48 From C to Hardware

Despite technological trends most new equipment does not take advantage of the capabilities of FPGAs. The main reason for this is that there are still relatively few FPGA experts. The latest developments in the EDA area can largely eliminate this obstacle.

info & market

- 6** Colophon
- 8** Mailbox
- 10** News & New Products
- 14** Get Stuck into Embedded Linux
- 18** Ethernut and the Kipp Family
- 69** Elektor Volume 2007 CD-ROM
- 72** Atmel AVR32 Gateway
- 80** Elektor SHOP
- 84** Sneak Preview

64 ECIO PLC

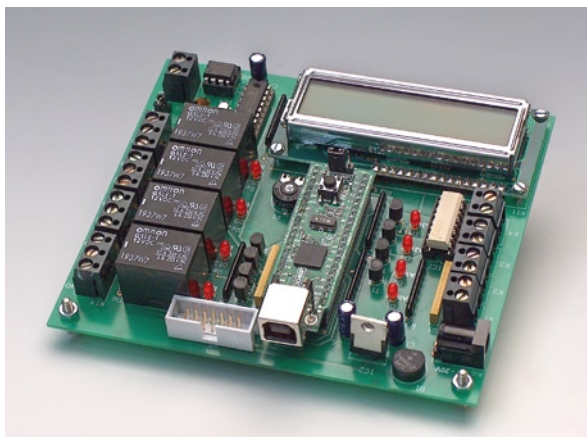

A low-cost ECIO module acts as the brains of a PLC board that has relays, optoisolators, CAN (!) connectivity and an LCD. All this I/O capacity together with Flowcode allows the board to act as a versatile, powerful PLC for quite complex control and automation projects.

infotainment

- 74** Hexadoku
- 76** Retronics: The 'Dekatron' decimal counter valve

elektor international media

Elektor International Media provides a multimedia and interactive platform for everyone interested in electronics.

From professionals passionate about their work to enthusiasts with professional ambitions.

From beginner to diehard, from student to lecturer. Information, education, inspiration and entertainment.

Analogue and digital; practical and theoretical; software and hardware.



English
German
Dutch
French
Chinese



Greek
Spanish
Swedish
Finnish



Volume 34, Number 375, March 2008

ISSN 0268/4519

Elektor Electronics aims at inspiring people to master electronics at any personal level by presenting construction projects and spotting developments in electronics and information technology.

Publishers: Elektor International Media, Regus Brentford, 1000 Great West Road, Brentford TW8 9HH, England. Tel. (+44) 208 261 4509, fax: (+44) 208 261 4447 www.elektor.com

The magazine is available from newsagents, bookshops and electronics retail outlets, or on subscription.

Elektor is published 11 times a year with a double issue for July & August.

Elektor is also published in French, Spanish, German and Dutch. Together with franchised editions the magazine is on circulation in more than 50 countries.

International Editor:
Wisse Hettinga (w.hettinga@elektor.nl)

Editor: Jan Buiting (editor@elektor.com)

International editorial staff: Harry Baggen, Thijs Beckers, Ernst Krempelsauer, Jens Nickel, Guy Raedersdorf.

Design staff: Antoine Authier (Head), Ton Giesberts, Paul Goossens, Luc Lemmens, Jan Visser, Christian Vossen

Editorial secretariat: Hedwig Hennekens (secretariaat@elektor.nl)

Graphic design / DTP: Giel Dols, Mart Schroijen

Managing Director / Publisher: Paul Snakkers

Marketing: Carlo van Nistelrooy

Customer Services: Anouska van Ginkel

Subscriptions: Elektor International Media, Regus Brentford, 1000 Great West Road, Brentford TW8 9HH, England. Tel. (+44) 208 261 4509, fax: (+44) 208 261 4447 Internet: www.elektor.com

CD-ROM Elektor 2007

➔ All articles published in 2007

NEW!

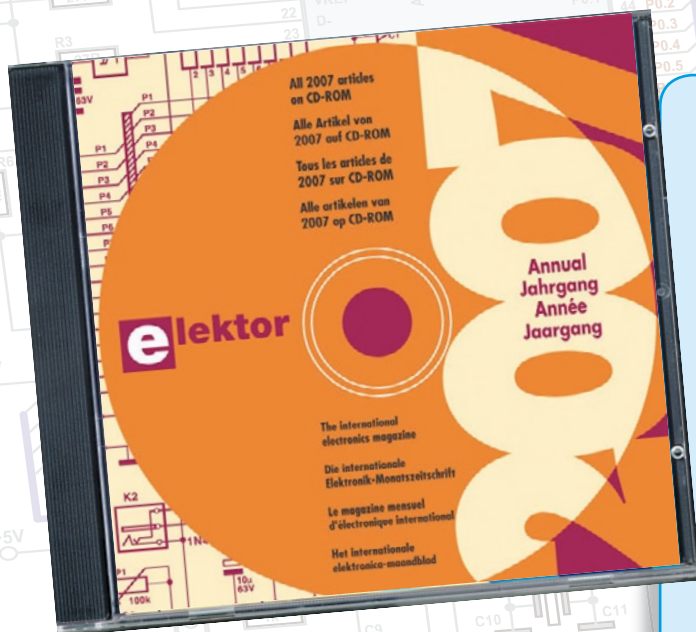

This CD-ROM contains all editorial articles published in Elektor Volume 2007. Using the supplied Adobe Reader program, articles are presented in the same layout as originally found in the magazine. An extensive search machine is available to locate keywords in any article. The installation program now allows Elektor year volume CD-ROMs you have available to be copied to hard disk, so you do not have to eject and insert your CDs when searching in another year volume. With this CD-ROM you can produce hard copy of PCB layouts at printer resolution, adapt PCB layouts using your favourite graphics program, zoom in / out on selected PCB areas and export circuit diagrams and illustrations to other programs.

ISBN 978-90-5381-218-1 • £16.90 • US\$ 33.80

elektor
SHOP

Order quickly and safe through www.elektor.com/shop
or use the Order Form near the end of the magazine

Email: subscriptions@elektor.com

Rates and terms are given on the Subscription Order Form

Head Office: Elektor International Media b.v.
P.O. Box 11 NL-6114-ZG Susteren The Netherlands
Telephone: (+31) 46 4389444, Fax: (+31) 46 4370161

Distribution: Seymour, 2 East Poultry Street, London EC1A, England
Telephone: +44 207 429 4073

UK Advertising: Huson International Media, Cambridge House,
Gogmore Lane, Chertsey, Surrey KT16 9AP, England.
Telephone: +44 1932 564999, Fax: +44 1932 564998

Email: p.brady@husonmedia.com

Internet: www.husonmedia.com

Advertising rates and terms available on request.

International Advertising: Frank van de Raadt, address as Head Office

Email: advertenties@elektor.nl

Advertising rates and terms available on request.

Copyright Notice

The circuits described in this magazine are for domestic use only. All drawings, photographs, printed circuit board layouts, programmed integrated circuits, disks, CD-ROMs, software carriers and article texts published in our books and magazines (other than third-party advertisements) are copyright Segment. b.v. and may not be reproduced or transmitted in any form or by any means, including photocopying, scanning on recording, in whole or in part without

prior written permission from the Publishers. Such written permission must also be obtained before any part of this publication is stored in a retrieval system of any nature. Patent protection may exist in respect of circuits, devices, components etc. described in this magazine. The Publisher does not accept responsibility for failing to identify such patent(s) or other protection. The submission of designs or articles implies permission to the Publishers to alter the text and design, and to use the contents in other Segment publications and activities. The Publishers cannot guarantee to return any material submitted to them.

Disclaimer

Prices and descriptions of publication-related items subject to change.
Errors and omissions excluded.

© Elektor International Media B.V. 2008

Printed in the Netherlands

A handy use for the Elektor coil meter

In the 'Practical use' section of the 'Coil Clinic' article (*Ed.*: June 2007 issue, p. 62), it was mentioned that this meter could be used to measure the A_L spec of a ferrite ring core, for example by winding 10 turns on the core.

Some other formulas that yield the same A_L value are the nH-per-turn and mH-per-1000-turns versions. I personally find the latter version more convenient in actual use.

$$n = \sqrt{L / A_L}$$

where $A_L = L / n^2$ and $L = A_L \times n^2$
(L in nH)

$$n = 1000 \times \sqrt{L / A_L}$$

where $A_L = 10^6 \times L / n^2$ and $L = A_L \times n^2 / 10^6$
(L in mH)

Square roots and squares always give 'odd' numbers, which means you may need a calculator – except with 10^2 or $\sqrt{100}$ and variants of these numbers. You can put this to good use.

If you do a lot of ring core calculations, you will notice that the A_L value obtained with 10 turns is the same as 10 times the μH value, or in other words the μH value with an extra zero tacked on.

For example, consider a 26-mm orange-red 3E25 core (TN26/15/10 from Yageo ferroxcube, formerly Philips) with an A_L value of 6420. With $n = 10$ you have:

$$L = A_L \times n^2 / 10^6 = 0.642 \text{ mH} = 642 \mu\text{H}$$

This means that the A_L value is **only** the same as the μH value with an extra zero **if the coil has 10 turns**.

If you want to use the *Elektor* coil meter for quick and easy measurement of unknown ring cores at radio swap meets or flea markets, the ideal method is to pass a bundle of 10 wires

through the core in one go, use a plug and socket to link the turns together, connect this arrangement to the meter, and read the value.

The reading proves to be too high in practice, but passing a bundle of 5 wires through the core twice and connecting them together with a plug and socket (DIL) yields excellent results (see drawing and photo).

This is a fast and convenient method for cores with diameters of 20 mm or larger. For smaller and even larger material (such as ferrite clamps), you can take along a bundle of 0.5-mm wire just in case.

The stray capacitance of the bundle of wires proves to affect the reading (the higher the capacitance, the higher the inductance reading). It's best to use five separate wires in a loose bundle instead of flat cable. Even then you have to recalibrate the meter or subtract 2 to 3 μH from the measured μH value in order to obtain the correct A_L value (which means a difference of 20 to 30 in A_L).

Ferrite cores for the highest possible usable frequency range (nickel-zinc (NiZn) ferrite) and small-diameter cores (less than 23 mm) give A_L values between 50 and 100. This is more or less the practical lower limit – not sufficiently accurate but suitable as an indication.

Small powdered-iron rings have even lower A_L values and thus also give inaccurate readings with this method, but it is a convenient way to identify them quickly.

The coil meter uses a 'digital' measurement method (frequency

counting with a resolution of 100 ms), which means it has a specific step size. As a result, the count **does not** follow a nice 1, 2, 3, ... sequence, but instead proceeds in steps of less than 2% of the indicated value. Adding a zero to the indicated value makes the A_L step resolution less than 20% of the full-range value. As ring cores can easily have a tolerance variation of 25%, this is not an especially large objection.

Walter Geeraert PE1ABR (The Netherlands)

Thanks Walter, that's a very practical suggestion for anyone who regularly uses ferrite cores and the like!

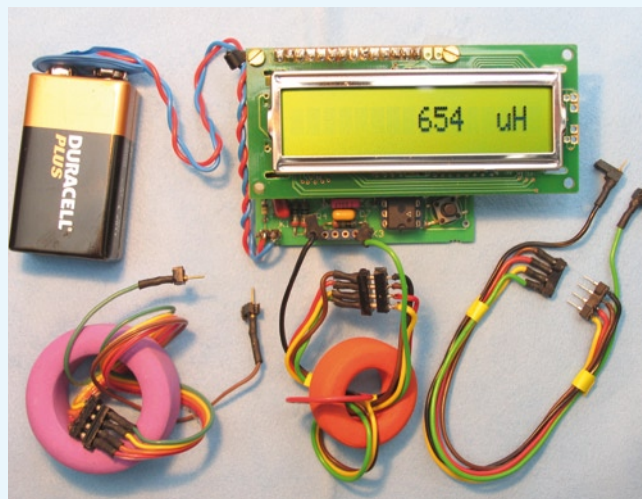
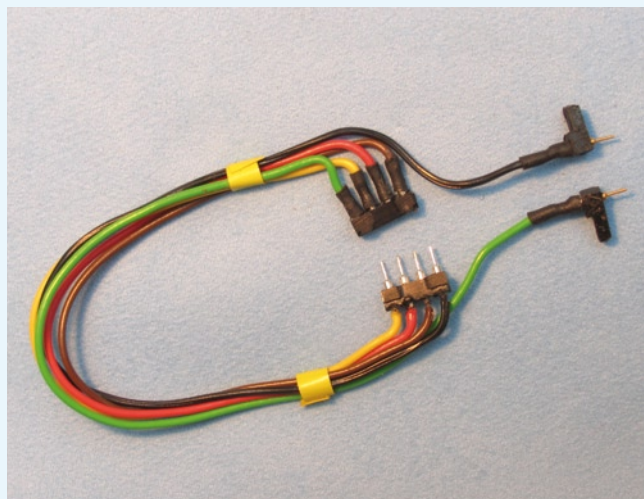
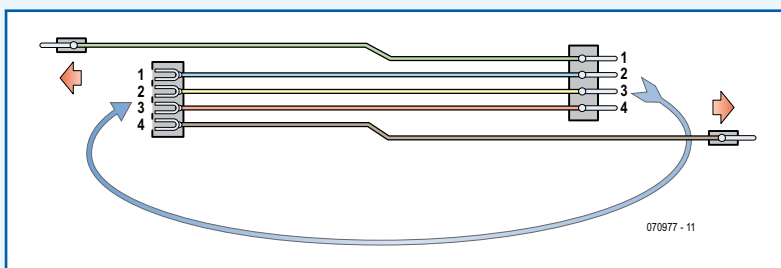

Standby switch – even greener?

I welcome every article that leads to lower power consumption and makes our world a bit greener and really liked the items presented in the January 2008 *Elektor*. Power consumption by equipment operating in standby mode requires constant vigilance. I found that it's possible to build a 'green' USB switch with zero standby power.

All that's necessary is to connect a 230-V semiconductor relay with optocoupler input to the USB.

Required components:

- 1 USB cable (perhaps second-hand) or USB socket
- 1 230 V opto/semiconductor relay with screw terminals (e.g. Clare)
- 1 power bar assembled using screw fasteners
- 1 fuseholder
- 1 fuse (to match the optocoupler specification)

If the circuit cannot be fitted into the power bar, you can remove the power switch to make room for the optorelay. You can use plastic screws to fit a small plastic cover (such as a scrap piece of PCB material) over the switch opening and mount the fuseholder on this cover.

Ralf Schmiedel (Germany)

There are always various ways to design a circuit. Some designers may prefer the use of a relay because:

- it can also be used to switch capacitive or inductive loads without any problems;
- both leads of any device not permanently connected to the 230-V mains must be switched, as otherwise (if only one lead is switched) there is a risk that only the neutral lead will be switched off, leaving the other lead connected to a live voltage.

Over Christmas

Dear Jan — I wrote to you last year complaining that there were no Xmas projects in the December 2006 edition of

Elektor magazine.

I opened this December 2007 issue wondering how to idle my time over the Christmas period. Imagine my delight when I found the i-TRIXX collection of projects.

My thanks to you and all the staff for such a wonderful Xmas edition.

Ken Barry (UK)

Thanks for that Ken, actually the December 2006 issue also had a free i-TRIXX supplement but it was not announced in relation to Christmas on the cover of the magazine.

Vista vs. LPT

Dear Paul Goossens and Jan Buiting — I read with sympathy your article in the January 2008 edition of *Elektor* concerning the problems you were having getting a parallel card to work under Vista. Recently, I bought a laptop which uses Vista, and it has no parallel port. I need the parallel port since we have a number of EVMs which use a JTAG through this port.

I bought a PCMCIA parallel port card from Quatech, and it installed fine. However, it simply did not work. Eventually, I looked in the Device Manager and changed the properties for the LPT port. First, you have to set the number of the port to be the same as the original in your XP machine (normally LPT1). Next, you also have to set up the resources to be the same. After that, everything should work ok.

Patrick Gaydecki (UK)

I've postponed binning my 25MHz 386 PC indefinitely because I need to do PROM programming and PMR radio configurations occasionally — would not miss that machine for the world.

Using the OBD2 analyser with an Audi

Dear Jan — I received the

Elektor OBD-2 analyser yesterday. I want to use it with an Audi A4 TDI (2004), but the OBD connector does not mate with the connector in the car. Although the connector does have 16 pins, it is a different type.

In *Elektor* I only see that the instrument can be used with all modern cars made since 1 January 2004. If the pins are in the right place, it's possible to cut off the housing. Please tell me how to solve this problem.

Joseph Farnborough (UK)

Volkswagen and Audi have a somewhat non-standard OBD connector. However, you shouldn't let this discourage you, because it does indeed fit. Simply make sure that the pins are all in line and then press the connector over them. Incidentally, some of our designers have recently experienced the same problem with an Audi.

OBD list

Dear Sir — I am interested in the Compact OBD-2 Analyser (*Elektor* kit # 070038-91). How can I find out whether it is suitable for our Alfa Romeo?

Pete Jacobs (UK)

The link below will take you to a list of all cars for which someone has already tried to see whether



data can be read out via the OBD interface.

If the date of manufacture of your Alfa is later than 2001, it should always be possible to read the data.

http://www.blafusel.de/misc/obd2_scanned.php

MailBox Terms

- Publication of reader's correspondence is at the discretion of the Editor.
 - Viewpoints expressed by correspondents are not necessarily those of the Editor or Publisher.
 - Correspondence may be translated or edited for length, clarity and style.
- When replying to Mailbox correspondence, please quote Issue number.
- Please send your MailBox correspondence to:

editor@elektor.com or

Elektor, The Editor,

1000 Great West Road,

Brentford TW8 9HH, England.

Advertisement

FLYPCB.com
NOTHING IS IMPOSSIBLE
PCB House
FROM CHINA TO WORLDWIDE
Start from £30
Prototype & Production
No Min Order
Fast Delivery
IMPOSSIBLE IS NOTHING
SALES@FLYPCB.COM

Visit China with Elektor

Elektor International Media is organising a study trip to China on 12–21 April of this year – and you're welcome to join us! This is an outstanding opportunity to get acquainted with China. Naturally, the main focus is electronics, but there is also room for culture. For instance, have you ever stood on the Great Wall?

In addition to visiting an electronics trade fair, you can visit interesting electronics companies in several cities. This will give you a good impression of business opportunities in China.

These company visits are an especially unique opportunity, because only a limited number of companies in China are allowed to receive groups of European visitors. Your contacts and business partners in China will undoubtedly offer you many opportunities. Naturally, you will also learn to know your fellow visitors – all of whom are actively involved in electronics – both formally and informally. This means that you can reinforce your local network during the Elektor

China tour. And of course, you will have an opportunity to see all the major attractions. China has more than one billion inhabitants with a unique history and culture.

Your tour begins in Shenzhen / Hong Kong. Here you will visit the China Electronics Fair (one of the five largest electronics fairs in Asia) and an electronics company, among other activities.

We then travel by air to Shanghai. Here we will visit not only several electronics companies, but also the well-known radio and television tower. You can enjoy an impressive view of Shanghai from the tower. That's something you don't want to miss!

We conclude the tour in Beijing, where you will visit interesting industrial electronics companies and (among other things) the Forbidden City. We will also arrange for a traditional dinner with Peking Duck. Naturally, a visit to the



Great Wall is included. After all, we know that everyone would like to stand on the Great Wall at least once in his or her life.

The definitive price will be known in mid-February 2008. The price of this all-inclusive tour will be at most € 3,950* (ex VAT) per person.

Business expenses are tax-deductible, and on request the tour costs can be invoiced as follows: 50% personal / 50% business; 100% personal; or 100% business.

* Including: Check-in service; Intercontinental air travel Amsterdam–Hong Kong and Beijing–Amsterdam; domestic flights inside China; all airport taxes; security surcharges and fuel surcharges (€ 198 per

person); local departure tax; all overnight accommodation; transportation by air-conditioned bus; all meals, including ½ litre wine per person or a number of equivalent beverages; excursions and admission charges; English-speaking local guides; luggage service.

* Excluding: tips; Visa expenses; travel accident and cancellation insurance; vaccinations; personal expenses; disaster fund contribution; travel class surcharge for international flights; air travel tax.

If you are interested, please email Mrs M. Debeij on m.debeij@elektor.com.

Note: only a limited number of places are available.

(071168-V)

PSoC® CapSense™ controller development kit

Cypress Semiconductor recently introduced the Universal PSoC® CapSense™ Controller Kit, a new kit designed for easy development and debugging of any CapSense design. It includes pre-defined control circuitry and plug-in hardware, along with controller boards for both the CY8C20x34 and CY8C21x34 PSoC devices. It also offers a breadboard module and a module for implementing up to five buttons and a slider with sample overlays to encompass a wide variety of designs.

The kit works with both PSoC Designer™ and PSoC Express™, and allows for monitoring and tuning of CapSense designs via an I2C-to-USB bridge that is included in the kit. The kit supports both the CapSense Successive Approximation (CSA) and Sigma-Delta (CSD) capacitive sensing methods. CSA offers outstanding interference immunity and low power consumption,

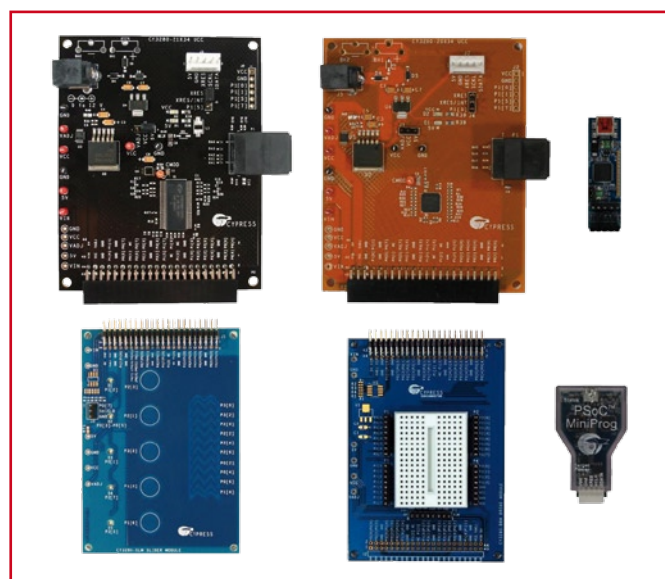

making it ideal for portable consumer applications. CSD delivers flawless operation in wet conditions, and offers superb tem-

perature response, ideal for white goods and other moisture-sensitive systems.

- CY3280-BK1 kit contents:
- CY3280-20x34 and CY3280-21x34 Universal CapSense Controller Boards
 - CY3280-SLM Universal CapSense Linear Slider Module
 - CY3280-BBM Universal CapSense Prototyping Module
 - CY3240-I2USB Board
 - CY3210 MiniProg1 Programmer
 - PSoC Express Installation CD
 - PSoC Designer and PSoC Programmer Installation CD
 - CY3280-BK1 Universal CapSense Controller Kit CD
 - 1.5 mm and 3 mm Polycarbonate Overlays

The kit is available now from Cypress's On-Line store and through authorized distributors. It costs US\$ 158.

www.cypress.com.

(071168-VIII)



EasyPIC5 Development Board

Complete Hardware and Software solution with on-board USB 2.0 programmer and mikroICD



Following tradition of its predecessor EasyPIC4 as one of the best PIC development systems on the market, EasyPIC5 has more new features for the same price. The system supports 8-, 14, 18, 20, 28 and 40 pin PIC microcontrollers (it comes with a PIC16F877A). **USB 2.0** on-board programmer with **mikroICD** (In-Circuit Debugger) enables very efficient debugging and faster prototype development. Examples in **C, BASIC** and **Pascal** language are provided with the board.

CAN-1 Board - Interface CAN via MCP2551.
CANSPI Board - Make CAN network with SPI interface.
RS485 Board - Connect devices into RS-485 network.
Serial Ethernet - Make ethernet network with SPI Interface (ENC28J60).
IrdA2 Board - IrdA2 serve as wireless RS232 communication between two MCUs.



LV24-33 Development Board

Complete Hardware and Software solution with on-board USB 2.0 programmer and mikroICD



System supports 64, 80 and 100 pins **PIC24F24HdsPIC33F** microcontrollers (it comes with PIC24FJ96GA010 - PIC24 16-bit Microcontroller, 96 KB Flash Memory, 8 KB RAM in 100 Pin Package). Examples in **BASIC, PASCAL** and **C** are included with(in) the system. You can choose between **USB** and **External Power supply**. **LV24-33** has many features that make your development easy. **USB 2.0** on-board programmer with **mikroICD** (In-Circuit Debugger) enables very efficient debugging and faster prototype development.

CF Board - Easy way to use Compact flash in your design.
MMC/SD Board - Easy way to use MMC and SD cards in your design.
EEPROM Board - Serial EEPROM board via I2C interface.
RTC Board - PCF8583 RTC with battery backup.



PICPLC16B Development Board

Complete Hardware and Software solution with on-board USB 2.0 programmer and mikroICD

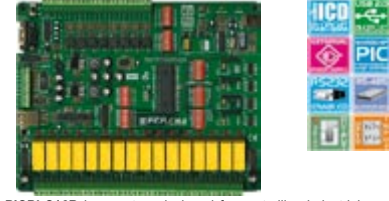

PICPLC16B is a system designed for controlling industrial systems and machines. 16 inputs with **optocouplers** and 16 relays (up to 10A) can satisfy many industrial needs. The ultra fast **mikroICD** (In-Circuit Debugger) enables very efficient debugging and faster prototype development. Features : **RS485, RS232, Serial Ethernet, USB 2.0** on-board programmer and **mikroICD** (In-Circuit Debugger) on-board.

ADC Board - 12-bit analog-to-digital converter (ADC) with 4 inputs.
DAC Board - 12-bit digital-to-analog converter (DAC) with SPI.
Keypad 4x4 Board - Add keypad to your application.
Accel. Board - Accel. is an electronic device that measures acceleration forces.



mikroElektronika Compilers

Pascal, Basic and C Compilers for various microcontrollers



Supporting an impressive range of microcontrollers, an easy-to-use IDE, hundreds of ready-to-use functions and many integrated tools makes MikroElektronika compilers one of the best choices on the market today. Besides **mikroICD**, mikroElektronika compilers offer a statistical module, simulator, bitmap generator for graphic displays, 7-segment display conversion tool, ASCII table, HTML code export, communication tools for SD/MMC, UDP (Ethernet) and USB, EEPROM editor, programming mode management, etc.

Each compiler has many routines and examples such as EEPROM, FLASH and MMC, reading/writing SD and CF cards, writing character and graphics on LCDs, manipulation of push-buttons, 4x4 keyboard and PS/2 keyboard input, generation of signals and sounds, character string manipulation, mathematical calculations, I2C, SPI, RS232, CAN, USB, RS485 and OneWire communications, Manchester coding management, logical and numerical conversion, PWM signals, interrupts, etc. The CD-ROM contains many already-written and tested programs to use with our development boards.

mikroElektronika manufactures competitive development systems. We deliver our products across the globe and our satisfied customers are the best guarantee of our first-rate service. The company is an official consultant on the PIC microcontrollers and the third party partner of Microchip company. We are also an official consultant and third party partner of Cypress Semiconductors since 2002 and official consultant of Philips Electronics company as well. All our products are RoHS compliant.

All of our products are shipped in special protective boxes.
 -On-line secure ordering provides fast and safe way of buying our products.

<http://www.mikroe.com/en/distributors/>

Find your distributor: UK, USA, Germany, Japan, France, Greece, Turkey, Italy, Slovenia, Croatia, Macedonia, Pakistan, Malaysia, Austria, Taiwan, Lebanon, Syria, Egypt, Portugal, India.

Uni-DS 3 Development Board

Complete Hardware and Software solution with on-board USB 2.0 programmer

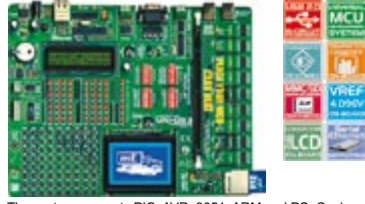

The system supports PIC, AVR, 8051, ARM and PSoC microcontrollers with a large number of peripherals. In order to continue working with different chip in the same development environment, you just need to switch a card. **UNI-DS3** has many features that make your development easy. You can choose between **USB** or **External Power supply**. Each MCU card has its own **USB 2.0** programmer!

LV 18FJ Development Board

Complete Hardware and Software solution with on-board USB 2.0 programmer and mikroICD

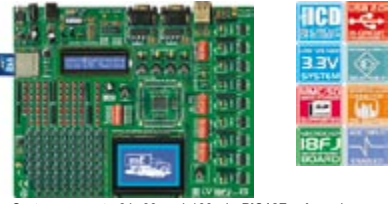

System supports 64, 80 and 100 pin **PIC18FxxJxx** microcontrollers (it comes with PIC18F87J60 - PIC18 Microcontroller with an integrated 10Mbps Ethernet communications peripheral, 80 Pin Package). **LV 18FJ** is easy to use Microchip PIC18FxxJxx development system. **USB 2.0** on-board programmer with **mikroICD** (In-Circuit Debugger) enables very efficient debugging and faster prototype development. Examples in **C, BASIC** and **Pascal** language are provided with the board.

EasysdsPIC4 Development Board

Complete Hardware and Software solution with on-board USB 2.0 programmer and mikroICD



The system supports **18, 28** and **40** pin microcontrollers (it comes with dsPIC30F4013 general purpose microcontroller with internal 12-bit ADC). **EasysdsPIC4** has many features that make your development easy. Many of these already made examples in **C, BASIC** and **PASCAL** language guarantee successful use of the system. Ultra fast **USB 2.0** on-board programmer and **mikroICD** (In-Circuit Debugger) enables very efficient debugging and faster prototype development.

dsPICPRO 3 Development Board

Complete Hardware and Software solution with on-board USB 2.0 programmer and mikroICD



The system supports dsPIC microcontrollers in 64 and 80 pins packages. It is delivered with dsPIC30F6014A microcontroller. **dsPICPRO3** development system is a full-featured development board for the Microchip dsPIC MCU. **dsPICPRO3** board allows microcontroller to be interfaced with external circuits and a broad range of peripheral devices. This development board has an on-board **USB 2.0** programmer and integrated connectors for MMC/SD memory cards, 2 x RS232 port, RS485, CAN, on-board ENC28J60 Ethernet Controller, DAC etc...

EasyARM Development Board

Complete Hardware and Software solution with on-board USB 2.0 programmer



EasyARM board comes with Philips LPC2214 microcontroller. Each jumper, element and pin is clearly marked on the board. It is possible to test most of industrial needs on the system: temperature controllers, counters, timers etc. **EasyARM** has many features making your development easy. One of them is on-board **USB 2.0** programmer with automatic switch between 'run' and 'programming' mode. Examples in **C** language are provided with the board.

BIGPIC4 Development Board

Complete Hardware and Software solution with on-board USB 2.0 programmer and mikroICD

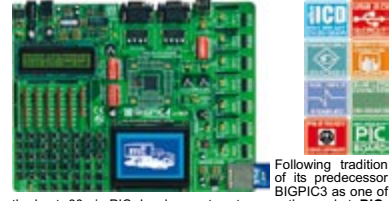

Following tradition of its predecessor **BIGPIC3** as one of the best 80-pin PIC development systems on the market, **BIGPIC4** continues the tradition with more new features for the same price. System supports the latest (64) and 80-pin PIC microcontrollers (it is delivered with PIC18F8520). Many of these already made examples in **C, BASIC** and **Pascal** language guarantee successful use of the system. Ultra fast on-board programmer and **mikroICD** (In-Circuit Debugger) enables very efficient debugging and faster prototype development.

EasyAVR5 Development Board

with on-board USB 2.0 programmer

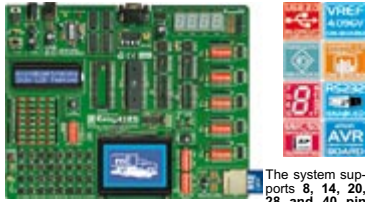

The system supports **8, 14, 20, 28** and **40** pin microcontrollers (it comes with ATMEGA16). Each jumper, element and pin is clearly marked on the board. It is possible to test the most of industrial needs on the system: temperature controllers, counters, timers etc. **EasyAVR5** is an easy-to-use Atmel AVR development system. On-board **USB 2.0** programmer makes your development easy. Examples in **BASIC** and **Pascal** language are provided with the board.

BIGAVR Development Board

with on-board USB 2.0 programmer

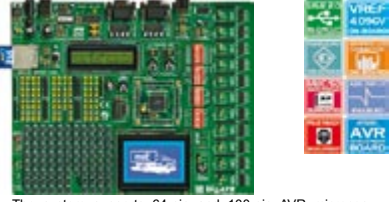

The system supports 64-pin and 100-pin AVR microcontrollers (it is delivered with ATMEGA128 working at 10MHz). Many already made examples guarantee successful use of the system. **BIGAVR** has many features that makes your development easy. You can choose between **USB** or **External Power supply**. **BIGAVR** also supports Character LCD as well as Graphic LCD.

Easy8051B Development Board

with on-board USB 2.0 programmer



System is compatible with **14, 16, 20, 28** and **40** pin microcontrollers (it comes with AT89S253). Also there are **PLCC44** and **PLCC32** sockets for 32 and 44 pin microcontrollers. **USB 2.0** Programmer is supplied from the system and the programming can be done without taking the microcontroller out.

EasyPSoC3 Development Board

with on-board USB 2.0 programmer



The system supports **8, 20, 28** and **48** pin microcontrollers (it comes with CY8C27843). Each jumper, element and pin is clearly marked on the board. **EasyPSoC3** is an easy-to-use PSoC development system. On-board **USB 2.0** programmer provides fast and easy in-system programming.

Please visit our website for more info <http://www.mikroe.com>

EasyDAQ USB relay card

EasyDAQ has announced the launch of a new low cost USB, 4 channel relay card, adding to its existing range of USB powered data acquisition and automation/control products. Controlled via a simple ASCII character text strings, the new USB4Mx range is available as a compact, integrated card with four opto-isolated relays, 4 general purpose DIO channels and screw terminal access to the USB power.

Available with two relay options, the USB4PRMx is fitted with a 240 VAC/10 amp relay (PCB designed to handle 240 VAC @ 10 amps) and the USB4SRMx is fitted with a 30 VDC/1 A, high sensitivity, (gold contact) signal relay. The DIO channels are capable of sourcing 20mA per channel. With

screw terminal access to the NO/COM/NC contacts and DIO channels, and LED relay/USB power status indicators, the cards are suitable for a wide range of mains and DC volt-

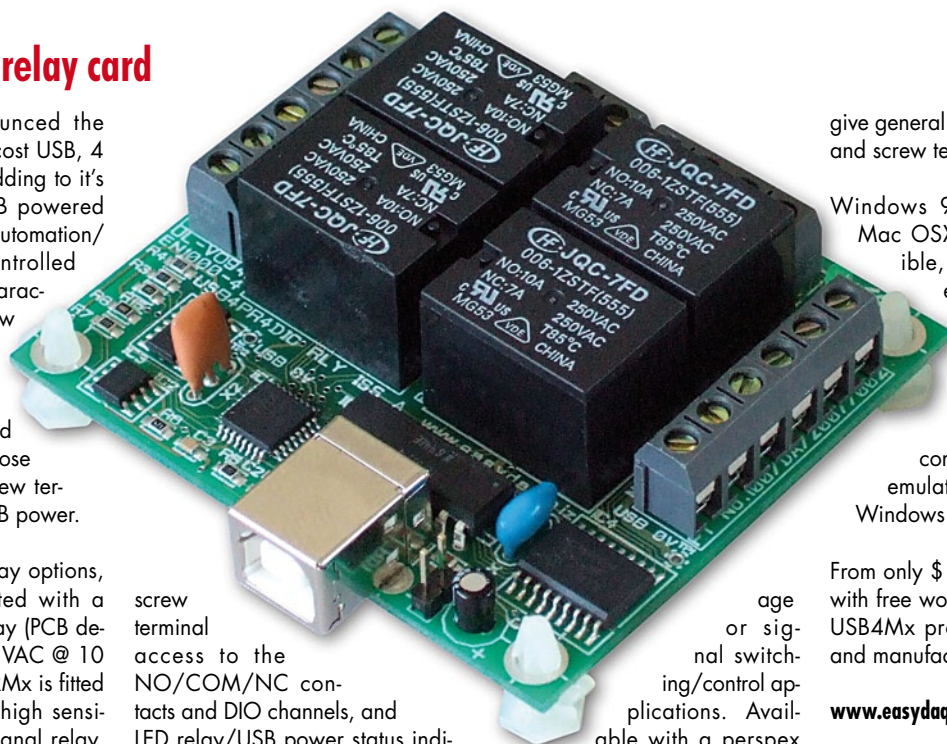

give general protection to the card and screw terminal blocks.

Windows 98SE/2K/XP/Vista, Mac OSX and Linux compatible, with downloadable example programs available for LabVIEW, Visual Basic, Visual C, Delphi & Agilent VEE, the card can also be commanded via terminal emulator programs such as Windows HyperTerminal.

From only \$ 78/€ 55/£ 38, and with free worldwide shipping, the USB4Mx products are designed and manufactured in the UK.

www.easydaq.biz

(070996-III)

LCD shop-window displays go interactive

ZYFILM™, a new through-glass touch sensing film announced by Zytronic, adds touch capabilities to TFT-LCD screens up to 30" in screen size mounted behind shop windows or similar glass panels. The film attaches to the window unobtrusively without adhesive, and provides an industry-standard USB interface for fast and convenient installation.

ZYFILM enables retailers to quickly add interactive features to window-mounted LCD displays, which are now widely used to present sales messages at street level. Touch capability allows these displays to transact sales and collect customer information.

The ZYFILM sensor detects user interactions through up to 20mm of glass, which allows installation on the inside of the shop window for extra security. ZYFILM adheres us-



ing an electrostatic surface treatment, so that repositioning or removal leaves no permanent residue on the glass. It also features a convenient USB connection for data as well as power, which eliminates the cost and complexity of an external power supply.

ZYFILM touch sensors incorporate Zytronic's patented Projected Capacitive Technology (PCT™), which uses an array of embedded micro-fine wires to create a capacitive touch sensor inside a clear, laminated structure. PCT sensors deliver several advantages to commer-

cial operators, including drift-free operation, high durability, and resistance to accidental or deliberate damage, allowing operators to minimise overheads such as servicing, maintenance and replacement costs. In addition, ZYFILM sensors accommodate the full range of commercial TFT-LCD screen sizes, including wide-screen displays. The complete Zytronic product range delivers a variety of rigid and flexible touch sensors for use in e-commerce, kiosks, point-of-sale equipment, public information systems and many other applications including terminals such as banking ATMs or keyless entry systems where high resistance to malicious damage is a pre-requisite.

www.zytronic.co.uk

(071168-IX)

High power 2.45 GHz RF module for ZigBee

Radiocrafts AS now expand their product line with a compact high power RF module design for ZigBee™ operating at 2.45 GHz. The new module deliver up to 18 dBm output power, and gives an increased communication range of

up to 10 times compared to standard low output power modules. The new RC2201HP is compliant with IEEE 802.15.4 and is designed for ZigBee Full Function Device (FFD) and Reduced Function Device (RFD) operation, or other

protocol stacks using star or mesh topologies.

The complete shielded module is only 16.5x35.6x3.5 mm, optionally available with integrated antenna. An integrated microcontroller makes it possible to embed the

complete application in this tiny module. The output power can be adjusted to comply with EU regulations for CE marking, as well as FCC and ARIB approvals.

Some of the unique features for the Radiocrafts RC2201HP mod-

ule are:

- up to 18 dBm output power, giving 10 times range increase
- receiver sensitivity of -94 dBm at 250 kbit/s
- 16 channels at 2.45 GHz compliant with IEEE 802.15.4
- small size: 16.5x35.6x3.5 mm
- shielded module with integrated antenna
- 128 kB flash memory, 8 kB RAM
- 32 digital and analogue I/Os, 8 channel 10 bit ADC

- UART and SPI interfaces
- Suitable for full or reduced function ZigBee stack

The module is based on DSSS (Direct Sequence Spread Spectrum) technology and offer exceptional range and performance even in crowded and noisy environments compared to other 2.45 GHz technologies. Low power modes for increased battery life are available.

Typical applications include home, building and industrial automation,

wireless security and alarm systems, automatic meter reading, remote control and telemetry, fleet and asset management.

Operation at the 2.45 GHz licence free band enables world-wide usage.

The modules are suitable for pick and place automatic assembly in volume production and are avail-



able in tape&reel.

www.radiocrafts.com

(071168-VI)

National Instruments free technical seminar tour visits 22 locations around UK & Ireland

Register now for a free, three-hour hands-on introduction to data acquisition with LabVIEW Seminar to learn how to design and build powerful measurement and control applications using National Instruments LabVIEW graphical programming and NI USB data acquisition devices. The tour of 30 seminars in 22 locations around UK & Ireland is designed for engineers, scientists and technicians who build test, measurement, process monitoring and control, or research and analysis applications. Attendees will test-drive professional PC-based data acquisition systems and learn how to create modular, flexible and scalable systems with short development times at low cost. NI data acquisition and signal conditioning products ensure highly accurate measurements, whilst the award-winning LabVIEW software gives engineers the power to easily acquire, analyse and present data.

Locations and Dates:

10/03/2008	09:00/13.30	Newbury, Berkshire
11/03/2008	09:00/13.30	Oxford
12/03/2008	09:00/13.30	London
13/03/2008	09:00	Gatwick
18/03/2008	09:00	Chelmsford
19/03/2008	09:00	Hatfield
20/03/2008	09:00/13:30	Cambridge

26/03/2008	09:00	Bournemouth
27/03/2008	09:00/13.30	Southampton
01/04/2008	09:00/13.30	Bristol
02/04/2008	09:00/13:30	Birmingham
03/04/2008	09:00	Loughborough
08/04/2008	09:00/13.30	Sheffield
09/04/2008	09:00	Halifax
10/04/2008	09:00/13.30	Manchester
15/04/2008	09:00	Glasgow
16/04/2008	09:00	Edinburgh
17/04/2008	09:00	Washington, Nr Newcastle Upon Tyne
22/04/2008	09:00	Belfast
23/04/2008	09:00	Dublin
24/04/2008	09:00	Cork

Registration is free — either through www.ni.com/uk/handson or ni.com/ireland/handson, by calling 01635 572498, or by sending an e-mail to events.uk@ni.com.

(071168-III)

Environmental email alerts in real-time

Lascar Electronics Ltd. has introduced the EL-USB-RT; a USB enabled temperature and humidity sensor designed to send email alerts of temperature or humidity readings that exceed acceptable conditions. The EL-USB-RT, which is connected to a PC via a USB port, is supplied with dedicated software that provides a real-time indication of ambient temperatures between -10 and +60°C and humidity between 0 and 100%RH. These, together with a calculated dew point, can be viewed as either a constantly updated graph, or a numerical indication of the last reading taken. Users can assign high and low alarms for both temperature and

humidity, and the software can be configured to send email alerts as these levels are exceeded. This feature is particularly useful for server room monitoring, where keeping the servers and other network equipment in a controlled environment helps eliminate down-time and minimises the risk of damage to expensive equipment. The EL-USB-RT is available immediately directly from Lascar Electronics at a price of £ 29.50 at one-off. Discounts for quantity are available upon request.

www.lascarelectronics.com

(071168-VII)



Get stuck into embedded Linux

Andrew Eliasz (First Technology Transfer)

It is surprising how few electronics engineers and hobbyists are aware of the fascinating world of embedded Linux. Hopefully this article will put you straight!

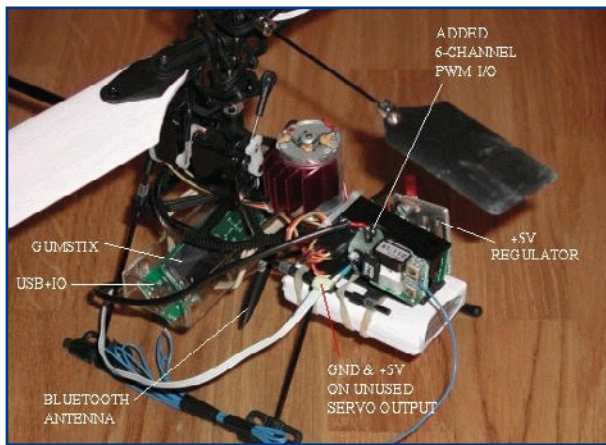

Figure 1.
Robotic Microhelicopter and its components.

One of the main things that transpired from the 2007 Embedded Systems Show was that surprisingly many companies developing and marketing systems based on 8-bit microcontrollers (e.g. 8051 clones, AVR's, PIC16's and PIC18's) were making plans to use powerful 32-bit microcontrollers and the Linux operating system as the basis for their next generation of products. My immediate thoughts were along the lines of "do these people realise what they are letting themselves in for?" The other source of 'inspiration' for this article came from a couple of outstanding software engineers from BT's Martlesham labs who attended an advanced FTT course on Linux Kernel and Device Driver programming and who 'introduced' me to the exciting world of "Gumstix".

Gumstix

For those of you who have not been exposed to them, Gumstix [1] are cheap and powerful ARM9 embedded Linux systems and add-on boards with a very small footprint (only somewhat larger than an old fashioned stick of chewing gum), and can provide a very good introduction to Linux, not just because of their relatively low price, but also because the Gumstix community is so helpful and enthusiastic. Just as *Elektor* readers have embraced 8-bit and 16-bit microcontrollers such as PIC16/18's, Atmel AVR's and PIC24's in a whole variety of projects, it's quite likely they will embrace Gumstix in a whole generation of new projects using a 32-bit ARM9 architecture and running the Linux operating system.

Enter Linux

For those who like a challenge and enjoy hard mental work Linux is great fun. To become an embedded Linux guru, many skills need to be mastered. It is possible to teach yourself Linux and there are many good books available covering both running Linux on PCs and using Linux in embedded systems. Skills learned on PCs can be transferred to embedded systems development and vice versa. Embedded systems engineers want to develop working systems as soon as possible — turn LEDs on and off, stop and start stepper motors, collect sensor readings, and implement various feedback control applications. The satisfaction of writing these simple Linux programs comes from an appreciation of the way in which the various pieces of Linux work together in the execution of the code, and an appreciation of how it is possible to put together far more complex applications built on these foundations. The whole point of working with Linux is that it permits the implementation of systems that can juggle many resources at once and to implement interactive applications for both 'communicating with' and 'controlling' all this juggling. There is the further bonus that a vast amount of free and very powerful open-source software running under Linux is readily available. This software is as good as, and often much better than, much proprietary commercial software. Many companies selling tools into the high-end real-time and embedded market are not just quietly including Linux based products in their product portfolios but also upgrading their IDEs (Integrated Development Environments) using Eclipse as their starting point. The business model of quite a few of these companies is based on the selling of expensive support services with their particular 'commercial' distribution. For instance, Wind River Systems has acquired FSMLabs and has embedded Linux products in its portfolio; LynuxWorks sells not only LynxOS (a hard real-time Posix compliant OS) but also an embedded Linux distribution called 'Bluecat'. MontaVista's business model is based on producing Linux distributions tailored to specific markets such as the mobile telephony and telecomms markets. For commercial organisations that need to get products to market fast the cost of using these commercial distributions can be justified. For most *Elektor* readers these costs are just too prohibitive. The good news is that it is possible to learn and master embedded Linux systems development without using these expensive products, and that the skills learned are exactly the same as those needed when working with the more expensive commercial distributions. Both

the embedded Linux community and the broader Linux and open-source community are enthusiastic and very supportive of beginners.

Gaining an understanding of developing embedded Linux requires focus and effort. How might this effort be directed? Here are some suggestions.

- Getting to know how to drive Linux from a terminal — the various Linux commands and utilities with mysterious names such as 'grep', 'find', 'ls', 'chmod' and so on; the techniques for combining them using pipes and redirection.
- Learning how to write programs for the bash shell.
- Learning how to program in C and C++ and how to write applications that make use of the Linux Application Programming Interface (API).
- Learning how to configure network interfaces.
- Learning how to install and configure Linux services such as DNS, mail servers, Apache, and DHCP.
- Understanding how to drive hardware from user applications.
- Learning how to build, load and boot tailored Linux kernels.
- Learning how to implement Linux device drivers.
- If you are interested in multimedia applications then start exploring the wealth of open source applications, tools and utilities available for Linux.
- If you are interested in telephony then you should explore VoIP and other open source applications including open source mobile telephony.

Most of your Linux skills can be developed using PCs, including older 80486 and Pentium II PCs. You might also consider installing Cygwin and Eclipse on your Windows XP, Vista or Windows 2000 PC or workstation and develop your skills here. Later you can install and set up cross-compilers for e.g. ARM or PowerPC targets. Sysgo sells a commercial Linux development system targeting e.g. ARM9 systems and running on Microsoft Windows called Elinos. You can also, of course, install cross-development tools on an Intel laptop or workstation running Linux.

Moving it to embedded

If you are planning to work professionally developing embedded Linux applications then, of course, I would recommend undertaking some professional training, and this might include considering some kind of University degree course that covers Linux and embedded Linux programming in depth.

For your initial foray into embedded Linux systems on a non Intel processor based platform, investing in a one of the Gumstix boards, and a few add-on boards is an excellent way to get started. There are many interesting Gumstix based projects out there including robotics applications, mobile telephony applications, and data acquisition applications. Gumstix are sold directly over the web so as to avoid costs associated with resellers and distributors. There are discounts when purchasing multiple boards, hence it is useful to group together with some likeminded people and purchase your Gumstix as a group. Linux builds for Gumstix boards can be downloaded from the Gumstix web site and there are also many useful examples of how to write device drivers and build applications that are either available or that can be tracked down starting from the Gumstix web site. Gumstix also sells bundles containing a base board and a selection of add on boards. Gumstix also has developed a sensor rich Atmel AVR board, the Robostix board, that can be connected to the ARM base boards. A setup

based on an ARM9 Gumstix board and the Atmel AVR based Robostix board can provide a very good introduction to implementing distributed multi-processor applications in which a central processor communicates with a number of small microcontroller based systems

Gumstix in practice

Here are just a few Gumstix based projects to whet your appetite.

PersonalSoundtrack — developed by Greg Elliot at the University of California, Irvine, uses Gumstix to implement a tiny wearable computer that detects the wearer's walking or running speed and plays songs from his/her music library that match the wearer's pace. Refinements include instantly adjusting the song speed to match small variations in your gait, and changing songs in response to a deliberate pace change (e.g. from walking to jogging).



Figure 2. Robot Fish resembles a 50-cm long) common carp, mimics the undulating motions of a real fish swimming and turning. Three Robo-fish swim in a tank in the London aquarium alongside their living counterparts. (courtesy Professor Huosheng Hu, Computer Science Department, Essex University)

ENIPS — a project at the State University of Arizona, which involves developing a robust, secure, easily configurable manageable intrusion detection and prevention system, all in a small mobile phone sized box.

Flightstix — a project from the Aerial Robotics Club at North Carolina which is developing a UAV autopilot module for the GumStix as part of a system to compete in the AUVSI international aerial robotics competition (**Figure 1**).

The various sensors used include

- 10-channel independent servo-type
- PWM input and output
- 3-axis gyroscope
- 3-axis accelerometer
- 3-axis magnetometer
- ultrasonic altimeter
- GPS
- two differential-pressure transducers (for pitot/static and barometric altitude)

Robo-fish — a project from Professor Hu at the University of Essex, London, which involved the design of a robotic fish swimming in the London Aquarium (**Figure 2**).

Sailing robots — Aberystwyth University is using Gumstix in various sailing boats which will be used in oceanographic research, and also entered into Microtransat Challenge, a transatlantic autonomous boat race.

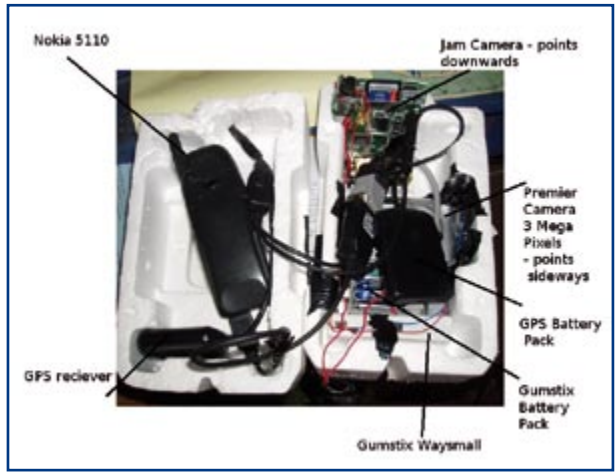

Figure 3.
The Pegasus payload.
(courtesy James Coxon)



Figure 4.
Image of stratosphere taken by Pegasus.
(courtesy James Coxon)

Pegasus High Altitude Balloon Project [2] — an amateur & student project involving sending payloads to ‘near space’ (60,000 to 325,000 ft) by use of helium weather balloons which are designed to burst at a certain height (**Figures 3, 4**). The Gumstix payload returns to earth via parachute. Some of the interesting features of this project include

- GPS (serial, compact flash and onboard);
- interfacing with mobile phones (gnokii);
- interfacing with radio (Aerocomm 868 MHz radio modems and 434 MHz beacons);
- using GPIOs to trigger camera shutters & cutdown circuits.

As *Elektor* readers these projects should inspire your imagination and your curiosity. FTI uses Gumstix in some of its embedded Linux training courses. For further information please visit <http://www.fti.co.uk>.

(071106-1)

Web Links

- [1] <http://www.gumstix.com>
- [2] <http://www.pegasushabproject.org.uk>

Advertisement

PCB-Soldering.co.uk

Suppliers of PCB Soldering Equipment & Rework Stations

NEW IN STOCK

328 Working Platform

<p style="writing-mode: vertical-rl; transform: rotate(180deg); font-weight: bold;">850A+ SMD Rework Station</p> <p style="text-align: center; font-weight: bold;">Online Price £44.95</p>	<p style="writing-mode: vertical-rl; transform: rotate(180deg); font-weight: bold;">932 Vacuum Pick Up Station</p> <p style="text-align: center; font-weight: bold;">Online Price £29.95</p>	<p style="writing-mode: vertical-rl; transform: rotate(180deg); font-weight: bold;">937+ 45W Soldering Station</p> <p style="text-align: center; font-weight: bold;">Online Price £37.95</p>	<p style="writing-mode: vertical-rl; transform: rotate(180deg); font-weight: bold;">Range Of Tools & Accessories</p>
<p style="writing-mode: vertical-rl; transform: rotate(180deg); font-weight: bold;">2738 CPU Controlled PCB Work Station</p> <p style="text-align: center; font-weight: bold;">Online Price £139.95</p>	<p style="writing-mode: vertical-rl; transform: rotate(180deg); font-weight: bold;">2900 70W Soldering Station</p> <p style="text-align: center; font-weight: bold;">Online Price £74.95</p>	<p style="writing-mode: vertical-rl; transform: rotate(180deg); font-weight: bold;">Soldering Iron Tips & Air Nozzles</p> <p style="text-align: center; font-weight: bold;">Wide Selection Available</p>	
<p style="writing-mode: vertical-rl; transform: rotate(180deg); font-weight: bold;">853A Quartz Infrared Preheater</p> <p style="text-align: center; font-weight: bold;">Online Price £69.95</p>	<p style="writing-mode: vertical-rl; transform: rotate(180deg); font-weight: bold;">950 SMD Hot Tweezers & Station</p> <p style="text-align: center; font-weight: bold;">Online Price £44.95</p>	<p style="writing-mode: vertical-rl; transform: rotate(180deg); font-weight: bold;">710 Infrared Welding Station</p> <p style="text-align: center; font-weight: bold;">Online Price £750.00</p>	<div style="text-align: center;"> <p style="font-size: 0.8em;">Suppliers of Test-pins, Receptacles & Probes...</p> <p style="font-size: 0.8em;">For Test-pins & Probes Visit www.test-pins.co.uk</p> <p style="font-size: 0.8em;">Above discount code also applies</p> </div>

www.pcb-soldering.co.uk

Allendale Electronics Ltd, 43 Hoddesdon Industrial Centre, Pindar Road, Hoddesdon, Hertfordshire. EN11 0FF.

T: +44 (0)1992 450780 W: www.pcb-soldering.co.uk
F: +44 (0)1992 450781 E: sales@pcb-soldering.co.uk

USB Connected High Speed PC Oscilloscopes

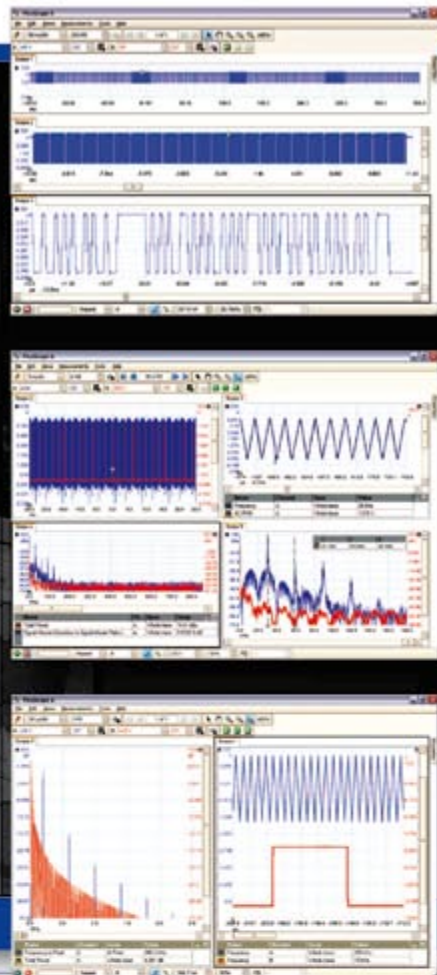

5000 SERIES

PicoScope 5000 Series The No Compromise PC Oscilloscopes

With class-leading bandwidth, sampling rate, memory depth and an array of advanced high-end features, the PicoScope 5000 PC Oscilloscopes give you the features and performance you need without any compromise.

250 MHz bandwidth
1 GS/s real-time sample rate
128 megasample record length

Advanced Triggers

In addition to the standard triggers the PicoScope 5000 series comes as standard with pulse width, window, dropout, delay, and logic level triggering.

250 MHz Spectrum Analyser
High-speed USB 2.0 Connection

Automatic Measurements

Arbitrary Waveform Generator

Define your own waveforms or select from 8 predefined signals with the 12 bit, 12.5 MS/s arbitrary waveform generator.

Waveform Playback Tool

PicoScope software now allows you to go back, review, and analyse up to 1000 captures within its waveform playback tool.

pico
Technology

3000 SERIES

The PicoScope 3000 Series of oscilloscopes from Pico Technology includes general purpose and high resolution models: With 12 bit resolution and 1% accuracy, the 10MHz PicoScope 3424 is able to detect changes as small as 0.024% (244ppm) – making it the ideal 4-channel oscilloscope for analog design and analysis. The higher speed 8 bit models in the PicoScope 3000 series feature sampling rates up to 200MS/s and up to 1 MS/s record lengths for general purpose and portable applications.



2000 SERIES

The PicoScope 2000 series oscilloscopes offer single and dual channel units that offer highly portable/low cost solutions to general purpose testing. The award winning 25MHz handheld PicoScope 2105 fits comfortably into the palm of your hand yet still includes the powerful features found in larger oscilloscopes.



The PicoScope 2000 series oscilloscopes offer single and dual channel units that offer highly



VISIT www.picotech.com/scope459

to check out our full line of PC-based instruments or call **01480 396 395** for information and a product catalogue

Ethernut and the Ki

or how to build a business with Open Source

Dr. Thomas Scherer

Talk to any business advisor about a new product you have in mind and the chances are that the first bit of advice you will get is to protect your idea with copyright and patent. Hi tech entrepreneurs would not consider a business plan based on an Open Source product as a good investment but then again they haven't met Harald Kipp. Be warned, as Harald found out, success can have a big effect on family life...



Harald Kipp was leading a life of contentment as the head of his small software company in a small town in Germany on the banks of the Ruhr when he first became interested in Open Source software and in those early days he was happy to look on it as a hobby interest rather than serious work. Thanks to the arrival of the Internet towards the end of the 1990s Harald found that he was not alone in his hobby. In fact the potential of networked communication became the source of inspiration for the project that was to go on to change his life. He could have just carried on with his successful software business, but with a mixture of happenstance and dogged determination together with support from the Open Source community he was able to turn a concept that began as a hobby into a sizeable business.

Microcontroller meets Internet

Towards the end of the last century optimism in the future of dot-com companies was reaching a peak and microelectronics had pervaded almost every item of electrical equipment. Practically every washing machine was now equipped with a microprocessor, mobile phones were becoming ever smaller while still managing to pack in more

Figure 1. The egnite team on the company roof garden in Castrop-Rauxe, Germany. Harald Kipp is on the left next to his family and co-workers.

pp Family...

products

and more features. Peripheral equipment for PCs became integrated into single chip solutions. New 8-bit microcontrollers were appearing which were more efficient and more powerful than their predecessors and which certainly could put the old IBM PC-XT workhorse of the eighties in the shade. Many engineers and designers were keen to exploit the power of these new microcontrollers in networked configurations and handling Internet protocols. By the year 2000 at least two Open Source projects had been produced to realise this goal: '1wIP' was the work of Adam Dunkel from SICS (Swedish Institute of Computer Science) and 'Liquorice' which was a high performance (network orientated) operating system written by Dave Hudson. By chance Harald stumbled upon Dave's work while surfing the Web and he was surprised to discover that there was no dedicated hardware design for the project. Using an STK-200 kit from Atmel (based on the ATmega103) together with additional memory and an ISA Ethernet card Harald was able to get the complete system running although he was not as yet entirely happy with the stability of the platform.

The birth of Ethernet

Following on from this early success Harald set out to design a dedicated PCB for the project, managing to squeeze an ATmega103, an RTL8010AS-Ethernet controller and 32 kB of RAM neatly onto a single, half-Eurocard sized board which he half-jokingly christened 'Ethernet'. The additional RAM was essential because the microcontroller is equipped with just 4 kB of RAM and 3 kB of this would be taken up by the send and receive data buffers of a single Ethernet frame. With the remaining 1 kB of memory even the most gifted software engineer would be hard pressed to write any Internet software to do anything at all useful. In the meantime Dave Hudson had moved to the company Ubicom who

market a competing Operating System so work on liquorice was halted and the software was incorporated into the Ethernet project and renamed Nut/OS to allow further software development. By the middle of 2001 Ethernet had been registered with SourceForge as a combined hard and software Open Source project. From this point on the community showed much interest in the project and surprisingly were asking where they could purchase the finished Ethernet board. Up until this point Harald had been busy with his own company 'egnite Software GmbH' which as you can guess from the title had concentrated on software development. It seemed a risky venture to take the company into the unknown territory of supplying both hardware and software products but with advice and support from another start-up company 'optiCompo Electronics' (who were already established in the field) he was

able to make the decision to go ahead. Initially the two-layer Ethernet board was assembled in-house by hand. However the first sizeable order from Japan for 50 units certainly put a strain on the modest production capability of the Kipp family assembly line!

MP3 down the line

As word got around so orders for Ethernet increased steadily until production of the boards overtook all other activity at the company. At first the orders were from private users, schools and Universities, but small companies and other industrial concerns were also finding interesting applications for the product. He was approached by one

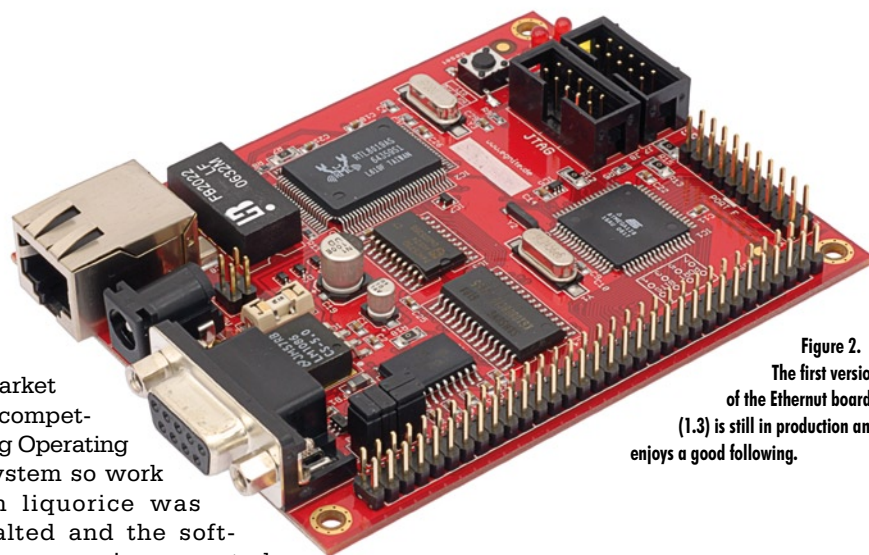

Figure 2.
The first version of the Ethernet board (1.3) is still in production and enjoys a good following.

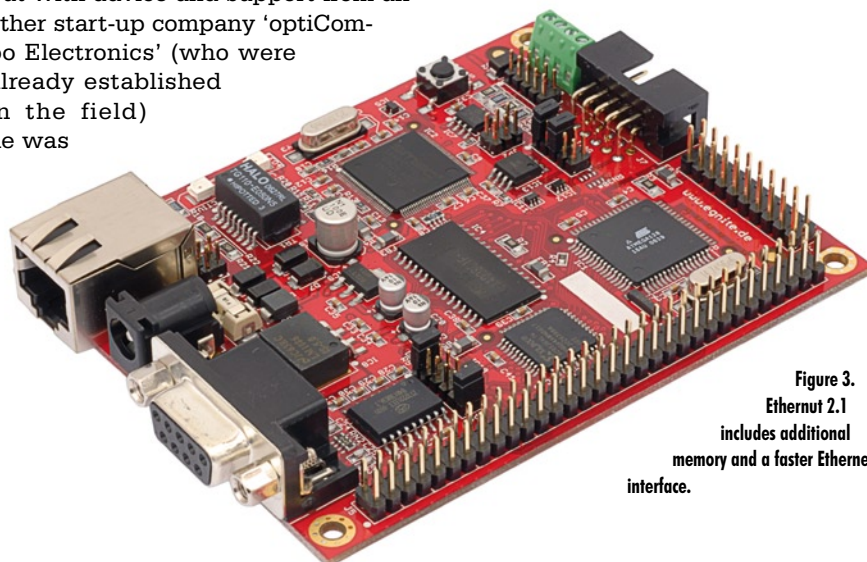

Figure 3.
Ethernet 2.1 includes additional memory and a faster Ethernet interface.

buyer from a chain of retail stores who was interested in installing web-connected listening booths in their shops. The idea was that by just scanning the EAN barcode on a music CD the customer would cause the tracks in MP3 format to be streamed to the listening booth using TCP/IP from a server. It would no longer be necessary to break the seal on a new CD case just to listen to some tracks before deciding whether to buy an album.

With good foresight the Ethernut board (**Figure 2**) had been designed with an expansion connector so it was a relatively simple job to devise a small plug-in expansion board containing an MP3 player chip type VS1001K. With the addition of some software the MP3 Streaming-Client was finished. Jesper Hansen made a significant contribution to this last part; he had already established a good reputation in the field with his Open Source project YAMPP [3].

The Ethernut Family

Transfer of MP3 streams over the internet suggested another application: Internet-Radio. There are any number of radio stations 'transmitting' on the Internet, no matter where in the world you may be if you have Internet access then you are just a mouse click away from even the most obscure 'local' radio programme. The broadcasts take the form of MP3 format files sent as SHOUTcast digital audio streams using TCP packets. To ensure continuous play it is necessary to store the packets in a relatively large memory buffer otherwise reception drop-outs occur. The relatively small Ethernut memory capacity was insufficient for this application and called for a redesign.

The result was Ethernut 2 (**Figure 3**) which has a 100-Mbit Ethernet and 512 kB RAM. The processor can only directly address 64 kB of memory so a

bank-switching technique is employed to access the entire on-board memory. The prototype used a few logic gates to implement the bank switching but after some intensive and helpful discussions with members of the user-group it was decided to replace the gates with a CPLD (**Complex Programmable Logic Device**).

By 2004 Ethernut 2 was introduced to the world and a Dutch company was one of the first to tap into its potential by incorporating it into a web radio device. The radio offers MP3 streamed church service programmes in the home for people who through disability are unable to attend church. The equipment is completely self contained and requires no PC expertise on the part of the user. Details of two companies using Ethernut based web radios are given in [6].

The need for more processing power led to the third incarnation of the board

Table 1. Technical specification of the Ethernut series.

Specification \ Board	Ethernut 1.3 G	Ethernut 2.1 B	Ethernut 3.0 E	Ethernut 5 (preliminary)
CPU	ATmega128	ATmega128 ATmega2561	AT91R40008 (ARM7)	AT91SAM9260 (ARM9)
Clock speed	14.7456 MHz	14.7456 MHz	73.728 MHz	180 MHz
RAM	32 kB	512 kB as 32 kB + 30 banks of 16 kB	256 kBytes	64 Mbytes
Non volatile memory	128 kB Flash 4 kB EEPROM	128/256 kB Flash 4 kB EEPROM 512 kB Flash serial	4 MB Flash 32 kB EEPROM serial	4 MB Flash 32 kB EEPROM serial
Ethernet	RTL8019AS 10 Mb/s	LAN91C111 10/100 Mb/s	DM9000E 10/100 Mb/s	DM9161A PHY 10/100 Mb/s
Programmable Hardware	-	XC9536XL (for internal use)	XC95144XL (partly available) + CY22393 (programmable clock)	-
USB	-	-	-	1 Host 1 Device
RS232 interface	DB9 socket	DB9 socket using RTS/CTS	DB9 connector using full handshake	DB9 connector using full handshake
Secondary RS232 interface	TTL on expansion connector	Via cable adapter or TTL on expansion connector	Via cable adapter or TTL on expansion connector	TTL on expansion connector
RS485 interface	-	Half duplex	-	-
Digital I/O-Ports	31	31	48 max, some via CPLD	Not yet defined
Analogue inputs	8	8	-	4
Memory expansion	Yes	Yes	Yes, via CPLD	Yes
Hardware Clock/calendar	-	-	Yes with capacitor Backup	Yes
Memory card slot	-	-	MMC/SD	Yes
Power requirements	8 to 12 V, 150 mA	8 to 12 V, 400 mA	Switch mode mains adapter. 5 V @ 200 mA and 24 V @ 70 mA	Switch mode mains 5 V and 24 V or USB or via POE
Temperature range	Commercial	Industrial	Commercial	Not yet defined
Board size mm	98 x 78	98 x 78	98 x 78	98 x 78

Ethernut 3 (Figure 4). The 8-bit controller was replaced by the more advanced ARM7-CPU giving sufficient power to support applications using encrypted data. During this time some interesting experiments were carried out to port the Nut/OS to a Gameboy Advance.

Under development at the moment is Ethernut 5, this board uses an ARM9-CPU which gives sufficient processing power to decode and display video streams on an LCD. Version 4 of the board shown in Figure 5 is a little less powerful than version 5 and is used as the basis of the Elektor Internet radio which we plan to feature in detail in the next edition of *Elektor*.

The Ethernut boards have a good reputation and have consequently built up a large community of users. Some software changes and extensions are contributed by the community and the job of egnite in this case is to test the code stability using different platforms and with different compilers before it can be officially released. Along with Harald there are now 18 other software engineers who have been granted 'write access' to the source code for the project. There is also healthy support and exchange with other Open Source projects, in particular with the YAGARTO toolchain by Michael Fischer.

Open Source and business

These two concepts would seem to be at odds with each other. The software and hardware for the project are available through LGPL or BSD licence which means that there are relatively few restrictions on their use, similar to 'public domain'. In contrast to GPL it is not necessary to disclose details of the finished product in which Ethernut is installed. These points along with the ease with which the complete Ethernut board can be incorporated into a manufacturer's end product means that it is attractive to commercial users. Harald Kipp has ensured that all the different versions of the board share the same pin out arrangement including the expansion connector.

The story of Ethernut began as a interesting sideline for Harold Kipp but as time went on the product 'somehow' became the main focus of activity for his company, don't assume that work on Open Source projects will always be an altruistic and non-profitable endeavour. The Open Source concept has much to offer, not only is it a good environment to learn new skills where the community can support the enthusias-

tic amateur but it can help develop your business skills and indeed may even be the start of a successful business enterprise.

In keeping with Open Source philosophy Harald is not at all secretive about his company activity: production is currently running at several thousand boards per year giving the company a turnover in excess of 600,000 euro (approx. £ 425,000). The company has expanded, taking on full and part-time employees together with trainees. The whole family is in fact fully engaged in all aspects of the company activities and have supported the venture from the start. Who would have guessed that it would be possible in the 21st century to make such a success of a business selling Open Source equipment?

(071080-1)

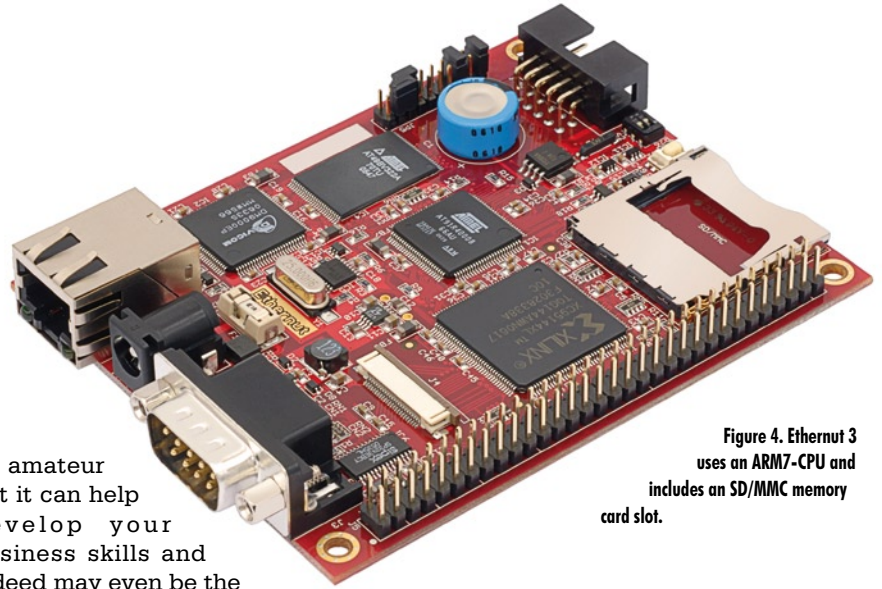

Figure 4. Ethernut 3 uses an ARM7-CPU and includes an SD/MMC memory card slot.

Web Links

- [1] Homepage for egnite: www.egnite.de
- [2] Websites for the Ethernut project: www.ethernut.de
<http://sourceforge.net/projects/ethernut/>
- [3] Website for YAMPP: www.myplace.nu/mp3/
- [4] Toolchain for Ethernut 1 & 2: <http://winavr.sourceforge.net>
- [5] YAGARTO Toolchain (for Ethernut 3): www.yagarto.de
- [6] Church service radio using Ethernut: www.solutionsradio.nl
www.streamit.eu

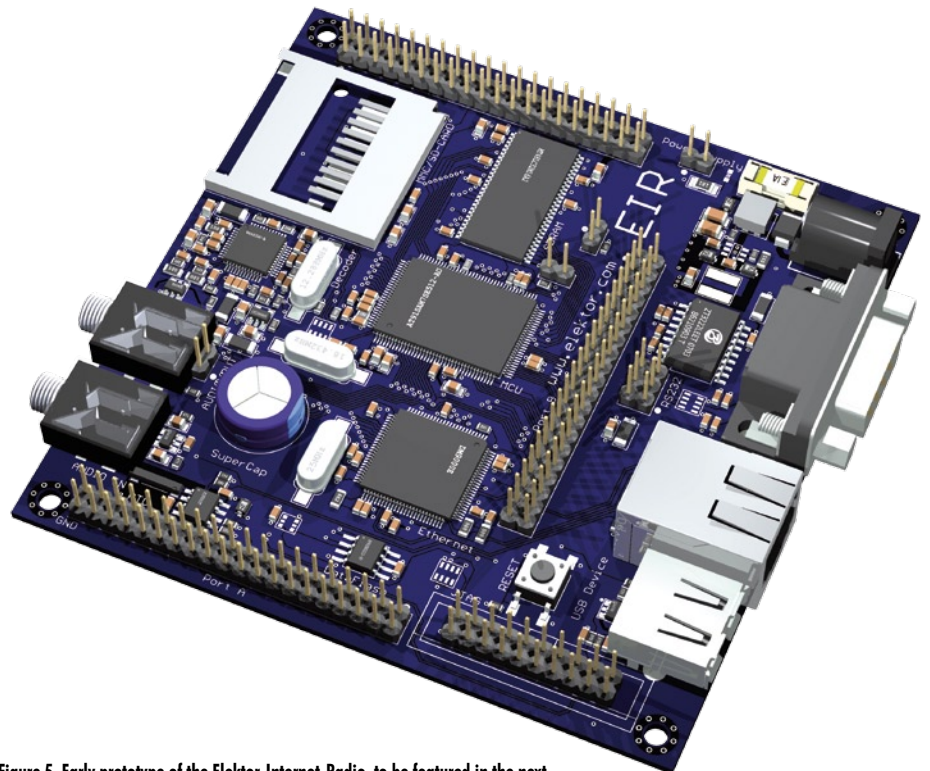

Figure 5. Early prototype of the Elektor-Internet-Radio, to be featured in the next edition of *Elektor*.

Plastics Replace Silicon

'Smart plastics': the future of electronics?

Helmuth Lemme

There is a whiff of revolution in the air in electronic circuit technology, with components made from conductive plastics threatening to replace their silicon-based counterparts. What are the benefits, what is the potential, and what is the cost of this technology? We give a glimpse into the future.

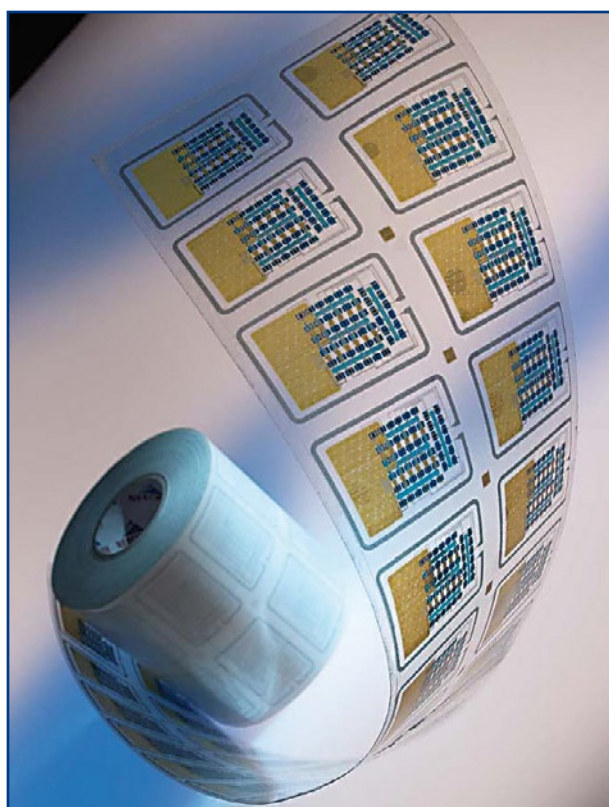

Figure 1.
As thin and flexible as paper: electronic circuits made from conducting plastics.

(Photograph: Fraunhofer Institute for Reliability and Microintegration)

Why would an industry invest large sums in the development of a completely new technology? Conventional methods for making electronic components are thoroughly well-established and proven, having undergone unprecedented evolution over the last few decades. Can these methods be superseded by a new technology?

In short, the reason is cost. It takes considerable effort to make significant reductions in the cost of a circuit built using printed circuit boards, semiconductor ICs and passive

components, and this restricts the application areas for conventional electronics. Many applications areas are out of reach unless costs can be reduced by orders of magnitude, and this is where the plastic electronics of the future holds the most promise.

The essential difference from conventional electronics lies not in the materials used but in the manufacturing processes. There is no growing of ultra-pure silicon crystals, no sawing into wafers, no photolithography, no high temperatures, no high-vacuum vapour deposition processes and no expensive clean rooms; instead manufacture simply involves printing on a couple of paper-thin sheets of plastic film (**Figure 1**). This is extremely cheap and lightning fast. Each micrometre-thick layer is printed on another, building up conductors, insulators and semiconductors. The process is purely additive, which means that there are no etching steps to remove previously deposited material. The completed circuit has a total cost of at most a penny or two. This makes the manufacture of disposable or single-use electronic circuits feasible, and so plastic circuits are in many ways complementing, rather than competing against, current technology, opening up entirely new markets that are beyond its reach.

That, at least, is the vision; it has not yet become reality. Nevertheless, many companies and institutions from all over the world are working hard to make it so. Market researchers expect explosive growth in market size and mass production in the billions of units within a few years, and of course industry will expect some return on the huge sums being invested in research and development. The very first, very simple products have just come onto the market.

Conduction along chains of carbon atoms

The main breakthrough that has made these new technologies feasible is the development of electrically conductive plastics. These are not simply ordinary plastics loaded with metal or carbon particles, but rather are 'genuine' conductors that convey electric charge along long-chain organic molecules. To make this work the chain must be 'conjugat-

ed', having alternating single and double bonds between the carbon atoms. The first substances of this type were investigated in detail in 1977, and at that time no practical applications could be found. They suddenly enjoyed renewed interest when semiconducting polymers were found, whose electrical conductivity could be varied over a wide range by the addition of dopants. This allowed the construction of transistors. Compared to silicon transistors, these first examples had decidedly poor performance characteristics, but nevertheless they worked.

These results were ultimately seen as so significant that in 2000 the three researchers, Alan Heeger, Alan MacDiarmid and Hideki Shirakawa, received the Nobel Prize in Chemistry for their efforts. Since then progress has been rapid and all over the world today there are many firms, research institutions and university departments working in the field. In Europe those involved include PolyIC, Plastic Logic, Plastic Electronic, Printed Systems and the Fraunhofer Institute for Reliability and Microintegration (see text box and internet links), and there are of course many others. New polymers are continually being discovered, making it ever harder to keep up-to-date with the range of materials available. The polythiophene group of materials, whose chain structure is shown in **Figure 2**, has particularly useful properties, as do the so-called PEDOT:PSS polymers [1].

The critical physical parameters for these materials are the conductivity (which is invariably orders of magnitude poorer than that of metals) and charge carrier mobility. This is the ratio between the velocity of the charge carriers (electrons or holes) in cm/s to the applied electric field in V/cm, giving overall dimensions of cm²/Vs. The 'fastest' materials reach a mobility of around 1 cm²/Vs, comparable to the value for amorphous silicon as normally used for thin-film transistors in active matrix displays. Research efforts are directed at improving this value, and it is hoped to reach values in the region of 10 cm²/Vs, comparable to that of polysilicon. Mobility in monocrystalline silicon is much higher again, and there is little hope of polymers reaching comparable levels. That, however, is not where the most interesting developments lie.

Simple circuits

So far, only p-type materials have reached technical maturity, with n-type materials still stuck in the laboratory. There are therefore no bipolar transistors or pn-diodes, but only p-channel FETs and Schottky diodes (which use a metal-semiconductor junction). Intensive work continues on n-channel FETs with the aim of one day being able to produce low-power CMOS circuits.

Figure 3 shows a cross-section through an 'OFET' or 'OTFT' (organic thin-film transistor). Because of the very poor conductivity practical transistors of this type take the form of interleaved finger-like structures. The first examples had a very low switching speed (with a maximum frequency of a few Hertz), but thanks to better understanding of the technologies more recent devices are orders of magnitude faster. The fastest produced in the laboratory to date is capable of switching at 600 kHz.

Besides transistors we of course also need resistors, capacitors and interconnects, all of which are readily made in this technology using conventional polymers loaded with metal or carbon particles, which exhibit good conductivity. Early circuits were simple, with transistor counts in single or double figures: no competition for VLSI circuits! However, the aim is not to compete with silicon on those terms, but rather to break into new areas where silicon would be

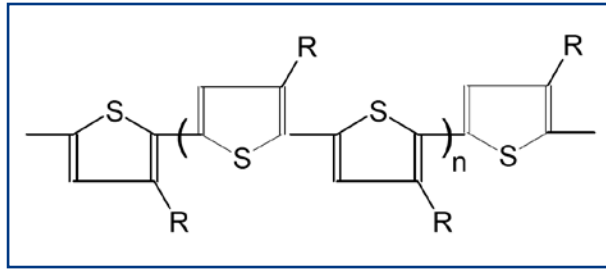

Figure 2. Polythiophene, an electrically-conductive plastic. (Source: PolyIC)

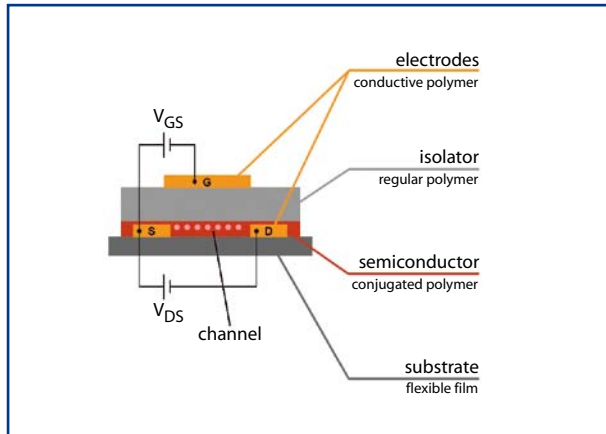

Figure 3. Construction of an organic field-effect transistor (OFET). (Source: PolyIC)

impossible to use. In any case, the distinction between individual transistors and integrated circuits is becoming a thing of the past.

Selected applications

PolyIC, based in Fürth, Germany, is developing RFID chips made from organic materials which one day, when mass produced, will be able to replace bar codes for product identification (see text) [2].

Plastic Logic [5], based in Cambridge, UK, claims to have built the first factory to manufacture active-matrix backplanes on plastic substrates. The aim is to produce ultra-thin, flexible, 'paper-like' displays which can be carried anywhere like a newspaper.

Plastic Electronic [6], from Linz in Austria, is developing an intelligent film. The flexible polymer film is provided with a matrix-like array of electrodes that enable the weight and position of any object placed on it to be determined.

Printed Systems, based in Dresden, has brought to market chip cards made of cardboard carrying printed organic electronic circuits [7]. When the card is inserted into a USB reader, the PC can be made to connect to a specified website. This can be used by companies for marketing purposes.

The Fraunhofer Institute for Reliability and Microintegration in Munich is dedicated to 'large area electronics' [8]. Active and passive electronic and photonic components, chiefly made from organic materials, are mounted on large-area substrates. The aim is to incorporate flexible, ultra-thin batteries and/or organic solar cells to supply power, with the ultimate goal of the research being to produce products such as a computer manufactured on a film, or an electronic newspaper.



Figure 4. Polymer circuits can be manufactured at speeds of up to 20 m per minute using conventional printing machines. (Photograph: PolyIC)

Manufacture by printing

In their raw form the materials used are either liquids or pastes. This means that they can be printed, using conventional printing machines, as if they were inks (**Figure 4**). The speed of this process is limited by the time it takes each layer to dry. The result is literally a 'printed circuit': what is conventionally called a 'printed circuit' is in fact etched, not printed. Modern printing machines employ a wide range of different process technologies, and no single one of these has emerged as a clear favourite in printing polymer circuits as, depending on the substance to be printed, one or other of the methods will be the more suitable. This means that it is not possible to carry out all the printing steps on a single machine. Normally the substrate is run through a series of different machines, being rolled up between each process stage.

A crucial question is that of the achievable feature sizes. Sizes comparable to those found in modern silicon technologies, of the order of tens of nanometres, are not remotely conceivable, and neither are they in demand. Features down to 50 μm can be made reliably; 20 μm is decidedly trickier, and 10 μm is a real challenge. Experts do not expect sizes to go considerably smaller than this last figure. The smaller the features, the more accurately the printed



Figure 5. Practically invisible: a security label helps prevent product counterfeiting. (Photograph: PolyIC)

layers must be registered over one another. Since there are practical limits to this accuracy, smaller transistors inevitably have a higher spread in their electrical characteristics; eventually the point is reached where the spread becomes so great that the devices are useless.

The chief motivation for reducing the channel length of a transistor is to increase its switching speed; overall reduction in circuit size is a secondary aim because as complexity increases it is relatively straightforward to increase the total area of the circuit. Whereas silicon area is expensive and considerable lengths are gone to to reduce the size of a die, this is not the case for plastic electronics where a few extra square centimetres do not add significantly to the cost. For use in many important applications it is thickness that is critical, and this chiefly depends on the thickness of the film substrate, typically a few tens of micrometres. The conductive tracks are only a few micrometres thick.

The materials themselves (the films and pastes) are very inexpensive, as are the manufacturing processes, at least once they become mature. The substrate materials can in principle be up to several metres wide (although this is not yet seen in practice) and their length is limited only by that of the rolls on which they are stored. They are usually made from various kinds of plastics (such as polycarbonate or PET), metal films (such as stainless steel) or even thin glass. At a thickness of 50 μm glass is very flexible and, as long as it is handled reasonably carefully, will not break.

The manufacturing process is astonishingly quick. Although speeds comparable to that of newspaper printing (up to 15 m/s or 54 km/h) are not yet attainable, a brisk 20 m per minute is already possible. This means that plastic circuits can be made in an instant, whereas silicon devices take several weeks from raw wafer to finished product. Costs are in the pennies or even less, and so plastic electronics can be added to a product without increasing its cost perceptibly. The biggest difference is in capital costs: a modern plant for silicon ICs costs billions of pounds, in comparison to which the cost of building a plastic circuit plant is negligible.

Function upon function

One of the first envisaged high-volume applications for plastic circuits is RFID (radio frequency identification). Silicon-based 'transponders' or 'tags' are already widespread, containing a chip with just two connections, which are wired to an antenna coil. The corresponding reader device emits short high-frequency pulses that induce an alternating current in the transponder's coil. The resulting voltage is rectified and powers the chip, which then sends a brief message back to the reader.

This is precisely the kind of circuit where plastic electronics can make a dramatic difference to production costs. Enormous quantities of the tags are desperately needed for applications such as authentication of goods to combat counterfeiting, a problem which has grown to epidemic proportions. An RFID transponder made using plastic technology is much thinner than its silicon-based counterpart and can be fitted in places which previously would have been infeasible. Often the tag can be made practically invisible (**Figure 5**). When the transponder is interrogated it will reply with a signal indicating that the product is genuine; but of course if there is no transponder, it cannot reply. If tags like this can be made for a penny or less they can be used on a whole range of goods, for example in a supermarket,

and so can supersede bar codes (**Figure 6**). Air tickets and entrance tickets for higher-priced concerts or football games could also be checked for validity. This is the subject of the PRISMA ('printed smart labels') project which is supported by the German Federal Ministry of Education and Research. In logistics applications transponders can be used to track and identify parts and products during the whole manufacturing process.

The frequencies used for transponder communications are selected to fall in the ISM bands, with 13.56 MHz a popular choice. No current OFET can operate at this frequency, but fortunately this is not necessary. All we need is that the diode is capable of rectifying the HF signal. The data clock frequency typically lies between 100 Hz and 1 kHz. PolyIC [2], based in Fürth, Germany, has already begun mass production of an RFID transponder of this type. In response to a request the tag replies with a single bit indicating whether it is genuine or not. For many purposes this is an adequate first indication of whether an item is genuine. The difficulty of copying this device will be a sufficient obstacle to make counterfeiting uneconomic.

In the longer term more and more functions will be implemented in plastic electronics. In development are sensors for measuring environmental parameters such as temperature, vibration, impacts etc., and switches and pushbuttons for manual input of data such as PINs. Showing information, such as the credit available on a card, requires a display, and again this is possible using printing technology. OLEDs (organic light-emitting diodes) show promise, as do so-called 'electronic inks', which allow small low-cost displays to appear on packaging [3]. Powering the circuit requires either a flexible battery or organic solar cells: in the future both of these will be printable. An electronic board game has been developed as a demonstration application, showing that these technologies work (**Figure 7**).

Composite technology

Things often turn out trickier in practice than they seem in theory. Not all devices are quite as simple to print as one might like. For this reason various hybrid processes are often used which combine printing technology with photolithography, resulting in mixtures of organic and conventional electronics. When the reverse of a silicon chip is etched down until it is only 20 µm thick it becomes flexible and can bend with the substrate film without breaking. The industry does not subscribe to dogmatic views such as 'no silicon, everything must be made of plastic', but rather lets the application determine the choice of technology and makes what the market demands. And that varies according to the particular application requirements.

The challenge is to integrate the best techniques from the worlds of printing and electronics. This demands very close cooperation between experts in the two fields, and to that end the Organic Electronic Association (OE-A) was formed in 2004 as a working group within the German Engineering Federation (VDMA) [4].

Problems ahead

In general, once a plastic electronic device has been used once, it ends up as waste. Exactly what will be the environmental impact of this is hard to predict. There has been little research on how these various substances, many of which have never previously been made, will affect humans, animals and nature in general. A further, entirely different, area also needs careful atten-



Figure 6.
A vision of the future: an electronic label on every item. (Photograph: PolyIC)

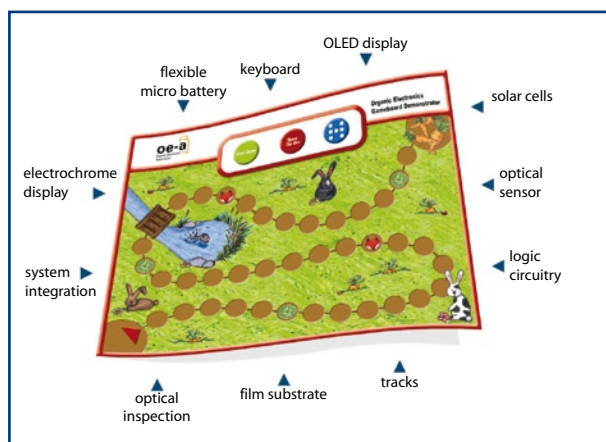

Figure 7.
A demonstration of plastic electronics: a board game. (Photograph: OE-A / Concept Company)

tion. Electronic devices are becoming more and more widespread throughout the world. In every corner there is a (possibly hidden) electronic circuit with some function. Mostly they gather information and transmit it to some other device, often without drawing attention to themselves. Reminiscent of '1984'? In that book Big Brother gathered information over cables connecting hidden monitoring microphones. Today we use radio communications, Bluetooth, ZigBee and the like, which are much harder to see. Are we heading towards a world where every finest device is connected to a global network?

(070999-1)

Web Links

- [1] <http://en.wikipedia.org/wiki/PEDOT:PSS>
- [2] <http://www.polyic.com>
- [3] http://w1.siemens.com/innovation/en/news_events/innovationnews/innovationnews_articles/lighting/wafer_thin_color_displays_for_packaging.htm
- [4] <http://www.oe-a.org>
- [5] <http://www.plasticlogic.com>
- [6] http://www.plastic-electronic.com/index.php?article_id=1&clang=1
- [7] <http://www.printed-systems.de/index.php?id=17&L=1>
- [8] <http://www.izm.fhg.de/EN/programme/ElektronikaufgrofchigenSubstraten.jsp>

Data Logger

"deLuxe"

We have had the pleasure of proposing various data acquisition units over the last few years. The one we describe here is a nice exercise in product development. It actually utilises an SD card as the media for data storage. The hardware design is compact and that makes the firmware and software features even more interesting.

Loïc Marty

This data logger is used to save the values of four analogue channels supplying any voltage ranging from 0 to 5 V onto a standard memory card (SD – Secure Digital).

Elektor has a long history when it comes to publishing data acquisition systems and loggers — the most recent project [1] proved very popular. The data logger we are proposing here is unique due to its simplicity and compact size; a microcontroller and a handful of common components are all it takes for hardware.

Our data acquisition unit has several operating modes available:

1. Triggering on the fly (internal trigger)... in other words, press the pushbutton!
2. Triggering from an external signal; this may come, for example, from a sensor operating at 12 or 24 V (say, a proximity detector); the signal input is protected by a 5.1 V zener diode.
3. Saving data at 10-second intervals.

4. Saving data at 1-minute intervals (e.g. temperature sensor).
5. Saving data when a signal exceeds a certain maximum value; in this case, analogue channel 3 defines the reference level.

The electronics

As the schematic in **Figure 1** shows, there is nothing special or too complicated as far as the electronics are involved.

The core of the setup is IC4, a top-level 18F452 PIC micro [2], set to maximum speed in HS mode, i.e. 20 MHz. It incorporates different peripherals put to good use here: A/D converters, an SPI port (to communicate with the SD card) and an RS-232 port (for possible future software extensions).

This PIC device, the top-of-the-line in the 18Fxx2 family (32 kB of Flash memory, 1,536 bytes of RAM and 256 bytes of EEPROM) also has an I²C port. Although this uses the same pins as the SPI port, it proved necessary to use two other pins for communication with the real-time clock (RTC) device, IC5. Here, this takes the physical form of a

PCF8583 [3], an IC that's very simple to configure. Some of its key data are listed separately in the **inset**. Note the presence of a CR2032 3-V lithium battery; this is used to save the time and date information if the normal supply voltage disappears. D2 and D3, a pair of low forward-bias (Schottky) diodes make it possible to power the RTC permanently. Note the presence of a trimmer capacitor, C14, used to correct possible frequency drift in crystal X1, which is used as a clock (not very critical). The RTC has an open-drain interrupt output with a pull-up resistor, R23, allowing for an excellent 1 Hz timebase, simplifying time management by the 18F452.

LCD1, a large display with 4 lines × 16 characters driven in 4-bit mode, makes it possible to visualise the various data: date, hour, recording file number, as well as the value of the analogue channel AN0 (0 to 1024, given that the A/D converter has a resolution of 10 bits). Three pushbuttons, S1, S2 and S3, are used to select the operating mode. Also note the presence of the RS-232 port, which may be implemented here. Future changes to the firmware might need this port in combination

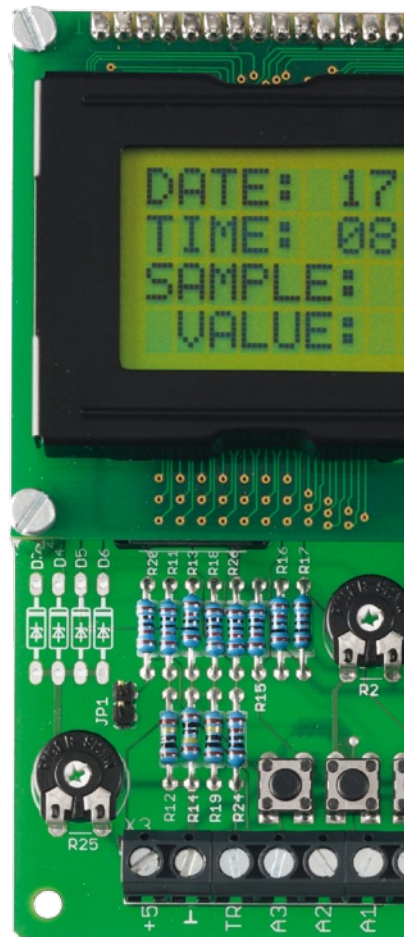

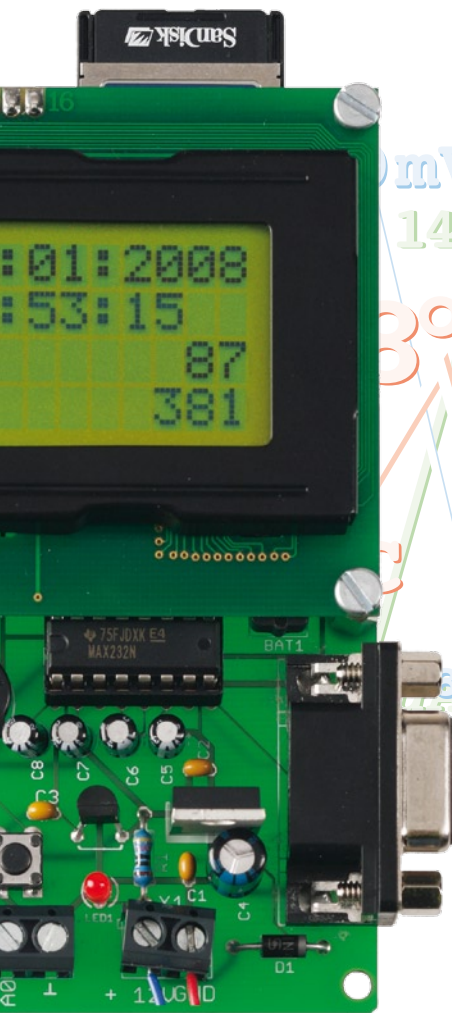

The efficiency of simplicity

Technical specifications

- 5 data recording modes
 - on the fly (button press)
 - external trigger
 - timed: every 10 s, every 60 s
 - on exceeding a preset level
- Data saved in .txt file format
- Max. 99 files
- Direct reading of SD card in PC word processing program
- Formats FAT16 SD cards
- RTC circuit to timestamp the files
- Available as a kit from Elektor Shop

with a bootloader to load the PIC executable code.

The SD card requires a 3.3 V supply; this voltage comes from a TS2950-3.3 low drop-out regulator that only requires a small voltage difference to supply the necessary voltage (from 5 to 3.3 V). This device is capable of withstanding the (relatively) large peak current consumption of an SD card starting up.

The PIC-to-SD card communication is in SPI format with 5 V on the PIC side and 3.3 V on the memory card side. By contrast, in the direction PIC-to-card direction, resistors R5–R10 are used to obtain the required voltage level at the card inputs (CS, DATA IN, CLK); in the other direction, DATA OUT @ PIC, the 3.3 V level is sufficient for the PIC to recognize valid logic states.

One note concerning the analogue and external trigger inputs (the signal which triggers the recording of the values in 'External trigger' operating mode): these lines may be protected by 5.1 V zener diodes, D4–D7, but these should only be fitted if you know how to handle the inherent voltage drop they will cause. Since they offset the measurement, it follows that you will

need to adapt the input stage according to your application — using a potential divider, for example, to measure variations above 5 V.

Note that a jumper can be fitted on connector JP1 to supply a fixed voltage (adjusted by the 10 kΩ potentiometer P2) to input RA3; this jumper should be fitted when the maximum signal value mode is being used (on AN0 only). This is very easy to adjust in practice: it defines the threshold above which the voltage peak is taken into account. It is worth noting that this project was originally designed with this prospect in mind.

The PCB

The project may be purchased as a kit of parts # **070745-71** from the Elektor Shop. **Figure 2** shows the component overlay. If you want to make your own board, you can download the copper track pattern from the Elektor website.

Given the (small) number of components involved and the size of the printed board, fitting the components should not pose any problems. Remem-

ber to adjust the LCD contrast using the 10 kΩ preset P1.

Construction is easy, since the components are common and readily obtainable, like the PIC18F452. The display is a 4 line/16 character model in standard green; it is mounted using four plastic 10-mm pillars. The electrical connection is made via a 16-way male header soldered onto the PCB; a strip of female contacts will be soldered onto the display side. Doing this makes assembly / disassembly much easier.

Note that we have made provision for an RS-232 section which makes the setup even more flexible. The RS-232 port makes it possible to employ the bootloader option (see the **inset** with screenshots devoted to this topic).

Since it is difficult to obtain SD card connectors as spares, you can use one cannibalized from a PC external card reader (bash the cheapest one you can find!). The pins for the Lock/Unlock contact on the SD card are not soldered (like pins 8 & 9); the PIC program in fact ignores the data they carry.

If the hardware part is simple, that often means that the software is hugely complex, as is the case here.

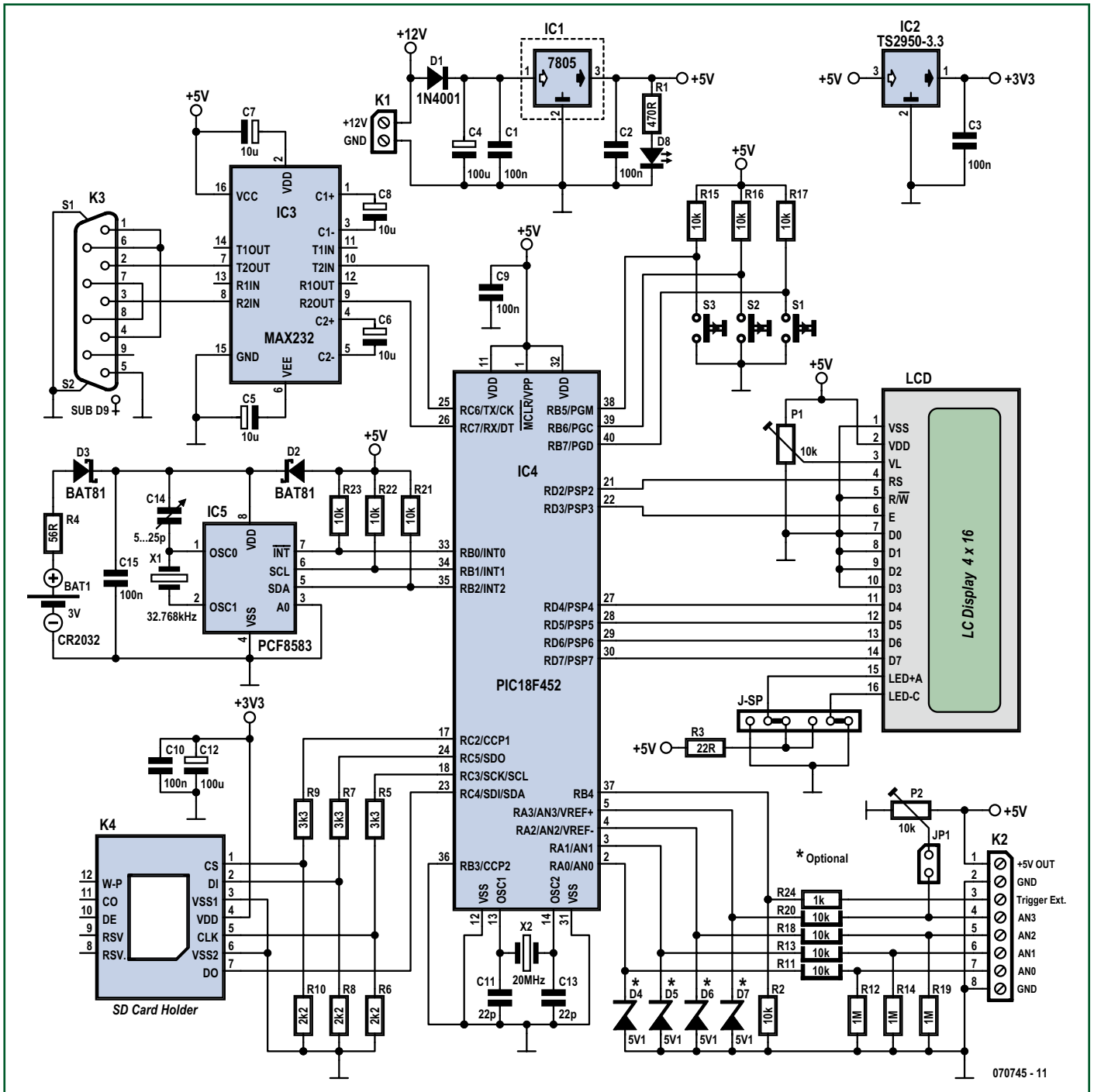

Figure 1. At the heart of the circuit, the PIC18F452, surrounded by (clockwise) LC display, SD card connector, the PCF8583 RTC, and the MAX232 level converter.

Keywords

LC Display – LC displays (LCDs) have replaced cumbersome, power-hungry, inflexible LED displays. There are many types, with characters (x lines of x characters) or graphic symbols. The present project employs an LCD with 4 lines of 16 characters.

I2C Bus – Inter-Integrated-Circuit bus. Developed by Philips in the early 80s for

home automation and interconnectable home electronics applications. The I²C bus comprises 3 lines: SDA (Serial Data) for the data, SCL (Serial Clock) for the clock, and a ground line.

EEPROM – Electrically Erasable Programmable Read Only Memory. This type of rewritable memory has the advantage of not losing the data it contains during power loss.

FAT (16 or 32) – Even before Windows existed, Microsoft developed and patented (in part) an operating system for files, for floppy disks as well as for removable optical media called FAT (File Allocation Table). For more information, see Wiki sites.

IDE – Integrated Development Environment. More and more complex software sets propose a centralized environment from which one can access different programs.

The software

The source code listing runs into 500+ lines and cannot possibly be printed in this article; you can download it from the Elektor website (www.elektor.com) under the filename **070745-11.zip**. This archive file also includes the .hex file you will need to program into the PIC18F452 if you have the means to program the controller yourself. Note that the device is also available ready-programmed from the Elektor Shop as item **070745-41**. There's a special **inset** to explain the programming procedure using the bootloader.

The program was written in C (a first for this author) and compiled using MikroC, the excellent compiler from Mikro Elektronika (very good technical support). The source code is fairly intuitive, even for those who do not know this language very well (in C, you start off with the function `main()`) There is a free version of this compiler; it supports code of less than 2 k words. For this project, which uses a lot of memory due to file management in FAT mode, you need to use the full version. The price is fair, considering the technical capacities of the compiler: IDE included, and especially the use of the built-in features. These were indispensable and put to good use for managing the files in FAT, their attributes (date/hour, etc.), as well as to manage communication with the RTC in implemented I²C mode. The author encourages you to discover this surprising and powerful compiler — see the link at the end of the article. Mikro Elektronika are also valued advertisers in Elektor.

The LCD screen messages mostly speak for themselves, using established terms like *Sample*, *Value* and *Save*.

MikroC – C compiler intended for PIC12, PIC16 and PIC18. A demo version is available for download, its only limitation being the 2 kB maximum size of the .hex file. Not bad to start out with...

RTC – Real Time Clock. This IC came out with the first microprocessors in order to have an accurate time/date stamp. Among other places, they are found on every PC motherboard.

The bootloader

The PIC18F452 microcontroller used in this project can be programmed in the usual manner using the .HEX file [logger.hex]. To make it easier to develop and especially debug the application, the author has included a bootloader in the firmware. The principle is simpler than it might appear at first. The bootloader is a tiny program that is executed whenever the microcontroller is reset. It scans the serial connection looking for a response (here, an 'r') to the message (here, a 'g') it sends. If it receives the agreed response within the time allotted (here, 5 s), it goes into firmware update mode (in other words, it flashes the part of the memory assigned to the firmware with the data carried by the serial connection, avoiding crashing). Otherwise, it sets the pointer to the firmware address, which then takes over control.

In this way, it is possible to reload software into the microcontroller at each start-up, as long as the serial connection is correctly set up (57,600 bps / 1 stop / 8 bits / no parity / software flow control) and the PC host software is ready to communicate.

Now we will see how to take advantage of this function. First the PIC must be programmed with the bootloader in the usual way, in order to have software for bootloading.

Next, just execute the software [mikroBootloader] available in the menu [Tools] in [mikroC]. Be careful to configure the serial connection correctly.

Connect the data logger and click on [connect] before the 5 second time delay elapses. Then you can relax: now the .HEX file must be loaded from the data logger firmware with [Open HEX file] and click on [Start bootloader] to flash the PIC.

Once this operation is over, just disconnect and reconnect the data logger power supply [Hard Reset], wait 5 seconds and the software should run. Do not forget to insert your SD before starting up again, reset takes place right at the start, otherwise you will need to reset again from off in order to use your module.

The screenshots shown here demonstrate the sequence of operations using the bootloader to update the software, from the first step to ...success (obviously!).

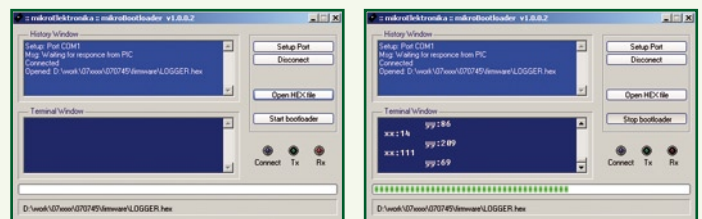

SD (Card) – Secure Digital (Card). Undoubtedly the most widely-sold removable Flash memory card in the world. Its format is a reference for many other cards whose minuscule dimensions require the use of an adaptor, like the microSD and miniSD.

SPI – Serial Programming Interface. This bus is used to establish a synchronous serial connection. It has 4 lines:

SCLK – Serial CLock (Master Output)

MOSI/SIMO – Master Output, Slave Input

MISO/SOMI – Master Input, Slave Output

SS — Slave Select (active low). Often used to program modern processors.

Wiki – open-source online encyclopaedia at http://en.wikipedia.org/wiki/Main_Page. You can find information there on practically anything... and why not contribute to it...

Implementation

Let's begin by describing the three pushbuttons:

S1: Used to select the operating mode. Also lets you adjust hour and date: in this case, keep it pressed during start-up. S2 and S3 are then used to increment/decrement the values, S1 is used to move to the next field, in the logical order: day → month → year → hour → minute → second. Pressing S1 twice at the end of data entry is used to memorize the time clock.

S2: Used to record on the fly in 'internal trigger' mode. Also used to select the number of analogue channels to be recorded when the operating mode is set to the one that allows selection of the number of analogue inputs to be recorded: note that only one analogue input, AN0, is displayed on the LCD, due to code execution speed.

S3: Used to select a new recording file (in .txt format, so as to allow direct reading on a PC that has an SD card reader and a text editor). The values recorded may range from 0 to 1024 (from 0 to 5 V), with the possibility of recording from 1 to 4 channels simultaneously.

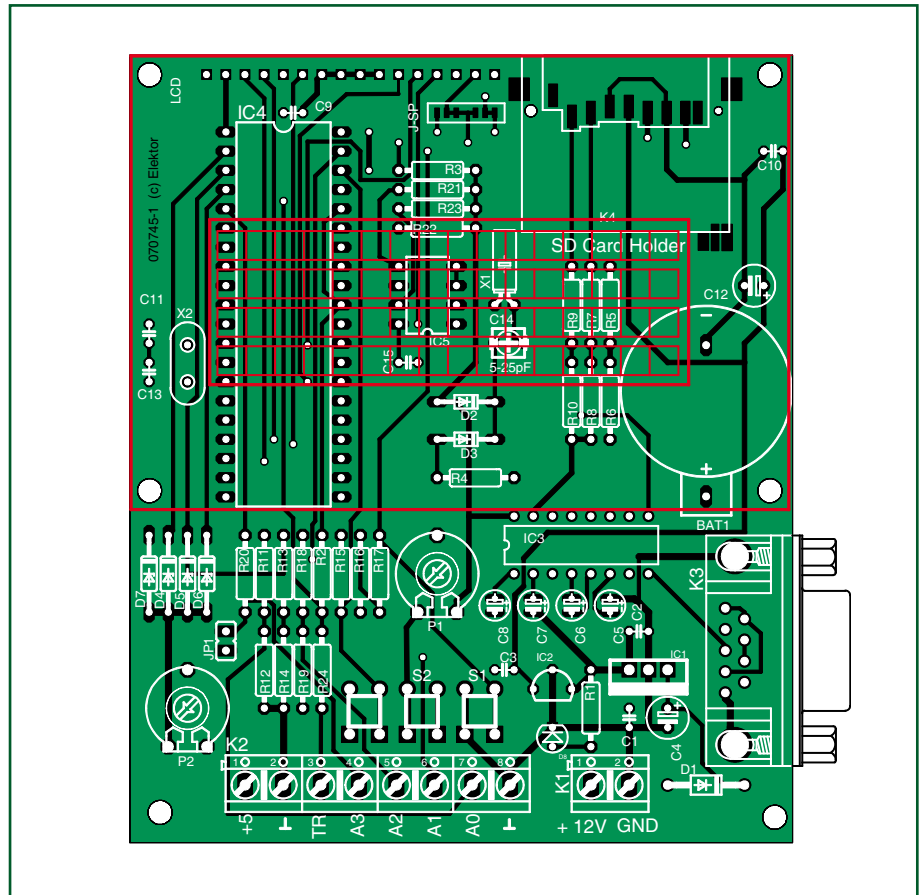

Figure 2. Component mounting plan for the compact PCB designed for this data acquisition system using an SD card.

Closing remarks

You will no doubt have spotted the jumper field J-SP. This is used to reverse the power supply for the LED display backlighting if you are using a

different type of LCD display from the one mentioned in the component list, with different characteristics. A word about the SD card: normally an

SD utilizes its own protocol to communicate with its host. At start-up, it is possible to communicate in serial mode (SPI), as long as certain conditions are

Reference

- [1] USB Data Acquisition Card, Elektor November 2007

Web Links

- [2] www.microchip.com/stellent/idcplg?IdcService=SS_GET_PAGE&nodeId=1335&dDocName=en010296
- [3] [www.nxp.com/#/pip/cb=\[type=product,path=50807/53497,final=PCF8583_5\]|pip=\[pip=PCF8583_5\]\[0\]](http://www.nxp.com/#/pip/cb=[type=product,path=50807/53497,final=PCF8583_5]|pip=[pip=PCF8583_5][0])
- www.f1ubz.fr
- www.mikroe.com (compiler and RTC diagram)
- www.sdcard.org

COMPONENT LIST

Resistors

- R1 = 470 Ω
- R2,R11,R13,R15,R16,R17,R18,R20,R21,R22,R23 = 10kΩ
- R3 = 22Ω
- R4 = 56Ω
- R5,R7,R9 = 3kΩ3
- R6,R8,R10 = 2kΩ2
- R12,R14,R19 = 1MΩ
- R24 = 1kΩ
- P1,P2 = 10kΩ preset

Capacitors

- C1,C2,C3,C9,C10,C15 = 100nF
- C4,C12 = 100μF
- C5-C8 = 10μF
- C11,C13 = 22pF
- C14 = 5-25pF trimmer *

Semiconductors

- D1 = 1N4001
- D2,D3 = BAT81
- D4-D7 = 5V1/400 mW zener diode
- D8 = LED, 3 mm, red
- IC1 = 7805

IC2 = TS2950-3.3

IC3 = MAX232

IC4 = PIC18F452, programmed, Elektor Shop # 070745-41

IC5 = PCF8583

Miscellaneous

- S1,S2,S3 = miniature push button
- JP1 = 2-way SIL pinheader with jumper
- K1 = 2-way PCB-mount screw terminal block, 5mm lead pitch
- K2 = 8-way SIL pinheader
- K3 = 9-pin PCB-mount sub-D socket (female)
- K4 = SD card connector
- X1 = 32.768 kHz quartz crystal
- X2 = 20 MHz quartz crystal
- BAT1 = CR2032 Lithium battery
- LCD = LCD display with 4 lines of 16 characters, e.g. DEM 16481 PCB, ref. 070745-1
- Kit of parts, Elektor Shop # 070745-71
- Project software (source code, hex file, PC program), file # 070745-11 from www.elektor.com

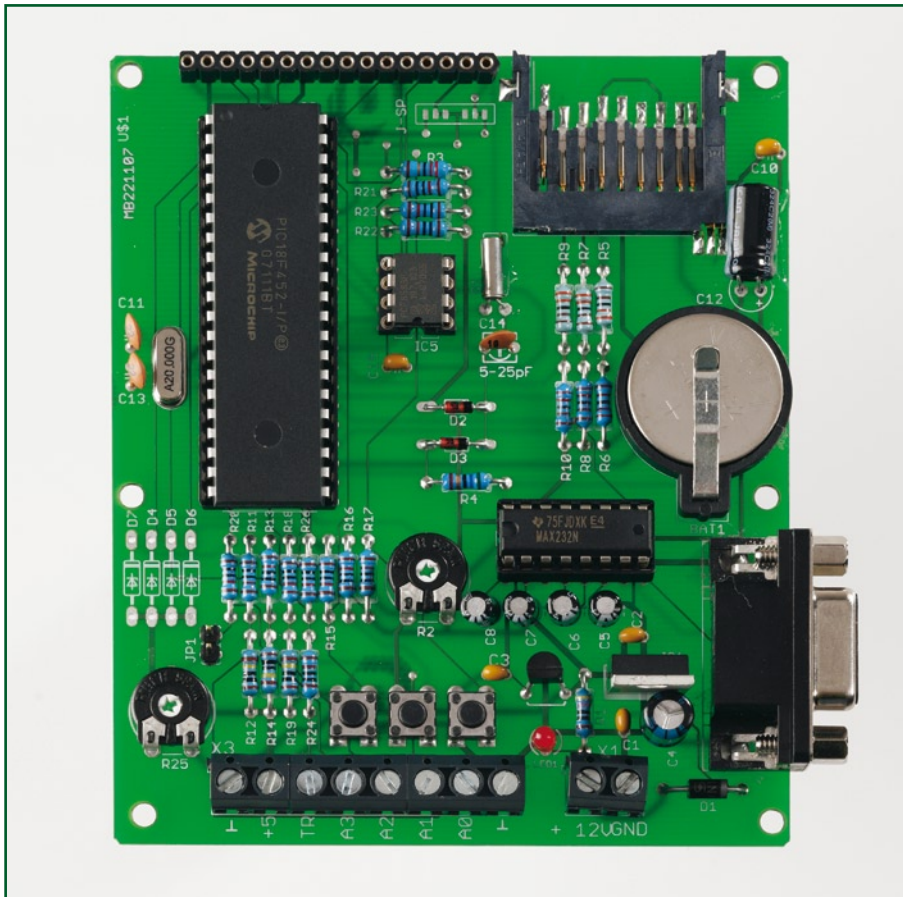

Figure 3. Completed example of our SD card data logger. The LCD display is neatly in place on the top of the main PCB. The real time clock capacitor in our prototype had a fixed value, determined by measurement.

ing it the cheapest card per MB. Who still remembers the £ 25+ introductory price of a 128 MB SD card just four years ago? The 1-GB card will work perfectly.

It is vital that this card is formatted in FAT16 mode (i.e. not FAT32). The files in which the data are recorded begin at 1.txt and go up to 9999.txt (incrementing automatically). Obviously, it will be necessary to reformat the card once it is full and you have transferred the contents to your PC (for your information, each file can record a maximum of about 65,000 discrete samples). Now you are equipped with a brand new data acquisition system. Use it to your advantage. We are here to listen to your feedback.

Loic.marty@neuf.fr (070745-1)

fulfilled; this is certainly slower, but is easier to manage using a microcontroller. This facilitates interfacing with the 18F452 and, even more so, with the

Built-ins from MikroC. A 1 GB SD card is surprisingly affordable these days. At the time of writing, it's found for less than a tenner mak-

The PCF8583

The PCF8583 is a clock/calendar IC from Philips (now NXP) with a 2,048 bit static CMOS RAM arranged as 256 bytes. Address and data transfer takes place via the 2-line I²C bidirectional bus. Address line A0 is used to program the hardware address, thereby allowing connection of two components to the bus without requiring additional hardware.

The built-in oscillator operates at 32.768 kHz; the first 8 bytes of RAM perform the clock/calendar and counting functions. The next 8 bytes may be programmed as alarm registers or used as free RAM space, if not otherwise used. The other 240 bytes are available to the user.

Note that this Real Time Clock can also be synchronised using an external 50 Hz clock signal.

Block diagram of the PCF8583 (Source: NXP/Philips Semiconductors)

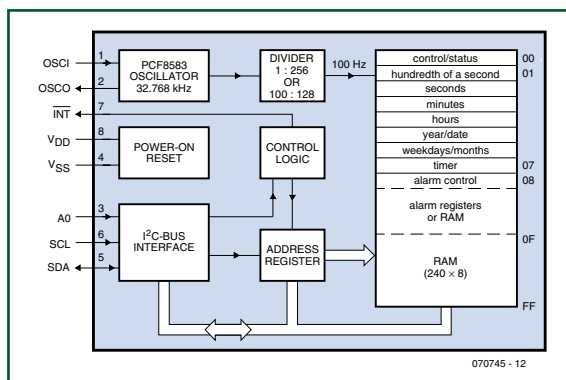

The author



Self-taught, a thirty-plus amateur radio operator, especially interested in everything that involves PIC programming, in assembly language (for video) and lately in C. Loic does not work in the electronics field at all, as he is a production agent (www.mapei.com); his website is www.f1ubz.fr

The Secrets of I²C

An I²C bus analyser to let you satisfy your curiosity

Etienne Boyer

In this article, we propose a microcomputing instrument that's valuable – not to say indispensable – when it comes to analysing what's happening on the I²C bus. It lets you examine the most interesting signals carried by this very common, easy-to-implement interconnection bus.

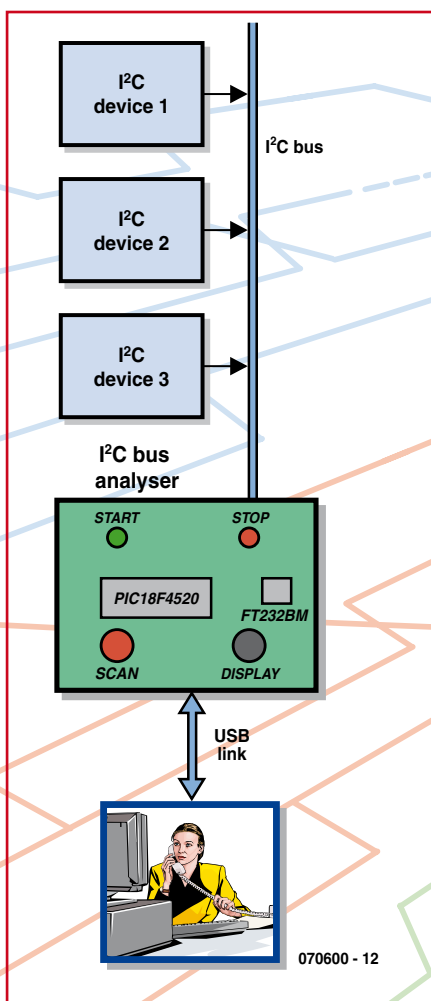

Figure 1. Block diagram of the I²C bus analyser stripped to its bare essentials.

The I²C bus analyser in this article connects to the I²C bus of an application in order to extract from it, for the purpose of examination, the characteristic information of the signals it's carrying; in particular, the START, STOP, ADDRESS, DATA, and ACKNOWLEDGE signals.

It can be used to troubleshoot a reluctant proprietary application or to 'reverse engineer' existing applications. The device communicates with a PC via a USB link configured as a virtual port (COMx) and so is powered directly from the USB, avoiding the need for an external mains adaptor (or even batteries).

Block diagram

Figure 1 gives the block diagram. As already explained, the I²C bus analyser is inserted between the subject being examined, using the application's I²C bus, and the 'watchful' PC. The analyser can have a maximum of three I²C modules connected to it.

The heart and brain of the circuit are combined in a single PIC, a PIC18F4520, the USB link achieved by the standard means of an FT232BM [1] from FTDI (hi Fred) – an IC that you'll already have encountered in many Elektor projects whenever they have anything to do with USB.

Electronics

Before taking a closer look at the actual circuit, we thought it might be a good idea to highlight certain specific points of the circuit, by way of a little reminder. The box 'The secrets of I²C and its bus' recaps the most important elements of the I²C bus specifications.

So now let's get back to our circuit. In I²C, the START procedure consists of detecting a negative edge on the SDA while the SCL signal is high ('1'), performed via monostable IC2a of the 4538 IC configured as per the detail from the circuit in Figure 2.

The monostable time-constant R2*C2 produces an 8.2 μs pulse that faithfully mimics the I²C bus Start procedure. This pulse width is quite compatible with the reaction time of a microcontroller, but not with the persistence of the human eye! To display the presence of a Start using an LED requires a second monostable. IC2b lengthens the pulse to around 150 ms to produce visible illumination of the green LED D2.

The same goes for the STOP procedure, this time with the help of the monostables in IC1 and the red LED D1. The timing diagram in Figure 3 shows the two START and STOP signals thus generated.

Note: the two pulses have different durations, as the START pulse ends ear-

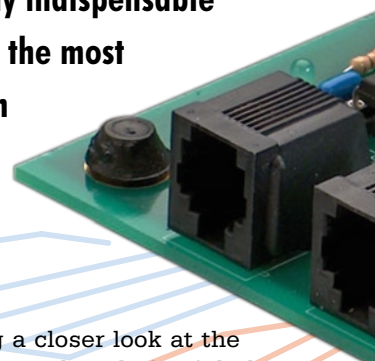

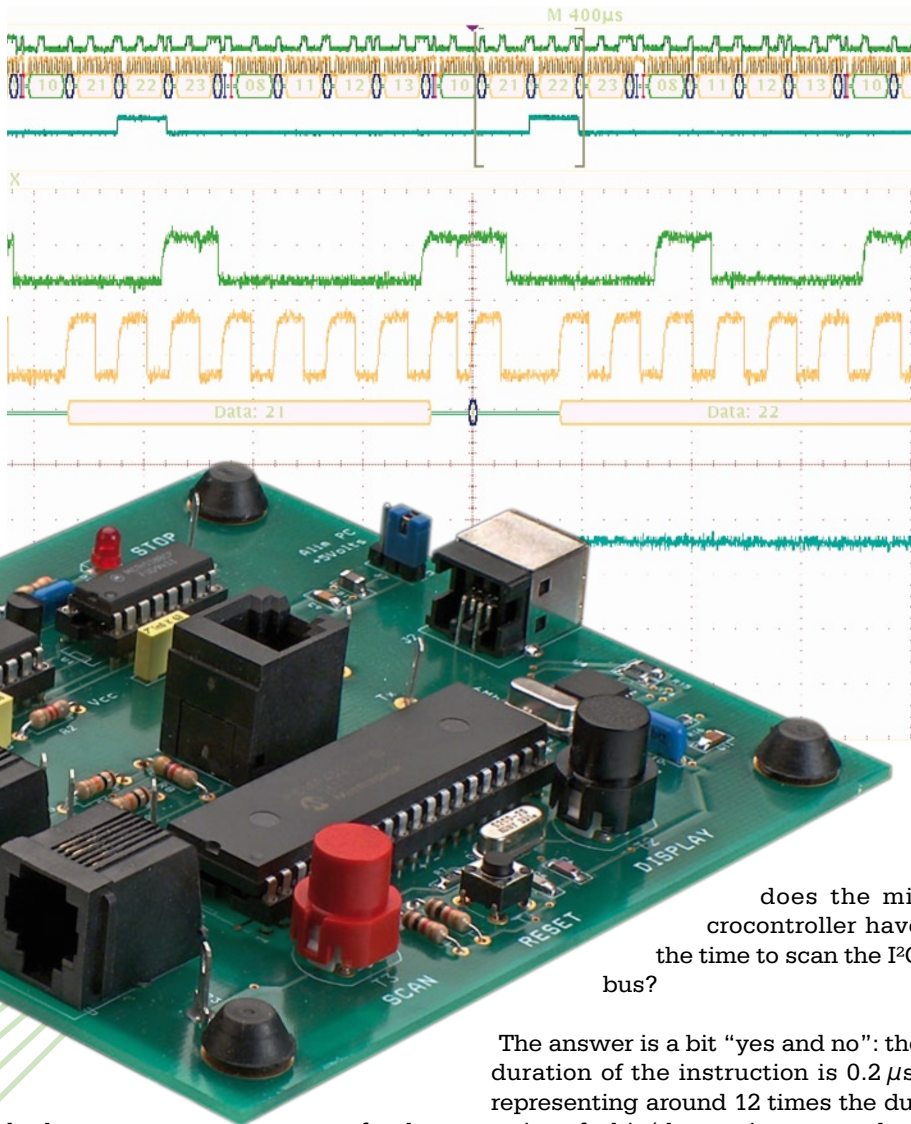

Technical spec

- Analyses 100 and 400 kbit/s I²C bus
- Stores 620 contiguous I²C events
- Hardware detection of START and STOP. Display on 2 LEDs
- USB communication by virtual com port
- Self-powered at 5 V via USB port
- PIC programmed in C (CCS compiler)
- Windows man/machine interface in C++ Builder V5 (Borland)

does the microcontroller have the time to scan the I²C bus?

ly because of the signal SCL going high. In practice, the START pulse lasts 3 μ s, and the STOP pulse is longer than in theory (8.2 μ s) as the circuit doesn't operate within the recommended range (100 μ s – 1 second).

Studying the circuit in **Figure 4** shows that there's really very little in the way of electronics: a PIC, a USB interface IC from FTDI, and a pair of 4538 dual monostable ICs. Let's look at their functions a little more closely.

The heart of the circuit takes the form of a microcontroller from Microchip. The PIC18F4520 [2] is an improved version of the 18F452, but is still pin-compatible, not only with the latter, but also with the famous 16F877. Its function is to analyse, by scanning, input lines RC3 and RC4 of the PIC, directly driven by the SCL (Serial CLock) and SDA (Serial DAta) signals. Push-button S3 (SCAN) starts the analysis. Closer examination of the circuit leads us to ask the inevitable question:

The answer is a bit "yes and no": the duration of the instruction is 0.2 μ s, representing around 12 times the duration of a bit (the maximum standard data rate is 400 kbit/s); however, this doesn't leave much room for manoeuvre to carry out the full processing. What's more, the START and STOP procedures are recognized via edge-detection, which complicates the software. So the microcontroller does not have the time to scan the I²C bus. So a hardware solution comes along to back up the software solution, through the use of edge-detecting monostables (see details in the **inset** 'The secrets of I²C and its bus').

Now that START detection has taken place, all we have to do is detect each SCL clock pulse and sample the data SDA at this moment. Once the signals have been analysed, the microcontroller will store each event in memory in the same way as a data logger. The four events are START, BYTE, ACKNOWLEDGE, and STOP. The memory gets filled up at the rate of the traffic on the bus, and once full is transferred by a serial link to the PC (*USB is by definition a serial link, not a parallel one*).

If the traffic on the bus is too slow, push-button S2 (DISPLAY) lets us purge the memory to the PC so as to display the result without having to wait until the buffer is completely full.

Communication with the PC is achieved by means of the now-standard FT232 IC from FTDI, which uses the USB in the CDC (Communication Device Class) mode. There are just a very few components around this IC, principally a 6 MHz crystal and its two colleagues C7 and C8, and the type B 4-pin USB socket. A pair of red and green LEDs are asso-

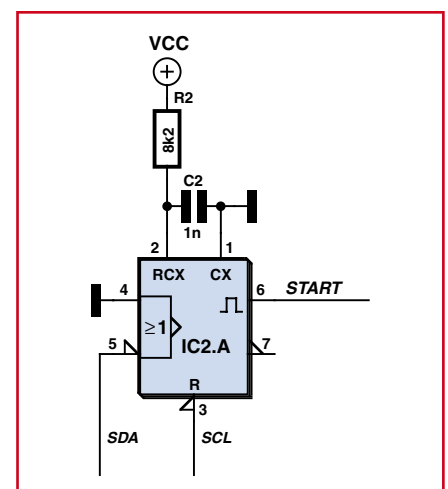

Figure 2. A monostable triggered by a falling edge.

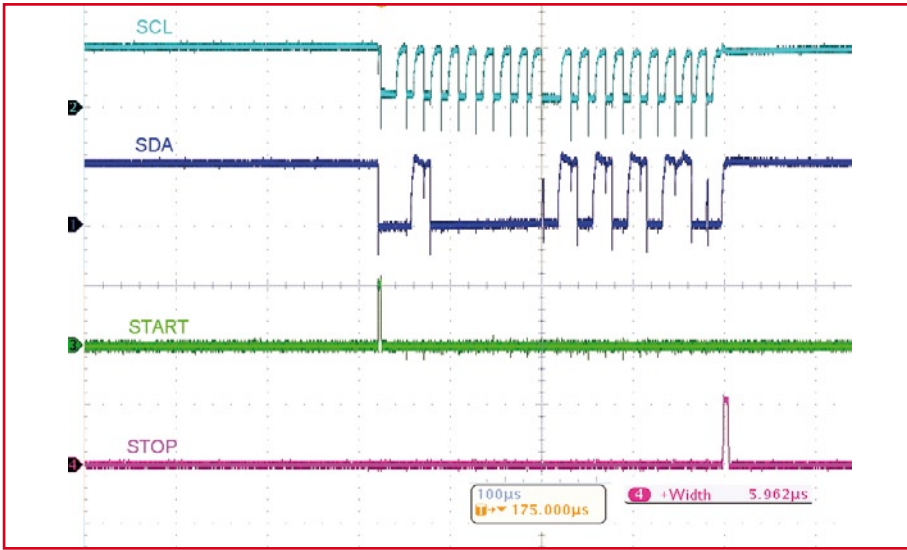

Figure 3. Creation of the Start and Stop.

ciated with the events STOP (D1) and START (D2) respectively.

Two 27 Ω resistors protect the Data+ and Data- lines. The FT232BM IC switches +5 V to resistor R16, indicating two things to the host USB (PC): first of all, presence of the peripheral, and secondly recognition of the Full Speed mode, since R16 is connected to Data+.

One interesting component is inductor L1, a ferrite bead intended to suppress high-frequency interference. Its impedance goes from 0.15 Ω at dc to 70 Ω at 100 MHz, thereby dissipating any electromagnetic interference (EMI) as heat. In addition, it acts as a fuse if you have the misguided idea of short-circuiting our circuit's +5 V sup-

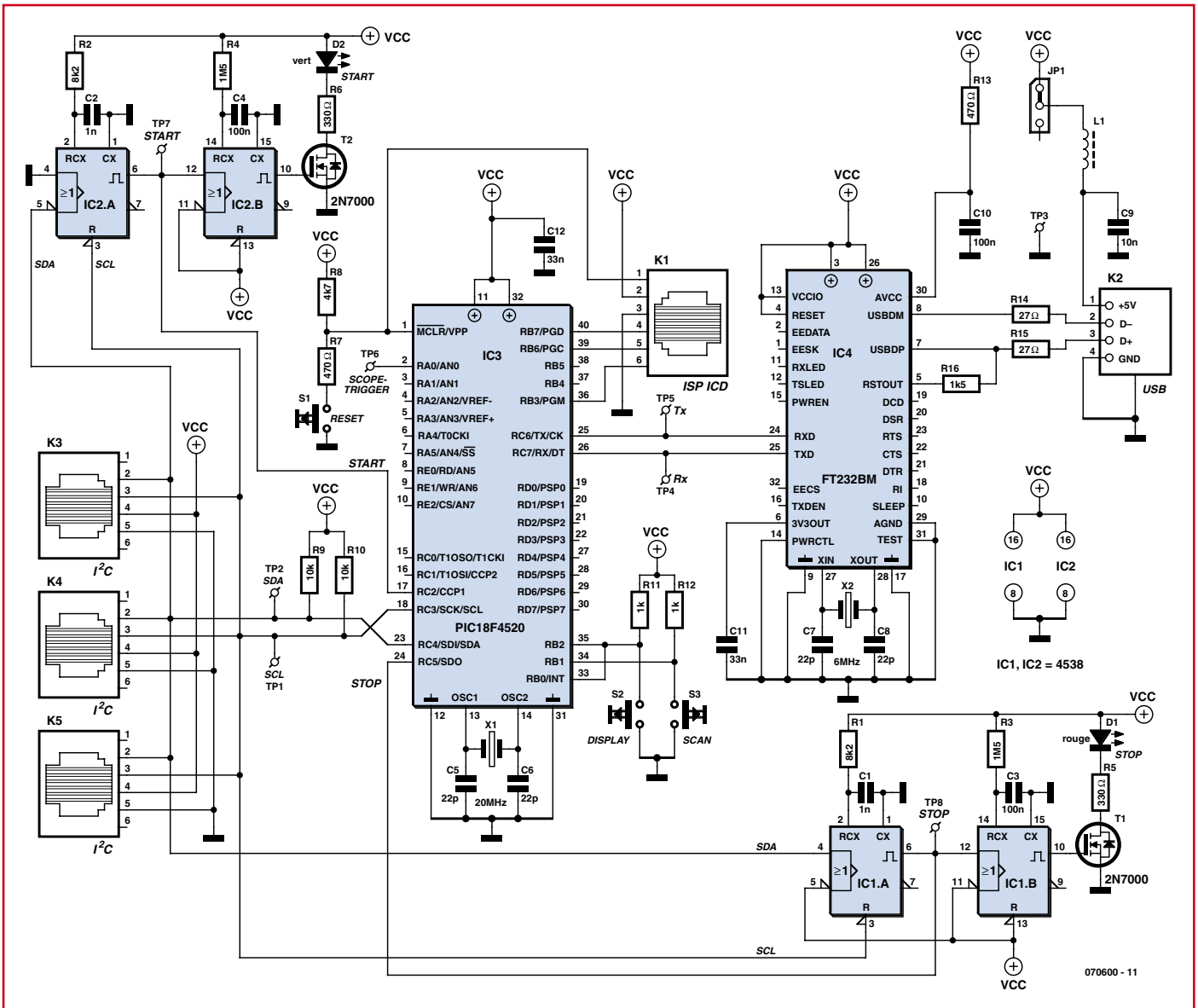

Figure 4. The circuit electronics don't amount to very much: a PIC/USB chip double-act surrounded by a handful of connectors of all types...

ply, thereby protecting the power supply from the PC. In connection with this, note the presence of a header + jumper JP1, which makes it possible to disconnect the PC supply.

PCB

It goes without saying that such a circuit merits a PCB. The screen-printed component overlay is shown in **Figure 5**.

The first step, and also the trickiest, consists of fitting IC4, the only SMD IC used in this project. As always with SMDs, soldering it requires a bit of care and a steady hand. The pads of IC4's LQFP-32 pinout have been lengthened to make it easier to solder this device using a soldering iron. Start by getting the orientation correct (pin 1 is the one immediately to the left of the round indent). On the component overlay, the position of pin 1 is identified by a small '1'. Start by soldering the two diagonally opposite legs. If the remaining legs line up properly with the remaining solder pads, they can be soldered quickly using a fine-tipped soldering iron and fine-gauge solder. Use a magnifying glass to check the quality of the soldered joints and that there are no shorts here. You can then go on to fit the remaining SMD components, in 1206 packages, followed by the small solder-through components, resistors, crystal, capacitors, LEDs and transistors (paying attention to polarities). Then you can fit the sockets (good quality ones!) for IC1, IC2, and IC3, and finish by installing the various sockets, RJ-11 for K1, K3, K4, and K5, and USB type B for K2.

All that then remains will be to fit push-buttons S2 and S3, and the reset button (S1).

Important: if you are powering the circuit via the analyser's USB port, which is the usual case, you need to fit the jumper in the 'on' position on header JP1.

After one last glance at the project to ensure there are no errors or shorts, now comes the moment to connect the board to the PC via a USB cable, to check for the presence of supply volts at the appropriate points on the sockets, with the aid of a multimeter. If everything is OK, you can disconnect the analyser and then fit the last ICs,

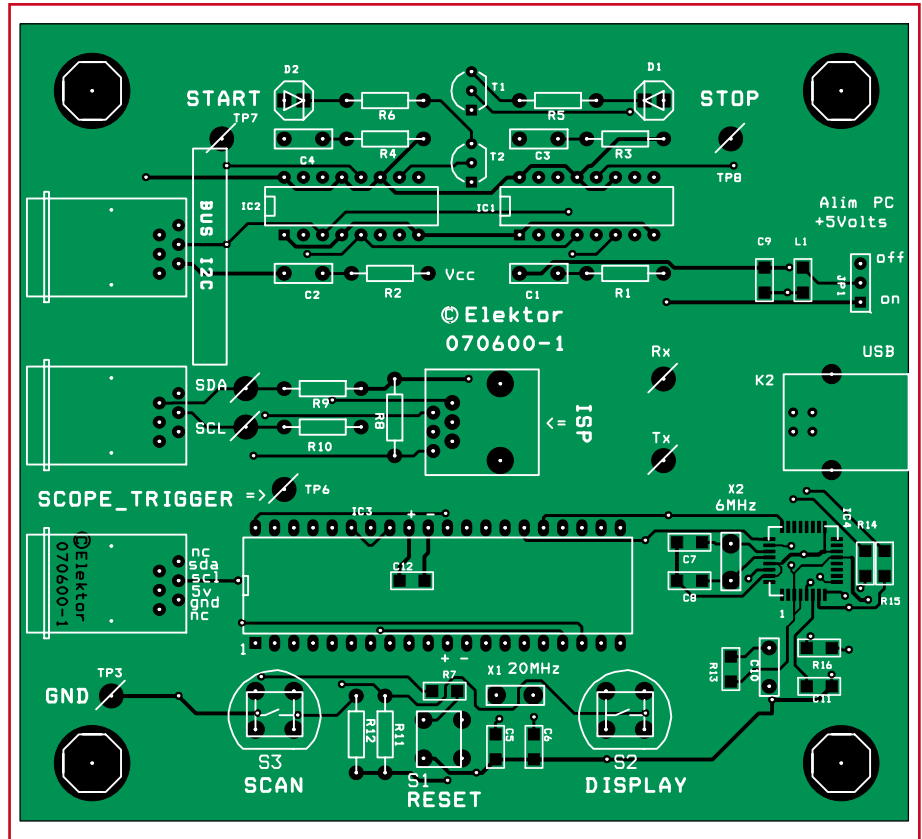

Figure 5. Component overlay for the I²C bus analyser.

IC1–IC3, watching out for their polarity. The board includes a number of test points (TP1–TP8 on the component overlay, test points TP1, TP2, TP4 and TP5 corresponding to the SCL, SDA, Rx, and Tx lines respectively), which can if desired be fitted with pins, as in our prototype.

For testing, the circuit can be powered at 5 V from the I²C bus connector or by wires soldered directly to the board.

Trouble-shooting the hardware part is made easier because the monostables are independent of the software: when the circuit is connected to an

COMPONENTS LIST

Resistors

- R1,R2 = 8kΩ2
- R3,R4 = 1MΩ5
- R5,R6 = 330Ω
- R7,R13 = 470Ω
- R8 = 4kΩ7
- R9,R10 = 10kΩ
- R11,R12 = 1kΩ
- R14,R15 = 27Ω
- R16 = 1kΩ5

Capacitors

- C1,C2 = 1nF
- C3,C4,C10 = 100nF
- C5-C8 = 22pF
- C9 = 10nF
- C11,C12 = 33nF

Semiconductors

- D1 = LED, 3mm, red
- D2 = LED, 3 mm, green
- T1,T2 = 2N7000

IC1,IC2 = 4538

IC3 = PIC18F4520, programmed, Elektor shop item # 070600-41

IC4 = FT232BM (FTDI)

Miscellaneous

- K1 = 6-way RJ-11 socket (vertical)
- K3,K4,K5 = 6-way RJ-11 socket (horizontal)
- K2 = USB socket, male, type B
- L1 = ferrite bead
- X1 = 20MHz quartz crystal, HC 49/4H case
- X2 = 6 MHz quartz crystal, HC 49/4H case
- S1 = miniature pushbutton
- S2,S3 = 'D6' pushbutton (red and black)
- JP1 = 3-way SIL pinheader with jumper
- PCB, item # 070600-1
- PCB artwork, free download from www.elektor.com
- Project software (PC executable and .hex file), item # 070600-11, free download from www.elektor.com

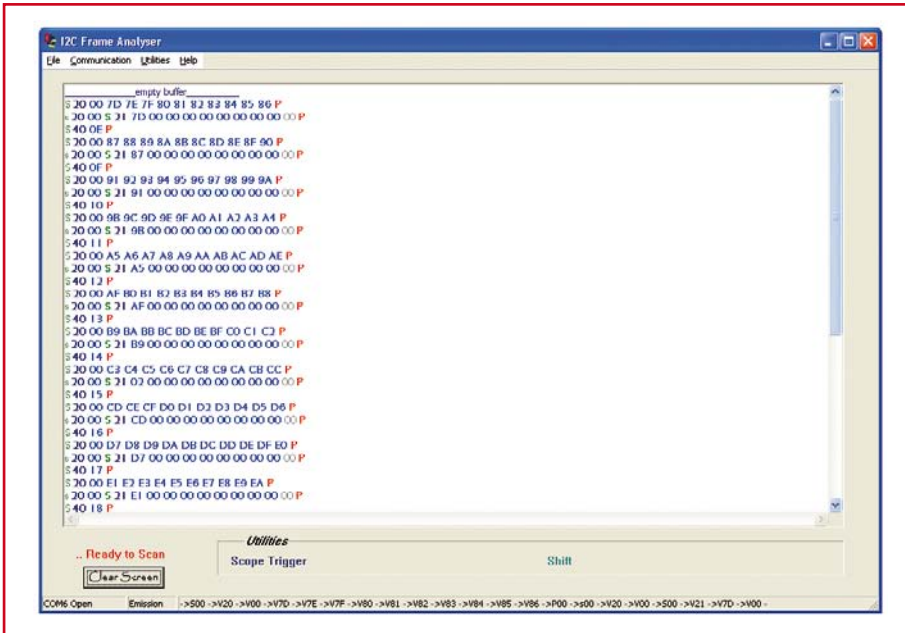

Figure 6. Screen dump of Monitor I2C program.

existing I²C bus, the four monostables ought to react to the arrival of a Start and a Stop by lighting the green and red LEDs respectively. Then the PIC can be programmed.

Software

The microcontroller source program is written in C and compiled with the

help of cross-compiler PCH compiler V4.010 from CCS (Custom Computer Services). This compiler tolerates a certain flexibility in the academic C language, and so is very well suited to programming by electronics technicians.

Development is carried out under MPLAB V.7.62. The program, which runs under Windows, is written in

C++ Builder V5 (Borland). The software for Windows can also compile under CodeGear 11, the latest IDE from Borland, available in 30-day evaluation version. And there you have it all.

An ISP connector K1 is fitted in the middle of the circuit to allow debugging (ICD = In-Circuit Debugging) and *in situ* programming (ISP = In System Programming) of the microcontroller.

A quick glance at the software

Though the electronics are simple, the program loaded into the microcontroller needs to be all the more powerful. You can download it from our website (www.elektor.com) as archive file 070600-11.zip. Let's take a look at a few of its practical aspects.

The man/machine interface: installation

This application, written in C++ Builder V5.0, runs under Windows and is easy to install by copying the executable **monitor_i2c.exe**. This application requires prior installation of drivers on the PC. To do this, it's worth consulting the FTDI [3] website and the previous Elektor articles on this subject.

RS-232 configuration

At start-up, an initial dialogue box lets you select the Virtual Com Port via which the USB link is going to receive the data sent by the PIC in the form of a standard asynchronous serial link (transfer speed 128,000 baud). Then the status bar indicates that the serial port has been opened properly.

Displaying the results

Scanning is started by operating push-button S3 (SCAN). The I²C events are then recorded by the circuit and appear according to a colour code corresponding to the I²C event. Screen dump **Figure 6** shows the main screen when acquisition is finished; in it you will be able to recognize the STARTs in green, the STOPs in red, the addresses in ultramarine blue, and the data in royal blue. However, this display will be modified by the value of the acknowledge bit: if it is present, we see these two in blue, but if it is absent, they will be greyed out. The status bar also shows the format of the codes transmitted on the serial link between the circuit and the PC (ASCII coding). Example:

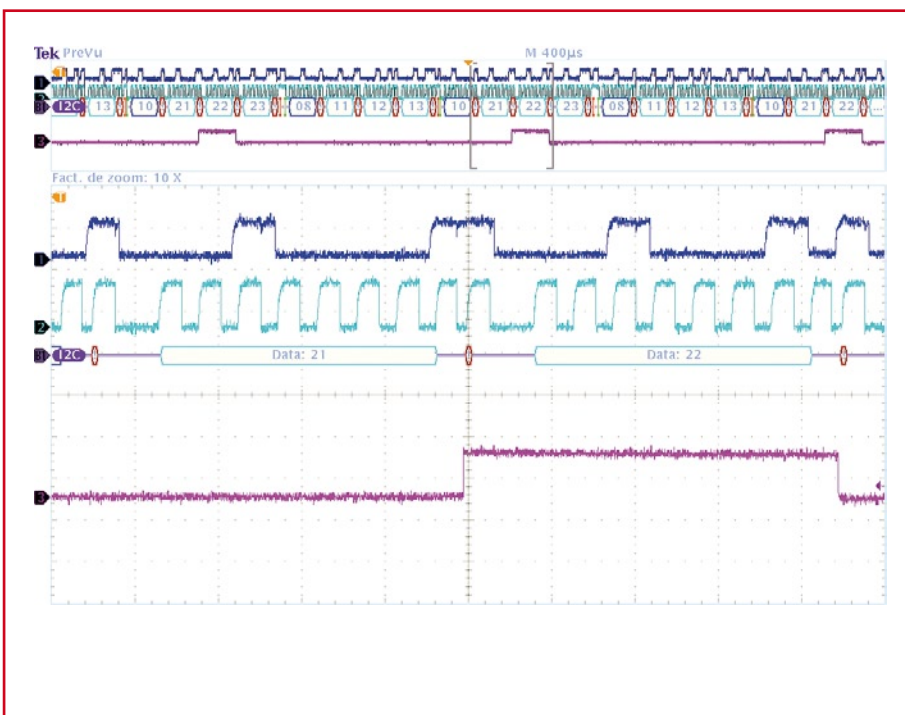
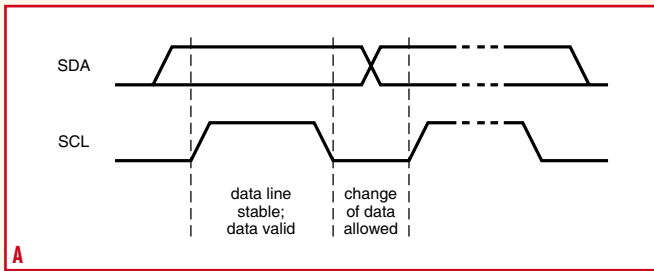

Figure 7. Scope_trigger screen dump

The secrets of I²C and its bus



The I²C (Inter Integrated Circuit) bus was dreamt up by Philips, at the time when they were one of the leading manufacturers of audio equipment. Its major fields of application were home automation and home electronics in the early 80s. Microprocessors were putting in an appearance in TVs, and they needed to find a cheap, easy technique for interconnecting the various electronic sub-assemblies in such devices.

The I²C bus is a synchronous serial bus with just 3 lines: Data, (SDA), Clock (SCL), and ground (used as a reference).

Operation of the bus is based on the concept of master (the peripheral that manages the communication, generates the clock, and transmits the data) and slave (the peripheral that receives the data and confirms reception by an 'acknowledge' signal). But don't let's be deceived: despite its rustic simplicity, this bus can handle several microcontrollers without conflicts, as long as certain rules are properly obeyed.

The four most important situations in this protocol are illustrated below.

1) Transfer of a bit onto the I²C bus (Figure A).

The clock doesn't really have the 'form' of a real clock, since it can have variable mark/space ratios (within constraints).

2) START and STOP conditions (Figure B).

At the start of communication, the SDA line goes to '0' while the SCL line is at '1'. This is the StartBit. At the end of communication, when

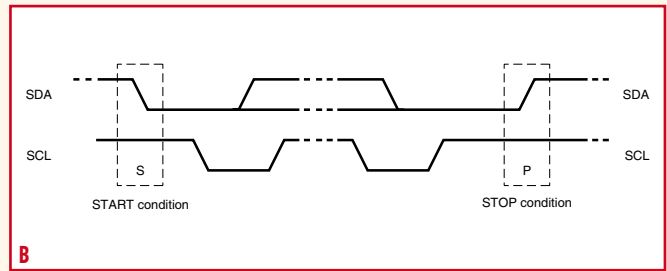

the SDA line has gone back to '1' and the SCL line is also at '1', we have the StopBit.

3) Transfer of data onto the I²C bus (Figure C).

This condition having been defined, the master places the MSB on the SDA line. It validates the data by briefly forcing the SCL line 'high'. It continues in the same way for the various bits right down to the LSB. The transmission over, the slave forces the SDA line low, this is the...

4) Acknowledge signal on the I²C bus (Figure D).

The slave component issues this signal to indicate reception of all the data. If everything is OK, it forces the line to '0'.

Despite its simplicity, the I²C bus allows handling of relatively complex operations. The various scope traces given in the article illustrate this operation very well.

It's worth noting that a master-component can also receive data from a slave (master-receiver).

If you want to find out more, all is explained in the I²C bus specifications from January 2000:

http://www.nxp.com/acrobat_download/literature/9398/39340011.pdf

(Illustrations: Philips Semiconductors)

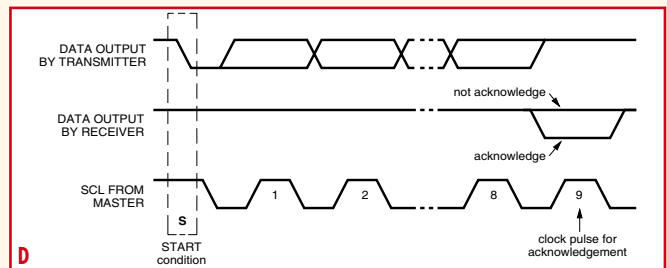
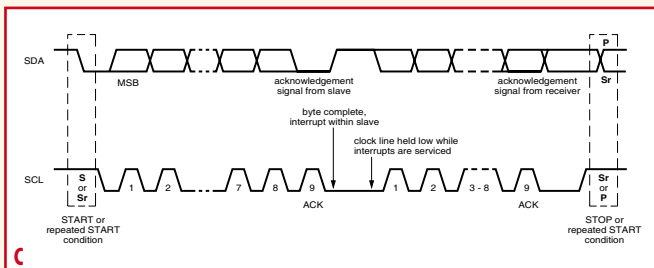

- >S00 for the START
- >V20 for an acknowledged byte with a value of 20 (HEX)
- >v20 for an unacknowledged byte with a value of 20 (HEX)
- >P00 for the STOP.

Oscilloscope synchronization function

This utility lets us configure the set-up with a synchronization byte, which when it is present in the frame triggers a synchronization pulse on the

SCOPE_TRIGGER pin to synchronize a scope in external trigger mode. This makes it possible to display the shapes of the SDA and SCL signals just at that instant. For example, the screen dump in **Figure 7** represents the SCOPE_TRIGGER signal for the sync byte 21 (HEX). The top part of the trace clearly shows how each time this byte occurs, the signal toggles for the duration of the next byte. The central section shows the magnified portion with a zoom factor of 10 and

reveals the transition of the SCOPE_TRIGGER signal at the moment of the ninth SCL clock pulse. This instant, which normally corresponds to the reply from the receiver, enables us to read a '1' on SDA, indicating that there has been no acknowledgment: from that moment on, the I²C circuit with the address 10 (HEX) for which data bytes 21 22 23 were intended is considered as absent from the bus or defective.

Delay function

Another utility function makes it possible to delay the start of recording of a certain number of events; in this case they are replaced on the display by a dot.

I²C summary

A built-in help page includes a brief summary of a few definitions of events present on an I²C bus. In addition, it shows the recording of real signals. To transmit data over the I²C bus, it is necessary to monitor two specific conditions: Start and Stop. The Start con-

dition corresponds to a falling edge on SDA while SCL is high. The Stop condition corresponds to a rising edge on SDA while SCL is high. Then, eight pulses supplied by the clock allow sampling of the eight bits of the byte, starting with the MSB. The ninth clock pulse allows a response, an acknowledgement by the receiving component of the preceding byte. If the component is present, then it acknowledges by taking the SDA line low. This is the principle of 'handshaking'. If not, the line remains high, and the transmitter of the byte may react.

Conclusion

This simple-to-use circuit using standard components (CMOS logic ICs, PIC microcontroller, USB interface) makes it possible to analyse the signals present on an I²C bus. One further development of the circuit might be to fit

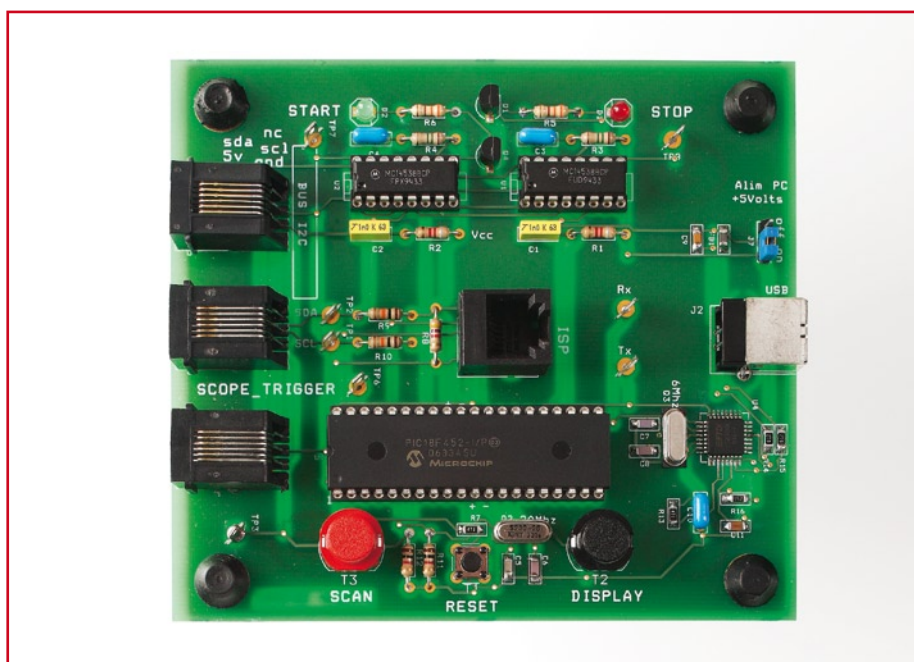

Photo of the prototype. Note that component designations have been changed in the final version.

dition corresponds to a falling edge on SDA while SCL is high.

The Stop condition corresponds to a rising edge on SDA while SCL is high.

Then, eight pulses supplied by the clock allow sampling of the eight bits of the byte, starting with the MSB.

The ninth clock pulse allows a response, an acknowledgement by the receiving component of the preceding byte. If the component is present, then it acknowledges by taking the SDA line low. This is the principle of 'handshaking'. If not, the line remains high, and the transmitter of the byte may react.

And what else?

Not a lot! All you have to do is connect an application's I²C bus to the I²C bus

a PIC with a USB stack (PIC18F4550). This solution would simplify the hardware (by eliminating the USB interface IC and the 6 MHz crystal) and improve speed, as the PIC 18F4550 uses a PLL to generate a clock at 48 MHz. The disadvantage would be in the increased complexity of the software. Libraries provided by the publishers of C cross-compilers do exist and provide numerous source files (MPLABC18Compiler, CCS) but overall debugging is likely to be trickier.

This practical tool will let you to see what's happening on the bus of the datalogger project described elsewhere in this issue, as it too has an I²C bus interconnecting the real-time clock to the rest of the system. Happy hunting!

(070600-1)

The author



The author studied as an engineer at the INSA in Lyons and then moved into teaching, passing the competitive examination for National Education.

Teaching electronics to students in the BTS (Higher Technician's Certificate) section for many years, he has experienced and passed on the fantastic evolution in technology: discrete components (2N2646 unijunction transistor!), memories, microprocessors, mainframes, then the arrival of personal computing.

Training has also evolved, nowadays relying on an understanding of complex electronic systems: installation, configuration, and troubleshooting.

And sometimes even now, faced with a successful project, he still feels that good old maxim: What a fine profession it is to be a teacher!

Etienne Boyer

Web Links and bibliography

[1] FT232BM Data Sheet:

www.ftdichip.com/Documents/DataSheets/ds232b18.pdf

[2] PIC18F4520 Data Sheet:

ww1.microchip.com/downloads/en/DeviceDoc/39631a.pdf

[3] FTDI website:

www.ftdichip.com

[4] CCS compiler:

www.ccsinfo.com

PCB-POOL®

SERVICING YOUR COMPLETE PROTOTYPE NEEDS

1 EUROCARD
(160 x 100 mm)
+ Tooling
+ Photoplots
+ VAT

€49

Price example
Any size and contour possible!

Optional:

- Soldermask
- Fast-turnaround
- Silkscreen
- 4-Layer Multilayer
- 6-Layer Multilayer

DOWNLOAD OUR FREE LAYOUT SOFTWARE!

Over 16,000 Customers

LEAD FREE

Beta

Freephone  **0800-3898560**

Tel.: +353 (0)61 701170
Fax: +353 (0)61 701165
pcb-pool@beta-layout.com

Simply send your files and order ONLINE: **PCB-POOL.COM**

PEAK

electronic design ltd

tel. 01298 70012
fax. 01298 70046
www.peakelec.co.uk
sales@peakelec.co.uk

Handheld Test Gear - Cool, Smart.

Atlas DCA **£55**



Atlas DCA Model DCA55
Semiconductor Analyser
Identifies type and pinout!

Atlas ESR **£85**



New Low Price!

Atlas ESR Model ESR60
ESR and Capacitance Meter
Resolution of 0.01 ohms!

Atlas LCR **£79**



Atlas LCR Model LCR40
Inductor, Capacitor, Resistor Analyser
Automatic part identification.

Atlas SCR **£99**



New Low Price!

Atlas SCR Model SCR100
Triac and Thyristor Analyser
Auto gate test current up to 100mA



UK: Please add £1.00 p&p to your order. Prices include UK VAT. Please see website for overseas pricing.

Embedded Linux Boards

FOX832
MCU: Axis EXTRAX 100LX 100MHz
8MB Flash 32MB RAM
Full Linux v2.4.31 (default) or 2.6.15
Two USB host interface
Two 40 pins sockets for expansion
Dimensions: 66 x 72 mm
GSM / GPS Module add on
Create CGI using C language
Apache, PHP and SQLite
RSS Reader and LCD demo

SAM9-L9260
MCU: Atmel AT91SAM9260
ARM9 180MHz operation
64 MB SDRAM
512MB NAND Flash (seen in Linux as silicon drive)
USB host and USB device connectors
RS232 interface and drivers
SD/MMC card connector
Single power supply: 5V DC
Expansion header
Dimensions: 100 x 30 mm

CS-E9302
MCU: Cirrus EP9302 ARM920T 200MHz
SDRAM 32MB (16MB x16bit)
Flash 16MB (8MB x16bit)
ETHERNET 10/100 PHY CS8952
2 x RS232 drivers and connectors
2 x USB host connectors
SD/MMC card
IrDA transceiver on board
JTAG interface
ADC extension port
Power supply plug in jack
Linux 2.4, Linux 2.6 and NetBSD
Dimensions: 110x90 mm







Secure online ordering
www.skpang.co.uk
sales@skpang.co.uk

ARM7 boards and JTAG programmers are also available





Cylon Voi

Robotalk from an ATtiny microcontroller

Gert Baars, g.baars13@chello.nl

Changing your voice into that of a robot is a task that is perfectly suitable for a microcontroller. This circuit shows how this can be performed by a simple setup built around a small ATtiny45 microcontroller.

A voice changer that emulates a so-called Cylon voice can be implemented with the help of a small microcontroller. Those of you who have watched the (recent or older) TV series of Battlestar Galactica will immediately know what we're talking about. For the non-SF fans amongst you, this is a metallic sounding robot voice. The circuit can be used as a gadget, but was originally designed to show how a simple digital circuit could be used for audio processing.

Hardware

The hardware (Figure 1) consists of a pre-amplifier built round opamp IC2, which has a gain of about 70. This is sufficient to amplify microphone signals. R1 and K1 can be used to supply the microphone with a DC voltage, which is required by electret types. The pre-amplifier feeds the amplified signal to the ADC input of the ATtiny45 controller, which then processes it. Since the clock for the controller doesn't have to be very accurate the internal RC oscillator has been used as the clock generator. It has an output with a frequency of about 8 MHz,

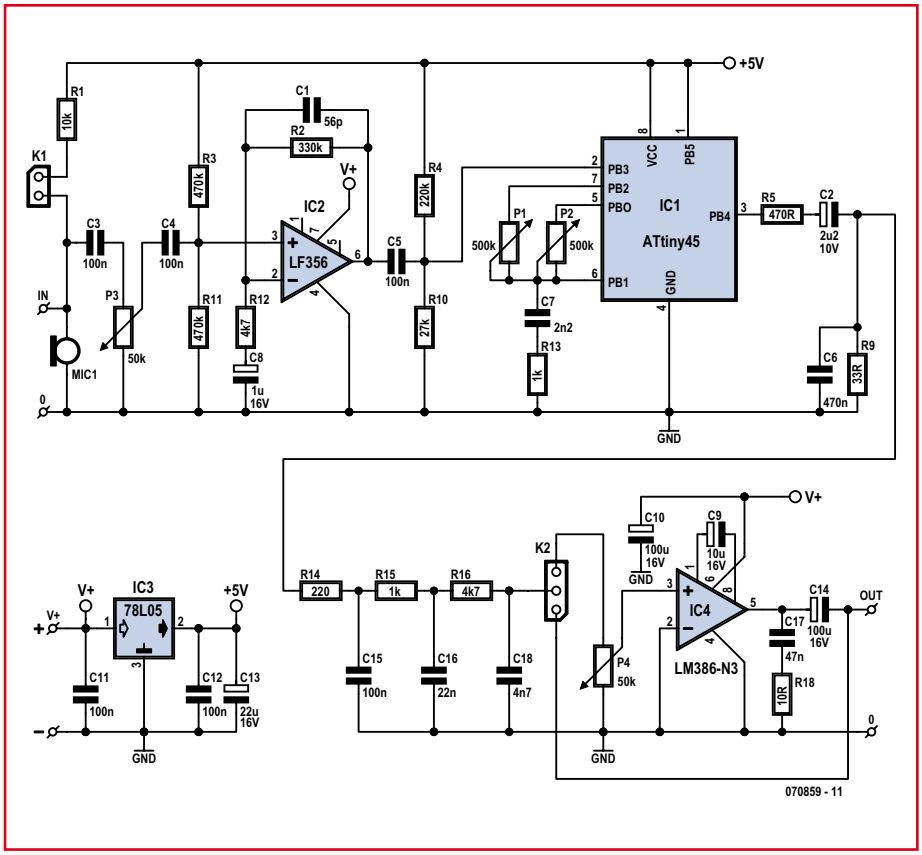
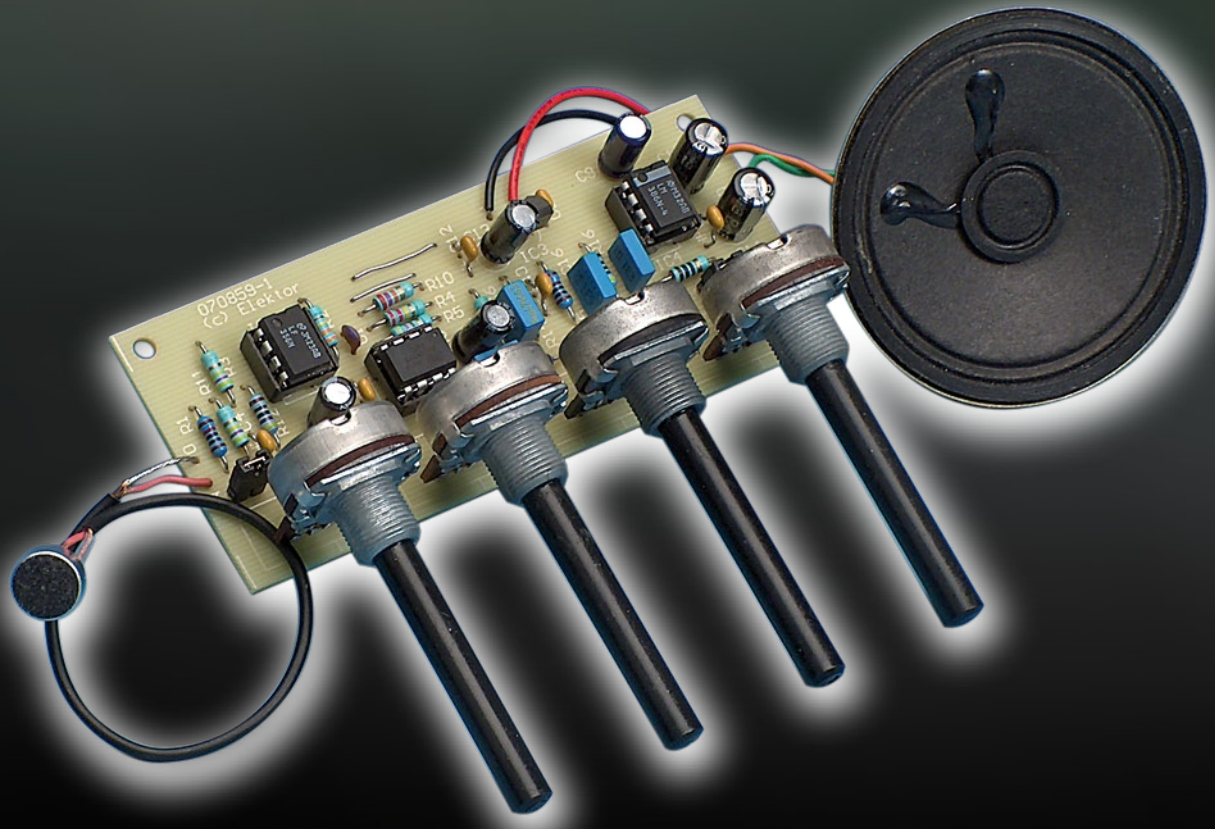

Figure 1. The voice changer consists of a pre-amp, a microcontroller and a power amp.



which is doubled to 16 MHz by an internal PLL. This method ensures that two inputs remain free on the 8-pin controller for connecting the two potentiometers. These are used to set the required 'Cylon' effect. If two other ADC channels were used for reading the two potentiometers it would mean that the audio input would be interrupted by the internal MUX whilst reading those inputs, which would be detrimental to the audio quality. It is therefore preferable to read the potentiometers by timing the charging of an external capacitor. The 'Cylon' software reads in the audio signal with a sampling frequency of about 10 kHz. According to the Nyquist Sampling Theorem the sampling frequency has to be at least twice that of the highest frequency in the input signal. From this it follows that the maxi-

imum input frequency is 5 kHz. As the 'Cylon' circuit is meant for speech signals, this is more than sufficient. The Nyquist Theorem isn't that difficult to understand if we first consider what sampling does in the frequency domain. During the sampling period the input signal can be thought of as multiplied by '1' and during the remaining period by '0'. This is in principle the same as 100% AM modulation with a square wave, which results in an AM spectrum as shown in **Figures 2a and 2b**. From these you can clearly see that overlapping occurs when the sampling frequency is less than twice the highest input frequency, which leads to distortion. This goes to show how important a good input filter is before the ADC. This so-called anti-aliasing filter blocks components that are higher in frequency than half the sampling fre-

quency. Since the 'Cylon' circuit usually operates with speech signals, which are mostly below 3 kHz, there is no need for an elaborate filter when sampling at 10 kHz. After reading each sample the controller software carries out certain processes to obtain the 'Cylon' effect. The result is then fed to the PWM output of the controller. This generates a square wave with a variable duty cycle at output PB4 of the ATtiny45. After integrating this through an RC filter (R14 to R16, C15, C16, C18) the audio signal reappears. This signal is then fed to audio amplifier IC4, which makes the sound audible via a loudspeaker. Setting the jumper on header K2 to the other position bypasses the power stage, so that the signal can be fed to the line input of, for example, a computer.

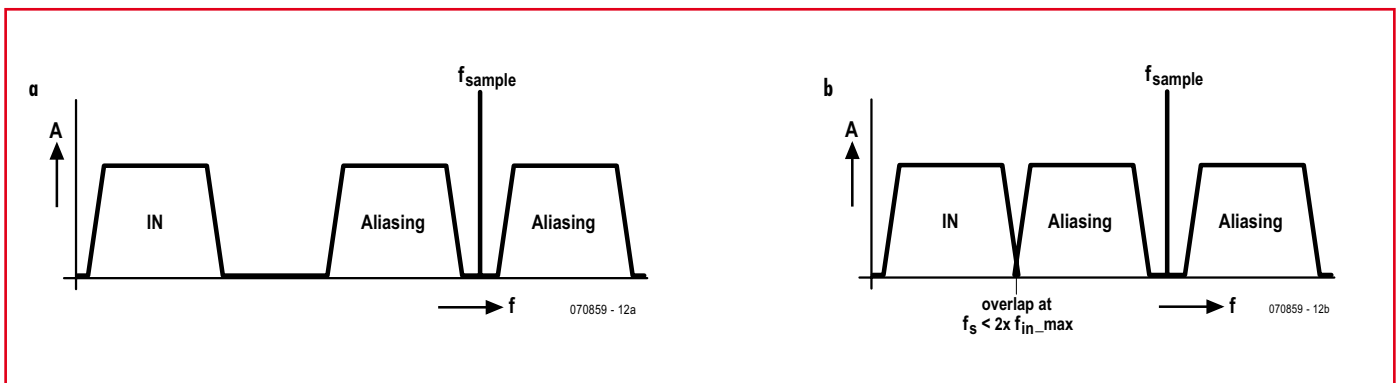

Figure 2. This shows that overlapping occurs when the sampling frequency is less than twice the highest component of the input signal.

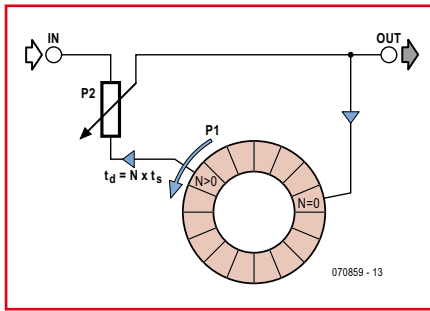

Figure 3. Graphical representation of the FIFO register, configured here as a ring-buffer.

Software

The software has to carry out a number of tasks. The main one is the reading, processing and outputting of the audio signal, but there are also two potentiometers that have to be read. As the ADC is fully occupied with reading the audio signal, an internal counter and comparator are used to read in the potentiometer values. First of all, C1 is discharged. Then an internal counter is started and C1 is charged via the potentiometer to a certain voltage, when the counter is stopped. The resulting counter value is then dependant on the resistance of the potentiometer.

To put it simply, the 'Cylon' effect is obtained by mixing a delayed version of the input signal with the direct input signal, and delaying the resulting signal again, and so on.

The same principle can be used to obtain an echo effect, but then the delay of the input signal needs to be at least 100 ms, whereas in the 'Cylon' version the delay is much smaller. The internal FIFO buffer used for obtaining the delay is 200 bytes long, so with a sampling frequency of about 10 kHz the maximum delay can only be 200/10 kHz = 20 ms.

In Figure 3 you can see a graphical representation of this method. The wheel 'turns' anti-clockwise with one revolution every 20 ms and represents the FIFO buffer, configured as a ring-buffer. The input signal is mixed with the delayed output signal (shown here using a potentiometer), creating a new output signal that is fed back again to the start of the ring-buffer.

The same effect can also be achieved mechanically with the use of magnetic tape and separate record and play heads, with the latter having a variable position to set the delay time.

The software is in effect a simulation of this method, where the memory is the equivalent of the magnetic tape, a store

instruction is the record head, and a load instruction is the play head.

The amount of delay is set using P1. The position of P1 is used by the software to set the position of the tap in the ring-buffer. P2 is used to set the strength of the delayed feedback signal. With a larger feedback signal the decay becomes less resulting in a stronger effect.

P1 is used to set the tap to positions between 1 and 200 in the ring-buffer. The delay is therefore variable from 100 μs to 20 ms. Since the delayed signal is fed back in a loop the damped resonances will become noticeable when the damping is small enough. This is the so-called 'Cylon' effect. The frequency of these resonances is 1/delay-time and can therefore be set between 50 Hz and 10 kHz. A setting

near 250 Hz sounds about the same as the original 'Cylon' robots.

Construction

Figure 4 shows the board layout for the voice changer. Populating the board should be simplicity itself, with all components clearly laid out. The controller can be obtained ready-programmed from Elektor Shop as item 070859-41. If you prefer, you could program it yourself (software 070859-11, but make sure you use the correct settings for programming the chip, as shown in the inset).

If you use an electret microphone you'll need to place a jumper across K1. The jumper on K2 selects the type of output signal (pins 2-3 uses the output amplifier, pins 1-2 for a line output signal).

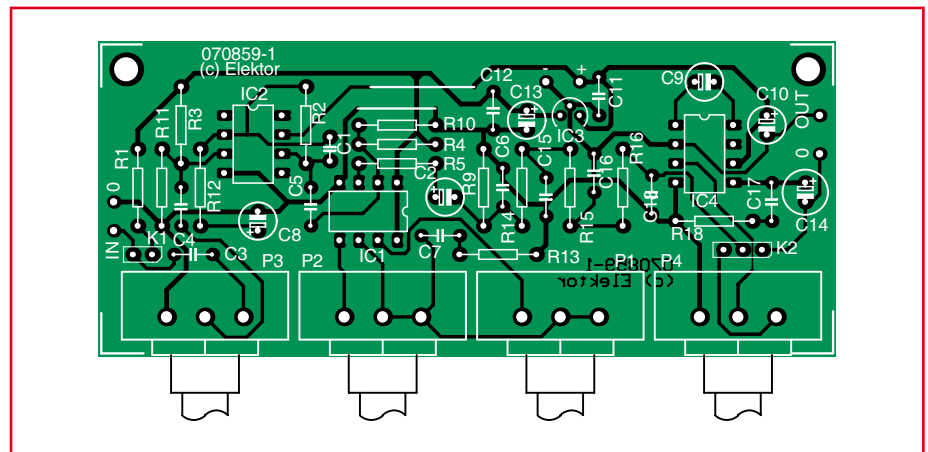

Figure 4. A small PCB has been designed for the voice changer, which makes the construction very easy.

COMPONENTS LIST

Resistors

- R18 = 10Ω
- R9 = 33Ω
- R14 = 220Ω
- R5 = 470Ω
- R13, R15 = 1kΩ
- R12, R16 = 4kΩ
- R1 = 10kΩ
- R10 = 27kΩ
- R4 = 220kΩ
- R2 = 330kΩ
- R3, R11 = 470kΩ
- P1, P2 = 500kΩ
- P3, P4 = 50kΩ

Capacitors

- C1 = 56pF
- C2 = 2μF2 25V
- C18 = 4nF7
- C17 = 47nF
- C6 = 470nF
- C3, C4, C5, C11, C12, C15 = 100nF

- C1 = 1μF 25V
- C9 = 10μF 25V
- C10, C14 = 100μF 25V
- C13 = 22μF 25V
- C7 = 2nF2
- C16 = 22nF

Semiconductors

- IC1 = ATtiny45, programmed, Elektor Shop # 070859-41
- IC2 = LF356
- IC3 = 78L05
- IC4 = LM386-N3

Miscellaneous

- K1 = 2-way SIL pinheader
- K2 = 3-way SIL pinheader
- MIC1 = electret microphone
- PCB, ref. 070859-1, see www.elektor.com
- Project software, 070859-11.zip, free download from www.elektor.com
- PCB layout, free download from www.elektor.com

The circuit doesn't require much current, which depends mainly on the output amplifier (between 25 mA and 150 mA). You could therefore use a 9 V battery as long as you don't use the circuit for long periods. When you don't use the output amplifier stage the current consumption drops to about 25 mA.

When you first switch it on it is best to set the effect to minimum. When you hear an undistorted audio signal you know that the circuit functions properly, so you can then increase the amount of effect. Too much effect eventually results in no audio at all (as you can work out from Figure 3). This can be set precisely using P1, giving a good effect whilst keeping the speech clearly understandable.

(070859-1)

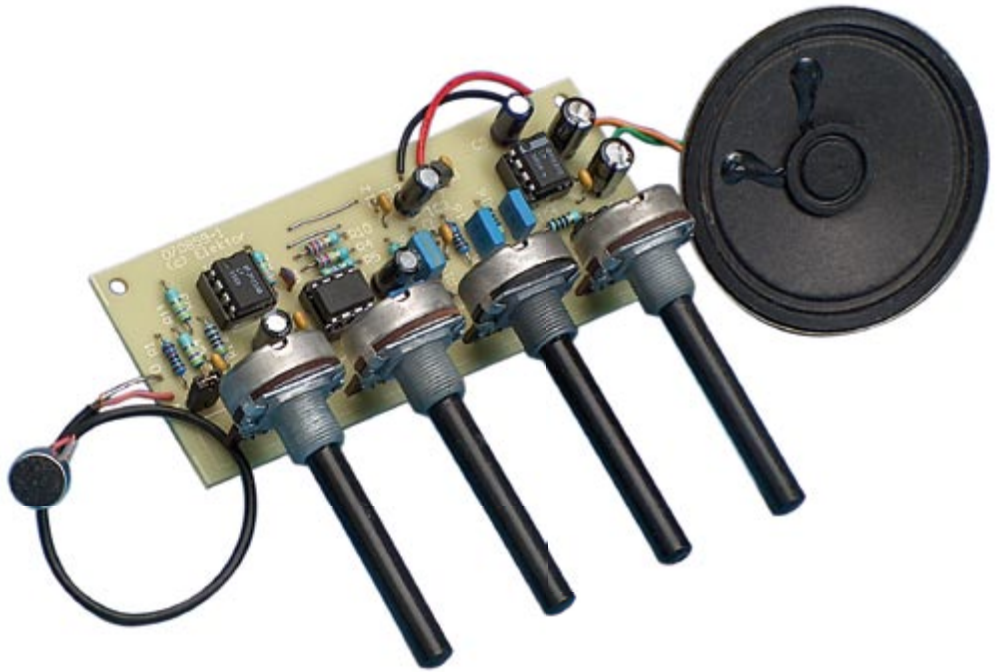

Settings for programming the controller

- Fuses:**
- Brown-out detection disabled: BODLEVEL=111
 - PLL clock: CKSEL=0001, SUT=11

P1 and P2 settings

- P1: Smaller value → higher frequency.
- P2: Larger value → bigger effect.

Advertisement

0845 226 9451

Microcontroller Development Tools	Robots & Accessories	Test Equipment
 <p>Gain the best start with PIC microcontrollers with MikroElektronika's EasyPIC5 development system. High-speed USB PIC programmer, in-circuit debugger and plentiful I/O devices on one board for £79.</p> <p>Similar boards available for 8051, ARM, AVR, dsPIC and PSoC, plus compatible add-on boards and compilers.</p>	 <p>Start experimenting with robotics with the Robo-Box 3.0 robot kit. Contains everything required to build wheel and track-based robots and carry out a large range of fun experiments for £79.</p> <p>Other robot kits available based on 68HC11, 8051, AVR, BASIC Stamp and PIC, plus large range of accessories.</p>	 <p>The PoScope features a logic analyser with serial bus decoding, oscilloscope, pattern generator, spectrum analyser, chart recorder and square-wave/PWM generator in one low-cost instrument for £79.</p> <p>New range of high-specification logic analysers from ZeroPlus now also available.</p>
Control Systems	Educational Products	Tools & Prototyping
 <p>The PICPLC16B makes an ideal platform for developing and implementing automation applications with its 16 relay outputs, 16 opto-isolated inputs and Ethernet controller for £99.</p> <p>A wide range of microcontroller and PC-based control boards and add-ons are also available.</p>	 <p>Designed specifically for teaching about 8051 microcontrollers, the NX-51 V2 incorporates a useful range of I/O devices and comes complete with detailed example programs for £99.</p> <p>Other training systems available for microcontroller and electronics teaching.</p>	 <p>The IDL-800 is a low-cost digital circuit lab incorporating a large solderless breadboard, DC power supply, function generator, volt meter and useful switches and displays for £199.</p> <p>We stock prototyping products from breadboards to advanced digital and analogue circuit labs.</p>

Please see our updated website at www.paltronix.com for even more new products

Paltronix Limited, Unit 3 Dolphin Lane, 35 High Street, Southampton, SO14 2DF | Tel: 0845 226 9451 | Fax: 0845 226 9452 | Email: sales@paltronix.com
 Secure on-line ordering. Major credit and debit cards accepted. Prices exclude delivery and VAT.

Real-Time How does a

```

ProcessingThread
Begin
  Forever Do
    Wait for message
    Read values from message
    Process values
  EndDo
End

tADCValue adcVal;
...;
avixPipe_Read(pipeADC, (unsigned char*)adcVal, sizeof(adcVal));

ADCThread
Begin
  Forever Do
    Wait for 1ms timer
    Read ADC values
    Put ADC values in message
    Send message to ProcessingThread
  EndDo
End
    
```

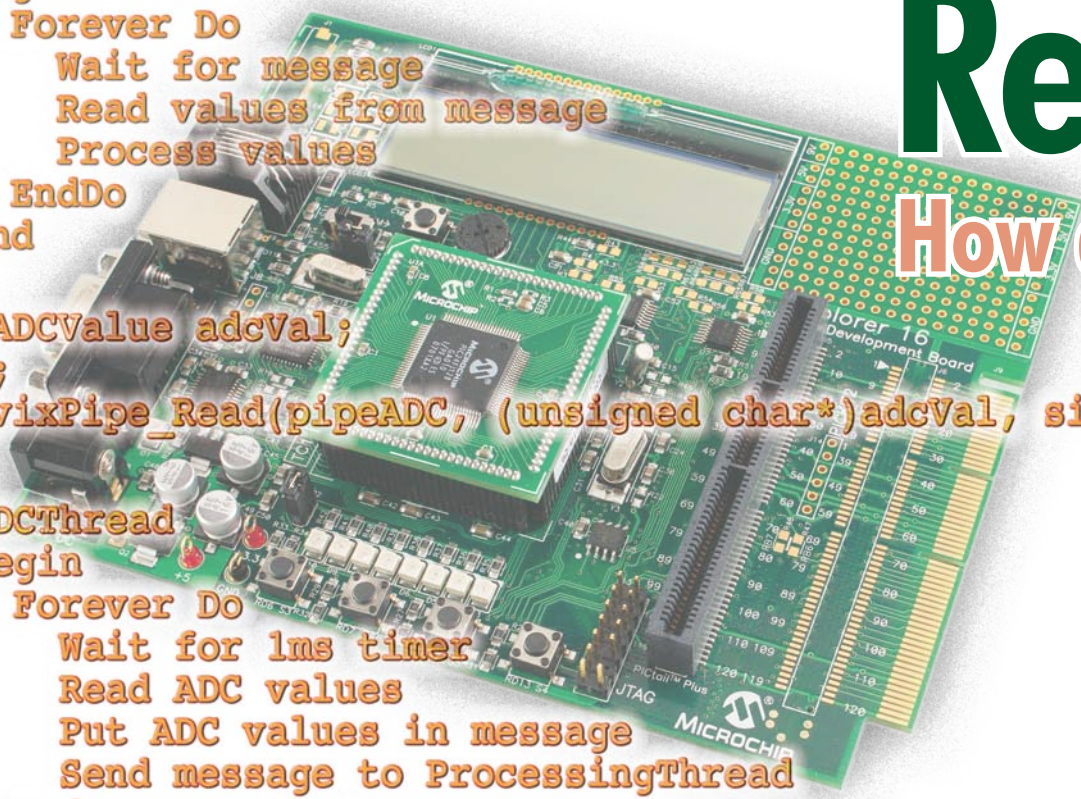

The use of microcontrollers in electronic systems is forever increasing. Recently we published a series of articles in Elektor Electronics, describing the

16-bit microcontrollers from the 24F, 24H and 33F families made by Microchip. These modern, powerful microcontrollers have many peripherals and an advanced interrupt structure. Using a Real Time Operating System (RTOS) can help with managing the software structure and timing characteristics of a system based on such a powerful microcontroller.

In this article we describe how such an RTOS works. The examples given here are based on AVIX, an RTOS that has been specifically designed by the author for the above-mentioned microcontroller families. At the end of this article we will describe a demo application for the Elektor Electronics Explorer-16 board.

scheduler. In this case the scheduler is nothing more than a main function that calls the other functions. If in this system the analogue values have to be read once per millisecond, then the signal processing has to be completed before the start of the next millisecond. If it takes longer than that, then the signal processing will have to be 'sliced up' so that the timing requirements can be satisfied. The signal processing module itself will then have to keep track which part has to be activated each time it is called, so that from the outside perspective of this signal processing module everything is executed in the correct order. This structure is shown in **Figure 2**.

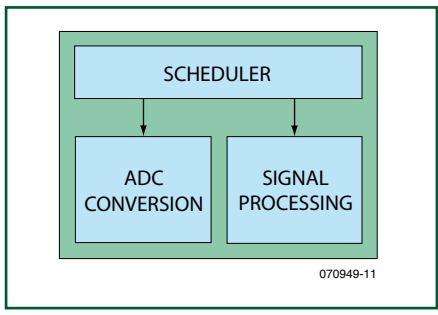

Figure 1. Typical software structure.

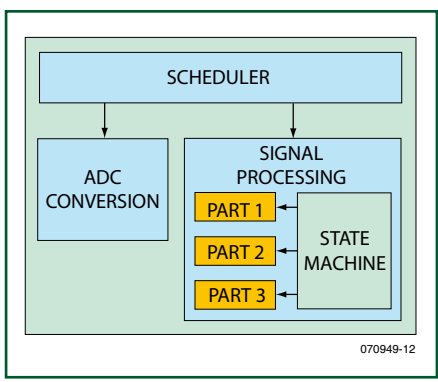

Figure 2. Complex software structure.

Typical software structure

Software is usually designed to be modular. With this approach it is important that the different modules each have their turn at the appropriate time to ensure that the system as a whole operates correctly.

As an example we take the system shown in **Figure 1**. Here we can see that we have one module for reading analogue values and another module for processing these values. These modules run under the control of the

The granting of processor capacity to the modules is now divided between the Scheduler and the State Machine. When a large number of modules are used this software structure will become increasingly complex and obscure. A second problem is the timing of this system. The correct timing depends on the execution time of the various (sub)modules. This execution time can generally only be determined experimentally. When changes are made to the software, switching to another microcontroller with a different speed or even when using different compiler-op-

Real-time Computing

real-time operating system (RTOS) work?

1));

Leon van Snippenberg, AVIX-RT

By using a Real Time Operating System (RTOS) the structure of the software and the timing characteristics of the microcontroller can be significantly improved. In this article we describe the operation and specific characteristics of such an RTOS.

timisations, the process of arriving at the correct timing has to be repeated. This is very time-consuming and prone to errors.

The scheduling of the modules is done by the programmer, by dividing the processor capacity among the modules by explicitly changing the code. This is a static model. Once it is running in the microcontroller this timing behaviour is fixed and cannot change dynamically. When the scheduler has called a module it can only continue its job after the module has finished. For the entire duration that the module is active the scheduler cannot take action. That is why this is sometimes called a cooperative scheduler.

A Real Time Operating System

These problems can be solved by using a so-called 'pre-emptive' scheduler, which also goes by the name of RTOS. With an RTOS the software structure can be well-organised and the timing is deterministic. This is possible because an RTOS, in contrast to a cooperative scheduler, can take action while a module is running. The structure of a module does not need to be adapted to ensure that the RTOS gets its turn often enough. If events occur in the system where the RTOS has to take

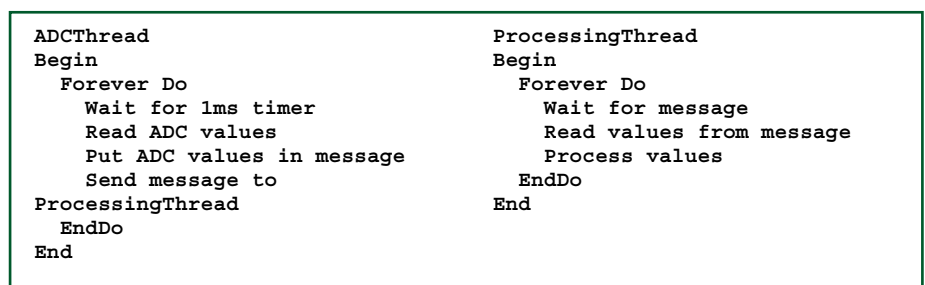

Figure 3. Basic system which uses an RTOS.

action, then it can interrupt the active module to determine whether another module has to go first. This is an important advantage of an RTOS. Every module is written as a linear program without splitting it up in several parts for the purpose of scheduling. The modules that run under the control of the RTOS are called threads. Each thread is coded as a linear program and there is nowhere in the program code indicating where the RTOS may interrupt it. When using an RTOS, each of the threads is assigned a priority and on the basis of this the RTOS decides which thread needs to be activated. Obviously, the RTOS also offers the facility for the threads to exchange information with each other (such as messages) and facilities to work with time

(such as timers). Using an RTOS, the system of **Figure 1** can be represented in pseudo-code as shown in **Figure 3**. Here an important aspect of the operation of an RTOS is shown. Both threads are waiting for an event. The ADCThread is waiting for a timer and the ProcessingThread is waiting for a message. These wait functions are implemented by the RTOS, so that the RTOS knows which thread is waiting for what. The RTOS will activate the thread the instant the desired event takes place and the corresponding thread has the highest priority. Waiting functions are not active. Waiting does not mean running through an endless loop until an event takes place. Waiting with the help of an RTOS means that the thread is completely stopped

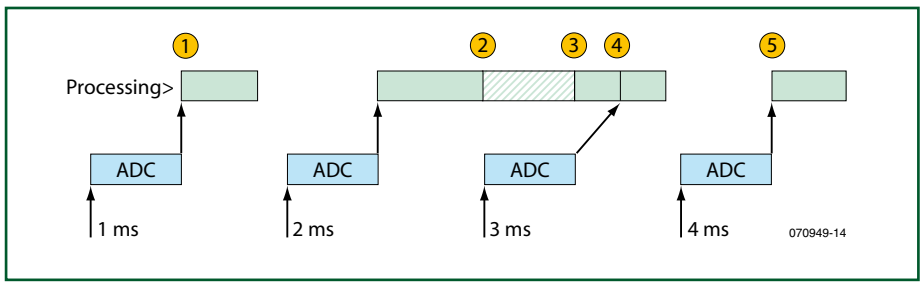

Figure 4. Scheduling threads with an RTOS.

```
tADCValue adcVal;
...;
avixPipe_Read(pipeADC, (unsigned char*)adcVal, sizeof(adcVal));
```

Figure 5. ADC-conversion with the aid of a pipe.

and is not using any CPU cycles at all. During this time the RTOS will ensure that another thread will be active. How does this work? The state of a program is determined by the current con-

tents of the processor registers. When executing the code the contents of the registers will be changing all the time. When an event takes place that results in the activation of another thread, the

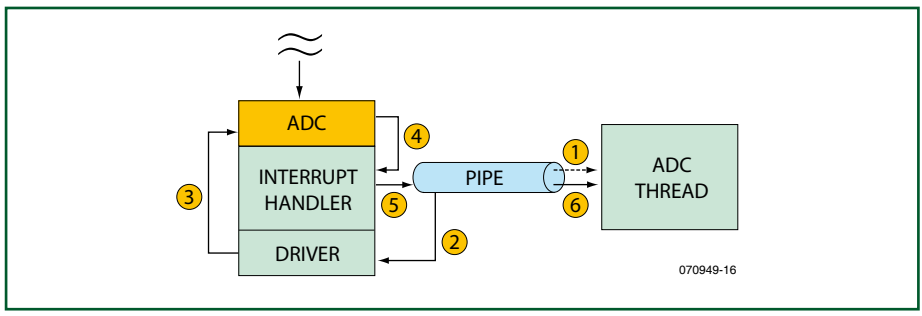

Figure 6: ADC Interrupt-Handler/Thread integration.

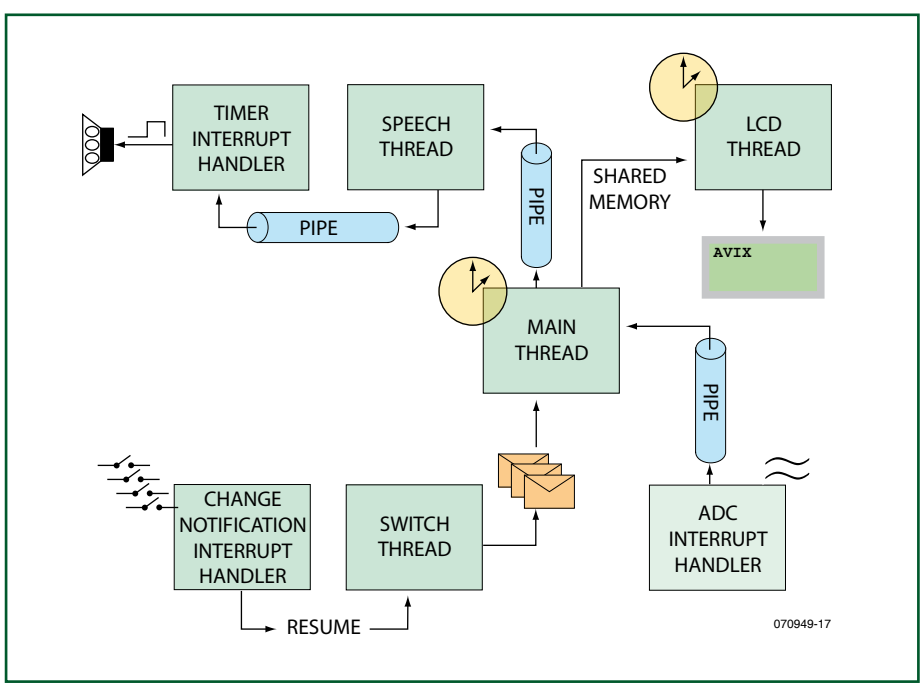

Figure 7: AVIX-based speaking thermometer.

RTOS will write the contents of all the registers to a section of memory that is reserved for this purpose. Each thread has its own section. In this way the state of the running program is safely stored.

Note that one of these registers is the program counter. This is the register that keeps track of where the program execution is up to. Since this register is also stored, the execution progress of the thread at the moment of interruption is implicitly saved as well.

The RTOS will subsequently load the processor registers with the contents of the thread that is, is determined by the RTOS on the basis of the priority of the threads. At any one time multiple threads could become active, because the desired events have taken place for these threads. The RTOS selects from this group the thread with the highest priority. Because in the system of **Figure 3** the ADCThread will have a higher priority than the ProcessingThread, when the timer expires the ADCThread will be activated irrespective of what the ProcessingThread is doing at that moment. This therefore solves the second problem of the cooperative scheduler. Without being able to recognise this directly in the program code, the timing requirements are satisfied. Because the ADCThread has a higher priority than the ProcessingThread the reading of the analogue values will happen the instant that the timer expires. Obviously when processing the data the total processing time for each cycle of ADCThread plus the ProcessingThread has on **average** to be less than the main cycle time of 1 ms.

If however, the processing takes a little longer every now and then, then this is not a problem because the RTOS ensures that the ADCThread is activated at the desired time. This is illustrated with the help of **Figure 4**. At the bottom of this figure the instants that the timer for the ADCThread expires are indicated. The RTOS will activate this thread and the message that this thread sends will subsequently activate the ProcessingThread at time 1. In this example the next processing cycle takes longer and at time 2 the ProcessingThread is not yet finished. The ADCThread is nevertheless activated because it has a higher priority. Once the ADCThread is finished the ProcessingThread will continue at time 3. The message of the 3 ms event will there-

fore be processed a little later, namely at time 4. For this to work it is necessary that the messages are placed in a queue, a function that is offered by practically any RTOS.

RTOS and Interrupts

When looking at the preceding architecture it could be noted that the same thing could be achieved without an RTOS, but by using interrupts instead. The reading and sending of analogue values can also be done in an interrupt handler. Interrupts too, can suspend a running program with a fixed loop for reading and sending of analogue values. This has a few disadvantages, however. The 16-bit controllers from Microchip function with an interrupt priority structure. While an interrupt is being processed, all other interrupts with a lower priority will be blocked. If there is no RTOS, the interrupt handler will have to do more work and as a result interrupts with lower priority will be blocked for longer, which increases the risk of missing an interrupt.

Secondly, the analogue values from the interrupt handler have to be made available to the signal processing routine. This is a complex procedure without an RTOS. The situation of writing to memory locations by the interrupt handler while those same memory locations are being read by the signal processing routine must be avoided, so that there is no risk of using incorrect values. This requires either a complex mechanism or – as is often the case – interrupts are temporarily disabled by the signal processing routine to guarantee that it uses the correct set of values. This however, increases the risk of missing interrupts again.

An RTOS internally makes extensive use of interrupts and also provides methods to send data safely from interrupt handlers to the thread that is responsible for further processing.

Interrupts are the basis of the aforementioned events. An example of this are timers. Practically every RTOS offers timers so that a thread can wait for a certain amount of time. These RTOS timers are software timers. These timers are based on one of the hardware timers in the controller. This hardware timer generates interrupts with a fixed interval. On every interrupt the RTOS will update the active timers and when one expires it activates the process of determining whether another thread needs to run. So a hardware interrupt as a result of an expired hardware ti-

mer, leads to an update of the software timers, which leads to the event as previously discussed.

Interrupts are also be used when controlling the peripherals and these interrupts can also lead to an event which can result in the activation of a thread. An RTOS offers mechanisms for doing these things, which allows programming at quite a high level because the RTOS deals with the complexity of handling interrupts. This is illustrated with the aid of an example, based on the pipe mechanism, which is also available in AVIX.

These pipes are FIFO-buffers which allows threads to exchange information with each other or with interrupt handlers. A thread that wants to read a pipe will be kept waiting while the desired quantity of information is not (yet) available. When writing, a thread will be kept waiting if the necessary empty space is not (yet) available. The RTOS will deactivate the thread so that it is not using any processor capacity. We will now have a look at how a pipe can be used to read data from the ADC. This reading takes place from within a thread and the code required to do this is shown in **Figure 5**.

The thread contains only the read function and blocks when the desired data is not available. What happens in the background? This is shown in **Figure 6**.

The flow of the software is as follows:

1. The thread reads from the pipe. The thread waits because the pipe is empty.
2. From within the pipe-mechanism a DRIVER-function is called.
3. The DRIVER activates the ADC. The ADC runs autonomously and generates an interrupt when it is finished.
4. This interrupt will activate the interrupt handler corresponding to that ADC. This handler will read the result of the conversion and:
5. Writes this to the pipe. In this way the data that the thread desires has become available and the RTOS ensures that:
6. The data is transferred to the thread which then subsequently can process it.

This mechanism is present in the demo program that the author wrote for this article.

A system based on AVIX

One of the demo programs in the Explorer-16 series of articles (beginning

of 2007) was a speaking thermometer. This uses a large number of peripherals which have to work together. The structure of this program is poorly organised and it is difficult to modify or expand it. Compiling with the highest level of optimisation already results in it not working any more, because the timing is completely different.

This program has been rewritten to work under the control of AVIX to demonstrate the advantages of an RTOS. This program can be downloaded, including a demo version of AVIX, from www.avix-rt.com and the Elektor website at www.elektor.com. After installing it, the program can be built from within MPLAB and be programmed in an 24FJ128GA010 controller on the Explorer-16 development board. This uses the Microchip PICtail Plus sound card (AC164125). The structure can be seen in **Figure 7**.

The demo includes an extensive description of the various parts comprising the program.

(070949-1)

Weblinks:

www.avix-rt.com

The author



Leon van Snippenberg wrote an RTOS himself which is called AVIX. This RTOS has been specifically developed for the PIC24 and dsPIC series of microcontrollers made by Microchip. His company AVIX-RT specialises in the supply of products and services for the development of embedded systems.

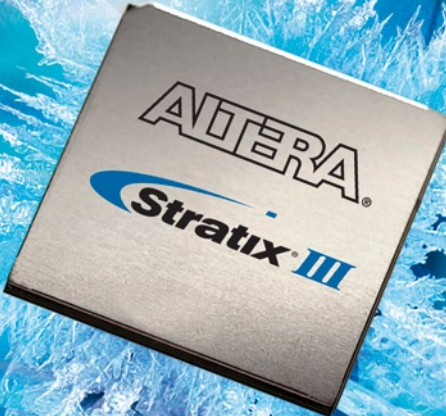

From C Using FPGAs

Paul Goossens

FPGA technology has evolved rapidly in just a short time, and FPGAs are now suitable for a broad range of applications. Nevertheless, most new equipment does not take advantage of the capabilities of these ICs. The main reason for this is that there are still relatively few FPGA experts. The latest developments in the EDA area can largely eliminate this obstacle.

Most of the equipment and devices in our everyday surroundings have a microcontroller inside. Even the simplest products often incorporate some sort of microcontroller. This was not always the case. In the early days of microcontrollers, their use was limited to a select group of engineers, and most electronic equipment was implemented using fully analogue electronics.

The mysterious FPGA

Not too long ago, microprocessors were only used in computers. The engineers who worked with these ICs were called 'experts' and occupied a special field separate from

everyday electronics. The associated firmware was primarily programmed in assembly language. Designers with a more analogue bent (which meant the vast majority of designers) regarded microprocessors and microcontrollers as mysterious components.

The same situation exists today with FPGAs. Although most designers have heard of FPGAs and are in fact interested in these promising ICs, they continue to use their tried-and-true microcontrollers in their designs. In many cases a microcontroller is also the most logical choice, but in more and more cases an FPGA could be a good replacement for a microcontroller.

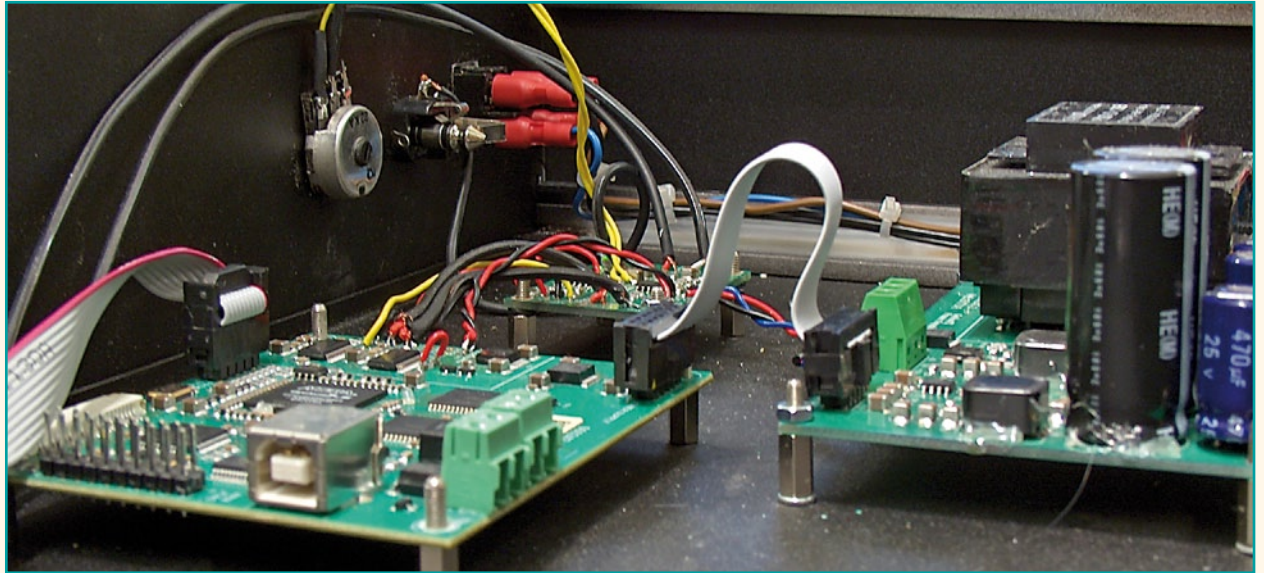

to Hardware and compilers

Progress

Compared with microcontrollers, FPGAs have the reputation of being expensive and power-hungry. FPGA manufacturers have responded to this by reducing the energy consumption of their ICs and developing inexpensive FPGAs. A lot has already been achieved in this area, and the specifications will only get better in the future.

If you look at the websites of various FPGA manufacturers, you will notice that every manufacturer offers low-cost and low-power families of FPGAs. As a result, the choice between a microcontroller and an FPGA is gradually becoming more difficult if your only criteria are low power and low cost.

Another major objection to using FPGAs is that there are still relatively few designers who are familiar with developing FPGA-based designs.

The most commonly used programming language for programming microcontrollers is C, which operates entirely according to the sequential principle. By contrast, the contents of FPGAs are primarily designed using VHDL or Verilog. These two languages do not belong in the sequential-logic camp. Switching from C to one of these languages requires a completely different way of thinking.

This forms a reasonably large challenge to the designers. If you want to be reasonably proficient in a language such as VHDL, you will certainly have to invest time in acquiring knowledge and experience. This means that your first few FPGA-based designs will take a lot more time than an equivalent design based on a microcontroller. For many companies, this is reason enough to use a microcontroller as a standard solution.

Two worlds

Even if the decision is made to use an FPGA, in many cases it is also accompanied by a microcontroller. This can be an external microcontroller or a microcontroller implemented in the FPGA.

This makes it possible to combine the best of both worlds. With this approach, a large part of the design can still be developed in the traditional manner. The FPGA is used for a specific part of the design, with the rest of the job being handled in firmware in the familiar manner.

Ready-made blocks of 'intellectual property' (IP) are joined together to form a working basis. Sometimes a bit of new design (developed using VHDL, Verilog, etc.) is added to the mix. In many EDA environments, everything can be put

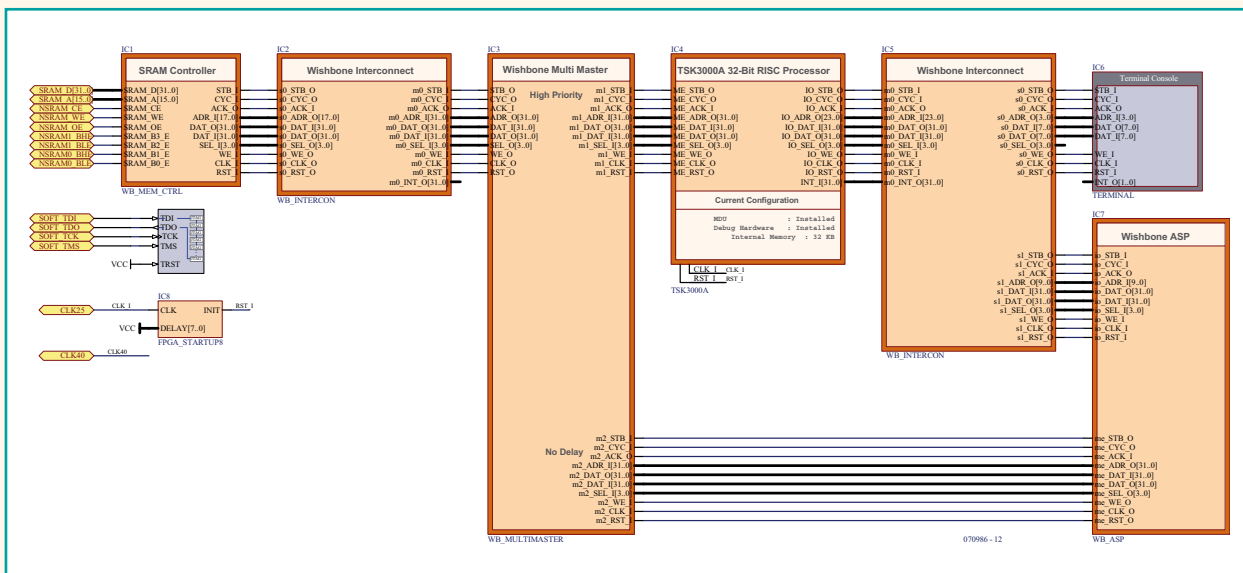

Figure 1. Internal structure of the FPGA design.

Static versus dynamic current consumption

The current consumed by an IC can be divided into two parts. One part of the current will always flow as long as a supply voltage is present. This current consists of various leakage currents as well as currents necessary for things such as maintaining the contents of static memory. This current is called the 'static current'.

The other part of the current is called the 'dynamic current'. This current results from changing the levels of the various signals inside the IC.

As you know, a digital IC (and thus an FPGA) consists of a collection of simple digital circuits. Each of these circuits has an output. In digital circuitry, each output can have one of two states, which are called '1' and '0' or 'high' and 'low'. The outputs are connected via conductors in the IC to one or more inputs of other logical circuits in the IC.

We know from physics that every conductor has a certain capacitance relative to other conductors in its vicinity. These unintentional parasitic capacitances are often sources of problems for electronics engineers and hobbyists, and they can cause problems in ICs as well. Each time an output changes state, the voltage level of the output signal changes.

As the output has a certain capacitance relative to ground and other conductors, a current must flow in order to charge or discharge this capacitance and thus change the voltage level.

If an output rises from 0 to +5 V, the output circuit must supply a current to charge the parasitic capacitance until it has reached the level of 5 V. If this output switches from +5 V to 0 V, the charge on the capacitance must be discharged to ground in order to return the voltage level to 0 V.

The amount of charge necessary to charge the capacitance depends on two factors. The first factor is the difference between the '0' and '1' voltage levels. If the supply voltage is reduced, the amount of charge that is necessary is also reduced. The second factor is the size of the parasitic capacitance. This capacitance can be reduced by modifying the internal structure of the IC and selecting the right materials. Here again, reducing the capacitance also reduces the amount of charge necessary for changing the voltage level.

Synchronous logic

In a synchronous design, the IC responds at the speed of a clock signal. The outputs of the flip-flops can change when a clock pulse appears. If there are combinational circuits following the flip-flops, they will then have different inputs. As a result, their output levels may also change.

After a small time delay, all of the outputs of the flip-flops and combinational circuits will have reached their final states. These outputs can only change when the next clock pulse arrives.

From Hz to current

All this means that the dynamic current consumption can be reduced by reducing the clock frequency. This means that there are fewer clock pulses per second, and this translates directly into a reduction in the dynamic current.

The dynamic current can be reduced even further by ensuring that as few outputs as possible change state on each clock pulse. This can be achieved by shutting down parts of the IC that are not doing anything useful at a particular time. With a clever design, a considerable power saving can be realised using this technique.

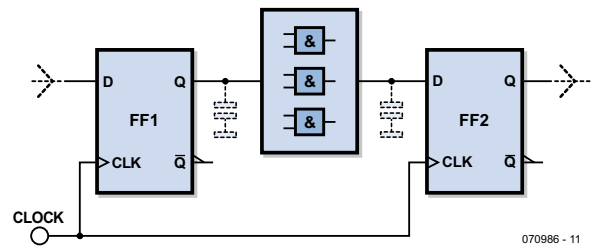

070986 - 11

Glossary

ASP – Application Specific Processor. Digital circuitry designed to perform a specific task.

EDA – Electronic Design Automation. A collective name for programs intended to simplify the design and development of electronic equipment.

FPGA – Field Programmable Gate Array. An integrated circuit composed of a large number of small logic circuits (in many cases several ten-thousands). Using a programmer, they can be linked together to form large, complex digital circuits. It is even possible to build complete microcontrollers, video cards and the like in this way.

IP – Intellectual Property. In the context of FPGAs, this means software code (such as an 'IP core') that can be purchased, usually with a licence. This code has a predefined complex function that can be used conveniently in an FPGA design.

together using a graphic interface without writing a single line of VHDL or Verilog code. These methods ensure that the designers do not have to invest too much time in the VHDL design.

From C to H

The latest development, which for convenience we can call 'from C to H', is the next step in VHDL-free design of FPGA circuitry. Several EDA developers have developed methods to design digital circuitry without using VHDL. The most remarkable method involves direct conversion of standard ANSI C source code into a digital design. There were already compilers available that could convert a specific subset of the C language into a digital circuit. The latest compilers can handle the full scope of standard C (ANSI C). Two suppliers have now developed compilers that can do this: FPGA manufacturer Altera with its C2H compiler, and EDA developer Altium with its CHC compiler. It is expected that other suppliers will quickly launch their own C to H compilers.

FPGAs for the masses

The strength of these compilers is that routines developed in the old, familiar manner can now take advantage of the power of the FPGA. Microcontrollers are by their nature developed to be as versatile as possible. This enables them to perform a very wide variety of tasks. This is also one of the reasons for the considerable success of microcontrollers, but it is also one of their weaknesses. Microcontrollers can do everything, but they are not specialists. FPGAs, like microcontrollers, can do everything – but at a different level. You can build your own digital circuit (including a microcontroller if you will) into an FPGA, but you can also turn it into a specialised bit of hardware that excels in a specific task. These bits of hardware can be developed in C by using these 'C to H' compilers. This means that even programmers with no experience in VHDL can take advantage of the power of FPGAs.

In practice

How does this work in practice? In our lab we can use Altium Designer, which from version 6.8 onwards is supplied with a C to H compiler called 'CHC'. Using this software, we used a simple example to see how various things work in practice. Our example (see **Figure 1**) uses only standard IP components from Altium. Using these components, you can create an embedded system in almost no time. The processor (IC4) is a TSK3000, which is a 32-bit processor. This processor is connected via several blocks to other modules, such as external memory, a terminal emulator, and our star player: the ASP. The result produced by the CHC compiler ends up in this block. Consult the Altium website for more information about the blocks used in the diagram.

Test

To test the design, we needed some hardware in addition to the software and an FPGA design. A future *Elektor* project was a perfect candidate for this. This hardware includes a Cyclone III FPGA along with 256 kB of external memory.

Listing 1: Square root calculation

```
unsigned int isqrt_sw (int number) {
    signed int n = 1;
    signed int n1 = ((n) + (number)/(n)) >> 1);

    while(((n1 - n) > 1) || ((n-n1) > 1)) {
        n = n1;
        n1 = ((n) + (number)/(n)) >> 1);
    }
    while((n1*n1) > number) {
        n1 -= 1;
    }
    return n1;
}
```

In our test firmware, we have the processor calculate the square root of a number 500,000 times. First we had the ASP (which is the result produced by the CHC compiler) perform this calculation, and we measured the elapsed time. After this, we had the software version of our square root calculation routine do the job 500,000 times and again measured the elapsed time.

The routine we used is shown in **Listing 1**. The first part of the routine uses a clever method to guess the result. The algorithm of this guess is written such that the result is always slightly too large. This value is then used to check whether the result is correct. If it is not, the predicted result is decremented by 1. This procedure is repeated until the correct result is obtained. The nice thing about this algorithm is that it uses two loops: shift instructions and multiply instructions. This means it contains a nice mix of commonly used operations.



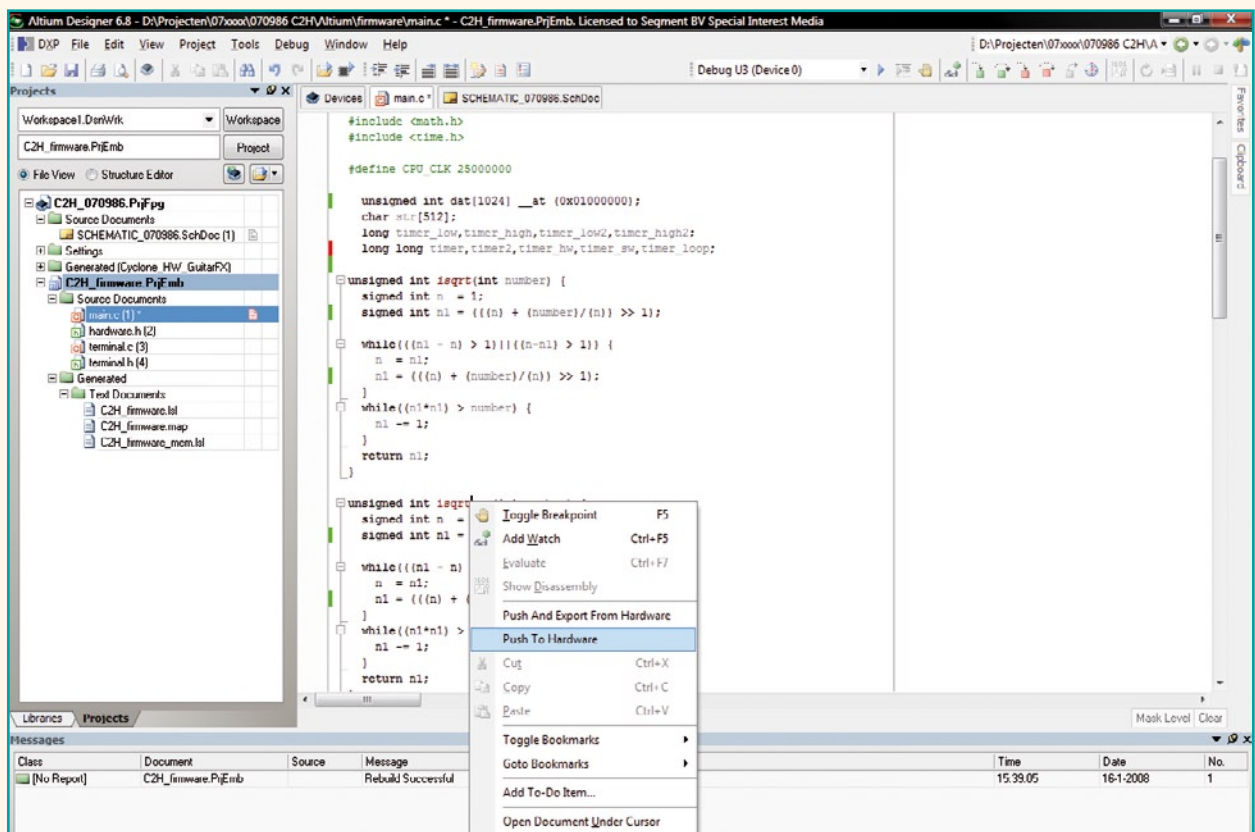

Figure 2. It could hardly be easier!

Exporting to hardware

We used this routine (called *isqrt_sw*) to measure the time required for performing this calculation. To test the CHC compiler, we made an identical copy of this routine. We named it *isqrt*.

The next step was to use the development environment to cause this routine to be converted to hardware by the CHC compiler. This is a very simple process. First you place the cursor on the name of the routine. If you right-click the mouse, a small menu appears. Select 'Push and

export hardware' in this menu (see **Figure 2**). This causes the CHC compiler to implement the selected routine in hardware. In addition, this action causes every call to the firmware of this routine to be replaced by a call to the ASP. All of this takes only one mouse click.

Results

After compilation and programming of the FPGA, the terminal emulator causes the output to be displayed on the PC (**Figure 5**). Here you can see that the hardware version takes slightly more than half a second to perform the square

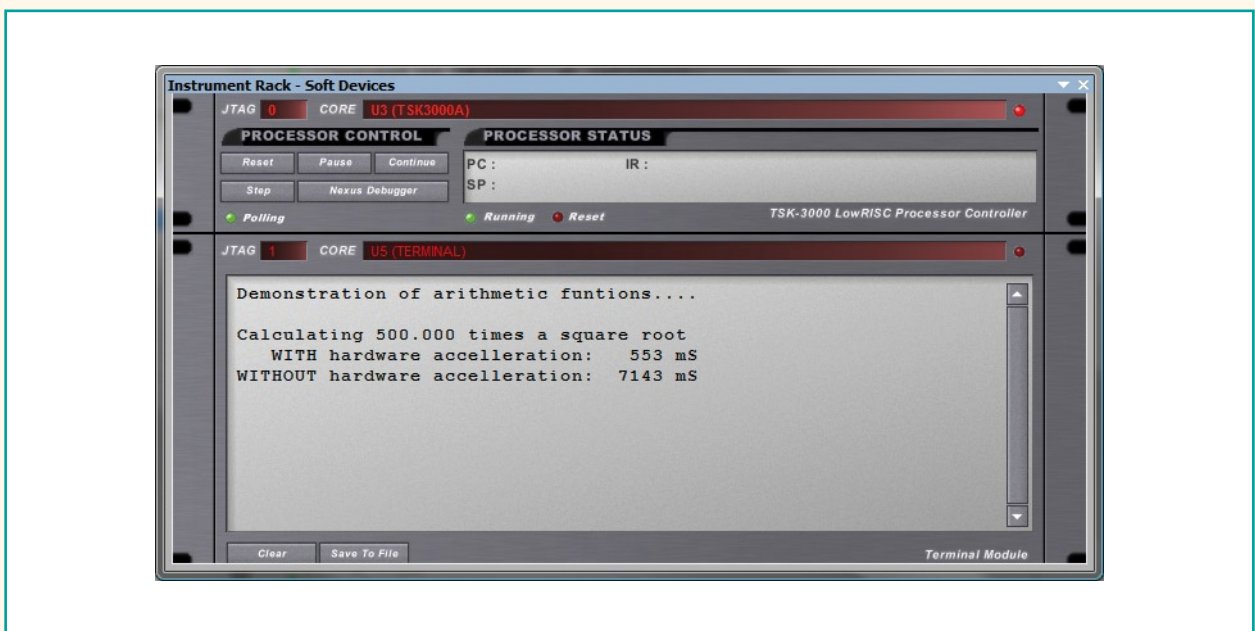

Figure 3. Test results.

root calculation 500,000 times. The software version takes nearly 13 times as long in this case.

The nicest thing about all this is that with this example we (intentionally) did not write even a single line of VHDL. This technology lets programmers take advantage of the potential of FPGAs without having to leave their familiar C environments.

Applications

The ASP can be regarded as a sort of DIY coprocessor. The ASP can be adapted to individual applications, which means that hardware acceleration can be used in almost any imaginable application.

It is also possible to access the memory from the ASP. This makes it possible to develop applications such as a video accelerator. In this case the speed of the routines for drawing lines, circles and areas could be accelerated by implementing them in an ASP.

The dynamic current consumption of the FPGA decreases in direct proportion to the reduction in the clock rate. The result is thus lower power consumption. This is primarily important in portable equipment and environmentally friendly products.

Final remarks

The new developments in C-to-H compilers make FPGAs accessible to programmers who do not have experience with FPGAs, VHDL and related matters. The reduced development time and the possibility of reusing existing, trusted routines in FPGAs also represent a major step forward in the acceptance of FPGA technology in the engineering world. In combination with the technological progress in FPGA fabrication, this means that FPGAs will become even more competitive alternatives to conventional embedded microcontrollers.

(070986-1)

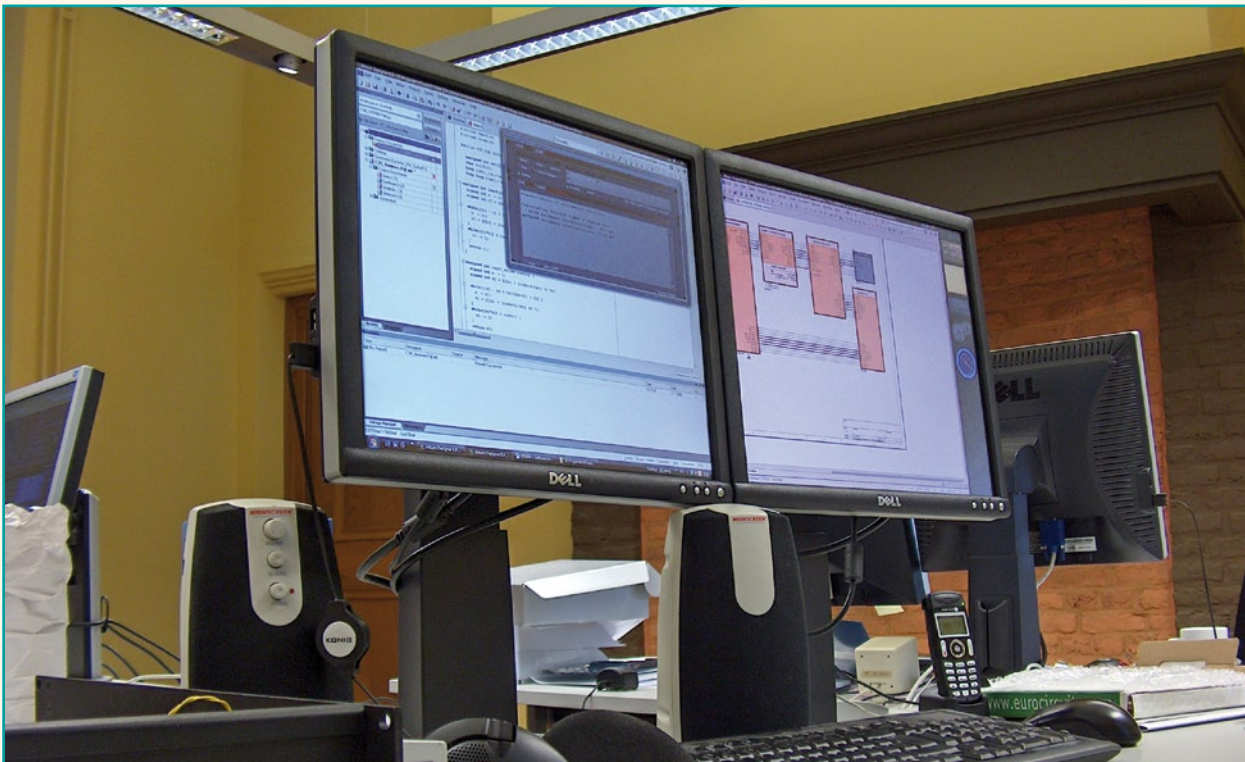

It is even possible to have routines in the ASP run in parallel with routines in software. However, this does require modifications to the software. The advantage of this approach is that it further boosts the processing power.

The previously mentioned example of a video accelerator is a suitable candidate for this approach. The processor does not have to wait until the video accelerator has drawn the line, circle or other object, and in between it can spend its time on other tasks.

Low power

A less obvious advantage is that power consumption can be reduced by using an ASP. The clock frequency can be reduced by using an ASP to increase the processing power. The speed gain obtained from using the ASP can be traded off either partially or entirely for a lower clock rate.

C-to-H for PCs?

FPGAs are already being used in a few supercomputers in order to assist processor ICs in performing demanding computational tasks.

It is certainly conceivable that in the future, FPGAs could also find a place on the motherboards of standard PCs. For this to be possible, it is necessary to have a standard that specifies how the processor communicates with the FPGA. Even more important is to have a standard technology for converting software routines into hardware versions that are suitable for implementation in FPGAs. The new C to H compilers are a step in this direction. Who knows what speed improvements this technology could offer for future PCs?

'LAOS' for ARMee

A mini operating system for the Elektor ARMee board

Dipl. Ing. (FH) Dirk Krämer

The 'ARMee' board described in the March and April 2005 issues of Elektor was a pioneering publication in that it opened the way to 32-bit ARM programming on a shoestring using the NXP LPC2106 processor. ARMs are complex things but now there's LAOS to make them more accessible in terms of programming.

New microcontrollers are like a good stew where the recipe reads: "best if left to simmer for a while". In this case, the stew on today's menu is called *Advanced RISC Machines Seven* (ARM7) and it was left to simmer for about two years (with some stirring and without getting burnt). Lest we forget, RISC stands for *Reduced Instruction Set Computer*.

To make the entry into the world of the ARM7 based LPC2106 microcontroller 'beast' a bit easier, the author developed a compact operating system framework for the Elektor ARMee board [1].

Aims

The operating system framework was dubbed LAOS for 'little applications operating system' to indicate the size of the applications it is capable of realizing for you, newbie to ARM7 or old hand lurking in internet newsgroups, slashdot, sourceforge and microcontroller forums. This article is for you. 'Little applications' is a slightly affectionate way of identifying not just PLC-like programmable processes of all

kinds, but also digital test and measurement instruments, communication gateways, data loggers, mobile robots and so on. Yes, to an ARM processor that's 'a little light work'.

One of the main requirements for the framework was to create a comfortable yet simple application interface while ensuring the 'portability' of the entire application. All source code files belonging to the framework are freely available (from the Elektor website) to enable everyone to extend and improve them as they like.

Layered thinking

An ARM application based on LAOS has a layered structure as illustrated in **Figure 1**. The application layer is capable of, and allowed to, get direct access to any of the layers beneath it, except the hardware. This is called the quasi-consistent layer model. The application only employs the service routines offered by the relevant layer interfaces.

The main part of LAOS is the Object eXecution Layer (OXL). While the other layers form just a pile of extremely

useful methods, OXL contains huge functionality. It all depends on the case whether or not an application employs methods pulled from the Device Driver Layer (DDL), the Protocol Layer (PL) or the Hardware Abstraction Layer (HAL). However, every application based on LAOS does use the essential methods of the OXL.

Broadly speaking the OXL is a *non-preemptive operating system* capable of storing asynchronous events in a queue and allocating relevant event handling routines to the processor on a FCFS (first come first serve) basis. Thanks to the enormous throughput of the LPC2106, all application tasks appear to be handled in parallel. Compared to a preemptive system, a non-preemptive system has the disadvantage of being unable to meet non-negotiable realtime requirements. This is caused by the event handler routines being run to completion without exception. Only interrupts can cause short interruptions. Ideally, however, in an interrupt, only new events should be reported to the OXL. The upshot: don't use LAOS to implement airbag sensor processing.

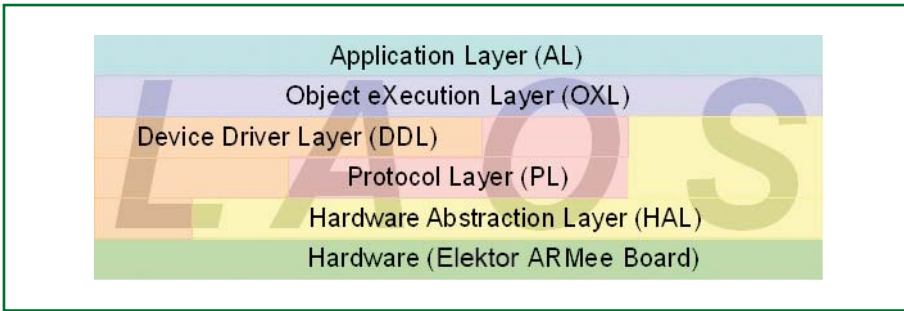

Figure 1. Layer model of an application based on LAOS.

Programming a LAOS application

The basic method is to define different objects capable of generating or processing asynchronous events only. The OXL layer will act as a mediator between objects. To guarantee unique referencing to objects, OXL issues a one-time ObjectHandle for each object reported. Each object is able to process certain events and for this, unique eventIDs are issued by the application developer. Using these two pieces of information the OXL allows an object to get in contact with another object without direct knowledge of it. The above is summarized and illustrated in **Figure 2**.

More tasks for the OXL

Apart from the inter-process communication, the OXL also manages the internal timers and message memories, a

runtime selfcheck and the calculation of runtime statistics. A look at a practical example may help to discover why and when these functions are individually required.

First, the function `oxl_init(<pSystemTime>, <bRuntimeSupervision>, <pErrorHandler>)` has to be called. The first parameter copied along, `pSystemTime`, is a pointer to a system variable that has to be incremented by a microcontroller hardware timer at millisecond rate. All internal timing services of the OXL operate relative to this system time. Alternatives to the proposed clocking method are also possible, but ill advised here because of unnecessary conversions. Using TRUE or FALSE indicated with the second parameter `bRuntimeSupervision` it is possible to decide whether or not the consistency of the event queue is to be guaranteed. The third parameter, `pEr-`

`rorHandler`, allows you to point to a function that's summoned up in the case of a critical exception error discovered by the OXL.

Next, you report all application objects required to the OXL, using the method `oxl_registerObject(<pEventHandler>, <pInitializer>)`. OXL will respond by returning the ObjectHandle mentioned above. The parameters are function pointers. The function stored as `pEventHandler` is called by the OXL if an event relevant to the object is found in the queue. The function reported as `pInitializer` is called once before the actual start of the OXL and is intended for any object specific initialization routines you might require. Next, the object execution is started by calling `oxl_start(void)`. Everything else takes place within the

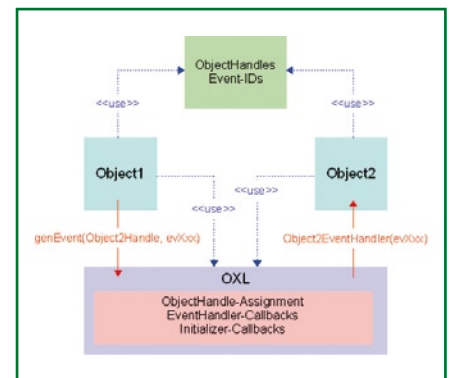

Figure 2. The OXL basic model.

Listing 1. Example of an OXL Initialisation phase.

```
int main(void)
{
    // initialise the target
    InitTarget();
    pl_ascii_sendString("Target initialized...\r\n");

    // initialise the OXL
    oxl_init(&SystemTime, TRUE, oxl_errorHandler);
    pl_ascii_sendString("OXL initialized...\r\n");

    // register the objects and get for each object an unique Handle
    ButtonHandle = oxl_registerObject(ButtonEventHandler, ButtonInitializer);
    DigInHandle = oxl_registerObject(DigInEventHandler, DigInInitializer);
    LcdHandle = oxl_registerObject(LcdEventHandler, LcdInitializer);
    LedHandle = oxl_registerObject(LedEventHandler, LedInitializer);
    SerHandle = oxl_registerObject(SerEventHandler, SerInitializer);

    sprintf(StringBuffer, "%d object(s) registered...\r\n", (int)SerHandle);
    pl_ascii_sendString(StringBuffer);

    pl_ascii_sendString("About to start the OXL...\r\n");

    // OXL shall start its work
    oxl_start();

    return (0);
}
```

endless loop implemented inside it. An example of such an initialisation phase is shown in **Listing 1**.

Generating Events

In order for things to really start happening, objects have to generate events addressed to themselves or to other objects. Four methods are available to do so. The two methods `oxl_genEvent(<ObjHandle>, <EventID>, <pData>, <DataLen>)` and `oxl_genFastEvent(<ObjHandle>, <EventID>, <pData>, <DataLen>)` only differ in the first one adding the event to the queue, and the second bypassing the queue (bad bad at bus stops and checkouts) allowing the EventHandler of the target object to be called straight away. The first two parameters brought along, `<ObjHandle>` and `<EventID>` enable you to address a very specific service within the application. Using the other two optional parameters `<pData>`

and `<DataLen>` you can transfer data that's copied by the OXL and stored in its own list. This method obviates the need for global data, and source data does not have to be valid anymore after the transfer. When it's necessary to generate an event within an interrupt service routine, the method `oxl_genEventIsr(<ObjHandle>, <EventID>, <pData>, <DataLen>)` is ready and waiting for you. Discerning it is required, because it may happen that an interrupt also wants to call `oxl_genEvent()` while the application is in the middle of calling the same. This could lead to inconsistent data being sent to the queue and disrupting the program flow.

The fourth method of generating an event comprises the method `oxl_genTimeoutEvent(<ObjHandle>, <EventID>, <TimeToEvtGen>)`. Calling it causes an OXL timer to be activated. When the period defined by `<TimeToEvtGen>` is over, the Event is generated that's addressed by the

first of the two parameters. **Listing 2** shows what it might look like in an application.

Conclusion

LAOS is a free download from the Elektor website. The archive file **070990-11.zip** on the project pager at www.elektor.com contains all building materials and the full source code file of the example. Despite its name LAOS still allows fairly complex applications to be implemented for the ARM7 processor, with a minimum of effort. The author may have additional information available on his own homepage, which is being set up at the time of writing [2].

(070990-1)

Web Links and References

- [1] LPC210x 'ARMee' Development Board, Elektor Electronics March & April 2005.
- [2] www.dk-embedded.info

Listing 2. Example of an event generating process.

```
void LedEventHandler(tU32 EventID, tU8* pData, tU32 DataLen)
{
    static tU8 BlinkState = 0;
    static tU8 LastBlinkState;
    static tBOOL LifeLedToggle = FALSE;

    // calm down the compiler
    pData = pData;
    DataLen = DataLen;

    switch(EventID)
    {
        case evLedUpdateBlinkPattern:
            // update the blinking pattern
            hal_clrBytePort(LED_PORT, LED_OFFSET, LastBlinkState);
            hal_setBytePort(LED_PORT, LED_OFFSET, ++BlinkState);

            // memorise the current blinking pattern
            LastBlinkState = BlinkState;

            // check for overrun
            BlinkState %= MAX_LED_VALUE;

            // execute this event in 50ms again
            oxl_genTimeoutEvent(LedHandle, evLedUpdateBlinkPattern, 50);
            break;

        case evLedToggleLifeLed:
            if(LifeLedToggle)
                hal_setPortpin(LED_OK);
            else
                hal_clrPortpin(LED_OK);

            LifeLedToggle = ~LifeLedToggle;

            // execute this event in 500ms again
            oxl_genTimeoutEvent(LedHandle, evLedToggleLifeLed, 500);
            break;
    }
}
```

FRONT PANELS & HOUSINGS

Cost-effective single units and small production runs

Customized front panels can be designed effortlessly with the Front Panel Designer. The Front Panel Designer is available free on the Internet or on CD.

- automatic price calculation
- delivery in 5–8 days
- 24-Hour-Service if required



Sample price: 32,50 € plus VAT/shipping

Schaeffer AG · Hohentwielsteig 6a · D-14163 Berlin · Tel +49 (0)30 8058695-0
Fax +49 (0)30 8058695-33 · Web info@schaeffer-ag.de · www.schaeffer-ag.de



EzPCB
Professional PCB Supplier

**High Quality
Competitive Price**

URL: www.EzPCB.com

Email: sales@ezpcb.com Tel: +86 139 1002 1704
HDI Up To 50 Layers, 2.5mil T/C, 0.1mm Hole Size
Other Products: Stencils, Keypads, Frontpanels,
Flex PCB, Enclosures, Turnkey Services

PIC Microcontrollers

Silent alarm, RGB fader, poetry box,
night buzzer and more!



This hands-on book covers a series of exciting and fun projects with PIC microcontrollers. You can built more than 50 projects for your own use. The clear explanations, schematics, and pictures of each project on a breadboard make this a fun activity. You can also use it as a study guide. The technical background information in each project explains why the project is set up the way it is, including the use of datasheets. All software used in this book can be downloaded for free, including all of the source code, a program editor, and the JAL open source programming language.

446 pages • ISBN 978-0-905705-70-5 • £27.00 • US\$ 54.00

Elektor
Regus Brentford
1000 Great West Road
Brentford TW8 9HH
United Kingdom
Tel. +44 20 8261 4509



Order quickly and safe through www.elektor.com/shop

DIY LED Projector

DLP projector with power LEDs

Jeroen Domburg

Although an evening at the cinema can be a nice experience, there are a few drawbacks as well. You can't just pause the film if you need to nip to the toilet, and the seating isn't always that comfortable. If you're really unlucky you could find yourself sharing the place with a horde of noisy kids who can't keep still. A home projector provides a good alternative: a nice big display, you can pause it when you want and you can choose your own company. It's a pity that the projector lamp wears out so quickly though...

There are certainly many advantages watching films at home. Invite a few friends round, grab a few drinks and you're bound to have an enjoyable time. The main difference of course is that whereas you have a huge screen in the cinema, most people only have a (relatively small) TV at home. And although those large LCD and plasma screens are becoming more affordable, the largest ones are still outside the budget of most people.

Another appliance that can produce a large display in the home is the projector. Point it at a white wall or projector screen, connect it to a laptop or DVD player and there it is: a high-quality display well over a metre in size.

Costs

Projectors aren't very expensive to buy. You can easily get a second-hand one for under a few hundred pounds and

new ones no longer cost the earth. But, and this is sometimes overlooked, they can be quite expensive to maintain. The internal lamp has a lifespan of only a few thousand hours and can cost up to £300 to replace. This does turn it into an expensive pastime when you often watch a film. It makes you think twice before you turn the projector on to watch the news or play a computer game on the big screen.

A recent development is the use of LEDs instead of a lamp in some new projectors. These last a lot longer and have the added advantage that they don't run as hot so are likely to have less noisy fans for cooling the lamp.

The disadvantage of these projectors is that not many of them are produced yet, and they are still quite expensive. You won't find one for under £500 (€ 350) at the moment.

In the last few years many improvements have been made in LED technology. This has also been realised

by many electronics hobbyists. Some electronics shops and web stores stock LEDs that leave incandescent lamps in the shade. Would it be possible to acquire an old projector and replace the lamp with a set of ultra-bright LEDs? This gives us all the advantages: a projector that is quiet, doesn't cost too much and doesn't need a replacement lamp at regular intervals.

A little bit of theory

Before we get started on the project we need to go over some theory first. How does the average consumer DLP projector work? A DLP projector is built round a Digital Mirror Device (DMD), which is a chip with thousands of microscopically small, electronically activated mirrors on its surface. Each mirror corresponds to one pixel. By rotating these mirrors an incident beam of light can be passed on or blocked. This does mean that pixels can only be



This is the projector we'll modify. It is a fairly compact model, which unfortunately doesn't have much spare room for our own circuits.



The removed, much too expensive, lamp that needs replacing at the drop of a hat.



This is where the lamp goes. At the bottom you can see one of the three fans that cool the lamp. The large circular opening goes to the colour wheel and light tunnel.

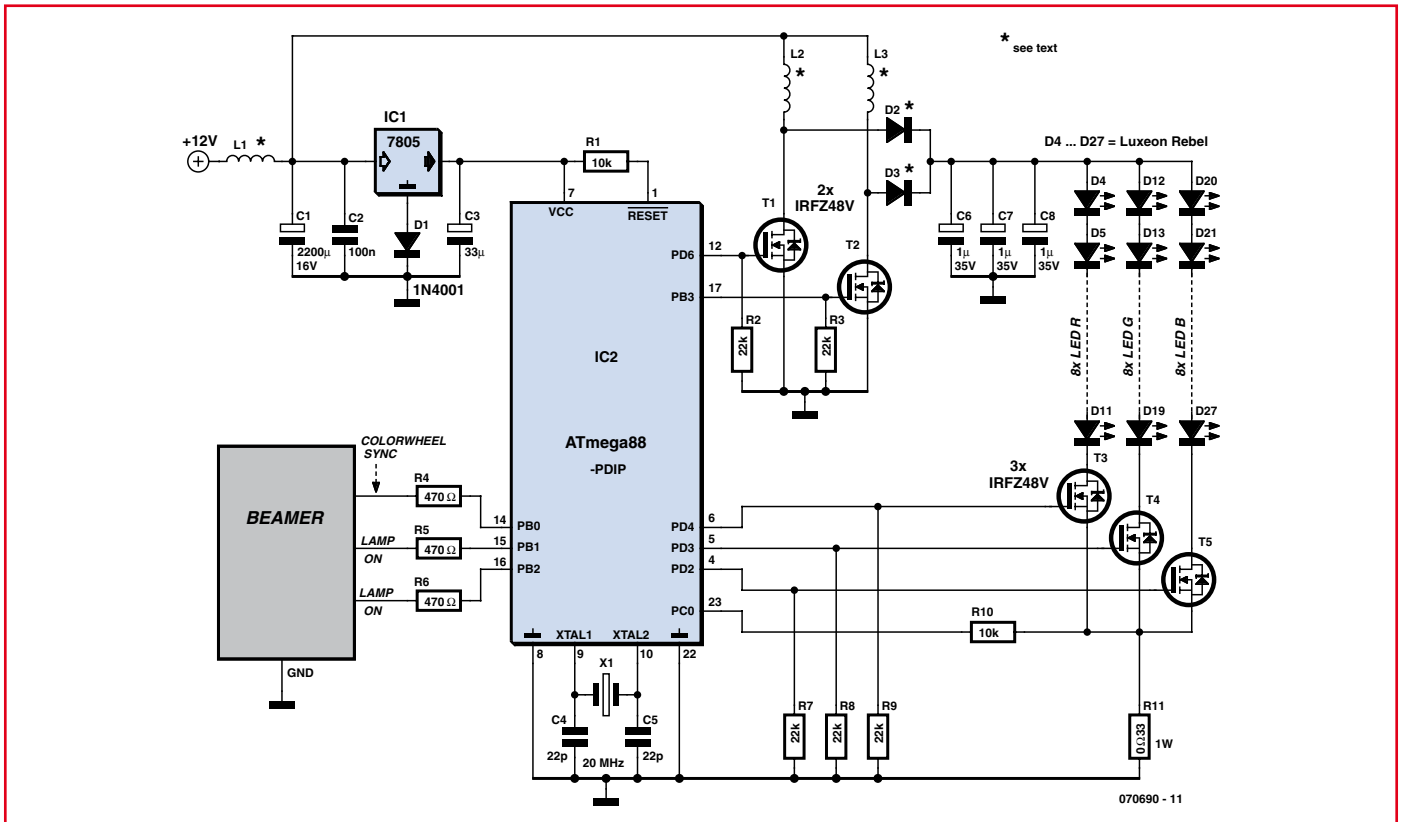
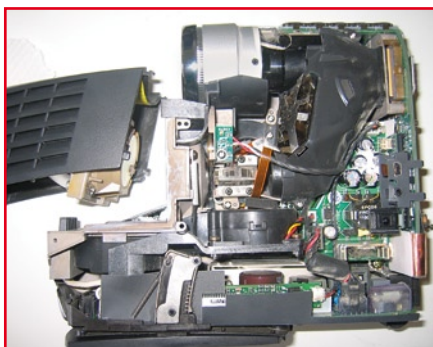

Figure 1. The circuit is built around a μC , as is often the case. This controller also takes care of the boost conversion.

turned 'on' or 'off'. The control electronics can generate intermediate levels of brightness by driving the mirrors tens of thousands of times per second. But you need more than just a DMD to make a projector. A large number of other components are also required. Normally, the light required for the display is generated by an expensive gas-discharge lamp. The light first goes through a colour wheel. This is a wheel with a number of colour filters, usually red, green and blue. The filters are put in front of the light source at a very high rate. Often this wheel turns at 100 revolutions per second.

After the colour wheel come a light tunnel, which consists of four mirrors stuck together, creating a type of rectangular 'tunnel' of mirrors. This converges and homogenises the light. The light then goes through a lens that focuses the coloured light onto the DMD. The electronics controlling the DMD keep track of the position of the colour wheel and adjust the positions of the mirrors accordingly. The reflected light leaves the projector via a set of lenses that focus the image onto the screen. This method has the disadvantage that it causes the so-called 'rainbow

effect'. This effect can be seen when you quickly look across the projected image. Along the sides of the image you'll be able to see the primary colours. It is of course perfectly possible to replace the gas-discharge lamp with a set of white LEDs, but there is a better solution. If white LEDs are used, you would on average only use one third of the generated light. Each segment of the colour wheel lets through light for just one of the three primary colours. This is rather impractical since LEDs are already less bright than a 150-W gas-discharge lamp.



The light travels from the lamp through the colour wheel (behind the small green PCB), through the light tunnel to the lenses and mirrors in the black parts. The gold coloured DMD chip is at the top right.



The colour wheel. As can be seen, it consists of red, green and blue segments, plus a white segment for the brightness. At the top right is the position detection PCB.

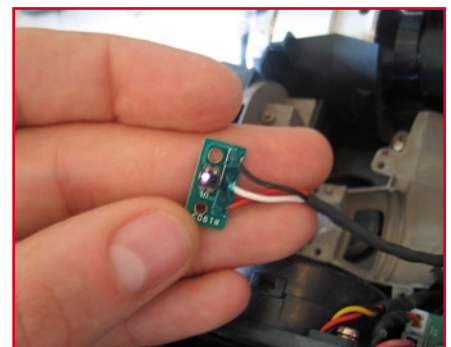

The detection PCB. The infrared LED and photodiode can't be told apart. However, the normally invisible infrared light from the LED is picked up by the camera, so you can quickly see which is which.

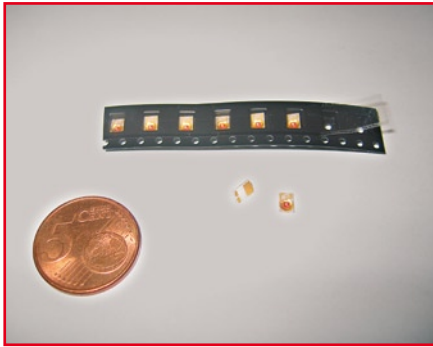

The Luxeon LEDs aren't very big, as you can see. That comes in handy since we need a small but intense light source. However, it does make the soldering trickier.

Fortunately we can get round this. We can simulate the colour wheel through the use of separate red, green and blue LEDs. In this way the light expected by the DMD can be generated directly by LEDs. You may now think that we need three times as many LEDs for the same light intensity, but this isn't true. Because the LEDs are on for only one third of the time it is possible to increase the current through them by a factor of three. This method only works for DLP projectors; there is no colour wheel inside LCD projectors so this method wouldn't work.

The project is now beginning to take shape: open the projector, take out the lamp, take out the colour wheel, put in the LEDs, program the microcontroller with a colour wheel emulator and that's it. This begs the question: can it really be this simple? There is only one way to find out and that is to try it.

Requirements

To get this project going we first need a projector. After looking on the Internet we found a nice DLP projector: the iPaq MP3800 made by Compaq, (now part of HP). This projector has the advantage that it is very small and has a resolution of 1024×786 pixels, which results in a very sharp picture. The critics found this projector too noisy and they weren't too happy with the lifespan of the lamp either, which could be as little as 500 hours. In our case this doesn't matter. When the projector is converted for use with LEDs as the light source, these problems are effectively overcome.

Whilst we're ordering things on the Internet we may as well get the other parts. The LEDs required are (red green and blue) Luxeon Rebels. These SMD LEDs, which have an area similar to a matchstick head, can draw up to

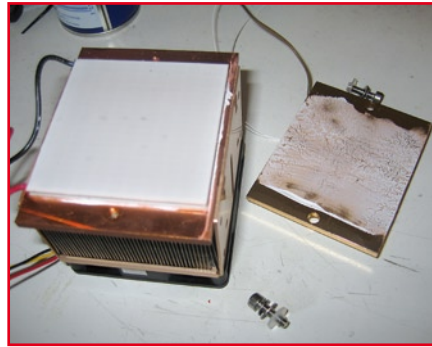

The cooling for the LEDs. The heat-spreader has been removed, exposing the Peltier element. This is where the LEDs will be mounted.

700 mA at which point they'll produce 100 lumens of light. They're not too expensive either. A set of 24 of these devices can be obtained for about £ 70 (€55) that's a total of 2400 lumens of raw LED power.

Since these LEDs are power devices they will generate much more heat than the usual 5 mm red indicator LEDs. Worse still, if you don't want the light output of the LEDs to drop they need to be cooled. As we didn't know exactly how much heat they'll generate and every degree warmer reduces the lifespan by a few hundred hours we decided on a solution that may be considered overkill. From the overclock world in computing we've obtained a heatsink-fan-Peltier combination that is meant for a Pentium 4 processor. This device can cool its surface below freezing point and can dissipate up to 130 Watts of heat. Because they are mass-produced they're not that expensive. They shouldn't cost more than about £ 20 (€14) and you'll also get a control panel with a (reusable!) blue LCD display.

And as we're buying overclock products we'll also buy two tubes of 'thermal adhesive'. This is a two-part glue that is good at conducting heat. It is meant for sticking heatsinks onto chips, but we'll use it to stick the LEDs onto the heatsink.

Now we begin

How can we turn all these parts into something that works? First we have to find out if we can make the LEDs produce the thousands of lumens they're rated at. The LEDs have to be mounted on a heatsink, otherwise they would overheat. We immediately see that could be a problem: the LEDs come in

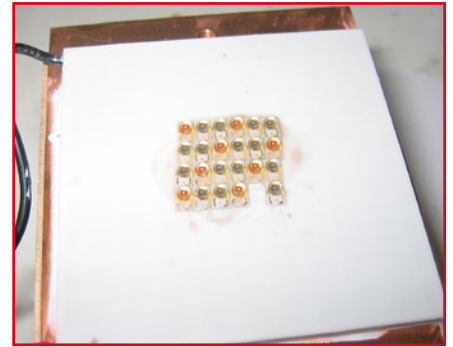

The LEDs have now been stuck neatly to the Peltier element using heat-conducting glue.

SMD packages, which have the connections on the underside. If they were mounted on a metal heatsink it would obviously produce short circuits. Fortunately there is a simple solution. When the metal plate of the heatsink is unscrewed we expose the Peltier element. On the outside this is made from a non-conducting ceramic material, which won't cause short circuits. However, with the LEDs stuck down it does mean that we can no longer get at the connections. Luckily there are also two 'tracks' on the top of the LEDs. When the silicone protection layer is scratched away they are easily soldered to.

Now for the connections. It is of course possible to connect a current-limiting resistor to each individual LED, but this would require 24 resistors, which would all consume power and generate heat. A better solution is to connect all LEDs of the same colour in series. This obviously requires a higher voltage, but the current needs to be limited in one place only. The LED chains are made by soldering thin wires onto the top of the LEDs.

For testing the LEDs all chains are connected to a bench power supply via a current limiting resistor. Take care when switching them on, since two thousand lumens is very bright!

Reverse engineering

Now that we've taken care of the lighting we'll have a closer look at the projector. With the side panel removed all parts can be seen clearly: the removable lamp, the colour wheel, the light tunnel and the rest are easily distinguishable. It is noticeable that the lamp has to be cooled by three fans. What do you mean, 'noisy'?

To check that our idea works we have



The first half of the LEDs has been connected together using thin klynar wire. Never use superglue to hold the wiring in place. Any repairs to loose wiring will then be made extremely difficult.



Only one half of the LEDs is connected and the camera can only just cope with the light intensity. The first test is successful!

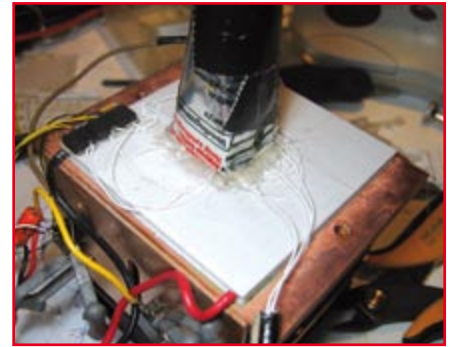

The first test set-up: all LEDs are connected and a few quick-and-dirty supplies have been added. The cover prevents unwanted light leakage.

to remove the colour wheel and emulate it in some way. The colour wheel is typical of those found in projectors. The motor used for turning the wheel round is a stepper motor, although the feedback for determining the position of the wheel is done optically. There is a black mark on the wheel that is detected with an IR LED and a phototransistor. This comes in very useful! When we take the colour wheel out, all we need to do is emulate the signal that is normally generated by the phototransistor and feed it to the DMD electronics. A quick look on the 'scope shows that this is a 100 Hz signal, which means that the colour wheel makes a revolution every 10 ms.

It is very easy to program the colour wheel emulation in a microcontroller. Here we've made use of an ATmega88. Three MOSFETs are added to turn the chains of LEDs on and off.

Looking at the colour wheel you can see that the first $\frac{2}{7}$ is blue, then $\frac{2}{7}$ red, then $\frac{2}{7}$ green and finally $\frac{1}{7}$ white. It is a simple matter to write a program that emulates this.

To free up some space for the heat-sink and LEDs we have to remove the fans. That immediately gives us another problem. Broken (or absent) fans mean that a non-modified projector could overheat and as such the projector will refuse to work. It is fortunately quite easy to fool the projector into thinking that the fans are present and working. All fans have a yellow wire that is pulled to ground when the fans are turning. All that needs to be done is to ground that connection on the projector PCB and the electronics will be happy.

The projector has another protection mechanism. Should the logic that drives the lamp not indicate within a few seconds that the lamp is lit properly, the electronics refuses to work. This signal can also be easily found. In this projector the driver board for the lamp is galvanically isolated from the rest of the projector using two opto-couplers. One indicates that the lamp should be turned on and the other returns the lamp status. These opto-couplers can be removed (desoldered). The first is

replaced with an LED so we can see when the logic wants to turn on the lamp. The second is replaced with a (normally closed) push button so we can manually simulate the 'all-clear' from the lamp logic.

It's now just a matter of connecting everything up and see if the concept is valid. The heatsink with LEDs is put inside the projector, the light tunnel, which has been removed together with the fans and colour wheel, is replaced with our own tin light tunnel. Connect it up, turn on the projector and...

Wow, a picture!

The firmware needed a few tweaks before all the colours came out correctly, but we had a picture. It wasn't as bright as with the original lamp, but that was to be expected. Now for the other parts.

Power supply

Apart from the 12V for the fan and 5V for the Peltier element, the projector also required a supply for the LEDs, which was provided by a bench power supply. This would obviously need to

Advertisement

ANDRE LAMOTHE'S
XGAMESTATION
LEARN STEP-BY-STEP HOW TO BUILD
AND DESIGN YOUR OWN VIDEO GAME CONSOLE!

Design inspired by the
Atari 800/2600, Sinclair ZX Spectrum,
Apple II & Commodore 64!

Parallax SX Key Compatible!

INCLUDES:

- Tools, Demos & Utilities!
- Great for Hobbyists AND Students!
- The Fun Way to Learn Embedded Systems!
- Fully Assembled XGS Micro Edition Unit!
- Complete Software Development KIT!
- eBook on Designing the XGS Console!
- Cables and Power Supply Included!

www.XGAMESTATION.COM
PH: 512.266.2399 | SUPPORT@NURVE.NET

NURVE ELECTRONICS LLC
13724 Bush Creek Lane
Austin, TX 78732 USA

**PCBs in
24 hours
from £30.00**

www.PCBTrain.com

Tel: 01635 40347
Fax: 01635 26143
e-mail: clmufa@newburytron.co.uk

Newbury Electronics Ltd
Forbury Road, Newbury, Berkshire RG14 2AD
www.newburyelectronics.co.uk

NE
Approved ISO 9001

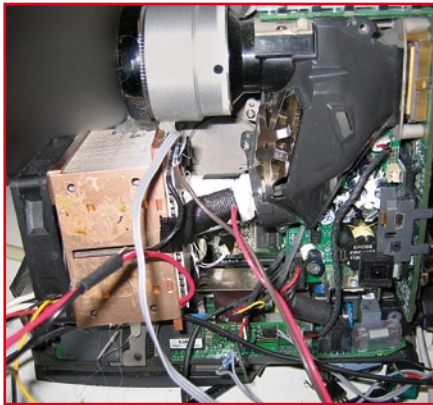

This is what the inside of the projector finally looks like: the lamp, fans, colour wheel and light tunnel have been replaced by the LEDs and associated parts.

be replaced by a decent power supply when the projector was put into normal use outside the lab. In our case it would also increase the brightness of the projector. The bench power supply should provide 60 watts just for the LEDs, which was more than what ours could deliver.

To keep everything fairly portable we added a powerful boost converter to the circuit (see **Figure 1**), which converts the 12-V supply into a 2.1 A current source for the LEDs. It has even been implemented as a double boost converter. L2 and L3 are alternately 'charged' via T1 and T2. D2 and D3 pass the current on to the capacitor bank, made by C6 to C8. The ATmega88 measures the voltage across shunt resistor R11 to control the voltage across and current through the LEDs.

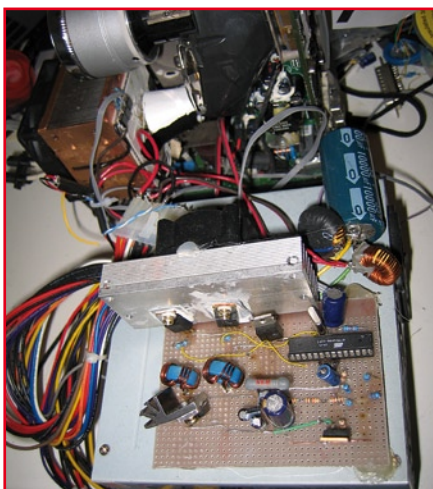

And this is what the completed project looks like. It does give an untidy impression and the use of an ATX power supply hasn't helped to keep the size down. But it can be considered as a successful proof of concept, and if everything is mounted in a larger case nobody can see it.

The capacitor bank may look a bit strange at first. The reason for using three capacitors with smaller values is because of the Equivalent Series Resistance (ESR). A capacitor has an internal resistance that 'normally' doesn't have much of an effect. But in this circuit the capacitors in the bank are charged and discharged tens of thousands of times a second with high currents. And then the ESR certainly counts. A single capacitor would have to be scraped off the ceiling after a short while, as the author knows from bitter experience, despite the fact that we've never exceeded the voltage limit for the capacitors. Connecting three capacitors in parallel spreads the load and reduces the total series resistance.

The total value of the capacitor bank shouldn't be too large either. When you switch between different coloured LEDs with lower forward voltage drops you don't want the capacitor bank to dump the excess voltage into the LEDs from a high capacitive source. This could even cause something or other to blow up. A smaller bank has the disadvantage that it produces some ripple on the supply, but this is at a frequency of several tens of kHz and won't matter when driving LEDs.

The supply voltage for the microcontroller is set to 5.6 V using a 7805 and a diode. This is 0.1 V above the recommended maximum supply voltage, but in practice it won't be a problem. The advantage of the slightly higher supply voltage is that the gates of the MOSFETs can be driven a little bit harder. This way we can be certain that they are either hard on or hard off. With the level of currents that flow in this circuit you'll find that a partially conducting MOSFET will quickly produce some smoke from the circuit. This is also the reason for the extra resistors from the gates of the MOSFETs to ground. Without them, a problem that caused the microcontroller to put its outputs into tri-state mode, could well cause the silicon of the MOSFETs to spontaneously turn into its gaseous state.

The LED driver circuit still requires about 100W. Added to this is the supply for the Peltier element. A cheap option is a standard ATX PC power supply. This can usually supply over 10 A at 12 V, whilst the 5 V output is suitable for the Peltier element. L1 and C1 have been added to protect the supply from interference caused by the peak currents drawn by the boost convert-

er. L1 is a suppression choke from the junk box and C1 is a large electrolytic capacitor.

The large currents and losses in the various components used in the boost converter mean that they have to be chosen with care. Both the MOSFETs and the coils have to be able to cope with very large currents. Luckily it's fairly easy to find high-current MOSFETs. The IRFZ48V does the job well and is widely available. Coils L2 and L3 are more difficult to find. For the prototype the author took two coils from an old P4 motherboard. They consist of three parallel windings of 1 mm² c.s.a. wire that has been wound round the toroidal core four times.

For D2 and D3 in the prototype the author used CTG24S ultra fast recovery diodes made by Sanken. They came from an old power supply and come in a TO-220 package, which means they are easily mounted on a heatsink. But ordinary power Schottky diodes should also be suitable.

And while we're talking about heatsinks, we would recommend that the MOSFETs are also provided with small heatsinks.

The end result

Is the idea viable and does it all work? According to the author it does. This LED modification is perfect for converting an old projector into a cheap 'film-viewer'. The area where you're projecting does have to be quite dark, but you'll then have a good viewing experience. To build this into a brand new projector is something we wouldn't recommend though.

Is there room for improvement? Possibly. New developments are still made in the world of LEDs. And every extra lumen that can be extracted from the LEDs gives a brighter picture.

Furthermore, the optical system in the experimental projector isn't perfect. Not all of the light from the LEDs reaches the DMD via the light tunnel. Improving this isn't easy, however. When the light is focussed too much you'll end up with coloured spots on the display. And optical components are less easily obtainable than electronic parts.

The firmware can be downloaded from the Elektor website, and may be modified if you need to.

(070690-1)

Web Link

<http://www.elektor.com>



08717 Credit Card Sales 177 168

Motor Drivers/Controllers

Here are just a few of our controller and driver modules for AC, DC, Unipolar/Bipolar stepper motors and servo motors. See website for full details.

PC / Standalone Unipolar Stepper Motor Driver

Drives any 5, 6 or 8-lead unipolar stepper motor rated up to 6 Amps max. Provides speed and direction control. Operates in stand-alone or PC-controlled mode. Up to six 3179 driver boards can be connected to a single parallel port. Supply: 9Vdc. PCB: 80x50mm.
Kit Order Code: 3179KT - **£12.95**
Assembled Order Code: AS3179 - **£19.95**



Bi-Polar Stepper Motor Driver

Drive any bi-polar stepper motor using externally supplied 5V levels for stepping and direction control. These usually come from software running on a computer. Supply: 8-30Vdc. PCB: 75x85mm.
Kit Order Code: 3158KT - **£17.95**
Assembled Order Code: AS3158 - **£27.95**



Bi-Directional DC Motor Controller (v2)

Controls the speed of most common DC motors (rated up to 32Vdc, 10A) in both the forward and reverse direction. The range of control is from fully OFF to fully ON in both directions. The direction and speed are controlled using a single potentiometer. Screw terminal block for connections.
Kit Order Code: 3166v2KT - **£17.95**
Assembled Order Code: AS3166v2 - **£27.95**



DC Motor Speed Controller (100V/7.5A)

Control the speed of almost any common DC motor rated up to 100V/7.5A. Pulse width modulation output for maximum motor torque at all speeds. Supply: 5-15Vdc. Box supplied. Dimensions (mm): 60Wx100Lx60H.
Kit Order Code: 3067KT - **£13.95**
Assembled Order Code: AS3067 - **£21.95**



Most items are available in kit form (KT suffix) or assembled and ready for use (AS prefix).

Controllers & Loggers

Here are just a few of the controller and data acquisition and control units we have. See website for full details. Suitable PSU for all units: Order Code PSU445 £8.95

8-Ch Serial Isolated I/O Relay Module

Computer controlled 8-channel relay board. 5A mains rated relay outputs. 4 isolated digital inputs. Useful in a variety of control and sensing applications. Controlled via serial port for programming (using our new Windows interface, terminal emulator or batch files). Includes plastic case 130x100x30mm. Power Supply: 12Vdc/500mA.
Kit Order Code: 3108KT - **£54.95**
Assembled Order Code: AS3108 - **£64.95**



Computer Temperature Data Logger

4-channel temperature logger for serial port. °C or °F. Continuously logs up to 4 separate sensors located 200m+ from board. Wide range of free software applications for storing/using data. PCB just 45x45mm. Powered by PC. Includes one DS1820 sensor.
Kit Order Code: 3145KT - **£17.95**
Assembled Order Code: AS3145 - **£24.95**
Additional DS1820 Sensors - **£3.95 each**



Rolling Code 4-Channel UHF Remote

State-of-the-Art. High security. 4 channels. Momentary or latching relay output. Range up to 40m. Up to 15 Tx's can be learnt by one Rx (kit includes one Tx but more available separately). 4 indicator LED's. Rx: PCB 77x85mm, 12Vdc/6mA (standby). Two and Ten channel versions also available.
Kit Order Code: 3180KT - **£44.95**
Assembled Order Code: AS3180 - **£54.95**



DTMF Telephone Relay Switcher

Call your phone number using a DTMF phone from anywhere in the world and remotely turn on/off any of the 4 relays as desired. User settable Security Password, Anti-Tamper, Rings to Answer, Auto Hang-up and Lockout. Includes plastic case. Not BT approved. 130x110x30mm. Power: 12Vdc.
Kit Order Code: 3140KT - **£54.95**
Assembled Order Code: AS3140 - **£69.95**



Infrared RC Relay Board

Individually control 12 on-board relays with included infrared remote control unit. Toggle or momentary. 15m+ range. 112x122mm. Supply: 12Vdc/0.5A
Kit Order Code: 3142KT - **£47.95**
Assembled Order Code: AS3142 - **£59.95**



PIC & ATMEL Programmers

We have a wide range of low cost PIC and ATMEL Programmers. Complete range and documentation available from our web site.

Programmer Accessories:

40-pin Wide ZIF socket (ZIF40W) **£14.95**
18Vdc Power supply (PSU010) **£18.95**
Leads: Parallel (LDC136) **£395** / Serial (LDC441) **£3.95** / USB (LDC644) **£2.95**

NEW! USB & Serial Port PIC Programmer

USB/Serial connection. Header cable for ICSP. Free Windows XP software. Wide range of supported PICs - see website for complete listing. ZIF Socket/USB lead not included. Supply: 16-18Vdc.
Kit Order Code: 3149EKT - **£39.95**
Assembled Order Code: AS3149E - **£49.95**



NEW! USB 'All-Flash' PIC Programmer

USB PIC programmer for all 'Flash' devices. No external power supply making it truly portable. Supplied with box and Windows Software. ZIF Socket and USB lead not included.
Assembled Order Code: AS3128 - **£44.95**



"PICALL" PIC Programmer

"PICALL" will program virtually all 8 to 40 pin serial-mode AND parallel-mode (PIC16C5x family) programmed PIC micro controllers. Free fully functional software. Blank chip auto detect for super fast bulk programming. Parallel port connection. Supply: 16-18Vdc.
Assembled Order Code: AS3117 - **£24.95**



ATMEL 89xxxx Programmer

Uses serial port and any standard terminal comms program. Program/ Read/ Verify Code Data, Write Fuse/Lock Bits, Erase and Blank Check. 4 LED's display the status. ZIF sockets not included. Supply: 16-18Vdc.
Kit Order Code: 3123KT - **£24.95**
Assembled Order Code: AS3123 - **£34.95**



www.QuasarElectronics.com

Secure Online Ordering Facilities • Full Product Listing, Descriptions & Photos • Kit Documentation & Software Downloads

ECIO PLC

Cheap, DIY and with CAN!

Ben Rowland (Matrix Multimedia) & Luc Lemmens (Elektor Labs)

Here's the first real-life application of ECIO modules introduced in the October 2007 issue of *Elektor*. An ECIO acts as the brains of a PLC board that has relays, opto-isolators, CAN (!) connectivity and an LCD. All this I/O capacity together with Flowcode allows the board to act as a versatile, powerful PLC for quite complex control and automation projects. The LCD module is used to display ASCII characters to the user as a means of troubleshooting during the software development stage or for monitoring the system.

ECIO PLC Features

- CAN bus connection
- 4 optically isolated inputs
- 4 relay driven outputs
- 2x16 character alphanumeric LCD
- Flowcode-programmed but will also take PIC18 hex files
- Free Flowcode for ECIO
- USB connectivity for programming

A full PLC application board comprising isolated outputs, inputs, LC display and CAN bus connectivity...sounds good! But you'd also like to hear that it's low cost, based on an ECIO module and easy to program using Flowcode, the all graphics method of mastering PICs (and other micros, too).

PLC

A PLC (programmable logic control) is a device typically used as the central, intelligent, control element in a flow-chart-designed industrial process, usually for mass manufacturing or quality checking and goods sorting. Conveyor belt controls will typically be PLCs.

PLCs exist commercially and their (high level) programming languages have been standardized to a wide extent. Unfortunately the price tag of almost any commercial PLC puts it well out of reach of enthusiasts. A pity, because many *Elektor* readers have affinity with industrial control systems.

PLC command sequences are in a way like computer programs — they follow a predefined sequence of events with all the options for conditional loops, event timers, logic conditions, event counters, analogue values (temperature; liquid level; pressure) and simple result logs.

If you have a slightly complex process you'd like to con-

trol using electronics on a machine, then a PLC is a good choice because of its (electrical) robustness and flexibility when it comes to connecting the real world through relays and optocouplers.

To be able to program a PLC (i.e. define the sequence of events to happen in a process) you need to write a program. Once debugged and simulated on a PC, you can download the program to the PLC and from then on it's *fingers crossed*.

PLC programs can be edited, debugged, extended, optimized and of course stored and retrieved. Right, just like any PC or microcontroller program!

Circuit description

The circuit diagram of the ECIO PLC is shown in **Figure 1**. The circuit comprises a number of distinct elements which we'll discuss below.

ECIO

The ECIO module is the brain of the board. It is used to control all of the peripheral devices on the board. ECIO modules, introduced in the October 2007 issue of *Elektor* [1], represent an ultra low-cost way of entering the world of PIC microcontroller programming. ECIOs are available from the *Elektor Shop* with good discounts for volume orders. Here we use the 40-pin version called ECIO-40P.

Relays

The relays the PLC is using to switch electrical devices on and off are controlled via ECIO pins RB4–RB7. Outputting a logic Low to these pins will switch off the corresponding relay and outputting a logic High will switch on the corresponding relay coil. If a relay is enabled then the LED next to that particular relay will light to give a visual on/off representation. The relays are used to provide electrical isolation between the ECIO module and the external switched voltage (which could be the 230 V mains). This means that power devices running from high voltages like 48 VDC or

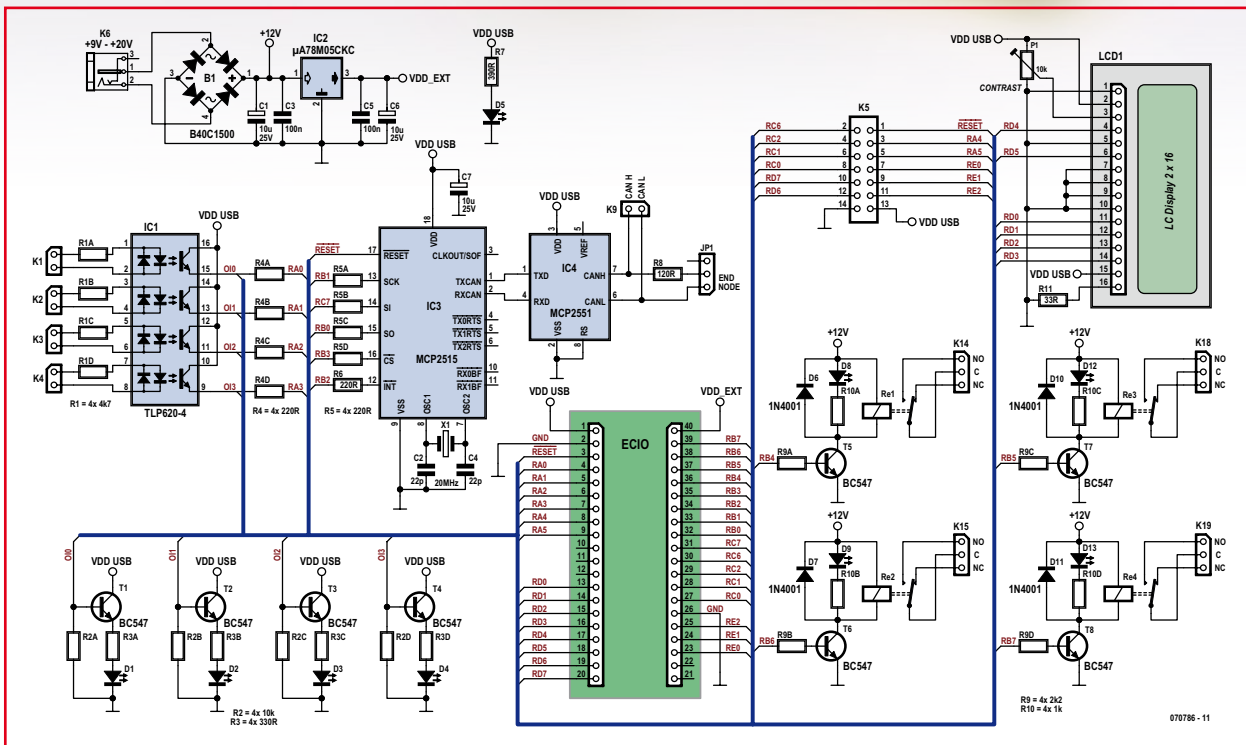
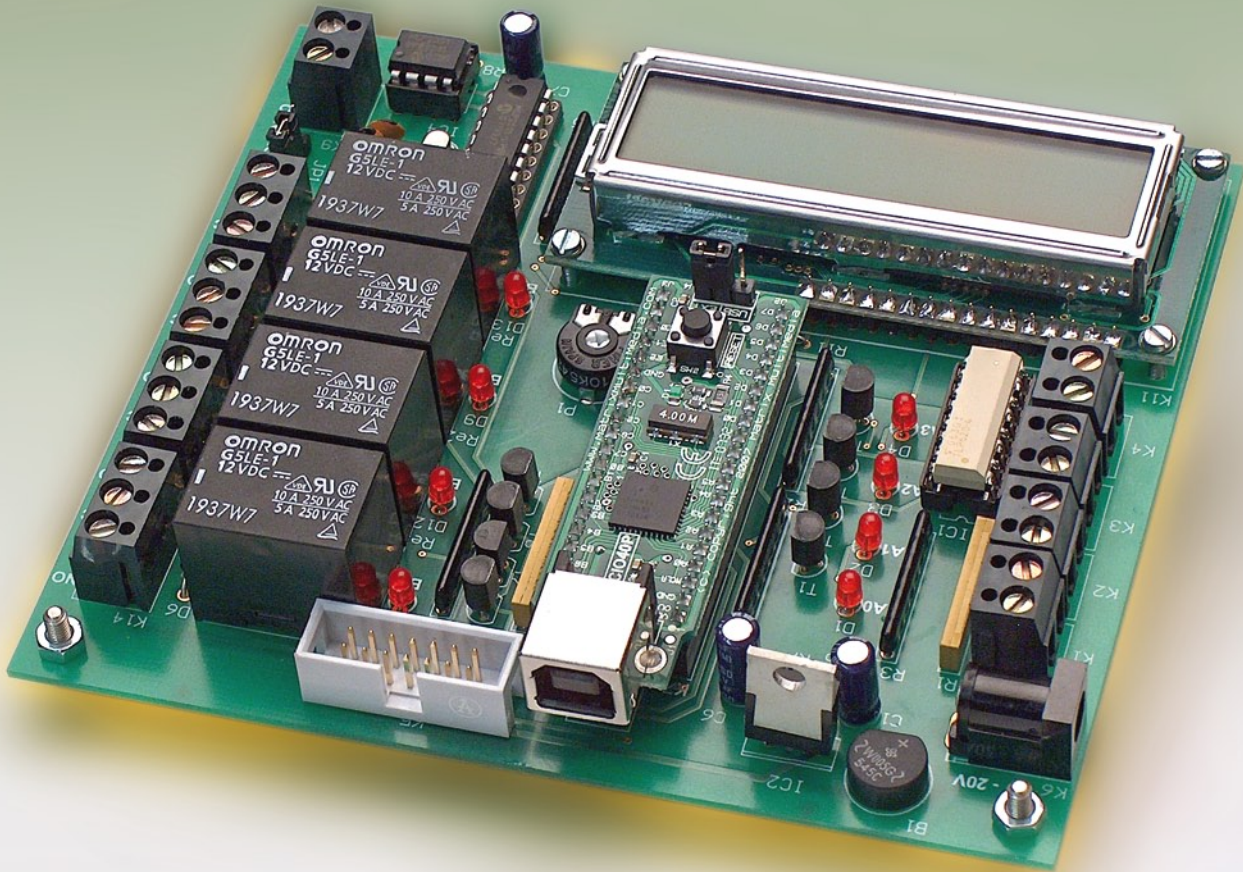

Figure 1.
Circuit diagram of the ECIO PLC board. Minimal hardware — great potential in terms of I/O.

230 VAC can be controlled safely via the ECIO module.

Each set of relay contacts (NO and NC) is brought out to three pins of a PCB mount screw terminal block — the centre pin (C) is the pole.

Opto-isolators

The opto-isolated inputs are special in not having a plus (+) and a minus (-) input terminal. Inside IC1, the two diodes on each input are in fact LEDs so the polarity of the control

voltage you wish to apply to ECIO PLC does not matter! The opto-isolator outputs are connected to ECIO pins RA0–RA3. These input pins will be at logic zero for no input voltage and at logic one for a voltage of 3.5 V or more. The opto-isolators are used to provide an isolation layer from input voltages. This means that relatively high voltages can be used to safely control the ECIO module. The signals you want to process in the ECIO PLC are applied to the circuit through PCB mounted 2-way screw terminal blocks. LEDs D1–D4 show the logic status of the opto-isolator inputs.

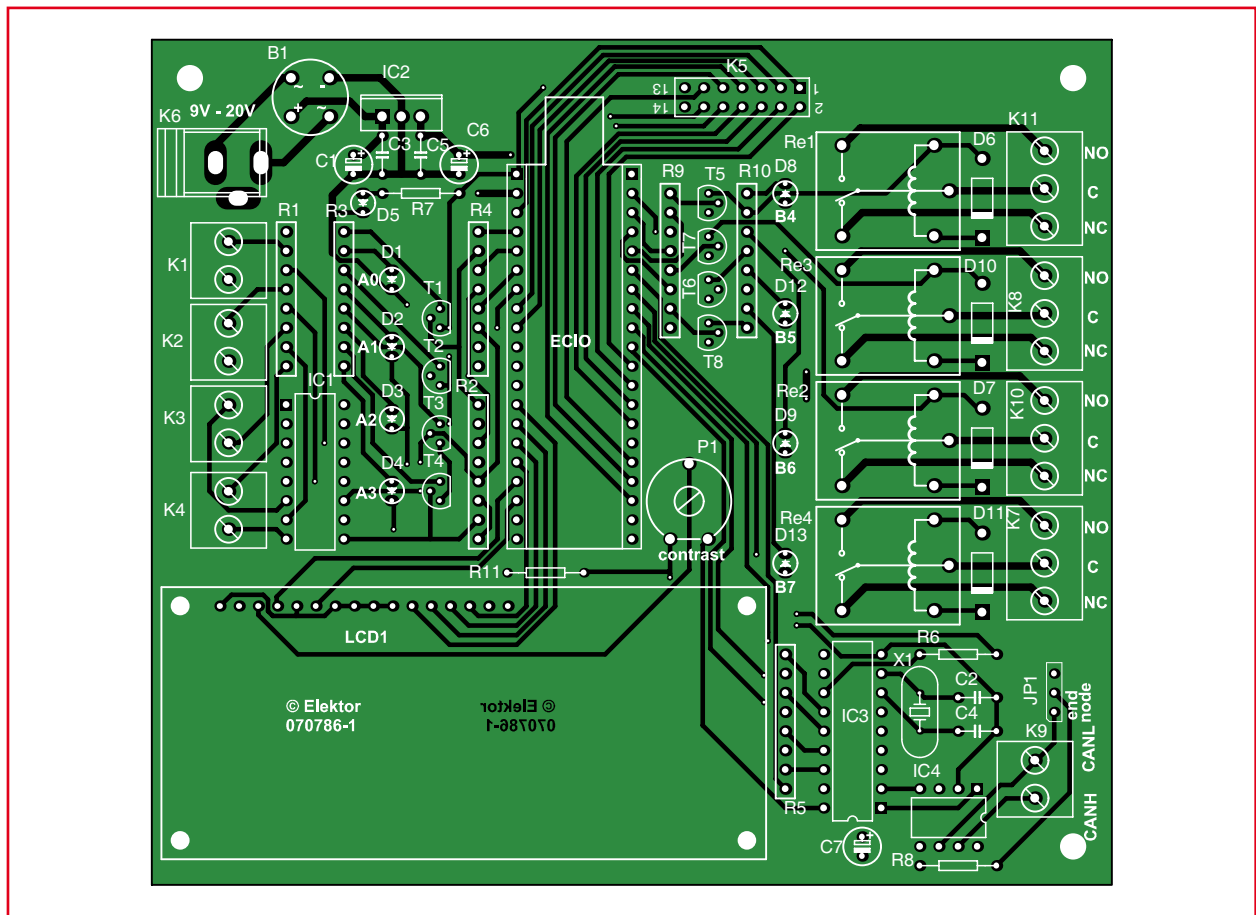

Figure 2.
The unstuffed ECIO PLC board is available from Elektor.

COMPONENTS LIST

Resistors

- R1 = 8-pin SIL array 4 x 4kΩ7*
- R2 = 8-pin SIL array 4 x 10kΩ*
- R3 = 8-pin SIL array 4 x 330Ω*
- R4,R5 = 8-pin SIL array 4 x 220Ω*
- R6 = 220Ω
- R7 = 390Ω
- R8 = 120Ω
- R9 = 8-pin SIL array 4 x 2kΩ2*
- R10 = 8-pin SIL array 4 x 1kΩ*
- R11 = 33Ω
- P1 = 10kΩ preset

* see text

Capacitors

- C1,C6,C7 = 10μF 25V radial

- C2,C4 = 22pF
- C3,C5 = 100nF

Semiconductors

- D1-D5,D8,D9,D12,D13 = 3mm LED
- D6,D7,D10,D11 = 1N4001
- B1 = B80C1500 (round case; 80V_{piv} @ 1.5A_p)
- T1-T8 = BC547
- IC1 = TLP620-4
- IC2 = 7805
- IC3 = MCP2515-I/P
- IC4 = MCP2551-I/P

Miscellaneous

- Re1-Re4 = 12V relay, SPDT, e.g. Omron G5LE-1
- X1 = 20MHz quartz crystal

- K1,K4,K9 = 2-way PCB screw terminal block, lead pitch 5mm
- K5 = 14-way boxheader
- K6 = AC/DC low-V adapter socket, PCB mount, e.g. CUI Inc. # PJ-002B (Digikey # CP-002B-ND) or Cliff Electronic Components # DC10B (Farnell # 224960)
- K7,K8,K10,K11 = 3-way PCB screw terminal block, lead pitch 5mm
- ECIO = ECIO-40P processor module (Elektor Shop)
- LCD1 = LCD, alphanumeric, 2x16 characters, e.g. Displaytech 162
- JP1 = 3-way SIL pinheader with jumper PCB, order code **070786-1** from Elektor Shop

CAN

The CAN (controller area network) interface is used for adding the ECIO PLC onto a CAN network. CAN is 'hip' and few PLCs we have seen offer this connectivity. Here we use an MCP2515 CAN controller chip and an MCP2551 line driver. The CAN controller chip is connected ECIO peripheral pins set up to do SPI comms. There is also an interrupt pin, which is connected to ECIO pin RB2 and a chip select pin, which is connected to ECIO pin RB3. The CAN controller has its own 20 MHz clock derived from a quartz crystal, X1.

The actual connection of the CAN bus to the ECIO is by way of K9, a 2-way PCB mount screw terminal block. Jumper JP1 has to be installed only if the MCP2551 is the end node of the bus.

LCD

The LCD module is used to display ASCII characters to the user as a means of troubleshooting during the software development stage, or for monitoring the system as it's busy checking and controlling the events in the automated process. The LCD is connected to ECIO pins RD0-RD5 with the four data bits taking up bits 0-3, the RS bit taking up bit 4 and the Enable bit taking up bit 5. P1 is the LCD contrast adjustment.

Power supply

Nothing special in this department — the usual 7805 voltage regulator (IC2) and the traditional set of decoupling capacitors. A bridge rectifier is used ahead of the regulator to

ECIO – the cheapest USB PIC progger out there

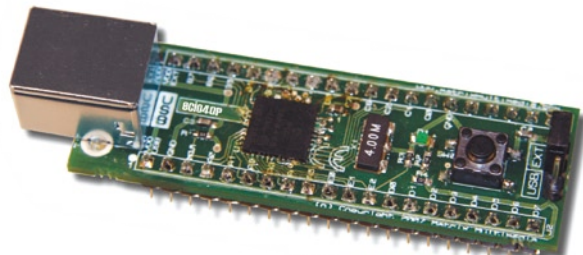
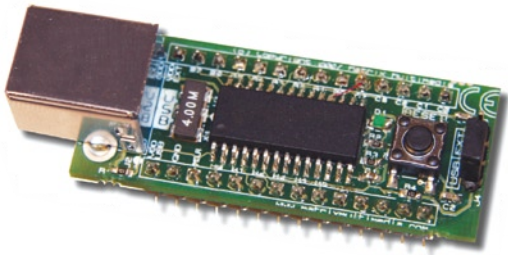

The ECIO family of USB programmable microcontrollers provides a simple way of adopting microcontroller technology into your projects. The device behaves just like a normal microcontroller — but when you plug the USB lead in and press the reset switch you can send a new program to the device.

This makes the ECIO one of the lowest cost USB-compatible PIC programmers in the world.

Currently there are two products in the range: ECIO-28P and ECIO-40P. These devices are based on PICmicro 18 series devices; the 18F2455 and the 18F4455 respectively.

The ECIO microcontrollers are pre-programmed with a boot-loader program which allows you to send a new program to the microcontroller via USB, in principle as many times as you like. ECIO is compatible with hex code from any appropriate compiler. ECIO is directly compatible with Flowcode — a graphical programming language which greatly simplifies the code generation process — but can also be used with any C compiler or Microchip's own development suite MPLAB.

ECIO is well supported with a wide range of learning and development tools including (free) Flowcode and inexpensive E-blocks.

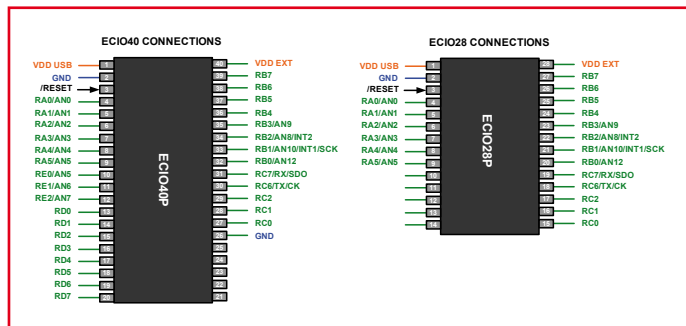

allow the ECIO PLC board to be powered by AC as well as DC wall warts with an output voltage between 9 and about 20 volts. For the DC connection, polarity is irrelevant.

Pheh, that ECIO PLC board has a lot of connections to the outside world and to prevent losing track of all those I/O lines and associated devices we've made a summary in **Table 1**.

Construction

The component mounting plan of the PCB designed for ECIO PLC is shown in **Figure 2**. As usual the copper track layout may be downloaded from our website for those with the wherewithal to etch & drill their own circuit board at home. All others will like to hear that the bare board is available ready-made from the Elektor Shop.

No SMD components are used in this project so stuffing the board should be mostly plain sailing if you use care and precision in handling and soldering the parts. The 8-pin resistor arrays containing four **individually wired** resistors (i.e. not top commoned!) may prove difficult to get. Instead of arrays, you can also use four individual resistors mounted vertically side by side.

Give your completed board a good visual inspection before inserting ICs and powering up for the first time.

ECIO hardware Testing — I/O and CAN

To help you find your bearings we have written a simple and instructive ECIO test program, of which the Flowcode listing is shown in **Figure 3**. Download it, load it into Flowcode, run the simulation, compile and blow it into the ECIO module.

The program includes a general PIC setup routine that does all the port and I/O pin configuring on the ECIO. For example, ECIO lines RB4-RB7 are set up as output lines (for the relay drivers). The test program is simple to use: if you drive the opto-isolator on RA0, the relay on RB4 will be energised. Similarly with the combination RA1/RB5, and so

Table 1. ECIO connections overview

Relay Output	ECIO I/O Pin
Relay Re1 (K14)	RB4
Relay Re2 (K15)	RB5
Relay Re3 (K18)	RB6
Relay Re3 (K19)	RB7
Opto-Isolator Inputs	ECIO I/O Pin / LED
K1	RA0 / D1
K2	RA1 / D2
K3	RA2 / D3
K4	RA3 / D4
CAN (from CPU)	ECIO I/O Pin
Serial Data Out	RC7
Serial Data In	RB0
Serial Clock	RB1
/Interrupt	RB2
/Chip Select	RB3
LCD	ECIO I/O Pin
D0	RD0
D1	RD1
D2	RD2
D3	RD3
RS	RD4
Enable	RD5

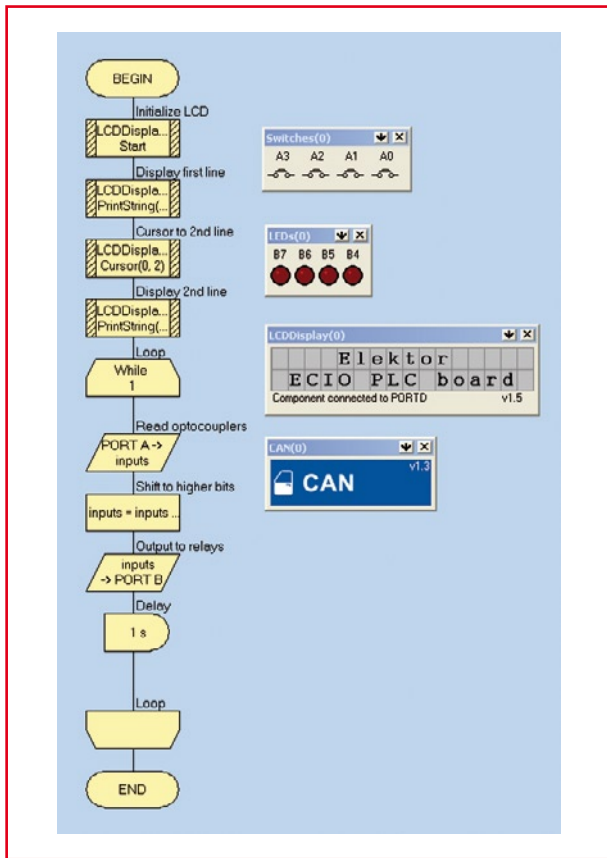

Figure 3. This Flowcode program runs a hardware test on the ECIO PLC.

on. The display will show: 'Elektor ECIO PLC board' (no? adjust that LCD contrast!). Neither family members nor PIC geeks may be too impressed but if this works then a whole lot of PIC code is being executed and you can safely assume that all hardware is functioning as it should.

The CAN test utility discussed in the inset is also included in the free software download for this project. The two test programs provided are educational and certainly worth looking at even if you do not actually build the project (hint: use the free Flowcode version to begin with). The archive file number is **070786-11.zip**.

PLC programming

All ECIO PLC programming bears great resemblance to E-blocks and Flowcode so if you have any experience with these you're in luck. If not, there's a mass of information out there on the Internet [1], in previous issues of Elektor and in the Flowcode package itself. Best of all, Flowcode for ECIO is **free** [1].

Writing a process control program for the ECIO PLC underscores what Flowcode is all about: rather than worrying about syntax and PIC assembly code you are working at a fairly high level, setting up a full-blown flowchart of the program and let Flowcode arrange all the compiling, initializing, error tracking and code downloading to the ECIO module. Of course you can simulate your PLC program so there's a good chance of instant success when the ECIO PLC board is connected up to the real world.

More advanced users may want to rely on their own methods of producing PIC18 code using C++ compilers or similar. The ECIO even accepts straight hex code from all you assembly code diehards out there. Simply use the free USB I/O drivers to connect ECIO to your PC.

(070786-1)

CAN interface testing

CAN is essentially good for sending complex message structures between a number of ECUs (microcontrollers). The test program written for Flowcode simply looks for an echo of the outgoing CAN message. This could be used to see how many nodes are on the network or used to calculate the distance between nodes based on echo time, etc.

Basically the ECIO test program is sending out a specific CAN message with a standard ID of 12. When the Multiprogrammer receives a CAN message it checks the ID and if it is equal to 12 then it resends the message ID 12. The ECIO continues to send out this message ID until it receives a CAN message back. Once it has received a message back it checks the ID and then confirms or denies if the echo was successful.

For this test you will need another ECIO PLC board or an E-blocks Multiprogrammer connected to an E-blocks CAN module. One ECIO PLC board will send several messages over the CAN bus. The other one will 'listen' until a predefined message appears and then replies to the ECIO. When the CAN transmitter is started the display reads 'Startup', followed by 'Done' a bit later once the CAN controller is initialized. If the CAN connection is okay the display shows 'Message returned', if not, you'll see 'Message failed'.

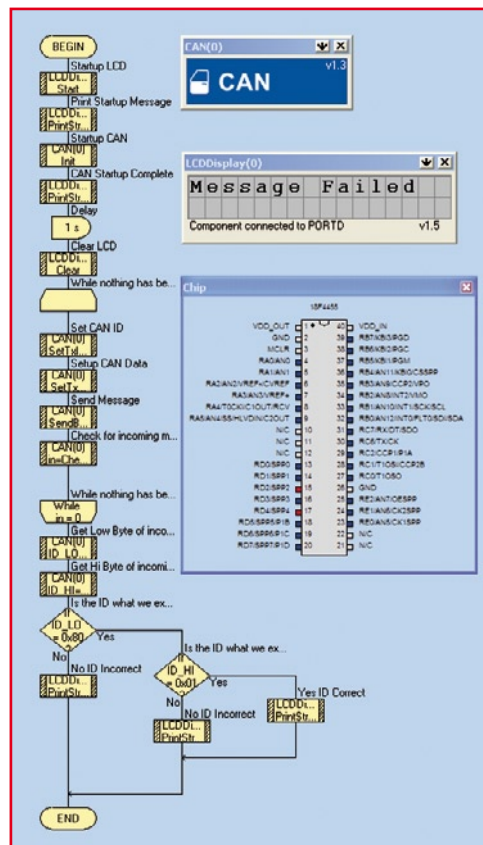

Web Link and reference

- [1] <http://www.matrixmultimedia.com/ECIO-X.php>
- [2] EasyControl I/O, Elektor October 2007.

Elektor Volume 2007 CD-ROM

Harry Baggen

Coinciding with this March 2007 issue we release the new Elektor 2007 CD-ROM containing all editorial articles of the past year in pdf format. Compared to the 2006 edition, the new version is much faster, working happily under Windows, Linux and Mac-OS. It also includes an index function for all published articles since 1998.

Elektor year volume CD-ROMs are established as extremely popular products. It's not surprising, as these discs are a handy way of locating a published article and viewing it on a PC display.

Last year, the structure of the Elektor annual CD was overhauled. The archive program used till then had to make way for a webserver-driven application. Nice, in principle, but in practice the new program was causing problems within some computer configurations. The problems were investigated and the outcome was a totally new structure using only an Internet browser with either an ActiveX or a Java set installed on the PC. To be able to use the CD 2007, you need to have ActiveX or Java available and activated in your browser.

At the request of several readers, an index function for older year volume CDs has been reinstated. This was sadly missing from the 2006 version. The index allows you to copy all article pdf files on older Elektor year volume CDs (from 1998 onwards) to the hard disk and retrieve them instantly from the overview page.

The new CD has Autorun implemented for MS Windows PCs. If autorun does not work, or if you have a non-Windows PC, look for the file 'index.html' in the root of the CD, and double-click on it. Your default browser will open the index file and display the start page. Start by selecting English from the menu. By first ticking the box at the

bottom of the page, your selection is stored as a 'cookie' and the program will automatically load the English language index/database the next time you run it. If you want to change the language, click on the Elektor logo to return to the start page.

The possibilities and the use of the 2007 CD-ROM are largely identical to those of the previous version and do not need further detailing here. We do, however, take this opportunity to explain a bit more about running the complete Elektor article database from hard disk.

From hard disk

Start by creating a new folder on your hard disk and give it a suitable name like C:\Elektor. Copy the entire contents of the Elektor CD into that folder.

The folder \Elektor should now contain five sub-folders. Click on the one with the desired language, in this case \uk for English. The sub-folders that now appear all have a folder \articles. These are further nested with sub-folders named 1998, 1999, etcetera, through 2007. The folder 2007 is already filled with all editorial articles of Elektor magazine volume 2007.

Now, if you have older Elektor year volume CDs available, simply copy the pdf files on those CDs into the sub-folders with the relevant year name. For example, for the Elektor 2005 CD, browse to the sub-fold-

er articles and then on to the sub-folder E. Select all files with the extension .pdf in that folder, and drag them to the folder C:\Elektor\uk\articles\2005. You will be prompted for a decision to replace all files already present. Confirm with Yes to All. This is necessary because all year volume folders contain a kind of dummy pdfs that need to be replaced at this point by real pdfs.

The simple 'drag the folder content' operations allows you to integrate all Elektor volumes from 1998 onwards into the system.

If the results of a search for older articles returns one you do not actually have because you do not have the relevant CD-ROM, you will see a link that takes you to the Elektor website where the article pdf can be downloaded against payment (usually 10 E-credits). This system works back to year volume 2000 (to be expanded further back in time to 1998).

Remarks, problems and suggestions for improvements may be reported and shared with other readers in the topic *Elektor 2007 CD-ROM* specially created on our online Forum.

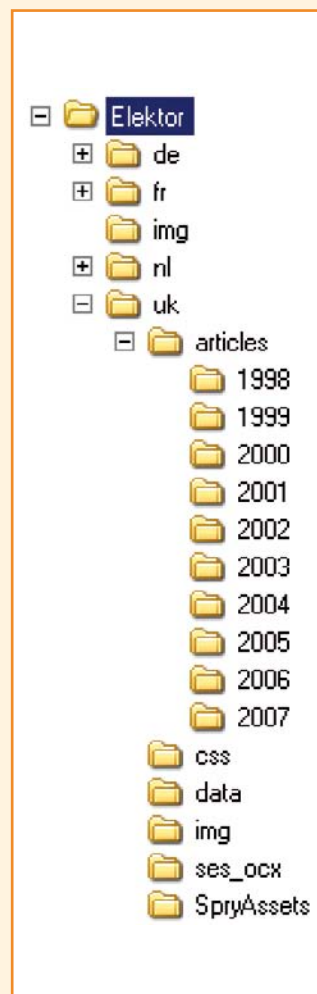

(080023-1)

Pimp your Shoes

Trendy shoe adornment

Ton Giesberts - Based on an idea by Antoine Authier

Shoes that light up? No problem, these days you can buy (almost) anything. But it is of course much more fun and challenging to enhance a pair of shoes yourself with these trendy lights, using a clever little circuit and some LEDs.



The idea behind this mini project is to provide your shoes with a string of LEDs. The well-known firm Nike sells several types of shoe with lights in the heels that react when you hit the ground hard enough with your shoe. There are several video clips on YouTube made by proud owners of such shoes

(for example www.youtube.com/watch?v=m46jJupXEic and www.youtube.com/watch?v=_z-VHNWyxOQ).

It isn't exactly an easy task to turn normal shoes into Christmas lights, but we've assumed that Elektor Electronics readers have enough ideas to implement this in some way (e.g. cut out part of the heel, put the PCB inside and let the LEDs 'look' out through small holes in the sides).

The circuit described here provides a running light with 18 LEDs. We've even designed a small (double-sided) PCB, with all components as SMD devices (apart from the LEDs and the battery), but this is intended to be built by more experienced constructors. The soldering of these small surface mount devices isn't very easy.

The PCB is small enough to fit inside the heel. For the battery a button cell is used, which can be stuck to the solder side of the board and connected to the circuit via a short length of wire.

An on/off switch isn't included on the board since it's unlikely that it would be accessible from the side of the shoe. You will have to think of an alternative method to add this.

Circuit diagram

The circuit consists of a few standard ICs from the well-known 4000 series. The advantage of these ICs is that the circuit can be easily adapted for use with different supply voltages in the range from 3 to 15 V (R4 is the only component that needs to be changed). For running lights using LEDs the 4017 (a decade counter with 10 outputs) is just perfect. The ten outputs go momentarily high one after the other, at the rate of the clock input. To expand the running lights (i.e. have more than 10 LEDs) we've added a second 4017 in series. However, this requires some extra logic and a clock signal. For this we've used a 74HC132, which has 4 NAND gates with Schmitt-trigger inputs. A simple RC oscillator was made with one NAND gate (IC1D). The other three are used to control the counters. In fact we need two AND gates for this. These were created here using three NAND gates and a discrete inverter made with a transistor (T1, a BC547, or a BC847 in SMD packaging) and two resistors. The operation of the circuit is fairly

straightforward.

When the power is turned on IC1C and IC1B pass on the clock pulses generated by IC1D to the first counter (IC2). When the tenth output (pin 11) in the first counter goes high it results in clock pulses being passed through NAND gate IC1A to the second counter. The second output of the second counter then goes high. The first output of the second counter goes low and thereby stops the clock signal reaching the first counter via IC1C. It's only when the second counter has completed a full cycle and the first output goes high that the first counter receives clock pulses again; the tenth output of the first counter is low again and the whole process starts from the beginning.

We have also added a flashing effect to the circuit. The flashing is implemented by connecting the common connection of the LEDs via R4 to the clock signal. The flashing makes the LEDs even more conspicuous and as a bonus halves the current consumption. The oscillator has been designed to have an adjustable frequency from 2 Hz to 42 Hz. Everybody should be able to find a frequency to their liking within this range. You'll find that at higher speeds of the running lights the flashing of the LEDs becomes almost unnoticeable.

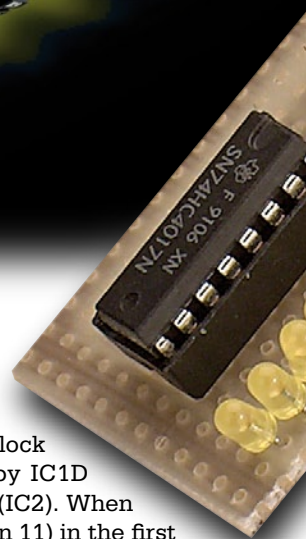

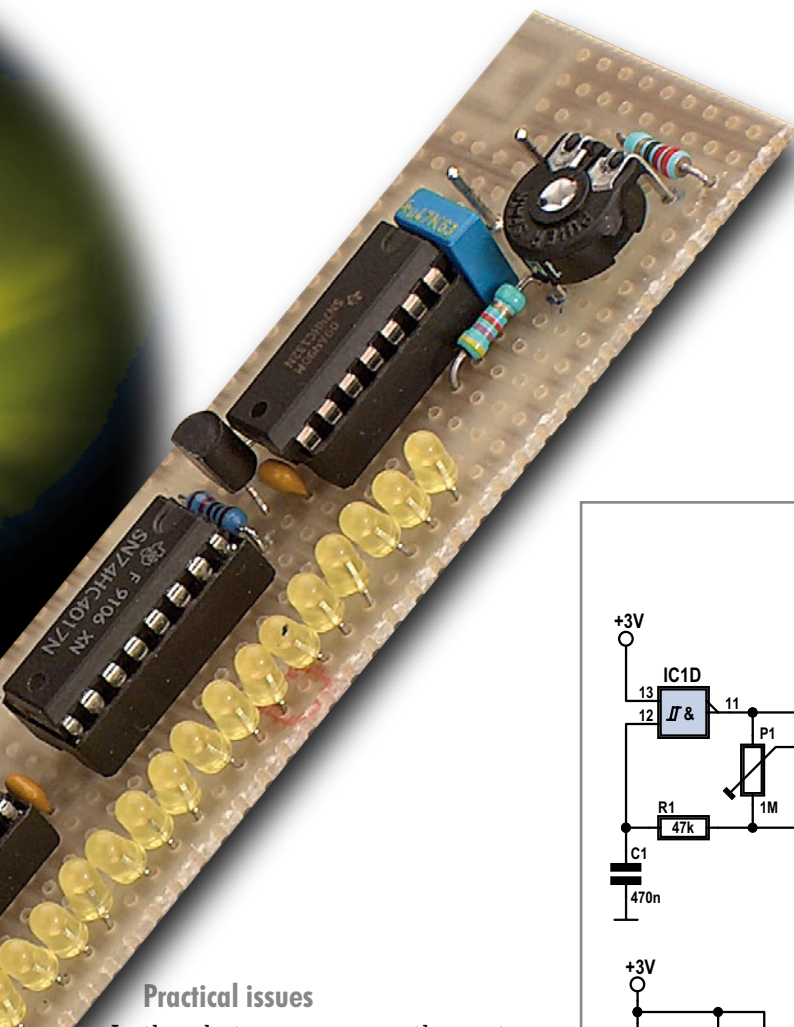

Practical issues

In the photo you can see the prototype that we built onto a piece of stripboard. In this version we used yellow LEDs. At 3 V the current consumption was about 2.3 mA. When R4 has a value of 220 Ω the current through a yellow LED is about 3.5 mA. It is therefore essential that you use low-current versions for the LEDs. If a CR2032 type battery is used, which normally has a capacity of about 220 mAh, then the expected life span of the battery is four days (with continuous use). That is quite a long time, but we'd still recommend that you fit a switch in the shoe that turns off the running lights when the shoes aren't worn.

(070851-1)

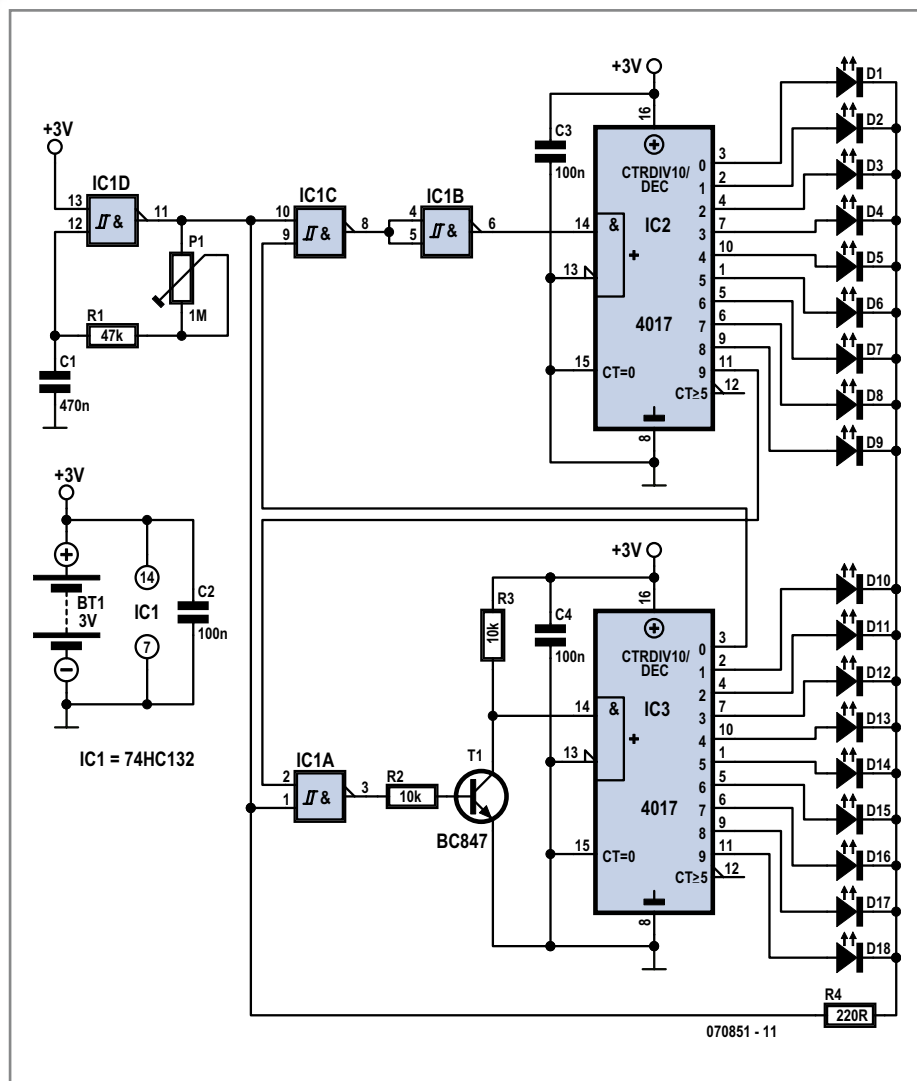

Figure 1. The circuit diagram for the 18-channel running lights: three ICs, a transistor and a few passive components.

COMPONENTS LIST

Resistors

R1 = 47kΩ (SMD 0805)
 R2,R3 = 10kΩ (SMD 0805)
 R4 = 220Ω (SMD 0805)
 P1 = 1MΩ preset

Capacitors

C1 = 470nF (SMD 0805)
 C2,C3,C4 = 100nF (SMD 0805)

Semiconductors

D1-D18 = low-current LED *
 T1 = BC847 (SMD)
 IC1 = 74HC(T)132 (SMD SO14)
 IC2,IC3 = 74HC4017 (SMD SO16)

Miscellaneous

BT1 = 3V Lithium button cell *
 PCB, ref. 070851-1, free artwork download
 from www.elektor.com

* see text

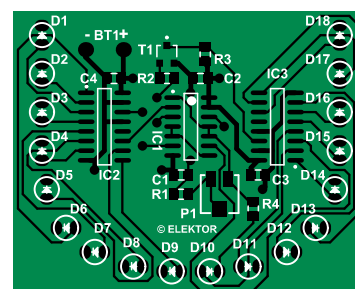

Figure 2. The whole circuit fits on this double-sided PCB, using SMD components. Some experience required here!

Atmel AVR32 Gate

Paul Goossens (Elektor Labs)

Chip manufacturer Atmel has built a good reputation for itself in the microcontroller market with its AVR controllers. It is less well known that this chip manufacturer also produces powerful 32-bit controllers that go by the name of AVR32. These are clearly different from the 8-bit AVR controllers. The Gateway Reference Design Kit from Atmel uses one of these new controllers. Reason enough for us to take a closer look at it.

We'll spill the beans right away: The NGW100 ('Network Gateway reference Design Kit') from Atmel costs about \$ 70. For this money you get a small box that contains an assembled and programmed circuit board. No power supply, no USB cable, no CD, nothing. Pure hardware for the enthusiast who will have a mains adapter (between 9 and 15 VDC preferably) plus some cables lying around somewhere. Software and manuals are available via the internet at no cost. This way you are ensured to receive the latest version for this kit. A speedy internet connection is very useful however, since the complete download involves several hundred megabytes. This will likely not be a problem for those people to whom this board appeals.

Reference Design vs. Development Board

We usually talk in these reviews about development boards. The big difference between a 'Reference Design' and a 'Development Board' is that an RD is designed for one specific purpose, while a DB is usually provided with a plethora of peripherals, that are at the disposal of the user for one or more applications.

In the case of the NGW100, the board has a specific application: a gateway. This is comparable to a router, but has some additional functionality.

The usefulness of this kit fortunately goes a lot further than that. All the important signals in this system are available on two expansion connectors. This allows you to add hardware to your heart's content, but for the board itself you will have to make do with the limited amount of I/O available.

The controller is, as already mentioned, an AVR32 controller. The AT32AP7000 to be exact. This controller is amply provided with peripherals (refer to the inset). Striking is the fact that a pixel-coprocessor is included. This arithmetic unit can be used to carry out certain computationally intensive algorithms very quickly. Atmel indicates that this coprocessor can be used for, among other things, speeding up conversions between colour spaces or MPEG decoding.

Also present is an interface that enables direct communication with an image sensor. As a consequence this controller is eminently suitable for the development of multimedia devices. We refer you to the sidebar for further information.

Software

The hardware is liberally provided with memory. For the RAM there is 32 MB of SDRAM and there is 16 MB of flash memory on board.

As supplied, the flash memory is already programmed, U-Boot has been installed as the bootloader. The main task of the bootloader is to load and start Linux (which is also programmed in flash memory). In addition to Linux you can obviously also install other software and start it with the aid of U-Boot.

A very useful option in U-Boot is the possibility of passing parameters to Linux when starting up. In this way, for instance, it is very easy using 'environment-parameters' to set an IP-address or define the speed of the serial port.

The installed version of Linux is v2.6 plus the well-known busy-box as command shell. This combination provides for a powerful system without taking up too much flash memory. There is still plenty of space in the flash memory for your own applications.

Development

Anyone who buys this kit will use it to develop their own code. This development can be done using a Windows 2000/XP system, but it is recommended to also use Linux on the development PC. Note that there is no development environment for Windows Vista yet. It is quite likely that with a few tricks it is possible to coerce the development system to work in Vista, but as at the time of writing it does not work 'out-of-the-box'.

Drivers are available or on the way for the peripherals in the controller. Using these drivers it is, for example, very easy to use the built-in LCD interface, or to control the AC97 interface (audio) or GPIO connections from within your user-space program.

There is no need to do much low-level programming, but you are obviously still allowed! This will, incidentally, be necessary if you want to use the timers, for example, from within Linux. There are at the moment no drivers available for these.

Support

The support for this kit is via a few websites, such as the AVR32 wiki on the AVR freaks website and avr32linux.org. Here you find, among other things, all the necessary documentation and the various tutorials & howto's to get you started quickly with this design kit. This is all with the open-source philosophy, just like the underlying operating system.

A little bit of familiarity with Linux would be useful, but thanks to the extensive documentation taking your first steps is quite easy.



Verdict

This kit is recommended for anyone who, for a small amount of money, would like to get started with the development of their own embedded project based on Linux. The choice in this market segment has increased significantly in recent times and an evening of searching on the internet can easily result in a long list of available development boards.

This kit is very attractive, particularly because of its price. On the other hand, the number of I/O options that are available as standard is limited. Certainly considering the capabilities of this controller in the multimedia area a built-in LCD would have been nice, but you cannot really expect that at this price of course.

Atmel has another development board based on the AT32AP7000 in their line-up, which, among other things, contains a QVGA LCD. The price for this kit is five times higher however!

For anyone who would like to have a go with this new controller from Atmel or would like to play around with an embedded Linux device this kit is most certainly recommended!

(070853-1)

Web Links

U-Boot:

<http://sourceforge.net/projects/u-boot>

AVR32 wiki:

http://www.avrfreaks.net/wiki/index.php/Documentation:AVR32_General

AVR32Linux wiki:

<http://www.avr32linux.org/twiki/bin/view/Main/LinuxPatches>

Datasheet AT32AP7000:

http://www.atmel.com/dyn/resources/prod_documents/doc32003.pdf

AVR32 family

The Network Gateway Reference Design has been designed around an AT32AP7000 controller. This is a controller from the AVR32 family. According to the manufacturer the AVR32 family is better and faster than an ARM7 controller, which are not that different in chip size.

A large difference between these two families is that the AVR32 controllers have a MMU (Memory Management Unit). This unit divides the memory into several sections and is a necessary part if you want to keep several processes separated from each other, such as is the case with Linux, for example. This is also the reason that a normal (but nonetheless slightly adapted) version of Linux can be used. The ARM7 controllers must use μ C Linux because there is no MMU.

Another nice 'detail' is that these AVR32 controllers have a DSP-unit which needs only one clock cycle for multiply and accumulate. All this with a 'saturation' memory so that the adverse effects of an overflow are kept to a minimum. This makes the controller immediately suitable for multimedia applications.

In addition, the hardware Java Virtual Machine is worth mentioning. This little piece of hardware ensures that Java byte-code, that is, applications written in Java, can be executed very efficiently.

AT32AP7000

Important characteristics:

- 210 MIPS at 150 MHz
- 32 kB SRAM (can be used as cache)
- external memory interfaces for SDRAM, MMC, SD, etc.
- DMA-controller
- Interrupt-controller
- realtime clock
- Pixel coprocessor
- LCD-interface QCIF to SVGA
- image sensor interface
- 16-bit stereo audio DAC
- AC97-interface
- 2(!) Ethernet MACs
- USB 2.0 device interface
- JTAG-interface with debug options
- hardware Java Virtual Machine

NGW100 characteristics

- Controller : AT32AP7000
- Ethernet interface (2 off!)
- USB 2.0 device (NOT host!)
- SD/MMC reader
- serial port
- JTA interface
- 2 LEDs that can be controlled by the user
- 32 MB SDRAM
- 16 MB Flash
- U-Boot bootloader pre installed
- Linux pre installed

Hexadoku

Puzzle with an electronics touch

No March 2008 issue without Hexadoku, of course! Forget about the TV for an evening (or two) and instead switch on the brain. Who knows, it may win you one of the prizes: an E-blocks Starter Kit Professional and three Elektor Shop vouchers.

The instructions for this puzzle are straightforward.

In the diagram composed of 16 x 16 boxes, enter numbers such that **all** hexadecimal numbers 0 through F (that's 0-9 and A-F) occur once only in each row, once in each column and in each of the 4x4 boxes (marked by the thicker black lines).

A number of clues are given in the puzzle and these determine the start situation.

All correct entries received for each month's puzzle go into a draw for a main prize and three lesser prizes. All you need to do is send us the numbers in the grey boxes. The puzzle is also available as a **free download** from our website.

SOLVE HEXADOKU AND WIN!

Correct solutions received enter a prize draw for an

E-blocks Starter Kit Professional

worth **£248.55**

and three **Elektor SHOP Vouchers** worth £35.00 each.



We believe these prizes should encourage all our readers to participate!

The competition is not open to employees of Elektor International Media b.v., its business partners and/or associated publishing houses.

PARTICIPATE!

Please send your solution (the numbers in the grey boxes) by email to: **editor@elektor.com** - **Subject: hexadoku 3-2008** (please copy exactly).

Alternatively, by fax or post to: **Elektor Hexadoku Regus Brentford - 1000 Great West Road - Brentford TW8 9HH United Kingdom - Fax (+44) 208 2614447**

The closing date is **1 April 2008**.

The competition is not open to employees of Elektor International Media, its business partners and/or associated publishing houses.

PRIZE WINNERS

The solution of the December 2007 puzzle is: **D148B**.

The **E-blocks Starter Kit Professional** goes to: Richard Ford (UK).

An **Elektor SHOP voucher worth £35.00** goes to: Cristina Aaguadro (I); Dan Dickout (CAN); Lukaèek Majda (SL).

Congratulations everybody!

7		1	9			6			5	B					A
	2	6	3				F	4	8	7					1
	4	E	8	B		3	1	2							0
	A	B		F	C	2			7		4	6	3		
D			B			0	9					6	7	C	
	3	C			9	7	A	2		0		F			
	9		4	E		6	F		1	D	B				
	7				D		B	4			3	E	9	5	
			A		F	0	B	E	D		2				9
	1	5		9	A		E				6				7
B	F									1					
E	6	4			7	8		C	5						2
		A			D		C	2	B			4	7		
			F	3			4	8		1		A		2	6
					A			F		3				8	
3			2	7				A		6	C	1	5	B	

(c) PZZL.com

0	4	2	9	5	C	8	A	B	E	D	1	F	3	6	7
F	6	E	B	0	2	4	D	C	7	A	3	1	5	9	8
8	1	C	7	3	E	F	6	5	9	0	4	2	B	D	A
D	5	3	A	7	B	1	9	2	6	8	F	C	4	0	E
3	D	0	1	A	6	2	4	9	B	C	8	E	7	5	F
A	B	9	F	E	0	C	3	D	1	5	7	8	2	4	6
E	8	7	5	1	D	9	B	6	F	4	2	3	C	A	0
C	2	4	6	F	8	5	7	A	0	3	E	9	D	1	B
2	A	5	4	6	F	B	0	3	C	1	9	7	E	8	D
B	3	1	0	C	9	A	8	7	D	E	5	4	6	F	2
9	C	F	E	2	7	D	1	4	8	B	6	0	A	3	5
6	7	8	D	4	5	3	E	0	2	F	A	B	1	C	9
7	9	A	C	B	3	0	F	E	4	6	D	5	8	2	1
5	F	6	2	8	4	E	C	1	A	7	0	D	9	B	3
1	0	B	3	D	A	7	2	8	5	9	C	6	F	E	4
4	E	D	8	9	1	6	5	F	3	2	B	A	0	7	C

XOR frequency multiplier

Gert Baars

Frequency multiplication is often used in RF designs, for example to increase the frequency from a crystal. This is often implemented using a non-linear transistor amplifier, where the output is tuned to a multiple of the input frequency. A PLL (phase locked loop) can also be used as a frequency multiplier. The multiplication factor is then determined by the divisor in the feedback loop. But there is an even simpler method. And more importantly, it operates over a wider bandwidth than the previous two methods. The truth table for an XOR gate is as follows:

Y	A	B
0	0	0
1	0	1
1	1	0
0	1	1

When A and B are TTL signals with the same frequency, but with a phase difference between them, the truth table shows that

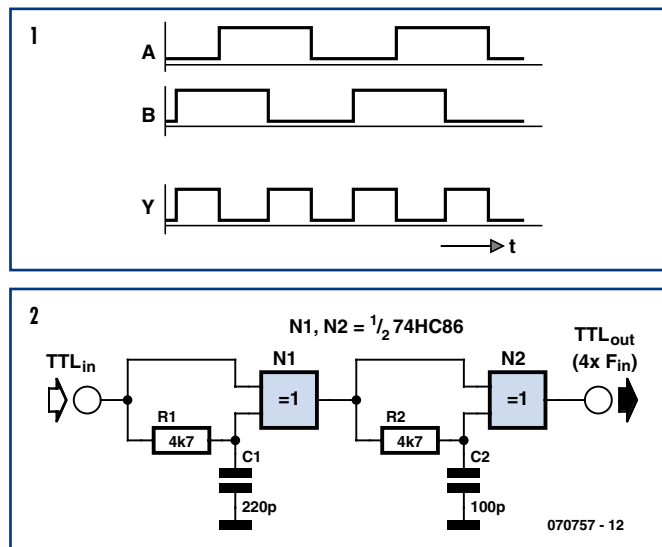

the output signal has twice the frequency of the input signal, as shown in **Figure 1**. In this example the phase difference between the signals is exactly 90°. This ensures that signal Y has a duty cycle of exactly 50%. When the

phase difference is less than 90° (but more than 0°) or more than 90° (but less than 180°), the duty cycle changes, but the frequency remains the same.

We then tried out the circuit shown in **Figure 2**. The phase

shift is created using a simple R-C network, and the duty cycle of each output varies with the frequency. When the phase shift becomes very small, the following stage won't work very well. In theory you could have four stages, but then the frequency range becomes restricted.

With an input signal ranging from 0.1 to 1.5 MHz fed to the circuit from Figure 2 the output signal was measured as 0.4 to 6 MHz, as expected. The duty cycle of the output signal was irregular, since there are two multiplication stages. For frequency synthesis in RF circuits, you would need a filter after the output to remove the higher harmonics from the signal. When the circuit is used to drive an input to a TTL flipflop or counter, for example, the higher harmonics aren't a problem. For these types of input the number of pulses is important and the duty cycle doesn't matter.

(070757-1)

Swap button cell for a GoldCap

Rainer Reusch

There is currently a good range of real-time clock chips available for use in microcontroller systems. One interesting, low-cost example is the DS1307 from Dallas Semiconductor which has a built-in serial I²C interface. The chip provides connections for a 3 V lithium button cell to ensure that the correct time and date are maintained in the event of a power failure. In applications where the system runs continuously the battery back-up should provide many years of service but will eventually need to be replaced. In these situations a better (lower-maintenance) alternative to the battery is a high capacity (GoldCap) capacitor.

The simplest way to implement such a circuit would be to connect a GoldCap capacitor (a value of around 0.1 Farad should do) in place of the battery and arrange for it to be charged from the 5 V supply via a resistor (100 Ω). A diode in series with the GoldCap would prevent the capacitor discharging when the supply volt-

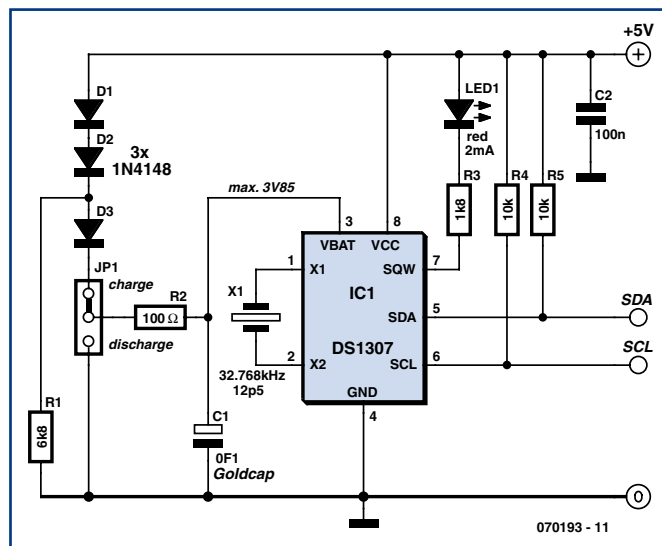

Figure 1: A few additional components are required to use a GoldCap to back-up the DS1307.

age fails. Unfortunately with the DS1307 this simple solution was not successful; once the GoldCap reached its maximum charge the I²C interface stopped talking. A closer look at the data sheet indicated that a 'no communication' mode is initiated when the supply

voltage is below a level equivalent to 1.25 x V_{BAT}. This mode is intended to prevent any possible overwriting and corruption of data in the clock chip by a system controller which is undergoing a power-down or brown-out whilst attempting communication

with the DS1307. As the supply voltage continues to fall below the battery voltage V_{BAT} the DS1307 switches into low-current mode. With these constraints in mind the circuit shown in **Figure 1** was produced. Resistor R1 draws current through diodes D1 and D2 which together produce a voltage drop of around 1.2 V. With a supply of 5 V the voltage at V_{BAT} is approximately 3.85 V. D3 prevents the GoldCap being discharged when the supply voltage falls and R2 limits the charging current (and discharge current when jumper JP1 is used to discharge C1, this process takes a few minutes).

The maximum back-up time produced by the circuit depends on the capacity of the GoldCap and to some extent the operating temperature which will have an influence on both supply and leakage currents. You can expect the circuit to provide back-up for many hours or maybe even a whole day which should be sufficient for most applications.

(070193-1)

The 'Dekatron' decimal counter valve

Jean Herman

These valves were developed in the 50s and lasted right up to the end of 1970. They were used as up/down decade counters in applications like calculating machines, counters of all types, and especially in the nuclear industry as particle counters. Even quite recently I've had digital voltmeters using Dekatrons in for repair. The whole measurement cycle was controlled by a cycling Dekatron: zeroing, measurement, range-changing, display, printout, zeroing, and so on.

Operation

The Dekatron consists (see **Figure 1**) of a central circular anode (a) and ten cathodes (k), numbered from 0–9. Between adjacent cathodes are two transfer electrodes, guides (A) and (B). A voltage applied between the anode (a) and the cathodes causes ionization of just one of the cathodes. To move on to the next cathode, a short negative pulse is applied to the next cathode. To drive a Dekatron takes a minimum of one triode or one transistor or a transformer, together with a differentiator circuit followed by an integrator. In the 60s, transistor circuits were developed for this purpose.

Note that the Dekatron shown in Figure 1 has a different pinout from the one in the circuit diagram. They are two quite different devices.

Application

I found a stray GS10D Dekatron in my drawer, and for old times' sake, I thought it would be interesting to get this valve working again. So I built an instructional counter module (circuit in **Figure 2**) like those used back in the 50s.

Power supply

This valve operates with an anode voltage of 475 V @ 1 mA (minimum, at an ambient temperature of 20 °C!!!), as it's not always easy to

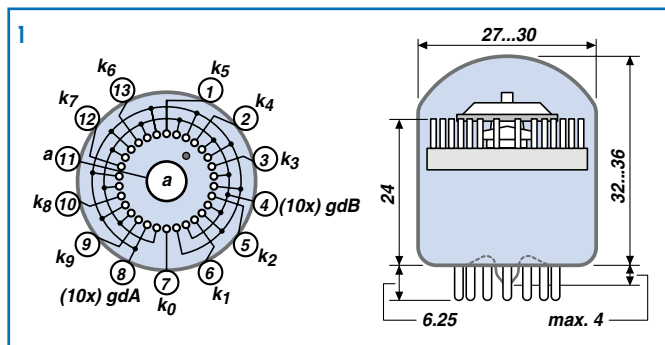

get them to ionize cold. It also has to be said that it is 50 years old, so it's will come as no surprise if it's a bit cantankerous! A cannibalized transformer will do the trick. A first rectifier to give 250 V, followed by a voltage multiplier to give a no-load 600 V. The valves are recovered

6J6 double triodes, with their 6.3 V/0.4 A heaters all in series across the 40 V winding. Luckily, this multi-tapped transformer made it easy to play around with the voltages.

Guide voltage generator

This is a 6J6 valve arranged as

a highly asymmetrical astable multivibrator (250 kΩ/500 pF/500 kΩ and 250 kΩ/0.1 μF/10 MΩ). The output frequency on anode 1 is 5 Hz, so as to be able to follow the movement of the ionization in the Dekatron with the eye. This frequency could be up to 10 kHz. Quiescent, the guides are pulled up to +51 V, which is the normal voltage of the ionized cathodes. When anode 1 switches negative, guide A receives the negative-going spike first via the 0.1 μF and 51 kΩ; guide B (0.1 μF/51 kΩ/10 nF circuit) receives the negative spike delayed by the 51 kΩ/10 nF RC network.

In this way, the jump from cathode n to cathode n+1 is achieved.

By reversing the drives to guides A and B, the set-up will also work as a down-counter.

The GS10D valve displays the count directly, but when the valve is shut away inside a rack, a separate display has to be added. For this instructional circuit, I've chosen the large ZM1040 valve with 31 mm high figures (magnificent!). The ZM1040 is powered at 170 V and draws a current of 4.5 mA, limited by the 22 kΩ resistor. Obviously, the GS10D Dekatron can't control the ZM1040 display directly. One triode per digit is required, i.e. five 6J6 double triode valves.

The cathodes of the Dekatron are taken to ground via 47 kΩ resistors, generating a potential of 40 V when ionized (and hence cathode current is flowing). The cathodes of all the 6J6s are returned to a 24 V zener diode, and their grids are connected to the counter tube cathodes via 1 MΩ resistors. In this way, the 6J6 grids are hard driven: -24 V valve Off, +15 V valve On (with respect to the +24 V on their cathodes). The ZM1040 valve ionization voltage is 140 V. Valve current: 250 V - (140 V + 24 V) = 81 V/22 kΩ = 4 mA. And all this just to cre-

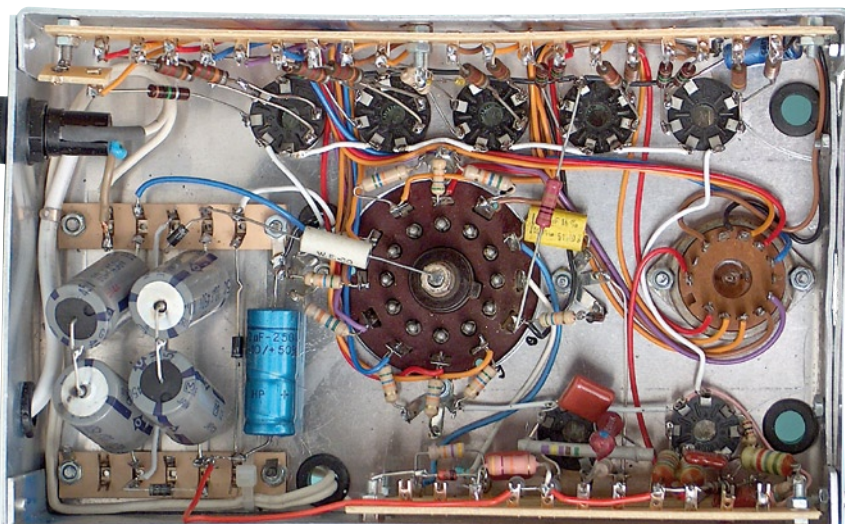

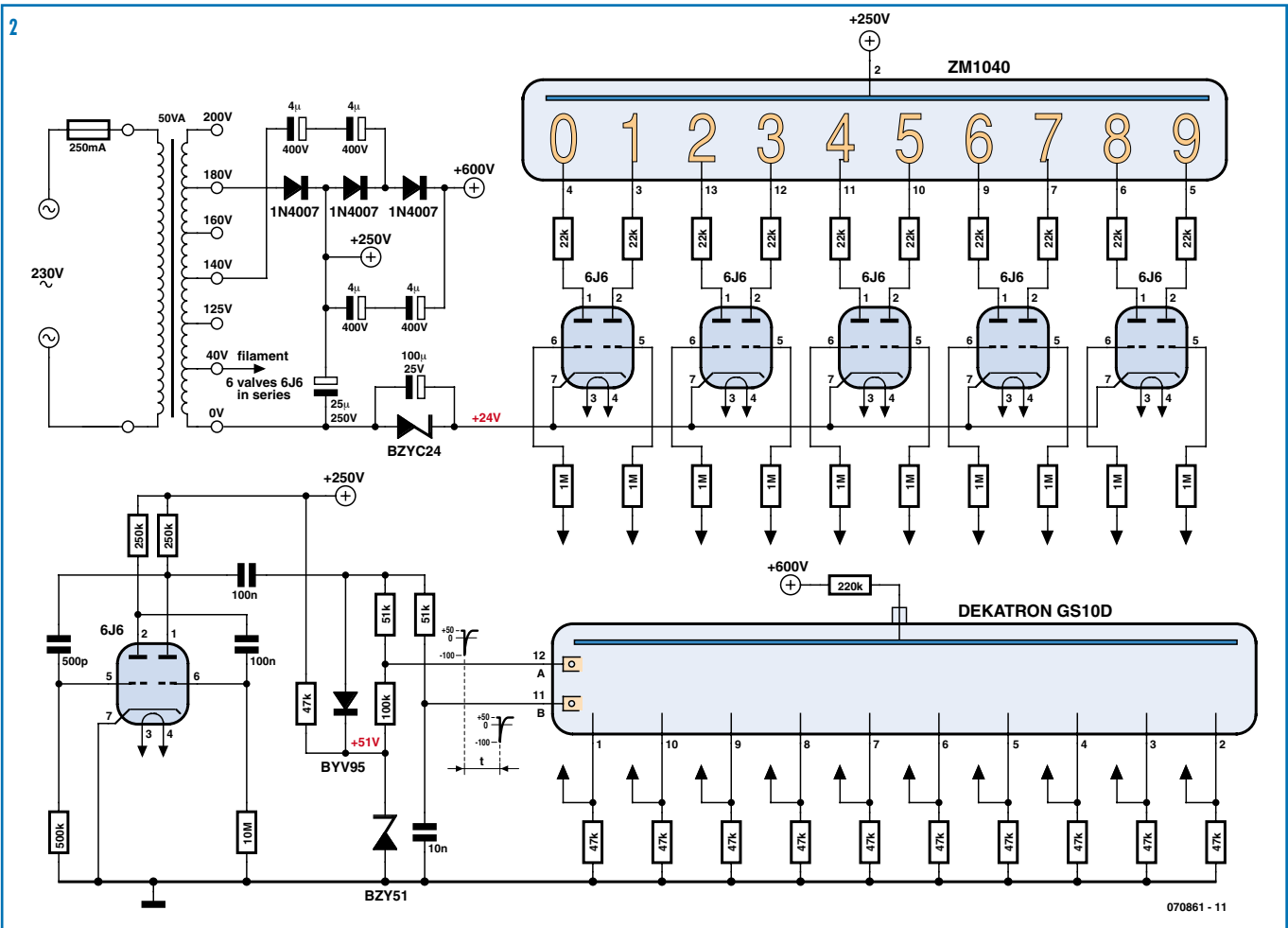

ate one decade of counting – imagine the amount of hardware needed for even six digits, as well as the power consumption (25 W just for this circuit)! There have been several brands and lots of models of Dekatrons on the market. For example:
 – Philips: Z502S (4 kHz), Z504S

(5 kHz), and Z505S (50 kHz)
 – Hivac: GS10D (10 kHz), GCA10G (5 kHz), and GS10H (5 kHz)
 – Elesta: ECT100 (100 kHz), EZ10B (100 kHz)
 – Cerberus: the GZ22 which can drive the GA11 and GA21 displays
 – Beeston: the type VS10K tro-

chotron (200 kHz) and its GR10H display
P.S. I'm on the lookout for Dekatrons to build a digital voltmeter for instructional purposes. If any readers have any, I'd be very glad to hear from them. Thanks in advance!

(070861-1)

Web Links

- <http://nixietube.info/Nixie.html>
- <http://www.wps.com/projects/decimal-tubes/index.html>

Ed: the original spelling is Dekatron (a trademark of Ericsson)

Reelectronics is a monthly column covering vintage electronics including legendary Elektor designs. Contributions, suggestions and requests are welcomed; please send an email to editor@elektor.com

Advertisement

Your price conscious PCB supplier

Online price calculation
 Online ordering
 Online order tracking
 Online 24/24H and 7/7D

Interested? Contact us: +44 2088 167 005
 E-mail: euro@eurocircuits.com
www.eurocircuits.com

Verified

- pooling for standard boards
- up to 6 layers
- from 1 to 1000 pieces
- from 3 working days onwards

A la carte

- pooling with more options
- up to 8 layers
- from 1 to 1000 pieces
- from 3 working days onwards

On demand

- your board, our challenge
- up to 16 layers
- from 1 piece onwards
- from 3 working days onwards

ELEKTOR SHOWCASE

To book your showcase space contact Huson International Media

Tel. 0044 (0) 1932 564999 Fax 0044 (0) 1932 564998

ATC SEMITEC LTD

www.atcsemitec.co.uk

Thermal and current-sensitive components for temperature control and circuit protection;

- NTC Thermistors
- Current Diodes
- Thermostats
- Re-settable Fuses
- Thermal Fuses
- Temperature Sensors

Call today for free samples and pricing

Tel: 01606 871680 Fax: 01606 872938

AVIT RESEARCH

www.avitresearch.co.uk

USB has never been so simple... with our USB to Microcontroller Interface cable. Appears just like a serial port to both PC and Microcontroller, for really easy USB connection to your projects, or replacement of existing RS232 interfaces.



See our webpage for more details. From £10.00.

BETA LAYOUT

www.pcb-pool.com

Beta layout Ltd Award-winning site in both English and German offers prototype PCBs at a fraction of the cost of the usual manufacturer's prices.



BOWOOD ELECTRONICS LTD

www.bowood-electronics.co.uk

Suppliers of Electronic Components

- Semiconductors
- Opto Electronics
- Passives
- Enclosures
- Switches
- Stripboard
- PCB Materials
- Popular Special Offer Packs

Online Store, all major cards

Same day despatch upto 3.00pm

Personal Service sales@bowood-electronics.co.uk

BYVAC ELECTRONICS

www.byvac.co.uk

32Bit ARM

Microcontroller, USB, built in RTC with it's own operating system, no complex tools, just a

terminal emulator, start writing programs in 20 minutes. Complete with CD-ROM, Software and 100 Page Foundation book



DECIBIT CO.LTD.

www.decibit.com

Smallest 2.4 GHz ISM band MCU embedded transceiver modules. Complete tiny solution, ready to transmit RF data by only attaching as example a CR2032 coin cell to it.



DESIGNER SYSTEMS

<http://www.designersystems.co.uk>

Professional product development services.

- Marine (Security, Tracking, Monitoring & control)
- Automotive (AV, Tracking, Gadget, Monitoring & control)
- Industrial (Safety systems, Monitoring over Ethernet)
- Telecoms (PSTN handsets, GSM/GPRS)
- AudioVisual ((HD)DVD accessories & controllers)



EasyDAQ

www.easydaq.biz

We design & supply low cost USB/RS232 based data acquisition, automation & control products:

- USB connected & powered, 8 opto isolated voltage inputs chans, 4DIO & 4 onboard relays capable of switching 240V@10A. With Labview, VC & VB examples - £60



EASYSYNC

<http://www.easysync.co.uk>

EasySync Ltd sells a wide range of single and multi-port USB to RS232/RS422 and RS485 converters at competitive prices.



ELNEC

www.elnec.com

- device programmer manufacturer
- selling through contracted distributors all over the world
- universal and dedicated device programmers
- excellent support and after sale support
- free SW updates
- reliable HW
- once a months new SW release
- three years warranty for most programmers



YOUR ELECTRONICS OPEN SOURCE

<http://dev.emcelettronica.com>

Website full of Projects and Resources for Electronics Engineers and DIY.

- Tutorial
- Hardware (Schematic & Gerber)
- Firmware (Asm & C)
- Reference Design

Everyone can submit a story as a useful source! 'Share for life'



FIRST TECHNOLOGY TRANSFER LTD.

<http://www.ftt.co.uk/PICProTrng.html>

Microchip Professional C and Assembly Programming Courses. The future is embedded.



Microchip Consultant / Training Partner developed courses:

- Distance learning / instructor led
- Assembly / C-Programming of PIC16, PIC18, PIC24, dsPIC microcontrollers
- Foundation / Intermediate

FLEXIPANEL LTD

www.flexipanel.com

TEAclippers - the smallest PIC programmers in the world, from £20 each:

- Per-copy firmware sales
- Firmware programming & archiving
- In-the-field firmware updates
- Protection from design theft by subcontractors



FUTURE TECHNOLOGY DEVICES

<http://www.ftdichip.com>

FTDI designs and sells USB-UART and USB-FIFO interface i.c.'s.

Complete with PC drivers, these devices simplify the task of designing or upgrading peripherals to USB



FUTURLEC

<http://www.futurlec.com>

Save up to 60% on

- Electronic Components
- Microcontrollers, PIC, Atmel
- Development Boards, Programmers

Huge range of products available on-line for immediate delivery, at very competitive prices.



ILP ELECTRONICS LTD

www.ilpelectronics.com

Tel +441233750481

Fax +441233750578

ILP have been manufacturing audio modules since 1971 and apart from our standard range we also offer a custom design service for the OEM market.



LONDON ELECTRONICS COLLEGE

<http://www.lec.org.uk>

Vocational training and education for national qualifications in Electronics Engineering and Information Technology (BTEC First National, Higher National NVQs, GCSEs and GCEs). Also Technical Management and Languages.



products and services directory

MARCHAND ELECTRONICS INC.

www.marchandelec.com

- power amplifier modules
- electronic crossovers solid state / valve / passive
- valve amplifiers
- phono preamps
- handheld sinewave generator
- kits or assembled
- software electronic instruments
- custom design services



MQP ELECTRONICS

www.mqp.com

- Low cost USB Bus Analysers
- High, Full or Low speed captures
- Graphical analysis and filtering
- Automatic speed detection
- Bus powered from high speed PC
- Capture buttons and feature connector
- Optional analysis classes



NEW WAVE CONCEPTS

www.new-wave-concepts.com

Software for Hobbyists:

- Livewire - circuit simulation software, only £34.99
- PCB Wizard - PCB design software, only £34.99
- Circuit Wizard - circuit, PCB and breadboard design software, only £59.99



Available from all Maplin Electronics stores and www.maplin.co.uk

RADIOMETRIX

www.radiometrix.com

The leading global developer of ISM band, low power radio modules for wireless data transmission:

- Transmitters • Receivers • Transceivers
- RF modems • Evaluation Kits



ROBOT ELECTRONICS

<http://www.robot-electronics.co.uk>

Advanced Sensors and Electronics for Robotics

- Ultrasonic Range Finders
- Compass modules
- Infra-Red Thermal sensors
- Motor Controllers
- Vision Systems
- Wireless Telemetry Links
- Embedded Controllers



ROBOTIQ

<http://www.robotiq.co.uk>

Build your own Robot!
Fun for the whole family!

- Meccano™ Compatible
- Computer Control
- Radio Control
- Tank Treads
- Hydraulics



Internet Technical Bookshop,
1-3 Fairlands House, North Street, Carshalton,
Surrey SM5 2HW
email: sales@robotiq.co.uk Tel: 020 8669 0769

COMPONENTBIN.COM

www.componentbin.com

Kickstart your development with modules and parts from componentbin.com

- ARM7 modules
- Ethernet modules
- Superb Graphic LCD displays (all with example software)



and much much more...

Online ordering and great prices!

ULTRALEDS

<http://www.ultraleds.co.uk>

tel: 0871 7110413 / 01625 576778

Large range of low cost Ultra bright leds and Led related lighting products. Major credit cards taken online with same day depatch.

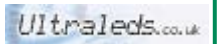

USB INSTRUMENTS

<http://www.usb-instruments.com>

USB Instruments specialises in PC based instrumentation products and software such as Oscilloscopes, Data Loggers, Logic Analysers which interface to your PC via USB.



VIRTINS TECHNOLOGY

www.virtins.com

PC and Pocket PC based virtual instrument such as sound card real time oscilloscope, spectrum analyzer, signal generator, multimeter, sound meter, distortion analyzer, LCR meter. Free to download and try.



SHOWCASE YOUR COMPANY HERE

Elektor Electronics has a feature to help customers promote their business, Showcase - a permanent feature of the magazine where you will be able to showcase your products and services.

- For just £220 + VAT (£20 per issue for eleven issues) Elektor will publish your company name, website address and a 30-word description
- For £330 + VAT for the year (£30 per issue for eleven issues) we will publish the above plus run a 3cm deep full colour

image - e.g. a product shot, a screen shot from your site, a company logo - your choice

Places are limited and spaces will go on a strictly first come, first served basis. So-please fax back your order today!

I wish to promote my company, please book my space:

- Text insertion only for £220 + VAT
- Text and photo for £330 + VAT

NAME: ORGANISATION:

JOB TITLE:

ADDRESS:

..... TEL:

PLEASE COMPLETE COUPON BELOW AND FAX BACK TO 00-44-(0)1932 564998

COMPANY NAME

WEB ADDRESS

30-WORD DESCRIPTION

.....

.....

.....

.....

Going Strong

A world of electronics from a single shop!

NEW!



Free of charge with FPGA product bundle!



Bestseller!

All articles published in 2007
Elektor 2007

Year volume CD-ROMs are among the most popular items in Elektor's product range. This CD-ROM contains all editorial articles published in Elektor Volume 2007. Using the supplied Acrobat Reader program, articles are presented in the same layout as originally found in the magazine. An extensive search machine is available to locate keywords in any article.

978-90-5381-218-1 • £16.90 • US\$ 33.80



More than 68,000 components

Elektor's Components Database 4

The program package consists of eight databanks covering ICs, germanium and silicon transistors, FETs, diodes, thyristors, triacs and optocouplers. A further eleven applications cover the calculation of, for example, LED series droppers, zener diode series resistors, voltage regulators and AMVs. A colour band decoder is included for determining resistor and inductor values. ECD 4 gives instant access to data on more than 68,000 components. All databank applications are fully interactive, allowing the user to add, edit and complete component data. This CD-ROM is a must-have for all electronics enthusiasts.

ISBN 978-90-5381-159-7 • £15.90 • US\$ 31.80

Modern technology for everyone

FPGA Course in 9 chapters

FPGAs have established a firm position in the modern electronics designer's toolkit. Until recently, these 'super components' were practically reserved for specialists in high-tech companies. That's all changed now, also because of the Elektor FPGA module. The combination of the module and the prototyping board is the perfect introduction to FPGAs. The nine lessons on the courseware CD-ROM are a step by step guide to the world of Field Programmable Gate Array technology. Subjects covered include not just digital logic and bus systems but also building an FPGA webserver, a 4-channel multimeter and a USB controller. The CD also contains PCB layout files in pdf format, a Quartus manual, project software and various supplementary instructions.

ISBN 978-90-5381-225-9 • £14.50 • US\$ 29.00

CD-ROMs



5.0, 6.0, VBA, .NET, 2005

Visual Basic for Electronics Engineering Applications

This book is targeted towards those people that want to control existing or self-built hardware from their computer. After familiarizing yourself with Visual Basic, its development environment and the tool-set it offers are discussed in detail. Each topic is accompanied by clear, ready to run code, and where necessary, schematics are provided that will get your projects up to speed in no time.

476 pages • ISBN 978-0-905705-68-2
£29.00 • US\$ 58.00

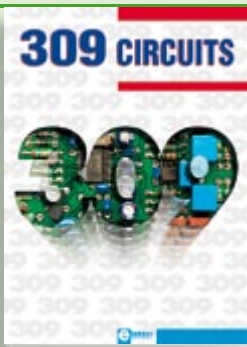

Fully elaborated electronics projects

309 Circuits

The present tenth edition of the popular '30x Circuits' series of books once again contains a comprehensive variety of circuits, sub-circuits, tips and tricks and design ideas for electronics. Among many other inspiring topics, the following categories are well presented in this book: test & measurement; RF (radio); computers and peripherals; audio & video; hobby and modelling; microcontrollers; home & garden; power supplies & battery chargers; etcetera.

432 pages • ISBN 978-0-905705-69-9
£19.95 • US\$ 39.95



Bestseller!

Silent alarm, poetry box, night buzzer and more!

PIC Microcontrollers

This hands-on book covers a series of exciting and fun projects with PIC microcontrollers. You can build more than 50 projects for your own use. The clear explanations, schematics, and pictures of each project on a breadboard make this a fun activity. You can also use it as a study guide. The technical background information in each project explains why the project is set up the way it is, including the use of datasheets. This way you'll learn a lot about the project and the microcontroller being used. Even after you've built all the projects it will still be a valuable reference guide to keep next to your PC.

446 pages • ISBN 978-0-905705-70-5
£27.00 • US\$ 54.00



Surround Light

(February 2008)

In 2004 Philips launched the Ambilight system for its television sets. Unfortunately this system is not available with other TV brands, let alone computer displays. This circuit, a complete analogue design, allows you to retrofit an image-controlled background light to your PC display. This generates a more intense experience, creates a visual point of reference, and produces refined mood lighting.

PCB, partly populated with SMDs (including parts and enclosure)

Art.# 070491-91 • £121.90 • US\$ 245.00



Bestseller!

CO₂ Measurement

(January 2008)

Carbon dioxide (CO₂) is not just a threat to the environment, it is also an important and often ignored factor in determining air quality in the office and at home. Too high a concentration of CO₂ leads to feelings of tiredness, disturbs concentration, and causes headaches. The Elektor CO₂ meter makes it easy to determine the concentration of carbon dioxide in the air. A microcontroller monitors the measured value and can trigger an alarm or start up a ventilation system when a preset threshold is exceeded.

Kit of parts, PCB, Sensor PCB, ATtiny26 and display

Art.# 070802-71 • £107.50 • US\$ 215.00

More information on the
Elektor Website:

www.elektor.com

Elektor
Regus Brentford
1000 Great West Road
Brentford
TW8 9HH
United Kingdom

Tel.: +44 20 8261 4509

Fax: +44 20 8261 4447

Email: sales@elektor.com

elektor
SHOP

March 2008 (No. 375)

£ US\$

Data Logger "deLuxe"

070745-1 PCB, bare	16.30	32.60
070745-41 Programmed controller	19.90	39.80
070745-71 Kit of parts (PCB, programmed controller and display)	71.75	143.50

The Secrets of I2C

070600-1 PCB, bare	13.60	32.60
070600-41 Programmed controller	19.90	39.80

Cylon Voice

070859-41 Programmed controller	4.70	9.40
-----------	-----------------------------	------	------

ECIO PLC

070786-1 PCB, bare	16.30	32.60
070786-71 Kit of parts (PCB, ECIO-module, all other components)	76.00	152.00

February 2008 (No. 374)

LEDBUS System

070459-1 PCB, power module	www.thePCBshop.com
070459-2 PCB, central	www.thePCBshop.com
070459-41 PIC12F638-1/SN, programmed (power module)	3.10 6.20
070459-42 ATmega32-16PC, programmed (central)	13.80 27.60

RGB LED Mood Lighting

070892-1 PCB, bare	www.thePCBshop.com
070892-2 PCB, bare	www.thePCBshop.com
070892-3 PCB, bare	www.thePCBshop.com

Surround Light for PC Monitor

070491-1 PCB, bare	21.50	43.00
070491-2 PCB, bare	5.00	10.00
070491-91 PCB, partly populated with SMDs	121.90	245.00

LED Ringflash

070612-1 PCB, bare	www.thePCBshop.com
070612-41 PIC16F628, programmed	10.50 21.00
070612-81 Software on CD-ROM	5.20 10.40

TV Surround Light

070487-1 PCB, bare	21.50	43.00
070487-41 Programmed controller	12.70	25.40
070487-42 Programmed controller	10.50	21.00
070487-81 Software on CD-ROM	5.20	10.40

CAN Explorer

060201-1 PCB, MCP2515 and MCP2551SN	www.thePCBshop.com
060201-W Testing & Error Sources Manual	www.elektor.com

Thermometer / Thermostat

070852-11 Software	www.elektor.com
-----------	----------------	-----------------

January 2008 (No. 373)

CO₂ Measurement

070802-1 PCB, bare	14.40	28.80
070802-41 Programmed controller ATtiny26	7.20	14.40
070802-71 Kit of parts, PCB, Sensor PCB, ATtiny26 and display	107.50	215.00
070802-81 Software on CD-ROM	5.20	10.40

Anti-Standby Switch

070797-1 PCB, bare	14.40	28.80
070797-41 ATtiny25, programmed	5.20	10.40

Control for Energy-saving Lamps

070638-71 PCB, FAN7710N and 2.5mH coil	14.40	28.80
-----------	------------------------------------	-------	-------

Versatile DC Power Meter

070559-1 PCB, bare	9.30	18.60
070559-41 Programmed controller ATmega8-16P	9.00	18.00

December 2007 (No. 372)

Reflow Solder Controller

060234-91 Populated PCB with enclosure	171.80	343.60
-----------	------------------------------------	--------	--------

AVR Web Server

060257-1 Printed circuit board	9.60	19.20
060257-41 ATmega644, programmed	13.80	27.60

Craft Drill Controller





060291-1 Printed circuit board	www.thePCBshop.com
----------	-----------------------------	--------------------

Christmas Flasher





010032-91 Kit of parts	3.60	7.20
-----------	--------------------	------	------

Bestsellers



Books

-  **PIC Microcontrollers**
ISBN 978-0-905705-70-5 £27.00 US\$ 54.00
-  **Visual Basic** for Electronics Engineering Applications
ISBN 978-0-905705-68-2 £29.00 US\$ 58.00
-  **309 Circuits**
ISBN 978-0-905705-69-9 £19.95 US\$ 39.95
-  **Microcontroller Basics**
ISBN 978-0-905705-67-5 £19.50 US\$ 39.00
-  **PC Interfaces under Windows**
ISBN 978-0-905705-65-1 £27.25 US\$ 54.50

CD-ROMs

-  **Elektor 2007**
ISBN 978-90-5381-218-1 £16.90 US\$ 33.80
-  **ECD4**
ISBN 978-90-5381-159-7 £15.90 US\$ 31.80
-  **Ethernet Toolbox**
ISBN 978-90-5381-214-3 £18.90 US\$ 37.90
-  **Home Automation**
ISBN 978-90-5381-195-5 £13.90 US\$ 27.80
-  **USB Toolbox**
ISBN 978-90-5381-212-9 £19.90 US\$ 39.80

Kits & Modules

-  **CO₂ Measurement**
Art. # 070802-71 £107.50 US\$ 215.00
-  **USB Flash Board**
Art. # 070125-71 £36.20 US\$ 72.40
-  **Surround Light**
Art. # 070491-91 £121.90 US\$ 245.00
-  **Reflow Solder Controller**
Art. # 060234-91 £171.80 US\$ 343.60
-  **Stand Alone OBD-2 Analyser**
Art. # 070038-72 £55.20 US\$ 110.40

Order quickly and safe through
www.elektor.com/shop
or use the Order Form near the end
of the magazine!

elektor
SHOP

Elektor
Regus Brentford
1000 Great West Road
Brentford TW8 9HH • United Kingdom
Tel. +44 20 8261 4509
Fax +44 20 8261 4447
Email: sales@elektor.com

MAY WE OFFER YOU SOME MORE?

You save:	Subscription PLUS
£39.00	10 magazines
+ £5.80	1 double issue (July/August)
+ £16.90	Annual-CD-ROM
+ £34.50	1 GB MP3 player

= £96.20	total value of individual items
- £49.00	Elektor year subscription PLUS

= £47.20	your saving

The Elektor PLUS subscription

Keep **£47.20** in your pocket!

11 x Elektor PLUS:

- Cheaper than 11 issues from the newsstand
- Subscribers get up to **40% discount** on special Elektor products
- As a welcome gift you get a **free** 1 GB MP3 player worth £34.50
- No queues, travelling, parking fees or "sold out" Elektor is supplied to your doorstep every month
- Always up to date – read your copy before everyone else



www.elektor.com/subs
Tel. +44 (0) 20 8261 4509

Or use the subscription order form near the end of the magazine.

elektor
electronics worldwide

Home Automation Server

This project employs a Freescale Coldfire micro and associated PC software that allows remote switching of electrical loads across networks including the biggest network of all – the Internet. The ingredients from the Freescale/Elektor kitchen: 32-bit embedded technology, free software, a low-cost kit for the hardware and all tools to expand the functionality of the server to your own liking. In the first instalment we describe the general structure of the server and the optional Turbo BDM programmer for Coldfire devices.

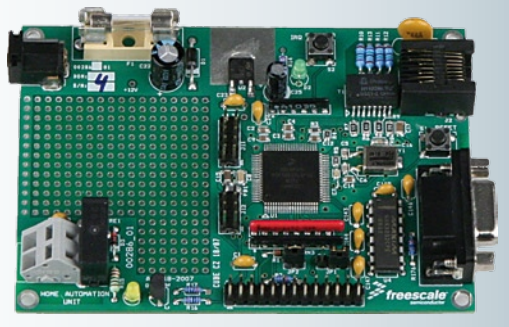

paX, an audio amplifier with error correction

Most audio power amplifiers employ strong overall feedback circuitry to keep distortion and output impedance as low as possible. In the audio world, the method is not beyond reproach as strong feedback is said to compromise sound fidelity. Next month we describe an amplifier with a radically different approach called error correction. Although the concept dates back to Malcolm Hawksford's publications in 1984, it was never realised in practice. The amplifier presented in the next issues of Elektor is not only remarkable for its fine specifications, but is also for stability compared to design with overall feedback.

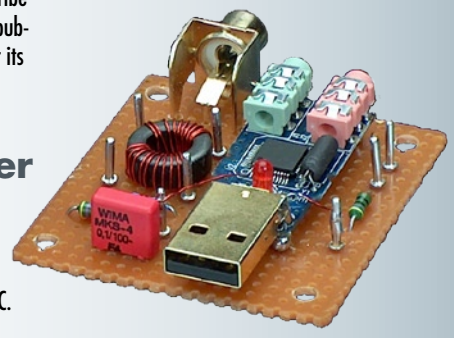

USB-to-S/PDIF converter

A proper D/A converter is still among the highest ranking options if you are after zero-compromise reproduction of digital sound sources via the computer. Unfortunately, proper sounding DACs are rarely used on PC sound cards or motherboards and the alternative is to 'go external'. Our interface allows the input of a high-end DAC to be driven by an S/PDIF signal, using an USB connection on the PC.

RESERVE YOUR COPY NOW!

UK mainland subscribers will receive the magazine between 22 and 25 March 2008.

The April 2008 issue goes on sale on Thursday 27 March 2008 (UK distribution only). Article titles and magazine contents subject to change, please check www.elektor.com.

NEWSAGENTS ORDER FORM

SHOP SAVE / HOME DELIVERY

Please save / deliver one copy of *Elektor* magazine for me each month

Name:

Address:

Post code:

Telephone:

Date:

Signature:



Please cut out or photocopy this form, complete details and hand to your newsagent. Elektor is published on the third Thursday of each month, except in July. Distribution S.O.R. by Seymour (NS).

www.elektor.com www.elektor.com www.elektor.com www.elektor.com www.elektor.com

Elektor on the web

All magazine articles back to volume 2000 are available online in pdf format. The article summary and parts list (if applicable) can be instantly viewed to help you positively identify an article. Article related items are also shown, including software downloads, circuit boards, programmed ICs and corrections and updates if applicable. Complete magazine issues may also be downloaded.

In the Elektor Shop you'll find all other products sold by the publishers, like CD-ROMs, kits and books. A powerful search function allows you to search for items and references across the entire website.

Also on the Elektor website:

- Electronics news and Elektor announcements
- Readers Forum
- PCB, software and e-magazine downloads
- Surveys and polls
- FAQ, Author Guidelines and Contact



ORDERING INSTRUCTIONS, P&P CHARGES

Except in the USA and Canada, all orders, except for subscriptions (for which see below), must be sent BY POST or FAX to our Brentford address using the Order Form overleaf. Online ordering: www.elektor.com/shop

Readers in the USA and Canada may (but are not obliged to) send orders, except for subscriptions (for which see below), to the USA address given on the order form. Please apply to Old Colony Sound for applicable P&P charges. Please allow 4-6 weeks for delivery.

Orders placed on our Brentford office must include P&P charges (Priority or Standard) as follows: Europe: £6.00 (Standard) or £7.00 (Priority) Outside Europe: £9.00 (Standard) or £11.00 (Priority)

HOW TO PAY

All orders must be accompanied by the full payment, including postage and packing charges as stated above or advised by Customer Services staff.

Bank transfer into account no. 40209520 held by Elektor Electronics with ABN-AMRO Bank, London. IBAN: GB35 ABNA 4050 3040 2095 20. BIC: ABNAGB2L. Currency: sterling (UKP). Please ensure your full name and address gets communicated to us.

Cheque sent by post, made payable to Elektor Electronics. We can only accept sterling cheques and bank drafts from UK-resident customers or subscribers. We regret that no cheques can be accepted from customers or subscribers in any other country.

Giro transfer into account no. 34-152-3801, held by Elektor Electronics. Please do not send giro transfer/deposit forms directly to us, but instead use the National Giro postage paid envelope and send it to your National Giro Centre.

Credit card VISA and MasterCard can be processed by mail, email, web, fax and telephone. Online ordering through our website is SSL-protected for your security.

COMPONENTS

Components for projects appearing in Elektor are usually available from certain advertisers in this magazine. If difficulties in the supply of components are envisaged, a source will normally be advised in the article. Note, however, that the source(s) given is (are) not exclusive.

TERMS OF BUSINESS

Delivery Although every effort will be made to dispatch your order within 2-3 weeks from receipt of your instructions, we can not guarantee this time scale for all orders. **Returns** Faulty goods or goods sent in error may be returned for replacement or refund, but not before obtaining our consent. All goods returned should be packed securely in a padded bag or box, enclosing a covering letter stating the dispatch note number.

If the goods are returned because of a mistake on our part, we will refund the return postage. **Damaged goods** Claims for damaged goods must be received at our Brentford office within 10-days (UK); 14-days (Europe) or 21-days (all other countries). **Cancelled orders** All cancelled orders will be subject to a 10% handling charge with a minimum charge of £5.00. **Patents** Patent protection may exist in respect of circuits, devices, components, and so on, described in our books and magazines. Elektor does not accept responsibility or liability for failing to identify such patent or other protection. **Copyright** All drawings, photographs, articles, printed circuit boards, programmed integrated circuits, diskettes and software carriers published in our books and magazines (other than in third-party advertisements) are copyright and may not be reproduced or transmitted in any form or by any means, including photocopying and recording, in whole or in part, without the prior permission of Elektor in writing. Such written permission must also be obtained before any part of these publications is stored in a retrieval system of any nature.

Notwithstanding the above, printed-circuit boards may be produced for private and personal use without prior permission. **Limitation of liability** Elektor shall not be liable in contract, tort, or otherwise, for any loss or damage suffered by the purchaser whatsoever or howsoever arising out of, or in connexion with, the supply of goods or services by Elektor other than to supply goods as described or, at the option of Elektor, to refund the purchaser any money paid in respect of the goods. **Law** Any question relating to the supply of goods and services by Elektor shall be determined in all respects by the laws of England.

September 2007

SUBSCRIPTION RATES FOR ANNUAL SUBSCRIPTION

	Standard	Plus
United Kingdom	£42.00	£49.00
Surface Mail		
Rest of the World	£56.00	£63.00
Airmail		
Rest of the World	£71.00	£78.00

USA & Canada For US\$-prices please check www.elektor.com

HOW TO PAY

Bank transfer into account no. 40209520 held by Elektor Electronics with ABN-AMRO Bank, London. IBAN: GB35 ABNA 4050 3040 2095 20. BIC: ABNAGB2L. Currency: sterling (UKP). Please ensure your full name and address gets communicated to us.

Cheque sent by post, made payable to Elektor Electronics. We can only accept sterling cheques and bank drafts from UK-resident customers or subscribers. We regret that no cheques can be accepted from customers or subscribers in any other country.

Giro transfer into account no. 34-152-3801, held by Elektor Electronics. Please do not send giro transfer/deposit forms directly to us, but instead use the National Giro postage paid envelope and send it to your National Giro Centre.

Credit card VISA and MasterCard can be processed by mail, email, web, fax and telephone. Online ordering through our website is SSL-protected for your security.

SUBSCRIPTION CONDITIONS

The standard subscription order period is twelve months. If a permanent change of address during the subscription period means that copies have to be despatched by a more expensive service, no extra charge will be made. Conversely, no refund will be made, nor expiry date extended, if a change of address allows the use of a cheaper service.

Student applications, which qualify for a 20% (twenty per cent) reduction in current rates, must be supported by evidence of student-ship signed by the head of the college, school or university faculty. A standard Student Subscription costs £33.60, a Student Subscription-Plus costs £39.20 (UK only).

Please note that new subscriptions take about four weeks from receipt of order to become effective.

Cancelled subscriptions will be subject to a charge of 25% (twenty-five per cent) of the full subscription price or £7.50, whichever is the higher, plus the cost of any issues already dispatched. Subscriptions cannot be cancelled after they have run for six months or more.

January 2008

Formula Flowcode Buggy

USB-programmable robot vehicle

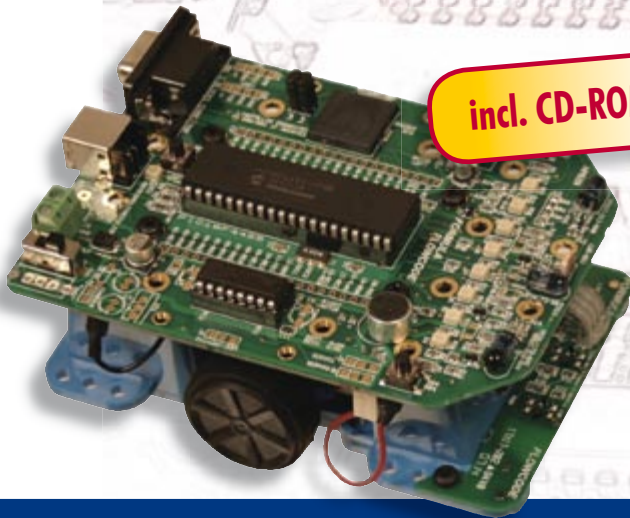

incl. CD-ROM

- A complete solution:
robot + software + curriculum
- Line following and maze solving
- High-tech specifications
- Also programmable with C or ASM
- E-blocks compatible
- Motivating for education and hobby

Ready to use only £85.00 • US\$ 169.00

Order now using the Order Form in the Readers Services section in this issue.

Elektor
Regus Brentford • 1000 Great West Road
Brentford TW8 9HH
United Kingdom
Tel. +44 20 8261 4509

elektor
SHOP

Order quickly and safe through www.elektor.com/shop

INDEX OF ADVERTISERS

Allendale Electronics Ltd	www.pcb-soldering.co.uk	16	MikroElektronika	www.mikroe.com	11
ATC Semitec Ltd, Showcase	www.atcsemitec.co.uk	78	MQP Electronics, Showcase	www.mqp.com	79
Avit Research, Showcase	www.avitresearch.co.uk	78	New Wave Concepts, Showcase	www.new-wave-concepts.com	79
Beijing Draco	www.ezpcb.com	57	Newbury Electronics	www.newburyelectronics.co.uk	61
Beta Layout, Showcase	www.pcb-pool.com	39, 78	Nurve Networks	www.xgamestation.com	61
Bitscope Designs	www.bitscope.com	3	Paltronix	www.paltronix.com	43
Bowood Electronics Ltd, Showcase	www.bowood-electronics.co.uk	78	SK Pang Electronics	www.skpang.co.uk	39
Byvac Electronics, Showcase	www.byvac.co.uk	78	Peak Electronic Design	www.peakelec.co.uk	39
Decibit Co. Ltd, Showcase	www.decibit.com	78	Pico	www.picotech.com	17
Designer Systems, Showcase	www.designersystems.co.uk	78	Quasar Electronics	www.quasarelectronics.com	63
EasyDAQ, Showcase	www.easydaq.biz	78	Radiometrix, Showcase	www.radiometrix.com	79
Easysync, Showcase	www.easysync.co.uk	78	Robot Electronics, Showcase	www.robot-electronics.co.uk	79
Eltec, Showcase	www.eltec.com	78	Robotiq, Showcase	www.robotiq.co.uk	79
EMCelettronica Srl, Showcase	www.emcelettronica.com	78	Schaeffer AG	www.schaeffer-ag.de	57
Eurocircuits	www.eurocircuits.com	77	Showcase		78, 79
First Technology Transfer Ltd, Showcase	www.ftt.co.uk	78	Tsien (UK) Ltd, Showcase	www.componentbin.com	79
FlexiPanel Ltd, Showcase	www.flexipanel.com	78	Ultraleds, Showcase	www.ultraleds.co.uk	79
FLYPCB	www.flypcb.com	9	USB Instruments, Showcase	www.usb-instruments.com	79
Future Technology Devices, Showcase	www.ftdichip.com	78	Virtins Technology, Showcase	www.virtins.com	79
Futurlec, Showcase	www.futurlec.com	78			
ILP Electronics Ltd, Showcase	www.ilpelectronics.com	78			
Jaycar Electronics	www.jaycarelectronics.co.uk	2			
Labcenter	www.labcenter.com	88			
London Electronics College, Showcase	www.lec.org.uk	78			
Marchand Electronics Inc, Showcase	www.marchandelec.com	79			

**Advertising space for the issue of 21 April 2008
may be reserved not later than 25 March 2008**

with Huson International Media – Cambridge House – Gogmore Lane –
Chertsey, Surrey KT16 9AP – England – Telephone 01932 564 999 –
Fax 01932 564998 – e-mail: gerryb@husonmedia.com to whom all
correspondence, copy instructions and artwork should be addressed.

PROTEUS

DESIGN SUITE

COMPUTER ~~AIDED~~ DESIGN ENHANCED

- Powerful, Easy to Use Schematic Capture
- Interactive Mixed Mode SPICE Simulation
- Unique Microcontroller Co-Simulation and Debugging
- Fully Featured PCB Design and 3D Viewer

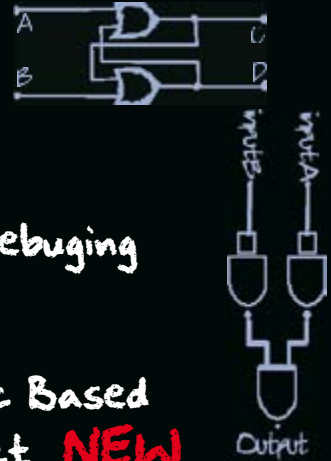

+

Worlds First Schematic Based
USB Simulation Product **NEW**

=

- Complete Engineering Solution
- Rapid Development Environment
- Maximum Return on Investment
- Faster Time to Market



WINTER SPECIAL OFFER

20% off all new orders for the Proteus Design Suite when you spend £400 or more.

Electronic Design from Concept To Completion

LABCENTER ELECTRONICS LTD

A technology Pioneer in the EDA industry since 1988.
Technical support direct from the program authors.
Flexible packages and pricing tailored to customer requirements.

CONTACT US NOW

to discuss your requirements or
request a FREE evaluation copy.

labcenter  www.labcenter.com
Electronics

TEL: +44 (0)1756 753440
FAX: +44 (0)1756 752857
Email: info@labcenter.com

Labcenter Electronics Ltd., 53-55 Main Street, Grassington
North Yorks, BD23 5AA. Registered in England 4692454