

elektor

electronics

Leading the way

June 2005

£3.70

www.elektor-electronics.co.uk

- Battery charging from
SOLAR CELLS

- ENERGY savings

- LEADFREE
soldering

- GPS RECEIVER on USB

- EAVESDROPPING
on WLANs

- TUNE IN TO
electrosmog



RADIATION HAZARD

GSM, UMTS, 3G, WLAN, DECT...
Detect & quantify with our
ELECTROSMOG TESTER

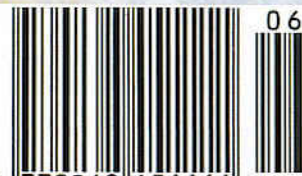

9 770268 451111

NERD PORN

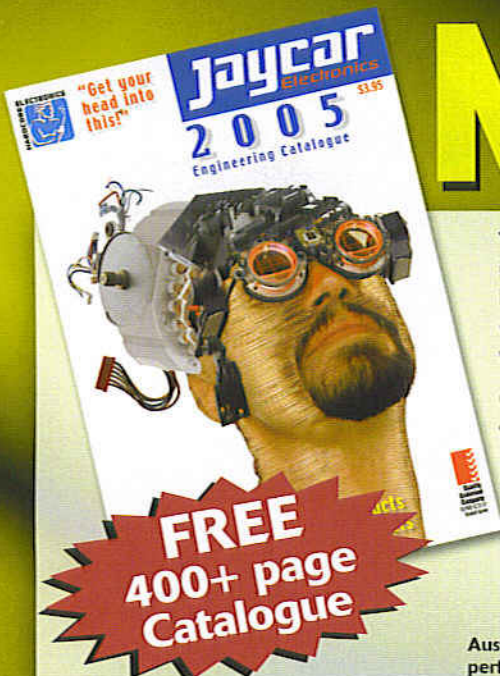

FREE
400+ page
Catalogue

This is what the guys in Australia call our Catalogue. It's full of electronic goodies and is soooooo seductive it's like pornography without the viscera. You might be titillated but won't be offended!

Grab a free one, all products priced in pounds sterling, at:
www.jaycarelectronics.co.uk/elektor

Check our website!

- All of our 6,000+ products with search facilities.
- 128-bit secure on-line ordering - safe & secure.
- Over 3,500 product datasheets & application notes.
- And we're from Australia, so you can trust us!
- Postage and Packing includes airmail to the UK



Moreinfo?

www.jaycarelectronics.co.uk

Post and Packing Charges:	
Order Value	Cost
£20 - £49.99	£5
£50 - £99.99	£10
£100 - £199.99	£20
£200 - £499.99	£30
£500+	£40
Max weight 12lb (5kg) - heavier parcels POA. Minimum order £20.	

Performance Electronics for Cars Book

BS-5080 £6.95 + post & packing

Australia's leading electronics magazine, Silicon Chip, has developed a range of projects for performance cars. There are 16 projects in total, ranging from devices for remapping fuel curves, to nitrous controllers, and more! The book includes all instructions, components lists, colour pictures, and circuit layouts. There are also chapters on engine management, advanced systems, DIY modifications, and more. Over 150 pages! All of the projects described are available in kit form, exclusively from Jaycar. Check out our website for all the details.

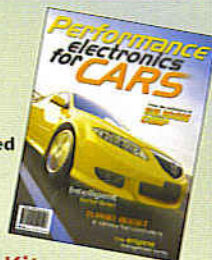

JUST ONE OF OUR MANY GREAT PRE-BUILT & TESTED PRODUCTS!

Map Reading Made Easy!

XC-0377 £12.50 + post and packing.
All you need to do is program the scale of your map, then roll the wheel top along the intended route. It will then display the **ACTUAL REAL WORLD DISTANCE** in miles (or kilometers). It also works in nautical miles for marine and aviation applications, has a backlit screen and a small torch. Measures 6 1/8" x 1 3/8" x 15/16".



NEW MODEL

Theremin Synthesiser Kit

KC-5295 £17.50 + post & packing

The Theremin is a weird musical instrument that was invented early last century but is still used today. The Beach Boys' classic hit "Good Vibrations" featured a Theremin. By moving your hand between the antenna and metal plate, you create weird sound effects like in those scary movies! Kit includes a machined, silk-screened, and pre-drilled case, circuit board, all electronic components, and clear English instructions.



9VDC wall adaptor required (Maplin #MGB0B £5.99).



10 Amp 12VDC

Motor Speed Controller Kit

KC-5225 £7.75 + post & packing

This project allows you to take control of DC motors, or dim incandescent lights. Control the speed of a fuel injection or water pump on your car, and a whole lot more. With the components supplied, it can handle up to 10 amps. By fitting an optional extra MOSFET transistor, it can handle up to 20 amps. Kit includes circuit board, all electronic components, and clear English instructions.

Optional extra MOSFET transistor - ZT-2450 £2.50.



We Stock...

Electronic Components

Electronic Project Kits

Test & Measurement Equipment

Power Products and Accessories

Audio & Video Equipment & Accessories

Computer & Telecoms Accessories

Security & Surveillance Equipment

Get the Video Quality You Paid For With Our Doctor Video Kit

KC-5390 £31.95 + post and packing

Copy protection is put in place on videos and DVDs for a good reason, but this robs you of the true high quality reproduction that it is capable of. Get the quality you paid for and strip out these annoying signals! It supports composite and S-video signals and can be configured for NTSC or PAL format. Kit includes case, circuit board, all electronic components, and clear English instructions. Note: Some SMD soldering required.



Caution: During signal conditioning, this unit removes copyright protection. Piracy is a crime, & Jaycar Electronics takes no responsibility for its potential for unlawful use.



Universal High Energy Ignition Kit

KC-5247 £16.95 + post and packing

Get better fuel efficiency and performance from your car! It produces a very intense 0.9ms spark which results in more complete fuel burning, lower emissions, and increased performance. It works with points, twin points, and reluctor ignition systems. Kit supplied with weatherproof diecast aluminium case, circuit board, and all electronic components.

- Works great on points ignition (ie. older cars). Can be used on newer cars with Hall-effect sensor.



Log on to

www.jaycarelectronics.co.uk/elektor

for your FREE catalogue!

0800 032 7241

(Monday - Friday 09.00 to 17.30 GMT + 10 hours only). For those that want to write:
100 Silverwater Rd Silverwater NSW 2128 Sydney AUSTRALIA

Jaycar

Electronics

DrDAQ Data Logger

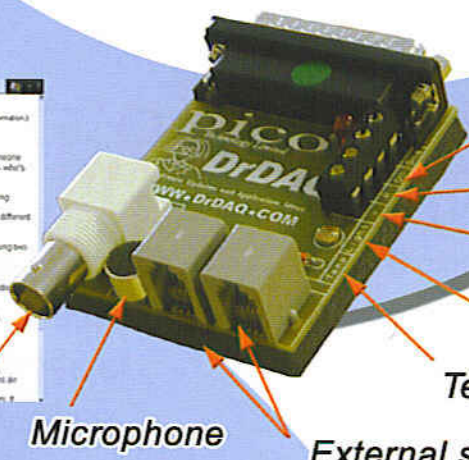
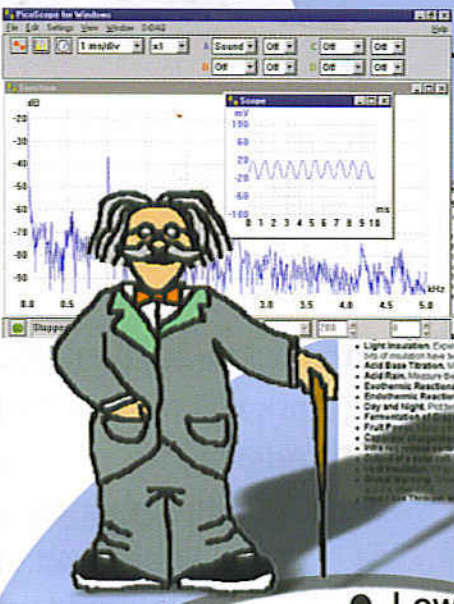

- Output
- Resistance
- Voltage
- Light level
- Temperature
- External sensors: Humidity
- Temperature
- O2 In Air
- Reed Switch

- Low cost - under £80 (+VAT)
- Built in sensors for light, temperature and sound (level and waveforms)
- Use DrDAQ to capture fast signals
- Outputs for control experiments
- Supplied with both PicoScope (oscilloscope) and PicoLog (data logging) software

For more information on DrDAQ, please visit:

www.picotech.com/drdaq121

PC Oscilloscopes

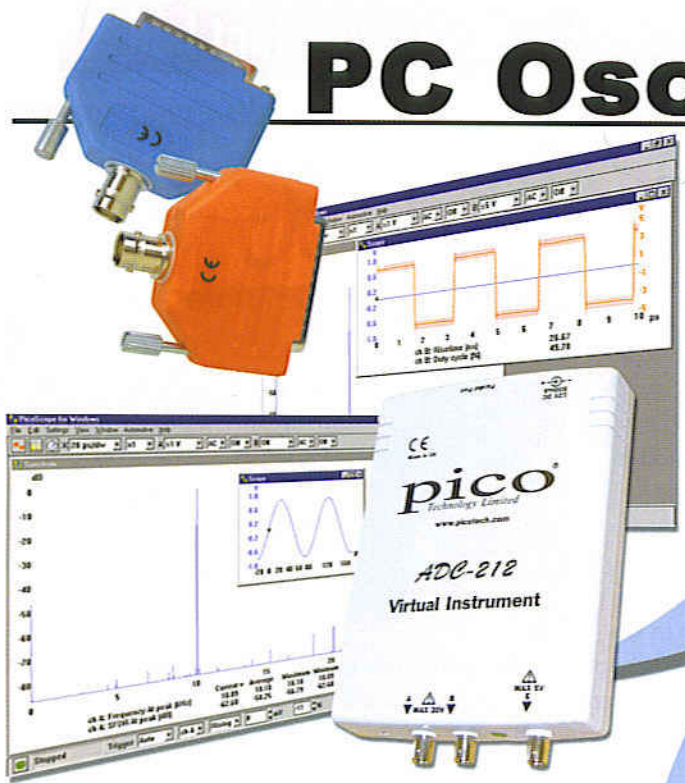

- Scope and spectrum analyser functions
- A fraction of the cost of benchtop scope
- Save multiple setups, for ease of use
- Save, print and e-mail your traces
- FREE technical support for life
- FREE software and upgrades
- Automated measurements

For more information on our scopes, please visit:

www.picotech.com/scope272

Tel: 01480 396395 Fax: 01480 396296 E-mail: sales@picotech.com



**WELCOME
TO YOUR
ENVIRONMENT**

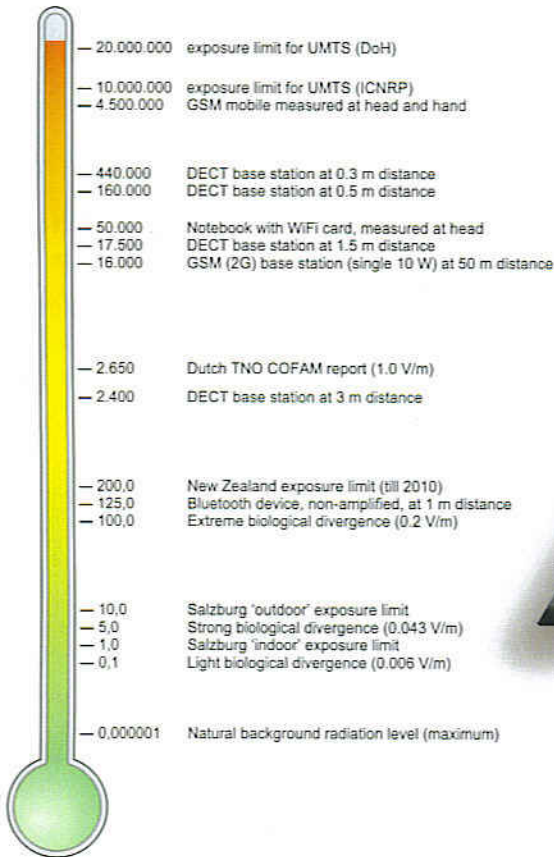

It will be hard to overlook that this month's issue of Elektor Electronics has a focus on electronics and the environment. The environment is omni- as well as ever-present yet surprisingly hard to define. It's largely subjective — deafening noise to some is music to others — while some factors said to affect your personal wellbeing are beyond the immediate detection capacities of human organs. You may feel great after smoking a cigarette but the cumulative and long-term effects of nicotine and ash are worrying to say the least. The same, basically, when you're getting good news through your mobile, or when you're happily WLANning or UMTSing away the odd kilobyte. Blissfully unaware, but just look at the above 'radiation thermometer' to check how the use of wireless gizmos may affect your and other people's environments. Illness comes with age — awareness with information. Page 14.

Jan Buiting, Editor

24 ELEC

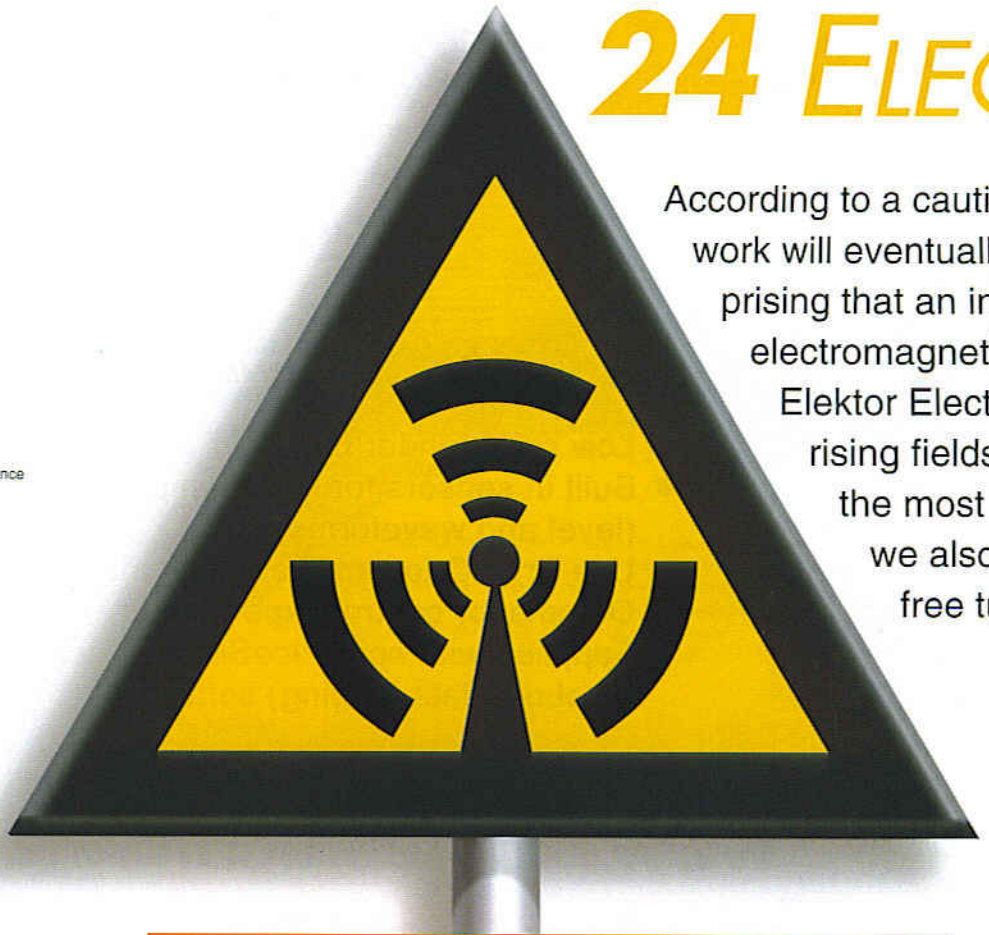

According to a cautious work will eventually surprising that an increasing electromagnetic Elektor Electro rising fieldstre the most ra we also sh free tune

14 Electrosmog: can't be that bad

An article with contributions from scientists, journalists, editors, researchers and other correspondents from various countries, aiming to present a bird's eye view over the confused and worrying situations created by radiation from mobile phone transmitters. The paradox: everybody wants to use his/her mobile phone but not the mast in the street or near the schoolyard. In good Elektor tradition we examine the problem from various disciplines including politics and research, not forgetting some interesting results of a poll-style Survey conducted on our four international websites.

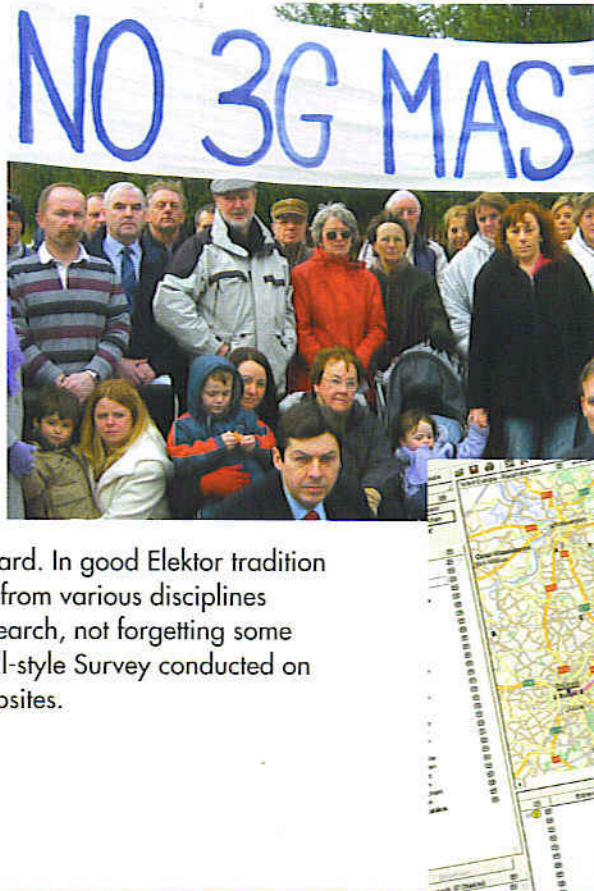

ELECTROSMOG TESTER

estimate, the roll-out of the UK's nationwide 3G network will require some 50,000 masts to be erected. It is not surprising that a number of people worry about the extra dose of electromagnetic radiation produced by 3G base stations. The sensitive Electrosmog Tester not only allows you to provide evidence of electromagnetic fields in your neighbourhood and home, but also to find radiation-free spots up and down the country. On page 33 we show you how to make wideband electrosmog audible — almost everywhere!

42 Solar Power Made simple

Complicated charge controllers and inverter circuits can be used to squeeze the last drop of energy out of a solar panel. Contrary to popular belief, however, it is also possible simply to connect the battery directly to the panel. In the UK, too!



60 GPS Receiver on USB

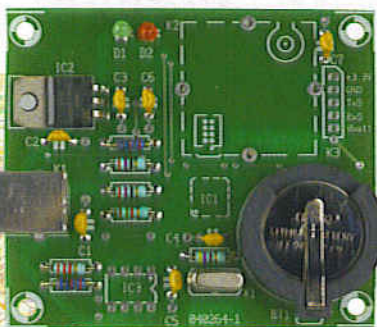

In this article we show that building a GPS receiver yourself is finally possible, and it has been worth the wait. The newest generation of GPS receivers are not only outstandingly small, but also offer considerably better reception performance and lower power consumption than their predecessors. We also offer a complete kit of parts!

know-how

- 14** Electrosmog: can't be that bad
- 20** What is Electrosmog — Survey
- 50** Energy Saving Tips
- 68** Labtalk (3): Lead-Free Electronics

hands-on

- 24** Electrosmog Tester
- 33** Tune In To Electrosmog
- 46** Solar Powered Charger (Mini Project)
- 54** Temperature Logger
- 60** GPS Receiver on USB
- 69** Design Tips resistors a la carte shift registers — a different approach DVM without isolation

technology

- 42** Solar Power Made Simple
- 70** Delphi for Electronic Engineers (6)

info & market

- 6** Colophon
- 8** Mailbox
- 11** Corrections & Updates
- 12** News & New Products
- 82** Elektor SHOP
- 84** Sneak Preview

infotainment

- 36** WiFi Eavesdropping
- 77** Retronics: Elektor Vocoder (1980)
- 78** Quizz'away

Design and Run a Digital Filter in SECONDS!

Signal Wizard 2: Easy-Use Real-Time Digital Filter and Analyser

Signal Wizard 2 is a unique real-time audio-bandwidth digital filter with infinitely adjustable characteristics – available at the click of a button. It uses a DSP unit that runs the filter and a Windows interface for designing and downloading almost any kind of filter. You don't need to know about maths, DSP or filter design – all you need to know is what filter you want. Signal Wizard designs finite impulse response (FIR), infinite impulse response (IIR) and adaptive filters in seconds. You can even import your own impulse or frequency responses. After you've designed the filter, click a button to download and run. Simple! Its flash memory means it can run filters from start-up, without the need for a PC.

Key Features:

- Runs under Windows 98 and XP.
- FIR: Multiple pass, stop or arbitrary; Butterworth, Chebyshev; analogue networks.
- Linear or arbitrary phase; response import mode.
- Rectangular, Bartlett, Hamming, Hanning, Blackman and Kaiser windows.
- Inverse or flipped filters.
- IIR: Butterworth, Chebyshev and arbitrary.
- Adaptive filter for noise cancellation.
- Independent dual channel operation with 24-bit resolution.
- Real-time dual channel scope and spectrum analyzer with data capture.
- Mixing, inversion and delays from 21 microseconds to 1.8 seconds.
- Real-time gain and sample rate control.
- Up to 8 filters in flash, two selectable, one per channel.
- Stand alone operation.
- Twelve sample rates from 48 kHz down to 4 kHz.
- Versatile plot and export of impulse and frequency responses.
- Off-line filter option for wave files.
- Includes board, CD, power supply and all cables.
- Serial interface operating at 115.2 kilo baud (auto-selected).

US \$450
(UK £235 approx)

For more information
Email: info@saellig.com

Full details and ordering information at: www.saellig.com/Suppliers/ezfir/signalwizard2.htm



Volume 31, Number 343, May 2005

ISSN 0268/4519

Elektor Electronics aims at inspiring people to master electronics at any personal level by presenting construction projects and spotting developments in electronics and information technology.

Elektor Electronics is produced and published by Elektor Electronics (Publishing), P.O. Box 190, Tunbridge Wells TN5 7WY, England. Tel.: (+44) (0)1580 200657, fax: (+44) (0)1580 200616. Email: sales@elektor-electronics.co.uk

The magazine is available from newsagents, bookshops and electronics retail outlets, or on subscription.

Elektor Electronics is published 11 times a year with a double issue for July & August.

Under the name Elektor and *Elektuur*, the magazine is also published in French, German and Dutch. Together with franchised editions the magazine is on circulation in more than 50 countries.

International Editor: Mat Heffels (m.heffels@segment.nl)

Editor: Jan Buiting (editor@elektor-electronics.co.uk)

International editorial staff: Harry Baggen, Thijs Beckers, Ernst Krempelsauer, Jens Nickel, Guy Raedersdorf.

Design staff: Karel Walraven (head of design), Ton Giesberts, Paul Goossens, Luc Lemmens (techdept@segment.nl)

Editorial secretariat: Hedwig Hennekens (secretariaat@segment.nl)

Graphic design / DTP: Ton Gulikers, Giel Dols

Managing Director / Publisher: Paul Snakkers

Circulation Control: Margriet Debeij (m.debeij@segment.nl)

Subscriptions

Worldwide Subscription Service Ltd., Unit 4, Gibbs Reed Farm, Pashley Road, Ticehurst TN5 7HE, England. Telephone: (+44) (0)1580 200657, Fax: (+44) (0)1580 200616. Email: wws@www.demon.co.uk
Rates and terms are given on the Subscription Order Form

Head Office

Segment b.v. P.O. Box 75 NL-6190-AB Beek The Netherlands. Telephone: (+31) 46 4389444, Fax: (+31) 46 4370161

Distribution: Seymour, 86 Newman Street, London W1P 3LD, England

UK Advertising

Huson International Media, Cambridge House, Gogmore Lane, Chertsey, Surrey KT16 9AP, England. Telephone: +44 (0)1932 564999, Fax: +44 (0)1932 564998. Email: re:gar@husonmedia.com. Internet: www.husonmedia.com. Advertising rates and terms available on request.

International Advertising

Klaas Caldenhoven, address as Head Office. Email: advertenties@elektuur.nl. Advertising rates and terms available on request.

Copyright Notice

The circuits described in this magazine are for domestic use only. All drawings, photographs, printed circuit board layouts, programmed integrated circuits, disks, CD-ROMs, software carriers and article texts published in our books and magazines (other than third-party advertisements) are copyright Segment b.v. and may not be reproduced or transmitted in any form or by any means, including photocopying, scanning or recording, in whole or in part without prior written permission from the Publishers. Such written permission must also be obtained before any part of this publication is stored in a retrieval system of any nature. Patent protection may exist in respect of circuits, devices, components etc. described in this magazine. The Publisher does not accept responsibility for failing to identify such patent(s) or other protection. The submission of designs or articles implies permission to the Publishers to alter the text and design, and to use the contents in other Segment publications and activities. The Publishers cannot guarantee to return any material submitted to them.

© Segment b.v. 2005

Printed in the Netherlands

FREE

Layout Software

EASY To Use!
Very **LOW** Cost!
Extremely **FAST**
Turnaround!

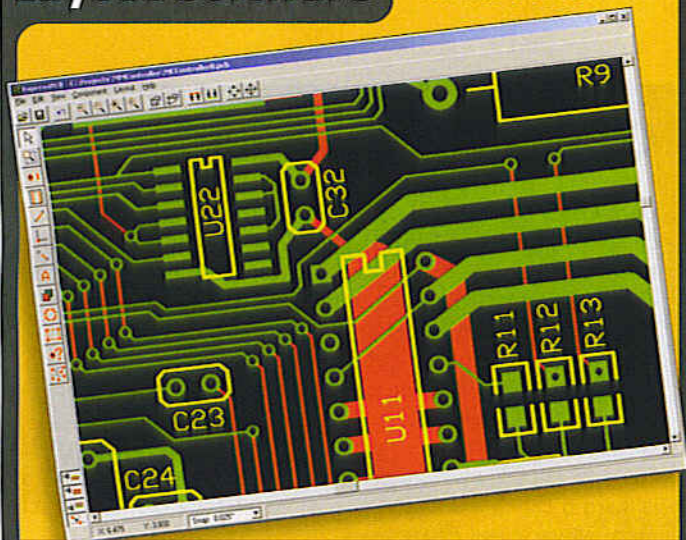

- 01 **DOWNLOAD** our free CAD software
- 02 **DESIGN** your two or four layer PC boards
- 03 **SEND** us your design with just a click
- 04 **RECEIVE** top quality boards in just days

expresspcb.com

Total Telematics

Control The World

Automation
PIC Technology
Standard Modules
Custom Design & Build



Ethernet uController

PIC18F452 CPU, 24LC256 EEPROM and demo Web Server.
32KBytes FLASH, 1536 Bytes SRAM and 32Kbytes EEPROM.
Web Server uses about half the available EEPROM memory,
heaps of space left for custom web pages!
Server based on the excellent Microchip TCP Stack.
13 user programmable I/O pins, 5 can be Analog Inputs.
LED's indicate Power, Collision/Link, Rx/Carrier, Tx.
RS232 interface via 3 pin connector or Front End connector.
Cable Included for connection to PC or DTE Device.
Has an ICSP (In Circuit Serial Programming) connector.
Full Technical and Programming Documentation.

Pay us a visit
Loads of uController and Automation kit
www.total-telematics.com

A QUANTUM LEAP IN EMBEDDED CONTROLLERS

Quick FIRE

SUPERCONTROLLERS

Our range provides:-

- The fastest 68000 based Core up to 66 Mhz.
- Extensive I/O:- Serial, IrDA, SPI, I²C, Analogue, Timers/Counters, RTC, etc.
- Large Memory Capacity:- Flash, SRAM, DRAM.
- Supports:- Mono & Colour LCD's, Touch Panels & Keypads, Very Low Power.

ALSO LOW COST

DEVELOPMENT

- Target easily & quickly.
- Full ANSI 'C' compiler, assembler & linker all Windows32 based.
- Source Level Debug.
- Full Driver Support with Libraries.
- Real Time Multitasking OS with a free run time licence.
- FREE Unlimited email support.

www.cms.uk.com

see our web site for full details

CAMBRIDGE MICROPROCESSOR SYSTEMS LTD



Unit 17-18 Zone 'D' Chelmsford Rd. Ind. Est
Great Dunmow, Essex CM6 1XG
Telephone: **01371 875644**
email: sales@cms.uk.com

VOX AC-30 query (2)

Dear Editor — in response to Greg's query in *Mailbox*, April 2005, The AC30 had many variants, most of which did not catch on — there was an AC50 and I believe an AC100 that both used EL34s (this may have caused the confusion Greg wrote about, *Ed.*). The younger engineers might be interested to know that valve radios etc were marked AC, DC or AC/DC because the UK mains voltage could be AC or DC and even at different voltages. However as this changed in my childhood I really can't remember the voltages used. The AC30 is an iconic design that remains popular to this day, it would make an interesting article, putting it through its paces with modern test equipment and an explanation of what that tremolo/vibrato circuit is about! I have never found an AC30 with the trem/vib working.

Good articles could be written about many other iconic designs, like the Fender Stratocaster. For example, why are the pickups on the old ones so revered? It's rumoured they were wound with second rate copper with the best copper going to the war effort in Korea? The Quad II HiFi amplifier would make an interesting article as well, other readers might have suggestions for iconic designs?

André James Howard (UK)

Thanks for that André James. An article on upgrading the VOX AC30 appeared in the April 1989 issue of Elektor Electronics.

Hex format(s)

Dear Jan — there seems to be a problem with the hex file

for the SC Analyser 2005 published in the April 2005 issue of your magazine. The programs I use to load the hex file to the PIC16F876 (Proteus VSM simulator, Picallw, Winpic) all report invalid addresses in the hex file. Can you verify this please.

Le Var Cabey (UK)



This question is asked at least a few times every month. Please have a look at the hex file using any text editor like Notepad or Word. Each line starts with: 10 (meaning 10H data bytes in this line) and the next 4 positions are the starting addresses for the data. As you can see, the addresses range from 0000 to 3535H. Also, address 4000 holds the 'options' information (i.e., what kind of oscillator etc) for the PIC processor.

If your programming software does not accept this format, please feel free to edit the file with any hex editor. You can easily find a freeware hex editor on the Internet (for example, trial versions of HexWorkshop and UltraEdit). Remove any data above 3800H.

As an aside, the PIC16F876A devices have a 13-bit program counter capable of addressing an 8 kword x 14-bit program memory space. The catch however is that each location is not 14-bit wide instead of 8-bit. Expressed in bytes, this means a maximum address of 3800H. The maximum address of 3535 in our hex file is well within this range. If you find this complicated (we do, but memory space is optimally used this way), feel free to blame Microchip.

Cuk Converter criticisms

Dear Editor — I was interested to read your article about Cuk converters (*Elektor* 1/2005, page 22), as I made a careful study of these myself, some years ago. I felt that your article did not really explain the merits of the Cuk converter: why it was such a ground-breaking topology, and why it has not been commercially successful.

The article by Georg Gerads concentrated only on the voltage and current waveforms but, since these are similar to those for existing topologies, they do not reveal anything particularly interesting. One could be left wondering exactly why is there a claimed advantage over existing topologies, which are now very well developed?

One point you did not mention is that controller ICs specifically designed for Cuk converters are available; and that the Cuk topology is closely related to the SEPIC (single-ended primary inductance converter) topology that has emerged in recent years.

But, in particular, you did not fully explain why the two inductors in a Cuk converter are coupled. In fact, they do not need to be: the basic Cuk converter uses two uncoupled inductors and the topology is that of an inverting converter but with continuous input and output currents. We can note that a buck converter has a discontinuous input current and a continuous output current; for the boost converter it is the other way around, whilst a conventional inverting converter has discontinuous input and output currents. So the Cuk converter allows us to make a power supply with the inherently better ripple performance that is obtained by operating with continuous currents at both the input and the output. But that is just a first step in understanding what the topology offers.

Because the two inductors have the same current waveform they can be wound on the same former without 'interfering' with each other, which gives a possible saving in space. This, in itself, is not particularly significant, but what the inventor showed was that if the turns ratio of the resulting transformer bears a certain relationship to the coupling co-efficient between the windings, then it is possible to steer all the ripple current to one side of the converter. In other words, the input or the output ripple current can be zero! In this situation the converter does not need a smoothing capacitor on the zero-ripple side (or, at least, only a very small one!).

Unfortunately, your project cannot demonstrate this important aspect of the converter. If the two inductors have a turns ratio of 1:1 then the coupling requirement for zero ripple is $k=1$, i.e. perfect coupling. Of course, this cannot be achieved in practice, and it does not work in theory either, so the ripple-current performance of such a converter is unpredictable.

The fact that the converter needs a special magnetic circuit in order to achieve zero ripple is a drawback. However, in some situations, the behaviour can be suitably modified by using an additional series choke. Another simple way of achieving the desired behaviour is to use a magnetic circuit based around two stacked toroids. One winding is wound around both cores, the other around just one core. With a

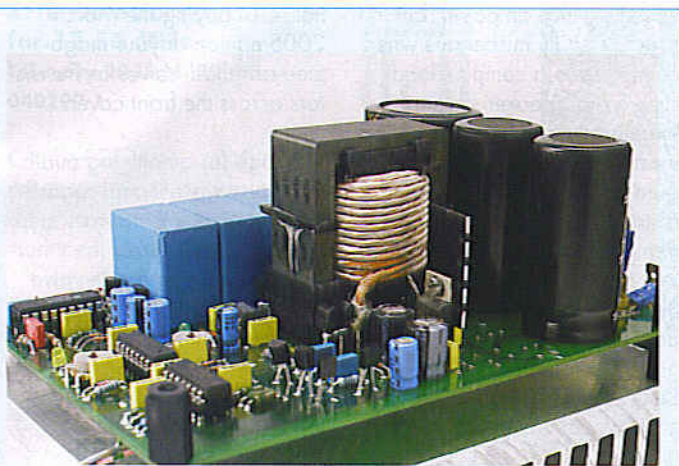

suitable turns ratio, the desired relationship between coupling and turns can be achieved. The need for specialised magnetic designs has led to the concept of 'integrated magnetics' which Cuk has been promoting.

Another disadvantage is that the design requires a very high-quality capacitor for the storage element. But neither of these disadvantages can explain why the converter has not been commercially successful because, in a commercial marketplace, components would have evolved to meet the requirements. (Much in the same way that very low ESR capacitors have evolved to cope with conventional topologies).

There are several advantages to the Cuk converter, which all relate to transfer functions of, for example, line to output voltage, duty cycle to output voltage and so on. The converter is claimed to be more stable than other topologies and easier to control. Part of the reason for this is that it works with continuous currents, as your project article does mention.

At one time, I was an enthusiastic supporter of this topology. It is certainly very impressive to run a PSpice simulation and see the ripple current disappear from one port without the need for a smoothing capacitor. But in practice, it appears to be difficult to make a Cuk converter live up to its promise - especially when it is competing against the very highly evolved designs that we can buy off-the-shelf from semiconductor manufacturers such as Maxim and National.

Much of the reason for the lack of commercial success of the Cuk topology can perhaps be explained because the design was so well patented. It was in a niche market where there were no 'evolutionary forces' to develop it further.

For other than a very specialised application, I can see no reason why the Cuk converter needs to be considered at all, especially when an incomplete understanding of its rather peculiar behaviour can lead to a design that does not truly take advantage of its characteristics. On the other hand, it is a fascinating topic for home experimenters.

David Gibson (UK)

We are very grateful to Mr. Gibson for his critical observations, which have been copied to the author/designer for his consideration. Meanwhile the Cuk Converter has turned out to be very popular project. The discussion may be continued on our Forum.

EL156 Audio Power Amplifier

Dear Elektor — I believe an error could cause output valves to draw very excessive anode current. Destructive failure could even occur a long time after amplifier has been put into service.

In Figure 1, decoupling capacitor C8 in the amplifier schematic is shown with the positive end connected to negative-biased grids of output valves (cathodes and negative end of capacitor essentially grounded). If the electrolytic fails due to reverse connection, this could present low resistance to ground that causes lower negative bias on the control grids.

Also, C7 is the wrong way around (valve cathode will be positive on an auto-bias arrangement); not very dangerous but possibly upsetting the operating conditions causing very loud and distorted output. C3 has no voltage rating. This device needs to be rated at least as high as C9 by the same criteria as C9 (see later). Adequate consideration of the effects of HT being supplied to components connected to cold valves and of powering with some valves unplugged does not appear to have been made. (Do you unreservedly trust switch-on delay circuits? I don't). For example, if C6 needs to be rated at 500 V (questionable in view of the zener diodes) then so do C5, C3, C9, C10 & possibly others. Also readers unfamiliar with the high voltages may not be aware of the power dissipations involved, for example R10 dissipates 1.25 W in normal operation.

Can I suggest (with the best of intentions since I enjoy your magazine!) that you get an 'old hand' with practical valve experience to examine the 'tube/valve' designs before



publishing? Someone who's never handled more than a few tens of volts might pick up the article in years to come and get a loud bang & smelly smoke for their trouble! PS, love the magazine, & let's have lots more Hi-tech Audio. What about some valve/transistor hybrids (best of both worlds if done properly).

Peter Hague (UK)

Mr. Hague's critical comments have been copied to the author/designer and we await his answers.

Valves versus transistors (1)

Dear Editor — I found the article 'Opinion on Valves, Valves versus Transistors' (page 25 of the March 2005 issue) very interesting. Surely, that topic is the source of never-ending debates and discussions. I found the technical aspect of the discussion a bit simplistic, however, as Mr. Ton Giesberts sounded like he was comparing the very best transistor amplifier with mediocre valve amplifiers: "that's not actually the fault of the valves, but instead comes from the fact that most valve amplifiers are poorly designed" (change both 'valve' words to 'transistor' in that sentence and it will remain true!). He claims that transistor amplifiers "add almost nothing to the sound" ('almost nothing' is 'something', nevertheless), but in my opinion what they add plays a more important

role in the final quality of the perceived sound reproduction. Also, there are features in an amplifier that are more important than the damping factor. Having designed, built, and more importantly, listened to both valve and transistor amplifiers, I just can't agree with Giesberts' general opinion about valve amplifiers: if they were 'simply not good', people wouldn't be listening to them! Yes, they colour the sound, and so do the transistors. There is no such thing as a 'neutral' amplifier, at least I haven't yet found two different amplifiers that sound exactly the same. Every amplifier distorts, and the harmonic distribution of the distortion components plays a major role in the final sound quality.

Take, for example, the spectrum analysis of the distortion graph of the EL156 Valve Amplifier (page 35, figure D), and compare it with the corresponding plot of the transistorized High-End Power Amplifier (page 17, figure C). Note the distribution of the different harmonic components: the EL156 valve amplifier distortion is dominated by the second harmonic, and the amplitudes of the remaining even harmonics gradually decrease, until the 8th and higher virtually disappear. Something similar happens with the odd-numbered harmonics: their amplitudes gradually decrease from 3rd to 9th, which is the last one discernible on the plot. Now look at the harmonic signature of the High-End Amplifier: again, the distortion is dominated by the second harmonic, with the 4th barely visible, the 6th and higher practically missing. But look at what happens with odd harmonics: the amplitude of the 5th is actually higher than the third (!), the 7th harmonic has the same amplitude as the 3rd; the 9th is fortunately smaller,

the 11th and higher disappear. Clearly, the distortion products of this amplifier are dominated by odd, high-order harmonics. And it is well known that odd harmonics tend to produce a rather unpleasant, strident, sound; the higher-order ones are believed to be responsible for the 'listener's fatigue' effect. Such harmonic signature is typical of transistor amplifiers, they create that characteristic 'tin-can' sound. A similar phenomenon can be seen in the distribution of the hum components: as one would expect, the valve amplifier produces more hum, and it can be seen that the amplitude of the hum harmonic components also gradually decrease, especially for the even-order components. In the other hand, the transistor amplifier shows 2nd and 3rd-order hum harmonics with low amplitude, but again higher-order ones experience a relative boost. (Incidentally, where does that 80 Hz component come from? The valve amplifier plot does not show it).

My final guess is that the EL156 Valve Amplifier will produce the best, more pleasant and enjoyable sound of the two, despite the higher overall THD figures. But that's only a guess, I actually prefer to listen to an amplifier before making any definitive conclusions. The distortion graphs shown for both amplifiers are taken for a modest output of only one watt. It would be nice to compare distortion components near, or at, clipping levels (clipping can happen when listening to low volume levels, often during the note attack phase). It would be also interesting to see the distortion and frequency response plots for both amplifiers when connected to a realistic (reactive, and not purely resistive) load. I have been very often disappointed by amplifiers whose characteristics look

extremely nice on paper, but in practice badly misbehave when connected to a complex load such a real speaker system. In general, I think it would nice if designers of audio amplifiers paid as much attention to the distribution of distortion harmonic components as they do to lowering the THD levels. Blindly lowering THD figures does not necessarily result in a good sounding amplifier. Below are a few links with information about distortion and amplifier sound that I found interesting and would like to share, if possible, with other readers. Although they are valve-minded, some concepts could be of interest to transistor amplifier designers as well:

<http://normankoren.com/Audio/FeedbackFidelity.html>
Feedback and Fidelity, by Norman Koren
<http://www.nutshellhifi.com/library/FindingCG.html>
The Sound of the Machine. The Hidden Harmonics behind THD, by Lynn Olson.

There is a very interesting section on power supply-generated noise ('Power Supply and Noise Spectra'). Other articles of the same author that I found interesting, although again valve-minded, are *Illusion Engines and Design Philosophy*, available from the same web site by following the corresponding links.

Hector Peraza (Belgium).

We are grateful to Mr. Peraza for expressing his viewpoints. Transistor advocates are invited to reply! The discussion may be continued in our on-line Forum.

Valves versus transistors (2)

dear Editor — as I am an audio nut into valves, I could

not resist buying the March 2005 edition of your magazine as it had *Valves or Transistors* across the front cover.

Although for amplifying audio analogue waveforms I regard transistors as a temporary step backwards (as surely the inherently more linear triode valve must reign supreme in the future), I studied the circuit of the High End Solid State Power Amp. I might be suffering from cathode poisoning but as drawn, wouldn't the negative feedback loop be in phase with the input? Shouldn't the base of T8 be connected to T1 pin 6, T7 base to T1 pin2 and the same changes to T9 and T10.

I enjoyed reading the valve versus transistor article although I can't say I agreed with all the opinions expressed.
Jerry (UK)

Eloquently written Jerry but our audio designer Ton Giesberts replies that there are no errors in the design. The High End Power Amp has been built by a good number of readers with excellent results.

MailBox Terms

- Publication of reader's correspondence is at the discretion of the Editor.
- Viewpoints expressed by correspondents are not necessarily those of the Editor or Publisher.
- Correspondence may be translated or edited for length, clarity and style.
- When replying to Mailbox correspondence, please quote Issue number.
- Please send your MailBox correspondence to: editor@elektor-electronics.co.uk or Elektor Electronics, The Editor, P.O. Box 190, Tunbridge Wells TN5 7WY, England.

RFID Detector for 13.56 MHz

February 2005, p. 38-42, 040299-1.

On the PCB copper track layout, all three pins of preset P1 are connected to ground instead of just two.

The problem is easy to solve: the copper pad of P1 connected to pin 7 of IC1 (at the edge of the board, near the 'Elektor' print) has to be disconnected from the ground plane by cutting the three thin tracks between the pad and the ground plane.

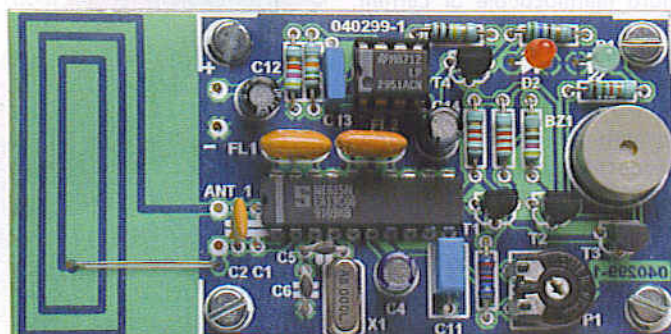
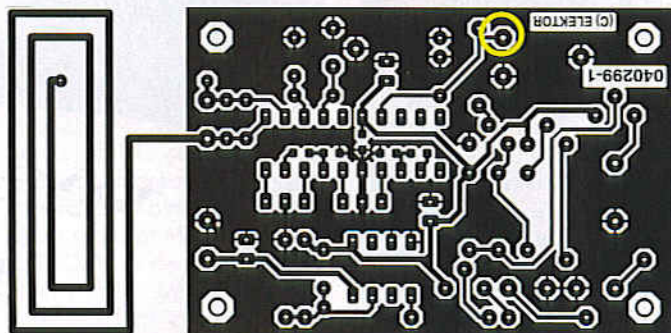

4 of IC4 from the rest of the circuit by cutting all copper tracks to these pins. On the IC socket, bend out pins 4 and 11 sideways and solder a short wire to each pin. Solder the IC socket in place (at the underside of the board). Connect the wire on socket pin 4 to the positive supply voltage. Connect the wire on socket pin 11 to the negative supply voltage. Populate the rest of the board as indicated by the component mounting plan.

Please note that sockets IC2, IC3, IC4 and LEDs D1 through D16 have to be fitted at the solder side (underside) of the board. This allows the board to be better mounted in a case.

SC Analyser

April 2005, p. 34-41, 030451-1.

Unfortunately, an early version of the PCB artwork is shown in Figure 5. Although it will produce a properly working instrument, the PCB design shown lacks the extra decoupling for the PLED display mentioned in the article. The PCB supplied through our Readers Services does have space and copper tracks for the extra decoupling network and comes with a corresponding note to customers. The correct PCB artwork is shown here.

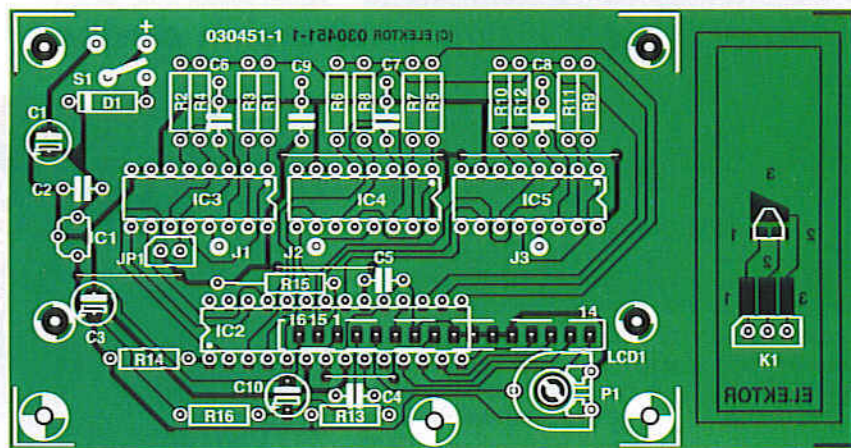

Opamp tester

March 2005, p. 74-75, 030386-1.

Unfortunately the printed circuit board for the above project contains a mistake concerning the supply voltage to the opamp in position IC4. However, the problem is easy to solve.

Using a sharp hobby knife, completely isolate pins 11 and

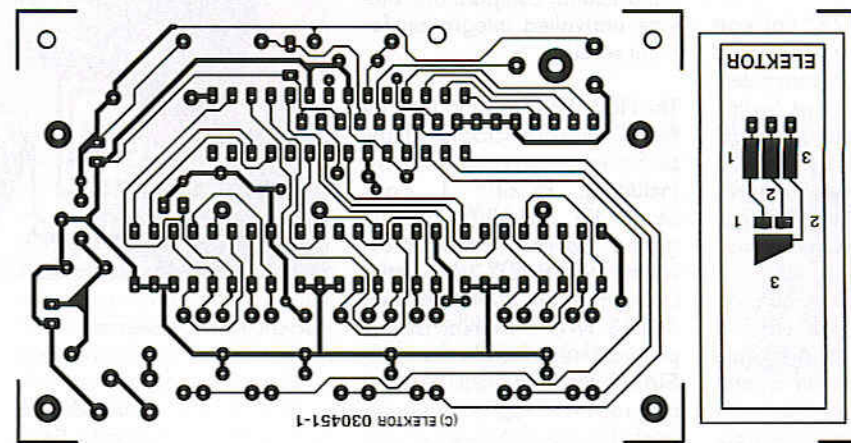

USB 11-channel data logger

Pico Technology announces the latest addition to their data acquisition range, the USB ADC-11 Data Logger. The new product has USB connectivity to allow fast sampling rates and additional digital outputs for use as control or alarm outputs. Available in two variants, the USB ADC-11/10 (10 bit) and USB ADC-11/12 (12 bit) are both compatible with the multi-purpose terminal block, providing a substantial enhancement to its flexibility.

The USB ADC-11 provides a cost effective solution for measuring and recording voltage signals onto any Windows based PC or laptop. When used with PicoLog® data logging software, which is able to record up to 1 million readings; the data can be viewed in real-time or stored on hard disk for later analysis. The popular PicoScope® can also be used with both models. Both variants of the USB ADC-11 are capable of measuring up to 11 channels of voltage at up to

20,000 samples per second. Resolution and accuracy depend upon the model used; the USB ADC-11/10 provides 1024 discrete voltage levels giving 1% accuracy, whilst the USB ADC-11/12 offers considerably higher accuracy with 4096 voltage levels and 0.5% accuracy. Using the optional terminal block significantly expands the functionality of the USB ADC-11. An area of PCB is reserved for the design and implementation of custom sensor circuits such as high precision thermister, standard thermocouple or current and light measurement.

Both USB ADC-11 models are available immediately directly from Pico Technology or any authorised Pico distributor. The product can be purchased with the optional terminal block with prices starting from £ 95. Further information can be accessed through the Pico Technology website www.picotech.com or by calling +44 (0)1480 396395.

(057053-4)

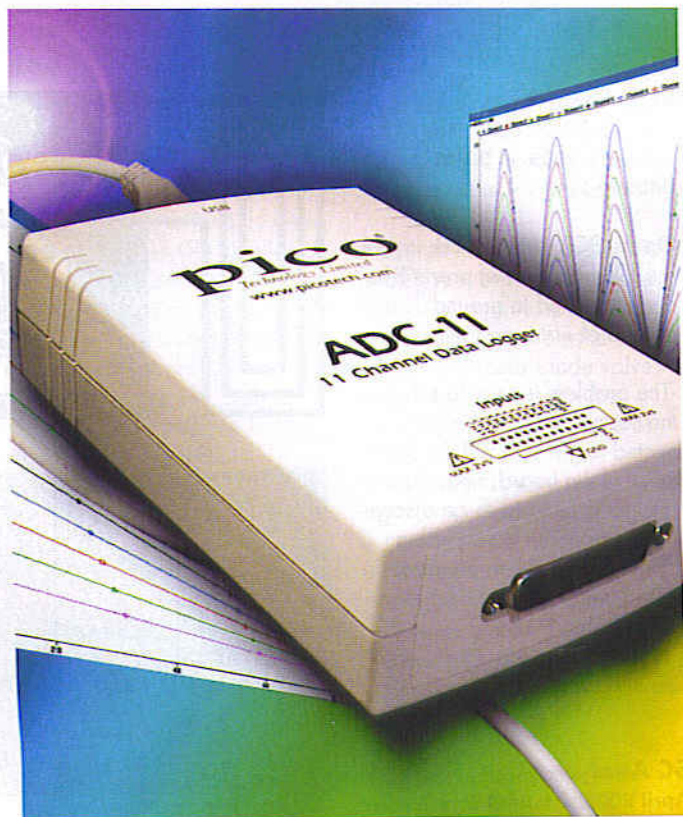

PIC Micro for intelligent power conversion designs

Microchip recently announced the PIC16F785, which provides large complement of onboard analogue peripherals, including analogue-to-digital converters (A/Ds), comparators, a voltage reference and two operational amplifiers (op amps). These make it ideal for cost-effective digital control in power conversion designs, as well as a broad range of sensing and closed-loop control applications.

The 20-pin PIC16F785 can cost effectively address a wide range of power-conversion parameters in applications such as Switch Mode Power Supplies (SMPSUs) and battery chargers. Today's electronic systems require intelligent control of multiple power rails, startup conditions, fault detection, exception handling, and complex battery-charging algorithms, and the PIC16F785 provides the familiar analogue building blocks within a programmable microcontroller, making it easy for power-supply

designers to utilize digital control in their power-conversion applications.

The two general-purpose op amps feature a 3-MHz Gain Bandwidth Product (GBWP) and 5 mV input offset voltage, ideal to implement filters, input gains stages and other functions. These two op amps, with the integrated 1.2 V bandgap voltage-reference and two high-speed (40 nanosecond) comparators, provide unrivalled integration for input sensing.

The PIC16F785 is supported by the full suite of Microchip's high-performance development tools, including: PICKIT™ 1 Flash Starter Kit, MPLAB® IDE (Integrated Development Environment), MPLAB ICD 2 (In-Circuit Debugger), PRO MATE® II and MPLAB PM3 universal device programmers, and the PIC-START® Plus cost-effective device programmer. Application notes related to power conversion are



currently being prepared.

(057053-3)

Microchip Ltd.,
Microchip House,

505 Eksdale Road,
Wokingham RG41 5TU.
Tel. (+44) (0)118 921 5869.
Fax (+44) (0)118 921 5820.
www.microchip.com.

High(er) density sEEPROM in 2x3mm package

Microchip is introducing 2x3 millimetre DFN (dual flat no leads) package options across its product line of I²C extremely small footprint and low profile for space-constrained applications such as portable devices and laptop computers. Its new 64-Kbit I²C and 16-kbit Microwire serial EEPROMs in the tiny DFN package offer the highest-density serial EEPROMs in the smallest standard package available today.

With a PCB footprint of just 6 square millimetres, the new DFN package is 80% smaller than an 8-lead SOIC package; 59% smaller than an 8-lead MSOP package; and 27% smaller than

a 5-lead SOT-23 package. In addition, for applications requiring a very low profile, the DFN package is only 0.9 millimetres tall — between 20 and 40% lower than other standard packages. The new DFN package is available for Microchip's 24xx series of I²C serial EEPROM products in densities from 128 bits to 64 Kbits, and for the 93xx series of Microwire serial EEPROMs in densities ranging from 1 kbit to 16 kbits. The 2x3 millimetre DFN package is lead (Pb)-free, and compatible with both higher temperature lead-free reflow processes, and existing tin/lead (Sn/Pb) processes.

(057053-5)



Microchip Ltd., Microchip House,
505 Eksdale Road,
Wokingham RG41 5TU.

Tel. (+44) (0)118 921 5869.
Fax (+44) (0)118 921 5820.
www.microchip.com.

µPFC™ IC for 75W to 4kW power correction

International Rectifier have started to supply the IR1150 family of µPFC™ for AC-DC power factor correction (PFC) circuits. The compact SO-8-packaged device cuts PFC control board space in half, and enables a simplified and flexible high density solution for computing, consumer electronics and home appliances from 75 W to 4 kW. IR's new One Cycle Control (OCC) approach in the IR1150 delivers the performance of continuous conduction mode (CCM) PFC with the simplicity, reliability and low component count of a discontinuous current mode (DCM) circuit for PFC applications. Power factor (PF) is the relationship between AC voltage and current waveforms and is a measure of "power quality" that

affects the efficiency of electrical transmission networks. With unity PF as the ultimate goal, the IR1150 enables 0.999 PF with only 4% total harmonic distortion, enabling AC-DC applications to conform to international legislative requirements.

The IR1150 is an elegant solution to PFC legislation such as IEC 1000-3-2 in Europe, JIC C 61000-3-2 in Japan and the China Compulsory Certificate (CCC) for products using more than 75 W. As manufacturers implement PFC in response to these energy standards, the IR1150 control IC simplifies effective PFC solutions, and enables a single design that can be used worldwide.

(057053-7)



International Rectifier,
European Regional Centre,
439/445 Godstone Road,

Whyteleafe, Surrey CR3 0BL
Tel. +44 (0)20 8645 8003.
www.irf.com

Four digits for any application

The new OEM 4-LED is an extremely compact, 4-digit, LED data display module from Lascar Electronics. Communication with the display is via a serial interface making this product ideally suited to micro-controller based applications. Each of the 7-segment digits (8 mm height) and three decimal places can be addressed individually and use low power red LEDs to produce a display that

whilst highly visible has a typical current consumption of just 20 mA at 5 V. Connection to the display is via a 12-pin DIL with industry standard 2.54 mm (0.1") pitch.

This cost effective display option is an excellent choice for applications where space and power consumption are considerations. Already proven in high volume applications, the OEM 4-LED is available now with prices start-

ing at £10.90 (£6.40 at quantities of 250+ pcs).

(057053-1)

Lascar Electronics Limited,
Module House, Whiteparish, Salisbury,
Wiltshire SP5 2SJ.
Tel. (+44) (0)1794 884567,
Fax (+44) (0)1794 884616.
www.lascarelectronics.com



Electrosmog:

A study conducted last year by physicians in the German city of Naila caused a lot of commotion. They sifted through their card files and compared a group of patients living near a mobile telephone network base station with another group. The results were not so good: there were approximately twice as many cases of cancer among the group located close to the transmitting tower.

The 'Reflex' study commissioned by the European Union [1]), which costed more than 3 million euros also caused a great stir. It was concluded that high-frequency electromagnetic radiation at UMTS and GSM frequencies causes an increased number of breaks in DNA strands: involuntary gene modification; modified genetic characteristics.

In more concrete terms: it was noticed that the herd produced less milk and lost weight after a GSM tower was placed in the vicinity of their pasture. The number of miscarriages and still-born calves also increased. Moving the herd to a different pasture outside the range of the new GSM tower improved milk production, and the other complaints also decreased significantly. To put things to the test, the herd was again moved back to the first pasture, and sure enough: milk production stalled again and medical complaints also increased. [2].

Can't be that serious?

Mr. J. Houtenbos of www.straling.nl finds these wild stories a bit exaggerated. Although in his opinion the hazard cannot be considered to be totally

References

- 1 www.starweave.com/reflex/
- 2 Repacholi MH, Basten A, Bebski V, Finnie J, Harris AW. Lymphomas in E mu-Pim1 transgenic mice exposed to pulsed 900 MHz electromagnetic fields. *Radiat Res* 1997; 147:631-40
- 3 *Journal of the Physical Society of Japan*, Vol. 7, p. 432
- 4 Hyland, G., *The Lancet*, November 25, 2000; 356:1833-40.
- 5 www.rivm.nl/bibliotheek/digitaaldepot/Zwamborn2003COFA/Mrapport.pdf

Mobile telecom operators are rolling out the systems they hope will recover the billions invested in 3G licences for the new UMTS services. The blessings: watching TV on your mobile, videophones, surfing, 70,000 extra masts, worrying electromagnetic radiation...

insignificant, since there's a lot to be said against holding a mobile telephone with its 2-watt transmitter right next to your head, he points out that the radiation from the antenna towers generally remains within the limits and well below the maximum levels specified by the standards, with a few exceptions. For instance, if a large number of calls are made from a single location, additional power is necessary so everyone can phone at the same time. The Japanese physicist Tsuyoshi Hondou, a member of the staff of Tohoku University in Sendai, carried out a study of the use of mobile telephones and field strength in trains. He found that the standard was already exceeded if 30 people made calls at the same time and their telephones transmitted with an average power of 0.4 W. That was naturally related to reflections of the signals and the small, enclosed space, which acted as a Faraday cage. Just imagine the radiation level in a full train in Japan with everyone phoning at the same time. If in addition they all have 'poor reception', the radiation level will be even higher, since each transmitter can, is allowed to, and will increase its power up to 2 W. [3]. That puts things in a different perspective.

What's up?

Mobile telephones use the same type of radiation (microwaves) as microwave ovens. Microwaves can thus be used to heat things. And if microwaves in a microwave oven can heat material, the microwaves from a mobile telephone can do the same thing. Naturally, the amount of heating is less, due to the lower output power (2 watts for a mobile telephone versus 750 watts for a microwave oven), but still occurs. There's no problem with a

single mobile phone, but what about when several mobile phones are being used at the same time? And what about the other equipment in your everyday environment: cordless (DECT) telephones, WLAN, Bluetooth, microwave ovens, wireless (security) cameras, radar, point-to-point transmission systems used by telecommunications companies, communications satellites, the taxi dispatch office around the corner, the walky-talkies used by the police, fire department and ambulance personnel, the radio-controlled model car belonging to the boy next door, and now UMTS (which stands for 'Universal Mobile Telecommunications System')?

A nice word has been invented for all of this: *electrosmog* (where 'smog' is borrowed from the word for a more visible and odorous form of air pollution, which was originally formed from the combination of 'smoke' and 'fog'). In terms of physics, it's all relatively simple. Transmitters (including mobile phones) generate electromagnetic fields. In human tissue, a portion of the received energy is absorbed and converted into heat. This is referred to as 'thermal effects'. These effects have been thoroughly investigated, and the processes are well understood. The statutory regulations specify that for health reasons, body tissue is not

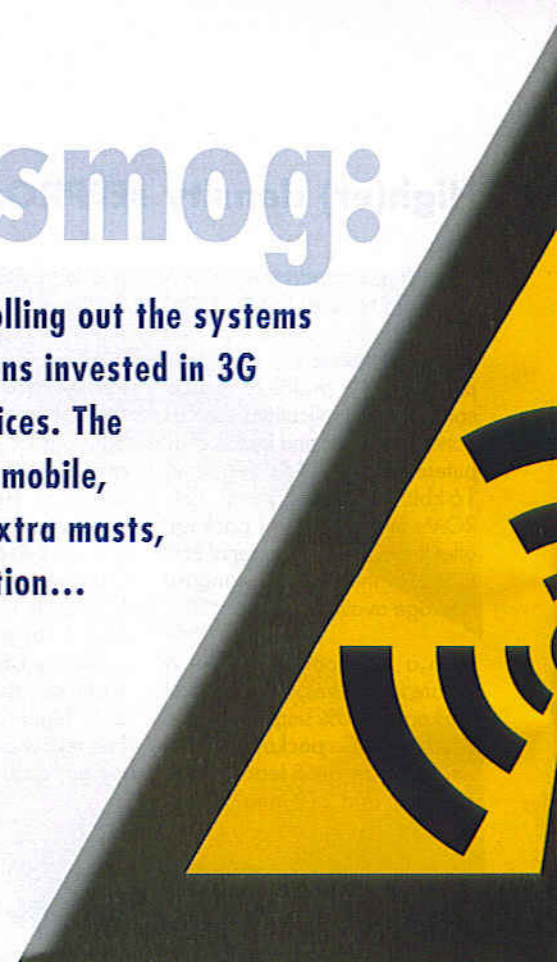

can't be that bad



allowed to be heated up more than one degree Celsius by radiation (see the 'Power density and SAR' inset). Anything more than this is prohibited.

Under control!

To be sure of entirely eliminating health hazards due to thermal effects, specific field strength thresholds apply to stationary transmitters with a power of more than 10 watts in areas where people stay for prolonged lengths of time. For transmitters with

frequencies above 2 GHz, such as UMTS base stations, the threshold value is 61 V/m, which corresponds to a power density of approximately 10 W/m². If a network operator wishes to erect an installation with a power of 10 W or more, an additional permit is required. Based on the antenna radiation characteristics and the structural situation, the responsible (government) authority determines a safe distance beyond which the threshold value is in no event allowed to be exceeded. As this authority only operates on a random-sample basis and is not aware of all sources of radiation, a safety factor is also applied according to the number of antennas already present and several other parameters. In addition, inspection departments make measurements over the entire RF spectrum in sensitive locations, such as schoolyards.

Studies and research

To provide objective information about emissions in the immediate vicinities of transmitters for mobile telephone systems, extensive studies have been carried out by various levels of government during recent years, as well as studies commissioned by network operators. For instance, in North Rhine-Westphalia the renowned 'Institut für Mobil- und Satellitenfunktechnik' (IMST GmbH) made measure-

ments in ten German cities, and the measured values inside and in the vicinity of buildings proved to be well below the threshold values, even close to the antennas. With a few exceptions, the measured power density was less than 1% of the permissible power density. Nevertheless, the experts also obtained some surprising results. For instance, the power density by no means decreased gradually up to around 100 metres; in that region the difference in the heights of the transmitter and the measurement point had a much larger influence. "Just like a lighthouse, the antennas radiate most of their power in the primary direction, but there are also several side lobes", explained IMST employee Christian Bornkessel, who coordinated the measurements. These side lobes are what negate the prevailing doctrine that the region directly below the antenna should be practically free of radiation. "To our surprise, you can't automatically assume that there's practically nothing to measure under the roof of a building with a transmitting antenna for mobile telephones", said Bornkessel. That depends a lot more on the structural situation.' Nevertheless, even in the worst case the values proved to be well below the threshold value. According to Bornkessel, there are thus no grounds for 'horror stories'. On the other hand, opponents contend

Base station locations

Probably as a result of political pressure and concern expressed by several organisations, Ofcom, the Office for Communication (formerly the DTI's Radio Agency) are supplying a mobile phone base station locator that's accessible by the Internet. Until recently, this information was either classified or only obtainable by cutting through a lot of red tape. The Sitefinder webpages also have an Information Sheet that's quite useful although neutral in terms of radiation hazards presented by the 70-k or so base stations eventually active up and down the country. The Sitefinder database is updated at a remarkably slow rate of once every three months. Compare that with the time it takes a crew of experienced suite building vertigo-free engineers to erect a mast and commission the equipment and you should not be surprised to



Antennas are not only hidden on the Internet!

suddenly see masts not yet identified by Sitefinder.

Sitefinder provides the following information on each base station: type of transmission, antenna height, frequency range, transmitter power and maximum licensed power. In Germany, a similar government's office goes at least one better than Ofcom by also showing measured (!) energy levels and associated safe distances.

Ofcom Sitefinder at:
www.sitefinder.radio.gov.uk/

German equivalent:
www.emf-forschungsprogramm.de/home

Dutch equivalent:
www.antennebureau.nl/start.htm

that the question of whether a measurement justifies a horror story depends entirely on the threshold values. 'In the direction of the main beam, the field strength is still 6 V/m at a distance of 100 m', argued instrumentation engineer Rainer Müller, who is also a consultant to the environmental organisation *Bund für Umwelt und Naturschutz Deutschland* (BUND). The expert put his findings in perspective by saying: "According to the legally permitted field strength, 90% of all *Elektor Electronics* circuits would fail the test!"

At the same time, Bornkessel thinks that the controversy regarding more restrictive threshold values, such as the frequently cited Swiss threshold value of 6 V/m, only fosters the uncertainty of the general public. That certainly became clear to him after conversations with Swiss colleagues. "The primary need for precautions is with mobile telephones, not base stations", said the mobile telephone expert. By way of exception, environmental activist Müller fully agreed with him on

this point. When you're phoning with a mobile telephone, the field strength inside your head can be as high as 800 V/m, which – as the master of visualization put it – is 'enough to ignite an explosive mixture of gasses'. The electromagnetic field of a household DECT base station can also easily reach the level of a mobile telephone base station transmitter.

Manufacturers are keeping mum

According to the recommendations of the International Commission on Non-ionizing Radiation Protection (ICNIRP), mobile telephones should not be able to radiate more than 2 W per kilogram of body weight into the user's head. Some of the current mobile phones are well below this threshold value for the specific absorption rate (SAR; see inset), but the manufacturers aren't saying this out loud. The industry has also refused to endorse the 'blue angel' environmental label for low-radiation mobile phones (with SAR values below

0.6 W/kg). As measurement engineer Bornkessel explained, "The manufacturers are in a difficult position. If they make too much of a fuss about low SAR values, that could be regarded as an admission that the radiation from mobile phones is in fact hazardous."

In the opinion of BUND expert Müller, there is a major need for additional studies of what happens inside children's heads when they use mobile phones. As he pointed out, 'Now that even three-year-olds are phoning, you can't rely on measurements made with a water-filled model the size of an adult head.'

To be on the safe side, the BUND argues for reducing the value to 0.5 V/m in order to account for the non-thermal effects on the organism. It appears that such effects do exist, but up to now it hasn't been possible to prove them. According to Müller, research more specifically focused on such effects is necessary. He said that in any case he missed this 'central theme' in the studies currently being conducted by the *Deutsche Mobilfunk Forschungsprogramm* (German Mobile Communications Research Programme).

Why so many base stations?

In the UK, the number of base stations carrying mobile phone services is eventually expected to almost double to a staggering 50,000 – 70,000. Alarming? Maybe not. Forgetting for the moment the line-of-sight effect applicable to SHF radio waves, let's assume you'd want to use a single antenna to cover the entire UK. You then build a massive antenna radiating an equally massive amount of power. The RF power levels produced would turn a large area around the antenna into a hazardous area because the locally present radiation level would far exceed human life conditions. The alternative using lots of antennas radiating lower power (20-100 watts each) results in restricted areas of just 3 metres or so. With even more transmitters, consequently with even lower power, there is no restricted area at all — after all, you hold your mobile against your head. So, 'more' base stations is not necessarily more dangerous because at least in theory it causes the local power to drop. The 'no masts-near-schools' campaigners are also faced with this dilemma.

Side effects

Müller has a point, because the current rules are based on the thermal effects and ignore the non-thermal effects. For example, why are people not allowed to have their mobile phones switched on in hospitals? The 'sensitive equipment' in the hospital won't be bothered by any thermal effects caused by a phone. That means there must be

Summary of wireless systems

	Frequency (MHz)	Pulse frequency	Terminal unit time slots	Base station power (Note 9)	Max. peak / average terminal unit power
GSM-900 network	890-960	217 Hz	1 or 8	5-50 W (Note 1)	2 W / 250 mW (Note 2)
GSM-1800 network	1710-1880	217 Hz	1 or 8	5-20 W (Note 1)	1 W / 125 mW (Note 2)
UMTS (G3)	1900-2170	various methods		5-50 W (Note 1)	1 W (Note 2)
DECT	1880-1900	100 Hz	1 or 24	250 mW max.	250 mW / 10 mW
WLAN	2400-2483	10 Hz	4)	100 mW max. (Note 1)	100 mW (Note 1)
Bluetooth	2402-2480	1600 Hz	1 or 2 (Note 6)	1; 2.5; 100 mW max. (Note 5)	1; 2.5; 100 mW (Note 5)

1. The actual power depends on call and data volumes. 2. The actual power depends on reception conditions. 3. Worst case: outdoors in the main beam direction of the antenna. 4. Depends on data volume. 5. Signal classes 3, 2, and 1 respectively. 6. Voice link. 7. Estimated. 8. According to the German Immission Protection Ordinance. 9. Local regulations may allow higher levels.

other effects beside thermal effects. Can these effects also influence living organisms? Or to put it in more scientific terms: what effect do high-frequency electromagnetic fields have on the wellbeing of the average person?

No consensus among medics

But long before, an article examining the operation of the human brain mobile telephones was recently published in *The Lancet*, a leading English journal. It highlighted the considerations described below.

There are electromagnetic frequencies in our brains, called the alpha and delta waves, that lie in the same frequency ranges as those used by DTX telephones and the TDMA protocol. (DTX is the name of a protocol in which the telephone transmits only when the user is speaking, and TDMA stands for 'time division multiple access', which is a technique that allows up to eight callers to use the same frequency concurrently by splitting it up into eight time slots.) Since brain and phone are exposed to the same frequency, mutual effects can be assumed, where the 2-watts from the mobile is sure to have the upper hand over the 'landline' of the human brain (a human aura will it easily disrupt a mobile phone). From this, it could be surmised that a mobile telephone next to your ear could influence the metabolism and operation of your brain. After all, what matters here is not the amount of energy that is absorbed, since that remains limited as previously described. Instead, what matters is the information that is sent

Base station electrical field strength limit (Note 8)	Distance within which 6 V/m occurs
$1.375 \sqrt{f}$ V/m	to 100 m (Note 3)
$1.375 \sqrt{f}$ V/m	to 100 m (Note 3)
61 V/m	to 100 m (Note 3)
no limit	to 0.5 m (Note 7)
no limit	to 0.5 m (Note 7)
no limit	to 0.5 m (Note 7)

Mobile phone tips

You can reduce your personal exposure to electromagnetic fields from mobile phones, cordless phones and WLAN systems by using a few simple rules. It boils down to 'keep your distance' and 'reduce exposure time'.



1. Keep your distance

- The best location for a WLAN or DECT base station (which transmits constantly) is in a hallway. Bedrooms are undesirable locations. A minimum distance of 3 to 4 metres is recommended. If a WLAN access point must be installed in a location frequented by many people, such as a classroom, it is best placed above the door.
- Mobile phones also transmit the odd signal even when in standby mode. Do not leave your mobile phone next to the bed overnight.
- Do not carry your mobile in a trousers pocket or in your jacket — instead, carry it in a briefcase or purse. Otherwise, use a pocket with special screened lining inside.
- Use a headset if one is available, preferably one with a cable, else you are exposed to additional Bluetooth radiation.
- Consider texting people (SMS) instead of placing lots of short calls
- Wait until the connection has been made before putting the phone to your ear (since GSM devices transmit at maximum power at first).
- A small spacer (made from wood or fabric) may be useful under certain conditions. According to Christian Bornkessel of the Institute for Mobile and Satellite Communication Techniques (IMST), 'even one to two millimetres of additional separation between the mobile phone and the head has a noticeable effect'.

2. Keep your exposure short

- Where possible use a normal (landline) telephone
- avoid long-winded calls
- Mobiles hardly transmit in the absence of a voice signal, so speak as little as possible.
- Switch off mobile phones, DECT base stations and WLAN access points when they are not needed (such as at night). In many cases the WLAN function of a WLAN DSL router is not needed. Most of this equipment continues to work just fine with the transmitter section switched off.

3. Optimise reception

- Whereas DECT telephones transmit at a fixed power level, mobiles automatically control their transmitted power. GSM (G2) mobiles initiate communication at the maximum power level and then step down to the minimum usable level. UMTS mobiles on the other hand start at a low level and then step up to the power to an optimum level. In both cases, this means that mobile phones should only be used under the best possible reception conditions, as this yields the lowest transmitted power levels.
- When indoors, stand next to a window
 - In your car, use an external antenna and switch off all mobile phones that are not being used.
 - When travelling by train, delay your call until you arrive at a station. Base stations are available there requiring less power from your mobile.
 - Do not use so-called mobile phone radiation shields — these only force the mobile to transmit at more power and therefore defeat their purpose.
 - Avoid calls in areas where lots of people are using their mobiles.
 - Avoid calls in metal-shielded compartments like buses, trains, elevators etc. Such compartments act like a Faraday cage causing most radiation to be reflected inside. Consequently, inside radiation levels rise while more power is required to enable some radiation to escape and reach the base station.
 - Keep your finger away from the antenna during the call, since it will detune the antenna and thus degrade the transmission characteristics.

Holding the mobile telephone vertical does not have any effect. That's because unlike the situation with previous systems, the polarisation of the field transmitted by the base station is not exclusively vertical. Besides this, the specific polarization of the waves is lost due to reflections on the way to the mobile phone.

to the brain. For instance, epileptic attacks can be induced in some people by a light source flashing at a frequency of 13-15 Hz (helicopter rotor blade effect). The intensity of the light is not what matters, but rather the fact that a certain frequency is detected by

the brain. That can evidently cause the brain to malfunction. Naturally, not everyone is susceptible to this, but the same sort of effect can also be seen with radiation: some people are more sensitive than others. And that's the way it works with radiation, too. A

recent Danish study (forming part of the Interphone study in thirteen European countries) published in the 12 April 2005 issue of *Neurology* showed that using mobile telephones did not have any effect on the development of brain tumours. The researchers

Controversy in the UK (and soon abroad): mobile phone masts near schools and hospitals

Up and down the country, teachers, parents and council members are not only voicing grave concerns but also staging protests over plans to install mobile phone masts near or even on top of school buildings. Allowing a mobile phone to be erected on school grounds or even the roof is highly lucrative considering the poor financial situation and tight budgets of many educational institutions. It also seems logical: where a mobile phone is close to a base station, it will sense the higher field strength and step down its antenna power to the lowest level. Not so, say campaigners and several independent researchers. The debate is currently a national news item much like that over the power lines in the 1980s. Interestingly, in Australia, New Zealand, Sweden, Italy and parts of the USA, mobile phone masts cannot be sited near schools.

Telcos (telephone companies) wishing to roll out their 3G telephony networks as quickly as possible to recoup some of their billion-pound investments include giants like T-Mobile, Orange and Hutchinson 3G. They find against them a large number of small but fervent action groups with strong local support and clever ways to access the very strongest transmitter available: the press. Squashed in between these contestants are (as usual) the law makers, judges and institutions like the Department of Health, Office for Communication (OfCom) and the National Radiological Protection Board (NRPB).

A few years ago, Amptill Against Aerials campaigners were victorious in their fight to get mobile phone antennas removed from Amptill Fire Station Tower, the tower being located next to residential areas and Russell Lower School so could be expected to cover areas with lots of children at high radiated power levels. The Bedfordshire Fire Authority eventually bowed to the public pressure based on the 'precautionary approach' expressed by the then topical Stewart report (www.doh.gov.uk) and asked the various phone companies to decommission and remove their equipment from the tower, even if incurring a penalty for contract breach. The success rate of protest action against masts near schools seems to increase, but not everywhere, Goliath also winning on occasions. The above three mobile phone giants recently won a test case in High Court for the right to erect a 25-m 3G mast near three schools in the Greater Manchester area, despite health concerns, protests and even government opposition. Campaigners were outraged at the Court ruling and voiced that "the consultation process was an utter shamble" and that "no consideration had been given to public opinion".

The Stewart report in 2000 concluded, among others, that 'evidence available did not suggest that mobile phone technologies put the health of the general population at risk'. Subsequently, schools were invited to register for Radio



Protesters with a clear message. (photo: Jim Murphy Labour MP)

Communications Agency (RA; now 'OfCom') audits and results have since been published. The audits and measurements made by OfCom and the NRPB show that exposure at publicly accessible locations near to base stations is very much below ICNIRP guidelines and at no location was exposure found to exceed 0.2% of ICNIRP guidelines. Soon after, however, some physics researchers said that masts should never be sited near schools because evidence showed they posed a threat to children's health. The main objection was that although the intensity of the radiation has been shown to be safe, its (switching) frequency had not — the pulses (of about 217 Hz) possibly affecting the brains of young children which were still developing up until the age of about 12. ICNIRP guidance levels often quoted by telcos are from 40-60 V/m and now widely considered as far too high. For example, the Swiss and Italian limits are much lower at 4-6 V/m while the old 'Salzburg residential level' is defined as low as 0.1 V/m.

Although mobile phone use in the UK is among the highest in the world, every second Brit now wielding a mobile, and the country was the first to auction off UMTS licenses worth 22.5 billion pounds, in the same country there is as yet no conclusive word about the possible dangers of long-term exposure to radiation from transmitters operating in the 900, 1800 and 2100 MHz bands.

Knowing that a 2G/3G mast is in your direct vicinity is one thing (use the OfCom Site Finder!), discovering when the operator has stepped up the power, added transmitters or changed antenna radiation patterns is another. Use the **Elektor ElectroSmog Detector** to first monitor and find out what's happening, then query and if necessary report.

Power flux density and SAR

An electromagnetic field consists of an electrical component and a magnetic component. The strengths (amplitudes) of the electrical (E) and magnetic (H) fields are expressed in volts per metre and amperes per metre, respectively.



made a comparative study of 400 persons with brain tumours and 800 randomly selected persons. A remarkable detail was that the incidence of a particular form of brain tumour proved to be lower among frequent callers.

Dutch research

Under commission of the Dutch Ministry of Economic Affairs, Professor P. Zwamborn of the Technical University of Eindhoven, The Netherlands carried out a study of effects of UMTS-like radiation. The hypothesis was that UMTS radiation had no influence on our wellbeing. To his surprise, he was forced to reject this hypothesis. The conclusion from the study [5] was that such radiation actually does affect the physical condition of people. Of course, this study must be reproduced in order to ensure that it was free of unintentional errors and coincidences, so it has been outsourced to a Swiss — arguably independent — research institute to provide independent verification. However, that institute has now become fully sponsored by mobile telephone companies and the government (you surely haven't forgotten the UMTS frequency auctions with their bids in the billions?).

Even more international rules

If you look at the recommendations made to government authorities by various health organisations, it's clear that there isn't any general agreement on the subject. The National Radiological Protection Board (NRPB) in England recommends that the use of mobile telephones by children should be avoided as much as possible, while in the Netherlands the *Gezondheidsraad* (Health Council) does not make any distinction between children older than two and adults, and thus does not make any recommendation discouraging the use of mobile phones. However, this doesn't detract from the fact that several municipalities in the Netherlands have chosen to ignore the good advice of the council and impose restrictions on the construction of UMTS transmitters.

France takes the attitude that there simply isn't a problem. The only government organisation that responded to requests for information (the Ministry of Finance) referred to studies carried out in 2002 and early 2003,

Under far-field free-space conditions (which means that the distance from the antenna is large relative to the wavelength and dimensions of the antenna, and there is no interaction with matter), the magnitudes of these two components have a fixed relationship [21] given by the expression

$$H = E / Z$$

where Z is the characteristic impedance of free space (377 Ω).

The radiated power passing through a defined area, which is called the power flux density (S), is given by the vector product of E and H. This yields the following expression for the magnitudes:

$$S = E^2 / Z$$

The power flux density thus decreases by a factor of 4 if the electric field strength is reduced by a factor of 2.

Part of the energy impinging on the human body is absorbed by the body and converted into heat, with the water contained in the tissue playing a decisive role in this process. If we consider the worst case situation of complete absorption and assume an area equal to half the body surface of an average adult (1 m²) and a body weight of 80 kg, at a power flux density of 320 W/m² exactly 320 W would be absorbed, or 4 W per kilogram of body weight. This latter quantity is designated

the 'specific absorption rate' (SAR).

The body is warmed by the absorbed radiation, which can give rise to various effects [1, 2]. Experiments have shown that a 1 °C increase in the temperature the entire organism is the limit of what is acceptable. For a body with an average 'air content', this corresponds to a SAR of approximately 4 W/kg [2].

Unfavourable situations (poor dissipation of body heat) can be taken into account by using a safety factor of 10, which yields a maximum recommended SAR of 0.4 W/kg. This target value is applicable in Germany for persons occupationally exposed to electromagnetic radiation, such as maintenance personnel for mobile telephone base stations. For the general population, the specified level is a fifth of this value, or 0.08 W/kg. As SAR values are difficult to measure, limits are instead imposed on the electrical field strengths of fixed transmitters.

A higher SAR value is permissible for limited regions of the body, such as the head, where locally induced warmth can be transported away by the blood. According to the recommendations of the International Commission on Radiological Protection, this value is 2 W/kg. No problem with an adult's head weighing several kilos, but an altogether different story in the case of a child.

which concluded that the air was literally clean as a whistle. And as the radiation is negligible and practically no one is complaining, why should anyone be concerned? At the risk of being unfair, we would not have expected to hear differently from a country that's 60% dependent on 56 nuclear power plants and arranged for the *Rainbow Warrior* to be sunk to put an end to protest campaigns against French nuclear bomb experiments on the Mururoa atoll?

In Germany, scientists are now disputing not only each other but also themselves. For instance, Professor Jiri Silny relegates the Reflex study of cell cultures with modified genes to the already abundant volume of inconclusive studies, and he maintains that the physicians in Naila obtained results

that are scientifically indefensible. According to Silny, "if you study two arbitrary random samples from the population, you can prove just about anything".

Be that as it may, new studies are still being conducted, primarily commissioned by mobile communications companies, in the hope of finding results that can remove the uncertainty once and for all. Silny could not give a definite green light, since as he explained, "a null effect can never be proven".

Which strengthens our hopes that in a couple of decades from now the mobile phone industry does not find itself in the same pickle as the coal mining, tobacco and asbestos industries today. ■

What is elect

Nine out of ten people do not know the meaning of the term electrosmog. This is evident from a small survey conducted in the weekend of 25 March 2005 by CentERdata, allied with Tilburg University, the Netherlands. Three questions on Electrosmog were answered by 2085 people of 16 years and older. The results are representative for the Dutch population and at least of interest to others.



Question 1:
Have you ever heard of electrosmog?

The term electrosmog is not commonly known (figure 1); 67% has never heard of it and 20% has heard of it, but does not know what it is. The remaining 12% has heard of the term and also knows what it means.



Question 2: Do you believe that this radiation can cause health problems with humans?

All participants in the survey having answered the question 'have you ever heard of electrosmog' have been given the following explanation on 'electrosmog': 'Electrosmog is caused by radiation from base stations for mobile telephony (GSM-2, GSM-3, UMTS), wireless networks, DECT (digital enhanced cordless telecommunications), ordinary mobile phones and other sources. Electrosmog is invisible and inaudible, but

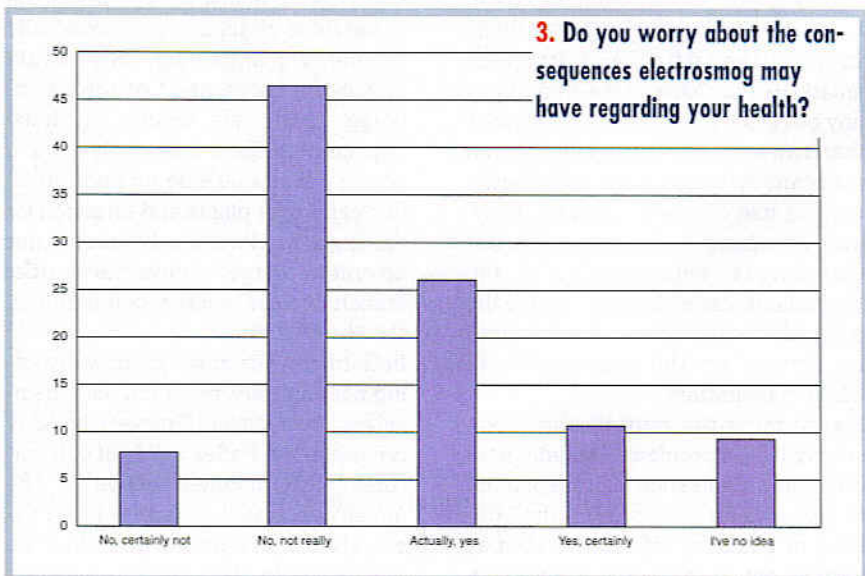
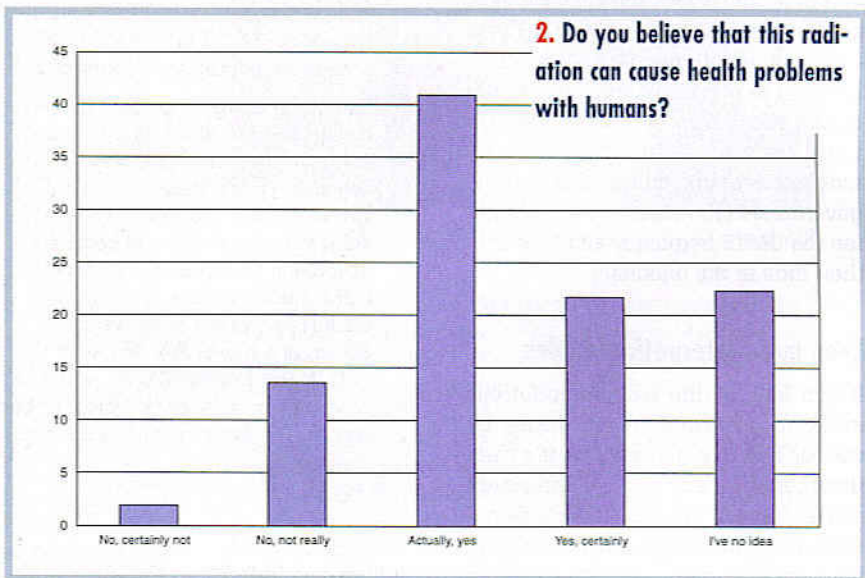
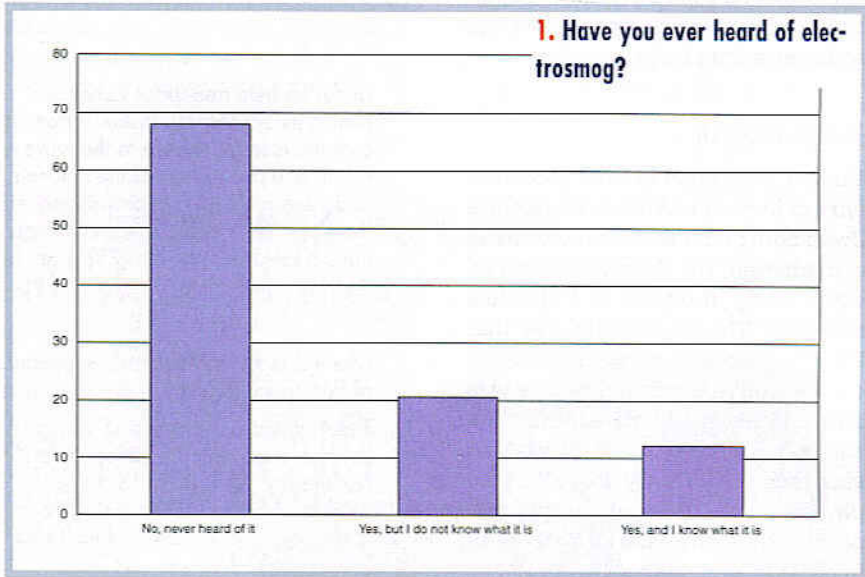

rosmog?

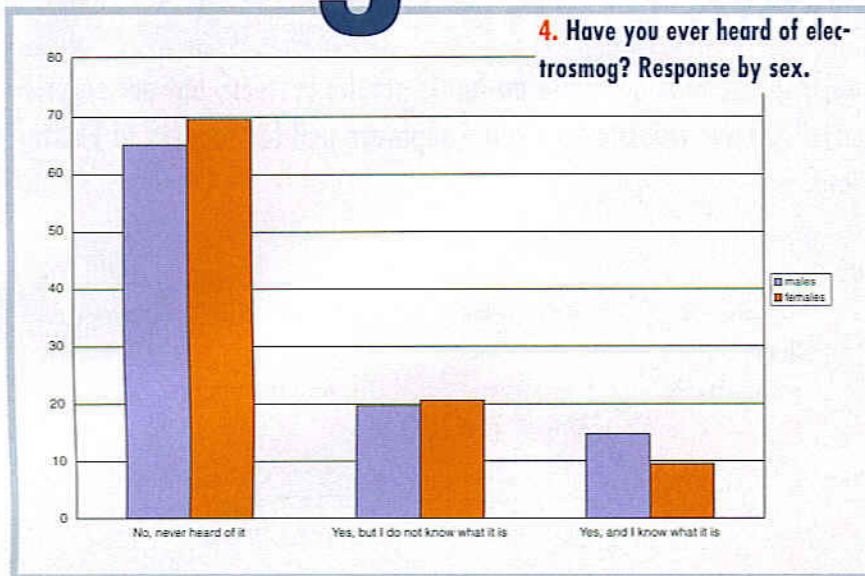

can be measured.' Next the bureau asked if this radiation is able to cause health problems with humans. Many participants believe it can (figure 2), 41% replies 'actually, yes'. Over 22% have no idea and the remaining participants reply that electrosmog can not really cause health problems. Females are more often convinced that electrosmog is a sure cause of health problems (females 26%; males 18%).

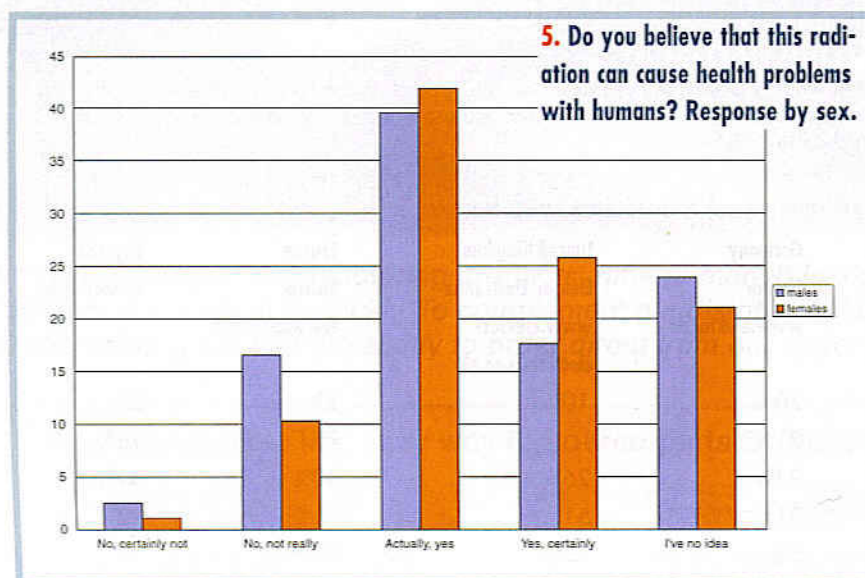

Question 3: Do you worry about the consequences electrosmog may have regarding your health?

The majority of participants reply that they are not worried (figure 3) (8% 'no, certainly not plus 46% 'no, not really'). Still, 11% is certainly worried and 25% 'actually, yes'.

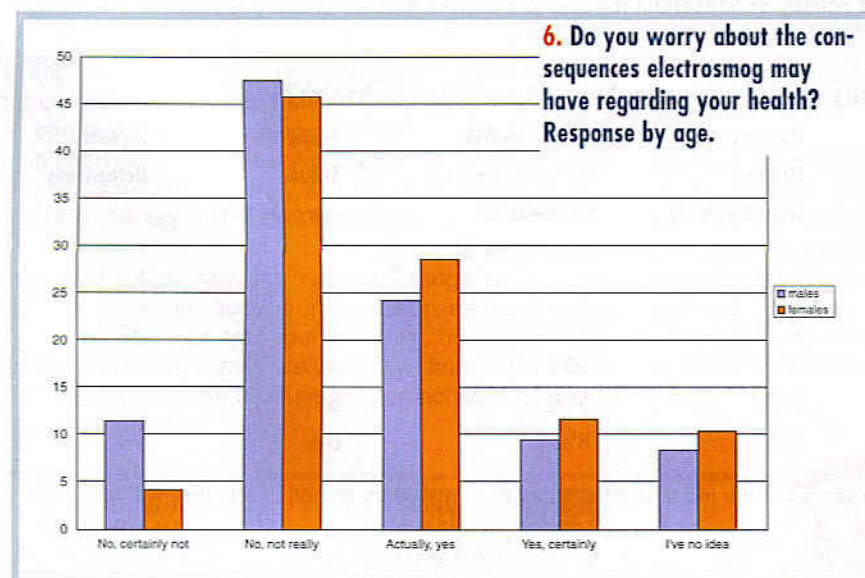

Males less worried than females

A statistically significant (i.e., not explained by coincidence) difference can be observed in the replies received from males and females. More males (14%) know the meaning of electrosmog than females (14%). Females, more often than males, are convinced that electrosmog can lead to health problems (26% females as opposed to 18% males, see figure 5).

Females are more often worried than men when it comes to the results electrosmog may have on health (figure 6).

Oops?!

And the experts?



The fact that the average Dutch (layman) population is not quite *au fait* is painful in itself, but not surprising. So what about the electronics experts? On our websites we ran a separate poll for readers of Elektor Electronics and its European sister editions.

1. Have you ever heard of electrosmog?

Percentage of respondents (on 20 April 2005)	Netherlands Elektuur www.elektuur.nl	Germany Elektor www.elektor.de	United Kingdom Elektor Electronics www.elektor-electronics.co.uk	France Elektor www.elektor.fr	Laymen Netherlands
No, never heard of it	10%	1%	18%	2%	67%
Yes, but I do not know what it is	4%	7%	5%	11%	20%
Yes, and I know what it is	86%	92%	77%	87%	12%

Dutch Elektor readers seem to attach little value to what is written in the papers on the subject. In the UK, where electrosmog is a hot issue, 18% is blissfully unaware, while in France, the country where the subject is hushed up, 87% claims to know the term. The non-initiated in electronics clearly know less than the experts.

2. Do you believe that this radiation can cause health problems with humans?

Percentage of respondents (on 20 April 2005)	Netherlands Elektuur www.elektuur.nl	Germany Elektor www.elektor.de	United Kingdom Elektor Electronics www.elektor-electronics.co.uk	France Elektor www.elektor.fr	Laymen Netherlands
No, certainly not	7%	20%	10%	2%	2%
No, not really	16%	21%	–	7%	13%
Actually, yes	30%	23%	26%	40%	41%
Yes, certainly	36%	31%	51%	51%	22%
I've no idea	11%	5%	13%	0%	22%

Again, some surprising results. In Germany, the country of Sauberheit (cleanliness) and the Reinheitsgebot (German Purity Laws of 1516) relatively few readers appear to worry despite the explanation of the term.

3. Do you worry about the consequences electrosmog may have regarding your health?

Percentage of respondents (on 20 April 2005)	Netherlands Elektuur www.elektuur.nl	Germany Elektor www.elektor.de	United Kingdom Elektor Electronics www.elektor-electronics.co.uk	France Elektor www.elektor.fr	Laymen Netherlands
No, certainly not	13%	25%	3%	2%	8%
No, not really	30%	27%	–	0%	46%
Actually, yes	22%	25%	23%	40%	26%
Yes, certainly	35%	20%	59%	58%	11%
I've no idea	0%	2%	8%	0%	9%

Clear-headedness in the low countries versus paranoia in the more isolated countries (involuntary or not)? Only time will tell.

Leaf through to page 24 for the Electrosmog Tester

buy.Microchip - source the parts you need - quickly and easily



<http://buy.microchip.com>

When developing or manufacturing products, time to market is essential and this may mean you need to get hold of parts quickly. To complement our distributors' inventory of Microchip product, buy.Microchip gives you the ability to order direct from our factory.

buy.Microchip - The easy way to source parts 24 hours a day, 7 days a week

Buy online, pay by credit card

Complements existing distribution channels

Currently available in 28 European countries

Buy any Microchip product - devices, tools and development kits

Special fast-turnaround, flexible factory test cell

Items in stock ship within 48 hours of ordering

Speed is important. You need to bring products to market fast to beat your competitors, and can't afford to wait around for long-leadtime components or development tools. Microchip has created buy.Microchip, an extension of the Microchip website that allows you to place orders directly with Microchip to ensure the fastest possible delivery of the parts you need.

Microchip's distributors carry an extensive range of our vast product range. However, sudden increases in demand mean your requirements change and your particular, unique, product requirements may not be immediately available from a distributor. Conventional semiconductor production approaches can make it difficult to respond quickly.

Microchip have built an innovative "Flex Cell" in our testing facility that is used to provide the parts sold through buy.Microchip.

Basically it's a flexible test cell, which is separate from our high volume test line. While the flex cell shares the same test platform, test software, testing method and quality standards, it has one difference. In the flex cell, Microchip breaks set-ups all day to reconfigure to the immediate need of our customers. As a result, flex cell delivers short lead-times, but it costs more to manufacture so this is reflected in the pricing. If you have an urgent requirement, buy.Microchip can get you parts fast!

buy.MICROCHIP
ONLINE CATALOG
One-stop shopping for MCUs, digital signal controllers, analog and serial EEPROMs.
<http://buy.microchip.com>

Now
Pb-free!

 **MICROCHIP**

Electrosmog Tester

UK mobile telephony providers are busy rolling out their nationwide 3G network for UMTS. According to a cautious estimate, it will eventually require some 50,000 masts to be erected. It is not surprising that an increasing number of people worry about the extra dose of electromagnetic radiation produced by 3G base stations. The sensitive Elektor Electrosmog Tester not only allows you to provide evidence of rising fieldstrengths in your neighbourhood, but also to find the most radiation-free spots up and down the country.

Karel Walraven, Design: Gert Baars

Up and down the country, new antenna masts are being erected in support of the new UMTS (3G — third generation) mobile phone services. The new antennas are not just co-sited with exiting ones for 2G and other networks (often without informing the general public), but also installed at completely new locations. The UK 3G networks will eventually run on about 50,000 masts, far more than the older 2G network. The reason is that a much finer grid of masts is required to service all areas reliably. You may have wondered already if and how these developments affect you health. If not, you may soon when a tall mast suddenly appears in your neighbourhood.

Elektor Electronics magazine can help you in two ways: first of all, to write as objectively as possible about what's dangerous or not and secondly by allowing you to check and appraise your personal situation in respect of SHF radiation levels using a tester you can handle yourself.

What's that radiation?

After just a quick walk through your house you'll soon find that you, yourself are the biggest source of pollution, that is, if you have a cordless phone and/or a wireless PC network. Especially your DECT phone will feature very prominently in respect of radia-

Hold the tester vertically at the location you wish to check for SHF electrosmog levels. The measurement starts when you press the button.

When the rightmost LED lights, the battery has to be replaced.

When this LED does not light, you are almost certainly receiving a 2G (GSM-900) signal only.

These ten LEDs indicate the radiation level. The lowest (green) LED indicates a low level; when the red LED lights, the level is starting to get critical.

In nearly all cases, RF energy is pulsed, causing several LEDs to light most of the time. The brighter the LEDs light, the longer the presence of the RF energy.

Health to



You will detect GSM mobiles, UMTS mobiles, WLAN (wireless network) routers and clients, DECT (cordless phones), Bluetooth devices, microwave ovens, wireless TV cameras, amateur radio/TV stations (23cm & 13cm).

tion produced. The good news is that you are in control of it all — after all, you can always pull the plug! Some more walking around is also sure to prove that received signal strengths drop rapidly with distance. In the



all, and above all

comfy chair, at 3 m from the DECT base station, the radiation level will be much reduced, while in the bedroom hopefully it is hardly noticeable on the tester. If that is not the case, we suggest relocating your DECT base station, not because we feel that the current standards for RF radiation levels are too high see Table 1), but because it is always good to ensure as low as possible incident radiation. The Electromog Tester will enable you to discover the effects of a different location for the base station in the home.

Fieldstrengths

How to interpret the indications provided by the Electromog Tester if we are aware that the instrument is not accurately calibrated and does not perform a scientifically reproducible measurement. In view of the complexity of the subject and the signals involved, such a measurement is not at all easy to implement. Our Electromog Tester measures RF signal levels in a section of the SHF (super high frequency) band between about 900 MHz and

2400 MHz, produced by transmitters in all GSM, DECT, UMTS and WLAN equipment, microwave ovens and (license-free wireless cameras to mention but a few. It will provide an impression of the SHF radiation levels you're exposed to, enabling you to at least quantify the relative hazards in your area. The instrument is also perfect for finding high as well as low radiation areas. You will be able to see with your own eyes that a base station's radiated energy is not constant and depends on the number of calls (equalling the amount of data) carried via the station.

Table 2 shows the relation between the LEDs and the fieldstrength. The widely quoted NIRCP standard of between 40-60 V/m far exceeds the highest range of our tester, its highest-level LED indicating 8.3 V/m and personally I would not like to be exposed to such energy levels.

The table clearly shows that values drop rapidly due to the tester's logarithmic scale and wide dynamic range of about 70 dB, which equates to a ratio of 1:3,000. The lowest-level LED will light at 0.005 V/m and we're pretty sure there are still outdoor locations on the UK mainland where it will be difficult to make this LED light. The table also includes entries expressed in the

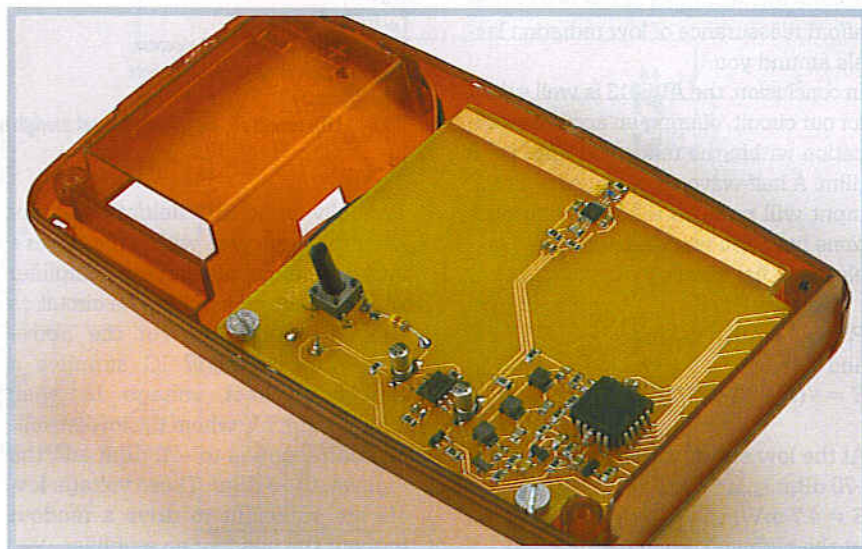

Get Cracking Get Cracking Get Cracking G

now obsolescent W/m^2 unit, which may be found in older literature.

Each LED on the scale represents a V/m value increment by a factor of 2.3. Using the W/m^2 unit, this scale rises even more rapidly — at the rate of 2.3 squared (approx. 5.3).

The correctness of the indicator scale has been verified and approved by an independent test facility company (see inset).

A logarithmic IC

Being able to pinpoint the major sources of SHF electromog requires a circuit capable of not only processing signal frequencies in excess of 2,000 MHz (2 GHz), but also offering sufficient dynamic range to reliably spot small and large fieldstrengths.

The above is of course possible using a spectrum analyser or a special superheterodyne receiver. Fortunately there are simpler ways, too.

Besides the well-known AD8307, Analog Devices also produce a number of related ICs with extended frequency range, like the AD8313. This detector IC is suitable for use up to 2.5 GHz and also supplies an output voltage that's proportional with the input signal strength in decibels. The available measurement range extends from about -73 dBm to 0 dBm. **Figure 1** shows a block diagram of the AD8313 internal architecture.

A cheaper alternative, the AD8314, is entirely pin-compatible. The '8314 is probably cheaper because of its reduced sensitivity of just 45 dB and it's exactly this property that makes it unsuitable for our application. After all, it's the lower ranges of the tester that afford reassurance of low radiation levels around you.

In conclusion, the AD8313 is well suited for our circuit, offering an accurate indication within the range -70 dBm to -5 dBm. A half-wave dipole antenna at the input will produce the following relations between received power (P_r) and electrical fieldstrength E :

$$P_r = E^2 \times 4.59e-6$$

and

$$E = \sqrt{(P_r \times 218000)}$$

At the low end of the scale,
-70 dBm = 10^{-7} mW = 10^{-10} W so
 $E = 4.7$ mV/m.

At the high end, we have
-5 dBm = 0.316 mW = 316 μ W so
 $E = 8.3$ V/m

TABLE 1. EU Council exposure limit reference levels for the general public; electromagnetic (E/H) fields; 0-300 GHz (1999).

Frequency range	E-component fieldstrength (V/m)	H-component fieldstrength (A/m)	B-field (μ T)	Equivalent power density for flat waves S_{eq} (W/m^2)
0-1 Hz	-	3.2×10^4	4×10^4	-
1-8 Hz	10000	$3.2 \times 10^4 f^2$	$4 \times 10^4 / f^2$	-
8-25 Hz	10000	$4\,000/f$	$5000/f$	-
0.025-0.8 kHz	$250/f$	$4/f$	$5/f$	-
0.8-3 kHz	$250/f$	5	6.25	-
3-150 kHz	87	5	6.25	-
0.15-1 MHz	87	$0.73/f$	$0.92/f$	-
1-10 MHz	$87/f^{1/2}$	$0.73/f$	$0.92/f$	-
10-400 MHz	28	0.073	0.092	2
400-2000 MHz	$1.375 f^{1/2}$	$0.0037 f^{1/2}$	$0.0046 f^{1/2}$	$f/200$
2-300 GHz	61	0.16	0.20	10

(noise-free, average values)

TABLE 2. Fieldstrength / LED indicator.

LED#	P_m (dBm)	E (V/m)	Colour	H (A/m)	S (W/m^2)
1	-70	5 m	green	12 μ	56 n
2	-62.8	11 m	green	28 μ	293 n
3	-55.6	25 m	green	64 μ	1.5 μ
4	-48.3	57 m	green	148 μ	8.3 μ
5	-41.1	130 m	orange	340 μ	43 μ
6	-33.9	300 m	orange	780 μ	230 μ
7	-26.7	680 m	orange	1.8 μ	1.2 μ
8	-19.4	1.6	red	4 μ	6.4 μ
9	-12.2	3.6	red	9.4 μ	34 μ
10	-5	8.3	red	22 μ	180 μ

Legend

P_m : received power

E: fieldstrength of electrical component

H: fieldstrength of magnetic component

S: power density

When all LEDs remain off, the measured signal strength is below -70 dBm.

Typically found SHF fieldstrengths of around 1 V are well within the tester's indicator range, making a preamplifier superfluous and keeping the circuit as simple as possible. For the above range, the detector IC supplies a matching direct voltage between 0.55 V and 1.7 V, where the lowest voltage corresponds to -70 dBm and the highest, to -5 dBm. These voltage levels are sufficient to drive a readout without the need for an amplifier. The readout consists of a 10-LED bargraph indicator. Because UMTS and

other 2G/3G services are pulsed, we are looking at 100% AM modulation.

The circuit

Figure 2 shows that the AD8313 is the main component in the circuit, followed by an LM3914 acting as the LED driver.

Received signals are picked up by a dipole antenna with a length of about 70 mm (the wavelength of the signals we're after is about 14.7 cm). This is small enough not only to enable the

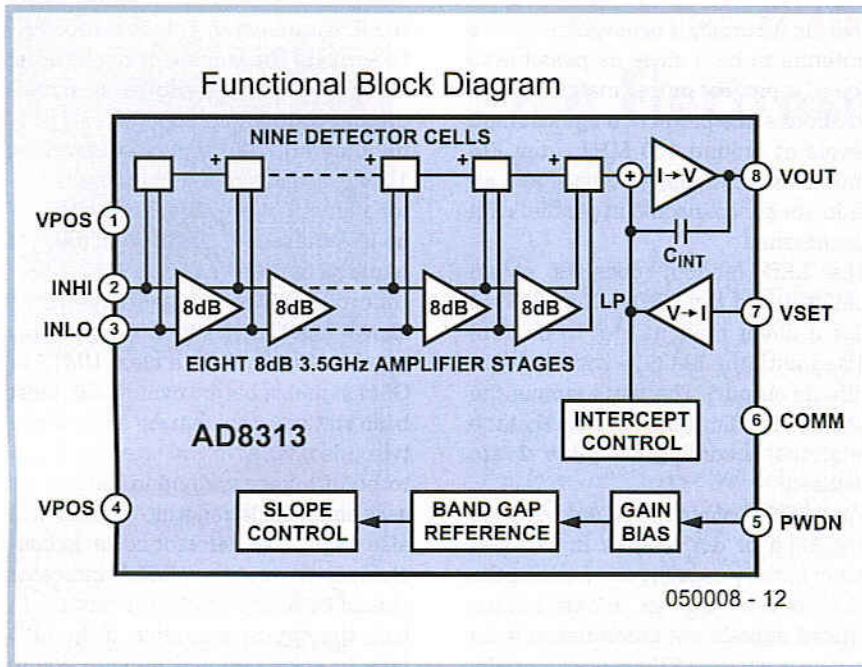
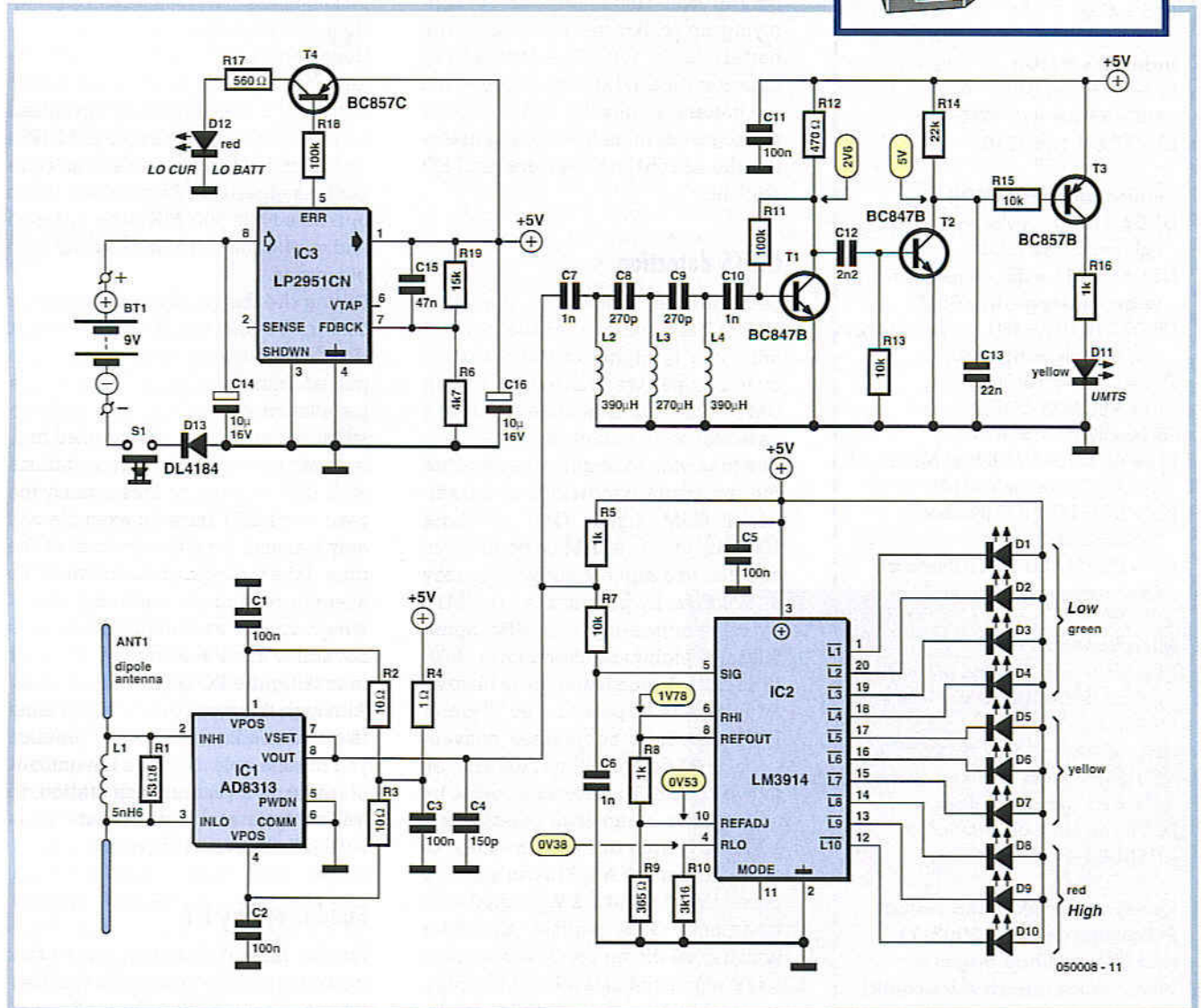
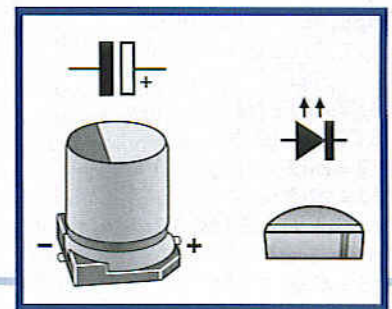

FIGURE 1. Internal architecture of the AD8313.

FIGURE 2. The circuit diagram of the Electromag Tester consists mainly of an AD8313 and an LM3914.



antenna to be fitted inside the case but also to print it in copper on the circuit board. The printed antenna has no construction problems, has no protruding parts and makes the tester a truly portable instrument that's easy to carry around in your pocket. Because the measured frequencies are so high that parasitic inductances are



COMPONENTS LIST

Resistors:

R1 = 56Ω
 R2,R3 = 10Ω
 R4 = 1Ω
 R5,R8,R16 = 1kΩ
 R6 = 4kΩ
 R7,R13,R15 = 10kΩ
 R9 = 365Ω
 R10 = 3kΩ
 R11,R18 = 100kΩ
 R12 = 470Ω
 R14 = 22kΩ
 R17 = 560Ω
 R19 = 15kΩ

Capacitors (SMD 0805):

C1,C2,C3,C5,C11 = 100nF
 C4 = 150pF
 C6,C7,C10 = 1nF
 C8,C9 = 270pF
 C12 = 2nF
 C13 = 22nF
 C14,C16 = 10μF 16V, 3.3x3.3mm or 4.3x4.3mm
 C15 = 47nF

Inductors (SMD):

L1 = 5nH6, type 0603
 L2,L4 = 390μH, type 1210
 L3 = 270μH, type 1210

Semiconductors (SMD):

D1-D4 = LED, high-efficiency, green, right angle, type 0805
 D5,D6,D7,D11 = LED, high-efficiency, yellow, right angle, type 0805
 D8,D9,D10,D12 = LED, high-efficiency, red, right angle, type 0805
 D13 = DL4148 (minimelf)
 T1,T2 = BC847B, SOT23
 T3,T4 = BC857B, SOT23
 IC1 = AD8313ARMZ 8-lead MSOP (Analog Devices, print: J1A)
 IC2 = LM3914V PLCC (National Semiconductor)
 IC3 = LP2951ACD SOIC8 (National Semiconductor, print: 51Ax8UL)

Miscellaneous:

S1 = miniature pushbutton with make contact, 6x6 or 10x10 mm, height 18.5mm
 Case: SERPAC H-65,9V TRANS RED SRH65-9VTR-ND (Digi-Key)
 9-V battery with clip-on leads
 PCB (bare, see text), order code **050008-1**

Ready-assembled and tested PCB: order code 050008-91 (see Elektor Shop pages or www.elektor-electronics.co.uk)

quickly incurred, it is essential for the antenna to be as close as possible to the IC input. For proper matching, and to afford some protection against high levels at around 100 MHz (from FM broadcast stations) a resistor and an inductor are connected in parallel with the antenna

The LED readout consists of an LM3914 and ten LEDs. The LM3914 has a linear readout (not to be confused with the LM3915 with its logarithmic output). The parts around the LM3914 are dimensioned such that the relations according to Table 2 are realised.

The LM3914 offers the choice between ' bargraph ' or ' dot ' readout. In the interest of battery capacity we went for the ' dot ' option. As an added bonus, pulsed signals are much better seen because several LEDs will light briefly at the same time.

The detector runs off a 5-volt supply voltage furnished here by an LP2951CN low-drop regulator in an 8-pin DIL case. This IC is capable of supplying up to 100 mA and allows the battery to be ' juiced '. A low-battery indicator (LED D12) will tell you when the battery is truly flat and in need of replacement. In addition to the detector, the LP2951 also powers the LED readout.

UMTS detection

Because the process of installing 50,000 base stations for the new 3G networks is highly controversial all over Europe, we wanted to add an UMTS detector to be able to see if a base station is actually a 3G one.

The idea was to employ the fact that the maximum bandwidth of a traditional GSM signal (2G) is about 200 kHz, which, at AM demodulation, equates to a highest audio frequency of 100 kHz. By contrast, a 3G UMTS signal requires up to 5 MHz bandwidth. A high-pass filter allows 1800-MHz GSM demodulation to be blocked and UMTS to be passed. The 7th-order HPF used here suppresses conventional GSM demodulation (100 kHz) by at least 80 dB. The filter is followed by an amplifier, a transistor detector and a LED driver. In this case we need to consider that the AD8313 can supply a maximum of about 1.2 V_{pp}. Applied to traditional GSM signals, the filter action of 80 dB suppression results in a maximum signal level of 0.12 mV_{pp}, or just 20 mV_{pp} after amplification by

the first transistor. This is far too low to activate the transistor detector let alone the LED driver. However, signals greater than about 300 kHz can pass unhindered. Assuming a level of 1.3 V_{pp} to activate the transistor detector and with it the detector, a signal of no less than 1.3 V_{pp}/140 = 10 mV_{pp} is required from the AD8313.

Unfortunately, practical experience shows that the indicator is not terribly reliable. The reason: a clear UMTS or GSM signal is hardly ever found, most base stations transmitting a mix of the two. Also, WLANs will often be found to be of a very wideband nature. At very small fieldstrengths, the LED will also respond to detector noise. In conclusion, the action ' UMTS ' indicator should be interpreted with caution. In fact, the opposite applies: if the LED fails to light, you can be sure you're near an exclusively GSM-1800 base station.

Because the antenna in our design is peaked at around 2 GHz, signals picked up from 2G (900 MHz) base stations will be subject to some attenuation. Fortunately, the difference amounts to no more than two LEDs. The design was purposely optimised for the ' new ' frequencies around 2 GHz and keeping the instrument as compact as possible. Remember, when optimised for 900 MHz the antenna and with it the instrument would double in size.

During the design of the Electromog Tester, we had to take into account that the relevant transmitters are pulsed. Initially, a large RC delay was installed after the detector in order to stabilise the readout. This worked fine, but unfortunately only on base stations with 100% occupancy. This is rarely the case — a DECT base for example will only transmit for a few percent of the time. Take the logarithm, and then the average results in... nothing, and it would appear as if the transmitter is not active at all. A solution was found in making the RC time much shorter. Although this results in a slightly more unstable readout, with some practice you're soon able to gauge the amount of traffic on a certain base station, to tell its type and approximate peak level (all relative, of course).

Build it or buy it?

For the fans of ultra-miniature work we've printed the artwork for the Electromog Tester PCB in **Figure 3**.



FIGURE 3. Copper track layout and component mounting plan of the PCB designed for the tester. The dipole antenna is a stripline circuit.

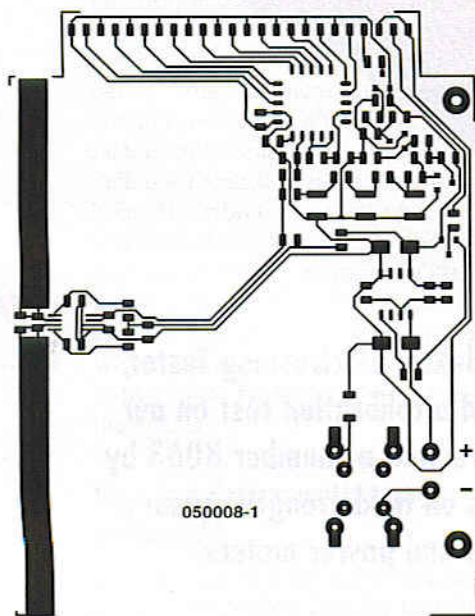

Please feel free to build the circuit all by yourself, but some caution is in order. The entire circuit is built from SMD parts and may be 'beyond' anyone with a good deal of experience and/or suitable equipment. Moreover, we hope and expect this tester to be a desirable item for many people less or not conversant with electronics. **That is why the printed circuit board is supplied ready-built and tested through the Elektor Shop.** All you need to do is install the board into the case, drill a hole for the on/off switch and connect the battery.

(050008-1)

Out and about with the Electromog Tester

So how to interpret the readings produced by the Electromog Tester? A cordless phone is ideal to practice a bit. If it's an old-fashioned C1 analogue phone, the LEDs will light continuously. Modern ECT phones, on the other hand, will cause the LEDs to flash. In this way you're soon able to tell one source from another. WLAN (WiFi) wireless networking equipment will show yet another pattern. If you do not have one, just go to your neighbour's door. A WLAN or wireless camera is perfectly detectable out in the street and yes, that means anyone with a suitable receiver can pick up and view the images transmitted by your security camera. That's why we advise against installing one in your bedroom as that will heavily compromise your privacy.

The tester is not directional, its antenna being simple and omnidirectional by nature. The advantage of it is speed of testing and not accidentally skipping a transmitter or being confused by reflections. If you want to know the direction the signal is coming from, it is usually sufficient to walk around for a bit. The LED indication will then tell you if the signal is getting weaker or stronger. Try it on your microwave oven — if it's on, some LEDs are sure to light if you hold the tester near the door.

The flashing of the LEDs and their not lighting at the same intensity is a sure indication of pulsed signals being detected. For example, your DECT base station in the standby state will only transmit for a few percent of the time. If a connection is made, the activity increases to about 5%. If you delve into hot debates in Internet news-groups and forums you know that pulsating radiation is supposedly more dangerous than exposure to a constant energy level over the same period. It is safe to say that most research has gone into the thermal effects of radiation, in other words, the heating up of the human body by radiation. The question is now what effect radiation has on individual body cells and if there is a danger of cancer growth or damaged genetic material. In the short term, these dangers

are of course hard to prove, but many are afraid that illness will come after a good many years.



Our opinion is the research carried out so far is not conclusive. In the article on radiation hazards and electromog elsewhere in this issue we discuss the matter in greater depth, and also the action taken so far by European governments. Whatever the case, our Electromog Tester allows you to see for yourself if the radiation is of the pulsating type, and what peak levels are reached. Depending on your views on the problem, feel free to take any action you see fit.

If there's a mobile phone mast in your street (or even on your roof) we recommend using the tester to check the radiation pattern for possible side lobes that may produce high radiation levels in your living area. On-site measurements in Germany revealed that certain mast locations had poorly designed antennas installed, radiating a part of the energy straight down — causing great concern among flat inhabitants and other residents.

With an assistant in the passenger seat of your car, a drive around your area is sure to make LEDs light on the tester if you pass a mobile phone base station. If you live near UHF broadcast TV transmitters, you'll find that these will also produce considerable field-strengths. To make it worse, these levels will be found to decay relatively slowly.



Tested & approved

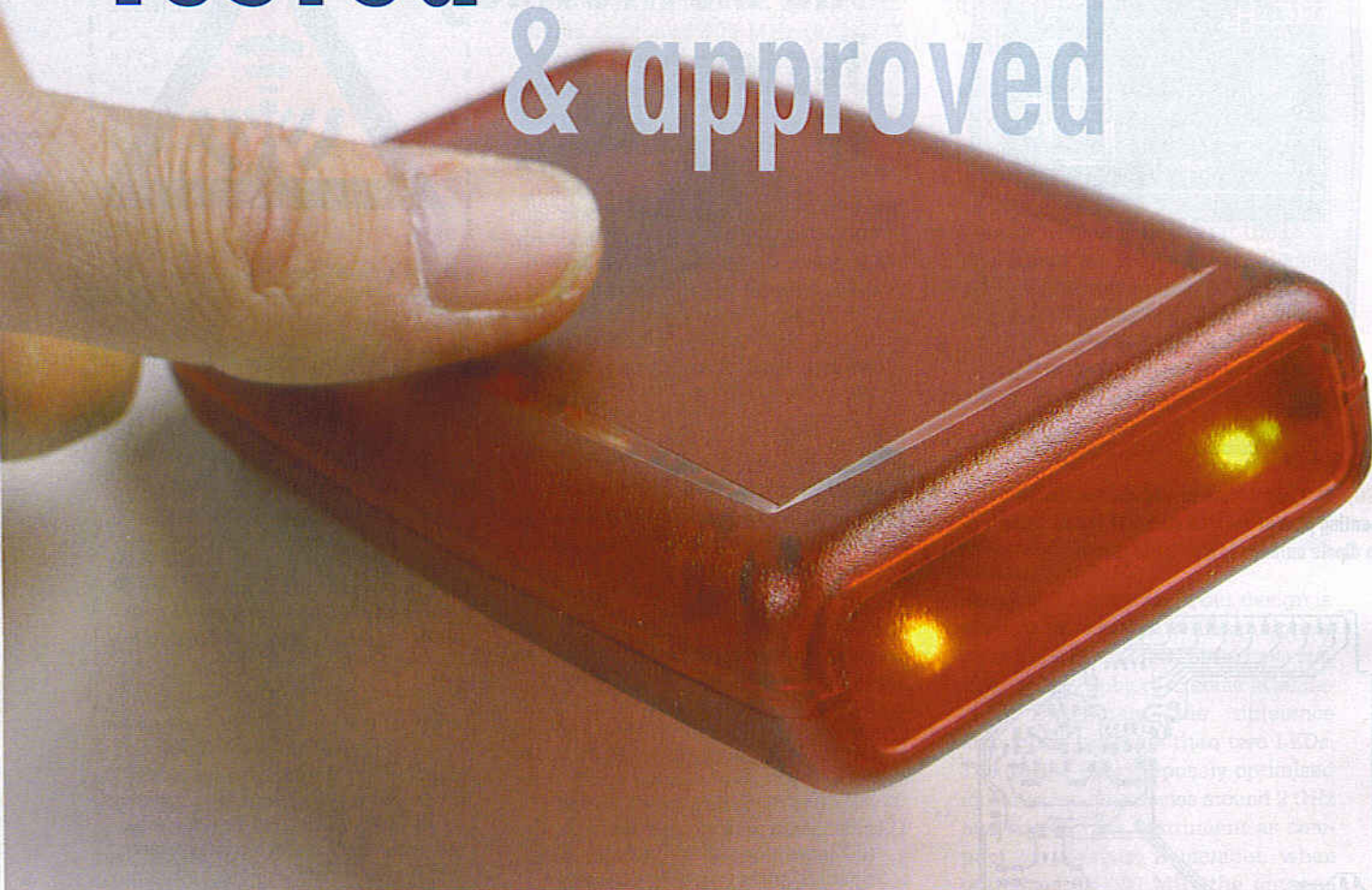

To make sure you can perform meaningful measurements using the Elektor Electrosmog Tester, D.A.R.E!! Calibrations in Woerden, The Netherlands, kindly performed a calibration test on our prototype. D.A.R.E!! Calibrations is a state of the art laboratory accredited as number K063 by the RVA. Under this accreditation, the company performs calibrations on fieldstrength sensors, antennas, monitor receivers, attenuators amplifiers signal generators and power meters. Calibrations are performed up to 18 GHz.

By René Dijkstra, D.A.R.E!! Calibrations

What does calibration entail? First of all, it is essential to know the error of test instruments. In the case of an electronic instrument, measurement results may often be compensated during the actual measurement. The instrument's discrete errors are used to build a correction-factor table that allows the measurement results to be adjusted on the fly.

As an example consider a digital thermometer. If the right temperature is applied for each degree, the error per

degree can be established. If the thermometer reads 19 degrees C when 20 degrees is applied, the error is 1 degree. If that error is constant across the range, the manufacturer may decide to shift the entire scale by 1 degree. In practice, however, this often results in an error with another discrete level. Consequently it would seem better to enter the deviation with each temperature into a table. If, for instance, 19 degrees is measured, the user or programmer knows that an amount of 1 degree should be added.

The process of establishing an instrument's error is called calibration.

What's the importance of calibration?

First of all, many important decisions are taken on the basis of measurements. This happens in cases where money is involved: the price of a product is determined on the basis of weight, volume and length. This is how it works in shops and at the petrol

station, where dispensing and weighing instruments are certified and relevant laws apply to protect customers. How are guarantees obtained that a calibration has been performed properly? Firstly, any calibration has to be reproducible and retraceable to a seamless chain of references to international standards. The best and safest way of to prove this is the case is by way of accreditation awarded not only by government institutions and standards like British Standards but also by independent agencies, often operating across national borders. If a calibration is performed under accreditation, it is by definition a retraceable calibration. Equipment calibrated in this way is marked as such, often by means of an adhesive with a logo or similar.

How accurate is a calibration?

As a matter of course, it will not be infinitely accurate. The deviation of a calibration, or rather of any measurement, is expressed by means of the so-called measurement uncertainty, which is subject to a large number of factors. Some contributing factors are ambient conditions like temperature, humidity, vibrations, test equipment used, the test set up, cables and connectors, as well as variation in measured values. All these contributing factors are captured in a single formula which, in the end, supplies the uncertainty factor for each discrete measured value.

How is a fieldstrength sensor calibrated?

This is done in a so-called anechoic room, essentially a Faraday cage not allowing radiation to enter or escape. The inner walls including the floors and the ceiling are covered with radiation absorbing material. The upshot is that it becomes possible to generate an electromagnetic field with homogenic distribution. By applying a calibrated fieldstrength to a sensor subject to calibration, it is possible to determine the error at a number of discrete frequencies. Also, the linearity may be determined at one or more of these frequencies. In this way we are checking if the sensor, responds with a linear output to a known-linear increase in fieldstrength. In addition, in the case of three-direction sensors, calibration of the isotropic properties is possible.

Beats commercial testers?

To be able to make comparisons with regard to practical use we also walked around for a bit with the popular HF32D from Gigahertz Solutions. This equipment goes by the name 'High Frequency Analyser' and looks impressive mainly thanks to its logarithmic-periodical (patented) antenna made from FR4 PCB material. Just like our Electromog Tester, it is capable of measuring fieldstrengths, however it has a digital readout. The measured **peak** value is displayed. The digital readout is of course enviable, because it is accurate in principle. However, the integrator time is so short that the display never indicates the same value twice in a row (remember, most SHF mobile phone signals are pulsed hence vary constantly in time), so you have to guess the actually measured value. The instrument also has a range switch allowing you to select between $\mu\text{W}/\text{m}^2$ and mW/m^2 . This suggests a larger measurement range but unfortunately the only thing that's actually switched is the decimal point on the display. The selection changes nothing in the way of indication or range.

It is understandable that a short integration time has been implemented because the analyser comes with an attractively styled wideband directional antenna. A directional antenna in together with a slow readout is an annoyance instead of a bonus. The antenna was found useful when determining the direction of relatively distant transmitters. To make it even easier, an audio signal may be switched on — this even works with signals beyond the maximum level of 1999



on the display.

For serious fieldstrength measurements the instrument needs to be mounted on a tripod. However, wherever accuracy of a few dB is desired, such measurements are best left to trained experts.

Returning to the measurement range, with $1999 \mu\text{W}/\text{m}^2$ and $2 \mu\text{W}/\text{m}^2$ as the respective highest and lowest indication, the Gigahertz Solutions analyser has a lame dynamic range of just 30 dB. That's so poor we initially thought the instrument was faulty because low fieldstrengths simply weren't indicated, while the Elektor Electromog Tester did not fail to indicate the weak source of radiation. To make the difference even clearer: 30 dB in this case equals a voltage ratio of 1:30, while the 70 dB range of the Elektor Electromog Tester corresponds to a ratio of 1:30,000! It is however possible to buy a plug-on antenna attenuator to extend the high end of the range.

We believe the HF32D is too limited in its options. Fortunately the manufacturer also supplies more sophisticated versions like the HF35B and higher that do have a real range switch to improve the measurement process. On the down side, the enhanced instruments are more expensive.

<http://www.gigahertz-solutions.de>

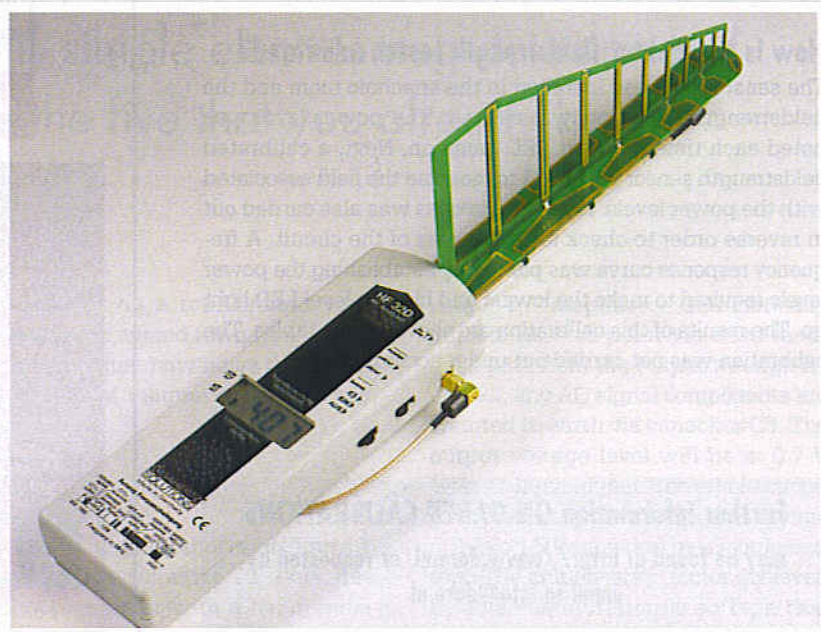

Frequency Range	Fieldstrength (V/m) at wick LED lights	Fieldstrength (V/m) at wick LED goes out
LED D1	0.0058	0.0057
LED D2	0.014	0.014
LED D3	0.030	0.029
LED D4	0.065	0.064
LED D5	0.14	0.14
LED D6	0.32	0.31
LED D7	1.05	0.72
LED D8	1.6	1.6
LED D9	3.6	3.6
LED D10	8.2	8.2

(Measured accuracy: 1.5 dB)

TABLE 1. Measured sensitivity at 2 GHz.

f (MHz)	Response (dB)	f (MHz)	Response (dB)
900	-16.2	1800	1.5
1000	-14.2	1900	0.9
1100	-11.9	2000	0.0
1200	-8.4	2100	-0.8
1300	-7.2	2200	-1.6
1400	-3.3	2300	-3.0
1500	-2.9	2400	-4.5
1600	-2.0	2500	-6.2
1700	-0.1		

TABLE 2. Measured frequency response.

How is the Elektor fieldstrength tester calibrated?

The sensor has been installed in the anechoic room and the fieldstrength was slowly increased. The power level was noted each time the next LED came on. Next, a calibrated fieldstrength sensor was used to measure the field associated with the power levels. Next, the process was also carried out in reverse order to check for hysteresis of the circuit. A frequency response curve was plotted by establishing the power levels required to make the lowest and highest level LED light up. The results of this calibration are shown in the tables. The calibration was not carried out under accreditation.

Further information ON DARE!! CALIBRATIONS

may be found at <http://www.dare.nl>, or requested by email to info@dare.nl

PIC On Screen Display Project Board

A Versatile, Programmable, Low Cost Platform for Video Text Projects.

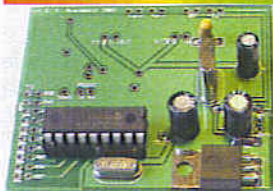

- PIC 16F628 microcontroller
- 28 by 11 character OSD
- Fully programmable
- Demo software available
- I/O lines for sensor interface
- RS232 serial interface
- PAL or NTSC compatible
- Enclosure option available



Visit www.STV5730A.co.uk



CD-ROM ECD

Now extended with even more ICs, transistors, FETs, thyristors and triacs!



ISBN 90-5381-159-1
£12.95 (US\$ 22.90)

Elektor's Components Database gives you easy access to design data for over 5,700 ICs, more than 35,000 transistors, FETs, thyristors and triacs, just under 25,000 diodes and 1,800 optocouplers. All databank applications are fully interactive, allowing the user to add, edit and complete component data.

Order now using the Order Form in the Readers Services section in this issue.

Elektor Electronics
(Publishing)
P.O. Box 190
Tunbridge Wells TN5 7WY
ENGLAND
Tel. +44 (0) 1580 200 657

More information on www.elektor-electronics.co.uk

ANDRE LAMOITHE'S

XGAMESTATION

LEARN STEP-BY-STEP HOW TO BUILD AND DESIGN YOUR OWN VIDEO GAME CONSOLE!

Design inspired by the Atari 800/2600, Sinclair ZX Spectrum, Apple II & Commodore 64!

Parallax 5X-Key Compatible!

INCLUDES:

- Tools, Demos & Utilities!
- Great for Hobbyists AND Students!
- The Fun Way to Learn Embedded Systems!
- Fully Assembled XGS Micro Edition Unit!
- Complete Software Development Kit!
- eBook on Designing the XGS Console!
- Cables and Power Supply Included!

WWW.XGAMESTATION.COM

PH: 925.736-2098 | SUPPORT@NURVE.NET

NURVE NETWORKS LLC
402 CANNON AVENUE WEST
DANVILLE, CA 94505 USA

Tune in to Elektrosmog

Listen to EMF soundscapes

Burkhard Kainka

The debate concerning the possible harmful effects of electrical and magnetic alternating fields in our environment goes on. The only thing that everyone seems to agree on is that you cannot see or smell these fields. No longer true! Build this simple electrosmog detector and add two extra senses to the five that you already have.

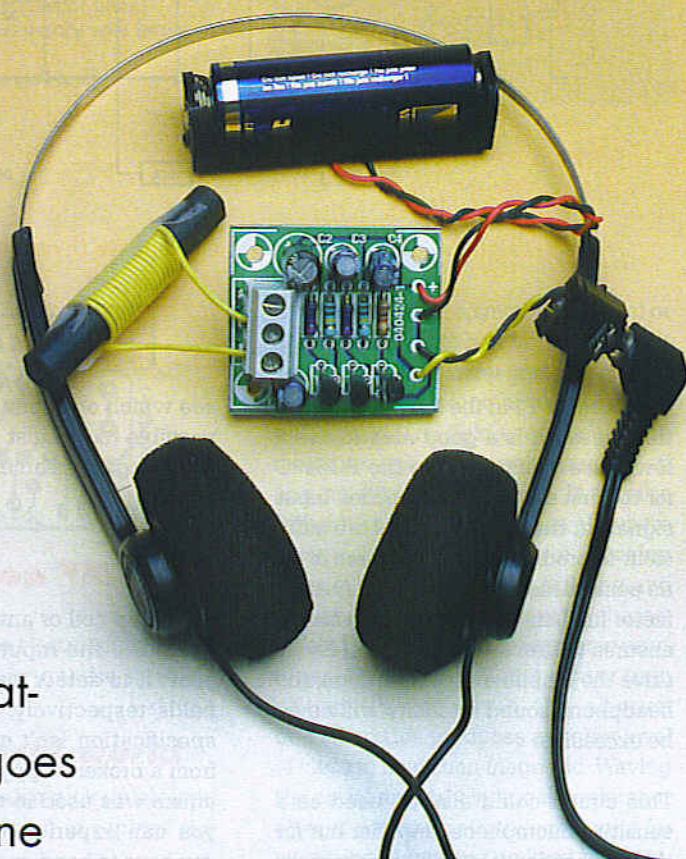

Electrosmog is a relatively new term referring to the electrical and magnetic fields (EMF) emitted by almost all the electrical equipment that we fill our environment with. Papers on the subject indicate that we cannot hear or see these fields but their effects on our body may prove to be harmful in the long term. The electrosmog detector is a very simple portable design that allows you to listen in to both magnetic and electric field activity. Take

the detector on a tour around your house or even around town, you will be surprised at just how noisy the invisible worlds of magnetic and electric fields can be.

The detector circuit

The circuit diagram shown in **Figure 1** consists of a sensitive LF (low frequency) amplifier with a headphone output socket. The three stage direct-

coupled amplifier automatically adjusts its bias point via a DC feedback path from the output through R4 and R2; any AC signal components are shunted to earth via capacitor C3. The output voltage level will be at 0.7 V with no input signal. The whole circuit runs from a supply voltage in the range of 1.2 to 1.5 V provided by a single battery. The amplification factor achieved by this configuration is so high that you can clearly hear the noise signal

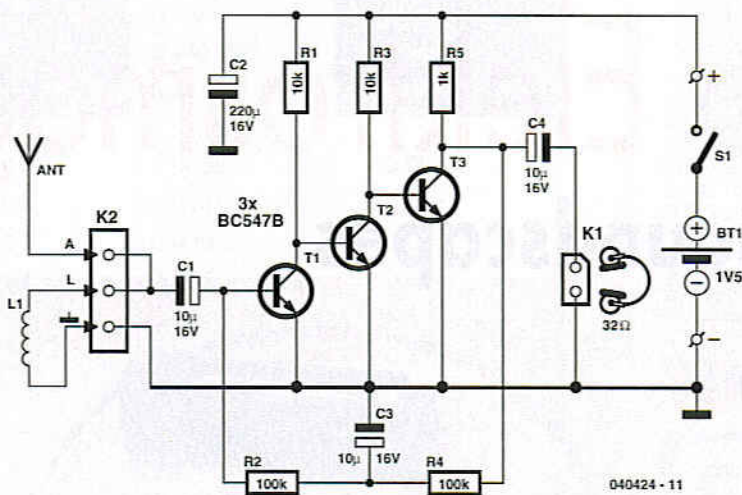

Figure 1. The circuit consists of a sensitive LF amplifier with an earphone output socket.

produced by T1 in the headphones. For this reason it is a good idea to use a low noise transistor like the BC549C for the first stage of the amplifier. Input signals at the microvolt level are sufficient to produce an output; there is little point in increasing the amplification factor further. The low supply voltage ensures that even if high signal levels drive the amplifier into saturation, the headphone sound intensity will never be excessive.

This circuit could also be used as a sensitive microphone amplifier but for this application it would be necessary to decrease the amplifier bandwidth so that unwanted HF signals will not be amplified. The detector circuit does not contain any low pass filters so it is sensitive to HF signals also. Non-linear transistor characteristics have the effect of demodulating these high frequency signals so that they also can be heard.

The circuit PCB shown in **Figure 2** greatly simplifies the job of construction. A three-way terminal block is used to connect the pick-up coil and aerial wires to the PCB while solder pins provide connections for the headphone socket and battery leads. A 3.5 mm jack socket (K1) allows normal Walkman type stereo earphones to be used. The output signal is mono so socket connections to the left and right earpieces can be wired either in parallel or series; try both connections to

see which one sounds best. It is also possible to use just a single earpiece providing it has an impedance greater than 32 Ω.

The EMF aerial

A pick-up coil or antenna can be connected to the input of the circuit to allow it to detect magnetic or electric fields respectively. The pick-up coil specification isn't critical, a flat coil from a broken floppy disk drive mechanism was used in the prototype but you can experiment with whatever you have to hand, in this case a screwdriver is far more useful than a calculator. A coil consisting of around 200 turns on a 20 mm diameter former can be wound up if you cannot find an alternative. The wire gauge is not critical. A ferrite rod or an open transformer core can also be used. The primary (230 V) winding of a small discarded mains transformer will also make an effective pick up coil because not all the magnetic field in a normal transformer is constrained to the core. It is these stray fields leaking from any transformer in operation that are picked up by the detector.

Magnetic-field noise sources

Using an air-spaced 200-turn coil it is possible to hear magnetic field activity generated by:

- Electrical appliances using mains transformers. These emit magnetic fields that can be detected up to 20 cm away.
 - A power cord or mains wiring concealed in a wall will only produce a field when power flows through the wires.
 - All types of fluorescent tube lighting produce a buzzing note with overtones. Low-energy lamps have a built-in voltage converter that produces a characteristic whistling.
 - An alarm clock with a quartz movement produces a double tick for each step of the second hand.
 - Switched-mode mains adapters emit a humming whistling sound.
 - Televisions and CRT computer monitors produce different frequency signals in the region around the screen and the power supply.
 - Loudspeakers and headphones emit magnetic fields as well as sound pressure waves.
 - DECT telephones periodically produce beeps when the phone is on-hook and send out a whole series of beeps and twittering when you make a call.
 - An oscilloscope produces a detectable magnetic field with a repetition rate equal to its timebase setting (turn up the beam intensity).
 - Equipment that is apparently switched off or in standby mode may produce signals; this indicates that the equipment is active and drawing current.
- Not so long ago you might have attracted some odd looks if you were to walk through town wearing earphones but now almost every other person you meet is plugged into their own source of personal entertainment so you will not cause too many raised eyebrows by taking the detector out onto the street. It is quite surprising to hear all the EMF activity that you can pick up while walking through town or visiting public buildings. Mains transformers are everywhere and can be recognised by their characteristic mains frequency hum. The High Street and shopping malls also has many examples of switched mode power supplies and each has its own individual spectrum of signals allowing the type of equipment to be identified with practise. Automated ticket dispensers and drinks machines also have their own characteristic sounds. Most museums and public places are now

COMPONENTS LIST

Resistors:

R1,R3 = 10k Ω
R2,R4 = 100k Ω
R5 = 1k Ω

Capacitors:

C1,C3,C4 = 10 μ F 16V radial
C2 = 220 μ F 16V radial

Semiconductors:

T1,T2,T3 = BC547B (for T1 also BC549C, see text)

Miscellaneous:

S1 = on/off switch, 1 contact
Bt1 = AA battery (preferably alkalimanganese) with holder
K1 = 3.5-mm jack socket, stereo (see text)
K2 = 3-way PCB terminal block, 5mm lead pitch
PCB, ref. **040424-1** (Elektor Shop)
L1 = pickup coil, if necessary with ferrite core (see text)
ANT = length of wire (see text)



Figure 2. Even though there are only a few components, construction is much easier with a PCB.

Figure 3. The author's original pick-up coil.

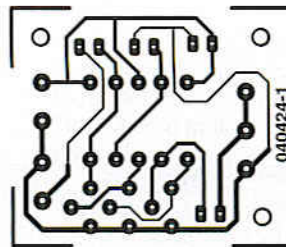
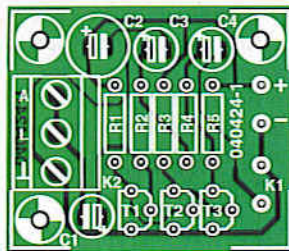

equipped with an inductive loop voice transmission system throughout the building (look for the blue sign with an ear symbol and the letter 'T'). This system allows the hard of hearing to pick up information on their hearing aid without any of the distracting back-

ground noises. The electrosmog detector can also listen in to these signals.

The Electrical world

The detector can also pick up electric field activity. To listen-in replace the

pick-up coil with a small stub aerial or short 10 cm length of wire. Place the aerial close to a power cord that is connected to the mains and you will be able to hear the field even though the mains switch on the equipment is off and no current is flowing. It is quite difficult to find any place at all where there are no humming or buzzing noises. Fluorescent tube lighting and low-energy lamps also have a characteristic sound with loud harmonic overtones. Oscilloscopes use a very high voltage to accelerate the electron beam and this produces a higher level of electric field than magnetic. Waving the aerial around electrical equipment always produces surprising results for example the buzzing emitted by a vacuum fluorescent display on the front panel of a stereo amplifier and more reassuring the relatively low level of fields produced by modern low-emission CRT monitors.

It is also possible to make the detector sensitive to both electrical and magnetic fields by fitting both the aerial and the coil at the input. Try experimenting with different lengths of aerial and other coils and don't be surprised if you pick up radio broadcasts, radio transmitters also produce alternating magnetic fields.

Two hundred years ago electrical storms and solar radiation were probably the only source of electric field activity on the planet but nowadays you would be hard pushed to find any corner of the globe that is not continually bathed in electrosmog!

Electrosmog in your ear

It is not only contemporary musicians and ambient/noise bands like Orbital, Nine Inch Nails and Einstürzende Neubauten who use sound to express themselves artistically. There is also a movement within contemporary art that specialises in locating, recording and manipulating unconventional sounds in the environment to make 'sound sculptures' or 'soundscapes'. For example, there has recently been UK media interest in the work of an artist who attaches sound sensors to railway suspension bridges. The German artist Christina Kubisch is also active in the field of 'sound art' and exhibited in Cologne in 2004 along with seven other artists from seven different countries. Visitors were invited to don a set of special headphones and take a stroll through the city. The headphones enabled them to actually hear magnetic fields in the busy city centre and the environment.

Engineer Manfred Fox developed the special headphones. Their design was based on inductive loop headsets used in museums and art galleries to provide visitor information. The inspiration for the project came when it was noticed that these headsets were also capable of picking up (unwanted) signals from other magnetic field sources in the exhibition area.

The artist's homepage is at: www.christinakubisch.de

(040424-1)

WiFi EAVESDROPPING

Is nobody safe any more?

Fedde Hettinga



If you want to keep up with the times you can buy a cheap WiFi/WLAN 'access point' and an expansion card or a plug-in device for your laptop. Have you done this already and do you use WiFi? You're not alone.

In the last year there has been a huge increase in the number of WiFi access points not just in the author's country (Holland) but all over the world. And why not? It is fast, simple, inexpensive and convenient, which are the most important considerations for many users. It's just not very secure, as we should all know by now. If you keep all the default settings during a WiFi access point installation, you know that you leave your network wide open to your neighbours, who then have the benefit of free Internet access. If there is a digital

peeping Tom amongst your neighbours, it may happen that your computer is searched for passwords and other personal information. That lesson should have been learnt by now, and those who still don't configure their access point properly shouldn't be surprised if their network is invaded.

And then there are the open WiFi networks, also known as 'hotspots'. These have become a common sight in cafés, airports and stock exchanges. Anyone who has a laptop with a WiFi card can use these to access the Internet and check his or her e-mails. Security doesn't appear to be a problem here. Aren't the hotspots open by design?

There are other security holes in WiFi. All information between the laptop and access point travels via radio waves and these can easily be picked up. Would it be possible to listen in on these wireless connections? If that is the case then the websites you visit, the e-mails you send and your MSN messages are no longer safe. Your private communications are simply left open to eavesdroppers. It's time to call in an expert! This expert is a first-year student in Artificial Intelligence. He has taken on the challenge to discover how WiFi communications work and if there is a danger that users' communications can be intercepted. The conclusion was that it was possible and the next section shows how it was done!

The theory

A wireless network allows several devices to communicate wirelessly with each other. For wireless computer networks WiFi (Wireless Fidelity, or 802.11) is the undisputed king. The maximum range of ordinary WiFi devices is about 100 metres indoors and 300 metres outdoors. The usual configuration of a wireless network is an 'access point', which is the central transmitter/receiver, and one or more 'wireless clients', which are computers equipped with a WiFi network card or a plug-in (USB) unit. In such a network, all traffic is routed through the access point. As long as wireless clients are within range of an access point, they can use that to communicate with each other. The access point often provides a connection to the Internet, providing all wireless clients with an independent Internet connection.

It is also possible to set up a network without using an access point. These have direct connections between the WiFi cards. This method is sometimes used to quickly set up a temporary connection between a small number of wireless clients.

The administrator of a network can give it a name, called the SSID (Service Set Identifier), to distinguish it from other wireless networks nearby (or to combine a number of networks). An access point announces its presence by regularly transmitting its name. In this way the wireless clients can discover which networks are available and set up a connection with them.

Protection

Wireless networks can be made more secure in two areas. Firstly, you can prevent third parties from gaining unauthorised access to the wireless network. The trans-

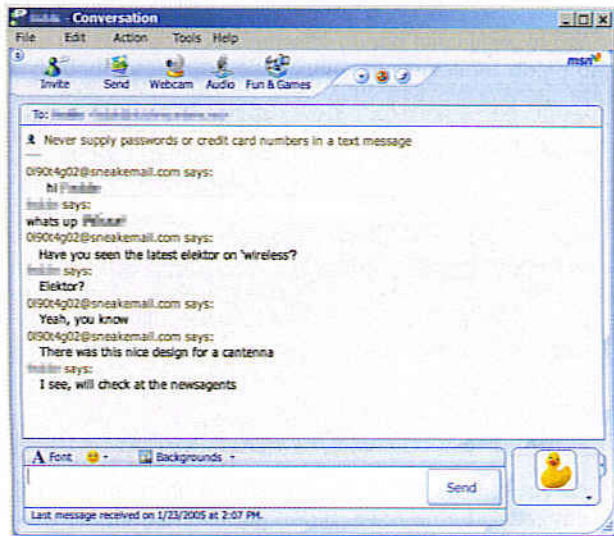

Figure 1. MSN conversation of an unwary user.

mission of the SSID can be turned off, hiding the presence of the network to wireless clients. It is also possible to restrict access to just a select group of wireless clients. This method makes use of a unique code stored in every network card, called the MAC address.

Another area that can be made more secure is the actual transmission of the data. Since all data is sent via radio waves it is possible for it to be picked up by outsiders. To keep the information secure all data can be encrypted. WEP (Wired Equivalent Privacy) is the most common standard for encrypting the data. This effectively lets the network communicate in a secret language. Outsiders who don't know the WEP key will only see gobbledygook.

The explosive growth in the number of wireless networks is due to the lower costs and their ease of use. Whereas in the past the setting up of a wireless network would be a challenge, these days it's a question of unpacking and connecting the equipment and then the software will do all the hard work for you. This ease of use often comes at

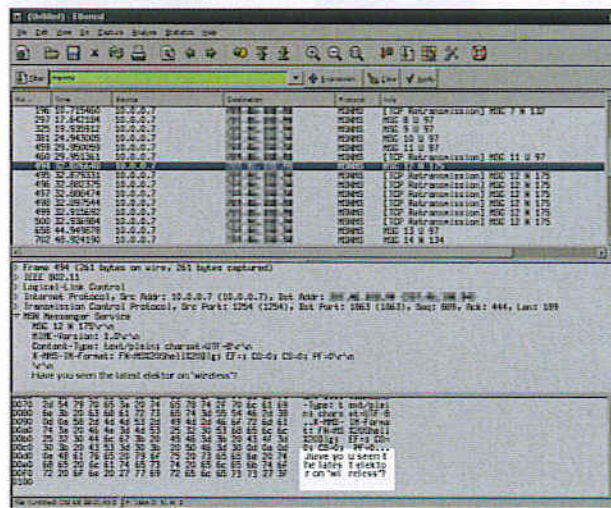

Figure 2. The same conversation captured out of thin air.

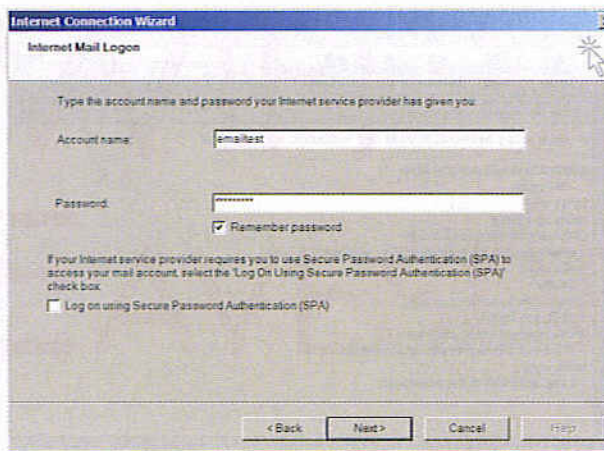

Figure 3. The logon details in an e-mail client.

the cost of reduced security. Worse still, most security settings are turned off by default and it is left to the user to enable them.

Upsurge in the number of WiFi networks

'Wardriving' (a term used to describe driving around with a notebook to search for open wireless networks) along the canals of Amsterdam three years ago resulted in dozens of wireless networks, an impressive number at that time. If you do the same today, you will quickly discover hundreds of networks. Despite this growth the ratio of secure to insecure networks has remained the same, which means that about half of all networks are insecure.

Information through the air

There are two risks involved with insecure networks. Outsiders can use the network, which often gives them access to the Internet connection and network devices such as computers and printers. It is less well known that they can also tap into all net-

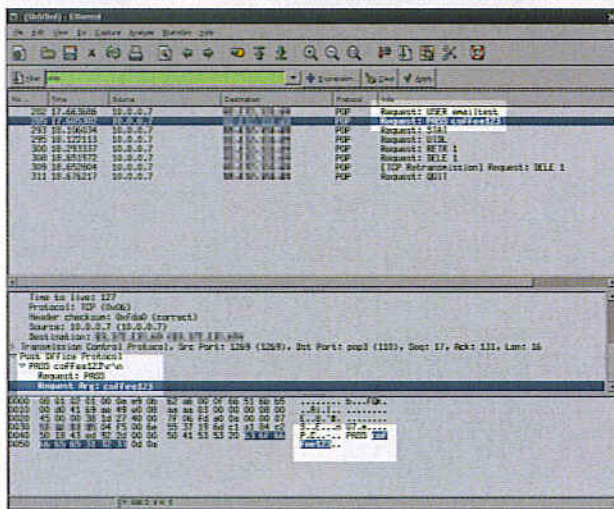

Figure 4. The same details in the log file.

work data; this includes everything from e-mail passwords to whole MSN conversations. Whereas it's possible to discover the first type of 'attack', it is virtually impossible to detect the second type of attack. The eavesdropping of wireless network traffic is therefore called a 'passive attack'.

But secure networks can be at risk as well. Some cafés nowadays offer their customers wireless access to the Internet. When WEP is used to encrypt the wireless data, the network would appear to be a lot safer. The customers have to request the WEP key from the counter before they can use the network. But we shouldn't forget that all computers on the network use the same key! Should you want to eavesdrop on the traffic of other customers, you only need to know the WEP key, which can be requested at the counter by anybody.

A passive attack

We mentioned earlier that every network card contains a unique code, called the MAC address. The same applies to every wireless network card. When data is transmitted over a network it is split up into one or more packets. Each of these packets has an identifier consisting of the MAC addresses of the sender and recipient. In a wireless network these packets will be received by all network cards that are within range of the transmitter. The network card will normally ignore all packets that are not destined for it. It is usually fairly easy to change this default behaviour of network cards. When a network card is put into a so-called 'monitor mode', it will accept all packets as if they were intended for it. In other words, a network card in monitor mode will receive the data of all wireless networks within range, which can then be stored on the computer. This information can be processed later.

Software

The best free software available runs under Linux and is called Kismet [1]. This program was specifically written to listen in on WiFi networks and therefore has special functions that are only relevant to WiFi networks. As an example, Kismet can run in a 'channel hopping' mode, whereby the WiFi receiver switches between the 13 available channels at a rate of 10 times per second. This increases the chance to discover wireless network traffic. Kismet can also detect hidden networks from the contents of the wireless network traffic. The security setting mentioned earlier, where the transmission of the SSID is turned off, is therefore circumvented. There is often so much traffic that it is impossible to see all e-mails and passwords on the screen. Fortunately, Kismet saves all received packets in a log file, which can be analysed at leisure at a later stage. A good (and free) program for this is 'Ethereal' [2], which runs under Linux and Windows. One of the features of this program is to analyse log files, such as those generated by Kismet. E-mails, MSN conversations and passwords are easily extracted with the help of a comprehensive filter function.

A realistic test

At the end of the day we want to see hard facts that prove that this approach works. For this test we used a

simple setup with two laptops. One of the laptops has a normal wireless Internet connection via an access point; the other is used with its WiFi card in monitor mode. As soon as the first laptop transmits data, the second captures it to the Kismet log file. When we later open this file with Ethereal and apply the MSN filter, we can see the whole conversation. We can't think of a better proof than this (Figures 1 and 2).

Before we leave our test environment and venture into the outside world, we'd like to carry out one more test. Here we try to capture the logon details of an e-mail account. The unsuspecting user checks his e-mails and all data ends up in the Kismet log file again. When we apply the POP3 filter in Ethereal the user name and password appear on the screen within a matter of seconds (Figures 3 and 4).

During the testing it became clear that not all packets were captured. The traffic between the laptop and access point uses just one of the 13 available channels because a WiFi card is incapable of using several channels simultaneously for data communications. However, Kismet tries to keep an eye on as many wireless networks as possible. It does this using a process called channel hopping, where it switches channels a maximum of 10 times per second. This is useful when you're trying to discover many networks. However, this can have a negative effect when you're trying to monitor a specific network, since Kismet will listen to the wrong channel 12 out of 13 times.

Fortunately there is a solution to this. In Kismet you should select the network that you want to listen to and press SHIFT + L. Kismet will then listen to the single channel for that network. SHIFT + H is used to make Kismet switch back to its normal channel hopping mode.

In the real world

And now back to the real world. The first trials with a 'sniff-bag' (a rucksack with a laptop) returned a flood of data. A stroll through the residential areas of Amsterdam yields, apart from hundreds of access points (more than half of which were insecure), a large amount of personal information. We captured all kinds of data: web accesses (HTTP), received e-mails (POP3), sent e-mails (SMTP) and dozens of MSN messenger conversations. The captured surfing data tells you which sites are visited, which is not terribly exciting. What is interesting is the e-mail traffic. This is where we enter the private domain of the unsuspecting WiFi user. The username and password fly across the screen, along with the sent and received e-mails. The most intimate MSN conversations are also there for the world to see.

For our second experiment we targeted the business community. This group appears to have its own working hours and hobbies. At Schiphol Airport, near the business class lounge, everything was quiet. Other WiFi hotspots in this airport didn't return many results either. But who was this 'Butch102' who sent this message: 'so when I join another corp I leave this one'? Is he really going to change his job? On further investigation we found that Butch102 was happily playing the game 'EVE Online'. Perhaps we have to get out of bed a bit earlier to catch the first horde of businessmen and discover which games they play.

Next we carried our equipment around the restaurants and cafés in posh Amsterdam, during lunchtime. In one crowded café there where many conversations going on, but hardly any surfing was seen to take place. If you want to discover some commercially sensitive information you stand a better chance if you just listen to the conversation at a nearby table.

Afterwards, on the way home, we achieved better results near a coffee shop. Here we saw a multitude of MSN messages and a variety of web pages flew across the screen. The best results are therefore in normal residential areas, where members of the family use the notebook to check their e-mails.

Do it yourself

If you don't mind breaking the law and want to spy on your neighbour's surfing habits, e-mails and chats, you need a Linux computer that runs Kismet and Ethereal. For those of you who don't have much experience in installing Linux, there is Auditor, a free Linux distribution that doesn't require installing [3]. After downloading this distribution it has to be unzipped (using WinZip) and then burnt on a CD (from Nero you should use 'File' → 'Burn Image'). Next, the laptop or computer has to be configured to boot from the CDROM. All you have to do now is to turn on the computer with the CD in the drive.

(050083-1)

Internet addresses

- [1] www.kismetwireless.net
- [2] www.ethereal.com
- [3] www.remote-exploit.org



MikroElektronika

MICROCONTROLLER DEVELOPMENT TOOLS

from Breadboarding Systems

Make PICmicro[®] development easy with the EasyPIC2 - *only £99!*

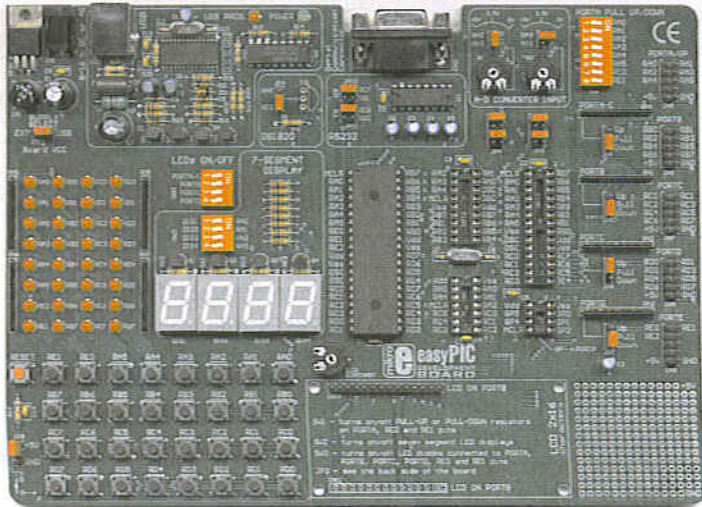

The MikroElektronika EasyPIC2 Development Board combines a versatile development/experiment board with a built-in USB programmer. With its wealth of on-board I/O devices and support for virtually all 8, 14, 18, 28 and 40-pin PICmicro[®] microcontrollers in the 12F, 16F and 18F families, we're certain you won't find a more versatile high quality board at such a low price.

The EasyPIC2 Development Board is supplied with USB programming/power cable, programming software and useful example programs.

Also available are similar boards for the 8051, AVR and dsPIC, each at the same great price of £99 including UK delivery and VAT—please telephone or see our website for further details.

EasyPIC2 Development Board features:

- High quality development/experiment board with built-in USB programmer.
- Programming software compatible with Windows operating systems including 2000 and XP.
- Comes with a PIC16F877A microcontroller but compatible with virtually all 8, 14, 18, 28 and 40-pin PICmicro[®] devices in the 12F, 16F and 18F families.
- On-board I/O devices including switches, LEDs, seven-segment displays, potentiometers and RS-232 interface.
- Provision for easy fitting of optional LCD display and DS1820 temperature sensor.
- All I/O lines available for off-board expansion.
- Wide range of optional add-on boards available including ADC, DAC, EEPROM, Compact Flash, RTC, RS-485, CAN and IrDA.
- Powered from your PC's USB port or optional mains adapter.
- Supplied with example programs written in assembly language, BASIC, C and Pascal.
- Supplied with Microchip Technology's MPLAB development software and demonstration versions of MikroElektronika's MikroBASIC, MikroC and MikroPascal compilers.

Learn about microcontrollers with our EasyPIC2 Starter Pack - *just £149!*

We've taken the EasyPIC2 Development Board and added a 16x2 character LCD display, matrix keypad, DS1820 temperature sensor, RS-232 serial communications cable, various different PICmicro[®] microcontrollers and our own easy-to-follow microcontroller tutorial to form a complete and self-contained Starter Pack—everything you need to learn about and experiment with microcontrollers! With this pack you will quickly become proficient in microcontroller programming and interfacing. Please see our website for list of covered topics.

Please visit our website for details of other MikroElektronika products

We stock the full range of MikroElektronika development boards and compilers for PICmicro, AVR, 8051, PSoC and dsPIC microcontrollers. Products may be ordered on-line at www.breadboarding.co.uk or by telephoning 0845 226 9451 using all major credit and debit cards. Our prices include delivery within the UK and VAT.

Call **0845 226 9451** or order online at www.breadboarding.co.uk

INDUSTRY LEADING DESIGN SOFTWARE

NEW

B² Spice v5

FREE 30 DAY TRIAL

FULL - OPERATIONAL SINGLE USER VERSION

Used worldwide by higher education, research and industrial professionals B2 SPICE is a powerful and most importantly, ACCURATE software package for professional and enthusiast alike.



New Powerful functions

FEATURES

- Instruments – Meters, Scopes, Transient Recorder, Function Generator, Power Supply
- Test mode, equivalent to the standard SPICE analyses and a separate continuous transient simulation mode that allows you to interactively alter device and circuit parameters and examine the results immediately
- Layered sweeps, meaning you can step almost any device or circuit parameter on top of any Test
- Monte Carlo analysis available for all tests
- Easier part selection, including a customizable Parts Palette
- User-friendly interface with buttons and control tabs
- Live updating in Simulation mode
- Circuit wizard makes it easy to generate standard circuits including Attenuators, Power Supplies, Filters, Op-Amp and Tube-based Circuits
- Tabbed-based Windows
- Highly flexible graphing
- 3D graphing

+10 NEW VIRTUAL INSTRUMENTS

- NEW "realistic" models for caps, resistors, inductors
- Interactive parts including switches, fuses, LEDs, etc.
- Layered Sweep tests (expanded).
- Expanded Monte-carlo tests

B2 SPICE is backed by comprehensive technical support both local rate telephone and online, full user manuals and tutorials and a NO QUIBBLE, FREE 30 DAY EVALUATION OFFER

ONLY
£229 INCLUDING p&p
Ex VAT



CALL 01603 872331

www.spice-software.com



SOLAR POWER

Solar charging with and without a controller

Jens Nickel with contributions by David Gibson

Complicated charge controllers and inverter circuits can be used to squeeze the last drop of energy out of a solar panel. Contrary to popular belief, however, it is also possible simply to connect the battery directly to the panel.



Figure 1.
An isolated solar panel system gives a degree of independence from the mains. (photo: Phocos)

During a sunny day the UK receives up to about 1000 W/m^2 of solar energy. It seems absurd to let this clean source of energy go to waste. Solar cells, of which the majority on the market are made from crystalline silicon, convert sunlight directly into electrical current. The manufacture and purification of silicon suitable for solar cells from silicon dioxide (quartz sand) is energy-intensive and therefore expensive. Nevertheless, the widely-held opinion that a solar panel (in which a number of the fragile solar cells are mounted and wired together) can never recoup the energy expended in its manufacture is not correct. The energy amortisation time for a commercially-available large-scale panel delivering 100 W to 200 W of power is, depending on its construction (whether it has an aluminium frame or not), in the region of 2 to 3 years.

Self-sufficiency with solar power

It is possible to connect an array of panels on the roof of a house or in the open to the national grid via an inverter, and then sell the energy generated back to the electricity company. In some countries, the refund is more per unit than the normal cost of supply. Where the grid is not available, for example on a boat or in a remote holiday home, or for buoys, emergency telephones on motorways and similar uses, solar panels are used in a different way (**Figure 1**). Isolated systems like these need a battery. The best price-performance ratio is still offered by lead-acid accumulators, although other types, such as NiCd cells, are used in smaller systems such as measuring devices. Special lead-acid batteries for solar use are available, with better charge-discharge cycle reliability

MADE SIMPLE

and lower self-discharge than commercially-available automotive batteries. The so-called charge controller connects together the components of a solar power generation system: the solar panels, the batteries, and the load. Its most important function is to protect the batteries from overcharging; then, in decreasing order of importance, protection against deep discharge, the maintenance or restoration of the capacity of the battery and its ability to accept charge, the efficient use of solar energy and finally convenient operation and monitoring of the system. The greater the power demands on the system, the more worthwhile complex and expensive multi-function charge controllers become. As well as the cost of the system, the amount of power wasted must be taken into account. In very small systems the charge controller can even be dispensed with, as we shall see later.

Solar cells: the basics

An ideal solar cell can be modelled as an ideal current source with an ideal diode connected in parallel (Figure 2). A part of the photocurrent generated in the cell, which depends on the lighting level and on the area of the cell, flows through the ideal diode and so the usable output photocurrent is given using the familiar diode formula:

$$I = I_{\text{phot}} - I_{\text{Diode}} = I_{\text{phot}} - I_0 [\exp (eU/kT) - 1]$$

Plot U against I and we obtain the characteristic curves shown in Figure 3. The lighting level increases from below left to above right. With no load connected the open-circuit voltage can be measured across the cells: in the case of silicon cells this is a little under 0.6 V (at a lighting level of 1000 W/m^2 and a temperature of 25°C). Short-circuit the cell, on the other hand, and a (theoretical) short-circuit current flows.

The maximum power output is obtained at the marked points, the so-called MPPs (maximum power points). In general a panel contains cells wired in series and in parallel to obtain both a higher voltage and a higher current. Depending on the cell and panel type, up to between 80 W/m^2 and 150 W/m^2 of power can be obtained, which represents an energy conversion efficiency of between 8% and 15%. As temperature rises the power from the panels falls, typically by between 0.2% and 0.5% per 1°C . Panels themselves can be connected together to form bigger power sources.

Charging the easy way

If the nominal output voltage of the solar panel is greater than that of the battery there is no reason why the battery cannot be connected directly to the panel. This might seem surprising at first sight, but let us dispose of a couple of myths:

– If the battery voltage is considerably less than the nominal voltage of the panel, a voltage divider or similar circuit must be used. In fact, a 12 V panel can be con-

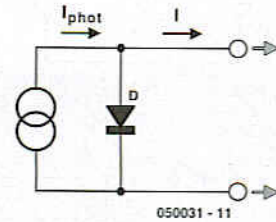

Figure 2. Equivalent circuit of an (ideal) solar cell: an (ideal) current source in parallel with an (ideal) diode.

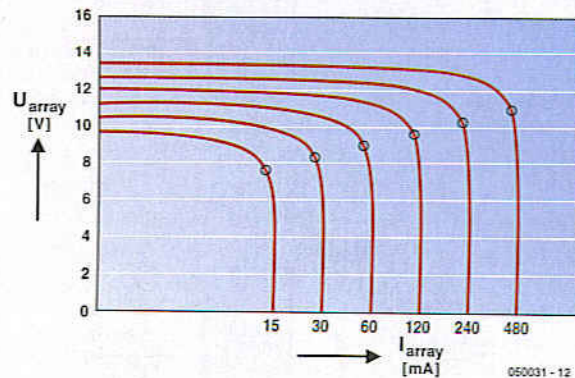

Figure 3. Characteristic curves of a solar panel at various light levels. The maximum power points (MPPs) are shown.

nected directly to a 3 V battery without damaging it: see Figure 3. A 12 V solar panel does not work as a voltage source with a constant output voltage of 12 V but rather as a current source. The only thing that will happen is that the panel will be operated a long way down its characteristic curve.

– The charge current must be controlled. In fact, the only criterion is that the panel power and the battery capacity need to be reasonably matched to prevent damage from overcharging (see below).

In darkness a directly-connected battery will partly discharge itself due to a small current flowing back into the solar panel. This can be prevented using the very simple circuit shown in Figure 4. In practice this simple circuit, without any kind of charge controller, is suitable for use in very small systems where the current produced by the solar panel is smaller than the maximum acceptable trickle charging current for the battery. NiCd batteries can be overcharged for up to 100 hours if the current (in amps) is less than a tenth of the capacity (in amp-hours). A small panel with a nominal current of 2 A can therefore be used to charge a 20 Ah battery without additional circuitry as long as a load discharges the battery from time to time. This is the case, for example, with an illuminated house number which comes on automatically at night.

Moderation in all things

Lead-acid batteries with a liquid electrolyte evolve gas when overcharged, which can ultimately result in damage to the battery. A charge controller can be used to prevent overcharging by disconnecting the battery. There

Figure 4. This circuit is adequate for very low power panels.

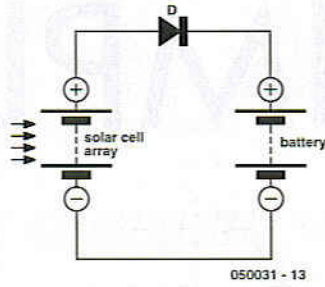

a

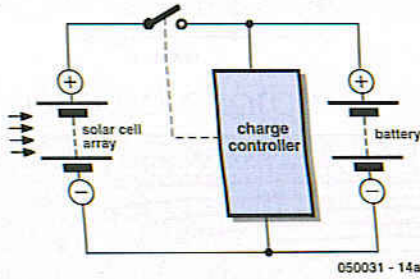

b

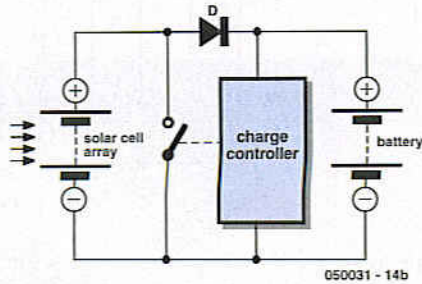

Figure 5. A charge controller provides protection against overcharging. Charging is interrupted using either a series (left) or shunt (right) technique.

Figure 6. Principle of a variable DC-to-DC converter for solar charging. Observe that it is the input voltage, not the output voltage, that is varied.

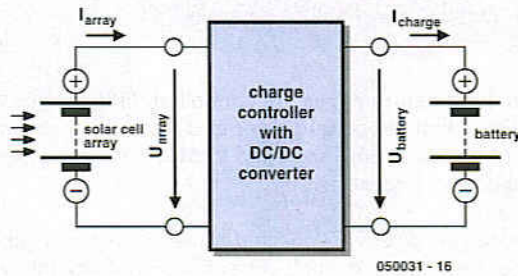

Figure 7. Two charge controllers, one made by Steca (left) and another by Phocos (right). With overcharging and deep discharge protection, MPP tracking and a host of extra functions, these units offer a complete charge control solution. (photos: Steca, Phocos)



are two different ways this can be achieved (Figure 5). In a series regulator the controller breaks the charging circuit, whereas in a shunt regulator a low-value resistor is switched in parallel with the panel so that the current from the panel flows through it. The diode shown is of course essential in this circuit! Switching is normally done using a semiconductor circuit. Ideally, once the battery is fully charged, a small charge current should continue to flow to maintain a constant terminal voltage. This can be achieved by the charge controller regularly and briefly connecting the panel to the battery with timing determined by the battery voltage. In practice pulse-width modulated systems operating at a fixed frequency are used.

Top-notch charge controllers

Maximum power is obtained from the panels when they are operated continuously at the MPP. In this case the panel voltage must vary continuously and be independent of the battery voltage. This function is built into some charge controllers using an adjustable DC-to-DC converter (Figure 6). Adjusting the operating point to follow the MPP as the light conditions change, typically every minute or so, is called MPP tracking. The efficiency gains from this technique are generally grossly overestimated: experiments show that the efficiency gain over an unregulated system is only about 5%. Since any DC-to-DC converter will involve losses and the MPP tracker makes the charge controller more expensive, this approach is only worthwhile in medium-to-large scale installations (from 200 W upwards).

A simple method for determining the MPP voltage is to measure the open-circuit voltage of the panel from time to time. The characteristic curves (Figure 3) show that the voltage at the MPP is about 80% of the open-circuit voltage. For even more efficient charging the charge current must also be monitored continuously. The panel voltage is then adjusted so as to maximise the charging current. As already mentioned, modern solar charge controllers offer a range of extra functions (Figure 7). Almost all the devices offer protection against deep discharge and disconnect the load if the battery becomes dangerously discharged. More expensive units include meters to indicate charge state, a display and even remote control functions.

(050031-1)

SERIAL COMMUNICATIONS SPECIALISTS

Test and Measurement Solutions



featured products



NETCOM-813
8 Port RS232/RS422/RS485 model
£350

NETCOM Ethernet- Serial Servers

NetCom are industrial strength, network based serial device servers for connecting RS232, RS422 and RS485 serial devices directly to a 10/100Mbps Ethernet network running TCP/IP. Netcom can control 1 or more serial devices located virtually anywhere (via Ethernet or Internet). NetCom can be configured over Driver Panels, WEB Browser, Serial Port, Telnet or SNMP and serves as a transparent serial channel without platform and distance limitation. Housed in a sturdy metal enclosure including DIN rail mount, one to eight port models are available. 19in rack-mount versions with internal switch mode PSU can also be supplied.

priced from £85 (NetCom 111)



DS1M12 Oscilloscope / Datalogger
2 1MS/s Input Channels + waveform generator output
£125

USB Instruments - PC Oscilloscopes & Logic Analyzers

Our range of PC Instruments may be budget priced but have a wealth of features normally only found in more expensive instrumentation. Our DS1M12 and PS40M10 oscilloscopes have sophisticated digital triggering including delayed timebase and come with our EasyScope oscilloscope / spectrum analyzer / voltage and frequency display application software and our EasyLogger data logging software. We also provide Windows DLLs and code examples for 3rd party software interfacing to our scopes. Our ANT8 and ANT16 Logic Analyzers feature 8/16 capture channels of data at a blazing 500MS/S sample rate in a compact enclosure.

priced from £125 (DS1M12 & ANT8)



USB-16COM-RM
16 Port USB Serial Server Rack Mount with Internal PSU
£265

1 to 16 port USB to Serial Adapters

With over 16 different models available, we probably stock the widest range of USB Serial Adapters available anywhere. We offer converter cables, multi-port enclosure style models in metal and plastic, also rack mount units such as the USB-16COM-RM opposite. Serial interfaces supported include RS232, RS422 and RS485. We also supply opto-isolated RS422 and RS485 versions for reliable long distance communications. All our USB Serial products are based on the premium chipsets and drivers from UK company FTDI for superior compatibility, performance and technical support across Windows, MAC-OS and Linux platforms.

priced from £20 (US232B/LC laptop Companion)



PCI-800L
8 Port PCI RS232 Serial card
£150 (including cables)

PCI Serial Cards

Discover our great value for money range of multi-port PCI serial cards. Supporting from two to eight ports, the range includes RS232, RS422, RS485 and opto-isolated versions. Our 4 port and 8 port models can connect through external cables or the innovative wall mounting COMBOX.

EasySync Ltd

373 Scotland Street, Glasgow G5 8QB, United Kingdom
Tel : 0141 418 1081 / Fax : 0141 418 0110

Web : <http://www.easysync.co.uk>
E-Mail : sales@easysync.co.uk

* Prices shown exclude PP and VAT where applicable

Solar-Powered Charger

Solar cell lead-acid charger

Paul Goossens

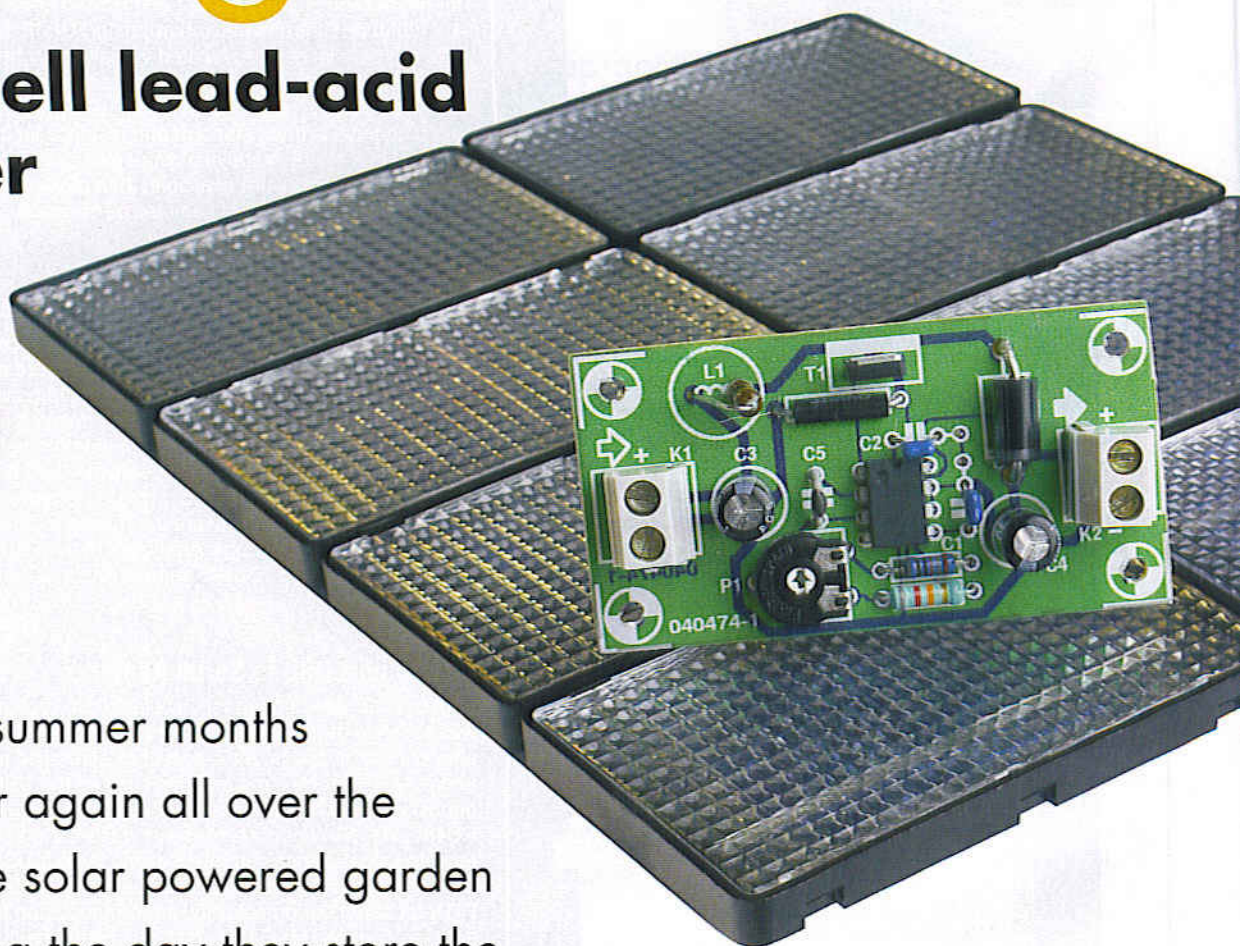

During the summer months they appear again all over the place: those solar powered garden lights. During the day they store the captured solar energy, which is used at night to provide lighting. If you'd like to use this energy for something different, such as listening to the radio or playing a CD, you'll find this circuit fits the bill.

During the summer we all thoroughly enjoy the sunshine. In this way we also experience just how much energy we receive from this big star.

All those people on the beach who end up looking like a lobster can certainly attest to this; a moment of carelessness and you could be subject to

an excess of thermal and radiation energy. We even pay to protect ourselves against this energy, buying suntan lotions and creams.

Even the wind and ocean currents are powered by the sun. Enormous amounts of energy are involved here as well.

We're not that interested here in changing our skin colour to a bright red (a nice tan is welcome though), neither do we welcome storms and dangerous sea currents. But all that energy that we could tap into for nothing is very appealing.

Solar power

Mankind has discovered a number of different 'converters' to change the sun's energy into a more useful form. This group of 'converters' (after all, they convert energy from one form into another) is known as solar cells. The

solar cell that converts the sun's energy into electrical energy is of course of most interest to us.

Such a photovoltaic cell produces an open-circuit voltage of about 0.55 V. This voltage drops as soon as a load is applied. These cells are in their element when the voltage has dropped to 0.45 V, since they are then working at their optimum efficiency.

Storage

The biggest problem with solar power is that it is not always available at the time when it is required. The solution to this is very simple: temporarily store this energy until such time that it is required. A lead-acid battery is often used for the temporary storage of this energy. The advantage is that a lot of (camping) equipment is designed to run off 12 V, so that they can be powered directly from the battery.

We can't just connect one or more solar cells directly to a lead-acid battery to charge it. The voltage from one cell is too small to charge the battery, whereas the voltage from a number of cells connected in series depends very much on the load they drive and the amount of solar energy striking the cells.

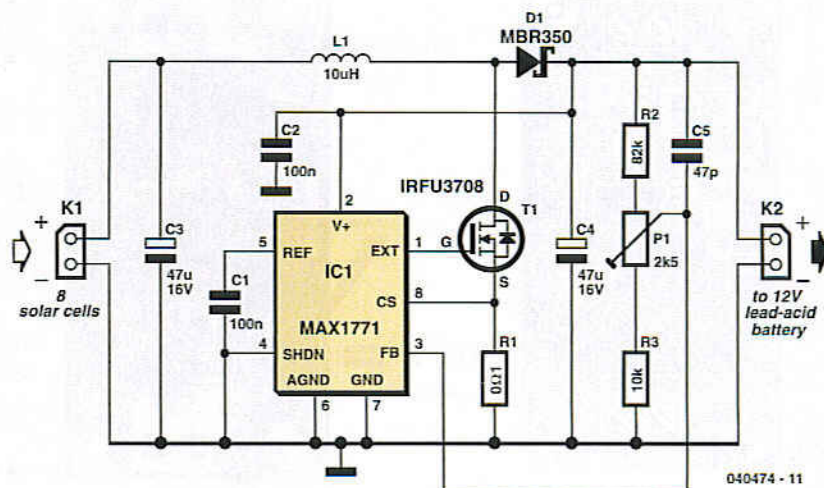

Figure 1. A simple step-up converter is sufficient to charge a lead-acid battery using just a few solar cells.

Charging voltage

A charger should have an output of about 13.5 V to 14 V in order to provide a constant charge to the battery without overcharging it. We are out of harm's way as long as we regulate the voltage.

For this we could use a standard series regulator, a step-up converter or a step-down converter. Both the series regulator and step-down converter require an input voltage that is higher than the output voltage. For both these options we have to connect a number of solar cells in series to provide an output that is greater than 14 V. This quickly takes us beyond 24 solar cells. This would be a costly option since solar cells don't come cheap.

A step-up converter works with an input voltage that is lower or equal to the output voltage. This type of circuit can therefore be used with a smaller number of solar cells. This can always be expanded with more cells by connecting them in parallel to capture more energy.

The circuit

The circuit designed by us (Figure 1) couldn't be simpler. IC1 only requires a handful of components to make a step-up converter. The supply for the IC comes directly from the battery. This

means that when the solar cells don't supply any energy, the circuit still takes its power from the battery. Since this current is very low, the battery won't discharge in a hurry.

The voltage from the solar cells is connected to K1. The IC makes FET T1 conduct, which causes a current to flow through L1. This turns the electrical energy into magnetic energy, which is stored in the inductor. When the current has exceeded a certain value the IC turns off the FET. At that instant the inductor attempts to maintain the current flow. In this way a voltage is induced so that the current can flow via D1 to the battery. In this manner the magnetic energy is converted back into electrical energy.

The current through the inductor should not rise too far. The IC is provided with current limiting to stop this from happening. The current through the inductor is converted into a small voltage via shunt resistor R1. The IC turns off the FET as soon as this voltage rises above 0.1 V.

Resistors R2, P1 and R3 are connected as a potential divider. This means that the voltage at the wiper of P1 is directly proportional to the output voltage. The IC attempts to keep this voltage fixed at 1.5 V. P1 can therefore be used to adjust the maximum output voltage.

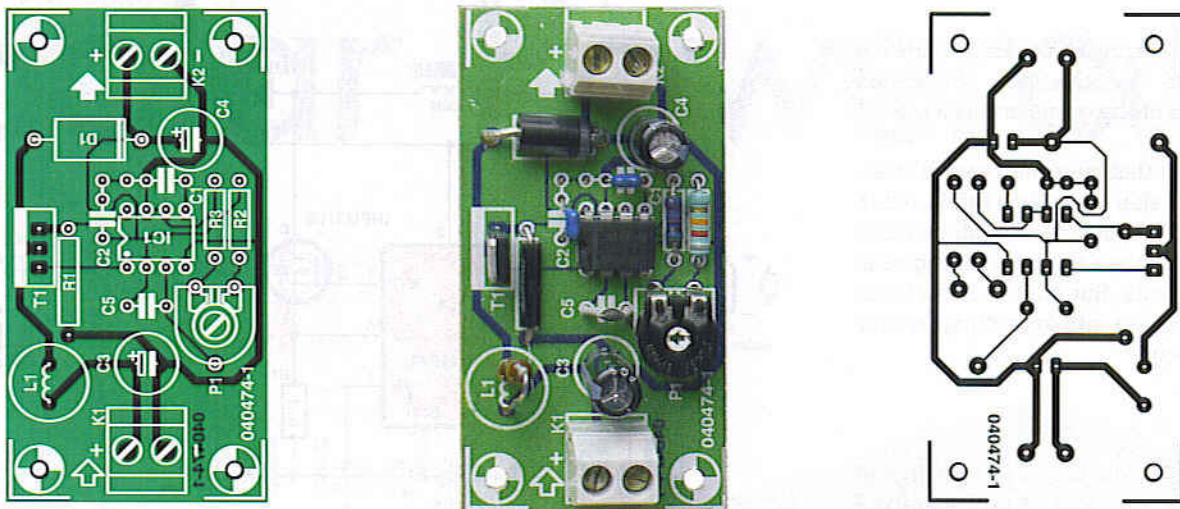

Figure 2. PCB layout for the solar lead-acid charger.

COMPONENTS LIST

Resistors:

R1 = 100mΩ (e.g. Digikey # 12FR100OH-ND)
 R2 = 82kΩ
 R3 = 10kΩ
 P1 = 2Ωk5 preset

Capacitors:

C1,C2 = 100nF
 C3,C4 = 47μF 16V radial
 C5 = 47pF

Semiconductors:

D1 = MBR350 (Digikey # MBR350-ND)
 IC1 = MAX1771-CPA (Digikey # MAX1771EPA-ND)
 T1 = IRFU3708 (Digikey # IRFU3708-ND)

Miscellaneous:

K1,K2 = 2-way PCB terminal bloc, lead pitch 5mm
 L1 = 10 μH high current (Digikey # M6007-ND)
 PCB, ref. 040474-1 from The PCBShop
 8 solar cells (e.g., Conrad Electronics # 198056-62)

Construction

There is nothing much to say about the construction itself.

When the circuit has been built you must first calibrate it before using it. Connect a number of solar cells in series to connector K1 and place them in bright sunlight. Don't connect the battery at this stage yet. Now measure the voltage on connector K2. Adjusting P1 will vary this voltage slightly. Set P1 such that the output voltage is somewhere between 13.5 V and 14 V. A battery can withstand these voltages continuously without coming to harm. You can now connect the battery to K2, making sure that you have the polarity right. The positive terminal of the battery should connect to the + of the circuit!

Experimentation

It is perfectly normal that the output voltage decreases when the battery is connected. This doesn't mean that the

battery isn't being charged, just that the solar cells cannot provide enough power to charge the battery as quickly as possible.

It is very easy to check that the battery is being charged. Disconnect the battery from the circuit and measure (after waiting at least 30 seconds) the battery voltage. Now reconnect the battery to the circuit and make sure that sunlight strikes the solar cells. Measure the battery voltage again and compare it with the previous measurement. If the voltage is now a bit higher, the battery is being charged. If this isn't the case then the solar cells aren't providing enough power.

You may get some improvement if you place them in direct, bright sunlight. It also helps if the solar cells point directly towards the sun.

More, I want more!

The circuit will work quite well with 8 solar cells connected in series. This is

a reasonable compromise between the cost and the charging time/efficiency. You will always get an improvement if you connect more solar cells in series. You should limit the number of cells to 24, as the voltage could otherwise become too high, which would have nasty consequences!

Once the output voltage is equal to the value set up during calibration, adding any more solar cells won't have any effect. The extra energy will just remain unused. But when the sun shines less brightly, the voltage may drop, when a few extra solar cells would prove useful.

If you really want to connect more than 24 solar cells to the circuit, you should connect them in parallel. This won't cause a rise in the open-circuit voltage, but the solar cells will be able to provide a larger current.

(040474-1)

DON'T LOSE YOUR TEMPER

Before phoning us - if you are looking for a hard-to-find part. We have over 20,000 items in stock - including obsolete and up-to-date parts.



WHY NOT VISIT OUR WEBSITE
www.cricklewoodelectronics.com

2N 2SA 2SB 2SC 2SD 2P 2SJ 2SK 3N 3SK 4N 6N 17 40 AD
 ADC AN AM AY BA BC BD BDT BDV BDW BDX BF
 BFR BFS BFT BFX BFY BLY BLX BS BR BRX BRY BS
 BSS BSV BSW BSX BT BTA BTB BRW BU BUK BUT BUY
 BUW BUX BUY BUZ CA CD CX CXA DAC DG DM DS
 DTA DTC GL GM HA HCF HD HEF ICL ICM IRF J KA
 KIA L LA LB LC LD LF LM M M5M MA MAB MAX MB
 MC MDAJ MJE MJF MM MN MPS MPSA MESH MPSU
 MRF NJM NE OM OP PA PAL PIC PN RC S SAA SAB
 SAD SAJ SAS SDA SG SI SL SN SO STA STK STR STRD
 STRM STRS SV1 T TA TAA TAG TBA TC TCA TDA TDB
 TEA TIC TIP TIPL TEA TL TLC TMP TMS TPU U UA
 UAA UC UDN ULN UM UPA UPC UPD VN X XR Z ZN
 ZTX+ many others

We accept Mail, telephone & email orders.
 Callers welcome.

Opening hours Mon-Sat 9:30 - 6:00

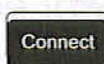

Cricklewood Electronics Ltd

40-42 Cricklewood Broadway London NW2 3ET
 Tel: 020 8452 0161 Fax: 020 8208 1441
sales@cricklewoodelectronics.com

PCB-POOL®

SERVICING YOUR COMPLETE PROTOTYPE NEEDS

- Prototypes at a fraction of the cost
- Industry standard quality
- Tooling and setup included
- Follow up series runs
- Any contour
- CAM / CAD consulting
- Fr4 1.6mm, 35µm Cu

PRICE EXAMPLE:
1 EUROCARD DS-PTH
 + Tooling
 + Photoplots
 + VAT
 = £ 29.89*



FREE



Tel: +353 (0)141 701170
 Fax: +353 (0)141 701164
 E-Mail: sales@beta-layout.com

Freephone
0800-389 8560

Simply send your files and order ONLINE:

WWW.PCB-POOL.COM



For rapid development of electronic systems...

NEW



E-blocks are small circuit boards each of which contains a block of electronics typically found in an electronic system. E-blocks can be programmed in C, Assembly and are tightly integrated with Flowcode - which instantly converts flow charts into PICmicro code.



Low cost USB PIC
 programmers
 (Starting at £27, model
 shown £65)



...plus a wide range of
 add-on boards and
 accessories...



.....plus incredibly easy
 to use software based on
 flow charts...

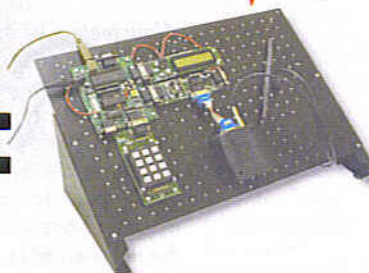

...equals extremely rapid system
 development: like this mobile text messaging
 system built from E-blocks.

...and solutions for learning and development...

Hands on training
 courses



training courses in PICmicro(R)
 programming, CPLD programming and
 ECAD

Resources for learning
 CPLD programming



Complete courses in
 electronics and programming



Equipment for datalogging,
 control and PC 'scopes



...and more at:



...see www.matrixmultimedia.co.uk

Matrix Multimedia Limited
sales@matrixmultimedia.co.uk
 t. 0870 700 1831 f. 0870 700 1832

ENERGY SAVING

trace energy wasting equipment

Karel Walraven (Elektor Labs)

Being mindful of our delicate environment starts at home with a thorough hunt for all electrical equipment large and small that's wasting energy and silently adding to your electricity bill. A direct reading or logging power consumption meter is very useful for this, and investing in one (perhaps together with your neighbour) gives peace of mind and possibly a financial return in the long term.

Wattmeters or energy monitors or as they are sometimes called can be bought at reasonable prices these days and may allow you to achieve considerably electricity savings. Any household has a many electrical devices that silently conspire to add considerably to your electricity bill simply because they are on all the time: the TV set (how many do you have?), the cordless phone, the mobile phone charger, the alarm clock, the kitchen radio, the list is endless. Lighting, too, often consumes more energy than you would expect. In your living room you may have halogen or low-energy lamps, but what about the stairway? Having the lights on there for an hour or so may well consume as much power as all of the living room lighting for the whole evening.

Stealthy consumers

Of course you want to enjoy the comfort of your home, at a price. However, unnecessary energy use is always bad, for your wallet as well as the environment. Significant savings may be earned simply by measuring the power consumption of every electrical appliance in your home. In your household, much energy is consumed by equipment that's left on all the time. Just tot up the power consumption of all 'small' loads and take a deep breath...

We may point the finger to these stealth consumers:

– firstly, all mains adapters (a.k.a. battery eliminators) are prime suspects. These will typically consume 1 to 2

watts around the clock, silently powering telephones, ADSL, cable and other broadband modems, kitchen radios, battery chargers, even the front doorbell.

– The second group comprises all equipment with remote control. To be able to respond to a remote control command, at least a part of a TV set, video recorder or audio rack has be on all the time. Maybe you've got one of those remote controlled lamps? They will always consume a little power even when off! Or is the halogen lighting transformer permanently connected to the mains? Although microwave ovens rarely have remote control, most now have a display that's always showing a clock. What about the bread machine you use once a week? Add it all up and you'll find that 10 to 50 watts of power is wasted.

– Third, we have those larger consumers. Fortunately, refrigerators and washing machines are now sold with labels stating their energy class. Note the actual use: a small wash load at 60 degrees easily eats up double the amount of power than one at 40 degrees. A badly defrosted freezer compartment with thick ice lining inside may raise energy consumption by half.

– Finally, the trusty PC. You may have several, and think they are off, but we measured 3.6 watts in the off state, day and night. When switched on, a PC will want as much power as an average TV set, its consumption

NG TIPS

varying between 150 to 400 watts. Of course, you will have a printer and a display to complete the set. A TFT screen will amount to 30-40 watts, but an old-fashioned CRT will weigh in at at least three times the amount. It all adds up and the only way to save money here is to completely disconnect the computer set from the mains using a dedicated, switchable power bar.

Clearly, it is of the highest importance to trace all these hidden energy eaters. Next, you can decide for your own if comfort outweighs the trouble of operating some switches from time to time, as the switched power bar is without doubt is the only remedy.

With mains adaptors, there is an alternative, however. Although not yet widely available from the highstreet shops, electronic (switch-mode) variants are available from mail-order outlets with an energy consumption we can safely describe as negligible.

At the end of the day

There can be no argument in favour of allowing energy to fritter away just like that. Being energy-wise is also good for your wallet. In most countries, electricity rates are no longer flat, so get out a recent bill to see just how much one kilowatt-hour costs. Energy taxes may be levied at often surprisingly high rates. The actual bill will also include fixed amounts for your use of the power grid, the electricity meter and other items. The fixed costs may easily double the actual kWh price.

If you manage to save a total of 100 watts, it equals 0.1 kWh per hour, or 876 kWh per year and that's not to be sniffed at because a typical household will consume something of the order of 3500 kWh. Savings may easily work out at 100 pounds per year, a pretty penny! Maybe 100 watts worth of savings is too ambitious for you. However, we would be surprised if any Elektor reader would not be able to scrape together energy reduction worth 25 watts. Even then the real savings at about 25 pounds (or even 40 pounds with all costs included) are still well worth the effort.

(040161-1)

Hidden energy eaters	
Mains adaptor	1 - 2 watts
TV set	5 - 10 watts
PC	2 - 5 watts
ADSL modem	5 - 10 watts
Microwave oven	1 - 10 watts
Video recorder	3 - 10 watts



Figure 1. Power measurements are easy — just insert the instrument between the power outlet and the plug. You'll be surprised about the results of the test!



Figure 2. A switch-mode battery eliminator is often more compact and invariably energy friendlier than older transformer-based counterparts.

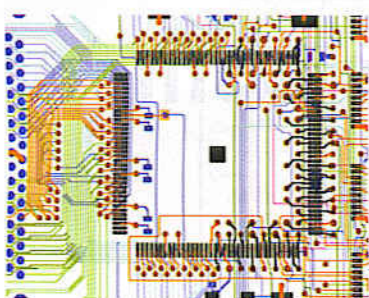

Figure 3. Example of an electricity cost meter. (Conrad Electronics)

No1 Number One Systems

Easy-PC for Windows

The world beating PCB design software



Easy-PC version 8 just gets better

Winning accolades the world over, Easy-PC for Windows V8 is a major milestone in the evolution of this extremely popular software tool. Try a demonstration copy of Easy-PC and prepare to be amazed at the power, versatility and remarkable value for money.

STILL FROM ONLY
£97
PLUS VAT

Version 8 features

- Sketch Mode Routing
- ODB++ Format Export
- Import Bitmap
- Single-Sided AutoRoute
- Customisable Toolbars
- Auto Smooth & Mitring of tracks
- Wires & Jumpers
- Unified Quality Check
- Plus lots more.....

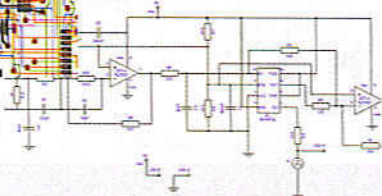

Fully integrated Schematics & PCB layout in a single application complete with forward and back annotation. Design and rules checks at all stages ensure integrity at all times. Professional manufacturing outputs allow you to finish the design process with ease.

Stop press... Stop press... Stop press... Stop press... Stop press...
By customer demand now with Eagle import as well as Tsien Boardmaker 2 import

call for a brochure, prices & CD on +44 (0) 1684 773662
or e-mail sales@numberone.com
you can also download a demo from

www.numberone.com



Number One Systems - Oak Lane - Bredon - Tewkesbury - Glos - United Kingdom - GL20 7LR UK

PicoScope 3000 Series PC Oscilloscopes

The PicoScope 3000 series oscilloscopes are the latest offerings from the market leader in PC oscilloscopes combining high bandwidths with large buffer memories. Using the latest advances in electronics, the oscilloscopes connect to the USB port of any modern PC, making full use of the PC's processing capabilities, large screens and familiar graphical user interfaces.

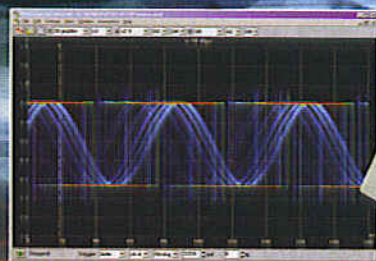

- High performance: **10GS/s** sampling rate & **200MHz** bandwidth
- **1MB** buffer memory
- High speed **USB 2.0** interface
- Advanced display & trigger modes
- Compact & portable
- Supplied with PicoScope & PicoLog software

PicoScope	3204	3205	3206
Bandwidth	50MHz	100MHz	200MHz
Sampling rate (real-time)	2.5GS/s	5GS/s	10GS/s
Sampling rate (single shot)	50MS/s	100MS/s	200MS/s
Channels	2+Ext trigger	2+Ext trigger;Sig gen	2+Ext trigger;Sig gen
Oscilloscope timebases	5ns/div to 50s/div	2ns/div to 50s/div	1ns/div to 50s/div
Timebase accuracy	50ppm	50ppm	50ppm
Spectrum ranges	0 to 25MHz	0 to 50MHz	0 to 100MHz
Buffer memory size	256KB	512KB	1MB
Resolution / accuracy		8 bits / 3%	
Range		±100mV to ±20V	
PC Connection		USB2.0 / USB1.1 compatible	

Tel: 01480 396395

www.picotech.com/scope271

pico
Technology Limited

TEMPERATURE LOGGER

measuring temperatures both indoors and outdoors

Niklas Langmaack

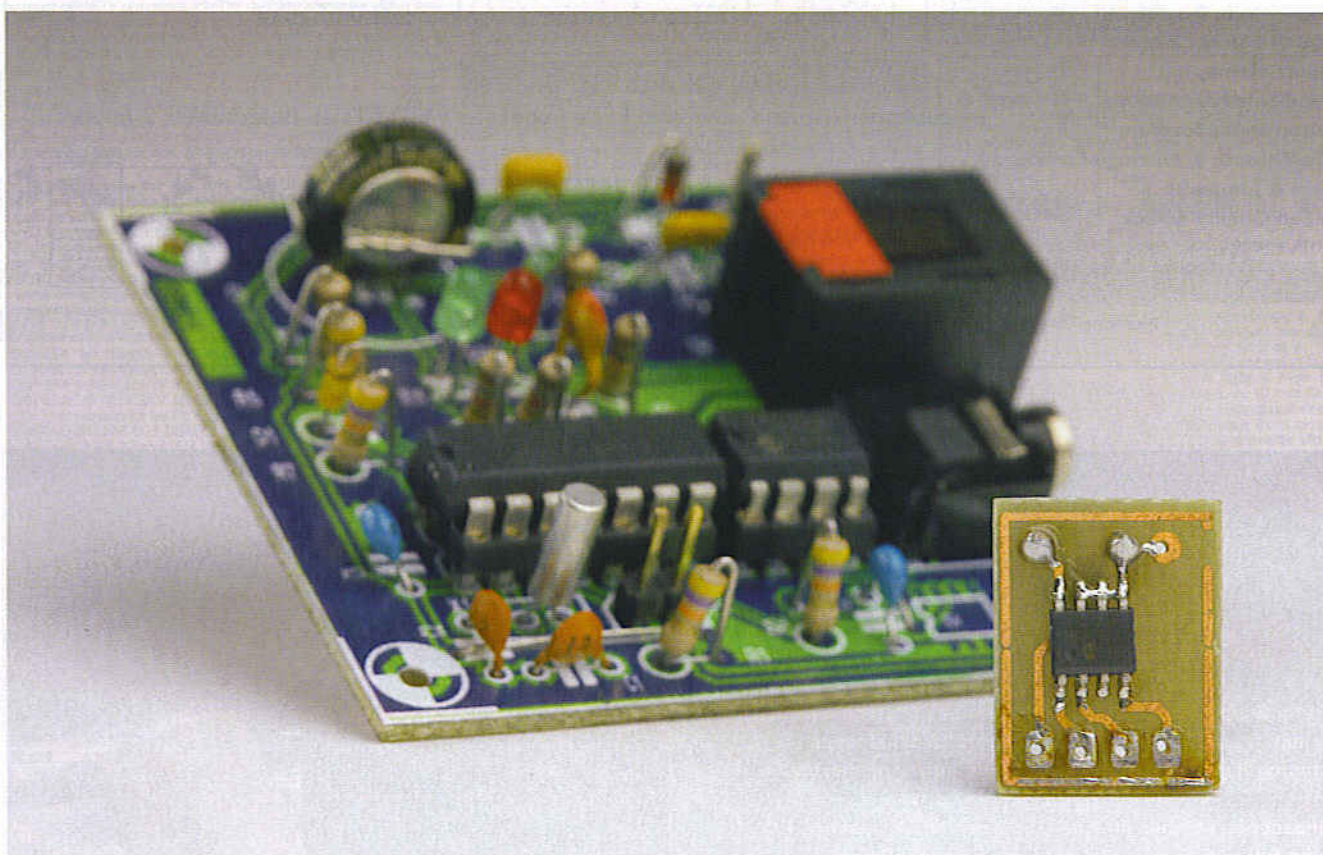

This temperature logger is a device which continuously records two temperatures for subsequent analysis on a PC. Thanks to its I²C bus it can also easily be used with a range of other types of sensor.

This simple data recording device is designed to make a continuous log of two temperatures. The chief application is of course the

measurement of temperatures indoors and outdoors over the course of, say, a year. The device includes a serial I²C bus interface to which an

A/D converter can be connected, allowing a wide range of other types of sensor (pressure, humidity, and so on) to be used. In principle a com-

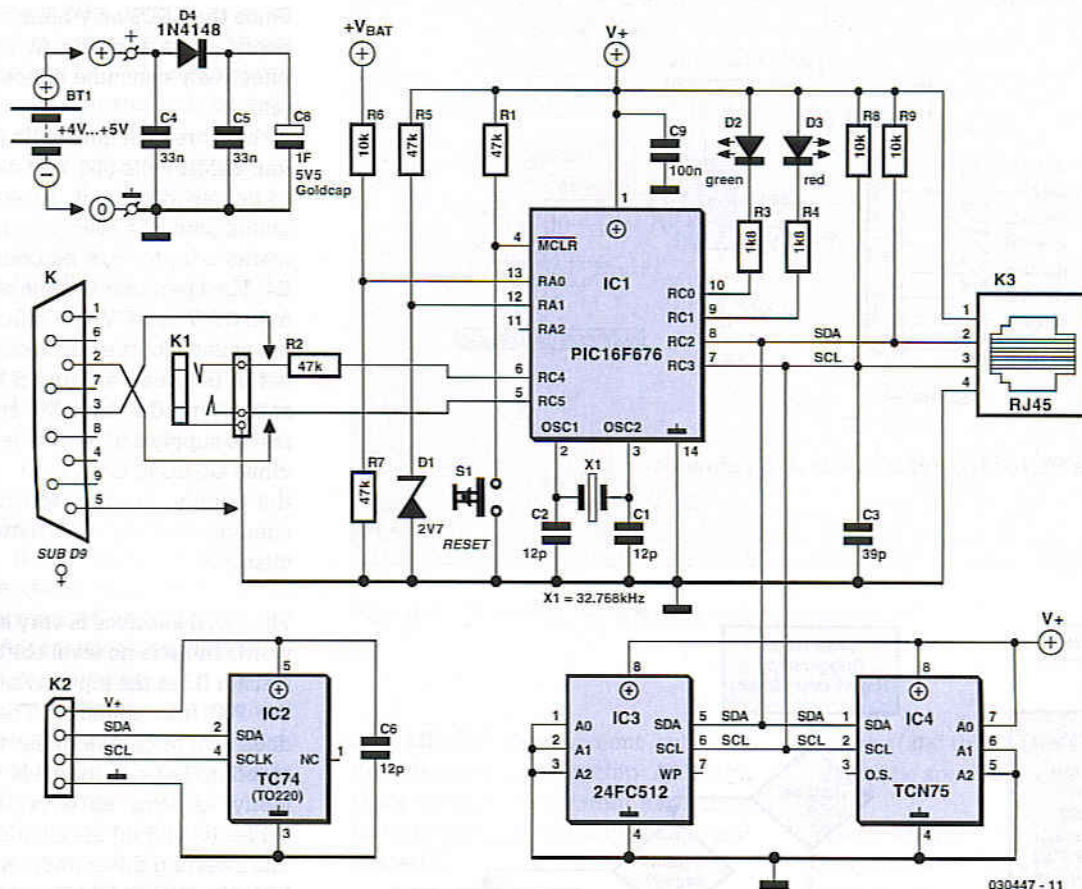

030447 - 11

Figure 1. Circuit of the temperature logger.

plete weather monitoring station could be built.

Omnis divisa in partes tres

The project as a whole is divided into three parts: the hardware, the firmware in the microcontroller, and the software running on the PC. The PC software allows the device to be configured and can read the data from the device's memory. The data can be displayed as a table or graphically, and can be saved as a text file for further processing, using Excel for example. The hardware is very simple, and, thanks to the I²C bus, general-purpose. Just a few simple modifications to the firmware are required to support a different sensor. Source code for the firmware and for the PC software can be downloaded for free from www.elektor-electronics.co.uk or from the author's homepage. For this reason, we will be looking in detail at the software later in this article. First, though, to the hardware. This comprises two digital temperature sensors, a non-volatile memory capable of storing over 32,000 pairs of data

values, and a serial interface to the PC. At the heart lies a Microchip microcontroller, which is responsible for reading the sensors, managing the memory and attending to the PC interface. The logger has a particularly low current consumption (see box), is small and is child's play to use.

As we can see from Figure 1, this is a typical microcontroller application. The device used, a PIC16F676, is a recent addition to the PIC16 family of microcontrollers from Microchip with an 8-bit architecture. It offers 64 bytes of SRAM data memory, while program memory consists of 1024 14-bit words. Each instruction occupies typically just one word, and so the program memory is enough to hold a good 1000 lines of machine code. As the 'F' in the part number indicates, the program memory is constructed from Flash ROM: in other words, the memory is non-volatile, and electrically erasable and reprogrammable.

The controller is connected to two digital temperature sensors and a 64 KB EEPROM over an I²C bus. It is also possible to add a small extra circuit to the microcontroller to allow it to measure its own power supply voltage. It

can then produce a warning when the voltage is too low and there is risk of logging being interrupted. The PIC16F676 microcontroller includes a built-in A/D converter (Figure 2) connected to pins AN0 (pin 13) and AN1/V_{REF} (pin 12). The microcontroller monitors the supply voltage via the potential divider formed by R6 and R7, and a reference voltage is produced by D1 and R5. The current through the Zener diode, and hence the reference voltage itself, is slightly dependent on the battery voltage, but for this purpose we have more than adequate accuracy. The two low-current LEDs D2 and D3 provide a visual indication of the state of the battery and the current mode of operation.

LED	Status
none	Quiescent state, or operating from GoldCap backup supply
D3	Active, supply voltage good
D2	Inactive, supply voltage low
D2 and D3	Active, supply voltage low

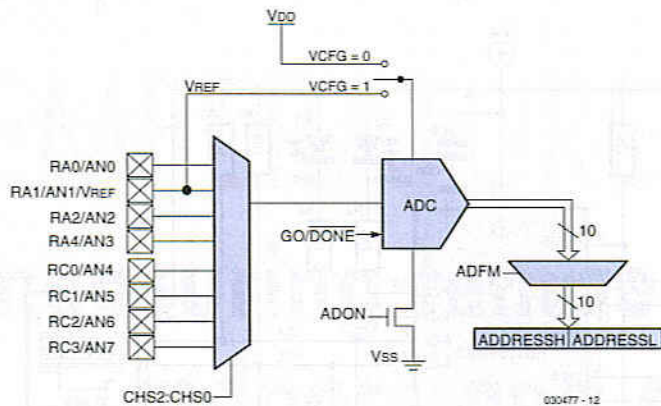

Figure 2. The PIC16F676 has a built-in A/D converter.

Since the LEDs only blink briefly once every eight seconds (if at all) they effectively consume almost zero current.

Either three alkaline cells (3-1.5 V) or four NiMH cells (4-1.2 V) can be used to power the circuit. Alternatively, if mains power is available, a regulated mains adaptor can be connected via K4. The operating voltage of the ICs is from 3.5 V to 5.5 V; the 'official' operating voltage for the whole circuit is thus set at between 4 V and 5 V. Ceramic capacitors C4 and C5 smooth the power supply and remove interference, while GoldCap C8 is used to maintain the supply during interruptions, for example when the batteries are changed.

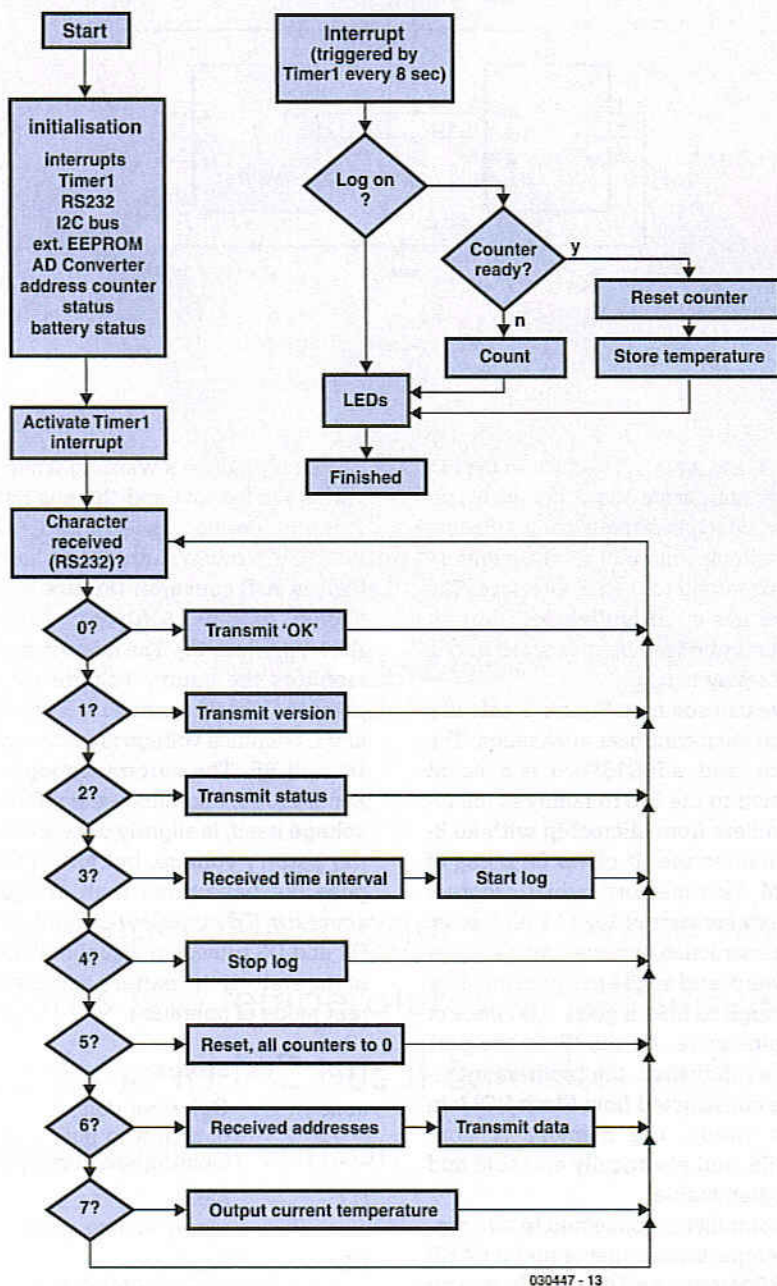

Figure 3. Firmware flowchart.

The serial interface is very straightforward. There is no level shifting, just a resistor R2 at the input, which protects the PIC from damage. The interface does not, of course, meet the RS-232 standard but nevertheless works perfectly as long as excessively long cables (over 3 m) are avoided.

The inverting driver integrated into the PIC, along with 32 kHz watch crystal X1, C1 and C2 form an oscillator which acts as the timebase for timer T1 in the microcontroller. The frequency of this oscillator, together with the supply voltage, largely determine the current consumption. Using the internal microcontroller clock, here set to 4 MHz, the current consumption should be less than 500 μ A at 5 V.

S1 and R1 form the usual reset circuit for the PIC. This is not required for normal operation, but it is sometimes useful to restart the microcontroller firmware execution in case of a fault or during program development.

Bus stop

The PIC16F676 does not have a built-in I²C bus interface, and so it must be emulated in software (just like the RS232 interface). Pull-up resistors R8 and R9 are required for communication on the I²C bus; C3 is not strictly necessary, but serves to improve the signal quality on the clock signal SCL and improves noise immunity. Three ICs are connected to the bus: two temperature sensors and the EEPROM for storing the pairs of measured values. Originally developed by National Semiconductor, the well-known LM75 combines a temperature sensor, a 9-bit A/D converter and an I²C bus interface in an 8-pin SOIC package. According to

the data sheet, the typical error is 0.5 °C. The device has three address pins which allow it to be configured so that up to eight sensors can be connected to a single bus.

Microchip offers many variations on this component. The TCN75 is based on the original LM75, but has a fully-programmable address and comes in an SOIC or MSOP package. The TC74, which can also be used, comes in a TO220 package with five pins, but has a resolution of only 1 °C. It dispenses entirely with address pins and is supplied with a pre-programmed address (TC74A0, TC74A1, and so on). One sensor is fitted to the printed circuit board of the data logger and directly measures the ambient temperature where the circuit is positioned; the other is connected by a cable with waterproof connections, and measures the temperature outside.

Temperature data values, as received from the sensors, are nine bits long, consisting of a sign bit, seven bits to represent the integer part of the temperature value, and one bit to represent the fractional part, which can be zero or half a degree. This gives a range of temperature values from -127.5 °C to +127.5 °C, which is much greater than we need for our application. We therefore convert these values in the PIC into a different format which encompasses a smaller temperature range, but which only requires eight bits. This saves precious space in the EEPROM.

The 8-bit format starts at -32 °C (zero) and runs up to +95.5 °C (255). The offset can be changed if desired; the important value here is 32. In line 48 of the firmware source code file `lm75.inc` this value is added to the raw data; in lines 572 and 573, and 608 and 609 of `Unit1.pas` 32 is subtracted from the 8-bit values to convert them back into real temperatures. It is easy to change the offset of the temperature window by modifying these lines suitably.

The serial electrically-erasable memory used for the logged data is a 24FC512 EEPROM, also from Microchip. The device is organised as 64K 8-bit words (512 kbits in total, or 64 kbytes). The 24FC512's address is configured using three address pins, allowing up to eight memory devices to be connected to the same bus. The 24FC512 comes in an eight-pin DIL package.

Firmware

The firmware in the PIC was written entirely in assembler using the MPLAB

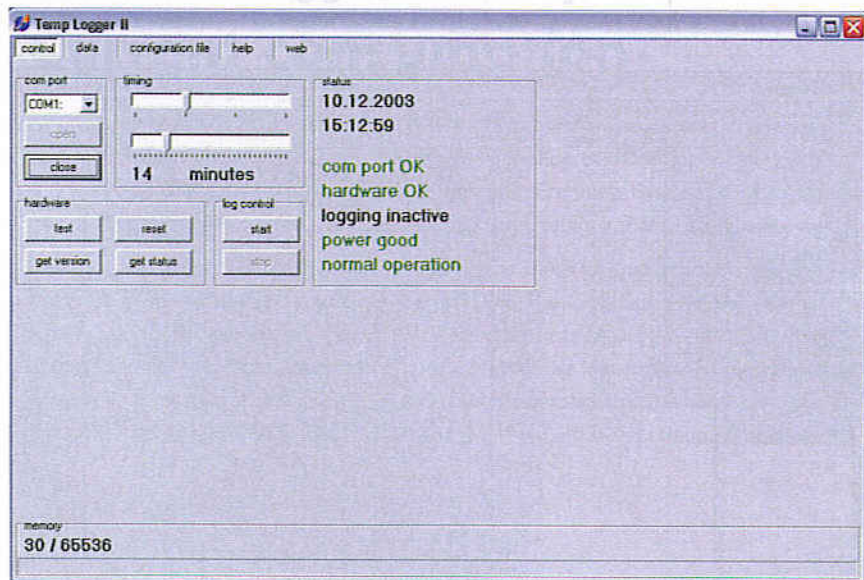

Figure 4. Controlling the temperature logger using a PC.

and MPASM development software provided free by Microchip. Although there are only 35 different assembler instructions, they are very flexible and powerful.

The flowchart in Figure 3 illustrates schematically the functions of the firmware. The firmware consists of two almost completely independent parts. On reset the PIC automatically starts executing the routine which initialises all the various components and then waits for a command from the PC. Every eight seconds an interrupt is generated by timer 1; the interrupt routine is responsible for actually storing the temperature data.

Most of the work involved with the RS232 interface is done by the functions `putc` (for transmission) and `getc` (for reception). The routine `putc` transmits the byte stored in the working register `W` over a predefined I/O pin. The data format is '8N1' (one start bit, eight data bits, no parity bit and one stop bit). The receive routine `getc` uses a polling technique: when called, the function waits until a complete data byte in 8N1 format has been received over a predefined I/O pin. The data byte is returned in the `W` register. Timing for both routines is handled by the delay loop `rsdel` which gives a data rate of 9600 baud with a processor clock of 4 MHz.

All the routines which are concerned with the RS232 interface are collected together in the library `soft_rs.inc`: only the definitions of which I/O pins are to

be used (and their tristate control bits) have to be specified in the main source code.

The library `soft_i2c.inc` is a little more complicated. In the I²C protocol the bus goes through a number of states, also called 'conditions'. These correspond to functions in the code:

i2c_start	generates a start command;
i2c_res	generates a repeated-start command;
i2c_stop	generates a stop command and returns the bus to its quiescent state;
i2c_send	transmits one byte;
i2c_rec	receives one byte;
i2c_ack	transmits an acknowledge bit after reception;
i2c_nack	transmits a negative-acknowledge bit after reception.

This gives a very flexible set of commands, which is helpful when integrating other I²C devices into the system. The functions allow various complex communication situations to be handled. Examples of using the functions can be found in the modules for interfacing with the external EEPROM (`eee24.inc`) and with the temperature sensors (`lm75.inc`).

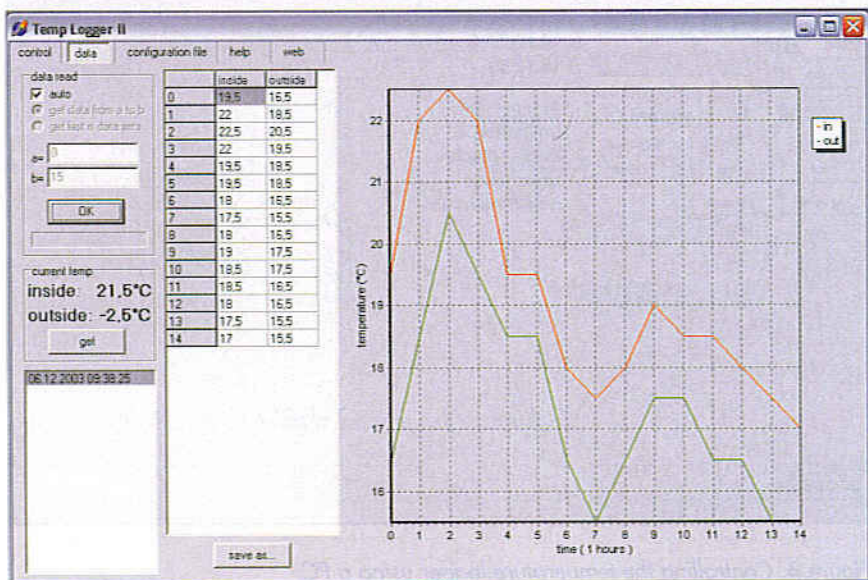

Figure 5. A series of measurements displayed in tabular and graphical form.

PC software

The PC software controls the unit over the serial interface, and reads and analyses the stored data. It was written using Borland Delphi 6 and uses the Windows API to access the interface. This means no extra DLLs are

required: it is sufficient to simply install the interface under Windows using the standard driver.

The application will work on all 32-bit Windows systems (from Windows 95 onwards) using Internet Explorer 4.0 or above. A Pentium I system has plenty

of processing power. It is not possible to compile the program under Linux using Borland Kylix because the interface is accessed directly using the Windows API. As a minimum the routines for handling RS232 communication would need to be rewritten.

The program window is divided into five pages accessed using tabs. The first page, 'control' (Figure 4) gathers together all the functions for controlling the data logger as well as the indicators that show the current state of the device (such as battery status and remaining EEPROM storage capacity). The second page, 'data', (Figure 5) includes all the functions for reading out and displaying the stored data. The third page shows the complete contents of the configuration file settings.ini to simplify debugging. You should only make changes here if you know exactly what you are doing! The fourth page gives a brief summary of the program's functions, and finally the fifth page leads (if a suitable Internet connection is available) to the author's website at

<http://www.Langmaack-IZ.de/TempLogger/>

where further information can be found, along with a discussion forum.

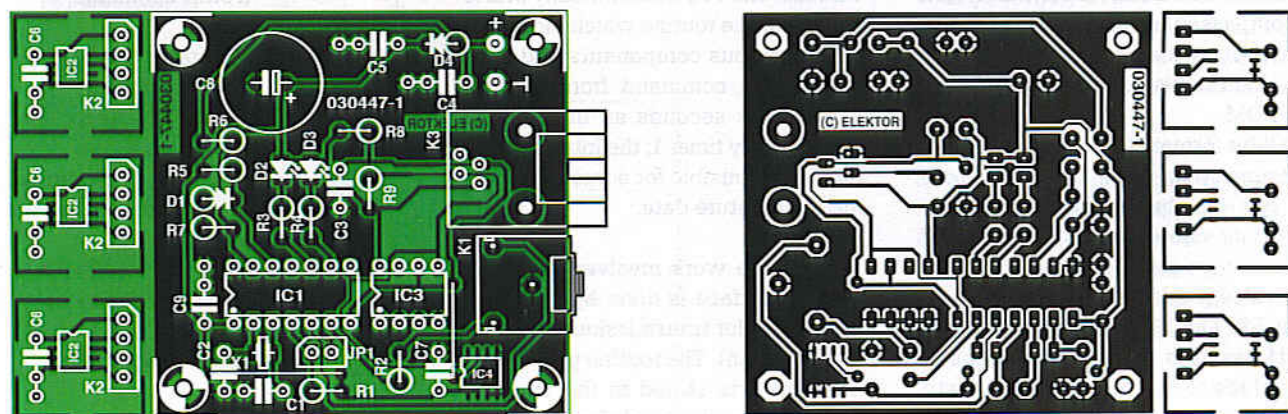

Figure 6. Printed circuit board layout for the temperature logger with remote outdoor sensor.

COMPONENTS LIST

Resistors:

R1, R2, R5, R7 = 47kΩ
R3, R4 = 1kΩ
R6, R8, R9 = 10kΩ

Capacitors:

C1, C2 = 12pF
C3 = 39pF
C4, C5 = 33nF

C6, C7, C9 = 100nF
C8 = GoldCap 1F 5.5V

Semiconductors:

D1 = Zener diode 2.7V, 400mW
D2 = low-current LED, green
D3 = low-current LED, red
D4 = 1N4148
IC1 = PIC16F676, programmed, order code **030447-41**
IC2 = TC74
IC3 = 24FC512
IC4 = TCN75 or LM75

Miscellaneous:

S1 = on/off switch, 1 contact
K1 = 3.5mm jack socket, stereo, PCB mount
K2 = 4-way SIL pinheader
K3 = 4-way RJ45 socket, PCB mount
X1 = 32.768kHz quartz crystal

PCB, order code **030447-1**

Disk, project software, order code **030447-11** or free download from www.elektor-electronics.co.uk

The most important functions of the program are to start and stop a session of measurements. A precise record is made of when a session is started, so that different sessions can be kept separate when the data are subsequently processed. Before starting a session, the time interval between measurement samples can be set using two sliders. The available range runs from eight seconds to six days. These settings are also recorded so that the user can access them later.

There are two ways to read the data out of the device. The first option offered by the program is automatic read-out, where the user selects one of the sessions from a list and the program determines the relevant region of memory to be read automatically. If the last log is selected and logging is not yet complete the program automatically loads all data available up to the last stored value.

In manual reading mode the user must manually select the region of memory to be transferred. The value 'now' indicates the position currently reached in the memory. For example, to read out the entire used area of memory, specify 0 for the start address and 'now' for the end address. In manual mode the data can only be presented as a table or graphically: the extra information such as start time and sample interval are only available in automatic mode.

Once the data values have been read out they can be displayed in tabular or in graphical format. The table can be stored as a text file which can then be loaded directly into a spreadsheet program such as Excel, where it can be processed further.

Finally, a few words on constructing the temperature logger. The printed circuit board is shown in Figure 6; as you can see, construction should present no difficulties. Be careful to ensure that all components are fitted the right way around. The microcontroller and the memory device can be fitted in sockets, while the temperature sensor is soldered to the back of the board. Connection to the external temperature sensor is via an RJ45 socket (and yet another sensor can be connected to connector K2, where the I²C bus signals are made available), and the reset button is connected across JP1. A mini stereo jack socket (K1) is provided for the serial interface to the PC; this can be replaced with a sub-D connector if desired. The markings show the correct connections.

(030447-1)

Current consumption

At maximum load, that is, with logging at eight second intervals and continuous status monitoring from the PC, the current consumption of the complete circuit is 1.8 mA at 4.8 V. This gives a calculated maximum running time of 46 days using four 2000 mAh (AA size) NiMH cells, or 81 days using 3500 mAh (C size) cells.

If the supply voltage drops below 4 V, the temperature logger indicates that the batteries need changing by flashing the red LED. The GoldCap will maintain a supply voltage between 3.7 V and 3.9 V for about a minute: if the batteries are changed within this time, logging will proceed without interruption. If power is lost completely, the logger will subsequently resume operation from where it left off: this can lead to gaps or time-shift effects in what should be continuous logs.

The TCN75

The TCN75 is a serially-programmable temperature sensor which converts temperatures in the range from -55 °C to +125 °C into 9-bit words and stores them in a memory. This memory can be read out using a host controller over the I²C

bus. It is also possible to set a threshold value T_{SET} and a hysteresis value T_{HYST} , on the basis of which an interrupt signal can be generated and sent to the host.

The TCN75 can operate in 'interrupt mode' or in 'comparator mode'. In both cases the INT/CMPTTR output is active (the polarity is programmable) when the threshold value is exceeded. In comparator mode the output is automatically reset again when the temperature falls below T_{HYST} ; in interrupt mode, however, the output can only be reset by accessing a register. Then, when the temperature falls below T_{HYST} , the INT/CMPTTR output again goes active (and must again be reset by a register access). In interrupt mode entering the shutdown state also resets the output.

Five registers control operation of the TCN75. The **register pointer** (2 bits) determines which of the four other registers will be accessed in the next operation.

The **configuration register** (5 bits) sets normal or shutdown mode, comparator or interrupt mode, and the polarity of the INT/CMPTTR output. Two bits determine how many times the threshold value must be exceeded before the INT/CMPTTR output will be made active. These bits give a degree a noise immunity to the sensor.

The read-only **temperature** register and the read/write registers for **threshold** and **hysteresis** are each 16 bits long, although only the top nine bits are used. The LSB represents 0.5 °C, and a binary two's complement representation is used:

Temperature	Binary value	HEX value
+125 °C	011111010	0FA
+25 °C	000110010	032
+0,5 °C	000000001	011
0 °C	000000000	000
-0,5 °C	111111111	1FF
-25 °C	1111001110	1CE
-40 °C	1110110000	180
-55 °C	110010010	192

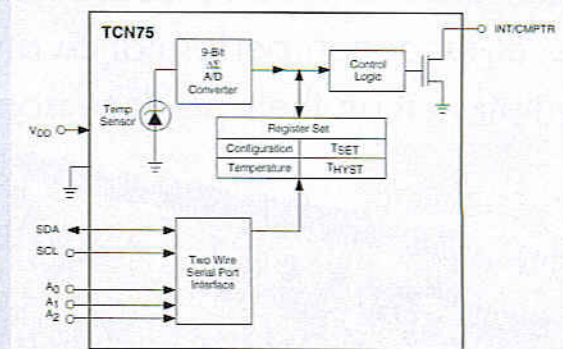

GPS RECEIVER

With contributions by Thomas Biel

The lack of availability of integrated modules in small quantities has until now been an obstacle to building a GPS receiver yourself. Now things are changing, and it has been worth the wait: the newest generation of GPS receivers are not only outstandingly small, but also offer considerably better reception performance and lower power consumption than their predecessors.

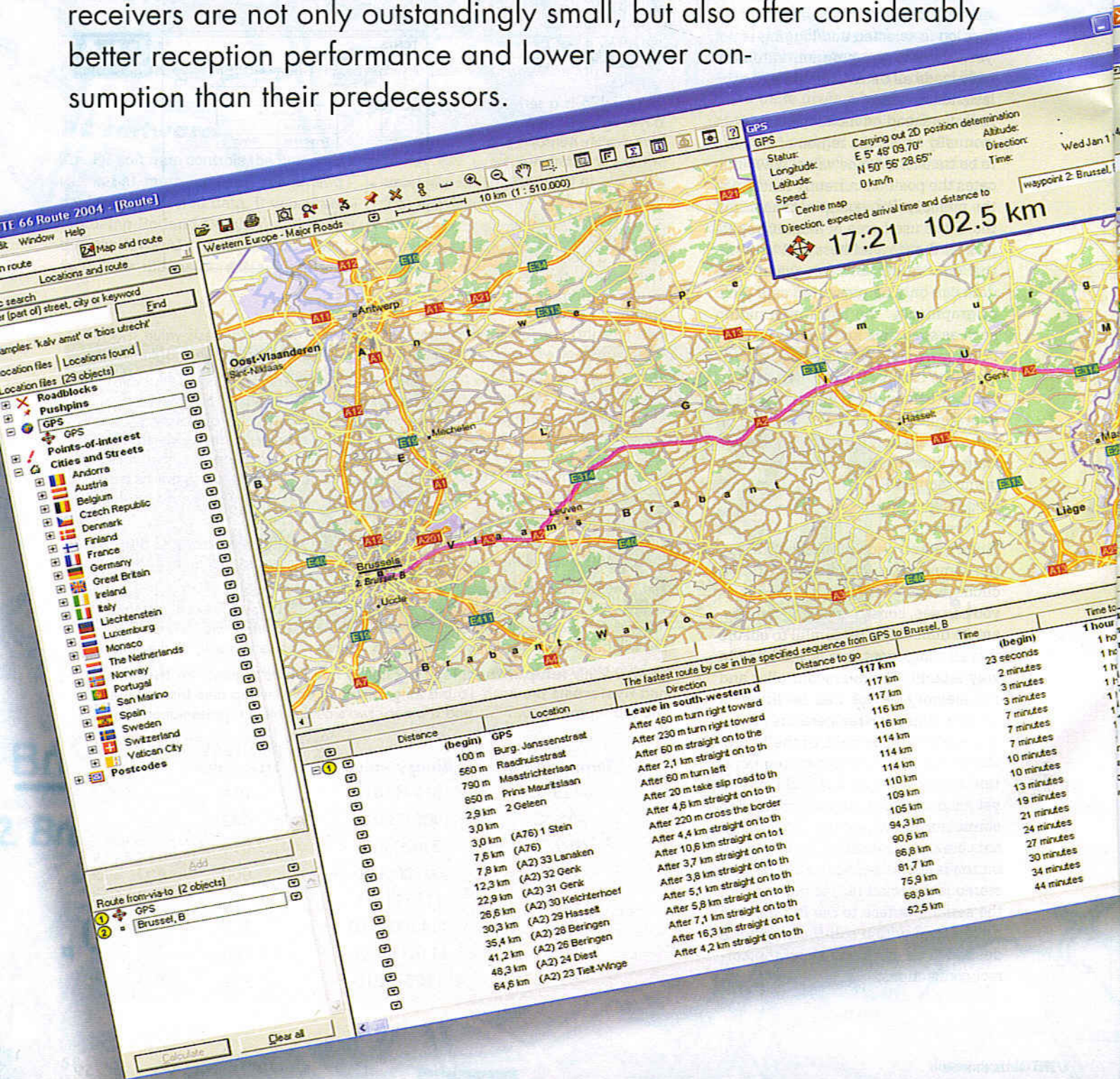

Global Positioning System for homebrew applications

DRIVER ON USB

Whether you are a fan of water sports, flying or amateur radio, a driver or a walker, whether for business or for pleasure, if you are interested in technology you will no doubt have seen a GPS receiver or marvelled at some system based on GPS technology. GPS technology was developed by the United States Department of Defense to provide military forces with a global navigation system. Twenty-nine satellites circle the earth to provide an almost complete coverage of the surface of our planet with the signals they beam out. Because of the curvature of the earth, a GPS receiver can never receive all 29 satellite signals simultaneously; fortunately this is never necessary and for basic operation it is only necessary to be able to see three satellites to obtain accurate positional information for navigation in two dimensions. If more than three satellites can be seen the results can be more accurate and altitude can also be determined (for navigation in three dimensions).

Until a few years ago GPS was expensive and not particularly accurate. For strategic reasons errors were deliberately introduced into the positional information made available to civilian users, so that the received GPS position was guaranteed to be out by up to a dozen metres or so. The rather involved DGPS (differential GPS) technology was introduced to compensate for this state of affairs: DGPS provides the necessary correction data to allow the system to measure position to an accuracy of one metre.

In 2000, for global political reasons, the US administration switched off the degradation of the signal. Errors are now of the order of one metre, and so we no longer need to pay the price for DGPS. In non-ideal conditions, however, the accu-

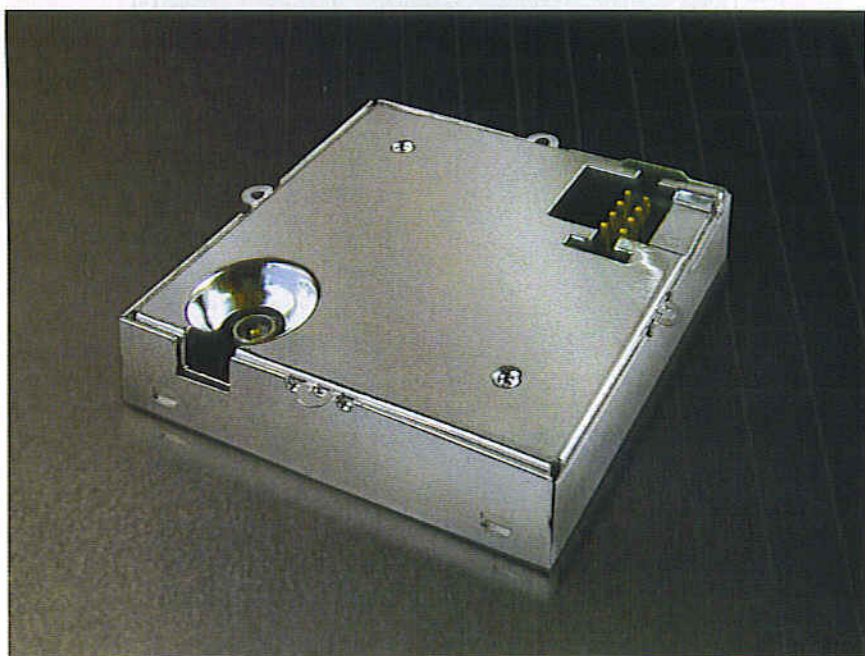

Figure 1. The GPS module is the size of a postage stamp – but a little bit thicker.

racy of the system can fall off rapidly: errors can amount to tens or hundreds of metres. DGPS is still used in applications where the greatest possible accuracy is wanted, for example in aircraft landing systems or for marine rescue. Satellite-based systems, such as WAAS in the USA, EGNOS in Europe, and MSAS in Japan, are also used for DGPS: the correction signal is calculated at GPS reference stations (so-called 'RIMS') on the ground and then transmitted via 'normal' geostationary communications satellites, such as the INMARSAT family. One of the channels of the GPS receiver can be used to receive this signal. WAAS is already in operation, and the other two systems are still in the test phase. After many delays EGNOS should be available by the middle of 2005, although initially not for 'safety of life' applications, that is, applications where human life would depend on the system, such as in air and sea

transport. In general navigation should never rely exclusively on one individual system, and failure of GPS reception is not a rare event.

The Trimble module

The GPS project described here consists of a GPS receiver module and an interface to connect to the USB port of a computer. The printed circuit board is laid out to accept either of two modules produced by Trimble, the Lassen SQ and the newer Lassen iQ (see Figure 1). The latter is a 12-channel GPS module, which means that it can simultaneously receive and process signals from up to twelve GPS satellites. The unit comes in a very compact enclosure with a footprint of just 26 mm by 26 mm and a height of just 6 mm. It achieves an accuracy of 5 m in the horizontal plane and 10 m in the vertical direction (50 % points). This receiver is therefore as accurate as that

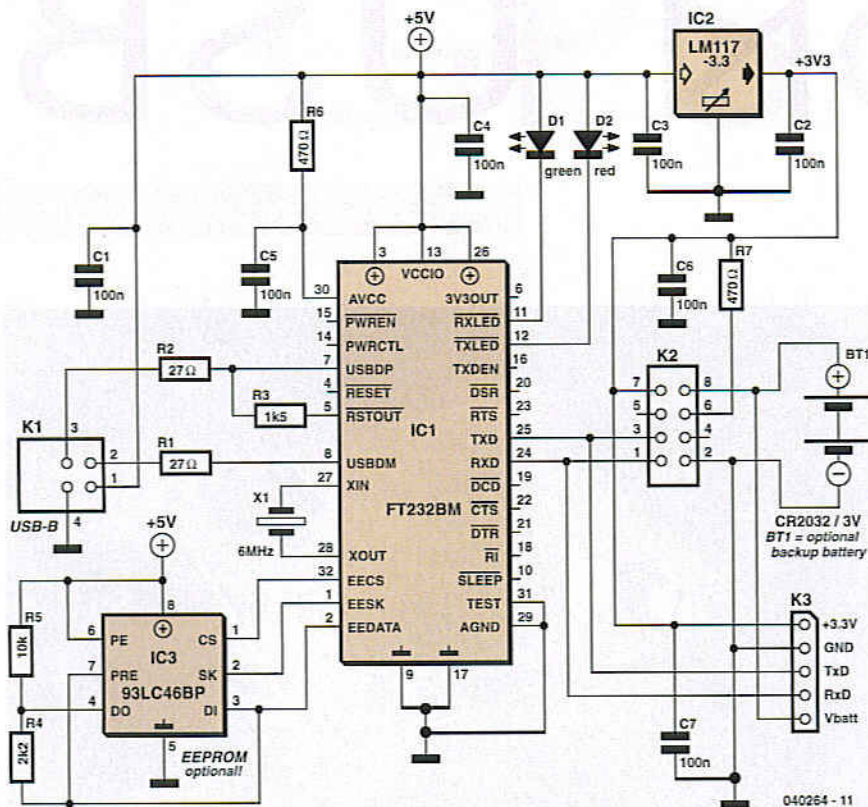

Figure 2. The FTDI chip connects the GPS module to the USB interface.

of one of the market leaders, TomTom, who use the Motorola SiRF II chipset, but offers more in terms of software. Compared to the pin-compatible 8-channel Lassen SQ module, the Lassen iQ offers more than just an improvement in positional accuracy. The time for a 'cold start' has been reduced from 90 seconds to 50 seconds, that for a

'hot start' from 14 seconds to 10 seconds. The module also offers the user an additional sensitivity mode. Power consumption is, at 86 mW, around a third lower than the Lassen SQ. As well as the TSIP, TAIP and NMEA 0183 protocols, which are supported by both modules, the Lassen iQ also supports RTCM SC-104, which is used to transfer

DGPS data, and has a second serial port. The firmware for this protocol is available from Trimble. A data sheet and a detailed comparison of the two modules can be found at the website of Framos, who are distributors for the Trimble modules: the address appears at the end of this article. The module costs around £35.

Interface chip

The FT232BM from FTDI, which will be familiar from many previous *Elektor Electronics* circuits, has been chosen to provide the USB interface (Figure 2). This provides a cost-effective USB UART, which allows us to send serial data over the USB. Offering data rates of up to 920 kbaud (RS232) or 2000 kbaud (RS422 or RS485), the FT232BM offers better performance than conventional ISA or PCI bus based UART systems, and also provides full plug-and-play functionality with a simple connection to the USB port.

As far as the PC is concerned data are transmitted using standard COM port functions, so that in the majority of cases no changes are required to application software. Its flexible architecture makes the IC ideal for use in a wide range of applications. Virtual COM port (VCP) drivers are available for Windows 98, Windows 98SE, Windows ME, Windows 2000, Windows XP, Linux, Mac OS 8, Mac OS 9 and Mac OS X. Windows CE drivers can be obtained from third-party suppliers. The most recent VCP drivers for Windows XP are Microsoft WHQL certified.

The circuit generally runs along the lines recommended in the FT232BM data sheet. Besides the FT232BM the circuit (Figure 2) includes just a 6 MHz crystal, a 93C46BP EEPROM, a fixed 3.3 V voltage regulator and a few passive components. The GPS module is connected to the circuit via K2. Not shown is the active antenna, which is connected directly to the antenna connector on the GPS module. An optional five-way header (K3) is provided so that an alternative GPS module can be used. The EEPROM IC3 is also optional. The circuit will work without this non-volatile memory, but in this case the interface will just present itself as a standard serial device. The EEPROM allows for the storage and

COMPONENTS LIST

Resistors:

R1, R2 = 27Ω
R3 = 1kΩ
R4 = 2kΩ
R5, R7 = 10kΩ
R6 = 470Ω

Capacitors:

C1-C7 = 100nF

Semiconductors:

D1 = LED, red, low-current
D2 = LED, green, 3mm, low-current
IC1 = FT232BM (FTDI)
IC2 = LM1117-3.3 (National Semiconductor)
IC3 = 93LC46A/P (Microchip)

Miscellaneous:

BT1 = 3V Lithium cell, 20mm (e.g. CR2032) with holder (e.g. Digikey # 1026K-ND)
K1 = USB-B connector, PCB mount
K2 = 8-way SMD connector (Samtec CLP-104-02-G-D-BE-PA)
K3 = 5-way SIL connector
X1 = 6MHz quartz crystal
GPS receiver module, Trimble Lassen iQ or SQ (see text, available from Framos, Geist or Molecular)
3.3V active antenna (see text)
PCB, order code **040264-1**, see *Elektor Shop* pages.
9 wire links

A kit of parts is available for this project; see this month's *Elektor Shop* pages or www.elektor-electronics.co.uk

retrieval of specific data such as the vendor and product identification numbers (VID and PID), serial number and so on. The EEPROM cannot be dispensed with if multiple USB-serial converters using the FTDI chip are to be connected to the same PC, since the driver will only create separate virtual serial ports for converters with distinct serial numbers. Without a stored serial number, only one virtual COM port is installed. A tool with accompanying guide to programming the EEPROM can be found on FTDI's website.

An external power supply is not required: the circuit is powered from the USB port of the PC. An optional Lithium battery allows the receiver to store the most recently calculated position data along with the ephemeris when the unit is switched off. The module can then perform a 'hot start', providing its first positional information after a much shorter delay than would be the case with a 'cold start'.

SMD construction

A kit of parts for the project is available from the Publishers — see the *Elektor Shop* pages in this issue, or visit our website at www.elektor-electronics.co.uk.

The nine wire links should be fitted first to the printed circuit board (Figure 3). Next, the FT232BM can be soldered to the underside of the printed circuit board: this device is only available in an LQFP-32 package, and so a steady hand and a fine-tipped soldering iron are required. SMD connector K2 is also fitted to the underside of the printed circuit board (Figure 4). Apart from these two components, populating the board should not present any difficulties.

A word of advice to home etchers: the enclosure of the GPS module is connected to ground. When the module is mounted on the copper side of the board, be careful not to cause a short to the tracks. A piece of insulating tape will serve to emulate the insulating function of the solder mask provided on the original *Elektor Electronics* printed circuit boards.

The GPS module is compatible with active 3.3 V DC antennas, which receive their 3.3 V DC supply from the

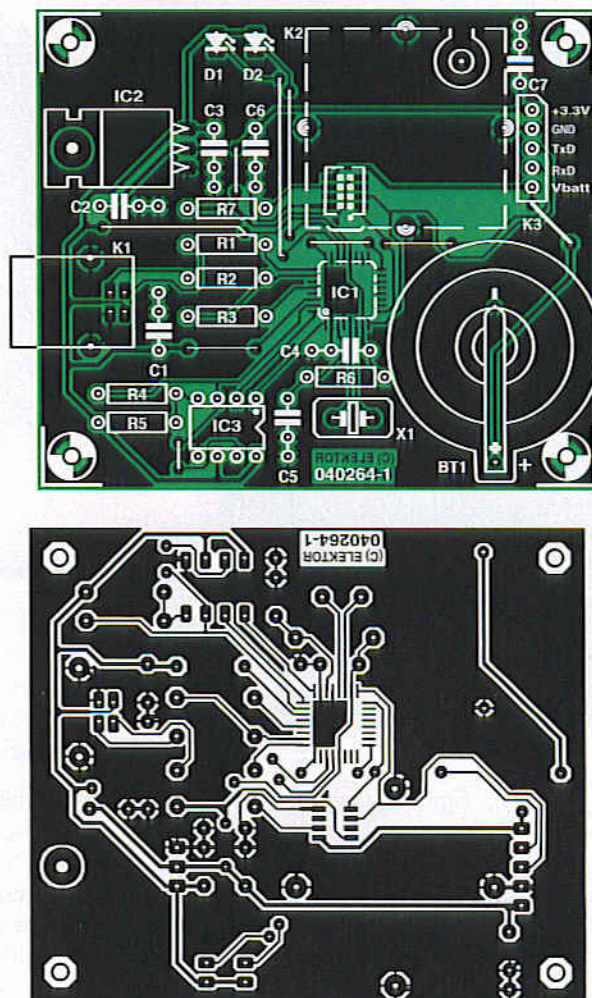

Figure 3. Layout and component mounting plan for the printed circuit board.

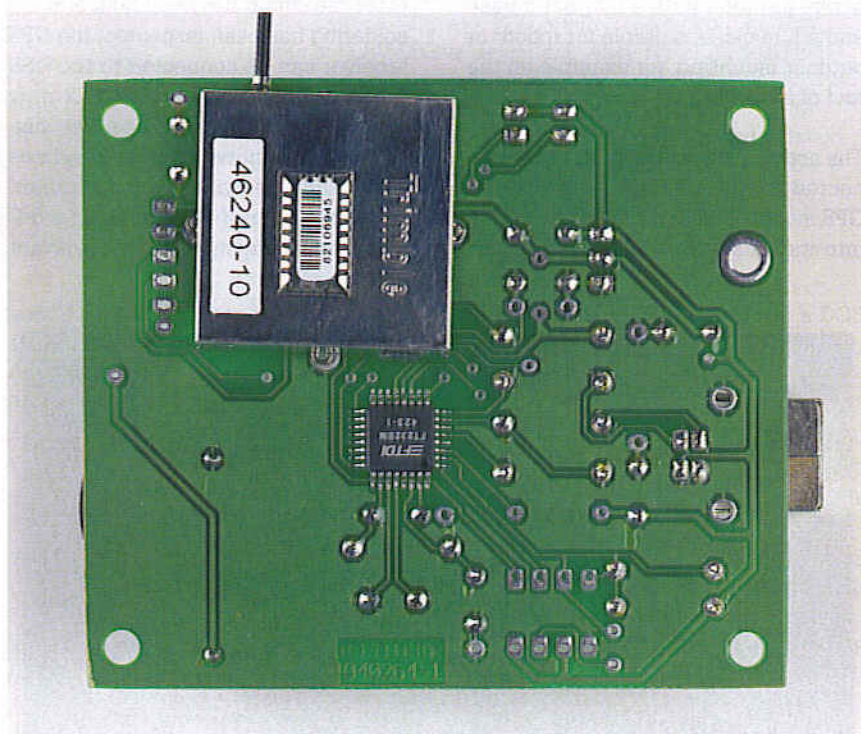

Figure 4. The IC and the GPS module are fitted to the underside of the printed circuit board.

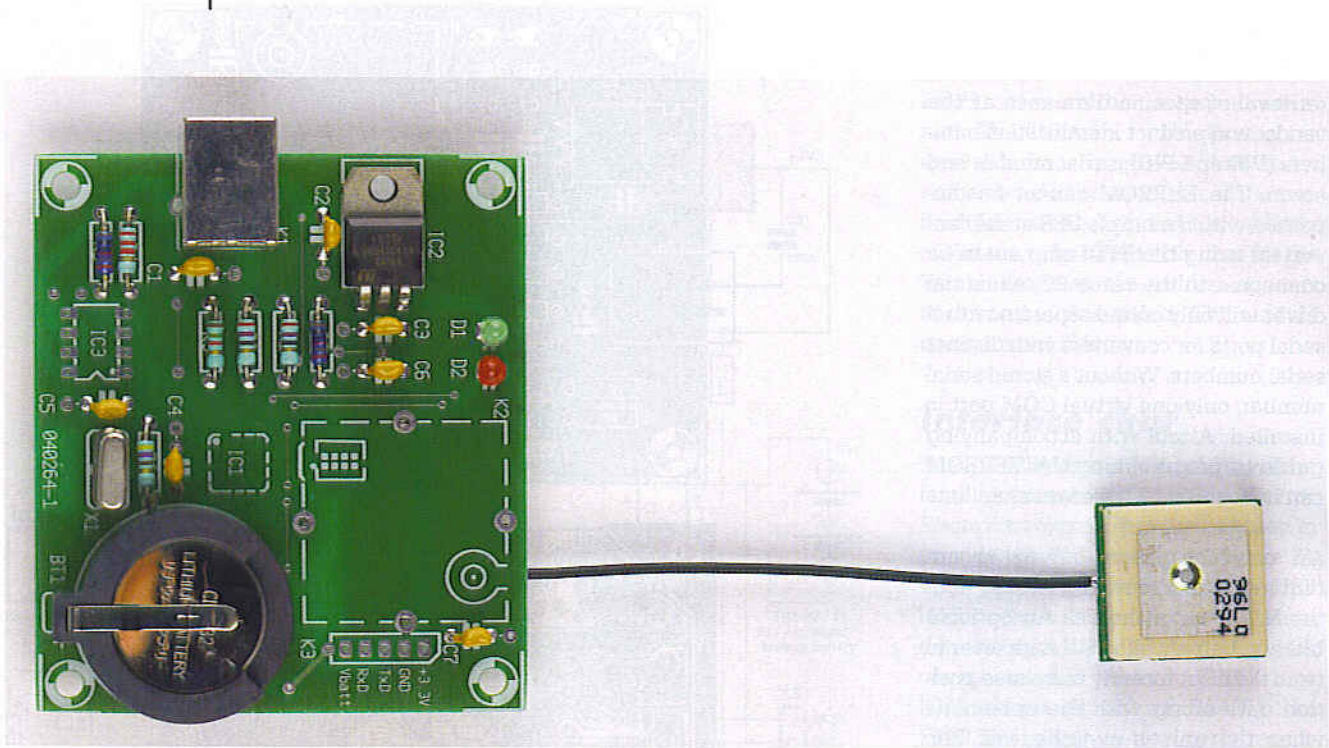

Figure 5. Our final prototype board with miniature active antenna connected.

antenna socket on the module. Trimble can supply an 'ultra compact embedded antenna' with an 8 cm cable and an HFL plug that mates directly with the socket on the module. This antenna is shown in **Figure 5**. With an adaptor cable, 3.3 V active antennas with MCX or SMA plugs can also be used. Trimble also offer a suitable active antenna with a magnetic base and a 5 m cable, suitable for indoor or outdoor mounting, for example on the roof of a car.

The active antenna cable must be connected to the antenna socket of the GPS module before the module is fitted into its socket on the printed circuit

board. For permanent fixing, the module enclosure should be soldered to ground at the points indicated on the component mounting plan, to help hold the connector in place and provide mechanical support.

Configuration

Once the circuit has been built and the soldering has been inspected, the GPS receiver can be connected to the USB port of a PC. Windows XP will now recognise a new USB device. The simplest course now is to let Windows find a suitable **driver** on the Internet. If you prefer (or if you are using a different operating system), the relevant

driver can be selected from FTDI's website and then downloaded. When installation is complete a new COM port will appear on the PC.

As supplied the Trimble GPS module uses a manufacturer-specific protocol called TSIP. The module must be configured (once) to make it emit data using the NMEA (National Marine Electronics Association) protocol. This is easily done using the program **SO Monitor**, which is available for free download from Trimble. The window which shows the serial interface settings for the GPS module, and where the data output protocol can be set to NMEA, is available under the menu option 'Configure/Serial Port'. The RS232 interface should be configured with parameters 4800,8,N,1, which is the standard for NMEA data and which is also used as a default interface setting by most PC-based navigation or route planning software.

TSIPChat

If problems are encountered in configuring the communication protocol, Trimble also provides a low-level configuration tool called 'TSIPChat.exe', which runs under DOS and communicates with the GPS module using COM1 or COM2.

To use this program, a virtual USB COM port must be installed on COM1 or COM2. This is done in the Device



Figure 6. Interface configuration using the 'TSIPChat' program.

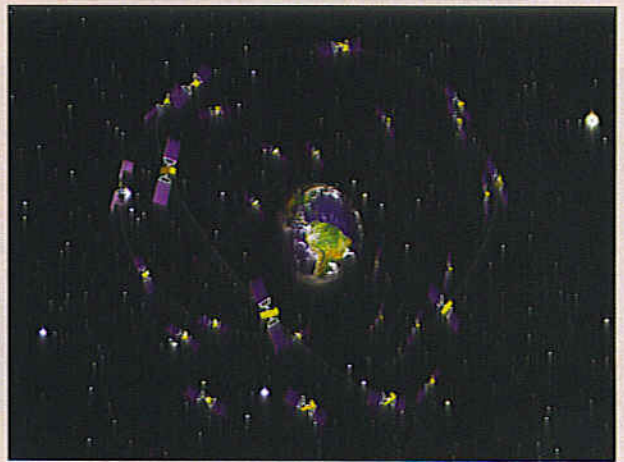

GALILEO

Europe's answer to GPS

Hans Weber

In order to reduce its dependency on the USA, the European Union, along with the European Space Agency, has initiated its own satellite navigation system. GALILEO should deliver better positioning data than GPS and, if things go according to schedule, be ready for full operation in 2008.

GALILEO is based on 30 satellites which are positioned in three different orbits. Of the ten satellites in each plane nine are active, the tenth acting as a backup that can be switched in at any time. The altitude of the orbits is approximately 23600 km, and the satellites are therefore in medium earth orbit (MEO).

GALILEO is exclusively designed for civilian applications, but there is also a security aspect. In particular, the following services are planned:

- a free basic service open to the public, comparable to the civilian GPS signal, but with better quality and reliability;
- a commercial service offering, for a fee, extra information to improve accuracy and reliability (or 'integrity') and aimed at professional services such as logistics and fleet management;
- a 'safety of life' service with especially high quality and

reliability for safety-critical applications, for example in sea and air transport;

- an search and rescue service; and
- a 'public regulated service' which is encrypted and offers a high degree of resistance against interference. Users must be 'agencies with responsibility for security and protection'.

Originally GALILEO was conceived as a competitor to GPS. Under pressure from the USA an agreement was signed in June 2004 to ensure the equal status, compatibility and – in the civilian sector – interoperability of GALILEO and GPS. Applications that use both systems are therefore possible. In any case the EU has already had to declare that the BOC (Binary Offset Carrier) 1.5 modulation scheme will not be used, being replaced by the BOC 1.1 scheme, which will also be used in the next generation of GPS ('GPS III'). Arrangements were also made to cooperate in preventing 'enemy use' of the signals. This means that in crisis areas or 'in the interests of national security' of one of the partners, the service can be restricted or cut off completely.

Critics who complain at the high development costs (estimated at approximately four billion Euro), claim that after this agreement GALILEO is redundant. Also, the original schedule has slipped. Speed is of the essence, since if the first satellite is not launched before the end of February 2006, the frequencies allocated by the ITU may be forfeited. The planned start to operations in 2008 has already been moved; now it is said that GALILEO may only go into service 'just before the end of the decade'.

Manager under 'Ports (COM and LPT)', where 'USB Serial Port (COM n)' can be selected with a double click. This brings up the properties of the USB serial port. Change from the tab marked 'General' to 'Port Settings' and use the 'Advanced...' button to reach the 'Advanced Settings' window. The field 'COM port number' gives a choice from the available COM ports: here we choose 'COM2'. The list may show the port as 'in use': this need not worry us as COM1 and COM2 are addressed via the computer's BIOS. If COM1 or COM2 were free the FTDI VCP would install itself as COM3 or, in the case of a laptop with a modem, as COM4. Note that on a laptop COM2 may be

used for IrDA. Now confirm by clicking on 'OK' and restart the computer. The new settings should now be checked in the Device Manager.

As well as Trimble's TSIPChat.exe there are also older navigation programs that will only work with port COM1 or COM2.

A right click on TSIPChat, followed by selecting 'Properties', brings up the 'Properties' window. Since it is a DOS program, there is a 'Program' tab next to the 'General' tab. Under this tab the option string '-c2' must be added to the end of the command line. The box 'Close on Exit' must not be checked. Clicking on 'OK' completes the configuration as far as Windows is con-

cerned. When TSIPChat is run a DOS window will appear. First type 'U'. You will be asked if you wish to change the COM port settings. Confirm with 'Y' and configure the interface to 4800 baud, 8 data bits, N (no) parity, 1 stop bit, TSIP input protocol and 'NMEA' output protocol (Figure 6).

When initialisation is complete GPS data will appear in the DOS window in NMEA format. To exit the program press ESC twice and close the DOS window.

Navigation programs

Many of the route planning programs available for PCs understand NMEA

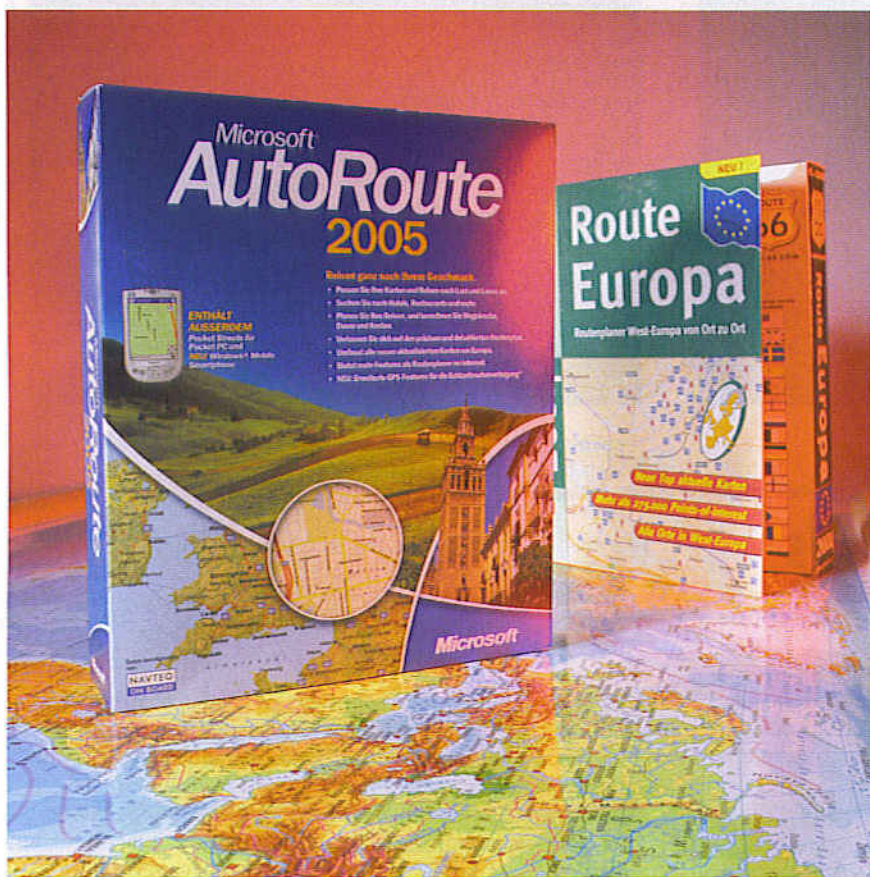

Figure 7. In conjunction with a commercially-available navigation program running on a portable computer the GPS receiver forms a complete navigation system.

protocol. The route planner can then be connected to a GPS receiver and display the current location on a map. Some route planners can metamorphose

into fully-fledged navigation systems with speech output as soon as a GPS module is connected. It is thus a very simple matter to use a laptop

along with the USB GPS receiver described here along with a route planner to create a navigation system. Suitable programs, such as 'Route 66', shown in the picture at the beginning of this article, are readily available from around twenty pounds. In many cases there will be no cost involved at all: for example, Microsoft's 'Autoroute' program is already delivered pre-installed on many notebooks and PCs as part of the MS Works package (Figure 7). To establish connection with the GPS receiver it is sufficient to simply enable the GPS function in the navigation program menu. In Route 66 the COM port number and baud rate must also be entered. In Autoroute you can click on 'Scan' in the GPS setting menu, and the program will then automatically find the GPS receiver connected to a USB port or the relevant virtual COM port.

VisualGPS

If you do not already have a navigation program or if you simply want to look in detail at the NMEA data, the free program 'VisualGPS' can be used. This can be downloaded from the Internet (see link below). As Figure 8 shows, this interesting program can even provide a display showing the movement of the satellites.

An alternative for special applications is the DIY approach. In the box 'NMEA data decoded' we give a practical example using Visual BASIC. The example program can be downloaded for free from the *Elektor Electronics* website, ref. 040264-11.zip.

(040264-1)

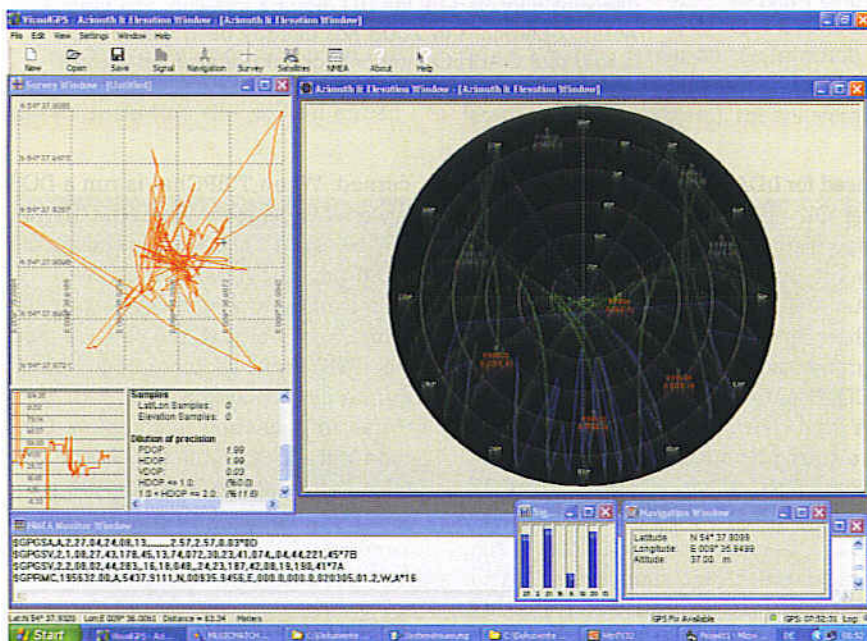

Figure 8. The program 'VisualGPS' can even display the movement of the satellites.

Elektor Electronics articles:

Automobile Navigation Systems based on the GPS, December 1997.
GPS Receivers with NMEA output, October 2001, p. 68.
USB-RS232 Interface, April 2003, p. 60.

Links:

USB interface chip
www.ftdichip.com/FTDrivers.htm

Information and firmware for the GPS module

<http://trl.trimble.com/docushare/dsweb/Get/Document-184028/Lassen+iQ+v9.pdf>
http://www.framos.de/pdf_sheets/Lassen_iQ_SQ_Comparison_Rev1.pdf
http://trl.trimble.com/dscgi/ds.py/Get/File-31560/SQ_Monitor.exe

NMEA0183 data decoded

using Visual BASIC

One of the standards defined by the NMEA (National Marine Electronics Association) is NMEA 0183, which describes data interchange between various electronic devices used for navigation.

This NMEA standard protocol is extremely widespread and allows almost any GPS device which generates NMEA data to be used in conjunction with navigational and mapping programs running on a PC, PDA or laptop.

The data are transmitted using ASCII characters. Each 'sentence' begins with the '\$' symbol and continues with a two-character transmitter, or 'talker' identifier (in our case 'GP'), a three-character sentence type identifier and a series of data items separated by commas. At the end of the sentence is an optional checksum, followed by a CR/LF (carriage return/line feed) pair. Each sentence can be up to 82 characters long. If the data expected in a particular field are not available, the value is simply omitted, with the comma separator remaining in place without extra space characters. A receiver can therefore extract the data it needs from each sentence simply by counting commas.

Some common talker identifiers include:

GP	GPS
LC	Loran-C (older positioning system)
II	Integrated Instrumentation (e.g. Autohelm Seatalk system and autopilots)

The Trimble GPS module generates the following NMEA sentences:

GPMRC:	the recommended basic minimum message that any GPS receiver should support.
GPZDA:	contains data about the local time zone.
GPGGA:	contains the most important information about the GPS position and accuracy.
GPGLL:	a relic from the time of Loran-C receivers. It contains information about geographical position.
GPVTG:	includes information about speed and course.
GPGSA:	includes information about the satellites used to obtain the position fix.
GPGSV:	includes information about satellites that may also

currently be in view, their position, signal strength and so on. Since one sentence can only hold the data for four satellites, there can be up to three sentences of this type.

At present there are seventy-nine different sentence types defined.

By way of an 'open source' project we have created a small program in Visual BASIC that shows how to use software to extract information from the NMEA sentences. The program is available for free download, either as source code or in installable form, from the *Elektor Electronics* website at <http://www.elektor-electronics.co.uk>.

We will only look briefly here at the procedures and functions, since the source code is thoroughly commented. Let us know about any extensions you might make to this program.

Start up Visual BASIC and then...

Using the MSComm.OCX control, three buttons, a text field, a timer, a check box, a few label controls and some code to run in the background it is very easy to set up a respectable GPS data analyser.

After starting up Visual BASIC we begin a new 'standard EXE' project. The main control used is MSComm.OCX, which is one of the standard controls provided with Visual BASIC. Under 'Project/Components' add 'Microsoft Comm Control x.x' to the project.

The telephone icon should appear in the toolbox below, and we can now place this on the form.

Next, we give the project a name and begin saving it regularly, as errors can send our program into an unbreakable loop, for example if we forget to include a call to 'DoEvents'. Since the *Elektor Electronics* USB GPS Receiver is configured with parameters 'COM2:4800,8,N,1', these are the settings that must also be entered on the 'Properties' page of the MSComm control.

We can now create a control array from the three buttons, calling the button click functions using a Select-Case block to improve the readability of the code.

We now place the text field, ensuring that the 'Multiline' property is enabled, since otherwise we will only see a single flickering line of text.

The timer control is responsible for updating the data. The check box control allows the form to be increased or reduced in size, and determines whether the text control (the data window) is visible or not.

The descriptive label controls are also placed in the control array area. Displaying the individual data items is also done by the label controls, which are implemented here as separate controls. The NMEA sentence is split up using special parsing functions grouped together in the module NMEA0183.BAS. There are nine subroutines associated with the form 'frm_master' which together can read a complete data block from the *Elektor Electronics* USB GPS Receiver.

Links: www.NMEA.org

VisualGPS

www.visualgps.net

Overview of NMEA and GPS information

<http://vancouver-webpages.com/pub/peter/index.html>
www.gpsm.com/eng/download_eng.htm (GPS TrackMaker, free download)

Component Sources:

Framos Electronic

Dauthendeystrasse 2
D-81377 Munich - Germany
Tel.: +49 89 71 06 67 69
Fax: +49 89 71 06 67 66
sales@framos.de
http://www.framos.de/www.dir/en/start_en.html

Molecular Computer

Bahnhofstrasse 33
D-63110 Rodgau
Germany
Tel.: +49 61 06 40 35 37
Fax: +49 61 06 6 15 12
<http://www.molecular.de>

Lead-Free Electronics

Luc Lemmens

The big day is 1 July 2006. From then on, use of lead in electronic circuitry will be prohibited by the Restriction of Hazardous Substances (RoHS) European directive.



This involves much more than just switching to lead-free solder. For instance, soldering methods must be adapted to the higher temperature needed by lead-free solders, components must be able to handle this temperature, and lead-based solder cannot be used for tinning component leads. It appears that manufacturers are finally getting up to speed in making their components suitable for the 'Pb-free' label during recent months, but it is certainly not inconceivable that a few older types of components may be temporarily unavailable next year.

Doomsayers claim that quite a few electronics firms will have to close shop because they waited too long to switch over to lead-free. Time will tell: similar pronouncements were made when the EMC directive was introduced, but there hasn't been much sign of the major shakeout that was feared at that time. Quite a few alternatives for lead-based solder have now been developed, and it's hard to see the forest for the trees when you browse through the catalogues of the major suppliers. For instance, there are alloys of tin with silver, tin with copper, and

tin with silver and copper, all with various proportions and different types of flux. We decided to put things to a test by simply ordering a few rolls of various alloys and trying them out. This wasn't intended to be a serious market study, but simply a way to find out what's available nowadays and how easy it is to use in the lab.

A colleague recalled the soldering test that was used in his technical secondary school days: soldering a large number of wire bridges in series, with the work being assessed by the instructor with the help of a milliohmeter. Since we anyhow needed something to solder, this exercise provided a perfect opportunity to compare the conductivity of the various types of solder. We could have saved ourselves the trouble, because the resistances of all the various types proved to be comparable. We could not measure any noticeable differences.

Lead-free solder does not flow nearly as well as the familiar lead-tin alloy. You have to use the tip of the soldering iron to push it a bit in the right direction. A lead-free solder joint always has a matt surface, which makes it

difficult to judge whether the solder actually flowed well. However, it's also a question of getting used to a material that reacts differently than what you're accustomed to. You get the knack of it after a few solder joints, and then you can work just as fast as before. Still, old-fashioned lead-tin solder is the nicest to work with; no lead-free product can touch it in that regard. For hand soldering, there's hardly any noticeable difference between the various types of lead-free solders – it's six of one and half a dozen of the other. But next year we'll simply have to accept it – or are things actually not so bad in practice?

What's the official word?

You can find all sorts of information about lead-free electronics on the Internet, but nothing at all about what it means in practice for the 'man in the street'. From the answers we received to questions posed to government authorities, it appears that the consequences for hobbyists aren't that drastic. For instance, you can continue to use lead-based solder in your own projects and for repairs to your own equipment after the RoHS direc-

tive has been introduced. Electronics merchants won't have to dump their old stocks of components on the rubbish tip next year, since these components are already on the market and the RoHS directive only applies to newly manufactured components and equipment. Production of lead-based solder will still be permitted, and it will only disappear from the market when its sales dry up.

Even if you don't necessarily have to make your hobby lead-free next year, you can certainly do the environment a favour by doing so. However, the enthusiasm for this change will probably be quite small, as lead-free solder is much more expensive than the old familiar SnPb 60/40 and it isn't nearly as nice to use. It will most likely take quite a while before it disappears entirely from the market.

Link:
Official version of the RoHS directive:

http://europa.eu.int/eur-lex/pri/en/oj/dat/2003/l_037/l_03720030213en00190023.pdf

Resistors à la carte

Andreas Graf

The extremely useful resistor calculation tool called RCalc for use on PCs has three menu items and three tabs. The three tab sheets allow voltage dividers, potentiometers and resistive parallel/series networks to be calculated. The program accepts real as well as desired voltages or resistor values to be entered. One click on the Calculate button does the rest and the values you require will appear instantly.

Although really superfluous, a short user manual is available under HELP. The program file as supplied by the author includes two resistor series, E12 and E24, that need to be stored in the same subdirectory. Because the resistor series tables are plain text files (with the extension OHM), it is easy to add other, more (or less!) accurate series like E192 and E6. Provided they have the right format and extension, any R series

you've added will be included in the calculations by RCalc.

The author makes RCalc freely available via the publishers' website at www.elektor-electronics.co.uk as item no. **050032-11.zip**.

The program is just one megabyte in size and runs without installation on all versions of Windows from 95 through XP.

(060032-1)

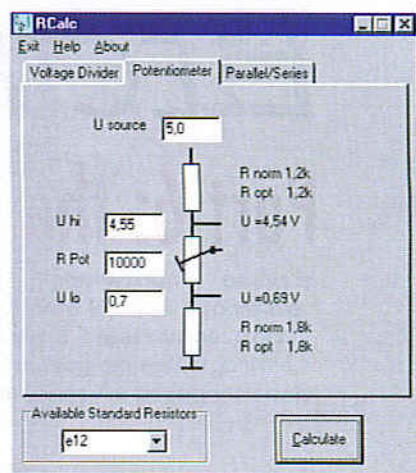

Shift registers — a different approach

Vincent Himpe

New technologies are causing the number of ICs working at the long-established 'TTL' (transistor-transistor logic) to decrease rather alarmingly. The process is not one of gradual substitution, designers being faced with ICs having different voltage swings for their logic levels. It may happen that a certain type of shift register employing TTL levels is suddenly no longer available. This Design Tip presents an example of how to approach and solve the problem.

The circuit diagram shows the use of a 74x574 shift register with

serial input and parallel output. As an alternative, you could use the 74x374. Although the '374 is slower than the 74x574, it is compatible in respect of function as well as pinout.

The 74x574 is an 8-way (octuple) D (data) flipflop with low-power Schottky TTL (LSTTL) compatible inputs and outputs. Te outputs are tri-stateable hence may be switched to high-impedance. This feature is not used here, however, so the \overline{OE} (output enable) input (pin 1) has to be permanently grounded.

Here, we propose to use D1

(pin 2) as the serial input. Q1 (pin 19) is connected to D2 (pin 3); Q2 (pin 18) is connected to D3 (pin 4), and so on.

The clock signal for the IC is applied to pin 11. One bit is 'shifted through' on each low-to-high clock transition of the CLK signal. Eight consecutive shift operations then allow 8-bit parallel data to be read from outputs Q1-Q8.

It is also possible to extend the shift register to 16 bits operation (or even more) simply by connecting the highest Q output (Q8, pin 12) to the first data input of a

further 74x574. On that chip, you connect Q1 to D2, Q2 to D3, and so on. The CLK inputs have to be interconnected and all \overline{OE} inputs on the ICs have to be tied to ground (0 V).

(040187-1)

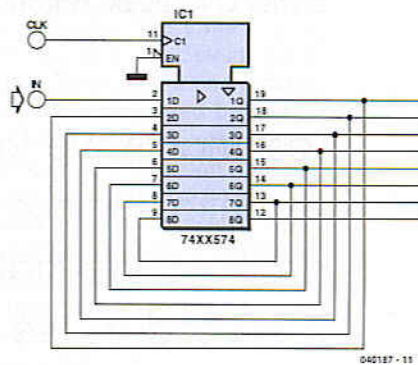

040187 - 11

DVM without isolation

Carsten Weber

Normally, commercial DVM modules based on the popular ICL7106/07 ICs require the measurement voltage to be electrically isolated ('floating') with respect to the supply voltage. Without appropriate precautions, it is, for example, not possible to measure a potential in a power supply with reference to ground.

The ICL7106/07 datasheets will tell you that INLO pin is an

output whose voltage is 2.8 V above $V+$. The operational amplifier shown in the circuit diagram may be just about any low-offset type like the OP07. It serves to adjust $V+$ (and with it INLO) to a level that pulls INLO to a virtual ground (neglecting, of course, the opamp's offset voltage). In this way, it becomes possible to measure the potential at INHI with respect to ground.

A supply voltage of 7.8 V is sufficient for the DVM module. Alternatively, by connecting it to -6 V, the module supply voltage becomes 8.8 V. As long as it is not too low, the positive supply voltage will not affect $V+$.

(040115-1)

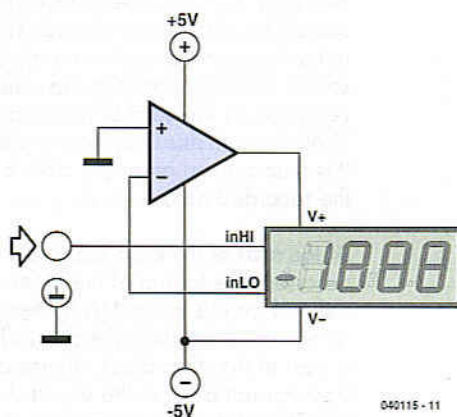

040115 - 11

DELPHI FOR ELECTRONIC ENGINEERS

Part 6: the PC as an oscilloscope



Detlef Overbeek, Anton Vogelaar and Siegfried Zuhr

Last month we familiarised ourselves with a few topics that are essential for our project, which we conclude this month: a PC oscilloscope that makes use of the sound card. Unit2 from part 5 is used as the main element in this program.

The WAV format is often used when we want to output something via the sound card. This was put into practice in the function generator in part 4. When we record a sound, the opposite happens. The information is recorded by the card and written to a data block in a WAV format. This is declared when the device is opened. It is then passed an empty data block, which it fills with the recorded data.

At the start of the data block is a header, which describes the format of the block. A type has been defined for this in the MMSystem unit, the 'TwaveHdr type', which contains the details for the data. The header is part of the data block, whereas the recording/play-back format is set in the sound device. The TPCMWaveFormat type is used for configuring the recording device. This works with the PCM format that

was used previously in the sound recorder. This contains extra information such as the number of bits per sample and how many samples per second were used. There is a TPCMWaveFormat type record, where we define that we use the PCM format, and set the number of channels (mono or stereo), the number of samples per second and a few other parameters.

The code

The source code for this project is divided into three sections (units), where each unit deals with a discrete functional part of the program (**Figure 1**). Unit1 deals with the display and contains the visible form. Unit2 holds everything to initialise the form when the program starts, as well as routines to draw on the form and to perform other tasks when the program is run-

ning. In this unit the background is calculated, the signal is drawn and the whole display is redrawn when a 'repaint' is issued (e.g. after moving the window). This unit has already been described when we drew the sine wave. Unit3 deals with the collection of data. The MMSystem again appears in the 'Uses' line, followed by the definition of a number of routines: LogInIt, LogClose, LogStart and LogStop. These are used to manage the collection of data.

This is followed by the declaration of a pair of variables, WaveInHandle and WaveHdr. WaveInHandle is a handle for the recording device with a type of hWaveIn. It is given a value of 0 and is linked in MMSystem to recording device 0, which is the sound card. Windows always uses handles to drive the hardware during its use. The handle for making the recording is therefore requested of Windows.

The variable WaveFormat is declared in the routine LogInIt, where the format of the wave file is defined. Here we establish that we work with a PCM format, in mono using 1 byte per sample. The value of BitsPerSample then becomes 8.

The sample rate is passed as a parameter to LogInIt, as is a handle to the calling procedure.

Once these values have been set up we use the routine WaveInOpen in Query mode to find out if the card supports these settings. If this is not the case it will return an error code. We then generate an error message that shows where in the program the fault occurred. If all went well then we open the recording device and link it to the handle.

LogClose does the opposite. In here we look if the handle has a non-zero value. If that is the case we reset the device, which frees up the memory blocks in use. We can then close the device and set the handle to 0. It's in LogStart where the real work starts. To make a recording we have to prepare a data block and place it in the queue. An array with 700 elements of type byte has been defined for this in Unit1 (we will cover this in more detail later on).

We then prepare the header by filling the fields of WaveHdr. The data block that was passed as a parameter to this routine is linked to the header and made ready for use by the WaveInPrepareHeader routine. This links the block to the sound card via the handle we requested earlier. The last stage is for the linked block to be put in the recording queue by the WaveInAddBuffer routine. We then start recording using the routine WaveInStart(handle).

The final routine is LogClose. Its task is to stop the recording and make the data block usable by running it through WaveInUnPrepareHeader.

We now have all the tools required to make a successful recording.

At the bottom of the page is another section:

Initialization

```
// this line is required by Finalization.
// if you leave this line out it will result
// in a compiler error
```

Finalization

```
LogClose;
```



040240 - 6 - 11

Figure 1. The oscilloscope program is divided into three units.

The program

The most important part of the program is Unit1, as this is responsible for creating the display. It is also responsible for the control of all processes and it uses routines from both other Units. This keeps the program well organised, which is particularly important when the project increases in size.

Let's start a new project (program) in Delphi: *File/New/Application*. We are then greeted by a blank form. A standard unit actually consists of two parts: the Unit itself, which contains the program code, and a Form where we place all objects used by the program. We also have to reuse Unit2 from the previous project and add the routines for the third unit. The last two units contain only code and no objects. For this reason they don't have an associated Form.

We start with Unit1 where we create the GUI (Graphical User Interface) and we begin with the background of the form.

In order to speed up the display we have used a bitmap that is displayed in its entirety whenever the screen has to be redrawn. We take a TPaintBox (from the System tab of the Component Palette, **Figure 2**) and put it on the form. (TPaintBox provides a canvas that can be used by applications for drawing on.) A PaintBox has the advantage that it draws directly onto the canvas of the form, but only in a restricted area. When you load a Bitmap (Image) onto it, it is put onto the canvas in one go and therefore won't cause any flickering. We have to bear in mind that the coordinates of the canvas are (0,0) in the top-left corner. Something similar also applies to the PaintBox. We set its top-left corner to Top=8 and Left=8. We set the Width to 510 pixels and the Height to 410 pixels. We now have the PaintBox in the top-left corner (see the example in **Figure 3**). We then add two buttons of type TButton from the Standard tab, a RadioGroup (choose one item from several options) from the same tab and a Memo. From the Additional tab we finally add a ValueListEditor (a list of values).

When we double-click on the onCreate event of the Events tab in the Object Inspector, Delphi will create this procedure and switch to the editor. We then have to enter the following:

```
Procedure TForm1.FormCreate (Sender : TObject);
```



Figure 2. TPaintBox can be found on the System tab of the Component Palette.

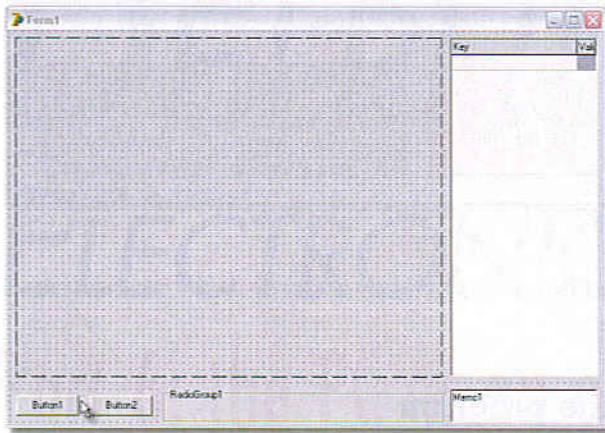

Figure 3. All basic elements for the oscilloscope screen are placed here.

```
(* These settings can also be modified via the
Object Inspector*)
Begin
  With Paintbox1 Do
    Begin Width := 510; Height := 410; OnPaint :=
PBxPaint; ControlStyle := ControlStyle + [csOpaque]
End;
  With Button1 Do
    Begin Caption := 'Clear'; OnClick := DoClear
End;
  With Button2 Do
    Begin Caption := 'Sample'; OnClick := DoSample
End;
  With RadioGroup1 Do
    Begin Caption := 'Time base [ms/div]'; Columns
:= 6;
      Items.CommaText := '20, 10, 5, 2, 1, 0.5';
ItemIndex := 0 End;
  Memo1.Text := 'Use RECORDING CONTROL to set
amplitude';
  ValueListEditor1.ColWidths [0] := 80;
  OscBackground (Paintbox1); // Calculate back-
ground
End;
```

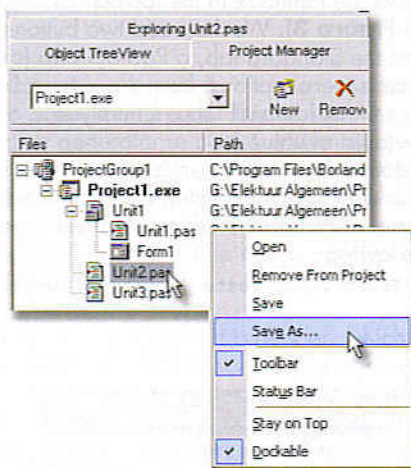

Figure 4. Unit2 and 3 still have to be added to the project.

The above shows that it is also possible to enter the settings in the program. The result is the same as if they were entered using the Object Inspector (F11), except that the result is not visible during the development! This completes the creation of the form. We still have to include Unit2 and Unit3, so we can use their internal routines. Unit2 already exists in last month's project, which makes it easy to include again. To do this, we first need to open it. Choose *File/Open* and select the folder where Unit2 is stored. You'll find that it is loaded into the current environment, but won't yet have been included in the new project. We do this as follows:

Select the unit (click in Project Manager) and save it in the directory of your current project with a right-click (Figure 4). You then have to use Alt+F11 to let Unit1 use Unit2.

We have now made a copy of Unit2 by storing it and including it in the project. If you're not completely clear what you should do, have a look at the accompanying listing, which is available on the www.learningdelphi.info and Elektor Electronics websites.

Unit2 contains everything to do with drawing and the bitmap. In the listing for the onCreate of the form we have as the last line:

```
OscBackground (Paintbox1); // Calculate back-
ground
```

This requires the inclusion of Unit2. This routine is part of that unit and it creates the background. The bitmap is created in the memory. This happens at the very end of Unit2 during the initialisation (the variable BmpOscBackgr was declared in the Var section of Unit2).

```
Unit Unit2;
```

```
(* ===== Interface ===== *)
Interface
```

```
Uses ExtCtrls, Graphics;
```

```
Var // Contains X-Y screen background
  BmpOscBackgr : TBitmap;
  // Buffer containing Y values
  OscData : Array [0..500] Of Integer;
  // Number of values in DataArray
  OscDataN : Integer;
```

```
(* ===== End ===== *)
```

```
Initialization
```

```
BmpOscBackgr := TBitmap.Create;
```

This variable is of the TBitmap type, which is defined in Delphi's libraries. The instruction `BmpOscBackgr := TBitmap.Create` creates a bitmap in memory, which can later be written to. This is done by the routine `OscBackground (Paintbox1)`. It makes sure that the width and height of the bitmap are equal to that of the Paintbox and it makes the pen (line colour) and brush (fill colour) black (clBlack is a property within Delphi that refers to the colour black). A rectangle covering the whole bitmap is then drawn using a black pen and fill colour. The subsequent drawing of the lines is the same as in the sine wave project and is described there.

We now have a useable bitmap available. When the program starts, onCreate will be processed first. After that the screen and its components are drawn. That also applies to the PaintBox. When this is drawn we hook into this by calling the PbxPaint routine from the onPaint event. This was linked to the Paintbox during the onCreate of the form.

PbxPaint in turn calls OscRepaint, a routine in Unit2, which finally puts the bitmap onto the screen and draws the samples, if any.

At the start the display shows a clear screen containing the buttons, a radio-button section, a memo with a message, the blank 'scope' screen and next to that an empty list. The functionality still has to be added for the buttons. This is fairly simple for the Clear button (Button1). This is already pointing to the DoClear routine. In this two things happen: the counter for the number of samples is set to zero and the paintbox is made to draw itself again using Invalidate. This results in a new, clear screen.

The second button, 'Sample', does the real work. This has been linked in onCreate to the procedure DoSample.

```

Procedure TForm1.DoSample (Sender : TObject);
Var SampleRate : Integer;
Begin
  Button2.Enabled := False;
  Case RadioGroup1.ItemIndex Of
    0 : SampleRate := 2500; // 20 ms/Div
    1 : SampleRate := 5000; // 10 ms/Div
    2 : SampleRate := 10000; // 5 ms/Div
    3 : SampleRate := 25000; // 2 ms/Div
    4 : SampleRate := 50000; // 1 ms/Div
  Else SampleRate := 100000; // 0.5 ms/Div
  End;
  // Initialise sound card
  LogInit (Form1.Handle, SampleRate);
  LogStart (@WaveData, SizeOf (WaveData));
End;

```

The local variable SampleRate is used to store the value of the selected RadioButton, which lets us choose the sample rate. We then call the routine LogInit from Unit3. If all went well, this should have been included in the project at the same time as Unit2, otherwise you have to repeat the process for Unit3.

LogInit has the handle for the form and the sample rate as parameters. The sound card is then prepared as described when we covered Unit3. Next, the recording begins. This takes a pointer to the variable WaveData and the size of WaveData. The variable WaveData is declared in Unit1 as a 700-element array of type Byte. This can store 700 values in the range 0 to 255. We decided to record 700 samples because during our tests we found that a lot of noise was present at the start of the recording. For this reason we take the last 500 samples from the 700, which corresponds to the 500 pixel width of the bitmap. The recording now takes place and when the data block is full it is taken out of the queue and a MM_WIM_DATA message is generated.

This mechanism is part of Windows and Delphi links into it. All of Windows is saturated with messages and events. It is often described as event-driven, a term we've mentioned previously in this course. Programs can also send messages via SendMessage or PostMessage and other programs or another part of the same program can react

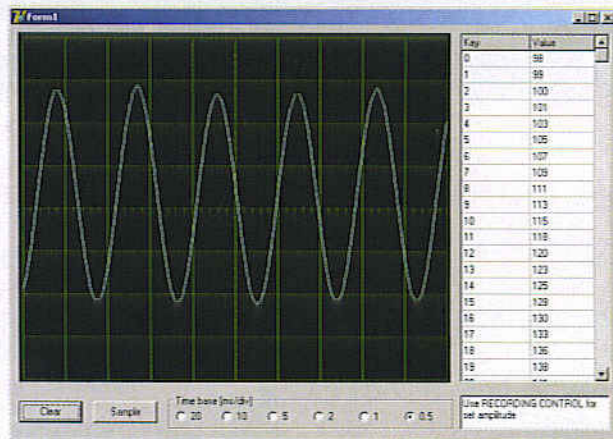

Figure 5. It works! The signal at the input of the sound card is made visible on the screen.

to those. That is what happens here.

The Private section of the unit has a routine called MMInDone, which listens for the MM_WIM_DATA Windows message.

```

Procedure TForm1.MMInDone (Var Msg : Tmessage);
Const SndAdjust = 65; // Sound card dependent
  // This value may be changed if necessary
Var I : Integer;
Begin
  LogStop (Msg.LParam);
  LogClose;
  Button2.Enabled := True; // Enable button after
  recording has finished
  OscDataN := 0; // Reset display buffer
  OscRepaint (Paintbox1);
  ValueListEditor1.Strings.Text := '';
  For I := 200 To 700 Do
    Begin
      OscAddY (Paintbox1, (WaveData [I] - 128) /
      SndAdjust);
      ValueListEditor1.InsertRow (IntToStr (I -
      200), IntToStr (WaveData [I]), True)
    End
  End;

```

We first call LogStop, which has a pointer to the data block as its parameter, taken from Msg.LParam. This is part of the message MM_WIM_DATA. The recording is then stopped and the data is 'unprepared', or processed ready for use.

Next we call LogClose to turn off the sound card. The 'Sample' button is enabled again. This was disabled when it was clicked so that it can only run once at a time. Next everything is cleared (OscDataN is set to zero and a repaint is issued which results in a blank oscilloscope screen) and then we process elements 200 to 700 from the recorded samples. The routine OscAddY from Unit2 is used to draw each sample. Finally the sample is added to the ValueList. The image will be on the screen when all samples have been processed. It has been quite a lot of work, but we now have a functional oscilloscope (Figure 5).

We hope you enjoy using it.

elektor

electronics • leading the way

Elektor's online services have been restyled and extended within a brand new easy to use website. Now featuring Elektor News Service, Forum, Marketplace, Online Shop and several download options.



restyled and
extended

MAGAZINE

- indexed article archive back to 1998
- summary for easy recognition
- search articles
by volume or keyword

www.elektor-e

register

- on paper and on the web

More than **20,000** visitors in the first month!

The screenshot shows the Elektor Electronics website interface. At the top, there are navigation links for 'CONSTRUCTION PROJECTS', 'FORUM', 'SHOP', 'MARKETPLACE', and 'SERVICE'. A search bar is located on the right side. Below the navigation, there are several article snippets with titles and dates, such as 'New PC based oscilloscope developed by Claverscope in New Zealand.' and 'Delphi for Electronic Engineers' course launched in the January 2005 issue of Elektor Electronics website.' There is also a 'Marketplace' section with a list of items for sale, including '28/01 WANTED: Zebon Model 72 Extend-a-Line' and '28/01 211 Elektors for sale'.

NEWS

- daily electronics newsfeed
- weekly free Newsletter

FORUM

- join in discussions with fellow enthusiasts and specialists
- get answers to technical problems

PROJECTS

- download construction projects (PDF) and associated software
- hundreds of articles available
- search by category, alphabetically and chronologically

SHOP

- everything you need to build projects, incl. PCBs
- books and CD-ROMs
- secure payment system

MARKETPLACE

- the place to visit for components, tools, old volumes, etc.

electronics.co.uk

and receive the free E-Newsletter!



Quasar Electronics Limited
PO Box 6935, Bishops Cleeve
CM23 4WP, United Kingdom
Tel: 0870 246 1826
Fax: 0870 460 1045
E-mail: sales@quasarelectronics.com
Web: www.QuasarElectronics.com

Postage & Packing Options (Up to 2Kg gross weight): UK Standard 3-7 Day Delivery - £3.95; UK Mainland Next Day Delivery - £8.95; Europe (EU) - £6.95; Rest of World - £9.95.
!Order online for reduced price UK Postage!
We accept all major credit/debit cards. Make cheques/PO's payable to Quasar Electronics. Prices include 17.5% VAT.
Call now for our FREE CATALOGUE with details of over 300 kits, projects, modules and publications. Discounts for bulk quantities.



QUASAR
electronics
Get Plugged In!

0871

CREDIT CARD SALES

717 7168

Motor Drivers/Controllers

Here are just a few of our controller and driver modules for AC, DC, unipolar/bipolar stepper motors and servo motors. See website for full details.

NEW! Bidirectional DC Motor Controller

Controls the speed of most common DC motors (rated up to 32VDC/5A) in both the forward and reverse direction. The range of control is from fully OFF to fully ON in both directions. The direction and speed are controlled using a single potentiometer. Screw terminal block for connections.
Kit Order Code: 3166KT - £14.95
Assembled Order Code: AS3166 - £24.95



DC Motor Speed Controller (5A/100V)

Control the speed of almost any common DC motor rated up to 100V/5A. Pulse width modulation output for maximum motor torque at all speeds. Supply: 5-15VDC. Box supplied. Dimensions (mm): 60Wx100Lx60H.
Kit Order Code: 3067KT - £11.95
Assembled Order Code: AS3067 - £19.95



NEW! PC / Standalone Unipolar Stepper Motor Driver

Drives any 5, 6 or 8-lead unipolar stepper motor rated up to 6 Amps max. Provides speed and direction control. Operates in stand-alone or PC-controlled mode. Up to six 3179 driver boards can be connected to a single parallel port. Supply: 9V DC. PCB: 80x50mm.
Kit Order Code: 3179KT - £9.95
Assembled Order Code: AS3179 - £16.95
Assembled Order Code: AS3113 - £24.95



NEW! Bi-Polar Stepper Motor Driver

Drive any bi-polar stepper motor using externally supplied 5V levels for stepping and direction control. These usually come from software running on a computer. Supply: 8-30V DC. PCB: 75x85mm.
Kit Order Code: 3158KT - £12.95
Assembled Order Code: AS3158 - £26.95



Most items are available in kit form (KT suffix) or assembled and ready for use (AS prefix).

Controllers & Loggers

Here are just a few of the controller and data acquisition and control units we have. See website for full details. Suitable PSU for all units: Order Code PSU445 £8.95

Rolling Code 4-Channel UHF Remote

State-of-the-Art. High security. 4 channels. Momentary or latching relay output. Range up to 40m. Up to 15 Tx's can be learnt by one Rx (kit includes one Tx but more available separately). 4 indicator LED's. Rx: PCB 77x85mm, 12VDC/6mA (standby). Two and Ten channel versions also available.
Kit Order Code: 3180KT - £41.95
Assembled Order Code: AS3180 - £49.95

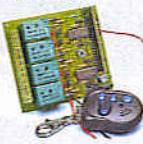

Computer Temperature Data Logger

4-channel temperature logger for serial port. °C or °F. Continuously logs up to 4 separate sensors located 200m+ from board. Wide range of free software applications for storing/using data. PCB just 38x38mm. Powered by PC. Includes one DS1820 sensor and four header cables.
Kit Order Code: 3145KT - £19.95
Assembled Order Code: AS3145 - £26.95
Additional DS1820 Sensors - £3.95 each



NEW! DTMF Telephone Relay Switcher

Call your phone number using a DTMF phone from anywhere in the world and remotely turn on/off any of the 4 relays as desired. User settable Security Password, Anti-Tamper, Rings to Answer, Auto Hang-up and Lockout. Includes plastic case. Not BT approved. 130x110x30mm. Power: 12VDC.
Kit Order Code: 3140KT - £39.95
Assembled Order Code: AS3140 - £49.95



Serial Isolated I/O Module

Computer controlled 8-channel relay board. 5A mains rated relay outputs. 4 isolated digital inputs. Useful in a variety of control and sensing applications. Controlled via serial port for programming (using our new Windows interface, terminal emulator or batch files). Includes plastic case 130x100x30mm. Power Supply: 12VDC/500mA.
Kit Order Code: 3108KT - £54.95
Assembled Order Code: AS3108 - £64.95



Infrared RC Relay Board

Individually control 12 on-board relays with included infrared remote control unit. Toggle or momentary. 15m+ range. 112x122mm. Supply: 12VDC/0.5A
Kit Order Code: 3142KT - £41.95
Assembled Order Code: AS3142 - £51.95

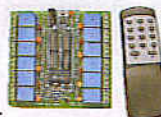

PIC & ATMEL Programmers

We have a wide range of low cost PIC and ATMEL Programmers. Complete range and documentation available from our web site.

Programmer Accessories:

40-pin Wide ZIF socket (ZIF40W) £15.00
18V DC Power supply (PSU010) £19.95
Leads: Parallel (LDC136) £4.95 / Serial (LDC441) £4.95 / USB (LDC644) £2.95

NEW! USB 'All-Flash' PIC Programmer

USB PIC programmer for all 'Flash' devices. No external power supply making it truly portable. Supplied with box and Windows Software. ZIF Socket and USB Plug A-B lead not incl.
Kit Order Code: 3128KT - £34.95
Assembled Order Code: AS3128 - £44.95



Enhanced "PICALL" ISP PIC Programmer

Will program virtually ALL 8 to 40 pin PICs plus a range of ATMEL AVR, SCENIX SX and EEPROM 24C devices. Also supports In System Programming (ISP) for PIC and ATMEL AVRs. Free software. Blank chip auto detect for super fast bulk programming. Available in assembled format with ZIF socket only.
Assembled Order Code: AS3144ZIF - £64.95



ATMEL 89xxx Programmer

Uses serial port and any standard terminal comms program. 4 LED's display the status. ZIF sockets not included. Supply: 16-18VDC.
Kit Order Code: 3123KT - £29.95
Assembled Order Code: AS3123 - £34.95



NEW! USB & Serial Port PIC Programmer

USB/Serial connection. Header cable for ICSP. Free Windows software. See website for PICs supported. ZIF Socket/USB Plug A-B lead extra. Supply: 18VDC.
Kit Order Code: 3149CKT - £34.95
Assembled Order Code: AS3149C - £49.95



www.quasarelectronics.com

Secure Online Ordering Facilities • Full Product Listing, Descriptions & Photos • Kit Documentation & Software Downloads



Elektor Vocoder (1980)

Jan Buiting

The Elektor Vocoder is a project with great nostalgic value, witness the interest expressed in it on quite a few web sites. Even if you do not know how a vocoder works, you may know its effects from hit records like 'Funky Town' by Lipps Inc. and some more recent songs like 'Believe' (do you believe in love after love) by Cher. In the early 1980s the vocoder was cherished mainly by sound studio technicians and producers. Most artists hated using them on 'live' performances as hearing the output of a vocoder may have rather dramatic effects on your natural voice.

The publication of the Vocoder hardware in the January and February 1980 issues of *Elektor* magazine must have been awaited with baited breath by many readers as, in good *Elektor* tradition, the 'real thing' was not published until after a solid dose of theory and market information contained in 'introductory' articles published in late 1979. It was a time when commercial vocoders were simply unaffordable.

The *Elektor* Vocoder filtered the input signal into two bands, a lowpass of about 600 Hz (A), and a highpass of about 2500 Hz (B), and envelope detectors followed by simple decision logic to the effect that 'voiced' was detected if $A > B$, and unvoiced if $A < B$. Though wrong in terms of psychoacoustics, the approach gave satisfactory results for 'all non-scientific work'.

The project was massive by any standard: three or four busboards were required, a hefty power supply, input and output boards and at least eight bandpass filter boards (BPFs), all crawling with opamps. The BPFs were of a standard design with only capacitor values changed per filter unit to reach the desired

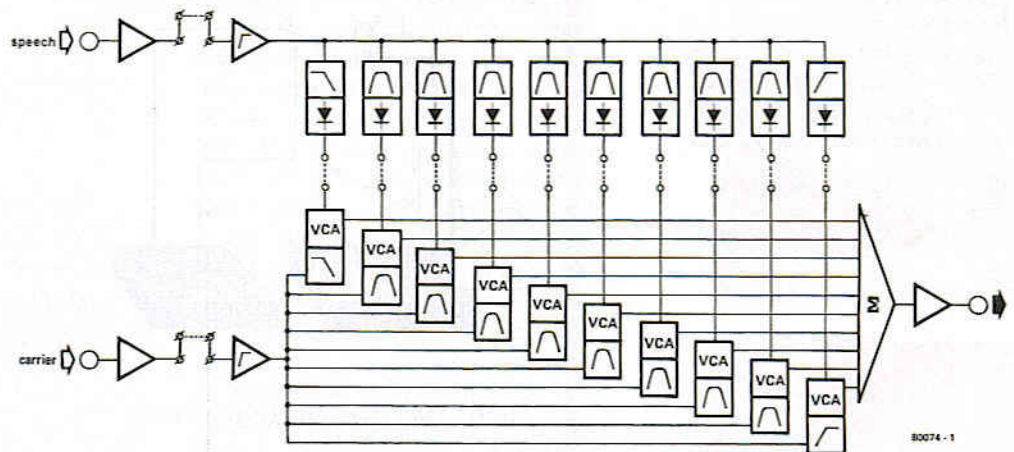

filter frequency. The articles recommended a Vero 19-inch 2-HU case with tilt feet to accommodate the unit.

The Vocoder unit shown here does not contain pull-out filter modules as suggested by a sumptuous two-page artist's impression in the February 1980 article.

The Vocoder project was by no means abandoned by the magazine after publishing the long awaited hardware. In the September 1980 issue, a 'how to use it' article was published containing a lot of hands-on information like patch cords for 'Donald Duck' and 'Hot Potato' effects. In later years, the Vocoder was a prominent unit for 'live' use on many an exhibition or trade fair graced by *Elektor* sales and/or editorial teams. Connected-up between a microphone and two MFB (motional

feedback) loudspeaker units on tripods the Vocoder was an irresistible attraction to many (younger) visitors who would not fail to exasperate all and sundry (except themselves) by constantly tweaking the Vocoder controls and producing hilarious sound effects at high volumes. Suddenly, anyone could be Klingon, Spaceman or Woody Woodpecker.

In February 1981, probably in response to criticisms on the crude high/low filter detection method in the original design, a much improved voiced/unvoiced detector was published, as well as details of a (disappointingly simple) computer interface. According to the article, the interface would "enable experimenters to control the unit by means of a computer without having to cope with complicated wiring problems". What

computer and what software, we wonder?

A full-blown Elektor Vocoder with a computer interface and the enhanced voiced/unvoiced detector is a monster in terms of hardware. Today, the whole thing could probably be crammed into a DSP (digital signal processor) chip or a Karaoke system. We look forward to seeing your suggestions.

(045136-1)

Web link:

www.msc175.de/projekte/vocoder/

Retronics is a monthly column covering vintage electronics including legendary Elektor designs. Contributions, suggestions and requests are welcomed; please send an email to editor@elektor-electronics.co.uk, subject: Retronics EE.

QUIZZ'AWAY



Martin Ohsmann is a Professor of Electrical Engineering and Information Technology at FH Aachen and a long-time contributor to *Elektor Electronics*. Through *Quizz'away* he aims at stimulating thought, speculation, construction and simulation as well as raise interesting questions.

This month look at current-carrying conductors. For example, two parallel running conductors carrying electrical currents of the same direction, are subject to mutual attraction.

The above effect can be proved by means of the setup shown in **Figure 1**. By analogy, forces are exerted between current carrying coils (solenoids or electromagnets), also if alternating currents are applied. With ac currents however, mutual induction occurs as an additional effect, causing one coil to induce a voltage in the other. Induction therefore

allows a current to be generated in the second coil. And that is our subject this month.

As illustrated in **Figure 2**, two coils are freely suspended close to one another. We send an alternating current through coil 1 (the 'primary' coil). A capacitor is connected across the terminals of coil 2 (the 'secondary' coil), the combination of the two forming a resonant circuit.

This month's question is:

Are the coils repelled or attracted?

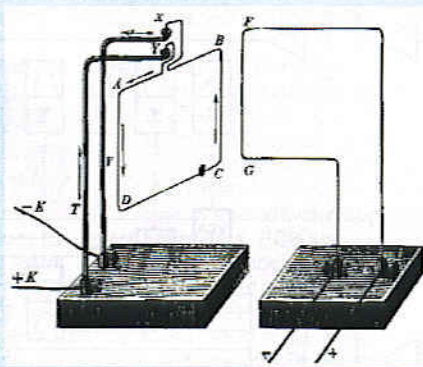

Figure 1. Examination of forces between conductors.

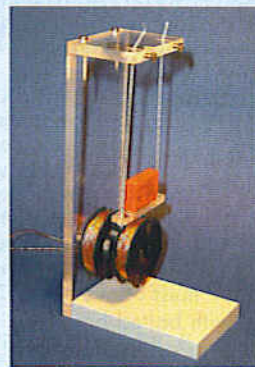

Figure 2. Nearby current-carrying coils.

Quizz'away and win!

Send in the best answer to this month's Quizz'away question and win a

Penscope PS40M10

with 10-bit resolution and 40 Msamples/s worth approx. £200.00. This USB oscilloscope was sponsored by **VEGO VOF** (www.vego.nl) and comes with extensive software.

All answers are processed by Martin Ohsmann in co-operation with Elektor editorial staff. Results are not open to discussion or correspondence and a lucky winner is drawn in case of several correct answers.



Please send your answer to this month's Quizz'away problem, by email, fax or letter to:
Quizz'away, Elektor Electronics,
PO Box 190,
Tunbridge Wells TN5 7WY, England.
Fax (+44) (0)1580 200616.
Email: editor@elektor-electronics.co.uk,
subject: 'quizzaway 6-05'.

The closing date is
30 June 2005

(solution published in the September 2005 issue). The outcome of the quiz is final. The quiz is not open to employees of Segment b.v., its business partners and/or associated publishing houses.

As of the September 2004 issue Quizz'away is a regular feature in Elektor Electronics. The problems to solve are supplied by Professor Martin Ohsmann of Aachen Technical University.

Hint:

For the practical experiment we used coils with 70 turns each of RF litz (multi-strand) 30x0.1 mm copper enamelled wire on a PS47x14.9 coil former. The coils were spaced by about 5 mm. The capacitor on the secondary coil is a 0.1- μ F MKP-10 type. Some amps of ac current will need to be put through the primary to obtain any useable force. By means of their magnetic coupling, the two coils form a transformer whose equivalent circuit is a 'T' (Figure 3) due to its symmetrical construction.

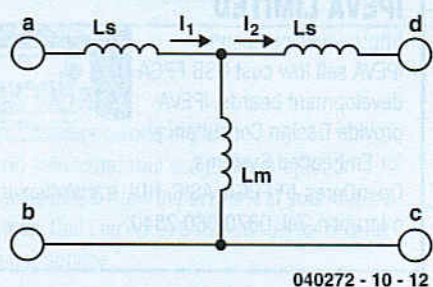

Figure 3. Equivalent circuit.

Solution to the April 2005 problem

(p. 78; 'Coin attraction?')

To be able to tell if an alloy-based coin is attracted or repelled by an electromagnet (solenoid) we first and foremost need to look at the frequency of the alternating current used in the experiment. The nickel component gives the coin ferromagnetic properties. As you can easily prove for yourself, a two-pound or a one-euro coin is attracted by a permanent magnet. This effect also dominates with relatively low frequencies on the solenoid. The top photo of Figure 4 shows that the euro coin is attracted at 50 Hz. In the centre, you can see the position of the euro coin in front of the solenoid when the current is switched off. The lower image shows what happens when 20 kHz is applied — the coin is pushed out of the magnetic field. The higher frequency causes eddy currents to increase because the voltage induced in the aforesaid ring rises with frequency. The eddy currents in turn cause a repelling force that becomes predominant at 20 kHz already. Hence: the coin is repelled at 20 kHz. As you can see, the euro coin by nature is subject to repelling as well as attracting forces around it, literally and politically!

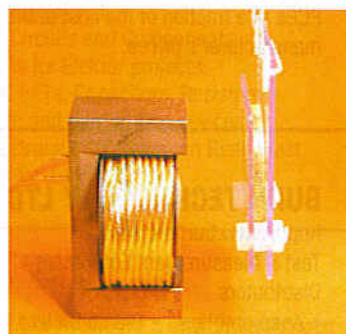

Figure 4. Top: 50 Hz; middle: no current; below: 20 kHz.

Advertisement



Prototypes and small series up to 1000 pcs

Value for Money

Up to 6 layer boards

Always Available

Attractive price

On-line Printed Circuit Boards

Double Sided, 1.6 mm,
Plated Through,
Green Solder mask,
Hot Air Level,
1 White Legend.
Price including
tooling + plotting + VAT

100 mm x 160 mm
1 pc = 45.74 Euro

100 mm x 80 mm
5 pcs = 68.97 Euro

www.ThePCBSHOP.com

ELEKTOR SHOWCASE

To book your showcase space contact Huson International Media

Tel. 0044 (0) 1932 564999 Fax 0044 (0) 1932 564998

ALLGOOD TECHNOLOGY

www.allgoodtechnology.com

Low-medium volume sub-contract assembly. SMT specialist since 1990. Customers include military, aerospace etc. 0402 to BGA capabilities, automatic assembly and hand built prototypes.

AUDIOXPRESS

www.audioXpress.com

The premier do-it-yourself audio magazine for 35 years.

- Hands-on projects
- Helpful articles
- Expert advice
- New technologies

Full range of books, back issues on CD



BETA LAYOUT

www.pcb-pool.com

Beta layout Ltd Award-winning site in both English and German offers prototype

PCBs at a fraction of the cost of the usual manufacturer's prices.



BURN TECHNOLOGY LTD

<http://www.burntec.com>

Test & Measurement Equipment Distributors

- Anemometers
- Clamp Meters
- Light Meters
- LCR Meters
- Sound Meters
- Multimeters
- Device Programmers

Burn Technology Limited, Winfrith Technology Centre, Dorchester, Dorset, DT2 8DH
Tel: (01305) 852090 Fax: (01929) 463214



COMPUCUT

<http://www.compucutters.com>

Computer Numerical Control from your home PC. Great for tricky jobs, and accurate repetitive work. We supply: - Software - Interface - Manual - Support
Price £250 plus postage.

CONFORD ELECTRONICS

<http://www.confordelec.co.uk>

Lightweight portable battery/mains audio units offering the highest technical performance. Microphone, Phantom Power and Headphone Amplifiers. Balanced/unbalanced signal lines with extensive RFI protection.

DANBURY ELECTRONICS

<http://www.livinginthepast.demon.co.uk>

Here you will find our mains and output transformers in Mike Holme's range of valve/tube amplifiers (PP & SE). Also circuits, parts lists, chassis, advice.

EASYSYNC

<http://www.easysync.co.uk>

EasySync Ltd sells a wide range of single and multi-port USB to RS232/RS422 and RS485 converters at competitive prices.



ELNEC

www.elnec.com

- device programmer manufacturer
- selling through contracted distributors all over the world
- universal and dedicated device programmers
- excellent support and after sale support
- free SW updates
- reliable HW
- once a months new SW release
- three years warranty for most programmers



FOREST ELECTRONIC DEVELOPMENT

<http://www.fored.co.uk>

FED supply PIC programmers, Basic modules, and development software including a PIC C

FUTURLEC

<http://www.futurlec.com>

Save up to 60% on

- Electronic Components
- Microcontrollers, PIC, Atmel
- Development Boards, Programmers

Huge range of products available on-line for immediate delivery, at very competitive prices.



FUTURE TECHNOLOGY DEVICES

<http://www.ftdichip.com>

FTDI designs and sells USB-UART and USB-FIFO interface i.c.'s.

Complete with PC drivers, these devices simplify the task of designing or upgrading peripherals to USB

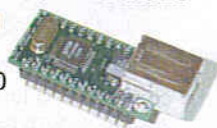

ILP ELECTRONICS LIMITED

<http://www.ilpelectronics.com>

ILP has been in the audio industry for over 30 years primarily manufacturing both standard and custom audio modules and pre-amplifiers.



IPEVA LIMITED

<http://www.ipeva.com>

IPEVA sell low cost USB FPGA development boards. IPEVA provide Design Consultancy for Embedded Systems, OpenCores-IP, FPGA, ASIC, HDL translation and migration. Tel. 0870 080 2340.



JLB ELECTRONICS

www.jlbelectronics.com

Suppliers of electrical / electronic parts and consumables. Including:

- Cable ties / bases
- Tools / hardware
- Bootlace ferrules
- Connectors
- Solvent sprays & cleaners
- PVC Tape
- Heat Sink compound

KOMCARD

<http://www.komcard.com>

Learn how to design a PCI card, and write a PCI device driver. We lead you step by step with practical PCI projects you build.

LONDON ELECTRONICS COLLEGE

<http://www.lec.org.uk>

Vocational training and education for national qualifications in Electronics Engineering and Information Technology (BTEC First National, Higher National NVQs, GCSEs and Advanced Qualifications). Also Technical Management and Languages.

products and services directory

MQP ELECTRONICS

<http://www.mqpelectronics.co.uk>

Leaders in Device

Programming Solutions.

- Online shop
- Low Cost Adapters for all Programmers
- Single Site and Gang Programmers
- Support for virtually any Programmable Device



PHYZX

<http://www.phyzx.co.uk>

Automatically Plot and Drill PCB's

- Accurately
- Repeatably
- Mains operated
- Robust Steel Construction
- Gerber RS274X compatible
- Full XYZ RS32 Control
- Including Accessories
- Complete system Under £500.

NEW WAVE CONCEPTS

<http://www.new-wave-concepts.com>

Software for hobbyists:

- Livewire circuit simulation software, only £29.36
- PCB Wizard circuit design software, only £29.36



Available from all Maplin Electronics stores and www.maplin.co.uk

PICDOS™

<http://www.picdos.com>

Hard disk, DOS & files on PIC16F877.

SmartMedia™ based.

No complex hardware just wires. Run-Debug existing PIC code & interrupts. Free schematics, software, debugger



PCB WORLD

<http://www.pcbworld.org.uk>

World-class site: Your magazine project or prototype PCB from the artwork of your choice for less. Call Lee on 07946 846159 for details. Prompt service.

QUASAR ELECTRONICS

www.QuasarElectronics.com

Over 300 electronic kits, projects and ready built units for hobby, education and industrial applications including PIC/ATMEL programming solutions. Online ordering facilities. Tel: +44 (0) 870 246 1826 Fax: +44 (0) 870 460 1045 Email: sales@QuasarElectronics.com



ROBOT ELECTRONICS

<http://www.robot-electronics.co.uk>

- Ultrasonic rangefinders
- Motor H-Bridge controllers
- Magnetic Compasses
- RC servos and controllers
- PIC programmers and components
- Electronic Design/Development and Manufacturer to industry



ULTRALEDs

[Ultraleds.co.uk](http://www.Ultraleds.co.uk)

<http://www.ultraleds.co.uk>

tel: 0871 7110413

Large range of low cost Ultra bright leds and Led related lighting products. Major credit cards taken online with same day despatch.

USB INSTRUMENTS

<http://www.usb-instruments.com>

USB Instruments specialises in PC based instrumentation products and software such as Oscilloscopes, Data Loggers, Logic Analysers which interface to your PC via USB.



VIEWCOM

<http://www.viewcom.f9.co.uk>

tel: 020 8471 9338 fax: 020 8552 0946

- Mail Order supplier of:
 - Integrated Circuits and Components.
 - Kit and parts for Elektor projects.
 - Transistors, FETs, Capacitors, Resistors, Crystals, etc and hard to find devices.
- Viewcom Electronics, 77 Upperton Road West, Plaistow, London E13 9LT

SHOWCASE YOUR COMPANY HERE

Elektor Electronics has a feature to help customers promote their business, Showcase - a permanent feature of the magazine where you will be able to showcase your products and services.

- For just £220 + VAT (£20 per issue for eleven issues) Elektor will publish your company name, website address and a 30-word description

- For £330 + VAT for the year (£30 per issue for eleven issues) we will publish the above plus run a 3cm deep full colour image - e.g. a product shot, a screen shot from your site, a company logo - your choice

Places are limited and spaces will go on a strictly first come, first served basis. So please fax back your order today!

I wish to promote my company, please book my space:

- Text insertion only for £220 + VAT
- Text and photo for £330 + VAT

NAME:..... ORGANISATION:.....

JOB TITLE:.....

ADDRESS:.....

TEL:.....

PLEASE COMPLETE COUPON BELOW AND FAX BACK TO 00-44-(0)1932 564998

COMPANY NAME.....

WEB ADDRESS.....

30-WORD DESCRIPTION.....

.....

.....

.....

.....

VIRTINS TECHNOLOGY

<http://www.virtins.com>

PC based virtual instrument for electronics enthusiasts, students and professionals, including full-fledged sound card real time Oscilloscope, Spectrum Analyzer and Signal Generator, Downloader and try.



ELECTRONIC ENTHUSIASTS

Only one magazine tests its projects and circuits in its own lab before publication

**ELEKTOR ELECTRONICS
THE ELECTRONICS &
COMPUTER MAGAZINE**

**SUBSCRIBE
TODAY!**

Contact: Worldwide Subscription Service Ltd,
Unit 4 Gibbs Reed Farm, Pashley Road,
Titchhurst TN5 7HE
Telephone: 01580 200657 Fax: 01580 200616
www.elektor-electronics.co.uk

Order now using the Order Form in the Readers Services section in this issue.

CD-ROM BESTSELLERS

Elektor 2004

This CD-ROM contains all editorial articles, with the exception of New Products items, published in Elektor Electronics magazine Volume 2004. Using the supplied Acrobat Reader program, articles are presented in the same layout as originally found in the magazine. The DiskMirror utility on this CD-ROM allows your earlier Elektor year volume CD-ROMs (1997-2003) to be added to a large archive on hard disk for fast access and easy reference. A built-in search function allows you to find references in any article from the archive on hard disk, or from individual year volume CD-ROMs you have available.

£16.25 (US\$ 28.75)



Audio Collection 2

A unique CD-ROM for the true audio lover, containing no fewer than 75 audio designs from the past five year volumes of Elektor Electronics magazine. The articles on the CD-ROM cover test & measurement equipment, amplifiers, digital audio and loud-speaker technology. Highlights include the Crescendo Millennium Edition, Audio-DAC 2000, Audio-ADC 2000 and the IR-S/PDIF Transmitter and Receiver. Using the included Acrobat Reader you are able to browse the articles on your computer, as well as print texts, circuit diagrams and PCB layouts.

£12.05 (US\$ 21.25)



Robotics

A large collection of data-sheets, software tools, tips, tricks and Internet links to assorted robot constructions and general technical information. All aspects of modern robotics are covered, from sensors to motors, mechanical parts to microcontrollers, not forgetting matching programming tools and libraries for signal processing.

£12.05 (US\$ 21.25)



Visit www.elektor-electronics.co.uk for various springtime offers!



302 Circuits

ISBN 0-905705-25-4
354 pages
£10.35 (US\$ 21.00)



304 Circuits

ISBN 0-905705-34-3
366 pages
£13.45 (US\$ 27.00)



305 Circuits

ISBN 0-905705-36-X
369 pages
£15.55 (US\$ 31.00)

Complete your 30x circuits series now!

The 30x series of Summer Circuit compilation books have been bestsellers for many years. You can use these books not only for building the circuits described, but also as a treasure trove of ideas or circuit adaptations for your own experiments. Many readers have found in these books that new approach, new concept, or new circuit they were looking for.



307 Circuits

ISBN 0-905705-62-9
342 pages
£18.20 (US\$ 37.00)



308 Circuits

ISBN 0-905705-66-1
367 pages
£18.20 (US\$ 37.00)

BESTSELLING BOOKS

Top-5

- 1 **308 Circuits**
ISBN 0-905705-66-1 £18.20
- 2 **PC-Interfaces under Windows**
ISBN 0-905705-65-3 £25.95
- 3 **Build your own Audio Valve Amplifiers**
ISBN 0-905705-39-4 £15.55
- 4 **307 Circuits**
ISBN 0-905705-62-9 £18.20
- 5 **Handbook for sound technicians**
ISBN 0-905705-48-3 £20.75



SC (semiconductor) Analyser 2005

(Elektor Electronics April 2005)

- Complete kit of parts including PCB and programmed controller (without LCD)

030451-71 £ 29.65 / \$ 55.85

- 'standard' back-lit LC display

030451-72 £ 7.25 / \$ 13.65

- Poly-LED display

030451-73

£ 25.50 /
\$ 48.05



LPC210x ARMeE Development System

(Elektor Electronics April 2005)

- Processor board, ready-built and tested

040444-91
£ 25.50 /
\$ 48.05

- Motherboard (bare, without components)

040444-2
£ 11.70 /
\$ 22.05

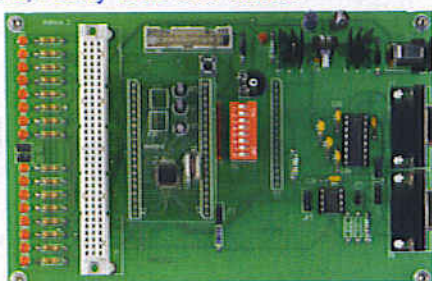

Check www.elektor-electronics.co.uk
for current pricing of the Electrosmog Tester!

GPS Receiver on USB

(Elektor Electronics June 2005)

Complete kit with
Lassen iQ-receiver,
extra long cable and
waterproof antenna
case

040264-71

£ 62.05 / \$ 116.95



Temperature Logger

(Elektor Electronics June 2005)

Complete kit of parts including
components, PCB and program-
med controller
(available from mid May 2005)

030447-71

£ 25.85 / \$ 48.75

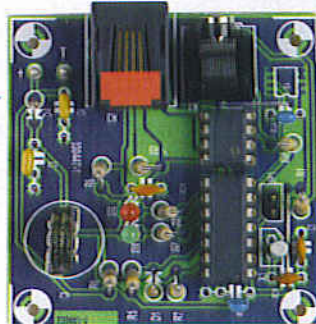

Further products from Elektor Electronics:

READY-BUILT PROJECTS	£	\$
ClariTy 300-W Class-T Amplifier		
030217-91 Amplifier board with SMDs pre-fitted; cores for L1 & L2	34.50	55.70
Flash Microcontroller Starter Kit		
010208-91 ready-assembled PCB incl. software, cable, adapter & related articles	69.00	112.50
Gameboy Digital Sampling Oscilloscope (GBDSO)		
990082-91 ready-assembled board, incl. the PC software and related articles	103.00	183.00
LPC210x ARMeE Development System		
040444-91 Processor board, ready-made and tested	25.50	48.05
Micro Webserver with MSC1210 Board		
030060-91 Microprocessor Board, ready-assembled	75.90	142.95
044026-91 Network Extension Board, ready-assembled	44.50	83.95
044026-92 Combined package (030060-91 & 044026-91 & related articles)	117.50	220.95
EVERGREENS	£	\$
Elektor Electronics Help Disk		
966022-1 Disk, Windows version	8.15	14.45
Elektor Electronics Item Tracer 1985-2003		
046003-11 contents database (disk, Windows version)	8.15	14.35
Universal Prototyping Boards		
UPBS-1 PCB	2.45	4.30
UPBS-2 2 PCBs	4.10	7.25
UPBS-4 4 PCBs	6.55	11.55
No. 343 JUNE 2005	£	\$
Electrosmog Tester		
050008-1 PCB, bare	5.15	9.75
050008-91 PCB, ready built and tested, check our website		
GPS Receiver on USB		
040264-1 PCB, bare	4.30	8.15
040264-71 Kit of parts	62.05	116.95
Temperature Logger		
030447-1 PCB, bare	3.80	7.15
030447-11 Disk, project software	5.20	9.75
030447-41 PIC16F876, programmed	5.50	10.35

030447-71 Kit of parts	25.85	48.75
Tune in to Electrosmog		
040424-1-1 PCB	3.40	6.45
No. 342 MAY 2005	£	\$
Glow Plug Heater		
040239-11 Disk, ST7 program	5.20	9.75
040239-41 ST7FLITE05, programmed	6.55	12.35
Magnetic Flux Density Meter		
040258-11 Disk, PIC source code	5.20	9.75
040258-41 PIC16F876-20/SP, programmed	16.55	31.15
Programmer for DCC Model Railway Control		
040422-1 PCB	18.60	35.05
040422-11 Disk, ATmega source & hex code	5.20	9.75
040422-41 ATmega8515-8PI, programmed	16.55	31.15
No. 342 APRIL 2005	£	\$
LPC210x ARMeE Development System		
040444-1 Processor board	4.70	8.85
040444-2 Motherboard	11.70	22.05
040444-11 Disk, project software	5.20	9.75
SC Analyser 2005		
030451-1 PCB	5.35	10.10
030451-11 Disk, project software	5.20	9.75
030451-41 PIC16F876-20/SP, programmed	13.75	25.95
No. 341 MARCH 2005	£	\$
High-End Power Amp		
040198-1 Amplifier PCB	9.65	18.15
040198-2 Indicator PCB	7.95	14.95
040198-3 Supply PCB	7.95	14.95

Products for older projects (if available)
may be found on our website
www.elektor-electronics.co.uk
home construction = fun and added value

More than 100 small circuits, design tips and weblinks

The year 2005 marks the return of the 100-plus-articles version of Elektor's celebrated and unique **Summer Circuits Issue**. Between 1988 and 2004 the English-language edition of Elektor contained 60-70 small circuits in the July/August issue, while the remaining 30-40 were published in the December issue. Both issues also contained regular-size articles. New production methods at our international offices now enable us to reinstate a great publication none of our direct competitors has ever managed to pull off these past 30 years. Here are a few articles you can look forward to seeing:

- PIC PWM Controller
- MIDI Interface for Soundblaster
- Project DS1620
- Frequency Meter
- 12-volt Regulator
- 3-30 MHz Active Antenna
- Servo Control Tester
- Toslink Booster/Splitter
- and at least 92 other bits & bobs for your hobby or profession.

OBD-2 Car Diagnostic Tool

Our cars are increasingly crammed with not-so-transparent electronics, enabling the vehicle to log massive amounts of service information about what's happening in and around it. The OBD-2 standard now implemented on most modern cars allows servicing staff to pick the car's brains not only to obtain internal fault reports but also essential data on important parameters like engine cooling, combustion efficiency, gearbox, battery voltage, and so on. Got a laptop PC? Then you, too, can view this information if you build our versatile OBD-2 interface.

Theme Plan for 2005

January	Power Supplies
February	Wireless
March	Sound
April	Microcontrollers
May	Sensors
June	Environment
July/August	Summer Circuits
September	Test & Measurement
October	Security
November	CAD Software
December	Optoelectronics



Do not miss the best selling issue of the year... demand is bound to be high.

RESERVE YOUR COPY NOW!

UK subscribers will receive the magazine a few days before this date.

The July 2005 issue goes on sale on Saturday 25 June 2005 (UK distribution only).

Article titles and magazine contents subject to change.

NEWSAGENTS ORDER FORM

SHOP SAVE / HOME DELIVERY

Please save / deliver one copy of *Elektor Electronics* magazine for me each month

Name:
 Address:
 Post code:
 Telephone:
 Date:
 Signature:



Please cut out or photocopy this form, complete details and hand to your newsagent. *Elektor Electronics* is published on the third Friday of each month, except in July. Distribution S.O.R. by Seymour (NS).

INDEX OF ADVERTISERS

Allgood Technology, Showcase	www.allgoodtechnology.com	80
Audioexpress, Showcase	www.audioexpress.com	80
Beta Layout, Showcase	www.pcb-pool.com	49, 80
The BlackBoxCamera	www.STV5730A.co.uk	32
Breadboarding Systems	www.breadboarding.co.uk	40
Burn Technology LTD, Showcase	www.burntec.com	80
CMS	www.cms.uk.com	7
Compucut, Showcase	www.compucutters.com	80
Conford Electronics, Showcase	www.confordelec.co.uk	80
Cricklewood	www.cricklewoodelectronics.com	49
Danbury, Showcase	www.livinginthepast.demon.co.uk	80
Display Electronics	www.distel.co.uk	52
Easysync, Showcase	www.easysync.co.uk	45, 80
Elnec, Showcase	www.elnec.com	80
Eurocircuits	www.thepcbshop.com	79
ExpressPCB	www.expresspcb.com	7
Forest, Showcase	www.fored.co.uk	80
Future Technology Devices, Showcase	www.ftdichip.com	80
Futurlec, Showcase	www.futurlec.com	80
ILP Electronics Limited, Showcase	www.ilpelectronics.com	80
Ipeva Limited, Showcase	www.ipeva.com	80
Jaycar Electronics	www.jaycarelectronics.co.uk	2
JLB Electronics, Showcase	www.jblelectronics.com	80
Komcard, Showcase	www.komcard.com	80
Labcenter	www.labcenter.co.uk	88
London Electronics College, Showcase	www.lec.org.uk	80
Matrix Multimedia Ltd	www.matrixmultimedia.co.uk	49
Microchip	www.buy.Microchip.com	23
MQP Electronics, Showcase	www.mqpelectronics.co.uk	81
New Wave Concepts, Showcase	www.new-wave-concepts.com	81
Number One Systems	www.numberone.com	53
Nurve Networks	www.xgamestation.com	32
PCB World, Showcase	www.pcbworld.org.uk	81
PHYZX, Showcase	www.phyzx.co.uk	81
Picdos, Showcase	www.picdos.com	81
Pico	www.picotech.com	3, 53
Quasar Electronics, Showcase	www.quasarelectronics.com	76, 81
RD Research	www.spice-software.com	41
Robot Electronics, Showcase	www.robot-electronics.co.uk	81
Showcase	www.total-telematics.com	80, 81
Total Telematics	www.total-telematics.com	7
Ultraleds, Showcase	www.ultraleds.co.uk	81
University of Manchester	www.saelig.com	6
USB Instruments, Showcase	www.usb-instruments.com	81
Viewcom, Showcase	www.viewcom.f9.co.uk	81
Virtins Technology, Showcase	www.virtins.com	81

Advertising space for the issue of 16 August 2005 may be reserved not later than 19 July 2005

with Huson International Media – Cambridge House – Gogmore Lane – Chertsey, Surrey KT16 9AP – England – Telephone 01932 564 999 – Fax 01932 564998 – e-mail: relgar@husonmedia.com to whom all correspondence, copy instructions and artwork should be addressed.

ORDERING INSTRUCTIONS, P&P CHARGES

Except in the USA and Canada, all orders, except for subscriptions (for which see below), must be sent BY POST or FAX to our Tunbridge Wells address using the Order Form overleaf. On-line ordering: <http://www.elektor-electronics.co.uk>

Readers in the USA and Canada may (but are not obliged to) send orders, except for subscriptions (for which see below), to the USA address given on the order form. Please apply to Old Colony Sound for applicable P&P charges. Please allow 4-6 weeks for delivery. **Orders placed on our Tunbridge Wells office** must include P&P charges (Priority or Standard) as follows:
UK: £4.00 (Standard) or £7.00 (Priority) Outside Europe: £8.00 (Standard) or £12.00 (Priority)

HOW TO PAY

Unless you have an approved credit account with us, all orders must be accompanied by the full payment, including postage and packing charges as stated above. Payment may be made by cheque drawn on a London clearing bank (but see para. 4 below), postal order, VISA, Access, MasterCard or EuroCard (when paying by credit card, the order must go the cardholder's address). Do not send cash through the mail. Cheques and postal orders should be crossed and made payable to 'Elektor Electronics (Publishing)'. Payment may also be made by direct transfer from a private or business Giro account to our **Giro account No. 34-152-3801** by completing and sending to the National Giro Centre, in a National Giro postage paid envelope, a National Giro transfer/deposit form. Do not send Giro transfers direct to us, as this will delay your order. If you live outside the UK, payment may also be made by Bankers' sterling draft drawn on a London clearing bank, Eurocheque made out in pounds sterling (with holder's guarantee card number written on the back), or US or Canadian dollar cheque drawn on a US or Canadian bank. If you pay by Bankers' sterling draft, make clear to the issuing bank that your full name and address MUST be communicated to the London clearing bank. Our bankers are **NAT WEST PLC, 1 St James's Square, Wadhurst, East Sussex TN5 6BH, England. Our account number is 3512 5225, Sorting Code 60-22-15. IBAN code: GB40 NWB K6 022 15 3512 5225 BIC code: NWB KGB 2L**

COMPONENTS

Components for projects appearing in Elektor Electronics are usually available from certain advertisers in this magazine. If difficulties in the supply of components are envisaged, a source will normally be advised in the article. Note, however, that the source(s) given is (are) not exclusive.

TERMS OF BUSINESS

Delivery Although every effort will be made to dispatch your order within 2-3 weeks from receipt of your instructions, we can not guarantee this time scale for all orders. **Returns** Faulty goods or goods sent in error may be returned for replacement or refund, but not before obtaining our consent. All goods returned should be packed securely in a padded bag or box, enclosing a covering letter stating the dispatch note number. If the goods are returned because of a mistake on our part, we will refund the return postage. **Damaged goods** Claims for damaged goods must be received at our Tunbridge Wells office within 10-days (UK); 14-days (Europe) or 21-days (all other countries). **Cancelled orders** All cancelled orders will be subject to a 10% handling charge with a minimum charge of £5.00. **Patents** Patent protection may exist in respect of circuits, devices, components, and so on, described in our books and magazines. Elektor Electronics (Publishing) does not accept responsibility or liability for failing to identify such patent or other protection. **Copyright** All drawings, photographs, articles, printed circuit boards, programmed integrated circuits, diskettes and software carriers published in our books and magazines (other than in third-party advertisements) are copyright and may not be reproduced or transmitted in any form or by any means, including photocopying and recording, in whole or in part, without the prior permission of Elektor Electronics (Publishing) in writing. Such written permission must also be obtained before any part of these publications is stored in a retrieval system of any nature. Notwithstanding the above, printed-circuit boards may be produced for private and personal use without prior permission. **Limitation of liability** Elektor Electronics (Publishing) shall not be liable in contract, tort, or otherwise, for any loss or damage suffered by the purchaser whatsoever or howsoever arising out of, or in connexion with, the supply of goods or services by Elektor Electronics (Publishing) other than to supply goods as described or, at the option of Elektor Electronics (Publishing), to refund the purchaser any money paid in respect of the goods. **Law** Any question relating to the supply of goods and services by Elektor Electronics (Publishing) shall be determined in all respects by the laws of England.

January 2005

SUBSCRIPTION RATES FOR ANNUAL SUBSCRIPTION

	Standard	Plus
United Kingdom	£39.50	£46.00
Economy Mail		
Rest of the World (excluding Europe)	£51.30	£57.80
Priority Airmail		
Europe & Eire	£51.30	£57.80
Outside Europe	£65.00	£71.50
Airfreight		
USA & Canada only	US\$88.00	US\$98.00

SUBSCRIPTION RATES FOR 18-MONTH SUBSCRIPTION

	Standard	Plus
United Kingdom	£59.25	£69.00
Economy Mail		
Rest of the World (excluding Europe)	£76.95	£86.70
Priority Airmail		
Europe & Eire	£78.75	£88.50
Outside Europe	£97.50	£107.25
Airfreight		
USA & Canada only	US\$132.00	US\$147.00

Payment should be made by:

- Cheque or bankers' draft in sterling drawn on a London clearing bank (except in the USA and Canada — see below);
- US\$ cheques drawn on a US or Canadian bank — only by subscribers in the USA or Canada.
- Direct transfer to our bank (NAT WEST PLC, 1 St James's Square, Wadhurst, East Sussex TN5 6BH, England).
Our account number is 3512 5225, Sorting Code 60-22-15.
IBAN code: GB40 NWB K6 022 15 3512 5225 BIC code: NWB KGB 2L
- Postal order.
- Credit card: VISA, ACCESS, Euro/MasterCard, JCB Electron or Switch.
- Transfer to our Giro Account number 34 152 3801. Giro transfers should be made by completing and sending the appropriate transfer/deposit form to the National Giro Centre (UK) or to your national Giro Centre.

Cheques and postal orders should be made payable to Elektor Electronics (Publishing). Do not send cash through the mail.

SUBSCRIPTION CONDITIONS

The standard subscription order period is twelve months. If a permanent change of address during the subscription period means that copies have to be despatched by a more expensive service, no extra charge will be made. Conversely, no refund will be made, nor expiry date extended, if a change of address allows the use of a cheaper service. Student applications, which qualify for a 20% (twenty per cent) reduction in current rates, must be supported by evidence of studentship signed by the head of the college, school or university faculty. A standard Student Subscription costs £31.60, a Student Subscription-Plus costs £37.60 (UK only). Please note that new subscriptions take about four weeks from receipt of order to become effective. Cancelled subscriptions will be subject to a charge of 25% (twenty-five per cent) of the full subscription price or £7.50, whichever is the higher, plus the cost of any issues already dispatched. Subscriptions cannot be cancelled after they have run for six months or more.

January 2005

Straight from the heart of electronics each month



This Month:

ELECTROSMOG - NO RISK?

More than
100
small
circuits

Next Month:

The Summer Circuits edition 2005!

More than 100 snappy projects, tips and ideas; special every year!

Want to know everything each month?

Select your own annual subscription and receive
a free 128 MB USB 2.0 Flash drive



Available options:

- Elektor Electronics annual subscription (standard)
You receive 11 issues, including the July/August double issue.
- Elektor Electronics annual subscription-PLUS
You receive 11 issues, including the July/August double issue,
plus a copy of the Elektor Electronics Volume 2005 CD-ROM
(normal price £16.25). Your saving: approx. £10.00!

elektor
electronics

Please fill out the Order Form with this issue.
Subscription rates and conditions may be found at the back of this issue.

PROTEUS

The Complete Electronics Design System

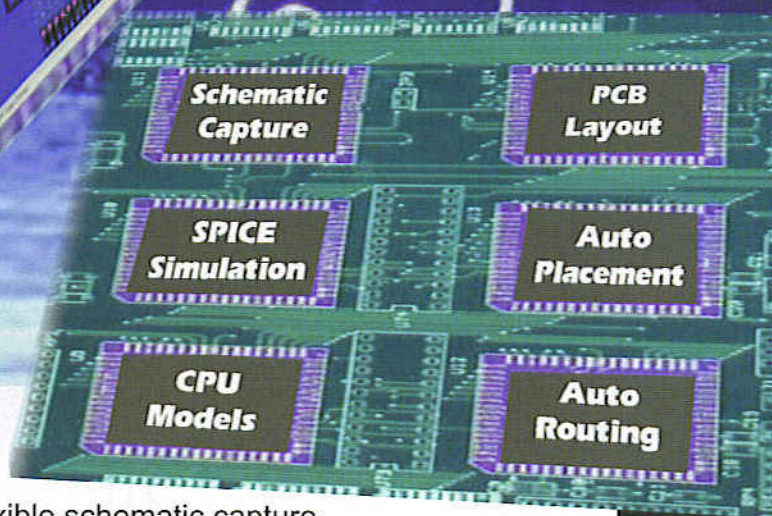
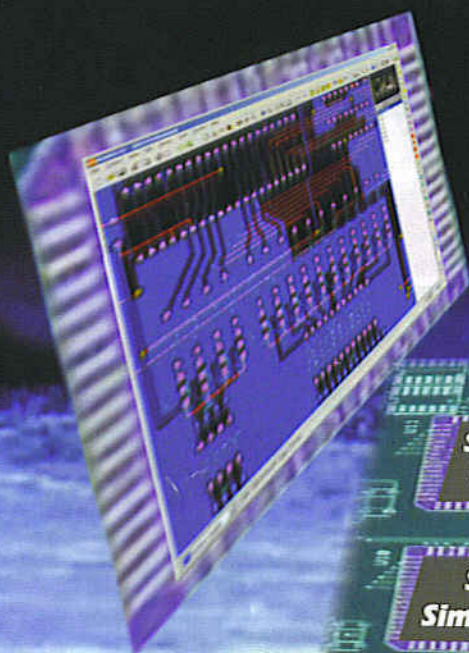

VSM
Virtual System Modelling

Schematic & PCB Layout

- Powerful & flexible schematic capture.
- Auto-component placement and rip-up/retry PCB routing.
- Polygonal gridless ground planes.
- Libraries of over 8000 schematic and 1000 PCB parts.
- Bill of materials, DRC reports and much more.

Mixed Mode SPICE Circuit Simulation

- Berkeley SPICE3F5 simulator with custom extensions for true mixed mode and interactive simulation.
- 6 virtual instruments and 14 graph based analysis types.
- 6000 models including TTL, CMOS and PLD digital parts.
- Fully compatible with manufacturers' SPICE models.

Proteus VSM - Co-simulation and debugging for popular Micro-controllers

- Supports PIC, AVR, 8051, and BASIC STAMP micro-controllers.
- Co-simulate target firmware with your hardware design.
- Includes interactive peripheral models for LED and LCD displays, switches, keypads, virtual terminal and much, much more.
- Compatible with popular compilers and assemblers from Microchip, Crownhill, IAR, Keil, and others.

New Features in Version 6.5

- Textual library part search.
- User defined keyboard map.
- CAD/CAM output to ZIP file.
- Bitmap import function.
- Truetype fonts on PCBs.
- Enhanced printer output.

Call Now for Upgrade Pricing



labcenter
Electronics
53-55 Main Street, Grassington. BD23 5AA

Tel: 01756 753440
Fax: 01756 752857

Contact us for
Free Demo CD

www.labcenter.co.uk
info@labcenter.co.uk