

PetInspect

Towards the blogging pet

**Universal
DCC Programmer**
model railway tuner

**Magnetic Flux
Density Meter**
attracting forces

**5.1 Surround Sound
Switch Box**
simple and useful

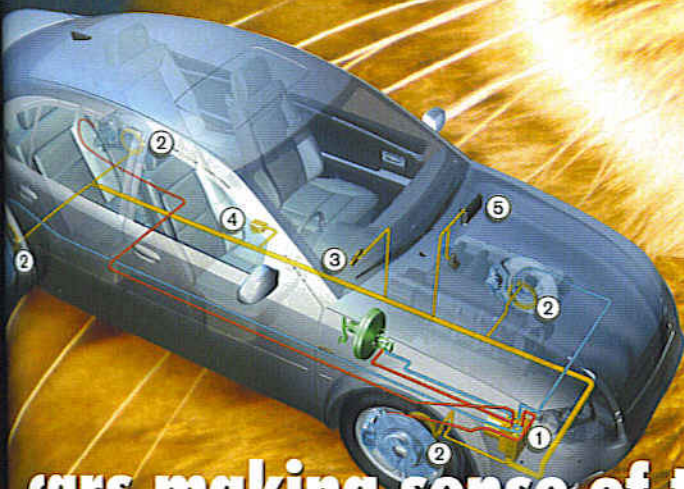

Catwalk model Elmo
presents 16-bit
wearable computing

cars making sense of the world

SENSORS

GPS in tunnels, too!



DrDAQ Data Logger

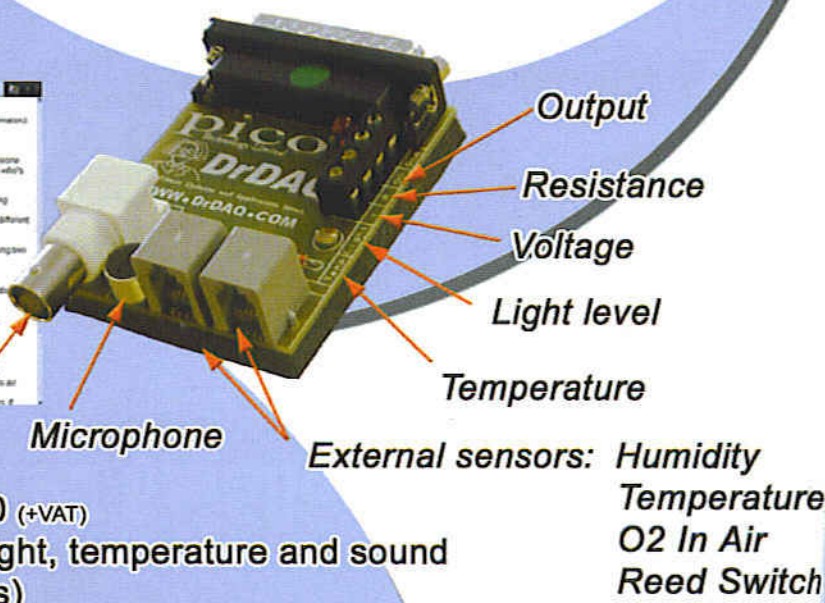
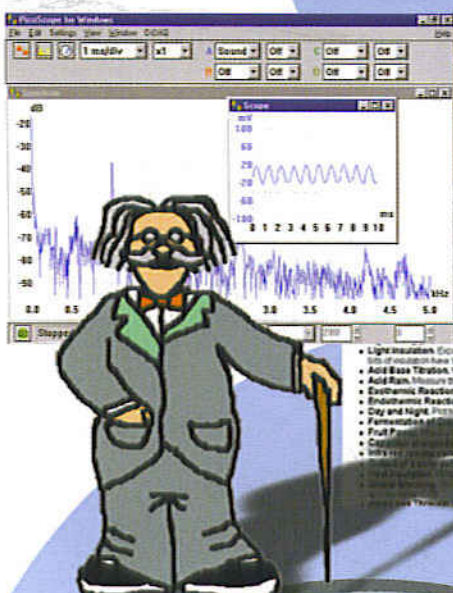

- Low cost - under £80 (+VAT)
- Built in sensors for light, temperature and sound (level and waveforms)
- Use DrDAQ to capture fast signals
- Outputs for control experiments
- Supplied with both PicoScope (oscilloscope) and PicoLog (data logging) software

For more information on DrDAQ, please visit:

www.picotech.com/drdaq119

PC Oscilloscopes

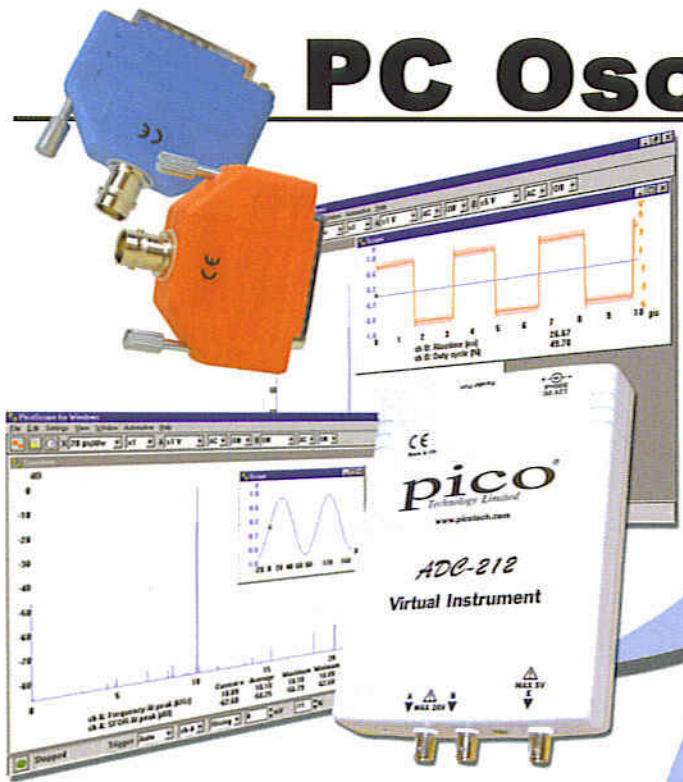

- Scope and spectrum analyser functions
- A fraction of the cost of benchtop scope
- Save multiple setups, for ease of use
- Save, print and e-mail your traces
- FREE technical support for life
- FREE software and upgrades
- Automated measurements

For more information on our scopes, please visit:

www.picotech.com/scope265

Tel: 01480 396395 Fax: 01480 396296 E-mail: sales@picotech.com

PICO
Technology Limited

NEW Catalogue Out Now



Get Your **FREE UK Pound Priced Catalogue** - all 400+ pages!
Just fill out the catalogue request form at www.jaycarelectronics.co.uk/catalogue

Check our website!

- All of our 6,000+ products with search facilities.
- 128-bit secure on-line ordering - safe & secure.
- Over 3,500 product datasheets & application notes.
- And we're from Australia, so you can trust us!
- Postage and Packing includes airmail to the UK



Moreinfo?
www.jaycarelectronics.co.uk

Post and Packing Charges:	
Order Value	Cost
£20 - £49.99	£5
£50 - £99.99	£10
£100 - £199.99	£20
£200 - £499.99	£30
£500+	£40
Max weight 12lb (5kg) - heavier parcels POA. Minimum order £20.	

Performance Electronics for Cars Book

BS-5080 £6.35 + post & packing

Australia's leading electronics magazine, Silicon Chip, has developed a range of projects for performance cars. There are 16 projects in total, ranging from devices for remapping fuel curves, to nitrous controllers, and more! The book includes all instructions, components lists, colour pictures, and circuit layouts. There are also chapters on engine management, advanced systems, DIY modifications, and more. Over 150 pages! All of the projects described are available in kit form, exclusively from Jaycar. Check out our website for all the details.

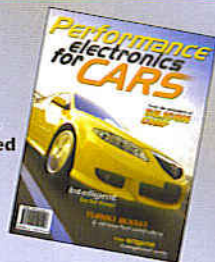

FREE 400+ page Catalogue

JUST ONE OF OUR MANY GREAT PRE-BUILT & TESTED CONSUMER PRODUCTS!

Noise Cancelling Headphones

AA-2054 £14.00 + post and packing
Designed for use in noisy environments such as an aircraft or cars. They reduce background noise by as much as 15dB, so you can sleep soundly, concentrate better, or listen to your music without trying to "drown out" the noise. Two AAA batteries are supplied for power. 6' lead with a 1/8" plug.



3 Stage FM Transmitter Kit

KJ-8750 £5.80 + post and packing
The circuit board may measure just 2"(L) x 1 1/16"(W)", but it can transmit signals over half a mile in the open. It has flexible power requirements, with 6 to 12VDC input voltage (so a 9V battery would be suitable). It is quick to build, and fun to use. Kit supplied with circuit board, electronic components, and clear English instructions.



Remote Control Extender Kit MkII

KC-5209 £6.70 + post and packing
If you have a source device such as a DVD player running to a TV in another room, or perhaps a Hi-Fi system with speakers in the other end of your house, you probably get tired of walking to the other room just to change tracks or fast forward etc. This project effectively transfers the IR signal from your remote control and re-transmits it in the other room! Kit includes case, circuit board, all electronic components, and clear English instructions.



Theremin Synthesiser Kit

KC-5295 £17.50 + post & packing
The Theremin is a weird musical instrument that was invented early last century but is still used today. The Beach Boys' classic hit "Good Vibrations" featured a Theremin. By moving your hand between the antenna and metal plate, you create weird sound effects like in those scary movies! Kit includes a machined, silk-screened, and pre-drilled case, circuit board, all electronic components, and clear English instructions.



9VDC wall adaptor required (Maplin #MG80B £5.99).



50MHz Frequency Meter Kit with LCD Display

KC-5369 £20.30 + post & packing
If you want a great value frequency meter, then this project is for you. It features autoranging operation for ease of use, switching between its three ranges. High resolution of 0.1Hz up to 150Hz, 1Hz between 150Hz and 16MHz, and 10Hz above 16MHz. It can be powered by a 9V battery or wall adaptor (not included) and the case measures just 5 1/8" x 2 5/8" x 1". Kit includes laser cut & silk screened case, circuit board, electronic components, & clear English instructions.



We Stock...

Electronic Components

Electronic Project Kits

Test & Measurement Equipment

Power Products and Accessories

Audio & Video Equipment & Accessories

Computer & Telecoms Accessories

Security & Surveillance Equipment

Explanation of icons used for kits

Indicates an approximate construction time for each project for a competent constructor. It does not however, include any installation etc that may be required.



Straightforward to assemble, generally built in one session. Requires basic electronics and soldering skills.

Requires a good knowledge of electronics to understand its operation, and troubleshooting techniques may be required.



Jaycar Electronics

Log on to www.jaycarelectronics.co.uk/catalogue
for your **FREE** catalogue!
0800 032 7241

(Monday - Friday 09.00 to 17.30 GMT + 10 hours only) For those that want to write:
100 Silverwater Rd Silverwater NSW 2128 Sydney Australia

The Simple Way to Learn About Microchip Analogue Products and PIC[®] Microcontrollers



Learn from the experts! Microchip is again offering engineers the chance to attend its exciting seminars in a location near you. Two seminars will be offered each day. The morning session is designed for those new to Microchip, the afternoon session is suited for those who are familiar with Microchip or who have attended the morning session.

The morning embedded control design session will present a typical application: temperature sensing. It demonstrates how simply designers that are new to

Microchip's products can add intelligence, an LCD display and simple connectivity using a PIC microcontroller and analogue devices from Microchip. Various easy-to-use development tools and starter kits will be used to demonstrate the concepts.

The afternoon begins where the morning seminar left off. It provides more advanced training, showing how to incorporate the latest connectivity solutions such as USB, ZigBee™ and Ethernet to your embedded control designs by using high-end PIC microcontrollers.

Costs

Morning beginners' session:
£20.00 (includes PICkit™ 1 Flash Starter Kit)

Afternoon advanced connectivity session:
£50.00 (includes a PICDEM™ HPC demonstration board.)

Prices quoted exclude VAT.

Become an Expert the Easy Way

Don't miss the chance to develop your knowledge and skills.

Register now at www.microchip.com/seminars



Microcontrollers • Digital Signal Controllers • Analog • Serial EEPROMs

Note: All prices, dates and contents stated are subject to change. The Microchip name and logo, PIC, PICmicro, dsPIC and MPLAB are registered trademarks of Microchip Technology Inc. in the USA and other countries and PICkit and PICDEM are trademarks of Microchip Technology Inc. in the USA and other countries. ZigBee is a trademark of the ZigBee Alliance. All other trademarks are property of their respective companies.
© 2005 Microchip Technology Inc. All rights reserved. ME136Eng/02.05

All change to online

Next month's issue will have two articles, one a background, the other a construction project, both covering a highly topical as well as controversial item: the (alleged) health hazards of electromagnetic radiation levels produced by cordless phones, mobiles and telecom operators' base stations. We present a novel RF field strength meter designed in our labs in good Elektor tradition, which means: tried & tested, educational, copiously illustrated and backed by a number of ready-made items like PCBs and kits. The other article is a background on radiation level standards, reports, debates, relevant authorities and so on, and for this we need your help! By the time this May 2005 issue reaches our UK subscribers, a web poll should be available on our website. Participation is free, anonymous and easy by answering a few yes/no questions. The results of the poll we hope to include in the background article.

Also on the subject of our website (www.elektor-electronics.co.uk) I and a number of my colleagues discovered that about 6 out of 10 emails sent to us by way of the Query Form service on the Contact page can be answered either by referring to an FAQ listed on the on the Service page or by inviting the correspondent to post his/her question in our Forum. In the latter case, although our technical team is often unable to provide immediate, exact answers to the (often vague and poorly formulated) questions, other readers — there are quite a few of them around — may recognise the problem and offer their expertise. Not forgetting Elektor's own editors, lab workers and freelance authors of course — Peter Moreton and Tony Dixon for example scour the Forum for entries on their respective 'heavyweight' projects, the PIC18F board and the ARM Development System. As the Forum may be searched for specific words, with your help it may be turned into an online 'Elektor knowledge base' with fast and easy access. I look forward to seeing your postings.

Meanwhile, interesting letters and emails have started to arrive in reply to a number of topics first published in Mailbox, our monthly crop of readers correspondence published on pages 8 and 9. While collecting and editing several letters I could not help noticing that two of the most popular topics for debate, mobile telephone masts and Nicad batteries, have a common denominator: electronics and the environment and that's next month's main subject.

Jan Buiting – Editor



Volume 31, Number 343, May 2005

ISSN 0268/4519

Elektor Electronics aims at inspiring people to master electronics at any personal level by presenting construction projects and spotting developments in electronics and information technology.

Elektor Electronics is produced and published by Elektor Electronics (Publishing), P.O. Box 190, Tunbridge Wells TN5 7WY, England. Tel.: (+44) (0)1580 200657, fax: (+44) (0)1580 200616. Email: sales@elektor-electronics.co.uk.

The magazine is available from newsagents, bookshops and electronics retail outlets, or on subscription.

Elektor Electronics is published 11 times a year with a double issue for July & August.

Under the name *Elektor* and *Elektuur*, the magazine is also published in French, German and Dutch. Together with franchised editions the magazine is on circulation in more than 50 countries.

International Editor: Mat Heffels (m.heffels@segment.nl)

Editor: Jan Buiting (editor@elektor-electronics.co.uk)

International editorial staff: Harry Baggen, Thijs Beckers, Rolf Gerstendorf, Ernst Krempelsauer, Guy Raedersdorf.

Design staff: Karel Walraven (head of design), Ton Giesberts, Paul Goossens, Luc Lemmens (techdept@segment.nl)

Editorial secretariat: Hedwig Hennekens (secretariaat@segment.nl)

Graphic design / DTP: Ton Gulkers, Giel Dols

Managing Director / Publisher: Paul Snackers

Circulation Control: Margriet Debeij (m.debeij@segment.nl)

Subscriptions

Worldwide Subscription Service Ltd., Unit 4, Gibbs Reed Farm, Pashley Road, Ticehurst TN5 7HE, England. Telephone: (+44) (0)1580 200657, Fax: (+44) (0)1580 200616. Email: vwss@vwss.demon.co.uk. Rates and terms are given on the Subscription Order Form.

Head Office

Segment b.v. P.O. Box 75 NL-6190-AB Beek The Netherlands. Telephone: (+31) 46 4389444, Fax: (+31) 46 4370161

Distribution: Seymour, 86 Newman Street, London W1P 3LD, England

UK Advertising

Huson International Media, Cambridge House, Gogmore Lane, Chertsey, Surrey KT16 9AP, England. Telephone: +44 (0)1932 564999, Fax: +44 (0)1932 564998. Email: gerryrb@husonmedia.com. Internet: www.husonmedia.com. Advertising rates and terms available on request.

International Advertising

Klaas Caldenhoven, address as Head Office. Email: advertenties@elektuur.nl. Advertising rates and terms available on request.

Copyright Notice

The circuits described in this magazine are for domestic use only. All drawings, photographs, printed circuit board layouts, programmed integrated circuits, disks, CD-ROMs, software carriers and article texts published in our books and magazines (other than third-party advertisements) are copyright Segment, b.v. and may not be reproduced or transmitted in any form or by any means, including photocopying, scanning or recording, in whole or in part without prior written permission from the Publishers. Such written permission must also be obtained before any part of this publication is stored in a retrieval system of any nature.

Patent protection may exist in respect of circuits, devices, components etc. described in this magazine. The Publisher does not accept responsibility for failing to identify such patent(s) or other protection.

The submission of designs or articles implies permission to the Publishers to alter the text and design, and to use the contents in other Segment publications and activities. The Publishers cannot guarantee to return any material submitted to them.

© Segment b.v. 2005

Printed in the Netherlands

16



PetInspect

Does the cat hotel keep your pet warm enough when you leave her for a long weekend? Does your dog walker really give your pet the exercise you've been paying for? Find out what your pet gets up to when you're not around, or discover how they're treated when left in the care of others. You can do all this with the animal data-logging transceiver described in this article.

24



Mobile Navigation PLUS

The market for GPS (Global Positioning System) navigation systems has grown at a staggering rate so that now there are dedicated systems available for practically every type of travel and/or vehicle. Modern GPS navigation aids achieve remarkable accuracy in comparison but when the satellite signal gets weak or obscured they still need to take a lesson from Columbus to fill in the gaps...

Informative Articles

- 24 Mobile Navigation PLUS
- 30 Sense Organs in Cars
- 42 Lab Talk (2): Component specifications
- 60 Delphi for Electronic Engineers (5)
- 77 retronics:
Philips TV servicing equipment ca. 1955

Regulars

- 5 Foreword & Colophon
- 8 Mailbox
- 10 News: The Digital Future
- 13 New Products
- 78 Quizz'away
- 82 Readers Services
- 84 Sneak Preview
- 84 Index of Advertisers

CONTENTS

Volume 31
May 2005
no. 343

46

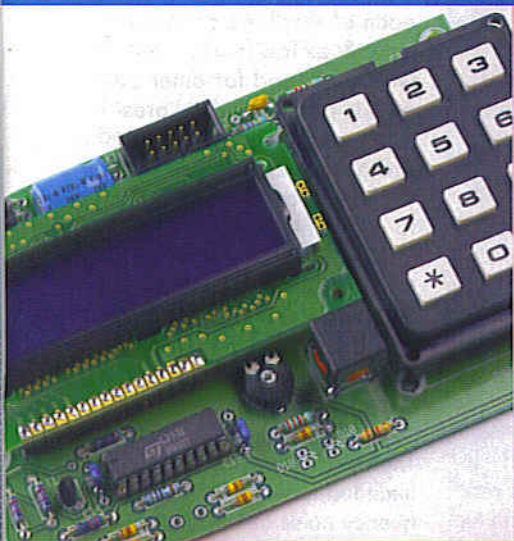

Programmer for DCC Model Railway Control

The DCC system distinguishes itself from the competition by being far more flexible, but also for the necessity of having to program the decoders. The majority of control boxes on the market perform this function only poorly. The stand-alone programmer presented here offers a great deal more functionality!

54

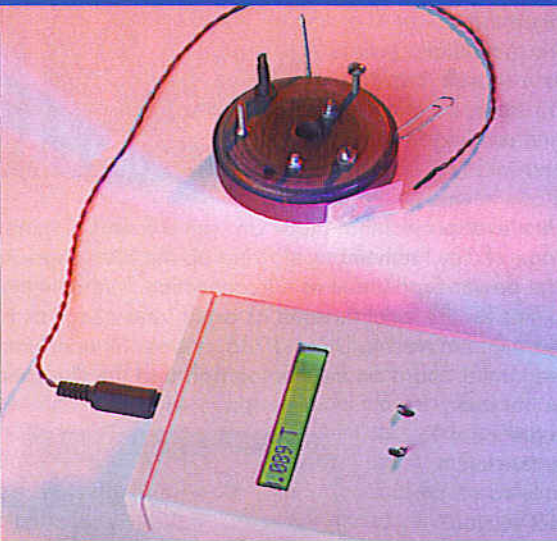

Magnetic Flux Density Meter

How do you know accurately if a magnet is stronger or weaker than one you've dubbed your reference device? This simple to build instrument has the answer. The meter employs a homemade search coil about 1.5 cm square. This is placed in the region where the field is to be measured and is withdrawn sharply.

66



Temperature & Humidity Sensor

The tiny surface-mount SHT11 sensor module provides calibrated digital readings of temperature and relative humidity. The chip includes two sensor elements, an A/D converter, calibration memory and a digital interface.

Construction Projects

- 16 PetInspect
- 38 Glow Plug Heater
- 46 Programmer for DCC Model Railway Control
- 54 Magnetic Flux Density Meter
- 66 Temperature & Humidity Sensor
- 70 Mini Project: 5.1 Surround Sound Switch Box
- 74 Design Tips: More Current from an LM2575
 - Inrush Current Limiter - 9-V Battery Replacement

WEB POLL on
www.elektor-electronics.co.uk

**GSM/UMTS/DECT/
Cellphone Basestation
radiation hazards
we want your opinion**

New website (1)

Hi Jan — I just want to congratulate you all on the magnificent new website. It is great to find a site that actually works, is intuitive and gives plenty of information. Very well done!

Mark Weir (New Zealand)

We are still working hard to clear several problems with the new site. Just like an electronic circuit, a lot of effort goes into getting it to work the way you want and constant tweaking is part of the activity.

New website (2)

Dear Elektor — while your new website took a bit of getting used too, I applaud the ability to download older articles in PDF format. I wonder though, as you are now producing them in PDF, why there is not a subscription format to download the complete magazine in PDF format every month. It would be so much easier for overseas readers and we wouldn't get them 2-3 months behind (I buy mine on standing order from the newsagent as it's much cheaper than a direct subscription). At least two of your competitors are doing it and I find this a most satisfactory way of obtaining them. They also do not consume huge amounts of space on the bookshelf, another bonus!

Terry Mowles (Australia)

The extension of our website services suggested by Terry and other correspondents is currently being studied for practical feasibility. Our articles have been published in pdf format since 1997 for the purpose of our year volume CD-ROMs. Meanwhile, distant readers like Terry can now download any individual article from the latest issue on the same day UK subscribers get their paper copy. Buying 11 issues from a news-

Fond memories of Edwin

Dear Jan — you have taken me back to my childhood with the Retronics instalment on the Edwin Amplifier in your March 2005 issue. I started reading Elektor in 1977 and Edwin was the first ever project that I took on with a friend of mine at the age of 16. I remember blowing up the filter capacitors on the power supply due to misconnection. We built the amplifier for the local mosque as a gift, and as far as I know, until I moved to UK in 1986, it was still operational. I note that the board on the photograph and the illustration does not indicate the 12 x 1 ohm resistors paralleled on the output section.

Cemal Ozturk (UK)

Thanks Cemal for letting us know. Several other readers also responded by sending us photographs of their Edwin amplifiers and some of these are reproduced here. By the way, the power R's were fitted at the underside of the board!

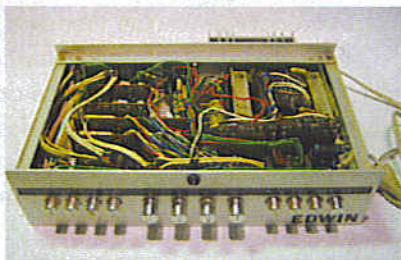
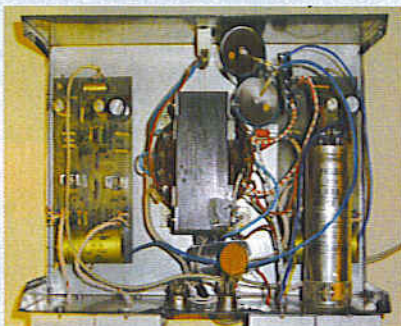

stand in Australia may be marginally cheaper than a year's subscription but on the down side (pun intended) you are at least 2 months behind European readers as the price advantage is based on surface mail delivery.

Seismometer design: help wanted!

Dear Jan — I have a triaxial seismometer head, and the

four channel data capture and processor. A really professional seismometer could be made for a fraction of those sold commercially. Because I am not a programmer, I would like to get in touch with a programmer to develop the source code. This latter would be best done in C++ to drive the machine in DOS mode. It is believed that this mode produces the least errors. The four channel chip is an

Analogue Devices AD7716. The machine would deliver its output as time and date stamped events to a PC via a serial port. Each event would be recallable for viewing and analysis for each of the three axis, i.e. x, y, & z. The fourth input would be used for other purposes, possibly temp, pressure, and humidity. There are a number of other chips that could be incorporated to assist the AD7716, including a 8051 microcontroller. The frequency range of interest would be 0-500 Hz. My ultimate aim would be to publish this design in Elektor magazine.

The device was originally intended for urban low frequency noise detection and control, however it might well work for Tsunami detection, but over what distance I would not like to guess. The instrument would also be of interest to geologists both professional and amateur. The prospect of checking it out on tectonic plate movements has increased my interest.

John Scott (UK)

This looks like a very ambitious, useful and topical project which we will be happy to publish. Anyone willing to help John with the software? The topic may be continued in our website Forum.

NiCd battery advantages (3)

Dear Editor — I've followed the nicad debate from November 2004 with interest because I use batteries all the time as an aeromodeller. Generally, I would have thought, that the differences between NiCds and NiMHs has been well documented. Certainly on a size and weight

basis the NiMH scores best on a capacity test every time but for sheer out and out performance the nicad still has the edge. I believe the military still use nicads as a power source in their equipment because they want guaranteed results in the harshest of environmental conditions.

The cycle life of Nicads may be another advantage, it can be in the thousands whereas the NiMHs are said to be in the low hundreds, although the newer ones may be much better. Metal Hydrides also suffer from the same wire corrosion as Cadmiums. I treat both types in exactly the same way, charging etc. and to date I've had no problems at all. That, of course, is not to say everyone should do this, see Gert Helles's splendid 'ABC of Rechargeable Batteries', Nov. '04. Talking of Nov. 04, your reply to George Price mentioned AA size 2-Ah NiCds. The best I've ever seen is a 1300 mAh. A 2-Ah AA size nicad would truly be a remarkable beast! As far as the environmental issues go, about a year ago the EU mooted a Battery Directive that stated that **all** battery materials must be recycled.

The battery industry today is a multi-million dollar money-spinner, and it is inconceivable not to believe that there may be many counterfeits and look-alikes in circulation. My concern is that I seem to be getting some of these. I've been checking and testing cells for fellow modellers for a number of years and I'm seeing more and more dodgy packs. This story is worth an article in itself. Unfortunately, the fact that there are so many poor quality cells being supplied does not seem to be widely reported. As far as aeromodelling goes, this is a bit of a safety issue with me.



There have definitely been some incidents with transmitter and receiver packs, which have resulted in bent models. One day it may be more serious. I realise some of what I've said may now be very rapidly becoming history. The new kid-on-the-block, the Lithium cell, is making it's presence felt in a very big way indeed. These have been around for a while but have usually been designed for a specific application. Now you can buy the individual cells in a great variety of sizes. We've been testing these for the last couple of years and now you can almost see the increase in use on a weekly basis. The global sale of rechargeable Lithium units expanded from 35 million to 280 million between 1995 and 1998. And up to 500 million in 2000. This figure could be well in excess of 2 billion for 2005.

To make a comparison, we have a 4-cell AA-size nicad pack, 800mAh at 5 volts. Capacity: up to about 4 watt hours. Then we have a lithim polymer gem, 3-cell, 340 mAh at 11.8 V. Capacity: again around 4 Wh. The nicads weigh 100 grams, the Lithiums, with voltage regulator, weigh 30 grams. Physically, the lithium pack is only about half the size of the nicads, too. Hydrides rate slightly better in this respect but there's still no real competition. It may be possible to discharge the nicads at 16 amps, that's 20

times capacity. The Lithiums will discharge at 6.8 amps, also 20 times capacity. There are snags, some Lithiums are made from flammable materials and then there is the much more precise charging/discharging regime. And, at the moment, depending on where you buy your batteries, they can be up to three times as expensive as NiCds or NiHM's. But for the future, I shall make every effort to use Lithiums whenever possible, which is in almost every case. Another measure of just how fast this change is coming in, is the fact that in 2004 the winning model of the European Aerobatic Championships for model planes was powered by Lithium cells and an electric motor. This is an achievement that back at the turn of the Millennium, just five short years ago, in some quarters may have been considered, to say the least, to be 'highly impossible'. Akin, perhaps, to saying today that in five years time an electric powered car will win a Formula One race. I'm sure this is all being driven (?) by the insatiable demand for portable power for all today's must-have toys. (Model aeroplanes are not toys. Well, that's what my friend tells his wife, anyway.) If / when nickel cadmium cells are eventually banned, this might not now be quite the problem that it once was. And, indeed, what better developments and technologies are just around the corner?

Peter Beeny (UK)

Peter's letter is published almost unabridged because it contains information and viewpoints not yet presented by other correspondents. Further information on Lithium Polymer batteries, theoretical and practical of course, may be found in last month's issue. By the way, we recently spotted 2100 mAh AA size NiCd batteries at knock-down prices.

CORRECTIONS & UPDATES

8958252 Flash Microcontroller Board December 2001, p. 54, 010208

A few users running Windows XP Home Edition SP2 have reported problems. Apparently, unaccounted for CTS line activity occurs on the RS232 port when P1 is programmed to supply fast pulses. This causes XP to hang even if the relevant COM port is not accessed. Also, a timing problem was discovered in the original download utilities. Both problems have been addressed and an update is available at: <http://www.b-kainka.de/basismufaq.htm>

SC Analyser 2005 April 2005, p. 34-41, 030451-1

In the Components List on page 39, the order code for the programmed PIC (IC2) should be corrected to read: 030451-41.

MailBox Terms

- Publication of reader's correspondence is at the discretion of the Editor.
- Viewpoints expressed by correspondents are not necessarily those of the Editor or Publisher.
- Correspondence may be translated or edited for length, clarity and style.
- When replying to Mailbox correspondence, please quote Issue number.
- Please send your MailBox correspondence to: editor@elektor-electronics.co.uk or Elektor Electronics, The Editor, P.O. Box 190, Tunbridge Wells TN5 7WY, England.

The Digital Future

The next generation of ICs for consumer electronics

Delano L. Klipstein

The preliminary events of the recent International Electron Devices Meeting (IEDM) included a full-day seminar titled 'Devices for Next Generation Digital Consumer Circuits and Systems', which dealt with the components needed for future digital consumer systems and the obstacles to their implementation. Here we describe some highlights of the discussions and possible solutions.



Figure 1. A mobile phone on your wrist – as easy to wear as a watch, but less easy to use. (Photo: Siemens)

Such presentations always start with some basic questions, such as 'What's the point of all these efforts? Don't we already have everything we need? Are there any conceivable technical devices that haven't already been invented?' Under the chairmanship of Akira Matsuzawa, an IEEE Fellow and a professor at the Tokyo Institute of Technology who played a leading role at Matsushita up to 2003, this seminar defined the objectives differently, in terms of new challenges instead of new media. His slogan was 'accessible everywhere and always', and the new technologies are subordinated to this demand – or perhaps we should say, to this future opportunity. After all, not everyone looks forward to this sort of universal accessibility and usability.

Matsuzawa justifiably termed the requirements for future devices a 'technology driver' for the ICs.

This can be clearly seen from the rapid advances in mobile phones, but even more clearly in PCs. Modern PCs are packed with capabilities that nobody actually needs for professional use in an office or on business trips. Entertainment electronics, and especially electronic games, stimulate extending the limits of IC technology much more than any professional application. The various product sectors exhibit impressive annual growth rates, with two-digit figures presently being posted by DVDs (20%), navigation (22%), servers (18%), and printers (10%). At 9%, desktop PCs lie just below this level, but notebooks are slightly above it. Although mobile phones are at the bottom of the growth chart (+5%), they have the largest volume with more than 450 new units per year. Many mobile phones are now fashionable lifestyle products, such as the 'Wristfone', a

mobile phone that is worn on the wrist like a watch (Figure 1). Digitalisation means good business for IC manufacturers. The semiconductor share of total production costs has significantly increased since the days of analogue television at the expense of other types of components, and especially at the expense of labour time. In a traditional television set with semiconductors accounting for around 25% of production cost and other components around 40%, labour costs were around 30%. In a modern digital television set, semiconductors account for 50% of the production cost, the other components take up 30%, software and licences are good for 10%, and labour costs are only 10%.

The 'mixed signal' challenge

Digital media have created a new class of ICs. Consumer electronics demands high-perform-

ance ICs with sophisticated microprocessor technology, but it also demands technologies with very low power consumption. These requirements are sometimes at odds with each other, so a third technology has taken root. It consists of 'mixed-signal' ICs, which often provide better solutions to difficult requirements than purely digital technology. With regard to the necessary processing capacity, the difference between digital audio technology at the bottom end and real-time virtual reality at the top end amounts to more than four orders of magnitude (Figure 2). With a processing capacity of around 1 gigaoperations per second (GOPs), Intel's famous Pentium III processor lies approximately halfway between these two extremes.

An MPEG-4 codec can serve as an example of the current requirements: it should be able

to deliver 12 GOPS at a power dissipation of less than 100 mW. As Matsuzawa explained, this requires some pretty fancy engineering. The IC designer's toolkit includes parallel processing, vector pipelining, highly specialised video codec machines, and sophisticated on-chip task distribution. The results can be clearly seen by comparing different chip architectures. A standard, general-purpose microprocessor with two parallel processor cores has a power dissipation of 7 W with a processing capacity of 1 GOPS. An application-specific IC, by contrast, can be designed to yield 2.5 times this processing capacity with only 12 mW of power dissipation. This represents an improvement of more than three orders of magnitude in the ratio of processing capacity to power consumption.

Katsuhiko Ueda, manager of the Matsushita development laboratory, also described the problems facing system designers (Figure 3). For one thing, transistor density on ICs has increased by a factor of more than 100 during the past 15 years. This increased packing density has created several problems, such as intense heating, increased crosstalk, and elevated leakage currents. However, such high packing density is compelled by the increasingly severe demands being placed on ICs. A CD player can manage with 200,000 transistors, but a DVD player requires 4 million, and the figure rises to nearly 40 million for a digital television set. If such quantities are to be economically placed on silicon, the only solution is to use 'shrunk' chip structures. Mixed-signal ICs, which contain both analogue and digital technology, are primarily used for interfaces and network circuitry in consumer electronics devices. In DVD systems, they are primarily used for error correction. This requires analogue and digital filters, fast A/D converters, and of course the actual correction circuitry, which is usually based on

the Viterbi algorithms. With his pioneering mathematical theories, Dr Andrew Viterbi paved the way for inexpensive mass production of such digital devices. Reproduction at a suitable quality level would not be possible without such error correction. If the necessary accuracy had to be implemented in the basic DVD system, the ICs would be unaffordable. The required accuracy is impressive: finding the 'right' pit on a 16x DVD is like locating an 0.4-mm dust particle in a football stadium while flying over it at a speed of Mach 160. For comparison, a normal passenger airplane flies at Mach 0.85. This makes it even more remarkable that the average price of a DVD recorder dropped by half between 2000 and 2002.

Multimedia

The term 'multimedia' has various definitions, and radio broadcasters, PC manufacturers and providers of communications infrastructures don't always use it with the same meaning. However, there are two particularly important aspects for consumer electronics. The first is a bidirectional link (unlike radio or television), and the second is integrated processing of audio, video and graphics. This requires special signal processors that can convert analogue signals in real time for digital processing and perform the necessary error correction on the digital signals.

The system architecture of such multimedia processors differs from the familiar architecture used for general-purpose processors. They are almost always parallel processors with separate command and data processing. The architecture of the command processor (execution unit) is roughly the same as the standard architecture, but the data processor consists of an arithmetic array that can be scaled as desired to meet the needs of the target device. If necessary, an outboard 'hardware engine' can be added to further accelerate

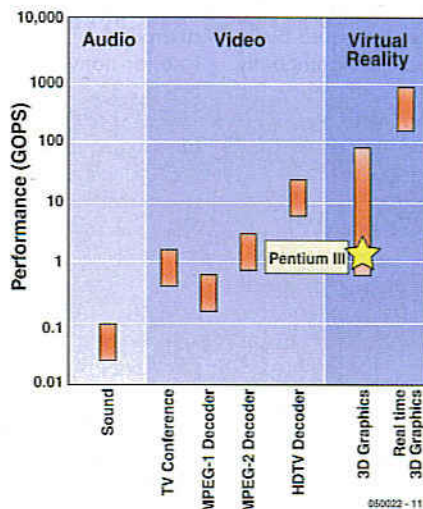

Figure 2. Performance figures for major digital systems. (Chart: A. Matsuzawa)

specific media processes, such as processing graphic data. Robots also employ such hierarchical processors on a large scale (see Figure 4). Maarten Vertregt of the Philips research laboratory in Eindhoven highlighted the relationships between digital and analogue technology, each of which has its particular strengths. Digital technology excels in programmability and data storage, while ana-

logue technology is better for human interfaces. He also presented an example to show that analogue technology still holds an important place in digital media: 75% of the silicon costs in the Nokia 7650 mobile phone are due to analogue circuitry.

The new demands are what determine future developments. Vertregt mentioned higher data rates, increased flexibility to sup-

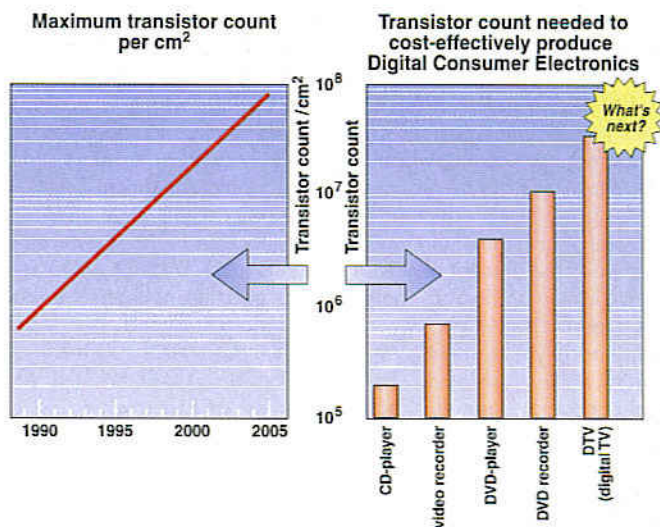

Figure 3. The number of transistors required to cost-effectively produce digital systems. (Chart: K. Ueda)

port different standards, greater dynamic range, increased bandwidth, and significantly improved energy efficiency. But the most important factor is lower cost, to make the new devices affordable.

Memory devices

One of the basic functions of digital consumer systems is storing information. It is an essential element of everything from conventional magnetic-tape recording for audio and video to CDs, DVDs, and iPods. Although magnetic recording is losing ground in the consumer sector, semiconductor memories are advancing rapidly, especially Flash memory. The average amount of NAND Flash memory in digital media is presently doubling every year. This trend is being driven by more than just digital cameras. Set-top boxes, instant-on laptops, and even mobile phones demand more and more memory capacity.

Data storage prospects for digital consumer electronics have been studied by Paolo Cappelletti, Development Manager for non-volatile memory technologies at STMicroelectronics in Agrate Brianza. The market for nonvolatile memory presently appears to be boundless. There are many reasons for this. Digital technology cannot manage without memory, and increasing application mobility favours semiconductor memory over hard disks, since it is smaller and consumes less power. Mass production for millions of consumer devices creates large piece counts, which in turn allows costs to be reduced. At the same time, reducing the size of Flash memory cells decreases the amount of silicon area used and also helps decrease costs.

In the early years, memory ICs had a 30% share of the total semiconductor market. Sharp price decreases since then have reduced their market share, although the number of memory bits sold throughout the world has constantly increased. The share of memory chips is now increasing again, but at different

rates. Volatile DRAM is growing at around 17% per year, but the rate for nonvolatile Flash memory is 23%.

There are also differences among the various circuit types. NOR Flash memory, which has dominated since the start of the Flash memory era, will probably surrender its position to NAND Flash in the coming year (**Figure 5**). NAND Flash memory promises higher packing density and lower production costs. The largest single market for NOR Flash memory is presently mobile phones. There is some hope that they will also penetrate the digital camera market or find their way into USB sticks for laptops. These applications are presently the domain of NAND Flash memory.

Other types of nonvolatile memory are already coming into sight, such as FeRAM, MRAM, PCM (phase-change memory), polymer memory, and chalcogenide memory. Their long-term prospects cannot be clearly identified from their relative strengths and weaknesses, especially since they are still at different maturity levels. Flash memory will most likely continue to dominate during the near future.

Sensors and packaging

The IDEM 'short course' also presented information about other subjects. We should mention imaging systems and in particular packaging, which is an especially tricky issue with the steadily decreasing dimensions of portable equipment.

The descriptions of imaging systems focussed on future developments in CCD and CMOS sensors and the necessary circuit and module technologies. Most system designers found the implications of this portion of the seminar less dramatic, especially as it did not address new display technologies.

Construction and packaging technologies, by contrast, play a major role in the design of integrated circuits. This is the realm of highly specialised designers,



Figure 4. The Sony Aibo dog and Quiro robot are among the first robots designed for consumers. They make significant demands on the capabilities of their processors. (Photo: Sony)

who often simply help their colleagues from the traditional school of IC design deal with questions such as what can be achieved using 'face-down' or 'flip-chip' technology with the ICs mounted upside down on the circuit board and directly attached

using 'bumps', or the practical limit on the number of pins per IC for system-on-chip designs. As such considerations must be dealt with very early in the IC design process, these specialists are rapidly assuming a key position.

(050022-1)

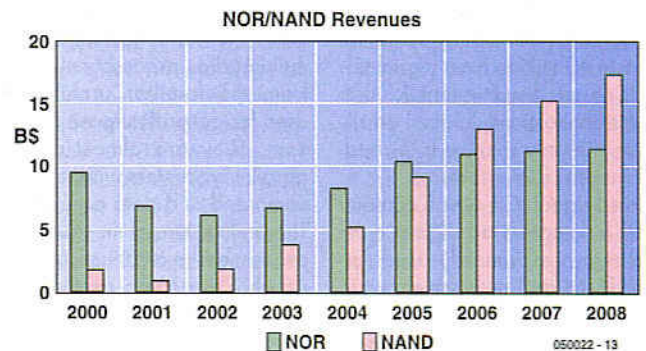

Figure 5. The NAND version of Flash memory can be expected to win the contest between NOR and NAND memories, since the cost advantages it provides are an important factor in consumer electronics. (Chart: P. Cappelletti)

More Memory for MSC1210 Development Board

We're happy to announce that a second version has been produced of our mighty popular MSC1210 microcontroller board. The upgraded product now has the Y5 version of the MSC1210 microcontroller, which means more memory is available for your applications.

As opposed to the previous version, the Y4, the new micro fitted on our MSC1210 boards has double the amount of memory, namely 32 kBytes instead of 16 kBytes. Although this up to date board may be used in stand alone fashion, by adding suitable hardware it may also act as a voltmeter or a BASIC computer (*Elektor Electronics* July through October 2003); an RS485 interface (*Elektor Electronics* November and December 2003) or a webserver (*Elektor Electronics* July/August 2004).

For the latter application in particular, extra memory will prove very useful, as not only will the chip be able to hold larger pro-

grams, in combination with the network extension card (July/August 2004) it's also capable of storing more web pages.

Old hands at programming may remark that a larger processor by itself is great, but needs to be supported by the (free) software. Fortunately, the designer of the software, Mr. Wickenhäuser, was found willing and able to adapt the free MSC1210 software for files up to 32 kBytes. A licensed version is only required if your software exceeds the 32-kByte limit. As a bonus, the new software now allows floating point routines to be added without problems.

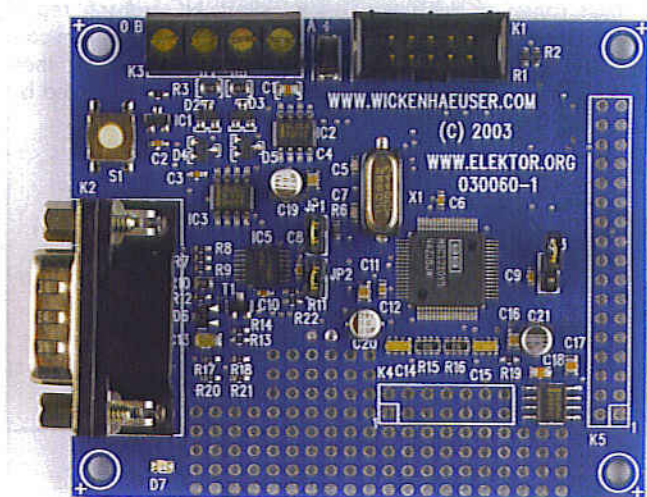

The MSC1210 system software may be downloaded free of charge from

www.wickenhauser.com/

We are offering the new MSC1210 board at the same price as the previous version, **only £ 69.00**, for a limited period.

This offer is valid till 31 May 2005. After that date, the price

of the MSC1210 board will be **£ 75.90**.

Ordering the new product is easy, just contact our Customer Services quoting order code **030060-91** (see Readers Services page). Online ordering is also possible (and much faster!) via www.elektor-electronics.co.uk

(050074-1)

Class D audio DirectFET™ for high performance amplifiers

International Rectifier recently introduced the IRF6665 DirectFET™ MOSFET for medium power Class-D audio amplifiers. The device parameters are tuned specifically for improved audio performance such as efficiency, total harmonic distortion (THD) and power density. Applications for Class D amplifiers range from battery-powered portable products to high-end professional amplifiers, musical instruments and car and home multimedia systems.

In addition to application-tuned silicon, IR's DirectFET packaging technology enhances performance in Class D audio amplifier circuits by reducing lead inductance, which improves switching performance and reduces EMI

noise. Thermal efficiency enables 100 W operation into 8 ohms without a heatsink. Eliminating heatsinks shrinks circuit size and bulk, giving designers more layout flexibility and reduces amplifier cost.

Critical MOSFET parameters determining Class-D audio performance include device on-resistance, or $R_{DS(on)}$ and gate charge, or Q_g . These parameters can determine efficiency in a Class D audio amplifier.

(057053-2)

**International Rectifier,
European Regional Centre,
439/445 Godstone Road,
Whyteleafe, Surrey CR3 0BL
Tel. +44 (0)20 8645 8003.
www.irf.com**



Fast-Acting NTC Thermistor Sensors

SeMitec's range of fast-acting thermistor sensors are claimed to offer unique solutions to the electronics industry.

Cost-effective, mini TO-220 style packages with R25s from 1 k_Ω to 100 k_Ω can be mounted directly to the PCB or fitted with flying leads. Exposed bead sensors monitor and control rapid airflow and 'Soft-Touch' sensors operating to 200 °C offer T.C.s down to 0.5 s.

The latest NC sensor reacts quickly to IR output in non-contact applications where thermopiles would be restricted by high local ambients.

ATC Semitec Limited,
Unit 14 Cosgrove Business Park,
Daisy bank Lane, Anderton,
Northwich CW9 6AA.
Tel. (+44) (0)870 9010777.
Email: sales@atcsemitec.co.uk.
Website: www.atcsemitec.co.uk

(047199-8)



Signal Wizard v. 2 from UMIST

The Signal Wizard 2 from UMIST is a unique, integrated system for designing, downloading and running very high performance filters in real-time. It includes the high-level PC-based software interface that designs the filter according to the user's requirements, a hardware module based on an advanced digital signal processor and a low-level firmware operating system that implements the filtering operations. Once designed, an integrated software interface is used to download the filter to the hardware module via a serial link where it is executed on demand. Most important, the system requires no knowledge of digital signal processing (DSP) theory on the part of the user, or of the mathematics associated with digital filter design. The Signal Wizard is a total-solution package. Due to its flexibility, it is particularly well suited to the real-time processing of audio signals. High quality analogue signal conditioning and a stereo 24-bit resolution codec provide extremely high resolution, sufficient for the most demanding applications. In short, The Signal Wizard 2 brings the power of digital signal processing to any audio-bandwidth domain that requires electronic signal filtering. Applications include audio signal processing, sensor signal

conditioning, signal analysis, vibration analysis, education and research in electrical, electronic and other physical sciences.

New features added for Signal wizard 2 include True stand-alone operation (without PC) once configured; IIR and adaptive filters; True dual channel operation; Impulse response import; Real or complex frequency response import; Delay options for in/out and FIR filter modes; Real-time spectrum analyzer; 6x faster operation; Off-line filter mode for wave (WAV) files.

Low pass, high pass, multiple band-stop / band-pass filters may be combined to produce very complex filters for frequencies up to 24 kHz, as well as standard infinite impulse response (IIR) and adaptive types. The software can also accept measured responses to define a filter template. This can be used to provide measurement equalisation or to search out signal signatures in noisy environments. In fact, it is a simple matter to produce filters with completely arbitrary frequency magnitude and phase characteristics using the finite impulse response (FIR) method, with no phase distortion, no matter how sharp the filter is. Alternatively, arbitrary phase distortion can be



introduced if this is desirable. It is even possible to design and execute real-time deconvolution (inverse) filters using the special invert mode. Because the processing module is so fast, it is possible to design filters with responses far beyond what is possible with traditional analogue techniques. The control program runs under Windows, and provides a user-friendly filter design tool that de-mystifies the process of specifying the filter. The filter design process simply becomes one of describing the desired frequency response. The design package indicates

the response that will be produced and also the deviation from that specified. User designs may be stored for re-use and actual responses may be entered from measurements for simulation or equalisation purposes. The filters are calculated and downloaded to the hardware within seconds.

(057043-1)

Patrick Gaydecki,
School of Electrical and Electronic Engineering, University of Manchester,
P.O. Box 88, The Faraday Building,
Manchester M60 1QD. Email
patrick.gaydecki@manchester.ac.uk

FREE Layout Software

EASY To Use!
Very **LOW** Cost!
Extremely **FAST**
Turnaround!

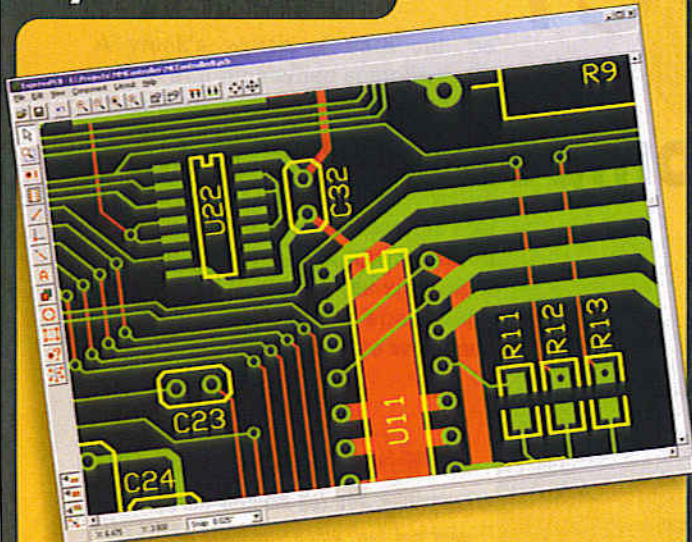

- 01 **DOWNLOAD** our free CAD software
- 02 **DESIGN** your two or four layer PC boards
- 03 **SEND** us your design with just a click
- 04 **RECEIVE** top quality boards in just days

expresspcb.com

Total Telematics

Automation
PIC Technology
Standard Modules
Custom Design & Build

Control The World

£49



£49

Ethernet uController

PIC18F452 CPU, 24LC256 EEPROM and demo Web Server.
32KBytes FLASH, 1536 Bytes SRAM and 32Kbytes EEPROM.
Web Server uses about half the available EEPROM memory,
heaps of space left for custom web pages!
Server based on the excellent Microchip TCP Stack.
13 user programmable I/O pins, 5 can be Analog Inputs.
LED's indicate Power, Collision/Link, Rx/Carrier, Tx.
RS232 interface via 3 pin connector or Front End connector.
Cable Included for connection to PC or DTE Device.
Has an ICSP (In Circuit Serial Programming) connector.
Full Technical and Programming Documentation.

Pay us a visit

Loads of uController and Automation kit
www.total-telematics.com

Design and Run a Digital Filter in SECONDS!

Signal Wizard 2: Easy-Use Real-Time Digital Filter and Analyser

Signal Wizard 2 is a unique real-time audio-bandwidth digital filter with infinitely adjustable characteristics – available at the click of a button. It uses a DSP unit that runs the filter and a Windows interface for designing and downloading almost any kind of filter. You don't need to know about maths, DSP or filter design – all you need to know is what filter you want. Signal Wizard designs finite impulse response (FIR), infinite impulse response (IIR) and adaptive filters in seconds. You can even import your own impulse or frequency responses. After you've designed the filter, click a button to download and run. Simple! Its flash memory means it can run filters from start-up, without the need for a PC.

Key Features:

- Runs under Windows 98 and XP.
- FIR: Multiple pass, stop or arbitrary; Butterworth, Chebyshev; analogue networks.
- Linear or arbitrary phase; response import mode.
- Rectangular, Bartlett, Hamming, Hanning, Blackman and Kaiser windows.
- Inverse or flipped filters.
- IIR: Butterworth, Chebyshev and arbitrary.
- Adaptive filter for noise cancellation.
- Independent dual channel operation with 24-bit resolution.
- Real-time dual channel scope and spectrum analyzer with data capture.
- Mixing, inversion and delays from 21 microseconds to 1.8 seconds.
- Real-time gain and sample rate control.
- Up to 8 filters in flash, two selectable, one per channel.
- Stand alone operation.
- Twelve sample rates from 48 kHz down to 4 kHz.
- Versatile plot and export of impulse and frequency responses.
- Off-line filter option for wave files.
- Includes board, CD, power supply and all cables.
- Serial interface operating at 115.2 kilo baud (auto-selected).

US \$450
(UK £235 approx)

For more information
Email: info@saellig.com

Full details and ordering information at: www.saellig.com/Suppliers/exfir/signalwizard2.htm

PetInspect

A 16-bit wearable computer for pets

Pete Cross

www.petinspect.com



Elmo shows off the latest in wearable computing. You can monitor the care of your pet too, when you build a PetInspect animal logging transceiver.

Does the cat hotel keep your pet warm enough when you leave her for a long weekend?

Does your dog walker really give your pet the exercise you've been paying for? Find out what your pet gets up to when you're not around, or discover how they're treated when left in the care of others. You can do all this with the animal data-logging transceiver described here.

PetInspect is a sophisticated data-logger and wireless communications device that lets you discover what environment your pet experiences and how they behave while you're not around. PetInspect consists of a 16-bit microcontroller with 256 kbytes of Flash memory and sensors for pressure, temperature, activ-

ity, light and proximity. The digital transceiver provides communication with a range of up to 30m. All this comes in a package 28mm in diameter, including batteries. This makes it small enough and light enough for a cat to wear comfortably as modelled by Elmo in the introductory photograph.

PetInspect comprises two circular PCBs. If you just want the sensing and datalogging capability, just build the digital board which has the microcontroller on one side and the sensors on the other. If you want to add transceiver capability, then you should also build the transceiver board. The transceiver board can be

built by itself to be used (or reused) as a general purpose unit for your own projects. **Figure 1** gives an overview of system functions.

Showing results

A week's worth of data can be stored at a time when sampling at a 15-minute logging interval. As long as you download once a week from your pet, you can get uninterrupted graphs for the life of the batteries — typically, two and a half months. **Figure 2** shows results downloaded from Elmo while she was wearing a PetInspect. The results span half a day and the sampling rate was once a minute.

Activity monitoring

Activity data is provided by the CW1600-1 ball-in-cage tilt-switch from ASSEMtech [1]. **Figure 3** shows the physical dimensions of the switch. The ball moves around, opening and closing the contacts of the switch. It will remain closed when held still in a vertical orientation plus or minus 15 degrees. This allows for basic posture recognition if oriented correctly on the animal. Even while the microcontroller core is stopped, the switch is feeding two timer-counters. The first timer is simply clocked by the tilt-switch wired between ground and a pull-up resistor to Vdd which provides the number of switch cycles per minute. The second timer gates the real-time clock 32-kHz crystal to another counter to provide a 'percent-closed' figure, i.e. the percentage of time the switch stays in the closed position. **Figure 2** shows increased activity when Elmo was generating most of the observed events throughout the day — except when napping!

Pressure sensing

The MS5534AM piezo-resistive pressure sensor from Intersema shown in **Figure 4** is micro-electro-mechanical structured (MEMS) device contains an integral 15-bit analogue to digital converter for accurately measuring both pressure and temperature. The pressure value is read out using a 3-wire synchronous serial interface, along with a temperature reading

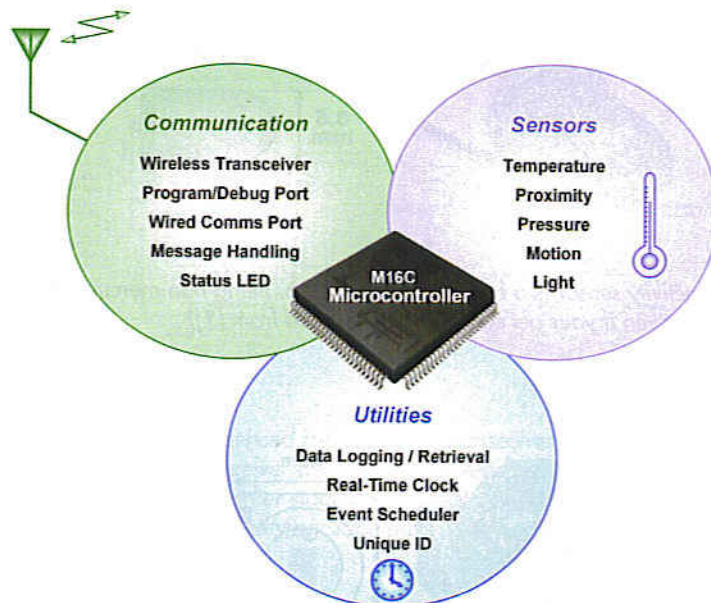

Figure 1. An M16C microcontroller is at the heart of the PetInspect sensor platform as it goes about its business of monitoring your pet and its environment.

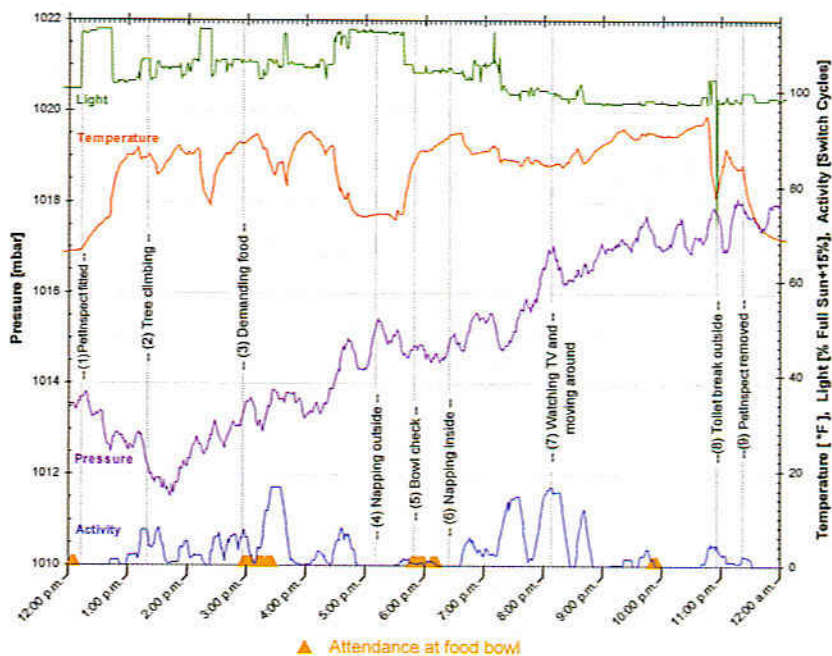

Figure 2. By downloading the data and graphing it in a spreadsheet you can see what your pet got up to. If the pet's in range, you can update the graph with live results using an Excel macro.

and calibration coefficients. The module is calibrated at two temperatures and two pressures at the factory for determining the six calibration coefficients. The calibration coef-

ficients are used by the software running on the microcontroller to correct for both the gain and offset errors of the pressure sensor and analogue to digital con-

This article describes an advanced circuit not tested or post-engineered by the Elektor Electronics design laboratory. It is offered as a source of inspiration for reader's own developments. The original, unabridged version of the article (24 pages) is available as a pdf file; see free download file no. 040327-11 on www.elektor-electronics.co.uk.

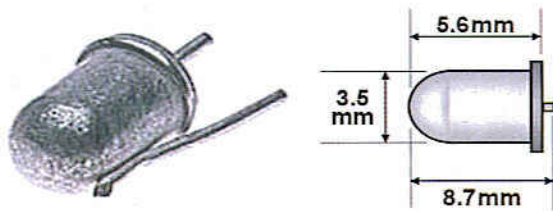

Figure 3. The activity sensor is a ball-in-cage tilt switch. Being non-mercury, it is completely safe, even if your pet swallows it. (Adapted from [1])

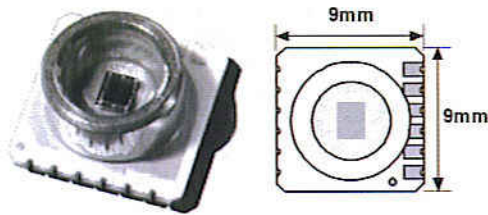

Figure 4. At 9x9 mm, the MS5534AM pressure sensor was originally designed for altimeter watches and the like. In PetInspect, the MS5534AM has enough resolution to tell you if your cat sleeps on the dining room table when she thinks you're not around. (Adapted from [2])

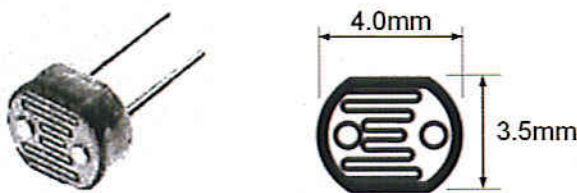

Figure 5. The LDR is not calibrated to any real units of light intensity. Instead, it simply reads in terms of "percentage of full sunlight", where 0% corresponds to an absence of light and 100% represents the maximum intensity ever expected when in full sun.

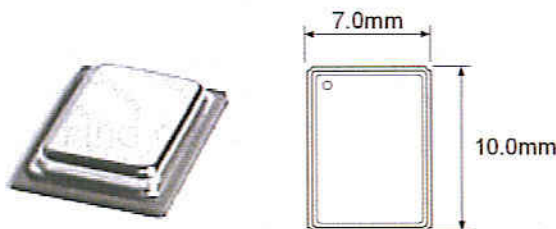

Figure 6. This is the TR3000 ASH Transceiver from RF Monolithics. I don't suppose the designers pictured their creation adorning the likes of my cat? (Adapted from [3])

verter. Second order compensation calculations involving the calibration constants and raw pressure and temperature readings provide enhanced accuracy of the calibrated pressure readings. In order to average noise, 8 readings

are combined. This averaged result gives a measurement which changes less than ± 0.05 mbar when the pet is still and at a constant height. To determine absolute pet altitude from pressure will require some math. After the pressure readings

are calibrated using the calibration constants and the formula supplied by the manufacturer, the following formula converts this actual pressure to an altitude above sea level:

$$h = \frac{T}{0.0065} \left[1 - \left[\frac{p}{p_0} \right]^{0.190262} \right]$$

This pressure-to-altitude conversion equation is based on US Standard Atmosphere 1976. T is the temperature in Kelvin, p_0 is the pressure of the day at sea level and p is the calibrated pressure reading from the MS5534AM pressure sensor. The height, h , is in units of meters. In Figure 2, event (2) shows Elmo climbing a tree. There is a marked short-term decrease in pressure when she is up the tree, followed by a rapid increase on her return journey Earthward. The slower variations in pressure across the graph are due to the changing ambient air pressure.

Temperature recording

When Rover takes a break at the pet motel, you like to make sure he's looked after. The temperature measurement is derived from the pressure sensor, since it needs this to provide its own temperature compensation. The reading is accurate to ± 0.5 °C with a resolution of 0.015 °C. The recorded temperature is influenced by three factors: ambient temperature, incident solar radiation and body heat generated by metabolism — which increases with physical exertion. This is just as well, because all of these contribute to the variable of interest: the core body temperature of your pet.

In Figure 2, when Elmo was napping outside (4) there was a greater amount of incident light and a lower temperature recorded throughout this time. Large sudden changes in temperature recorded by the device exhibit exponential arrival at the new level, even in the presence of small fluctuations. For example, when PetInspect was removed from Elmo (9), the recorded temperature plummeted in this way, but you can also see this with less definition when Elmo exits the house just before taking her nap outside (4) and again when she enters the house for her six o'clock feed (5).

Light intensity recording

The light dependant resistor (LDR) is a good inside/outside indicator. In Figure 2 I've added 15% to the light readings purely to prevent the light intensity results from overlapping on the temperature data. Due to changes in orientation and shadowing, the light readings will fluctuate markedly, however the average reading is a very good indicator for establishing inside/outside location during the day. A semi-opaque enclosure for the PetInspect helps to diffuse light from any angle, reducing these fluctuations, see Figure 5.

In Figure 2, napping outside (4) shows a greater amount of incident light than napping inside (6). When Elmo takes a toilet break from the artificial light inside just before 11:00pm, she goes outside which results in a sudden momentary decrease in light and temperature (8). Careful mounting of the device will ensure that the readings are not affected by changes in positioning. When Elmo climbed the tree (2), there was a false indication of lower light, probably due to the fact that the PetInspect got rotated so that the LDR pressed against her neck, rather than away from it.

Proximity recording

So who's eating all the brekkies? Since each pet has the ability to both transmit and receive information, they have the ability to communicate with one another over a short range (30 m line-of-sight). Each PetInspect constantly listens for ID transmissions from other PetInspects, and transmits its own ID number every 15 minutes (or at whatever period you like).

This allows you to assess the social grouping of pets. If you place a PetInspect by the feed bowl, you can check for feeding attendance. During the test in Figure 2, I had another PetInspect sitting by the feed bowl. It has a short antenna to reduce the range, localizing the capture of ID transmissions to about 1 m. As you can see by the orange triangles representing feed bowl attendance, Elmo likes her food!

Transceiver

The TR3000 Amplifier Sequenced Hybrid (ASH) transceiver IC from RF

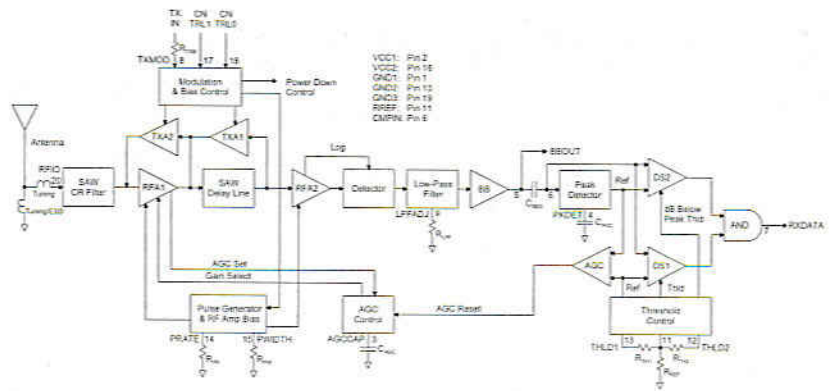

Figure 7. Amplifier Sequenced Hybrid (ASH) transceiver block diagram. A gain-limiting factor in most receiver amplifiers is the feedback from later stages affecting the sensitive high-gain earlier stages. This problem is eliminated in the ASH design by switching only one amplifying stage on at a time. (Adapted from [3])

Monolithics (Figure 6) was chosen for the wireless transceiver [3]. The TR3000 was the only device that fitted into the restricted physical space, and was integrated enough to easily form part of a circuit with the minimum amount of components. It also met the minimum requirements for data rate, power consumption, and ease of development. Being of fixed carrier frequency, the part number determines the frequency of operation. This device uses Amplitude Shift Keying (ASK) or

On/Off Keying (OOK) at a carrier of 433.92 MHz. OOK was selected because the amplitude shift keying mode is only available at higher data rates which have correspondingly reduced range. These transceivers have been used in products to track climbers on Mt. Everest and runners in the Boston Marathon.

The ASH design employed in the TR3000 contains an amplifier time-sequenced receiver section which provides over 90 dB of RF gain without the use of frequency down con-

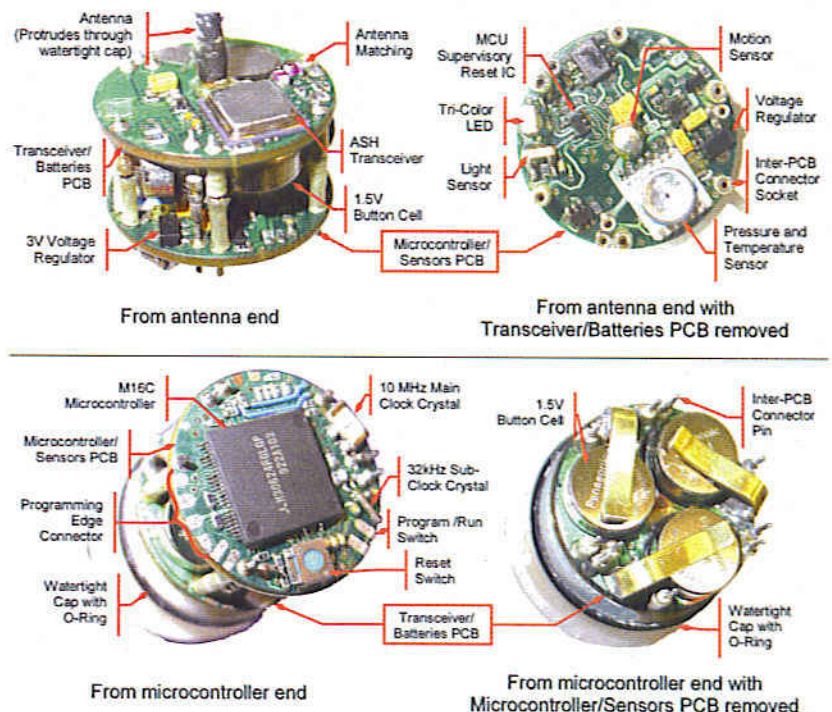

Figure 8. The six layer PCB has dedicated power and ground planes on each board, which along with other techniques, means bulky shielding is unnecessary. As a result, the electronics package, including batteries fit into a cylinder 28mm in diameter and 23mm length.

PetInspect Main Features

Overall

Operational temperature range	-10 to +70 °C
Operating voltage	3.0 V nominal
Battery life	10 weeks with a sensor sampling period of 15 minutes.
Sleep current	90 mA while maintaining the real time clock, continuously integrating animal movements and listening once a second for wireless data

Peak current	17 mA
Dimensions	electronics package: 28.6 x 28.6 x 25.0 mm
Flash ROM	256 k
RAM	20 k
Main clock	10 MHz

Transceiver Section

Transmit output power	-6dBm (0.25mW)
Range	15 m line of sight (typical)
Raw data rate	23 kbps
Modulation	on-off keying
Carrier frequency	433.92 MHz (licence-exempt ISM)
Carrier frequency tolerance	± 200 kHz
Receiver dynamic range	-10 to -84 dBm

version. Unlike a superheterodyne receiver which achieves stability by distributing RF gain over multiple frequencies, the ASH transceiver distributes the total RF gain over time. **Figure 7** explains this in block diagram form.

In this application, the transceiver is configured for OOK modulation at 23k Bits Per Second (BPS).

The transceiver draws too much current to be kept in receive mode while listening for the start of transmissions. Instead, the transceiver is placed in receive mode for 8 ms out of every 600 ms. It is asleep for the remaining part of the receive polling cycle.

When PetInspect or a base station wants to send a message, it transmits a 800ms preamble before the first packet. This 'tickle' wakes up all PetInspect units in range and keeps

them awake and in full-time receive mode until they detect 2.5 seconds of continuous silence. They then re-enter sleep mode to continue receiver polling.

Construction

Layout is crucial to the success of the transceiver operation. Normally, microcontrollers are not used in close proximity to radio frequency components. The spurious signals coupled from the microcontroller clocking elements into the radio circuits can affect both transmission and reception. To mitigate this, the transceiver and microcontroller are placed at opposite ends of the device. Attention to power supply distribution, shielding and other design rules allows a successful arrangement of components. The result of this care-

ful layout is shown in **Figure 8**. Extensive constructional notes, including useful tips on making waterproof PetInspect units are provided in the unabridged version of this article.

Base station

The purpose of the base station is to relay commands typed into the laptop for transmission over the wireless link. As shown in **Figure 9**, the commands are parsed and sent to the base station transceiver over the RS232 serial cable at 57,600 baud. PetInspect reply packets are captured by the base station transceiver and reformatted for serial transmission over cable in the reverse direction to the laptop. Although the wired link is duplex, the RF transceiver link is half-duplex at 23 kbits per second. The base station can be constructed from a PetInspect running different software. The actual action to be carried out is decided upon by the "Message Centre" module.

A base station might also be configured to control the immediate environment for your pet. For example, the door to the cat brekkies might only open if all of the following conditions are true:

Integrated activity over last two hours > 12,
AND cat has not accessed brekkies within the last hour,
AND time is after 4:30pm.
OR Cat has not eaten for four hours.

If you really want to get serious, putting the dispenser on a weigh scale that can be queried for the amount of brekkies eaten at each sitting would allow you closely track feed intake.

Software

The source code for the base station and PetInspect is common, being written almost entirely in the C programming language. Assembly was used sparingly where C was not suitable. The full source code listings are available free of charge from our website, the files are included in archive no. 040327-11.zip.

Schematics!

Now that we've talked about all the peripherals the full schematic starts

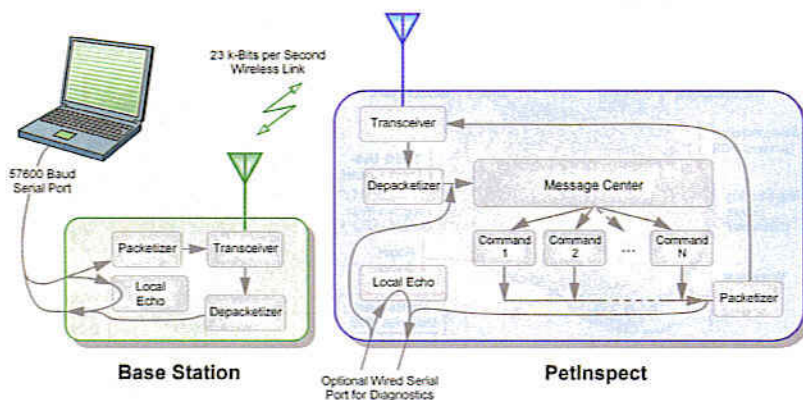

Figure 9. Base Station/PetInspect communication flow: The user types in a command on the laptop. This is echoed back by the base station over the serial port. PetInspect replies to all received messages via the wireless link to confirm that the command has been received and actioned.

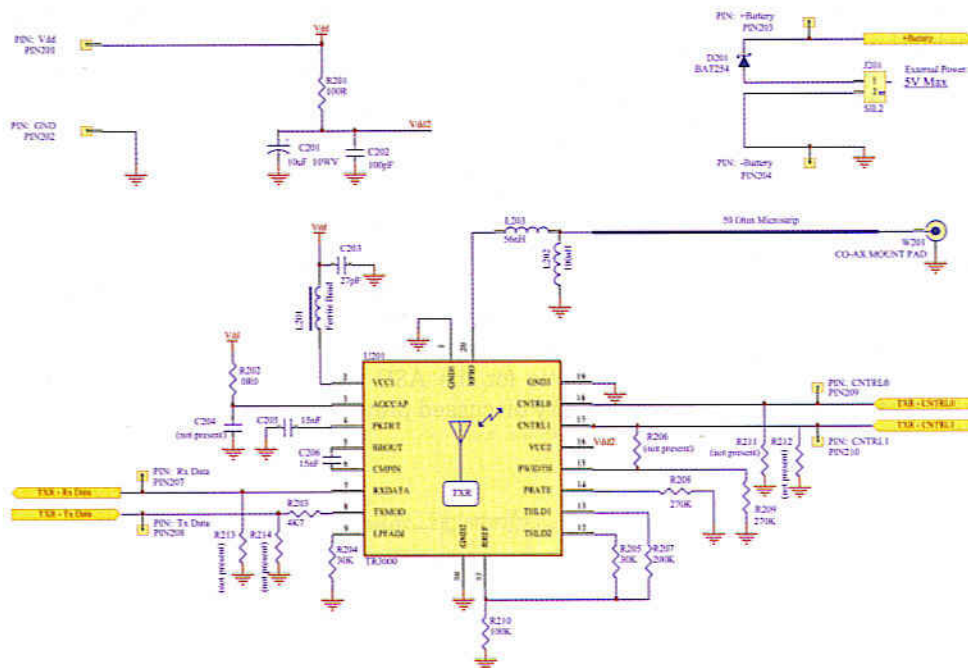

Figure 11. ASH transceiver schematic. Luckily, you can buy a DR3100 transceiver PCB module pre-assembled at the factory and change a few discrete components to alter the Baud rate.

The various power modes are as follows:

Sleep Mode: Microcontroller core stopped, timers being clocked by 32 kHz sub-clock for real-time clock and motion activity counters, transceiver in sleep mode. 10 MHz oscillator is off.

Doze Mode: As for sleep mode, but transceiver is in receive mode.

Low Speed Mode: As for doze mode but microcontroller core is operating from a 32 kHz sub-clock.

Fully Awake Mode: Microcontroller core is clocked from 10 MHz oscillator. Transceiver is in receive or transmit mode.

Further work

If you decide to build a PetInspect, you might like to extend its capabilities by adding more peripherals. Other sensors could be included: for example, an accelerometer could be added for posture recognition. GPS is an obvious choice for tracking and a microphone could be used to measure sound levels and detect hazardous environments such as busy roads.

As you can see, this article has described only the platform of a system that could be greatly enhanced by the application of your own enthusiasm and ideas.

References

- [1] ASSEMtech Europe Ltd., CW1600-1 Moving Sensing Switch Product Data Sheet, Rev B, 1998.
- [2] Intersema Sensoric SA., MS5534A Barometer Module Data Sheet, DA5534_024, 2003.
- [3] RF Monolithics Inc., TR3000 433.92 MHz Hybrid Transceiver Datasheet, TR3000p, rev 2000.12.08, 2000.

Acknowledgements

The hardware and software for this project was created as part of an M. Phil in conjunction with The University of Waikato and InterAg Ltd. It was supported by the Dick and Mary Earle Scholarship in Technology and a Masters scholarship from The University of Waikato.

Availability of parts and software

A full schematic, PCB layout, source code, compiled executables and Bill of Materials (BOM) lists with supplier details is freely available from the magazine website should you wish to make a PetInspect all by yourself. This includes everything required for the PetInspect, base station and the programming cable. Use the executable if you don't want to go to the bother of installing the compiler.

Parts are also available through the author at www.petinspect.com. Due to the difficulty of soldering the ASH transceiver IC, it would be easier to use the transceiver module based on this same IC by the manufacturer: the DR3100. This module needs a few passive components replaced to convert it 23kbps operation. The instructions to modify the DR3100 are part of the download from the magazine website. The only disadvantage of the DR3100 is that it is a little bigger.

Due to the extreme miniaturization using very small surface mount parts, this project is recommended for experienced electronics enthusiasts. A construction manual will be available before you commit to buying parts to ensure that you get an accurate idea of what's required in assembling the device.

You can build just one PetInspect and download the data with a wired link after retrieving it from your pet. To get the most benefit however, you should build two PetInspects and configure one as a base station. The base station connects to the PC serial port, allowing communication with any PetInspect in range over the wireless link. You can then download from Rover while he is still wearing the PetInspect.

PCB-POOL®

SERVICING YOUR COMPLETE PROTOTYPE NEEDS

- Prototypes at a fraction of the cost
- Industry standard quality
- Tooling and setup included
- Follow up series runs
- Any contour
- CAM / CAD consulting
- Fr4 1.6mm, 35µm Cu

PRICE EXAMPLE:
1 EUROCARD 05/PTH
 + Tooling
 + Photoplots
 + VAT
 = £ 29.89*

€ 49

*Sterling rates may vary. Price = €49



Beta
LABORATORY

Tel: +353 (0)61 701170
 Fax: +353 (0)61 701164
 E-Mail: sales@betolab.com

Freephone
0800-389 8560

Simply send your files and order ONLINE:

WWW.PCB-POOL.COM

VANSET Protel orcad GraphiCode PROTELS Electronics

PIC On Screen Display Project Board

A Versatile, Programmable, Low Cost Platform for Video Text Projects.

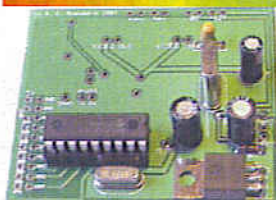

- PIC 16F628 microcontroller
- 28 by 11 character OSD
- Fully programmable
- Demo software available
- I/O lines for sensor interface
- RS232 serial interface
- PAL or NTSC compatible
- Enclosure option available



Visit www.STV5730A.co.uk

ANDRE LAMOTHE'S
XGAMESTATION
 LEARN STEP-BY-STEP HOW TO BUILD
 AND DESIGN YOUR OWN VIDEO GAME CONSOLE!

Design inspired by the
 Atari 800/2600, Sinclair ZX Spectrum,
 Apple II & Commodore 64!

Parallax SX-Key Compatible!

INCLUDES:

- Tools, Demos & Utilities!
- Great for Hobbyists AND Students!
- The Fun Way to Learn Embedded Systems!
- Fully Assembled XGS Micro Edition Unit!
- Complete Software Development Kit!
- eBook on Designing the XGS Console!
- Cables and Power Supply Included!

WWW.XGAMESTATION.COM NURVE NETWORKS LLC
 PH: 925.736.2098 | SUPPORT@NURVE.NET 4022 CAMINO ARROYO WEST
 DANVILLE, CA 94505 USA

Forest Electronics - PIC and AVR C Compiler Products

FED's ANSI C Compiler for PIC or AVR processors

- Fully integrated editor with syntax highlighting, multiple pages etc.
- Full project support - include and manage multiple source files, simulator, assembler files and notes/comments within one project
- Fully integrated simulator and waveform analyser step from C line to C line, or examine code in assembler form. View device pins using a logic analyser application.
- Simulator supports LCD modules, keypad, buttons, LED's, displays, analogue inputs, serial and asynchronous data and more.
- Designed to ANSI C standards
- PIC - Supports 18xxx, 16xxx, 12xxx series 14 and 16 bit core processors
- AVR - Supports standard and MEGA core processors
- Generates MPLAB/AVR Studio projects and source files and completely standard hex output files.

WIZ-C / AVIDICY

Drag and Drop rapid application development
 using ANSI C for PIC and AVR

- Rapid Application Development for the PIC or AVR microcontroller using the C language (WIZ-C for the PIC, AVIDICY for the AVR)
- Drag and drop your software component selections on to your design
- Included components support timers, serial interfaces, I2C, LCD, 7 Seg displays, keypads, switches, port controls, many bus interfaces including IIC and Dallas iButton, AVR/PIC Hardware, and more.
- Connect software components to MCU pins by point & click
- Parameters set from drop down list boxes, check boxes, or text entry
- Links your code automatically into library events (e.g. Button Pressed, Byte Received etc.)

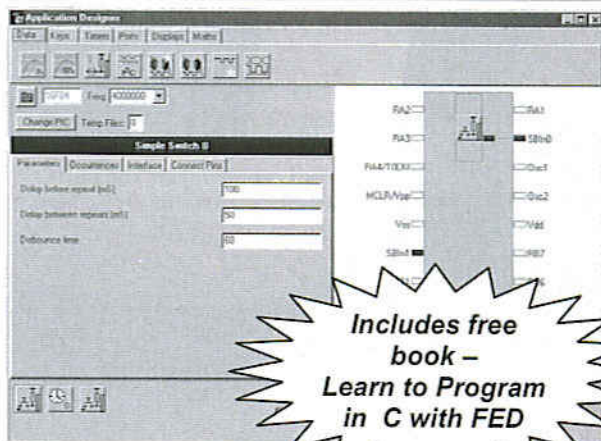

Includes free
 book -
 Learn to Program
 in C with FED

- Automatically generates your base application including full initialisation, interrupt handling and main program loop
- The complete C Compiler and AVR Simulator programs are integrated into AVIDICY - total editing / compilation / assembly / simulation support in one program
- Also includes the Element Editor to enable you to create your own components with ease.
- Demonstration available from our web site

Prices from £45.00 - details & demo from
www.fored.co.uk



Forest Electronic Developments
 01590-681511 (Voice/Fax)

email : info@fored.co.uk



www.fored.co.uk

Also programmers, ICE, & development systems

Movement sensors enhance GPS reliability

MOBILE NAVIG

Ekkehard Scholz



In the 1490s when Columbus sailed the ocean blue he wasn't able to plot a course with the aid of a GPS navigation system. Instead, he worked out his position on the globe (as it turned out) by meticulously recording the ship's speed and compass bearing in a process known as 'dead reckoning'. In those days it was quite common to be a couple of hundred miles out on long journeys.

NAVIGATION PLUS

Modern GPS navigation aids achieve remarkable accuracy in comparison but when the satellite signal gets weak or obscured they still need to take a lesson from Columbus to fill in the gaps...

The market for GPS (Global Positioning System) navigation systems has grown at a staggering rate so that now there are dedicated systems available for practically every type of travel and/or vehicle. As a consequence of the high level of system integration, mass production of specialist chips and lower production costs of both in-car (Figure 1) and portable (Figure 2) navigation equipment has fallen dramatically over recent years. Vehicular navigation installations use additional information from turn-rate sensors and distance trip data to help keep the system on course and display the correct on-screen position between GPS 'fixes'. The process of position plotting using distance travelled and compass heading is known as 'dead reckoning' (DR). DR information is important because it can be used in conjunction with digital map information stored on a CD or flash memory to update the displayed vehicle position when the GPS signal is obscured in tunnels or by tree canopy cover in a forest or buildings in town.

GPS and Dead Reckoning

The idea to support the GPS information with data from movement sensors is not new but it is only since the availability of low cost movement sensors such as electronic accelerometers, gyroscopes and compasses that the systems can be targeted at a mass-market.

Navigation systems that use both GPS and DR information fall into one of two camps in the way they handle the data: The most basic system uses GPS data for positional information and only falls back to DR when the GPS signal is unavailable. The second type is more sophisticated and combines both GPS and DR information to achieve better positional accuracy.

SiRFDrive is a commercial navigation software package marketed by SiRF Technology that combines (or 'couples') both GPS and DR information. The software has good modular design to help simplify the development process of a GPS/DR system. The close coupling of GPS and DR data is achieved using Kalman navigation filtering software. This technique is essentially an optimised interpolation algorithm using the last position together with actual GPS information and movement sensor data to predict the next position with minimum error. A feature of Kalman filtering is that it does not use all past data relating to the path taken it just calculates the new position using information from the last position, this therefore requires fewer resources but leads to some inaccuracy. To optimise positional accuracy Kalman filtering allows



Figure 1. The TravelPilot RNS 149 from Blaupunkt crams a car radio, CD player and navigation system into a standard DIN vehicle radio-housing format. (photo: Blaupunkt)

an adaptive approach to DR and GPS data handling: with a good GPS signal strength GPS data has a greater influence on the interpolated position but with poor GPS reception or low-speed travel the DR information has more influence.

Movement sensors

Acceleration can be measured with a closed-loop accelerometer. This device uses a servo amplifier to drive current into deflection coils positioned either side of a swinging mass to keep the mass steady. The current required to keep the mass stationary is directly proportional to the applied acceleration. This type of sensor has

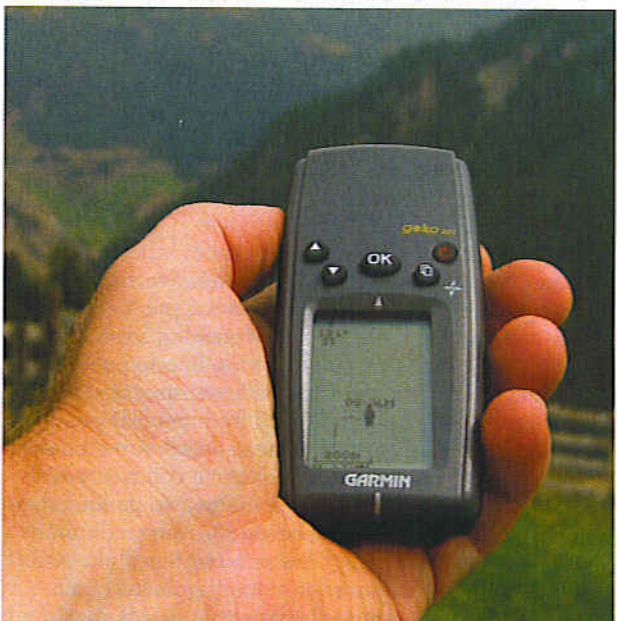

Figure 2. A personal navigation aid for serious ramblers. (photo: Garmin)

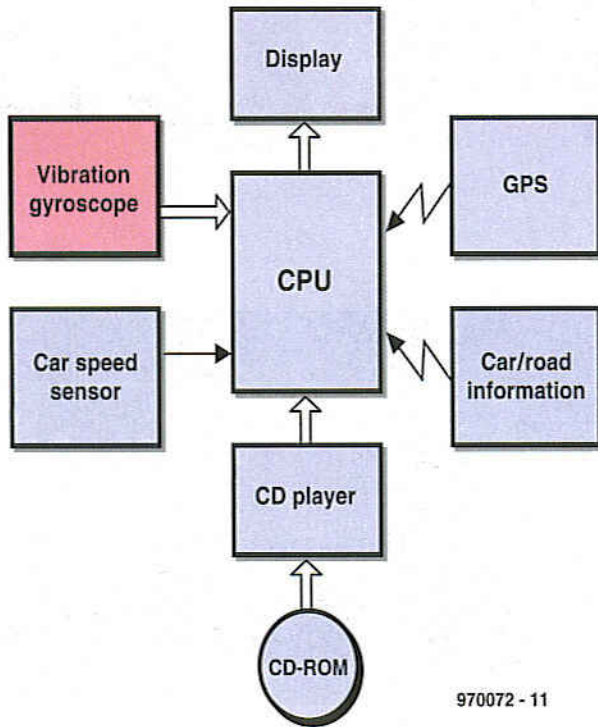

Figure 3.
Components of a
typical car
navigation system.

970072 - 11

good linearity throughout the measurement range and is typically capable of detecting forces of ca. 20 g to a resolution of 10 μ g. The unit is shockproof (100 g max) and has been used in many military and civilian applications for many years with proven reliability.

Two different types of turn rate sensors can be used, each relies on a different physical effect to sense rotation. They are briefly discussed below.

- The **vibrating gyroscope** (The word gyro here simply indicates that the device senses rate of turn, it does not imply that the device contains a rotating mass like a traditional gyroscope) uses the mechanical Coriolis force (a) experienced by a vibrating mass that is rotated (ω) in a plane orthogonal to its plane of vibration (v) (see **Figure 4**). A piezo harmonic vibrator or capacitive driver produces the moving mass. This type of gyro is often used in low-cost non-critical applications. It has a poorer performance compared with laser gyro particularly in terms of its noise, sensitivity to mechanical vibration and its temperature dependant output drift ($3^\circ/s$).

- The **optical gyroscope** ('laser gyro'). Once again no spinning mechanics are involved but instead this type of gyro relies on the 'Sagnac effect' to sense rotation. **Figure 5** shows the basic Fibre Optic Gyroscope (FOG) layout. It consists of a light emitting super luminescent diode (SLD), a modulator, an interference detector and a coil of fibre optic cable consisting of n turns enclosing an area A . When light from the SLD passes through the second beam splitter one half of the beam is injected at one end of the fibre optic coil and travels in a clockwise direction through the coil while the other half is injected at the other end and travels in an anti-clockwise direction. The phase relationship of the two exiting beams is compared in an interferometer. Both beams travelled the same distance (but in different

TomTom GO the story (1)

A GPS system using a MEMSIC sensor, ARM controller and Linux software

TomTom (based in The Netherlands) are suppliers of sophisticated navigation equipment worldwide. This unit uses the CMOS thermal accelerometer from MEMSIC to provide DR data. The TomTom GO is promoted as being the smallest and most intelligent All-in-one car navigation unit in the world. This compact unit has a full colour TFT display and contains the mapping software and a GPS receiver. The unit can be mounted in the vehicle using the supplied bracket. The unit has its own Lilon rechargeable battery so it is ready to go as soon as it is out of the box and switched on.

The route display can be switched between 3D or 2D representation with either day or night views. Language is selectable and the touch screen is intuitive to use. The battery can be recharged from a cigarette lighter socket. The built-in dead reckoning facility enables the unit to be

TomTom GO the story (2)

An open system

Technically, the TomTom GO is interesting not just for its integrated Dead Reckoning feature (or 'Assisted Satellite Navigation' as it is referred to by the manufacturer) but also for its system architecture. It employs a 200 MHz ARM920T processor which was recently found to run a Linux (!) operating system. Use of Linux meant that TomTom, in response to pressure from the Linux community, eventually had to make its control software available as an open source program. This information together with some clever reverse engineering information available on the Internet makes this device the most transparent navigation equipment available today. With all the information available it is perfectly possible to develop the platform further, for example, as a media player. A look at the Wiki page mentioned below details the use of a TomTom system in this field of application.

TomTom are continuing with product development and unveiled three further models at the CeBit Exhibition in March. The basic GO300 has a 200 MHz processor but does not have an accelerometer or dead reckoning capability. The GO500 is similar to the earlier model but has a clock speed of 400 MHz like the GO700. This model also has a 64 MB memory and a built-in 2.5 GB hard disk with pre-installed map data for the whole of Europe. All three models have a built-in blue tooth transceiver.

A software development kit called SDK5 is also available



Photo TomTom GO

used as a portable unit. Travel information and country specific mapping data for all European countries is pre-loaded to the unit via the SD memory card. At the country border it is only necessary to plug the SD card for the next country and carry on with the journey. Once the country-specific SD memory card is plugged into the unit the driver will have access, not only to detailed map information but also to places of interest (POIs) such as hotels or restaurants in the vicinity.

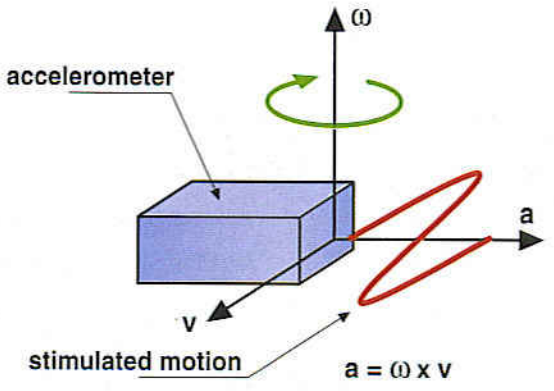

Figure 4. The principle of the vibration gyro (Picture: IMAR Navigation)

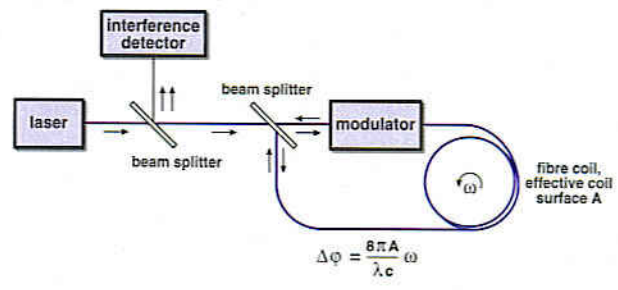

Figure 5. Laser gyro block diagram. (Picture: IMAR Navigation)

The serial Port

OpenTom

```

decompressing
Linux.....
.... done, booting the kernel.
Linux version 2.4.19-rm4-sw15-
t1200 (ayy@chilles.lutra.local)
gcc version 2.95.2 19991024
(release) #1 Fri Sep 3 15:03:17
CEST 2004
CPU: SAMSUNG S3C2410(Arm20T1x)id
level revision 4
Machine: SAMSUNG ELECTRONICS Co.,
Ltd
On node 0 totalpages: 8192
zone(0): 8192 pages.
zone(1): 0 pages.
zone(2): 0 pages.
TomTom Go Boot, built at 2004-09-
03 15:04:15
Mounting /proc
Waiting for SD card to mount
          
```

„Reverse Engineering“

for professional with special features including a method to transfer data using GPRS radio interface.

There is also an official GO development toolkit available which allows the development of C++ programs under Windows using the Cygwin compiler. So it just goes to show that almost anything is possible with Linux...

Weblinks:

- www.tomtom.com/?language=5 (manufacturers site)
- <http://wiki.opentom.org/> (Wiki with lots of information on the TomTom Go)

directions) so the phase difference of the outputs will be zero. An interesting thing happens when the whole apparatus is rotated around the coil axis (where ω is the angular rotation speed). If the rotation is in a clockwise direction then the light travelling in the same direction around the coil will travel a slightly longer path because the detector has moved further away from the transmitter while the light is in transit through the coil. Similarly the anticlockwise light beam will hit the detector sooner because it has moved nearer to the transmitter. Careful observation of the two output beams by an interferometer indicates a phase shift proportional to the rotational speed. In another variant (the closed loop FOG) the beam can be fed to a phase shifting element which corrects the phase difference and the amount of correction indicates the turn rate.

Compared with mechanical or piezoelectric gyros the fibre optic gyro is much less sensitive to the effects of vibration and acceleration this is the main reason they are preferred to any other type for precise measurement.

The Thermal accelerometer

An ingenious new type of accelerometer does not use a conventional mechanical pendulum to detect movement or inclination. Instead the unit senses tiny variations in the convection currents generated by a heating element suspended inside a hermetically sealed chamber. The complete device comprising the micro-machined chamber, heater, thermocouple sensors and amplifiers are contained within a 5 mm square LCC-8 chip outline. The small heating element is supported in the chamber and has two thermocouple sensors (for sensing single axis movement) fixed either side (Figure 6). The element produces a circulating 'bubble' of warm air centred between the two thermocouples. Whenever the device is moved or

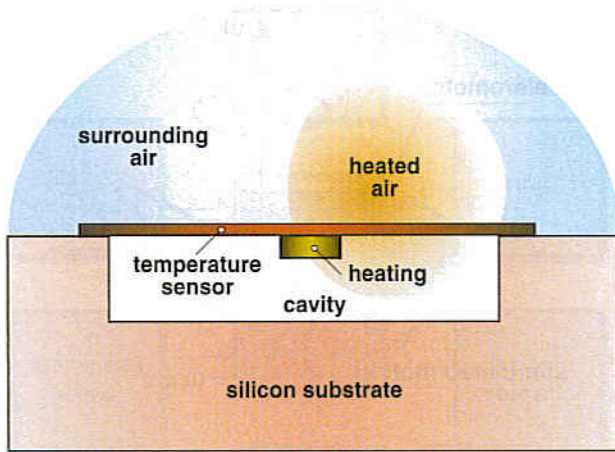

Figure 6.
The heated air shifts
under the influence
of acceleration
(Picture:
Memsic Inc.)

inclined along its sensing axis the bubble of warm air shifts (it has a different mass from the surrounding air in the chamber) so that one thermocouple now becomes warmer and the other cooler (proportional to the rate of acceleration or angle of incline). The two thermocouples are connected as elements in a Wheatstone-Bridge so that the voltage change outputs a difference voltage (Figure 7). The output signal indicates the direction and force of acceleration. The sensing axis is horizontal to measure velocity increase/decrease or tilt angle.

This device is built-into the TomTom navigation system (see insets) and is particularly flexible for stand-alone applications because the unit is completely self-contained and does not require an interface to any vehicle sensor.

(050006-1)

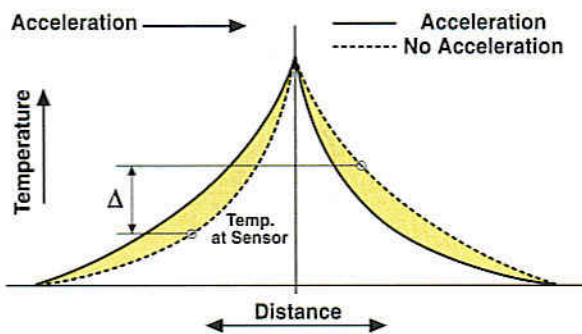

Figure 7.
As acceleration or
inclination increases
so the temperature
difference gets
larger. (Picture:
Memsic Inc.)

Advertisement

For rapid development of electronic systems...

E-BLOCKS™

E-blocks are small circuit boards each of which contains a block of electronics typically found in an electronic system. E-blocks can be programmed in C, Assembly and are tightly integrated with Flowcode - which instantly converts flow charts into PICmicro code.



Low cost USB PIC
programmers
(Starting at £27, model
shown E55)

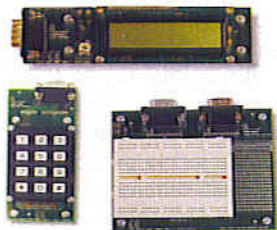

..plus a wide range of
add-on boards and
accessories...



.....plus incredibly easy
to use software based on
flow charts...

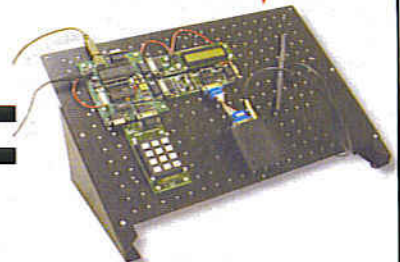

...equals extremely rapid system
development: like this mobile text messaging
system built from E-blocks.

...and solutions for learning and development...

Hands on training
courses



training courses in PICmicro(R)
programming, CPLD programming and
ECAD

Resources for learning
CPLD programming



Complete courses in
electronics and programming



Equipment for datalogging,
control and PC 'scopes

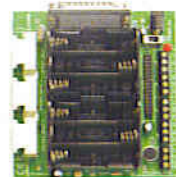

...and more at:



...see www.matrixmultimedia.co.uk

Matrix Multimedia Limited
sales@matrixmultimedia.co.uk
t. 0870 700 1831 f. 0870 700 1832

SERIAL COMMUNICATIONS SPECIALISTS

Test and Measurement Solutions



featured products



NETCOM-813
8 Port RS232/RS422/RS485 model
£350

NETCOM Ethernet- Serial Servers

NetCom are industrial strength, network based serial device servers for connecting RS232, RS422 and RS485 serial devices directly to a 10/100Mbps Ethernet network running TCP/IP. Netcom can control 1 or more serial devices located virtually anywhere (via Ethernet or Internet). NetCom can be configured over Driver Panels, WEB Browser, Serial Port, Telnet or SNMP and serves as a transparent serial channel without platform and distance limitation. Housed in a sturdy metal enclosure including DIN rail mount, one to eight port models are available. 19in rack-mount versions with internal switch mode PSU can also be supplied.

priced from £85 (NetCom 111)



DS1M12 Oscilloscope / Datalogger
2 1MS/s Input Channels + waveform generator output
£125

USB Instruments - PC Oscilloscopes & Logic Analyzers

Our range of PC Instruments may be budget priced but have a wealth of features normally only found in more expensive instrumentation. Our DS1M12 and PS40M10 oscilloscopes have sophisticated digital triggering including delayed timebase and come with our EasyScope oscilloscope / spectrum analyzer / voltage and frequency display application software and our EasyLogger data logging software. We also provide Windows DLLs and code examples for 3rd party software interfacing to our scopes. Our ANT8 and ANT16 Logic Analyzers feature 8/16 capture channels of data at a blazing 500MS/S sample rate in a compact enclosure.

priced from £125 (DS1M12 & ANT8)



USB-16COM-RM
16 Port USB Serial Server Rack Mount with Internal PSU
£265

1 to 16 port USB to Serial Adapters

With over 16 different models available, we probably stock the widest range of USB Serial Adapters available anywhere. We offer converter cables, multi-port enclosure style models in metal and plastic, also rack mount units such as the USB-16COM-RM opposite. Serial interfaces supported include RS232, RS422 and RS485. We also supply opto-isolated RS422 and RS485 versions for reliable long distance communications. All our USB Serial products are based on the premium chipsets and drivers from UK company FTDI for superior compatibility, performance and technical support across Windows, MAC-OS and Linux platforms.

priced from £20 (US232B/LC laptop Companion)



PCI-800L
8 Port PCI RS232 Serial card
£150 (including cables)

PCI Serial Cards

Discover our great value for money range of multi-port PCI serial cards. Supporting from two to eight ports, the range includes RS232, RS422, RS485 and opto-isolated versions. Our 4 port and 8 port models can connect through external cables or the innovative wall mounting COMBOX.

EasySync Ltd

373 Scotland Street, Glasgow G5 8QB, United Kingdom
Tel : 0141 418 1081 / Fax : 0141 418 0110

Web : <http://www.easysync.co.uk>

E-Mail: sales@easysync.co.uk

* Prices shown exclude PP and VAT where applicable

SENSE ORGANS

Helmuth Lemme

Modern vehicles are computer networks on wheels in which sensors provide the links to the real world. These sense organs for the onboard electronics are subject to extremely severe requirements. Here we provide an overview of the virtually unlimited variety of sensors and highlight current trends and new developments.

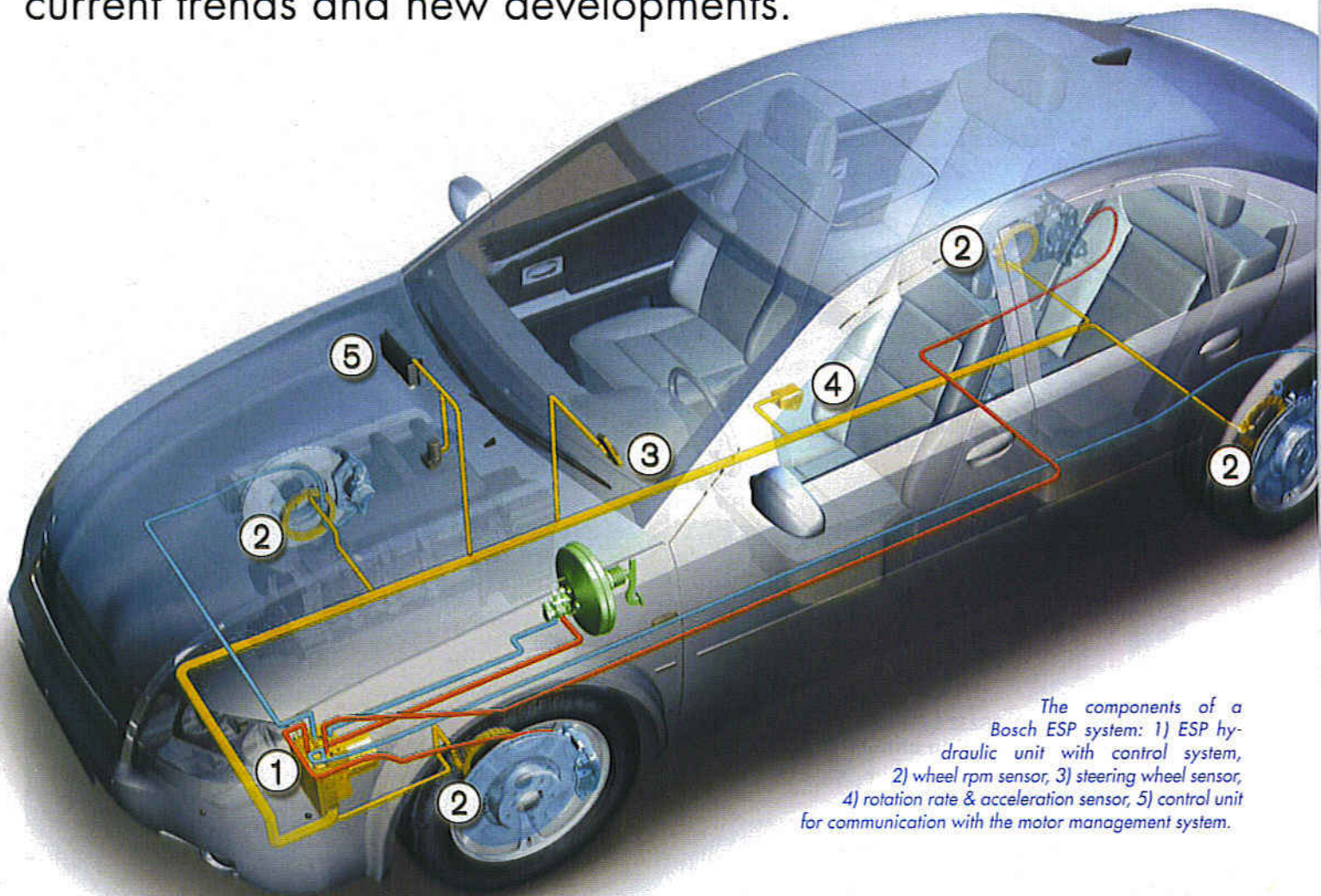

The components of a Bosch ESP system: 1) ESP hydraulic unit with control system, 2) wheel rpm sensor, 3) steering wheel sensor, 4) rotation rate & acceleration sensor, 5) control unit for communication with the motor management system.

FOR VEHICLES

Increasing competitive pressure is forcing motor vehicle manufacturers to make ever more sophisticated innovations. This applies not only to passenger vehicles, but also to commercial vehicles such as lorries and busses, and of course to motorcycles as well. The decisive improvements made in recent years are:

- increased driving safety,
- reduced fuel consumption,
- reduced environmental pollution,
- increased comfort and convenience, and
- improved diagnostic functions.

To make all of this possible, many physical quantities – mechanical, thermal, and other – must be measured at innumerable locations in the vehicle and conveyed to a microcontroller. The microcontroller monitors the measured values and triggers suitable control functions as necessary. In contemporary top-end vehicles, the number of sensors can easily run into the hundreds, and motor vehicles are gradually turning into mobile electronic fortresses.

Generally speaking, the trend is moving away from independently operating individual modules and toward full networking of the entire vehicle using suitable busses.

In a manner of speaking, the objective is to have every nook and cranny know what's happening everywhere else. Some of the functions that would be inconceivable without sensors are:

- ABS (anti-lock braking system): brake locking is prevented by reducing the pressure on the brake pads under electronic control in order to maintain the steerability of the vehicle.
- ASR (acceleration slip regulation, a.k.a. 'traction control'): prevents individual wheels from spinning.
- ESP (Electronic Stability Program): prevents skidding in order to keep the vehicle on the course desired by the driver.
- ACC (Adaptive Cruise Control): automatic control of the optimum distance from the preceding vehicle according to the vehicle speed.
- Minimising harmful emissions by monitoring the exhaust gas and suitably adjusting the fuel/air mixture.
- Triggering airbags in case of a collision – but only if the associated seat is occupied.
- Backing off a window if it cannot be raised without encountering resistance (because a finger is in the way, for instance).
- Warning signals for doors that are not properly closed while the vehicle is moving, insufficient fuel in the tank, icy roads, seat belts that are not fastened, and so on.

As human life, significant property values and the reputations of entire corporations depend on the trustworthy operation of these sensors, they are subjected to extremely strict reliability requirements. The ambient conditions faced by these sensors are challenging, with temperatures ranging from well below freezing ($-40\text{ }^{\circ}\text{C}$) to the sizzling heat of a highly overheated engine ($160\text{ }^{\circ}\text{C}$, with brief excursions up to $200\text{ }^{\circ}\text{C}$), as well as rainwater, ice, de-icing salts, oil, brake fluid, battery acid, dust, exhaust gasses, vibration, mechanical shocks, and strong electromagnetic fields arising from the immediate vicinity. Besides being secure against total failure, the sensors must maintain their measurement accuracy within specified tolerances under all of these conditions over many years. At the same time, they are also exposed to unrelenting cost pressures. As a result, only a small fraction of the nearly unimaginable variety of commercially available types of sensors can meet the selection criteria. **Figure 1** gives an overview of the most significant vehicle systems incorporating sensors.

Engine sensors

Here one of the most important quantities to be measured is crankshaft rpm. The 'classic' way to do this is to use an inductive sensor consisting of a coil and a permanent magnet. A steel cam or lobe is located on the shaft. When it passes in front of the sensor, the magnetic flux through the coil changes. For each rotation of the shaft, a single voltage pulse is induced and then further processed by the electronic circuitry.

Another option involves a magnet attached to the shaft. If this type of sensor is located next to a gearwheel or a magnetised wheel with several poles (multipole ring), a corresponding number of pulses will be obtained for each rotation of the shaft. This principle is simple and economical. The frequency of the generated signal is a measure of the rpm. However, a drawback of this approach is that the voltage that is generated is also proportional to the rpm, so it is difficult to sense very low rotational speeds.

This problem can be avoided by using a sensor that responds to a static magnetic field, such as a Hall-effect sensor or a magnetoresistive sensor. Such sensors are wear-free and reliable, and they are already widely used in automotive systems due to their low cost.

The second important quantity is the instantaneous angular position of the crankshaft or the camshaft, which rotates at half the speed of the crankshaft in a four-stroke engine. This quantity is needed by electronic ignition controls. Inductive and magnetic sensors are again suitable for this purpose. The development trend is moving away from traditional mechanical valve control and toward electronic valve control. The Siemens/VDO *Electronic Valve Train* (EVT) system, for instance, provides an increased range of options for valve opening and closing times and thus allows the engine to be operated more efficiently.

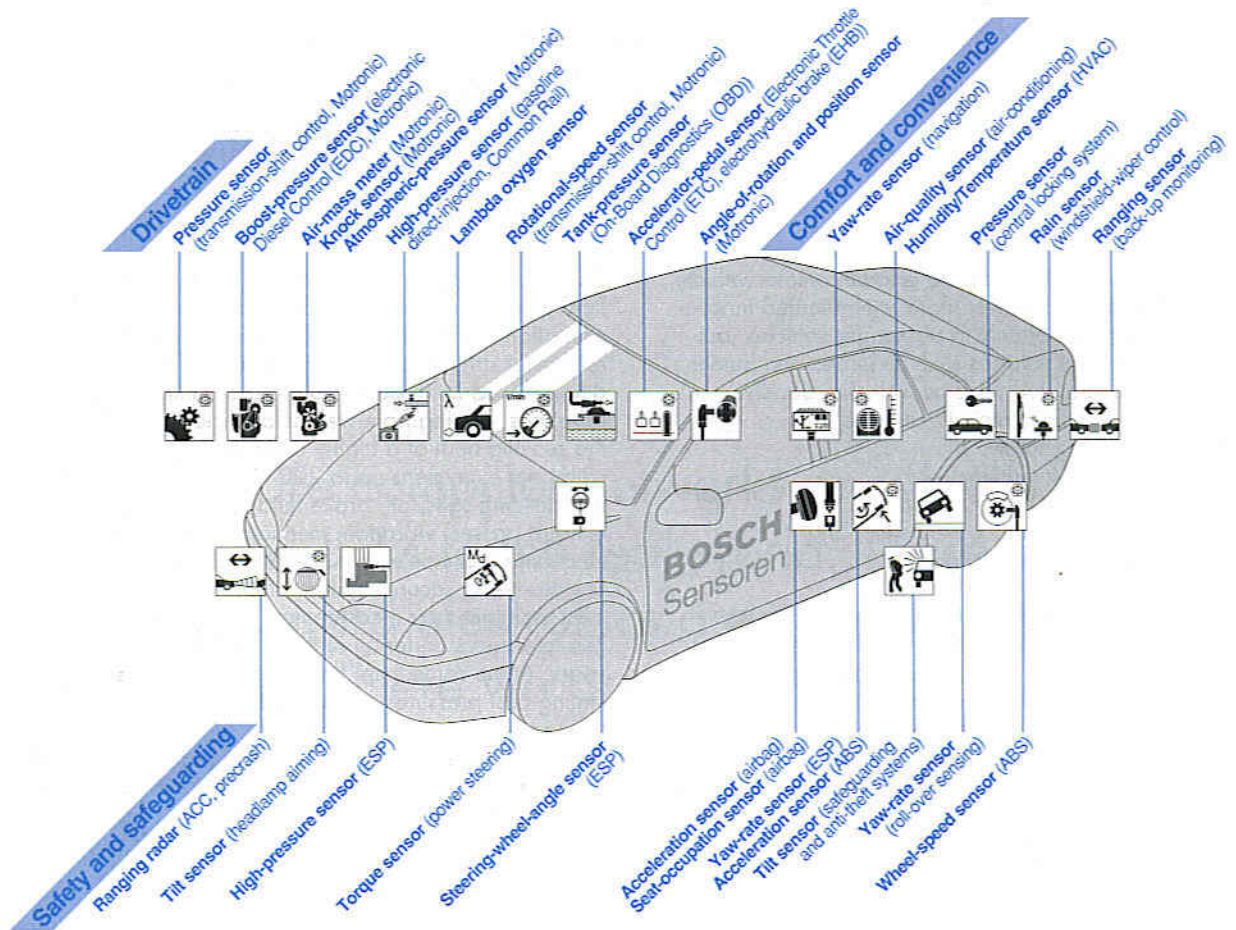

Figure 1. Sensors are used in a wide variety of vehicle systems.

Another parameter that requires monitoring is the engine temperature, since overheating due to failure of the cooling system poses a serious threat. Semiconductor sensors and metallic sensors (using platinum or other metals) are suitable for use as temperature sensors.

A flow sensor in the fuel supply line can provide an indication of the instantaneous fuel consumption. However, it can be omitted with modern fuel-injection engines, since the amount of fuel being consumed can be precisely calculated from the volume of fuel delivered by the injection pump. The on-board computer can then compute and display the average consumption per 100 km, the total consumption since the last reset, and (if the amount of fuel in the tank is also included in the computation) the anticipated distance that can still be travelled.

Measuring the amount of air taken in by the engine (or more precisely, the mass of the intake air) is very important for optimum engine control. As is well known, air density depends on the air temperature and elevation above sea level. With sensors that essentially measure the air volume, the measured value must be suitably corrected.

Mechanical airflow sensors use a potentiometer to sense how far a flap (air vane) located in the air stream is deflected by the dynamic pressure. Moving parts can be dispensed with by using thermal airflow sensors (hot-wire and hot-film airflow sensors). Such sensors use a platinum wire or small ceramic plate with a platinum heating element and vapour-deposited metal-film resistors as sensor elements. The cooling effect of the air stream flowing past

the sensor is compensated by using a closed-loop control system to maintain the sensor at a constant temperature. The heating current required to maintain the sensor at a constant temperature is proportional to the airflow and thus provides a measure of the mass airflow.

Torque measurement

Modern automatic transmissions are controlled by micro-controllers. To determine the optimum shifting point, the microcontroller needs information about the amount of torque generated by the engine as well as the crankshaft rpm. This represents a particular challenge to sensor designers, since this quantity must be measured on a rotating shaft. One option is to use the magnetoelastic effect, which is the change in the magnetic permeability of steel under mechanical stress. Another option is to measure the torsion of the shaft by using two incremental angular sensors located a certain distance apart.

'x by wire'

When the driver is assisted by electronic aids such as ABS, ASR, ESP, ACC and so on, the control elements (throttle and brakes) are no longer directly actuated by mechanical links to the pedals. The circuitry connected between the pedals and the control elements has its own 'intelligence' and takes corrective action if necessary. This is referred to as *drive by wire* and *brake by wire*.

The pedal positions are sensed using angular sensors, usually potentiometers, which are subject to extremely severe reliability requirements. Normal types of potentiometers with carbon tracks wear over time, with the result that their resistance increases. Besides this, the wiper can intermittently lift off the track due to soiling. Increased service life can be achieved by using zero-wear designs, such as a new Novotechnik product that combines inductive and resistive operating principles. In this sensor, a sliding ferrite yoke modulates the inductive coupling between two conductive loops. The degree of coupling is measured by an attached ASIC.

Electronic power steering

In a few standard production models, the force for power steering assistance is provided by electric motors instead of a hydraulic system. This has the advantage of reduced fuel consumption and lower weight. Electric power steering requires an angular sensor attached to the steering wheel to measure the total angle of rotation over a range of around four full turns. The output signal from this sensor is also important for the ESP system. The steering-wheel sensor can use a potentiometer or employ optical or magnetic effects to sense rotation.

Steer by wire refers to a purely electronic steering system similar to the systems used in aircraft, with no mechanical link between the steering wheel and the front wheels. It is presently in the research stage and not yet ready for mass production. The safety requirements in this area are extremely high. An interim solution developed by Bosch allows the electronics to intervene via a planetary gear drive. If the electronics fail, the vehicle can still be steered using the mechanical system.

Brake by wire is also a reality in the form of an interim solution with an electromechanical brake pedal that electronically controls electrohydraulically actuated brakes. Besides safety considerations, the primary obstacle to a purely electrical system is the fact that the amount of current necessary for operation with a 12-V electrical system would be too large for practical implementation. Conversion to a 42-V system, which has been urged for some time now (see the February 2000 issue of *Elektor Electronics*), is being kept on hold by the industry, primarily for cost reasons.

Minimising pollutants

Minimising pollutant emissions requires maintaining an optimum air/fuel ratio (λ) in the engine intake mixture. The lambda sensor in the exhaust pipe is an oxygen sensor based on the principle of ionic conduction in a solid electrolyte. The signal from the lambda sensor is used to adjust the fuel/air mixture fed to the engine. Lambda sensors have also become technically sophisticated devices, and they are available in numerous versions to meet different requirements.

Intelligent windows

Besides position sensors that switch off the motor in the fully open and fully closed positions, electrically operated windows and sunroofs have force sensors to detect resistance to the closing motion. This is because there's a risk of body parts being trapped or pinched, particularly

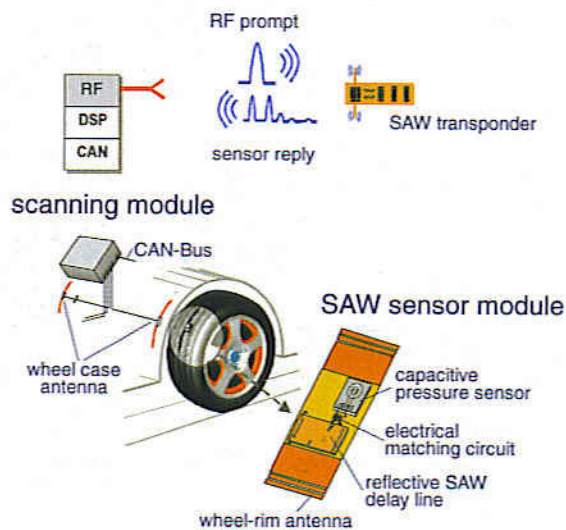

Figure 2. A sensor system for measuring pressure and temperature in rotating tyres using a surface acoustic wave transponder. (Source: Siemens-VDO)

when children carelessly play with the windows or sunroof. The windows and roof are required to automatically open again if resistance is encountered. One sensor that has been specially developed for this purpose is the Infineon TLE49x6. This is a dual Hall sensor containing two Hall-effect elements on a single chip, which determine the position and direction of motion.

Tyre pressure and brakes

Tyres are among the most important safety-related components. Tyre damage has been responsible for innumerable accidents. Underinflation is particularly hazardous, since excessive sidewall flexing can cause tyres to overheat and rupture. Electronic monitoring systems can provide an advance warning of underinflation. They are initially being fitted in commercial vehicles (lorries, buses, etc.). A special problem in this case is transmitting the measurement data from the rotating wheel to the (relatively) stationary chassis. Wireless links are much more reliable than slip rings for this purpose. With a wireless system, pressure and temperature sensors are linked to a transmitter inside the tyre that sends the measurements using radio waves. Early versions of such systems were powered by lithium batteries, but eliminating the battery is desirable for maintenance reasons. Modern batteryless systems, such as the *Tire IQ* system developed by Siemens VDO Automotive and Goodyear, use surface



The individual components of a Bosch ESP system. (Source: Bosch)

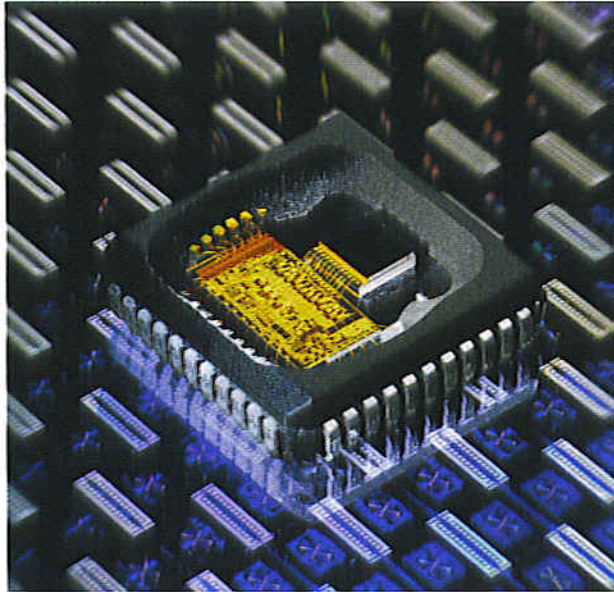

Figure 4. A micromechanical rotation-rate sensor senses the rotation of the vehicle around its vertical axis. (Source: Bosch)

acoustic wave transponders powered by the RF field. ABS, ASR, and ESP systems need to know how fast the wheels are turning. In early systems, this was determined using inductive sensors such as those already mentioned, with the disadvantage that they give poor results at low rotation speeds. Magnetic sensors using the Hall effect and various types of magnetoresistive sensors have proven to be superior for this purpose.

Electronically enhanced driving stability

Many accidents are caused by skidding. The Bosch Electronic Stability Program (ESP) illustrated in **Figure 3** includes ABS and ASR functions and goes even further. It detects any skidding motion of the vehicle at a very early stage and actively attempts to counter the skid in order to bring the vehicle back under control. This is done by suitably braking individual wheels and reducing engine power. To do this, the controller correlates the angular position of the steering wheel and the applied braking

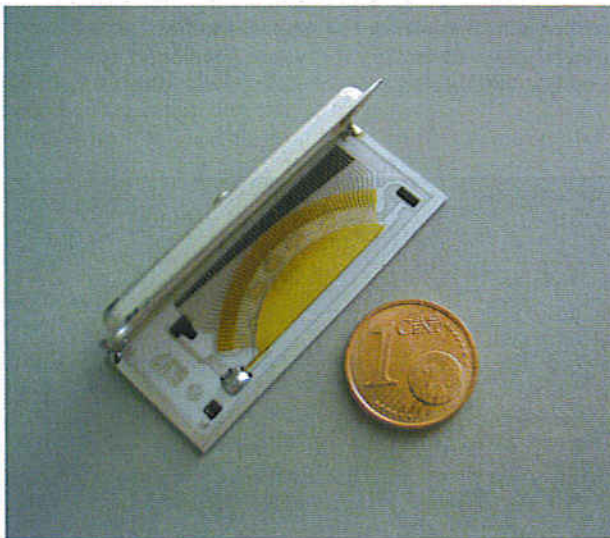

Figure 5. A high-reliability fuel level sensor with many fine contact arms actuated by an external magnet passing alongside the contacts. (Source: Siemens-VDO)

force with the rotation of the vehicle about its vertical axis (yaw rate) and the vehicle's speed.

There are many different types of sensors that can be used to measure the yaw rate. Most of them make use of the *Coriolis force*, which causes the oscillation pattern of a vibrating micromechanical structure (such as a rotary pendulum or a tuning fork) to change when it is rotated. This change is detected by variations in the capacitance between the oscillating element and the substrate (**Figure 4**).

If a vehicle rolls over and comes to rest on its roof or its side, the tightly cinched safety belts must be loosened to make it easier to free the occupants. A tilt sensor can be used to sense the attitude of the vehicle. Many different operating principles can be used for such sensors, but sensors based on thermal principles are especially suitable for manufacturing small, inexpensive devices. Such sensors contain an electrically heated wire surrounded by a bubble of hot air. If the sensor is horizontal, the two temperature sensors on either side of the heater receive the same amount of heat. These sensors are wired into a measurement bridge whose output voltage is zero in this condition. If the sensor is tilted, the sensors will have different temperatures and there will be a non-zero output voltage. At least two manufacturers (Memsec and Vogt) presently offer this type of sensor (see also the 'Mobile Navigation' article in this issue).

Reliable fuel level measurement

The common method for measuring the fuel level employs a tank float connected by a lever arm to a potentiometer that is sealed to prevent fuel penetration. With such an arrangement, wear can lead to incorrect readings with unpleasant consequences.

Siemens-VDO manufactures a wear-free sensor. It contains an array of magnetically actuated contact elements resembling a harp. The field of a magnet attached to the float lever passes through the case and closes individual contacts in turn (**Figure 5**).

Morgan Electro Ceramics has introduced a completely different principle that does not require a float. It uses ultrasonic waves emitted by piezoelectric transducers in the floor of the tank to measure the fuel level. The level is determined by measuring the travel time of the reflected waves.

PERSONAL SAFETY writ large

The utmost in reliability is demanded for airbag deployment sensors. They must respond with absolute certainty when a collision with a certain force level occurs, but otherwise they must never respond to shocks below the threshold level, in order to prevent them from actually causing an accident. The sensors used for this purpose are acceleration sensors. Many different operating principles can potentially be used for this purpose. Most of them involve an inertial mass suspended using a spring mechanism, with the deflection of the mass from its quiescent position being sensed. Micromechanical versions etched from monolithic silicon crystals are widely used. Deflection of the mass causes the capacitances between the 'fingers' of interleaved comb electrodes to change, and this change is measured by electronic circuitry integrated into the same chip. Despite their delicate microscopic structures, such sensors have outstanding durability (**Figure 6**).

If the passenger seat is empty, there is no point in triggering the passenger-side airbag if there is an accident. One way to implement *occupant classification* (OC) is to place a synthetic composite mat containing force-dependent resistors beneath the seat upholstery in order to measure the pressure distribution profile (this approach has been developed by Bosch and IEE). If no pressure is present, the airbag is not triggered, even if a child seat is fitted. Other options include force sensors fitted to the four seat attachment points (see **Figure 7**) and 'intelligent bolts' (the Bosch *iBolt* system). In this case, evaluation circuitry computes the weight on the passenger seat and the weight distribution and derives a suitable airbag deployment strategy from this information: full deployment, soft deployment, or trigger suppression.

Internal and external climate

Regardless of what the weather may be like outside, the climate inside the vehicle should be comfortable. *Regulated air-conditioning* units are becoming increasingly common. Their temperature sensors usually operate on the principle of resistance variation.

The driver needs clean air in order to give his or her best attention to the task at hand. During travel through a tunnel, the concentration of noxious gasses (CO_2 , CO, NO_x , and unburned hydrocarbons) can increase sharply. In this case, it is better to block the supply of external air and allow the interior air to recirculate until the outside air is again clean. This can be accomplished using an air quality sensor that measures the concentration of undesirable gasses (essentially CO and NO_x) and closes an inlet flap valve when a threshold value is exceeded (such sensors are made by Bosch, for example).

Windscreen wipers that automatically switch on when it starts raining reduce the burden on the driver. Rain sensors operate optically using a combination of an LED and an infrared photodiode. The reflection characteristics of the surface of the windscreen are different when it is dry and when it is wet. The speed of the windscreen wipers can also be adjusted according to the measured amount of rain. Other types of sensors, such as a system made by Preh, detect mist on the glass and suitably control the air conditioning system.

An outside temperature display on the dashboard is particularly important in the winter. Many modern vehicles have temperature sensors to warn against black ice conditions. They are fitted far enough away from the engine and exhaust to prevent them from being affected by warmth from those sources.

Faultless navigation

Navigation systems are becoming increasingly popular. They determine the position of the vehicle using a GPS receiver, but they don't work in tunnels or underground car parks. In order to determine the orientation of the vehicle, it is also necessary to use an electronic compass with highly accurate magnetic field sensors. Hall-effect sensors are far too insensitive for use with the earth's magnetic field (approximately $40 \mu\text{T}$), so flux gate sensors (which are distinctly better but more expensive) are used instead.

The earth's magnetic field can be locally distorted due to perturbing influences such as concrete buildings contain-

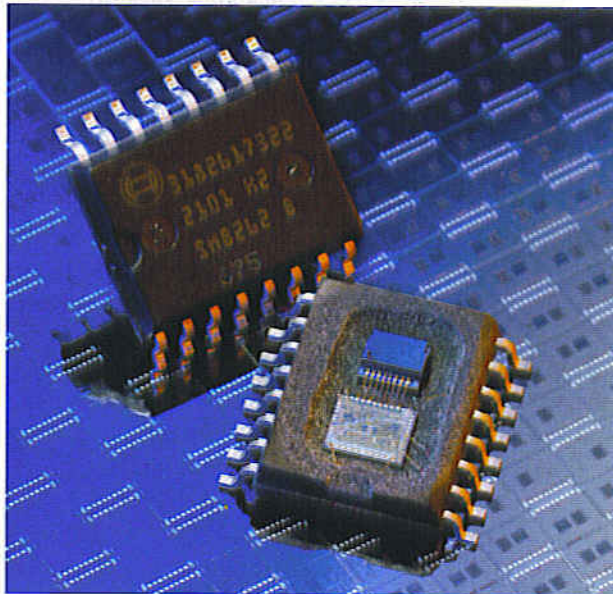

Figure 6. An acceleration sensor for triggering an airbag, built in the form of a micro-mechanical device with an inertial mass that is deflected from its quiescent position. (Source: Bosch)

ing a large amount of steel, and of course the body of the vehicle also distorts the field. For this reason, navigation systems use the distance travelled by the vehicle as a form of supplementary information. This distance can be obtained from the number of wheel rotations or by twice integrating the data obtained from an acceleration sensor. The rotation angle of the steering wheel is not sufficiently accurate for measuring travel along curves. The previously described yaw-rate sensors provide a more reliable source of information in such cases.

Automatically keeping a safe distance

Electronic distance sensors make parallel parking easier. Piezoelectric oscillators in the bumper emit ultrasonic pulses and receive the echoes. The pulse delay is a measure of the distance. The measurement range is around three metres.

At high speeds, one of the most common causes of accidents is following too closely behind the vehicle in front.



Figure 7. Electronic seat occupancy detection using force sensors at the attachment points. (Source: Siemens-VDO)

A radar sensor can measure the distance using millimetre waves in the 76–77-GHz frequency band. The beam is tightly focused to avoid interference from objects alongside the road. In the Bosch *Adaptive Cruise Control* (ACC) system, four overlapping radar beams scan the space in front of the vehicle with a measurement range extending up to 200 metres. This system can also detect several different vehicles within the measurement range. The next step is to fit short-range radar monitoring systems in regular production vehicles. The prerequisite for such short-range radar (SRR) systems is approval of the

24-GHz frequency band for this application (see the 'EU Frequency Wrangle' inset). Radio amateurs will not be happy!

What we have briefly described here represents only a fraction of the sensors currently being used in modern vehicles. Innovations are proceeding so rapidly that the number will multiply in just a few years. Hopefully, this will have the effect of making vehicles even safer, more fuel-efficient and cleaner.

(050005-1)

EU Frequency Wrangle



One distance warning radar system already available as a regular production item, which was christened 'Adaptive Cruise Control' (ACC) by Bosch, operates in the 77-GHz frequency band and has a range of more than 100 m, but it is expensive and occupies a relatively large amount of space in the car. In addition, it only scans a relatively narrow region directly in front of the vehicle.

The industry anticipates that a significantly larger contribution to reducing accident statistics could be realised using short-range radar, which is intended to provide full-perimeter monitoring with a range of up to 20 metres. For this purpose, inexpensive radar sensors operating in the 24-GHz frequency band have been developed, and an industrial consortium called SARA (for 'Short range Automotive Radar frequency Allocation') was founded with the objective of having this frequency band be approved internationally for broadband automotive radar sensors.

Although this regulatory objective was already achieved in 2002 in the USA, the EU commission chose the 79-GHz frequency band instead in mid-2004. This was because some of the Member States were afraid that there would be interference with the 21–26-GHz band, which is used for applications such as point-to-point radio links, weather satellites, radio astronomy, and police radar.

Besides putting export-oriented manufacturers in the EU at a competitive disadvantage, this decision created a conflict with the EU's own objectives. The 'European Action Programme for Road Traffic Safety' obliges the Member States to achieve a 50-percent reduction in the number of traffic accident victims by 2010 (relative to 2000). This objective cannot be achieved without using driver assistance systems based on short-range radar (SRR), and without access to the 24-GHz band it will take several years until such systems are available, since currently available 79-GHz sensors use expensive GaAs semiconductor devices and are not sufficiently mature.

The solution to this problem was found in a typical EU compromise, consisting of limited-term approval of 24-GHz systems with various restrictions, reservations, interim

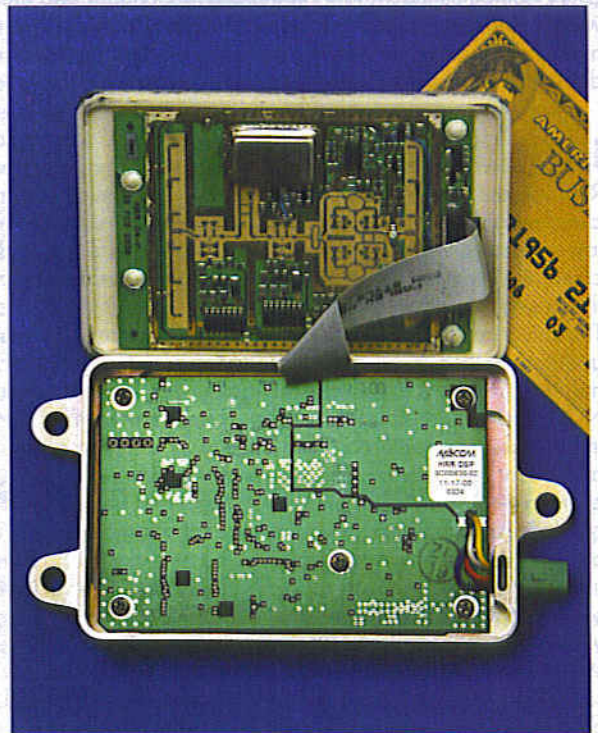

reports and monitoring measures. The decision of the commission on 17 January 2005 affirms in principle the previous decision to use the 79-GHz band, but it allows the 24-GHz band to be used 'as long as the proportion of vehicles fitted with such systems in each national market is less than 7%' and adds that 'it is presently assumed that this limit will not be reached before 30 June 2013'. This rule only applies to new vehicles for which the system is fitted as factory equipment, but their 24-GHz radars may still continue to be used after 2013.

An especially original aspect is the establishment of prohibition zones for protecting radio astronomy stations. When a vehicle approaches such a prohibition zone, the 24-GHz radar sensors in the vehicle are to be disabled. Up to 30 June 2007, manual disabling by the driver is permissible, but after that date only vehicles whose 24-GHz systems are automatically disabled (in whatever manner) when approaching such a prohibition zone will be approved for registration.

Be that as it may, the automotive industry immediately gave the go-ahead for introducing 24-GHz technology as factory equipment, which means that all newly developed models can be fitted with it. Naturally, this will start with the top-end models, such as the new Daimler-Chrysler S class in the second half of the year.

Ernst Krempelsauer

The world beating PCB design software

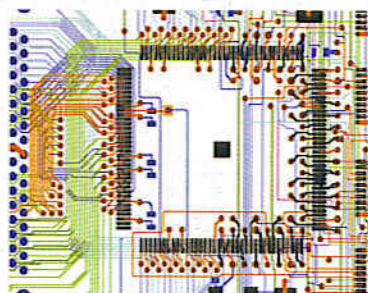

Easy-PC version 8 just gets better

Winning accolades the world over, Easy-PC for Windows V8 is a major milestone in the evolution of this extremely popular software tool. Try a demonstration copy of Easy-PC and prepare to be amazed at the power, versatility and remarkable value for money.



Version 8 features

- Sketch Mode Routing
 - ODB++ Format Export
 - Import Bitmap
 - Single-Sided AutoRoute
 - Customisable Toolbars
 - Auto Smooth & Mitring of tracks
 - Wires & Jumpers
 - Unified Quality Check
- Plus lots more.....

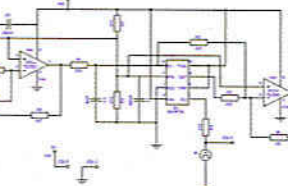

Fully integrated Schematics & PCB layout in a single application complete with forward and back annotation. Design and rules checks at all stages ensure integrity at all times. Professional manufacturing outputs allow you to finish the design process with ease.

Stop press... Stop press... Stop press... Stop press... Stop press...
By customer demand now with Eagle import as well as Tsien Boardmaker 2 import

call for a brochure, prices & CD on +44 (0) 1684 773662
or e-mail sales@numberone.com
you can also download a demo from

www.numberone.com



Number One Systems - Oak Lane - Bredon - Tewkesbury - Glos - United Kingdom - GL20 7LR UK

PicoScope 3000 Series PC Oscilloscopes

The PicoScope 3000 series oscilloscopes are the latest offerings from the market leader in PC oscilloscopes combining high bandwidths with large buffer memories. Using the latest advances in electronics, the oscilloscopes connect to the USB port of any modern PC, making full use of the PCs' processing capabilities, large screens and familiar graphical user interfaces.

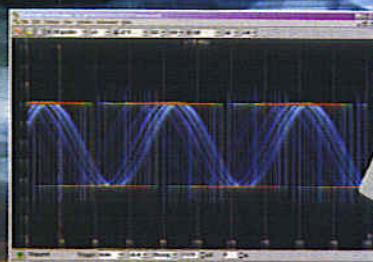

- High performance: **10GS/s** sampling rate & **200MHz** bandwidth
- **1MB** buffer memory
- High speed **USB 2.0** interface
- Advanced display & trigger modes
- Compact & portable
- Supplied with PicoScope & PicoLog software

PicoScope	3204	3205	3206
Bandwidth	50MHz	100MHz	200MHz
Sampling rate (repetitive)	2.5GS/s	5GS/s	10GS/s
Sampling rate (single shot)	50MS/s	100MS/s	200MS/s
Channels	2 + Ext trigger	2 + Ext trigger/Sig gen	2 + Ext trigger/Sig gen
Oscilloscope timebases	5ns/div to 50s/div	2ns/div to 50s/div	1ns/div to 50s/div
Timebase accuracy	50ppm	50ppm	50ppm
Spectrum ranges	0 to 25MHz	0 to 50MHz	0 to 100MHz
Buffer memory size	256KB	512KB	1MB
Resolution / accuracy	8 bits / 3%		
Range	±100mV to ±20V		
PC Connection	USB 2.0 / USB 1.1 compatible		

Tel: 01480 396395

www.picotech.com/scope264

pico
Technology Limited

GLOW PLUG HEATER

for RC models

Florent Coste

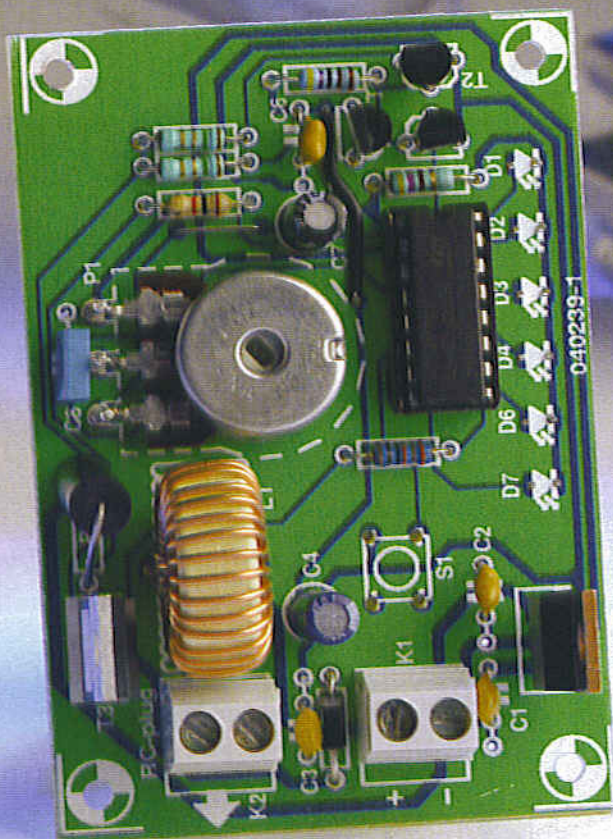

This article is intended for those readers who work on all types of models which include combustion engines,

such as airplanes, cars, boats, and other vehicles, who would like to be able to adjust the heating current of the glow plug and have an indication of its physical state.

This circuit is specifically designed for hobbyists who use models which include combustion (or more generally, thermal) engines, generally operating with a mixture of oil, methanol, and nitromethane. The combustion of this mixture is used to maintain the glow plug filament at a sufficient temperature to ensure proper engine operation without an external power supply. Of course, during start-up, an initial energy boost is required in order to produce internal combustion which will then automatically continue spark plug incandescence.

Generally, a small external battery (1.2V low amp cell) is used to ensure glow plug heating and does not permit the heating current to be adjusted. Moreover, how many times do we all forget to recharge the battery the night before, or it simply went dead after prolonged use with a stubborn engine. In connection with field boxes equipped with power panels that can carry out this function, the methods employed by the manufacturers are somewhat obsolete (but we imagine, very inexpensive) because they usually rely on a simple resistor inserted between the power supply (car battery) and the glow plug.

The heat produced by such a device is sure to quickly bring it back to our attention! Obviously, an active, more intelligent circuit is required.

Glow plug heater

The core of this set-up relies on an ST-type microcontroller, the ST7Flite05. You can find the datasheet at the following url:

www.st.com/stonline/books/ascii/docs/8348.htm.

This tiny 'black box' is only Light in name; it actually integrates no less than 1.5 kB of Flash memory, 128 bytes of RAM, as well as numerous peripherals which make it a top performer using a minimum of external components. For our set-up, we happily use its internal RC oscillator (calibrated to 1%), an integrated PLL ensures an 8-MHz clock of the core, multiple interrupt sources (external: pushbutton; internal: RTC counter), the analogue-

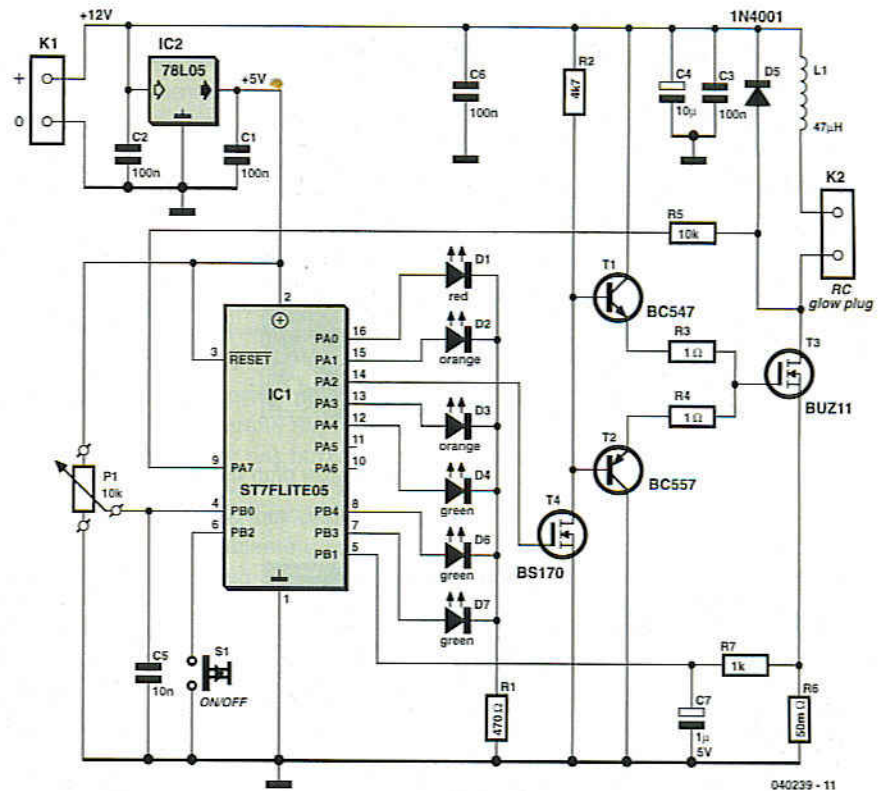

Figure 1. The diagram of our Glow Plug Heater is remarkable for its simplicity; a modern microcontroller assisted with a few external components.

digital converter (ADC) as well as the PWM mode (Pulse Width Modulation) of the 12-bit counter.

Operation relies on a switching power supply design generating current pulses in the glow plug filament in order to heat it up to the proper temperature and so enable the combustion engine to start.

Circuit diagram

A quick glance at the diagram shown in Figure 1 is sufficient to realize the small number of required components: this microcontroller is indeed perfectly sized for this application. Everything is already integrated, no need for an external quartz crystal, a load resistor for the pushbutton, or an amplifier for current detection.

A small 5-V regulator supplies power to the ST7Flite05. This microcontroller handles several functions:

1. Generating the PWM signal at 10 kHz frequency at pin PA2.

2. Reading the desired current using potentiometer P1 and an on-chip analogue-to-digital converter (ADC).
3. Continuously reading the actual heating current using the ADC and an internal operational amplifier.
4. Displaying the current and state of the glow plug on a multicoloured LED bar.
5. Validating/deactivating the heating current with the pushbutton S1.

Output stage

A glow plug filament employs a considerable amount of current —anywhere up to 10 amperes at just 1 volt. The power will be supplied by a traditional MOSFET BUZ11 (usually found in the drawers of every electronics specialist). We could have chosen a Logic Level MOSFET so we wouldn't have needed a pre-stage (R2, T4) to

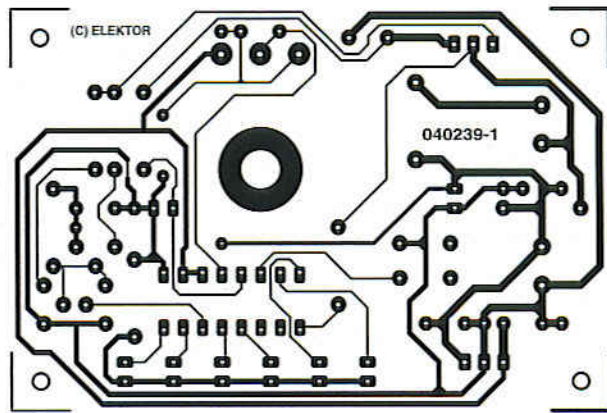
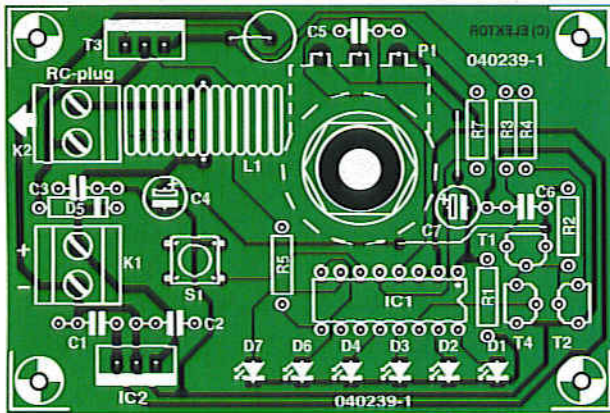

Figure 2. Copper track layout and component mounting plan of the PCB designed for this project.

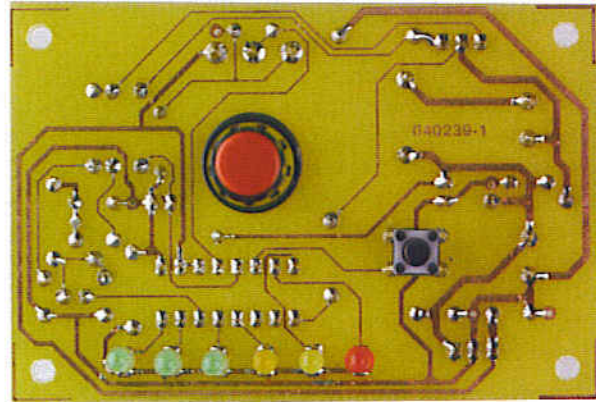
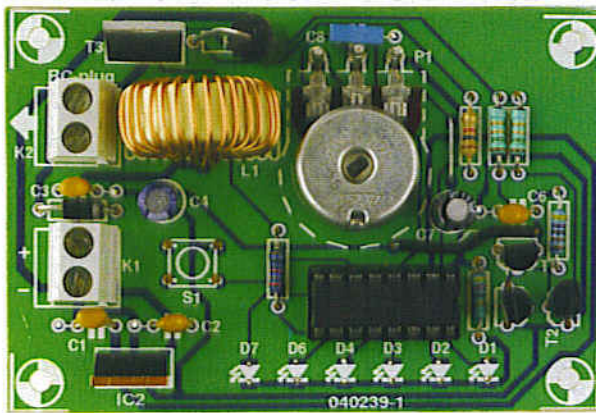

Figure 3. Finished example of the Glow Plug Heater.

drive the gate signal (5 V to 12 V), but this type of component is less common and usually more expensive than similar 12-V components. R2 is the 12-V load resistor which is used to drive the push-pull input stage, composed of T1

and T2. These two transistors are used later to ensure very rapid charging and discharging of the BUZ11 gate, despite the relatively high value of resistor R2. Those of you wishing to use a different MOSFET (N-channel) could lower the

value of R2 in order to shorten the switching time, if necessary. However, be careful not to make it too short because this resistor constantly dissipates energy. Current level detection is ensured by

COMPONENTS LIST

Resistors:

R1 = 470Ω
 R2 = 4kΩ7
 R3, R4 = 1Ω5
 R5 = 10kΩ
 R6 = 0Ω05 (50 mΩ)
 R7 = 1kΩ
 P1 = 10kΩ logarithmic low potentiometer

Capacitors:

C1, C2, C3, C6 = 100 nF
 C4 = 10μF/25 V
 C5 = not used
 C7 = 1μF 25V
 C8 = 10nF

Semiconductors:

T1 = BC547
 T2 = BC557
 T3 = BUZ11
 T4 = BS170
 IC1 = ST7FLITE05 (programmed, order code **040239-41**)
 IC2 = 78L05

D1 = LED, red, 3mm, ultrabright

D2, D3 = LED, orange, 3mm, ultrabright

D4-D7 = LED, green, 3 mm, ultrabright

D5 = 1N5820

Inductors:

L1 = 47μH

Miscellaneous:

S1 = pushbutton, 1 make contact

K1, K2 = 2-way PCB terminal block, lead pitch 5mm

PCB, ref. 040329-1, available from The PCBShop

one 50-m Ω resistor, R6, and one R/C combination (R7/C7) which supplies a few tens of millivolts to pin PB1. Diode D5 protects against unwanted voltage spikes during switching. Resistor R5 is used to verify the presence of a glow plug and to make sure that it is working (low state detected on pin PA7 of IC1 in this case).

We have yet to discuss the function of inductor L1. Due to the type of load (likened to a very low value resistor), the tungsten filament efficiently restores the energy which has been stored during current pulsing, so that we observe averaged intensity of the current without, theoretically, the need to add an inductor in the output stage. We have, however, opted for safety, in our glow plug as well as in the models being worked on nearby (the wire connecting the glow plug set-up could act as an antenna and be a source of potentially dangerous spikes) so we added inductor L1. We did not want to make a big deal out of a few extra square centimetres of additional PCB surface required by the inductor which has to be capable of withstanding tens of amperes.

Construction and operation

The single-sided circuit board of which the track layout and component mounting plan may be found in **Figure 2** does not elicit any special comments.

First, we put in the wire bridge, then the resistors, the capacitors, the inductor, and the integrated circuits (be careful with the polarities, IC1 should be mounted in a high-quality socket) and end with the connectors, K1, for the supply voltage (+12V) provided by a mains adaptor or an old car battery (as is customary in the modelling world), K2 is connected to the glow plug, and finally the potentiometer. A small heatsink will be necessary to cool the MOSFET and the diode, considering the currents they have to withstand. Before inserting the microcontroller in its socket, you should verify that the +5 V supply voltage is present at pin 2 after having connected the (unloaded) circuit to a 12-V source. Next, after having cut the power, mount the

ST7Flite05 and turn the potentiometer fully counter-clockwise to make sure that the heating current is adjusted to a minimum setting. Plug in to the power supply. Since no glow plug is hooked up at this time, the various coloured LEDs (1 red, 2 orange, and 3 green) should light up in sequence (light chain) to signal that nothing has been detected (or that the glow plug has burnt out... if of course it is connected to the circuit!).

Next, adjust the current using the potentiometer. Be careful not to overload the glow plug or risk burning out the filament (you should watch it, especially when using 'hot' glow plugs which have finer filaments than 'cold' types). Just making the filament slightly red is usually sufficient.

Then, all that is left to do is to press pushbutton S1 to heat the glow plug filament. The circuit draws about 11 mA without load.

In conclusion

The program running in the ST7Flite05 micro was written in C and compiled using a METROWERKS compiler (www.metrowerks.com). In addition, another C compiler is available at COSMIC www.cosmic-software.com. Free beta versions and Lite versions limited to a few kilobytes can be used to work without any restrictions on this type of micro. The program may be downloaded for free from our website, or obtained on disk (order code **040236-11**) for the convenience of those readers who do not have access to the Internet. The program can be modified to your liking, although we must add that a minimal knowledge of the C programming language and an ST7 programmer will be necessary. Inexpensive programming tools, utilized by the whole family of Flash ST7 microcontrollers, are also available at ST Microelectronics (*stick programmer*) and Softec-microsystems (Indart STX/D), which can also be used to debug the application if necessary.

(040236-1)

Internet Links

Metrowerks: www.metrowerks.com
Cosmic: www.cosmic-software.com
ST: www.st.com

About the author

Florent Coste graduated in 2000 with an Engineering degree in Microelectronics from the Charles Fabry Institute in Marseilles, France. He is employed by STmicroelectronics as a software engineer in application development and support and is based in Hong Kong.

Specializing in microcontroller software, he has worked closely with Asian customers for two years in order to utilize multimedia platforms.

He specialized in 'motor control applications' which led him to develop projects on micros (ST7MC, just to refer to the latest fashionable ST micro) dedicated to controlling synchronous motors (brushless, air conditioned, for example) and asynchronous (induction) motors.

A passionate fan of airplane modelling and electronics, he happily combines both disciplines in his spare time.

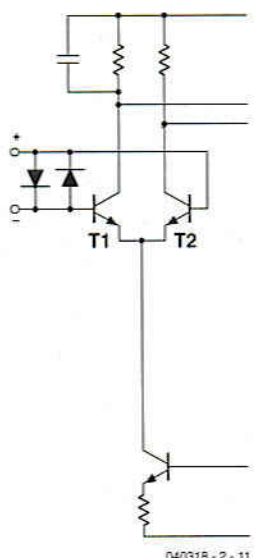

Figure 1. The input of an opamp usually consists of a differential amplifier.

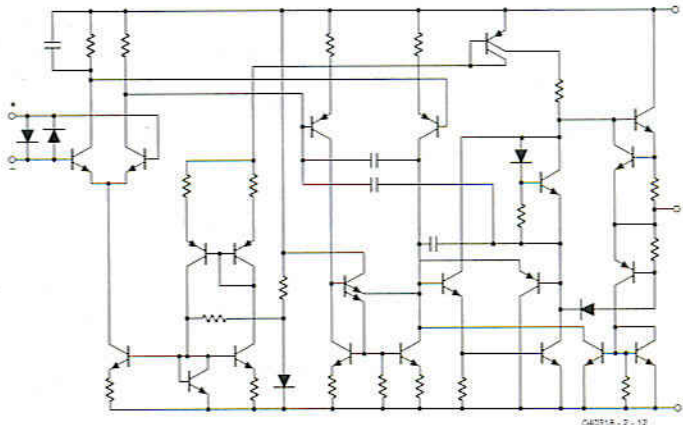

Figure 2. The complete schematic of an opamp, this example is an NE5532.

Part 2: Component specifications

Karel Walraven

We receive a quite few schematics from readers at our editorial offices. With these, it is frequently the case that the designer has not taken the common mode range of (usually) opamps into account. This is a characteristic that is repeatedly overlooked. It is therefore worthwhile to delve into this topic a little more.

Operational amplifiers and comparators (the latter could be considered operational amplifiers as well, but with more emphasis on speed and less on linearity and noise) are almost always constructed internally as differential amplifiers. In **Figure 1** you can see what such a stage typically looks like. **Figure 2** shows a real world example (in this case an NE5532, more modern opamps are much more complex). Differential stages are not only used in opamps, but for example also in power amplifiers. In that case

they are usually built from discrete parts, because a larger power handling and higher operating voltage are required. There are also variations where FETs are used instead of bipolar transistors, but this makes no real difference when it comes to understanding the operation.

In order for the differential stage to work properly, T1 and T2 need to be driven fully. As you already know, this will require a voltage drop of at least 0.6 V from base to emitter. The current source, which

is connected to the emitters, also requires a small amount of voltage to work properly. You can imagine therefore, that this whole arrangement will not work unless there is at least 1 to 1.5 V on the bases of both transistors (with respect to the negative power supply rail). A similar effect takes place when the voltage at the transistor bases is *too high*: the collector resistors as drawn, are in practice not actual resistors, but made from transistors which will also require a minimum voltage to perform their task properly. So if the voltage at the base is equal (or higher!) than the positive supply voltage, the voltage at the collector cannot be much lower (in practice about 0.4 to 0.5 V below the voltage at the base). That leaves too little voltage for the transistors that form the collector resistor. Therefore: with this architecture the input voltage always has to a little higher than the negative supply voltage and a little lower than the positive supply voltage.

In the datasheets you will usually find this characteristic in a table with the heading 'Electrical Characteristics' in a section named 'Input Voltage Range' or 'Common mode

input voltage range' or some similar phrase. Refer to **Figure 3** where the relevant part of the datasheet of the most famous opamp, the 741, is shown. The manufacturer takes quite a wide margin, with a ± 15 V supply rail the inputs have to remain within -13 and $+13$ V. If we include the extremes of manufacturing tolerances we have to be within ± 12 V. In more intelligible language: the voltage at the inputs has to be at least 2 V above the negative power supply voltage (the negative supply voltage can also be zero) and 2 V below the positive supply voltage. If you do not take this into account the circuit is likely to give **completely unpredictable** results.

Naturally, opamp designers have worked from the beginning to eliminate these shortcomings. By using a different architecture, some opamps can operate down to the negative supply rail (a well-known example is the LM324, which will even permit a voltage of a few tenths of a volt **below** (!) the negative rail). Some other opamps can operate up to the positive rail (TL084 and LF357). In recent years so-called 'rail-to-rail' opamps have appeared, which can operate with all input

Electrical Characteristics

Parameter	Conditions	LM741A			LM741			LM741C			Units
		Min	Typ	Max	Min	Typ	Max	Min	Typ	Max	
Input Offset Voltage	$T_A = 25^\circ\text{C}$										mV
	$R_D \leq 10\text{ k}\Omega$				1.0	5.0		2.0	6.0		mV
	$R_D \leq 500\Omega$	0.5	3.0								
Average Input Offset Voltage Drift	$T_{\text{MIN}} \leq T_A \leq T_{\text{MAX}}$			4.0							mV
	$R_D \leq 500\Omega$					6.0		7.5			mV
	$R_D \leq 10\text{ k}\Omega$		15								V/C
Input Offset Voltage Adjustment Range	$T_A = 25^\circ\text{C}, V_D = \pm 20\text{V}$		± 10		± 15			± 15			mV
Input Offset Current	$T_A = 25^\circ\text{C}$	3.0	30		20	200		20	200		nA
	$T_{\text{MIN}} \leq T_A \leq T_{\text{MAX}}$		70		65	500			300		nA
Average Input Offset Current Drift	$T_A = 25^\circ\text{C}$		0.5								nA/C
Input Bias Current	$T_A = 25^\circ\text{C}$	30	80		80	500		80	500		nA
	$T_{\text{MIN}} \leq T_A \leq T_{\text{MAX}}$		0.210			1.5			0.8		A
Input Resistance	$T_A = 25^\circ\text{C}, V_D = \pm 20\text{V}$	1.0	6.0		0.3	2.0		0.3	2.0		M Ω
	$T_{\text{MIN}} \leq T_A \leq T_{\text{MAX}}$		0.5								M Ω
	$V_D = \pm 20\text{V}$										
Input Voltage Range	$T_A = 25^\circ\text{C}$				± 12	± 13		± 12	± 13		V
	$T_{\text{MIN}} \leq T_A \leq T_{\text{MAX}}$										

040318-2-1/3

Figure 3. The specifications (this example is from a 741) detail the input voltage range.

voltages, provided they remain within the applied power supply voltage. The concession that has to be made for this is that such rail-to-rail opamps usually permit a much lower operating voltage than the 36 V of the 741.

In Table 1 we have listed a few of the more common opamps.

Up to now it was customary that the first few letters of the part number indicate the manufacturer of the part, so you really didn't have to take much note of that. However, manufacturers like to squeeze as much as possible out of their bread-and-butter parts by introducing new versions. So you can buy, for example, variations of the LM324 called the LP324 (LP2902) and the LMV324. LP means 'low power' and this

opamps draws less than one tenths the supply current compared to the old version. It is also 10 times slower and has a lower output current capability. The LMV324 (low voltage) operates with a supply voltage of 5.5 V maximum (compared to the 32 V of the other types), uses less current, can deliver less current, but operates at the same speed. These three parts have the same number but different prefixes and the differences are significant! So in the event of doubt, consult the datasheet!

(040318-2)

Table 1. Input Voltage Range

Part Number	above V-	below V+
LM741	2	2
LM324, LM358, LM2902	0	1.5
LF356, LF357	3	-0.1
TLO61...TLO84	3	0
TLC271...TLC274	-0.3	0.8
TS924	0	0



Improve Your C51 C16x ARM Environment

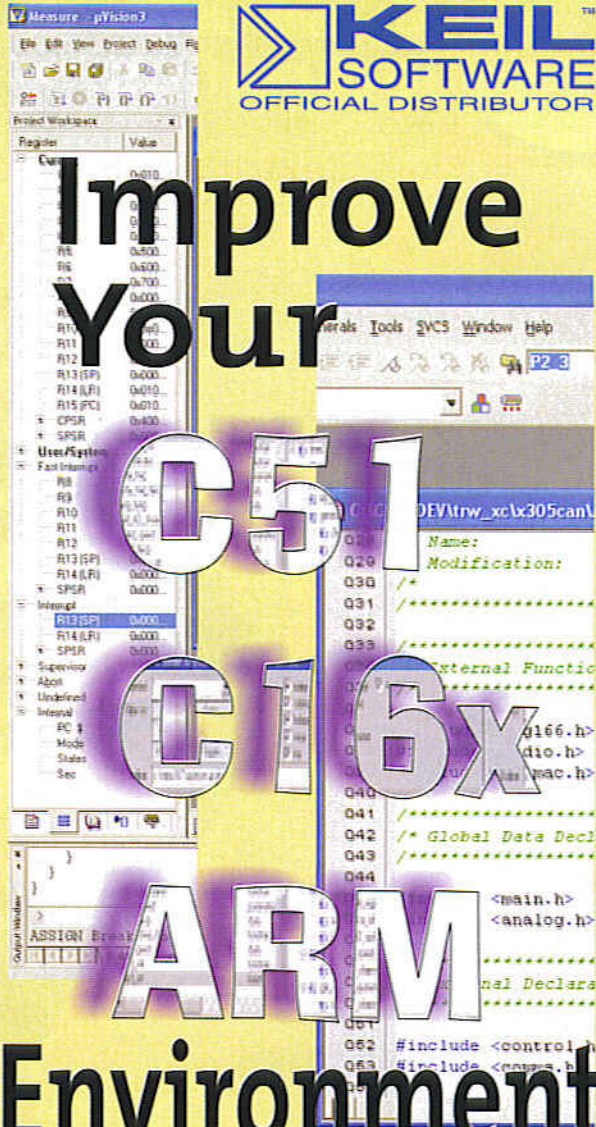

- ◆ uVISION3 Industry-Standard Workbench For Microcontrollers
 - ★ Options Wizard for Tool Configuration
 - ★ Customisable Editor
 - ★ Source Browser
 - ★ CPU & Peripheral Simulation
- ◆ Complete integration with emulators
- ◆ Dedicated high-optimisation C compilers
- ◆ Microcontroller language extensions
- ◆ Classroom training, see website for dates
- ◆ With free hands-on user guides and manuals

Download your trial compiler version from:

www.hitex.co.uk

Hitex (UK) Ltd
Tel: 024 7669 2066
Email: sales@hitex.co.uk

hitex DEVELOPMENT TOOLS
Fax: 024 7669 2131
Web: www.hitex.co.uk

E5-2005

elektor

electronics • leading the way

Elektor's online services have been restyled and extended within a brand new easy to use website. Now featuring Elektor News Service, Forum, Marketplace, Online Shop and several download options.

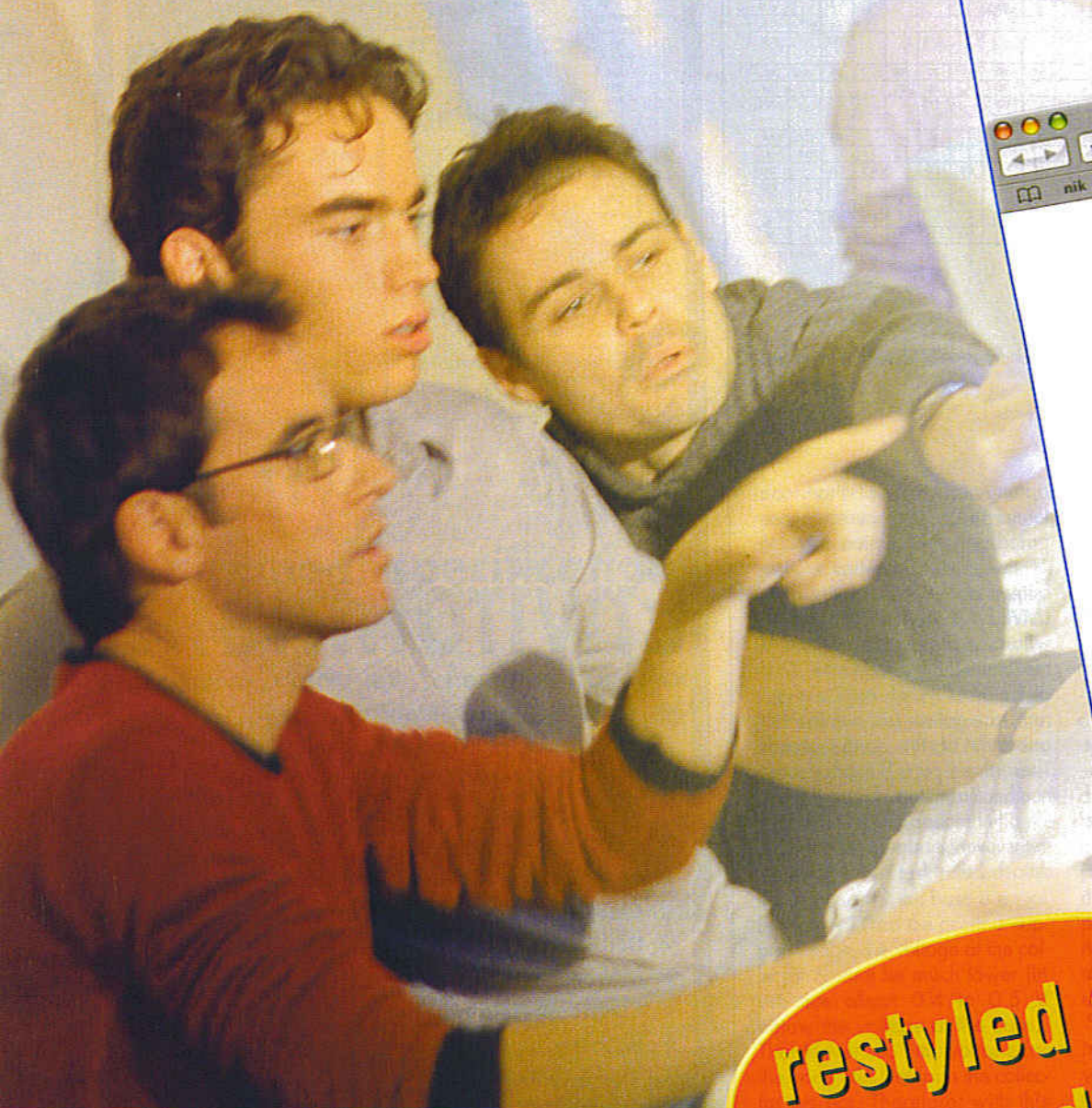

restyled and extended

MAGAZINE

- indexed article archive back to 1998
- summary for easy recognition
- search articles by volume or keyword

www.elektor-el

register

- on paper and on the web



electronics.co.uk

and receive the free E-Newsletter!

NEWS

- daily electronics newsfeed
- weekly free Newsletter

FORUM

- join in discussions with fellow enthusiasts and specialists
- get answers to technical problems

PROJECTS

- download construction projects (PDF) and associated software
- hundreds of articles available
- search by category, alphabetically and chronologically

SHOP

- everything you need to build projects, incl. PCBs
- books and CD-ROMs
- secure payment system

MARKETPLACE

- the place to visit for components, tools, old volumes, etc.

Opens the door to new possibilities

PROGRAMMER FOR DCC MODEL RAILWAY CONTROL

Benoît Bouchez

The DCC system distinguishes itself from the competition (the Märklin/EEDTS-system) by being far more flexible, but also for the necessity of having to program the decoders. The majority of control boxes on the market perform this function only poorly, usually only a limited number of parameters are accessible. The stand-alone programmer presented here offers a great deal more functionality!



was the case with the Märklin decoders of the first generation. In addition, the model had to be disassembled every time the address of the decoder needed to be changed.

In the case of DCC, the programming of the decoders takes place by sending information via the rails, so there is no need to fiddle with the trains. The control options are nearly unlimited and are only determined by the chip in the decoder.

The NMRA standard contains 1024 configuration variables (CV). At the moment only about fifty CVs have been defined, the remainder are reserved for the designers of decoders to allow for the implementation of special functions (CV49 to CV64, CV112 to CV128, CV545 to CV593 and CV624 to CV640), or reserved by the NMRA for future applications (CV15, CV16, CV20, CV26, CV47, CV48, CV96 to CV104, CV107 to CV111, CV129 to CV891, CV594 to CV623 and CV641 to CV1024). From all these defined CVs, only a handful (CV1, CV7, CV8 and CV29) must be implemented in every decoder. All the others are optional or only recommended.

Due to lack of space, it is impossible to describe the function of every CV in this article. We therefore recommend that you read the manuals of the decoders that you may have.

Incidentally, the values of the CVs are stored in non-volatile memory (in most cases in the EEPROM of the microprocessor) so that the settings of the decoder are preserved when the power supply voltage is not present.

Circuit description

As is shown in **Figure 1**, the circuit is built around a microcontroller, the ATmega8515, from Atmel. The ATmega8515 is the successor of the AT90S8515, which is now obsolete, but is compatible with respect to pin out and programming. The main characteristics are: 8 kBytes of Flash program memory, 512 bytes of EEPROM, 512 bytes of RAM, two counters/comparators, one serial port and one SPI-interface. This ATmega version also has an interrupt input and three additional I/O-ports (port E).

The chips from the AT90 series from Atmel, ATmega and ATTiny, all have the same RISC core with the same instruction set, irrespective of the actual type.

Power supply

The power supply provides two volt-

ages: 5 V for the logic and a regulated voltage of +15 to +18 V for the output stage. That is why we have two separate regulators. IC1 provides the voltage on the rails. An LM317 was selected for this task. The output voltage from this regulator is adjustable with potentiometer R15. This is to take into account the recommendations from the NMRA (in principle the voltage applied to the rails varies a little, depending on the scale). The values indicated on the schematic result in an output voltage of 18 V. This corresponds exactly with the requirements for decoders for the scales of 0, HO and N.

In front of IC1 is the traditional combination of rectifier and filter stage. The 5 V power supply is provided by IC2. Neither IC1 nor IC2 require a heatsink. To dissipate what little heat they generate it is sufficient to bolt them to the PCB.

Output stage

A power stage is built around IC3, an L293E from ST MicroElectronics. Starting with a TTL-level signal, this IC generates an AC voltage of sufficient amplitude to allow programming via the rails.

Diodes D5 through D8 protect the output transistors of IC3 from surge voltages. The function of R1 is to measure the current that flows through these transistors so that our system can detect the acknowledge pulse from the decoder to be programmed.

LED D10, protected by D9 (remember that the DCC voltage is actually AC!), indicates the presence of a DCC signal on the rails.

The current measured with R1 is filtered by R3/C6 before sending it to dual comparator IC4. IC4b senses currents greater than 51 mA (acknowledge signal current). IC4a senses currents greater than 250 mA (default value). The outputs from the comparators go to the microcontroller to indicate a possible overload and the presence of the acknowledge signal.

We now return to IC3 to explain the two signals it receives from the microprocessor. The TRACK ENA-signal enables the output transistors of IC3. As long as this signal is logic zero, no voltage appears on K3. The DCC signal is inverted with the circuit around T1 in order to generate the necessary signals for the two half-bridges in IC3.

Controller

We complete the description of the schematic with the central component: IC5. The microcontroller takes care of

all driving and control tasks in the programmer: driving of the LCD, reading the keyboard, generating the DCC signal, processing the current measurement, etc. A program, specifically written for this application, handles everything.

The LCD is driven in 4-bit mode to reduce the number of traces on the PCB. P1 is used to adjust the contrast. Any standard LCD module based on the HD44780 controller is suitable for this programmer (most LCD modules, except the graphics versions use this chip: this ensures a wide selection regarding the colour, character size, with or without backlight, etc.).

IC5 also takes care of the keyboard. Although the schematic assumes a number of individual pushbuttons, the circuit is also suitable for small keypads in the 4x3 format (telephone keypad). The only button separate from this is S2.

Diodes D13 through D15 protect the microcontroller from the short circuits that would otherwise result when the user presses more than one key at a time. Resistors R14 to R16 pull the inputs of IC5 low when no keys are pressed.

IC5 runs at 8 MHz thanks to X1 and is initialised at start-up by the combination of R10/C11/D11.

K1 is an optional connector that makes it possible to program IC5 in the board using the Atmel programming cable. If you buy IC5 pre-programmed from *Elektor Electronics* then you can omit K1 and D12 from the board.

Construction

Although the circuit for the programmer is quite straightforward, the construction still requires that we explain a few of the details.

To facilitate the first stage, and in the tradition of *Elektor Electronics*, we have designed a nice printed circuit board, the component side of which is shown in **Figure 2**. The ready-made PCB is available through Readers Services as order code **040422-1**. The parts are mounted in the usual order: first the low-profile parts, resistors and diodes, followed by the low capacitors. A quick note regarding the capacitors C11 and C12: we have used ultra-miniature types here. If you are unable to find this size, there is nothing stopping you from using the size you do have and mount it flat on the PCB; there is enough room. Then it is the turn of the connectors and the header for K4, the keyboard. K4' in the

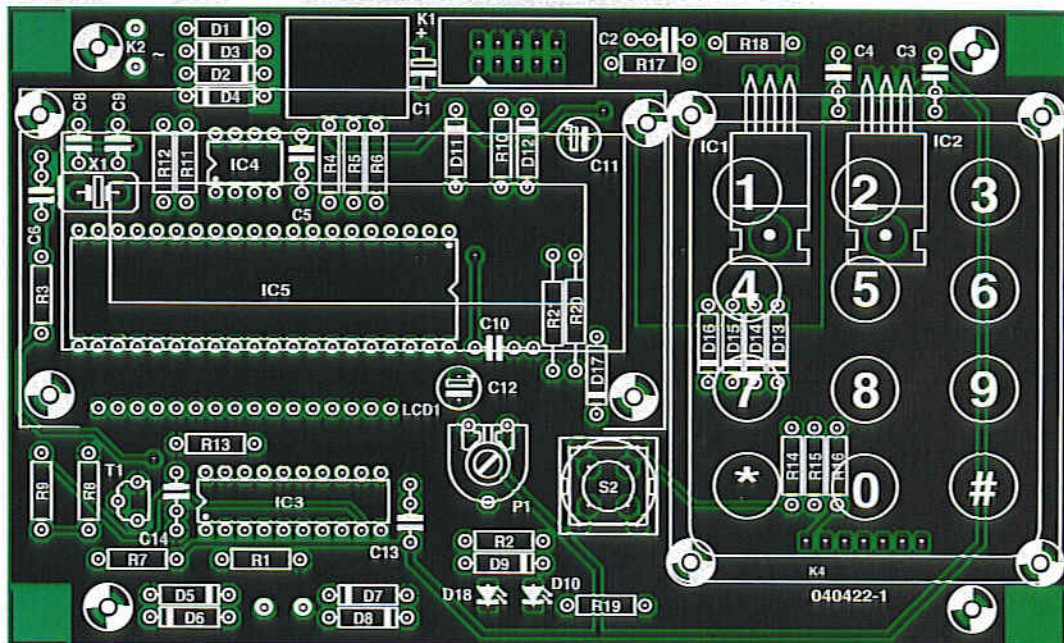

Figure 2. Component overlay for the PCB that has been designed for this circuit.

COMPONENTS LIST

Resistors:

R1 = 1Ω 0.5W
 R2, R5 = 2kΩ
 R3, R7, R8, R9, R13-R16 = 10kΩ
 R4, R10, R11, R12 = 47kΩ
 R6 = 510Ω 1%
 R17 = 2kΩ
 R18 = 220Ω
 R19 = 5kΩ
 R20 = 33Ω
 R21 = 27Ω
 P1 = 10kΩ preset

Capacitors:

C1 = 1000μF 35V radial
 C2-C5 = 100nF

C6 = 10nF
 C8, C9 = 22pF
 C10, C13, C14 = 47nF
 C11 = 1μF 16V radial
 C12 = 10μF 16V radial

Semiconductors:

D1-D8 = 1N4001
 D9, D11, D13-D17 = 1N4148
 D10, D18 = LED, low-current, 3mm
 D12 = BAT85
 T1 = BC547
 IC1 = LM317
 IC2 = 7805
 IC3 = L293E
 IC4 = LM393
 IC5 = ATmega8515-8PI (programmed,
 order code **040422-41**)

Miscellaneous:

K1 = 10-way pinheader (2x5 pins)
 K4 = 7-way pinheader
 LCD1 = LCD module, 2x16 characters,
 backlight optional. Alternatively a PLED
 display (ASI-G-162FS-GF-EWS/W)
 X1 = 8MHz quartz crystal (low-profile
 model, case type HC49/4H)
 S1 = keypad, 3x4 keys (e.g., Conrad
 Electronics # 709840)
 S2 = pushbutton with make contact, e.g.,
 DT6-O
 16-way pinheader and socket for display
 connection
 PCB, order code **040422-1** (see
 Readers Services or website)
 Disk, ATmega source & hex code, order
 code 040422-11 or Free Download

schematic represents the male connector on the keypad.

As usual, we advise to mount all the ICs in good quality sockets (turned pin). This applies above all to IC3 because it is directly connected to the outside world and could possibly come in contact with electrostatic charges. Even though the risk of damage is small, it is much easier to make the IC easy to replace should it become necessary.

The two voltage regulators IC1 and IC2 (an LM317 and an L7805) are mounted flat on the PCB so that the PCB can act as a heatsink. Make sure that the metal tab of IC1 is well insulated and does not make electrical contact with the ground plane (in contrast

to the 7805, the metal tab of the LM317 is not connected to ground).

Another note regarding IC1, which is mounted flat in the PCB. Because it is underneath the LCD, we have to make sure that we use a version with the correct height.

Controller

Concerning IC5, you need to know that the program has been written for an ATmega8515, but it will also work with the older AT90S8515 (because the latter is obsolete now, it may be possible to obtain it cheap from somewhere). The controller can be obtained pre-programmed from Readers Services as item **040422-41**, but you can also program it yourself.

If you choose the latter solution, you will need to fit K1 and D12 on the board and buy (or make) a programming cable that is compatible with the Atmel standard. You will also need programming software suitable for the Atmel ATmega. For this purpose we can recommend the free software program called PonyProg, available from <http://www.lancos.com>. Incidentally, on the same website you can also find the schematic for the Atmel cable (cable type STK200+/STK300).

Note: for the ATmega it is not sufficient to just send the HEX file to the controller to get it to function. The chips from the ATmega series first need to be configured before programming. At the factory, Atmel sets the chips to a

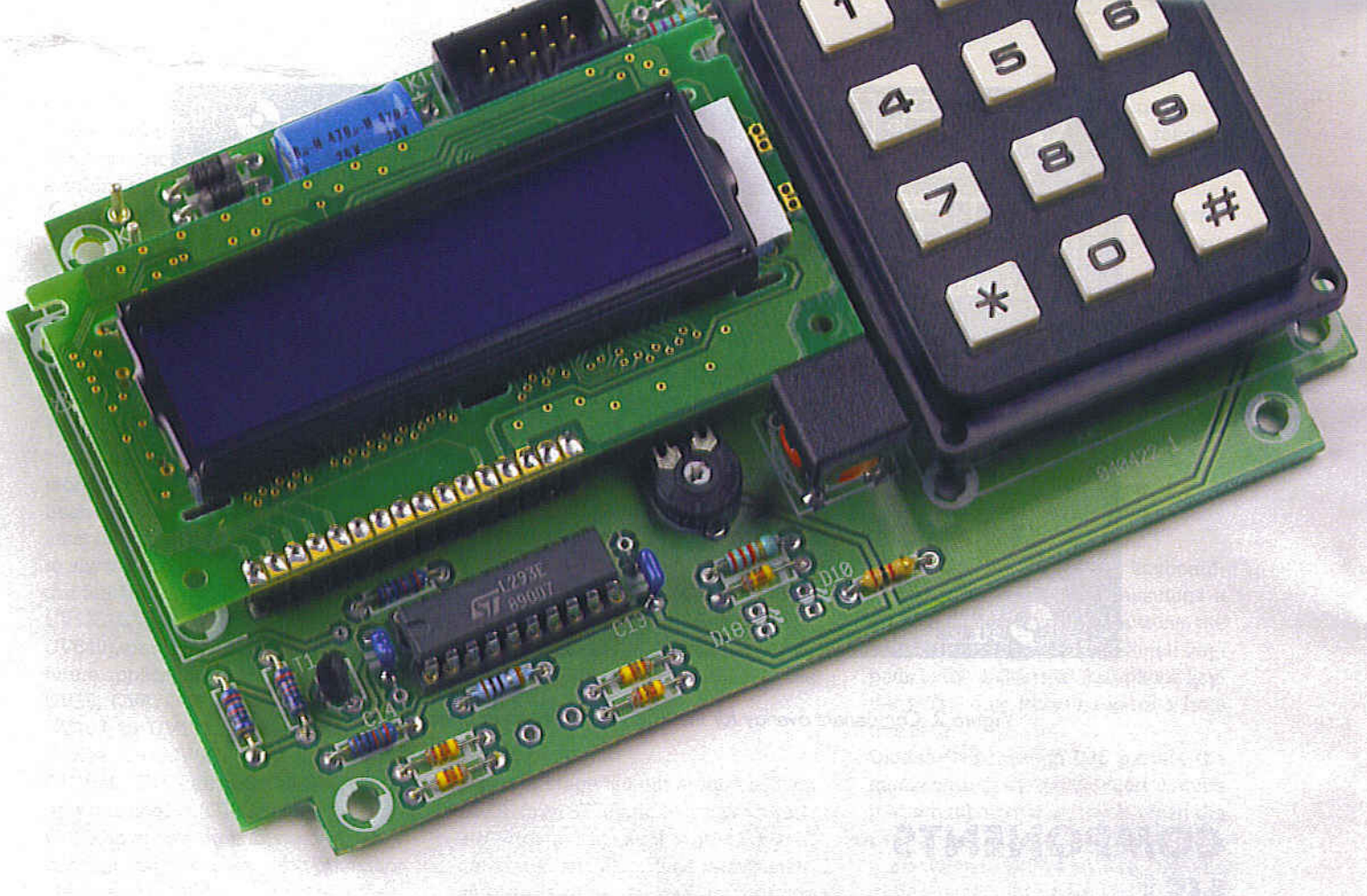

Figure 3. Fully built-up prototype of the DCC programmer.

default configuration, but this is not suitable for our application. You will need to change it, otherwise the circuit will not work.

The configuration of the chip is made with what are called 'fuse bits'. In **PonyProg** we click on the padlock symbol in the main window after having selected the ATmega8515 in the **Device** menu (choose 'AVR Micro' then 'ATmega8515'). In the window that now appears all the tick boxes need to be deselected (or click on 'Clear All'). Then click on **Write**. Once the configuration bits have been programmed, you can send the HEX file (menu 'Command '/' Write program (FLASH)'). If necessary, you can consult the user manual for PonyProg. This procedure is not necessary, of course, when using the pre-programmed processor (order code 040422-41).

Remember to use a low-profile socket for IC5 to prevent problems later on when mounting the LCD module.

Keyboard

Regarding the keyboard we need to note that if you are using a ready-made

keypad you will need to check carefully that the wiring at the connector corresponds with that of the schematic. If necessary you can easily make a keyboard yourself by using pushbuttons of the type 'ITT D6' or something similar, mounted on a small piece of prototyping board. The majority of telephone keypads follow the connections as shown in the schematic, but it is better to be safe than sorry.

LCD

Final note: the mounting of the LCD. You may already have noticed that the PCB has a connection for this purpose, namely LCD1. This connector has 16 pins, while a standard LCD module has only 14 pins. The reason for this is that with certain models of LCD module the backlight is connected to two extra pins next to the data bus. Here we have selected a PLED display because of the fantastic quality and readability of this type of display.

If your display has only 14 pins (a type without backlight or with a separate backlight supply) then pin 1 of the display has to be connected to the leftmost pin of connector LCD1 (next to R9/R3).

Other considerations

A comment regarding resistor R20. This resistor is used to limit the current through the backlight. Look for the correct value in the datasheet for your display (the value is typically in the order of 33 to 47 Ω , our PLED display required a resistance of 33 Ω).

It is a good idea to check the power supply voltages at the IC sockets before fitting the ICs. Verify that the correct voltage is present at the appropriate pins (+5 V on pin 40 of IC5, 8 of IC4, 10 of IC3 and +18 V on pin 20 of the same socket). At least we can now be sure that the power supply is functioning properly. Once this has been checked, the ICs can be inserted in their sockets (after first turning the power supply off, of course). Now mount the LCD in such a place that the top part of the enclosure fits nicely over the top of it. This also applies the switch S2.

Using the programmer

After everything has been assembled it is time to power up the programmer for the first time. The circuit is pow-

DCC background

Elektor Electronics would not be Elektor Electronics unless we provided a brief explanation of the DCC system for which a programmer is described here. DCC means **DIGITAL COMMAND CONTROL** and for clarity: It has nothing to do with the unfortunately failed digital compact cassette system that Philips introduced in 1992 with the same abbreviation.

In a DCC system an AC voltage is applied to the rails. The peculiar aspect is that this AC voltage (a square wave) not only provides the energy to drive locomotives, switching points and signals, but also contains the digital information that is necessary to send commands, such as desired speed and direction to the appropriate device.

Depending on the frequency, the AC voltage on the rails can be interpreted as either a logic one or zero. A wave shape with a period of 116 μs (8.6 kHz) consisting of a positive and negative half of 58 μs each represents a logic one. A logic zero has a length of at least $2 \times 100 \mu\text{s}$ (5 kHz) and at most a total length of 12,000 μs . A logic zero may therefore be 'stretched'. The transmission is no more complicated than this, by putting long and short waveforms one after the other any desired digital message can be sent. The oscilloscope picture gives you an indication as to what these signals look like.

Now that it is clear how ones and zeros are transmitted, you will wonder how a complete message is assembled. This consists of the following things:

- First the preamble is sent, consisting of 14 or more logic ones. This signal provides the necessary synchronisation between messages and indicates that the receiver has to be ready because a new message may begin at any moment.
- Then follows a start bit ('0'), this zero after the preamble indicates the actual beginning of the message.
- Subsequently there is one byte (8 bits) that contains the address. All decoders read this address and in that way determine if the message is intended for it, because normally every decoder has a unique address. Of these 8 bits, 7 bits are used for the address, so there are 128 possible addresses. The eighth bit provides the option of interpreting more bits from the next byte as address as well. In this 'extended' addressing mode addresses with 9, 11 or 14 bits are possible.
- After the address there are one or more data bytes. Usually a command byte (set speed, for example) is sent first, followed by a data byte that contains the corresponding value (the desired speed, for example).
- The last byte is a checksum (error detection byte). This is used to check if the entire message has been received correctly.
- You have probably already asked yourself how the decoder separates the various bytes. Just as with normal RS232 serial communication, each byte is preceded with a start bit (logic zero). After the last byte the start bit is omitted and a stop bit ('1') is transmitted instead. This way the decoder 'knows' that the transmission is complete.

All messages are frequently repeated. It is, after all, easily possible that a bit has been lost because of noise or sparks on the rails. Moreover, something has to be continually sent, otherwise the rail voltage will disappear and everything will stop...

Messages with extended addresses are longer and take up more time. They are therefore repeated less frequently and are used for switching points and signals. In this way, the moving objects (i.e., locomotives) can be controlled more responsively.

Three addresses are reserved: they are 0, 254 and 255. To program a decoder it is not necessary to know the address of the decoder. The programming instructions contain one of the reserved addresses (normally address 0, the so-called broadcast address) and every decoder responds to this. This is also the reason why programming may only occur to one decoder at a time, usually on a separate section of rail. If other decoders are also connected then they would be programmed as well. In addition, this method makes it possible to work with a decoder with which you have lost contact (you don't know its address any more or lost what you programmed in the CVs) and reset it to its original factory default settings.

While programming, the receiver (decoder) generates a receive acknowledge signal once the desired action, for example programming a CV, has been carried out. This acknowledge consists of a brief increase of current consumption of at least 60 mA for 6 ms. The transmitter is usually able to detect this increase in current and therefore knows that there is a connection. In order to be able to signal with a higher current consumption it is usually necessary for a decoder to be connected to a load (the motor for example).

In most of the recent standards the options for return messages has been greatly expanded. The newest decoders can, after special commands, make use of transmission pauses and actively transmit entire bytes, by injecting current into the rails. But this is all so very new that very little of it is actually available.

If you feel up to it you can read the standards here:

http://www.dcc.info/standards_rps/

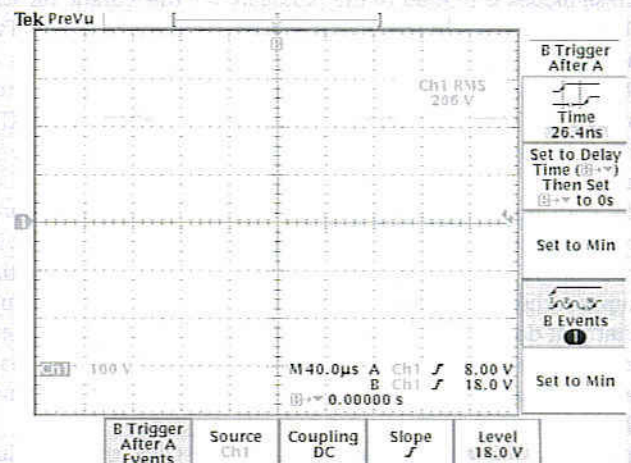

This oscilloscope picture gives an impression of the shape of DCC signals. The second trace shows the acknowledge pulse from the decoder.

ered directly from an AC voltage source of around 18 to 24 V, which is able to deliver about 250 mA (a transformer rated about 6 VA is eminently suitable).

The circuit should start up as soon as it is powered up. The display should show the message 'DCC Prog. Vx.x' where x.x is the version of the program). If this message does not appear we start by adjusting the contrast of the display with P1. If that is not successful, turn off the power supply and check the wiring of the PCB. Also check that the display is connected correctly.

Press any key on the keypad once the welcome message is displayed. The programmer now wants to know which mode you would like to work in. You can select from the following modes:

- *Direct CV Write* (write to CV in the direct mode)
- *Paged CV Write* (write to CV in the paged mode)
- *Address Only Write* (write to CV1 in simple mode)
- *Direct CV Read* (read CV in direct mode)
- *Paged CV Read* (read CV in paged mode)
- *Address Only Read* (read CV1 in simple mode)
- *Factory Reset* (restore factory default settings)

With each press of the *Function* button you can select the next operating mode from the list.

You will have noticed that it is possible to read the CV using two different methods: the direct mode and the paged mode. The difference between these modes is related to the protocol that is used to send commands to the decoder. From the user's standpoint the modes are identical (same number of CVs and same purpose).

The vast majority of decoders recognises the direct mode, hence the default mode proposed here. The paged mode is available to you if you have some old decoders that do not support the direct mode. If you notice that you do not get an acknowledge from a decoder in direct mode, you can try to program it in paged mode.

Before we delve into the details of programming our decoders we have to stress two important points. First: when programming your trains, use a separate section of rail that is not connected to the remainder of your railway. If you do not do this, you run the risk of

programming a different locomotive that is accidentally also on the tracks with the same values as the first.

For example, if you are changing the address of the decoder, that will result in two locomotives with the same address... Even if you do want to program two decoders with the same data, this is not the way to do it. Each decoder has to be programmed separately. When two decoders are connected in parallel the acknowledge signals may be corrupted (the current pulse has an abnormal value) or results in faulty behaviour of the decoders!

Second point: program your decoder only after it is fitted in the model. The great majority of decoders generate the acknowledge signal by powering the motor of the locomotive in which they are installed for a few milliseconds (also refer to the box 'DCC backgrounder'). If the decoder is not connected to the motor then this pulse cannot be generated and the programmer will indicate a programming error (see further on).

In practice

We now change from theory to practice and actually program a CV. Select a write mode (either direct or paged) using the *Function* button. Confirm your choice by pressing *Enter*. The programmer now shows the following line:

CV#: _ Val :

We start, using the keypad, by entering the CV number, between 1 and 1024. With the button *Delete* we can erase the last character by moving the cursor backwards. Press *Enter* again after the CV number has been entered: the cursor on the display will now jump to the field named *Val*.

In this field you can enter the value, ranging from 0 to 255, that has to be written to the CV. Here too you can use the *Delete* key to correct the entered value.

If the value entered is outside the allowed range, it is erased and the cursor is moved to the start of the field. The programming procedure can be aborted at any time by pressing *Function*. You will then be returned to the menu for selecting the mode.

Once the CV value has been entered, the output stage of the programmer is activated: LED D10 lights up to indicate that voltage is applied to the decoder. At the same time the programmer indicates

Programming... This entire operation takes less than one second!

When the decoder has successfully completed the programming cycle the programmer shows *Done!* Pressing any key will return you to the CV entry screen (that way you can enter multiple CVs without having to select the programming mode each time).

If the decoder does not generate the acknowledge signal during the programming phase the programmer will show the text *No Ack detected!* This does not necessarily mean that the procedure has failed — the programming of the decoder could actually have been successful. This situation can sometimes arise with models having small motors, which are unable to generate the acknowledge signal of 60 mA (this often happens with older Jouef models with a 5-pole motor). The only means you have of verifying the programming is to place the model on the rails and check its behaviour.

The programmer can also be used to read back values stored in the decoder. To do this, we have to first select a read mode (direct or paged) and then press *Enter* to confirm our selection. In read mode the programmer only asks you to enter the CV number. The read procedure starts after pressing *Enter*. The display shows *Reading...* while at the same time LED D10 is lit.

As you will now realise, reading a CV takes much more time than programming it. This is because the decoder cannot send any data. The programmer sends a message to the decoder for each of the allowed values of 0 to 255. When the decoder recognises the value found in its memory it will send the acknowledge signal. The programmer now knows that the value sent corresponds with the value of the CV in the decoder.

Once the decoder has processed the read request the programmer shows the following message:

CV#xxxx=yyy

Where xxxx is the number of the CV read and yyy is its value. By pressing any key you are returned to the screen for entering the CV number.

If the decoder does not react to anything the programmer will display *No Ack detected!* again.

When the current consumption is excessively high (more than 250 mA) while programming or reading, the programmer will show *Decoder fault!* This usually indicates a faulty decoder (short circuit in the output stage).

Table 1. Comparison between protocols from Märklin, EEDTS and DCC

Protocol	Märklin 1 st generation (a.k.a. Motorola format)	Märklin 2 nd generation	EEDTS Pro	DCC / NMRA
Originator	Märklin	Märklin	Elektor Electronics	Lenz / NMRA
Driving current	Asymmetric square wave from 18 to 22 V/38 kHz (76 kHz for additional functions)	Asymmetric square wave from 18 to 22 V/38 kHz (76 kHz for additional functions)	Asymmetric square wave from 18 to 22 V/38 kHz (76 kHz for additional functions)	Symmetric square wave 18 to 22 V frequency-modulated
Number of supported decoders	80	80	79/80 (249 with software V1.2)	99 with basic and >1 000 with extended protocol
Number of speed settings	14	14/15/28 (depends on decoder)	14/15/28 (depends on decoder)	14/28/126 (depends on decoder)
Absolute direction of travel	No	Yes	Yes	Yes
Transmission error detection	No	No	No	Via control code
Compatible with	EEDTS	EEDTS Pro Märklin 1 st generation	EEDTS Märklin 1 st and 2 nd generation	Any NMRA system
Specific functions per decoder	1 command per direction	1 command per direction + 4 additional functions	1 command per direction + 4 additional functions	1 additional function in 'BASIC' 12 additional functions in 'EXTENDED'
Emergency stop	No	No	No	Yes

When you select the *Address Only* mode, the programmer uses a special routine defined by the NMRA. This makes it possible to access CV1 (decoder address) directly. In this case it is not necessary to enter the CV number, but the other operations remain the same.

The ZTC brand decoders contain a catch: their addressing system differs from the NMRA system. CV1 to CV1024 are stored as decoder addresses 0 to 1023 according to the NMRA system (the program in the decoder takes care of the conversion from CV number to actual address). In the ZTC decoders, CV1 is stored at location 1, which causes a shift. In order to program this brand of decoders you need to add 1 to the number of the CV to be operated on so that the correct memory location is manipulated (for example, to change CV1 you need to enter address 2 on the keypad).

The last function on the programmer is the factory reset. The DCC standard includes a message that allows the decoder to return to its default state, as it was shipped from the factory. This function is not available with all decoders. To use this function, press the *Function* button until the text *Factory Reset* appears. Confirm your

choice by pressing *Enter*. The programmer now asks *Confirm?* After pressing *Enter* again the programmer will send the appropriate code. If at the end of the operation everything has gone well (ack from the decoder) the programmer will indicate *Done!* In the other event one of two fault messages will appear.

Finally

We now wish you long, enjoyable hobby evenings to familiarise yourself with your decoder by experimenting with the different CVs of your decoders.

(040422-1)

Table 2.

NMRA defines 1024 CVs, but the vast majority of decoders recognise only a handful. The first 20 variables are the most common and are recognised by the majority of decoders.

CV	Function	Comment
1	Base address	Identifies decoder
2	Starting voltage	Minimum motor voltage
3	Acceleration characteristic	Simulates acceleration
4	Deceleration characteristic	Simulates deceleration
5	Maximum voltage	Maximum motor voltage
6	Average voltage	Correction of the motor characteristic
7	Program version numbers	Read only
8	Manufacturer number	Read only
9	PWM	Adjustment of switching frequency
10	EMF Feedback Cutout	Speed control
11	Power supply selection	Non-DCC power supply
17/18	Extended address	Decoder identification using 14 bits
19	Link address	Multi-traction control
29	Decoder-configuration	Bit-for-bit control

MAGNETIC FLUX DENS

Ben J. Climer

How do you know accurately if a magnet is stronger or weaker than one you've dubbed your reference device? This simple to build instrument has the answer.

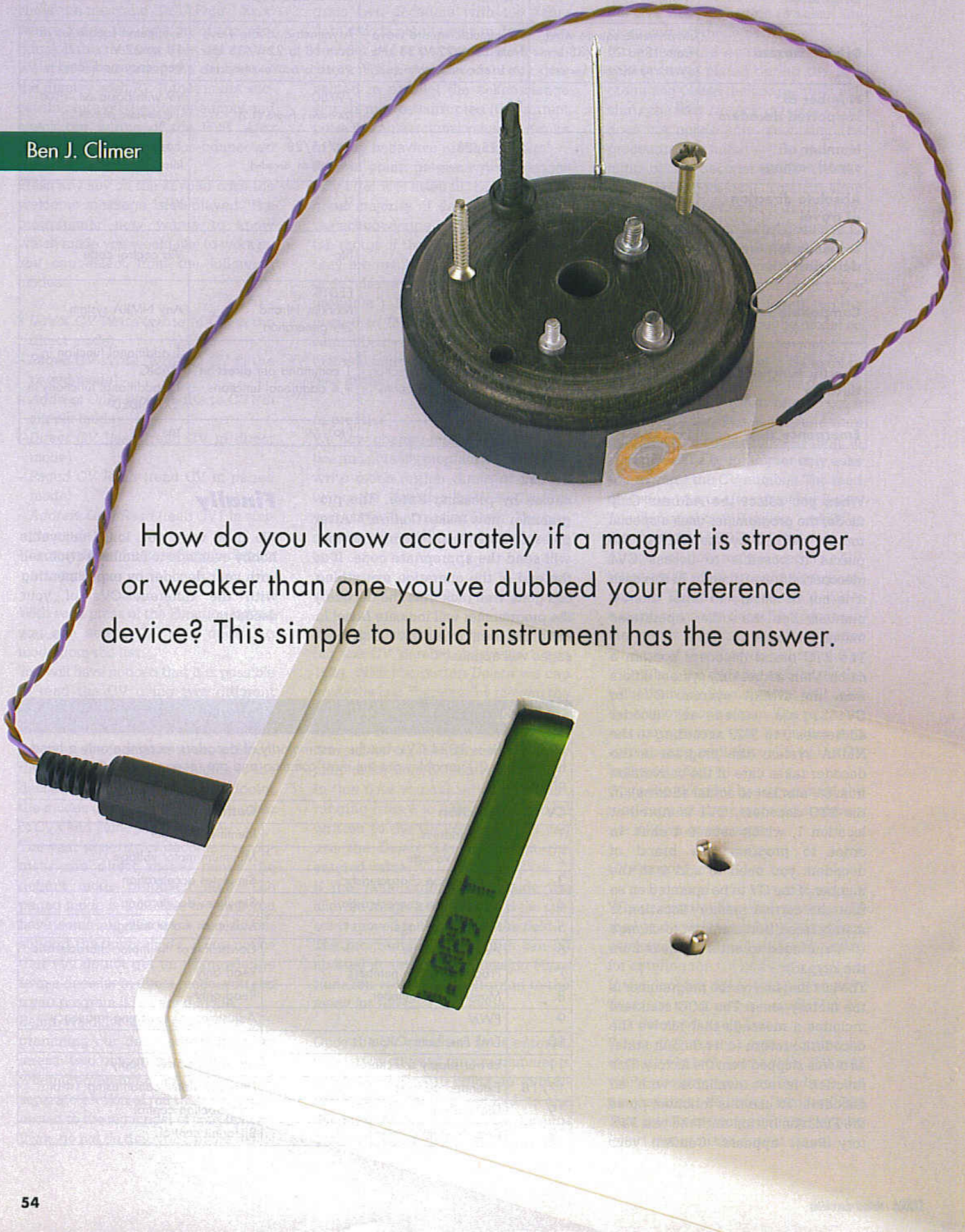

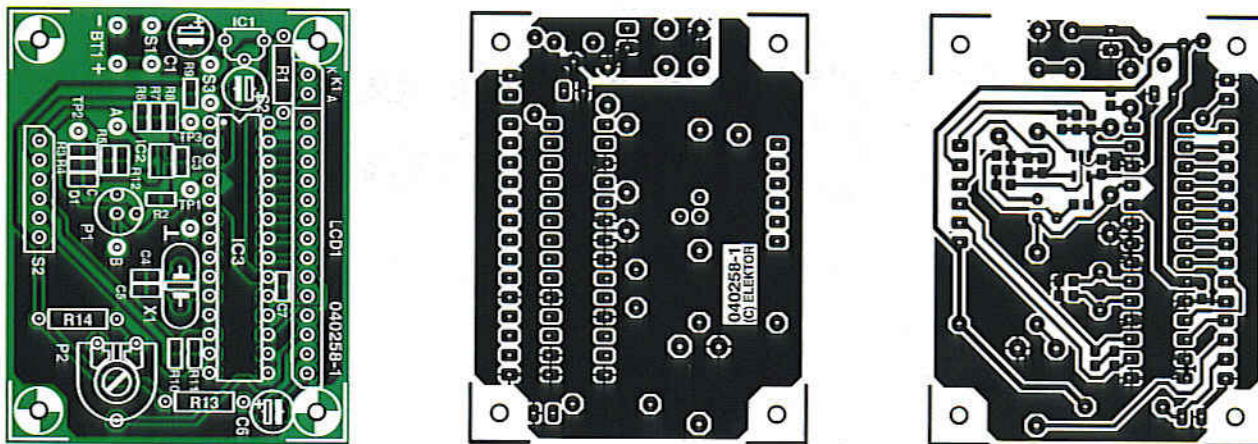

Figure 2. Copper track layout and component mounting plan of the PCB designed for the instrument.

ferromagnetic materials where the flux density can be enhanced by a factor of 1,000 or more. One tesla is equivalent to 10,000 Gauss.

Mains electric motors and transformers employ flux densities up to about one tesla (1 T). Modern permanent magnets can generate similar values. Superconducting coils can reach about 10 T. By comparison, the earth's magnetic flux density is less than one ten thousandth of a tesla.

Magnetic flux is measured in webers (Wb). In fact, 1 tesla is a density of 1 Wb per metre².

A search coil works by means of lines of flux 'linked' through the coil. The effect of the flux is magnified by the number of turns in the coil. 'Flux linkage' is the flux through the coil times the number of turns.

When the flux linkage through a coil changes with time, a voltage appears across the ends of the coil. This voltage is equal to the rate of change of flux linkage measured in webers per second. If the coil has 10 turns, has an area of 1 cm² and is withdrawn from a flux density of 1 tesla in 0.1 seconds, the average voltage is only... 10 mV! This is inconveniently low but the search coil has to be small to fit into small narrow gaps in magnetic circuits. It is necessary to amplify this voltage to a value that can be easily digitised. Time for some non-theoretical electronics!

Overall description of the meter

The meter employs a homemade search coil about 1.5 cm square. This is placed in the region where the field is to be measured and is withdrawn

sharply. The coil is connected via an amplifier, to an A/D port on a microprocessor. As soon as a voltage is detected, the processor measures the voltage 256 times within a time slot of about 0.25 seconds. At the end of this time the coil is assumed to be out of the field. The microprocessor adds up all of the voltages it has measured and the total is proportional to the flux change. For the mathematicians, it has *integrated* the rate of change of flux.

The microprocessor then computes the result and displays it on an LCD. The result stays on the display until the instrument is reset.

Only one orientation of the search coil can be used since the A/D converter will only work with positive voltages. The meter is portable and powered by four AA size 1.5 volt batteries. The current drain is only 10 mA.

The circuit

The circuit schematic is shown in **Figure 1**. To make the instrument simple and portable, it operates on four AA batteries. Their output is regulated to 5 V with a low dropout regulator type LP2950CZ-5.0. This supply is then used by the single rail opamp, IC2, and by the microprocessor.

Single rail amplifiers do not work well if the output is within a few millivolts of the negative rail, so it is necessary to establish another 'ground' about 100 mV higher. This is done using a low barrier height Schottky diode, D1. The forward voltage of this diode is low when the current is only 2 mA. The raised 'ground' level is used at the negative input of the opamp and at the reference input of the A/D converter.

The amplifier used is a Max4130EUKT-T. This has an input voltage offset of up to ± 3.5 mV. At the output of the amplifier this could become an error of up to 400 mV. The A/D converter in the microprocessor converts to 10-bit accuracy which equates to a resolution of about 5 mV. Thus the offset error from the amplifier should be less than this value. In the circuit, preset P1 allows the voltage at the negative input of the amplifier to be adjusted by about ± 4 mV to remove the offset error.

We should not forget that the input offset voltage is also subject to a temperature coefficient which is typically ± 2 $\mu\text{V}/^\circ\text{C}$. This is acceptable since the error at the output of the amplifier should be less than ± 5 mV over a ± 20 $^\circ\text{C}$ temperature range.

The meter has two ranges switched by a 2-gang switch, S2.A/B. As well as varying the gain of the amplifier, it switches a voltage to pins 12 and 13 of the microprocessor to indicate the range setting.

The micro is a PIC16F876 using a 16-MHz crystal. This micro has Flash memory and A/D input. The output is displayed on a 16-character LCD with one line. Resistor R1 is only used if your LCD module has a backlight option. If the instrument is actually battery powered as shown in the circuit diagram, then the display **must** be a P-LED type if the current consumption is to remain within limits (max. 20 mA). The value of R1 will be governed by the display specs — check yours to make sure! The backlight voltage (if applicable) is supplied by the LP2950-5.0 and this is rated at 100 mA maximum. Our prototype without backlight was happy with just 10 mA.

Editor's Choice

Some instruments you can build yourself are a godsend in that they help you understand the true cause of 'vague' problems encountered equipment not easily associated with modern electronics. I am happy to say that Ben Climer's Magnetic Flux Density Meter described in this article is one of them.

A good number of two-stroke engines on vintage motorcycles and mopeds use a flywheel with internal magnets to generate the high voltage for the spark plug (10 kV and up) and the vehicle lighting voltage (usually 6 or 12 V). Although specialists in mechanical engineering will be able to overhaul such engines almost with their eyes closed (leaving electronics enthusiasts in awe), the ignition is often recognised as 'special' and 'mysterious'. I have seen and heard 100% mechanically sound vintage two-stroke engines refusing to start altogether or running in very erratic ways, and the frustrated owners unable to get to grips with the obvious cause: insufficient spark voltage.

On closer inspection, this time by an 'electrics' specialist, the problems are nearly always; worn contact breakers, burnt out high-voltage coils, broken wires and faulty or leaky damper capacitors. All this is a good laugh and plain sailing for anyone capable of identifying a soldering iron and a capacitor, but the one thing that remains a total mystery to all and sundry is why one flywheel works just fine, and

another, hardly or not at all.

The stronger the magnet swishing across the core of the high-voltage coil (actually, a step-up transformer), the better the combustion as a stronger spark is produced. Although a spark voltage of just 1 kV is sufficient to make my low-compression two-stroke engines run, more than 10 kV is required for a reliable cold start and a properly 'singing' engine. Flywheels salvaged from the 49 cc moped engines often do not see the light until after tens of years of storage in damp cellars. The resultant rust is not usually a problem, but having cleaned the flywheel and putting it to the test the results are nearly always disappointing. The four magnets having been unable to commute to a small extent for so many years seem to have lost a great deal of their original magnetic force. The problem could have been avoided by dropping the associated ignition base plate into the flywheel and then putting the lot into reasonably dry and clean storage like a loft.

Using the Magnetic Flux Density Meter I am now able to predict with near 100% certainty if a flywheel bought on a car-boot sale or given to me for inspection by friends, will work perfectly, marginally or not at all on an otherwise fine engine. I'm now drawing small crowds on vintage motorcycle markets and never buy dud flywheels again! Because I have a reference value available obtained from a 'known good' flywheel, I can now get to investigating how weakened flywheel magnets can be reliably restored to their original strength. I guess it will take a few amps here and there...

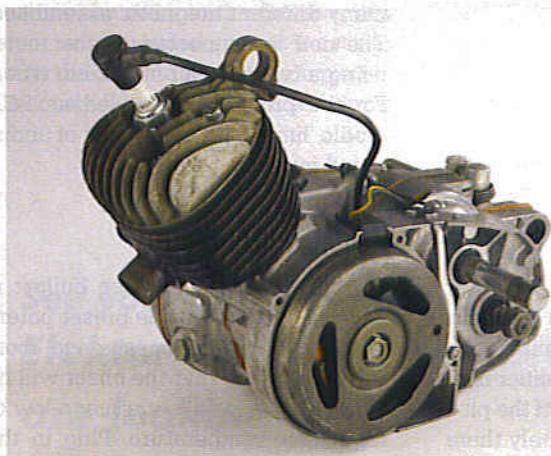

COMPONENTS LIST

Resistors:

R1 = * Ω (100 Ω suggested starting value only)
R2,R5 = 2k Ω 7 SMD case size 0805
R3,R4 = 2 Ω 2 SMD case size 0805 (e.g., Farnell # 310-4515)
R6,R9,R10,R11 = 10 k Ω , SMD, case size 0805
R7,R8 = 100k Ω SMD, case size 0805
R12 = 1k Ω , SMD case size 0805
R13 = 22 Ω
R14 = 39k Ω
P1 = 10 Ω preset, Bourns type 3329H (e.g., Farnell # 345-970)
P2 = 10k Ω preset H

Capacitors:

C1,C2 = 2 μ F2 25V radial
C3,C7 = 100nF, SMD, case size 0805
C4,C5 = 22pF, SMD, case size 0805
C6 = 10 μ F, 63V, radial

Semiconductors:

D1 = high current Schottky diode, case size SOD-323, e.g., Zetex type ZHCS400 (Farnell # 301-4850)
IC1 = LP2950CZ-5.0
IC2 = MAX4130EUK-T (Maxim) case size 5-lead SOT-23, or MAX4122EUK-T (Farnell # 353-4169)
IC3 = PIC16F876-20/SP, programmed, order code **040258-41** (28-pin narrow DIP case)

Miscellaneous:

K1 = 2-way pinheader
S1 = on/off switch, 1 make contact, chassis mount

S2 = 2-pole, 2-way changeover switch, chassis mount (+ 6-way SIL header if necessary)
S3 = pushbutton, 1 make contact
X1 = 16MHz quartz crystal, HC-49/4H case
LCD1 = LCD, 1 line, 16 characters, with 14-way pinheader
BT1 = battery pack, 4 x 1.5V AA size
Enclosure with battery compartment for 4 AA batteries, e.g. OKW shell-type case V155 (SG155), version III (OKW # A9408338), size approx. 158x95x33 mm
PCB, ref. 040258-1, from The PCBShop
Disk, PIC source code files, order code **040258-11** or download from website**

* see text

** www.elektor-electronics.co.uk

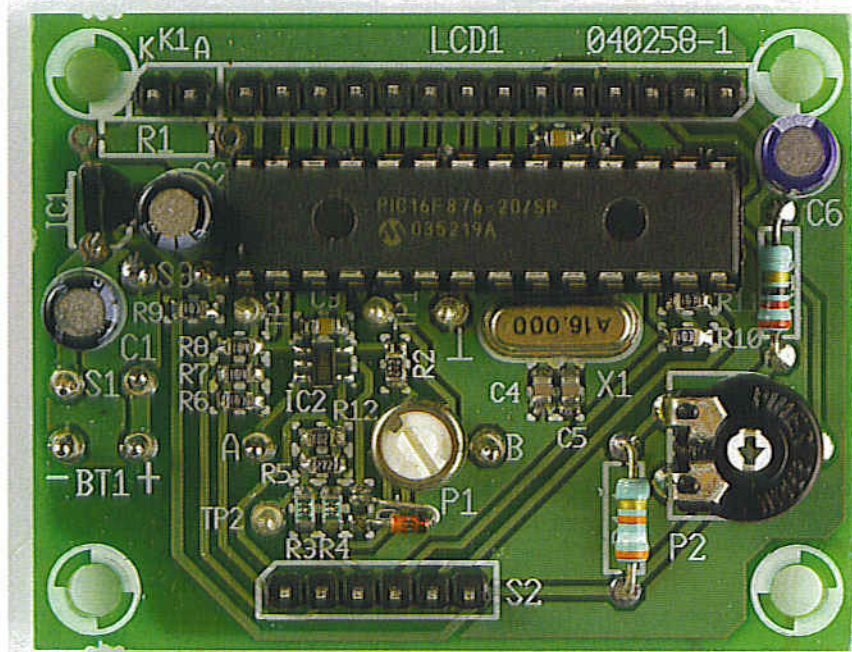

Figure 3. The finished board, ready for fitting inside the plastic case. We did not use a reset switch; instead, a 10-microfarad electrolytic cap was connected across the pins for S3. Also note the use of a leaded BAT85 instead of the SMD diode.

The LCD supply voltage is decoupled separately with C6 and R13. The LCD contrast is adjusted using preset P2.

Software

The code was written in assembly language. It uses subroutines to handle A/D conversion, driving the display, delays and binary to decimal conversion.

After setting up, the micro stays in a loop, repeatedly measuring the amplified voltage from the search coil. As soon as this changes from zero, it measures the input 256 times and maintains a running total in a 16 bit register. If at any stage the voltage reaches the maximum value which the A/D converter can handle, it stops and displays an error message.

When it has reached a valid total, it converts the 16-bit binary number to its decimal equivalent and displays it on the LCD. The decimal point is placed using the range information available at pins 12 and 13. The result is displayed until the instrument is reset using a press switch.

Versions of the code are available from the Elektor web site, the file number is 040258-11.zip and it may be found with other on-line information stored for this article.

Construction

The circuit is built on a single sided board with a ground plane. The artwork is given in Figure 2. If necessary, a pdf file containing reflected and non-reflected versions of the copper track layout may be downloaded from our website. Almost all of the components are surface mount. The amplifier is in a SOT23 package. The pitch of the pins is only 0.95 mm but fortunately there are only five of them so that hand soldering is possible.

Remember to fit the one diode the correct way round.

It is best to fit a base under the 28-pin PIC16F876 to avoid damage during soldering. Perhaps the most difficult part of the construction is connecting the LCD to the board. If a suitable connector (K1) is not available, this can be done using a short length of ribbon cable with 14 conductors. The ends need to be splayed out to match the spacings on the circuit and the LCD. All 14 of the pads down one side of the board are used. They are in the same sequence as the pads on a standard LCD. Pin 1 of the LCD is connected to the end nearer pin 15 of the PIC. The other pads are connected in turn up to pin 14 of the LCD.

The three switches need to be fitted on the front panel together with the LCD. The wiring between the board and switch S2 has to be kept as short as possible.

The circuit fits in a plastic box about 150x90 mm. They are available with a battery compartment to take the four AA size batteries. Alkaline batteries are required since the voltage from rechargeable ones (NIMH or NiCd) would be too low at 4.8 volts nominally.

Pickup coil

The pickup coil is made by securing a very flat M4-size nut on a piece of sticky tape and then tightly but carefully winding 10 turns of 0.2-mm diameter (SWG36) enamelled copper wire around it. The nut is then carefully removed and the resultant coil shape sealed and secured in place by covering it with a second piece of sticky tape. The result is a very flat pickup coil that's small enough to probe into many different magnetic assemblies. The coil is connected to the meter using a twisted pair of flexible wires. For the prototype we used an RCA (audio 'line') plug and socket of undisputed quality.

Adjustment

When the meter has been built it is necessary to adjust the preset potentiometer. Do this at an 'average' room temperature so that the offset will be as small as possible at either a low or high room temperature. Plug in the search coil and switch on with the instrument case open and the range switch on the more sensitive range. The LCD should either read 'SET' or a number with 'T' for tesla after it. If it shows the number, it means that the amplifier offset is positive so that the instrument has started to count immediately. 'SET' either means that you are very lucky and the offset is zero or, more likely, the offset is negative. Connect a voltmeter or 'scope to pins 2 (TP3) and 4 (Sensor B terminal) of the PIC i.e. the analogue input and the analogue reference, and alter the preset until the voltage is within 1 mV of zero. After this, press 'reset' (S3) and the display should show 'SET'.

If an accurate and sensitive voltmeter is not available, it is possible to perform the adjustment by trial and error. Get a condition where the display shows a number and 'T', then turn the

preset slightly and press reset. If it still reads a number, turn the preset a little more and press reset. Repeat until the display reads 'SET'. Obviously, beware of taking the offset too far in the negative direction.

Use of the instrument

To read the flux density, insert the search coil into the magnetic field with the magnetic field perpendicular to the coil. If the meter shows a reading, it probably means that the coil needs to be flipped. Turn the coil over and reinsert it. Press 'reset' and sharply withdraw the coil. The meter should now display a reading.

It should be noted that any movement of the coil producing a change of linked flux results in a voltage so it is easy to trigger a reading accidentally. Just press 'reset' and try again.

It is possible to take a measurement by pushing the coil into the field but this is not recommended since it is easy to crash the coil into a metal pole piece. Obviously, if the display indicates 'over

range', you need to change to the less sensitive range setting. Another possibility is to withdraw the coil slightly more slowly.

The meter is not a high precision instrument but it should be accurate to $\pm 10\%$.

Search coil experiments and calibration

The PCB search coil used for initial experiments was a printed circuit type. Although it was found to be stable and repeatable alternative coils may be made from insulated or, in our case, enamelled wire. However, unless you are lucky enough to have access to magnetic standards you have a problem with calibration.

It is possible to create standard fields using solenoids or other suitable coils but to obtain even 0.1 T it is necessary to put a whopping 10 A through some hundreds of turns. The coils heat up within seconds so the current changes fast if a constant voltage power pack is used.

One possible approach is to create your own 'transfer standard'. This could be

any available permanent magnet. It needs to be big enough to provide a fairly uniform field over the area of a search coil. Measure it with the 'standard' search coil and then measure it the coil of your own design (possibly a PCB). Add turns or change the surface area until the readings agree or give a reading different by some chosen factor. The pickup coil as described above in relation with our prototype is a **suggested construction only and not intended to act as a reference coil**. In a good many cases, however, comparative rather than absolute measurements of magnetic field strengths are more than adequate

(040258-1)

Reference

Small wind turbines, see www.scoraiqwind.co.uk

See your design in print! Elektor Electronics (Publishing) are looking for Freelance Technical Authors/Designers

If you have

- * an innovative or otherwise original design you would like to see in print in Europe's largest magazine on practical electronics
- * above average skills in designing electronic circuits
- * experience in writing electronics-related software
- * basic skills in complementing your design with an explanatory text
- * a PC, email and Internet access for efficient communication with our in-house design staff

then do not hesitate to contact us for exciting opportunities in getting your designs published on a regular basis.

Elektor Electronics

K. Walraven, Head of Design Dept.

P.O. Box 75, NL-6190-AB Beek, The Netherlands, Fax: (+31) 46 4370161

Email: k.walraven@segment.nl

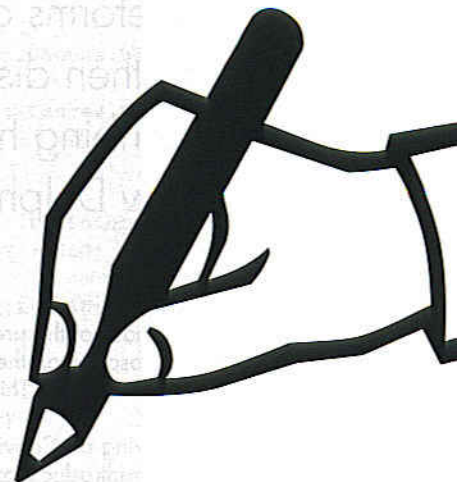

DELPHI FOR ELECTRONIC ENGINEERS

Part 5: measuring with the sound card

Detlef Overbeek, Anton Vogelaar and Siegfried Zuhr

In Part 4 of this course, we used the PC sound card to generate a variety of waveforms. In this instalment, we turn this around. Here waveforms arriving via the line input of the sound card are stored and then displayed on the screen. Before turning our attention to describing how to program such a 'PC oscilloscope', we examine a few Delphi topics you'll need for this task.

The purpose of the project described here is to implement an oscilloscope on the PC that uses the PC sound card as an A/D converter. This project consists of four parts:

1. Drawing on Canvas, the 'drawing window' in Delphi, as an introduction to familiarise yourself with the material.
2. Drawing a sine wave. In the process, you'll learn a bit about reusing code in Delphi.
3. Checking the essential equipment in the PC: the sound card.
4. The most important part: building an oscilloscope that can be used to display (on the screen) an AC signal present at the line input of the sound card.

The first three items are addressed in this instalment. The fourth one is somewhat more extensive, so we're saving it for next month.

Drawing

First we want to show you how easy it is to display your own drawings on the screen (**Figure 1**). (In capsule form, this is 'painting on Canvas'.) Start a new project via **File/New/Application**. A form will appear, along with an editor. You should save this right away. Assign the name *CanvasSimple.dpr* to the Delphi project resource (DPR) file, and name the form *Canvas.pas*. To build the program quickly, proceed as follows. First, go to the Standard component tab, select the panel component, and place it at the bottom of the Main form. Set the Align property to *allBottom*. Then place an image from the Additional tab on the remainder of the form. Using the Object Inspector (which you can bring up using the F11 key), set the Align property to *allClient*. Place a timer from the System tab on the form. Now go back to the bottom, where you have to do seve-

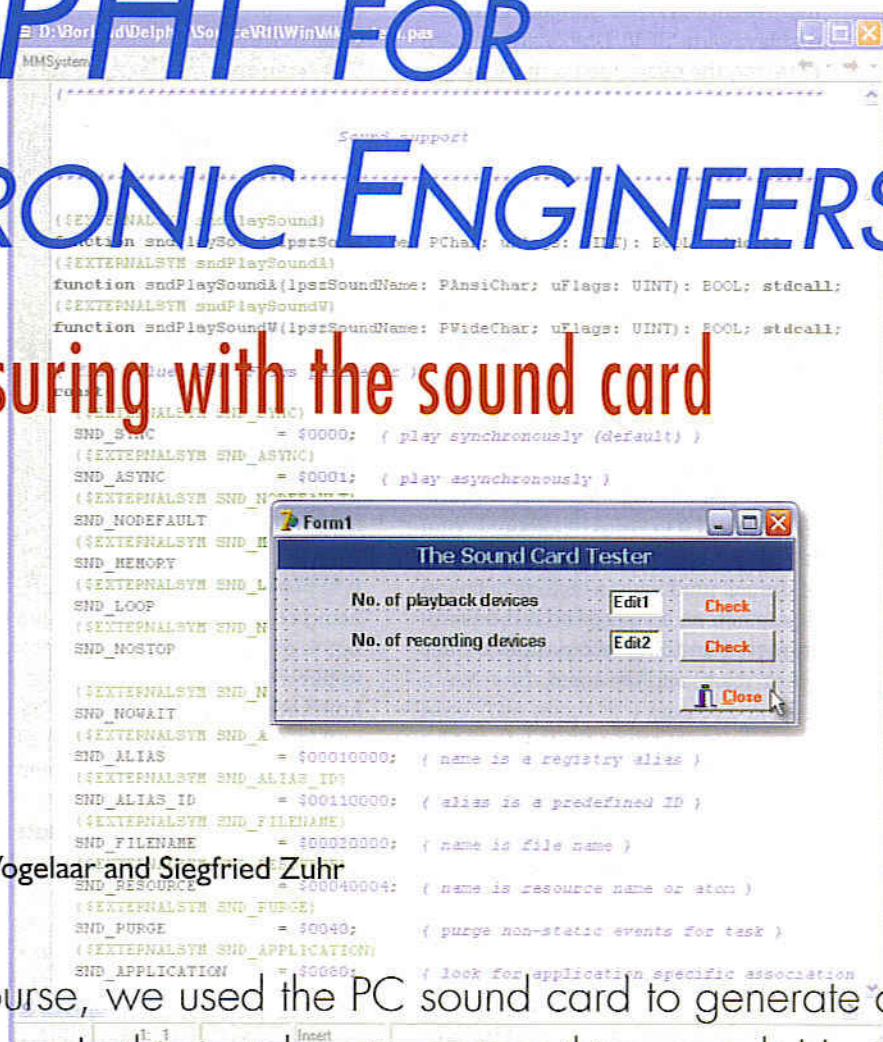

ral things with the panel. Give it a colour, put a label on it, and enter a name here (select whatever name you want to give the program). A panel has the special property that it becomes the owner of everything that is placed directly on top of it. That has a lot of advantages for searching, relocating and processing.

Continue by placing another eleven Speed buttons from the Additional tab here. The icons that are placed on the buttons are supplied with the project. They are miniature bitmaps, which are also called 'glyphs'. The Glyph property generates a window where you can enter a path that specifies which icon you want to use. You can also make your own icons. Selecting **Tools/Image Editor** starts a program that you can use to make all sorts of images, but that's a subject on its own.

After you have configured the glyph (of type *Tbitmap*), you also have to specify the number of glyphs, which is four. The button has four states, so it needs an icon for each state.

Now you have everything you need. The program listing clearly shows what you can do. It's a good idea to first create this program and study it, since that will help you understand the things you'll be needing shortly. You can use this program to place a variety of coloured shapes (round, elliptical or rectangular) and put lines in specific locations or delete them. The principle is quite simple: the form has a Canvas property, which is what you draw on. It's also important to know that the form puts the origin for all coordinates at the top left (0, 0), which also holds true for all objects you place on the form.

```

Procedure DrawFig1;
  Begin
    Canvas.Rectangle (10, 10, 600, 300);
  End;
Procedure DrawFig2;
  Begin
    Canvas.MoveTo (10, 10); Canvas.LineTo
(600, 300);
    Canvas.MoveTo (10, 300); Canvas.LineTo
(600, 10);
  End;

```

The first procedure draws a rectangle. The second procedure goes to a certain point and then draws a line from that point to another point.

It's important to realise that the drawn image is not saved unless you have this task run under procedure `TMainForm.FormPaint (Sender : TObject)`. That's annoying, since you lose the image every time another window slides over the drawing. However, this doesn't happen if you execute the procedure in `FormPaint`. If other procedures are nested inside this procedure, you can clearly see that a particular task is executed each time, after which a selection is made as the last operation.

```

Begin
  If Fig1 In Figs Then DrawFig1;
  If Fig2 In Figs Then DrawFig2;
  If Fig3 In Figs Then DrawFig3;
  If Fig4 In Figs Then DrawFig4;
End

```

These types are declared (under `uses`), and they are filled in procedures such as the following:

```

Procedure DrawFig1;
  Begin
    Canvas.Rectangle (10, 10, 600, 300);

```

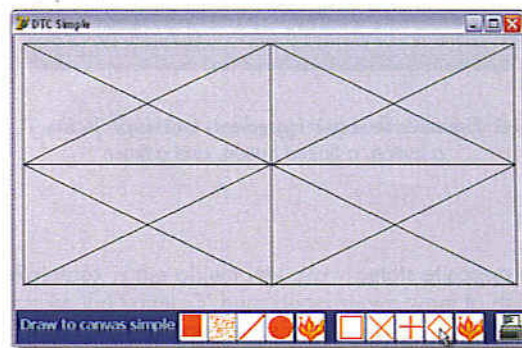
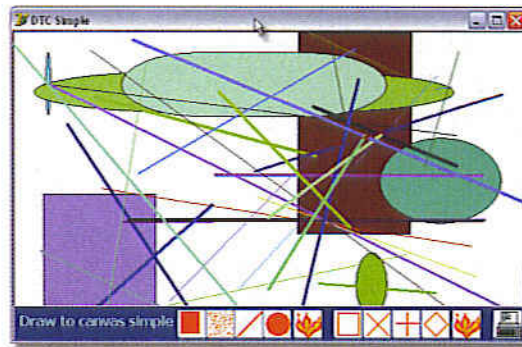

Figure 1. A user-generated drawing on the Delphi canvas.

```

End;
Procedure DrawFig2;
  Begin
    Canvas.MoveTo (10, 10); Canvas.LineTo
(600, 300);
    Canvas.MoveTo (10, 300); Canvas.LineTo
(600, 10);
  End;
Procedure DrawFig3;
  Begin
    Canvas.MoveTo (305, 10); Canvas.LineTo
(305, 300);
    Canvas.MoveTo ( 10, 155); Canvas.LineTo
(600, 155);
  End;
Procedure DrawFig4;
  Const Window : Array [0..4] Of TPoint
    = ((X : 305; Y : 10), (X : 600; Y :
155),
      (X : 305; Y : 300), (X : 10; Y :
155),
      (X : 305; Y : 10));
  Begin
    Canvas.Polyline (Window)
  End;

```

However, there's also another way to ensure that whatever is drawn doesn't immediately disappear, which is to draw on the canvas of an image. This is what happens in the example, and the image is 'switched' on or off by enabling or disabling the `Visibility` attribute. The `Visibility` attribute has the property `Boolean`, and it can be enabled or disabled.

```

Image1.Visible := True;
Timer1.Enabled := Not Timer1.Enabled;

```

`Enabled` is reset in the last line of code above. It's useful to remember that this always causes the result to change

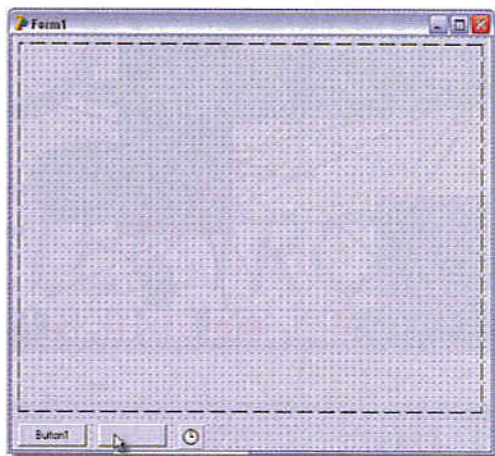

Figure 2. The basic ingredients for this project: a button, a Speed button, and a timer.

to the opposite state.

The timer is used to cause a single operation to be repeated several times in succession, as in the previously mentioned procedure. To allow a few more things to be incorporated, there is also an extended version called 'Canvas Extended', which is helpful for learning how to use menus. A method for installing a printer and printing your drawings is also included in this version. The listings of these two programs are available on the Delphi website of the Pascal Users' Group (www.learningdelphi.info) and the *Elektor Electronics* website.

Sine wave

Now you're getting closer to your ultimate objective, which is building an oscilloscope. As you have seen, drawing on the canvas is actually not all that difficult, but you have to bear in mind that what you want can become rather complex in use. That's why we decided to do something we haven't done so far in Delphi: using two units, one of which contains only code, while the other one, as usual, is a unit (form) that also displays an object. That means you can also use units to organise things in Delphi. Give each of the units a name, and link them to each other so they are aware of each other. This allows even very complex things to be organised in a comprehensible manner. That's exactly what you're going to do now. Naturally, the listing is available at the previously mentioned locations.

Start with **File/New/Application**. That gives you your basic program. Save Form1 and Unit1 with the object display and code as *Unit1.pas*. Next, select **File/New/Unit** to create a second unit to be used exclusively to hold code. New units are numbered automatically, so Delphi will assign the name Unit2 to this unit. When you save everything, you will be automatically offered the following names: *Unit1.pas*, *Unit2.pas*, and *Project1.dpr* for the Delphi project resource file. The executable file will also be assigned the name *Project1.exe*.

It's important to know that Delphi can do the naming for you. That's handy for a small, simple project, but generally speaking it's better to assign your own names – preferably names that are meaningful, such as *UserInter-*

face.pas and *DisplayAlgorithm.pas*. However, that's something you can do later on when you create your own projects. Here we decided to keep the default names so everyone is offered the same names.

Now that you've saved everything, you have to introduce all the members of the project to each other. You're using Unit1 and Unit2, and they have to be able to work together. **File/UseUnit** or **ALT+F11** shows a list of units that can be added, and here there is only one choice: Unit2. Use F12 to bring the form (Form1) to the foreground. Place a Paintbox from the System tab (second from the left) on the canvas. If you're looking for a component and you can't find it, go to **View/Component** and type the name of the component in the window that is displayed. Next, place a button and a Speed button. You also need a timer. These are all the basic ingredients of the project (**Figure 2**). Is it really that simple, or is the hard part still to come? Practical experience shows that the best way to approach problems is to treat them like a tree with a lot of branches. If you break a problem down into little pieces, it becomes easier to understand. Before you start on this project, it's a good idea to download all the code so you can see how everything fits together. However, we recommend that you build everything yourself as instructed, despite the fact that you already have the finished project in your hands. If you do the work yourself, you'll understand everything much better. Now it's time to carry on:

```
Procedure TForm1.PBxPaint (Sender : TObject);
(* Invalidate Paintbox 1 *)
Begin
    OscRepaint (Paintbox1);
End;
```

What's happening here? Double-click on Invalidate in order to select it. Then press function key F1. The Delphi help menu will appear and display the following (or similar) explanation:

Use Invalidate when the entire object must be redrawn. If more than one region must be redrawn, Invalidate will do this in a single operation without any flickering of the screen. If you look at the buttons and double-click in the IDE, you can expect Delphi to create a process. This process takes the following form:

```
procedure TForm1.Button1Click(Sender: TObject);
begin
end;
```

The next procedure also has something special in it:

```
Procedure TForm1.DoAcquire (Sender : TObject);
(* Handle button data acquiring OnClick event *)
Begin
    If SpeedButton1.Down Then
        Begin
            OscDataN := 0; // No data present
            // This global variable is expressly included
            // in this unit to make the unit reusable.
            // Placing the var here makes it always available
            // as soon as unit2 is linked to a project.
            Timer1.Enabled := True; // Start data
            aanmaak
            Paintbox1.Invalidate // Hertecken het form
        End Else Timer1.Enabled := False // Stop
        data generation
    End;
```

This procedure was generated by hand. That's not always necessary in Delphi, but it is possible. Here's an explanation of how to do it. You start with the **Procedure** line. The name of the form in which the procedure is located naturally belongs in this line. Here it's TForm1, but you can use whatever frame is appropriate. After this, enter a name that describes what happens in the procedure. In the above example we chose the name DoAcquire, which indicates what the procedure is supposed to do. In this case a Sender is also declared to allow another object to be controlled later on:

```
Procedure TForm1.DoAcquire(Sender : TObject);
```

As we selected a Speed button and this type of button has four states, you can provisionally have the button manage several different things. If it is in the down state, it checks whether any data are present, enables the timer, and recognises the form. If it is no longer in the down state, it must stop creating data. The code is entered between **Begin** and **End** as usual.

The following example deviates from this arrangement. Here the button is located in a FormCreate:

```
Procedure TForm1.FormCreate (Sender : TObject);
(* These settings can also be handled in the
Object Inspector (F11).
You can also have them be triggered by a double-click event in the Events tab of the
Object Inspector on OnCreate.
In that case, Delphi creates the basic procedure and you fill it in. *)
Begin
  With Paintbox1 Do
    Begin
      Width      := 510;
      Height     := 410;
      OnPaint    := PBxPaint;
      ControlStyle := ControlStyle + [csOpaque]
    End;
  With SpeedButton1 Do Begin Caption :=
'Acquire'; AllowAllUp := True; GroupIndex :=
1; OnClick := DoAcquire End;
  With Timer1 Do Begin Enabled := False;
Interval := 30; OnTimer := DoTimer End;
  With Button1 Do Begin Caption := 'Clear';
OnClick := DoClear End;
  OscBackground (Paintbox1); // Calculate
background
End;
```

You can divide the text up in various manners as long as you pay attention to the **semicolon**, which acts as an end-of-line character or command delimiter. The compiler will object immediately if there's something wrong here. The DoTimer procedure uses a bit of good, old-fashioned arithmetic:

```
Procedure TForm1.DoTimer (Sender : TObject);
(* Handle the timer timeout event *)
Begin
  If OscDataN = 500 Then // Global variable
declared in Unit2
    Begin
      OscDataN := 0;
      Paintbox1.Invalidate
    End Else OscAddY (Paintbox1, Sin (5 * 2 * Pi
+ OscDataN / 500))
End;
```

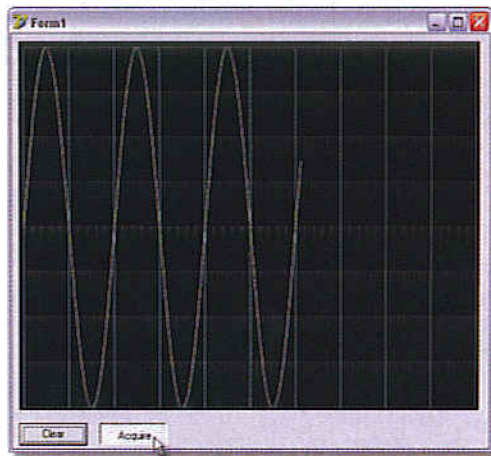

Figure 3. A window displaying several sine wave cycles.

The Paintbox is the object you draw on.

We chose the value '5' here because we want to draw five periods of the sine wave in order to fill the entire screen.

The **End Else** line (near the bottom) needs a bit of explanation. Each time OscAddY is called, OscDataN is incremented by 1. This causes OscDataN to cycle through the range of 0 to 500 and draw a new sine wave for each cycle. Delphi works with radians for the sine function, so a full period of the sine wave corresponds to 2π radians.

We can also do bit of cleaning up:

```
Procedure TForm1.DoClear (Sender : TObject);
(* Handle the Button Clear event *)
Begin
  OscDataN := 0; // Date becomes empty
  Paintbox1.Invalidate
End;
```

That completes the description of the 'normal' form.

Unit2 is actually intended to be reused, as we promised earlier on. This unit is very well documented, so it's worth taking the trouble to read through it carefully.

Controlling the sound card

Now we want to show you how you can use the Windows environment to call the code (via Delphi) that you will ultimately need to build the oscilloscope we have in mind.

Windows comes with a simple sound recorder (Start / All Programs / Accessories / Entertainment / Sound Recorder). It's a convenient tool for recording audio data via the microphone or line input (Figure 4). This is a good way to check whether everything is working properly and make adjustments as necessary. This functionality is a component of Windows. You can also use Delphi to access most Windows components and use them for your own purposes. This can be done via Windows, but it can also be done from the Delphi IDE. This is made possible by Windows application programming interface (API) calls. That's exactly what we want. The sound recorder can store the recorded audio data in a .wav file, and that's exactly what we used for the function generator in the previous instalment.

Now comes the question: where can you find these API calls? Windows uses *mmsystem.dll* for this purpose, and



Figure 4. The Windows Sound Recorder makes it easy to record a signal via the sound card.

Delphi provides access to this via *MMSystem.pas*, which is also called the 'Borland Delphi Runtime Library / Win32 multimedia API Interface Unit'.

Before you can proceed any further, you have to specify that Delphi *MMSystem* will be used for executing commands, and you must manually insert this unit at the beginning of the header of the form where the units being used are declared under **uses**. You can also find the file under *Program Files\Borland\Delphi7\Source\Rtl\Win*. Numerous routines for using DLL are named or declared in this file, along with how they are called from Delphi. The interesting part for our purposes can be found in the *Waveform audio support* section. All the routines and parameters related to audio input and output are listed there.

Start off by checking to see whether you can actually find the sound card using a mini-application running under Delphi. The DLL contains a routine called *WaveOutGetNumDevs*, which returns the number of devices that can play back sound. Next to it is the routine *WaveInGetNumDevs*, which returns the number of devices that can record sound. To obtain this information, you can run a little test in the form of a program. Start a new project and place two labels and two edit boxes (from the Standard tab of the Component palette) on the blank form, along with three



Figure 5. This test program detects which sound options are present in the PC.

bit buttons (from the Additional tab of the Component palette). Place a label, an edit box and a button for each line, and add a third bit button underneath. Configure the third bit button as a Close button by using the Object Inspector to set the Kind property to *btClose*. This will cause an icon to appear automatically, and the Close task will be executed without any visible code because this function is simply configured via the property. Change the text by entering 'Number of playback devices' for the caption of the first label. The caption for the second label is 'Number of recording devices'. Use the caption 'Check' for the remaining two buttons. If you click on the top bit button, Delphi will open the text editor with a procedure already generated for this *onClick* event. You can also see this using the Object Inspector in the Events tab. The *BitBtn1Click* procedure is entered there after the *onClick* property. Enter the following code between the **Begin** and **End** statements:

```
If WaveOutGetNumDevs = 0 then // Execute command requests.
    application.MessageBox('Error',
        'No playback device found',mb_ok)
Else
    edit1.Text := IntToStr(WaveOutGetNumDevs);
// Convert found quantity into text.
```

You use the *WaveOutGetNumDevs* command to call a function in *mmsystem.dll* that returns the number of devices that can play back sound. You do the same thing for the second button, but using a command for the number of devices that can record sound.

Double-click on the button and enter the following code between **Begin** and **End**:

```
If WaveInGetNumDevs = 0 then
    // Execute command requests.
    application.MessageBox('Error',
        'No recording devices found',mb_ok)
else
    edit2.Text := IntToStr(WaveInGetNumDevs);
// Convert found quantity into text.
```

If you compile the program and run it (Figure 5), you'll see that the *edit1* text (the number of devices) changes after the Check button is clicked. This also happens with the other Check button for the number of recording devices. Now you know two things: a recording device has been found (the sound card), and you can find it using code.

If you want to use the sound card for recording, you have to specify how you want to do this (that is, in which format). If you look at the properties of the sound recording device, you'll see that it uses a PCM format. The other parameters are the sampling rate, the number of bits per sample, and whether the information is mono or stereo. Mono with an 8-bit value is adequate for this purpose, and you can use 11,000 samples per second for recording (the lowest available value). Various structures for this information have already been defined in the *MMSystem* unit. If you want to know whether the recording yielded usable data, it's easy to check this by playing back the stored .wav file.

(040240-5)

For readers who are following this course, an explanatory Delphi Course Glossary is available at www.learningdelphi.info and on the Elektor Electronics website at www.elektor-electronics.co.uk. It clearly defines a number of terms used in the course.



Quasar Electronics Limited
PO Box 6935, Bishops Cleeve
CM23 4WP, United Kingdom
Tel: 0870 246 1826
Fax: 0870 460 1045
E-mail: sales@quasarelectronics.com
Web: www.QuasarElectronics.com

Postage & Packing Options (Up to 2Kg gross weight): UK Standard 3-7 Day Delivery - £3.95; UK Mainland Next Day Delivery - £8.95; Europe (EU) - £6.95; Rest of World - £9.95.

!Order online for reduced price UK Postage!

We accept all major credit/debit cards. Make cheques/PO's payable to Quasar Electronics. Prices include 17.5% VAT.

Call now for our FREE CATALOGUE with details of over 300 kits, projects, modules and publications. Discounts for bulk quantities.



QUASAR
electronics

Get Plugged In!

0871 CREDIT CARD SALES 717 7168

Motor Drivers/Controllers

Here are just a few of our controller and driver modules for AC, DC, unipolar/bipolar stepper motors and servo motors. See website for full details.

NEW! Bidirectional DC Motor Controller

Controls the speed of most common DC motors (rated up to 32VDC/5A) in both the forward and reverse direction. The range of control is from fully OFF to fully ON in both directions. The direction and speed are controlled using a single potentiometer. Screw terminal block for connections.
Kit Order Code: 3166KT - £14.95
Assembled Order Code: AS3166 - £24.95



DC Motor Speed Controller (5A/100V)

Control the speed of almost any common DC motor rated up to 100V/5A. Pulse width modulation output for maximum motor torque at all speeds. Supply: 5-15VDC. Box supplied. Dimensions (mm): 60Wx100Lx60H.
Kit Order Code: 3067KT - £11.95
Assembled Order Code: AS3067 - £19.95



NEW! PC / Standalone Unipolar Stepper Motor Driver

Drives any 5, 6 or 8-lead unipolar stepper motor rated up to 6 Amps max. Provides speed and direction control. Operates in stand-alone or PC-controlled mode. Up to six 3179 driver boards can be connected to a single parallel port. Supply: 9V DC. PCB: 80x50mm.
Kit Order Code: 3179KT - £9.95
Assembled Order Code: AS3179 - £16.95
Assembled Order Code: AS3113 - £24.95



NEW! Bi-Polar Stepper Motor Driver

Drive any bi-polar stepper motor using externally supplied 5V levels for stepping and direction control. These usually come from software running on a computer. Supply: 8-30V DC. PCB: 75x85mm.
Kit Order Code: 3158KT - £12.95
Assembled Order Code: AS3158 - £26.95



Most items are available in kit form (KT suffix) or assembled and ready for use (AS prefix).

Controllers & Loggers

Here are just a few of the controller and data acquisition and control units we have. See website for full details. Suitable PSU for all units: Order Code PSU445 £8.95

Rolling Code 4-Channel UHF Remote

State-of-the-Art. High security. 4 channels. Momentary or latching relay output. Range up to 40m. Up to 15 Tx's can be learnt by one Rx (kit includes one Tx but more available separately). 4 indicator LED's. Rx: PCB 77x85mm, 12VDC/6mA (standby). Two and Ten channel versions also available.
Kit Order Code: 3180KT - £41.95
Assembled Order Code: AS3180 - £49.95



Computer Temperature Data Logger

4-channel temperature logger for serial port. °C or °F. Continuously logs up to 4 separate sensors located 200m+ from board. Wide range of free software applications for storing/using data. PCB just 38x38mm. Powered by PC. Includes one DS1820 sensor and four header cables.
Kit Order Code: 3145KT - £19.95
Assembled Order Code: AS3145 - £26.95
Additional DS1820 Sensors - £3.95 each



NEW! DTMF Telephone Relay Switcher

Call your phone number using a DTMF phone from anywhere in the world and remotely turn on/off any of the 4 relays as desired. User settable Security Password, Anti-Tamper, Rings to Answer, Auto Hang-up and Lockout. Includes plastic case. Not BT approved. 130x110x30mm. Power: 12VDC.
Kit Order Code: 3140KT - £39.95
Assembled Order Code: AS3140 - £49.95



Serial Isolated I/O Module

Computer controlled 8-channel relay board. 5A mains rated relay outputs. 4 isolated digital inputs. Useful in a variety of control and sensing applications. Controlled via serial port for programming (using our new Windows interface, terminal emulator or batch files). Includes plastic case 130x100x30mm. Power Supply: 12VDC/500mA.
Kit Order Code: 3108KT - £54.95
Assembled Order Code: AS3108 - £64.95

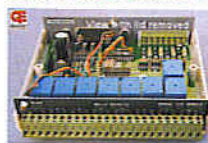

Infrared RC Relay Board

Individually control 12 on-board relays with included infrared remote control unit. Toggle or momentary. 15m+ range. 112x122mm. Supply: 12VDC/0.5A
Kit Order Code: 3142KT - £41.95
Assembled Order Code: AS3142 - £51.95

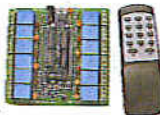

PIC & ATMEL Programmers

We have a wide range of low cost PIC and ATMEL Programmers. Complete range and documentation available from our web site.

Programmer Accessories:

40-pin Wide ZIF socket (ZIF40W) £15.00
18V DC Power supply (PSU010) £19.95
Leads: Parallel (LDC136) £4.95 / Serial (LDC441) £4.95 / USB (LDC644) £2.95

NEW! USB 'All-Flash' PIC Programmer

USB PIC programmer for all 'Flash' devices. No external power supply making it truly portable. Supplied with box and Windows Software. ZIF Socket and USB Plug A-B lead not incl.
Kit Order Code: 3128KT - £34.95
Assembled Order Code: AS3128 - £44.95



Enhanced "PICALL" ISP PIC Programmer

Will program virtually ALL 8 to 40 pin PICs plus a range of ATMEL AVR, SCENIX SX and EEPROM 24C devices. Also supports In System Programming (ISP) for PIC and ATMEL AVRs. Free software. Blank chip auto detect for super fast bulk programming. Available in assembled format with ZIF socket only.
Assembled Order Code: AS3144ZIF - £64.95



ATMEL 89xxx Programmer

Uses serial port and any standard terminal comms program. 4 LED's display the status. ZIF sockets not included. Supply: 16-18VDC.
Kit Order Code: 3123KT - £29.95
Assembled Order Code: AS3123 - £34.95



NEW! USB & Serial Port PIC Programmer

USB/Serial connection. Header cable for ICSP. Free Windows software. See website for PICs supported. ZIF Socket/USB Plug A-B lead extra. Supply: 18VDC.
Kit Order Code: 3149CKT - £34.95
Assembled Order Code: AS3149C - £49.95



**No.1
KITS**

www.quasarelectronics.com

Secure Online Ordering Facilities • Full Product Listing, Descriptions & Photos • Kit Documentation & Software Downloads

SHT11 sensor for precision measurements

TEMPERATURE & H

Jürgen Maib

The tiny surface-mount SHT11 sensor module provides calibrated digital readings of temperature and relative humidity. The chip includes two sensor elements, an A/D converter, calibration memory and a digital interface.

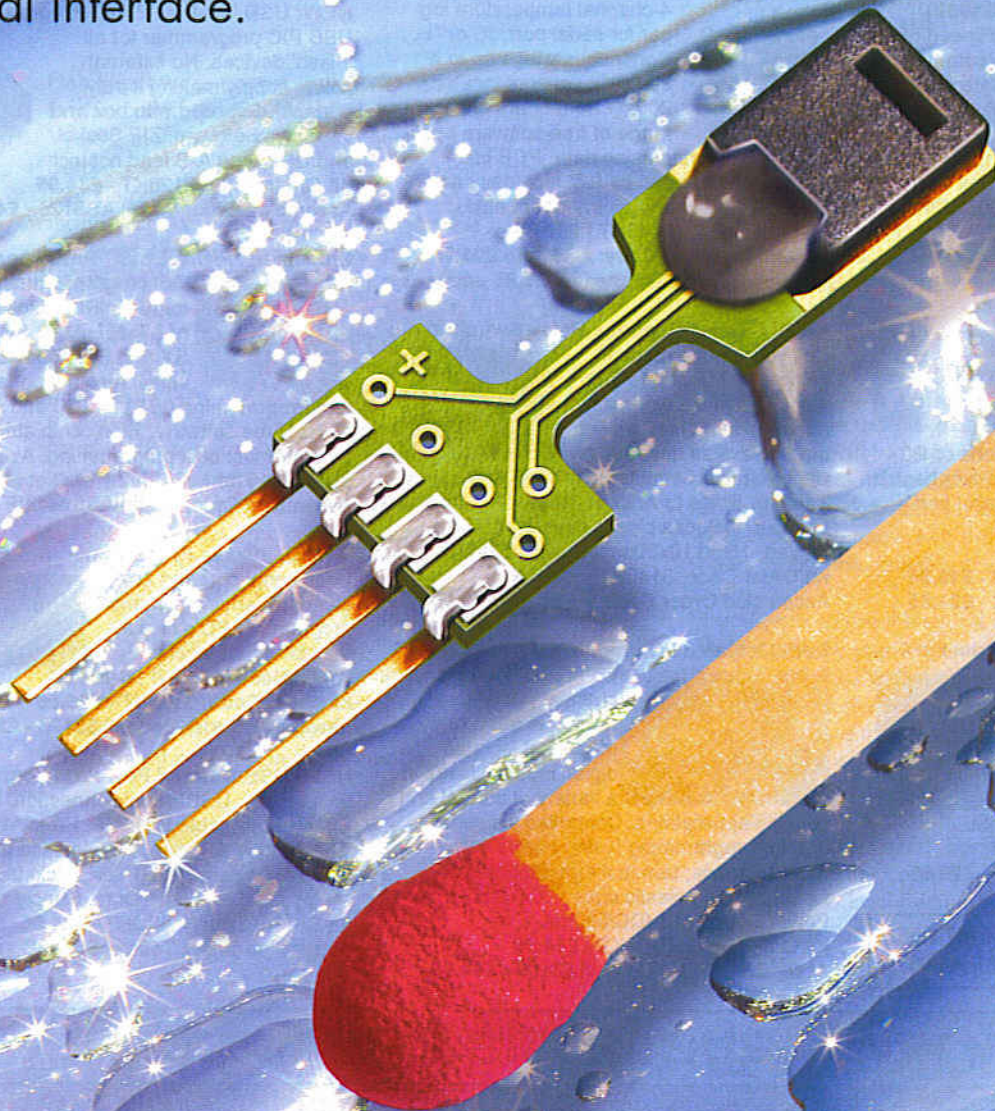

HUMIDITY SENSOR

Temperature and humidity

Temperature and humidity determine to a large extent how comfortable an environment is for humans, animals and plants, and there are many goods which can only be preserved in the right environmental conditions. The atmosphere is never perfectly dry: there is always a certain amount of water vapour present in the air.

Air has the property that it can carry water in the form of water vapour. The amount of water so carried, measured in grams per cubic metre (g/m^3) or grams per kilogram (g/kg), depends on the temperature of the air: the warmer the air, the more water vapour can be carried. The maximum quantity of water vapour that can be carried at a given temperature is called the saturation vapour density, and the temperature at which the vapour density in the air is equal to the saturation vapour density is called the dew point.

Dry air at a given temperature can only carry a certain amount of water vapour: at $25\text{ }^\circ\text{C}$ at sea level 1 kg of air

can carry a maximum of about 20 g of water. The absolute humidity in this case is thus $20\text{ g}/\text{kg}$, while the relative humidity is 100% . Under the same conditions, if the air is carrying $10\text{ g}/\text{kg}$ of water, the relative humidity is 50% . Relative humidity, or RH, is thus the ratio of the absolute humidity to the maximum possible absolute humidity.

If a body of air which has an RH of say 80% and a temperature of $30\text{ }^\circ\text{C}$ is cooled, there will come a point when the relative humidity reaches 100% : condensation will form. This temperature is called the dew point. In meteorology the dew point is an important indicator for predicting mist and fog. If the evening temperature is close to the dew point, there is a very high probability of fog in the night. Furthermore, the lowest night-time temperature can be estimated from a measurement of the dew point temperature in the evening.

In electronics shops and on the Internet humidity sensors are easy to come by. Unfortunately they tend to either be cheap and offer poor accuracy, or offer good accuracy, but at a cost.

Electronic measurement of humidity is generally done using a capacitive sensor. The result is subject to an error of between 1% and 10% , giving rise to large differences from device to device because of discrepancies in calibration. A very accurate technique is to use a dew point hygrometer. Here the condensation of water vapour on a mirror surface when the dew point is reached is detected using an optical sensor. The technique is highly accurate, but, of course, also rather expensive.

The measurement system described below determines the temperature, the relative humidity and hence the absolute humidity and the dew point to an extremely high degree of accuracy.

The SHT11 module

The measurement device in this system is the SHT11 single-chip sensor module from Sensirion, which provides calibrated digital readings of relative humidity and temperature over a digi-

tal interface. The use of an industrial CMOS manufacturing process in combination with a subsequent processing stage called 'CMOSens technology' guarantees high reliability and excellent long-term stability. The sensor, which is the size of a match head (7.5 mm by 5.0 mm by 2.5 mm) is shown in **Figure 1**. It includes two calibrated sensors, for temperature and relative humidity, integrated on a single chip with a 14-bit A/D converter. The digital two-wire interface allows connection to a microcontroller. Further advantages include long-term

stability, low drift and a short response time of 4 s .

Its excellent signal quality and good interference rejection characteristics make the sensor module a particularly attractive choice. At the factory, each sensor is calibrated in a precision humidity-controlled chamber, and the calibration coefficients are stored in OTP memory on the chip. During measurements, these values are used to process the internal sensor signals. Application areas for the SHT11 range from greenhouse monitoring, through climate control for animal enclosures,

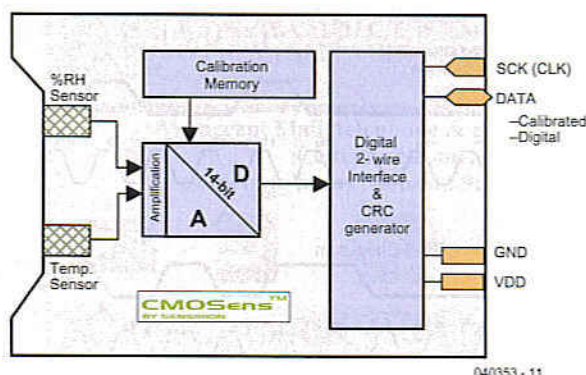

040353 - 11

Figure 1. Internal block diagram of the SHT11.

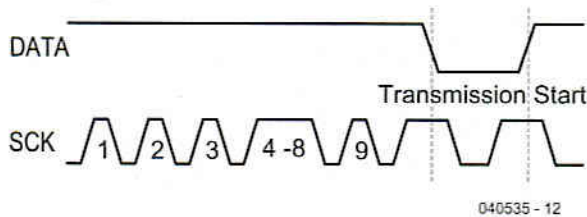

Figure 2. Initialising the interface.

Table 1. Overview of commands.

Command	Code
Reserved	0000x
Measure temperature	00011
Measure humidity	00101
Read status register	00111
Write status register	00110
Reserved	0101x - 1110x
Soft reset	11110

Table 2. Coefficients required to calculate humidity.

SO _{RH}	c1	c2	c3
12 bit	-4	0.0405	-2.8 · 10 ⁻⁶
8 bit	-4	0.648	-7.2 · 10 ⁻⁴

to ventilation and process control systems.

Current consumption

The sensor requires a readily-provided 2.4 V to 5.5 V power supply voltage. The voltage source should be stable,

as variations can directly affect the measured values. After power is applied there is a delay of about 11 ms before the sensor is ready for the first measurement command. The current consumption of the sensor in operation is about 550 µA, and in sleep mode is about 1 µA, which is negligible for all practical purposes.

Serial two-wire interface

The bidirectional serial two-wire interface offered by the SHT sensor module is similar to, but not directly compatible with, the I²C interface: the role of the master continuously switches from controller to sensor and back again. The SCK connection (serial clock input) serves to synchronise the sensor with the connected microcontroller, while data are sent to and from the sensor using the DATA pin. The data pin is tristatable; it changes on the falling edge of SCK and is validated by the rising edge. The data pin is provided with a pull-up resistor and can be pulled low when needed by the master (the microcontroller).

Command transmission

To initiate a measurement the 'transmission start' sequence must be sent to the sensor. This entails pulling down the DATA line while SCK remains high, followed by an active-low pulse on SCK, after which the DATA line rises again (see Figure 2). The command which follows consists of three address bits and five instruction bits. At present only address 000 is supported. The instruction bits for a temperature measurement are 00011, while those for a humidity measurement are 00101. The complete command set for the sensor is shown in Table 1.

After sending the command the microcontroller must wait until the sensor completes the measurement. This takes about 11 ms for an 8-bit measurement, 55 ms for a 12-bit measurement and 210 ms for a 14-bit measurement. The sensor indicates that a measurement is complete by pulling the data line to ground. The microcontroller must wait for this 'data ready' signal and then restart SCK. Two bytes of data can now be read out (more significant first), followed by a one-byte CRC checksum. The microcontroller acknowledges receipt of each byte by pulling the data line low. The acknowledge bit after the CRC marks the end of the communication.

If the CRC checksum is not to be used the microcontroller can terminate the communication immediately after the

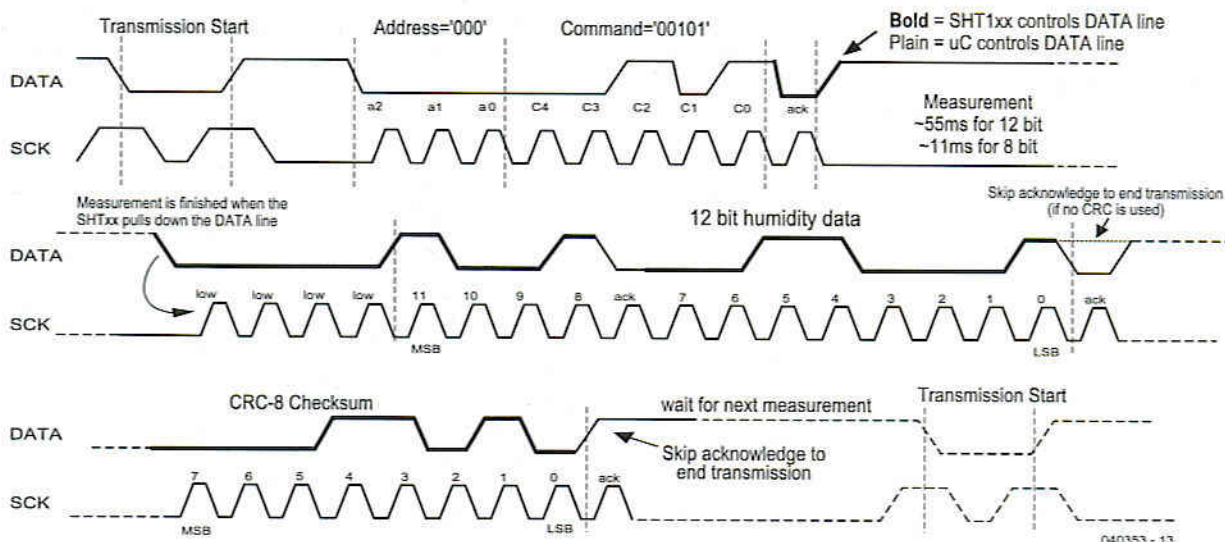

Figure 3. Timing diagram for transferring a single reading.

LSB has been received by taking the data line high for the following acknowledge bit.

If communication is interrupted, the serial interface of the sensor can be reset using the sequence of signals shown in **Figure 3**. Nine or more SCK pulses with DATA held high, followed by a transmission start sequence, will reset the interface so that a new command can be sent.

Processing the readings

From this point on it is just a matter of calculation: the sensor data have been transferred to the microcontroller and it is an easy job to convert these values into a temperature result in °C and a relative humidity RH.

Since the temperature sensor is highly linear, it is very easy to convert the output value SO_{Temp} into the actual temperature value:

$$T = d1 + (d2 \times SO_{Temp})$$

With a 5 V power supply, d1 is -40 °C. For a 14-bit reading, d2 is 0.01 °C, for a 12-bit reading 0.04 °C. Values for other voltages and for conversion to the Fahrenheit scale appear in the data sheet.

A more complicated equation is needed to compensate for the non-linearity of the humidity sensor:

$$RH_{linear} = c1 + (c2 SO_{RH}) + (c3 \times SO_{RH}^2)$$

The constants c1, c2 and c3 are given in **Table 2**. A simpler (and correspondingly less accurate) calculation is described in the application note 'Non-Linearity Compensation'.

At temperatures far from 25 °C the temperature coefficient of the humidity sensor needs to be taken into account:

$$RH_{comp} = (T - 25 \text{ °C}) \times [0.01 + (t2 \times SO_{RH})] + RH_{linear}$$

Coefficient t2 is 0.00008 for a 12-bit measurement, and 0.00128 for an 8-bit measurement.

A complete system

The author has designed a measurement system based on the SHT11 sensor and an Atmel ATmega8 microcontroller. The circuit and a description of the system which offers an internal and an external sensor, along with printed circuit board layouts and software, are available for free download from the *Elektor Electronics* website at www.elektor-electronics.co.uk. Please note that the above information has not been post-engineered by the Elektor lab, or checked by editorial staff.

The original Sensirion data sheet and application notes are available for download from the manufacturer's website at www.sensirion.com.

(040053-1)

Advertisement



CD-ROM ECD

Now extended with even more ICs, transistors, FETs, thyristors and triacs!



ISBN 90-5381-159-1
£12.95 (US\$ 22.90)

Elektor's Components Database gives you easy access to design data for over 5,700 ICs, more than 35,000 transistors, FETs, thyristors and triacs, just under 25,000 diodes and 1,800 optocouplers. All databank applications are fully interactive, allowing the user to add, edit and complete component data.

Order now using the Order Form in the Readers Services section in this issue.

Elektor Electronics (Publishing)
P.O. Box 190
Tunbridge Wells TN5 7WY
ENGLAND
Tel. +44 (0) 1580 200 657

More information on www.elektor-electronics.co.uk

DON'T LOSE YOUR TEMPER

Before phoning us - if you are looking for a hard-to-find part. We have over 20,000 items in stock - including obsolete and up-to-date parts.



WHY NOT VISIT OUR WEBSITE
www.cricklewoodelectronics.com

2N 2SA 2SB 2SC 2SD 2P 2SJ 2SK 3N 3SK 4N 6N 17 40 AD
ADC AN AM AY BA BC BD BDT BDV BDW BDX BF
BFR BFS BFT BFX BFY BLY BLX BS BR BRX BRY BS
BSS BSV BSW BSX BT BTA BTB BRW BU BUK BUT BUV
BUW BUX BUY BUZ CA CD CX CXA DAC DG DM DS
DTA DTC GL GM HA HCF HD HEF ICL ICM IRF J KA
KIA L LA LB LC LD LF LM M M5M MA MAB MAX MB
MC MDAJ MJE MJF MM MN MPS MPSA MPSH MPSU
MRF NJM NE OM OP PA PAL PIC PN RC S SAA SAB
SAD SAJ SAS SDA SG SI SL SN SO STA STK STR STRD
STRM STRS SVI T TA TAA TAG TBA TC TCA TDA TDB
TEA TIC TIP TIPL TEA TL TLC TMP TMS TPU U UA
UAA UC UDN ULN UM UPA UPC UPD VN X XR Z ZN
ZTX+ many others

We accept Mail, telephone & email orders.
Callers welcome.

Opening hours Mon-Sat 9:30 - 6:00

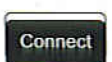

Cricklewood Electronics Ltd

40-42 Cricklewood Broadway London NW2 3ET

Tel: 020 8452 0161 Fax: 020 8208 1441

sales@cricklewoodelectronics.com

5.1 SURROUND SWITCH BOX

simple but extremely useful

Ton Giesberts

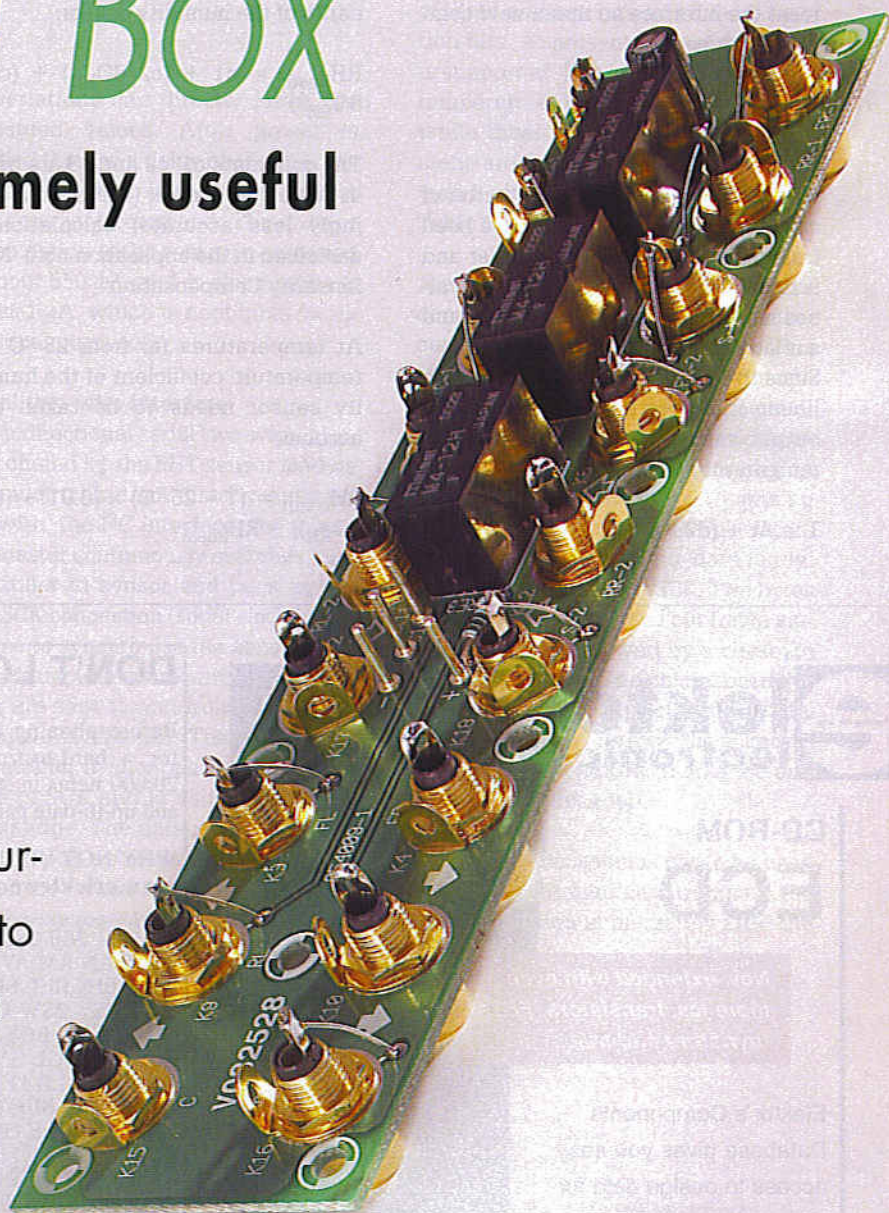

Of necessity, today's (surround) amplifiers have to come with lots of inputs and outputs. However, a problem occurs if you want to use several signal sources having an analogue 5.1 output: there's only one compatible input available! The switch box described in this article solves the problem in a simple and elegant way.

Surround sound equipment has become widespread and is quickly invading our living rooms. The 5.1 standard is not just used in the DVD player — a SACD player will also have one (SA stands for Super Audio), while modern PC soundcards have a plethora of signal outputs. Unfortunately, it is hard to find an amplifier with more than one 5.1 Surround Sound input. Although switch boxes are available commercially, their price tags make home construction a necessity rather than a luxury. Here is the proof.

Three relays

The design is as simple as it is effective, allowing you to switch between two 5.1 signal sources. We're using three relays with double-pole changeover contacts. This is done to make sure one input group is always connected through even if there is no supply voltage on the relays. Switch S1 enables the signal sources to be routed appropriately. Network R1/C1 serves to debounce the switch contact.

At about 35 mA (at 12V), the current consumption of the relays is a little too high to enable the circuit to be powered by a battery pack. That is why we recommend using a small mains adapter. The relays used here will work reliably even down to 5.9 volts. Such a low voltage causes the current demand to drop a little.

The motivation for the use of relays as switches is their fairly good price/performance ratio and availability. Of course, switches are passive, requiring no supply voltage at all. However, within the same price class, relay contacts are not only better, but also more reliable than the traditional switch. Incidentally, the parts list indicates a generic, industry standard relay, allowing you to apply other, compatible types as well.

Double-sided board

In order to keep it as compact as possible, the project is built on a double-sided printed circuit board (PCB). The artwork is based on the use of cinch sockets with a 6.3-mm thread. Apparently there are also sockets with a thread of 7.2 mm or even larger. If these larger sockets are used, the rele-

Measurement results

(outputs loaded with 10 k Ω)

Current consumption:	ca. 35 mA (switched on) 0 (switched off)
Channel separation:	>87 dB (1 kHz) 60 dB (20 kHz)
Crosstalk	<88 dB (1 kHz) <63 dB (20 kHz)

vant PCB holes have to be made a little larger. This will remove the through-plating but that is of little consequence as the sockets themselves will establish a contact between the

top and underside of the board. If you use a larger type socket, you have to prevent the nut from creating a short-circuit with the signal connection or the positive supply track for the relays.

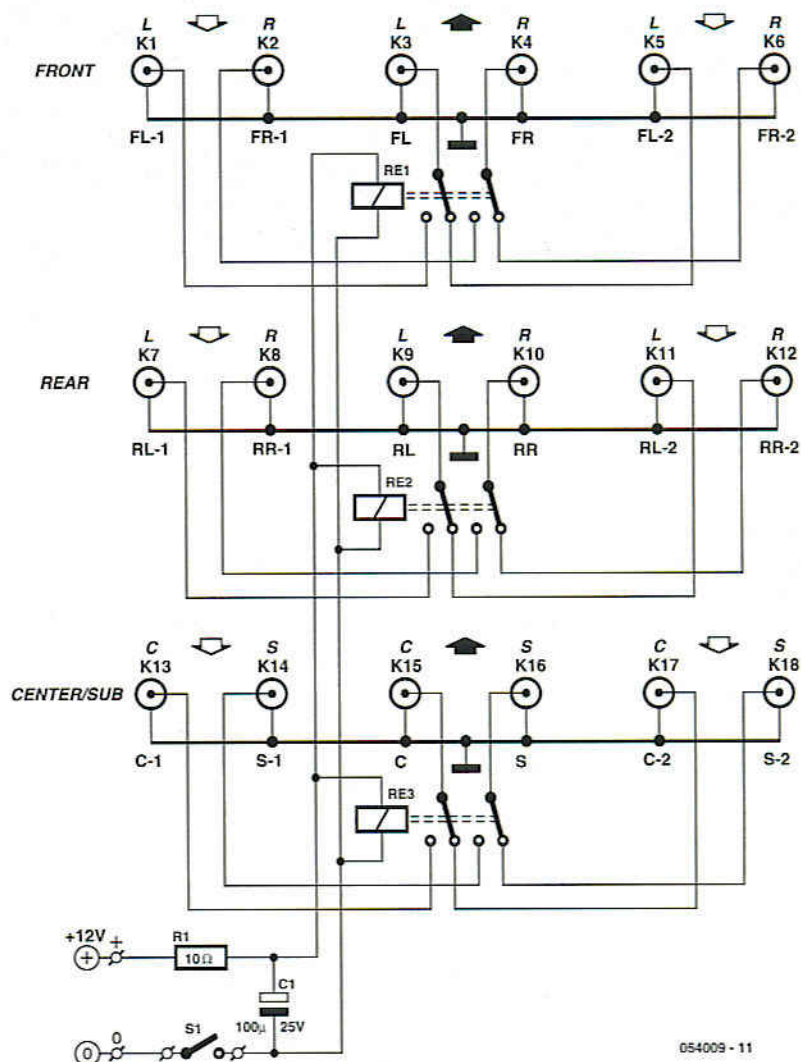

Figure 1. The circuit diagram excels in simplicity.

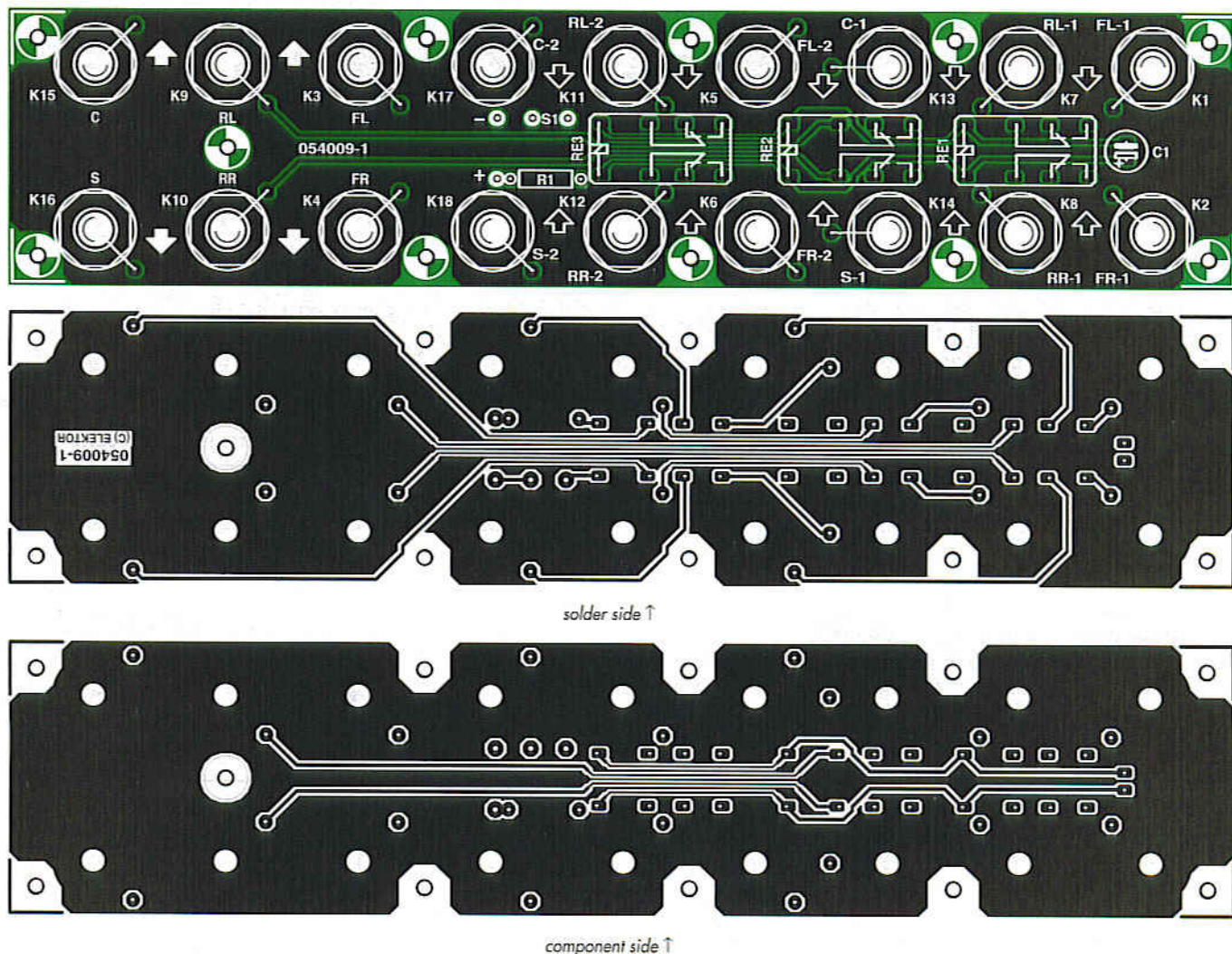

Figure 2. The PCB has been designed for maximum channel separation (note the earth plane running between signal lines).

The connection labels printed on the Elektor PCB are of course, free to adapt to your own wishes. For best results, one of the relay supply

lines has to be connected to the signal ground. This is done to eliminate the effect of the relay coil on the signals. Because the supply floats with respect

to the signal voltage, it makes no difference if you connect the positive or negative supply line. The enclosure is preferably a metal type. Do ensure a proper connection between the case and ground of one of the input or output sockets. The mains adapter may be connected to the circuit by a low voltage DC supply socket for chassis mounting.

Our audio lab measurements on the circuit indicated that most cross-talk between two channels is caused by the contacts in one relay. The separation between the other signals was greater than 100 dB. The circuit is open to countless variations and we wish you lots of fun building and using the switch box!

COMPONENTS LIST

Resistor:
R1 = 10Ω

Capacitor:
C1 = 100 μF 25V radial

Miscellaneous:
K1-K18 = cinch socket, chassis mount, gold-plated, 6.3mm threading
S1 = switch, 1 make contact
RE1, RE2, RE3 = 12V relay, 2 changeover contacts, e.g., Meisei M4-12H 960 Ω/12 V (Conrad Electronics order code 505170) or equivalent.
PCB, ref. 054009-1 from ThePCBShop

(054009-1)

Visit our website
www.distel.co.uk

THE ORIGINAL SURPLUS WONDERLAND!

THIS MONTH'S SELECTION FROM OUR VAST EVER CHANGING STOCKS

Surplus always
wanted for cash!

GIANT 10" 7 SEGMENT DISPLAYS

A bulk purchase enables us to bring to you these GIANT 7 segment digital displays at a now affordable price! The 10" character size gives exceptional readability at long distances and enables a host of applications including score boards, digital clocks, counters, event timers etc. As the units are a simple electromechanical device and operate from 12V DC, simple switching via switches, relays, PIC or PC may be used to control single or multiple digits. Units feature integral Zero Power memory which greatly simplifies design. For an excellent DIY practical article, see the May issue of 'Everyday & Practical Electronics' magazine, Ideal School / College construction project. Supplied in good RFE condition, complete with data sheet.



Less than 30% Only £29.95(B) or 4 / £99.00(D) of makers price!

Order RW44

Order PH26

THE AMAZING TELEBOX



TV SOUND & VIDEO TUNER
CABLE COMPATIBLE

Converts your colour monitor into a QUALITY COLOUR TV!!

The TELEBOX is an attractive fully cased mains powered unit, containing all electronics ready to plug into a host of video monitors or AV equipment which are fitted with a composite video or SCART input. The composite video output will also plug directly into most video recorders, allowing reception of TV channels not normally receivable on most television receivers (TELEBOX MB). Push button controls on the front panel allow reception of 8 fully tuneable off air UHF colour television channels. TELEBOX MB covers virtually all television frequencies VHF and UHF including the HYPERBAND as used by most cable TV operators. Ideal for desktop computer video systems & PIP (picture in picture) setups. For complete compatibility - even for monitors without sound - an integral 4 watt audio amplifier and low level Hi Fi audio output are provided as standard. Brand new - fully guaranteed.

TELEBOX ST for composite video input type monitors £36.95
TELEBOX STL as ST but fitted with integral speaker £39.50
TELEBOX MB Multiband VHF/UHF/Cable/Hyperband tuner £69.95
For overseas PAL versions state 5.5 or 6 mHz sound specification.
*For cable / hyperband signal reception TELEBOX MB should be connected to a cable type service. Shipping on all Teleboxes, code (B)

NEW State of the art PAL (UK spec) UHF TV tuner module with composite 1V pp video & NICAM hi fi stereo sound outputs. Micro electronics all on one small PCB only 73 x 160 x 52 mm enable full tuning control via a simple 3 wire link to an IBM pc type computer. Supplied complete with simple working program and documentation. Requires +12V & +5V DC to operate. **BRAND NEW - Order as MY00. Only £39.95 code (B)**
See www.distel.co.uk/data_my00.htm for picture & full details

HARD DISK DRIVES 2 1/2" - 14"

2 1/2" TOSHIBA MK1002MAV 1.1Gb laptop (12.5 mm H) New £59.95
2 1/2" TOSHIBA MK4313MAT 4.3Gb laptop (8.2 mm H) New £105.00
2 1/2" TOSHIBA MK6409MAV 6.1Gb laptop (12.7 mm H) New £98.00
2 1/2" TOSHIBA MK1814GAV 18 Gb laptop (12 mm H) New £149.95
2 1/2" to 3 1/2" conversion kit for Po's, complete with connectors £15.95
3 1/2" COMPAQ 313706-B21 (IBM) 9 gb ULT/SCSI3 New £199.00
3 1/2" FUJITSU 309-26 20mb MFM I/F RFE £59.95
3 1/2" CONNER CP3024 20 mb IDE I/F (or equiv.) RFE £59.95
3 1/2" CONNER CP3044 40 mb IDE I/F (or equiv.) RFE £69.00
3 1/2" QUANTUM 40S Prodrive 42mb SCSI I/F, New RFE £49.00
5 1/4" MINISCRIBE 3425 20mb MFM I/F (or equiv.) RFE £49.95
5 1/4" SEAGATE ST-238R 30 mb RLL I/F RFE £69.95
5 1/4" CDC 94205-51 40mb HH MFM I/F RFE tested £69.95
5 1/4" HP 97548 650 Mb SCSI RFE tested £99.00
5 1/4" HP C3010 2 Gbyte SCSI differential RFE tested £195.00
6" NEC D2246 65 Mb SMD interface. New £99.00
6" FUJITSU M2322K 160Mb SMD I/F RFE tested £195.00
6" FUJITSU M2392K 2 Gb SMD I/F RFE tested £345.00
Many other floppy & H drives, IDE, SCSI, ESDI etc from stock, see website for full stock list. Shipping on all drives is code (C)

TEST EQUIPMENT & SPECIAL INTEREST ITEMS

MITSUBISHI FA3445ETKL 14" ind. spec SVGA monitors £245
FARNELL 0-60V DC @ 50 Amps, bench Power Supplies £995
FARNELL AP3080 0-30V DC @ 80 Amps, bench Supply £1850
KINGSHILL CZ403/1 0-50V @ DC 200 Amps - NEW £3950
1KW to 400 kHz - 400 Hz 3 phase power sources - ex stock EPOA
IBM 8230 Type 1, Token ring base unit driver £760
Wayne Kerr RA200 Audio frequency response analyser £2500
IFODEC 1U, 24 port, RJ45 network patchpanels, #TH93 £49
3COM 16670 12 Port Ethernet hub - RJ45 connectors #LD97 £69
3COM 16671 24 Port Ethernet hub - RJ45 connectors £89
3COM 16700 8 Port Ethernet hub - RJ45 connectors NEW £39
IBM 53F5001 Token Ring IC5 20 port lobe module EPOA
IBM MAU Token ring distribution panel 8228-23-5050N £45
AIM 501 Low distortion Oscillator 9Hz to 330KHz, IEEE I/O £550
ALLGON 8360, 11805-1880 MHz hybrid power combiners £250
Trend DSA 274 Data Analyser with G703(2M) 64 I/O EPOA
Marconi 6310 Programmable 2 to 22 GHz sweep generator £4500
Marconi 2022C 10KHz-1GHz RF signal generator £1550
HP1650B Logic Analyser £3750
HP3781A Pattern generator & HP3782A Error Detector EPOA
HP6621A Dual Programmable GPIB PSU 0-7 V 160 watts £1800
HP6264 Rack mount variable 0-20V @ 20A metered PSU £475
HP54121A DC to 22 GHz four channel test set EPOA
HP1810A opt 020 300 MHz pulse generator, GPIB etc £7900
HP A1, A0 8 pen HPGL high speed drum plotters - from £550
HP DRAFTMASTER 1 8 pen high speed plotter £750
EG+G Brookdeal 95035C Precision clock in amp £1800
Keithley 590 CV capacitor / voltage analyser EPOA
Racal ICR40 dual 40 channel video recorder system £3750
Fishers 45KVA 3 ph On Line UPS - New batteries £4500
Emerson AP130 2.5KVA industrial spec UPS £1499
Mann Tally MT645 High speed line printer £2200
Intel SBC 486/133SE Multibus 486 system, 8Mb Ram £945

IC's - TRANSISTORS - DIODES

OBSELETE - SHORT SUPPLY - BULK
10,000,000 items EX STOCK
For MAJOR SAVINGS
CALL or see web site www.distel.co.uk
COMPUTER MONITOR SPECIALS

Legacy products
High spec genuine multisync.
CGA, EGA, VGA, SVGA

Mitsubishi FA3445ETKL 14" SVGA Multisync colour monitor with fine 0.28 dot pitch tube and resolution of 1024 x 768. A variety of inputs allows connection to a host of computers including IBM PC's in CGA, EGA, VGA & SVGA modes, BBC, COMMODORE (including Amiga 1200), ARCHIMEDES and APPLE. Many features: Etched faceplate, text switching and LOW RADIATION MPR specification. Fully guaranteed, in EXCELLENT like used condition. Tilt & Swivel Base £475

VGA cable for IBM PC included. Order as CG73
Only £129 (E)

External cables for other types of computers available - CALL
Generic LOW COST SVGA Monitors
We choose the make, which includes Compaq, Mitsubishi, IBM, etc. Supplied ready to run with all cables, Standard RTB 90 day guarantee.

14" £59.00 order TD84	15" £69.00 order TG21	17" £79.00 order TJ66
-----------------------------	-----------------------------	-----------------------------

Supplied in good used condition. Shipping code (D)

VIDEO MONITORS

PHILIPS HCS35 (same style as CM8833) attractively styled 14" colour monitor with both RGB and standard composite 15.625 KHz video inputs via SCART socket and separate phono jacks. Integral audio power amp and speaker for all audio visual uses. Will connect direct to Amiga and Atari BBC computers. Ideal for all video monitoring / security applications with direct connection to most colour cameras. High quality with many features such as front concealed flap controls, VCR correction button etc. Good used condition - fully tested - guaranteed
Dimensions: W14" x H12 1/2" x 15 1/2" D.
Only £99.00 (D)
PHILIPS HCS31 Ultra compact 9" colour video monitor with standard composite 15.625 KHz video input via SCART socket. Ideal for all monitoring / security applications. High quality, ex-equipment fully tested & guaranteed (possible minor screen burn). In attractive square black plastic case measuring W10" x H10" x 13 1/2" D. 240 V AC mains powered.
Only £79.00 (D)

INDUSTRIAL COMPUTERS

Tiny shoebox sized industrial 40 Mhz 386 PC system measuring only (mm) 266 x 5 X 88 h X 272 d. Ideal for dedicated control applications running DOS, Linux or even Windows! Steel case contains 85 to 265 V AC 50 / 60 Hz 70 Watt PSU, a 3 slot ISA passive backplane and a Rocky 318 (PC104) standard, single board computer with 8 MByte NON VOLATILE solid state 'Disk On Chip' RAMDISK. System comprises: Rocky 318 (PC104) SBC ISA card with 40MHz ALI 386SX CPU, 72 pin SIMM slot with 16 MByte SIMM, AMI BIOS, battery backed up real time clock, 2 x 9 pin D 16550 serial ports, EPP/ECF printer port, mini DIN connector, floppy port, IDE port for hard drives up to 528 MByte capacity, watchdog timer and PC/104 bus socket. The 8 MByte solid state 'disk on a chip' has its own BIOS, and can be formatted, formatted & booted. Supplied BRAND NEW fully tested and guaranteed. For full data see featured item on website. Order as QG36
100's of applications inc:
firewall, routers, robotics etc
Only £99.00 (D)

Unless marked NEW, items in this section are pre owned.

HP6030A 0-200V DC @ 17 Amps bench power supply £1950
Intel SBC 486/125C08 Enhanced Multibus (MSA) New £1150
Nikon HFX-11 (Ephiphot) exposure control unit £1450
PHILIPS VM5518 pro. TV signal generator £1250
Motorola VME Bus Boards & Components List, SAE / CALL EPOA
Trio 0-18 vdc linear, metered 30 amp bench PSU. New £550
Fujitsu M3041R 600 LPM printer with network interface £1950
Siemens K4400 64Kb to 140Mb demux analyser £2250
Perkin Elmer 299B infrared spectrophotometer £500
Perkin Elmer 597 infrared spectrophotometer £3500
VG Electronics 1035 TELETEXT Decoding Margin Meter £3250
LightBand 60 output high spec 2u rack mount Video VDA's £495
Sekonic SD 150H 18 channel digital Hybrid chart recorder £1995
B&K 2633 Microphone pre amp £300
Taylor Hobson Talysurf amplifier / recorder £750
ADC SS200 Carbon dioxide gas detector / monitor £1450
BBC AM20/3 PPM Meter (Emest Turner) + drive electronics £75
ANRITSU 9654A Optical DC-2.5Gb waveform monitor £5650
ANRITSU ML93A optical power meter £990
ANRITSU Fibre optic characteristic test set EPOA
R&S FTDZ Dual sound unit £650
R&S SBUF-E1 Vision modulator £775
WILTRON 6630B 12.4 / 20GHz RF sweep generator £5750
TEK 2445 150 MHz 4 trace oscilloscope £1250
TEK 2465 300 MHz 300 MHz oscilloscope rack mount £1955
TEK TDS380 400Mhz digital realtime + disk drive, FFT etc £2900
TEK TDS524A 500Mhz digital realtime + colour display etc £5100
HP3585A Opt 907 20Hz to 40 Mhz spectrum analyser £3950
PHILIPS PW1730/10 60KV XRAY generator & accessories EPOA
VARIACS - Large range from stock - call or see our website
CLAUDE LYONS 12A 240V single phase auto. volt. regs £325
CLAUDE LYONS 100A 240V/415V 3 phase auto. volt. regs £2900

19" RACK CABINETS

Europe's Largest Stocks of
quality rack cabinets,
enclosures and accessories.
Over 1000 Racks from stock

This month's special
33 / 42 / 47 U - High Quality
All steel Rack Cabinets

Made by Eurocraft Enclosures Ltd to the highest possible spec, rack features all steel construction with removable side, front and back doors. Front and back doors are hinged for easy access and all lockable with five secure 5 lever barrel locks. The front door is constructed of double walled steel with a 'designer style' smoked acrylic front panel to enable status indicators to be seen through the panel, yet remain unobtrusive. Internally the rack features fully slotted reinforced vertical fixing members to take the heaviest of 19" rack equipment. The two movable vertical fixing struts (extras available) are pre punched for standard 'cage nuts'. A mains distribution panel internally mounted to the bottom rear, provides 8 x IEC 3 pin Euro sockets and 1 x 13 amp 3 pin switched utility socket. Overall ventilation is provided by fully louvred back door and double skinned top section with top and side louvres. The top panel may be removed for fitting of integral fans to the sub plate etc. Other features include: fitted castors and floor levelers, prepunched utility panel at lower rear for cable / connector access etc. Supplied in excellent, slightly used condition with keys. Colour Royal blue, some grey available - CALL - Can be supplied in many other configurations.



33U Order as BC44 External dimensions mm=1625H x 635D x 603 W. (64" H x 25" D x 23 3/4" W) Only £245	42U Order as DT20 External dimensions mm=2019H x 635D x 603 W. (79 5/8" H x 25" D x 23 3/4" W) Only £345	47U Order as RV36 External dimensions mm=2235H x 635D x 603 W. (88" H x 25" D x 23 3/4" W) Only £410
---------------------------------------------------------------------------------------------------------------------------	-------------------------------------------------------------------------------------------------------------------------------	---------------------------------------------------------------------------------------------------------------------------

Call for shipping quotation

COLOUR CCD CAMERAS

Undoubtedly a miracle of modern technology & our special buying power! A quality product featuring a fully cased COLOUR CCD camera at a give away price! Unit features full autolight sensing for use in low light & high light applications. A 10 mm fixed focus wide angle lens gives excellent focus and resolution from close up to long range. The composite video output will connect to any composite monitor or TV (via SCART socket) and most video recorders. Unit runs from 12V DC so ideal for security & portable applications where mains power not available. Overall dimensions 66 mm wide x 117 deep x 43 high. Supplied BRAND NEW & fully guaranteed with user data, 100's of applications including Security, Home Video, Web TV, Web Cams etc, etc.
Order as LK33 ONLY £79.00 or 2 for £149.00 (B)

SOFTWARE SPECIALS

NT4 WorkStation, complete with service pack 3 and licence - OEM packaged. ONLY £89.00 (B)
ENCARTA 95 - CDROM, Not the latest - but at this price! £7.95
DOS 5.0 on 3 1/2" disks with concise books c/w QBasic £14.95
Windows for Workgroups 3.11+ Dos 6.22 on 3.5" disks £55.00
Windows 95 CDROM Only - No Licence £19.95
Wordperfect 6 for DOS supplied on 3 1/2" disks with manual £24.95
shipping charges for software is code B

SOLID STATE LASERS

Visible red, 670nm laser diode assembly. Unit runs from 5 V DC at approx 50 mA. Originally made for continuous use in industrial barcode scanners, the laser is mounted in a removable solid aluminium block, which functions as a heatsink and rigid optical mount. Dims of block are 50 w x 50 d x 15 h mm. Integral features include over temperature shutdown, current control, laser OK output, and gated TTL ON / OFF. Many uses for experimental optics, comms & lightshows etc. Supplied complete with data sheet.
Order as TD91 ONLY £24.95 (A)

DC POWER SUPPLIES

Virtually every type of power supply you can imagine. Over 10,000 Power Supplies Ex Stock - Call or see our web site.

RELAYS - 200,000 FROM STOCK

Save ££££'s by choosing your next relay from our Massive Stocks covering types such as Military, Octal, Cradle, Hermetically Sealed, Continental, Contactors, Time Delay, Reed, Mercury Wetted, Solid State, Printed Circuit Mounting etc... CALL or see our web site www.distel.co.uk for more information. Many obsolete types from stock. Save ££££'s

DISPLAY
-ELECTRONICS-

ALL MAIL TO
Dept EK, 29 / 35 Osborne Rd
Thornton Heath
Surrey CR7 8PD, UK
Open Mon - Fri 9.00 - 5.30

18 Million Items On Line Now!
Secure Ordering, Pictures, Information
www.distel.co.uk
email = admin@distel.co.uk

ALL ENQUIRIES
0208 653 3333
FAX 0208 653 8888

MasterCard VISA

All prices for UK Mainland, UK customers add 17.5% VAT to TOTAL order amount. Minimum order £10. Bondi Fide account orders accepted from Government, Schools, Universities and Local Authorities - minimum account order £100. Cheques over £100 are subject to 7 working days clearance. Carriage charges (A)=£3.50, (B)=£6.50, (C)=£10, (D)=£15.00, (E)=£18.00, (F)=CALL. Allow approx 3 days for shipping - faster CALL. All goods supplied to our Standard Conditions of Sale which can be viewed at our website and unless stated guaranteed for 90 days. All guarantees on a return to base basis. All rights reserved to change prices / specifications without prior notice. Orders subject to stock. Discounts for volume. Top CASH prices paid for surplus goods. All trademarks, tradenames etc acknowledged. © Display Electronics 2002. E & O.E.

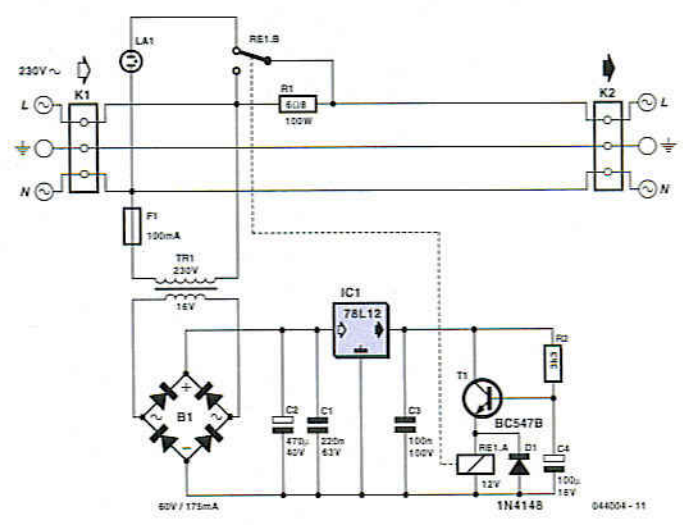
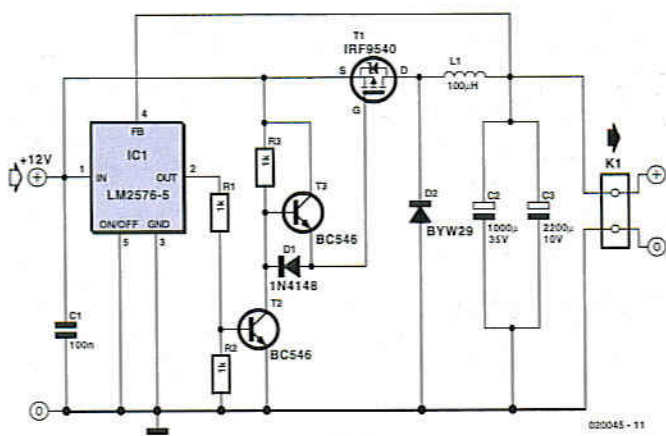

More Current from an LM2575

A. Vogel

The LM2575 is a 'Simple Switcher' from National Semiconductor, which means it's a switch-mode controller IC that's relatively easy to use. The members of the Simple Switcher family are designed for output currents of 1 A, 3 A and 5 A. However, sometimes even more current is necessary. A 'professional' designer solves this problem by using a PWM controller with an external power MOSFET, but such controllers (and integrated controllers with even higher output currents) are rather expensive, difficult to obtain and highly susceptible to design errors. The best solution is thus to increase the output current of a Simple Switcher. This can be done by using the output signal to drive an external power switch in the form of a p-channel MOSFET with a low 'on' resistance. The Simple Switcher, in this case an LM2576, is only used as a switching circuit. When its output is on (High), transistor T2 conducts and pulls the gate of the MOSFET to ground potential via D1. By contrast, T2 is cut off when the output of the

switching controller is low. The gate capacitance is then discharged via T3 and D1, causing the MOSFET to quickly switch off. Without this emitter follower, the gate capacitance could only be discharged much more slowly via R3. Seen from the outside, the circuit acts the same as a simple LM2575 (aside from the increased output current, of course). We must also mention a drawback of this arrangement: the circuit does not have short-circuit protection or overtemperature protection. This must be taken into account when it is used. The BC546 used for T2 is not especially fast. The power dissipation of T1 decreases as the edges of the gate signal are steeper. It would thus be better to use a BS170 for T2, since it is faster. If a BS170 is used for T1, the value of R1 must be chosen to keep the gate voltage below 12 V. If the input voltage is 12 V, R1 can be replaced by a wire bridge. Naturally, the output inductor must be suitable for the desired output current, and the core (as well as the output capacitors) must be suitable for use with high-frequency signals. The following considerations must be borne in mind in designing the circuit board. First, conductors carrying

high currents must be as short and broad as possible. In addition, currents flowing into the inductor and electrolytic capacitors must be kept separate from currents flowing out of these components. Finally, the feedback path must never pass through the magnetic field of the inductor.

Author's home page: <http://www.aca-vogel.de>

LM2576 datasheet www.national.com/pf/LM/LM2576.html

(020045-1)

Inrush Current Limiter

Alexandr Smertenko

In many households, computers are switched on with all of their peripherals at the same time. As these devices are normally fitted with switch-mode power supplies, which briefly draw very high currents when first switched on, it may happen that the fuse blows or the circuit breaker trips (just as with heavy-duty electrical tools). The circuit described here provides versatile, competent protection against extremely high inrush currents, all at a reasonable cost.

simple and effective. When power is switched on, the current is limited to around 14–15 A by a high-power series resistor (R1). At the same time, a dc voltage generated by a small power supply starts charging C4 via R2. When the voltage on the capacitor reaches 0.7 V after a good half a second, T1 passes enough current to energise the relay and short out the series resistor. The load is thus directly connected to the mains. The only luxury in the circuit is a neon lamp that lights up while current limiting is active. If the lamp does not go out immediately after the power is switched on, something is wrong and the series resistor is at risk of going up in smoke, despite its impressive power rating of 100 W.

Its operating principle is both

(041004-1)

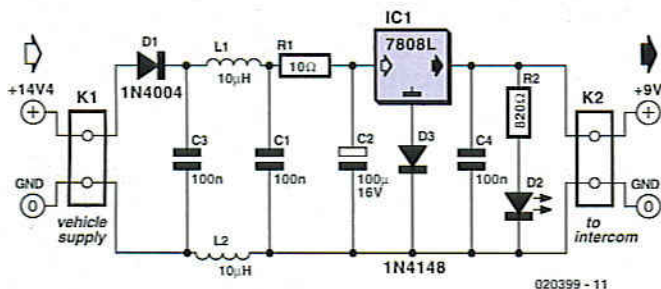

9-V Battery Replacement

Lex de Hoo

This circuit was originally designed to power a motorcycle intercom from the vehicle supply system. This type of intercom, which is used for communication between driver and passenger, generally requires quite a bit of power. In order to improve intelligibility there is often elaborate filtering and a compander is sometimes used as well. The disadvantage is that a battery doesn't last very long. You could use rechargeable batteries, of course, but that is often rather laborious. It seems much more obvious to use the motorcycle power supply instead.

A 9-V converter for such an application has to meet a few special requirements. For one, it has to prevent interference from, for example, the ignition system reaching the attached circuit. It is also preferable that the entire circuit fits in the 9-V battery compartment. This circuit meets these requirements quite successfully and the design has nonetheless remained fairly simple. In the

schematic we can recognise a filter, followed by a voltage regulator and a voltage indicator, D1, which protects the circuit against reverse polarity, is followed by an LC and an RC filter (C3/L1/L2/C1/R1/C2). This filter excludes various disturbances from the motorcycle power system. Moreover, the design with the 78L08 and D3 ensures that the voltage regulator is operating in the linear region. The nominal system voltage of 14 V can sometimes sag to about 12 V when heavy loads such as the lights are switched on.

Although the circuit is obviously suitable for all kinds of applications, we would like to mention that it has been extensively tested on a Yamaha TRX850. These tests show that the converter functions very well and that the interference suppression is excellent.

(020399-1)

A QUANTUM LEAP IN EMBEDDED CONTROLLERS

Quick FIRE SUPERCONTROLLERS

Our range provides:-

- The fastest 68000 based Core up to 66 Mhz.
- Extensive I/O:- Serial, IrDA, SPI, I²C, Analogue, Timers/Counters, RTC, etc.
- Large Memory Capacity:- Flash, SRAM, DRAM.
- Supports:- Mono & Colour LCD's, Touch Panels & Keypads, Very Low Power.

ALSO LOW COST

DEVELOPMENT

- Target easily & quickly.
- Full ANSI 'C' compiler, assembler & linker all Windows32 based.
- Source Level Debug.
- Full Driver Support with Libraries.
- Real Time Multitasking OS with a free run time licence.
- FREE Unlimited email support.

www.cms.uk.com

see our web site for full details

CAMBRIDGE MICROPROCESSOR SYSTEMS LTD



Unit 17-18 Zone 'D' Chelmsford Rd. Ind. Est.
Great Dunmow, Essex CM6 1XG
Telephone: 01371 875644
email: sales@cms.uk.com



BS2-IC

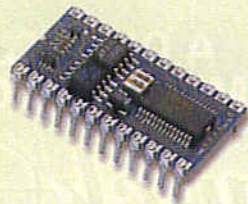

BS2-SX

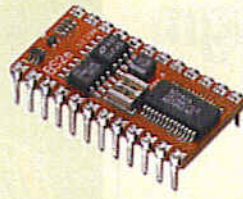

BS2E-IC

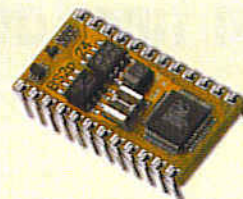

BS2P/24

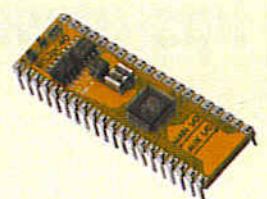

BS2P/40

Parallax BASIC Stamps - still the easy way to get your project up and running!

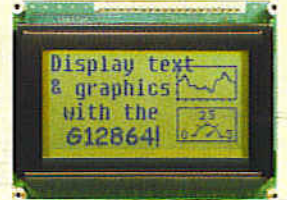
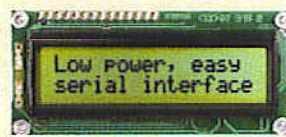
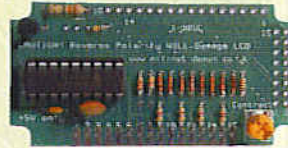
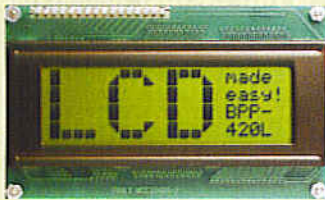

**Serial Alphanumeric and Graphic Displays,
Mini-Terminals and Bezel kits**

www.milinst.com



Animated Head



3-Axis Machine



Six-Legged Walkers

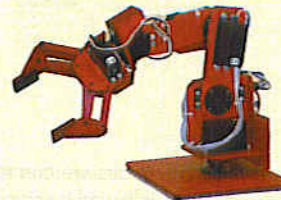

Robotic Arms



Bipeds

Robotic models for both the beginner and the advanced hobbyist

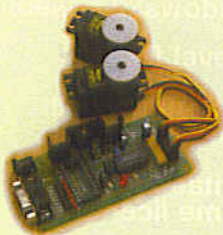

Servo Drivers

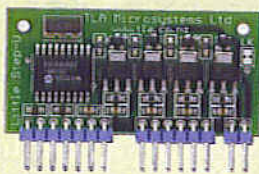

Motor Drivers

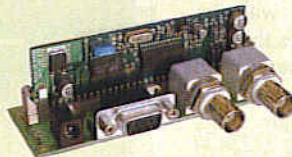

On-Screen Displays



DMX Protocol

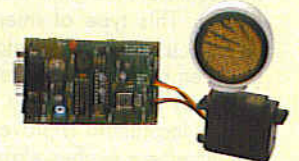

U/Sound Ranging

Animatronics and Specialist Interface-Control Modules



Quadravox
MP3 & Speech Systems



SensoryInc
Voice Recognition



Parallax
Ubicom Tool Kits



Tech-Tools
PIC & Rom Emulators

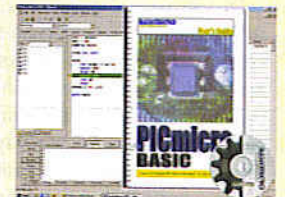

BASICMicro
PIC BASIC Compilers

Development Tools

Milford Instruments Limited Tel 01977 683665, Fax 01977 681465, sales@milinst.com

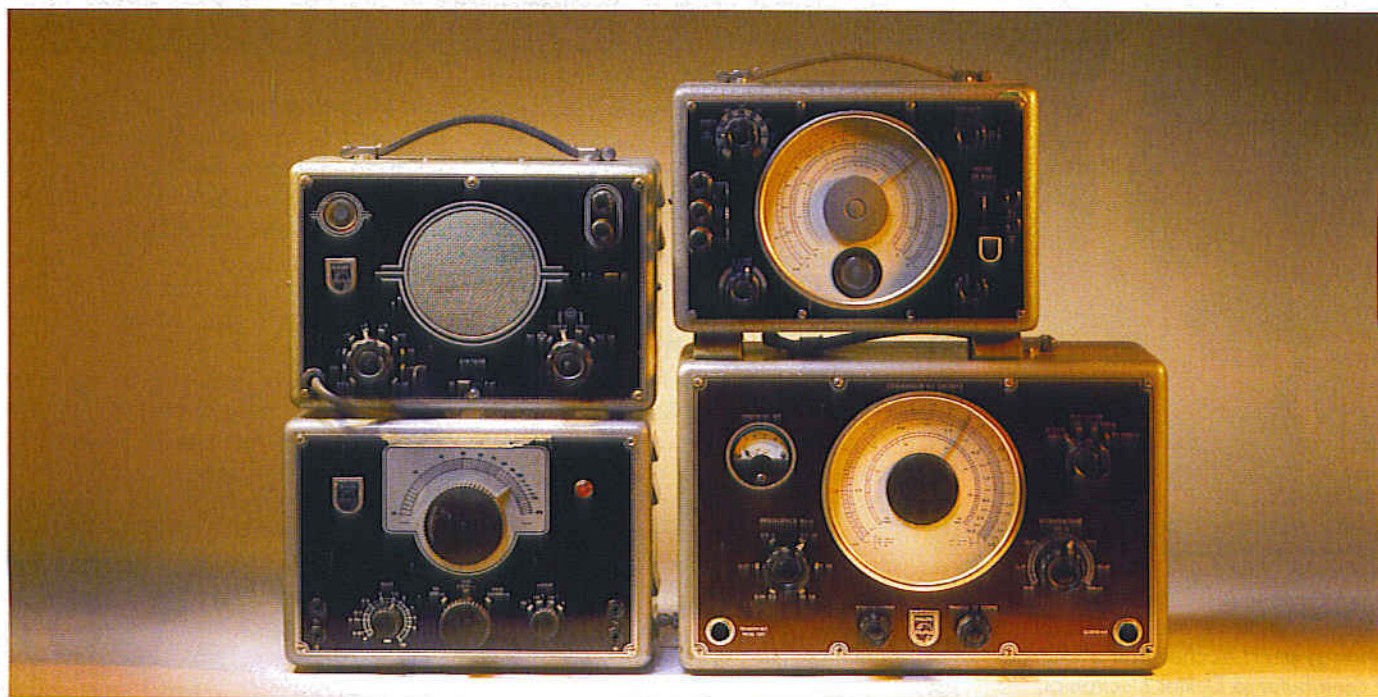

TV servicing equipment ca. 1955

Jan Buiting

Up to about 1985 radio and TV repair and servicing was a serious business providing employment to thousands of trained technicians. With the arrival of the microcontroller and dirt-cheap Far East import TV sets the noble art of repairing TV sets at the component level (one hand in pocket!) was no longer economic and disappeared in all but the lowest developed countries in the world. The last fairly authentic TV Service Chop (*sic*) I saw was in an idyllic street near Pythagorion harbour on the Greek island of Samos (yes, the birthplace of Pythagoras). The lettering on the shop window did not belie the (admittedly minimum) activity in the shop, which actually had a cluttered workbench and fair piles of 1970s test equipment. The weary-looking shop owner, an English expatriate, I would describe as an old hippy. In most European countries, the TV set took about ten years to

become an affordable and common electrical item in households. The equipment shown in the picture dates from about 1955 and was Philips' way to give backing to their massive sales of early TV sets (all with valves, of course). Retailers selling Philips TV sets would also install Philips test equipment in the service and repair department.

The photograph shows three items typically found therein in the mid-1950's, and one perhaps less usual instrument. The large instrument is a GM2893 RF Signal Generator for 90 kHz – 50 MHz with AM modulation facilities. I guess this 'boatanchor' was mostly used to test TV IF amplifiers at the then widely used 37-38 MHz frequency. The specimen shown has French-language print with the controls. Its output signal is incredibly stable.

The GM2315 AF Signal Generator¹ I would expect to have been used in conjunction with the GM7628 RF/AF Signal Tracer² in order to locate faults in all kinds of amplifiers. The signal tracer still has the original probe. The odd man out is the PR9500 unit³ which after some

Googling turned out to be a conductance tester for liquids. Typical use would be in a laboratory to check the quality of (drinking) water. However, the instrument was also used as an accurate internal bridge circuit, the TV servicing fraternity soon found out that the PR9500 was also great for R, C and even L measurements.

GM denotes a series of early electronics lab instruments and eventually comprised more than 50 items, including several all-valve oscilloscopes. All were designed and built between 1948 and about 1958 (*cf* the design/lifecycle of today's 'disposable' equipment!). Philips 'GM' test equipment with black, shiny front panels and knurled black knobs almost invariably contains '40' and '80' series consumer electronics valves throughout the designs. These valves are still widely available today and the instruments themselves are also easily repaired and calibrated thanks to service manuals and the use of fairly common parts. These 50-year-old test instruments are still a common find on radio rallies, hence do not

represent any great value except to the keen collector. I obtained the instruments as part of an inheritance. Unfortunately, the previous owner had been a lifetime chain smoker so drastic action was required to remove a persistent nicotine 'look & smell'. Each instrument was scrubbed clean with a mild detergent, dried and then put into a box and fully covered in cat litter to absorb the smell¹. The process takes about a week to complete and did not fail to restore the equipment to its former glory.

(045126-1)

Reference:

1. Electronic Classics, Collecting, Restoration and Repair, Andrew Emmerson, Newnes, ISBN 0-7506-3788-9.

- ¹ (lower left)
- ² (upper left)
- ³ (upper right)

Retronics is a monthly column covering vintage electronics including legendary Elektor designs. Contributions, suggestions and requests are welcomed; please send an email to editor@elektor-electronics.co.uk, subject: Retronics EE.

QUIZZ'AWAY



Martin Ohsmann is a Professor of Electrical Engineering and Information Technology at FH Aachen and a long-time contributor to Elektor Electronics. Through Quizz'away he aims at stimulating thought, speculation, construction and simulation as well as raise interesting questions.

This month we present an extremely simple circuit. We operate a transistor as shown in **Figure 1** and use a high-impedance voltmeter (any standard digital voltmeter will be fine) to measure the voltage U between terminals A and B.

Figure 2 shows the experimental setup — the 15-V benchtop supply is however not yet switched on.

Hint:

The result is astounding and it is well worth to carry out this experiment. After the measurement, the transistor should not be returned to a drawer or the junkbox! In fact we recommend binning it.

This month's question is:

What is value of the voltage U measured between A and B?

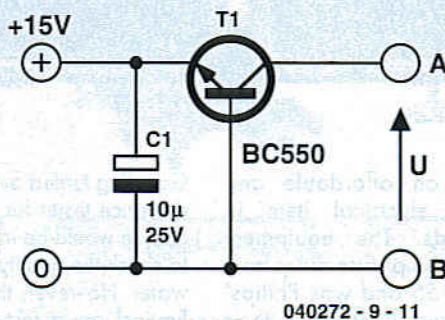

Figure 1. Test circuit.

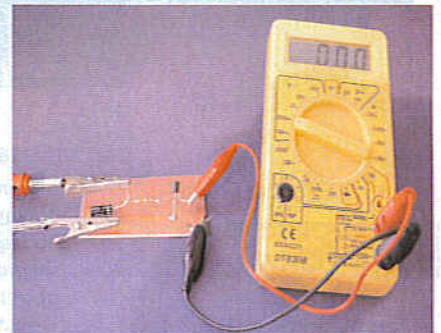

Figure 2. Practical construction.

Quizz'away and win!

Send in the best answer to this month's Quizz'away question and win one of three

**Weather Stations
with outdoor thermometer
and prediction function**

worth approx. £89.00 each.

All answers are processed by Martin Ohsmann in co-operation with Elektor editorial staff. Results are not open to discussion or correspondence and a lucky winner is drawn in case of several correct answers.



Please send your answer to this month's Quizz'away problem, by email, fax or letter to:

**Quizz'away, Elektor Electronics,
PO Box 190,
Tunbridge Wells TN5 7WY, England.**

Fax (+44) (0)1580 200616.

**Email: editor@elektor-electronics.co.uk,
subject: 'quizzaway 5-05'.**

**The closing date is
31 May 2005**

(solution published in the July/August 2005 issue). The outcome of the quiz is final. The quiz is not open to employees of Segment b.v., its business partners and/or associated publishing houses.

Solution to the March 2005 problem

(p. 78; 'Oddball Oscillator')

With this circuit, the decisive factor is the use of a current feedback amplifier (CFA). Today, many fast operational amplifiers employ this circuit topology. Most circuits will allow normal opamps to be replaced by CFAs... but not all!

Whereas with an ordinary opamp the voltage between the non-inverting input (IN+) and the inverting input (IN-) is used to generate an output voltage based on extremely high amplification, the CFA is based on a different principle. The voltage at the IN+ input of the CFA is amplified by a buffer (emitter follower with unity gain). The output of the buffer is the inverting 'input' (IN-) of the CFA.

The output current I of the buffer stage (i.e., the input current of the IN- input) is used, by means of high amplification, to generate an output voltage. Normally, CFAs are configured such that the current I is reduced to zero by feedback.

Armed with this knowledge, our circuit looks far less intelligible: together with components C1, C2 and L, the (invisible) buffer between the IN+ and IN- input is used to build a Colpitts oscillator. The output current of the buffer is used to generate the output signal (due to gain). The output stage inside the CFA acting as a limiter, a square wave signal will appear at the output. The signal frequency f is approximated using the equation

$$f = 1 / [2 \pi \sqrt{LC / 2}] = 32.8 \text{ kHz}$$

where $C = C1 = C2 = 47 \text{ nF}$ and $L = L1 = 1 \text{ mH}$. The calculated and practical results match quite well.

The left part of **Figure 4** shows the typical input stage of a CFA. The buffer consists of a double complementary emitter follower. Current mirrors in the collector lines of the buffer's output transistors quasi-capture the output current and the resultant signals are used to drive the output stage. The concept of re-using one stage's output current to control further stages is sometimes found in audio amplifiers and high-voltage opamp circuits. As shown in the right-hand part of Figure 4, the supply currents of an opamp may be sensed in order to control a further output stage. The same concept transpires — a current is used as the controlling element in a regulation loop.

Literature recommendation: LM6181 datasheet and application notes from various manufacturers covering the 'current feedback amplifier'.

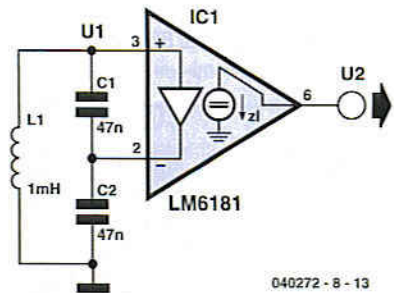

Figure 3. Oscillator based on a CFA.

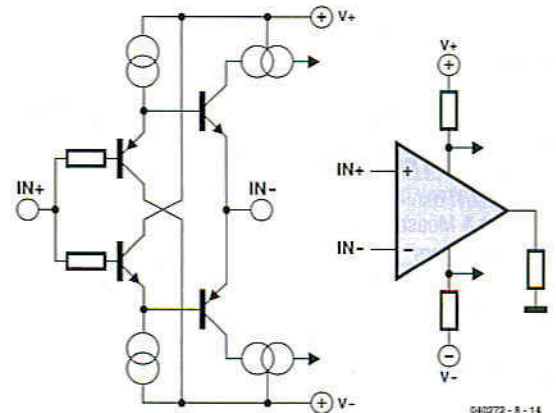

Figure 4. Current Feedback concept.

Advertisement



Prototypes and small series up to 1000 pcs

Value for Money

Up to 6 layer boards

Always Available

Attractive price

On-line Printed Circuit Boards

Double Sided, 1.6 mm,
Plated Through,
Green Solder mask,
Hot Air Level,
1 White Legend.
Price including
tooling + plotting + VAT

100 mm x 160 mm
1 pc = 45.74 Euro

100 mm x 80 mm
5 pcs = 68.97 Euro

www.ThePCBSHOP.com

To book your website space contact Huson International Media

Tel. 0044 (0) 1932 564999 Fax 0044 (0) 1932 564998

ALLGOOD TECHNOLOGY

www.allgoodtechnology.com

Low-medium volume sub-contract assembly. SMT specialist since 1990. Customers include military, aerospace etc. 0402 to BGA capabilities, automatic assembly and hand built prototypes.

AUDIOXPRESS

www.audioXpress.com

The premier do-it-yourself audio magazine for 35 years.

- Hands-on projects
- Helpful articles
- Expert advice
- New technologies

Full range of books, back issues on CD



DANBURY ELECTRONICS

<http://www.livinginthepast.demon.co.uk>

Here you will find our mains and output transformers in Mike Holme's range of valve/tube amplifiers (PP & SE). Also circuits, parts lists, chassis, advice.

EASYSYNC

<http://www.easysync.co.uk>

EasySync Ltd sells a wide range of single and multi-port USB to RS232/RS422 and RS485 converters at competitive prices.



FUTURE TECHNOLOGY DEVICES

<http://www.ftdichip.com>

FTDI designs and sells USB-UART and USB-FIFO interface i.c.'s.

Complete with PC drivers, these devices simplify the task of designing or upgrading peripherals to USB



ILP ELECTRONICS LIMITED

<http://www.ilpelectronics.com>

ILP has been in the audio industry for over 30 years primarily manufacturing both standard and custom audio modules and pre-amplifiers.



BETA LAYOUT

www.pcb-pool.com

Beta layout Ltd Award-winning site in both English and German offers prototype PCBs at a fraction of the cost of the usual manufacturer's prices.



ELEXOL PTY LTD

<http://www.elexol.com>

Developer and manufacturer of

- USB Development Modules.
- USBMOD Series.
- USBIO24 Digital Input/Output Module.
- MP3 Solutions.
- MP3MOD4 Module.

Distributor inquiries welcome.



IPEVA LIMITED

<http://www.ipeva.com>

IPEVA sell low cost USB FPGA development boards. IPEVA provide Design Consultancy for Embedded Systems, OpenCores-IP, FPGA, ASIC, HDL translation and migration. Tel. 0870 080 2340.



BURN TECHNOLOGY LTD

<http://www.burntec.com>

Test & Measurement Equipment Distributors

- Anemometers
- Clamp Meters
- Light Meters
- LCR Meters
- Sound Meters
- Multimeters
- Device Programmers

Burn Technology Limited, Winfrith Technology Centre, Dorchester, Dorset, DT2 8DH
Tel: (01305) 852090 Fax: (01929) 463214



ELNEC

www.elnec.com

- device programmer manufacturer
- selling through contracted distributors all over the world
- universal and dedicated device programmers
- excellent support and after sale support
- free SW updates
- reliable HW
- once a months new SW release
- three years warranty for most programmers



JLB ELECTRONICS

www.jlbelectronics.com

Suppliers of electrical / electronic parts and consumables. Including:

- Cable ties / bases
- Tools / hardware
- Bootlace ferrules
- Connectors
- Solvent sprays & cleaners
- PVC Tape
- Heat Sink compound

COMPUCUT

<http://www.compucutters.com>

Computer Numerical Control from your home PC. Great for tricky jobs, and accurate repetitive work. We supply: - Software - Interface - Manual - Support
Price £250 plus postage.

FOREST ELECTRONIC DEVELOPMENT

<http://www.fored.co.uk>

FED supply PIC programmers, Basic modules, and development software including a PIC C

KOMCARD

<http://www.komcard.com>

Learn how to design a PCI card, and write a PCI device driver. We lead you step by step with practical PCI projects you build.

CONFORD ELECTRONICS

<http://www.confordelec.co.uk>

Lightweight portable battery/mains audio units offering the highest technical performance. Microphone, Phantom Power and Headphone Amplifiers. Balanced/unbalanced signal lines with extensive RFI protection.

FUTURLEC

<http://www.futurlec.com>

Save up to 60% on

- Electronic Components
- Microcontrollers, PIC, Atmel
- Development Boards, Programmers

Huge range of products available on-line for immediate delivery, at very competitive prices.



LONDON ELECTRONICS COLLEGE

<http://www.lec.org.uk>

Vocational training and education for national qualifications in Electronics Engineering and Information Technology (BTEC First National, Higher National NVQs, GCSEs and Advanced Qualifications). Also Technical Management and Languages.

MQP ELECTRONICS

<http://www.mqpelectronics.co.uk>

Leaders in Device Programming Solutions.

- Online shop
- Low Cost Adapters for all Programmers
- Single Site and Gang Programmers
- Support for virtually any Programmable Device



PHYZX

<http://www.phyzx.co.uk>

Automatically Plot and Drill PCB's

- Accurately
- Repeatably
- Mains operated
- Robust Steel Construction
- Gerber RS274X compatible
- Full XYZ RS32 Control
- Including Accessories
- Complete system Under £500.

NEW WAVE CONCEPTS

<http://www.new-wave-concepts.com>

Software for hobbyists:

- Livewire circuit simulation software, only £29.36
- PCB Wizard circuit design software, only £29.36



Available from all Maplin Electronics stores and www.maplin.co.uk

PICDOS™

<http://www.picdos.com>

Hard disk, DOS & files on PIC16F877.

SmartMedia™ based.

No complex hardware just wires. Run-Debug existing PIC code & interrupts. Free schematics, software, debugger



QUASAR ELECTRONICS

www.QuasarElectronics.com

Over 300 electronic kits, projects and ready built units for hobby, education and industrial applications including PIC/ATMEL programming solutions. Online ordering facilities.

Tel: +44 (0) 870 246 1826

Fax: +44 (0) 870 460 1045

Email: sales@QuasarElectronics.com



ROBOT ELECTRONICS

<http://www.robot-electronics.co.uk>

- Ultrasonic rangefinders
- Motor H-Bridge controllers
- Magnetic Compasses
- RC servos and controllers
- PIC programmers and components
- Electronic Design/Development and Manufacturer to industry



ULTRALEDS

[Ultraleds.co.uk](http://www.Ultraleds.co.uk)

<http://www.ultraleds.co.uk>

tel: 0871 7110413

Large range of low cost Ultra bright leds and Led related lighting products. Major credit cards taken online with same day despatch.

USB INSTRUMENTS

<http://www.usb-instruments.com>

USB Instruments specialises in PC based instrumentation products and software such as Oscilloscopes, Data Loggers, Logic Analysers which interface to your PC via USB.



PCB WORLD

<http://www.pcbworld.org.uk>

World-class site: Your magazine project or prototype PCB from the artwork of your choice for less. Call Lee on 07946 846159 for details. Prompt service.

PROMOTE YOUR WEBSITE HERE

Elektor Electronics have a feature to help customers to promote their websites, Net Links - a permanent feature of the magazine where you will be able to highlight your site on a regular basis.

- For just £220 + VAT (£20 per issue for eleven issues) Elektor will publish your company name, a 25-word description and your website address.

- For £330 + VAT for the year (£30 per issue for eleven issues) we will publish the above plus run a 3cm deep full colour screen shot from your site.

Places are limited and spaces will go on a strictly first come, first served basis, please fax back your order today!

I wish to promote my company, please book my space:

- Text insertion only for £220 + VAT
- Text and photo for £330 + VAT

NAME:..... ORGANISATION:.....

JOB TITLE:.....

ADDRESS:.....

..... TEL:.....

PLEASE COMPLETE COUPON BELOW AND FAX BACK TO 00-44-(0)1932 564998

COMPANY NAME.....

WEB ADDRESS.....

25-WORD DESCRIPTION.....

.....

.....

.....

.....

VIRTINS TECHNOLOGY

<http://www.virtins.com>

PC based virtual instrument for electronics enthusiasts, students and professionals, including full-fledged sound card real time Oscilloscope, Spectrum, Analyzer and Signal, Generator, Downloader and try.



ELECTRONIC ENTHUSIASTS

Only one magazine tests its projects and circuits in its own lab before publication

**ELEKTOR ELECTRONICS
THE ELECTRONICS &
COMPUTER MAGAZINE**

**SUBSCRIBE
TODAY!**

Contact: Worldwide Subscription Service Ltd.
Unit 4 Gibbs Reed Farm, Pashley Road, Titchhurst TN5 7HE
Telephone: 01580 200657 Fax: 01580 200616 www.elektor-electronics.co.uk

Order now using the Order Form in the Readers Services section in this issue.

CD-ROMs

Elektor 2004

This CD-ROM contains all editorial articles, with the exception of New Products items, published in Elektor Electronics magazine Volume 2004. Using the supplied Acrobat Reader program, articles are presented in the same layout as originally found in the magazine. The DiskMirror utility on this CD-ROM allows your earlier Elektor year volume CD-ROMs (1997-2003) to be added to a large archive on hard disk for fast access and easy reference. A built-in search function allows you to find references in any article from the archive on hard disk, or from individual year volume CD-ROMs you have available.



£16.25 (US\$ 28.75)

Audio Collection 2

A unique CD-ROM for the true audio lover, containing no fewer than 75 audio designs from the past five year volumes of Elektor Electronics magazine. The articles on the CD-ROM cover test & measurement equipment, amplifiers, digital audio and loudspeaker technology. Highlights include the Crescendo Millennium Edition, Audio-DAC 2000, Audio-ADC 2000 and the IR-S/PDIF Transmitter and Receiver. Using the included Acrobat Reader you are able to browse the articles on your computer, as well as print texts, circuit diagrams and PCB layouts.



£12.05 (US\$ 21.25)

Robotics

A large collection of data-sheets, software tools, tips, tricks and Internet links to assorted robot constructions and general technical information. All aspects of modern robotics are covered, from sensors to motors, mechanical parts to microcontrollers, not forgetting matching programming tools and libraries for signal processing.



£12.05 (US\$ 21.25)

More information on www.elektor-electronics.co.uk

MSC1210 Development Board

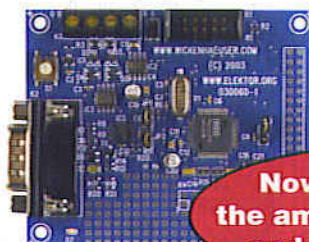

Now with double the amount of memory and free software!

The MSC1210 Development Board is still an incredibly popular item. A second version has been produced, now extended with some considerable improvements!

- The board contains the latest version of the MSC1210 processor (the Y5)
- This new micro has double the amount of memory (32 kBytes instead of 16 kBytes)
- The free MSC1210 software has been adapted for files up to 32 kBytes

Limited period offer: only £ 69.00

Order now! This offer is valid until 31 May 2005. After that date, the price of the MSC1210 board will be £ 75.90.

For the webserver application, extra memory will prove very useful. Not only will the Y5 chip be able to hold larger programs, in combination with the network extension card it's also capable of storing more web pages.

Micro Web Server for Internet and Intranet

Unfortunately, web servers usually sit in large, humming grey cabinets. That's not the ideal solution for keeping an eye on your refrigerator, coffee machine or central heating system. The Elektor Electronics Micro Web Server provides an alternative. Our incredibly popular MSC1210 microcontroller board (also known as 'Precision Measurement Central') now provides network and Internet connectivity, allowing the processor to publish its own data pages onto the web. The article describes a temperature logger allowing the user to enter, via the Internet, temperature limits and an email alarm address. The Micro Web Server can also switch network ports from an Internet-connected PC, literally anywhere on the globe.

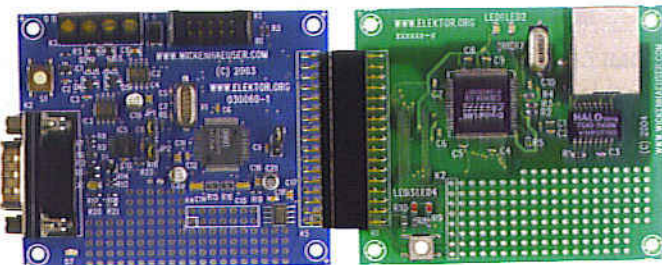

- **MSC1210 board** (assembled and tested) **£ 69.00 (US\$112.50)**
- **Network extension** (assembled and tested) **£ 41.95 (US\$73.95)**
- **Combined package** (incl. software and all related Elektor Electronics articles on CD-ROM) **£ 103.50 (US\$184.95)**

SC (semiconductor) Analyser 2005

(Elektor Electronics April 2005)

- Complete kit of parts including PCB and programmed controller (without LCD)

030451-71 £ 29.65 / \$ 55.85

- 'standard' back-lit LC display

030451-72 £ 7.25 / \$ 13.65

- Poly-LED

display

030451-73

£ 25.50 /

\$ 48.05



LPC210x ARMee Development System

(Elektor Electronics April 2005)

- Processor board, ready-built and tested

040444-91

£ 20.55 /

\$ 38.70

- Motherboard (bare, without components)

040444-2

£ 11.70 /

\$ 22.05

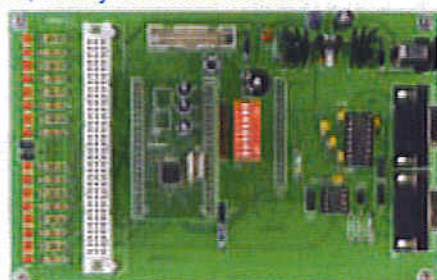

Further products from Elektor Electronics:

READY-BUILT PROJECTS

	£	\$
ClariTy 300-W Class-T Amplifier		
030217-91 Amplifier board with SMDs pre-fitted; cores for L1 & L2	34.50	55.70
Flash Microcontroller Starter Kit		
010208-91 ready-assembled PCB incl. software, cable, adapter & related articles	69.00	112.50
Gameboy Digital Sampling Oscilloscope (GBDSO)		
990082-91 ready-assembled board, incl. the PC software and related articles	103.00	183.00
LPC210x ARMee Development System		
040444-91 Processor board, ready-made and tested	20.55	38.70
Micro Webserver with MSC1210 Board		
030060-91 Microprocessor Board, ready-assembled		
044026-91 Network Extension Board, ready-assembled	41.95	73.95
044026-92 Combined package (030060-91 & 044026-91 & related articles)	103.50	184.95

EVERGREENS

	£	\$
Elektor Electronics Help Disk		
966022-1 Disk, Windows version	8.15	14.45
Elektor Electronics Item Tracer 1985-2003		
046003-11 contents database (disk, Windows version)	8.15	14.35
Universal Prototyping Boards		
UPBS-1 PCB	2.45	4.30
UPBS-2 2 PCBs	4.10	7.25
UPBS-4 4 PCBs	6.55	11.55

No. 342 MAY 2005

	£	\$
Glow Plug Heater		
040239-11 Disk, ST7 program	5.20	9.75
040239-41 ST7FLITE05, programmed	6.55	12.35
Magnetic Flux Density Meter		
040258-11 Disk, PIC source code	5.20	9.75
040258-41 PIC16F876-20/SP, programmed	16.55	31.15
Programmer for DCC Model Railway Control		
040422-1 PCB	18.60	35.05

Now available: new Elektor Electronics kits and modules

GPS Receiver on USB

(Elektor Electronics June 2005)

Complete kit with extra long cable and waterproof antenna case (available from mid May 2005)

040264-71

£ 62.05 / \$ 116.95



Temperature Logger

(Elektor Electronics June 2005)

Complete kit of parts including components, PCB and programmed controller (available from mid May 2005)

030447-71

£ 25.85 / \$ 48.75



040422-11 Disk, ATmega source & hex code	5.20	9.75
040422-41 ATmega8515-8PI, programmed	16.55	31.15

No. 342 APRIL 2005

	£	\$
LPC210x ARMee Development System		
040444-1 Processor board	4.70	8.85
040444-2 Motherboard	11.70	22.05
040444-11 Disk, project software	5.20	9.75
040444-91 Processor board, ready-made and tested	20.55	38.70

SC Analyser 2005

030451-1 PCB	5.35	10.10
030451-11 Disk, project software	5.20	9.75
030451-41 PIC16F876-20/SP, programmed	13.75	25.95

No. 341 MARCH 2005

	£	\$
High-End Power Amp		
040198-1 Amplifier PCB	9.65	18.15
040198-2 Indicator PCB	7.95	14.95
040198-3 Supply PCB	7.95	14.95
040198-4 Fuse PCB	4.50	8.45

Opamp Tester

030386-1 PCB	6.85	12.95
--------------	------	-------

Play Solitaire

030410-11 Disk, project software	5.20	9.75
030410-41 AT90S2313-10PC, programmed	5.50	10.35

Remote Temperature Logger for PIC18F Board

040441-11 Disk, project software	5.20	9.75
----------------------------------	------	------

Serially Programmable Crystal Oscillator

040351-11 Disk, project software	5.20	9.75
----------------------------------	------	------

Products for older projects (if available)
 may be found on our website
www.elektor-electronics.co.uk

home construction = fun and added value



SHF ElectroSmog Detector

Do sources of electromagnetic energy like the cellphone base station around the corner, your DECT telephone or the newly installed WLAN router represent a health hazard? In next month's issue we not only show ways to find answers to these 'hot' questions, but also present an ElectroSmog detector that allows you to check radiation levels in and around your home or the children's play-ground. The detector responds to transmitter activity within the 800-2400 MHz SHF frequency range used for mobile communications and wireless applications. Ten LEDs provide a logarithmic field strength indication up to a maximum level of 10 V/m.

Web poll on
www.elektor-electronics.co.uk
 Thanks for participating!

Theme Plan for 2005	
January	Power Supplies
February	Wireless
March	Sound
April	Microcontrollers
May	Sensors
June	Environment
July/August	Summer Circuits
September	Test & Measurement
October	Security
November	CAD Software
December	Optoelectronics

USB-GPS

This article describes an interface between navigation applications and a miniature GPS module coupled to an equally small active antenna. The modular structure of the project allows you to use selected parts for your own applications.

Also...

Solar Cell Charger; EMC Sleuth; Delphi for Electronic Engineers (6); Lead-free Soldering; WiFi Eavesdropping.

27(C)512 Emulator

Despite the inroads of Flash technology, lots of microcontroller applications still employ an EPROM for program storage. The reasons are probably best summarized in two words: 'cost' and 'tradition'. The downside of an EPROM is the need for an emulator when it comes to debugging. Our emulator is based on a combination of an FPGA and an AT90S8515 controller. For connectivity it offers SPI, JTAG and RS232 interfaces.

RESERVE YOUR COPY NOW!

UK subscribers will receive the magazine a few days before this date.

The June 2005 issue goes on sale on Saturday 21 May 2005 (UK distribution only).

Article titles and magazine contents subject to change.

NEWSAGENTS ORDER FORM

SHOP SAVE / HOME DELIVERY

Please save / deliver one copy of *Elektor Electronics* magazine for me each month

Name:

Address:

Post code:

Telephone:

Date:

Signature:



Please cut out or photocopy this form, complete details and hand to your newsagent. *Elektor Electronics* is published on the third Friday of each month, except in July. Distribution S.O.R. by Seymour (NS).

INDEX OF ADVERTISERS

Allgood Technology, Net Links	www.allgoodtechnology.com	80	MQP Electronics, Net Links	www.mqpelectronics.co.uk	81
Audioexpress, Net Links	www.audioexpress.com	80	Net Links		80, 81
Beta Layout, Net Links	www.pcb-pool.com	23, 80	New Wave Concepts, Net Links	www.new-wave-concepts.com	81
The BlackBoxCamera	www.STV5730A.co.uk	23	Number One Systems	www.numberone.com	37
Burn Technology LTD, Net Links	www.burntec.com	80	Nurve Networks	www.xgamestation.com	23
CMS	www.cms.uk.com	75	PCB World, Net Links	www.pcbworld.org.uk	81
CompuCut, Net Links	www.compu-cutters.com	80	PHYZX, Net Links	www.phyzx.co.uk	81
Conford Electronics, Net Links	www.confordelec.co.uk	80	Picdos, Net Links	www.picdos.com	81
Cricklewood	www.cricklewoodelectronics.com	69	Pico	www.drdaq.com	2, 37
Danbury, Net Links	www.livinginthepast.demon.co.uk	80	Quasar Electronics, Net Links	www.quasarelectronics.com	65, 81
Display Electronics	www.distel.co.uk	73	Robot Electronics, Net Links	www.robot-electronics.co.uk	81
Easysync, Net Links	www.easysync.co.uk	29, 80	Total Telematics	www.total-telematics.com	15
Elxol, Net Links	www.elxol.com	80	Ultraleds, Net Links	www.ultraleds.co.uk	81
Eltec, Net Links	www.eltec.com	80	University of Manchester	www.saelig.com	15
Eurocircuits	www.thepcbshop.com	79	USB Instruments, Net Links	www.usb-instruments.com	81
ExpressPCB	www.expresspcb.com	15	Viewcom, Net Links	www.viewcom.f9.co.uk	81
Forest, Net Links	www.fored.co.uk	23, 80	Virtins Technology, Net Links	www.virtins.com	81
Future Technology Devices, Net Links	www.ftdichip.com	80			
Futurlec, Net Links	www.futurlec.com	80			
Hitex	www.hitex.co.uk	43			
ILP Electronics Limited, Net Links	www.ilpelectronics.com	80			
Ipeva Limited, Net Links	www.ipeva.com	80			
Jaycar Electronics	www.jaycarelectronics.co.uk	3			
JLB Electronics, Net Links	www.jibelectronics.com	80			
Komcard, Net Links	www.komcard.com	80			
Labcenter	www.labcenter.co.uk	88			
London Electronics College, Net Links	www.lec.org.uk	80			
Matrix Multimedia Ltd	www.matrixmultimedia.co.uk	28			
Microchip	www.microchip.com/seminars	4			
Milford Instruments	www.milinst.demon.co.uk	76			

Advertising space for the issue of 21 June 2005

may be reserved not later than 24 May 2005

with Huson International Media – Cambridge House – Gogmore Lane – Chertsey, Surrey KT16 9AP – England – Telephone 01932 564 999 – Fax 01932 564998 – e-mail: garryb@husonmedia.com to whom all correspondence, copy instructions and artwork should be addressed.

ORDERING INSTRUCTIONS, P&P CHARGES

Except in the USA and Canada, all orders, except for subscriptions (for which see below), must be sent BY POST or FAX to our Tunbridge Wells address using the Order Form overleaf. On-line ordering: <http://www.elektor-electronics.co.uk>

Readers in the USA and Canada may (but are not obliged to) send orders, except for subscriptions (for which see below), to the USA address given on the order form. Please apply to Old Colony Sound for applicable P&P charges. Please allow 4-6 weeks for delivery. **Orders placed on our Tunbridge Wells office** must include P&P charges (Priority or Standard) as follows:
UK: £4.00 Europe: £5.00 (Standard) or £7.00 (Priority) Outside Europe: £8.00 (Standard) or £12.00 (Priority)

HOW TO PAY

Unless you have an approved credit account with us, all orders must be accompanied by the full payment, including postage and packing charges as stated above. Payment may be made by cheque drawn on a London clearing bank (but see para. 4 below), postal order, VISA, Access, MasterCard or EuroCard (when paying by credit card, the order must go the cardholder's address). Do not send cash through the mail. Cheques and postal orders should be crossed and made payable to 'Elektor Electronics (Publishing)'. Payment may also be made by direct transfer from a private or business Giro account to our **Giro account No. 34-152-3801** by completing and sending to the National Giro Centre, in a National Giro postage paid envelope, a National Giro transfer/deposit form. Do not send Giro transfers direct to us, as this will delay your order. If you live outside the UK, payment may also be made by Bankers' sterling draft drawn on a London clearing bank, Eurocheque made out in pounds sterling (with holder's guarantee card number written on the back), or US or Canadian dollar cheque drawn on a US or Canadian bank. If you pay by Bankers' sterling draft, make clear to the issuing bank that your full name and address MUST be communicated to the London clearing bank. Our bankers are **NAT WEST PLC, 1 St James's Square, Wadhurst, East Sussex TN5 6BH, England. Our account number is 3512 5225, Sorting Code 60-22-15. IBAN code: GB40 NWB K6 022 15 3512 5225 BIC code: NWB KGB 2L**

COMPONENTS

Components for projects appearing in Elektor Electronics are usually available from certain advertisers in this magazine. If difficulties in the supply of components are envisaged, a source will normally be advised in the article. Note, however, that the source(s) given is (are) not exclusive.

TERMS OF BUSINESS

Delivery Although every effort will be made to dispatch your order within 2-3 weeks from receipt of your instructions, we can not guarantee this time scale for all orders. **Returns** Faulty goods or goods sent in error may be returned for replacement or refund, but not before obtaining our consent. All goods returned should be packed securely in a padded bag or box, enclosing a covering letter stating the dispatch note number. If the goods are returned because of a mistake on our part, we will refund the return postage. **Damaged goods** Claims for damaged goods must be received at our Tunbridge Wells office within 10-days (UK); 14-days (Europe) or 21-days (all other countries). **Cancelled orders** All cancelled orders will be subject to a 10% handling charge with a minimum charge of £5.00. **Patents** Patent protection may exist in respect of circuits, devices, components, and so on, described in our books and magazines. Elektor Electronics (Publishing) does not accept responsibility or liability for failing to identify such patent or other protection. **Copyright** All drawings, photographs, articles, printed circuit boards, programmed integrated circuits, diskettes and software carriers published in our books and magazines (other than in third-party advertisements) are copyright and may not be reproduced or transmitted in any form or by any means, including photocopying and recording, in whole or in part, without the prior permission of Elektor Electronics (Publishing) in writing. Such written permission must also be obtained before any part of these publications is stored in a retrieval system of any nature. Notwithstanding the above, printed-circuit boards may be produced for private and personal use without prior permission. **Limitation of liability** Elektor Electronics (Publishing) shall not be liable in contract, tort, or otherwise, for any loss or damage suffered by the purchaser whatsoever or howsoever arising out of, or in connexion with, the supply of goods or services by Elektor Electronics (Publishing) other than to supply goods as described or, at the option of Elektor Electronics (Publishing), to refund the purchaser any money paid in respect of the goods. **Law** Any question relating to the supply of goods and services by Elektor Electronics (Publishing) shall be determined in all respects by the laws of England.

January 2005

SUBSCRIPTION RATES FOR ANNUAL SUBSCRIPTION

	Standard	Plus
United Kingdom	£39.50	£46.00
Economy Mail		
Rest of the World (excluding Europe)	£51.30	£57.80
Priority Airmail		
Europe & Eire	£51.30	£57.80
Outside Europe	£65.00	£71.50
Airfreight		
USA & Canada only	US\$88.00	US\$98.00

Payment should be made by:

- Cheque or bankers' draft in sterling drawn on a London clearing bank (except in the USA and Canada — see below);
- US\$ cheques drawn on a US or Canadian bank — only by subscribers in the USA or Canada.
- Direct transfer to our bank (NAT WEST PLC, 1 St James's Square, Wadhurst, East Sussex TN5 6BH, England).
Our account number is 3512 5225, Sorting Code 60-22-15.
IBAN code: GB40 NWB K6 022 15 3512 5225 BIC code: NWB KGB 2L
- Postal order.
- Credit card: VISA, ACCESS, Euro/MasterCard, JCB Electron or Switch.
- Transfer to our Giro Account number 34 152 3801. Giro transfers should be made by completing and sending the appropriate transfer/deposit form to the National Giro Centre (UK) or to your national Giro Centre.

Cheques and postal orders should be made payable to Elektor Electronics (Publishing). Do not send cash through the mail.

SUBSCRIPTION RATES FOR 18-MONTH SUBSCRIPTION

	Standard	Plus
United Kingdom	£59.25	£69.00
Economy Mail		
Rest of the World (excluding Europe)	£76.95	£86.70
Priority Airmail		
Europe & Eire	£78.75	£88.50
Outside Europe	£97.50	£107.25
Airfreight		
USA & Canada only	US\$132.00	US\$147.00

SUBSCRIPTION CONDITIONS

The standard subscription order period is twelve months. If a permanent change of address during the subscription period means that copies have to be despatched by a more expensive service, no extra charge will be made. Conversely, no refund will be made, nor expiry date extended, if a change of address allows the use of a cheaper service. Student applications, which qualify for a 20% (twenty per cent) reduction in current rates, must be supported by evidence of studentship signed by the head of the college, school or university faculty. A standard Student Subscription costs £31.60, a Student Subscription-Plus costs £37.60 (UK only). Please note that new subscriptions take about four weeks from receipt of order to become effective. Cancelled subscriptions will be subject to a charge of 25% (twenty-five per cent) of the full subscription price or £7.50, whichever is the higher, plus the cost of any issues already dispatched. Subscriptions cannot be cancelled after they have run for six months or more.

January 2005



Time, Date, Weather Forecast, Humidity, In/Out Temperature and Moon Phase on one display.

*Read elektor
electronics
leading the way*

**PICK YOUR OWN ANNUAL SUBSCRIPTION
and receive this wireless 433 MHz weather station*!**

Make your choice:

- **Elektor Electronics annual subscription (standard)**
You receive 11 issues, including the July/August double issue.
- **Elektor Electronics annual subscription-PLUS**
You receive 11 issues, including the July/August double issue, plus a copy of the Elektor Electronics Volume 2005 CD-ROM (normal price £16.25). Your saving: approx. £10.00!

Please fill out the Order Form with this issue.

Subscription rates and conditions may be found at the back of this issue.

* Offer available to Subscribers who have not held a Subscription to Elektor Electronics in the last 12 Months. Offer Subject to Availability.



PROTEUS

The Complete Electronics Design System

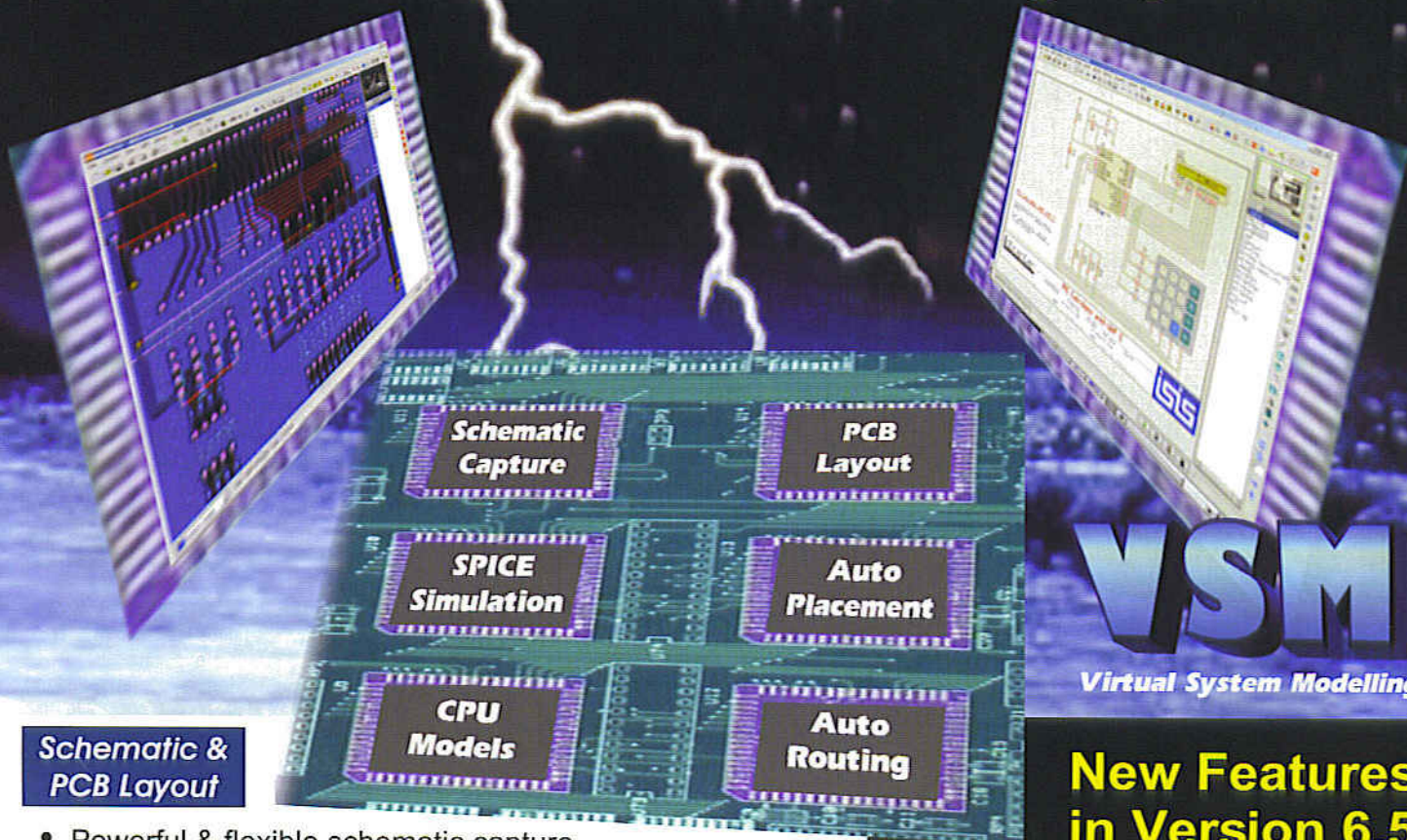

Schematic & PCB Layout

- Powerful & flexible schematic capture.
- Auto-component placement and rip-up/retry PCB routing.
- Polygonal gridless ground planes.
- Libraries of over 8000 schematic and 1000 PCB parts.
- Bill of materials, DRC reports and much more.

Mixed Mode SPICE Circuit Simulation

- Berkeley SPICE3F5 simulator with custom extensions for true mixed mode and interactive simulation.
- 6 virtual instruments and 14 graph based analysis types.
- 6000 models including TTL, CMOS and PLD digital parts.
- Fully compatible with manufacturers' SPICE models.

Proteus VSM - Co-simulation and debugging for popular Micro-controllers

- Supports PIC, AVR, 8051, and BASIC STAMP micro-controllers.
- Co-simulate target firmware with your hardware design.
- Includes interactive peripheral models for LED and LCD displays, switches, keypads, virtual terminal and much, much more.
- Compatible with popular compilers and assemblers from Microchip, Crownhill, IAR, Keil, and others.

New Features in Version 6.5

- Textual library part search.
- User defined keyboard map.
- CAD/CAM output to ZIP file.
- Bitmap import function.
- TrueType fonts on PCBs.
- Enhanced printer output.

Call Now for Upgrade Pricing

labcenter
Electronics
53-55 Main Street, Grassington. BD23 5AA

Tel: 01756 753440
Fax: 01756 752857

Contact us for
Free Demo CD

**NEW
ELECTRA
SHAPE BASED
AUTOROUTER
NOW AVAILABLE**

www.labcenter.co.uk
info@labcenter.co.uk