

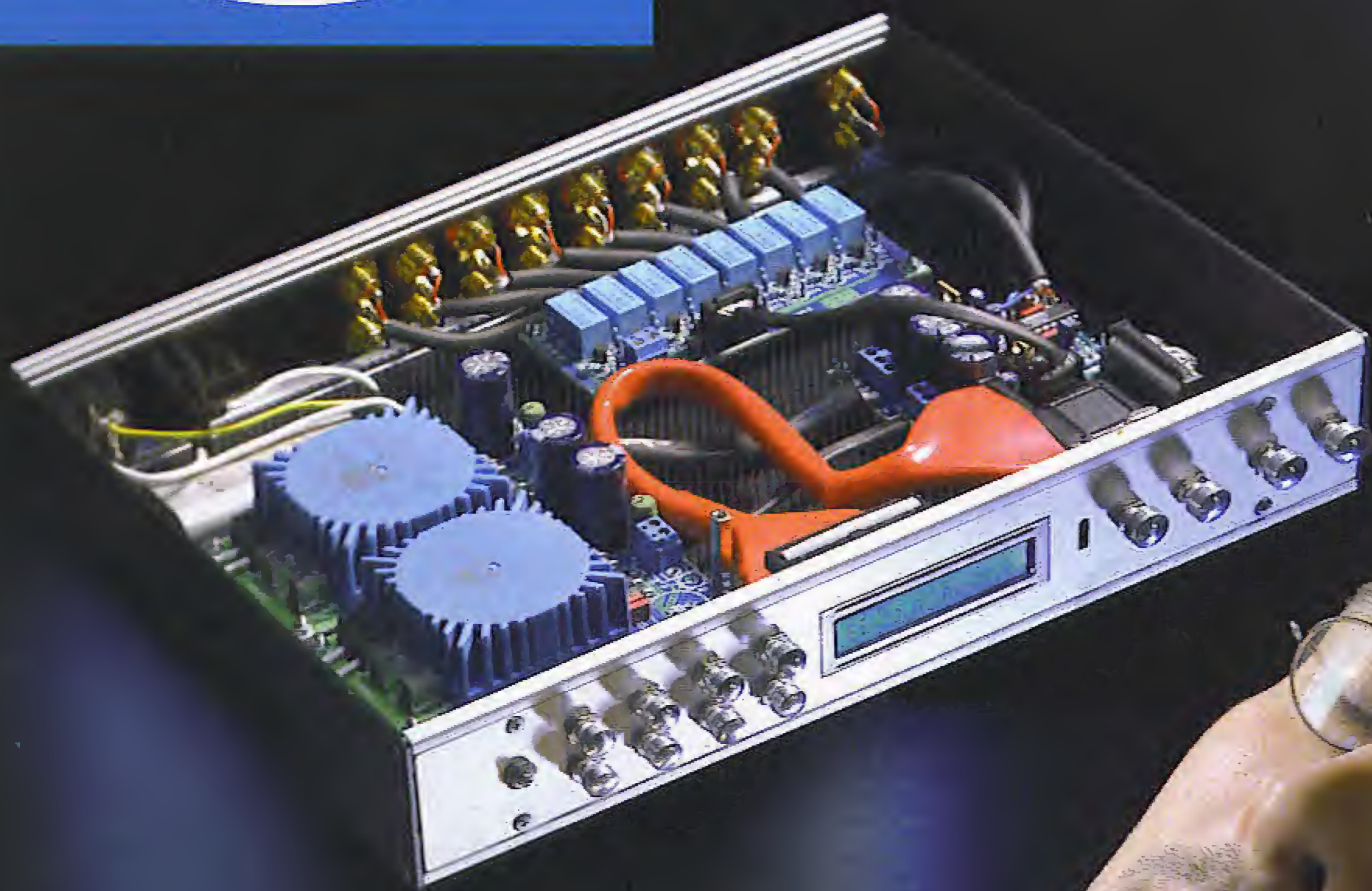

elektor electronics



**Economical
high-end preamp**

**Pandora's
sound & music box**

VHF-low explorer



www.elektor-electronics.co.uk

April 2004 • £3.70



PAGM

The leaders in PIC development

FROM

£99

- ◆ All you need to get started with PIC
- ◆ Industry standard/quality board
- ◆ Open the box and get coding
- ◆ Available with C compiler or use our PicScript to write programs using simple commands...

**NO ASSEMBLER,
NO COMPILER,
JUST WRITE AND RUN**



EASE OF USE

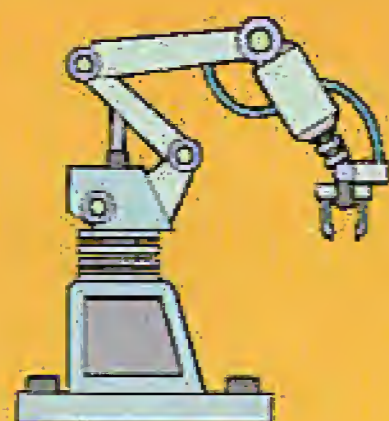

AUTOMATION

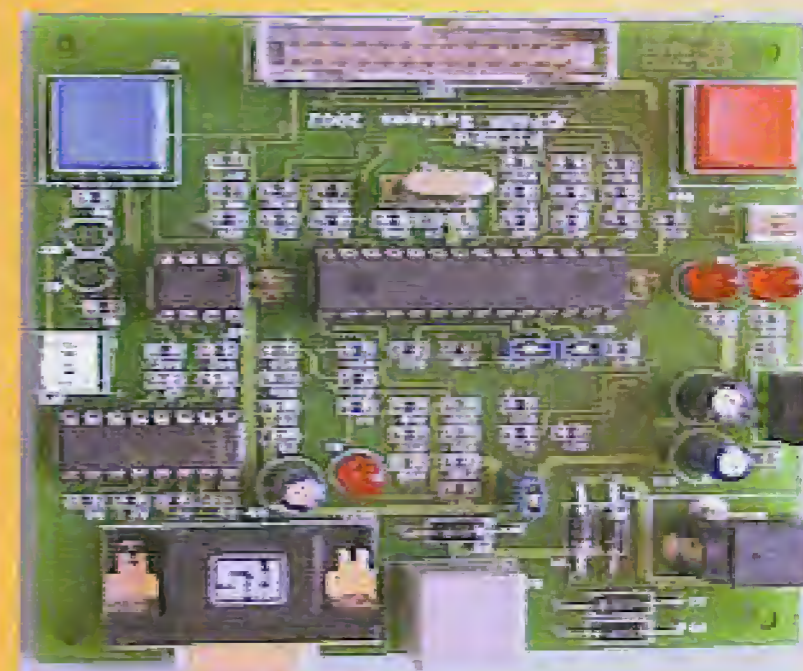

SCRIPTABILITY

PicDev Board with PicScript

£99.00 (plus p+p)

This is a complete development suite for the novice or non programmer.

It is shipped with:

- PicDev Board
- PicShell and PicScript software
- Breakout board
- Cables
- Example scripts

PicDev Board with C Compiler

£165.00 (plus p+p)

This is a complete development suite for the more advanced programmer.

It is shipped with:

- PicDev Board
- PicShell and PicScript software
- C compiler
- Breakout board
- Cables
- Example scripts
- ICD1

Both items require

- PC with serial port available
- Power supply adapter

To order:

www.pagm.co.uk

sales@pagm.co.uk

Tel: +44 (0)1792 891927

A TECHNICAL BACKGROUND AND (OVERLY) MODEST

How often do you hear technical types say, "That's so good, it will simply sell itself"? In practice, we see that such judgements may not correspond to our everyday experience. Many very good, technically sophisticated products have failed to win consumer acceptance, because it was not clear what benefits they provided for users. The field of electronics is not immune to this problem. We all take it for granted that electronics forms an indispensable part of our society, but at the same time we find it unavoidable that there is less interest in the technical disciplines.

Elektor Electronics has reflected these attitudes, but now it's time for a change. We consider it our duty to make electronics and information technology a source of inspiration for everyone who is even remotely interested in these subjects.

To start with, we want to show that *Elektor Electronics* publishes articles that have been written with gusto – articles that are not ashamed to show that they are worth reading, even by the non-initiated. And to inspire their readers.

Our ultimate goal is to hear you say, "Not only do I find it good, but so does he, and she, and everyone else." That's why we have modified the magazine cover, rearranged the standard features, added new ones and changed the layout of the articles. The new format features full colour, different photos and better-quality paper. It is intended to not only be informative and inspirational, but also to show that electronics can be fun. Regardless of whether this takes the form of the well-proven construction projects, reporting on new developments, reviving old expertise or reviewing interesting construction kits, sites and books. We hope that the enhanced *Elektor Electronics* will be just as inspiring for you as it has been for us in the preparation phase during the past few months. In any case, please let us know what you think. With an eye to the future of electronics and people who are interested in electronics, our aim is to prepare *Elektor Electronics* to meet the challenge of the future.



International Editor (ad interim), **Han Mensink**



elektor electronics

Volume 30, Number 331, April 2004

ISSN 0268/4519

Elektor Electronics aims at inspiring people to master electronics at any personal level by presenting construction projects and spotting developments in electronics and information technology.

Elektor Electronics is produced and published by Elektor Electronics (Publishing), P.O. Box 190, Tunbridge Wells TN11 7WY, England. Tel.: (+44) (0)1580 200657, fax: (+44) (0)1580 200616. Email: sales@elektor-electronics.co.uk.

The magazine is available from newsagents, bookshops and electronics retail outlets, or on subscription.

Elektor Electronics is published 11 times a year with a double issue for July & August.

Under the name *Elektor* and *Elektuur*, the magazine is also published in French, German and Dutch. Together with franchised editions the magazine is on circulation in more than 50 countries.

International Editor (ad interim): Han Mensink

Editor: Jan Buiting (editor@elektor-electronics.co.uk)

International editorial staff: Harry Baggen, David Daamen, Rolf Gerstendorf, Ernst Krampelsauer, Guy Raedersdorf, Sijf van Rooij.

Laboratory staff: Karel Walraven (head of design), Ton Giesberts (design), Paul Goossens (design), Luc Lemmens (design), Matti Schroyen (drawing), Peter Verhoosel (PCB design), Jan Visser (prototyping, software service) (techdept@segment.nl)

Editorial secretariat: Hedwig Hennekens (secretariaat@segment.nl)

Page layout: Giel Dols, Ton Gulikers

Managing Director / Publisher: Paul Snakkers

Circulation Control: Margriet Debeij (m.debeij@segment.nl)

Subscriptions

Worldwide Subscription Service Ltd., Unit 4,
Gibbs Reed Farm, Pashley Road, Ticehurst TN5 7HE, England.
Telephone: (+44) (0)1580 200657. Fax: (+44) (0)1580 200616
Email: wwss@wwss.demon.co.uk
Rates and terms are given on the Subscription Order Form

Head Office:

Segment b.v. P.O. Box 75 NL-6190-AB Beek The Netherlands
Telephone: (+31) 46 4389444. Fax: (+31) 46 4370161

Distribution: Seymour, 86 Newman Street, London W1P 3LD, England

Copyright notice

The circuits described in this magazine are for domestic use only. All drawings, photographs, printed circuit board layouts and article texts published in the editorial section of the magazine are copyright Segment, b.v. and may not be reproduced or transmitted in any form or by any means, including photocopying, scanning or recording, in whole or in part without prior written permission from the Publishers. Such written permission must also be obtained before any part of this publication is stored in a retrieval system of any nature.

Patent protection may exist in respect of circuits, devices, components etc. described in this magazine. The Publisher does not accept responsibility for failing to identify such patent(s) or other protection.

The submission of designs or articles implies permission to the Publishers to alter the text and design, and to use the contents in other Segment publications and activities. The Publishers cannot guarantee to return any material submitted to them.

Technical Queries

We can only answer questions or remarks of general interest to our readers, concerning projects not older than two years and published in *Elektor Electronics*. In view of the amount of post received, it is not possible to answer all correspondence, and we are unable to respond to individual wishes and requests for modifications to, or additional information about, *Elektor Electronics* projects. To find article titles and issue/page references, please use our EIT (Elektor Item Tracer) which is available on floppy disk (see Readers Services).

We do not supply kits for the projects described in this magazine. Our supply range is limited to PCBs, CD-ROMs, diskettes, programmed microcontrollers, GALs, PALs, EPGAs and EPROMs. All other parts for building our projects should be purchased from kit/component suppliers advertising in this magazine.

© Segment b.v. 2004

Printed in the Netherlands



leading the way

32

DREAM TEAM

How to build your own DRM software....

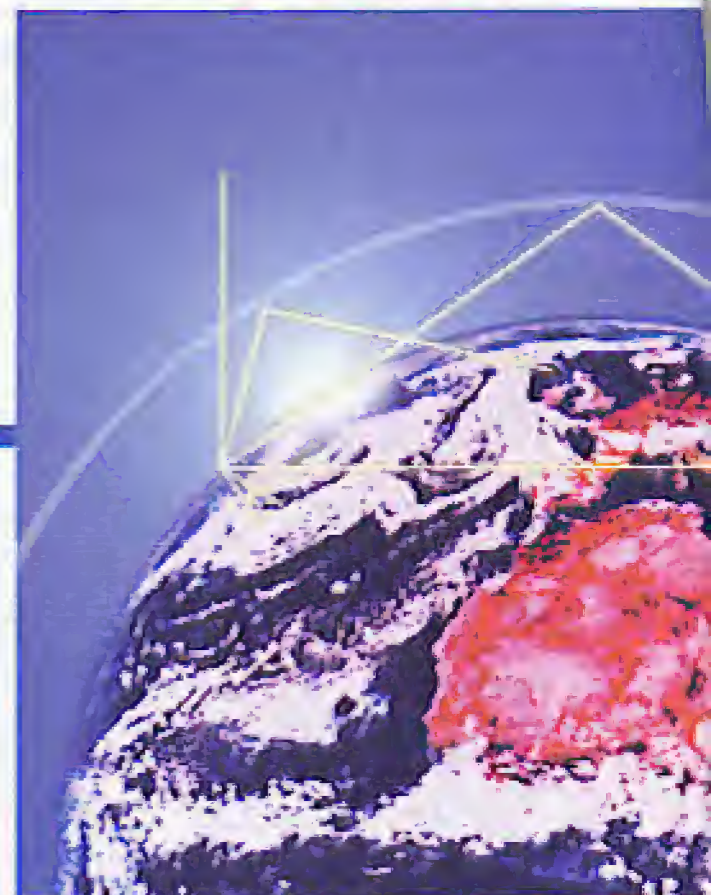

10

Digitally Controlled High-End Preamp (1)

Super sonic quality redefined.

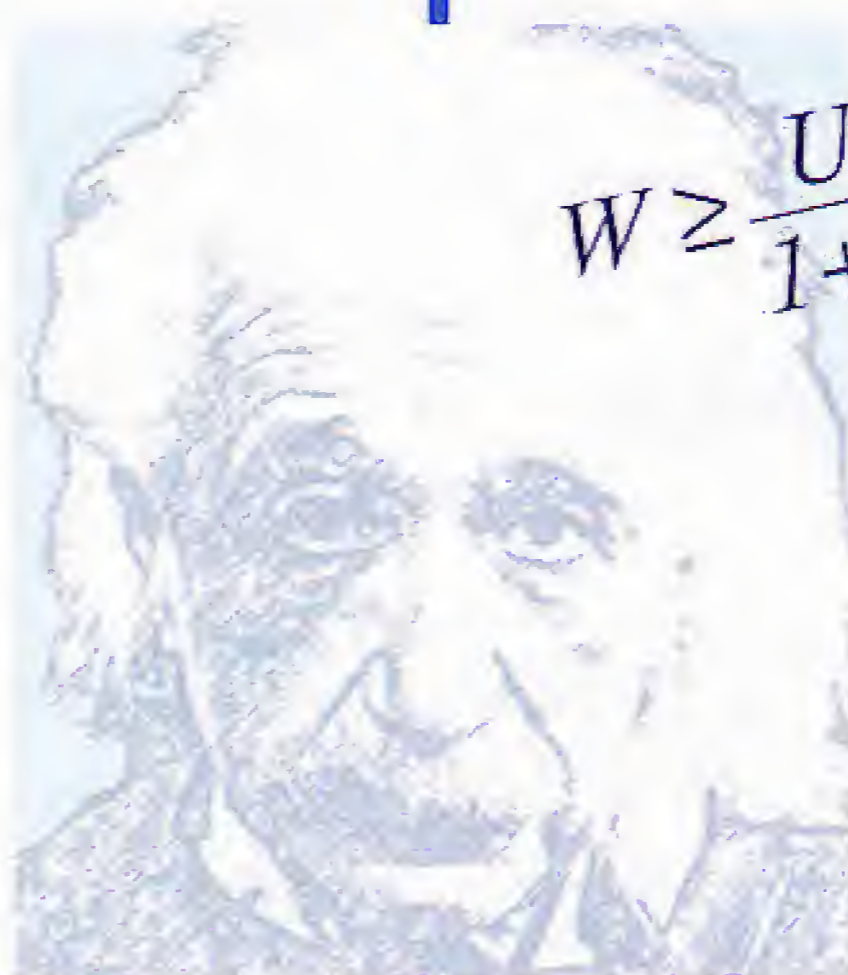

$$W \geq \frac{U+V}{1+U \frac{V}{C^2}}$$

28

Project C+

Data overtaking light, if only this April.



18

VHF-Low Explorer

Anyone out there on 70 MHz?

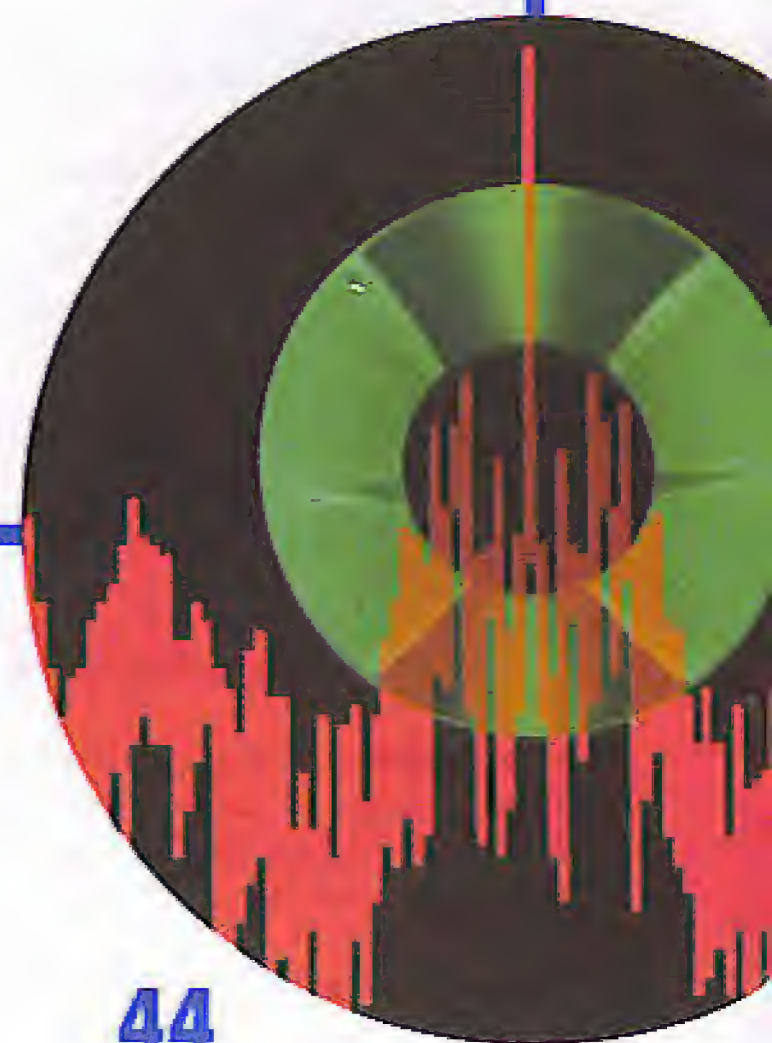

44

Wavecatcher

... and improve reception quality.

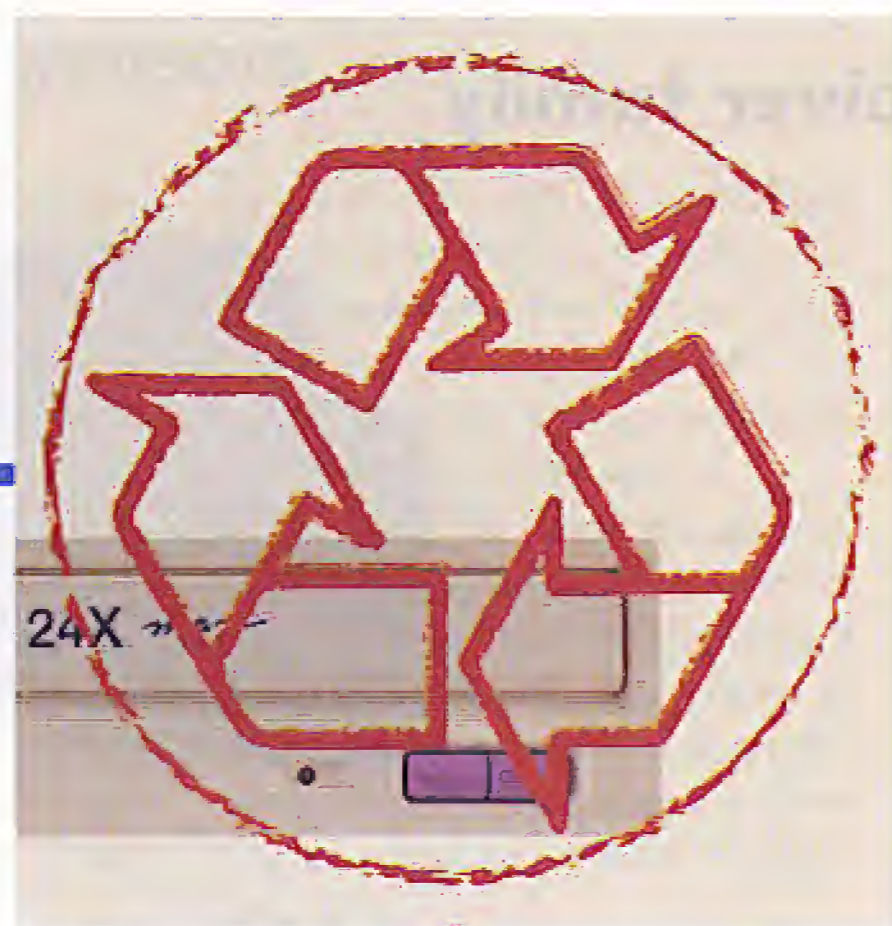

52
**Pandora's Sound
& Music Box**
Recycling old
CD-ROM drives.



72
**Drop-in
Microcontroller Board**
Enter a jack-of-all-trades for
popular micros.

Contents

VOLUME 30

APRIL 2004 • no. 331

Construction Projects

- 10 Digitally-controlled
High-End Preamp (1)
- 18 VHF-Low Explorer
- 52 Pandora's Sound & Music Box
- 60 *kitchen table*
Low-power LED Flash
- 62 Drop-in Microcontroller Board

Informative Articles

- 17 Elektor Electronics Year Volume
CD-ROMs on Hard Disk
- 28 Project c+
- 32 DREAM TEAM
- 38 *start here*
leaking batteries – through-hole plat-
ing – battery-backed RAM – SOT tem-
perature switches – Poor man's DRM
- 44 Wavecatcher
- 58 *inside out* of Mice and Light
- 68 *review copy*
Audio Power Amps on the Internet –
DSPs at 1 GHz

Regulars

- 6 News & New Products
- 70 Mailbox
- 72 News & New Products
- 77 Readers Services
- 81 PCB layouts
- 82 Sneak Preview
- 82 Index of Advertisers

SRD TRANSCEIVER CHIPS

Long-range 430 - 950 MHz transceiver family with embedded MCU & ADC

Nordic VLSI ASA have launched the nRF9E5 transceiver with MCU, ADC and the nRF905 transceiver. The nRF9X5 components are designed for 430-950 MHz wireless transceiver applications in industrial as well as domestic environments. Typical applications include security systems, wireless data transfer, automatic meter reading, car alarm systems, point-of-sale systems, sensors and various telemetry systems. Both the nRF9E5 and nRF905 are manufactured in an ultra modern 0.18-µm CMOS process. The entire transceiver including all inductors and filters is integrated in a single chip. The nRF9E5 transceiver has an embedded 8051 compatible MCU, and 4-input 10-bit ADC

— for the first time providing the market with a complete low cost wireless system-on-a-chip solution with a single 1.9 V-3.6 V supply. Voltage regulators are embedded on-chip to further lower the system cost, and to enhance performance. Both components include the unique ShockBurst™ feature that is used in both receive and transmit mode and greatly simplifies software and protocol design. ShockBurst™ includes features for CRC computation in both TX and RX mode, and address decoding in RX mode, greatly reducing the load and cost of the MCU running the RF protocol, compared to existing transceivers in the market. A crystal and a resistor are the two components needed externally to

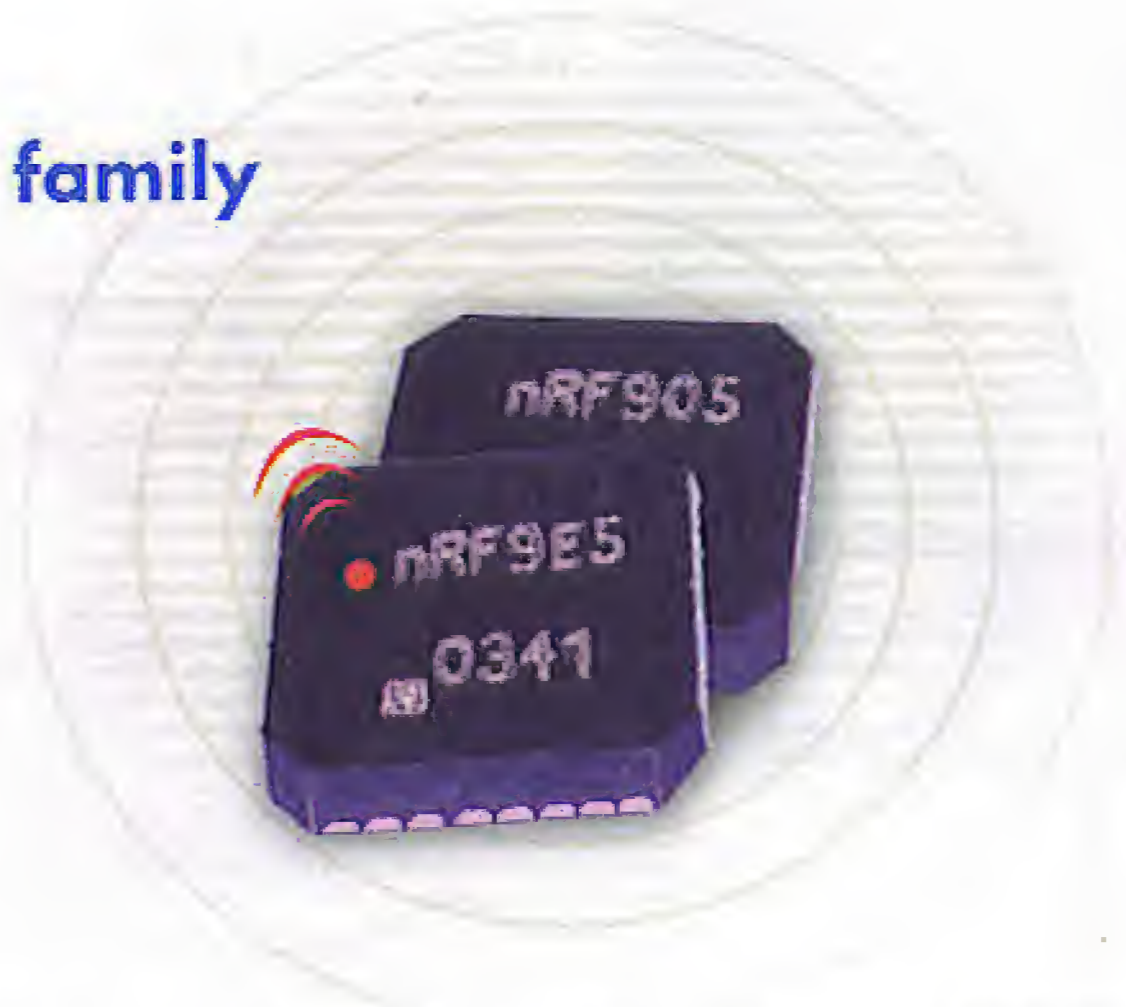

make up a complete system around the nRF905. The nRF9E5 requires an external EEPROM for external program storage. Both components are delivered in a "Green" lead-free 32 pin 5x5mm QFN package. A unique feature of the nRF9X5 family is the ability to operate with the same layout and identical external components in the

unlicensed European 868 MHz ISM band as well as the North-American 915 MHz SRD band, easing logistics and lowering cost for manufacturers who have customers in both territories.

geir.langeland@nvlisi.no
http://www.nvlisi.no

(047062-1)

MENTOR & INTEL TEAM UP

PCB Design Kit for Grantsdale chipset

Mentor Graphics Corporation announced it has worked to provide Intel Corporation with drop-in core layout (DCL) kits for use with the Mentor Graphics® Expedition™ PCB design flow for Intel's next-generation chipset, codenamed Grantsdale. The DCL kit, available through Intel, will provide an Intel reference motherboard design, integrating the CPU, chipset and other motherboard components for use with the Expedition PCB design flow, enabling personal computer motherboard OEMs and ODMs to shorten their design times. The DCL kit for Expedition will be available this year following the introduction of the new chipset by Intel. As microprocessor speeds continue to increase, it is becoming more complex to meet interconnect timing and signal integrity constraints while placing and

routing the critical components, while also minimizing the number of layers and overall size of the PCB. Intel is addressing this challenge by providing a reference motherboard design in Mentor's Expedition design solution to its customers. The Expedition Series offers advanced functionality with ease-of-use for the creation of today's most complex PCB designs. The Expedition Series features the industry's best place and route environment, powered by AutoActive® technology. The scalable product configuration of the Expedition Series allows designers to choose the right level of automation for their design needs. Expedition's tightly integrated systems design

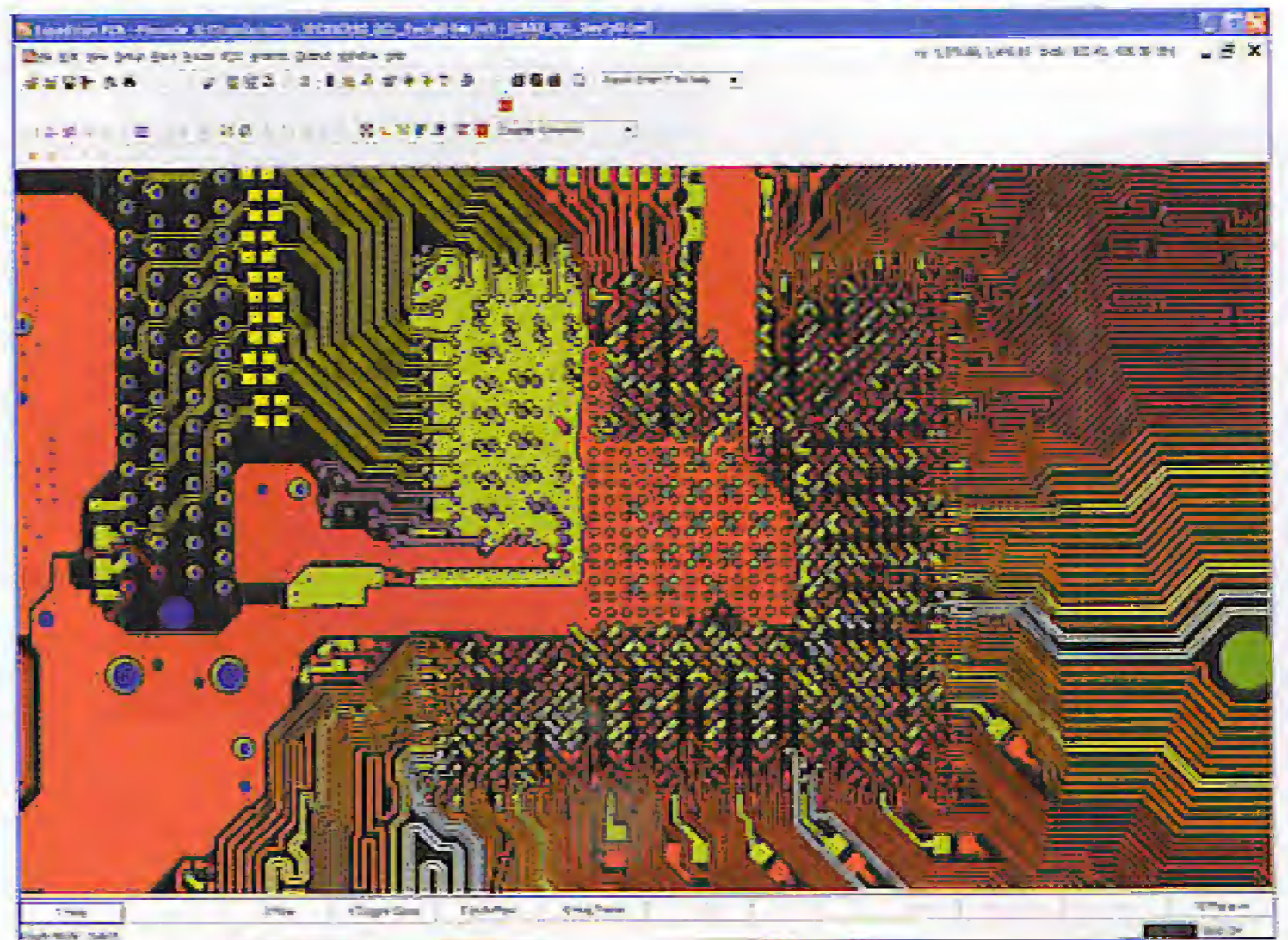

environment features a common database and common user interfaces and rules to ensure data integrity is maintained from concept to manufacturing.

www.mentor.com/expedition/
design_kits/

(047062-2)

IEEE 1451.1 & SC2000 COMPLIANT Plug & play sensors

Honeywell Sensotec has launched its plug, play and calibrate systems for its sensors and signal conditioning. The system is compliant to IEEE 1451.4 standard for connectivity of sensors and associated signal conditioning.

The transducer electronic data sheet (T.E.D.S) containing sensor specifications, calibration data and user defined location information is stored within the sensor. When connected to the SC2000

or any IEEE 1451.4 compliant signal conditioning the sensor is interrogated for the TEDS information and automatically sets up and calibrates the signal conditioning with the sensor.

IEEE 1451.4 compliant sensors and systems are set to revolutionize the test and measurement market. Users will never have to search for sensor calibration data sheets nor worry about the identity of blind cable and connec-



tors. The data will be right there, stored in the sensor and automatically recognized when the sig-

nal conditioning is powered up. www.honeywell.com/sensotec

(047062-4)

UMTS APPROACHING 3G network optimization

Radioplan recently announced that their commercially available WiNeS UMTS optimization solution has cut the cycle time for tuning the radio access network of a large city by over 80%.

WiNeS, a sophisticated, fully-featured 3G optimization toolset that has been developed to its current level of advanced functionality over several years, is available for use in-service

today. This fact has generated immense interest in Radioplan's unique solution.

Trials with major network operators and equipment vendors have shown that Radioplan's proprietary software technology and flexible interfaces allowed for an exceptionally smooth integration of the WiNeS toolset into the deployment process, and an extremely fast turnaround time

for optimized radio network configuration results.

Radioplan's WiNeS platform cuts redundant steps from the optimization process by bridging the gap between planning and measurement data, and by integrating the stages required into a single platform. This approach has the dual advantage of eliminating unproductive conversion stages while updating planning

models with real world data. The subsequent efficiency of the system greatly accelerates the availability of data for evaluation and optimization.

A new document which outlines the thinking behind Radioplan's solution can be downloaded from their website.

www.radioplan.com

(047062-3)

MICROPROCESSOR-READY Cost optimized mass flow meters

Sensirion presents a new generation of mass flow sensors with patented CMOSens® technology. The main advantage of the CMOSens® EcoLine is its very wide flow range (0-200 l/min with only one instrument) at an attractive price, especially for OEM applications.

Thanks to the fusion of a thermal sensor element with the readout circuitry on a single semiconductor chip (patented CMOSens® technology), the EcoLine achieves an unusually high dynamic range of up to 1:1'000. This indicates that a single CMOSens® EcoLine meter covers the range of several

traditional mass flow meters, which reduces the system cost significantly.

The EcoLine presents an accuracy of down to 3% of the measured value over the entire range of 2.5 to 100% of the flow range. The digital output can deliver the measurement data with a speed of 5 ms.

The rugged chemically inert housing is made of polycarbonate and is resistant to pressure of up to 8 bar (116 psi). This opens up a wide range of application varieties, for instance in process industry, medical applications or in the pharmaceutical industry as



well as in chemical engineering. The CMOSens® EcoLine is particularly suitable for OEM applications requiring precision and speed at minimal cost.

Modern technology permits a simple operation following the plug and play principle. The dig-

ital readout delivers the data via an RS-232/SPI interface. The supply voltage can vary between 7 and 18 VDC.

www.sensirion.com

(047062-5)

FOR EUROPEAN & US MARKETS

Drop-In RF modules for SRD

XEMICS' 868-MHz and 915-MHz Drop-In RF modules have been designed to facilitate the development of wireless communication applications and to reduce the time to market as they can be soldered directly onto a host board to add RF capabilities. Using these DP1203 modules ranges of up to several kilometres may be achieved, through high output power and excellent sensitivity. The 868-MHz module is ETSI pre-certified and the 915-MHz module is FCC pre-certified. All critical high frequency circuits are in a shielding can for extra protection against shock and EMI.

No external components (apart from an antenna) are required. The module incorporates an on-board antenna matching circuit, making integration straightforward even for engineers with no previous RF experience. The DP1203 868-MHz and 915-MHz modules can be soldered

directly onto the main system board just like other components. The modules are suited for automated assembly systems for high volume production, which significantly reduces the cost of manufacture.

The DP1203 offers the unique advantage of high data rate communication up to 152.3 kbit/s. Offering high output power and exceptional receiver sensitivity, the 868MHz radio module is suitable for applications conforming to the European (ETSI EN300-220-1 and EN301 489-3) regulatory standards whilst the 915 MHz module conforms to FCC Part 15 applicable in the United States. The DP1203 is the perfect module for complex wireless networks; high speed data rate applications, voice-over-RF, and applications where small size and extremely short time to market are high priorities.

With an 18 mm x 30 mm foot-

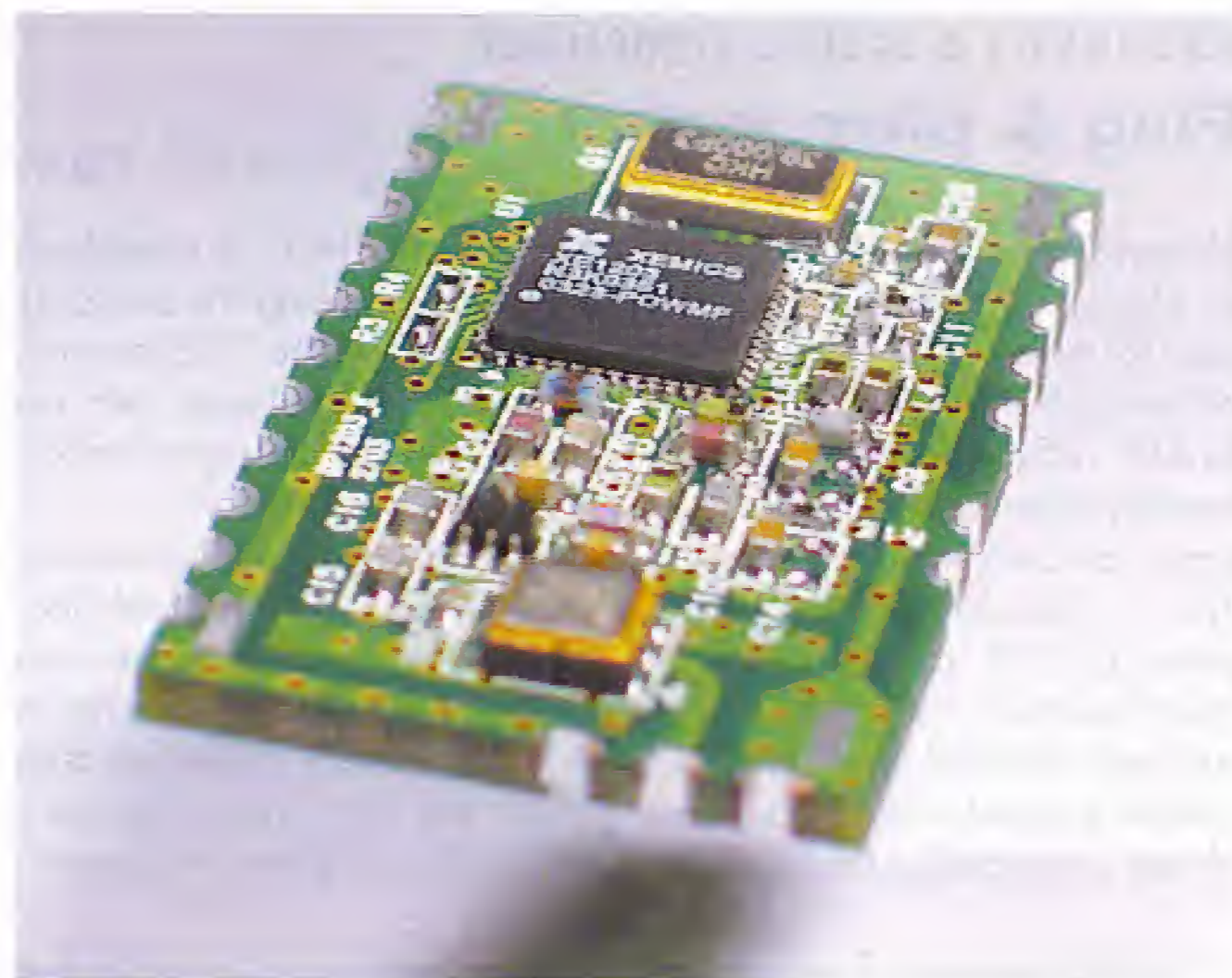

print, the DP1203 module fits perfectly into most customers' applications. Based on Surface Mount Technology (SMT) with components mounted only on one side, this module offers the advantage of being both very small and inexpensive. No additional interface circuitry is required between the drop-in module and the microcontroller. The modules are priced at below

\$10.00 in volume. Samples are available ex-stock direct from XEMICS and will be deliverable in volume from mid-February 2004.

www.xemics.com

(047062-7)

FIGHTING POLLUTION

No escape from the labyrinth

Most lasers used in the manufacture or marking of boards generate hazardous dust and fume that should be controlled by an extraction and filtration system. This is also true in hand or machine soldering application producing solder fume. The cost of ownership of these filtration systems in terms of replacement filters can be a concern for the end user but the new patented Labyrinth filter from Purex may just be the answer.

Extensive trials with laser manufacturers and long term research and development work with filter media specialists have resulted in the new patented Labyrinth filter that overcomes the disadvantages of current pleated paper and bag filter technology.

The Labyrinth filter is a radical

departure from current 'off the shelf' filters and has been specifically designed for filtration of laser fume. A conventional paper filter can only capture particles on a single thin face of media whereas the multi layered Labyrinth filter media is deep and graded and so has a much greater dust holding capacity throughout without affecting air-flow.

The greater dust holding capacity means that the end user does not have to change the filter as often and therefore laser downtime is kept to a minimum and because they buy fewer filters, the annual cost of replacements is much lower, in some cases over 10 times less. Further savings are made by the customer in shipping costs, as compared to

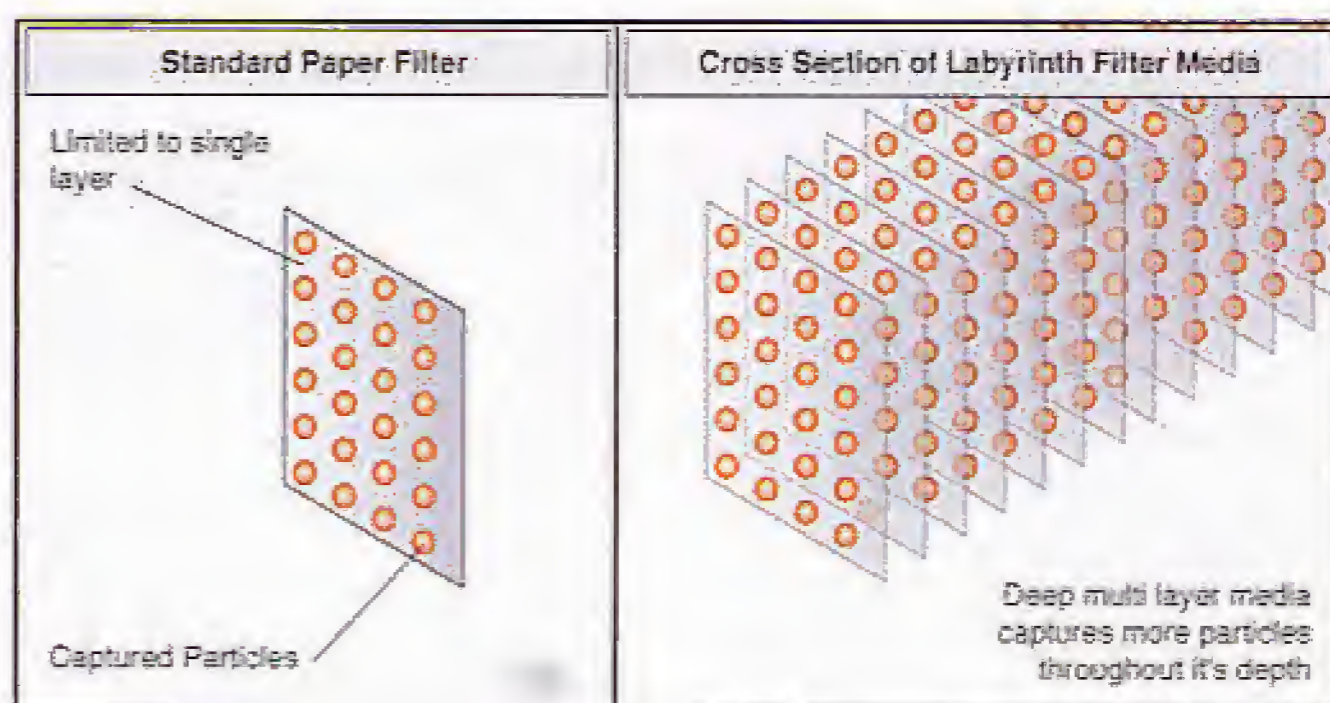

bulky rigid filters which may be expensive to transport; the Labyrinth is small, compact and lightweight and is less likely to be damaged in transit.

purex@purexlimited.co.uk
www.purexlimited.com

(047062-5)

POISED FOR WIRELESS APPLICATIONS

Tiny synchronous dc-dc converters

The ultra low ripple performance of Torex Semiconductor's new XC9215/16/17 series of synchronous-rectification type step-down DC-DC converters in a chip scale USB-6B (2.0 x 1.8 x 0.88 mm) package, makes them an ideal choice for noise sensitive RF applications such as Bluetooth and next-generation mobile phones.

With a built-in 0.5- μ P-channel driver transistor and 0.6- μ N-channel switching transistor, these highly integrated DC-DC converters require only the external connection of a chip inductor and two small ceramic capacitors to realise a stable power supply with an output current of 400 mA.

Three different types of switching control are available. The XC9215 provides synchronous-rectified PWM switching control, the XC9216 automatically switches between PWM/PFM depending on output load, and

the switching operation of the XC9217 can be manually controlled between PWM and PFM/PWM using the device's CE/MODE pin. This MODE pin function gives the designer ultimate control over the switching mode of the IC, which is a big advantage in RF applications. However, regardless of which version is selected, the IC provides fast response, low ripple output and high efficiency over a broad range of output loads.

Input voltage range is 2.0 V to 6.0 V. Output voltage is internally programmable between 0.9 V and 4.0 V in increments of 0.1 V. The switching frequency is 600 kHz or 1.2 MHz, the higher frequency allowing the designer to use small chip style inductors.

The new XC9215/ 16/17 can be supplied in either small SOT-23-5 or ultra compact USP-6B (2.0 x 1.8 x 0.8mm) packages.



www.torex.co.jp

(047062-8)

PREPARE FOR THE ELECTRICITY BILL

New meter reading solution

LogicaCMG, Dyomes and T-Mobile have launched new ways to allow companies to remotely get insight in their energy consumption.

The energy metering and reporting system of Dyomes, retrieves the data from the remote energy meters. The metering data is processed and maintained on LogicaCMG's hosting environment. This environment is connected to the energy meters through the T-Mobile wireless network. The solution enables companies to gain access to their daily energy consumption over the Internet.

As a result of the liberalization of the energy markets many companies need information about their energy consumption. Companies have become aware of the fact

that energy is just another 'raw material' and that the costs should be managed. The solution does not only give insight in the usage data, but also allows companies to reduce their energy costs.

LogicaCMG's platform Mobile2U is connected to T-Mobile's bulk SMS server. In the future the platform will also be connected to the GPRS network. It can then also be used to remotely operate the energy installations.

<http://www.logicacmg.com/>

(047062-9)



High-End-Preamp

Benjamin Hinrichs

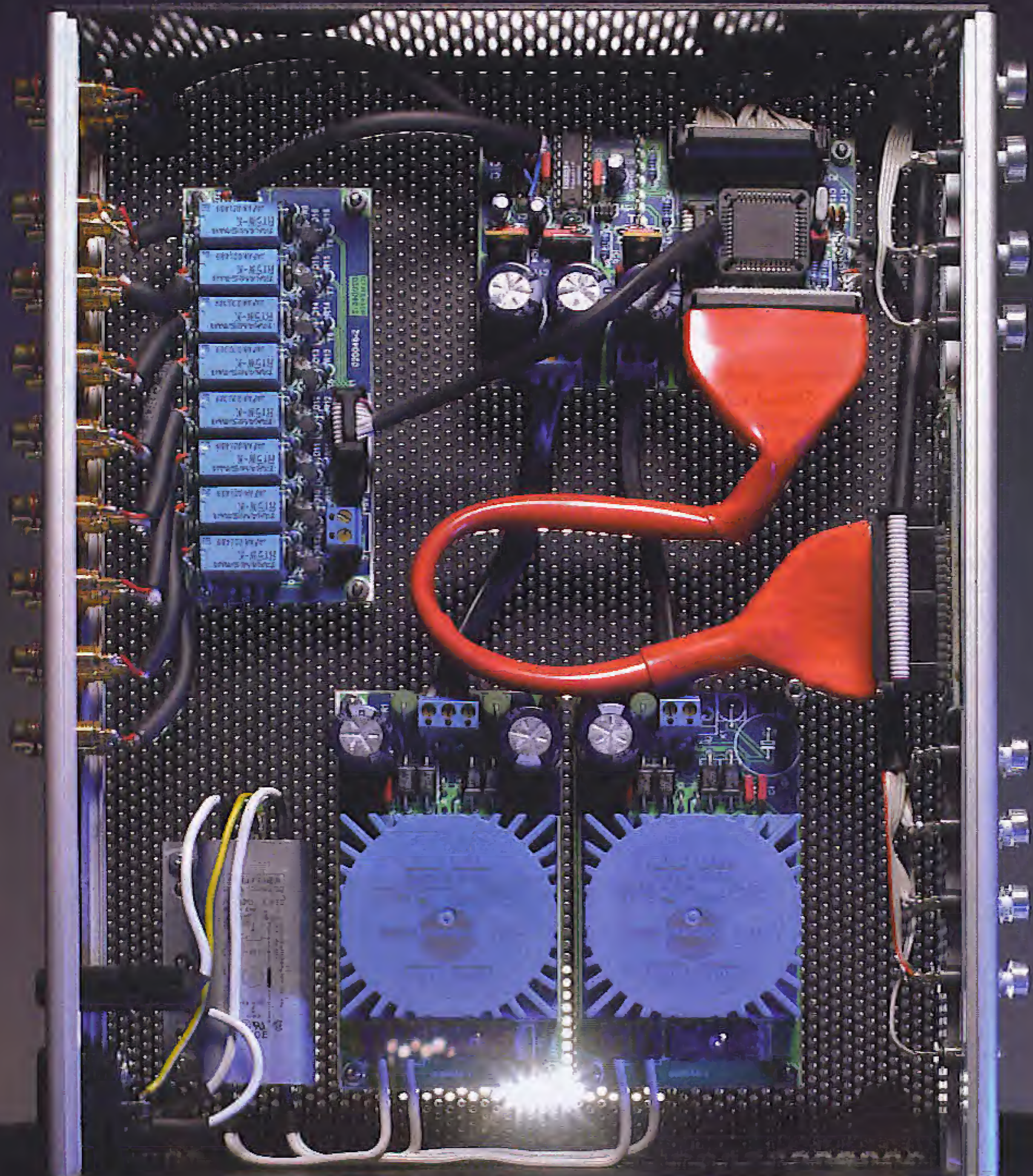

The modern design of this preamplifier yields audiophile specs, convenient operation and an attractive price. This is made possible by using a top-end digitally controlled attenuator/amplifier IC.

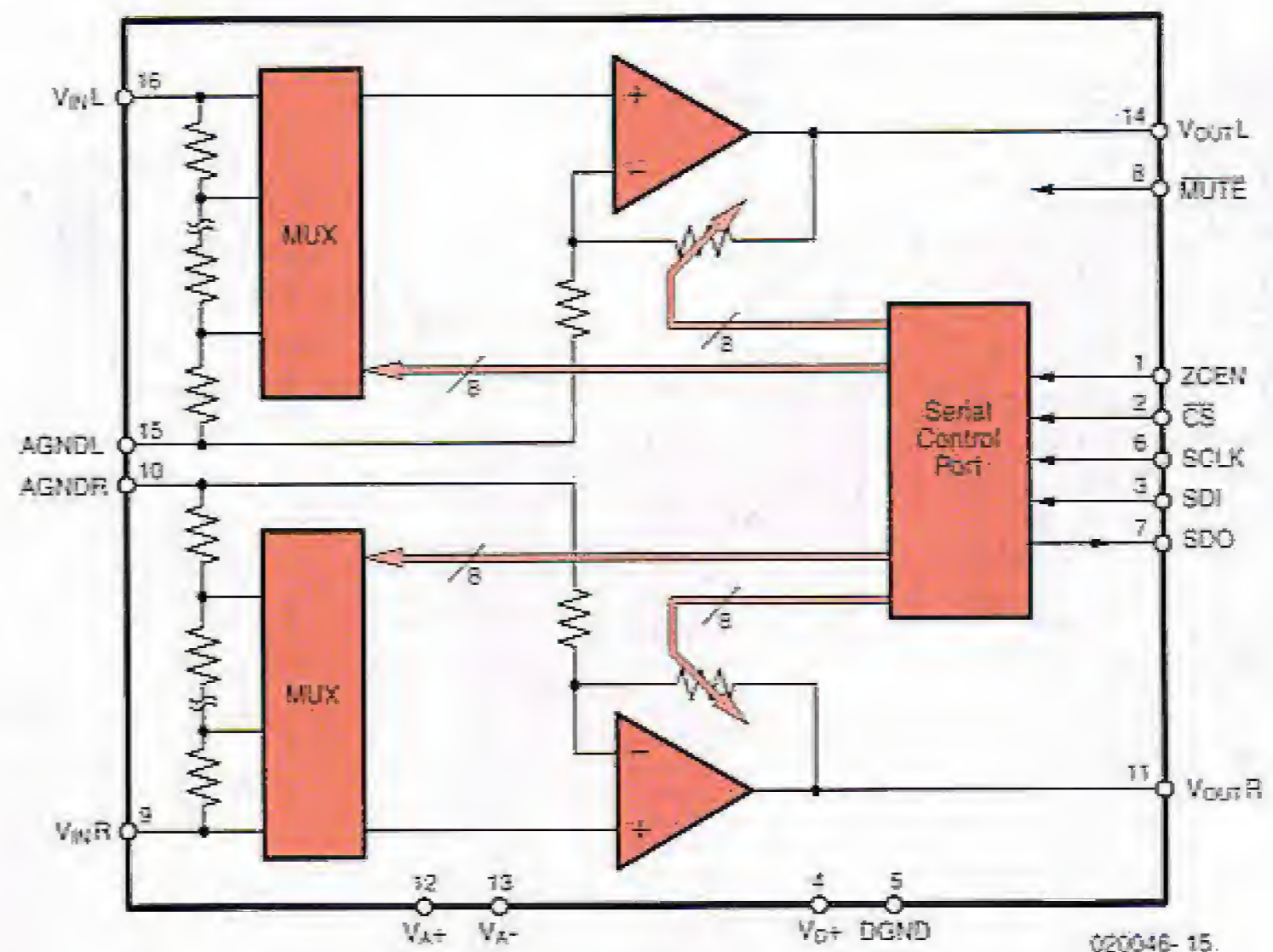

Figure 1. Functional block diagram of the PGA2311. The attenuation and gain are configured using a 3-wire serial bus.

Analogue audio electronics appears to have entered a dormant stage. In our present age of CDs, DVDs and MP3, traditional preamplifiers have been relegated to the role of signal distribution and, primarily, adjusting the volume level.

Our expectations for a modern high-quality preamplifier are that in addition to being easy to use, it should perform these signal distribution and volume adjustment functions with the greatest possible accuracy and the least possible distortion. And that is exactly where things start to get difficult.

Volume controls are commonly implemented using potentiometers, which are available in a wide variety of price ranges and types. Since we are normally dealing with a stereo signal, we need two mechanically coupled potentiometers. The decisive factor is the tracking of the two potentiometers, since this determines how closely the volumes of the right and left channels will match each other. Poor tracking is especially noticeable (and disturbing) at low volume settings. If we also want to have a balance control, we need an additional set of coupled potentiometers, and the tracking errors will add together.

The maximum permissible tracking error for 'audiophile' sensibility is 3 dB, but ideally it should be less than 1 dB. As can easily be seen from Table 1, these values are clearly exceeded by normal carbon-film potentiometers, and even high-quality

carbon-film potentiometers have difficulty maintaining adequate tracking accuracy with increasing age.

An audiophile alternative to potentiometers is to use high-quality, multi-position rotary switches with close-tolerance resistors. However, the right-hand column of the table shows that suitable special rotary switches having extremely low crosstalk and contact resistance cost around £80-90, which is rather expensive.

The disadvantage of this solution involves more than just the price (we will need two or three such switches for the volume and balance controls and the input selector switch, if present), since rotary switches cannot be remotely controlled.

If we wish to have the convenience of remote control as well as excellent tracking, there's no getting around a design using conductive-plastic potentiometers with a motor and the associated control electronics and mechani-

cal parts. This also involves considerable effort and expense, and just about everything must be duplicated for a balance control.

The PGA2311 stereo audio volume control IC

Admittedly, the idea of using a 'digital' IC for volume adjustment, and furthermore controlling it using a microcontroller, may evoke a sceptical frown from many an audiophile. Ten years or more ago, this scepticism would certainly have been justified, but the semiconductor industry has made enormous progress in this area. All of the major functions can now be integrated into a single chip, with results that can easily hold their own against the best mechanical solutions.

The Texas Instruments PGA2311 volume control IC used in this project is moderately priced and provides out-

Table 1. Tracking errors and price indications of various types of volume control

Type	Tracking error [dB]	Approximate price [£]
Carbon-film potentiometer	>3	3
High-quality carbon-film potentiometer	0.5 - 3	10 - 20
Conductive plastic potentiometer	0.1 - 0,3	25 - 55
Rotary switch	0.1	80 - 90
Motor and accessories	-	12 - 80
PGA2311PA	0.1	2.5 - 12

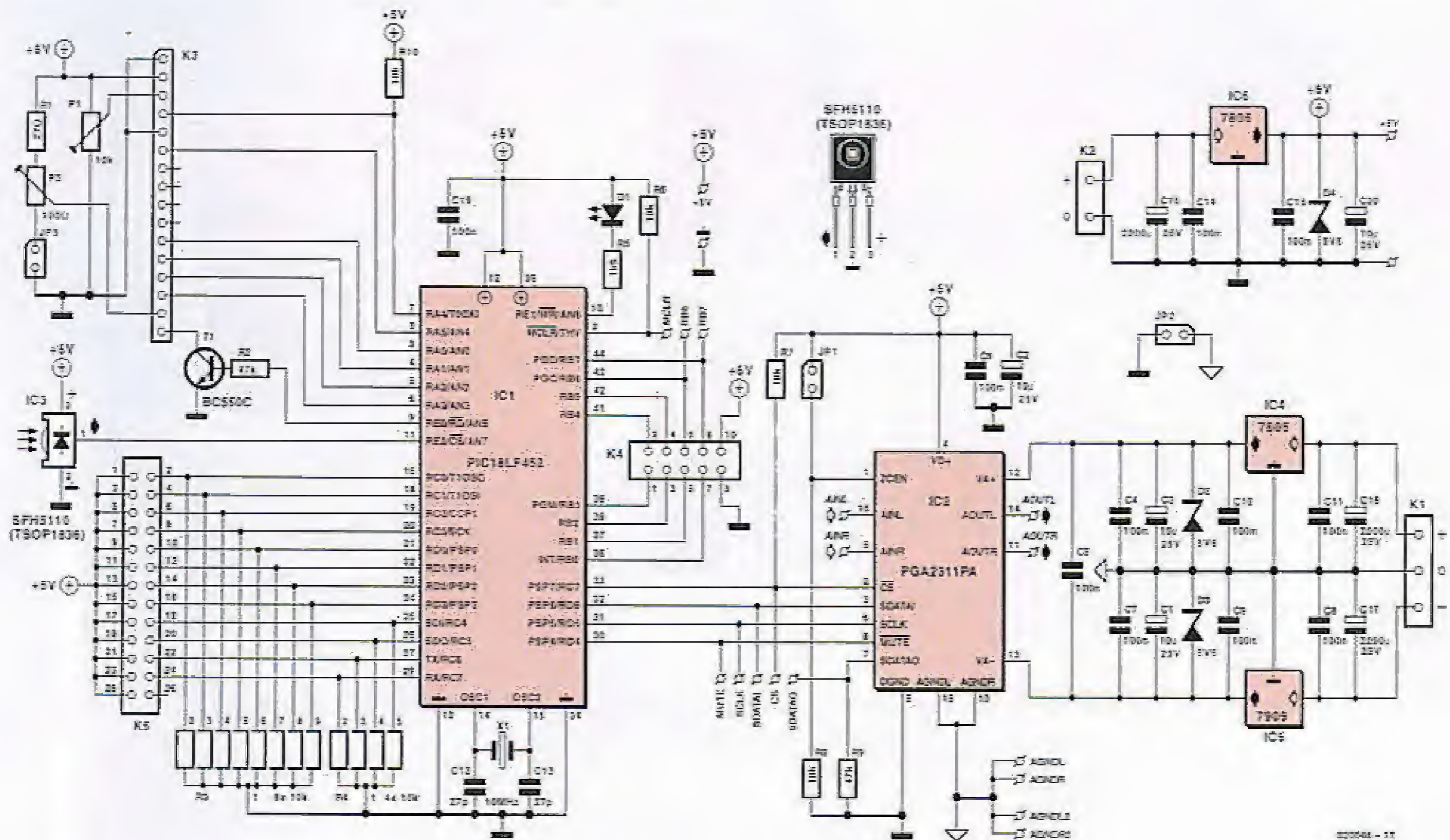

Figure 2. Circuit diagram of the main circuit board, which is divided into an analogue part and a digital part.

standing tracking without any degradation of tracking accuracy when balance adjustment is used, and it also has very good technical specifications. Another major advantage is that it can be digitally configured. This makes user-friendly operation possible (including remote control). An example of a high-end builder who uses this technology is Jeff Rowland.

The PGA2311, whose internal structure is shown in Figure 1, is a digitally controlled analogue stereo volume control with certain refinements. The two channels can be independently adjusted over a range of -95.5 dB to +31.5 dB in steps of 0.5 dB, which yields an adjustment range of 127 dB. The tracking error between the two channels, as well as the absolute setting accuracy of each of the channels, is ± 0.05 dB. This naturally means that a balance adjustment can also be implemented without any problems, since the high absolute setting accuracy prevents any offset from occurring. Another noteworthy feature is that the IC can directly drive 600- Ω loads.

The multiplexer (MUX) switches individual resistors to set the attenuation. After the attenuator, the signal passes through an output buffer, which can also provide gain via an adjustable feedback resistance.

The IC is controlled via a serial SPI

interface. Clock signal SCLK transfers a single 16-bit word to the IC via the SDI line. The first eight bits set the volume level for the right channel, while the second eight bits set the level for the left channel. The minimum value (0) represents Mute, and the maximum value (255) represents a gain of +31.5 dB.

For fully noise-free switching, zero-crossing detection can be enabled via the ZCEN lead. If it is enabled, the IC analyses the music signal and attempts to perform the switching during a zero crossing. If no zero crossing is detected within 16 milliseconds, the switching is performed without waiting any longer. Due to system design constraints, the ramp function of the software does not work properly if zero crossing detection is enabled.

In principle, four different types of ICs can be used in this circuit. Table 2 lists the differences among these ICs. The original design was developed for the Crystal (Cirrus Logic) type CS3310. The equivalent competitive product from Texas Instruments is the PGA2310, which is not only pin-compatible, but also has significantly better internal specifications. A particularly attractive feature of the latter IC is that it can handle signals up to 27 V_{pp} if the analogue supply voltage

is increased to 30 V. The improved type PGA2311 has even better channel separation, and the selected 'A' version has a better specification for total harmonic distortion plus noise (THD+N). For this reason, we selected the PGA2311A for his project.

We can also mention the PGA4311 in passing. This is a four-channel version of the PGA2311 and is only available in the SOIC package. It can be used with only minor modifications to the circuit board layout and software.

The control centre

The main circuit board, which forms the control centre for the preamplifier, requires surprisingly few components. This is due to the high integration density of the two ICs used here. By far the majority of the components are used to generate clean supply voltages.

The circuit is split into an analogue portion and a digital portion. The digital portion contains a Microchip PIC18LF452 microcontroller clocked at 10 MHz by a crystal oscillator. This microcontroller has 8-bit registers and 16-bit instruction words. Microchip has not shown much flair in assigning part numbers to its PIC microcontrollers. For instance, the PIC16F84, PIC16F628, PIC16F877 and PIC12F675 belong to the PIC14 family, while the

The project

This project has a modular structure, so it can easily be adapted to individual preferences. It consists of a general-purpose power supply board, an input selector board and the main circuit board, which holds the volume control IC and microcontroller. An LC display module, a keypad and an IR remote control unit complete the package. The hardware and software are described in this article, which is the first of two parts. The other two circuit boards are described in Part 2, which will appear in next issue of *Elektor Electronics*. Modifying the control program for the microcontroller is also described in Part 2.

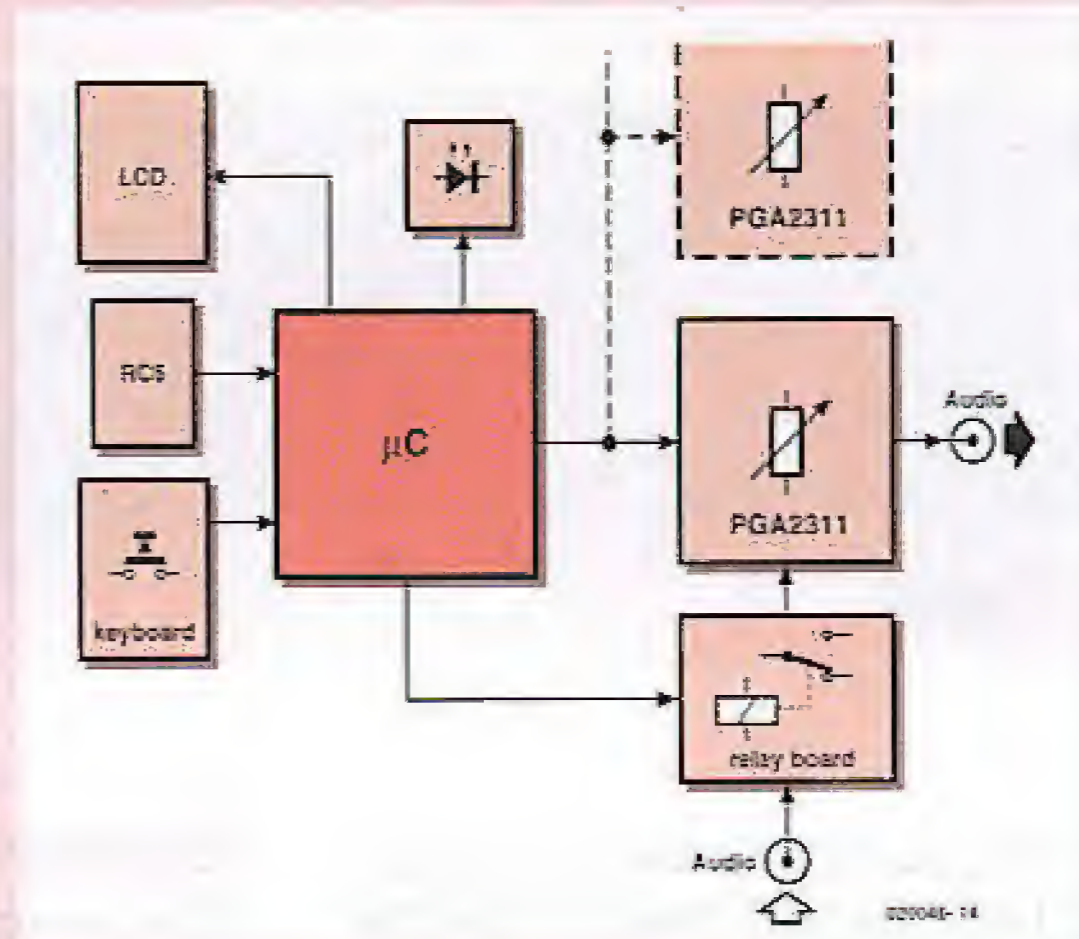

Block diagram of the preamplifier. The option of connecting additional PGA2311 ICs in parallel, as indicated by the dashed outline, is described in Part 2.

If you build all of the circuit boards as described, you will have a complete, remotely controllable preamplifier with input selection and function display. However, you can also dispense with the input selector and use only the volume control capability. If you wish, you can also omit the display, or you can omit the volume control IC on the main circuit board and use the remainder of the circuit as a remotely controllable relay circuit board for various applications. It is also possible to operate several volume controls in parallel, for instance in order to construct a multi-channel amplifier. For this purpose, only the volume control ICs have to be fitted to the main circuit boards for the additional channels. The control software for the microcontroller can be adapted to suit almost any imaginable application without reprogramming the microcontroller.

PIC18LF452 used here belongs to the PIC16 family.

The PIC18LF452 has a Flash program memory with a capacity of 32 KB (which is adequate for the rather extensive software), 1.5 KB of RAM and a 256-byte EEPROM. Its 31 stack levels provide adequate manoeuvring room for calling functions and procedures if the contents of all of the registers are written to the stack to allow the called procedure to use the registers. When control is returned to the calling procedure, the register contents are retrieved from the stack to allow the calling procedure to continue processing from the point where it transferred control. If frequently used subroutines are implemented using functions and procedures, the resulting interleaving of program execution can quickly exceed the capacity of a relatively shallow stack.

Before discussing the software in any more detail, let's have a look at the peripheral resources available to the microcontroller. The volume control (IC2) is connected to the microcontroller via the serial SPI bus. In addition, the microcontroller can select the PGA2311 using the CS line, and it can mute the output by placing a Low level on the MUTE line. These four lines, as well as the data output line (SDO), are externally accessible to allow several volume controls to be connected in parallel (as described in Part 2 of this article).

The remainder of Port D and all of Port C are fitted with pull-down resistors (consisting of the two SIL arrays R3 and R4) and routed to pin header K5, to which the pushbutton switches for controlling the preamplifier are connected.

K5 pins

- 1&2, ..., 15&16
- 17&18
- 19&20
- 21&22
- 23&24

Function

- Channels 1-8
- Volume Down
- Volume Up
- Volume Left
- Volume Right

The functions are essentially self-explanatory, but as you might imagine, additional functions are also implemented using combinations of buttons. All of the functions can also be selected using a remote control unit. IC3 is a 36-kHz infrared receiver, which filters, demodulates and cleans up the received light signal and boosts it to TTL levels, all without a single external component. An RC5 decoder is built into the software, so all types of RC5 remote control units (Philips, Grundig, etc.) can be used to control the preamplifier. The IR receiver is connected to RE2, which is one of the three Port E lines.

Table 2. Volume control ICs suitable for use in this project.

Type	Dynamic range [dB]	THD+N [%]	Channel separation [dB]	U _{out} (max) [V _{pp}]
CS3310-KP	116	0.001	-110	7.5
PGA2310PA	120	0.0004	-126	27
PGA2311P	120	0.0004	-130	7.5
PGA2311PA	120	0.0002	-130	7.5



The configuration options are so manifold that without a clearly organised display presentation you could quickly lose track of where you are, particularly when programming the basic settings. Via Port A, the microcontroller software drives an LC display with two lines of 16 characters and background illumination. In normal operation the display shows the channel names and volume setting, while in Set-up mode it is used to select channel designations and basic volume control settings. Pull-up resistor R10 connected to RA4 is necessary because this port lead has an open-drain output and thus cannot switch to a High level without a pull-up resistor. Trimpot P1 adjusts the display contrast, while trimpot P2 adjusts the brightness of the background illumination. JP3 extends the adjustment range. The microcontroller can switch the background illumination on or off via port line RE0 and transistor T1.

The microcontroller drives the relay board via K4. Each of port lines RB0–RB7 selects one of the eight audio inputs. The behaviour of the Status LED (D1) can be configured using the Set-up menu. This is described in more detail later on, along with the significance of the three lines MCLR, RB6 and RB7 that are led out from the board.

The main circuit board has separate power distribution for the analogue and digital portions. The ground potentials must be connected at a suitable location via wire bridge JP2. The single +5-V digital supply voltage and the symmetrical ± 5 -V analogue supply voltages are stabilized in the traditional manner using fixed voltage regulators with the customary buffer and decoupling capacitors. For all three voltages, 5.6-V Zener diodes are provided as 'backup' safety devices in case excessively high voltages appear on the outputs of the fixed voltage regulators.

Operation

After switch-on, the software checks whether reasonable values are located in the EEPROM. If this is not the case, such as immediately after the microcontroller has been programmed, default values are loaded. Otherwise the software loads the stored values and configures the volume control accordingly.

When a volume control button is pressed (Up, Down, Left, or Right), the software checks whether the adjustment is possible and whether the lower or upper limit of the adjustment range has been reached. Pressing the Up and Down buttons simultaneously causes the preamp output to be muted. Pressing the Left and Right buttons simultaneously restores the balance to the middle position, with the volume being set to the average of the values for the two stereo channels. If one of the input channel buttons is pressed, the channel is changed, with the output being muted during switching. Alternatively, the preamplifier can be configured via the Set-up menu to use a ramp. In this case, when the channel is switched the volume is first ramped down and then ramped back up again after the channel change.

An offset can be assigned to each channel, which is useful if the signal sources have different volume levels. The offset is applied to the set volume level when the associated channel is selected, and when a different channel is selected it is automatically removed. If an offset would cause one of the volume limits to be violated, it is ignored. The channel name selected using the Set-up menu is shown on the display. All of the functions of the preamplifier can be controlled using an RC5-compatible remote control unit. Naturally, the preamplifier can be freely configured using the Set-up menu to allow an existing RC5 remote control unit to be used to control all of its functions.

The selected configuration settings are stored in the microcontroller EEPROM and are thus available each time the preamplifier is subsequently used.

Set-up

The software has default values for all configuration settings. All of the functions of the software can be adapted to individual needs via the Set-up menu. To enter the Set-up mode, hold the Channel 1 button pressed while switching on the preamp.

The Set-up configuration can only be modified using the control buttons on the preamplifier; it cannot be adjusted using the remote control. The buttons have the following functions in the Set-up mode:

DOWN	Next entry
UP	Previous entry
LEFT	Exit
RIGHT	Enter

1) RC5 IR Set-up

Reads an RC5 code from a remote control unit, displays the code and assigns it to one of the following buttons: Channel 1–8, Down, Up, Left, Right, or Mute.

Defaults

Configured for a Grundig remote control unit.

Buttons

LEFT	Exit
RIGHT	Next

2) RC5 IR Test

Reads and displays an RC5 code from a remote control unit. Intended to be used to check settings made using IR Set-up. Can also be used to test an RC5 remote control unit.

Button

LEFT	Exit
------	------

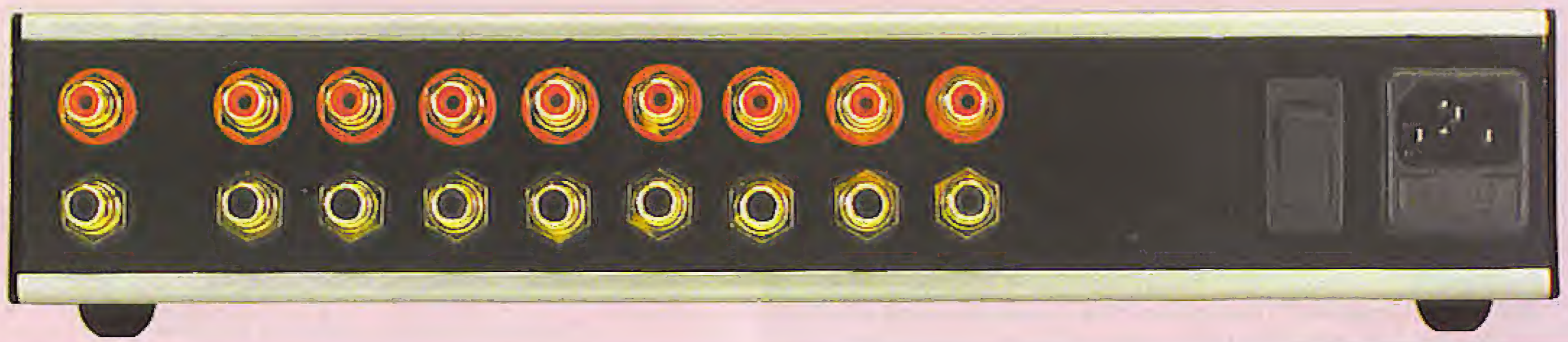

3) Maximum Volume

Sets the maximum allowable volume level in dB.

Default
+31.5 dB (maximum)

Buttons

DOWN Reduce volume level
UP Increase volume level
LEFT Exit

4) Ramp

The ramp function gradually decreases the volume before switching channels and gradually restores it afterwards. The ramp function can be enabled or disabled, and the delay between successive volume steps can be configured. Enabling the zero crossing detection function (JP1) can impair the operation of the ramp function.

Defaults

Use ramp: Yes
Ramp delay: 15 ms

Buttons

DOWN Use ramp: Yes/No
Ramp delay: - 1 ms
UP Use ramp: Yes/No
Ramp delay: + 1 ms
LEFT Exit
RIGHT Next

5) Relay Test

Energizes all relays for testing.

6) Input Type

This allows the input configuration to be set to either 8 channels (Single) or 2 x 4 channels (Double). This is useful if you want to switch not only the signal leads but also the ground leads. The input type should also be set to Double for balanced signal sources. In the Double mode, the relays are switched in pairs as follows: RE1+RE5, RE2+RE6, RE3+RE7, and RE4+RE8.

Default
Single

Buttons

DOWN Single / Double
UP Single / Double
LEFT Exit

7) Offsets

An offset can be defined for each channel. It is applied when the channel is selected and removed when a different channel is selected. If applying an offset would violate one of the volume limits (Mute or Maximum Volume), it is not used. The value is shown in dB.

Defaults

Channel 0-8: 0 dB

Buttons

DOWN - 0.5 dB
UP + 0.5 dB
LEFT Exit
RIGHT Next

8) Channel Names

Each channel can be assigned a name selected from the following list:

Aux, Aux2, CD, CD2, DAC, DAC2, DVD, DVD2, DVD-Audio, DVD-Audio2, Line, Line2, Phono, Phono2, SACD, SACD2, Tape, Tape2, Tuner, Tuner2, TV, TV2, VCR, VCR2, Video, Video2, Sat, Sat2, DCC, DCC2, MD, MD2, DAT, DAT2, PC, PC2.

Defaults

Channel 1: CD
Channel 2: Phono
Channel 3: DVD
Channel 4: SACD
Channel 5: DVD-Audio
Channel 6: DAC
Channel 7: Tape
Channel 8: Line

Buttons

DOWN Next list item
UP Previous list item

LEFT Exit
RIGHT Next

9) Hardware Set-up

Configures the type of hardware used. This only affects what is shown on the display. The options are Normal (pre-amp), Input Only (channel selection only), and Volume Only (volume adjustment only).

Default

Normal

Buttons

DOWN/UP Normal / Input Only /
Volume Only
LEFT Exit

10) LED Set-up

Sets the LED behaviour. Options: Delay Off, Always Off, Always On.

Default

Delay Off

Buttons

DOWN/UP Delay Off / Always Off /
Always On
LEFT Exit

11) LED Set-up

Sets the behaviour of the LCD background illumination. Options: Delay Off, Always Off, Always On.

Default

Delay Off

Buttons

DOWN/UP Delay Off / Always Off /
Always On
LEFT Exit

12) Power-up Volume

Sets the switch-on behaviour. This menu can be used to configure two settings. The first setting controls the switch-on behaviour and has the following options: Last (set the volume to

Measured performance

Confidence (in the data sheets) is good, but measurement (by the *Elektor Electronics* lab) is better! The results of the FFT analysis of a 1-kHz signal with an amplitude of 1 V_{eff} indicate two things. First, the overall harmonic distortion figure of 0.0012 % is dominated by the induced 50-Hz mains noise (at -100 dB) if the measurement is made over a bandwidth of 20 Hz to 20 kHz. Second, the first three harmonics of the test frequency are located in the range of -116 dB to -118 dB. If the bandwidth range for the measurement is shifted to 100 Hz - 200 kHz, the THD+N value drops to only 0.0005 %. This is a fantastically low value.

In order to further reduce the effect of mains interference, it is recommended to separate the mains input and power supply board as far as possible. Fully enclosing the main circuit board and relay board (inside a tinned sheet-metal box located inside the main enclosure, for example) could also have a beneficial effect.

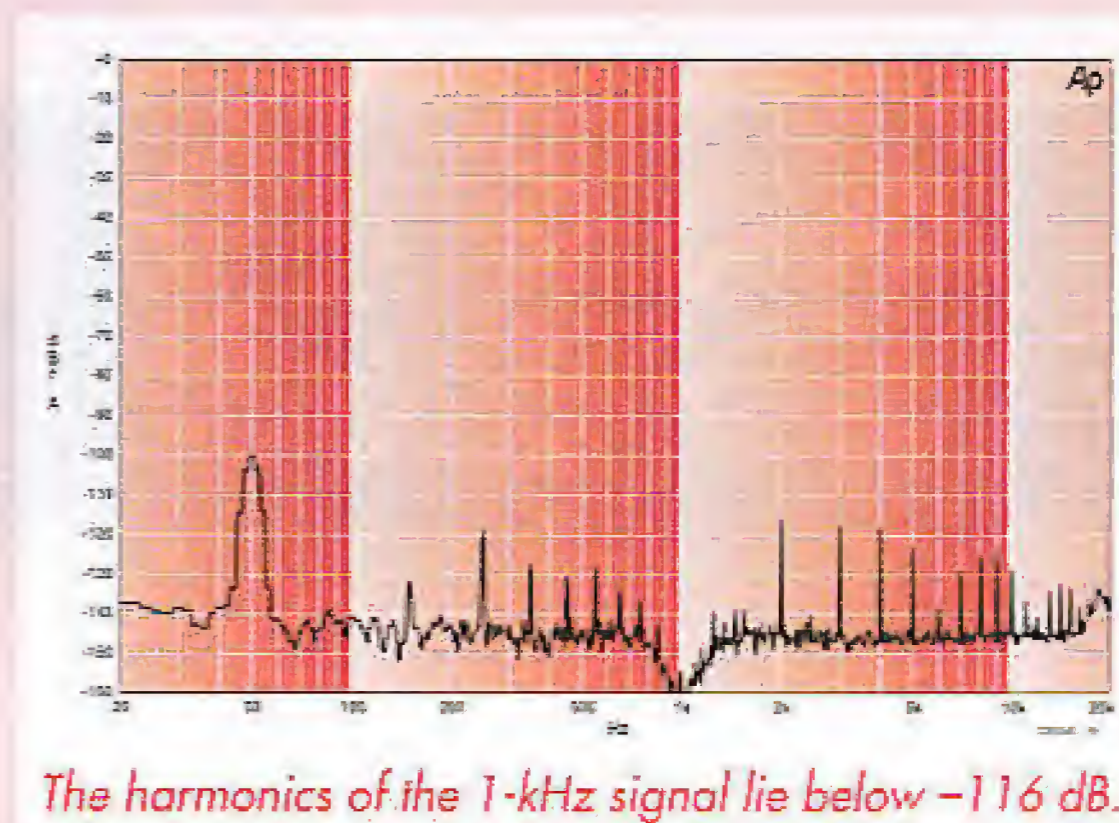

Test results at unity gain (0 dB)

Nominal input sensitivity	200 mV
Nominal output voltage	200 mV
Maximum output voltage	2.4 V _{rms} (THD+N = 0.01 %)
Input impedance	10 k Ω (input selected) ∞ (input not selected)
Output impedance	< 0.6 Ω
Bandwidth *	0-3 MHz 0-150 kHz (gain 31.5 dB)
Harmonic distortion (THD+N) *	0.0005 % (1 kHz, B = 100 Hz - 22 kHz) 0.0012 % (1 kHz, B = 80 kHz) 0.002 % (20 Hz - 20 kHz, B = 80 kHz)
Signal to noise ratio (S/N) *	100 dB (B = 22 kHz) 113 dBA
Channel separation **	> 88 dB (1 kHz) > 62 dB (20 kHz)
Crosstalk **	< 98 dB (1 kHz) < 88 dB (20 kHz)

* at V_{out} = 1 V

** with open input terminated in 560 Ω

the same level as when the preamp was switched off), Mute, Mute \rightarrow Last (muted on switch-on, with the previous volume setting being restored after a button is pressed), and Preset (always use a configurable preset value).

The second setting is the preset value. The current volume level can be stored as the preset value by pressing Up or Down.

Default
Last
Preset values: Mute, Mute

Buttons

DOWN/UP Last / Mute /
Mute \rightarrow Last /
Preset (store current volume as preset)

LEFT Exit
RIGHT Next

13) Restore Defaults

Restores the predefined default configuration settings. This also occurs if a newly programmed microcontroller without reasonable configuration values in the EEPROM is fitted.

Default
Volume: Mute
Channel: 1
All others: see above

(020045-1)

References

- [1] www.ii.com
<http://focus.ii.com/docs/prod/folders/print/pgs2311.html>
- [2] www.jeffrowland.com/Concentra%20Page.htm
www.jeffrowland.com/docs.htm
- [3] 'Top of the Range Volume Control', Elektor Electronics, Oct. 2000, pp 32 ff.
- [4] www.cirrus.com
www.cirrus.com/en/pubs/rdDatasheet/3310.pdf
- [5] www.microchip.com
www.microchip.com/download/lit/pline/picmicro/families/18fxx2/39564b.pdf

Elektor Electronics Year Volume CD-ROMs on Hard Disk

Faster & comprehensive access

Harry Baggen

The recently published *Elektor Electronics* 2003 CD-ROM has a useful extra for even easier use of several earlier volumes you may already have. It is now possible to copy most of our year volume CD-ROMs to hard disk using the program Diskmirror supplied. With a few tricks, you can even do so using relatively little hard disk space.

Elektor Electronics year volume CD-ROMs have been around for almost ten years and form a handy and compact way of archiving and searching thousands of *Elektor Electronics* articles. So far, these CDs had just one disadvantage: discs had to be physically exchanged if you wanted to look in a different year volume. Without special

tools it was not possible to copy the contents of a year volume CD-ROM to hard disk and run it from there. This problem has been solved once and for all with the release of the volume-2003 CD. The program Diskmirror found on this CD now allows you to copy (nearly) all CDs from the series to hard disk and access them there. One restriction exists regarding the CDs for year volumes 1995 and 1996, these having been produced using a proprietary data format which is incompatible with the current standard (i.e., Adobe Acrobat Reader). Although the 1995 and 1996 CDs may also be copied to hard disk, the relevant archives need to be opened using their own browser program.

Year volumes from 1997 through 2003 together occupy about 3 Gbytes of hard disk space. Although that is peanuts in view of today's hard disk capacities (which are often in excess of 100 Gbytes), we can well imagine that the sheer magnitude of the collected archive is a bit too much for many older PCs sporting, say, a 20-Gigabyte hard disk.

Since all year volume CDs pro-

duced by us contain all editorial articles in four languages (after all, we are an international publication), it is possible to select just one language when copying the 1998 through 2003 CDs to hard disk.

First, create individual folders on the hard disk for every CD-ROM from 1998 onwards, using folder names like Elek_98, Elek_99, Elek_00, etc. These year-volume folders may be contained in a larger folder named, for example, 'EE_Volumes'. Next, create a sub-folder named 'Articles' in each of these year volume folders. Copy the program 'easetup.exe' found on each year volume CD-ROM into the associated year volume folder. Then copy the folder 'E' (English) from the year volume CD-ROM to the folder 'Articles' on the hard disk. On the CD, the folder 'E' containing all English-language articles may be found in the folder 'Articles'.

Using the above method of selective copying the total size of the *Elektor Electronics* Archive 1997-2003 is limited to about 1.1 Gbytes.

Having copied all files and folders to their final destinations on the hard disk,

Diskmirror needs to be informed about the whereabouts of the various year volumes. This is done by entering the relevant paths on the hard disk.

Here at the editorial offices we use the HD version of our archive many times every day, mainly to answer readers' enquiries and dig up our own articles. The access to the articles is extremely fast.

(040066-2)

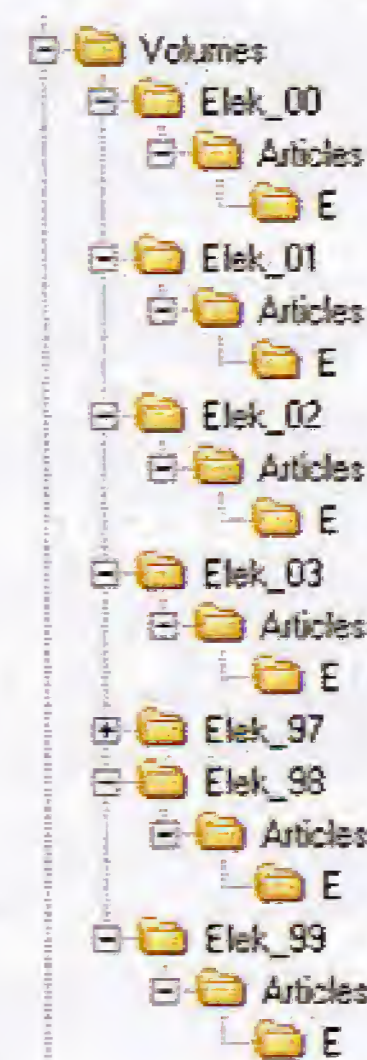

Gert Baars

VHF-LOW Explorer

A low-cost NBFM receiver for 68-88 MHz

This article, we hope, will have serious consequences. Not negative, mind you, because apart from enabling beginners to experience the thrill of picking up radio traffic in a generally neglected band, the arrival of this inexpensive 4-m receiver should help to get the IARU section of the 4-m band released to radio amateurs in countries all over the world in due course.

For many decades the UK has been home to the 4-m amateur radio band, also known as '70 MHz', and the IARU-approved band plan shown in Figure 1 is on the wall in many a radio shack up and down the country. So far, only a few other countries including Ireland, Denmark and — quite recently — Croatia have followed suit by releasing the frequency range between 70.000 and 70.5000 MHz for use by licensed radio amateurs. Unfortunately, in many other countries the relevant frequency range is in use by government or military services which need to have a few arms twisted (pun intended) before they move out. Although it is too early to say whether or not the arrival of new communication systems like Tetra, C2000 and Astrid on the European Continent and elsewhere will free up the 70 MHz band to amateurs, there can be no harm in increasing the pressure on various national radio regulatory authorities to do the necessary paperwork. At least in Holland and Poland, the word is out that amateurs are 'interested' in the 70 MHz band. Let's hope the pressure rises as the 4-m band is fantastic for VHF DX-ing. *Elektronik Electronics* being an international publication, we will gladly assist in spreading the word in as many countries as possible.

What's in it for me

While the radio amateur fraternity is poised to grab their share of the spectrum around 70 MHz, it should be noted that the 68-88 MHz band has other, equally interesting users and applications including Government, MoD and PMR (private mobile radio) communications (not encrypted in many cases), security services, telemetry and the odd TV station. Unless you live in a really remote place, even a simple antenna

in your loft will bring in a surprising number of stations using the 4-m band. Tune and Explore!

Design considerations

From the very start of this project, the design was to remain as simple as possible. This decision has important consequences as well as a background we'd like to share with you. Sure, a receiver for the 68-88 MHz band could be a double-conversion superheterodyne design employing a 10.7-MHz filter, a 10-turn pot for the tuning and a final intermediate frequency (IF) bandwidth of 15 kHz to suit NBFM (narrow-band frequency modulated) signals picked up at a sen-

sitivity of 1 μ V or so, not forgetting a squelch to make sure the receiver is quiet when nothing is received. Great shopping list, but such a receiver will be expensive as well as difficult to adjust by beginners. Next, please! The good news is that an attractive alternative is available in the form of the TDA7000 chip from Philips that's been around for more than 10 years now, which is quite remarkable for a consumer-market chip. This 'ever-green', then, contains a complete radio receiver with a very low IF of just 70 kHz. Okay, so image frequencies occur just $2 \times 70 \text{ kHz} = 140 \text{ kHz}$ away from the desired signals, but that need not be a problem because on the positive side we do not have to worry too much about the input filtering. Also, the IF filter responsible for

70MHz (4m)		Licence Notes:	
IARU		Amateur Service: Secondary. Available on the basis of non-interference to other services (inside or outside the UK). Power limit: 22dBW PEP. Permitted modes: Morse, telephony, RTTY, data, fax, SSTV	
UK Usage		U/A Rem Ctrd	U/A Beacon
70.000			
Beacons	70.030		Personal beacons
70.030			
SSB and CW only	70.150 70.185 70.200		Meteor scatter calling Cross-band activity centre SSB/CW calling
70.250			
All modes	70.260		AM/FM calling
70.300			
Channelised operation using 12.5kHz channels	70.3000	✓	RTTY/fax calling/working
	70.3125		Digital modes
	70.3250	✓	Digital modes
	70.3375		Digital modes
	70.3500		Emergency comms priority
	70.3625		Digital modes
	70.3750		Emergency comms priority
	70.3875		Digital modes
	70.4000		Emergency comms priority
	70.4125		Digital modes
	70.4250		FM simplex - used by GB2RS
	70.4375		Digital modes
70.4500		FM calling	
70.4625		Digital modes	
70.4875		Digital modes	
70.500			

Notes:
1. 70.085MHz \pm 0.005 designated for PSK31 use in the UK.

Figure 1. If and when radio regulatory authorities eventually decide to allocate the 4-m to radio amateurs then the IARU recommendations will be followed, with strong guidance available from the UK example.

COMPONENTS LIST

Resistors:

R1=100k Ω
 R2=150k Ω
 R3=100 Ω
 R4=22k Ω
 R5=330k Ω
 P1=50k Ω logarithmic potentiometer

P2=50k Ω linear potentiometer

Capacitors:

C1=39pF
 C2=27pF
 C3,C6,C14=10nF
 C4,C11,C13,C19,C23,C24,C25,C26,

C29=100nF
 C5,C12=1nF, lead pitch 5mm
 C7=100nF, lead pitch 5mm
 C8=220pF
 C9,C18=330pF
 C10=10pF
 C15,C17=3nF3, lead pitch 5mm
 C16=180pF
 C20=22pF PTFE trimmer
 C21=150pF

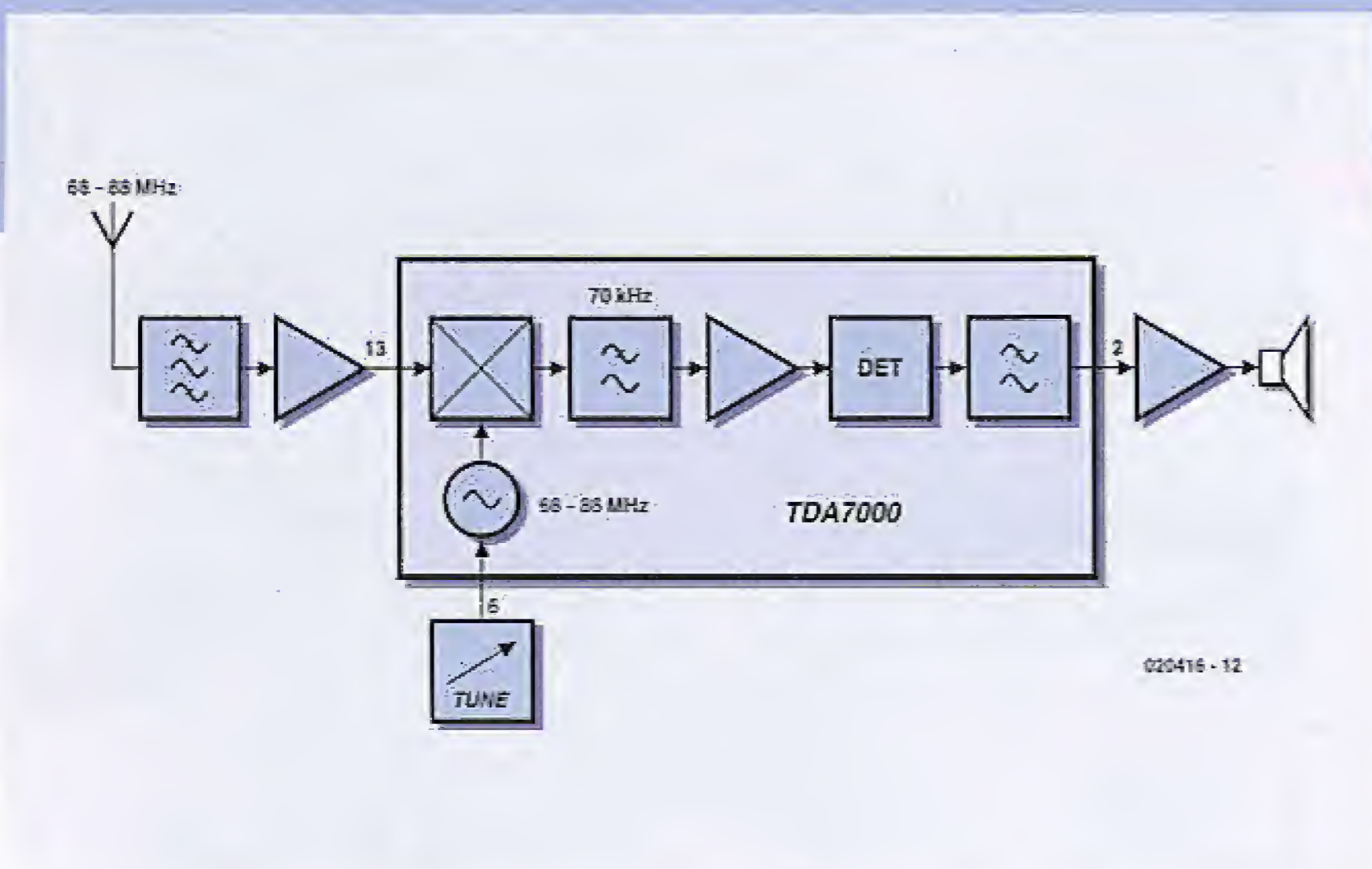

Figure 2. Block diagram of the single-conversion receiver. Note the low intermediate frequency of just 70 kHz which in our case has a number of advantages!

the selectivity may be realised as a simple R-C network, obviating the need for expensive and esoteric quartz or ceramic filters.

Block diagram

Even if you are not a radio boffin, the block diagram of the proposed receiver in Figure 2 should be largely self-explanatory. The TDA7000 contains a muting circuit which is activated at a level of about 6 μ V. As we will want to use a whip antenna as the bare minimum, an RF preamplifier will have to be inserted between the antenna and the input of the TDA7000. Everything from the output of the RF preamp right up to the input of the audio amplifier is contained in the TDA7000. If you want to know everything about the chip, get a copy of the datasheet (see Web pointers).

Inside the receiver

Figure 3 pictures the circuit diagram of our little receiver. MOSFET T1 at the antenna input provides a gain of about 18 dB across the band, driving the TDA7000 RF input via coupling capacitor C5. The receiver's input imped-

ance is 50 Ω to match most types of coax cable available these days. A number of capacitors strewn around the TDA7000 ensure an IF bandwidth of about 70 kHz. The VFO (variable frequency oscillator) inside the chip is tuned by a varicap (D1) which gets its bias voltage from tuning pot P2. IC2, a 78L05, supplies the regulated 5 volts for the receiver chip, the preamp and, importantly, the tuning pot.

The circuit configuration around the TDA7000 follows information from Philips on making the chip better compatible with NBFM signals. After all, the TDA7000 was originally designed for reception of VHF FM broadcast stations, which at 100+ kHz deviation are much wider than the 'thin' PMR signals (3 kHz) we're interested in. None the less, as the IC will produce a rather low net output signal, some extra amplification is furnished in the audio section by adding an electrolytic capacitor between pins 1 and 8 of the LM386 AF power amp (another evergreen). Hang on, where are the adjustments and the dreaded home-made coils in this receiver? Well there's only trimmer C20 to adjust the tuning to 68-88 MHz.

The receiver employs off the shelf miniature chokes only, so there are 0 (say, zero) coils to wind.

Build it!

At this point, you should have enough confidence and 'inside knowledge' about the receiver to start building it, if necessary with the help of a friend with RF experience. If you do not have the means to make your own board, you can easily order a ready-made one through our Readers Services. The board, pictured in Figure 4 together with its external elements, is single-sided with a large copper plane at the solder side to assist in RF stability, screening and decoupling. There are many small ceramic capacitors on the board which need to be positively identified before they are soldered in place. The same goes for the three miniature chokes, the coloured bands on them indicating the value in microhenries. The TDA7000 should be soldered directly on to the board.

The 4-legged MOSFET T1 is mounted at the solder side of the board, perched directly onto four solder pads. The close-up photograph in Figure 5 should help to get our message across.

We would suggest using a small diecast case from Hammond to house the receiver and the battery. The case is then drilled to secure the volume pot, tuning pot and the loudspeaker. Battery powering is not a must however, and you may decide to power the receiver from an existing DC source like a cheap mains adapter. This will require one additional hole to be drilled and filed for the mains adaptor socket.

Caveats and limitations

Due to the simplicity of the design, some inherent limitations should be

C22=100pF
 C27=2nF2
 C28=10µF 16V radial
 C30,C31=100µF 16V radial

Inductors:

L1=100nH (brown, black, silver)
 L2=330nH (orange, orange, silver)
 L3=180nH (brown, grey, silver)

Semiconductors:

D1=BB911
 T1=BF981
 IC1=TDA7000
 IC2=78L05
 IC3=LM386N4

Miscellaneous:

8 ohm, 1 watt miniature loudspeaker
 Diecast case: e.g., Hammond type 1590B

9V battery (PP3 / .6F22) with clip-on leads
 PCB, order code 020416-1 (see Readers
 Services page or www.elektor-
 electronics.co.uk)

taken into account. First, the receiver will be found rather susceptible to cross modulation, breakthrough and general interference from nearby FM broadcast transmitters. This not at all surprising in view of the nearby frequencies (89-107 MHz) and power levels in the kilowatts range. Good shielding, coax cable and a tuned antenna for 4 m (see 'Antenna' inset) should remove most of the interference. Second, a small problem with spurious oscillation was discovered when the receiver's RF input is not terminated

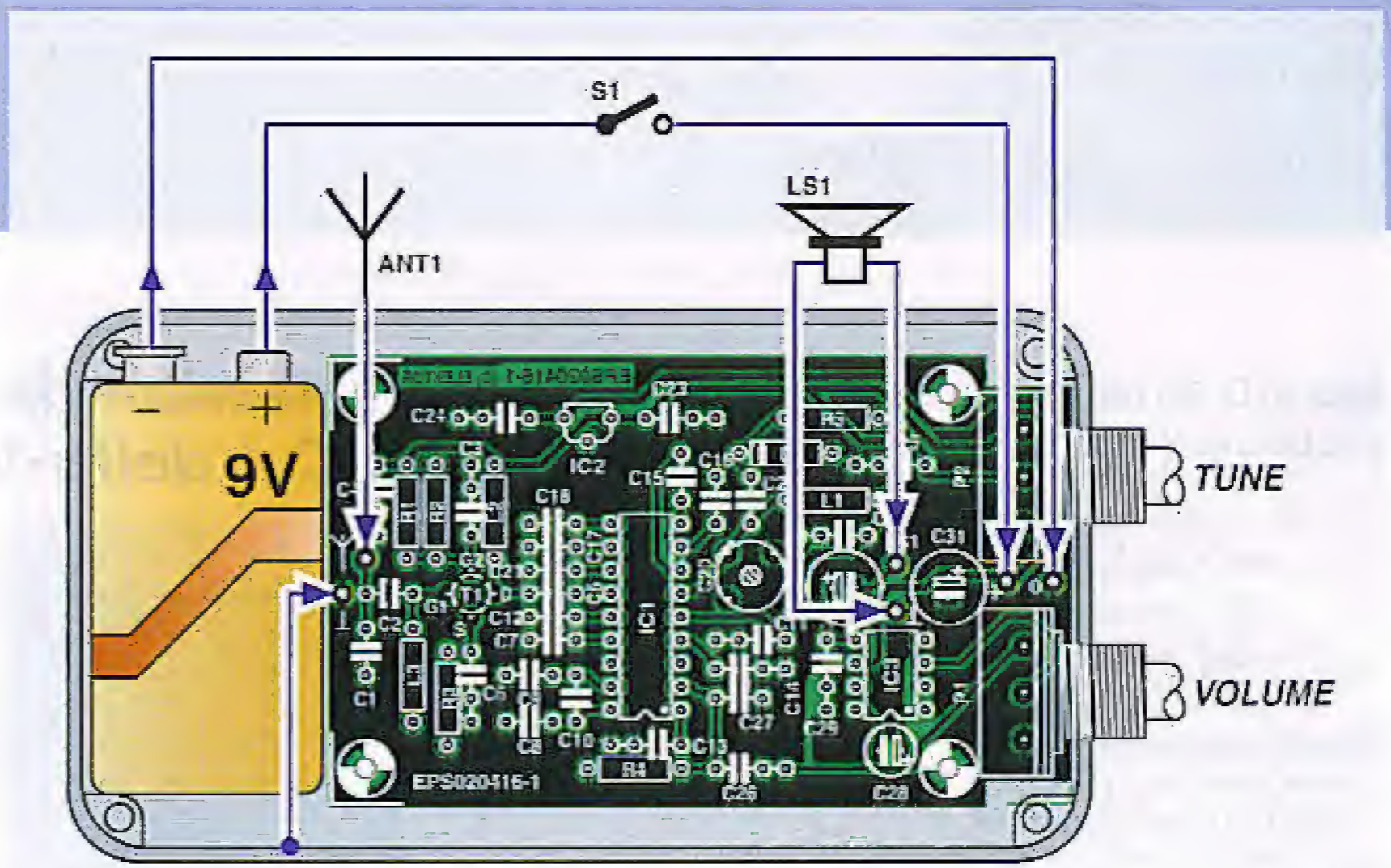

Figure 4. A drawing to show how the board is connected to its external elements. The copper track layout may be found elsewhere in this issue.

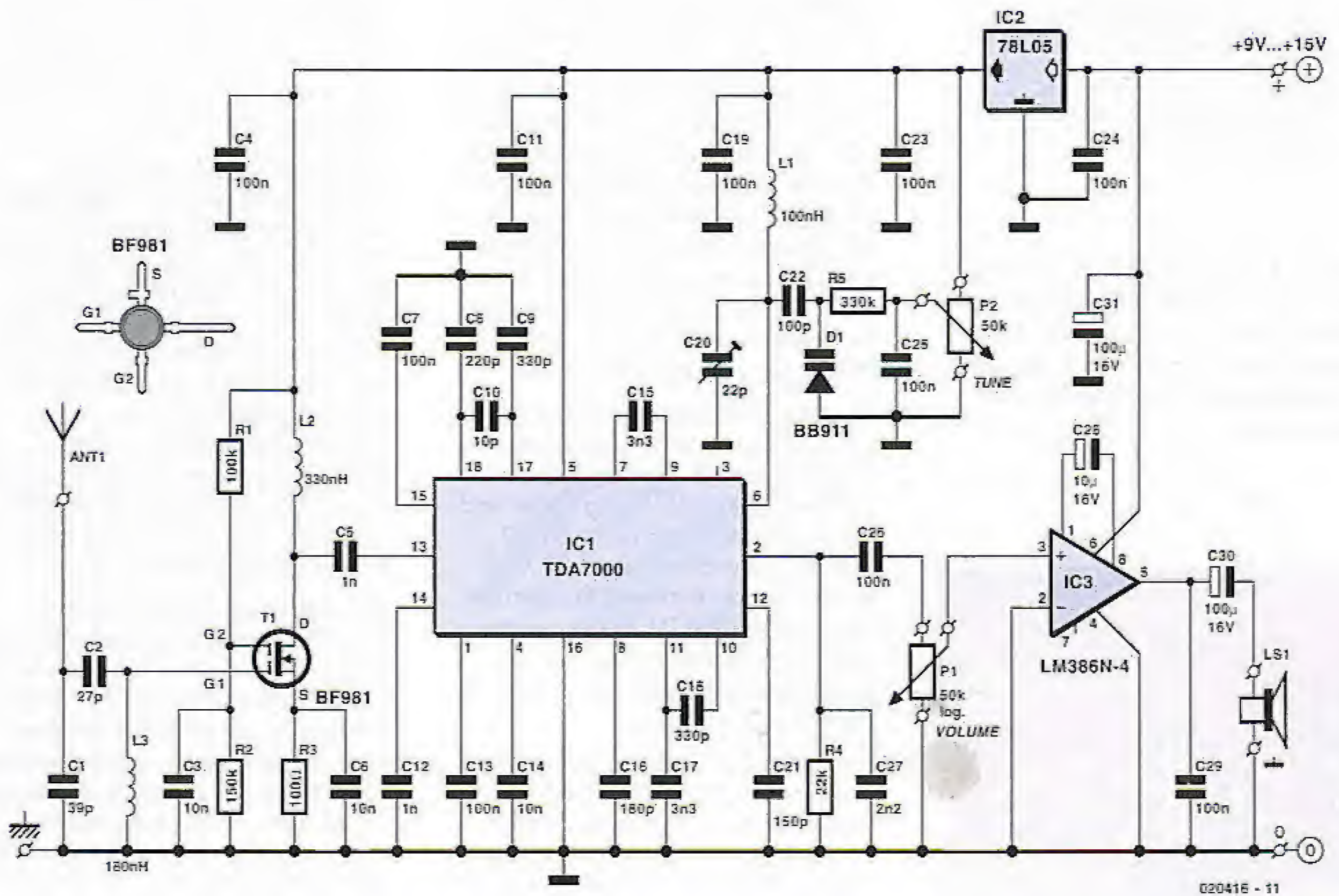

Figure 3. The circuit diagram of the VHF-Low Explorer has few surprises and proves the simplicity of the design.



About the author

Gert Baars (42) has been active in electronics from a young age. In 1988 he graduated in electronics at the Polytechnic of Alkmaar in the Netherlands. Gert's main interest is RF electronics, but also software and digital hardware. He has had over 20 projects published in this magazine since 1997, including the successful Airband Receiver, the 20-m Band Receiver and the DDS RF Signal Generator. In the future, Gert hopes to write about Atmel micros in control of RF equipment, and possibly the design of a UHF sweep generator. He invites comments and suggestions by email, g.baars13@chello.nl.

with 50 Ω . For the rest, nothing to stop you from exploring the 4-metres band.

(020416-1)

Web pointers

TDA7000 datasheet:
www.semiconductors.philips.com/pip/TDA7000.html#datasheet

70 MHz info page and news reflector:
www.70mhz.org

International Amateur Radio Union (IARU):
www.iaru.org

Radio Society of Great Britain (RSGB):
www.rsgb.org

4-m band in Ireland:
www.qsl.net/ei7gl/vhfpag.htm#70mhz

70 MHz Yagi antennas (DK7ZB):
www.qsl.net/dk7zb/start1.htm

7-element Yagi for 70 MHz (M1CCZ):
www.qsl.net/zr6dxb/PROJECTS/4mBeam/4MBeam.htm

Figure 5. This is as close as we could get a lens to the MOSFET at the solder side of the board. Use the MOSFET pinout drawing in the circuit diagram to get the device positioned the right way around.



Varicap selection or the delta-C / delta-V issue

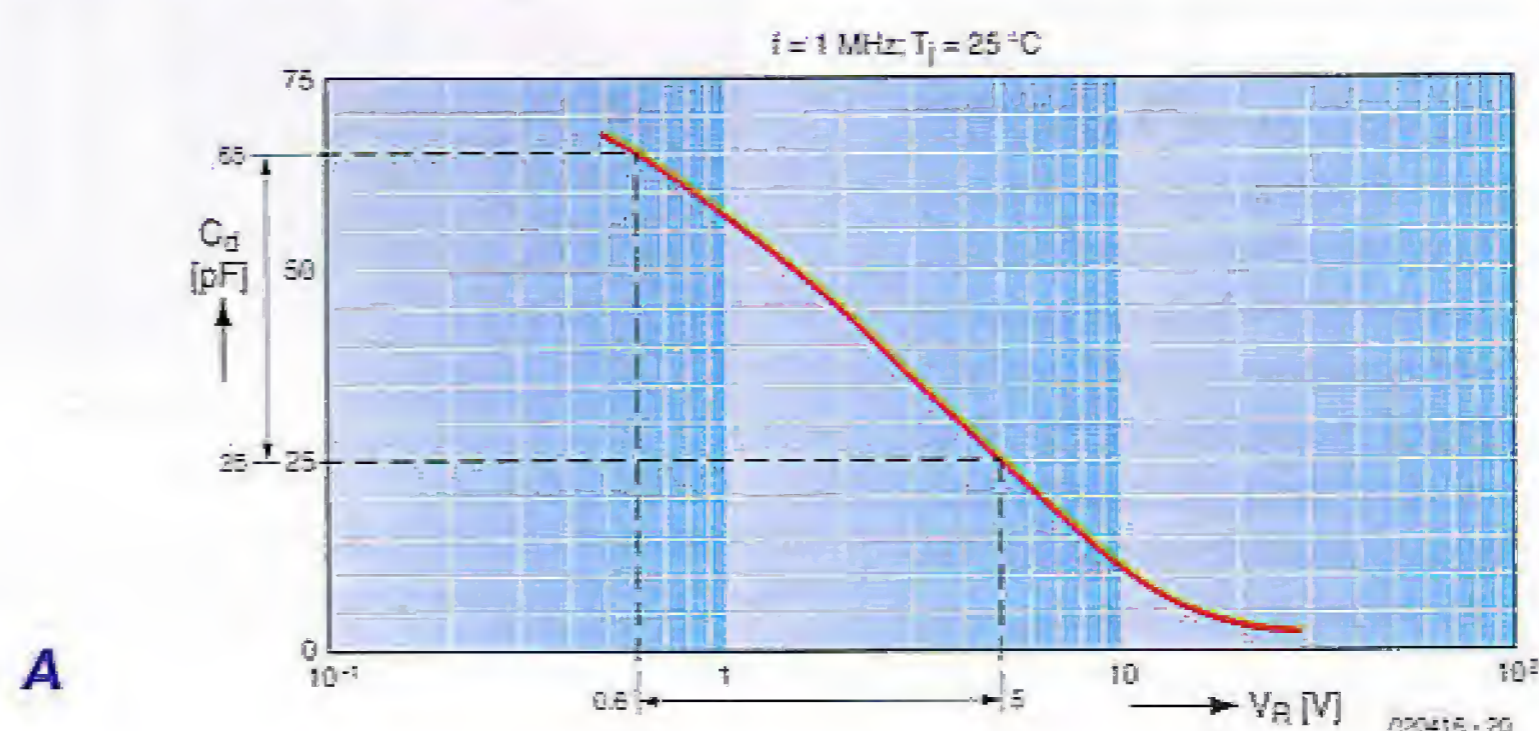

For some strange reason varicaps (or variable capacitance diodes) have always been rather elusive components. Try this: design, engineer and publish a design at instant T and you'll find that the varicap you've specified after hours of careful researching has disappeared from the market at $[T+1 \text{ day}]$. Here at Elektor we're optimists by nature but because we anticipate supply problems with the BB911 varicap specified for this present receiver, we thought we'd give you a few clues to help you find equivalent types.

The component values in the circuit diagram guarantee a tuning range of 68-88 MHz, with trimmer C20 defining the edges of the tuning range and the capacitance ratio of the BB911 defining the width of about 20 MHz. In other words, trimmer C20 shifts the tuning range and D1 determines the width of the tuning range. The two parameters have some interaction, of course.

If you are only interested in, say, the 4-m amateur band (70.0-70.5 MHz) then a narrow tuning range is sufficient and you will have no trouble getting just about any old VHF varicap to work in the receiver, simply by adjusting C20 to a 'known-good' signal in the band (ask for assistance from a local licensed radio amateur).

If, on the other hand, you want everything from low-band TV (68 MHz) to police, MoD and government PMR (in some cases just below 87 MHz) then some thought should be given to the selection of the varicap.

The Philips BB911 was chosen because of its relatively large capacitance range of 25 pF to 65 pF for a corresponding tuning voltage of 0.6 V to 5 V — see **Figure A** (courtesy Philips Semiconductors). That's right, the capacitance presented by a varicap is inversely proportional to the voltage applied across the device! Mathematically, though, $[\Delta C / \Delta V]$ is a dimensionless device constant which, in the case of the BB911, works out at about 9 for the linear part of its capacitance range.

If you can't get the BB911 locally there's no reason to abandon the project or send Blue Murder emails to the Editor because there are lots of alternatives. Do not be afraid to experiment. In many cases, unlabelled varicaps picked up at radio rallies or salvaged from an FM radio may be used, provided you know they are for VHF. Connecting a few varicaps in parallel ('stacking') is perfectly legitimate in order to arrive at the desired $\Delta V / \Delta C$ value and hence the receiver's tuning span.

Features at a glance

- Single conversion receiver
- Frequency range 68-88 MHz (VHF-Low band)
- Free-running VFO
- TDA7000 FM Radio Circuit modified for NBFM
- MOSFET preamplifier
- Single-board construction
- On-board audio amplifier
- 1.7 μV sensitivity for 12 dB SINAD (3 kHz deviation)
- Power supply 9-18 VDC, 20 mA (muted)

Propagation — the total surprise factor

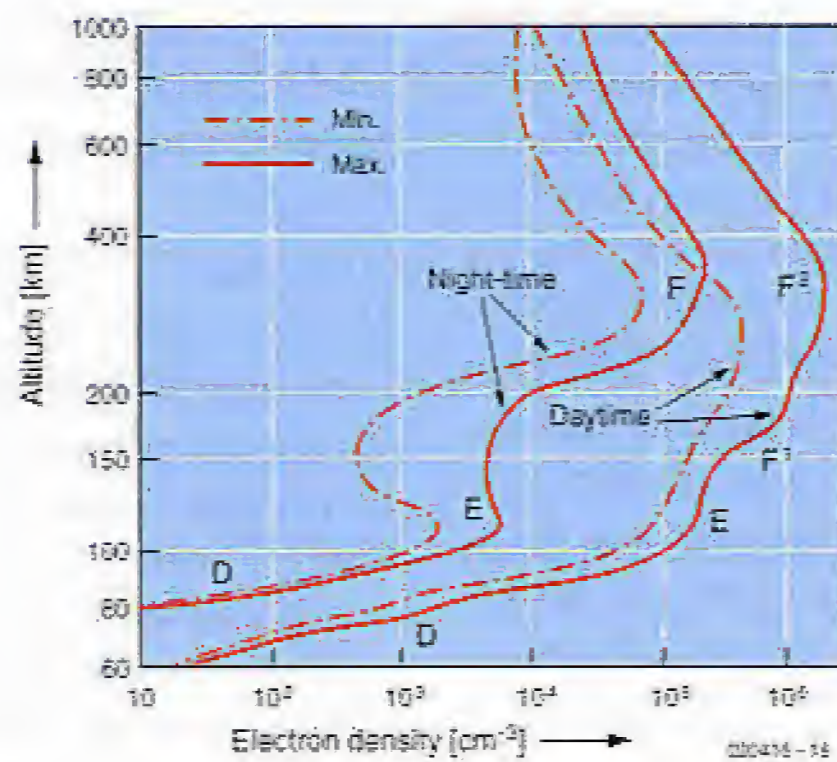

A

The propagation of radio waves is a fascinating phenomenon because most of it is guesswork and sheer surprise. That is not to say the subject has not been studied extensively by researchers and radio amateurs — far from it, a number of underlying principles have been described in scientific terms as early as the 1920s by Nobel Laureate Sir Edward V. Appleton (1892-1965). Appleton discovered that radio waves, depending in their frequency, were subject to refraction, reflection and (partial) absorption by certain regions of the earth's atmosphere. These regions are marked by different electron densities and occur at heights of 60-400 km above the earth. The basic distribution is shown in **Figure A**. You will search in vain for the A, B and C regions. This is because Appleton first discovered the region around 100 km height and called it 'electron' region. The D and F (actually F1 & F2) regions were discovered later when the name E region was already established. Today, researchers employ extremely sophisticated radio equipment as well as observations from radio amateurs in an attempt to prove the existence of more 'layers' in the atmosphere.

Because it is easily ionised, the E region is favourable for reflection and refraction of signals in the 70 MHz

and VHF bands in general. Apart from rather unexpected behaviour, usually during periods of high air pressure, the E region is also predictable in that the electron density drops considerably at sunset due to a lesser degree of ionisation. As an aside, the E region reflects medium-wave band signals at night time when the absorption by the D region largely disappears.

it will reach receiver R1 as the farthest location. However, with a bit of help from Es the signal may be reflected and reach receiver R2 which, seen from T, is way below the horizon. In extreme case the signal may even 'bounce' within the E layer and reach receiver R3.

Es is due to the formation of 'clouds' of densely ionised regions in the atmosphere at a height of 100-125 km. Es typically occurs during summer months, but exceptions have been noted. Given a sufficient degree of ionisation (sometimes helped by sunspot outburst), radio contacts via sporadic E have been made over distances of 2000 miles and more. A good way to check for Es activity is to use your receiver to monitor the signal strength of one of the many beacons in the 70-MHz radio amateur band, or TV stations near the low end of the band. Many years ago, thanks to a peak in sunspot activity coupled with massive Es cloud activity across the Atlantic Ocean, police cars from

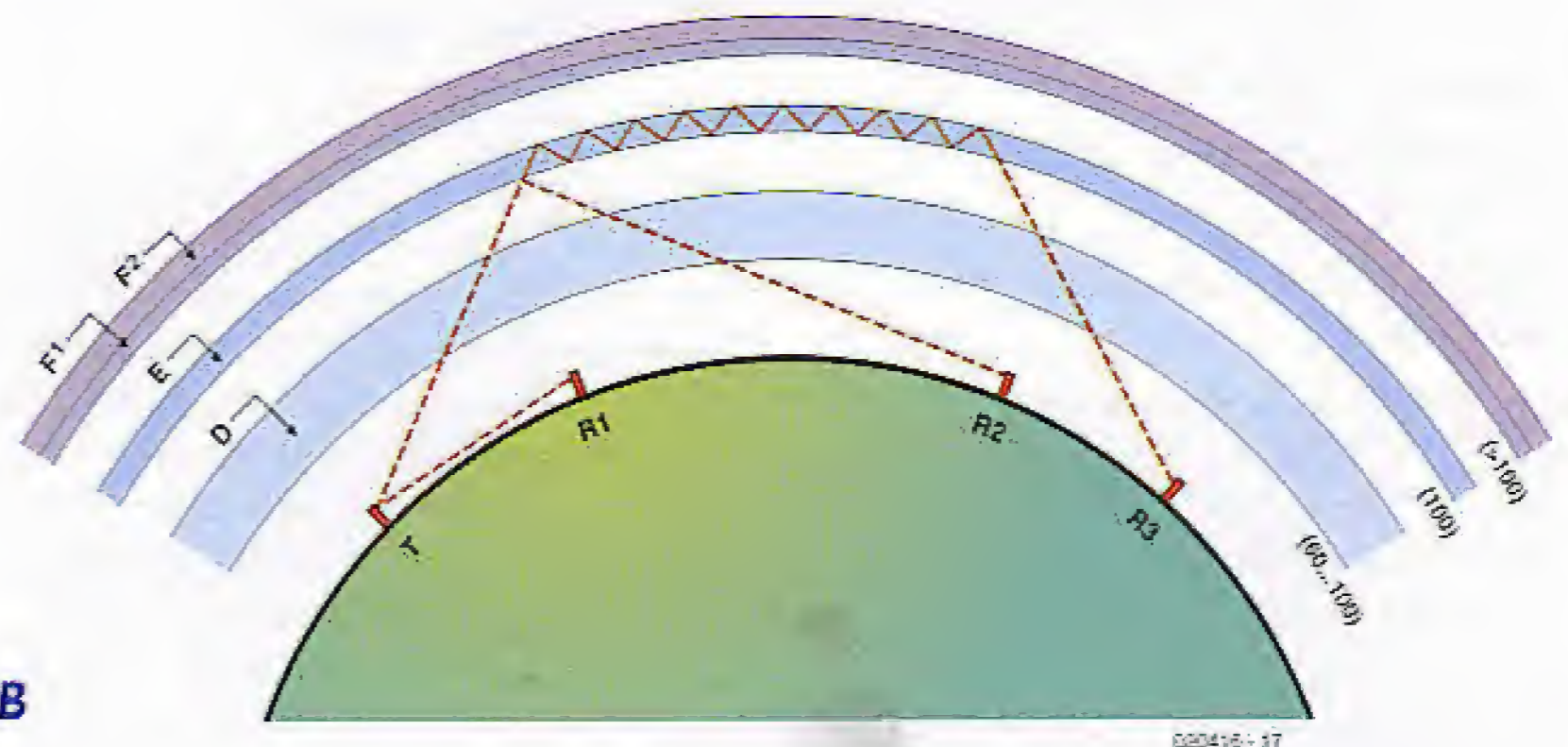

B

Sporadic E (Es) is what we are after for our 70-MHz receiver, and the reason should be obvious if you look at **Figure B**. Normally, the range of a transmitter T using the VHF-Low band is governed by line of sight, so

Boston and New York could be heard loud and clear in Europe, some signals even making it across police repeaters on this side of the ocean. Starski & Hutch Ten-four!

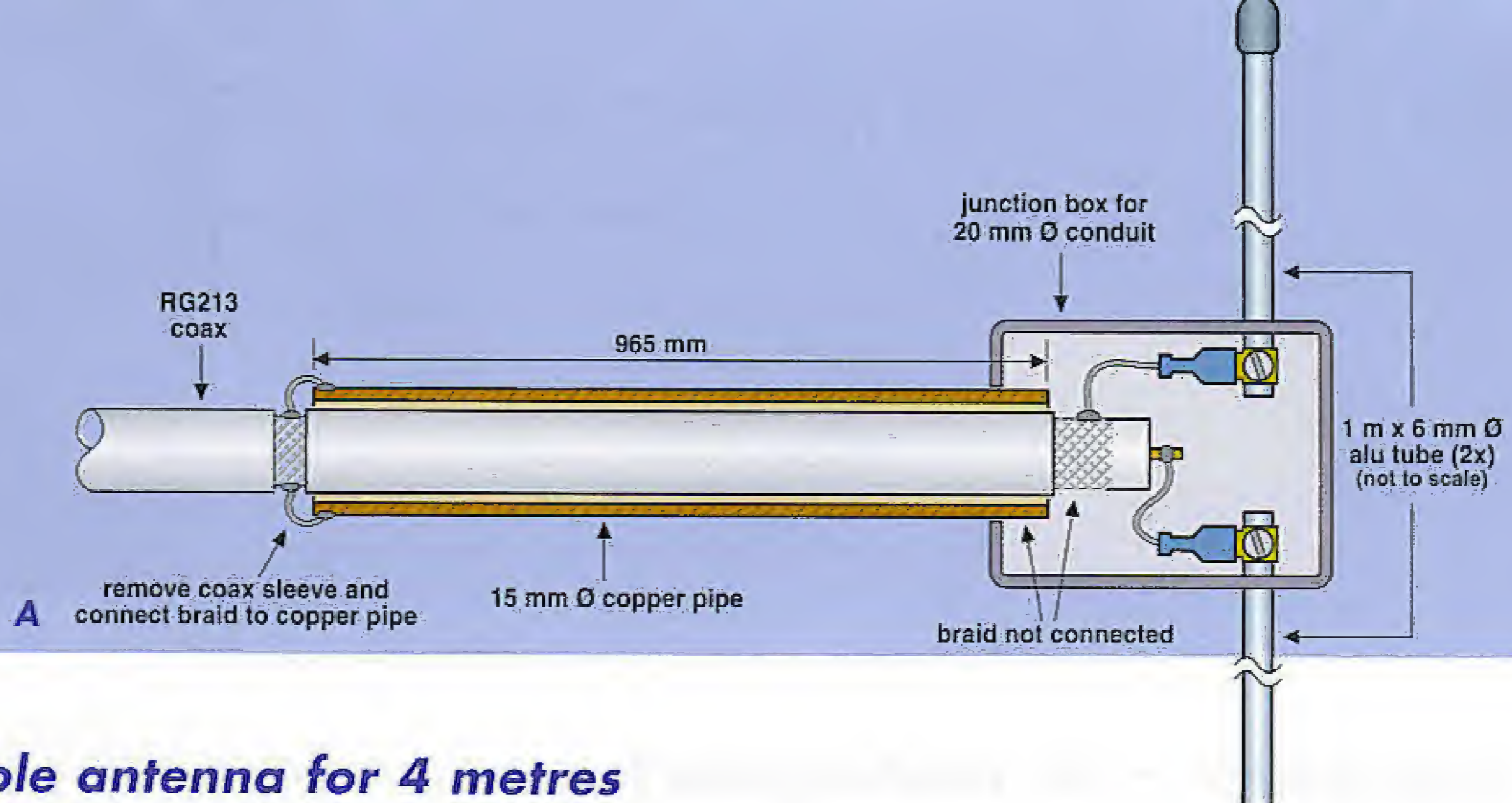

A dipole antenna for 4 metres

No receiver is complete without a matching antenna. Commercial offerings for the 4-m band being few and far between (or scrapped by PMR fleet owners), we decided to present a design for a low-budget get-u-going dipole. Not sophisticated, want a directional antenna? Then try the links at the end of this article. Too difficult? It doesn't get much simpler than this, so give this antenna design a try and you'll be pleasantly surprised. The antenna is great for initial experiments even when installed on your attic.

Our ingredients and tools are:

- a length of 50 Ω RG213 or RG8 coax cable (10.3 mm outside diameter)
- a piece of copper pipe, 15 mm outside diameter, length 965 mm
- two aluminium rods, 6 mm diameter, length 1 m
- two cable eyelets
- a round T-junction box for electrical conduit, 20 mm openings
- some not too thin wire
- a powerful soldering iron (> 50 watts)
- nylon or plastic bushes, 20 mm diameter
- permission from the missus

The drawing in **Figure A** is intended as a guide to constructing the antenna. The copper pipe acts as a balun (balanced to unbalanced transformer), not only matching the asymmetrical coax cable to the symmetrical dipole, but also stepping down the dipole impedance of about 72 Ω to the cable impedance of 50 Ω . RF buffs will like to refer to it as a bazooka or sleeve balun. Unless you have electrical connection materials to fit to the rod ends

(like a 60-A electrical 'chocolate block' terminal strip), simply flatten and drill the ends of the aluminium rods to allow screws to be used for the connection with the cable eyelets. For extra rigidity, the rods are fed through bushes (drilled to accept them) where they enter the junction box, and the box itself may be filled with potting compound or hard setting silicone sealant. The other ends of the alu rods should be deburred, rounded off and sealed to prevent moisture ingress.

If the antenna is to be used out of doors, the junction of the copper pipe and the coax braid should be protected as well. This may be achieved by inserting the balun assembly in a length of 20-mm dia conduit and filling the lot with silicone sealant. All soldering to the coax cable should be

done as quickly as possible to prevent deformation of the PTFE (Teflon) core and consequently creating 'impedance humps'.

Variations on the theme are possible, but be careful if you lack experience. You may, for instance, decide to use much thinner material for the dipole arms (for instance, lengths of welding rod), thinking it will make no difference as it is only the length that counts. Wrong, because your antenna will lose much of its broadband response and will present an acceptable VSWR at about 75 MHz \pm 2 MHz only. A larger rod diameter increases the bandwidth so the antenna can be used for the entire VHF-Low band (68-88 MHz). That is why base antennas use for PMR services in the VHF bands are so thick!

On the rack!

While tidying up the design of the VHF-Low Explorer for publication in this issue, an opportunity arose to have our little receiver tested on a high-end instrument called the **Rohde & Schwarz CMS 54 Radio Communications Service**

Monitor. This instrument (pictured here) can perform automated measurements across the frequency range 0.4 MHz to 1 GHz which is not normally within the capacity of the RF test equipment available in the Elektor Electronics design laboratory. The offer came from Mr. Ed Warnier PA1EW who is totally conversant with this piece of kit, handling and operating it as if he were driving his car to the supermarket. Not only the test

results obtained from the receiver are worth telling you about, but also the basics of some of the specific tests the instrument can perform, as they may be unknown to many readers entering the radio hobby.

A few facts had to be established first. Our receiver is designed for narrow-band FM (NBFM) reception between 68 MHz and 88 MHz, these values marking what is generally referred to as the VHF-Low communications band. As the receiver is of specific interest to radio amateurs, it was decided to tune it to **70.250 MHz** being the centre of the 4-metre band as defined by the IARU. The receiver being VFO tuned

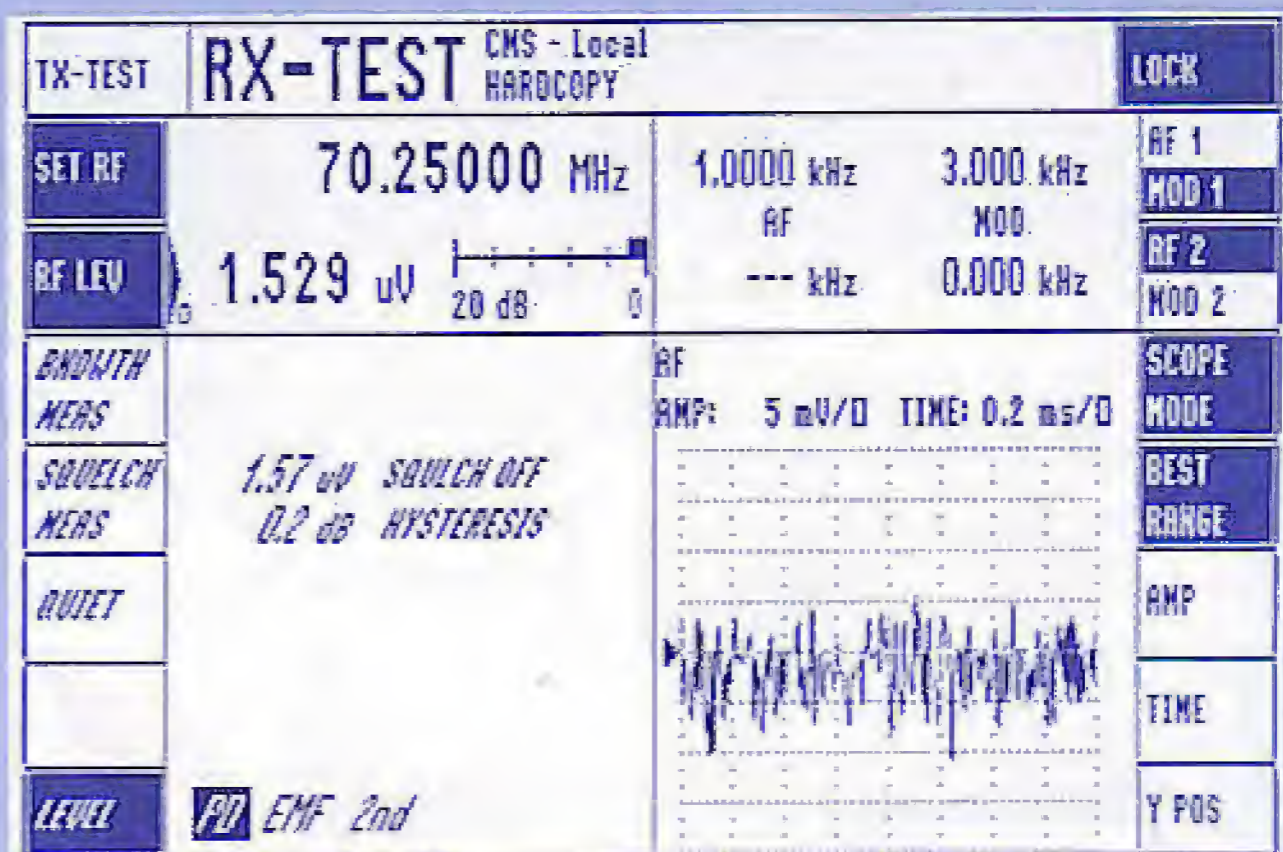
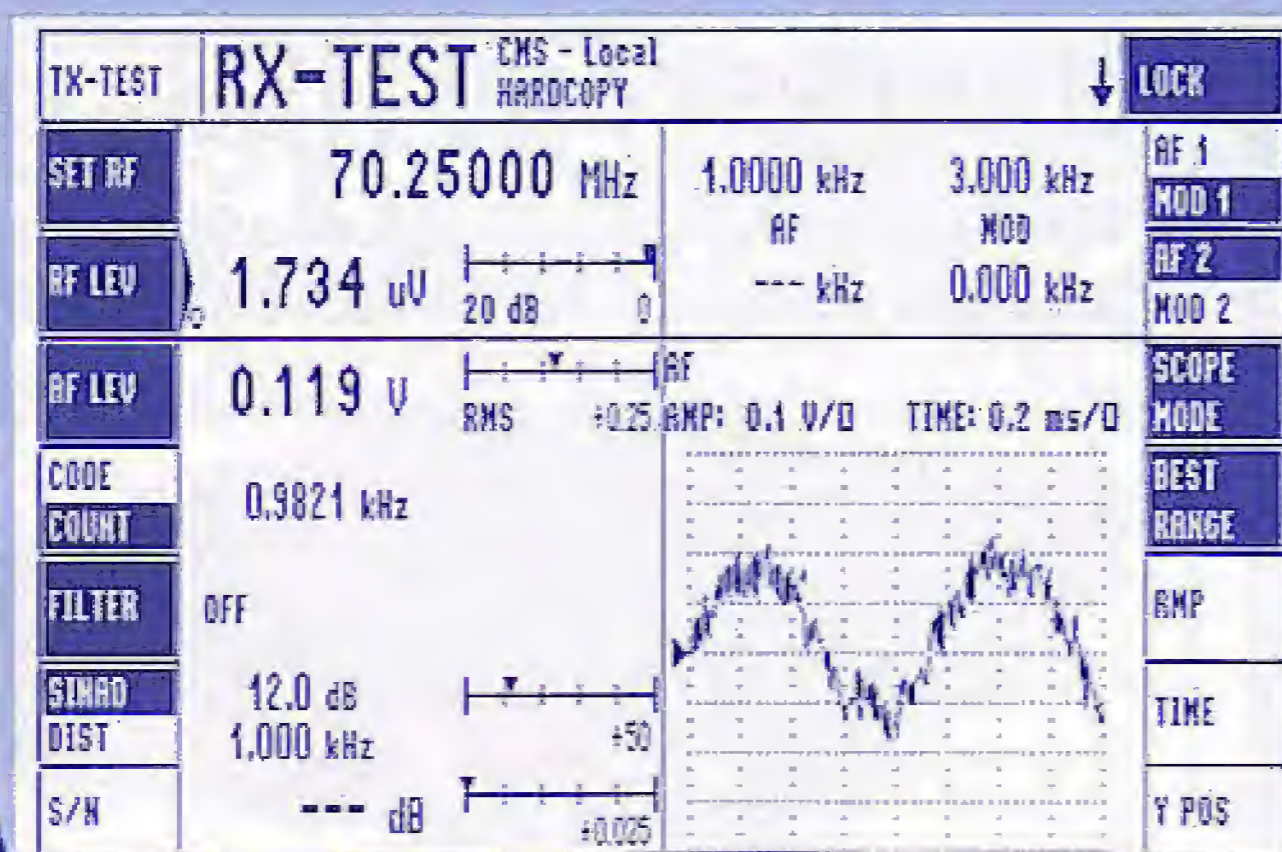

and lacking a frequency readout, reverse thinking quickly lead to the CMS 54 being set to 70.250 MHz and cheerfully tuning the receiver until the test signal was audible. Hooray, it works!

Receiver sensitivity measurement

With the generator tuned to the receiver (or was it the other way around?) a great moment arrives — we're ready to decrease the RF output level on the generator until the receiver under investigation loses the signal. The VHF-Low Explorer not having an adjustable squelch or squelch defeat switch, the transition from 'very noisy signal' to 'muted' was found to be fairly abrupt (more about this further on).

Receiver sensitivity is defined as the RF signal level at which the receiver's audio output signal achieves a certain signal-to-noise ratio. For NBFM receivers, SINAD = 12 dB is considered the standard — meaning that the signal we would like to hear is 12 dB above the sum of noise and distortion (hence the acronym SINAD; an older measurement standard, S/N, employs noise only in the quotient). The RF signal level is usually given in microvolts pd (potential difference) although emf (electromotive force) is preferred by purists. The CMS 54, then, had its RF signal output connected to the receiver input (by a length of RG58 coax cable) and the audio input, to the receiver's audio output. After a manual adjustment of the volume control on the receiver, an automated measurement is started on the CMS 54 which steps down its RF signal level until it measures an audio signal of 12 dB SINAD. The RF signal level at which that happens is frozen and displayed — see **screen dump A**. In our case, a sensitivity of about **1.7 microvolts for 12 dB SINAD** was obtained which is not bad at all given the sim-

plicity of the design. The test was carried out using a test tone of 1 kHz and a deviation of 3 kHz. As you can see in the screendump, the CMS 54 also displays a real-time image of the receiver's output signal.

Absolute sensitivity and squelch action

Since the CMS 54 is capable of interpreting audio signals with such amazing precision it has no problems at all detecting when such a signal is passed or muted by the receiver. The latter action is taken care of by the squelch ('mute') function built into the TDA7000. An automated, stepped measurement was launched again, this time to establish the RF-signal level at which the squelch closes. The result, about 1.6 microvolts, can be seen in **Screen dump B**. Ed kindly informed us that a squelch hysteresis of just

0.2 dB is not favourable for NBFM listening, a value of 2-3 dB being the standard. A bit more hysteresis ensures that stations dropping into the noise do not cause the squelch to close abruptly. Rather, the receiver will 'follow' such flutter-infested signals which, although barely intelligible in the noise will not cause the squelch to 'chatter'.

The CMS 54 has a plethora of other functions for some really gruelling tests on radio communications equipment and in particular PMRs. We hope to be able to use it again some time in the future.

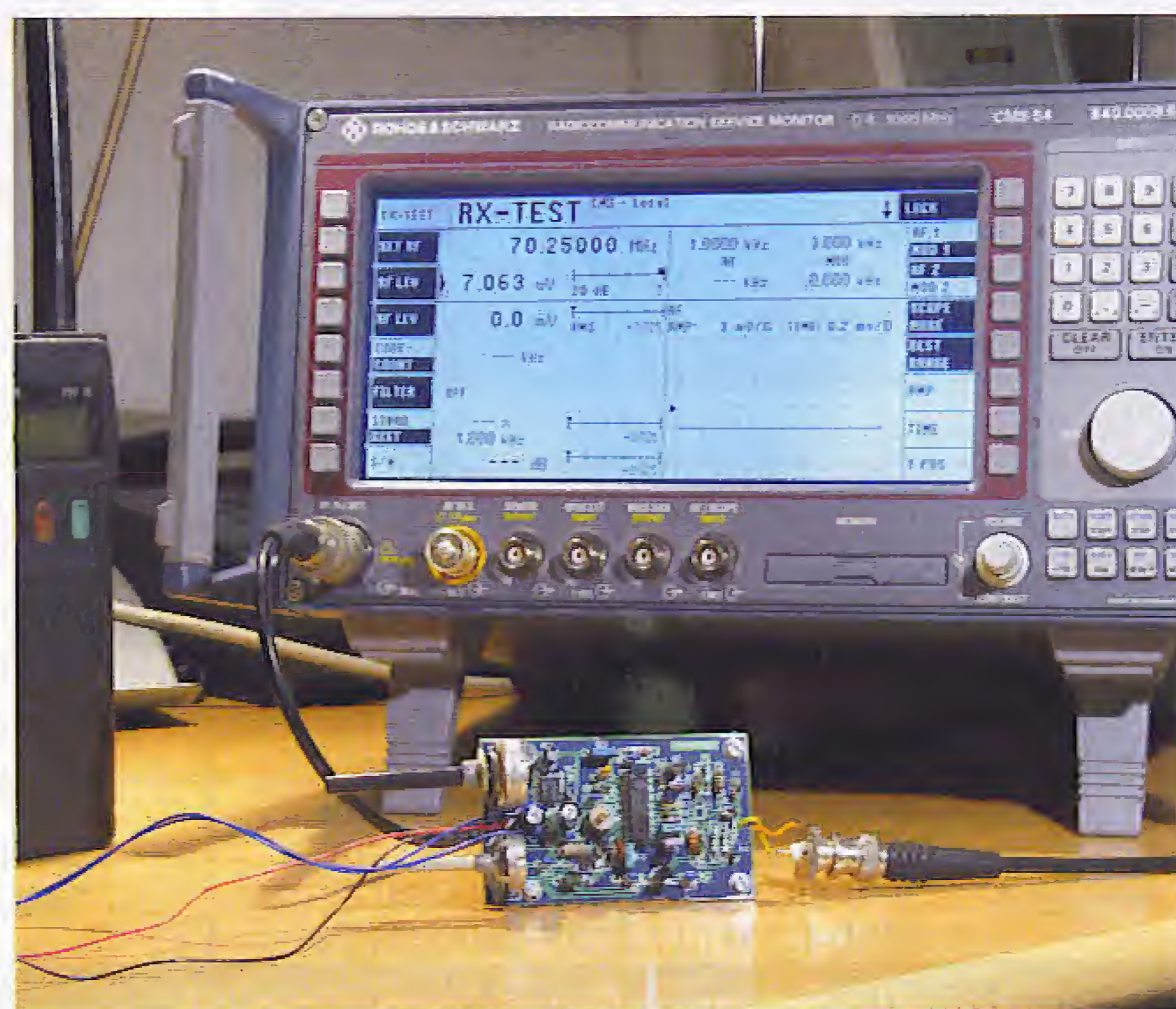

PCB-POOL®

SERVICING YOUR COMPLETE PROTOTYPE NEEDS

- Prototypes at a fraction of the cost
- Tooling and setup included
- Any contour
- Fr4 1.6mm, 35µm Cu
- Industry standard quality
- Follow up series runs
- CAM / CAD consulting

PRICE EXAMPLE:
1 EUROCARD 05/PTH
 + Tooling
 + Photoplots
 + VAT
 = £ 29.89*

*Sterling rates may vary. Price = €49

€49

FREE

with first order
 (while stocks last)



may differ slightly
 to model shown

Seta
 ELECTRONICS

Tel: +353 (0)61 701170
 Fax: +353 (0)61 701164
 E-Mail: sales@seta-prototype.com

FreePhone
0800-389 8560

Simply send your files and order ONLINE:

WWW.PCB-POOL.COM



Handyscope HS3 2 Ch

Resolution Menu - 12, 14 or 16bits

Sample Rates - 5,10,25,50,100 Ms/s models



- ✓ Oscilloscope
- ✓ Spectrum Analyzer
- ✓ Voltmeter plus!
- ✓ Transient Recorder
- ✓ Arbitrary Waveform Gen.
- ✓ Two hi-z probes 1:1~1:10
- ✓ USB 1.1 or 2.0
- ✓ Windows OS- all

5 Ms/s Model

£435

ex VAT/pp

iTp Ltd

28 Stephenson Road, Industrial Estate, St Ives, Cambs. PE27 3WJ

Telephone: 01480 300695 Fax: 01480 461654

info@itp101.com www.itp101.com www.tiepie.com

Forest Electronics – PIC and AVR ANSI C Compiler Products

FED's ANSI C Compiler for PIC or AVR processors

- Fully integrated editor with syntax highlighting, multiple pages etc.
- Full project support - include and manage multiple source files, simulator, assembler files and notes/comments within one project
- Fully integrated simulator and waveform analyser step from C line to C line, or examine code in assembler form. View device pins using a logic analyser application.
- Simulator supports LCD modules, keypad, buttons, LED's, displays, analogue inputs, serial and asynchronous data.
- Designed to ANSI C standards
- PIC - Supports 18xxx, 16xxx, 12xxx series 14 and 16 bit core processors
- AVR - Supports standard and MEGA core processors
- Generates MPLAB/AVR Studio projects and source files and completely standard hex output files.

Prices from £45.00 – www.fored.co.uk for full details.

WIZ-C / AVIDICY

**Drag and Drop rapid application development
 using ANSI C for PIC and AVR**

- Rapid Application Development for the PIC or AVR microcontroller using the C language (WIZ- C for the PIC, AVIDICY for the AVR)
- Drag and drop your software component selections on to your design
- Included components support timers, serial interfaces, I2C, LCD, 7 Seg displays, keypads, switches, port controls, many bus interfaces including IIC and Dallas iButton, AVR/PIC Hardware, and more.
- Connect software components to MCU pins by point & click
- Parameters set from drop down list boxes, check boxes, or text entry
- Links your code automatically into library events (e.g. Button Pressed, Byte Received etc.)

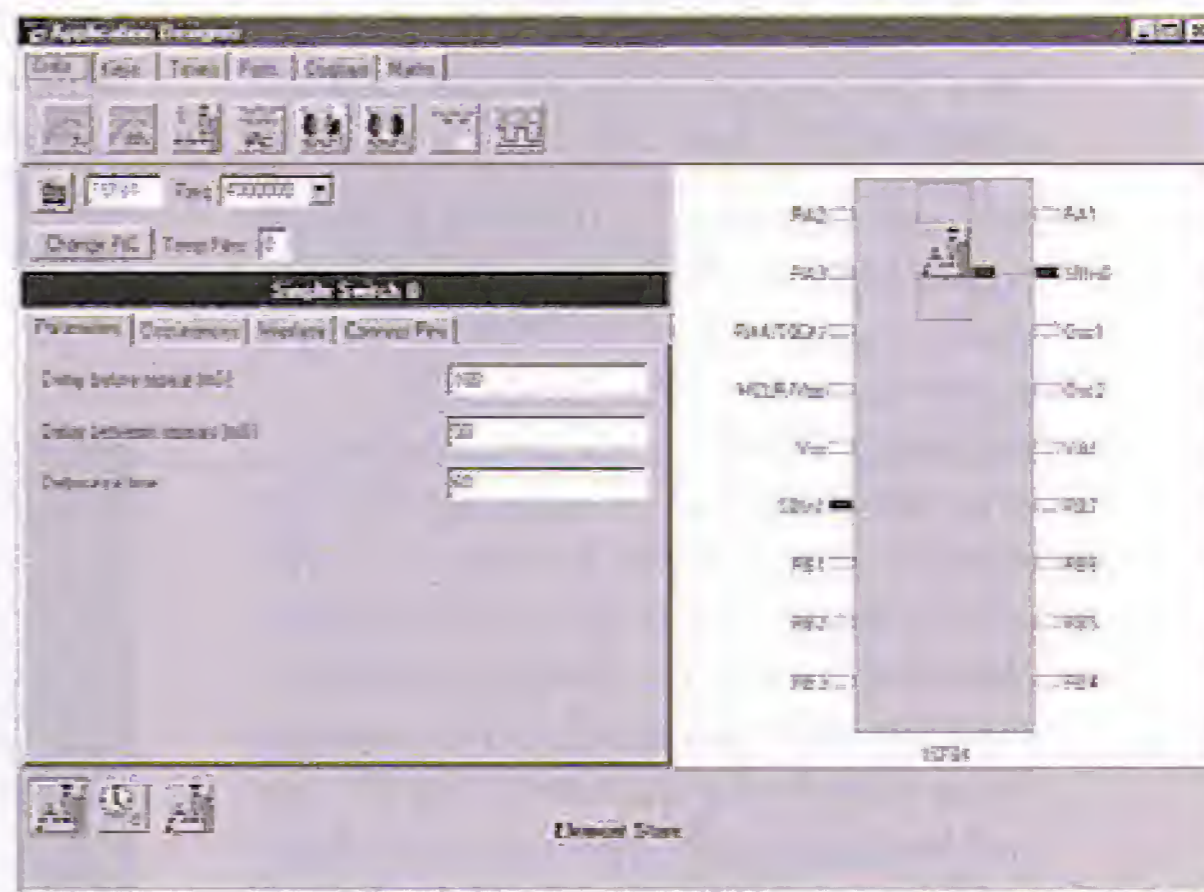

- Automatically generates your base application including full initialisation, interrupt handling and main program loop
- The complete C Compiler and AVR Simulator programs are integrated into AVIDICY - total editing / compilation / assembly / simulation support in one program
- Also includes the Element Editor to enable you to create your own components with ease.
- Demonstration available from our web site

Prices from £50.00 - full details from www.fored.co.uk



Forest Electronic Developments

12 Buldowne Walk, Sway
 LYMINGTON, Hampshire, SO41 6DU.
 01590-681511 (Voice/Fax)

Email –
 "info@fored.co.uk"

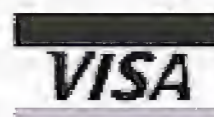

Full details from - www.fored.co.uk

Easy-PC for Windows

World Beating Value in PCB Design Software

from
£97

High performance Windows based PCB Design Capture, Simulation and Layout software at prices you'd expect from your local computer store!

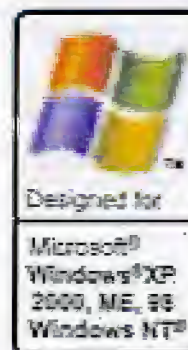
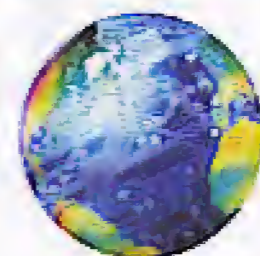

NEW! in Easy-PC 7

- Library Databook
 - Step and repeat plotting
 - Swap Connection Mode
 - Dimensioning
 - Copy to Metafile
- plus much more.....

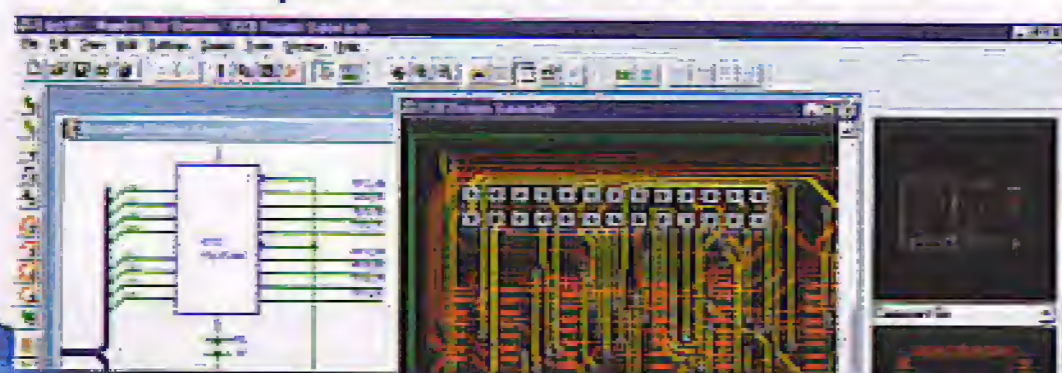

Stop press... by customer demand, now with Tsien Boardmaker 2 design import...

Number One Systems delivers true 32 bit Windows software applications including features that a few short years ago would only have been available in software tools priced in the thousands!

Test drive Easy-PC and Easy-Spice for yourself and be prepared to be amazed at the super value...

Call for a brochure, price list and demo CD on +44 (0)1684 773662 or email sales@numberone.com

No1 Number One Systems

Number One Systems
Oak Lane, Bredon
Tewkesbury, Glos GL20 7LR
United Kingdom

or download from

www.numberone.com

Danbury Electronics

U.K. Manufacturers & designers of quality **Transformers** for over 20 years.

- IVA-750VA size range, medium quantities
- Mains, Audio, Loudspeaker & ferrite types
- Specialise in Valve/Tube mains and output transformers.
- Rewind/Replacement of rare/special transformers
- A standard range of Valve/Tube Amp mains & Output Tx's (P/P, SE etc) is available through Mike Holme's web site: www.mc-h.demon.co.uk/transformers.html (Also, Valve circuits, Parts lists, Chassis & Advice)
- Established supplier to Maplin Electronics (www.maplin.co.uk) for over 15 years.

Contact **David Brooks** I.Eng MIE (Proprietor)

Phone : 01245 328174

Fax: (24Hr) 01245 328963

Email: DanburyElecTX@aol.com

20 Cutlers Rd, Saltcoats Ind. Estate,
South Woodham Ferrers, Essex. CM3 5XJ (UK)

The Simple Solution! **Flexit**

AVR Modular Development System

- Based on the Atmel AVR controller
- Flexible and powerful
- Simple to configure
- Very compact

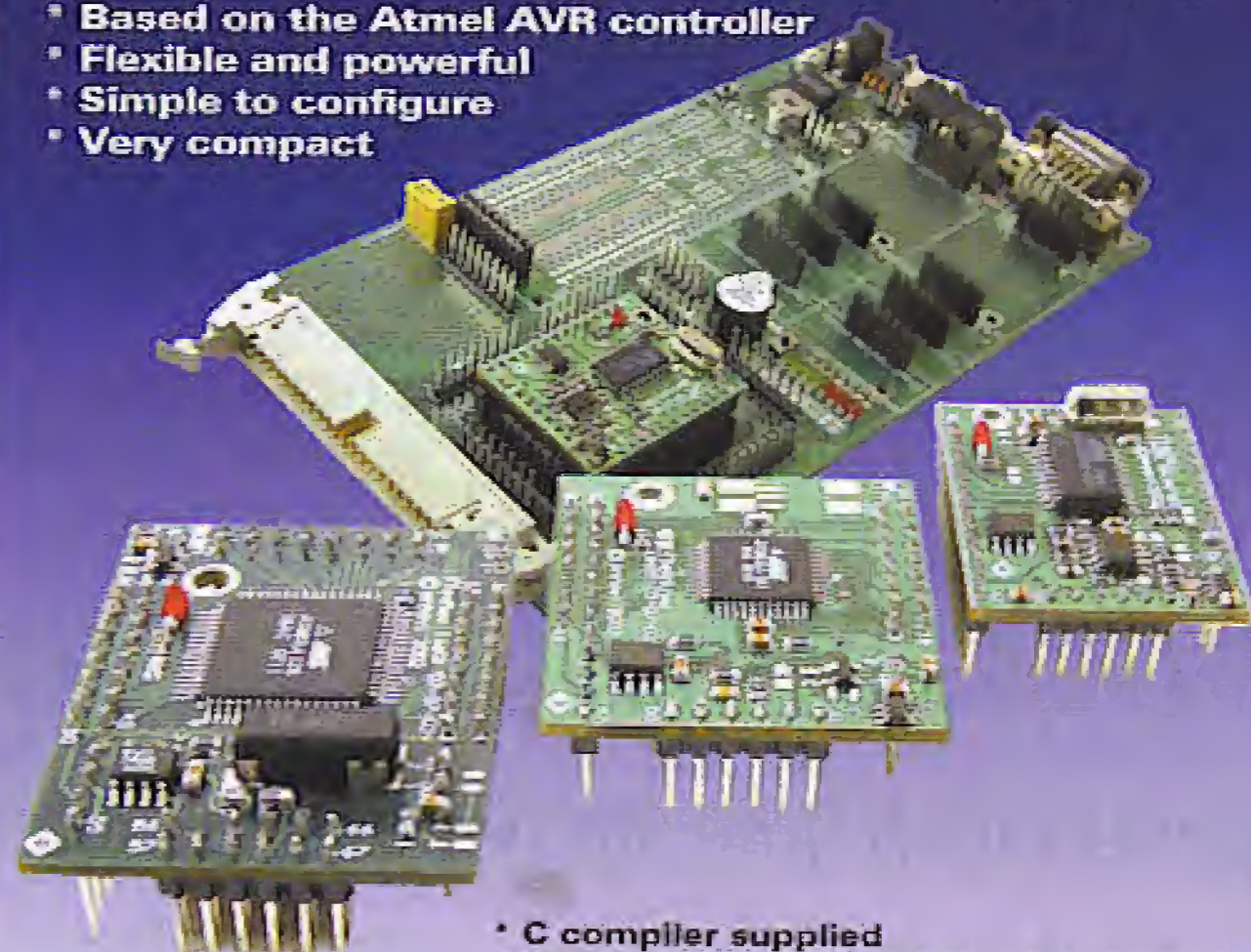

- C compiler supplied
- Compatible with most development tools
- In-system programmable
- Free Atmel debug simulator available
- Peripheral drivers and libraries supplied
- Increasing range of expansion modules
- Full web site support

Check out Flexit at www.ennovi.co.uk

ennovi ltd
Dynamic Design

+44 (0)1425 478884
sales@ennovi.co.uk

Precision measurement
Embedded control
Intrinsic safety
Internet embedded systems
USB interface

$$W \geq \frac{U+V}{1+U\frac{V}{C^2}}$$

Project C+

Data comms beyond light speed

Research papers by their nature are difficult for the average layman to understand. Here in the *Elektor Electronics* laboratory between the odd cup of coffee we spend much time studying scientific reports. A recent paper by a Japanese research group caught our eye because we were able to replicate the effects described using a very simple circuit and the results are so profound that it could change forever the way we send data.

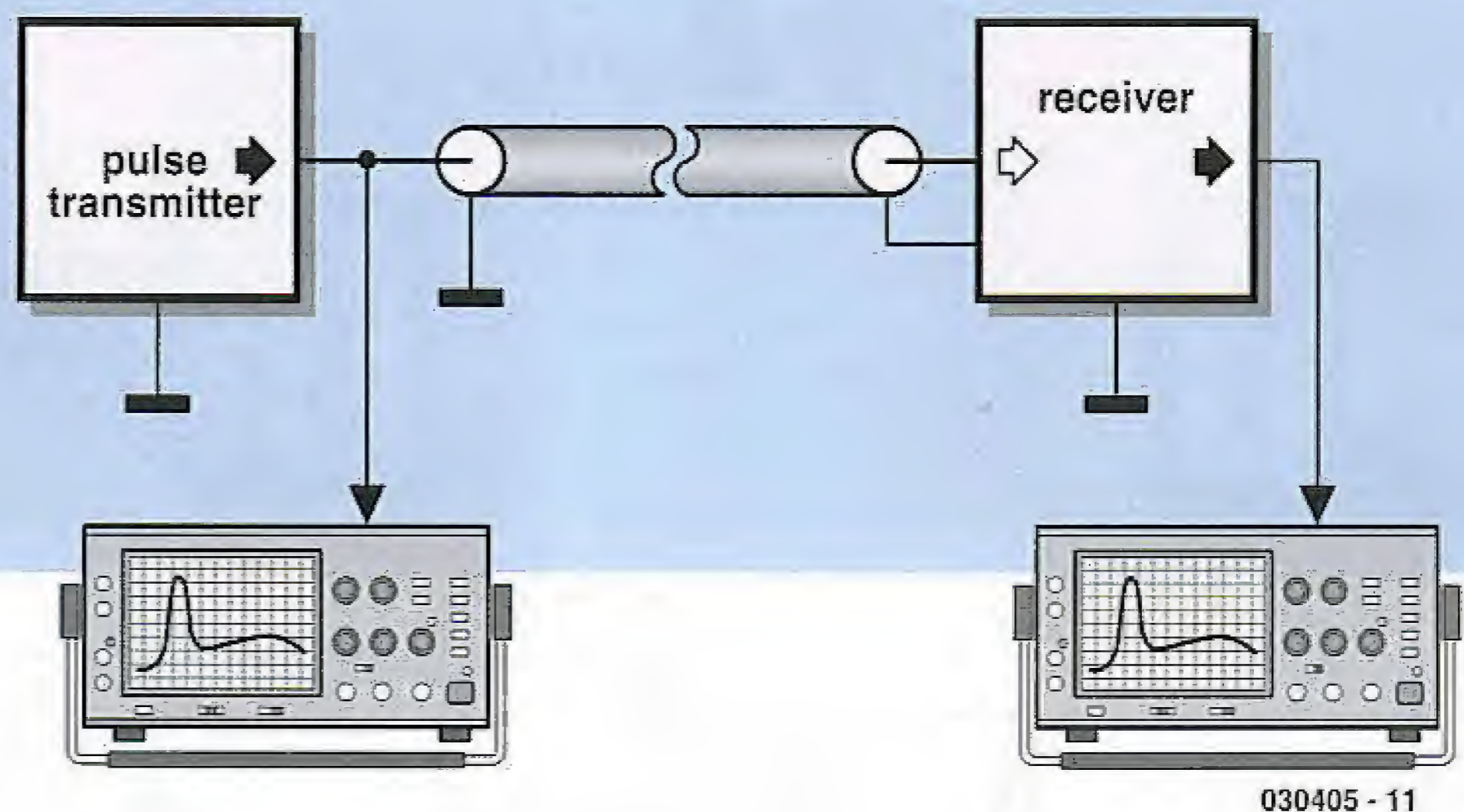

Figure 1. Experimental circuit for the Project c+.

The properties of light that most of you will be familiar with are that it travels in a straight line at a speed, c , of approximately 3×10^8 m/s. We should not forget to mention that this is only true when it is passing through a vacuum and not influenced by gravity. As soon as it enters another medium, light is slowed down and bent (refracted). In the latter part of 2003 M. D. Lukin and his colleagues at Harvard University announced in Nature [1] that they had successfully slowed down a pulse of light in a matrix of rubidium atoms such that it was stationary for a few hundred milliseconds before it was released and accelerated to regain light speed. The uses of this technology are manifold in the fields of quantum communications and photonics. Drawing on these techniques a team of Japanese researchers have adapted the technology (termed *I-Ging*) to accelerate precise (low frequency) pulses of electromagnetic energy along transmission lines to achieve incredible propagation speeds.

Inverting causality?

The experimental set-up is shown in Figure 1. The pulse transmitter on the left of the diagram generates a signal pulse that is sent through the medium (either an optic fibre or simple cable) to the receiver circuit on the right hand side of the diagram. Two oscilloscopes are used to display the signal pulse when it is introduced to the medium and recovered by the receiver. The purpose of Project c+ is to

demonstrate that by careful matching of the pulse to the fundamental characteristics of the transmission medium it is possible to achieve vastly reduced propagation delays.

The breakthrough

It is often the case that a scientific breakthrough occurs by accident where unexpected or anomalous results suddenly cause the investigation to veer off in a totally different direction. The story of this breakthrough is a case in point, it seems as though during routine network testing one of the research team mistakenly entered a frequency range of mHz (yes, that's millihertz) rather than MHz (megahertz) into a programmable waveform generator. The resultant effect on the test circuit was truly bizarre and may have easily been dismissed or overlooked had the researcher been less observant.

Normally in the field of high speed communications we are accustomed to propagation delays in the order of picoseconds or even femtoseconds but provided we use the correctly profiled pulse shape (a fundamental *I-Ging* pulse containing no higher order harmonics) coupled to a transmission medium originally intended for much higher frequency signals it seems as though it is possible to accelerate the pulse to such an extent that it undergoes localised temporal inversion in its passage through the medium and arrives much earlier than predicted (hence c+).

The experimental circuit

The pulse generator in Figure 2 is quite straightforward and consists of a CMOS 555 timer IC together with two cascaded band-pass filters to produce the necessary pulse shape. The filter resistors are all 1% tolerance metal film types with a value of 1 M Ω (choose matched values where possible). Filter capacitors are low-loss foil types with 1% tolerance. The correct choice of components is critical to the success of the circuit, a fact to which any competent audio engineer will attest.

There are two possible power supply configurations for the circuit: either plus and minus 4.8 V consisting of eight NiMH AA type cells (if the TL082 op-amp is used) or a single-ended 4.8 V supply if a precision rail to rail op-amp like the OP290 is used. In this case the negative pole of the supply must be connected to the earth and all minus supply connections in the circuit diagram. To be scientifically rigorous the generator and receiver should be powered from separate power supplies to avoid cross coupling but a common supply will suffice for this experiment.

Once the circuit is completed the output waveform of the *I-Ging* generator can be observed on an oscilloscope. When S1 is pressed a transmission pulse similar to that shown in Figure 3 will be generated and sent down the medium. Each square graticule represents 1 second.

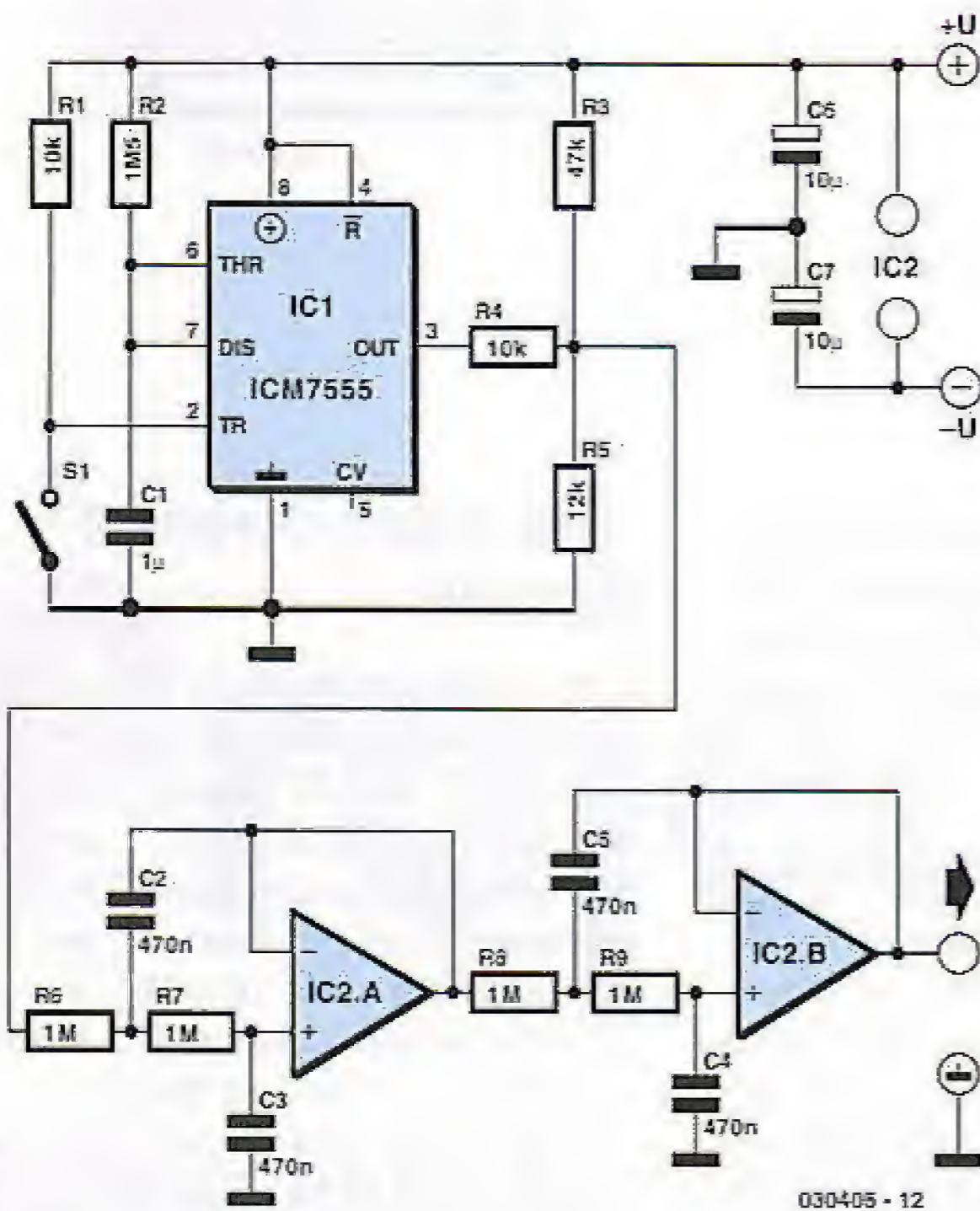
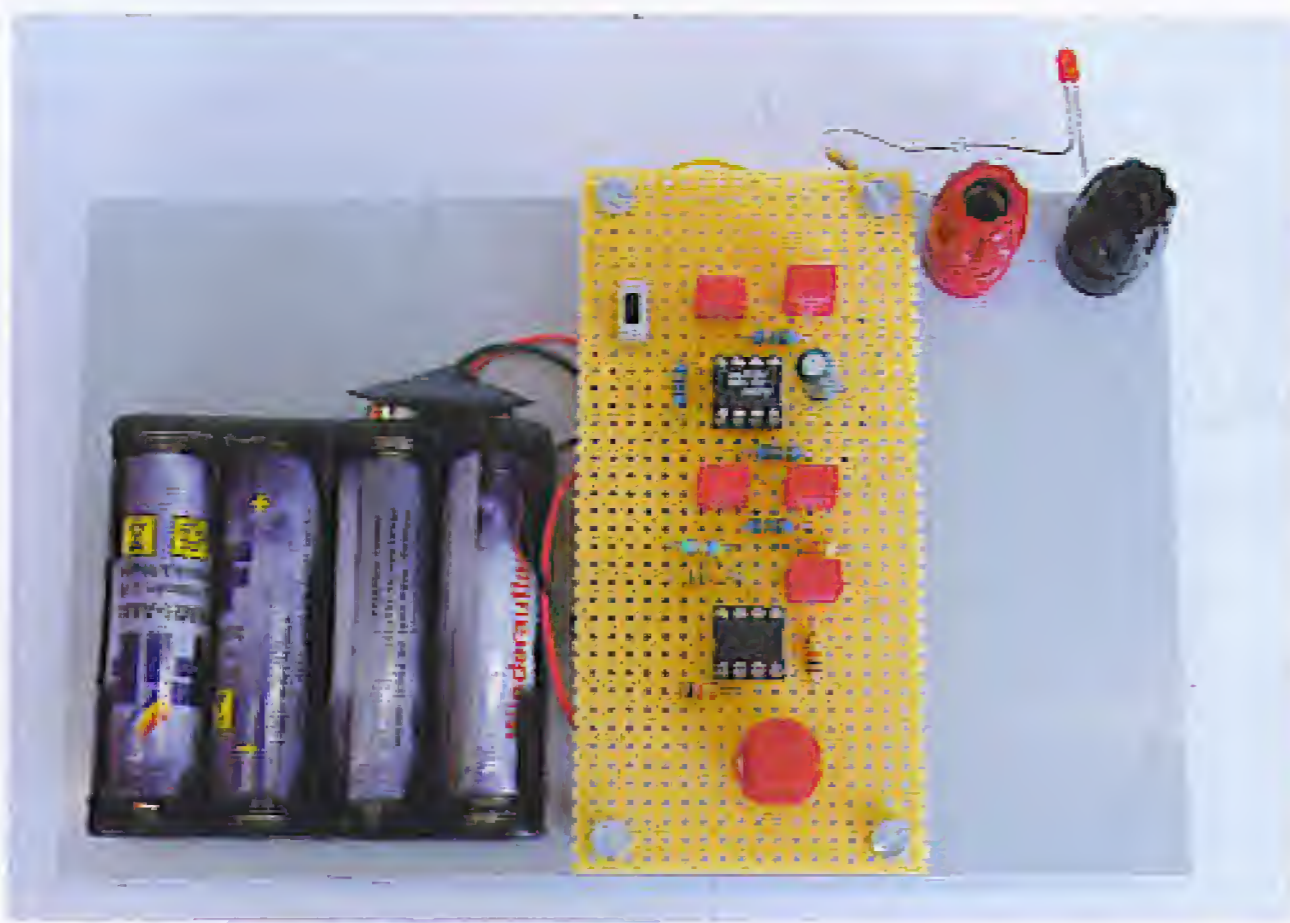

Figure 2. The I-Ging pulse generator uses high precision components.

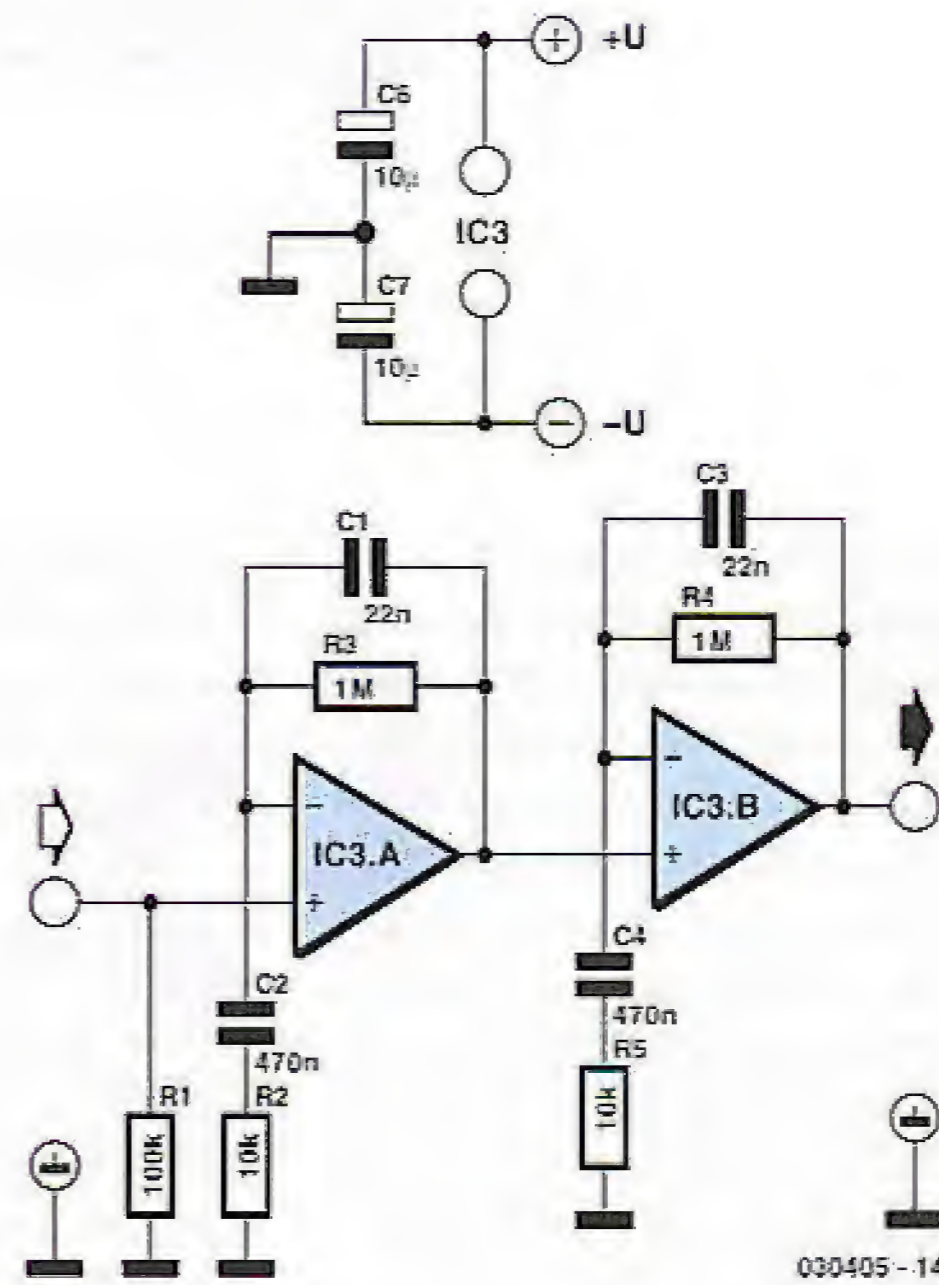

Figure 4. The regeneration amplifier.

The medium

The choice of cable is vital in order to match the pulse profile to the characteristics of the transmission medium and thereby achieve the observed pulse acceleration. After much trial and error in the *Elektor Electronics* laboratory we concluded that a length of twisted-pair 100 Mbit/s Ethernet cable (CAT5) operated in the sub-hertz frequency range gave the most consistent results.

A cable length of 400 m was used in the prototype. In practice it is a good idea to cut it slightly longer so that it can be trimmed during testing to find its optimum length. The cable introduces a certain degree of attenuation to the low-frequency content of the pulse so the receiver circuit is pro-

vided with some amplification to compensate. The receiver circuit diagram is shown in **Figure 4** and uses a configuration similar to the transmitter. To operate reliably it is essential to ensure that the specified components are used throughout the circuit. The power supply can again either be single rail if you choose the OP290 op-amp or split-rail for the TL082. Once the receiver has been carefully completed and checked we can begin with the experiment.

Back to reality

Figure 5 shows the test configuration for sending and measuring the high-speed pulses. With an oscilloscope connected to the transmitter output

and another connected to the receiver output it can be clearly confirmed that when push button S1 is pressed, the transmitted pulse arrives at the receiver before it is detected as having left the transmitter! Even if you do not have an oscilloscope the effect is so pronounced that it can be demonstrated by substituting two simple LEDs at the measuring points and observing the events that occur when S1 is pressed. It is clearly observable that the receiver LED is lit slightly before the transmitter LED and then extinguishes before the transmitter LED! **Figure 6** shows the pulse waveforms as seen on a scope. It may be necessary to adjust the length of the cable slightly if the effect is not observed.

The revolution begins

The simple circuit described here replicates the findings of the original paper but only achieves a data rate of 0.5 b/s. To be truly useful this needs to be much faster, certainly in the region of Gb/s. To make the technology more practical a form of dynamically adaptive pulse shaping will also be necessary to compensate for the medium characteristics. Research into I-Ging is still in its infancy but these early results are so promising that we will undoubtedly see its adoption in more and more applications as the technology matures.

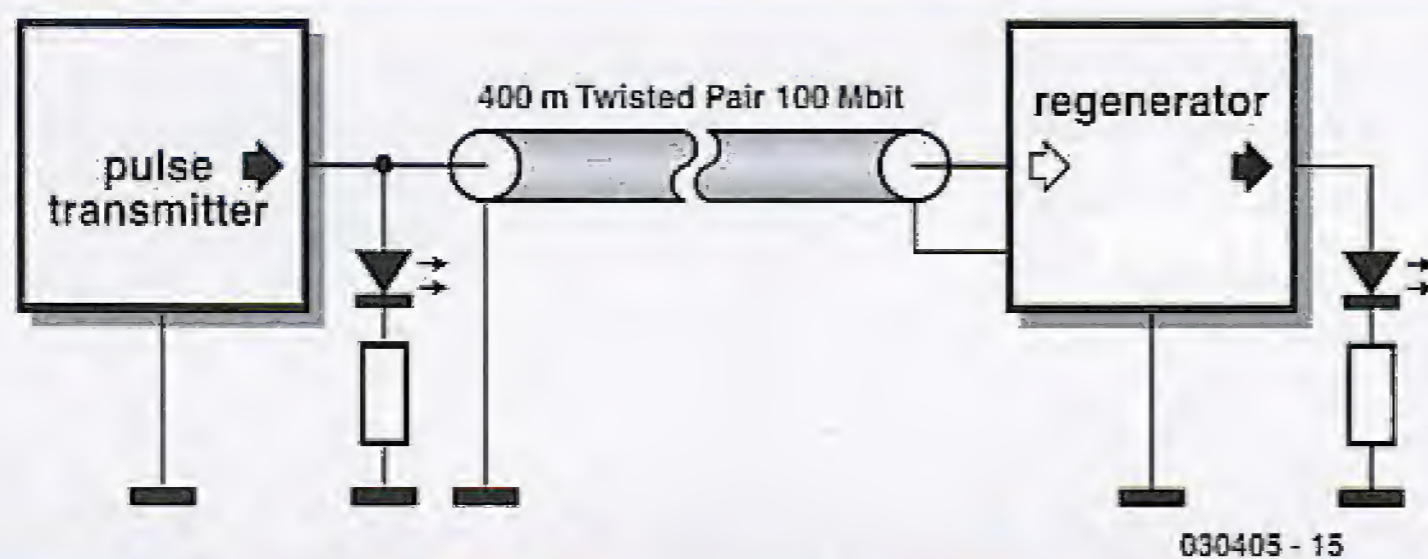

Figure 5. Test configuration with two LEDs to demonstrate the effect. A two channel scope can also be used in place of the LEDs.

The principle of causality is a cornerstone of our interpretation of the physical world but the observed negative propagation delay of approximately 0.4 s through the transmission medium and receiver combination seems to conflict with our understanding of this principle and will no doubt set alarm bells ringing for many *Elektor Electronics* readers, theoreticians and scientists.

In practice this technology would be used to send a stream of data at incredibly high speed rather than just a single pulse. The circuit was modified to send a pseudo random data sequence and the results are shown in Figure 7. The received signal shows very low levels of distortion and noise and more importantly still exhibits

identical negative propagation delay through the medium.

The circuit described here is quite simple and we feel that many sceptics amongst you will not be silenced until they have built the circuit for themselves and witnessed what must surely be a new dawn for communication science and computing.

Can you explain the $c+$ phenomenon? If so, let us know as soon as you can so we can revert to the subject in next month's issue.

(030405-1)

Reference

[1] http://lukin.physics.harvard.edu/Nature426_638.pdf

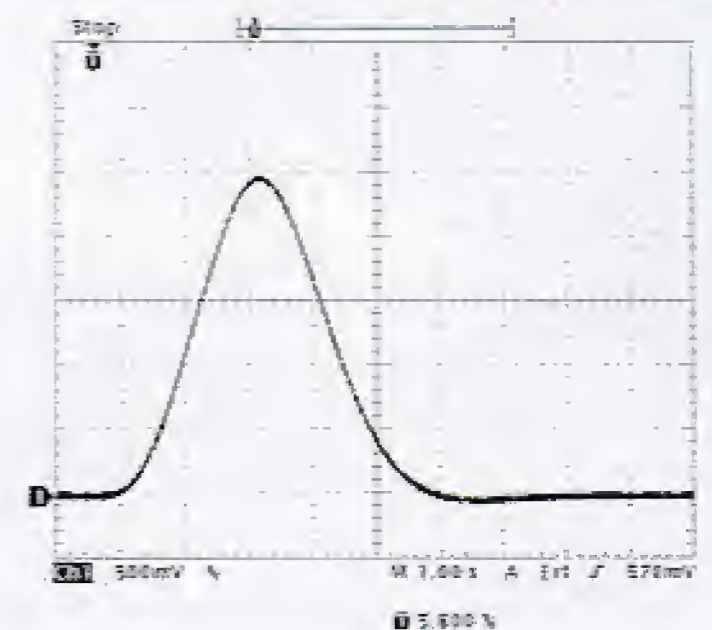

Figure 3. The transmission pulse.

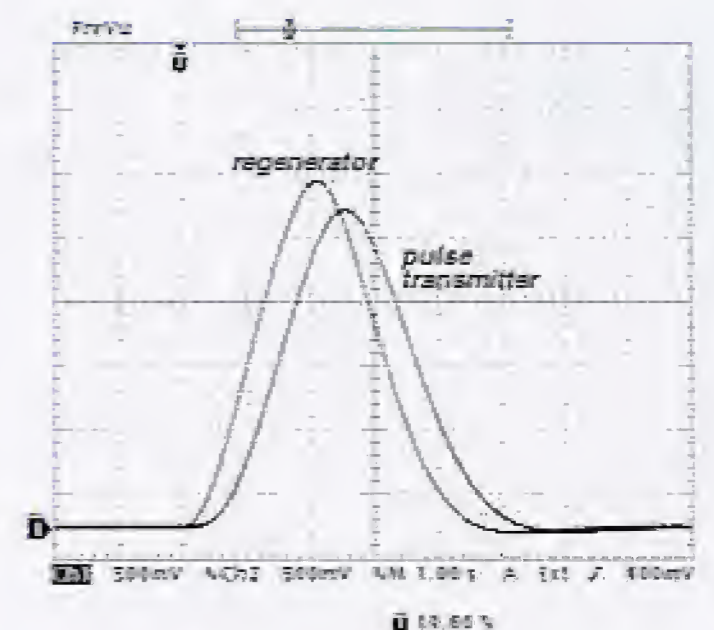

Figure 6. The impulse demonstrates localised temporal inversion.

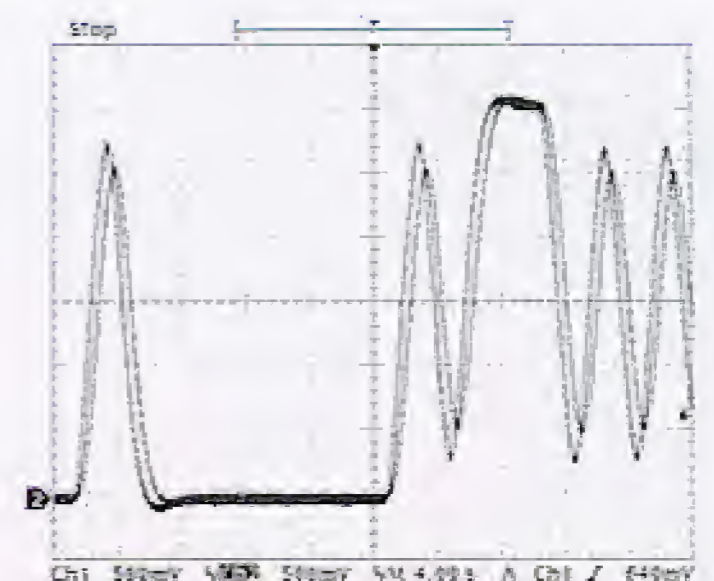
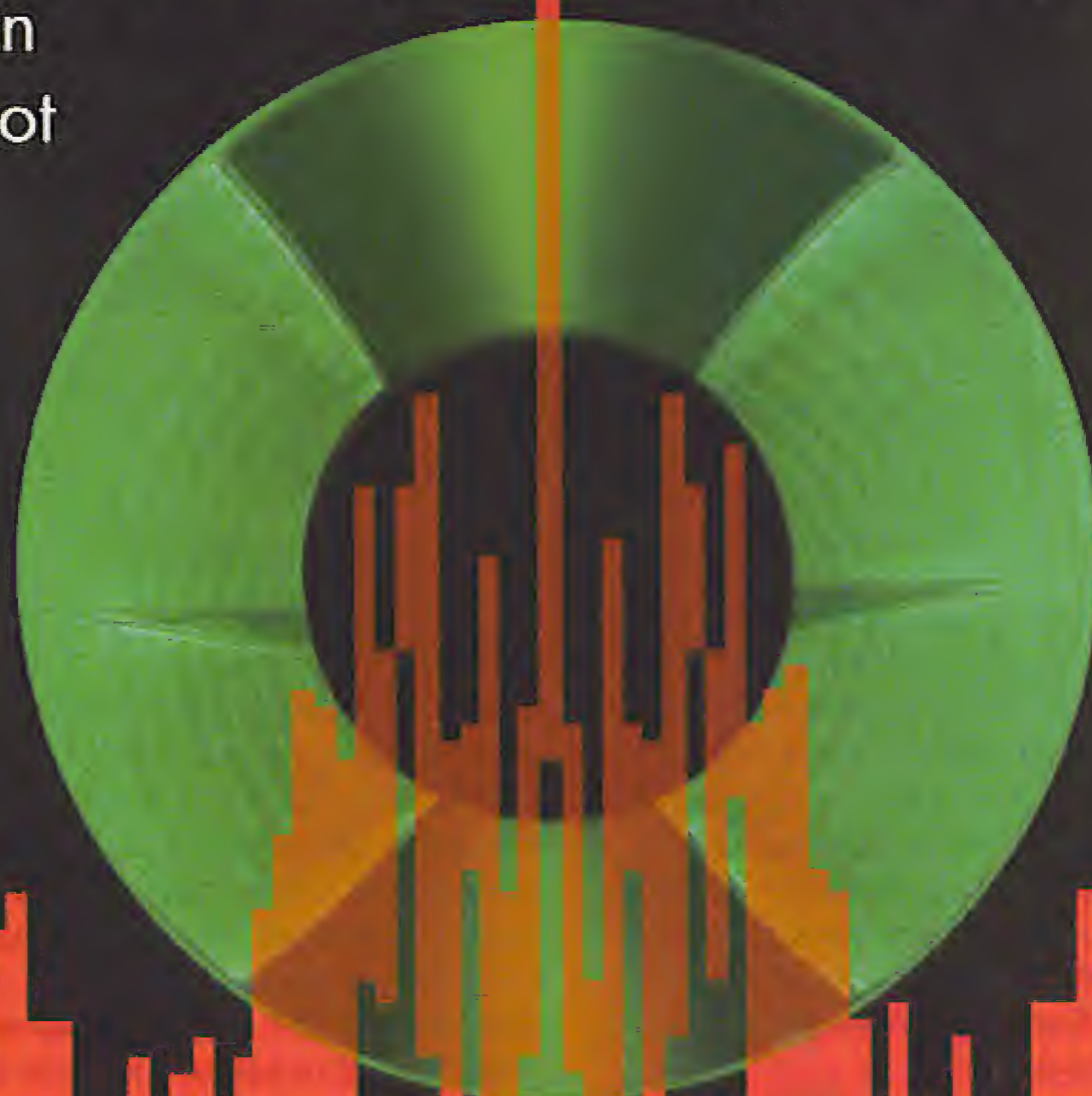

Figure 7. The technique applied to data transmission.

DREAM TEAM

Software DRM receiver

Low-cost digital radio receivers for short- and medium-wave are not yet on the market. There is, however, software available for processing DRM signals on a PC which can be used during the evaluation and changeover period. The two programs that have been developed differ in application, in features, and, not least, in cost.



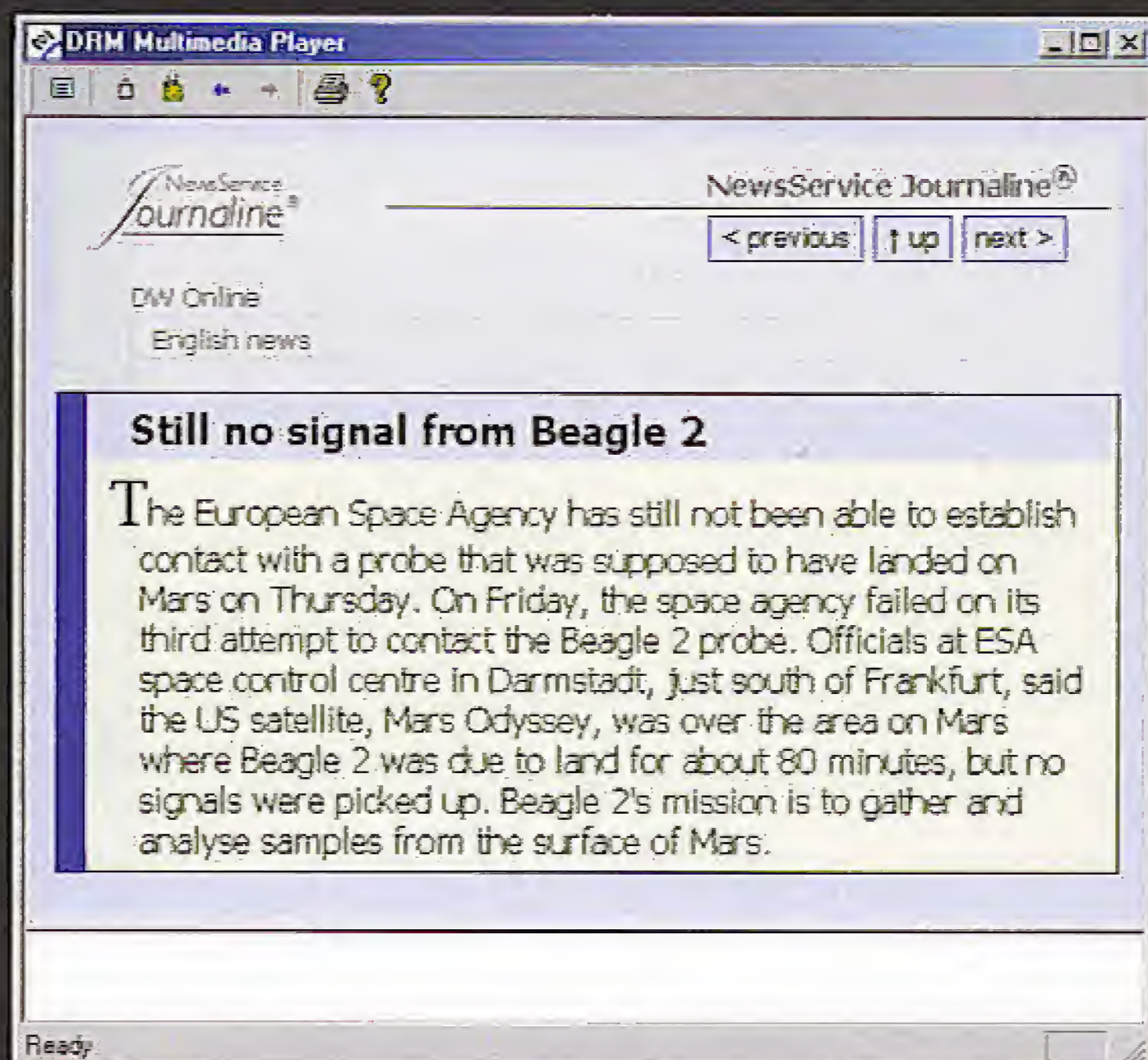

Figure 1. DRM can also carry text and images. Here is an example from the Deutsche Welle (German world service) news service, displayed using the DRM Software Radio program via a multimedia player.

Whether you use a modified world radio or the *Elektor Electronics* DRM receiver to surf the digital wave, you will need a software decoder running on a PC. This program takes the signal input to the sound card and decodes the data stream from it, which it returns as audio data to the sound card for output. There are at the moment two programs available: the 'DRM Software Radio' developed by Fraunhofer IIS, and the open source project 'DREAM', run by Volker Fischer and Alexander Kurpiers of the Communications Technology Institute at the University of Darmstadt.

A significant difference between the two programs lies in the requirements on the input signal. The standard intermediate frequency used is 12 kHz, putting the 10 kHz-wide band of the DRM signal between 7 kHz and 17 kHz. The DRM Software Radio allows a maximum deviation in the intermediate frequency of 500 Hz, whereas DREAM can decode DRM signals anywhere in the range from 0 kHz to 24 kHz.

DRM with text and images

'DRM Software Radio' is a commercial program and can be ordered online from www.drmrx.org for about 60 Euros.

Each user is given their own software key and is automatically registered. The user can then take part in the DRM field trials and send in reception reports. Reception reports, especially from Europe, can certainly influence broadcasters' plans. The DRM Software Radio homepage gives information as to which stations can be received in which areas.

The function of the software as a DRM demodulator and decoder has already been described in the article 'Build your own DRM Receiver' project in the previous (March 2004) issue of *Elektor Electronics*. DRM can carry more than just speech and music. As well as the 'audio service', information such as the name of the station and news headlines is also broadcast: these can be viewed as a scrolling or as a

steady display. Some broadcasters also transmit images or other information using a format similar to the World Wide Web. The DRM Software Radio program makes these additional services available via a multimedia player. When a particular service is available, a click in the corresponding area in the window starts the player. After a delay while the requested data is collected, it is displayed. In this way, for example, the Deutsche Welle (German world service) transmitter in Jülich on 6140 kHz has recently started an additional service called 'Journaline', carried alongside the audio signal. A click in the audio window opens the multimedia player; in the background news summary information (in both English and German) is collected, and, after a delay, the pages of news can be viewed. This service works even when reception conditions mean that the audio signal breaks up: the news text still gets through, although it may take a little longer.

Figure 1 shows an example from the English-language 'Journaline' service.

Open Source Project

In contrast to take 'ready to run' DRM Software Radio, the DREAM open source project requires a little preparatory work. The authors have made the program available only as C++ source code (<http://sourceforge.net/projects/drm/>). Distributing the compiled version DREAM.EXE is not possible for copyright reasons, as patent-protected components are used. We shall look at these components individually, and present a step-by-step guide to compiling the project yourself, written by Thorsten Godau DL9SEC.

The complete project, along with advice on compilation and on the additional libraries required, can be found at www.tu-darmstadt.de/fb/et/uet/fguet/mitarbeiter/vf/DRM/DRM.html and at <http://www.tu-darmstadt.de/fb/et/uet/drm.html>.

The aim of the project was to develop an installable DRM software receiver with basic functionality. The project, in C++, was begun in June 2001 and version 1.0, which supports

Onward with fewer bits

Progress in digital audio

MP3

Way back in 1987 researchers at the Fraunhofer Institute started to develop an audio encoding method that made use of psycho-acoustic effects. The result was called **ISO-MPEG Audio Layer 3**, a.k.a. MP3 — and it became the standard for the 1990s. MPEG Layer 3 achieves CD quality in stereo at a data rate of **112-118 kbit/s**.

the new DRM standard using the FAAD2 library, has been available since 17 December 2003.

Although the software can be freely distributed under the GNU General Public Licence (GPL), that is not to say that there are no third-party rights attached to it. In certain countries use of the software by be in breach of patent law. The project is intended for those who want to find out how the DRM data stream is decoded, to learn about the software algorithms used, and then help to improve the software. If you only want to evaluate the quality of DRM transmissions, the authors recommend installing the commercial DRM Software Radio.

Microsoft Visual C++ V6.0 Service Pack 4 or Service Pack 5 is required for compilation, along with Trolltech QT 2.x. The following libraries are needed: FFTW, Qwt and FAAD2. We shall now look at these components in more detail:

Qwt (Qt Widgets for Technical Applications) is a library of GUI components, including graph plotting and controls. The entire C++ source code is independent of the underlying operating system and is used so that DREAM can run under Windows as well as under Linux. The library can be downloaded from <http://qwt.sourceforge.net/>.

FFTW (the Fastest Fourier Transform in the West) was developed at MIT by Matteo Frigo and Steven G. Johnson. The package can be downloaded from <http://www.fftw.org/>. DREAM uses the fast Fourier transform to analyse the individual carriers in the DRM signal in terms of amplitude and phase. The data obtained from these carriers is assembled to form the complete data stream, which includes both audio and multimedia components.

FAAD2, by the Dutch company AudioCoding.com, includes the DRM-specific algorithms for decoding the received digital data. AAC (Advanced Audio Coding) is the ISO high quality audio coding algorithm developed by leading companies AT&T, Dolby Laboratories, Fraunhofer IIS and Sony, which is also used in the Fraunhofer IIS DRM Software Radio. MPEG-2 and MPEG-4 AAC are also implemented. Version 2 also implements decoding of HE (High Efficiency) AAC streams. FAAD2 may be installed for private and scientific use under the GNU General Public Licence, although of course any patent restrictions must be observed. This is one of the reasons that a compiled version DREAM.EXE cannot be

distributed without restriction. It is also not certain whether free use of FAAD2 will still be permitted as DRM is developed further. We should nevertheless warmly welcome this opportunity for those interested in DRM to gain access to this new technology.

Here are Thorsten Godau's comments on how to proceed.

The first requirement for compiling the DREAM source code for Windows is a working installation of:

- Microsoft Visual (Studio) C++ V6.0, and either
- Visual C++ Service Pack 4 and Processor Pack for SP4, or
- Visual C++ Service Pack 5 and Processor Pack for SP5

Then proceed as follows:

- **Download** the non-commercial version of QT (QT-Win V2.3 NC) from Trolltech at http://www.trolltech.com/download/qt/download_noncomm.html and install it (use the standard paths).
- **Download** the source code of DREAM V1.0 (or higher) from http://prdownloads.sourceforge.net/drm/drm_1_0.zip?download (select one of the mirrors).
- **Download** the precompiled FFTW package from <http://www.tu-darmstadt.de/fb/et/uet/fguet/mitarbeiter/vf/DRM/download/WinFFTWInst.zip>.
- **Download** the precompiled Qwt package from <http://www.tu-darmstadt.de/fb/et/uet/fguet/mitarbeiter/vf/DRM/download/WinQWTInst.zip>.
- **Download** the FAAD2 package from <http://www.tu-darmstadt.de/fb/et/uet/fguet/mitarbeiter/vf/DRM/download/WinFAAD2SBRNewInst.zip>.

Create directories and copy in the precompiled files:

- Create a directory called, for example, C:\vcprojects
- Open `drm_1_0.zip` and unpack it into subdirectories of C:\vcprojects.
- Open `WinFFTWInst.zip`. Copy the files `libfftw.lib`, `fftw.h` and `rfftw.h` from the subdirectory `lib` into the directory

AAC

In 1997 the cooperation between the Fraunhofer Institute and large companies like AT&T, Sony and Dolby culminated in the **MPEG-2 Advanced Audio Coding (AAC)** method. AAC achieves high quality thanks to 1-48 audio channels and sampling rates between 8 kHz and 96 kHz.

mp3PRO

Using **Spectral Band Replication Technology (SBR)** developed by Coding Technologies the data reduction efficiency can be doubled without loss of quality.

mp3PRO is the **MP3-compatible** implementation of SBR. It is for available as a plug-in for the current version of the famous Nero Burning ROM software.

aacPLUS/MPEG-4 HE AAC

The combination of AAC with bandwidth-extended SBR was originally marketed as **aacPLUS** by Coding Technologies. Having been standardised by MPEG as a one of the MPEG-4 audio profiles, the system became known as **MPEG-4 High Efficiency (HE-AAC)**. This recently introduced standard allows full CD-quality in stereo at 48 kbit/s, very good stereo quality at 32 kbit/s and 'parametric' stereo in FM-radio quality at just 20 kbit/s. The latter is employed for DRM since December 2003.

MPEG-4 HE AAC is also available as a plug-in for Nero Burning ROM.

C:\vcprojects\drm\libs.

- Open WinQWTInst.zip. Copy all the files (.lib und .h) from the subdirectory \lib into the directory C:\vcprojects\drm\libs.
- Open WinFAAD2SBRNewInst.zip and unpack it into sub-directories of C:\vcprojects.

Compile the FAAD2 package:

- Go to the directory C:\vcprojects\faad2\libfaad and double-click on libfaad.dsw (if Visual Studio is correctly installed the Visual C++ IDE will now open).
- In the IDE, select 'Build/Set Active Configuration' and in the window that appears select 'libfaad - Win32 Release', and then click 'OK'.
- In the IDE, select 'Build/Rebuild All'. Compilation begins, and should complete with 43 warnings, but no errors.
- Now, go to the directory C:\vcprojects\faad2\libfaad\Release and copy libfaad.lib into the directory C:\vcprojects\drm\libs. Likewise, copy faad.h from c:\vcprojects\faad2\include into the directory C:\vcprojects\drm\libs.

Build the QT MOC files:

- Go to the directory C:\vcprojects\drm\windows and double-click on MocGUI.bat to launch it. A number of files will automatically be created in the directory C:\vcprojects\drm\windows\moc.

Compile DREAM:

- Go to the directory C:\vcprojects\drm\windows and double-click on FDRM.dsw (if Visual Studio is correctly installed the Visual C++ IDE will now open).
- In the IDE, select 'Build/Set Active Configuration' and in the window that appears select 'FDRM - Win32 Release', and then click 'OK'.
- In the IDE, select 'Build/Rebuild All'. Compilation begins, and should complete with one linker warning, but no errors.

Run DREAM:

- Go to the directory C:\vcprojects\drm\windows\Release. Copy DREAM.EXE from here to a newly-created directory C:\Program Files\Dream.

- If DREAM.EXE is to be run on a computer where QT is not already installed, first copy the file qt-mt230nc.dll from the directory C:\qt\bin into C:\Program Files\Dream. Then run DREAM.EXE.

It's as simple as that.

Results

A click on DREAM.EXE starts the program. Once the receiver has been tuned to a suitable frequency, an audio signal will be produced after a short delay. The station being received and transmission information will be displayed on the screen (Figure 2).

Further information is available under 'View/Evaluation Dialogue'. This mode (Figure 3) shows the DRM spectrum and a large quantity of additional information including the current signal-to-noise ratio (SNR), the bandwidth, and the operating mode. It is also possible to experiment with a range of software options. A broken red line indicates the measured centre frequency of the DRM signal, which simplifies calibrating the receiver. DREAM is not restricted to a 12 kHz fre-

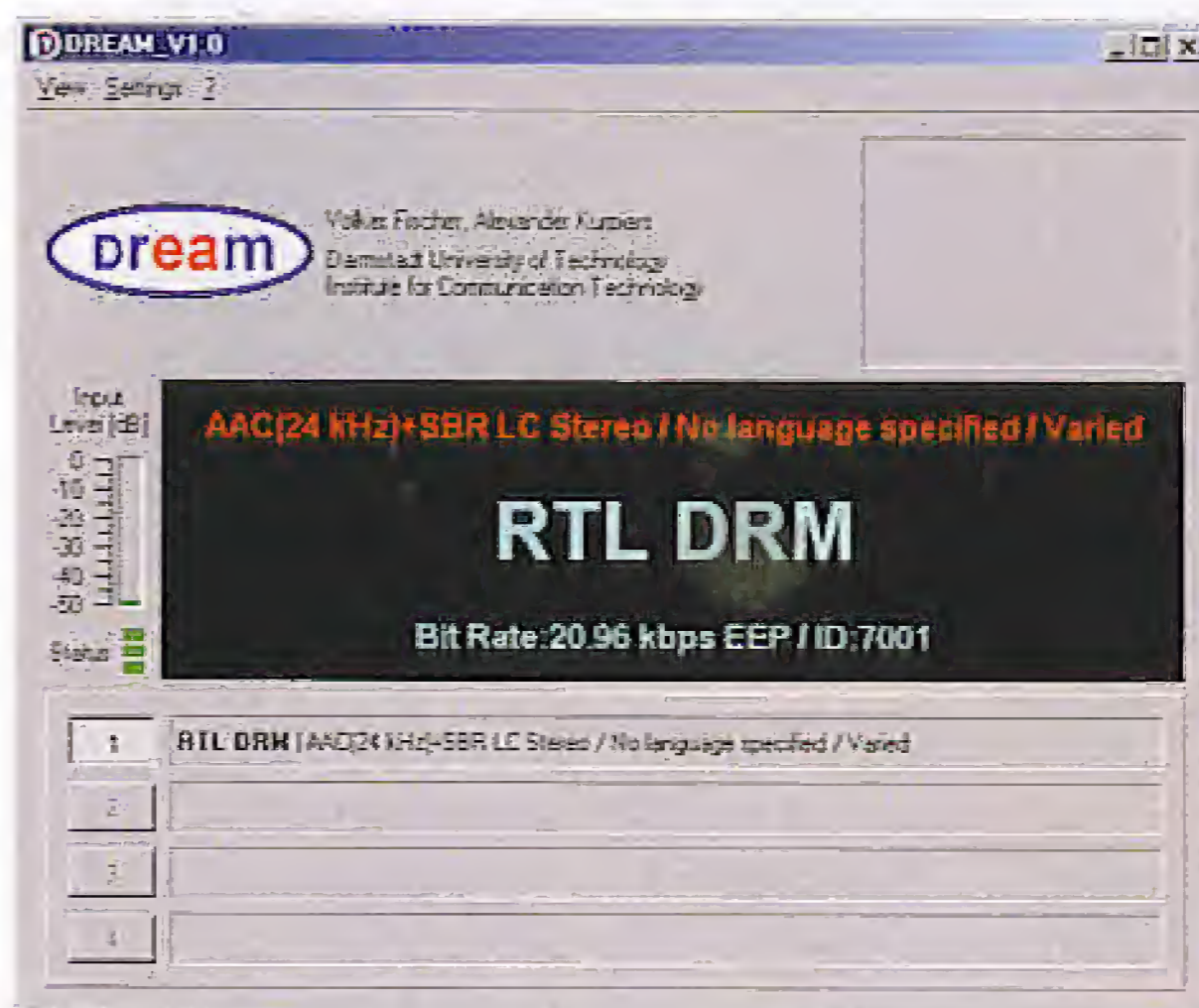

Figure 2. DREAM receiving RTL DRM.

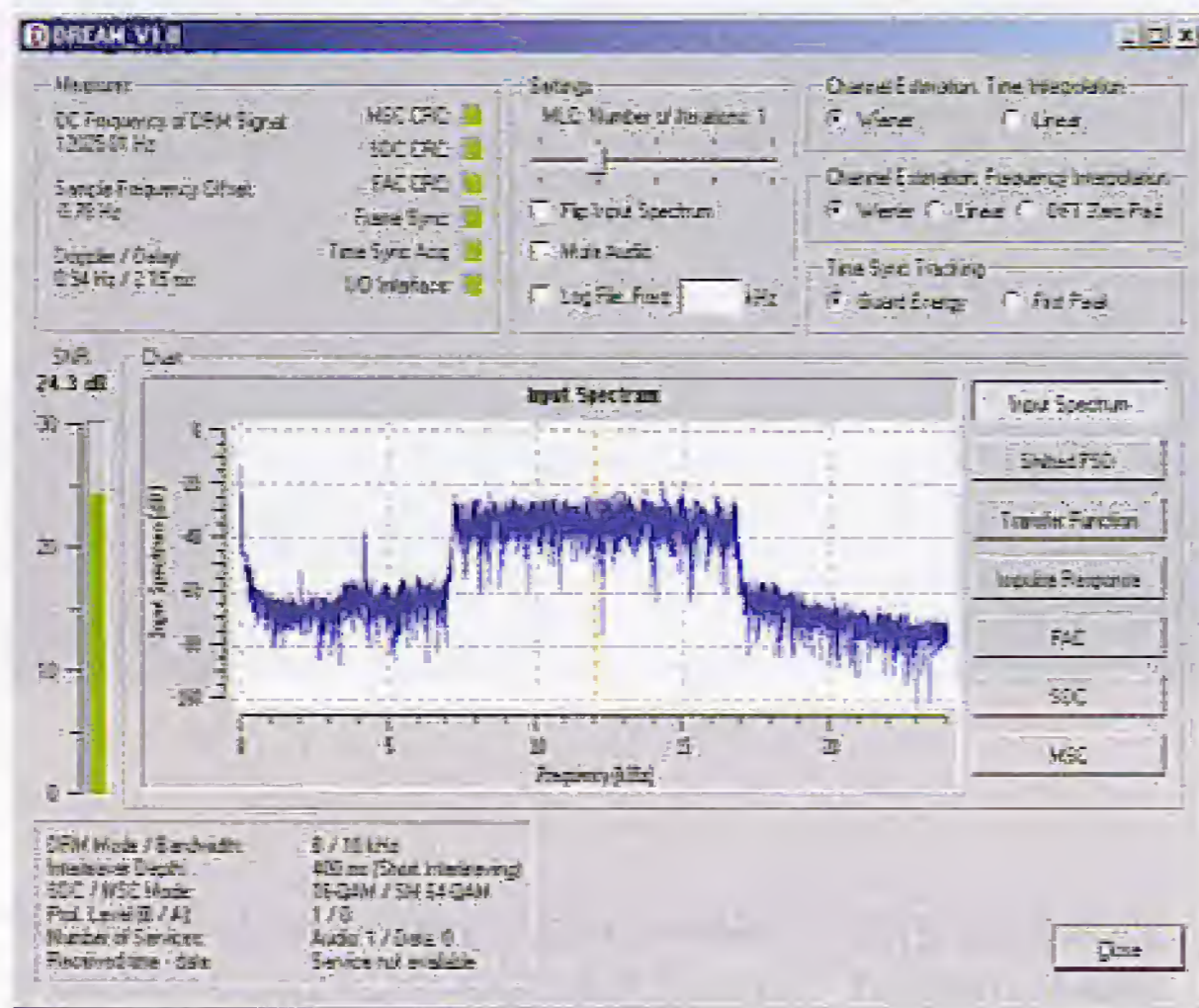

Figure 3. The DREAM evaluation dialogue displays the most important parameters.

quency band, but rather accepts the entire input band between 0 kHz and 24 kHz. This relaxes the constraints on the receiver and allows the receiver to be detuned by a few kilohertz, for example to avoid an unwanted interfering carrier on the image frequency.

AM reception

The receiver option Settings/Receiver mode/AM (analogue) allows DREAM to receive amplitude-modulated signals from normal AM broadcasters. DREAM looks for a strong carrier in the input spectrum and subtracts its frequency from the upper sideband of the received signal. The receiver thus operates as a single sideband (SSB) receiver. This allows both SSB, CW and utility signals such as weather fax and RTTY to be decoded.

In order to receive an AM station, first ensure that the frequency band to be received sits in the middle of the filter

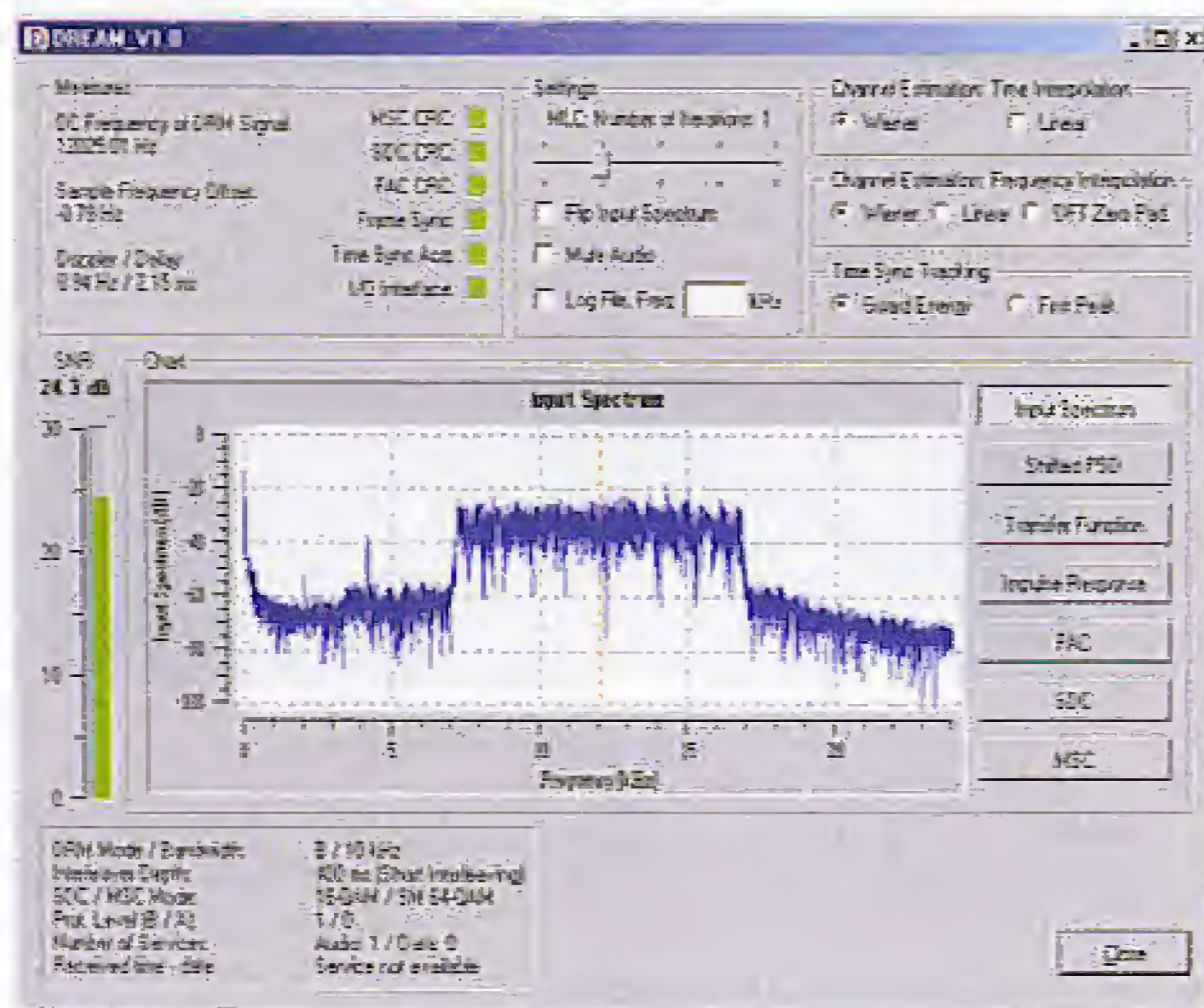

Figure 4. In contrast to the DRM software radio, DREAM can also demodulate normal AM transmissions on the PC.

bandwidth around 12 kHz. Use DRM mode to search for the AM station: the carrier should stand out clearly from the spectrum at 12 kHz. Then switch to AM mode. In the evaluation dialogue the broken red line again indicates the detected carrier frequency at around 12 kHz. This setting remains fixed as long as AM mode is active. The receiver can therefore be retuned freely to bring in other stations.

The single sideband demodulation process gives a number of advantages over the conventional envelope detector. Selective fading normally causes severe distortion if the carrier is significantly attenuated. DREAM, however, can offer trouble-free reception in these conditions, although the sound quality may vary slightly. Also, DREAM includes a very good low-pass filter. The input signal is analysed by an FFT, the upper sideband moved down to zero frequency, and then the audio sig-

nal re-synthesised by an inverse FFT covering the band from 0 kHz to 5 kHz. When the result compared with a conventional short-wave radio tuned to the same frequency, the delay introduced by the digital processing and data buffering is clearly apparent.

Single-sideband (SSB) reception also offers the possibility of obtaining better reception from severely distorted AM stations. Since short-wave broadcast channels are at multiples of 5 kHz, it is often the case that there are pairs of stations just 5 kHz apart: the upper sideband of one then completely overlaps the lower sideband of the other. With DREAM it is possible to receive only the undistorted sideband. In some cases this will mean inverting the input spectrum (option 'Flip Input Spectrum' in the evaluation dialogue). This is also required in order to receive an SSB transmission using the lower sideband. When the *Elektor Electronics* DRM receiver is being used, fine adjustment of its intermediate frequency is possible using the program DRM.EXE. Reception results are better than when using direct conversion, since the software completely discards the unwanted sideband.

Conclusions

DREAM_V1.0 is certainly a serious alternative to the DRM Software Radio. The program is absolutely stable in use and requires less processor power than the earlier versions. It is possible to receive images, and the program can create a log file with reception results. As already noted, DREAM is very tolerant of the position of the DRM baseband signal within its input bandwidth, scanning the entire range from 0 kHz to 24 kHz. It also offers an analogue AM reception mode, allowing it to be used with the *Elektor Electronics* DRM receiver for standard broadcasts.

039365-3

**ELEKTOR ELECTRONICS
IS STAGING
ITS FIRST SEMINAR
FOR ELECTRONIC
PROFESSIONALS**

*THE FUTURE
OF THE
MICROELECTRONICS
INDUSTRY IN EUROPE*

Start of a boom or merely a blip.

Electronics guru
Peter Kember makes this
ground-breaking address

Plus CAN control area networking,
The LPC2100 – the new family
32-bit microcontroller
Datalogging and sensors
Low power radio solutions.....

All from the industry's leading experts
gathered together on one day
– at Warwick University, Coventry

MAY 7

For further details and
to book your place contact:

PRB Public Relations and
Marketing,
3, Crescent Terrace
Cheltenham GL50 3PE
Tel: 01242 51070
Fax: 01242 226626

Email: bernardhubbard@prb-marketing.com

**A QUANTUM LEAP IN
EMBEDDED CONTROLLERS**

Quick  **FIRE**
SUPERCONTROLLERS

Our range provides:-

- The fastest 68000 based Core up to 66 Mhz.
- Extensive I/O:- Serial, IrDA, SPI, I²C, Analogue, Timers/Counters, RTC, etc.
- Large Memory Capacity:- Flash, SRAM, DRAM.
- Supports:- Mono & Colour LCD's, Touch Panels & Keypads, Very Low Power.

ALSO LOW COST

DEVELOPMENT

- Target easily & quickly.
- Full ANSI 'C' compiler, assembler & linker all Windows32 based.
- Source Level Debug.
- Full Driver Support with Libraries.
- Real Time Multitasking OS with a free run time licence.
- FREE Unlimited email support.

www.cms.uk.com

see our web site for full details

CAMBRIDGE MICROPROCESSOR SYSTEMS LTD



Unit 17-18 Zone 'D' Chelmsford Rd. Ind. Est.
Great Dunmow, Essex CM6 1XG
Telephone: **01371 875644**
email: sales@cms.uk.com

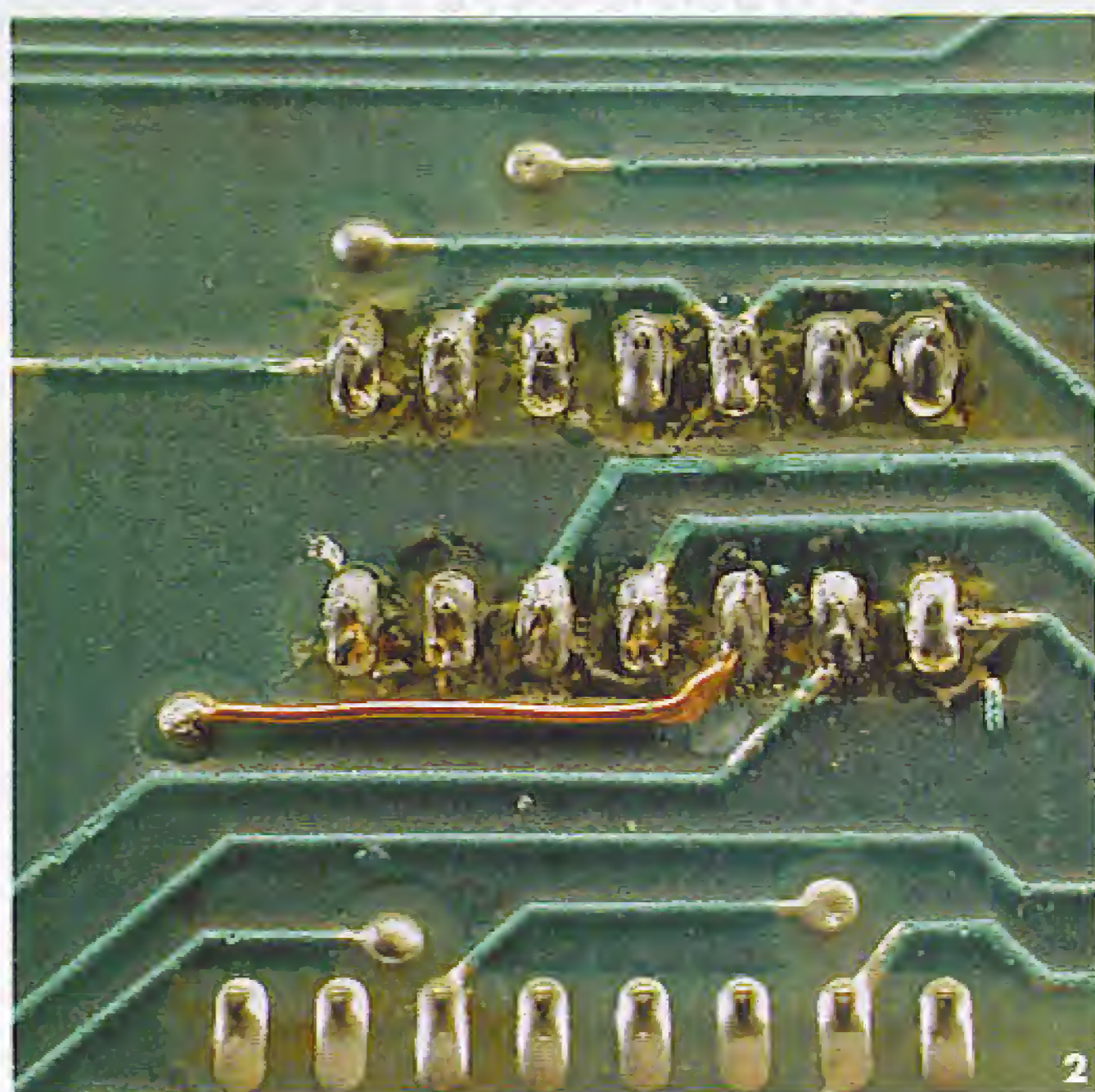
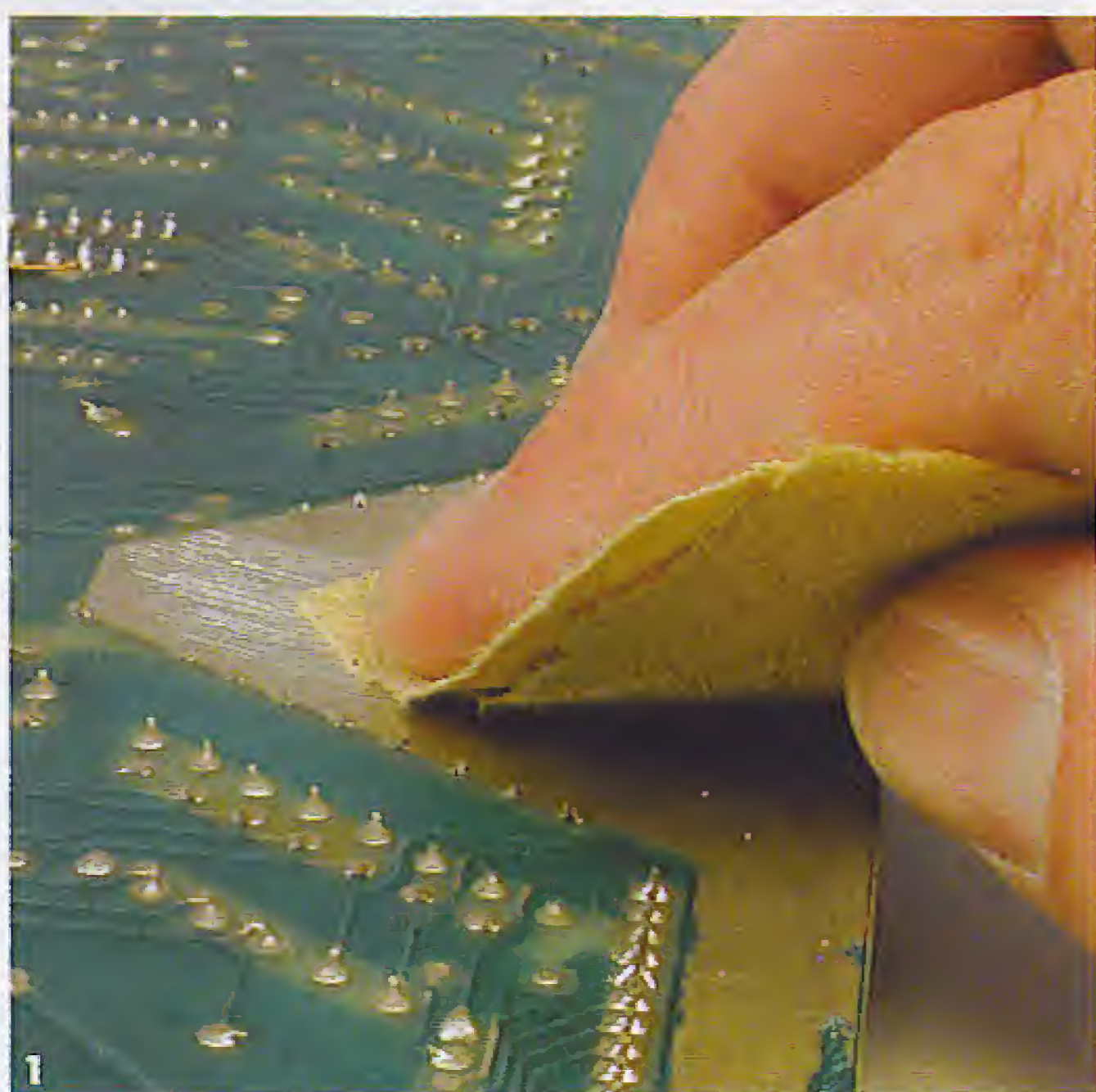

Repairing the damage caused by leaking batteries

Most of you will have suffered from this at one time or another: a torch or other battery-powered equipment has been neglected too long and the batteries started leaking. After all, these cells contain a cocktail of corrosive chemicals that will eventually find their way through the battery housing and end up in all those places where they're not wanted.

NiCad cells that are over-charged can vent the electrolyte in gas form. The metal parts in particular will be damaged by this, with disastrous consequences.

It becomes even worse when the batteries, whether in a holder or not, are mounted on a PCB. This can be the case with (older) microprocessor boards, which have, for example, a real-time clock that has to keep running, or a volatile memory that stores settings that have to be maintained when the power is turned off or lost. A leaking battery on

a PCB leads to corrosion, which has both visible and invisible consequences.

When repairing this it is pointless just to polish those areas that are visibly affected; any repair has to stand the tests of time. The electrolyte can penetrate into certain materials and continue with its destructive process underneath the surface. Just cleaning the surface is therefore not enough; the only remedy is the complete removal of every bit of electrolyte.

On a PCB the corrosion can be seen in various ways. Firstly as a simple mark where the battery is mounted. Next, it can be seen as a green or white deposit on the pins, components and solder joints.

We start with the removal of all components that are on the affected part of the PCB. Use a good quality solder sucker and/or desoldering braid and keep in mind that in many cases, such as for resistors, capacitors, IC sockets and standard logic ICs, the PCB is more important than the component that has to be removed. In those cases, you can cut the connections and remove them one by one.

One problem that occurs when

desoldering is that solder affected by corrosion often won't flow properly. In that case you should add some fresh solder and try it again. If you are still unsuccessful, you should sand the joint until the corrosion has gone, and try again with the solder sucker. In extreme cases you may have to use a PCB drill to restore the connections.

When all components have been removed from the corroded part of the PCB, it should be sanded with fine wet-and-dry sandpaper. Any solder resist should be removed as well; you just keep sanding until all tracks become shiny again.

To finish the job properly any remaining electrolyte has to be neutralised by rinsing the PCB in a 1:1 mixture of water and vinegar. It is often thought that all batteries contain acids, but Nicads and alkaline cells have KOH as electrolyte, which is an alkaline. Hence we need to use an acidic solution to neutralise it. After this it should be rinsed with water, dried and then cleaned with alcohol (white spirit is much cheaper, but less pure). The PCB should then be sprayed with a solder lacquer, which protects

the tracks from oxidation and lets the solder flow cleanly when the PCB is repopulated.

The PCB now has to be inspected carefully, and any broken tracks have to be repaired using enamelled copper wire, cut to length. The components can then be soldered back onto the PCB.

It's quite a time-consuming job, but if it is done properly the PCB should give many years more service, unless the batteries start leaking again...

(040025-1)

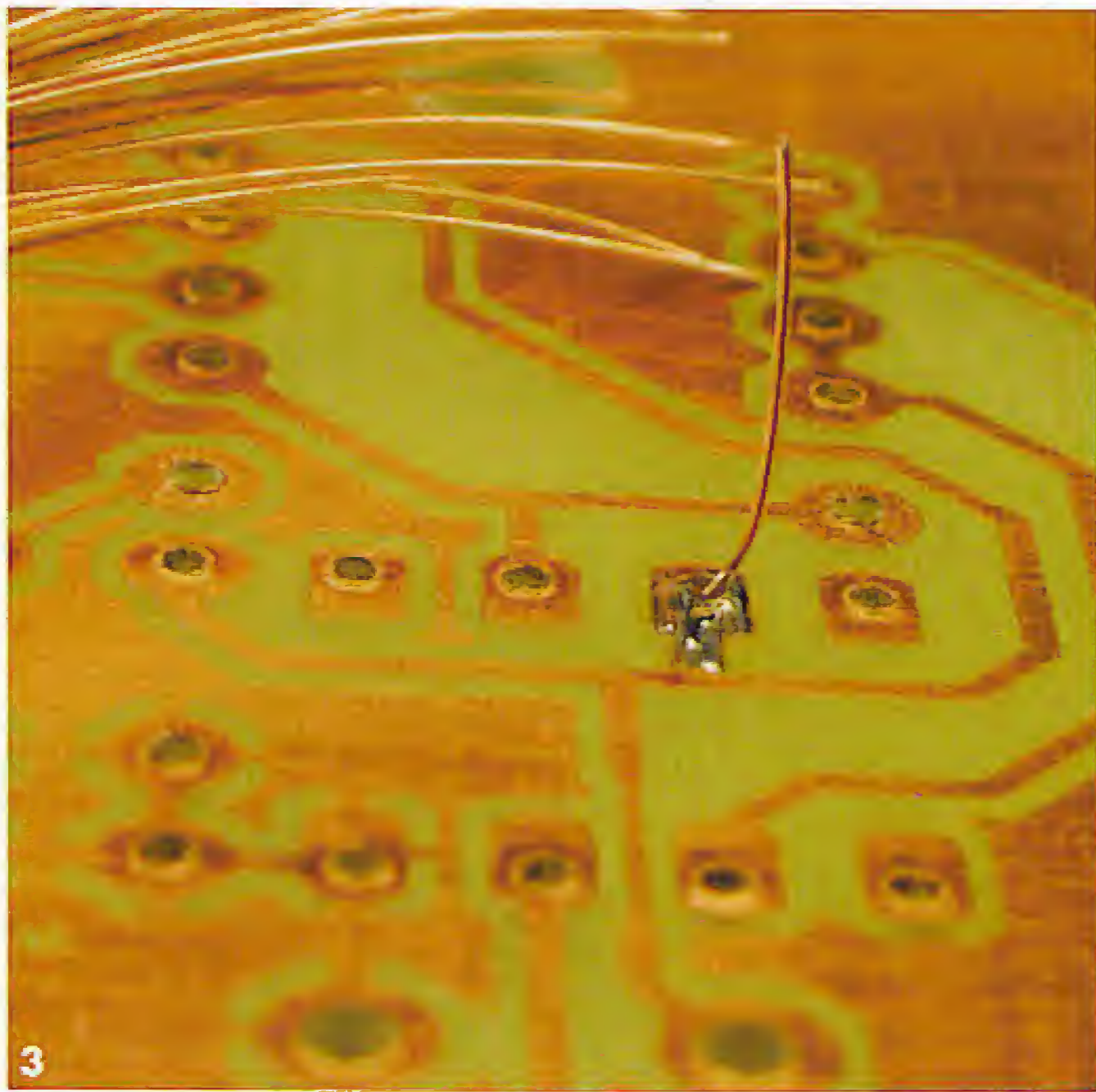

Through-hole 'plating' double-sided PCBs

Making a double-sided PCB is far from easy. It is quite a task to make sure that the artwork films with the tracks and pads are perfectly aligned on both sides. And it becomes even more difficult when both sides have to be connected at various points.

The professional PCB manufacturer uses through-hole plating: the board is drilled and a thin layer of copper is deposited in the holes that require a connection between the top and bottom side. An electrochemical process is then used to make the actual connection. This however requires specialist equipment, which won't be available in many electronics labs. Fortunately there are other methods, although they are somewhat laborious. These methods are also useful when repairing damaged double-sided boards.

The simplest solution is to solder the pins or leads of the components on both sides of the board. This is easily accomplished with

conventional components (resistors, diodes, transistors, etc.), but with radial capacitors and ICs (in sockets) this is more difficult. The second method uses Litz wire, which is often on hand in the electronics workshop. This wire consists of many thin copper strands, which are highly suitable for making connections between two sides of the board and still leave enough room in the holes for the component leads (Figure 3). The thin strands are soldered on the component side of the board, taking care that the solder joint doesn't rise above the board too much, and that the hole doesn't become blocked by the solder. When all connections have been made, the components can be placed on the board and soldered on the solder-side. We recommend that you use two strands per connection, thereby reducing the risk that a connection is damaged when the component pin is stuck through the board.

For DIL-IC sockets there is a much simpler method: there are contact strips that have the same type of contacts as turned-pin IC sockets. These have the advantage that they are raised slightly further above the board, provid-

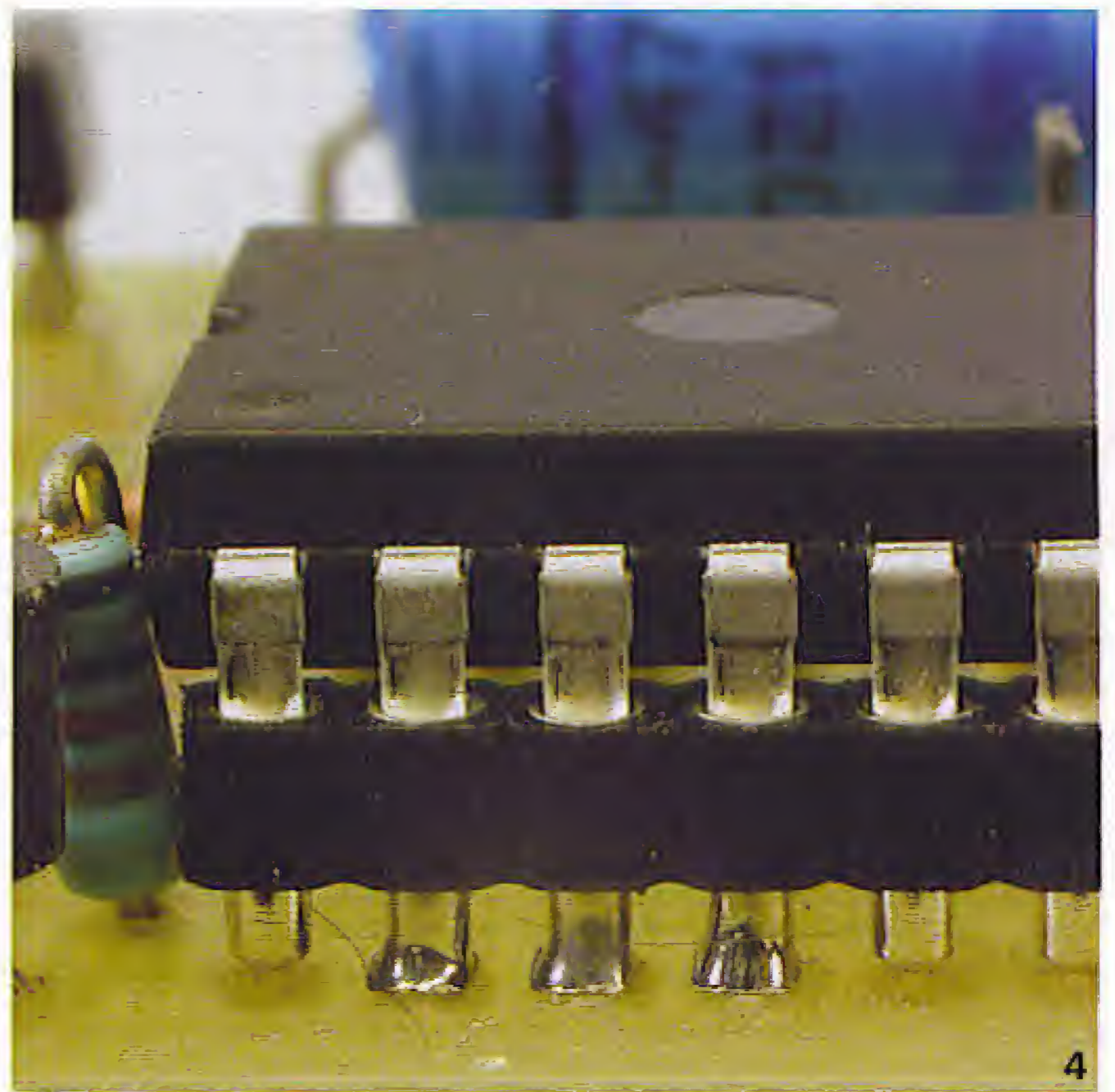

ing enough room to solder the pins on both sides of the board (Figure 4). These strips are preferable to ordinary turned-pin sockets because the pins on the component side of the board are easier to get to with a soldering iron from both sides.

(040025-2)

Alternatives for battery-backed RAM

Many microprocessor boards include a static RAM that stores a variety of system settings. It is often desirable to keep these settings when the power supply is turned off or interrupted. For this reason a backup battery is mounted on these boards, which provides standby power to the SRAM.

At first sight, this seems a simple solution, but it is far from ideal. Batteries take up a fair amount of space on the PCB. They also need to be checked regularly for any possible leakage and that they supply the correct voltage. On modern processor boards a

flash memory or EEPROM is often used, neither of which require a backup battery. Older boards can be given a new lease of life by replacing the SRAM and batteries with a modern alternative such as FRAM.

Ramtron International Corporation has introduced two ICs, the FM1608 and FM1808, which are ideal for removing the need for backup batteries in older systems, and which are of course very useful in new designs too. These are a special type of non-volatile memory, Ferroelectric RAM, which is being developed further by the manufacturer. A detailed description of the technology can be found on their website

at www.ramtron.com/aboutfram. The manufacturer guarantees at least 10 billion read/write cycles and a 10-year data retention for these ICs. The best characteristic of these memories is that they are pin compatible with standard 8 K x 8 (FM1608) and 32 K x 8 (FM1808) SRAMs and EEPROMs, and can therefore be used in existing designs without having to make any drastic modifications.

There is just one aspect of the design that has to be taken into account when a 'normal' SRAM

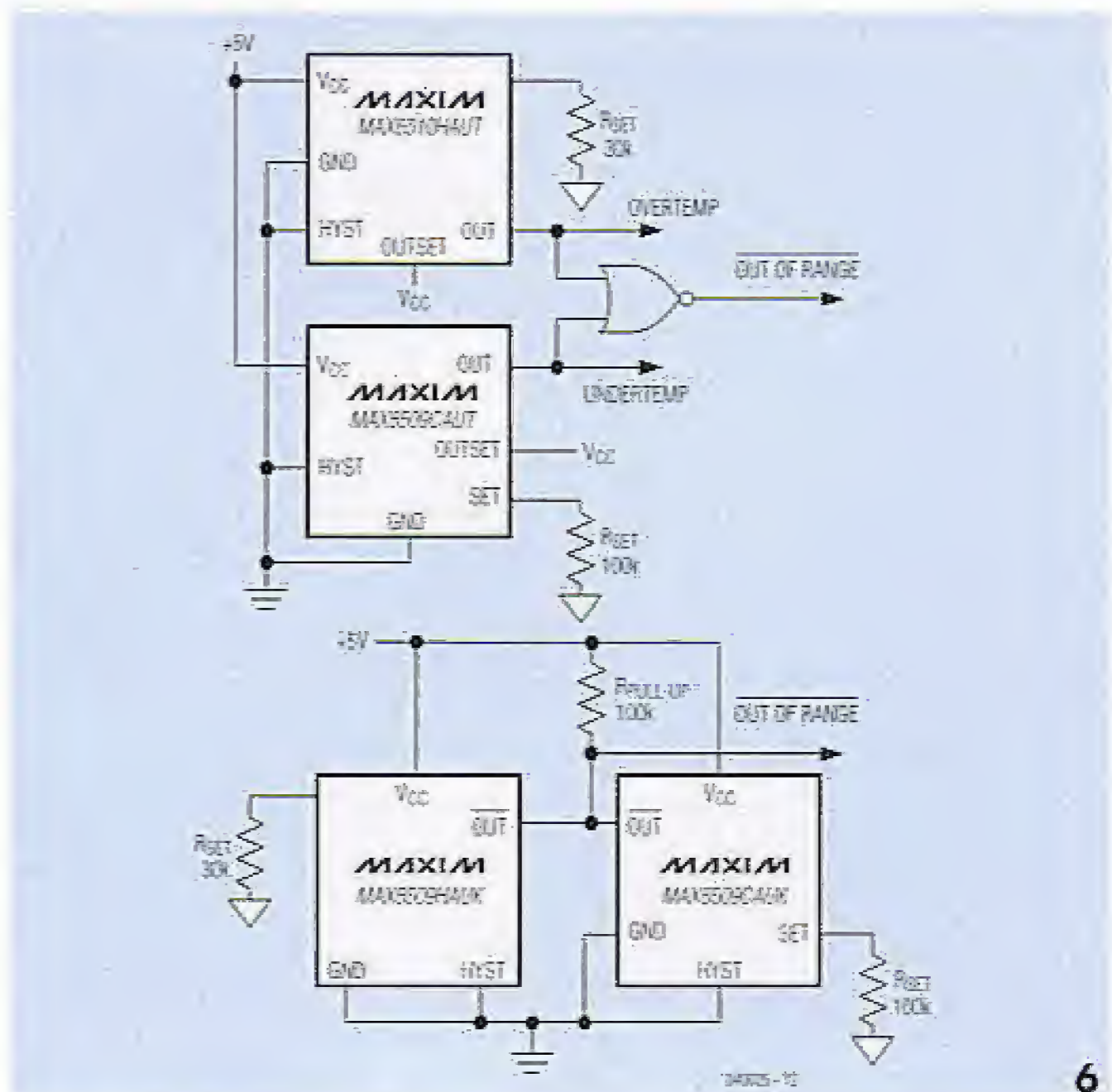
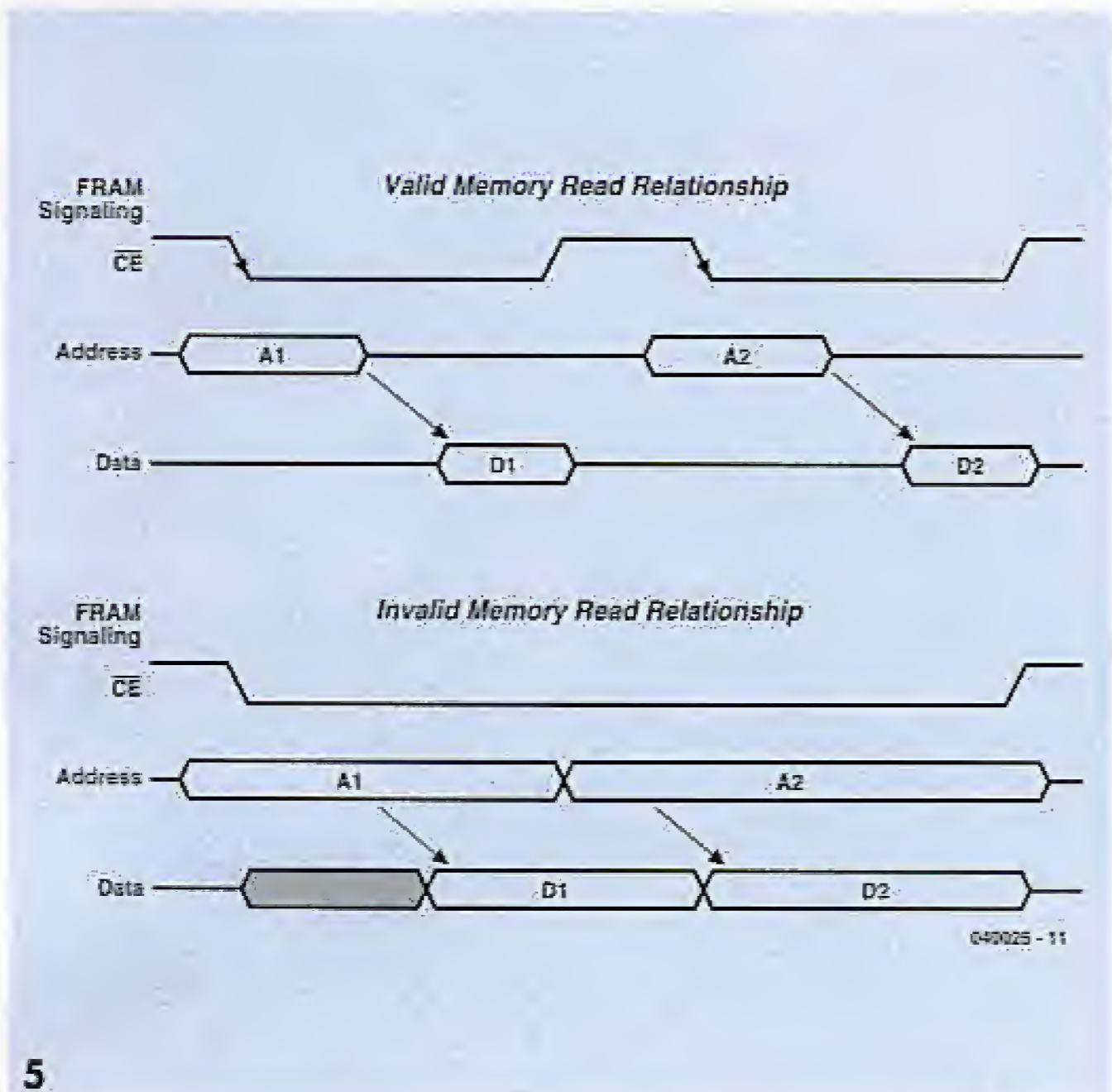

is replaced by an FRAM: the \overline{CE} signal of an FRAM is used to clock an internal address latch, as shown in the timing diagram. This means that the IC requires a falling edge on this pin after a valid address has been put on the address bus, otherwise the address won't be recognised!

between an output that is active high, active low, or an open-drain with a pull-up resistor. The output could for example drive a reset or interrupt to a microcontroller system, switch a supply or activate an external alarm. The current through these components should be kept as small as possible, to limit any temperature variation due to internal dissipation.

design, it is very simple to monitor a temperature between lower and upper limits. Two possible configurations are shown in **Figure 6**. The lower circuit uses the open-drain outputs of the MAX6509 as a wired-OR, with a common pull-up resistor. All of the temperature switches in this example have a hysteresis of 2°C (input HYST connected to ground). When the trip temperature has been chosen, the corresponding value for R_{set} can be read from one of the graphs in **Figure 7**. For an exact value; one of the following formulae should be used.

For temperatures between -40°C and 0°C use:
 $R_{set} = [(1.3258 \times 10^5) / (T+1.3)] - 310.1693 - [(5.7797 \times 10^6) / (T+1.3)^2]$
 For temperatures between 0°C and +125°C use:
 $R_{set} = [(8.3793 \times 10^4) / T] - 211.3569 + [(1.2989 \times 10^5) / T^2]$
 where T is in K, R_{set} is in kΩ.

Temperature switches in SOT packages

The MAX6509 and MAX6510 made by Maxim are very small temperature switches, which can be configured with a single external resistor to trip at any temperature between -40°C and +125°C. The accuracy of the trip point is typically ±0.5°C and ±4.7°C maximum. They have a pin that sets the hysteresis to either 2°C or 10°C. The MAX6509 has an open-drain output. The MAX6510 uses the OUTSET pin to choose

With these components you should pay particular attention to the suffix (the letters immediately following the part number) and specifically the first letter!

An 'H'-type ('Hot') switches the output when a rising temperature exceeds the trip point and switches back when the temperature falls below the trip point, **minus** the hysteresis. A 'C'-type ('Cold') in contrast will switch when the temperature falls below the trip point and switches back when it rises above the trip point **plus** the hysteresis. In other words: the hysteresis is either above or below the trip point, depending on the type of sensor. By combining both types in one

From the graphs you can determine that the switches in the examples have trip points of about 0°C ($R_{set} = 100 \text{ k}\Omega$) and 65°C ($R_{set} = 30 \text{ k}\Omega$).

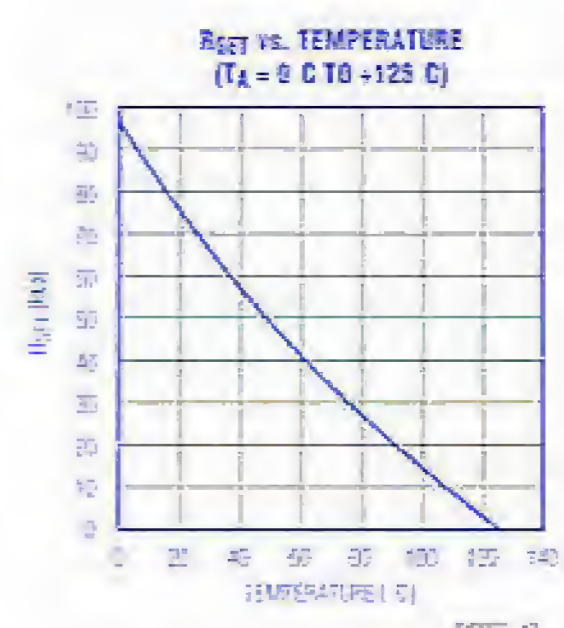

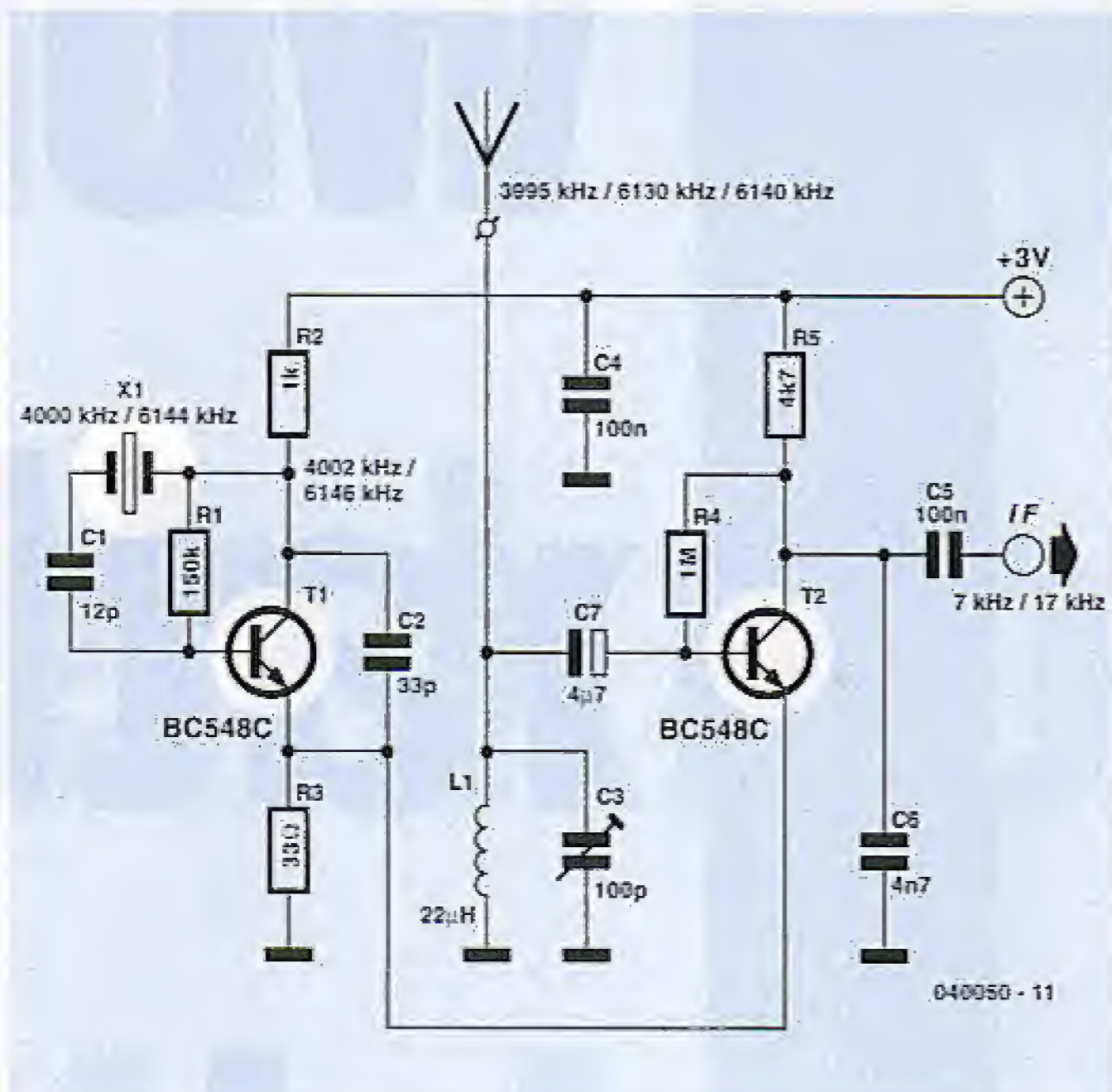

2 Transistors, 1 Crystal — that's it!

Poor Man's DRM is here

Burkhard Kainka

Almost too good to be true but tried & tested: a totally undemanding receiver giving you an opportunity to experience DRM digital broadcasts on shortwave. Digital SW almost for free!

There are a large number of shortwave stations broadcasting not only conventional analogue signals but also digital programme material. This raises the exciting question if there might be stations that 'fit' standard quartz crystal frequencies and so can be captured using the ultra-simple receiver presented in this short article. Ultra-simple?

Yes, the receiver consists of nothing more than a direct mixer and a crystal oscillator.

As you could have surmised there are off the shelf crystals that fit the bill (else there would not have been an article). Three shortwave frequencies used by Deutsche Welle (German world service), 3995 kHz, 6130 kHz

and 6140 kHz, match the common microprocessor quartz crystal frequencies of 4.000 MHz and 6.144 MHz — that is, with a trick! In each case, the oscillator should run about 2 kHz above the nominal crystal frequency. In many cases, a crystal frequency can be 'pulled' a little by using a load capacitance which is slightly larger than the usual 20 to 30 pF (assuming the crystal operates at fundamental resonance). In our circuit a series capacitor of 12 pF does the job, forcing the crystal to resonate a little above its nominal frequency. It is not terribly important if the actual frequency is 4002 kHz or 6146 kHz.

Inside the receiver the digitally modulated signal received at the DRM station frequency is mixed down into the audio range. This simple operation causes the DRM baseband (which is still digitally modulated) to appear at 7 kHz for the station frequencies 3995 kHz and 6140 kHz, or 17 kHz for the transmitter at 6130 kHz. Decoding these signals on the PC will only succeed if you use the DREAM software for DRM, because this program is tolerant of input frequencies between 0 and 24 kHz. Luckily, DREAM is an open-source program hence does not incur any costs.

It should be noted that the received DRM baseband will need spectrum-inversion. This is because high-side injection is used, that is, the local oscillator operates at a frequency above the station frequency. In the program, activate the 'Flip Input Spectrum' option.

Oscillator and mixer

From a point of view of modern electronics the lower parts of the shortwave bands can hardly be called 'high frequency'. Consequently there are no problems building the receiver from AF / fast switching transistors like the ubiquitous BC548C or BC549C. The oscillator around T1 feeds its

output signal directly onto the emitter of mixer transistor T2. Mixing takes place on the curved part of the transistor characteristic. The base gets the RF signal directly from a heavily damped hence wideband input circuit that's tuned for maximum RF with the aid of a trimmer. The upshot is that the DRM baseband is available at the collector. Depending on the available level, the DRM signal coupled out via C5 is fed to the Line or Microphone input of your soundcard for processing by the DREAM software.

Under favourable circumstances (including propagation and the absence of man-made noise), an indoor wire antenna of about 3 metres will be sufficient. Better results are achieved with an outdoor antenna of about 10 m. The Deutsche Welle (DW) transmitters put up usable signal strengths across most of Western Europe. However, if DREAM starts to indicate a poor signal/noise (S/N) ratio (less than 15 dB), look for wideband noise as a cause for signal corruption. Under good conditions, our little receiver supplies an S/N greater than 20 dB. The DRM broadcast schedule on DW may be gleaned from, among others, Stefan Mahn's website at www.drm/info.de

(040050-1)



Wou
rath
wha

*Read elektor
electronics.*

leading the way

ouldn't you
er know
t's inside?

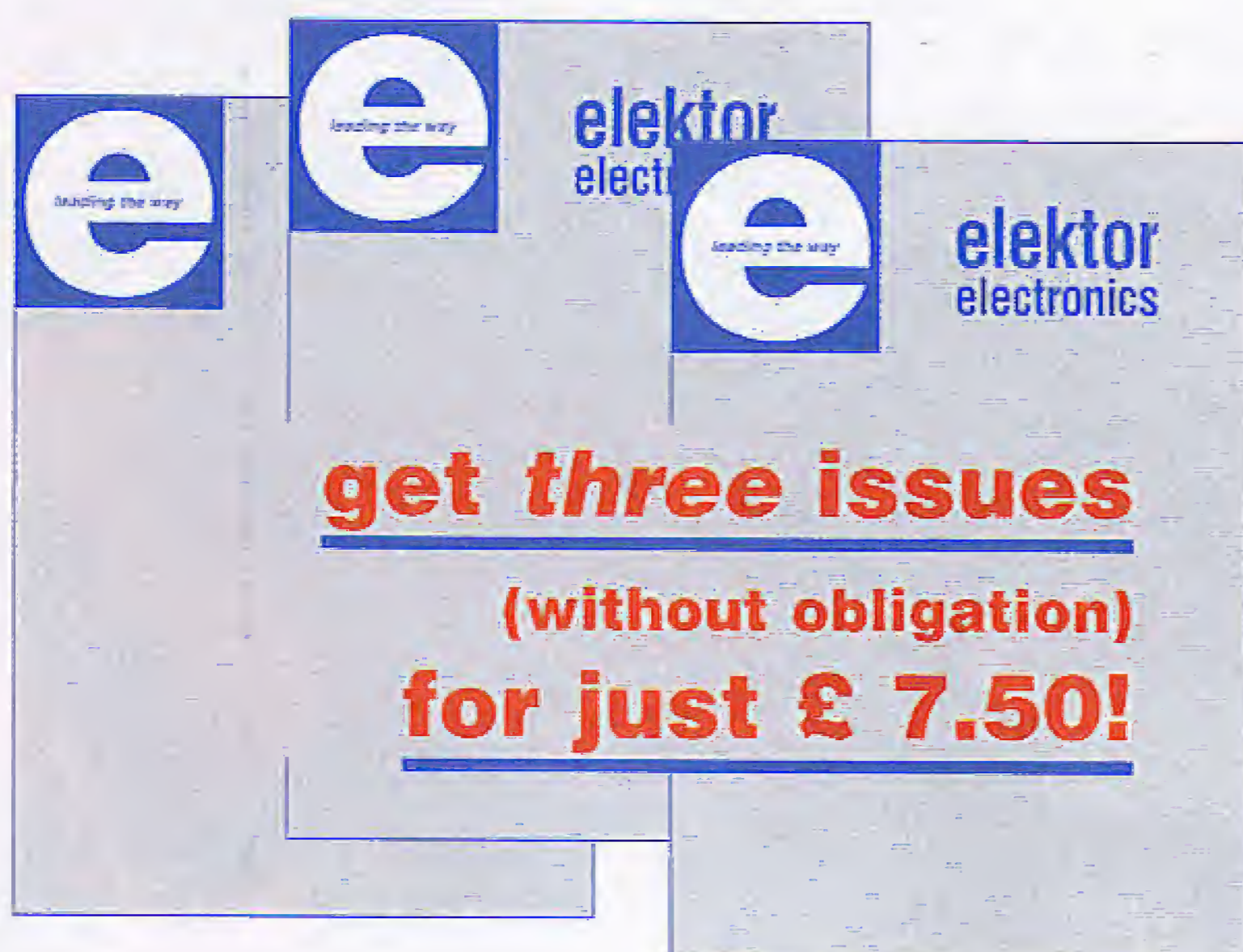

get three issues
(without obligation)
for just £ 7.50!

Try out the new *elektor electronics* and get the next 3 issues (May, June and the July/August 2004 double issue) delivered at your doorstep.

**YOUR SAVING:
MORE THAN 41%!**

The trial subscription expires automatically.

Fill out the reply card with this issue.

WAVECATCHER

Aerials and preselectors for AM and DRM

For initial experimenting and radio listening with a DIY short-wave or DRM receiver, a simple rod aerial or piece of wire is sufficient. But it's only natural to want something better. This article gives you the right tips for better reception.



Transmitter

In the UHF band, radio waves propagate essentially in a line-of-sight manner, similar to light, and this limits their reception to a range of around 100 km, depending on aerial height. However, radio waves at frequencies below 30 MHz show completely different behaviour, which makes a significantly larger reception range possible. Of course, the complex propagation mechanisms in this frequency range also lead to special problems, such as dependence on the time of day, field strength fluctuations (fading) and selective fading.

Radiation and propagation

The decisive role in the propagation of radio waves in the short-wave bands is played by the ionosphere, a set of weakly conductive layers in the atmosphere at great height that are formed by solar ionization. The ionosphere results from collisions between particle radiation and gamma radiation from the sun and air molecules, which become ionized with the release of electrons. Within certain frequency bands and at certain incident angles, the free electrons generated in this manner act like a mirror. At large incident angles and high frequencies, the ionosphere is instead transparent.

A short-wave transmitter can be received in the nearby region via ground-wave propagation over a range of only around 30 to 100 km, depending on the height of the aerial. At greater distances, the transmitter disappears behind the horizon due to the curvature of the earth, making a direct link impossible. However, radio waves reflected from the ionosphere can reach receivers located in a region starting at certain minimum distance away from the transmitter, as illustrated in **Figure 1**.

Between the limit of reception of the ground wave and the start of reception of the reflected signal, there is a region called the 'skip zone' where the signal cannot be received. The reflection angle that would be necessary for the signal to be received in this region is too large. Of course, the transmitter also radiates energy at this angle, but it leaves the atmosphere without being used, perhaps to be received sometime later on by one of our neighbours in outer space.

The minimum dis-

tance between the transmitter and the receiver varies with the time of day for each frequency, and it also depends on the level of solar activity, which varies over time.

High frequencies can only be reflected at very shallow angles. Consequently, the ground distance spanned by the reflected signal is generally greater in the higher-frequency bands. The skip zone is also correspondingly larger; during the day it ranges up to around 200 km at 6 MHz and around 1000 km at 15 MHz.

The skip zone expands at night, and with it the reception range. As a result, it often happens that a particular transmitter can be initially received quite well near dusk but then suddenly disappears, since in a manner of speaking it has slid into the skip zone. If the same programme is also being broadcast on other frequency bands (as is customary with BBC, DW, etc.), it is recommended to change to a lower frequency when this happens.

Generally speaking, radio waves arrive at a receiver via more than one path. The differences in the path lengths give rise to phase differences, which lead to partial reinforcement or cancellation of the waves. Especially in the short-wave band, rapid fluctuations in field strength are common. This frequently causes selective fading, which is particularly noticeable with AM transmitters in the form of unpleasant distortion resulting from nearly total loss of the carrier signal, causing it to be overshadowed by the sidebands. DRM (the new digital transmission technique) is also affected by this fading, but the modulation and coding methods used for DRM are especially robust and can tolerate partial loss of data. Thanks to effective error handling, even deep dropouts in the DRM spectrum, such as those caused by cancellation at certain frequencies, generally do not interfere with reception.

DRM restores excitement to radio listening on the medium- and short-wave bands. There are already quite a few stations available (see **Table 1**), and new transmitters are constantly being added to the list.

A longish wire

Strong short-wave transmitters can be received using an 'aerial system' (rod aerial or piece of wire) with a length of less than a metre. For long-distance reception, it is naturally much better to use a 'longish' wire aerial, which preferably should be strung up outdoors – as widely separated from other objects as possible, as high as possible and sufficiently far away from the house, in order to avoid the 'noise cloud' emanating from the house.

In theory, a wire aerial has a resonant frequency at one quarter of the signal wavelength, although a good earth connection acting as a counterpoise is important for this. In practice, wire aerials with lengths of around 10 metres have proved to be satisfactory.

If the receiver is located close to a window or the outside wall of the house, it is sufficient to connect the end of the wire directly to the inner contact of the aerial socket. However, if the distance between the aerial and the receiver inside the house is relatively long, the connection should be made using coaxial cable, with the opposite pole being provided by an earth connection close to the feed point of the aerial (see **Figure 2**). Here it makes no difference whether you use 50-Ω cable or 75-Ω cable. After all, the base resistance of the aerial varies with frequency, and it has a complex impedance with

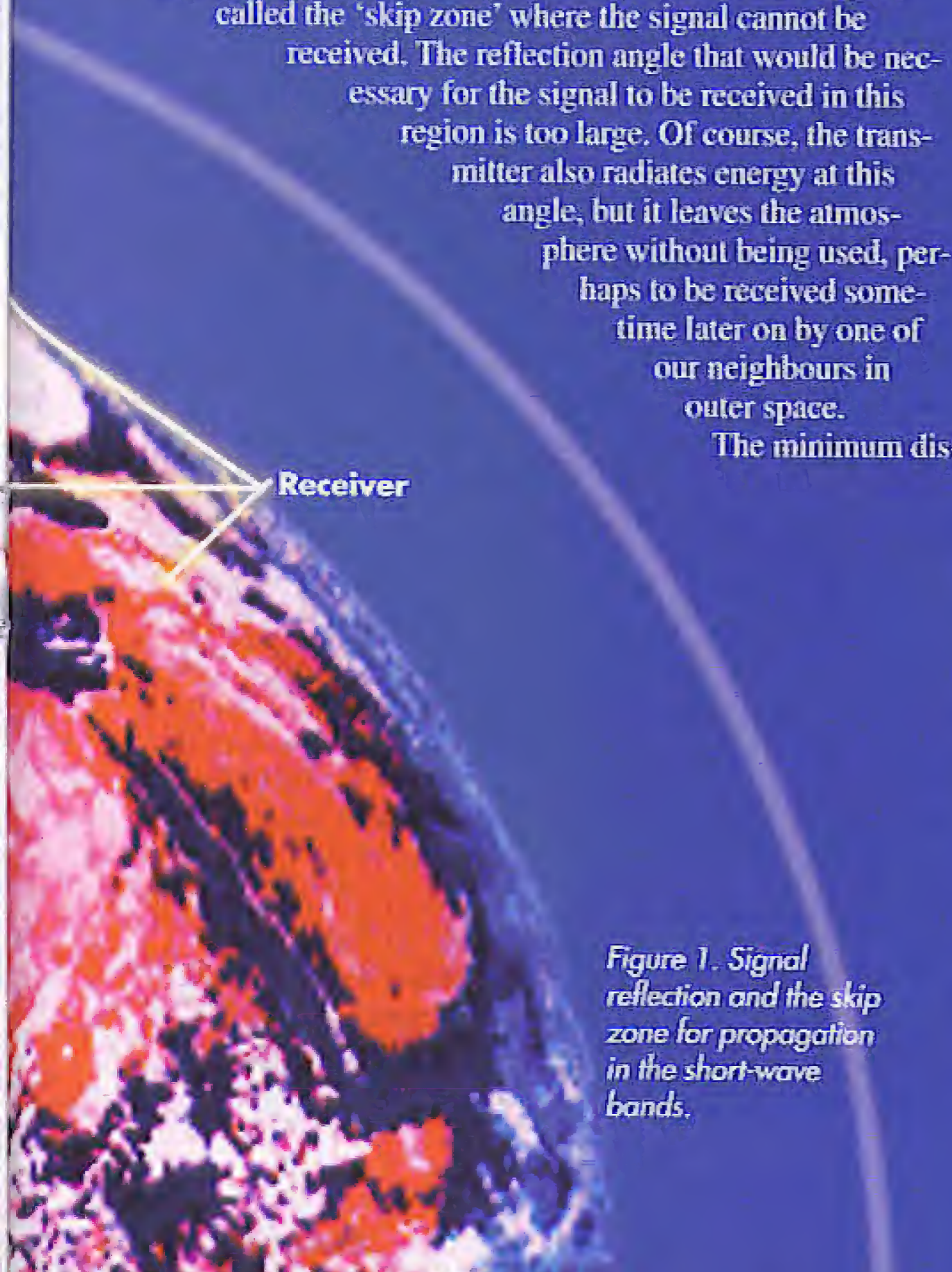

Figure 1. Signal reflection and the skip zone for propagation in the short-wave bands.

Figure 2. An outdoor wire aerial connected via a coax cable.

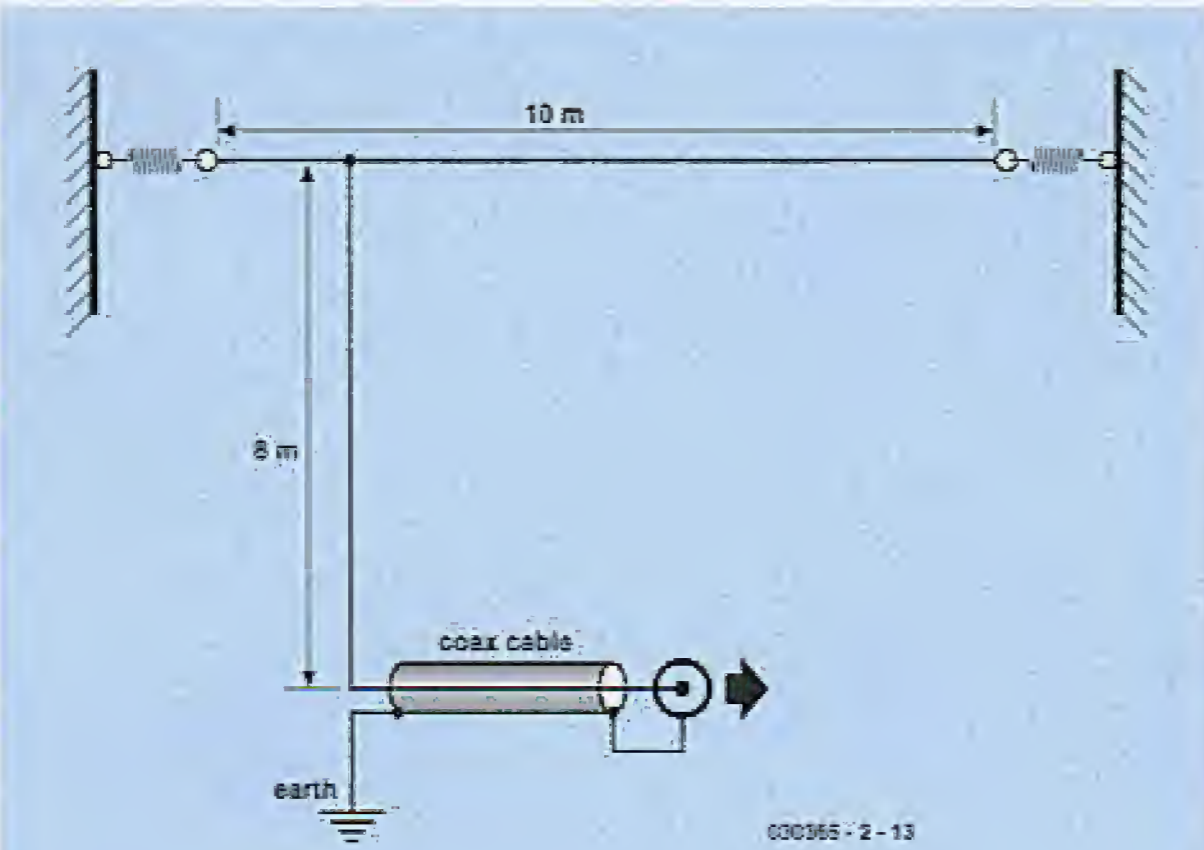

Figure 3. A freely tuneable resonant circuit used for preselection.

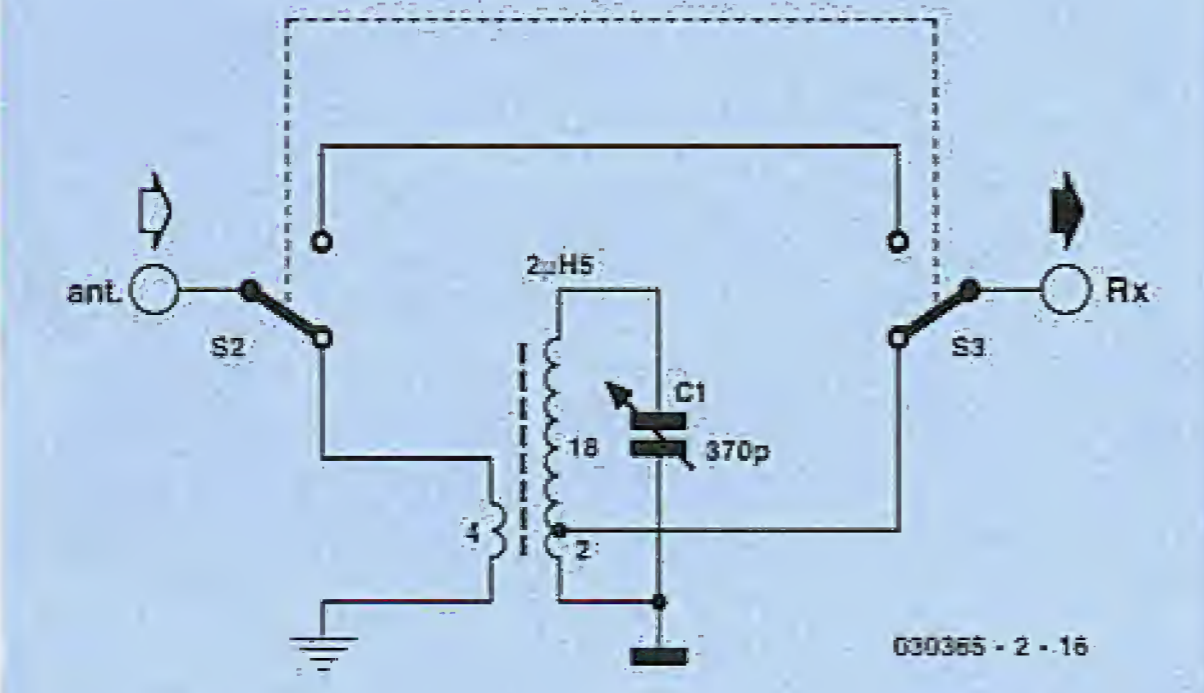

Figure 4. Tuning using a variable-capacitance diode instead of a rotary variable capacitor.

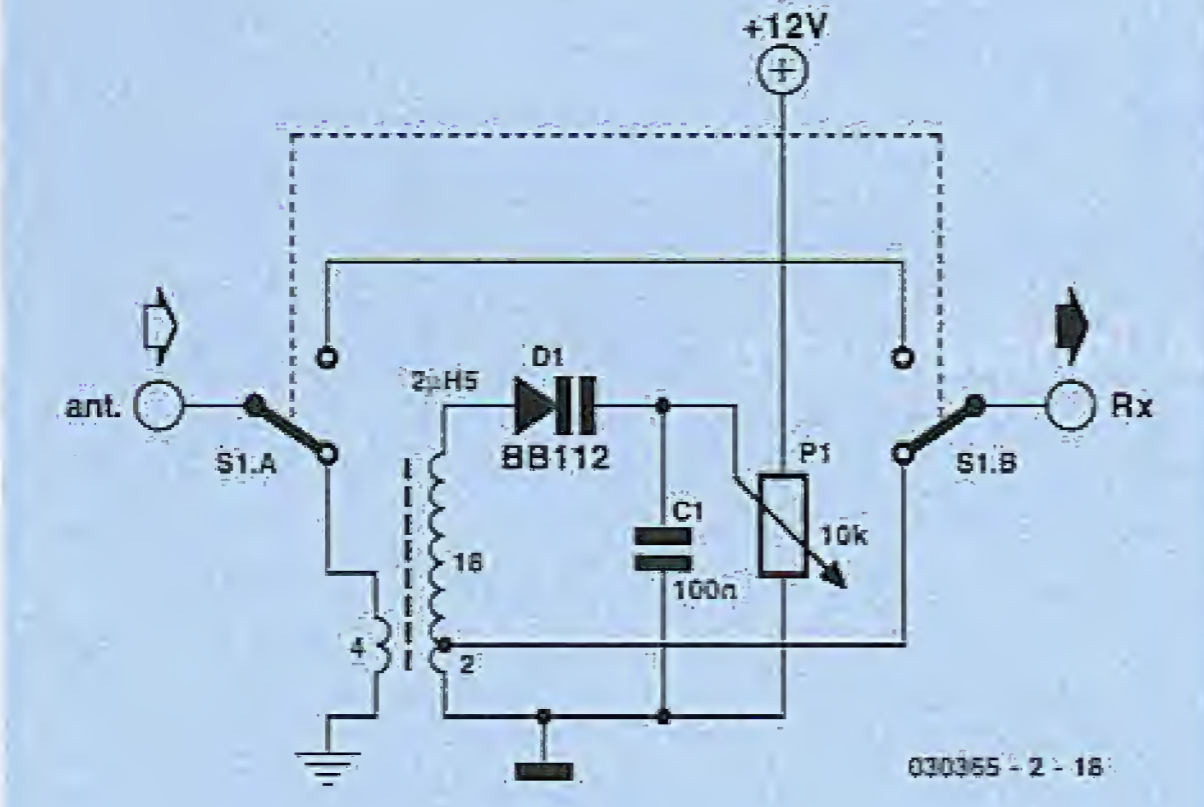
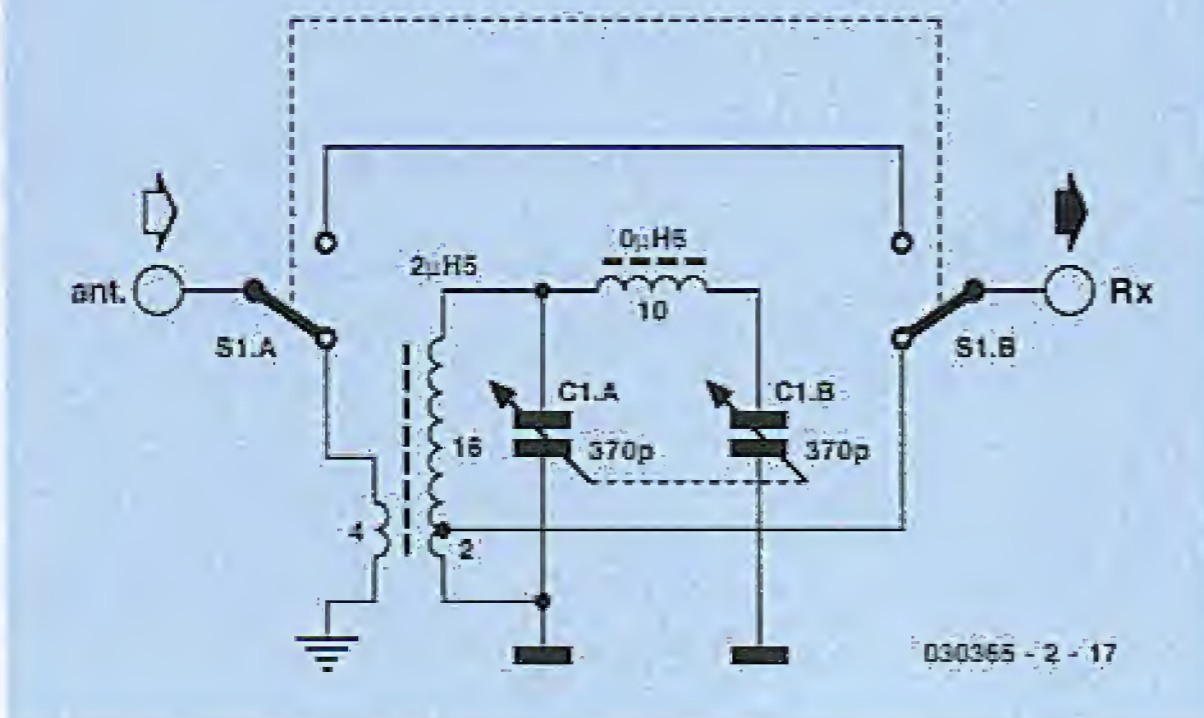

Figure 5. Tuning from 3 MHz to 30 MHz using a dual variable capacitor.



alternating capacitive and inductive components. The coaxial cable also has its own resonances, since it is not being used at its characteristic impedance, and it transforms the aerial impedance, with the net result that resonances other than those to be expected from the length of the aerial can also occur. However, this does not have much of a noticeable effect at the receiver, since signal level variations of around 10 dB hardly matter with DRM.

Outdoor wire aerials are normally made from stranded wire with a sufficiently large cross-sectional area, in order to obtain good mechanical strength as well as low ohmic losses. A lead from a standard mains cable or loudspeaker cable with a cross-sectional area of 0.75 to 1.5 mm² is suitable for this purpose. It is also possible to use significantly thinner wire. A test using 10 m of thin magnet wire (0.3 mm diameter) yielded usable results for DRM reception, and it has the advantage of being quite inconspicuous.

If you shy away from constructing your own aerial, in many cases you can make use of existing systems or cables. A typical aerial system provides not only television and UHF signals, but also the entire AM range from long-wave to short-wave. It's certainly worth trying.

In many cases, better results can be obtained with a rooftop aerial than with an indoor aerial. Old rooftop aerials are often no longer in use, but the aerial cables leading to the roof are still in place. The cable by itself can also be useful. Such a 'forgotten' aerial cable that has been converted into a 'single lead', which means with the inner conductor and the screen shorted together, forms a usable vertical aerial. The cable usually runs all the way to the roof of the building and thus reaches a greater height than a horizontally strung wire aerial. Especially at relatively high frequencies (above 15 MHz), better results can be achieved using such an aerial than with an outdoor wire aerial.

Preselection

A 'longish' wire aerial has a broadband characteristic and receives the entire AM radio band between 0.5 MHz and 22 MHz relatively uniformly, so no additional tuning is need for the aerial itself. However, preselection is worthwhile if reception is degraded by mirror frequencies.

Practically every receiver that works on the superhet principle has two reception frequencies: the intended frequency and the mirror frequency, which is separated from the intended frequency by twice the intermediate frequency. With the usual IF of 455 kHz (as used in the DRM receiver published in the March 2004 issue), this means the mirror frequency is located 910 kHz above the tuned frequency. For receivers having a switching mixer (such as the diode-ring mixer of the DRM receiver), the received signal is mixed with not only the fundamental frequency of the oscillator signal, but also (with a certain amount of attenuation) with all odd harmonics of the fundamental oscillator frequency. Primarily in case of reception in the medium-wave band, this can lead to interference from mixer products formed by harmonics of the mixer oscillator and strong short-wave signals. Consequently, a medium-wave preselector often provides significant improvement.

A preselector connected between the aerial and the receiver is most commonly used, and such preselectors are generally tuneable. Suitable preselectors are available from specialist (amateur) radio shops, but you can also build your own.

Tuneable

The standard approach to building a preselector is to use a tuneable resonant circuit (Figure 3). The coil can be wound as an air-core coil, which means without using an actual core. The wire diameter is not all that important for such air-core coils. For small coils, you can use enamelled copper wire with a diameter of 0.3 to 0.7 mm; somewhat heavier wire should be used for larger coils for the sake of mechanical stability.

A coil having a diameter of 8 mm and 20 turns over a length of 10 mm has an inductance of 2.5 μ H. In combination with a 370-pF variable capacitor, it has a lower resonant frequency of approximately 5 MHz. This circuit can thus be tuned across the 49-m band and the higher-frequency bands up to around 16 MHz. A tap at the second turn provides the proper impedance for connection to the receiver.

The aerial can be connected using a coupling coil with two to four turns. If you make the coupling coil such that it can be moved back and forth, the degree of coupling can be adjusted. You can then experimentally determine the best adjustment. Tighter coupling yields a higher signal voltage, but it decreases the Q factor of the resonant circuit and thus reduces the attenuation at the mirror frequency. If it is necessary to use a short aerial (such as a rod aerial), the coupling must be designed to be relatively tight. In this case, the aerial can be connected directly to the hot end of the resonant circuit.

The resonant circuit shown in the figure has a high Q factor (typically 50). This yields a bandwidth of 120 kHz at 6 MHz. As a result, the variable capacitor must be tuned relatively precisely. For DRM reception, the optimum tuning can be recognised by a maximum signal level in the spectrum display generated by DRM software, but the delay in processing the data for this display makes adjustment difficult. It is easier to use direct acoustic monitoring by connecting the receiver output directly to the Line In socket of the sound card. It's then easy to tune for maximum noise volume for the DRM transmitter using the speakers of the PC.

If the preselector is built into an enclosure, the most important frequencies should be marked on a scale.

Figure 4 shows the same type of resonant circuit with the rotary variable capacitor replaced by a high-value variable-capacitance diode, such as the type BB112 (available from Geist Electronic). Here it is important to use a stable, well-filtered voltage for the tuning potentiometer, since otherwise reception can be degraded by phase modulation of the aerial signal.

The tuning range of a simple resonant circuit does not exceed 1:3 with a standard variable capacitor. One solution is to use several coils that can be selected using a rotary switch.

Another approach is used by radio amateurs, who are faced with the same problem in the standard amateur radio bands (80 m to 10 m, which corresponds to 3.5–29.7 MHz). This requires a preselector with a tuning range of 1:10. The solution is to use coupled circuits with two fundamentally different resonant frequencies. Figure 5 shows a proven circuit using a dual variable capacitor and a second coil with 10 turns. Although there are two 'bad' pass frequencies for every setting, they are well separated from the mirror frequency of the receiver.

Good air-dielectric variable capacitors are no longer easy to come by. It is often possible to scavenge them from old

Table 1 DRM transmitters and frequencies.

Time	Frequency	Station	Language
06.00–24.00 Tu–Su	6095	RTL	various
08.00–14.00 daily	15440	DW	English
10.00–12.00 daily	6140	DW	English
10.00–12.00 daily	9850	RNW**	English
10.00–15.00 daily	7320	BBCWS	English
11.00–13.00 Sa & Su	9410	BBCWS	English
12.00–12.57 daily	9850	RNW**	Dutch
12.00–13.00 daily	6140	DW	German
13.00–15.00 Mo–Fr	9410	BBCWS	English
14.00–15.59 daily	6130	DW	German
15.00–16.00 daily	9490	VoR*	English
16.00–17.00 daily	9490	VoR*	German
16.00–17.29 daily	3995	DW	German
16.00–18.00 daily	6140	DW	English
16.00–19.15 daily	1296	BBCWS	English
17.00–18.00 daily	9490	VoR*	French
18.00–19.00 daily	6140	DW	German
19.00–20.00 daily	11925	BBC	Russian
21.00–22.55 daily	11730	RNW**	Dutch
21.15–24.00 daily	1296	BBCWS	English
* Voice of Russia			
** Radio Netherlands World Service (Wereldomroep)			

Figure 6. A 1296-kHz aerial filter.

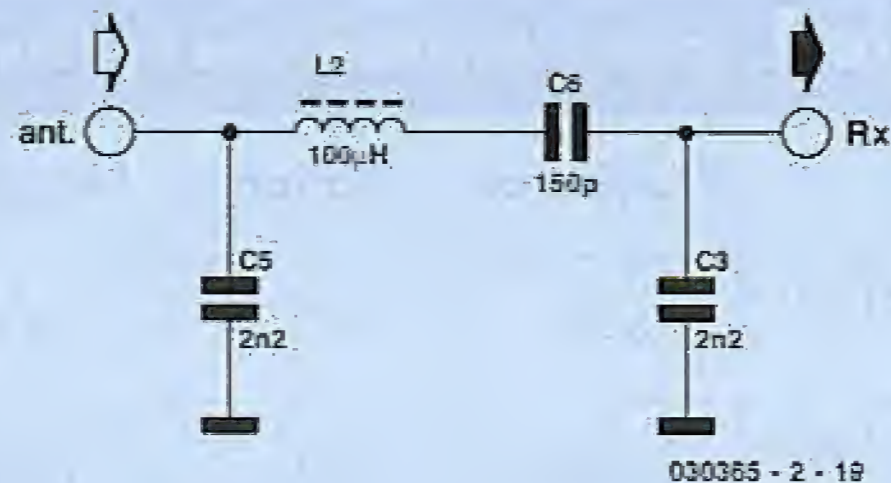

Figure 7. Using a ceramic IF filter for preselection.

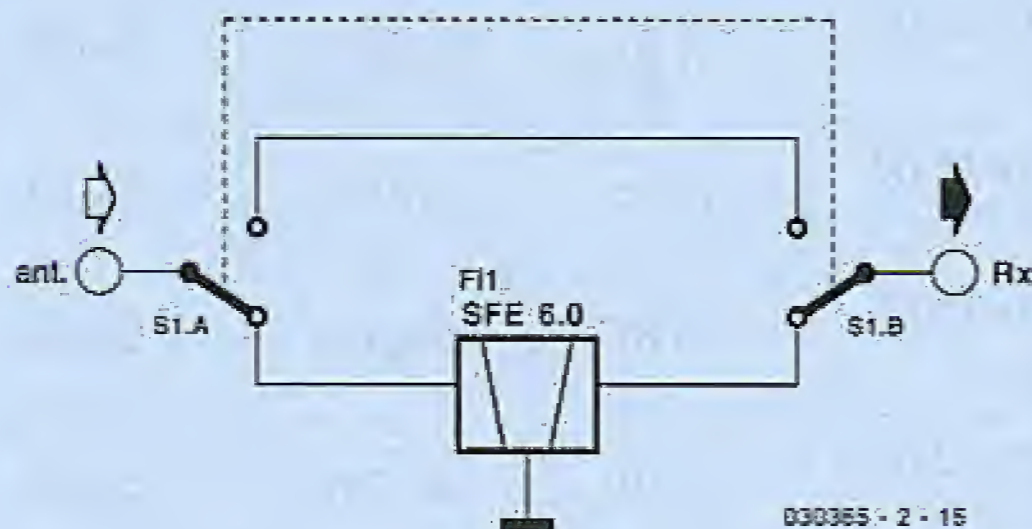

Figure 8. A magnetic-loop aerial.

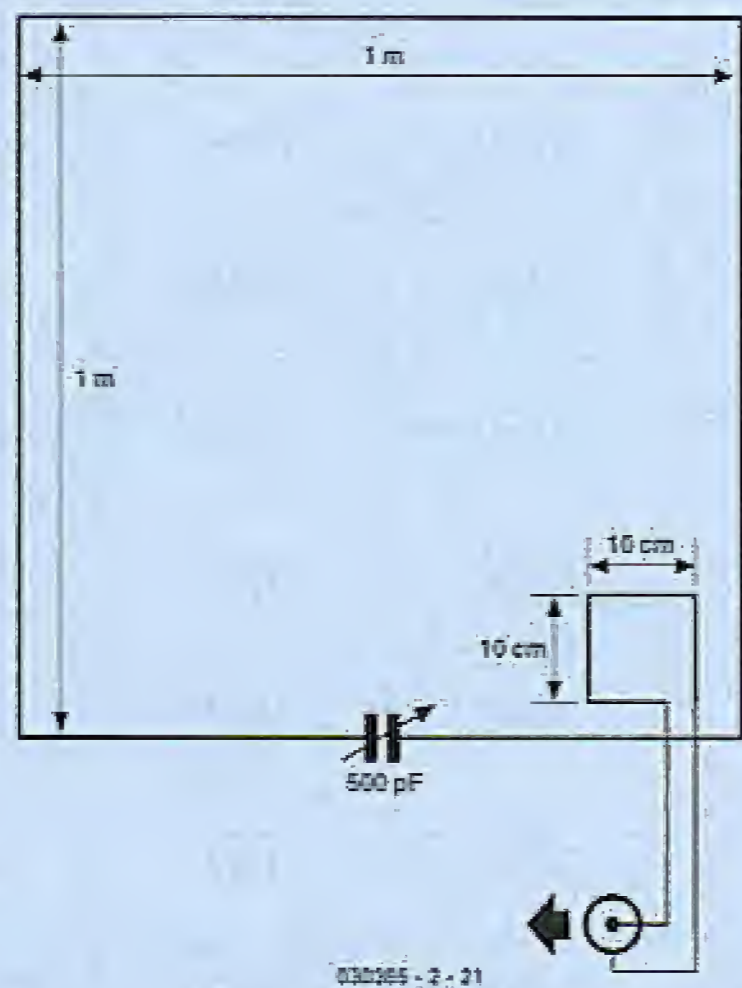
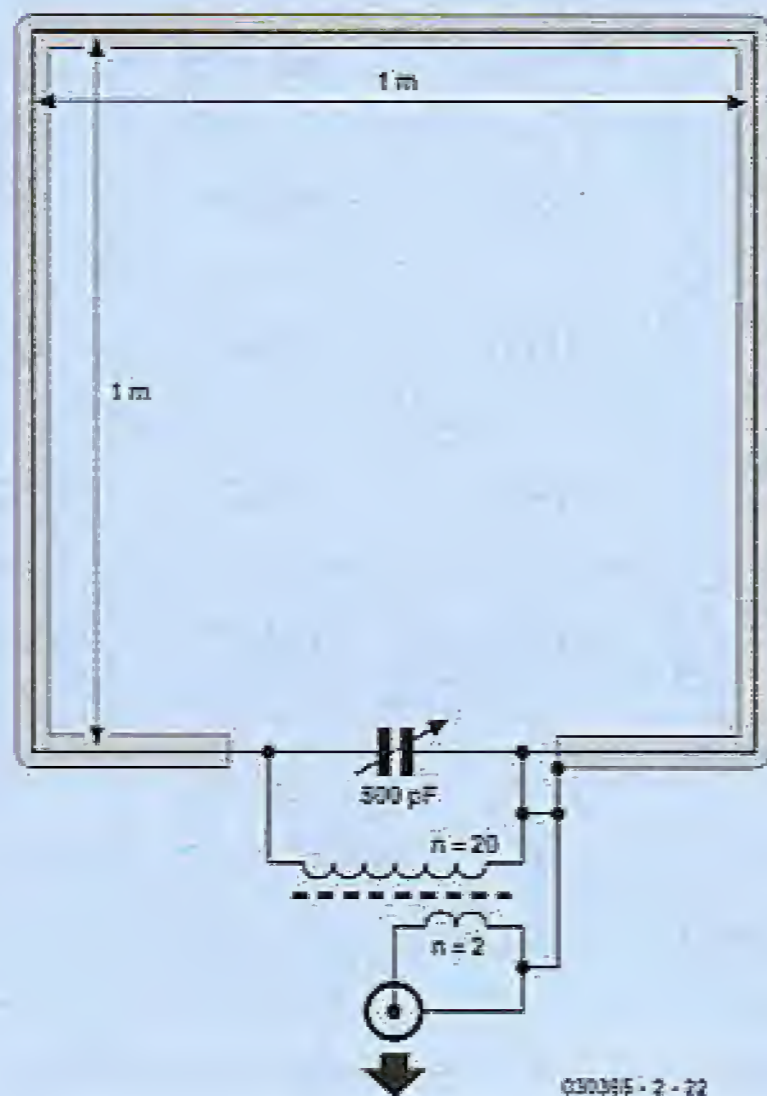

Figure 9. A tuned and screened loop aerial made from coaxial cable.



radios. One source of suitable multi-gang variable capacitors from current production is Geist Electronic (www.geist-electronic.de).

Fixed-frequency

An alternative to a circuit with adjustable tuning is to use a fixed-frequency filter. In the medium-wave band, there is often only one usable reception frequency. Although the relative bandwidth of the input circuit is relatively large, good selectivity is possible thanks to the low frequency. A circuit such as that shown in Figure 6 can thus manage with a fixed inductor. This fixed-frequency filter for 1296-kHz improves reception of the BBC transmitter in the evening hours. It primarily reduces interference from multiples of the oscillator frequency in the short-wave bands.

For the 49-m band, a quite simple solution is possible using the type SFE 6 ceramic IF filter, which is used for the sound IF in television sets. Figure 7 shows how to connect the filter to the receiver input so it can be switched in or out as necessary. The specified 3-dB bandwidth of around 100 kHz, which is actually too narrow, is broadened by the low impedances of the aerial and receiver to such an extent that the measured 6-dB corner frequencies are located at 5850 kHz and 6150 kHz. In practice, this filter is primarily useful in the 49-m band when interference occurs from strong transmitters in the 40-m band. At 7 MHz, the filter provides an attenuation of around 40 dB.

Magnetic-field aeriels

A 'longish' wire aerial receives electrical energy from both the electrical and magnetic components of the radio waves. By contrast, short aeriels such as rod aeriels predominantly receive energy from the electrical component. This results in a higher level of interference, especially inside a building. The coupling between the receiver aerial and electrical equipment or the mains wiring is primarily capacitive. Better results can thus be obtained by receiving the magnetic-field component. In principle, all that is necessary for this is a wire loop or a coil. Commonly used solutions are loop aeriels with a few turns of wire or single-winding loops, sometimes called 'magnetic loops'. Tuned loops with high Q factors are particularly effective. For instance, you can use a length of copper pipe formed into a circle with a diameter of one metre. However, a broad piece of aluminium foil wound around a cardboard box with suitable dimensions also provides good results. When connected to a variable capacitor with a maximum capacitance of 500 pF, the loop forms a high-Q resonant circuit and thus delivers a significantly higher aerial voltage than would be expected from an aerial of this size. The receiver should be loosely coupled using a small coupling coil, in order to avoid excessively damping the resonant circuit (see Figure 8). The optimum size and position of the coupling coil is best determined experimentally. Due to the high Q factor of the aerial, an additional preselector is in any case unnecessary. A magnetic loop aerial can also be constructed using normal wire, although this yields a lower Q factor and thus a lower aerial voltage, as well as a larger bandwidth. If it is necessary to make the aerial smaller, two or more turns of insulated wire can be used.

An especially effective solution is an electrically screened loop

aerial, which in its simplest form can be made from a length of coaxial cable. Such an aerial can be inconspicuously fitted in a bookshelf, and it provides a relatively good signal to noise ratio. The resonant frequency depends on the size of the loop and the capacitor setting. If the total length of the coaxial cable is four metres, a resonant frequency range extending to below 6 MHz can be obtained with a 500-pF variable capacitor (see Figure 9). The primary inductance of the wideband transformer should be greater than that of the wire loop. Good results can be obtained with 20 turns on a ferrite core or toroidal core. In the interest of obtaining a high Q factor, the tuned circuit should not be too heavily damped. Consequently, the secondary has only two to four turns. The best value for the coupling coil should be determined experimentally. In the medium-wave band, ferrite rod aeri- als have long since proven their worth. Like magnetic loops, they are relatively insensitive to electrical interference. Figure 10 shows a ferrite rod aerial followed by an impedance converter. With a 10-mm diameter ferrite rod, the coil requires 70 turns of stranded RF wire ('litz wire') or 0.3-mm enamelled copper wire. Approximately 100 turns are necessary on a thinner rod (8 mm diameter). Relatively large resonant voltages arise across the tuned circuit, even with distant transmitters. For example, at the author's location in Essen, Germany, at peak reception times

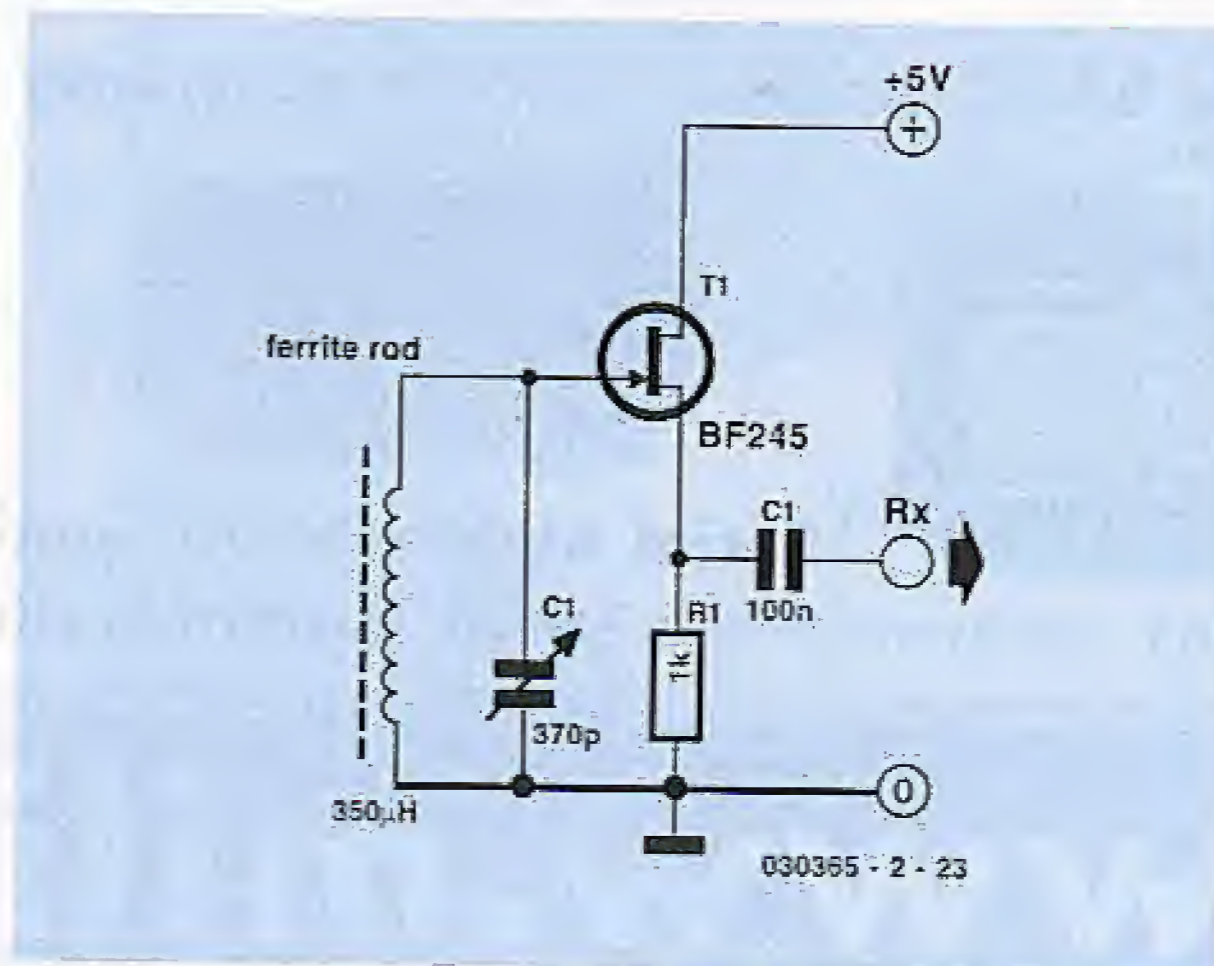

Figure 10. A ferrite rod aerial with an impedance converter.

an open-circuit voltage of 50 mV can be measured across a ferrite rod aerial with a length of 20 cm for the BBC signal at 1296 kHz. At the low-impedance receiver input, this still amounts to 5 mV, which is more than enough steam for our new digital steam radio.

(030365-2)

Advertisement

FLASH MICROCONTROLLER STARTER KIT

ELEKTOR Hardware & Software

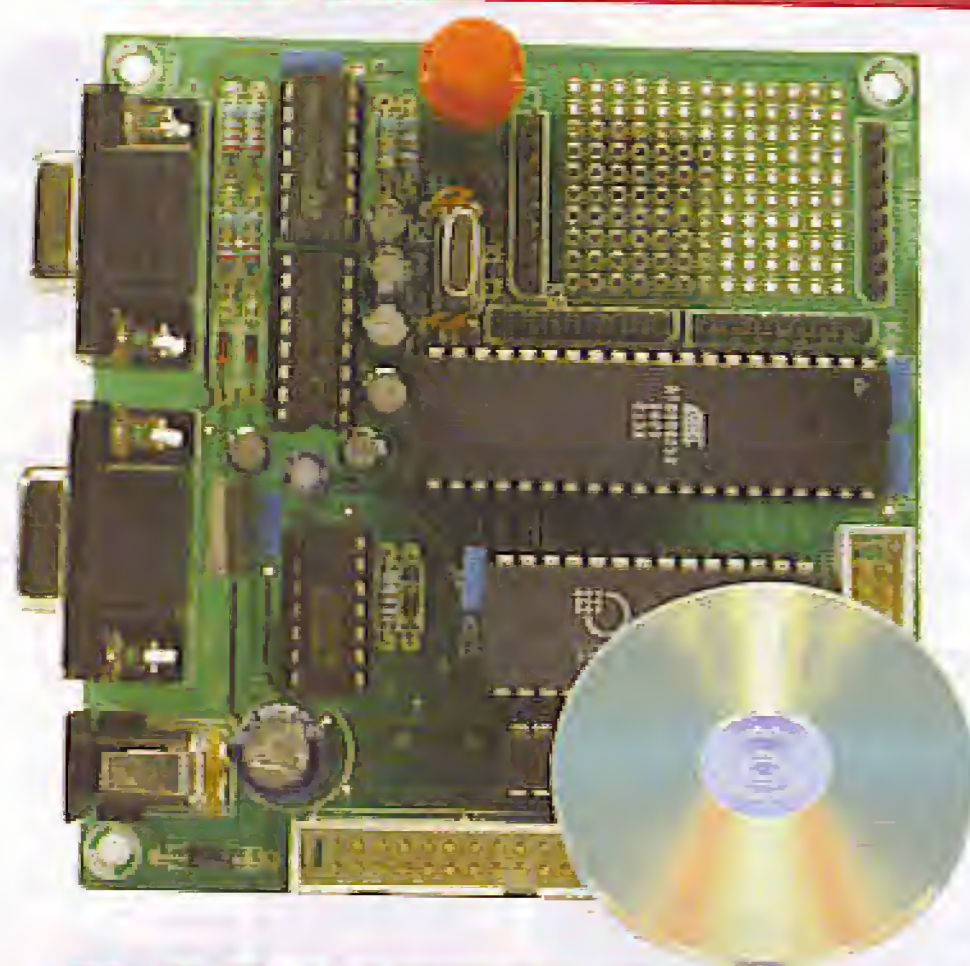

The Flash Microcontroller Starter Kit costs just **£ 69.00 / US\$ 112.50** (plus postage).

Order now using the Order Form in the Readers Services section in this issue

Elektor Electronics (Publishing) • P.O. Box 190 • Tunbridge Wells TN5 7WY • England. Telephone +44 (0) 1580 200 657 • Fax +44 (0) 1580 200 616

Step into the fascinating world of microcontrollers with the Elektor Electronics **Flash Microcontroller Starter Kit.**

Contents of Starter Kit 1:

- 89S8252 Flash Microcontroller board (ready-assembled and tested PCB)
- 300-mA mains adapter
- Serial cable for COM port
- Software bundle on CD-ROM
- Article compilation on CD-ROM:

- 89S8252 Flash Microcontroller Board (December 2001)
- Microcontroller Basics Course parts 1-6 (January through June 2002)
- Microcontroller Basics FAQ (September 2002)
- Port Line and ADC Extension for 89S8252 Flash Micro Board (December 2002)
- Chess Computer using the Flash Micro Board.

ELEKTOR ELECTRONICS
THE ELECTRONICS & COMPUTER MAGAZINE

See also
www.elektor-electronics.co.uk

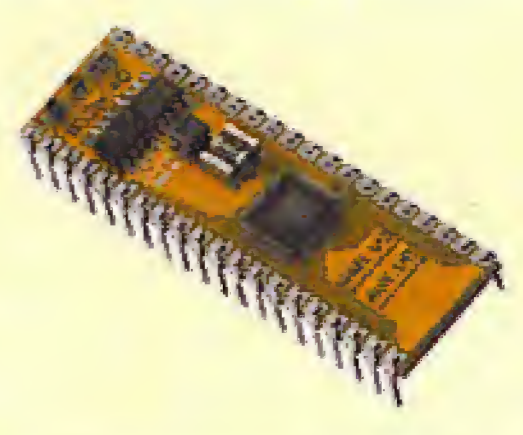
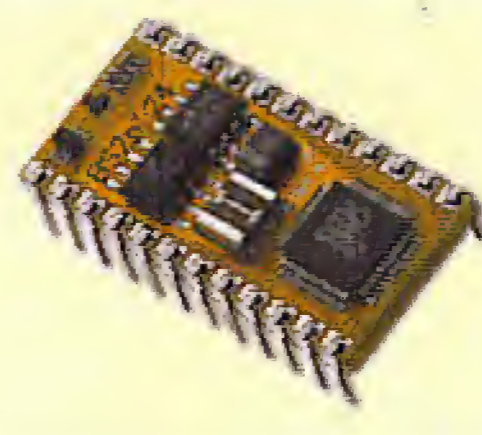

BS2-IC

BS2-SX

BS2E-IC

BS2P/24

BS2P/40

Parallax BASIC Stamps - still the easy way to get your project up and running!

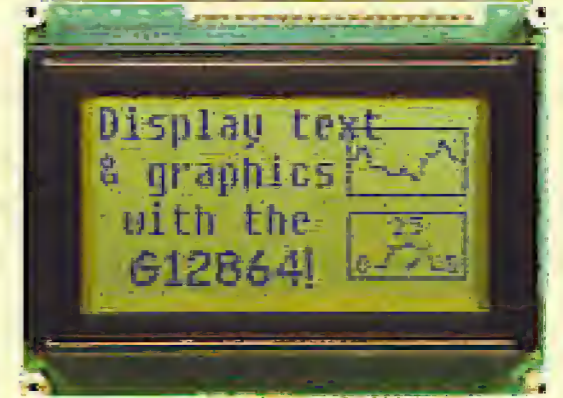
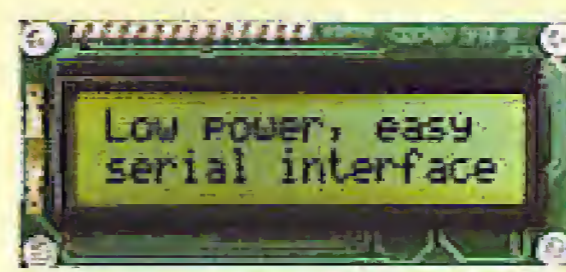
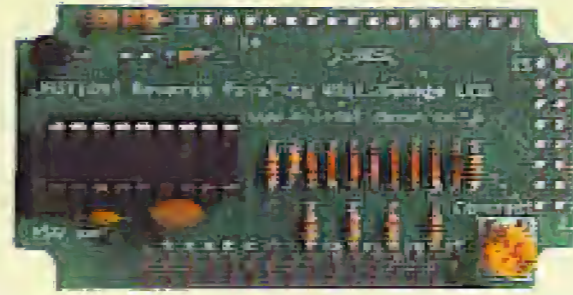
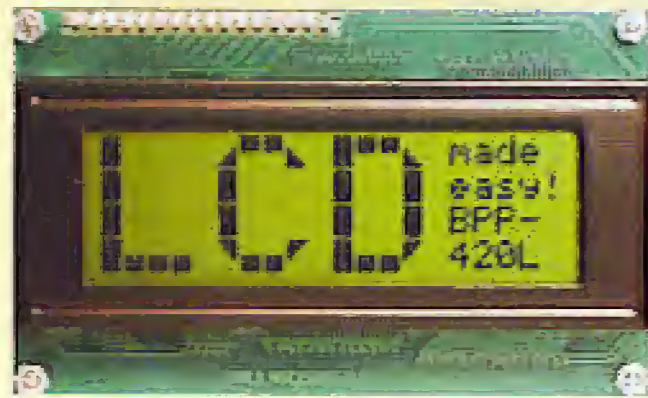

**Serial Alphanumeric and Graphic Displays,
Mini-Terminals and Bezel kits**

www.milinst.com

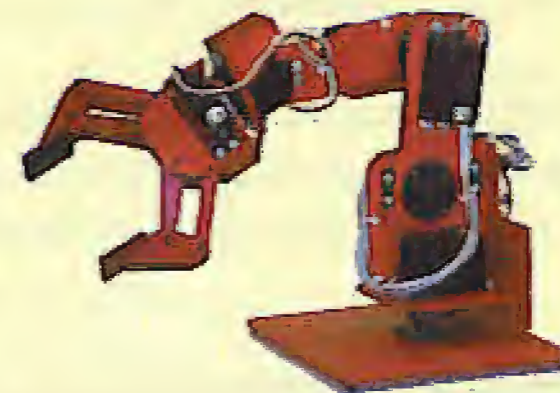
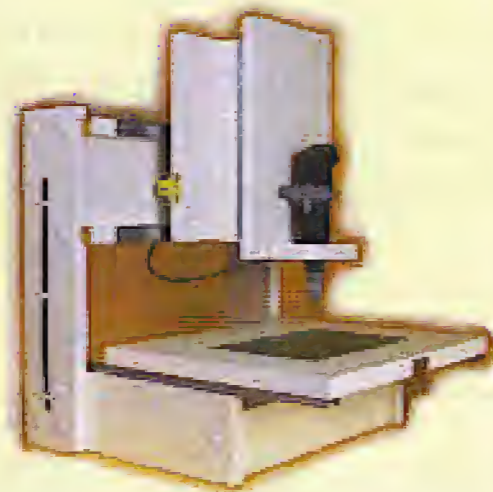

Animated Head

3-Axis Machine

Six-Legged Walkers

Robotic Arms

Bipeds

Robotic models for both the beginner and the advanced hobbyist

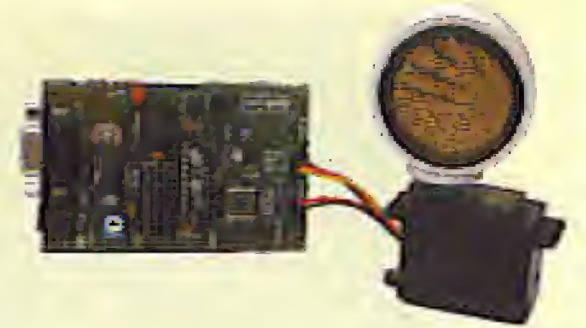
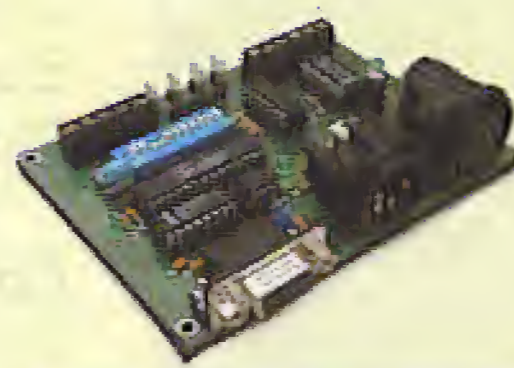
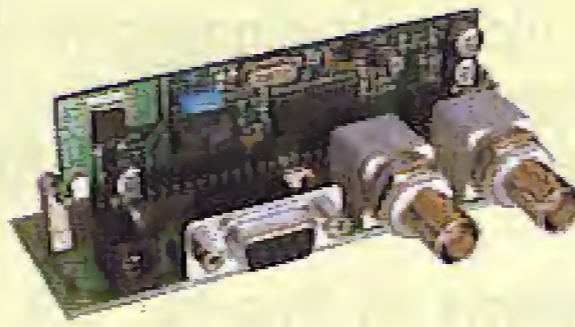
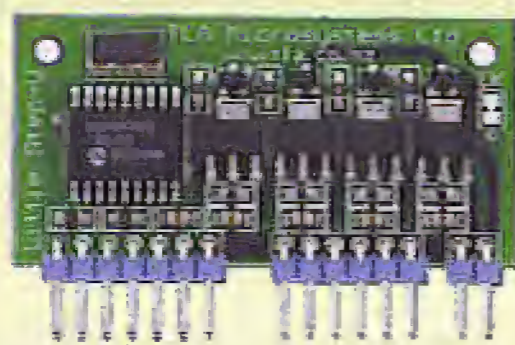
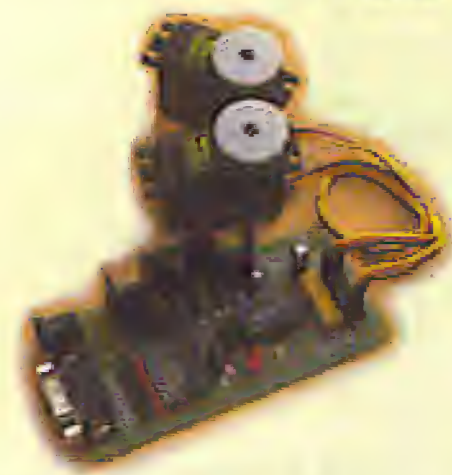

Servo Drivers

Motor Drivers

On-Screen Displays

DMX Protocol

U/Sound Ranging

Animatronics and Specialist Interface-Control Modules

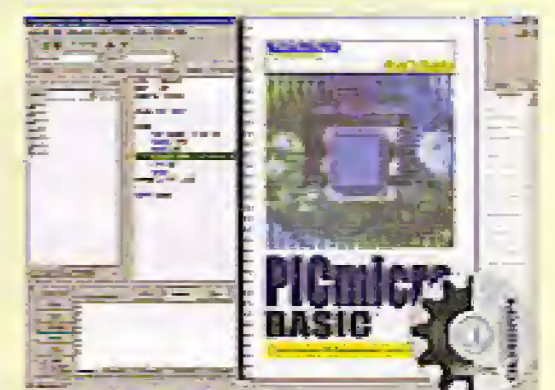
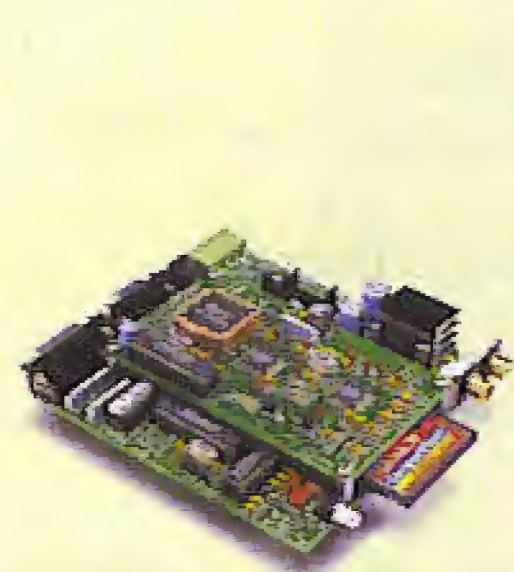

Quadravox
MP3 & Speech Systems

SensoryInc
Voice Recognition

Parallax
Uvicom Tool Kits

Tech-Tools
PIC & Rom Emulators

BASICMicro
PIC BASIC Compilers

Development Tools

Ken Bromham

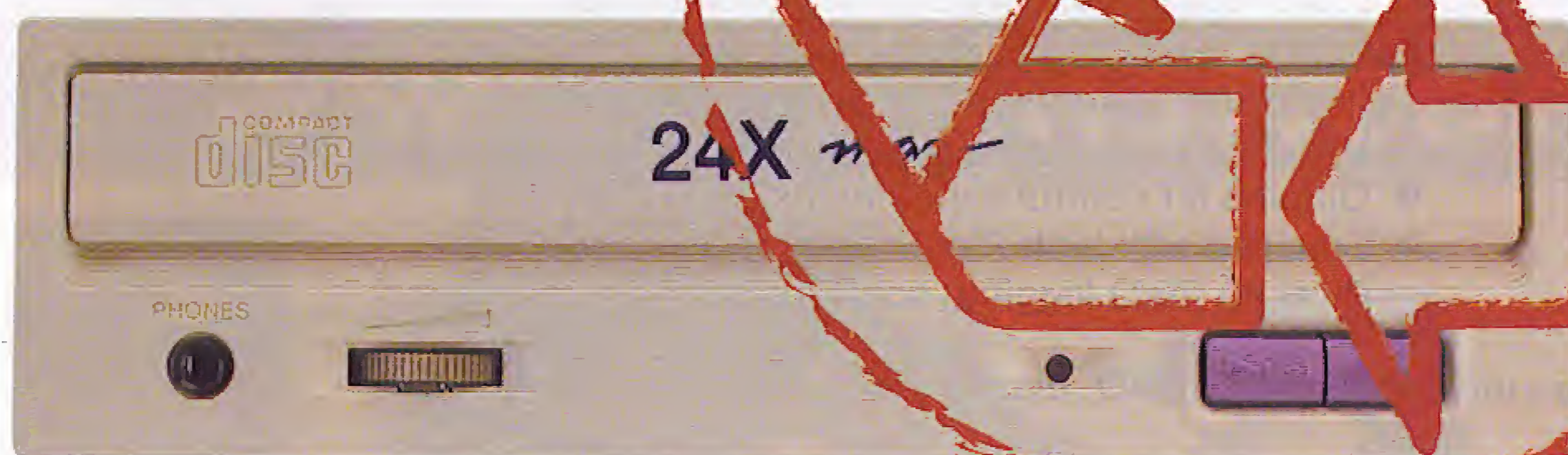

Pandora's Sound & Music Box

Recycle an old CD-ROM drive for (triggered) playback

This project was originally conceived for model making applications as a cheap way to provide high quality audio playback in response to a trigger signal (typically from a pushbutton or PIR detector), but we're pretty sure Elektor readers can find many other uses.

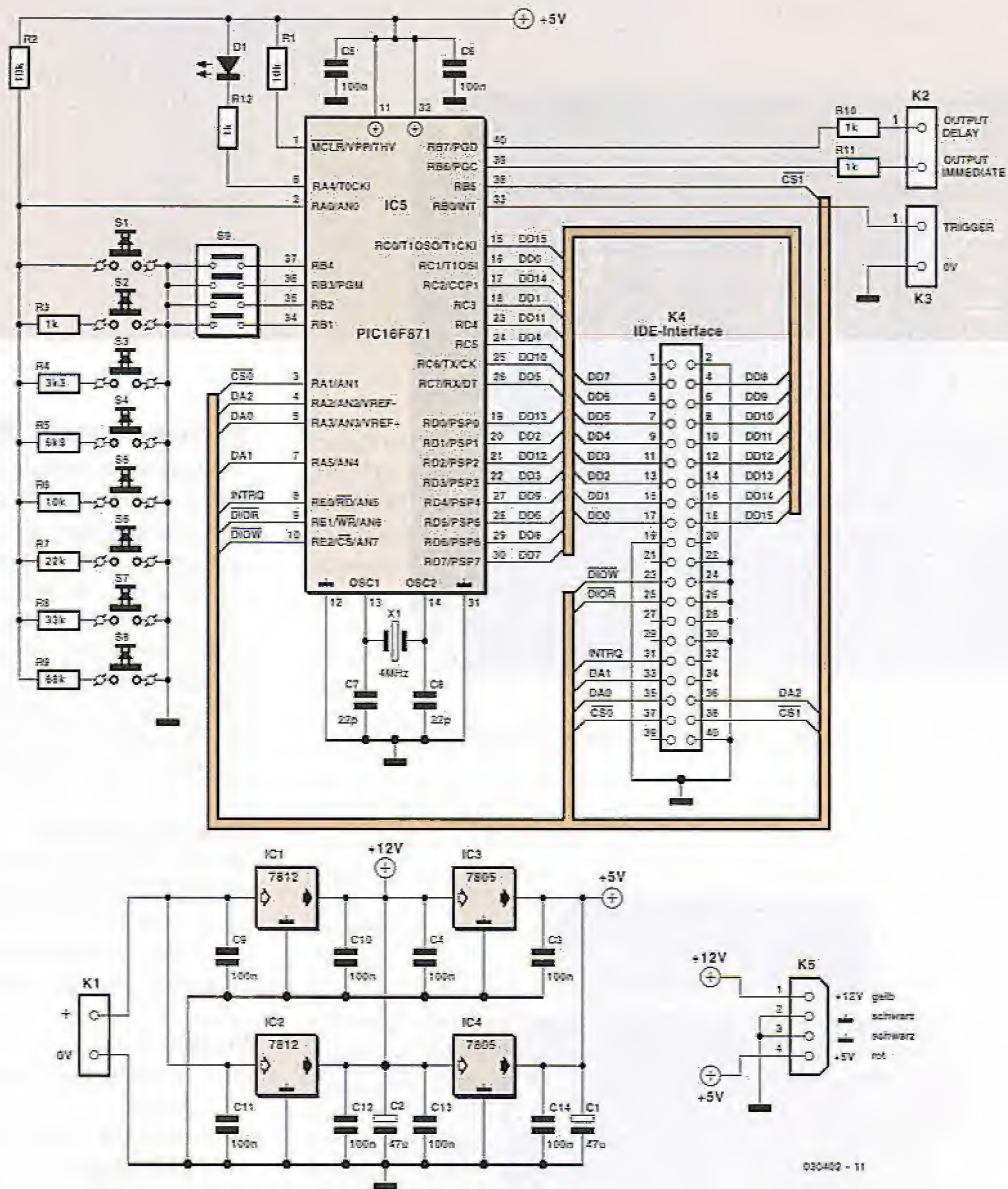

Figure 1. The modern version of Pandora's Box is a black one governing triggered response from an old CD-ROM drive playing back music or sound samples. You determine what 'horrors' (if any) lurk inside the box.

The standard low cost solution to creating auto-playback sounds is to use a record/playback chip (say, the ISD25XX series) but these devices are limited to about 3 kHz audio bandwidth, not to mention a lot of hiss and noise, so the sound quality is not the best unless you're specifically after for voice messages of the Stephen Hawking type.

The Elektor approach

Over the past few years we have received many requests from readers asking for a circuit that would allow them to use an old CD-ROM player for the sole purpose of playing back music CDs. In many cases, that is possible

just by connecting a power supply and headphones to your drive, inserting a CD and pressing the Play button. Simple as this may sound, there are pitfalls, particularly with later CD-ROM drives that do not have a music playback button. Also, we really could not stand the thought of being unable to select and skip tracks, etc. In true Elektor fashion we wanted to be in control of things and make the old CD-ROM drive do something really useful. The alternative approach developed by Ken Bromham and described in this article makes use of a 40-pin PIC 16F87X microcontroller which, helped by a small number of external components, provides a versatile controller

module that will interface to any old ATAPI CD-ROM drive. Mind you, ATAPI is not a brand, but a connectivity standard for 99% of all CD-ROM drives in PCs for home and office use. Don't worry about it, just start rummaging around in the attic or cellar, dig a CD drive out the IT skip at work, or commandeer the oldest (usually read-only) CD drive from the kiddies' PC leaving a note saying 'drive removed for scientific purposes'. Never tell them you got the idea from Elektor, instead, tell them to keep using the CD/RW drive which is much faster, better, etc. or better still buy them a mini MP3 player and headphones.

COMPONENTS LIST

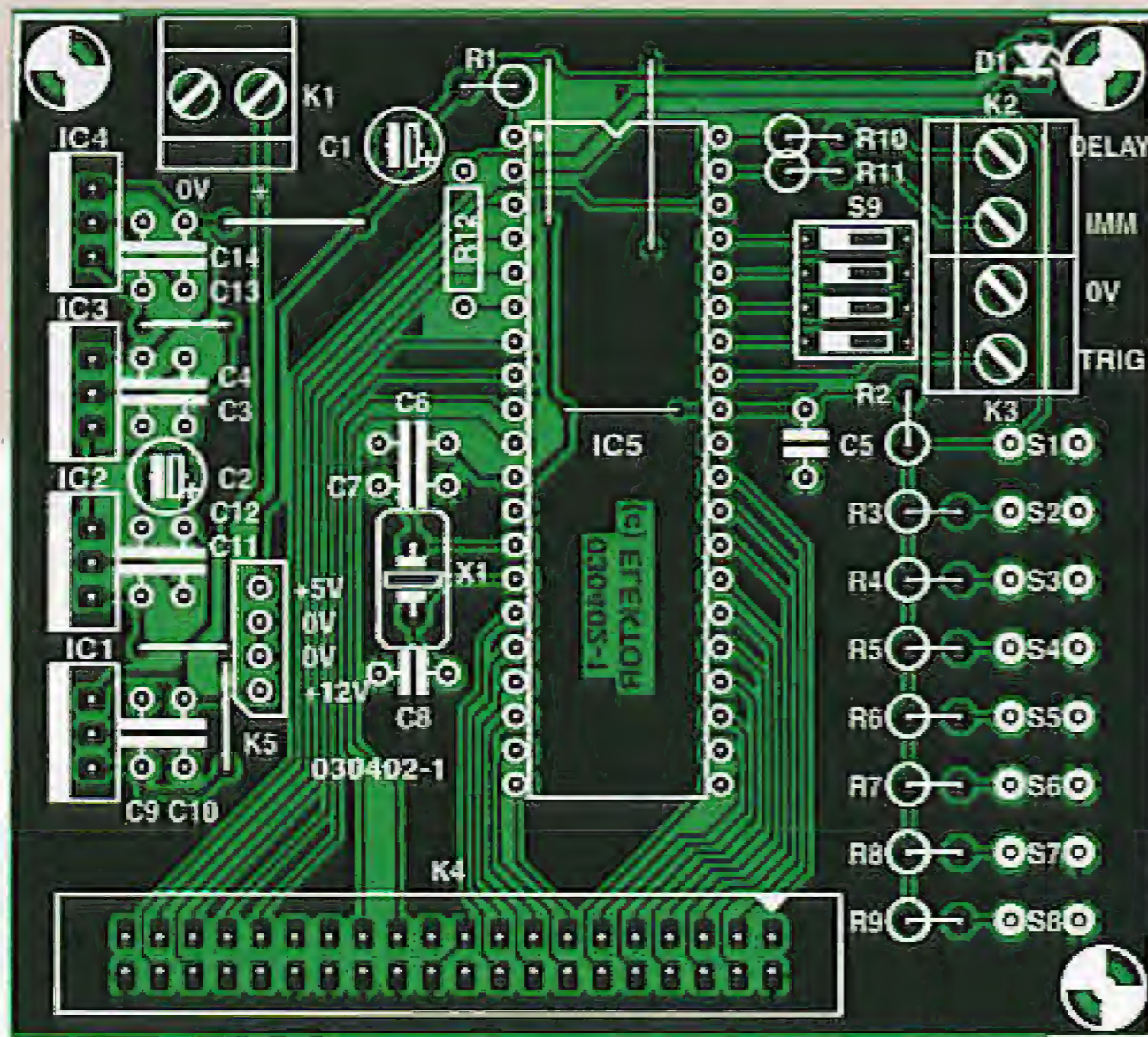

Figure 2. The printed circuit board is single-sided and contains seven wire links.

Resistors:

R1,R2,R6 = 10k Ω
 R3,R10,R11,R12 = 1k Ω
 R4 = 3k Ω
 R5 = 6k Ω
 R7 = 22k Ω
 R8 = 33k Ω
 R9 = 68k Ω

Capacitors:

C1,C2 = 47 μ F 16V radial

What can it do?

The controller module has two main modes of operation, single trigger use or multiple-trigger use, with further options selected by a 4-way DIL switch (psst... in fact both modes run simultaneously). There are also two digital switching outputs, asserted during playback, to allow other features (for example, lights or a motor) to be automatically switched on for the duration of the audio playback.

Single-trigger mode

The function here is very simple. Activating the single trigger input will cause playback of one track from the CD. There are four options (selected with a DIL switch), as follows :

DIL switch # 1

off = normally open contact for single trigger
 on = normally closed contact for single trigger

DIL switch # 2

off = no response to trigger until end of track
 on = respond anytime

DIL switch # 3

off = random track selection
 on = sequential track selection

DIL switch # 4

off = keep disc continually spinning (defeat drive's inactivity timeout)
 on = allow the CD-ROM drive to power down.

The latter options may require some elucidating. In the first case the playback will always start almost immediately as the disc is always spinning, but this may have some impact on the drive MTBF value (mean time between failure — you'll find it hard if not impossible to find data on this). In the second case, if the disc has stopped spinning, there will be a short 'spin up' delay before playback starts. No problem for applications that are likely to

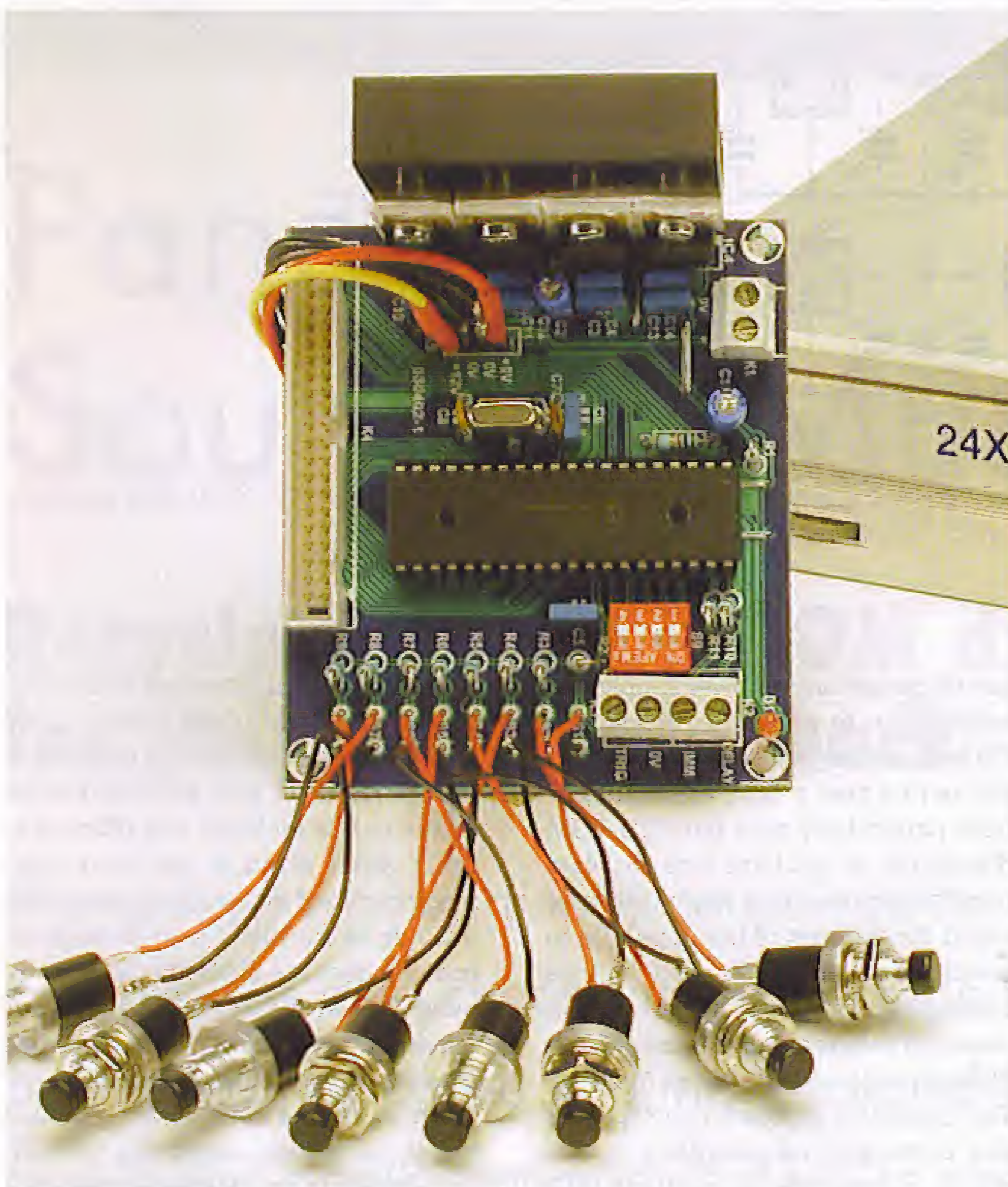

Figure 3. When in doubt about any constructional aspect, just use this photograph for guidance.

C3, C6, C9-C14 = 100nF
C7, C8 = 22pF

Semiconductors:

D1 = LED, red, low current
IC1, IC2 = 7812
IC3, IC4 = 7805
IC5 = PIC16F871/P, programmed, order code **030402-41** (see Readers Services page)

Miscellaneous:

S1-S8 = pushbutton, 1 make contact

S9 = 4-way DIP switch
X1 = 4.000MHz quartz crystal
K1, K2, K3 = 2-way PCB terminal block, lead pitch 5mm
K4 = 40-way boxheader
K5 = power supply plug for CD-ROM drive
PCB, order code **030402-1** (see Readers Services page)
Heatsink, e.g., Fisher SK59 (6 K/W)
Disk, PIC source and hex code files, order code **030402-11** or Free Download CD-ROM drive

Free Downloads

PIC source and hex code files.

File number: **030402-11.zip**

PCB layout in PDF format. File

number: **030402-1.zip**

www.elektor-

electronics.co.uk/dl/dl.htm,

select month of publication.

spend a lot of time 'doing nothing'. There may be up to 24 tracks on the CD (the PIC chip is storing the table of contents data in its limited RAM). The multiple trigger inputs should be left open.

Multiple-trigger mode

In this mode you can have a maximum of eight separate triggers (for instance, push buttons). Pressing button 1 will always play track 1, button 2 will always play track 2, etc., up to and including track 8. It can be used with normally-open contacts only. If, for example, there are only three tracks on the CD then pressing buttons 4-8 will have no effect.

DIL switch 1 must be configured as normally open and the single trigger input left open.

DIL switch 2 is not relevant.

DIL switch 3 has the same function as above.

DIL switch 4 has the same function as above.

Digital switching outputs

Pandora's Sound & Music Box has two digital outputs for control of external devices like sounders, lamps, amplifiers, signal routers, door locks, you name it, anything can be controlled as long as it has a simple 0/5 V (TTL) digital control input, or can be switched on and off with a few mA of drive current. The 'Output Immediate' output goes high immediately after triggering and remains high until end of playback. The other output called 'Output Delay' goes high only after playback has started (that is, after any spin-up delay) and remains high until end of playback.

Circuit and construction

The circuit diagram shown in **Figure 1** has few surprises, basically showing a microcontroller sitting between a

bunch of switches and some connectors. The heart of the circuit is a 40-pin PIC16F871 microcontroller which fortunately has enough input/output pins to connect to all of the necessary ATA interface lines with enough left over to handle the trigger inputs, option selections and the switching outputs. As can be seen from the schematic, only a handful of extra components are required. Note that the single trigger input RB0 (K3) and the option select inputs RB1-RB4 (S9) make use of internal, that is, invisible, pull-up resistors. All other port lines of the PIC16F871 are connected to the drive's IDE (ATAPI) interface via connector K4. Together with R2, resistors R3-R9 provide a simple potential divider network connected to input A0 on the PIC. The upshot is that a different voltage is applied to A0 depending on which button is pressed (multiple-trigger mode). This voltage is read by an internal A/D converter. It is assumed here that it is not necessary to distinguish multiple simultaneous button presses. If multiple trigger mode is not required then resistors R3-R9 and switches S2-S8 can be omitted, but R2 must be retained to keep input A0 pulled high. The PIC ticks at 4 MHz as determined by quartz crystal X1 and its usual pair of small satellite capacitors, here identified as C7 and C8. The user-defined settings are read from DIL switch S9. One LED, D1, has been included to act as a 'PIC awake' indicator (very useful!). Capacitors C5 and C6, finally, ensure the 5-V supply voltage to the PIC remains as clean as possible.

The circuit has been designed to operate from a single 15-18V DC supply, which should be 'heavy' enough to also supply the drive's 12-V line. Two parallel 7805 fixed voltage regulators, IC3 and IC4, provide +5 V for the PIC and the CD-ROM drive's 5 V line. The 12-volt supply is realised in a similar way by two 7812s in parallel. Alternatively,

an old PC power supply can be used to power the CD-ROM drive directly. In this case it is recommended to retain the 7805s and use 12 V from the pc power supply for the controller board. A heatsink will still be necessary.

Resistors R10 and R11 provide current limiting for the digital outputs and have been given the nominal value of 1 k Ω . The PIC chip can source/sink an absolute maximum of 25 mA for each pin, so the value of these resistors can be changed so long as this maximum is not exceeded. In any case, it is sufficient to drive a transistor/relay combination for example.

The PCB shown in **Figure 2** was designed for ease of use by you, the constructor. It is available ready-made through our Readers Services under number **030402-1**. Alternatively, you may decide to make your own board using the artwork file that can be downloaded free of charge from our website.

As there are only regular components to fit on the board we doubt the construction will present any problems. The simplest and cheapest component on the board, however, is often the one that's forgotten, causing major headaches and dozens of unnecessary emails of the 'Help it don't work' type! We're talking about the infamous **wire link**. There are seven of them on the board and they are best fitted before any other component so they're not forgotten. Bolt the voltage regulators onto a common heatsink (see **Figure 3** and the parts list), insulating washers are not required as all metal tabs are connected to ground. The PIC being the most expensive part, it deserves to be fitted into a 40-way DIL socket with good quality contacts.

Although the circuit diagram suggests that there are rather a lot of wires and other things to connect to the board, in reality the situation is not that bad as you can see from **Figure 4**. The cables

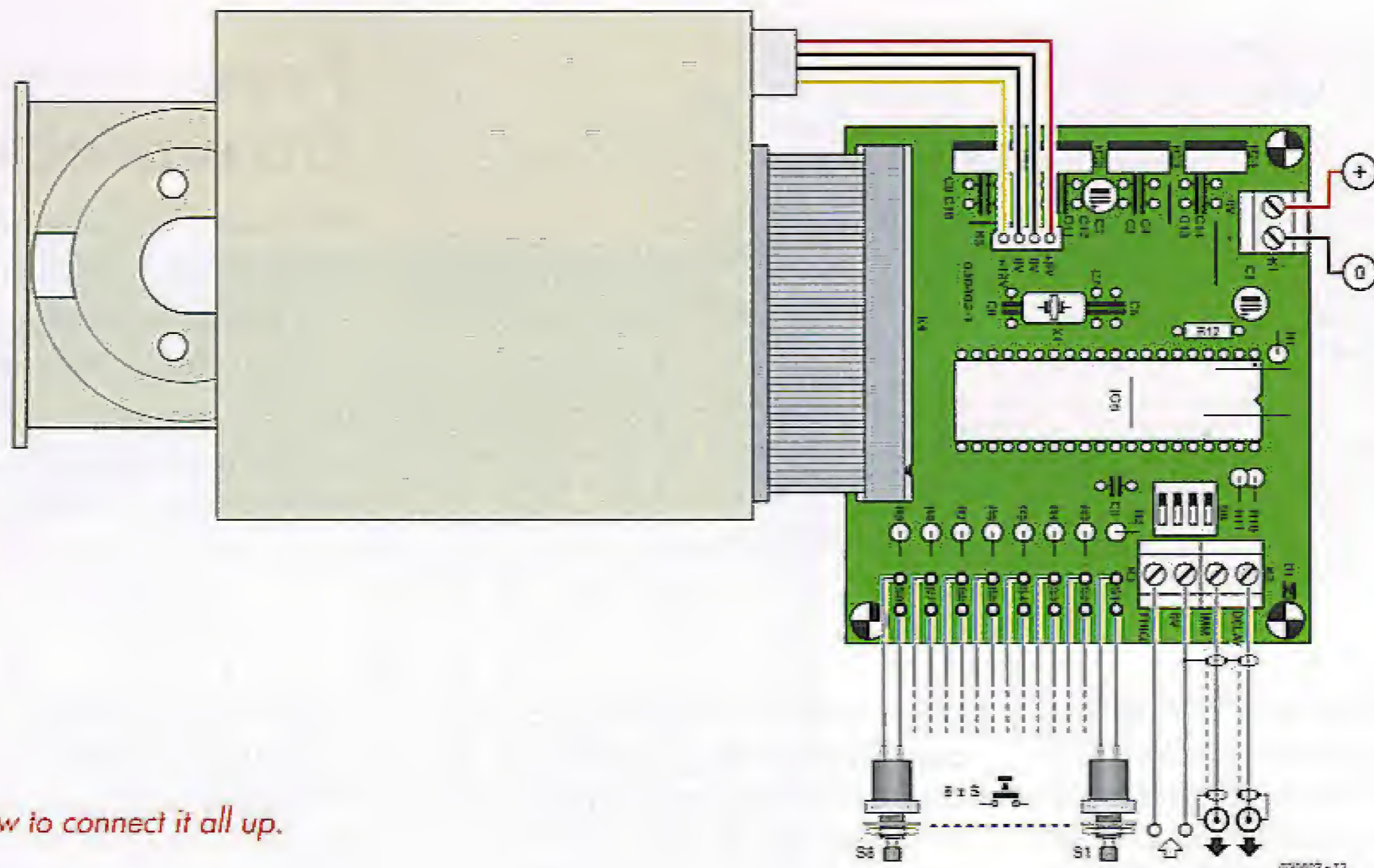

Figure 4. How to connect it all up.

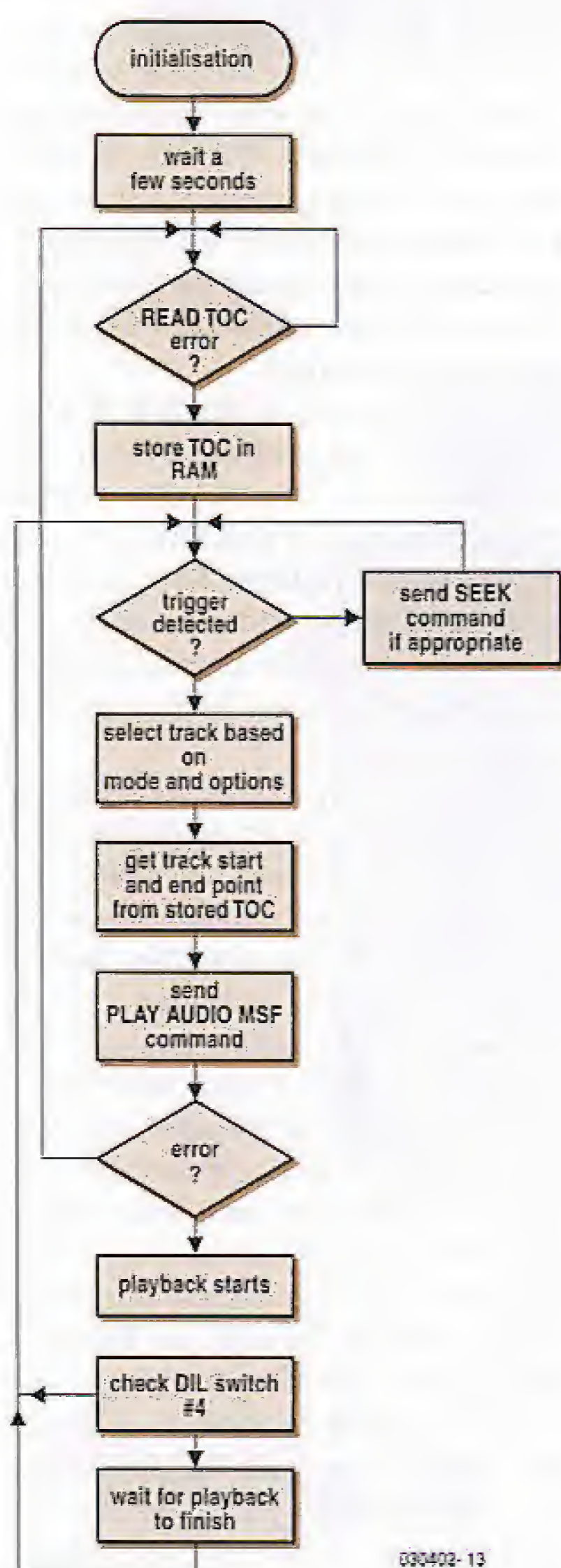

Figure 5. Use this flowchart of the main program if you don't fancy reading assembly code but still want to understand how the software works.

between the board and the CD-ROM drive, for example, are ready-made ones pulled from the junkbox or an old computer.

Program

The program that runs inside the PIC micro has been written in assembly language. The source code and hex file are available on floppy disk (anyone out there still using these?) or as free downloads from the Publishers' website. If you wish to program your own PIC, please feel free to do so using the files supplied. Alternatively a pre-programmed PIC is available from Readers Services, the order code being 030402-41.

The source code supplied by Ken Bromham is well worth studying, even if you do not build the project. Ken succeeded in including plenty of comments so if you are familiar with this assembly language it should be possible to follow the program, despite some classic spaghetti code. If not, you may still want to grasp the 'broader lines' offered by the flowchart of the main program shown in Figure 5.

The actual ATAPI commands used by the PIC firmware are:

PLAY AUDIO MSF (play from specified start to end location. MSF = Minutes, Seconds, Frames, 75 Frames = 1 Second).

READ TOC (get the table of contents).
READ SUBCHANNEL (used to get the current audio status).

SEEK (position the head at start of track 1, but will also cause the disc to spin up, so used to defeat the

CD-ROM drive inactivity timeout). The READ SUBCHANNEL command is used at various points in the above sequence, whenever the program needs to know if playback is currently in progress or if playback has finished.

Testing

As usual, check for the presence of 5-V before inserting the PIC chip. The module can then be tested without connecting to a CD-ROM drive. Simply power up and check that the LED on pin A4 flashes a few times. Nothing else will happen, but this confirms that the PIC is up and running. Switch off, connect to CD-ROM drive, power up. The LED should flash a few times and then continue to flash until a disc is inserted, the tray is closed and the TOC (table of contents) successfully read. When the LED stops flashing, the module is ready to respond to a trigger and the different options can be experimented with.

Note that the CD-ROM drive must be configured as a MASTER device, and pin 1 on the PCB socket (K4) must go to pin 1 on the CD-ROM ATA interface socket (usually indicated by a red wire in the ribbon cable). When used with a single 12-V DC supply make sure this supply can provide a minimum of about 1.2 A. The audio output can be taken from the analogue out on the back of the CD-ROM drive or from the headphone jack at the front. To continue the low-cost theme, we recommend a cheap pair of active 'multimedia' speakers (whatever that means), unless, of course, you really want to build your own amplifier!

ATAPI protocol in brief

ATAPI (AT Attachment Packet Interface) devices use the same physical interface as ATA (AT Attachment) devices such as a hard disk drive, so it is necessary to understand how this works first. In summary, the ATA device has a limited number of 8-bit registers (for example, COMMAND, STATUS) and a single 16 bit DATA register. The interface is of the parallel type with 16 bi-directional data lines, where only the lower 8 data lines are used for reading/writing the 8 bit registers. ATAPI devices use the same register set, although some registers have been renamed and serve a different function. Unfortunately this does not provide enough flexibility for the increased range of commands required, so the concept of a command packet was introduced along with a new ATA command, the 'ATAPI packet command'. To send a command to an ATAPI device the general procedure is to first write the (generic) ATAPI packet command to the device's COMMAND register, and then send the command packet by writing multiple times to the device's DATA register. For CD-ROM drives the command packet is 12 bytes in length and so 6 consecutive writes to the DATA register are required, sending 2 bytes each time. The command packet contains an opcode for the specific ATAPI command along with any additional parameters that are required.

Here is an example of the packet for the PLAY AUDIO MSF command:

Byte 0:	Operation Code (0x47)
Byte 1:	Reserved
Byte 2:	Reserved
Byte 3:	Start Location Minutes
Byte 4:	Start Location Seconds
Byte 5:	Start Location Frames
Byte 6:	End Location Minutes
Byte 7:	End Location Seconds
Byte 8:	End Location Frames
Byte 9:	Reserved
Byte 10:	Reserved
Byte 11:	Reserved

You can see that the command packet is padded with spare (reserved) bytes if necessary to give the 12-byte length.

Detailed documentation can be found on the web, www.t13.org is a good place to start looking, just be prepared for some serious bed-time reading.

ATA Interface pinning

Pin no.	Label	Description
1	HRESET	Reset
2	GND	Ground
3	HD7	Data bus bit 7
4	HD8	Data bus bit 8
5	HD6	Data bus bit 6
6	HD9	Data bus bit 9
7	HD5	Data bus bit 5
8	HD10	Data bus bit 10
9	HD4	Data bus bit 4
10	HD11	Data bus bit 11
11	HD3	Data bus bit 3
12	HD12	Data bus bit 12
13	HD2	Data bus bit 2
14	HD13	Data bus bit 13
15	HD1	Data bus bit 1
16	HD14	Data bus bit 14
17	HD0	Data bus bit 0
18	HD15	Data bus bit 15
19	GND	GND
20	N/C	Key pin
21	DMARQ	DMA request
22	GND	Ground
23	HWR	I/O write
24	GND	GND
25	HRD	I/O read
26	GND	Ground
27	IORDY	I/O channel ready
28	SPSYNC:CSEL	Spindle sync or cable select
29	DMACK	DMA acknowledge
30	GND	Ground
31	INTRQ	Interrupt request
32	IOCS16	16 BIT I/O
33	HA1	Address bus bit 1
34	PDIAG	Passed diagnostics
35	HA0	Address bus bit 0
36	HA2	Address bus bit 2
37	CSTFX	Chip select 0
38	CS3FX	Chip select 1
39	DASP	Drive active/drive 1 present
40	GND	Ground

With compliments, Pandora

(030402-1)
There's only one limit to the applications of Pandora's Sound & Music Box: your imagination. Just couple the two notions 'some kind of trigger' to 'an audible, pre-recorded response' and away you go. Here are some possible applications to get you going, in fairly random order:

- a voice message system employing the public address sound equipment in a large building. Very useful for guiding the public to fire exits in case of an emergency, when written notices are hardly ever seen, let alone read.
- an electronic dog barking in response to your doorbell; a track with More & Fiercer Dogs for really persistent callers that push the bell a second time (Pandora must have heard of Cerberus), gunfire for a third time, then police sirens, and so on.

- a door- or doormat-triggered muzak or 'welcome' generator.
- a voice guide in museums, triggered by visitors approaching an exhibit.
- a low-cost jingle-and-tune box for quizmasters and deejays.
- a language training aid.
- a spoken Callsign / 'CQ Contest' generator for radio amateurs.

For all of the above applications, you will need to burn your own music CD. Programs to compile music or sound samples onto your own CDs abound in PC land, CoolEdit being one of the best known. Note however that you can't use MP3 files just like that — a suitable decoder will have to be added.

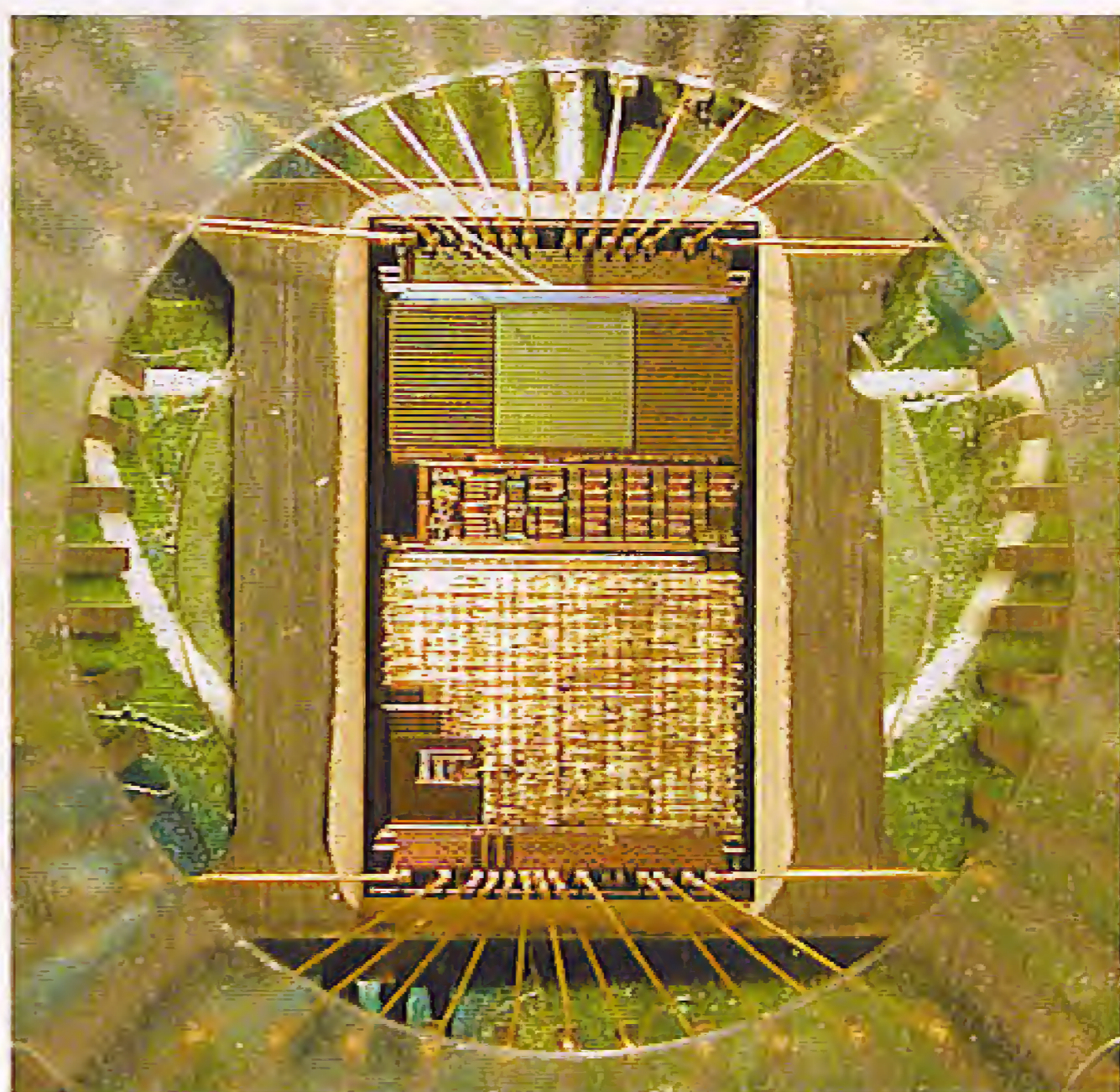
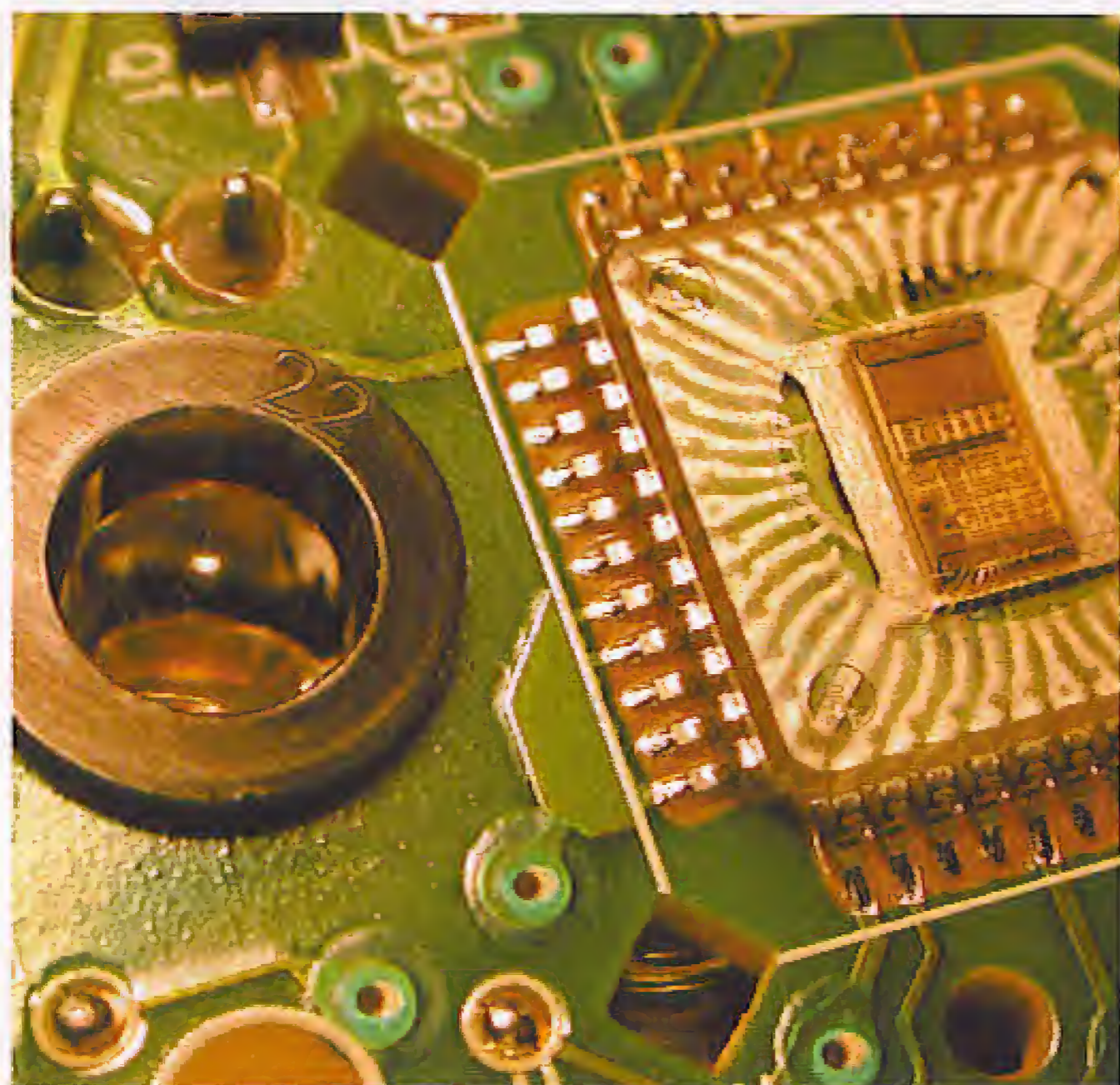

Of Mice and Light

increased accuracy without mechanics

Harry Baggen

These days, no one is surprised any more about a mouse without a ball, although optical mice have been around for only a few years. Meanwhile, optical sensors have evolved to the point where they can easily compete with the accuracy of a mechanical assembly. In fact, they are often even more accurate and react quicker.

Nowadays a personal computer without a mouse is practically unimaginable. So many operations are carried out with the mouse that using Windows, for example, with the keyboard only is next to impossible, because you are constantly moving over a graphical desktop. That the (optical) mouse has become an essential part of any modern PC is confirmed by the large numbers sold. The largest manufacturer of optical mouse sensors, Agilent (the

former component division of HP), has sold more than 200 million units since the introduction of the first sensor in 1999! In addition, there are several other manufacturers of these types of sensors and mechanical mice continue to be produced in large quantities.

The major advantage of the optical mouse compared to its mechanical counterpart is the virtual immunity to dirt and dust. Cleaning of the ball and rollers is a thing

of the past. None the less, there are (or were) disadvantages. The first optical mice were slow to react, inaccurate and power hungry. These problems have now all been solved, so only the advantages remain. There is still one small weakness: an optical mouse does not work well on some surfaces, because it cannot find enough identifying marks. However, this problem is easily solved with another mouse mat.

As a result of falling sensor prices and the simple construction of the sensor (practically everything, except the LED, is accommodated in one IC) the mechanical mouse is now slowly disappearing from the retail shelves.

Camera and DSP

At first glance, it would seem easy to detect the movement of the mouse using an optical system. But behind this simple idea hides some complex electronics that's comparable to a simple video camera combined with an intelligent digital movement detector.

Figure 1 shows a cross-section of the mouse near the optical sensor. All the electronics, including the 'camera' part and the lens, are contained in a single IC labelled *sensor* in the diagram (Figure 2 shows a block diagram of the IC). An LED next to the IC provides for sufficient illumination of the surface over which the mouse is moved. The sensor catches some of this reflected light and translates it into an image. The camera section is relatively small, usually only 20_20 or 30_30 pixels. These generate a black-and-white image for

the image-processor (a DSP), which repeatedly performs a pattern analysis and compares this with the previous pattern. Using patented technology, the DSP can deduce in an instant in which direction the pattern is moving and at which speed. Figure 3 shows two images separated in time by about 0.7 ms. The processor recognises similar patterns in each of these images and uses these to calculate the displacement in the X- and Y-direction.

Modern sensors have a resolution of 400 or 800 CPI (counts per inch) and reach unbelievably high processing speeds of around 2500 frames per second. This makes movement speeds of up to 12 inches (approx. 30.5 cm) per second possible! Wireless optical mice use special techniques to reduce the power consumption as much as is possible. For example, the frame-rate is reduced when little movement has been detected.

Finally, a quick look at the output signals produced by the mouse sensor. The cheaper sensors are limited to a serial output, which transmits the X- and Y-displacement data to a processor in the mouse for further processing. Larger sensors often have additional quadrature outputs, which provide signals similar to a mechanical mouse. In principle you could use such a sensor to modify an existing mouse yourself...

(040026-1)

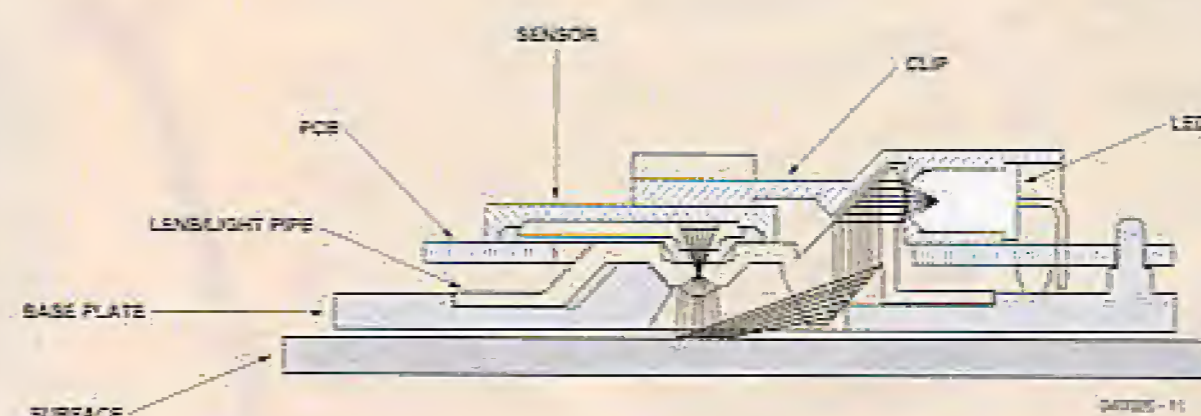

Figure 1. This drawing shows a cross-section of a mouse near the sensor and LED. (source: Agilent)

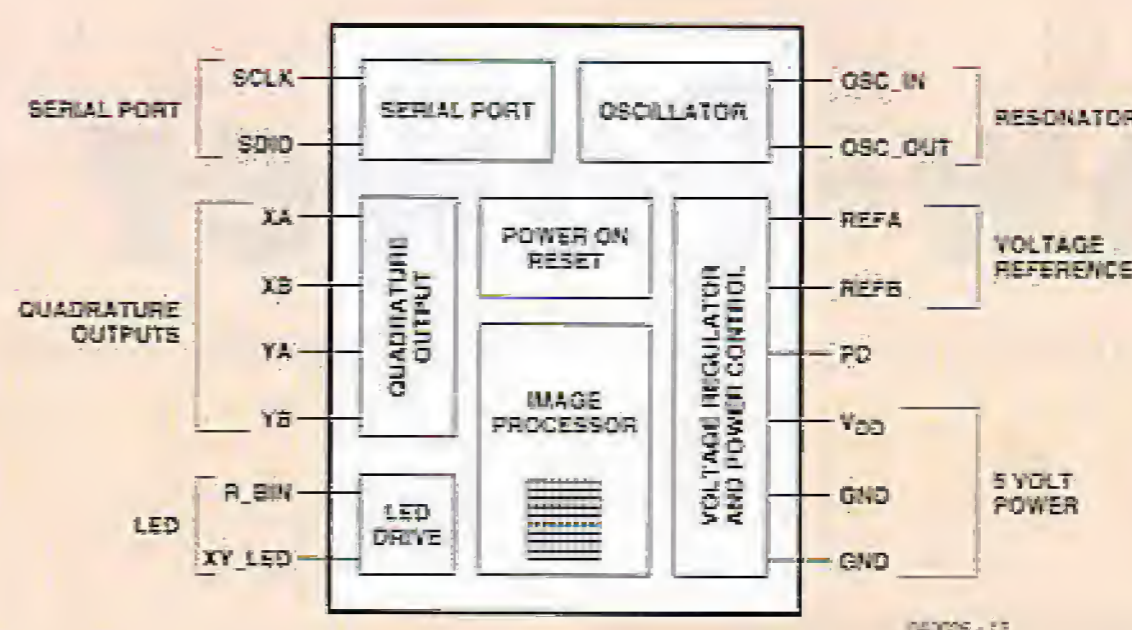
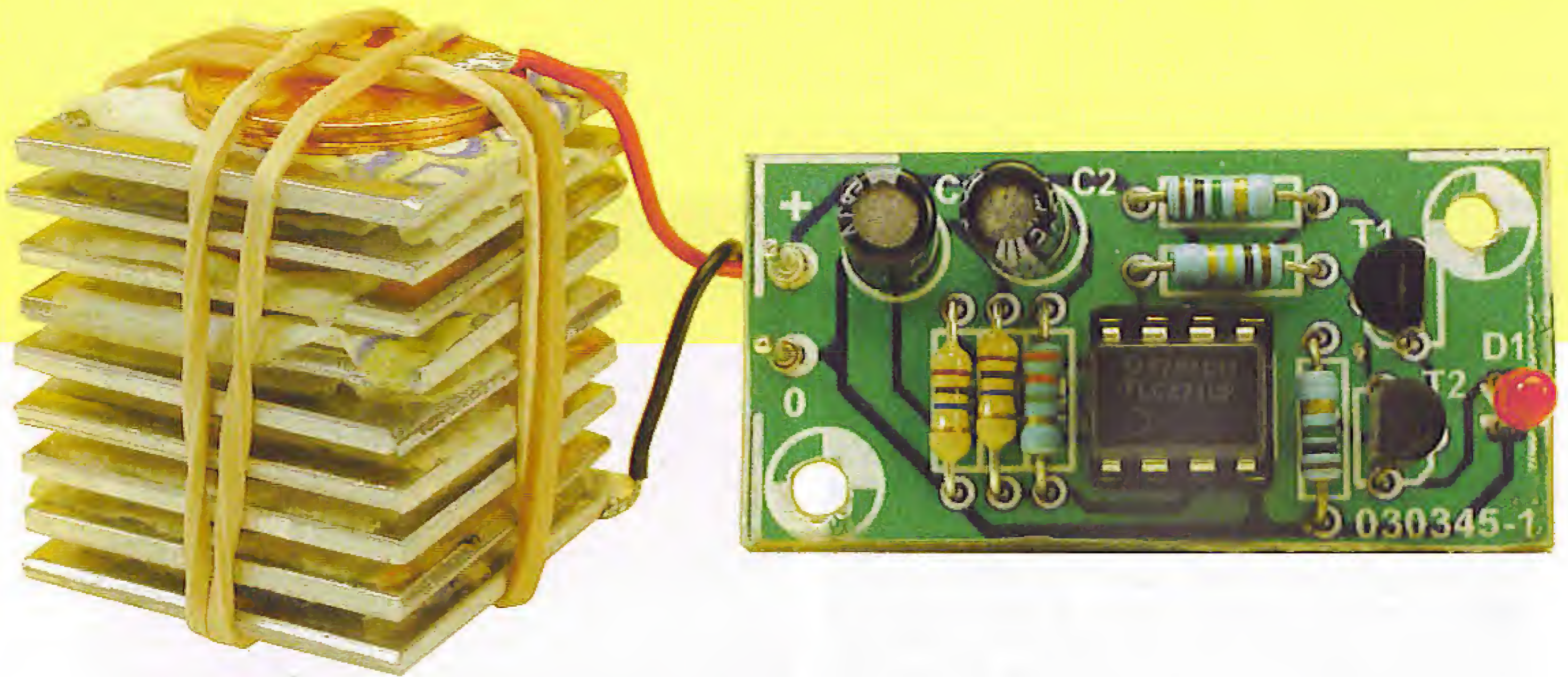

Figure 2. Block diagram of the design of an optical mouse sensor, in this case an ADNS-2051. (source: Agilent)



Figure 3. These are two images recorded by the sensor 0.67 ms apart. From this information the DSP calculates the displacement in the X- and Y-direction. (source: Agilent)



Prof. Dr. Martin Ohsmann

Low-Power LED Flash powered by lemon juice

This circuit will need just a few micro-amps to make an LED flash. The energy comes from a home made 'vegetarian' battery.

We have to admit that the circuit shown in **Figure 1** appears a bit over the top for an on/off indicator, as the same functionality could have been achieved from a classic combination of an LED and a series resistor. However, the circuit is unbeaten we feel in that it shows how a visual on/off indication may be realised in battery-powered equipment, while using a minimum of energy.

It is of course impossible to make an LED light continuously with very little current. The solution is to make it flash briefly. The requirement, then, is for a low-energy oscillator capable of

creating an extremely low duty factor (on/off ratio). A large time constant is realised by capacitor C1 in conjunction with charging resistor R1. Micropower opamp IC1 acts as an inverting comparator, monitoring the voltage on C1 and comparing it with a threshold level defined by resistors R2 and R3. Once capacitor C1 contains sufficient charge, it has to be discharged again. The energy stored in the capacitor is of course not wasted but put to good use — in this case powering the LED.

In order to create a relatively intense current peak through the LED, the

capacitor is discharged through a 'thyristor tetrode' formed by T1 and T2. This composite device is triggered by the comparator via R5. Because the thyristor tetrode does not consume current as C1 is being charged and the Micropower opamp itself is an extremely energy-wise component, the total current consumption remains extremely low — just 15 μA at 12 V. The circuit will function from a supply voltage as low as 3.5 V, although the LED in that case will not light brightly anymore. On a positive note, the current consumption is then reduced to just 4 μA !

Søren Petersen

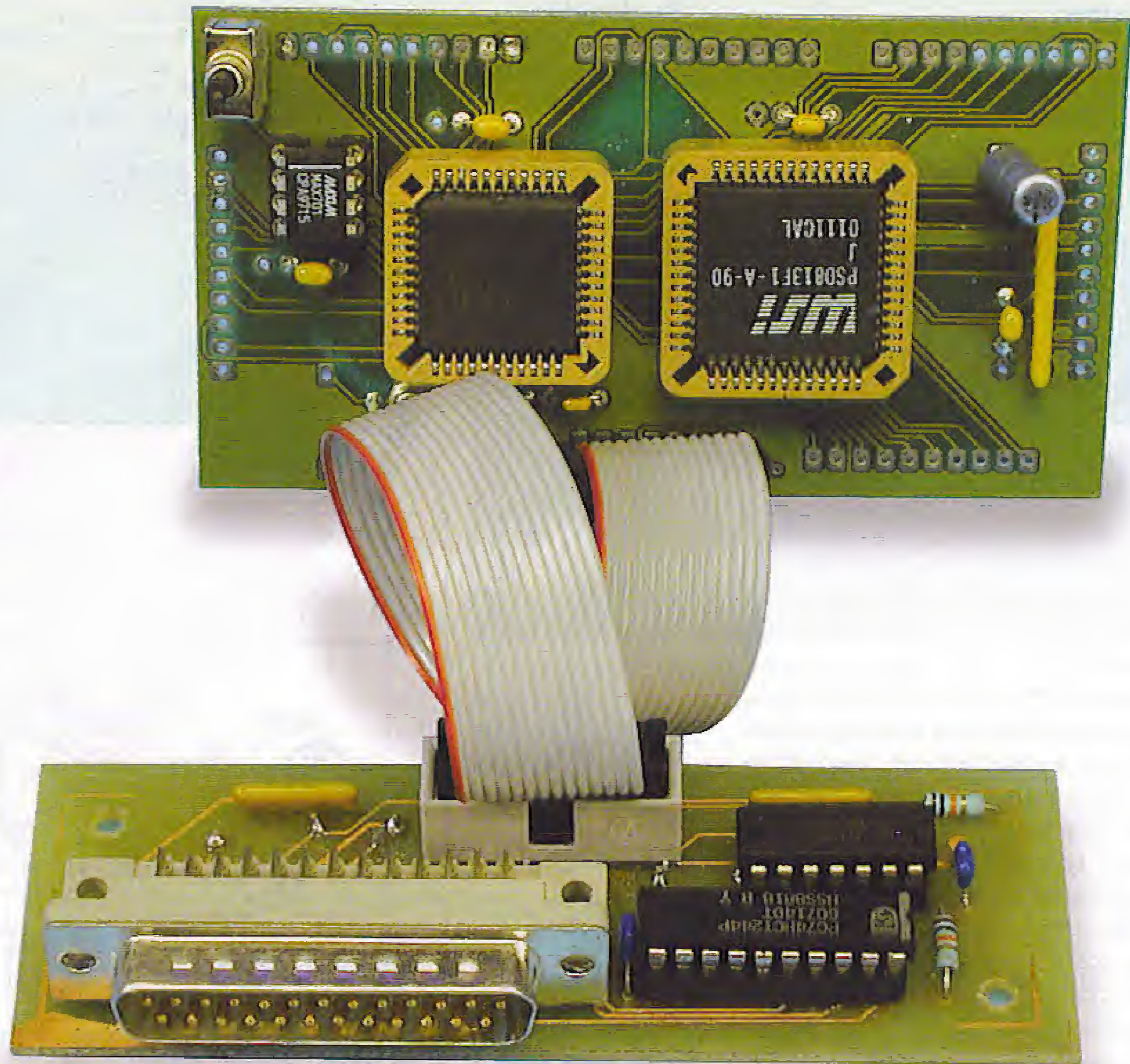

Drop-in Microcontroller Board An 80C32 jack-of-all-trades

At the heart of this remarkably compact microcontroller board you'll find an ingenious bit of integration technology. The combination acts as a versatile plug-in module for lots of applications requiring some form of intelligent control. Thanks to the extensive software that comes with the board and the presence of a PC interface, our drop-in board is excellent for hardware development, too.

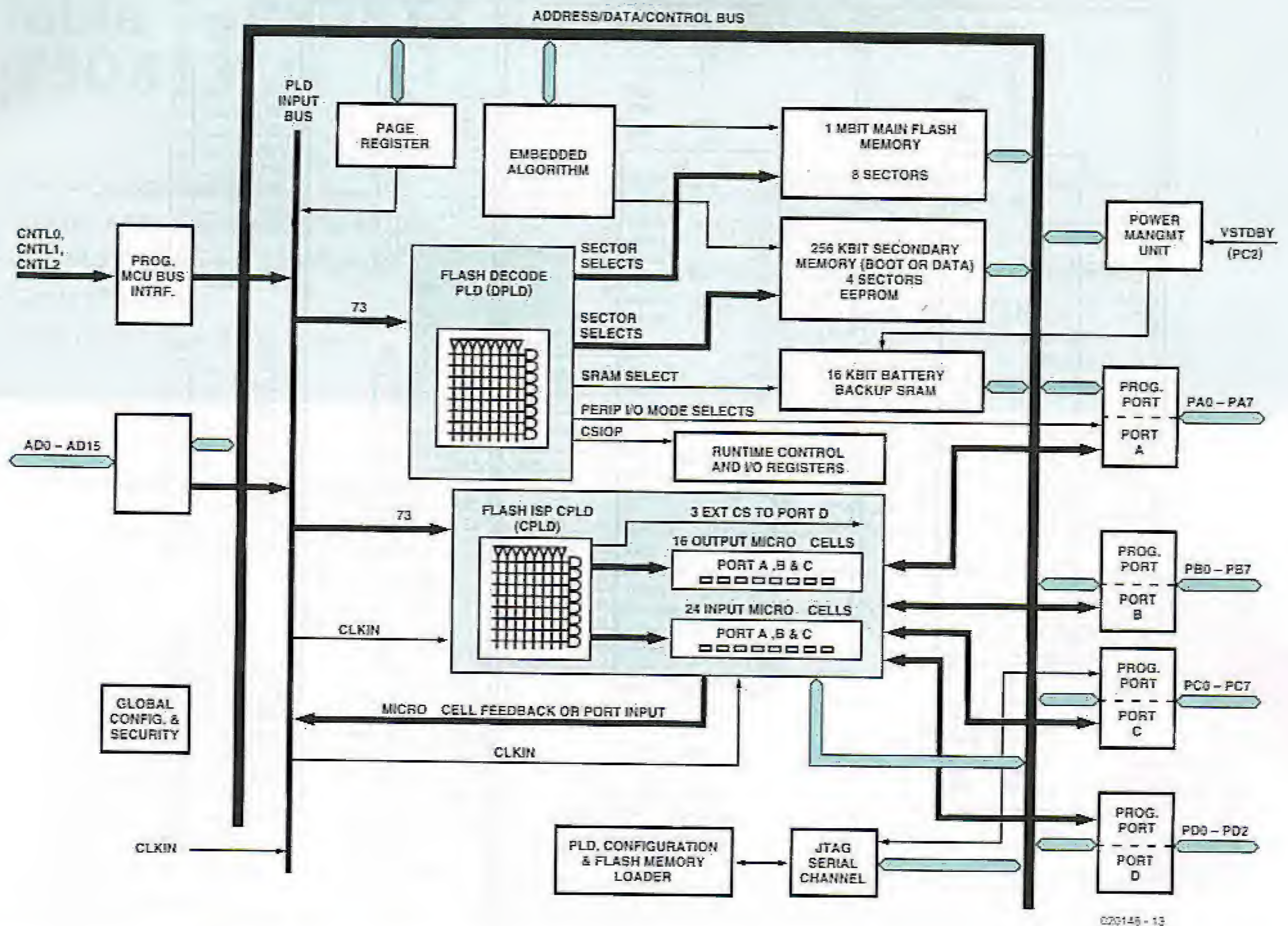

Figure 1. Internal structure of the smart 'all-in-one' chips from the PSD813xxx series.

As many of our readers will be able to confirm, the majority of microcontroller boards look very similar. If the microcontroller used has no program memory, an EPROM is added. Similarly, if there is a lack of RAM, the problem is solved by adding an external RAM device like the 62256. The lot is then complemented with a few logic gates and *hey presto* we have a basic microcontroller system. In some cases the designer will go one step further by employing a little more than just the microcontroller I/O pins. Some more digital electronics is then in order, but that really wraps it up as far as the circuit is concerned.

PSD813 series

Okay, if all these microcontroller circuits are so similar, why not design a single integrated circuit that contains all functionality? That way, circuits can become much smaller and the designer could concentrate on those points that are unique to the circuit. This, we figure, must have gone through the heads of several designers at STMicroelectronics (formerly SGS

Thomson), the general idea having culminated in a series of ICs called 'PSD813xxx'. The individual components inside the chip are found back in **Table 1**. Obviously, this IC offers far more possibilities for a wide variety of microcontroller circuits.

Figure 1 shows a block diagram illustrating the internal structure of the PSD813xxx chips.

The memories may be mapped on a segment by segment basis. This creates many different configurations, for example, first 16 K Flash, followed by two 8 K EEPROM segments and then another 32 K of Flash memory.

The memory management is also very handy. For example, using the page registers allows you to increase the controller's address range. Another possibility is to configure the memory in a different way depending on the page register contents. The samples show how this is done in practice.

The CPLD section in principle obviates the logic that's normally required to drive peripheral devices, but only if the designer is satisfied with 27 I/O pins. For a controller with a multiplexed bus, this allows a de-multiplexed address

to be created by the chip and, if necessary, a tri-state databus. Other applications include generating chip select signals for the peripheral devices or even creating extra I/O ports.

The PSD813 series has not been designed for one specific family of microcontrollers. In fact, it is so versatile that it can be used with several microcontroller families. These include not only micros with a standard address bus and databus, but also types with a multiplexed data/address bus like the 80C32, 8051XA and the 68HC11.

One final point to mention in this short profile is the JTAG port that allows all functions of the chip to be programmed in-circuit. In other words, it is not necessary to buy an expensive programmer — and that's good news.

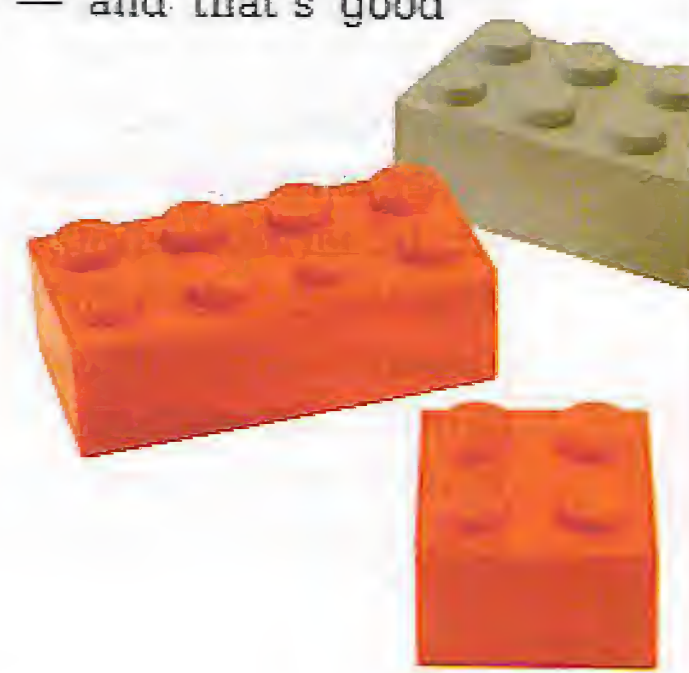

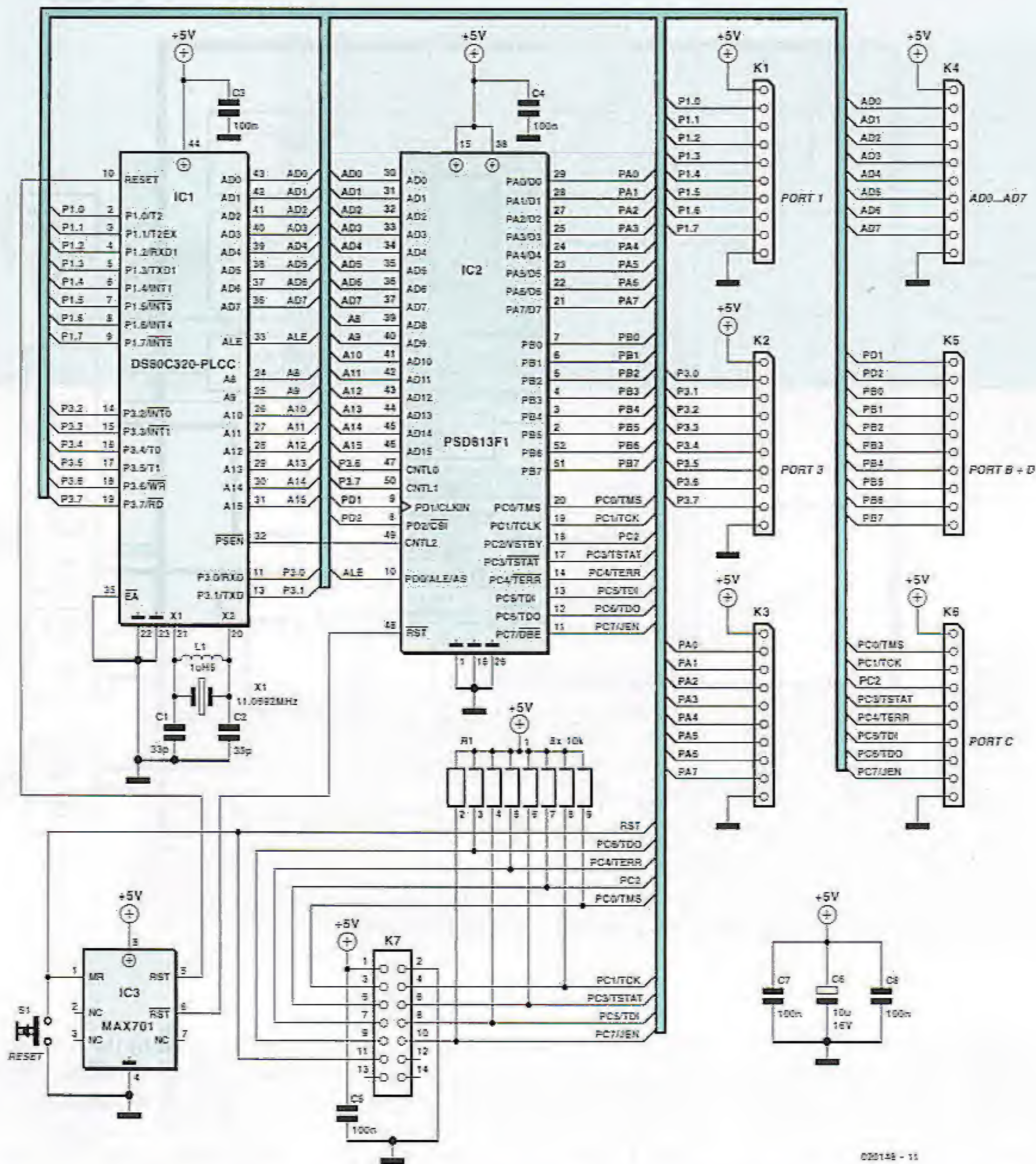

Figure 2. The application of a PSD813 results in a considerably smaller and simpler circuit diagram than you have come to expect from controller boards.

Hardware

The starting point for your experiments with this chip is a piece of hardware we developed that could be 'dropped' into several circuits. The circuit diagram of the drop-in module may be found in **Figure 2**. Even a cursory glance at the drawing should convince you that simplicity is trumps. Thanks to the multifunctional character of the PSD813 chip, this bit of hardware may be used in combination with a microcontroller in many different application circuits. What's more, the JTAG interface makes the total configuration great for

use as an experimental or development system.

For the heart of the circuit we went for a DS80C320 (IC1). This is an 80C32 compatible micro that's much faster than the ordinary 80C32, hence will not let easily let you down in regard of processing speed. Its main pins are all connected to the PSD813F in position IC2. Furthermore, the circuit contains a microprocessor supervisor circuit built around IC3 and S1, some components to complete the clock oscillator and a handful of small caps to clean and buffer the supply voltage.

An on-board power supply is not provided because this module will typically act as an add-on to an existing

circuit supplying +5 V, rather than a stand-alone unit. We did, however, bond out all relevant signals to pins on connectors K1 through K6. Connector K7 is the JTAG interface that allows the chip to be programmed. This interface has been described several times already in this magazine.

A suitable interface to connect the parallel port to the JTAG interface is shown in **Figure 3**. This programmer is directly accessible from the associated program called PSDSoft and that is why we believe it's really indispensable. The programmer is connected to the PC's parallel port via K8 and a cable with 1-to-1 pin correspondence. K9 is the JTAG port — this is con-

Table 1. PSD813 function overview (PSD813F1)

- Memory management
- 8 Flash RAM segments (128 kBytes)
- 4 EEPROM segments (32kBytes)
- SRAM (2 kBytes)
- CPLD (more than 3000 gates)
- 27 configurable I/O ports
- JTAG port
- Programmable power management
- Address and data demultiplexer

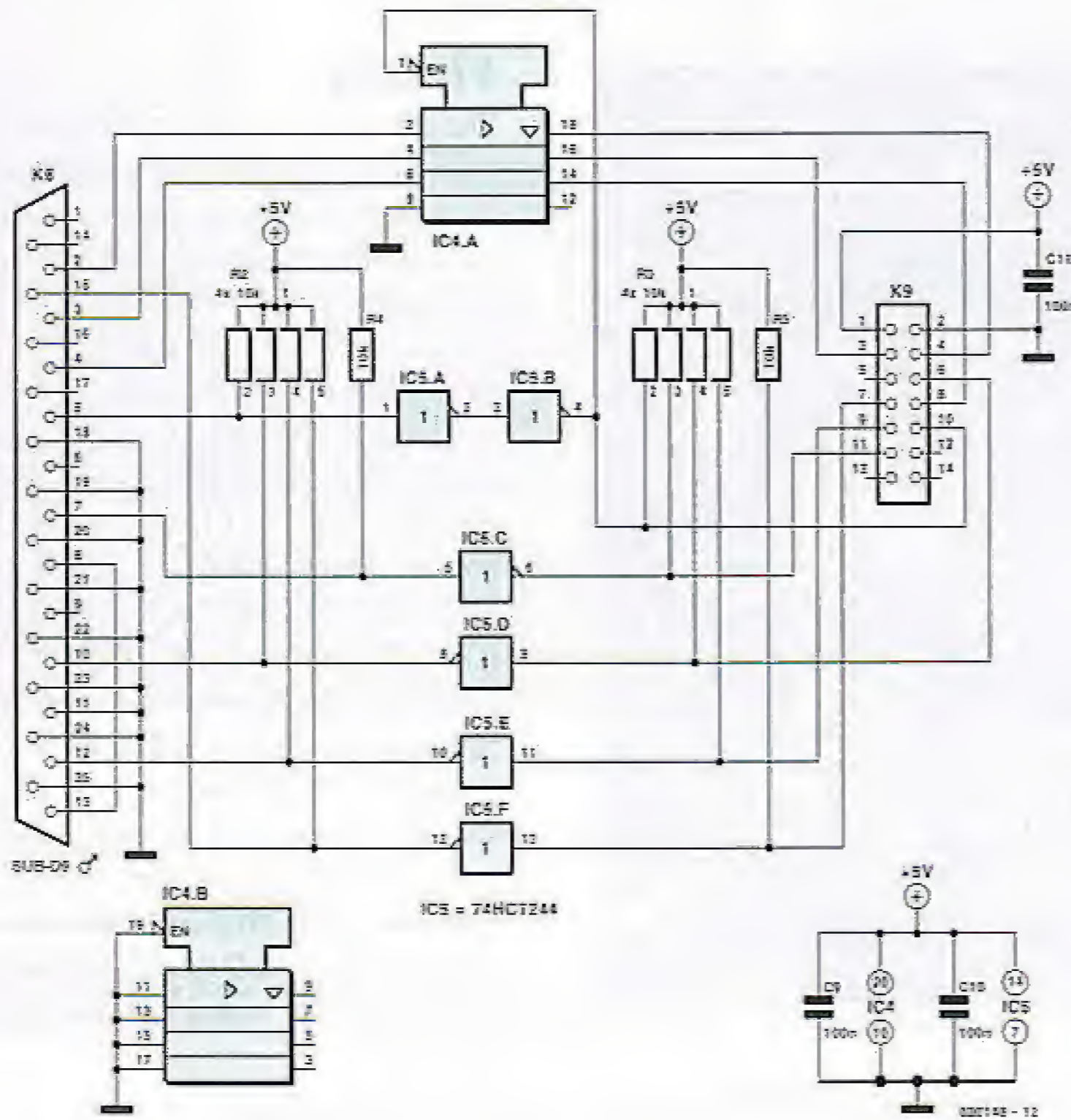

Figure 3. 'Glue' to connect the PC's parallel port to the JTAG interface.

connected to the plug-in module via a 14-way flatcable. IC5 affords buffering and inverting of the signals. The enable input is controlled by the PC, ensuring that the relevant signals do not load the circuit connected when in the 'off' state.

Building it

Having purchased the printed circuit board and all components you are ready to start building the circuit. As shown in Figure 4, the PCB consists of two sections that are easily separated using a hacksaw. One section is for the interface with the PC, the other, for the drop-in module proper.

In view of the relatively small number of parts, building up the two sub-boards is unlikely to take much of your time. As usual, we recommend you start with the low-profile parts. For the rest, hardly anything that can go wrong if you stick to the component overlay on the PCB and, of course, the parts list. Connectors K1-K5 have to be soldered at the underside of the board, their task being to link the module to the host equipment in which it is to function. Figure 5 shows our ready-assembled and tested board.

Before we can test the circuit, we need to look at the software.

Software

The galaxy of features offered by the PSD813F1 may startle instead of encourage. A chip with so many functions is usually difficult to configure and you may quickly feel lost in bits and bytes. Fortunately, STMicroelectronics have written a clearly structured program called PSD-soft Express that may be obtained free of charge from their website at www.st.com. The documentation with the PSD813 series is impressive to say the least.

The program comes with a wizard guiding you through the configuration process in a step-by-step manner, using unambiguous questions. You'll quickly get the hang of the program simply by using it a few times.

To enable everyone to make a head start with the PSD813 chip we produced a small example program that may be downloaded free of charge from our website. The program demonstrates how extra ChipSelect signals and I/O ports may be generated and created respectively.

Having launched PSDSoft Express you are ready to create a new project. Programming the PSD chip could not be easier using the wizard. The individual pins of the PSD chip connected to the JTAG interface and the controller are immediately assigned names by the wizard. Figure 6 illustrates the ease of defining an extra CS signal. Once all steps have been completed, the PSD chip is ready for programming through the JTAG interface.

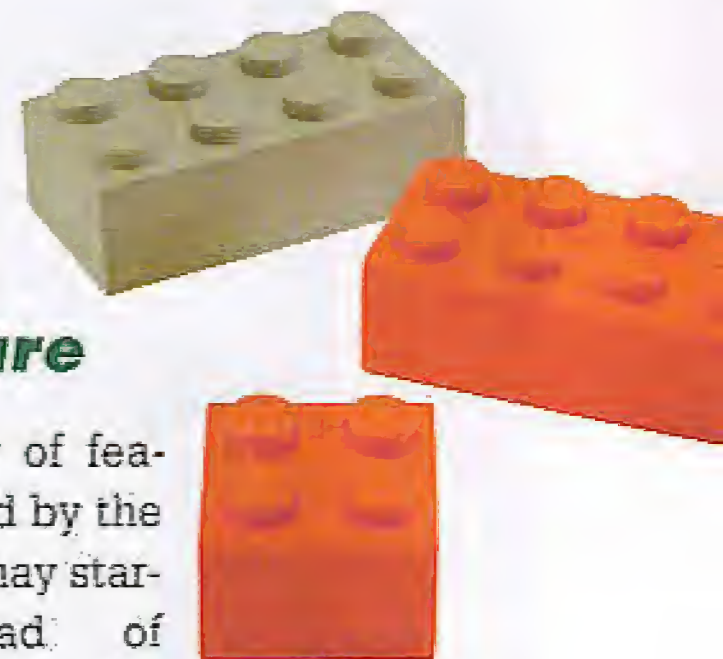

Components list

Resistors:

R1 = SIL array 8 x 10kΩ
R2,R3 = SIL array 4 x 10kΩ
R4,R5 = 10kΩ

Capacitors:

C1,C2 = 33pF
C3,C4,C5,C7-C11 = 100nF
C6 = 10μF 16V radial

Semiconductors:

IC1 = DS80C320QCL (44-pin PLCC)
IC2 = PSD813F1 (RS Components # 417-5726)
IC3 = MAX701CPA
IC4 = 74HCT244P
IC5 = 74HCT04

Miscellaneous:

K1-K6 = 10-way SIL-header
K7,K9 = 14-way boxheader

K8 = 25-way sub-D plug (male), angled pins, PCB mount
L1 = 1.5 μH miniature choke
S1 = pushbutton, 1 make contact
X1 = 11.0592MHz quartz crystal
44-way PLCC socket
50-way PLCC socket
PCB, order code **020148-1** (see Readers Services page)
Disk, example project file, order code **020148-11** or **Free Download**

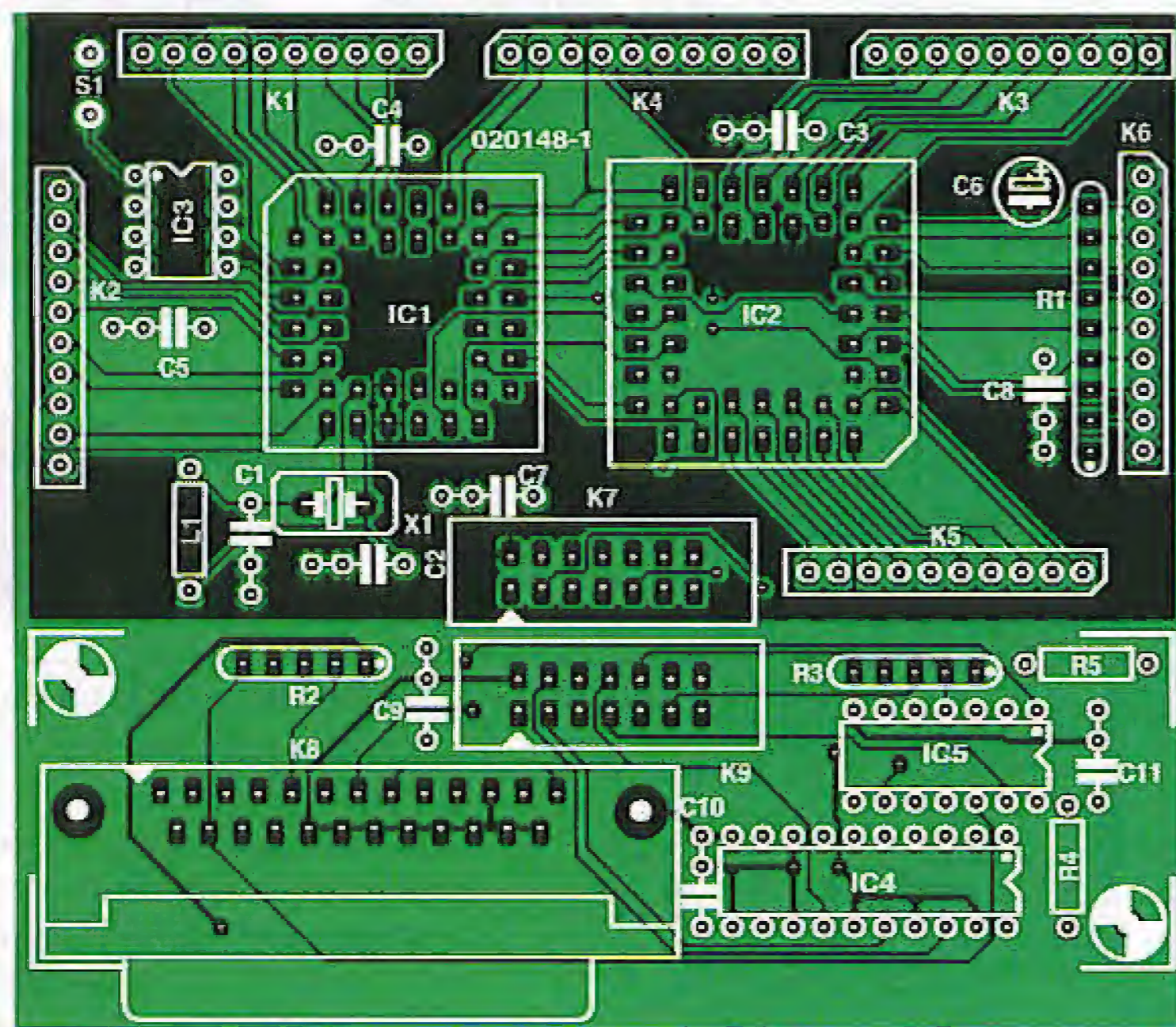

Figure 4. The PCB consists of two sections that are easily separated by sawing.

Finally

The PSD831 chip offers far more possibilities than those used in our simple example. None the less, the drop-in module discussed in this article will not fail to underline the versatility and multifunctional character of the PSD813xxx chips. Together with a suitable microcontroller, these chips form a solid base for a wide range of applications. The PSD813xxx allows much space to be saved in circuits normally requiring an EPROM, Flash memory and a handful of discrete logic. Thanks to the extensive software support and the ability to be programmed through a JTAG interface, the chip will easily prove worth its salt during circuit development and debugging. Updates to the chip software and hardware (in the CPLD parts) are also easy to implement using the same JTAG interface.

(020148-11)

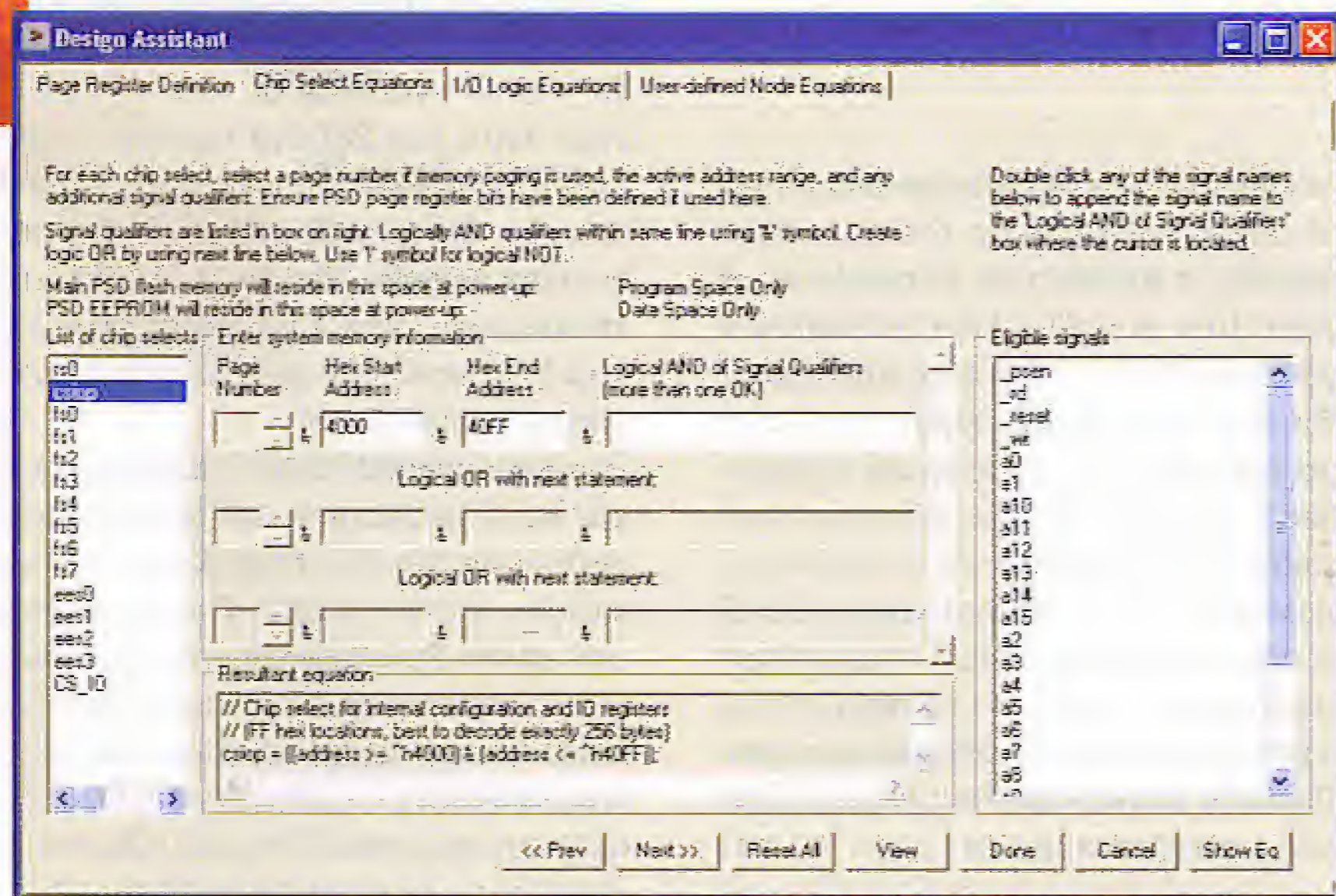

Figure 5. Using ST's PSDsoft Express to assign a software address range.

Free Downloads

- PSD813 example project file. File number: 020148-11.zip
- PCB layout in PDF format. File number: 020148-1.zip

www.elektor-electronics.co.uk/dl/dl.htm,

select month of publication.

FLOWCODE



Allows users with no programming skills to design complex electronic systems

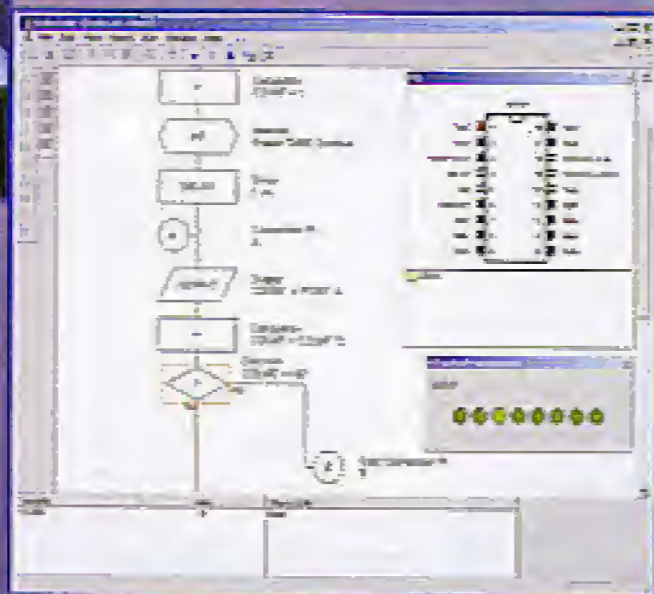

Flowcode is a programming system for PICmicro microcontrollers based on flowcharts. Flowcode includes macros to facilitate the control of complex devices like 7-segment and LCD displays. Flowcode allows complete novices to design control systems without getting bogged down in the programming involved.

- Requires no programming experience
- Full on screen simulation
- Produces PICmicro hex code for a range of 8, 18, 28, and 40 pin devices
- Full suite of demonstration tutorials
- Allows complex PICmicro designs to be produced in minutes

for full specification see:

www.matrixmultimedia.co.uk

or contact us for a full colour brochure

email: sales@matrixmultimedia.co.uk
tel: 0870 700 1831 fax: 0870 700 1832

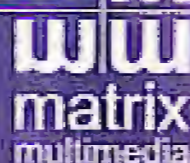

PICmicro[®] microcontroller development board

The World's most advanced solution for learning and programming PICmicro microcontrollers

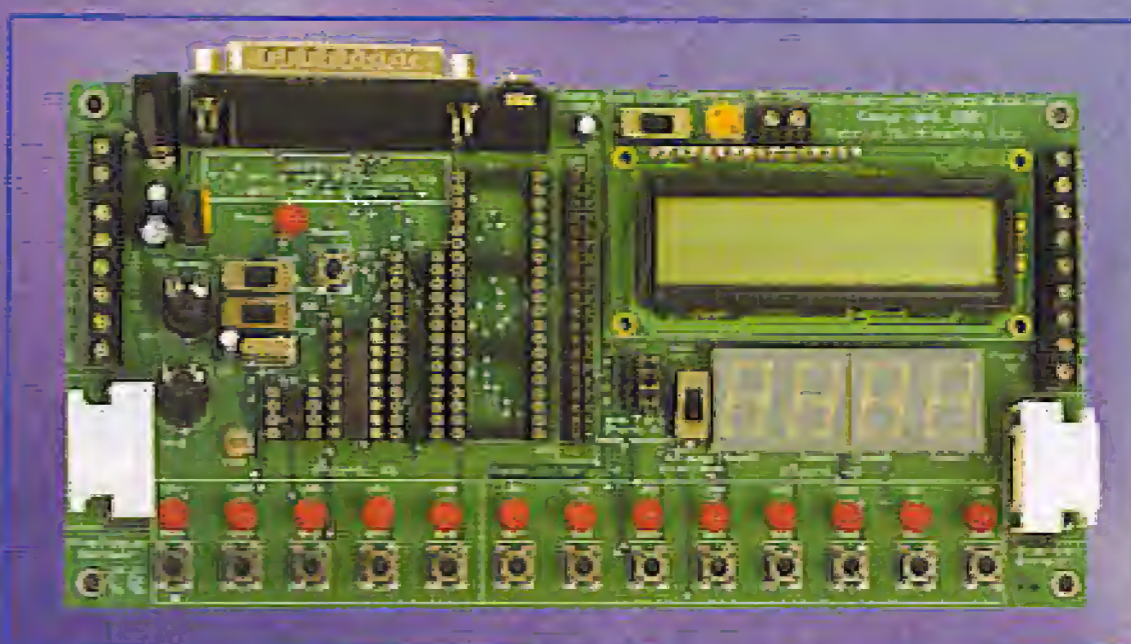

- Allows you to program PICmicros and test your programs
- Designed for education, hobbyists and industry
- Supports low cost Flash programmable PICmicro devices
- Fully featured displays including 2 line LCD and quad 7-segment LED
- Programs most 8, 18, 28, 40 pin devices - including those with ADC capabilities
- Free download software provides seamless send and verify function
- 3 CD ROM courses in C, assembly code, and flowchart programming are available

for full specification see:

www.matrixmultimedia.co.uk

or contact us for a full colour brochure

email: sales@matrixmultimedia.co.uk
tel: 0870 700 1831 fax: 0870 700 1832

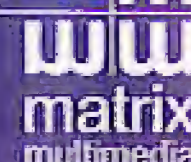

Electronic prototyping products and services from the makers of Veroboard



- Veroboard
- Prototyping Boards
- Extender Boards
- Wiring and Terminal Pins
- Standard Backplanes
- Verowire
- Cardframes
- Front Panels
- IBM PC Brackets

vero

TECHNOLOGIES

Vero Technologies Limited

Unit 25, Solent Trading Estate, Shamblehurst Lane, Hedge End, Hants, SO30 2FY

• 01489 776931 telephone • 01489 776938 fax • sales@verotl.com email •

sales: 087 0225 9505 internet: www.verotl.com

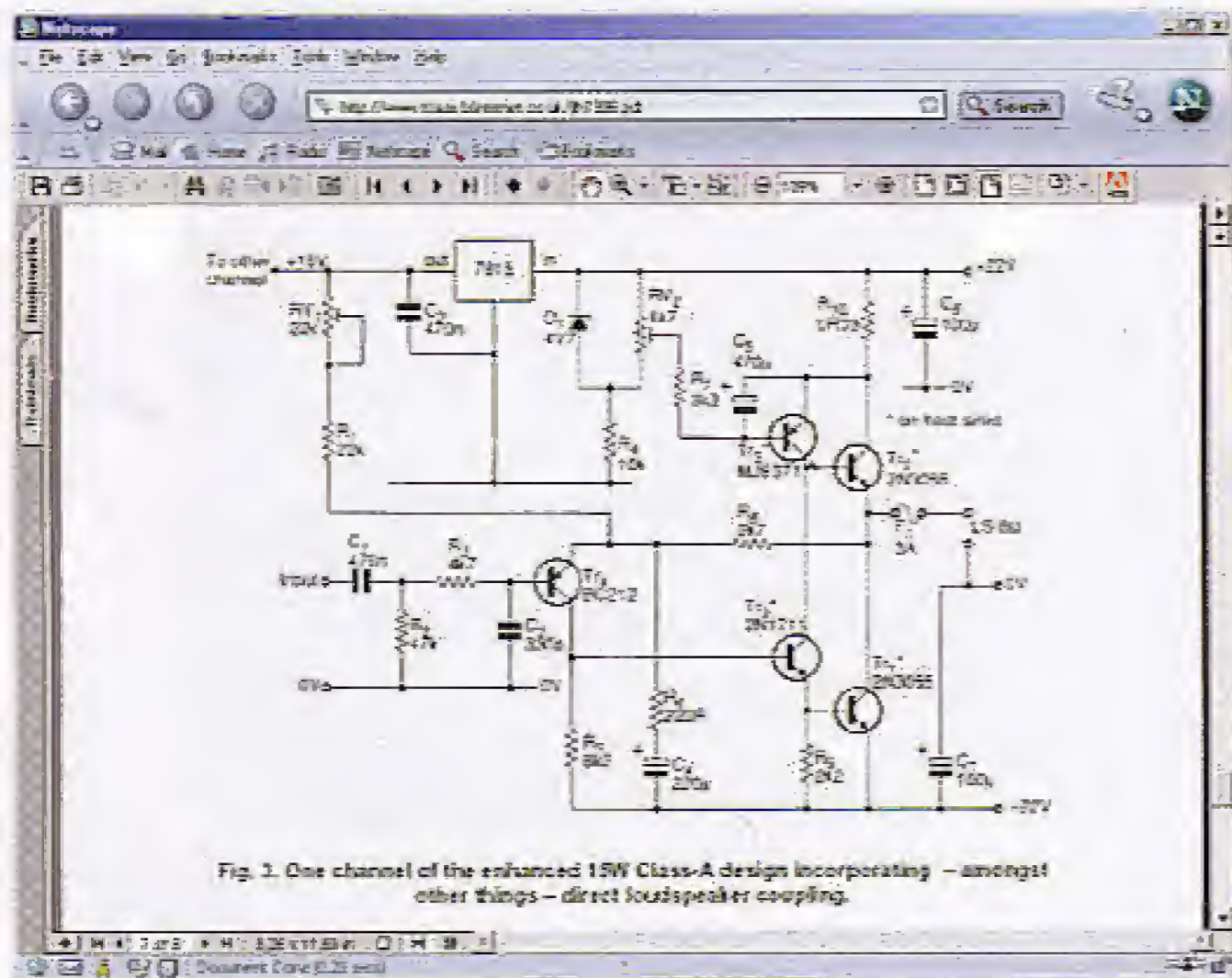
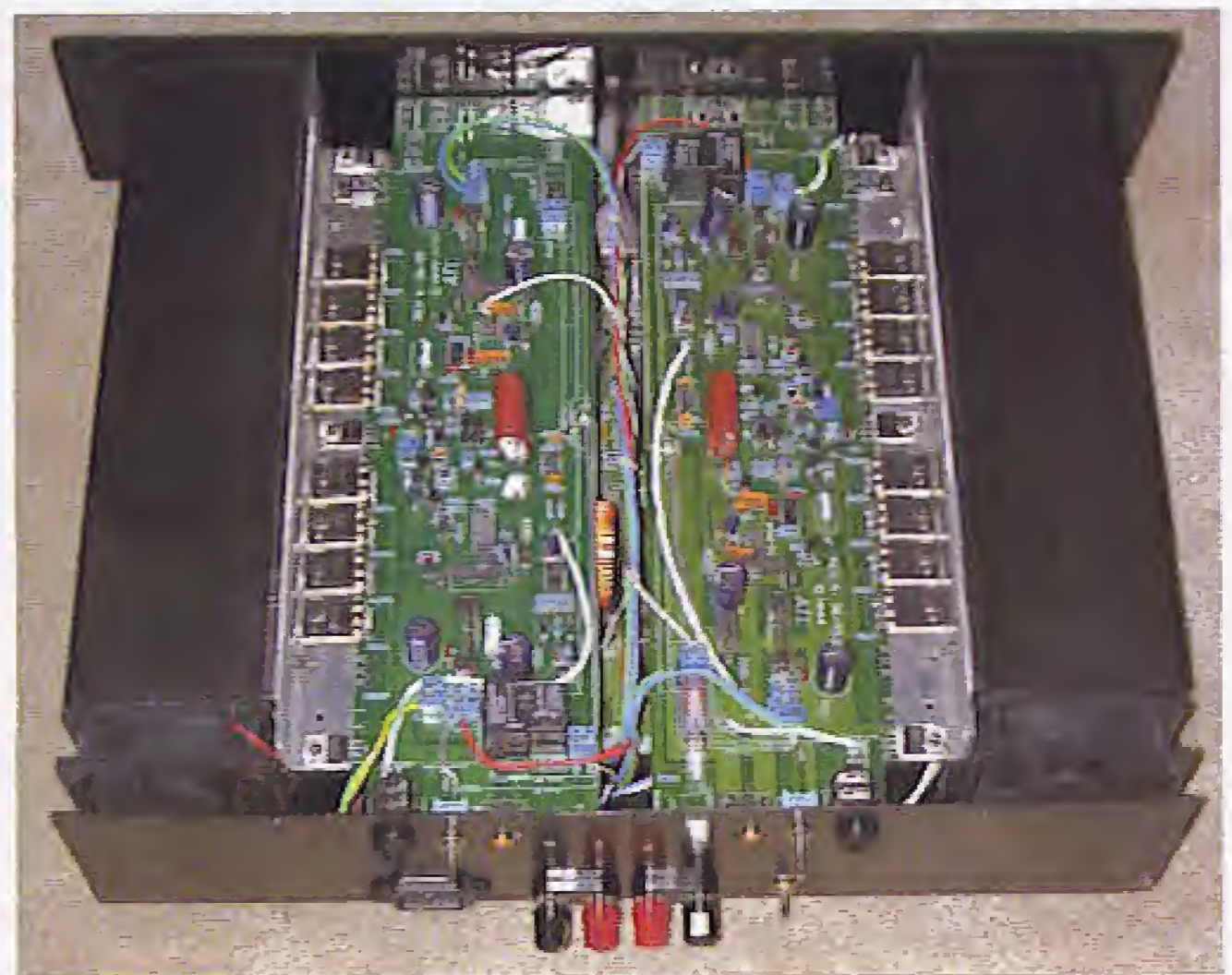

Fig. 3. One channel of the enhanced 15W Class-A design incorporating – amongst other things – direct loudspeaker coupling.



Audio Power Amps on the Internet

Fewer components, better sound?

Harry Baggen

Audio lovers will no doubt drool over the new Elektor preamp with digital control published in this issue. This, of course, calls for a matching power amplifier! Sure, there are enough high-quality Elektor designs to choose from, but it may also be interesting to trawl the Internet for alternative designs from all over the world.

Elektor Electronics is renowned when it comes to high-end audio designs. Our magazine frequently runs projects for preamplifiers and final amplifiers that are built by thousands of readers. The designs achieve excellent sonic quality at a fraction of the price of commercial products. It is in this tradition that we are proud to present, in this issue, our new digitally controlled preamp. The audio section of this preamp is marked by a minimalist design, guaranteeing superb sound reproduction while being successfully combined with a microcontroller and a display for extensive yet man-

ageable control of it all.

Such an optimised design calls for a power amplifier with matching performance. Excellent candidates from our own stable include the IGBT Power Amp (June 1995), the Compact Amp (May 1997) and even the Crescendo Millennium Edition (April 2001).

Audiophiles may however also find interesting designs on the Internet, allowing them to 'follow their faith'. Some people will insist on keeping things as simple as possible, while others will not rest until their equipment is technically perfect.

The first category certainly embraces the legendary 'Zen' amplifier brought to us by American designer Nelson Pass, with follow-up versions carrying names like 'Son of Zen' and 'Bride of Zen'. Nelson is a master of electronic minimalism — the amplifier stage proper having just one active element, a power MOSFET. This is complemented by no more than a cur-

rent source built around a power MOSFET and a transistor. The Zen amp delivers a modest 10 watts in Class A. Over the years a number of variations on the theme have emerged, many of these showing great activity from Nelson Pass himself.

Nelson Pass runs a website, **Pass DIY** [1], containing homebrew designs and covering all Zen projects in great detail. Another website describing interesting audio power amplifier projects is called **ESP, Elliott Sound Products** [2]. One of the projects is ominously called 'Death of Zen', this is a Zen variant employing bipolar transistors. A version actually built from this circuit diagram is found at **Bebe** [3]. Believe it or not, it is built around the legendary (and still available) power transistor type 2N3055! Another well-known and highly respected designer of, among others, class-A power amplifiers is John Linsley Hood, who in the 1960s became famous through his designs published in *Wireless World* (now *Electronics & Wireless World*). A large number of these 'evergreen' articles may be found at the **Class-A Amplifier Site** [4]. The site also supplies circuit diagrams of a headphone amplifier and a preamplifier as well as power amplifier

projects from other designers. Electronics enthusiasts who would rather rely on a more extensive design with a symmetrical layout and higher output power may be interested in the well-known power amplifier proposed by W. Marshall Leach. An extensive description is supplied by the designer himself at **The Leach Amp** [5]. A well elaborated design for an amplifier with relatively high output power (2 x 350 W into 8 Ω) may be found at a website called **A and T Labs** [6]. The power output section is built around complementary power MOSFETs. Another peculiarity of the design is the application of a switch-mode power supply unit (SMPSU) with a whopping output of 1 kW, allowing the entire assembly to be housed in a relatively low 19-inch rack. To close off this article we'd like to draw your attention to **Schematic.info** [7], a website packed with circuit diagrams of twentieth-century audio classics like Dynaco, SAE, Quad, NAD and Crown. Take your pick!

(04/0028-1)

Internet Addresses

- [1] **Pass DIY:**
www.passdiy.com/legacy.htm
- [2] **ESP, Elliott Sound Products:**
<http://sound.westhost.com/index.html>
- [3] **Bebe T:**
<http://diyaudio.8m.com/Bebet/bebet.html>
- [4] **The Class-A Amplifier Site:**
www.tcaas.biinternet.co.uk/
- [5] **The Leach Amp:**
<http://users.ece.gatech.edu/~mleach/lowtim/>
- [6] **A and T Labs:**
www.a-and-t-labs.com/K6_Sw_Amp/
- [7] **Schematic.info:**
http://schematic.narod.ru/a_index.htm

functional block and CPU (DSP core) diagram

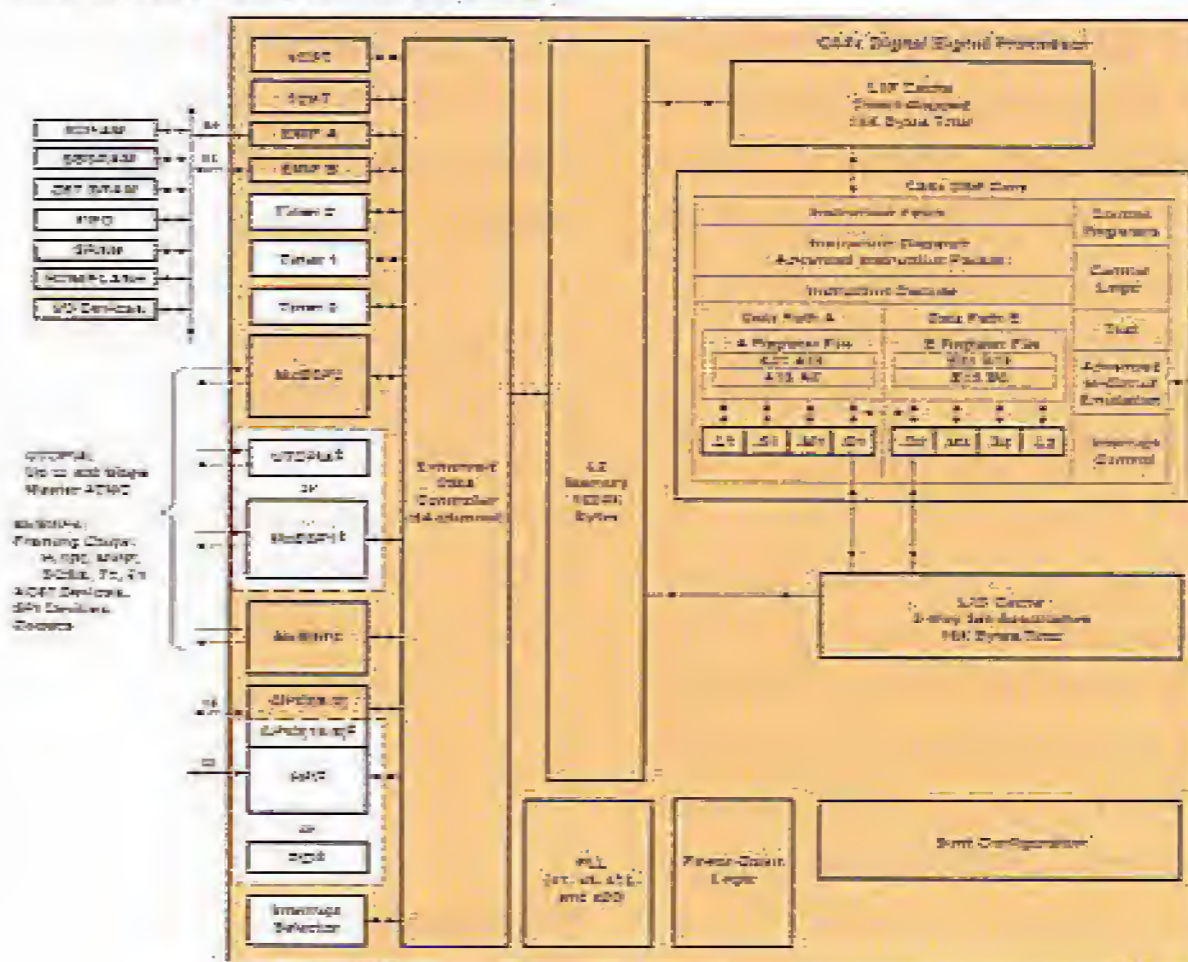

DSPs at 1 GHz

Top performance from 90-nm technology

The 90-nm process technology employed by Texas Instruments gives a spectacular boost to DSP performance. For the first time, DSPs pass the 1-GHz barrier.

DSPs (digital signal processors) type TMS320C6414/ 15/16 sample at 1 GHz, providing stunning throughput levels. They provide the user with 8 GigaMACs for 8-bit data width for video applications, or 4 GigaMACs for 16-bit data commonly used in speech and audio processing. This sort of throughput not only improves the bandwidth and channel capacity of existing real-time applications like base stations for mobile phones and radios, IP-based video, fast wideband networks, medical diagnosis equipment and radar, but also opens the way to new applications ranging from adaptive antenna arrays and intelligent vehicles right up to artificial vision.

A single 1-GHz component, for example, can now manage real-time transrating of eight MPEG-2 channels at D1 resolution (720x 480) or the processing of 55 GSM channels using AMR (adaptive multirate) speech encoding in a cellphone base station. In this way, designers

no longer have to implement complex circuits using multiple processors.

The speed breakthrough has been achieved thanks to an innovative design method and improved manufacturing processes employing 90-nm technology, making it possible to produce faster and smaller ICs than ever before. TI's ability to pack transistors in an extremely tight space has resulted in dramatic increases in speed and chip density. The change to 90-nm technology reduces the chip size and with it the production costs, allowing almost 50% more chips to be made from a single wafer. This not only had a positive effect on the new chips, but also allowed the price of the existing 720-MHz 'C64x series to be reduced by more than 50%. The 90-nm technology also simplifies the integration of System-on-a-Chip architectures by rationalising the communication between the DSP core, memory, peripherals, RISC processors and analogue components. These innovations comprise a command pipeline for efficient use at frequencies greater than 1 GHz, a

dual data architecture with 32 32-bit registers per data path and optimized implementation of data functional units required for the execution of critical program paths.

The new components are software compatible with the earlier generations — the 'C64 command set was not changed, so the design and process improvement are virtually invisible to software developers. The new DSPs being pin compatible with the earlier versions, they can easily be dropped into existing designs, boosting the data throughput, lowering energy consumption and keeping system costs within reason.

The 1-GHz DSPs types C6416, C6415 and C6416 are currently only available as samples. All three components have an on-chip 1-MB memory and only dif-

fer in respect of their integrated peripheral devices. The DSPs will be available in volume quantities by Autumn 2004. Unit prices start at US\$ 189.

To prevent time loss, software engineers can avail themselves of the C64x Starter Kit and make a head start with the design of key software elements of a target system, including algorithms, command codes and initial software system integration. The C64x kit contains didactic exercises, reference framework support, the integrated Code Composer Studio development platform, the DSP/BIOS real-time kernel and a number of standard algorithms. The Kit is already available at a cost of US\$ 395. Further information on this interesting starter kit may be found at www.ti.com/c6000dsksp.

(040066-1)

Contact information:

European Product Information Center (EPIC)

Texas Instruments Germany

Haggertystrasse 1 - D-85350 Freising - Germany.

Tel. (+49) 8161 803311

Email: epic@ti.com

Internet: www.ti.com/sc/epic/

www.ti.com/1ghzsamplingp

64-k 80C552

Flash Board Dear Editor, regarding the above project (January 2004, Ed.) I am at a loss as to which software to obtain for the board and where to find it. Can you help me?

Mike Miller (by email)

Well Mike the article clearly states at several points, including the Free Downloads inset at the end, that the same software is used as with the Precision Measurement Central (a MSC1210 development system; cover item, July/August 2003, Ed.). Not to worry, though.

Go to www.elektor-electronics.co.uk/dl/dl.htm, then to issue 324 (September 2003), then select and download the large (!) file 030060-1b.zip. The folder structure of this 'beast' is shown in Elektor Electronics September 2003 on page 54. The 80C552 Flash board also requires file number 030042-11.zip which may be found under issue 328 (January 2004). This zip file contains the source code files of the OS552 and Hello programs, as well as Flash552.hex and the GAL source and JEDEC files. As you can see, we've got it taped!

Long(ish) wire Dear Sir, the Longwire Match for SW Receivers article on page 111 (July/August 2003, Ed.) has a couple of errors. A long wire antenna is generally considered to be long with respect to the wavelength received, that is, at least 10 times the wavelength. The 3-m wire mentioned is actually a short antenna at HF! A balun's primary function is to convert a balanced line to an unbalanced one, not to step down an antenna's impedance. The circuit is simply an impedance converter for

matching a short antenna to 50 ohms, not a balun equivalent for a long wire.

Leon Heller, G1HSM (by email)

So it is true — length does matter! We stand corrected yet hope the inappropriate use of the term 'long wire' does not detract too much from the usefulness of the circuit.

CoolRunner-II — not so cool

Dear Jan, I was surprised and somewhat disappointed to see that the Xilinx CoolRunner-II Development Kit reviewed in your February 2004 issue could not actually be ordered from the Xilinx website using the hyperlink you printed. The product seems to have been discontinued. As I am still interested in making a head start with CPLDs, I'd like to know what, if any, replacement product you or Xilinx recommend?

Stuart Galbraith (by email)

Things are moving fast in the silicon chip industry — faster than we can print pages and get them into the newsstands or your mailbox. Literally minutes after hitting the Return key and sending our magazine to the printers we too discovered that the product had been removed from the Xilinx website. Fortunately, within days Xilinx advised us that the CPLD Design Kit (part # DO-CPLD-DK) is a perfect substitute. We were glad to see that the new kit contains even more goodies than the Coolrunner-II while the price has remained the same at \$ 49.99 plus shipping.

Where to start? I am currently travelling the world and have just bought your

magazine in OZ (is that Denmark? Ed.). I come from the UK but have never seen your magazine there. I wonder if you could help me. I would very much like to learn about electronics but after years of trying to find evening courses, I gave up. Do you have any suggestions as to how a complete idiot to electronics can learn about electronics. I am not very good at learning from books unless it has a large practical content.

Tim (by email)

Hello Tim, and welcome to Elektor Electronics. We envy you, being confined to our offices and answering readers' letters. Amazing you have never seen our magazine in the UK as it has been around in vast quantities since 1975. May I suggest you follow our Mini Project article series? The complete series is available free of charge from our website, simply click on Mini Projects Online. We're sure you'll find the content far from bookish.

Mirror mirror on the wall

Dear Editor, I have a problem with the PCB layouts in PDF format. I need to print a mirror image because I use the 'print-it-on-a-laser-printer-and-iron-it-on-the-copper' method of making PCBs. The Minolta Pro 6 driver for Win 2000 has no provision for printing an mirror image, and Acrobat Reader does not seem to do it by itself. Moving the design from Acrobat Reader to PaintShop Pro or some other graphics program seems to destroy the fine lines by pixelation, if you know what I mean. Can you help?

Per Troelsen, probably the most faithful subscriber in Denmark (15+ years) (by email)

Per, despite being a faithful reader you may have missed that since mid 2001 our PCB downloads contain pdf files with non-reflected as well as reflected artwork. See also 'Printing PCB Artwork' in the May 2003 issue.

Alarm! Clock deviation!

Gentlemen, the timing error admitted in the Digital Alarm Clock article (February 2004, Ed.) — 0.256 ms slow per minute — amounts to just over a third of a second per day, or two and a quarter minutes per year. However, looked at another way, it is equivalent to the 4 MHz master oscillator running 17.067 Hz slow. In practice, this is far less than the likely frequency error for an unadjusted oscillator of this type — possibly by an order of magnitude! Might I suggest replacing one of the fixed capacitors C1 or C2 with a small preset trimmer? Then adjusting the oscillator to 4,000,017.067 Hz will allow the clock to keep 'perfect' time.

Mathematically, at least, it is also easy to correct the division ratio so that an accurate 4,000,000.00 MHz clock (adjusted as above) will keep time, but whether this is actually possible with the PIC only you can answer. Apparently you use the overflow of TIMER_0 to increment a 16 bit counter. If this 8-bit TIMER_0 counter could be preset so that it divided by 160 instead of 256, and the 16-bit counter set for a maximum count of 46875, this would give a precise 60 second interval. If TIMER_0 can only divide by 256, could the prescaler be set to divide by 5 instead of 8? That would achieve an identical result.

It would be ideal if the division ratios could be configured accurately as described, then the 4 MHz oscillator could be more easily adjusted; a frequency reference would be available for other uses, and there would be the possibility of using an external 1 MHz clock. However, failing that, simple adjustment as described in the first paragraph would at least give accurate time-keeping.

Peter Vince (by email)

The designer of the circuit, Manoel Conde de Almeida, replies: You are right. The 0.256 ms error is the admitted error considering that the crystal oscillator will run at the nominal crystal oscillation frequency (in this case 4 MHz). Of course, we all know that off the shelf crystals have a tolerance of around 100 ppm.

The idea of replacing one of the capacitors by a trimmer looks good and seems to be the most effective one. But we have to remember that it would require special equipment (a calibrated frequency meter, for instance) for the adjustment process. Some readers interested in building the clock may not have that kind of infrastructure available.

Using the firmware (mathematics) is an alternative but, since we never know the exact frequency, the oscillator will be running at (assuming that the user does not have equipment to measure/adjust the frequency), it becomes more difficult to develop a 100% accurate solution.

Anyway, along that line of thought, I have worked on a firmware solution that tries to minimize the issue by giving the user the opportunity to change the maximum count of the register that keeps track of the TIMER_0 interrupts and updates the clock's seconds counter.

The user may select 1 of 3 operating modes depending on the clock's behaviour (slow, OK, fast).

Each mode establishes different maximum counts for the TIMER_0 counter.

It doesn't solve the problem entirely but minimizes the error when the oscillator is running near the limits of the crystal tolerance. The solution, though, works with the PIC16F628 and not the PIC16F84A because of programming memory space. If you're interested I can share more information and exchange more ideas with you and other Elektor readers.

Self-discharging NiMH batteries

Dear Jan, in a recent article on digital cameras published by a renowned computer magazine I stumbled on the following rather bold statement: "NiMH batteries suffer from energy loss at a rate of about 1% per day". I am not an electronics buff and although the statement does not come from any of your articles I would still invite your comment?

G. Lisabeth (by email)

The statement is correct. All cells lose energy owing to self-discharging and NiMH batteries are no exception. Although the exact rate of discharge depends on the cell type (i.e., technology) '1% per day' is a generally accepted value.

ECD CD-ROM

Dear Editor, I recently bought a copy of your ECD CD-ROM. I have a few questions on the product: 1. Reference is made to an elusive 'booklet' explaining the installation and use of the CD-ROM. What I was able to find was a leaflet (inlay) giving just the minimum system requirements.

2. Is it possible to use the CD-ROM without having to copy the lot to hard disk? If so, how is it done? I was unable to find any guidance. 3. Eventually I did install the product on hard disk and found it a pleasure to work with. My only objection is that a subject has to be closed before another can be selected, or am I missing something? Otherwise, full marks for the ECD!

Robert Fruytier (Netherlands)

Thanks for your positive criticisms Robert, and glad to read that you like the product. As the installation is mostly self-evident, any sort of description is superfluous and would not fill a booklet anyway. There's no way you can avoid copying all data on the CD-ROM because the immense size of the component database makes it impossible to handle from CD-ROM particularly on slower PCs.

There's no need to close subjects every time. Several subjects may be opened in sequence and you may switch between them using the ALT+TAB key combination (yes the method dates back to Windows 3.1). The selection menu is also accessible by right-clicking on the icon in the status bar.

Economic forces Dear Publisher, thanks for your notice to renew my subscription to Elektor Electronics this year. Your information that you have to increase the subscription rate yet again this year due to economic reasons, I fully understand. Unfortunately, due to the strong British Pound and your increases of subscription over the last three years, the cost of your magazine is no longer affordable for myself. This is very disturbing for myself, but having been a

reader and subscriber of this magazine for over 26 years, I have, with a heavy heart, decided not to continue my subscription to your wonderful magazine. The main reason is that, being a pensioned person and still active in various fields of electronics, I just cannot afford it anymore!

I wish you all the best and hope you will continue to produce a wonderful and A-1 magazine!

Sejjad Salam (Slovenia)

Sejjad, we were sorry to read your email but fully appreciate your problems and thank you for having been a subscriber for so long. Despite the recent price increases we can still claim to offer the best cost per circuit figure of all electronics magazines published in the UK.

We hope that in the future you will still be able to pick up the odd copy of Elektor from a newsstand if a subject to your liking is published (do check our website — it is free).

MailBox Terms

- Publication of reader's correspondence is at the discretion of the Editor.
- Viewpoints expressed by correspondents are not necessarily those of the Editor or Publisher.
- Correspondence may be translated or edited for length, clarity and style.
- When replying to Mailbox correspondence, please quote Issue number.
- Please send your MailBox correspondence to: editors@elektor-electronics.co.uk or Elektor Electronics, The Editor, P.O. Box 190, Tunbridge Wells TN5 7WY, England.

SMART Ships One-Millionth Bluetooth Module

SMART Modular Technologies, Inc., recently shipped its one-millionth Bluetooth module since January 2003, an important milestone that demonstrates the relative success of the Bluetooth technology in the short-range wireless module market. SMART's Bluetooth modules have been designed into PC, PDA, medical, consumer and industrial products. SMART's communication products division (CPD) has developed a broad line of Bluetooth-enabled modules and devices to support OEM/ODM designs at all stages of the development cycle. SMART's current product and service portfolio includes USB and RS-232 Bluetooth

adapters, mini-modules and developer boards, as well as complete product lifecycle support built with next generation technology.

According to a recent report from In-Stat MDR titled, Bluetooth 2003: Are PMGs Another Driver, over three million notebooks with Bluetooth are forecasted to ship in 2003, which indicates a significant increase from the previous year.

SMART Modular Technologies, Inc.,
PO Box 1757, Fremont, CA 94538.
Tel. (+1) 510-623-1231,
fax (+1) 510-623-1434.
Internet: www.smartmodulartech.com

(047031-4)

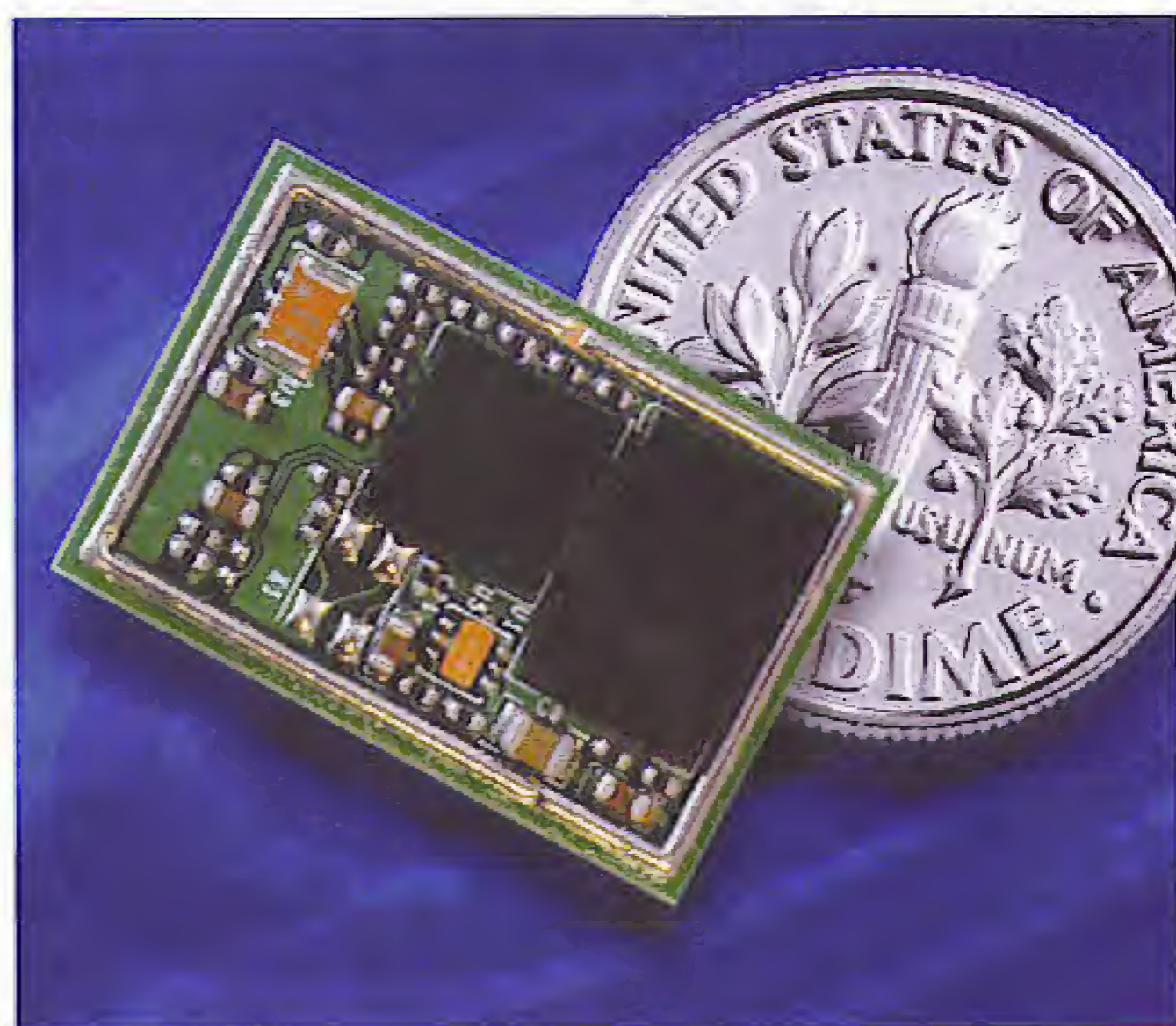

FRUSTRATED!

Looking for ICs TRANSISTORS? A phone call to us could get a result. We offer an extensive range and with a world-wide database at our fingertips, we are able to source even more. We specialise in devices with the following prefix (to name but a few).



2N 2SA 2SB 2SC 2SD 2P 2SJ 2SK 3N 3SK 4N 6N 17 40 AD
 ADC AN AM AY BA BC BD BDT BDV BDW BDX BF
 BFR BFS BFT BFX BFY BLY BLX BS BR BRX BRY BS
 BSS BSV BSW BSX BT BTA BTB BRW BU BUK BUT BUV
 BUW BUX BUY BUZ CA CD CX CXA DAC DG DM DS
 DTA DTC GL GM HA HCF HD HEF ICL ICM IRF J KA
 KIA L LA LB LC LD LF LM M M5M MA MAB MAX MB
 MC MDAJ MJE MJF MM MN MPS MPSA MPSH MPSU
 MRF NJM NE OM OP PA PAL PIC PN RC S SAA SAB
 SAD SAJ SAS SDA SG SI SL SN SO STA STK STR STRD
 STRM STRS SVI T TA TAA TAG TBA TC TCA TDA TDB
 TEA TIC TIP TIPL TEA TL TLC TMP TMS TPU U UA
 UAA UC UDN ULN UM UPA UPC UPD VN X XR Z ZN
 ZTS + many others

We can also offer equivalents (at customers' risk)
 We also stock a full range of other electronic components
 Mail, phone, Fax Credit Card orders and callers welcome

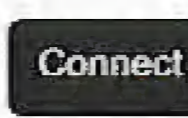

Cricklewood Electronics Ltd
 40-42 Cricklewood Broadway London NW2 3ET
 Tel: 020 8452 0161 Fax: 020 8208 1441

ELEKTOR ELECTRONICS ITEM TRACER 1985 - 2003

NEW

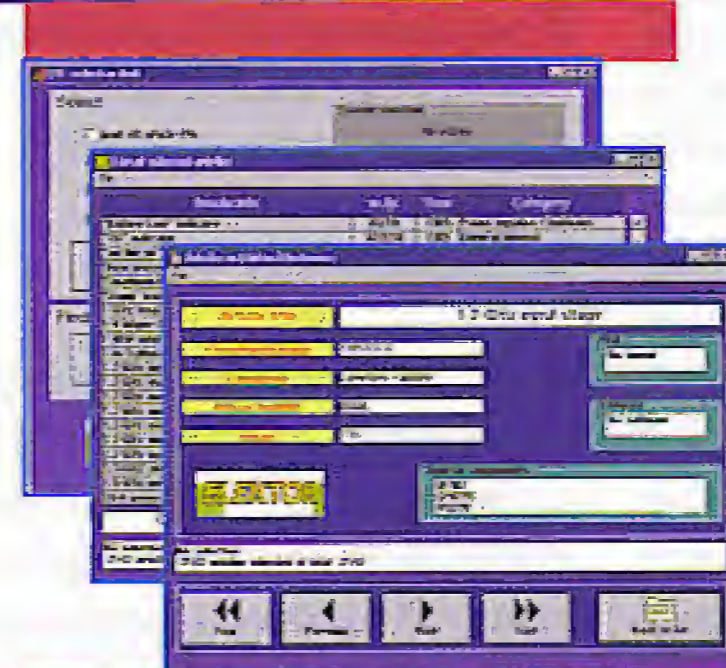

The EIT retails at £ 8-25 (US\$9.50)

Minimum computer requirements: PC386/486/pentium; at least 4 MB RAM; Windows 3.1/3.11/95/98; at least 2 MB free space on hard disk.

The new Elektor Item Tracer (EIT) is now available!

EIT contains the digital contents list of all articles (except news columns) published in the magazine over the period 1985-2003. EIT 1985-2003 is a user-friendly program supplied on a 3.5-inch diskette, running under Windows and offering an attractive graphics interface.

The program allows searching for various keywords or combinations, such as name of article; name of component; classification (audio; computers, etc); special components; order number of PCB or software item.
 EIT prints hard copy via the Windows printer driver.

**ORDER NOW USING THE ORDER FORM
 IN THE READERS SERVICES SECTION, OR
 WRITE TO**

Internet www.elektor-electronics.co.uk

P.O. Box 190 • Tunbridge Wells TN11 7WY • England
 Telephone +44 (0) 1580 200 657 • Fax +44 (0) 1580 200 616



Visit our website
www.distel.co.uk

THE ORIGINAL SURPLUS WONDERLAND!

THIS MONTH'S SELECTION FROM OUR VAST EVER CHANGING STOCKS

Surplus always
wanted for cash!

GIANT 10" 7 SEGMENT DISPLAYS

A bulk purchase enables us to bring to you these GIANT 7 segment digital displays at a now affordable price! The 10" character size gives exceptional readability at long distances and enables a host of applications including score boards, digital clocks, counters, event timers etc. As the units are a simple electromechanical device and operate from 12 V DC, simple switching via switches, relays, PIC or PC may be used to control single or multiple digits. Units feature integral 'Zero Power' memory which greatly simplifies design. For an excellent DIY practical article, see the May issue of 'Everyday & Practical Electronics' magazine. Ideal School / College construction project. Supplied in good RFE condition, complete with data sheet.

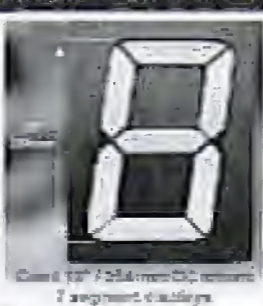

Less than 30% of makers price! Only £29.95(B) or 4 / £99.00(D)
Order RW44 Order PH26

THE AMAZING TELEBOX



TV SOUND &
VIDEO TUNER
CABLE COMPATIBLE

Converts your colour monitor into a QUALITY COLOUR TV!!
The TELEBOX is an attractive fully cased mains powered unit, containing all electronics ready to plug into a host of video monitors or AV equipment which are fitted with a composite video or SCART input. The composite video output will also plug directly into most video recorders, allowing reception of TV channels not normally receivable on most television receivers* (TELEBOX MB). Push button controls on the front panel allow reception of 8 fully tunable 'off air' UHF colour television channels. TELEBOX MB covers virtually all television frequencies VHF and UHF including the HYPERBAND as used by most cable TV operators. Ideal for desktop computer video systems & PIP (picture in picture) setups. For complete compatibility - even for monitors without sound - an integral 4 watt audio amplifier and low level Hi Fi audio output are provided as standard. Brand new - fully guaranteed.

TELEBOX ST for composite video input type monitors £36.95
TELEBOX STL as ST but fitted with integral speaker £39.50
TELEBOX MB Multiband VHF/UHF/Cable/Hyperband tuner £59.95
For overseas PAL versions state 5.5 or 6 mHz sound specification.
*For cable / hyperband signal reception Telebox MB should be connected to a cable type service. Shipping on all Teleboxes, code (B)

NEW State of the art PAL (UK spec) UHF TV tuner module with composite TV pp video & NICAM hi fi stereo sound outputs. Micro electronics all on one small PCB only 73 x 160 x 52 mm enable full tuning control via a simple 3 wire link to an IBM pc type computer. Supplied complete with simple working program and documentation. Requires +12V & +5V DC to operate. BRAND NEW - Order as MY00. Only £39.95 code (B)
See www.distel.co.uk/data_my00.htm for picture + full details

HARD DISK DRIVES 2 1/2" - 14"

2 1/2" TOSHIBA MK1002MAV 1.1Gb laptop (12.5 mm H) New £59.95
2 1/2" TOSHIBA MK4313MAT 4.3Gb laptop (8.2 mm H) New £105.00
2 1/2" TOSHIBA MK6409MAV 6.1Gb laptop (12.7 mm H) New £98.00
2 1/2" TOSHIBA MK1814GAV 18 Gb laptop (12 mm H) New £149.95
2 1/2" to 3 1/2" conversion kit for PC's, complete with connectors. £15.95
3 1/2" COMPAQ 313706-B21 (IBM) 9 gb ULT/SCSI3. New £199.00
3 1/2" FUJII FK-309-26 20mb MFM W/ RFE £59.95
3 1/2" CONNER CP3024 20 mb IDE W/ (or equiv.) RFE £59.95
3 1/2" CONNER CP3044 40 mb IDE W/ (or equiv.) RFE £69.00
3 1/2" QUANTUM 40S Prodrive 42mb SCSI W/ New RFE £49.00
5 1/4" MINISCRIBE 3425 20mb MFM W/ (or equiv.) RFE £49.95
5 1/4" SEAGATE ST-238R 30 mb RLL W/ Refurb £69.95
5 1/4" CDC 94205-51 40mb Hi MFM W/ RFE tested £69.95
5 1/4" HP 97548 850 Mb SCSI RFE tested £99.00
5 1/4" HP C3010 2 Gbyte SCSI differential RFE tested £195.00
8" NEC D2246 85 Mb SMD interface. New £99.00
8" FUJITSU M2322K 160Mb SMD W/ RFE tested £195.00
8" FUJITSU M2392K 2 Gb SMD W/ RFE tested £345.00
Many other floppy & H drives, IDE, SCSI, ESDI etc from stock, see website for full stock list. Shipping on all drives is code (C)

TEST EQUIPMENT & SPECIAL INTEREST ITEMS

MITSUBUSHI FA3445ETKL 14" Ind. spec SVGA monitors £245
FARNELL 0-60V DC @ 50 Amps, bench Power Supplies £995
FARNELL AP3060 0-30V DC @ 80 Amps, bench Supply £1850
KINGSHILL CZ4031 0-50V @ DC 200 Amps - NEW £3950
1kW to 400 kW - 400 Hz 3 phase power sources - ex stock EPOA
IBM 8230 Type 1, Token ring base unit driver £760
Wayne Kerr RA200 Audio frequency response analyser £2500
INFODEC 1U, 24 port, RJ45 network patchpanels. #TH93 £49
3COM 16670 12 Port Ethernet hub - RJ45 connectors #LD97 £69
3COM 16671 24 Port Ethernet hub - RJ45 connectors £89
3COM 16700 8 Port Ethernet hub - RJ45 connectors NEW £39
IBM 53P5501 Token Ring ICS 20 port lobe modules EPOA
IBM MAU Token ring distribution panel 8228-23-5050N £45
AJM 501 Low distortion Oscillator 9Hz to 330KHz, IEEE I/O £550
ALLGON 8360.11805-1880 MHz hybrid power combiners £250
Trend DSA 274 Data Analyser with G703(2M) 64 I/O EPOA
Marconi 6310 Programmable 2 to 22 GHz sweep generator £4500
Marconi 2022C 10KHz-1GHz RF signal generator £1550
HP1650B Logic Analyser £3750
HP3781A Pattern generator & HP3782A Error Detector EPOA
HP8621A Dual Programmable GPIB PSU 0-7 V 160 watts £1800
HP6264 Rack mount variable 0-20V @ 20A metered PSU £475
HP54121A DC to 22 GHz four channel test set EPOA
HP8130A opt 020 300 MHz pulse generator, GPIB etc £7900
HP A1, A0 8 pen HPGL high speed drum plotters - from £550
HP DRAFTMASTER 1 8 pen high speed plotter £750
EG+G Brookdeal 95035C Precision lock in amp £1800
Keithley 590 CV capacitor / voltage analyser EPOA
Racal ICR40 dual 40 channel voice recorder system £3750
Fiskers 45KVA 3 ph On Line UPS - New batteries £4500
Emerson AP130 2.5KVA industrial spec UPS £1499
Mann Tally MT645 High speed line printer £2200
Intel SBC 486/133SE Multibus 486 system, 8Mb Ram £945

IC's - TRANSISTORS - DIODES

OBSOLETE - SHORT SUPPLY - BULK
10,000,000 items EX STOCK
For MAJOR SAVINGS
CALL or see web site www.distel.co.uk

COMPUTER MONITOR SPECIALS

Legacy products
High spec genuine multisync.
CGA, EGA, VGA, SVGA

Mitsubishi FA3415ETKL 14" SVGA Multisync colour monitor with fine 0.28 dot pitch tube and resolution of 1024 x 768. A variety of inputs allows connection to a host of computers including IBM PC's in CGA, EGA, VGA & SVGA modes, BBC, COMMODORE (including Amiga 1200), ARCHIMEDES and APPLE. Many features: Etched faceplate, text switching and LOW RADIATION MPR specification. Fully guaranteed, in EXCELLENT little used condition. Tilt & Swivel Base £4.75

VGA cable for IBM PC included. Only £129 (E) Order as CG73

External cables for other types of computers available - CALL

Generic LOW COST SVGA Monitors

We choose the make, which includes Compaq, Mitsubishi, IBM, etc. Supplied ready to run with all cables, Standard RTB 90 day guarantee.

14" £59.00 order TD84	15" £69.00 order TG21	17" £79.00 order TJ66
-----------------------------	-----------------------------	-----------------------------

Supplied in good used condition. Shipping code (D)

VIDEO MONITORS

PHILIPS HCS35 (same style as CM8333) attractively styled 14" colour monitor with both RGB and standard composite 15.625 KHz video inputs via SCART socket and separate phono jacks. Integral audio power amp and speaker for all audio visual uses. Will connect direct to Amiga and Atari BBC computers. Ideal for all video monitoring / security applications with direct connection to most colour cameras. High quality with many features such as front concealed flap controls, VCR correction button etc. Good used condition - fully tested - guaranteed
Dimensions: W14" x H12 1/4" x D 15 1/2" D. Only £99.00 (D)

PHILIPS HCS31 Ultra compact 9" colour video monitor with standard composite 15.625 KHz video input via SCART socket. Ideal for all monitoring / security applications. High quality, ex-equipment fully tested & guaranteed (possible minor screen burns). In attractive square black plastic case measuring W10" x H10" x 1 3/4" D. 240 V AC mains powered. Only £79.00 (D)

INDUSTRIAL COMPUTERS

Tiny shoebox sized industrial 40 Mhz 386 PC system measuring only (mm) 266 w x 88 h x 272 d. Ideal for dedicated control applications running DOS, Linux or even Windows! Steel case contains 65 to 265 V AC 50 / 60 Hz 70 Watt PSU, a 3 slot ISA passive backplane and a Rocky 318 (PC104) standard, single board computer with 8 MByte NON VOLATILE solid state 'Disk On Chip' RAMDISK. System comprises: Rocky 318 (PC104) SBC ISA card with 40MHz ALI 386SX CPU, 72 pin SIMM slot with 16 Mbyte SIMM, AMI BIOS, battery backed up real time clock, 2 x 9 pin D 16550 serial ports, EPP/ECP printer port, mini DIN keyboard connector, floppy port, IDE port for hard drives up to 528 MByte capacity, watchdog timer and PC104 bus socket. The 8 MByte solid state 'disk on a chip' has its own BIOS, and can be formatted, formatted & booted. Supplied BRAND NEW fully tested and guaranteed. For full data see featured item on website. Order as QG36
100's of applications inc:
firewall, routers, robotics etc. Only £99.00 (D)

19" RACK CABINETS

Europe's Largest Stocks of
quality rack cabinets,
enclosures and accessories.
Over 1000 Racks from stock

Save
£££'s

This month's special
33 / 42 / 47 U - High Quality
All steel Rack Cabinets

BIG £
SAVER

Made by Eurocraft Enclosures Ltd to the highest possible spec, rack features all steel construction with removable side, front and back doors. Front and back doors are hinged for easy access and all lockable with five secure 5 lever barrel locks. The front door is constructed of double walled steel with a 'designer style' smoked acrylic front panel to enable status indicators to be seen through the panel, yet remain unobtrusive. Internally the rack features fully slotted reinforced vertical fixing members to take the heaviest of 19" rack equipment. The two movable vertical fixing struts (extras available) are pre punched for standard 'cage nuts'. A mains distribution panel internally mounted to the bottom rear, provides 8 x IEC 3 pin Euro sockets and 1 x 13 amp 3 pin switched utility socket. Overall ventilation is provided by fully louvered back door and double skinned top section with top and side louvres. The top panel may be removed for fitting of integral fans to the sub plate etc. Other features include: fitted castors and floor levelers, prepunched utility panel at lower rear for cable / connector access etc. Supplied in excellent, slightly used condition with keys. Colour Royal blue, some grey, available - CALL - Can be supplied in many other configurations.



33U Order as BC44 External dimensions mm=1825H x 635D x 603 W. (64" H x 25" D x 23 3/4" W) Only £245	42U Order as DT20 External dimensions mm=2019H x 635D x 603 W. (79.5" H x 25" D x 23 3/4" W) Only £345	47U Order as RV36 External dimensions mm=2236H x 635D x 603 W. (88" H x 25" D x 23 3/4" W) Only £410
---	---	---

Call for shipping quotation

COLOUR CCD CAMERAS

Undoubtedly a miracle of modern technology & our special buying power! A quality product featuring a fully cased COLOUR CCD camera at a give away price! Unit features full autolight sensing for use in low light & high light applications. A 10 mm fixed focus wide angle lens gives excellent focus and resolution from close up to long range. The composite video output will connect to any composite monitor or TV (via SCART socket) and most video recorders. Unit runs from 12V DC so ideal for security & portable applications where mains power not available. Overall dimensions 66 mm wide x 117 deep x 43 high. Supplied BRAND NEW & fully guaranteed with user data, 100's of applications including Security, Home Video, Web TV, Web Cams etc. etc.



Order as LK33 ONLY £79.00 or 2 for £149.00 (B)

SOFTWARE SPECIALS

NT4 WorkStation, complete with service pack 3 and licence - OEM packaged. ONLY £89.00 (B)
ENCARTA 95 - CDROM, Not the latest - but at this price! £7.95
DOS 5.0 on 3 1/2" disks with concise books c/w QBasic. £14.95
Windows for Workgroups 3.11+ Dos 6.22 on 3.5" disks £55.00
Windows 95 CDROM Only - No Licence £19.95
Wordperfect 6 for DOS supplied on 3 1/2" disks with manual £24.95
shipping charges for software is code B

SOLID STATE LASERS

Visible red, 670nm laser diode assembly. Unit runs from 5 V DC at approx 50 mA. Originally made for continuous use in industrial bar-code scanners, the laser is mounted in a removable solid aluminium block, which functions as a heatsink and rigid optical mount. Dims of block are 50 w x 50 d x 15 h mm. Integral features include over temperature shutdown, current control, laser OK output, and gated TTL ON / OFF. Many uses for experimental optics, comms & lightshows etc. Supplied complete with data sheet.
Order as TD91 ONLY £24.95 (A)

DC POWER SUPPLIES

Virtually every type of power supply you can imagine. Over 10,000 Power Supplies Ex Stock - Call or see our web site.

RELAYS - 200,000 FROM STOCK

Save ££££'s by choosing your next relay from our Massive Stocks covering types such as Military, Octal, Cradle, Hermetically Sealed, Continental, Contactors, Time Delay, Reed, Mercury Wetted, Solid State, Printed Circuit Mounting etc. CALL or see our web site www.distel.co.uk for more information. Many obsolete types from stock. Save ££££'s

Display
Electronics

ALL MAIL TO
Dept EK, 29 / 35 Osborne Rd
Thornton Heath
Surrey CR7 8PD, UK
Open Mon - Fri 9.00 - 5:30

18 Million Items On Line Now!
Secure Ordering, Pictures, Information
VeriSign
www.distel.co.uk
email = admin@distel.co.uk

ALL ENQUIRIES
0208 653 3333
FAX 0208 653 8888

All prices for UK Mainland. UK customers add 17.5% VAT to TOTAL order amount. Minimum order £10. Bone Fide account orders accepted from Government, Schools, Universities and Local Authorities - minimum account order £100. Cheques over £100 are subject to 7 working days clearance. Carriage charges (A)=£3.50, (B)=£6.50, (C)=£10, (D)=£15.00, (E)=£18.00, (F)=CALL. Allow approx 3 days for shipping - faster CALL. All goods supplied to our Standard Conditions of Sale which can be viewed at our website and unless stated guaranteed for 90 days. All guarantees on a return to base basis. All rights reserved to change prices / specifications without prior notice. Orders subject to stock. Discounts for volume. Top CASH prices paid for surplus goods. All trademarks, tradenames etc acknowledged. © Display Electronics 2002. E & O E.



NET LINKS

To book your website space contact Bernard Hubbard

Tel 00 44 (0)1242 510760 Fax: 0044 (0)1242 226626

BETA LAYOUT

www.pcb-pool.com

Beta layout Ltd Award-winning site in both English and German offers prototype PCBs at a fraction of the cost of the usual manufacturers' prices.

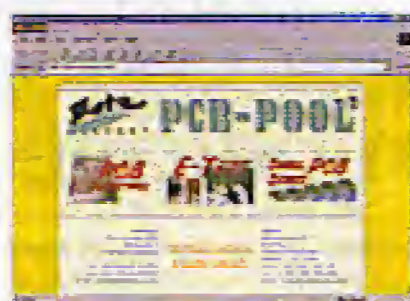

BURN TECHNOLOGY LTD

<http://www.burntec.com>

Distributors of a wide range of device programmers, package adaptors, test and soldering equipment. Order online and get free delivery on all orders over £30.00.

COMPUCUT

<http://www.compucutters.com>

Computer Numerical Control from your home PC. Great for tricky jobs, and accurate repetitive work. We supply: - Software - Interface - Manual - Support
Price £250 plus postage.

CONFORD ELECTRONICS

<http://www.confordelec.co.uk>

Lightweight portable battery/mains audio units offering the highest technical performance. Microphone, Phantom Power and Headphone Amplifiers. Balanced/unbalanced signal lines with extensive RFI protection.

DANBURY ELECTRONICS

<http://www.mc-h.demon.co.uk/transformers.html>

Here you will find our mains and output transformers in Mike Holme's range of valve/tube amplifiers (PP & SE). Also circuits, parts lists, chassis, advice.

DEBUG INNOVATIONS UK

<http://www.debuginnovations.com>

Introducing hassle free prototyping

- RF / Analogue
- High speed digital
- Surface mount
- 0.1" grid
- Power planes
- Unique patch architecture

Forget custom PCBs, start your project now!



EASYSYNC

<http://www.easysync.co.uk>

EasySync Ltd sells a wide range of single and multi-port USB to RS232/RS422 and RS485 converters at competitive prices.

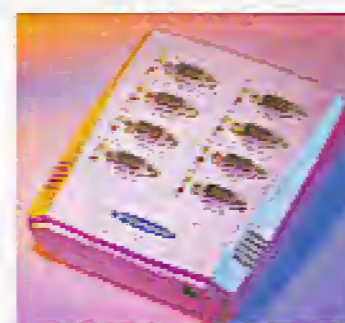

ELEXOL PTY LTD

<http://www.elexol.com>

Developer and manufacturer of

- USB Development Modules.
- USBMOD Series.
- USBIO24 Digital Input/Output Module.
- MP3 Solutions.
- MP3MOD4 Module.

Distributor inquiries welcome.



ELM ELECTRONICS

<http://www.elmelectronics.com>

Offering a variety of unique and low cost integrated circuits for the experimenter. Secure ordering via the web site with worldwide shipping.

ELNEC

www.elnec.com

- device programmer manufacturer
- selling through contracted distributors all over the world
- universal and dedicated device programmers
- excellent support and after sale support
- free SW updates
- once a months new SW release
- reliable HW
- three years warranty for most programmers



ERVAN INTERNATIONAL Co.

<http://www.ervan-int.com>

Power Electronics and Solar Energy Design and Consultants. Also offers:

Discount prices of:

- Ultra Bright LEDs
- PCB LED Cluster Kits
- Laser Pointers
- Solar Modules
- Batteries

FOREST ELECTRONIC DEVELOPMENT

<http://www.fored.co.uk>

FED supply PIC programmers, Basic modules, and development software including a PIC C Compiler, Prog'n Drop Visual Development and a well featured debugging environment.

FUTURLEC

<http://www.futurlec.com>

Save up to 60% on

- Electronic Components
- Microcontrollers, PIC, Atmel
- Development Boards, Programmers

Huge range of products available on-line for immediate delivery, at very competitive prices.



FUTURE TECHNOLOGY DEVICES

<http://www.ftdichip.com>

FTDI designs and sells USB-UART and USB-FIFO interface i.c.'s.

Complete with PC drivers, these devices simplify the task of designing or upgrading peripherals to USB



HAMMOND ELECTRONICS

<http://www.hammondmfg.com>,

sales@hammond-electronics.co.uk

tel: 01256 812812.

Small die-cast, plastic and metal enclosures for the hobbyist and professional. Widely available from major distributors.



LONDON ELECTRONICS COLLEGE

<http://www.lec.org.uk>

Vocational training and education for national qualifications in Electronics Engineering and Information Technology (BTEC First National, Higher National NVQs, GCSEs and Advanced Qualifications). Also Technical Management and Languages.

MQP ELECTRONICS

<http://www.mqpelectronics.co.uk>

Leaders in Device Programming Solutions.

- Online shop
- Low Cost Adaptors for all Programmers
- Single Site and Gang Programmers
- Support for virtually any Programmable Device

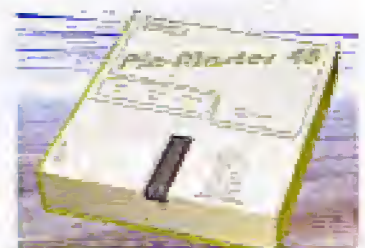

NEW WAVE CONCEPTS

<http://www.new-wave-concepts.com>

Software for hobbyists:

- Livewire circuit simulation software, only £29.36
- PCB Wizard circuit design software, only £29.36

Available from all Maplin Electronics stores and www.maplin.co.uk



PEAK ELECTRONIC DESIGN LIMITED

www.peakelec.co.uk

Cool component test gear for your passives and semis.

Instant identification, measurement and validation. Connect anyway round. The Peak Atlas family starts from £59.



POND ELECTRONICS

<http://www.pond.ie>

tel +353-1-821-5060

fax +353-1-820-9384

Innovative systems for PIC development & embedded applications.

- µFlash876
- PIC C Compilers & Programmers
- MicroStack • Basic Stamp
- Custom development Service

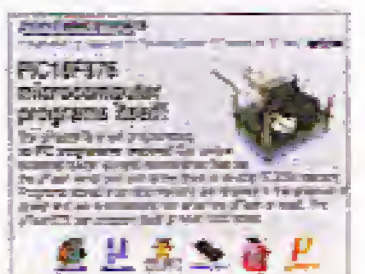

QUASAR ELECTRONICS

www.QuasarElectronics.com

Over 300 electronic kits, projects and ready built units for hobby, education and industrial applications including PIC/ATMEL programming solutions. Online ordering facilities.
Tel: +44 (0) 870 246 1826
Fax: +44 (0) 870 460 1045
Email: sales@QuasarElectronics.com

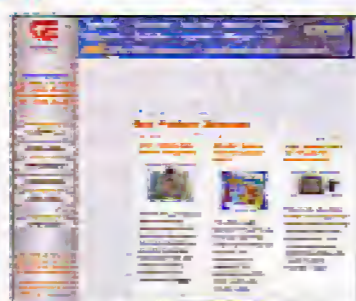

ROBOT ELECTRONICS

<http://www.robot-electronics.co.uk>

- Ultrasonic rangefinders
- Motor H-Bridge controllers
- Magnetic Compasses
- RC servos and controllers
- PIC programmers and components
- Electronic Design/Development and Manufacturer to industry



SPICEAGE AND SPICYCLE

<http://www.spiceage.com>

Spicycle circuit design program (schematic drawing, well-featured PCB drawing, SpiceAge simulation). SuperFilter digital and analogue filter synthesis and optimisation. Download a free working evaluation and enjoy software renowned for its high quality at prices that make it seem like Christmas all year round. Make contact with Those Engineers (020 8906 0155), real engineers, who will understand your needs.



The World is getting onto Spicycle

TECHNOBOTS

<http://www.technobots.co.uk>

Welcome to Technobots - the one stop shop especially for the remote operated robot builder, radio control and engineering hobbyist.

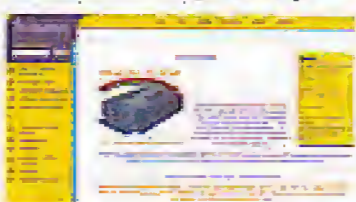

TELNET

<http://www.telnet.uk.com>

The site shows graphically Telnets wide range of quality second-user test and measurement equipment, including oscilloscopes and spectrum analysers.



ULTRALEDs

<http://www.ultraleds.co.uk>

tel: 0871 7110413
Large range of low cost Ultra bright leds and Led related lighting products. Major credit cards taken online with same day despatch.

USB INSTRUMENTS

<http://www.usb-instruments.com>

USB Instruments specialises in PC based instrumentation products and software such as Oscilloscopes, Data Loggers, Logic Analysers which interface to your PC via USB.



VIEWCOM

<http://www.viewcom.f9.co.uk>

tel: 020 8471 9338 fax: 020 8552 0946

- Mail Order supplier of:
 - Integrated Circuits and Components.
 - Kit and parts for Elektor projects.
 - Transistors, FETs, Capacitors, Resistors, Crystals, etc and hard to find devices.
- Viewcom Electronics, 77 Upperton Road West, Plaistow, London E13 9LT

PROMOTE YOUR WEBSITE HERE

Elektor Electronics have a feature to help customers to promote their websites, Net Links - a permanent feature of the magazine where you will be able to highlight your site on a regular basis.

- For just £120 + VAT (£10.90 per issue for eleven issues) Elektor will publish your company name, a 25-word description and your website address.
- For £300 + VAT for the year (£27.27 per issue for eleven issues) we will publish the above plus run a 3cm deep full colour screen shot from your site.

Places are limited and spaces will go on a strictly first come, first served basis, please fax back your order today!

I wish to promote my company, please book my space:

- Text insertion only for £120 + VAT
- Text and photo for £300 + VAT

NAME:.....ORGANISATION:.....

JOB TITLE:.....

ADDRESS:.....

.....TEL:.....

PLEASE COMPLETE COUPON BELOW AND FAX BACK TO 00-44-(0)1242 226626

COMPANY NAME.....

WEB ADDRESS.....

25-WORD DESCRIPTION.....

.....

.....

.....

.....

.....

ELECTRONIC ENTHUSIASTS

Only one magazine tests its projects and circuits in its own lab before publication -

ELEKTOR ELECTRONICS
THE ELECTRONICS & COMPUTER MAGAZINE



Contact: Worldwide Subscription Service Ltd,
Unit 4 Gibbs Reed Farm, Pashley Road, Ticehurst
TN5 7HE Telephone: (+44) (0) 1580 200657
Fax: (+44) (0) 1580 200616 Or visit our Website:
www.elektor-electronics.co.uk

Please Note

Software items marked @ are available from the Free Downloads page of the Publishers' website at www.ellektor-electronics.co.uk. Diskettes are supplied for the convenience of readers without internet access.

EVERGREENS

Elektor Electronics Help Disk

966022-1 Disk, Windows version 8-15 14.45

Elektor Electronics Item Tracer 1985-2002

036003-11 contents database (disk, Windows version) 8-15 14.35

Medium power HEXFET amplifier (December 1993)

930102-1 PCB 10-90 19.25

Universal Prototyping Boards

UPBS-1 PCB 2-45 4.30

UPBS-2 2 PCBs 4-10 7.25

UPBS-4 4 PCBs 6-55 11.55

no. 331 APRIL 2004

Drop-in Microcontroller Board

@ 020148-1 PCB 8-60 15.20

@ 020148-11 Disk, sample project file 4-90 8.65

Pandora's Sound & Music Box

@ 030402-1 PCB 10-60 18.75

@ 030402-11 Disk, source and hex code files 4-90 8.65

030402-41 PIC16F877R, programmed 20-55 36.40

VHF-Low Explorer

@ 020416-1 PCB 8-80 15.50

No. 330 MARCH 2004

Build Your Own DRM Receiver

@ 030365-1 PCB 9-10 16.10

@ 030365-11 Disk, DRM.exe program 4-90 8.65

Code Lock

@ 020434-1 PCB 9-60 16.95

@ 020434-11 Disk, source & hex code files 4-90 8.65

020434-41 PIC16F84A-4P, programmed 14-70 26.00

Hands-on CPLDs (2)

@ 030052-1 PCB 8-90 15.75

@ 030052-11 Software 4-90 8.65

030052-41 EPM7128SLC84-15, programmed 33-40 59.10

Multichannel Failsafe for Radio Controlled Models

@ 020382-11 Disk, source code file 4-90 8.65

020382-41 AT89C52-24JL, programmed 8-70 15.40

Multifunction Frequency Meter

@ 030136-1 PCB 9-35 16.55

@ 030136-11 Disk, project software 4-90 8.65

030136-41 AT90S2313-10PC, programmed 7-95 14.05

No. 329 FEBRUARY 2004

Digital Alarm Clock

@ 030096-11 Disk, PIC source and hex code 4-90 8.65

030096-41 PIC16F84-04/p, programmed 15-20 26.90

iAccess

@ 020163-11 Disk set, source code and control software 7-50 13.30

020163-41 AT89S8252-12PC, programmed 13-90 24.80

Simple 12-10-230V Power Inverter

@ 020435-1 PCB 8-50 15.05

Touch-controlled Switch

@ 030214-11 Disk, PIC source code 4-90 8.65

030214-41 PIC12C508A04/S08, programmed 6-15 10.90

No. 328 JANUARY 2004

64-K 80C552 Flash Board

@ 030042-1 PCB 9-35 16.55

@ 030042-11 Disk, misc. project software 4-90 8.65

030042-21 29F010, programmed 10-00 17.70

030042-31 GAL 16V8D150R, programmed 6-10 10.80

Climate Logger

@ 030076-1 PCB 7-75 13.70

@ 030076-11 Disk, Windows software 4-90 8.65

FMS Flight Simulator Encoder

@ 030066-1 PCB 10-20 18.05

030066-41 87LPC767BN, programmed 17-05 30.15

LED Roulette

@ 030168-1 PCB 17-90 31.60

@ 030168-11 Disk, source and hex files 4-90 8.65

030168-41 89C2051-12PC, programmed 8-05 14.25

Multi-event Alarm Clock

@ 020304-11 Disk, C (source) hex files 4-90 8.65

020304-41 AT89C2051-12PC, programmed 6-10 10.80

Stepper Motors Uncovered

020127-41 PIC16F873-20/SP 19-10 33.80

No. 327 DECEMBER 2003

FM Remote Control Transmitter & Receiver

@ 034044-1 PCB 10-20 18.05

GENERAL

Printed-circuit boards (PCBs), self-adhesive front panel foils, ROMs, EPROMs, PALs, GALs, microcontrollers and diskettes for projects which have appeared in Elektor Electronics may be ordered using the Order Form printed opposite. The form may also be used to order books (private customers only).

* The artwork for making a PCB which is not available ready-made through the Readers Services may be found in the relevant article.

- EPROMs, GALs, PALs, (E)PLDs, MACHs, FPGAs and other microcontrollers are supplied ready-programmed.

Prices and item descriptions subject to change. The publishers reserve the right to change prices without prior notification. Prices and item descriptions shown here supersede those in previous issues. E. & O.E

PAST ISSUES

Past issues, if available, should be ordered from Worldwide Subscription Service Ltd, Unit 4, Gibbs Reed Farm, Pashley Road, TICEHURST TN5 7HE, England, telephone (+44) 1580 200657, fax (+44) 1580 200616, email wwss@wwss.demon.co.uk

Prices of past issues (except July/August and December), including postage for single copies, are £4.75 (UK and Eire); £5.30 (air mail Europe); £6.10 (airmail outside Europe). Prices of past July/August and December issues, including postage for single copies, are £6.65 (UK and Eire); £7.35 (airmail Europe); and £8.45 (airmail outside Europe).

PAST ARTICLES

For information on past articles, please contact our Editorial and Administrative Offices, telephone (01580) 200657, fax 200616, email sales@ellektor-electronics.co.uk.

	£	US \$
LED Christmas Decoration		
@ 030157-1 PCB	7-55	13.35
P87LPC76x Programmer		
@ 030313-11 Disk, project software	4-90	8.65
Project Timekeeper		
@ 020350-11 Disk, source & object code files	4-90	8.65
020350-41 PIC16F84-10R, programmed	13-15	23.25
Stepper Motors Uncovered (2)		
@ 020127-11 Disk, source code file	4-90	8.65
Universal Clock Generator		
@ 020395-11 Disk, source code file	4-90	8.65
Wireless RS232 Link		
@ 030204-1 PCB	8-70	15.40

No. 326 NOVEMBER 2003

Precision Measurement Central

@ 030060-4 PCB 8-70 15.40

No. 326 NOVEMBER 2003

Rev Counter for R/C Models

@ 024111-1 PCB 17-50 31.00

024111-11 Disk, source and hex code 4-90 8.65

024111-41 89C2051-12PC, programmed 8-85 15.65

Running Text Display

@ 020407-11 Disk, source and hex code 4-90 8.65

USB Analogue Converter

@ 020374-1 PCB 7-65 13.50

@ 020374-11 Disk, hex code and Windows software 4-90 8.65

020374-41 PIC16C765, programmed 13-25 23.45

No. 325 OCTOBER 2003

DDS RF Signal Generator

@ 020299-1 PCB, generator 11-60 20.55

@ 020299-2 PCB, control/supply 12-10 21.45

020299-41 AT90S8515 8PC, programmed 30-55 54.05

Minimalist Induction-Balance Metal Detector

@ 020290-1 PCB 8-95 15.85

Xilinx PROM Programmer

@ 010109-11 Software 4-90 8.65

No. 324 SEPTEMBER 2003

ATV Picture Generator

@ 020295-11 Disk, source & hex code files 4-90 8.65

020295-41 AT90S8515-8PC, programmed 15-20 26.90

020295-42 AT90S1200-12PC, programmed 13-90 24.60

DTMF Remote Telephone Switch

@ 020294-1 PCB 11-65 20.60

@ 020294-11 Disk, project software 4-90 8.65

020294-41 PIC16F84A-20/R, programmed 14-70 26.00

LC Display with I2C Bus

@ 030060-2 PCB 7-35 13.00

PICProg 2003

@ 010202-1 PCB 9-05 16.00

@ 010202-11 Disk, Windows software 4-90 8.65

010202-41 PIC16F874-20/R, programmed 23-55 41.65

Polyphonic Doorbell

@ 020354-11 Disk, project software 4-90 8.65

020354-41 PIC16F84A-10/R, programmed 14-45 25.55

Precision Measurement Central

030060-91 Ready-assembled & tested board 89-00 112.50

Valve Pre-amplifier (1)

@ 020383-1 PCB, amplifier board 11-55 20.40

@ 020383-2 PCB, power supply board 11-40 20.20

@ 020383-3 PCB, I/O board 10-10 17.80

No. 323 JULY/AUGUST 2003

Add a Sparkle

@ 020293-11 Disk, HEX and source files 4-90 8.65

020293-41 PIC12C509A-04/SM, programmed 7-40 13.10

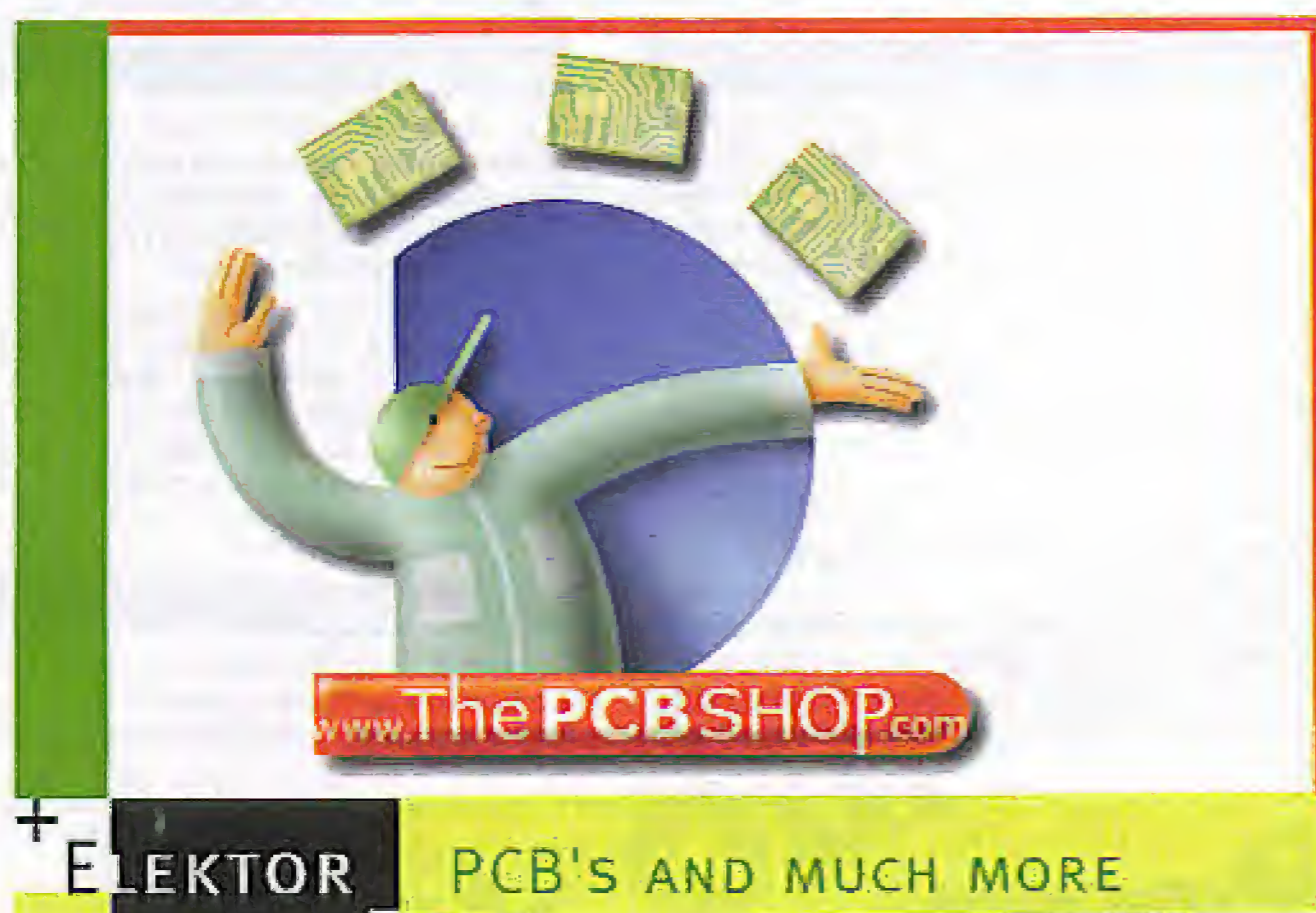

	£	US \$
AT90S2313 Programmer		
@ 034036-1 PCB	9.05	16.00
Hard Disk Selector		
@ 034050-1 PCB	9.45	16.75
Mini Running Text Display		
@ 020365-11 Disk, source code file	4.90	8.65
Mini Test Chart Generator		
@ 020403-11 Disk, PIC source code	4.90	8.65
Programming Tool for ATtiny15		
@ 030030-1 PCB	7.55	13.35
@ 030030-11 Disk, project software	4.90	8.65
Quad Bridge Car Amp		
@ 034039-1 PCB	8.70	15.35
Remote Light Control with Dimmer		
@ 020337-11 Disk, HEX and source files	4.90	8.65
020337-41 AT89C2051-12, programmed	6.25	11.05
No. 322 JUNE 2003		
AVR TV Tennis		
@ 030026-1 Main PCB	8.70	15.40
@ 030026-2 Pushbutton PCB	8.60	15.25
@ 030026-11 Disk, AVR source code	4.90	8.65
030026-41 AT90S8515, programmed	15.20	26.90
Electronic Knotted Handkerchief		
@ 020308-11 Disk, PC and controller software	4.90	8.65
020308-41 AT90S2313-10PC, programmed	12.60	22.30
Low-Cost LCD Controller (2)		
@ 020114-1 PCB	8.70	15.35
@ 020114-11 Disk, project software	4.90	8.65
Night Light Control		
@ 020115-11 Disk, hex and source code	4.90	8.65
020115-41 AT90S2313-10PC, programmed	12.85	22.75
Universal XA Development Board		
@ 010103-1 PCB	13.20	23.35
@ 010103-11 Disk, GAL code, EPROM hex files, XADEV	4.90	8.65
010103-21 EPROM IC6, 27C256-90, programmed	10.00	17.70
010103-22 EPROM IC9, 27C256-90, programmed	10.00	17.70
010103-31 GAL 16V8, programmed	4.80	8.50
No. 321 MAY 2003		
Countdown Timer		
@ 020296-11 Disk, source and hex code	4.90	8.65
020296-41 AT90S1200, programmed	13.90	24.60
USB Audio Recorder		
@ 012013-11 Disk, EPROM hex code	4.90	8.65
012013-21 EPROM 27C512, programmed	12.60	22.30
Valve Final Amp (2)		
@ 020071-1 Amplifier board (one channel)	15.10	26.75
@ 020071-2 Power supply board	10.05	17.75
No. 320 APRIL 2003		
8-Channel Disco Light Controller		
@ 010131-1 PCB	13.10	23.15
010131-41 87C750 or 87C71, programmed	23.00	40.70
Pico PLC		
@ 010059-1 PCB	18.70	33.10
@ 010059-11 Disk, test program	4.90	8.65
Single-Chip Tone Control		
@ 020054-4 PCB	10.90	19.30
Switched-Outlet Power Bar with RS232 Control		
@ 020298-1 PCB	10.80	19.10
@ 020298-11 Disk, project software	4.90	8.65
Temperature Indicator for the PC		
@ 020380-11 Disk, source and compiled code	4.90	8.65

	£	US \$
020380-41 AT89C2051, programmed	10.25	18.15

No. 319 MARCH 2003

17 V / 10 A Switch-Mode Power Supply		
@ 020054-3 PCB	9.45	16.65
Add-on Switch unit for R/C Models		
@ 020126-1 PCB	8.95	15.85
@ 020126-11 Disk, hex and source files	4.90	8.65
020126-41 PIC16C712-041/S0, programmed	15.20	26.90
AVR Development System		
@ 020351-1 PCB	13.20	23.35
@ 020351-11 Disk, example programs	4.90	8.65
Guitar Effects Switchbox		
@ 020181-1 PCB	13.15	23.30
Intelligent Fan Timer		
@ 020170-11 Disk, project software	4.90	8.65
020170-41 MSP430F1121, programmed	11.30	20.00
SAA3049 Replacement		
@ 020085-1 PCB	13.05	23.10
@ 020085-11 Disk, source and hex code	4.90	8.65
020085-41 87LPC7648N, programmed	9.90	17.55
Two-Colour Running Light		
@ 010134-1 PCB, controller board	8.25	14.60
@ 010134-2 PCB, LED board	10.85	18.80
@ 010134-11 Disk, project software	4.90	8.65
010134-41 AT89C2051-12PC, programmed	7.15	12.65

No. 318 FEBRUARY 2003

20/40 MHz Logic Analyser		
@ 020032-1 PCB	15.20	26.85
@ 020032-11 Disk, demo program	4.90	8.65
020032-41 AT90S8515-8PC, programmed	15.10	26.70
Active Loudspeaker System (2)		
@ 020054-2 PCB	7.95	14.05
Autoranging Capacitance Meter		
@ 020144-1 PCB	7.35	13.00
@ 020144-11 Disk, source and hex files	4.90	8.65
020144-41 PIC16F84A-20/P, programmed	15.20	26.90
Dimmer with 0-10 V Control Input		
@ 010125-1 control PCB	9.60	17.00
@ 010125-2 dimmer PCB	8.95	15.85
Electronic Hourglass		
@ 020036-1 PCB	18.55	32.85
@ 020036-11 Disk, project software	4.90	8.65
020036-41 PIC16F84-04/P, programmed	15.20	26.90
Optimise your PC Soundcard		
@ 020184-11 Disk, Excel spreadsheet	4.90	8.65

No. 317 JANUARY 2003

Active Loudspeaker System (1)		
@ 020054-1 PCB	6.90	12.20
Electronic RPG Dice Roller		
@ 020005-1 PCB	10.05	17.75
@ 020005-11 Disk, source code file	4.90	8.65
020005-41 AT90S4433-8PC, programmed	30.80	54.50
Rodent Deterrent		
@ 020110-1 PCB	12.05	21.30
SMS-Controlled Mains Sockets		
@ 020157-1 PCB	12.90	22.85

No. 316 DECEMBER 2002

DCI PLC		
@ 010113-1 PCB, converter board	8.40	14.85
@ 010113-2 PCB, terminal board	12.50	22.10
@ 010113-11 Disk, project software & source code	4.90	8.65
010113-41 AT90S8515-8PC, programmed	21.20	37.55
Port Line and ADC Extension		
@ 020307-11 Disk, BASCOM-51 programs	4.90	8.65
Programmable Dial-Out Blocking Device		
@ 020106-1 PCB	12.20	21.55
@ 020106-11 disk, project software	4.90	8.65
020106-41 AT89C2051-1, programmed	6.50	11.50
USB Audio Codec with S/PDIF		
@ 020178-1 PCB	11.10	19.60

No. 315 NOVEMBER 2002

Audio Level Check for Line Input		
@ 020189-1 PCB	9.25	16.35
EPROM Emulator		
@ 024066-1 PCB	9.35	16.50
@ 024066-11 Disk, GAL JEDEC listing	4.90	8.65
024066-31 GAL 16V8, programmed	5.00	8.85

Products for older projects (if available) may be found on our web site <http://www.elektor-electronics.co.uk>

ORDERING INSTRUCTIONS, P&P CHARGES

Except in the USA and Canada, all orders, except for subscriptions (for which see below), must be sent BY POST or FAX to our Tunbridge Wells address using the Order Form overleaf.

On-line ordering: <http://www.elektor-electronics.co.uk>

Readers in the USA and Canada may (but are not obliged to) send orders, except for subscriptions (for which see below), to the USA address given on the order form. Please apply to Old Colony Sound for applicable P&P charges. Please allow 4-6 weeks for delivery.

Orders placed on our Tunbridge Wells office must include P&P charges (Priority or Standard) as follows:

UK:	£3.50
Europe:	£5.00 (Standard) or £7.00 (Priority)
Outside Europe:	£8.00 (Standard) or £12.00 (Priority)

HOW TO PAY

Unless you have an approved credit account with us, all orders must be accompanied by the full payment, including postage and packing charges as stated above.

Payment may be made by cheque drawn on a London clearing bank (but see para. 4 below), postal order, VISA, Access, MasterCard or EuroCard (when paying by credit card, the order must go the cardholder's address). Do not send cash through the mail. Cheques and postal orders should be crossed and made payable to 'Elektor Electronics (Publishing)'.

Payment may also be made by direct transfer from a private or business Giro account to our Giro account No. 34 152 3801 by completing and sending to the National Giro Centre, in a National Giro postage paid envelope, a National Giro transfer/déposit form. Do not send Giro transfers direct to us, as this will delay your order.

If you live outside the UK, payment may also be made by Bankers' sterling draft drawn on a London clearing bank, Eurocheque made out in pounds sterling (with holder's guarantee card number written on the back), or US or Canadian dollar cheque drawn on a US or Canadian bank.

If you pay by Bankers' sterling draft, make clear to the issuing bank that your full name and address MUST be communicated to the London clearing bank.

Our bankers are NAT WEST PLC, 1 St James's Square, Wadhurst, East Sussex TN5 6BH, England. Our account number is 3512 5225, Sorting Code 60-22-15.

IBAN code: GB40 NWB K6 022 15 3512 5225

BIC code: NWB KGB 2L

COMPONENTS

Components for projects appearing in *Elektor Electronics* are usually available from certain advertisers in this magazine. If difficulties in the supply of components are envisaged, a source will normally be advised in the article. Note, however, that the source(s) given is (are) not exclusive.

TERMS OF BUSINESS

Delivery Although every effort will be made to dispatch your order within 2-3 weeks from receipt of your instructions, we can not guarantee this time scale for all orders.

Returns Faulty goods or goods sent in error may be returned for replacement or refund, but not before obtaining our consent. All goods returned should be packed securely in a padded bag or box, enclosing a covering letter stating the dispatch note number. If the goods are returned because of a mistake on our part, we will refund the return postage.

Damaged goods Claims for damaged goods must be received at our Tunbridge Wells office within 10 days (UK); 14 days (Europe) or 21 days (all other countries).

Cancelled orders All cancelled orders will be subject to a 10% handling charge with a minimum charge of £5.00.

Patents Patent protection may exist in respect of circuits, devices, components, and so on, described in our books and magazines. Elektor Electronics (Publishing) does not accept responsibility or liability for failing to identify such patent or other protection.

Copyright All drawings, photographs, articles, printed circuit boards, programmed integrated circuits, diskettes and software carriers published in our books and magazines (other than in third-party advertisements) are copyright and may not be reproduced or transmitted in any form or by any means, including photocopying and recording, in whole or in part, without the prior permission of Elektor Electronics (Publishing) in writing. Such written permission must also be obtained before any part of these publications is stored in a retrieval system of any nature.

Notwithstanding the above, printed-circuit boards may be produced for private and personal use without prior permission.

Limitation of liability Elektor Electronics (Publishing) shall not be liable in contract, tort, or otherwise, for any loss or damage suffered by the purchaser whatsoever or howsoever arising out of, or in connexion with, the supply of goods or services by Elektor Electronics (Publishing) other than to supply goods as described or, at the option of Elektor Electronics (Publishing), to refund the purchaser any money paid in respect of the goods.

Law Any question relating to the supply of goods and services by Elektor Electronics (Publishing) shall be determined in all respects by the laws of England.

January 2004

Subscription rates from January 2004 issue

	Standard	Plus
United Kingdom	£39.50	£45.50
Economy Mail		
Rest of the World (excluding Europe)	£51.30	£57.30
Priority Airmail		
Europe & Eire	£52.50	£58.50
Middle East, Africa, Southwest Asia, Central & South America	£64.00	£70.00
Australia, New Zealand, Far East & Pacific Territories	£66.00	£72.00
Airfreight		
USA & Canada only	US\$88.00	US\$96.50

Payment should be made by:

- Cheque or bankers' draft in sterling drawn on a London clearing bank (except in the USA and Canada — see below); Eurocheques must have the holder's guarantee card number written on the back.
- US\$ cheques drawn on a US or Canadian bank — only by subscribers in the USA or Canada.
- Direct transfer to our bank (NAT WEST PLC, 1 St James's Square, Wadhurst, East Sussex TN5 6BH, England). Our account number is 3512 5225, Sorting Code 60-22-15.
- Postal order.
- Credit card: VISA, ACCESS, Euro/MasterCard, JCB Electron or Switch.
- Transfer to our Giro Account number 34 152 3801. Giro transfers should be

made by completing and sending the appropriate transfer/déposit form to the National Giro Centre (UK) or to your national Giro Centre.

Cheques and postal orders should be made payable to Elektor Electronics (Publishing). Do not send cash through the mail.

Subscription conditions

The standard subscription order period is twelve months. If a permanent change of address during the subscription period means that copies have to be despatched by a more expensive service, no extra charge will be made. Conversely, no refund will be made, nor expiry date extended, if a change of address allows the use of a cheaper service.

Student applications, which qualify for a 20% (twenty per cent) reduction in current rates, must be supported by evidence of studentship signed by the head of the college, school or university faculty. A standard Student Subscription costs £31.60, a Student Subscription-Plus costs £37.60 (UK only).

Please note that new subscriptions take about four weeks from receipt of order to become effective.

Cancelled subscriptions will be subject to a charge of 25% (twenty-five per cent) of the full subscription price or £7.50, whichever is the higher, plus the cost of any issues already dispatched. Subscriptions cannot be cancelled after they have run for six months or more.

January 2004

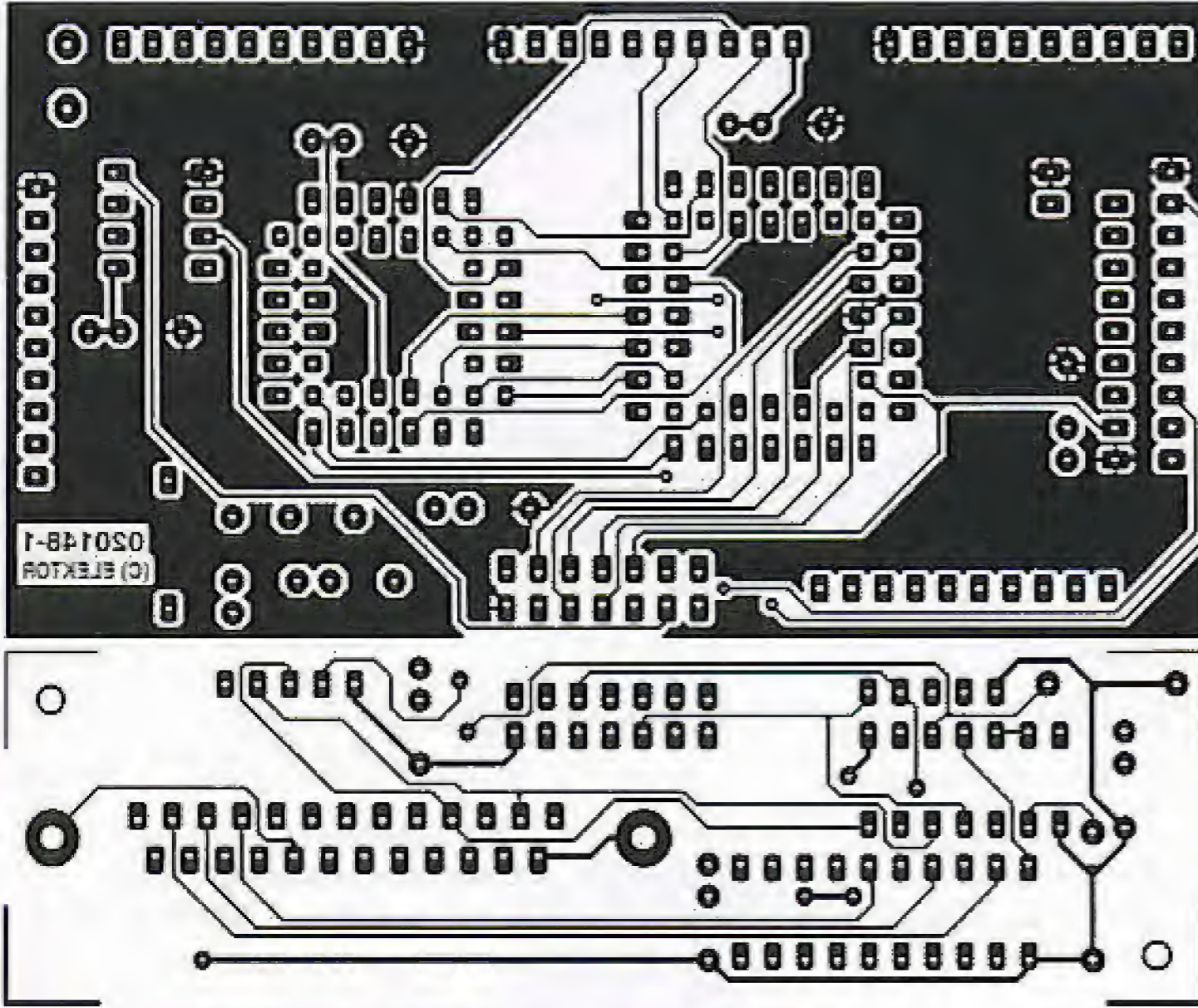

Drop-in Microcontroller Board 020148-1 (solder side)

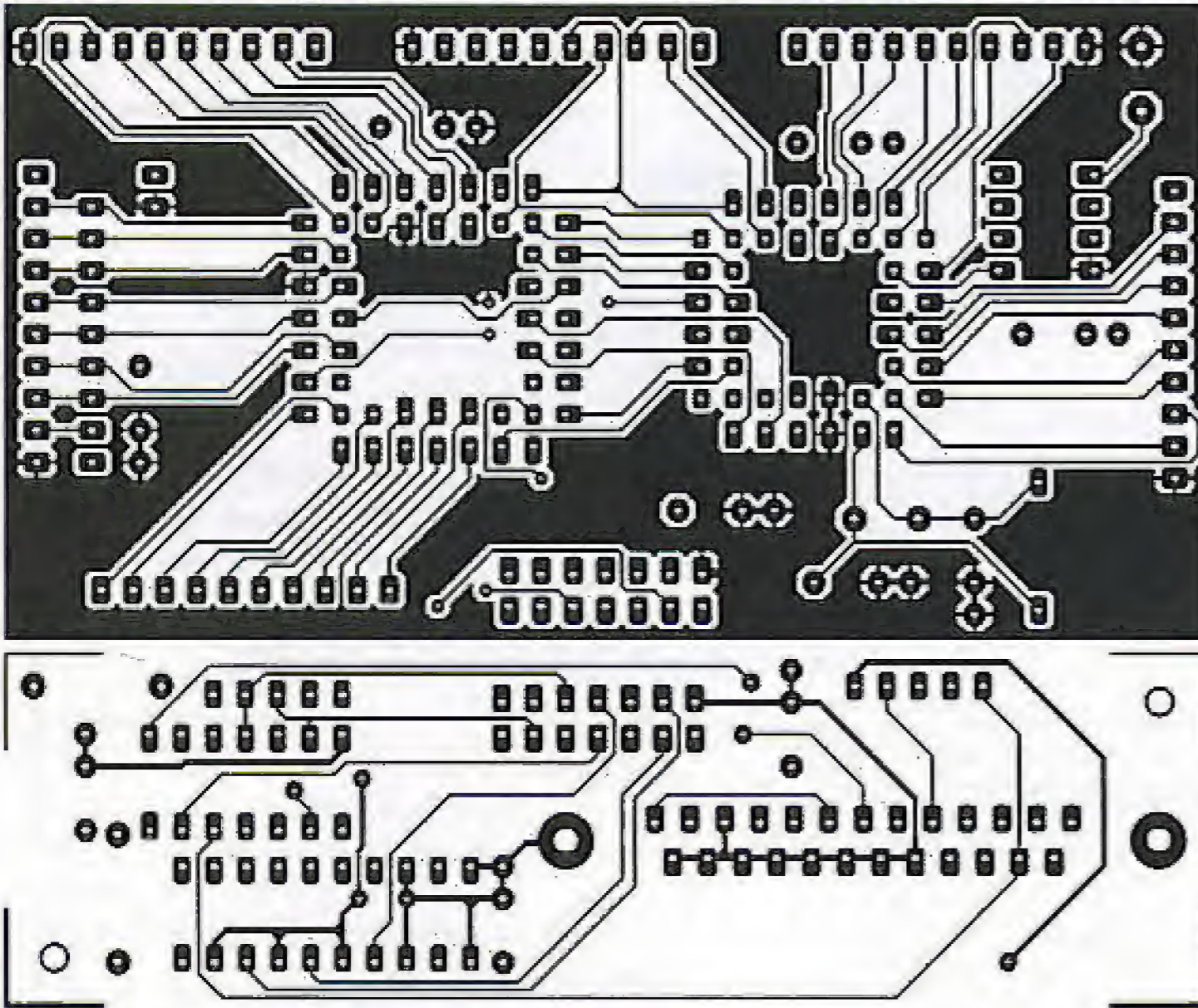

Drop-in Microcontroller Board 020148-1 (components side)

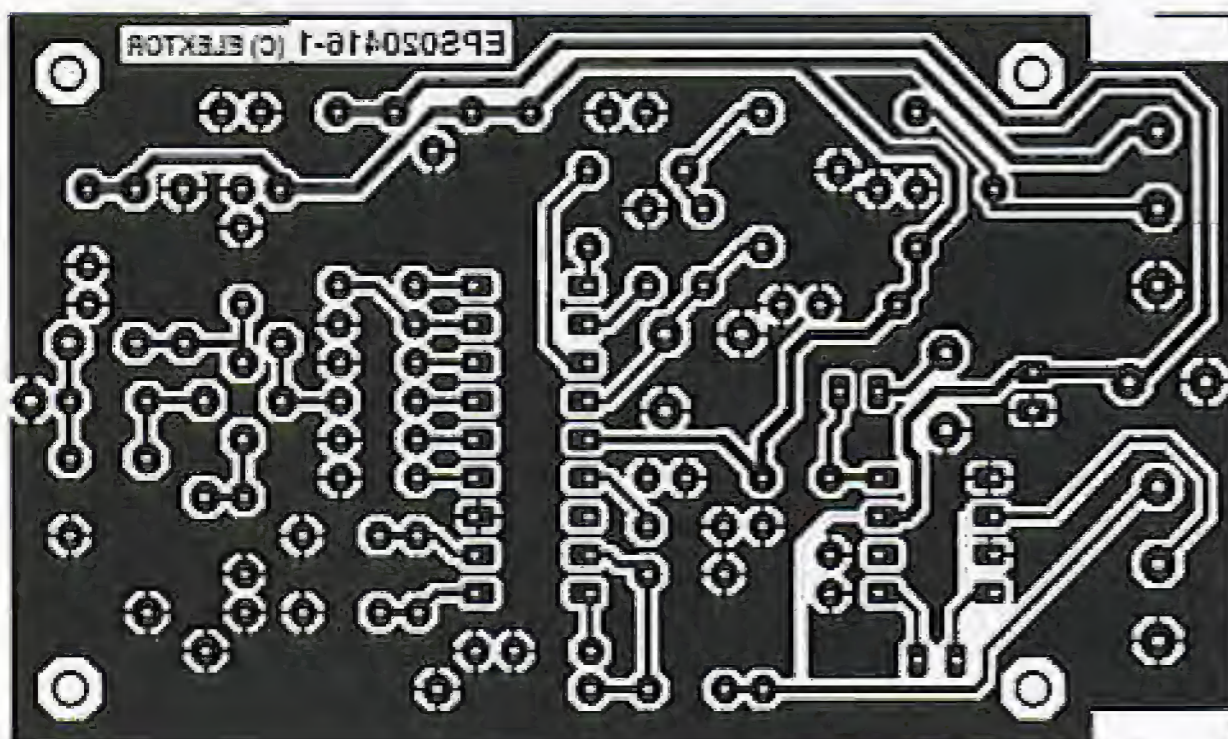

VHF-Low Explorer 020416-1

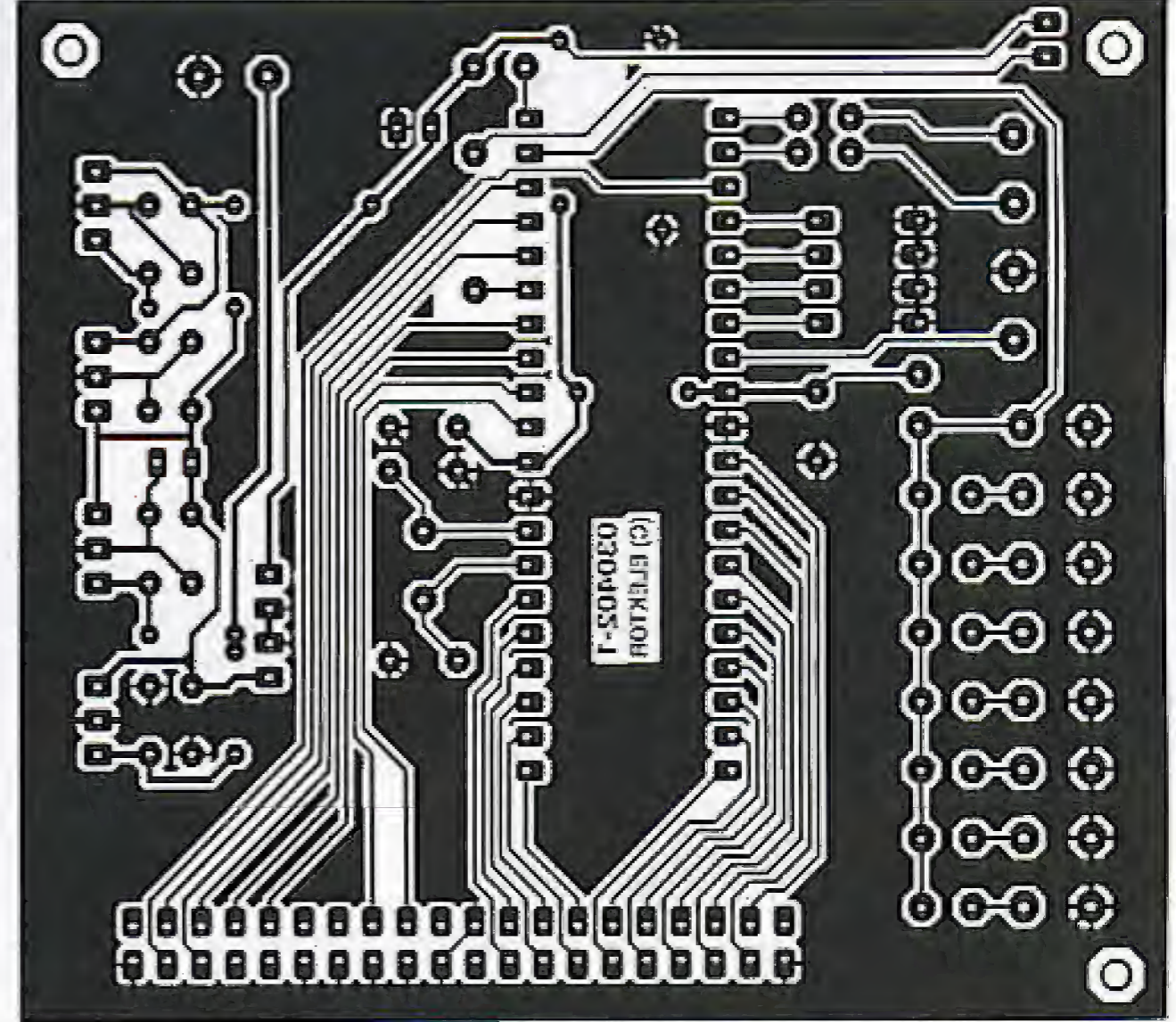

Pandora's Sound & Music Box 030402-1

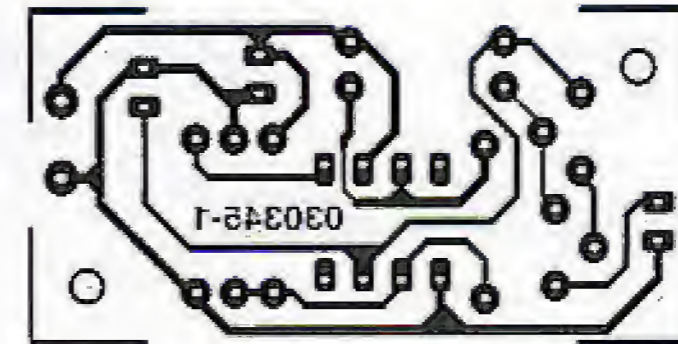

Low-Power LED Flash 030345-1

All PCB layouts shown reflected and at true size (100%) unless otherwise stated.

Digital Anemometer with Wind Direction Indicator

Apart from the use of a PIC 16F876 micro-controller in combination with a digital readout, this project is special because the wind direction meter does not employ a vane or similar. Instead, the wind direction is derived from the rotational signal supplied by the wind speed sensor!

Sensors

The main feature in the May 2004 issue will be 'sensors' and include subjects like

- news from the Massachusetts Institute of Technology (MIT) on polymer sensors and their miniaturization;
- developments and trends;
- insight and background: tyre pressure sensor and systems.

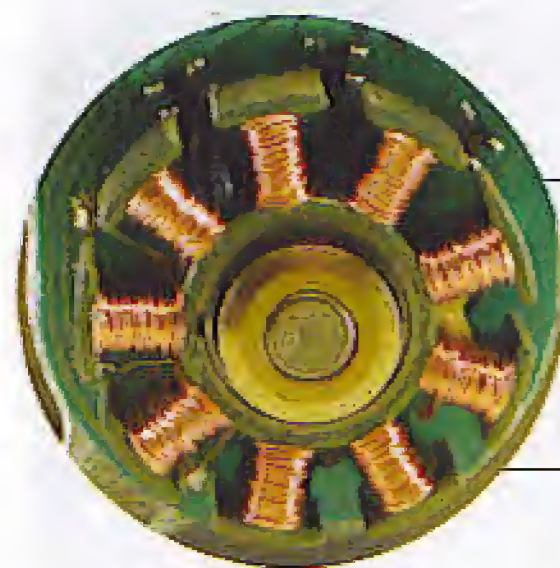
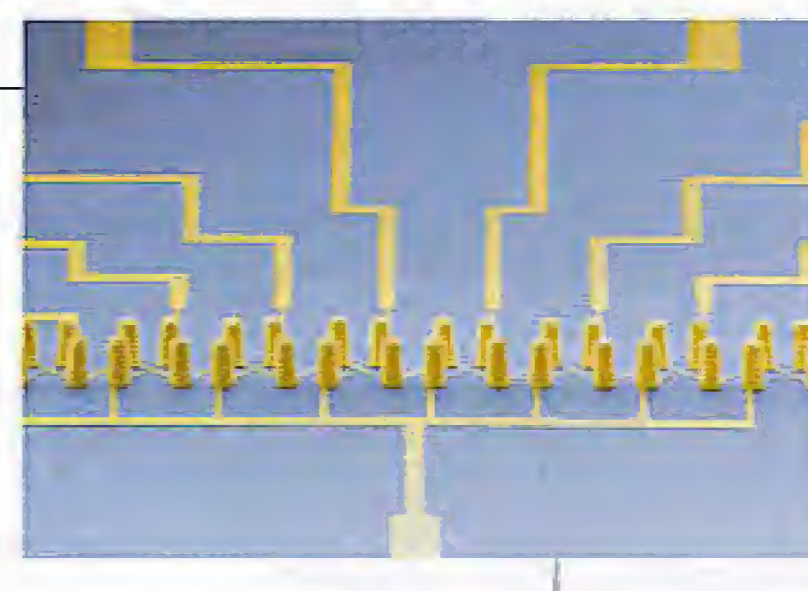

Stepper Motor Control

Lots of practical advice and hardly any theory — taking it step by step using a driver board and example programs for popular software development platforms.

Also...

- Infrared module for microcontrollers and PDAs
- Voltage control for SMPSUs
- Quartz crystal oscillator
- MAX7000 prototyping board
- Room thermometer
- Canon AOS cameras go wireless

TV Commercials Killer for VCRs

TV commercials are a nuisance to say the least, particularly if they are recorded with a film or a sports programme. It doesn't have to be like that. Our TV Commercials Killer analyses the broadcast signal and responds the moment the station logo disappears (or appears again) — controlling the VCR by means of infrared (as with the remote control).

RESERVE YOUR COPY NOW!

The May 2004 issue goes on sale on Friday 22 April 2004 (UK distribution only). UK subscribers will receive the magazine a few days before this date. Article titles and magazine contents subject to change.

NEWSAGENTS ORDER FORM

SHOP SAVE / HOME DELIVERY

Please save / deliver one copy of *Elektor Electronics* magazine for me each month

Name:
 Address:
 Post code:
 Telephone:
 Date:
 Signature:



Please cut out or photocopy this form, complete details and hand to your newsagent. *Elektor Electronics* is published on the third Friday of each month, except in July. Distribution S.O.R. by Seymour (NS).

INDEX OF ADVERTISERS

Beta Layout, Net Links	www.pcb-pieol.com	26, 74	MOP Electronics, Net Links	www.mopelectronics.co.uk	74
Burn Technology LTD, Net Links	www.burntec.com	74	Net Links		74, 75
CMS	www.cms.uk.com	37	New Wave Concepts, Net Links	www.new-wave-concepts.com	74
Compucut, Net Links	www.compucutters.com	74	Number One Systems	www.numberone.com	27
Conford Electronics, Net Links	www.confordelec.co.uk	74	PAGM	www.pagm.co.uk	2
Cricklewood		72	Peak Electronic, Net Links	www.peakelec.co.uk	74
Danbury, Net Links	www.mc-h.demon.co.uk	27, 74	Pico	www.drdaq.com	51
Debug Innovations, Net Links	www.debuginnovations.com	74	Pond Electronics, Net Links	www.pond.ie	74
Display Electronics	www.distel.co.uk	73	Quasar Electronics, Net Links	www.quasarelectronics.com	75, 83
Easysync, Net Links	www.easysync.co.uk	74	Robot Electronics, Net Links	www.robot-electronics.co.uk	75
Elexol, Net Links	www.elexol.com	74	Spiceage and Spicycle, Net Links	www.spiceage.com	75
ELM Electronics, Net Links	www.elmelectronics.com	74	Stewart of Reading	www.stewart-of-reading.co.uk	76
Eltec, Net Links	www.eltec.com	74	Technobots, Net Links	www.technobots.co.uk	75
Ennovi	www.ennovi.co.uk	27	Telnet, Net Links	www.telnet.uk.com	75
Ervan, Net Links	www.ervan-int.com	74	Ultraleds, Net Links	www.ultraleds.co.uk	75
Eurocircuits	www.thepcbshop.com	78	USB Instruments, Net Links	www.usb-instruments.com	75
Forest, Net Links	www.ired.co.uk	26, 74	Vero Technology	www.verotl.com	67
Future Technology Devices, Net Links	www.ftdichip.com	74	Viewcom, Net Links	www.viewcom.f9.co.uk	75
Futurtec, Net Links	www.futurtec.com	74			
Hammond Electronics, Net Links	www.hammondmfq.com	74			
ITP	www.itp101.com	26			
Labcenter	www.labcenter.co.uk	84			
London Electronics College, Net Links	www.lec.org.uk	74			
Matrix Multimedia Ltd	www.matrixmultimedia.co.uk	67			
Milford Instruments	www.milinst.demon.co.uk	50			

ADVERTISING SPACE for the issue of 18 May 2004 may be reserved not later than 21 April 2004 with Elektor Electronics (Publishing) Advertisement Office – 3 Crescent Terrace – Cheltenham GL50 3PE – England – Telephone 01242 510 760 – Fax 01242 226 626 – e-mail: bernardhubbard@ukonline.co.uk to whom all correspondence, copy instructions and artwork should be addressed.



Quasar Electronics Limited
 PO Box 6935, Bishops Stortford,
 CM23 4WP
 Tel: 0870 246 1826
 Fax: 0870 460 1045
 E-mail: sales@quasarelectronics.com

Add £3.00 P&P to all UK orders or 1st Class Recorded - £5,
 Next Day (insured £250) - £8, Europe - £6, Rest of World - £10 (order
 online for reduced price UK Postage).
 We accept all major credit/debit cards. Make cheques/PO's payable
 to Quasar Electronics. Prices include 17.5% VAT.
 Call now for our FREE CATALOGUE with details of over 300 kits,
 projects, modules and publications.
 MAIL ORDER ONLY.

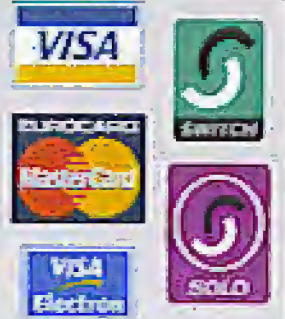

QUASAR
 electronics
 Helping you make the right connections!

0871

CREDIT CARD
 SALES

717 7168

Motor Drivers/Controllers

Here are just a few of our controller and driver modules for AC, DC, unipolar/bipolar stepper motors and servo motors. See website for full details.

DC Motor Speed Controller (5A/100V)

Control the speed of almost any common DC motor rated up to 100V/5A. Pulse width modulation output for maximum motor torque at all speeds. Supply: 5-15VDC. Box supplied. Dimensions (mm): 60Wx100Lx60H. Kit Order Code: 3067KT - £12.95
 Assembled Order Code: AS3067 - £19.95

NEW! PC / Standalone Unipolar Stepper Motor Driver

Drives any 5, 6 or 8-lead unipolar stepper motor rated up to 6 Amps max.

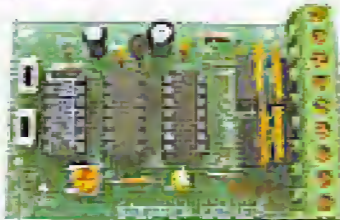

Provides speed and direction control. Operates in stand-alone or PC-controlled mode. Up to six 3179 driver boards can be connected to a single parallel port. Supply: 9V DC. PCB: 80x50mm. Kit Order Code: 3179KT - £9.95
 Assembled Order Code: AS3179 - £16.95

PC Controlled Dual Stepper Motor Driver

Independently control two unipolar stepper motors (each rated up to 3 Amps max.) using PC parallel port and software interface provided. Four digital inputs available for monitoring external switches and other inputs. Software provides three run modes and will half-step, single-step or manual-step motors. Complete unit neatly housed in an extended D-shell case. All components, case, documentation and software are supplied (stepper motors are NOT provided). Dimensions (mm): 55Wx70Lx15H. Kit Order Code: 3113KT - £15.95
 Assembled Order Code: AS3113 - £24.95



NEW! Bi-Polar Stepper Motor Driver

Drive any bi-polar stepper motor using externally supplied 5V levels for stepping and direction control. These usually come from software running on a computer. Supply: 8-30V DC. PCB: 75x85mm. Kit Order Code: 3158KT - £12.95
 Assembled Order Code: AS3158 - £26.95

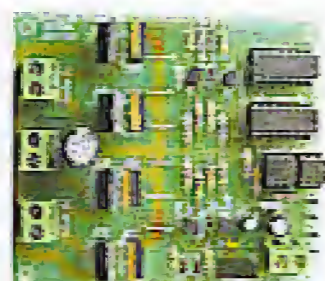

Most items are available in kit form (KT suffix) or assembled and ready for use (AS prefix).

Controllers & Loggers

Here are just a few of the controller and data acquisition and control units we have. See website for full details. Suitable PSU for all units; Order Code PSU203 £9.95

Rolling Code 4-Channel UHF Remote

State-of-the-Art. High security. 4 channels. Momentary or latching relay output. Range up to 40m. Up to 15 Tx's can be learnt by one Rx (kit includes one Tx but more available separately). 4 indicator LED's. Rx: PCB 77x85mm, 12VDC/6mA (standby). Two and Ten channel versions also available. Kit Order Code: 3180KT - £41.95
 Assembled Order Code: AS3180 - £49.95



Computer Temperature Data Logger

4-channel temperature logger for serial port. °C or °F. Continuously logs up to 4 separate sensors located 200m+ from board. Wide range of free software applications for storing/using data. PCB just 38x38mm. Powered by PC. Includes one DS1820 sensor and four header cables. Kit Order Code: 3145KT - £22.95
 Assembled Order Code: AS3145 - £29.95
 Additional DS1820 Sensors - £3.95 each



NEW! DTMF Telephone Relay Switcher

Call your phone number using a DTMF phone from anywhere in the world and remotely turn on/off any of the 4 relays as desired. User settable Security Password, Anti-Tamper, Rings to Answer, Auto Hang-up and Lockout. Includes plastic case. 130x110x30mm. Power: 12VDC. Kit Order Code: 3140KT - £39.95
 Assembled Order Code: AS3140 - £59.95

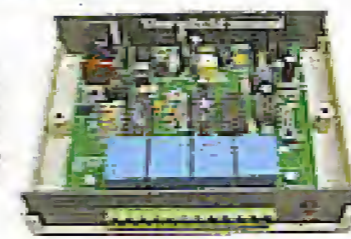

Serial Isolated I/O Module

PC controlled 8-Relay Board. 115/250V relay outputs and 4 isolated digital inputs. Useful in a variety of control and sensing applications. Uses PC serial port for programming (using our new Windows interface or batch files). Once programmed unit can operate without PC. Includes plastic case 130x100x30mm. Power Supply: 12VDC/500mA. Kit Order Code: 3108KT - £54.95
 Assembled Order Code: AS3108 - £64.95

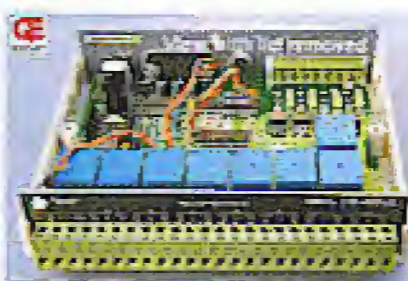

Infrared RC Relay Board

Individually control 12 on-board relays with included infrared remote control unit. Toggle or momentary. 15m+ range. 112x122mm. Supply: 12VDC/0.5A
 Kit Order Code: 3142KT - £41.95
 Assembled Order Code: AS3142 - £59.95

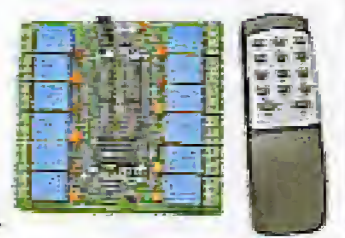

PIC & ATMEL Programmers

We have a wide range of low cost PIC and ATMEL Programmers. Complete range and documentation available from our web site.

Programmer Accessories:

40-pin Wide ZIF socket (ZIF40W) £15.00
 18V DC Power supply (PSU215) £19.95
 Leads: Parallel (LEAD108) £4.95 / Serial (LEAD76) £4.95 / USB (LEADUAA) £2.95

NEW! USB 'All-Flash' PIC Programmer

USB PIC programmer for all 'Flash' devices. No external power supply making it truly portable. Supplied with box and Windows Software. ZIF Socket and USB Plug A-A lead not incl. Kit Order Code: 3128KT - £29.95
 Assembled Order Code: AS3128 - £39.95



Enhanced "PICALL" ISP PIC Programmer

Will program virtually ALL 8 to 40 pin PICs plus a range of ATMEL AVR, SCENIX SX and EEPROM 24C devices. Also supports In System Programming (ISP) for PIC and ATMEL AVRs. Free software. Blank chip auto detect for super fast bulk programming. Requires a 40-pin wide ZIF socket (not included). Kit Order Code: 3144KT - £54.95
 Assembled Order Code: AS3144 - £59.95



ATMEL 89xxx Programmer

Uses serial port and any standard terminal comms program. 4 LED's display the status. ZIF sockets not included. Supply: 16-18VDC. Kit Order Code: 3123KT - £29.95
 Assembled Order Code: AS3123 - £34.95

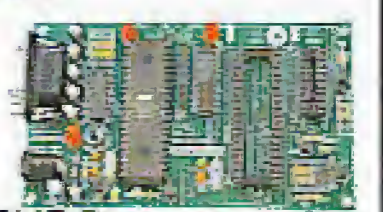

NEW! USB & Serial Port PIC Programmer

USB/Serial connection. Header cable for ICSP. Free Windows software. See website for PICs supported. ZIF Socket/USB Plug A-A lead extra. Supply: 18VDC. Kit Order Code: 3149KT - £29.95
 Assembled Order Code: AS3149 - £44.95

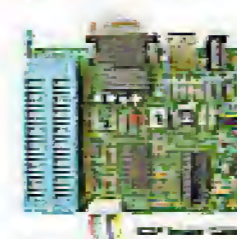

No.1
3KITS

www.quasarelectronics.com

Secure Online Ordering Facilities • Full Product Listing, Descriptions & Photos • Kit Documentation & Software Downloads

PROTEUS

The Complete Electronics Design System

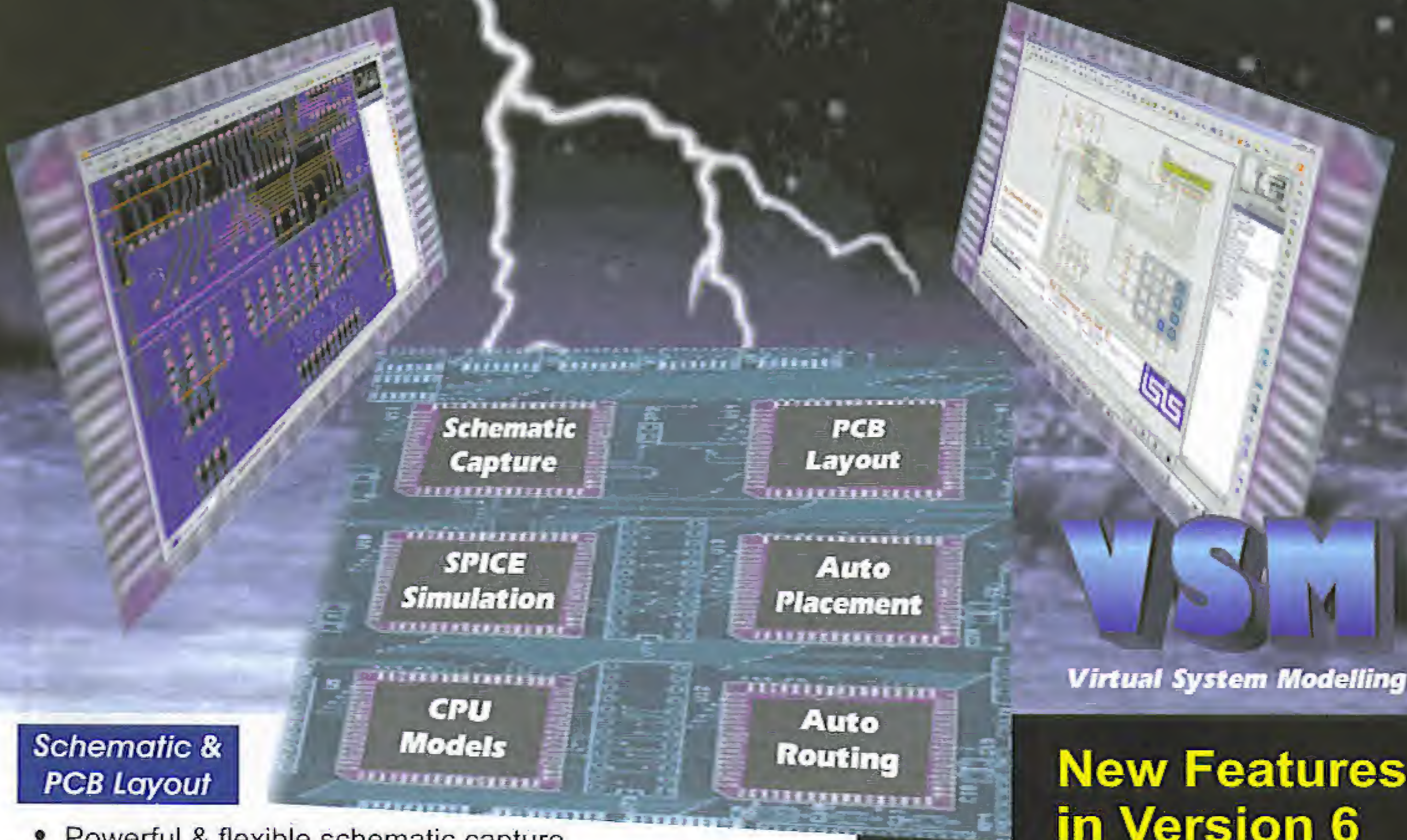

Schematic & PCB Layout

- Powerful & flexible schematic capture.
- Auto-component placement and rip-up/retry PCB routing.
- Polygonal gridless ground planes.
- Libraries of over 8000 schematic and 1000 PCB parts.
- Bill of materials, DRC reports and much more.

Mixed Mode SPICE Circuit Simulation

- Berkeley SPICE3F5 simulator with custom extensions for true mixed mode and interactive simulation.
- 6 virtual instruments and 14 graph based analysis types.
- 6000 models including TTL, CMOS and PLD digital parts.
- Fully compatible with manufacturers' SPICE models.

Proteus VSM - Co-simulation and debugging for popular Micro-controllers

- Supports PIC, AVR, 8051, HC11 and ARM micro-controllers.
- Co-simulate target firmware with your hardware design.
- Includes interactive peripheral models for LED and LCD displays, switches, keypads, virtual terminal and much, much more.
- Provides source level debugging for popular compilers and assemblers from Crownhill, IAR, Keil, and others.

VSM

Virtual System Modelling

New Features in Version 6

- Drag and drop toolbars.
- Visual PCB packaging tool.
- Improved route editing.
- Point and click DRC report.
- Multiple design rules (per net).
- Multiple undo/redo.

Call Now for Upgrade Pricing

labcenter

Electronics
53-55 Main Street, Grassington. BD23 5AA

Tel: 01756 753440
Fax: 01756 752857

Contact us for
Free Demo CD

Works with
PIC Basic Plus
from Crownhill
Associates

www.labcenter.co.uk
info@labcenter.co.uk