

ELEKTOR ELECTRONICS

MARCH 2004
£3.70

THE ELECTRONICS & COMPUTER MAGAZINE

www.elektor-electronics.co.uk



**Multifunction
Frequency
Meter**



**Multichannel
Failsafe for
RC Models**

Wind Power

**Data Storage
on CF Cards**

Code Lock

**AVR450
Battery Charger**

BUILD YOUR OWN DRM RECEIVER

enjoy digital

MW & SW

broadcasts

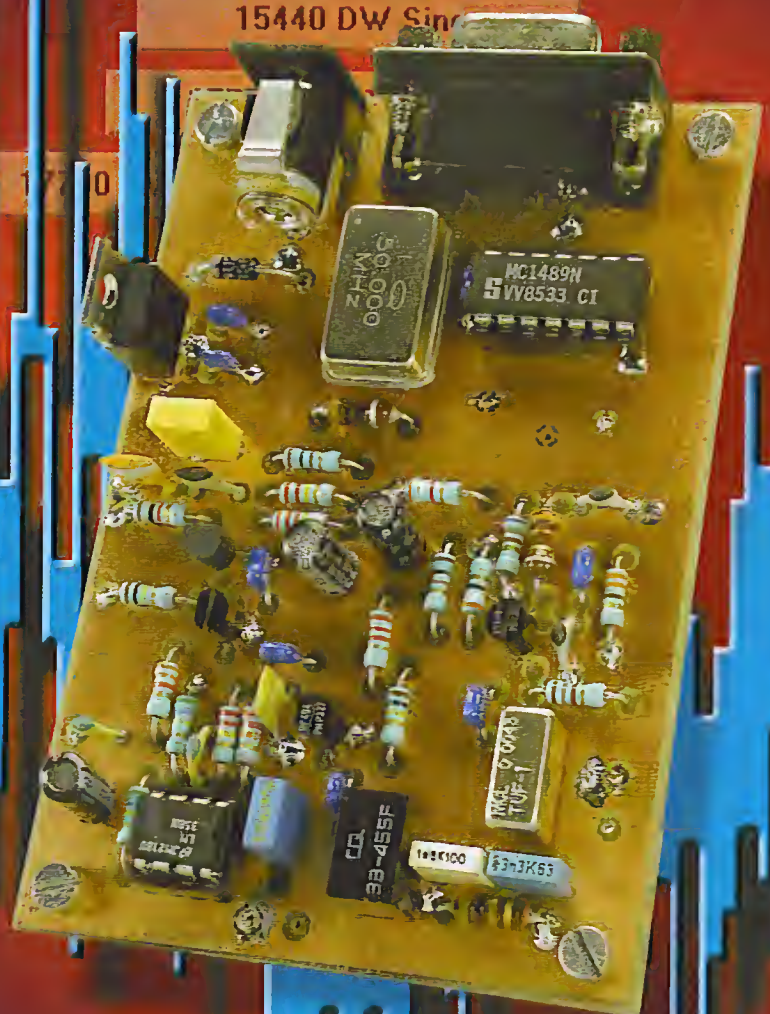

PAGM

The leaders in PIC development

FROM

£99



EASE OF USE

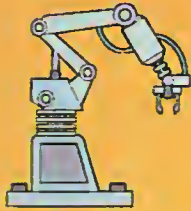

AUTOMATION

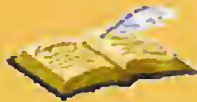

SCRIPTABILITY

- ◆ All you need to get started with PIC
- ◆ Industry standard/quality board
- ◆ Open the box and get coding
- ◆ Available with C compiler or use our PicScript to write programs using simple commands...

**NO ASSEMBLER,
NO COMPILER,
JUST WRITE AND RUN**

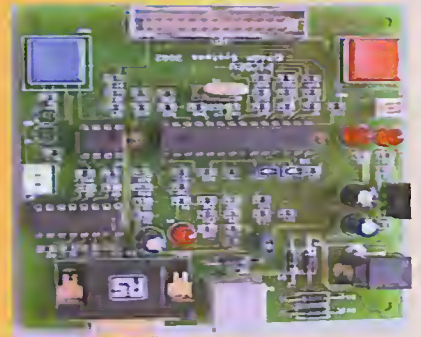

PicDev Board with PicScript

£99.00 (plus p+p)

This is a complete development suite for the novice or non programmer.

It is shipped with:

- PicDev Board
- PicShell and PicScript software
- Breakout board
- Cables
- Example scripts

PicDev Board with C Compiler

£165.00 (plus p+p)

This is a complete development suite for the more advanced programmer.

It is shipped with:

- PicDev Board
- PicShell and PicScript software
- C compiler
- Breakout board
- Cables
- Example scripts
- ICD1

Both items require

- PC with serial port available
- Power supply adapter

To order:

www.pagm.co.uk

sales@pagm.co.uk

Tel: +44 (0)1792 891927



The choice is yours!
Fill out the Subscription
Order Form in this maga-
zine or on our website
and post it today!
Your welcome gift will be
sent to you as soon as
possible after receipt of
your subscription pay-
ment.

The Volume 2003 CD-ROM is
automatically sent to you when
published (February 2004)

If you take out an
annual subscription
to ELEKTOR ELEC-
TRONICS you may
choose between
two types of sub-
scription.

[www.elektor-
electronics.co.uk](http://www.elektor-electronics.co.uk)

PICK YOUR OWN SUBSCRIPTION TYPE AND RECEIVE THIS SURVIVAL KIT¹

This survival kit consists of a collapsible compass with various functions, a lightweight but robust torchlight (batteries included) and a 9-piece stainless steel pair of pliers with 14 functions.



- 1 Elektor Electronics Subscription-PLUS priced at £45.50 (UK).**
You receive 11 issues (includes July/August double issue) **plus a copy of the Volume 2003 CD-ROM.** This CD-ROM contains the complete Volume 2003 of Elektor Electronics, including **diagrams, PCB layouts and an extensive search function.**
The normal price is £16.25 (plus P&P). However on choosing Subscription Plus the Volume 2003 CD-ROM is included in the price, and you do not pay postage.
Your saving: £10.00!
- 2 Elektor Electronics annual subscription priced at £39.50 (UK).**
You receive 11 issues (includes July/August double issue).

A standard annual subscription costs £39.50 in the United Kingdom; ECONOMY MAIL: £51.30 in the rest of the world; PRIORITY AIRMAIL: £52.30 in Europe and Eire, £64.00 in the Middle East, Africa, Southwest Asia, Central & South America, £66.00 in Australia, Far East & Pacific Territories; AIRFREIGHT: US\$88.00 in USA & Canada only.
Subscription-PLUS prices may be found on the reverse of the Subscription Order form, and on our website.

**ELEKTOR
ELECTRONICS**
THE ELECTRONICS & COMPUTER MAGAZINE

¹ Only applicable if the new subscriber did not subscribe to Elektor Electronics in the past 12 months. Offer subject to availability.

Produced and published by
Elektor Electronics (Publishing), PO. Box 190,
Tilburgse Weide TNS 7MY, England.
Telephone: (+44) (0)1580 200657. Fax: (+44) (0)1580 200616
Internet: www.elektor-electronics.co.uk
Email: sales@elektor-electronics.co.uk

Editor: Jan Buiting
Email: editors@elektor-electronics.co.uk

Laboratory Staff: Karel Walraven, Ton Giesberts, Paul Goossens,
Luc Lemmens, Peter Verhoosel (PCB design)
Email: techdept@segment.nl
International Secretariat: Hedwig Herreijnders, Marion Jeurhormie
Email: secretariat@segment.nl

Publisher: Pierre Kersemakers
Email: p.kersemakers@segment.nl

UK Advertising
Bernard Hubbard, 3 Crescent Terrace,
Cheltenham GL50 3FE, England
Telephone: (+44) (0)1242 510740. Fax: (+44) (0)1242 226626
Email: bernardhubbard@ukonline.co.uk
Advertising rates and terms available on request.

International Advertising
K. Caldenhoven, address as Head Office
Email: advertsales@elektuur.nl
Advertising rates and terms available on request.

Subscriptions
Worldwide Subscription Service Ltd., Unit 4
Gibbs Read Farm, Pashley Road, Ticehurst TN5 7HE, England.
Telephone: (+44) (0)1580 200657. Fax: (+44) (0)1580 200616
Email: wvss@wvss.demon.co.uk
Rates and terms are given on the Subscription Order Form

Head Office
Segment b v
PO. Box 75 NL-6190-AB Beek The Netherlands
Telephone: (+31) 46 4389444. Fax: (+31) 46 4370161

Distribution
Seymour, 86 Newman Street, London W1P 3LD, England

Copyright notice
The circuits described in this magazine are for domestic use only. All drawings, photographs, printed circuit board layouts and article texts published in the editorial section of the magazine are copyright Segment b v and may not be reproduced or transmitted in any form or by any means, including photocopying, scanning or recording, in whole or in part without prior written permission from the Publishers. Such written permission must also be obtained before any part of this publication is stored in a retrieval system of any nature.

Patent protection may exist in respect of circuits, devices, components etc. described in this magazine. The Publisher does not accept responsibility for failing to identify such patent(s) or other protection.

The submission of designs or articles implies permission to the Publishers to alter the text and design, and to use the contents in other Segment publications and activities. The Publishers cannot guarantee to return any material submitted to them.

Technical Queries
We can only answer questions or remarks of general interest to our readers, concerning projects not older than two years and published in Elektor Electronics. In view of the amount of post received, it is not possible to answer all correspondence, and we are unable to respond to individual wishes and requests for modifications to, or additional information about, Elektor Electronics projects. To find article titles and issue/page references, please use our EIT (Elektor Item Tracer) which is available on floppy disk (see Readers Services). We do not supply kits for the projects described in this magazine. Our supply range is limited to PCBs, CD-ROMs, diskettes, programmed microcontrollers, GALs, PALs, FPGAs and EPROMs. All other parts for building our projects should be purchased from kit/component suppliers advertising in this magazine.

Overseas Editions
Elektor is also published in The Netherlands, Germany, France. French-edition also appear in Sweden, Finland, Greece, India, Poland, Portugal and Spain. Please contact Head Office for address information.

© Segment b v 2004
Printed in the Netherlands

Elektor Electronics is published monthly, except in August. The magazine is available from newsagents, bookshops and electronics retail outlets, or on subscription.

CONSTRUCTION PROJECTS

Build Your Own DRM Receiver

One again Elektor Electronics makes its competitors take a very distant back seat by publishing the world's first homebuilt DRM receiver for digital (MP4-quality) broadcasts in the medium and shortwave bands. The receiver is of a surprisingly simple design and supplies a 12-kHz output signal for easy connection to your PC's soundcard which handles the demodulation and MPEG decoding.



12

Multifunction Frequency Meter

Despite its surprisingly simple hardware design and construction, the superb frequency meter / event counter described in this article couples ease of use to a plethora of measurement options.

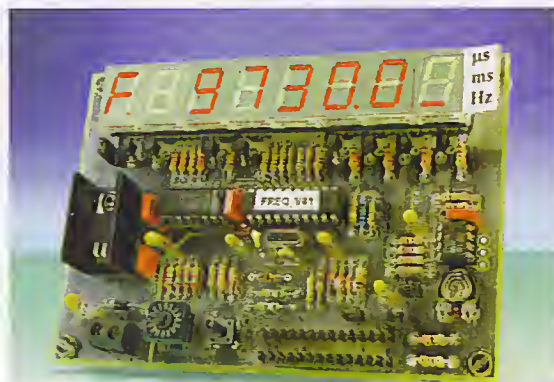

The successful combination is mainly due to the use of a microcontroller running some really ingenious software. The keywords in the general design of the instrument were noise immunity, reliability and functionality.

20

Code Lock

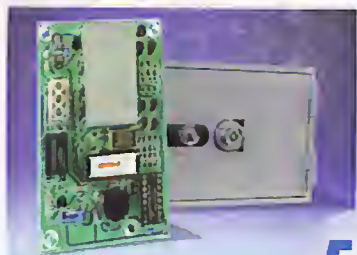

Most code locks or electronic entry systems need a 10-way keypad to enter a code number sequence. This design performs the same function but takes a more circular route...

52

INFORMATIVE ARTICLES

Wind Power

The UK Government recently announced the world's biggest ever expansion in wind energy. So how realistic is this scheme? What are the pitfalls, technical and otherwise, and how viable is it economically? It's time to look at wind generation in the round.



56

Blackfin DSP Development Kit

Experimenting with DSPs is a fascinating pastime, but it can be difficult to find a good place to start. Generally speaking, DSP circuits use very high frequencies, which makes the PCB layout quite critical. In addition, DIY soldering of these components is almost impossible, because they are packaged in so-called Ball Grid Arrays (BGAs). How then, can we overcome these difficulties?

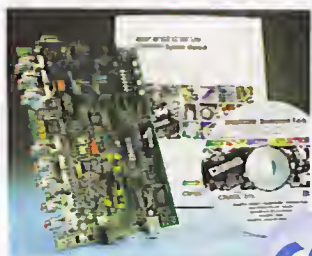

60

Construction Projects

- 12 Build Your Own DRM Receiver
- 20 Multifunction Frequency Meter
- 28 Hands-on CPLDs (2)
- 36 Multichannel Failsafe for Radio Controlled Models
- 46 Data Storage on Compact Flash Cards
- 50 Voltage & Continuity Tester
- 52 Code Lock

Informative Articles

- 40 Application Note: AVR450 Battery Charger
- 56 Wind Power
- 60 Blackfin DSP Development Kit
- 64 500 Links on Microcontrollers

Regulars

- 11 New Products
- 67 Readers Services
- 74 Sneak Preview
- 74 Index of Advertisers



Quasar Electronics Limited
 PO Box 6935, Bishops Stortford,
 CM23 4WP
 Tel: 0870 246 1826
 Fax: 0870 460 1045
 E-mail: sales@quasarelectronics.com

Add £2.00 P&P to all UK orders. 1st Class Recorded - £4.
 Next day (insured £250) - £7. Europe - £5. Rest of World - £10.
 We accept all major credit/debit cards. Make cheques/PO's
 payable to Quasar Electronics Limited.
 Prices include 17.5% VAT. MAIL ORDER ONLY.
 Call now for our FREE CATALOGUE containing details of
 over 300 electronic kits, projects and modules.



QUASAR 0871 CREDIT CARD 717 7168
 electronics SALES

Motor Drivers/Controllers

Here are just a few of our controller and driver modules for AC, DC, unipolar/bipolar stepper motors and servo motors. See website for full details.

DC Motor Speed Controller (5A/100V)

Control the speed of almost any common DC motor rated up to 100V/5A. Pulse width modulation output for maximum motor torque at all speeds. Supply: 5-15VDC. Box supplied. Dimensions (mm): 60Wx100Lx60H. Kit Order Code: 3067KT - £12.95
 Assembled Order Code: AS3067 - £19.95

NEW! PC / Standalone Unipolar Stepper Motor Driver

Drives any 5, 6 or 8-lead unipolar stepper motor rated up to 6 Amps max. Provides speed and direction control. Operates in stand-alone or PC-controlled mode. Up to six 3179 driver boards can be connected to a single parallel port. Supply: 9V DC. PCB: 80x50mm. Kit Order Code: 3179KT - £9.95
 Assembled Order Code: AS3179 - £16.95



PC Controlled Dual Stepper Motor Driver

Independently control two unipolar stepper motors (each rated up to 3 Amps max.) using PC parallel port and software interface provided. Four digital inputs available for monitoring external switches and other inputs. Software provides three run modes and will half-step, single-step or manual-step motors. Complete unit neatly housed in an extended D-shell case. All components, case, documentation and software are supplied (stepper motors are NOT provided). Dimensions (mm): 55Wx70Lx15H. Kit Order Code: 3113KT - £15.95
 Assembled Order Code: AS3113 - £24.95



NEW! Bi-Polar Stepper Motor Driver

Drive any bi-polar stepper motor using externally supplied 5V levels for stepping and direction control. These usually come from software running on a computer. Supply: 8-30V DC. PCB: 75x85mm. Kit Order Code: 3158KT - £12.95
 Assembled Order Code: AS3158 - £26.95



Most items are available in kit form (KT suffix) or assembled and ready for use (AS prefix).

Controllers & Loggers

Here are just a few of the controller and data acquisition and control units we have. See website for full details. Suitable PSU for all units: Order Code PSU203 £9.95

Rolling Code 4-Channel UHF Remote

State-of-the-Art. High security. 4 channels. Momentary or latching relay output. Range up to 40m. Up to 15 Tx's can be learnt by one Rx (kit includes one Tx but more available separately). 4 indicator LED's. Rx: PCB 77x85mm, 12VDC/6mA (standby). Two and Ten channel versions also available. Kit Order Code: 3180KT - £41.95
 Assembled Order Code: AS3180 - £49.95



Computer Temperature Data Logger

4-channel temperature logger for serial port. °C or °F. Continuously logs up to 4 separate sensors located 200m+ from board. Wide range of free software applications for storing/using data. PCB just 38x38mm. Powered by PC. Includes one DS1820 sensor and four header cables. Kit Order Code: 3145KT - £22.95
 Assembled Order Code: AS3145 - £29.95
 Additional DS1820 Sensors - £3.95 each



NEW! DTMF Telephone Relay Switcher

Call your phone number using a DTMF phone from anywhere in the world and remotely turn on/off any of the 4 relays as desired. User settable Security Password, Anti-Tamper, Rings to Answer, Auto Hang-up and Lockout. Includes plastic case. 130x110x30mm. Power: 12VDC. Kit Order Code: 3140KT - £39.95
 Assembled Order Code: AS3140 - £59.95

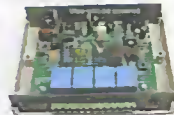

Serial Isolated I/O Module

PC controlled 8-Relay Board. 115/250V relay outputs and 4 isolated digital inputs. Useful in a variety of control and sensing applications. Uses PC serial port for programming (using our new Windows interface or batch files). Once programmed unit can operate without PC. Includes plastic case 130x100x30mm. Power: 12VDC/500mA. Kit Order Code: 3108KT - £54.95
 Assembled Order Code: AS3108 - £64.95

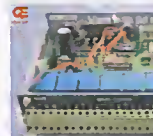

Infrared RC Relay Board
 Individually control 12 on-board relays with included infrared remote control unit. Toggle or momentary. 15m+ range. 112x122mm. Supply: 12VDC/0.5A
 Kit Order Code: 3142KT - £41.95
 Assembled Order Code: AS3142 - £59.95

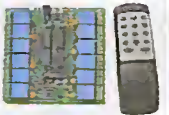

PIC & ATMEL Programmers

We have a wide range of low cost PIC and ATMEL Programmers. Complete range and documentation available from our web site.

Programmer Accessories:

40-pin Wide ZIF socket (ZIF40W) £15.00
 18V DC Power supply (PSU201) £5.95
 Leads: Parallel (LEAD108) £4.95 / Serial (LEAD76) £4.95 / USB (LEADUAA) £4.95

NEW! USB 'All-Flash' PIC Programmer

USB PIC programmer for all 'Flash' devices. No external power supply making it truly portable. Supplied complete with 40-pin wide-slot ZIF socket, box and Windows Software. Kit Order Code: 3128KT - £49.95
 Assembled Order Code: AS3128 - £54.95



Enhanced "PICALL" ISP PIC Programmer

Will program virtually ALL 8 to 40 pin PICs plus a range of ATMEL AVR, SCENIX SX and EEPROM 24C devices. Also supports In System Programming (ISP) for PIC and ATMEL AVRs. Free software. Blank chip auto detect for super fast bulk programming. Requires a 40-pin wide ZIF socket (not included). Kit Order Code: 3144KT - £54.95
 Assembled Order Code: AS3144 - £59.95



ATMEL 89xxxx Programmer

Uses serial port and any standard terminal comms program. 4 LED's display the status. ZIF sockets not included. Supply: 16-18VDC. Kit Order Code: 3123KT - £29.95
 Assembled Order Code: AS3123 - £34.95



NEW! USB & Serial Port PIC Programmer

USB/Serial connection. Ideal for field use. Header cable for ICSP. Free Windows software. See website for PICs supported. ZIF socket not incl. Supply: 18VDC. Kit Order Code: 3149KT - £29.95
 Assembled Order Code: AS3149 - £44.95



www.quasarelectronics.com

Secure Online Ordering Facilities Full Product Listing, Descriptions & Photos Kit Documentation & Software Downloads



Easy-PC for Windows

World Beating Value in PCB Design Software

from
£97

High performance Windows based PCB Design Capture, Simulation and Layout software at prices you'd expect from your local computer store!



NEW! in Easy-PC 7

- Library Databook
- Step and repeat plotting
- Swap Connection Mode
- Dimensioning
- Copy to Metafile
- plus much more.....

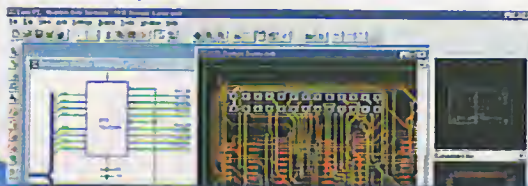

Stop press... by customer demand, now with Tsien Boardmaker 2 design import...

Number One Systems delivers true 32 bit Windows software applications including features that a few short years ago would only have been available in software tools priced in the thousands!

Test drive Easy-PC and Easy-Spice for yourself and be prepared to be amazed at the super value...

Call for a brochure, price list and demo CD on +44 (0)1684 773662 or email sales@numberone.com

Number One Systems

Number One Systems
Oak Lane, Bredon
Tewkesbury, Glos GL20 7LR
United Kingdom

or download from

www.numberone.com

CD ELEKTOR 2003 VOLUME 2003 ON CD-ROM

NEW

ELEKTOR CD-ROMS



RRP £16.25 (US\$28.75)

The CD-Elektur/Elektor 2003 CD-ROM contains all articles, with the exception of the news columns, published in *Elektor Electronics* volume 2003.

Using the supplied Acrobat Reader program, articles are presented in the same page layout as in *Elektor Electronics* magazine. To find expressions, the extensive search system on this CD-ROM allows you to scan previously published *Elektor AnnualCD-ROMs*.

- print PCB layouts with up to 600 dpi resolution;
- adapt PCB layouts with a drawing program;
- quickly find articles, components, subjects, and so on, from monthly contents lists, the year index (on subject basis), or on the basis of titles, words, and components;
- transfer diagrams, illustrations, PCB layouts, and text, to other programs.
- HTML overview for MacOS and Linux users
- **New! Now includes DiskMirror to run multiple year volumes from hard disk.**

Order now using the Order Form in the Readers Services section in this issue

Elektor Electronics (Publishing) • P.O. Box 190 • Tunbridge Wells TN9 7WY
• England. Telephone +44 (0) 1580 200 657 • Fax +44 (0) 1580 200 616

**ELEKTOR
ELECTRONICS**
THE ELECTRONICS & COMPUTER MAGAZINE

See also
www.elektor-electronics.co.uk

Big Chips Are Good For You



Hitex (UK) Ltd.

Tel: 024 76692066

Fax: 024 76692131

Email: sales@hitex.co.uk

Web: www.hitex.co.uk/bigchip



PHYTEC Microcontrollers
and more ...

TQ components

8051, ARM7, TriCore,
C16x/ST10, MPC5xx/8xx
MPC82xx, PIII, Sc520

Hitex BigChip 8, 16 or 32-bit microcontroller modules are the easiest way to increase the performance of your embedded design. By concentrating the CPU/memory sub-system into a low-cost, high density BigChip, there's more time for getting your IO hardware and application software right first time. Their small size and guaranteed low EMC will get your project into great shape fast.

BigChip starter kits are available for all modules and include C compilers, debuggers and example applications.

hitex
DEVELOPMENT TOOLS

FLOWCODE



Allows users with no programming skills to design complex electronic systems

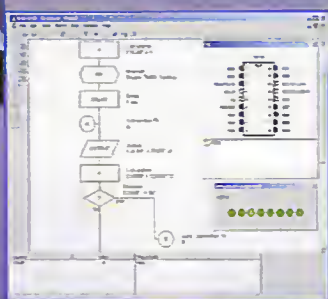

Flowcode is a programming system for PICmicro microcontrollers based on flowcharts. Flowcode includes macros to facilitate the control of complex devices like 7-segment and LCD displays. Flowcode allows complete novices to design control systems without getting bogged down in the programming involved.

- Requires no programming experience
- Full on screen simulation
- Produces PICmicro hex code for a range of 8, 18, 28, and 40 pin devices
- Full suite of demonstration tutorials
- Allows complex PICmicro designs to be produced in minutes

for full specification see:

www.matrixmultimedia.co.uk

or contact us for a full colour brochure

email: sales@matrixmultimedia.co.uk
tel: 0870 700 1831 fax: 0870 700 1832

ww
matrix
multimedia

PICmicro[®] microcontroller development board

The World's most advanced solution for learning and programming PICmicro microcontrollers

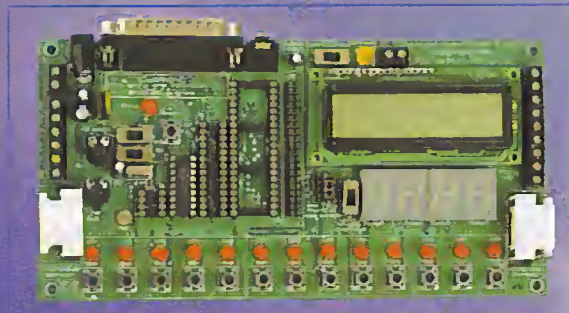

- Allows you to program PICmicros and test your programs
- Designed for education, hobbyists and industry
- Supports low cost Flash programmable PICmicro devices
- Fully featured displays including 2 line LCD and quad 7-segment LED
- Programs most 8, 18, 28, 40 pin devices - including those with ADC capabilities
- Free download software provides seamless send and verify function
- 3 CD ROM courses in C, assembly code, and flowchart programming are available

for full specification see:

www.matrixmultimedia.co.uk

or contact us for a full colour brochure

email: sales@matrixmultimedia.co.uk
tel: 0870 700 1831 fax: 0870 700 1832

ww
matrix
multimedia

Handyscope HS3 2 Ch

Resolution Menu - 12, 14 or 16bits

Sample Rates - 5,10,25,50,100 Ms/s models



- ✓ Oscilloscope
- ✓ Spectrum Analyzer
- ✓ Voltmeter plus!
- ✓ Transient Recorder
- ✓ Arbitrary Waveform Gen.
- ✓ Two hi-z probes 1:1~1:10
- ✓ USB 1.1 or 2.0
- ✓ Windows OS- all

5 Ms/s Model
£435
ex VAT/pp

iTp Ltd

28 Stephenson Road, Industrial Estate, St Ives, Cambs. Pe27 3WJ
Telephone: 01480 300695 Fax: 01480 461654

info@itp101.com www.itp101.com www.tiepie.com

A QUANTUM LEAP IN
EMBEDDED CONTROLLERS

Quick FIRE

SUPERCONTROLLERS

Our range provides:-

- The fastest 68000 based Core up to 66 Mhz.
- Extensive I/O:- Serial, IrDA, SPI, I²C, Analogue, Timers/Counters, RTC, etc.
- Large Memory Capacity:- Flash, SRAM, DRAM.
- Supports:- Mono & Colour LCD's, Touch Panels & Keypads, Very Low Power.

ALSO LOW COST



DEVELOPMENT

- Target easily & quickly.
- Full ANSI 'C' compiler, assembler & linker all Windows32 based.
- Source Level Debug.
- Full Driver Support with Libraries.
- Real Time Multitasking OS with a free run time licence.
- FREE Unlimited email support.

www.cms.uk.com

see our web site for full details

CAMBRIDGE MICROPROCESSOR SYSTEMS LTD



Unit 17-18 Zone 'D' Chelmsford Rd. Ind. Est.
Great Dunmow, Essex CM6 1XG

Telephone: **01371 875644**

email: sales@cms.uk.com

The Simple Solution! Flexit

AVR Modular Development System

- Based on the Atmel AVR controller
- Flexible and powerful
- Simple to configure
- Very compact

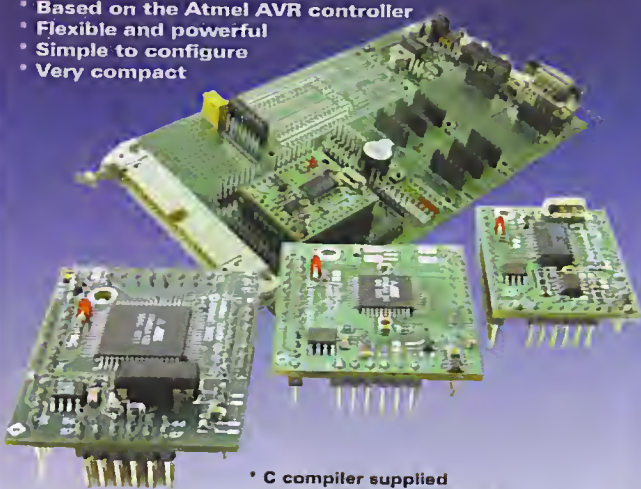

- C compiler supplied
- Compatible with most development tools
- In-system programmable
- Free Atmel debug simulator available
- Peripheral drivers and libraries supplied
- Increasing range of expansion modules
- Full web site support

Check out Flexit at www.ennovi.co.uk

ennovi Ltd

Dynamic Design



+44 (0)1425 478884
sales@ennovi.co.uk

Precision measurement
Embedded control
Intrinsic safety
Internet embedded systems
USB interface

DrDAQ Data Logger

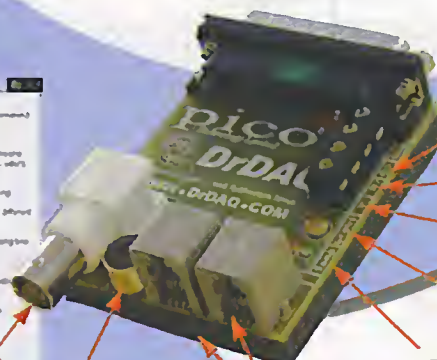
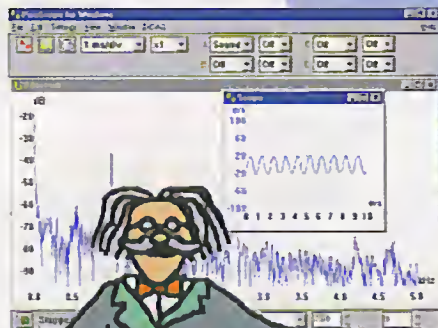

- Output
- Resistance
- Voltage
- Light level
- Temperature
- External sensors: Humidity
- Temperature
- O2 In Air
- Reed Switch
- pH
- Microphone

- Low cost - under £60
- Built in sensors for light, temperature and sound (level and waveforms)
- Use DrDAQ to capture fast signals
- Outputs for control experiments
- Supplied with both PicoScope (oscilloscope) and PicoLog (data logging) software

For more information on DrDAQ, please visit:

www.picotech.com/drdaq87

PC Oscilloscopes

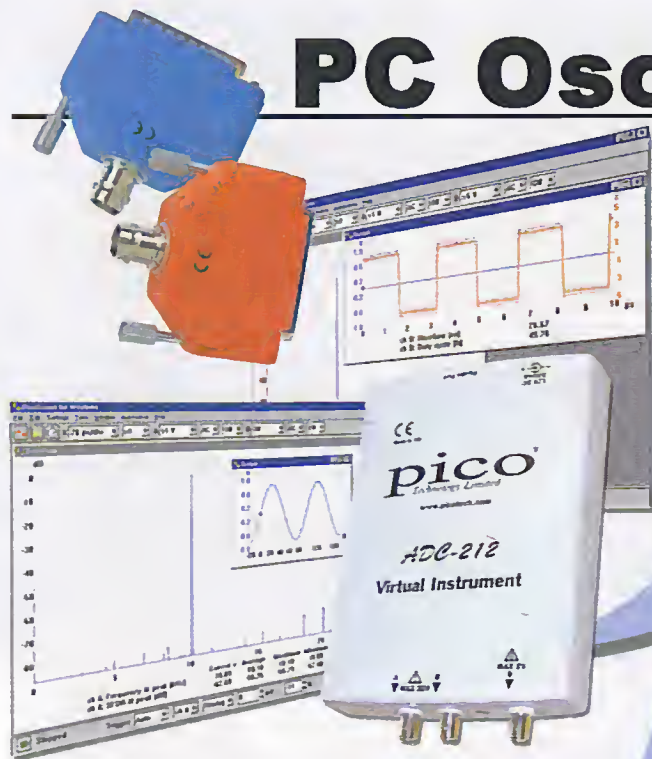

- Scope and spectrum analyser functions
- A fraction of the cost of benchtop scope
- Save multiple setups, for ease of use
- Save, print and e-mail your traces
- FREE technical support for life
- FREE software and upgrades
- Automated measurements

For more information on our scopes, please visit:

www.picotech.com/scope156

Tel: 01480 396395 Fax: 01480 396296 E-mail: sales@picotech.com

PICO
 Technology Limited

Long-wave Time Code Receiver IC

Oki Electric has developed a long-wave time code receiver, the ML6190A, based on SOI-CMOS (silicon-on-insulator complementary-metal-oxide-semiconductor) technology, an industry first. By using fully depleted SOI-CMOS technology, the chip provides highly sensitive radio reception functionality, together with a one-third or better reduction in power consumption compared to existing time code receivers. Oki has already started shipping sample shipment, and expects volume shipments to commence December 2003. The ML6190A uses fully depleted SOI-CMOS technology, which involves forming CMOS on an SOI substrate in which an insulated film is buried, instead of a silicon substrate. As transistors are created on an insulation film, the chip consumes quite a low current, which in turn, decreases the concomitant

thermal noise. Noise transmitted from the substrate is also decreased, as transistors are completely isolated from the substrate by the insulation film. This construction has very high sensitivity. As current consumption is one-third or better compared with existing time code receivers, the new ML6190A is ideal for small, portable devices. It can also be used for time correction applications in audiovisual equipment, home appliances, PCs and car clocks. SOI-CMOS technology excels in the level of integration of digital and analogue circuits into a chip, because the transistors are completely isolated from the substrate by an insulated film, which reduces the noise transmitted to analogue circuits from digital circuits via the substrate. Based on this technology, Oki plans to integrate a receiver circuit with a decoder circuit, a driver circuit,



or a watch LSI, so further enhancing its product line-up. The ML6190A is an RF receiver for time code signals transmitted over long-wave frequencies ranging from 40 kHz to 100 kHz. Voltage sensitivity is 0.7 μ Vrms and the input voltage range is from 0.7 μ Vrms to 100 mVrms. Current consumption is 17 μ A, which is from one-third to one-tenth of that of bipolar devices. By using two connected crystals, the ML6190A is able to receive two different radio fre-

quencies. The LSI comes in a particular small package version 20-pin SSOP with dimensions of 6.5 mm length, 4.4 mm widths and 1.45 mm height. Operating temperature range is -40°C to $+85^{\circ}\text{C}$.

OKI Semiconductor (UK) Ltd., 3 Etongate, Windsor Road, Slough, Berkshire SL1 2JA.
Tel: +44-1753-787700,
fax: +44-1753-517195.
Web: www.oki.com

(0+7012-7)

FREWARE & SHAREWARE CD-ROM'S

Internet www.elektor-electronics.co.uk

Free & Shareware 2000-2003

This series contains hundreds of freeware and shareware programs related to electronics. Interest fields include audio, components, test and measurement, development tools, simulation, CAD and RF systems. Applications vary from schematic capture including digital and analogue simulation right up to PCB design, complete with calculation tools and microcontroller development tools. Depending on their origins the programs run under Windows, DOS and/or Linux. Each CD-ROM (except Volume 2000) contains a PDF file with a clear overview of programs on the CD-ROM.

NEW

£12.05 (US\$ 21.25)
PER VOLUME

ORDER NOW USING THE ORDER FORM IN THE READERS SERVICES SECTION, OR WRITE TO

P.O. Box 190 • Tisbury Wells TN5 7WY • England
 Telephone +44 (0) 1580 200 657 • Fax +44 (0) 1580 200 616

Internet www.elektor-electronics.co.uk

ELEKTOR ELECTRONICS ITEM TRACER 1985-2003

NEW

The new Elektor Item Tracer (EIT) is now available!

EIT contains the digital contents list of all articles (except news columns) published in the magazine over the period 1985-2003. EIT 1985-2003 is a user-friendly program supplied on a 3.5-inch diskette, running under Windows and offering an attractive graphics interface.

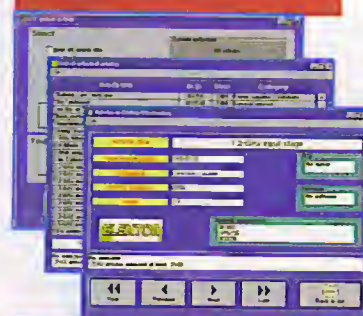

The EIT retails at £ 8-25 (US\$9.50)

Minimum computer requirements: PC386/486/penitium; at least 4 MB RAM; Windows 3.1/3.11/95/98; at least 2 MB free space on hard disk.

The program allows searching for various keywords or combinations, such as name of article; name of component; classification (audio, computers, etc); special components; order number of PCB or software item. EIT prints hard copy via the Windows printer driver.

ELEKTOR ELECTRONICS
 THE ELECTRONICS & COMPUTER MAGAZINE

Build Your Own DRM Receiver

A digital radio for 500 kHz to 22 MHz

Design by B. Kainka

One again Elektor Electronics makes its competitors take a very distant back seat by publishing the world's first homebuilt DRM receiver for digital (MP4-quality) broadcasts in the medium and shortwave bands. The receiver is of a surprisingly simple design and supplies a 12-kHz output signal for easy connection to your PC's soundcard which handles the demodulation and MPEG decoding. The receiver is also tuned by the PC via an RS232 link.

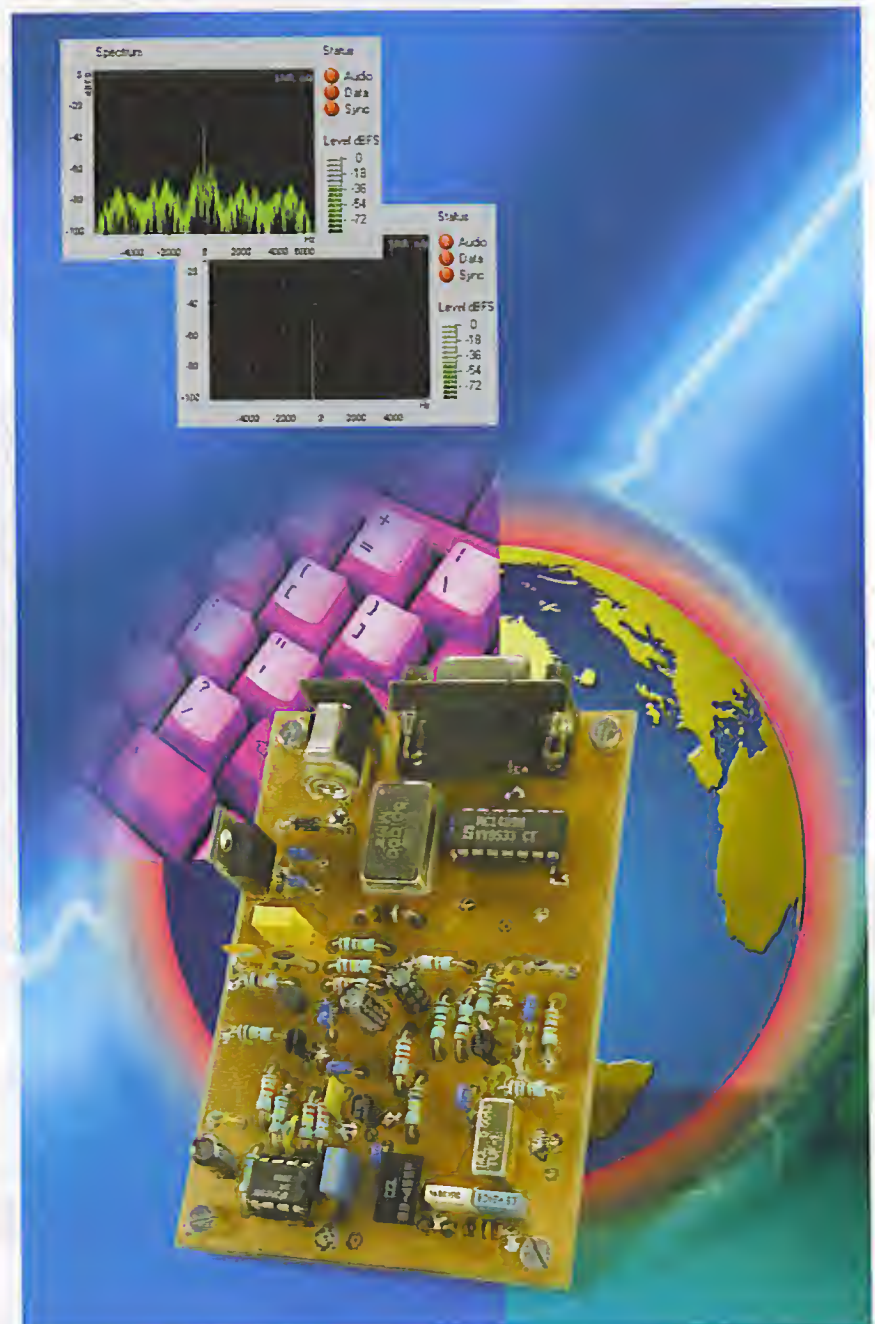

On 15 December 2003, DRM (Digital Radio Mondial) entered a new phase on the shortwave and medium-wave bands. The encoding was changed to MP4 in order to improve the quality of the received audio signals even further. The unique receiver described in this article was developed for all readers interested in listening to DRM broadcasts at a modest investment.

One of the targets set for the design was good receiver performance without any adjustment points. No special inductors or tuning capacitors are used in this project, just off-the-shelf fixed inductors. This, we hope, encourages those readers with more experience in digital electronics than RF design and construction. There's no adjustment to worry about and no need for special test equipment. A very simple software-driven alignment is sufficient to illuminate tolerances in the oscillator frequencies used in the circuit.

The basic operation of DRM and in particular its signal encoding and transmission method was described in *Elektor Electronics* December 2002 [1]. Exactly one year later, in the December 2003 issue [2] we ran an article describing how DRM signals could be picked up and turned into audio using an experimental receiver based on our DDS RF Signal Generator and a PC or notebook. The present DRM receiver also contains a DDS (direct digital synthesis) chip. The two articles mentioned above provide a good technical background to the workings of DRM and were published at a time when none of our competitors was able to come up with technical specifications on DRM let alone an experimental yet reproducible receiver. The publication of this article is sure to increase the distance.

A DRM interface

It is perfectly possible to view the receiver as a DRM interface for the PC. As illustrated in Figure 1a, the DRM receiver has two links to the PC. By way of an RS232 connection, it gets digital control information for tuning the DDS to the desired DRM broadcast station.

As opposed to a normal radio or

general coverage receiver the DRM receiver does not supply an audio signal you can make audible using analogue means like headphones, a loudspeaker or an audio amplifier. Internally, the DRM receiver mixes the signal received from the DRM station down to an IF (intermediate frequency) of 12 kHz. Its output therefore supplies a mix of modulated carriers that together convey the audio signal in the form of a digital datastream. This DRM spectrum, a mix of various frequencies covering a bandwidth of 10 kHz, is connected to the Line input of the PC soundcard. Alternatively the Microphone input may be used if the signal is rather weak. The DRM signal is digitised by the soundcard, while a special DRM receiver program looks after the demodulating of the DRM signal as well as the decoding of the MP4 datastream. Again, all demodulation and decoding is done in software. The resulting hi-fi stereo audio signal is then available at the output of the soundcard for reproducing by a (PC) loudspeaker or headphones.

Double-conversion

As you can see from the block diagram (Figure 1b), the signal received from the DRM station is mixed two

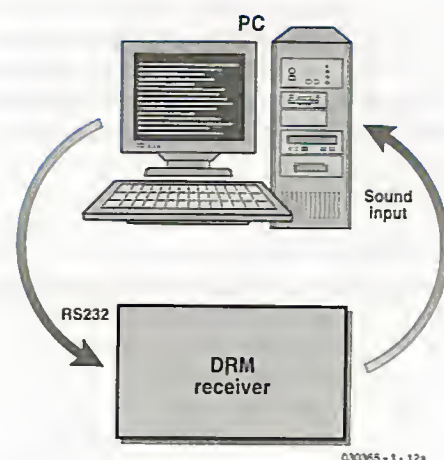

Figure 1a. The DRM receiver has two connections to the PC: a serial link for the receiver tuning and a connection feeding an MPEG datastream to the Line or Microphone input on the soundcard. All decoding and demodulation is done in software.

times — first, a variable oscillator frequency is used to mix it down to a fixed intermediate frequency (IF) of 455 kHz. This provides the station tuning on the receiver. The second heterodyning operation is against a fixed 467 kHz signal in order to mix the 455-kHz signal down to 12 kHz. Using receiver terminology, the DRM receiver is a 'double-conversion' or 'super-heterodyne' type. The first injection signal is obtained from a synthe-

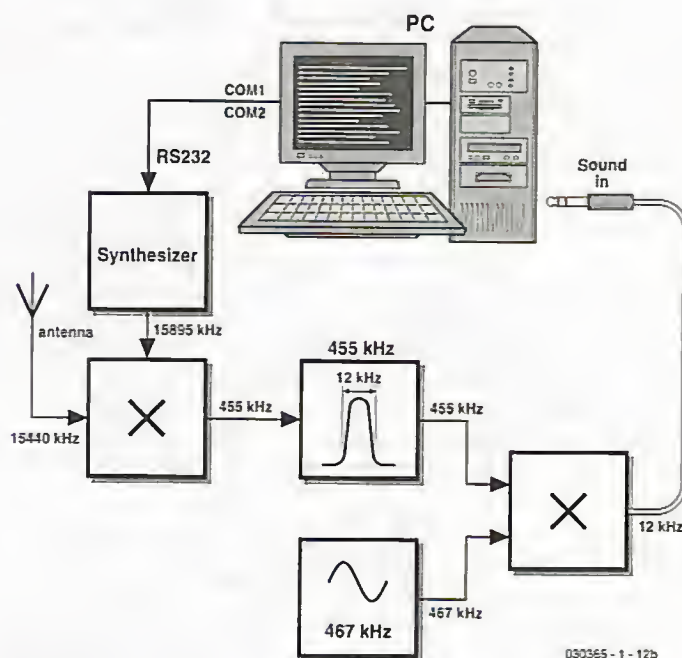

Figure 1b. The block diagram of the DRM receiver reveals a double-conversion ('super-heterodyne') design with intermediate frequencies at 455 kHz and 12 kHz.

sised oscillator supplying an output frequency that's programmable by means of control data generated on the PC and sent to the receiver over the RS232 link. The second injection signal at 467 kHz originates from a ceramic resonator.

Practical circuit

The block diagram is easily found back in the

circuit diagram shown in **Figure 2**. The DDS oscillator based around IC2 supplies an output signal to the first mixer (MIX1) via a buffer stage, T1. In case you've never seen such a beast, MIX1 is a wideband double-balanced diode ring mixer. The IF signal at 455 kHz is taken through a steep ceramic filter (F11) with 12-kHz bandwidth. An IF amplifier stage

around T2 raises the level by about 20 dB before the signal is applied to the second mixer comprising (passive) FET T4, a type BF245. The second injection oscillator is frequency-stabilised by a CSB470 ceramic resonator (X1) whose nominal output frequency is pulled down by 3 kHz to arrive at 467 kHz. The 12-kHz IF signal at the drain of T4 goes through a

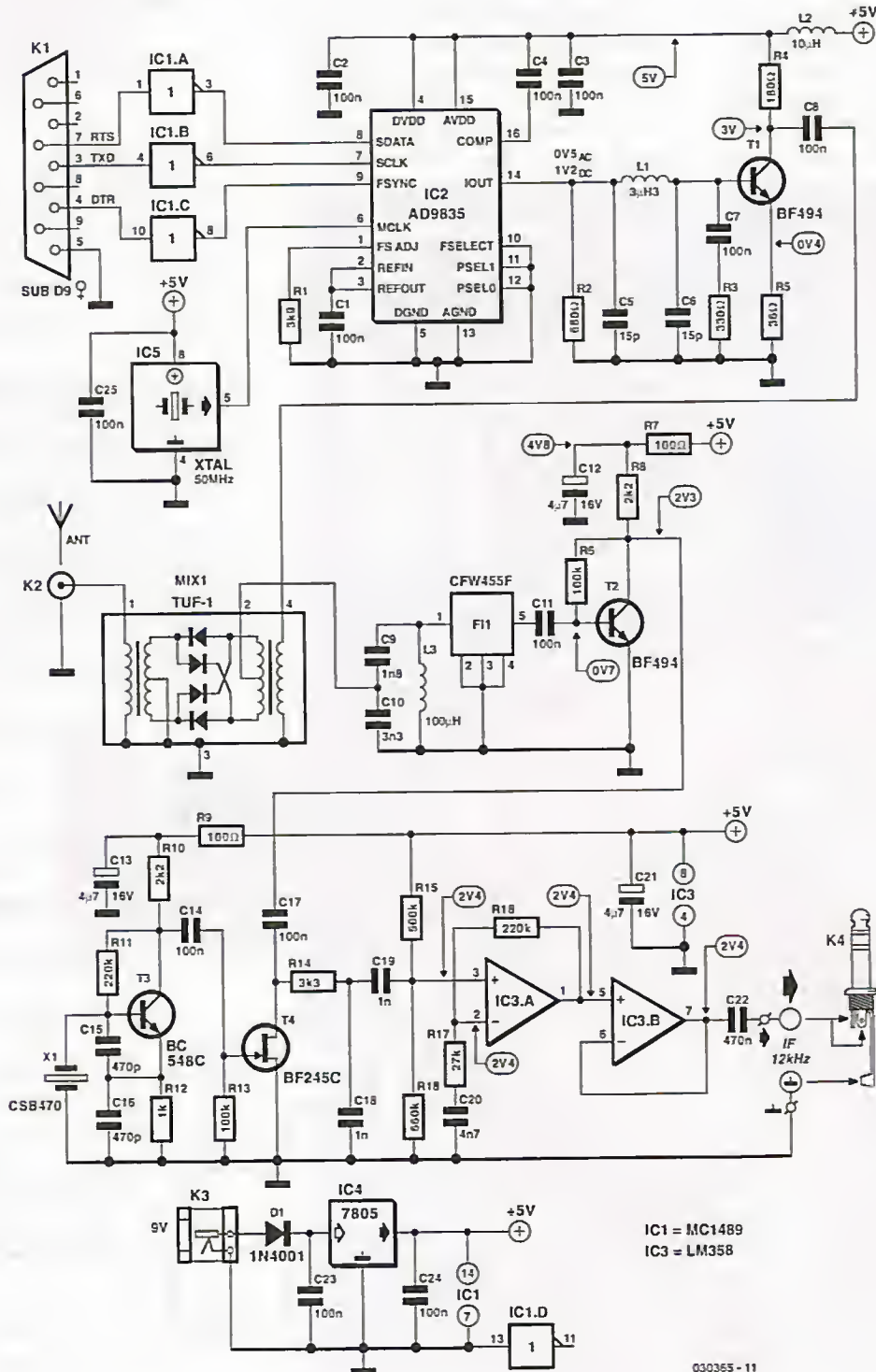

IC1 = MC1489
IC3 = LM358

030355 - 11

Figure 2. The practical circuit of the DRM receiver is marked by PC-driven tuning of a DDS oscillator and two large-signal resistant mixers.

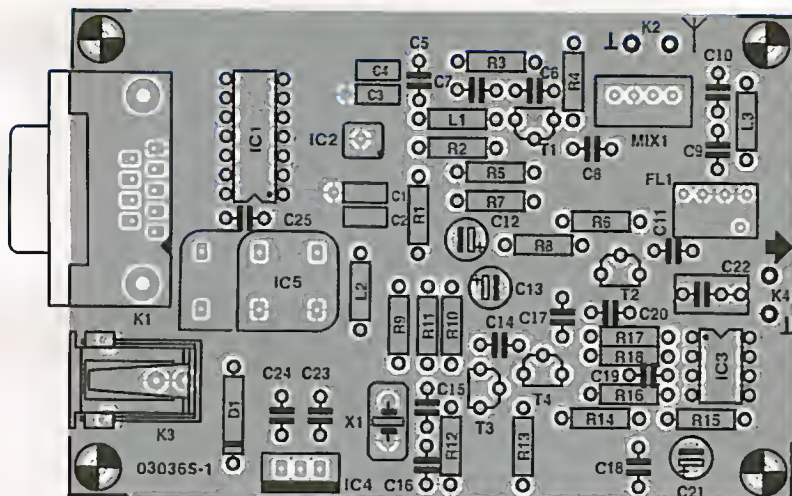

Figure 3. The PCB is double-sided and through-plated. All parts in the RF sections have to be soldered with the shortest possible lead lengths.

COMPONENTS LIST

Resistors:

R1 = 3k Ω
 R2 = 680 Ω
 R3 = 330 Ω
 R4 = 180 Ω
 R5 = 39 Ω
 R6, R13 = 100k Ω
 R7, R9 = 100 Ω
 R8, R10 = 2k Ω
 R11 = 220k Ω
 R12 = 1k Ω
 R14 = 3k Ω
 R15, R16 = 560k Ω
 R17 = 27k Ω
 R18 = 220k Ω

Capacitors:

C1-C4 = 100nF, 5MD, case shape 1208
 C5, C6 = 15pF
 C7, C8, C11, C14, C17, C23, C24, C25 = 100nF, lead pitch 5mm
 C9 = 1nF8, lead pitch 5mm
 C10 = 3nF3, lead pitch 5mm
 C12, C13, C21 = 4 μ F7 16V radial
 C15, C16 = 470pF
 C18, C19 = 1nF, lead pitch 5mm
 C20 = 4nF7, lead pitch 5mm
 C22 = 470nF

Inductors

L1 = 3 μ H3
 L2 = 10 μ H
 L3 = 100 μ H

Semiconductors:

D1 = 1N4001
 T1, T2 = BF494
 T3 = BC548C, BC549C or BC550C

T4 = BF245C

IC1 = MC1489N
 IC2 = AD9835 BRU (Analog Devices)
 IC3 = LM358N
 IC4 = 7805
 IC5 = 50MHz oscillator module in 8-way or 14-way DIP case

Miscellaneous:

K1 = 9-way sub-D socket (female), angled pins, PCB mount
 K2 = 2 solder pins
 K3 = mains adapter socket
 K4 = cable with 3.5-mm mono or stereo jack plug
 MIX1 = TUF-1 (Mini Circuits)
 FL1 = CFW455F (455kHz ceramic filter, bandwidth 12kHz) (Murata)
 X1 = CSB470 (470kHz ceramic resonator) (Murata)
 RS232 cable with 1:1 pin connections, plug and socket, no zero-modem or crossed wire cable.
 PCB, order code 030365-1*
 Disk, PC software DRM.exe, order code 030365-11* or Free Download

* see Readers Services page or visit www.elektor-electronics.co.uk

Suggested component / kit suppliers:

- Geist Electronic (www.geist-electronic.de)
- Segor electronics (www.segor.de).
- AK Modul Bus (www.ak-modul-bus.de)

simple bandpass filter before it is buffered and amplified for another 20 dB by two opamps, IC3.A and IC3.B. The output of the second opamp supplies the MPEG datstream to the PC soundcard input via coupling capacitor C22.

The nitty-gritty of DRM reception is not stability or even spectral purity but extremely low phase noise of the injection oscillator. In this respect the DDS VFO gets full marks because it fully meets this requirement, hence our DIY DRM receiver is an excellent performer. Another important design consideration, large-signal response, is fully covered by the passive double-balanced mixer used. The results obtained from our prototype were impressive, to say the least: with a simple wire antenna connected to the receiver input, the DRM software achieves 30 dB quieting, a value only matched by expensive receivers.

Because a couple of characteristics that are crucial in the context of AM reception are less important with DRM, the circuit is able to achieve such excellent results despite the heavily simplified and alignment-free realisation.

The joint dynamic range of the DRM software and the PC soundcard is sufficient to cope with signal variations of up to 30 dB, which are not uncommon on SW and MW. This conveniently saves on an ALC (automatic loudness control) circuit. High receiver sensitivity is not an issue for DRM. Very weak DRM signals (say, below 10 μ V) do not improve by increasing the receiver gain because the actual signal to noise ratio is insufficient at a large bandwidth like 10 kHz. A number of practical tests proved that the receiver can make do without a tuned front-end. For one, the image frequencies at a distance of 910 kHz (2 x 455 kHz) will nearly always fall outside the neighbouring broadcast bands. On the other hand, the DRM software is remarkably tolerant of interference thrown at it.

Of course, the above considerations should not keep you from using a preselector and a matching antenna if you have a fine combination available. If not, rest assured that a 3-10 m long free-hanging wire is sufficient for direct connection to the mixer RF input.

Details

The antenna input directly on the double-balanced TUF-1 mixer has an impedance of 50 Ω . The mixer does the frequency conversion to 455 kHz at a low impedance. The TUF-1 is designed for a frequency range of 2-600 MHz. However, it may operate below 2 MHz with some reduction in the input impedance and

the occurrence of a strong inductive component. In practice, however, the receiver was found to work satisfactorily even down to 500 kHz in the MW range.

The output of the ring mixer is connected to a wideband matching network for 455 kHz. The impedance is stepped up using a resonant circuit with a 1:10 ratio capacitive tap. The result is an impedance of about 1 k Ω to suit the CFW455F ceramic filter. High accuracy is not an issue here because the actual antenna impedance will typically be higher than 50 Ω . The resonant circuit employs a fixed 100- μ H inductor with a low Q factor (<10), ensuring a bandwidth greater than about 50 kHz yet avoiding component tolerance issues. Consequently, no alignment is required on the inductor while the step-up matching circuit still adds to the remote signal rejection of the IF filter.

The CFW455F has a bandwidth of 10 kHz, with 10 kHz being occupied by DRM and the remaining 2 kHz, well, harmless. Actually, a little more bandwidth is important to have as it provides a way of compensating frequency deviations of the second injection oscillator. For example, if the oscillator runs at 467.5 kHz instead of 467.0 kHz, the first IF is automatically shifted up to 455.5 kHz, which may be countered by the software retuning the DDS 500 Hz 'up'. After all, a nominal frequency of 12 kHz must be maintained at the output of the receiver. The slightly shifted IF will easily fit in the bandpass of the IF filter, allowing us to omit an expensive second oscillator and design one around a cheap ceramic resonator type CSB470. Due to the large capacitance presented by the oscillator (C15 and C16), the resonator is pulled down 3 kHz with a tolerance of about 1 kHz.

The IF signal is raised by about 20 dB by a single transistor stage (T2). Overdriving is unlikely to occur because the signal levels are relatively small due to the slight attenuation by the IF filter and the absence of prestage or mixer gain.

JFET T4 operates as a passive mixer, that is, a switch for RF signals, being opened and closed by the 467-kHz local oscillator signal. Besides utter simplicity, the main advantage of a passive FET mixer is its large dynamic range — signal levels up to 100 mV are handled without problems.

DDS tuning

The DDS VFO based on an AD9835 from Analog Devices is controlled almost directly from the PC's serial port. An MC1489 RS232 receiver chip (IC1) takes care of the swing conversion. Although the DDS clock signal of 50 MHz would allow a highest receiver fre-

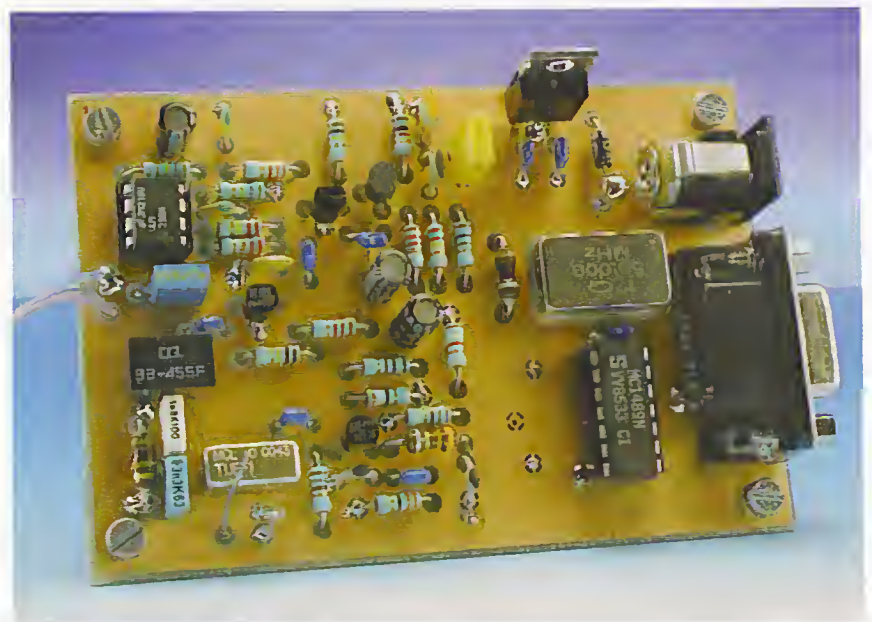
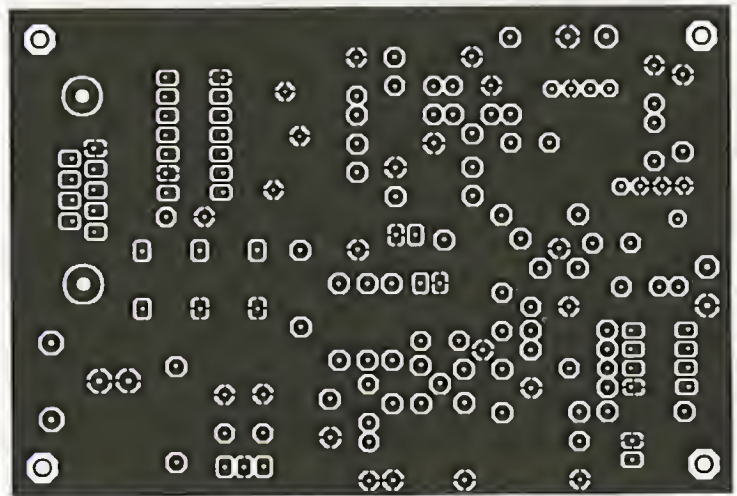
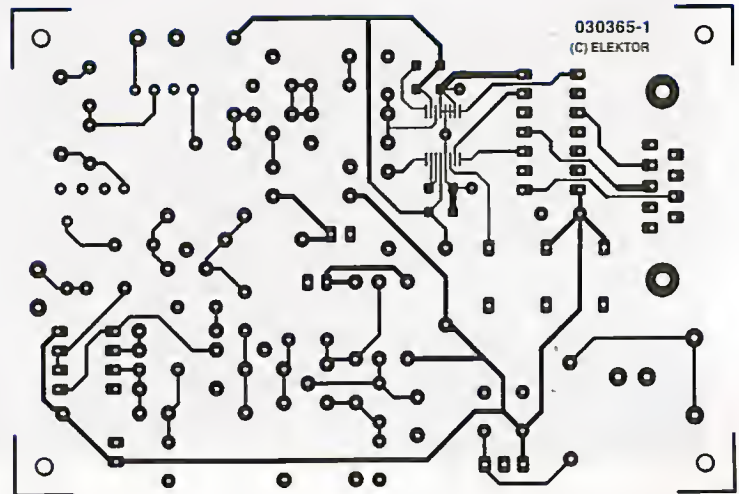

Figure 4. Component mounting plan of the board tested and approved by the Elektor design laboratory. The large copper plane allows short ground connections.

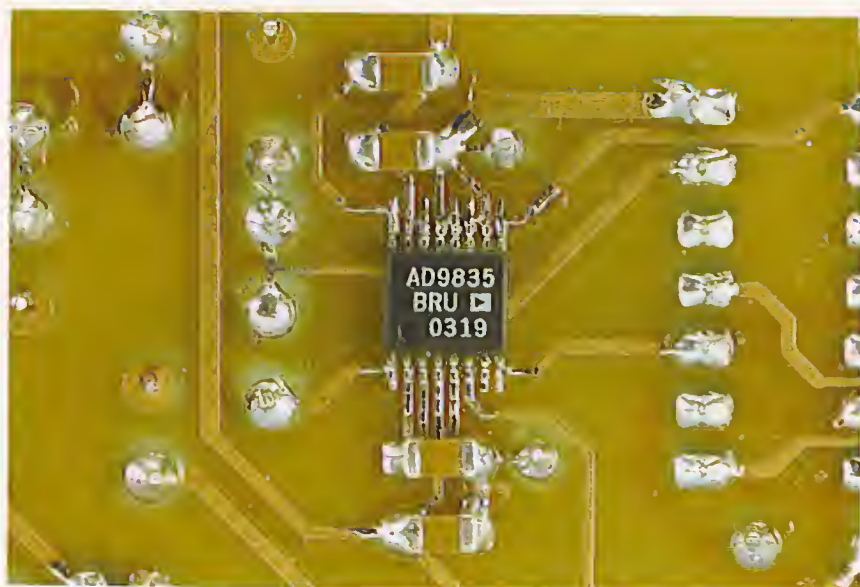

Figure 5. The DDS IC (only available in an SMD case) is soldered to the underside of the board, together with four SMD capacitors.

quency of 25 MHz, the output signals near this frequency become too weak and 24 MHz should be regarded as the absolute limit. A simple low-pass filter (C5, L1, C6) with a roll-off at about 24 MHz provides sufficient rejection of harmonics. Likewise, an additional amplifier, T1, ensures sufficient LO drive for the mixer.

Analog Devices offers a wide range of DDS integrated circuits including a few with a higher clock frequency. The AD9835 was chosen

for its relatively low cost and easy availability (Segor Electronics, Geist Electronics, Barend Hendriksen). The low intermediate frequency of 455 kHz causes a VFO frequency that's only a little above the received signal. The upper limit of the VFO frequency range is not sharply defined — the VFO output level will simply drop gradually above 20 MHz or so. As an aside, this allowed us to receive the Deutsche Welle DRM broadcast from Trincomalee, Sri Lanka, without too much of an effort.

Step-by-step

The following sequence is suggested when connecting the receiver to a PC.

1. Connect the 1:1 RS232 cable to the PC and the receiver.
2. Connect the receiver output to the Line input of your soundcard by means of a screened audio cable.
3. Switch on the receiver,
4. Launch the DRM software on the PC; select soundcard as target and source.
5. Double-click on the loudspeaker symbol in the right-hand bottom corner of the Windows desktop (or via Programs – Accessories – Entertainment – Volume Control) to open the volume control window (the one with the slide controls).
6. Select Properties, then Options and check the box Adjust volume for: **Recording**.
7. Check the box for the soundcard input you want to use (Line or Microphone) and click OK.
8. In the window that pops up, adjust the volume of the desired input.
9. Return to Options – Properties and now select **Playback**. Disable all inputs (remove the check mark) except for the one you're using for the receiver (normally Wave). Use the two slide controls at the left-hand side to control the volume on the PC loudspeakers.
10. Launch DRM.exe to tune the receiver to a DRM station.

The receiver is tuned by a program called DRM.exe, which makes provision for the receiver calibration. The inset 'Step-by-Step' tells you how to start using the receiver. When DRM.exe is first started, it needs to be told which COM port you want to use. The program default is COM1 which may be changed into COM2, for example. By clicking on 'Save Setup' the COM port selection is saved in a file called 'init.txt', along with a few other salient parameters for easy retrieval the next time the program is used. As soon as the serial connection is successfully established, the slider (at the top in Figure 6) may be used to tune the receiver with 1-kHz resolution. The arrows at the edges cause 1-kHz steps, a click in the areas beside the slider, a step of 10 kHz.

Calibration

Frequency calibration is required because the two local oscillators in the receiver are subject to a certain tolerance for which no hardware adjustments are available. First, the software needs to know the exact frequency of the 467-kHz oscillator. Adjust the receiver frequency to 0.00 (slider to leftmost position) and start the DRM software. (Note: in the following description it is assumed that the program 'DRM Software Radio' from Fraunhofer IIS is used — however, it is also possible to employ 'Dream' (see 'Decoder Software' inset). No antenna should be connected at this point. The spectrum (Figure 7) will show a straight line caused by the first oscillator being tuned to the intermediate frequency. (Note: if the receiver were switched on after

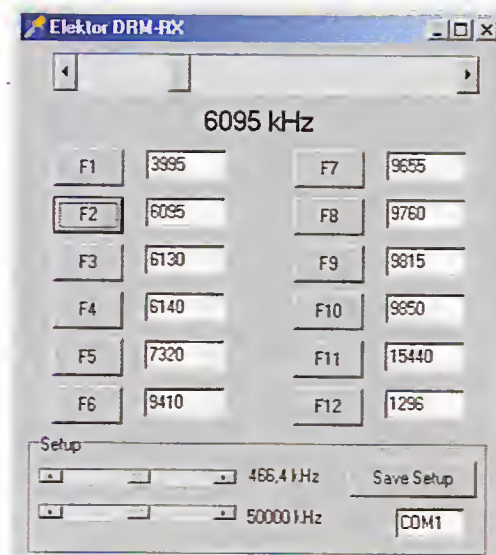

Figure 6. Windows program DRM.exe for the receiver tuning in action.

launching the software, the line does not become visible after you've moved the slider a little. If the line still does not appear, the receiver's output signal may be too small for the Line input — change to the microphone input and try again. Receiver noise should be just visible in the lower part of the screen. Possibly, the line falls outside the screen area — adjust the slider until the line appears). Next, the upper slider in the Setup Range has to be adjusted for the line to appear exactly in the centre of the spectrum. If that is achieved, the

Listing 1

VB code snippets

```
Const XTAL = 40000
Const IF1 = 454.3

Private Sub output(Data)
    TXD 0
    Delay 0.1
    DTR 1          ' CE
    Delay 0.1
    BitValue = &H8000&
    For n = 0 To 15
        If (Data And BitValue) >
            0 Then RTS 0 Else RTS 1
            Delay 0.1
            TXD 1          ' clock
            Delay 0.1
            TXD 0
            Delay 0.1
            Delay 0.1
            BitValue = BitValue \ 2
    Next n
    Delay 0.1
    DTR 0
    Delay 0.1
End Sub

Private Sub LO(freq)
    HScroll1.value = freq
    Labell.Caption =
        . Str$(freq) + " kHz"
    Dim frg As Long
    Dim freqLo As Long
    Dim freqHi As Long
    Dim Daten As Long
    freq=freq+IF1 'add IF1
    frg=Int(freq/XTAL*
        4294967296#)
    freqHi=frg\&H10000
    freqLo=frg-freqHi*&H10000
    freqLoL=freqLo And &HFF
    freqLoH=freqLo\&H100
    freqHiL=freqHi And &HFF
    freqHiH=freqHi \ &H100
    output &HF800& 'Reset
    '4 Bytes to FREQ0
    output(&H3000& + freqLoL)
    output(&H2100& + freqLoH)
    output(&H3200& + freqHiL)
    output(&H2300& + freqHiH)
    output &H8000& 'Sync
    output &HC000& 'Reset end
End Sub
```

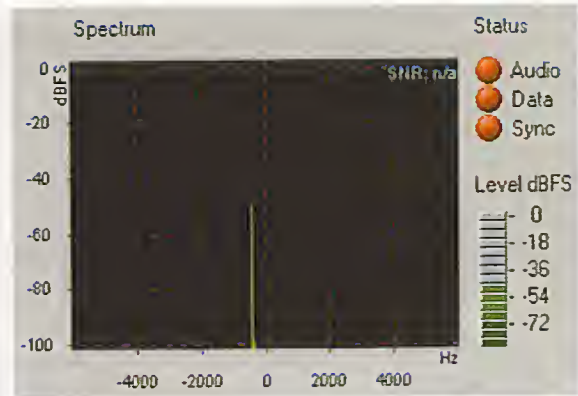

Figure 7. Illustrating IF calibration, here using the program DRM Software Radio (v. 2.034).

receiver supplies an output signal of exactly 12 kHz. On our prototype, the setting was found to correspond to a frequency of 466.4 kHz from which we can conclude that the second oscillator had an error of 600 Hz. This error, then, is compensated by the software offsetting the DDS oscillator by the same amount. The adjustment range of the calibration is ± 2 kHz.

The second step is to eliminate the error in the DDS clock oscillator frequency. The 50.000-MHz quartz crystal oscillator has a basic tolerance of ± 100 ppm or 100 Hz per MHz, so that a final error of up to 5kHz may occur at 50 MHz. Consequently, the error would be 1 kHz for a receive frequency of 10 MHz. The calibration begins by connecting the antenna to the receiver input and tuning to a strong AM station in the shortwave range (tune using the top slider in DRM.exe). The vast majority of SW broadcast stations can be used as frequency standards, their

station frequencies complying with high stability standards and a 5-kHz raster. Figure 8 shows the spectrum of an AM transmitter at 6805 kHz. The lower slider has to be adjusted for the carrier to occur exactly in the centre.

Theoretically, at this point you would have to repeat the first calibration step, then the second and so on. In practice, that is not necessary because the small error in the clock oscillator frequency amounts to no more than 1% in the IF range. With an error of 1 kHz at 50 MHz established, the error at 455 kHz is an insignificant 10 Hz. The DRM software we propose to use requires an absolute accuracy of 'just' ± 500 Hz.

When you are done calibrating the oscillators, do not forget to save the setup data to make them quickly available again the next time the receiver is switched on. By the way, more data is saved, including the current station frequency. Station buttons may be linked to your pre-

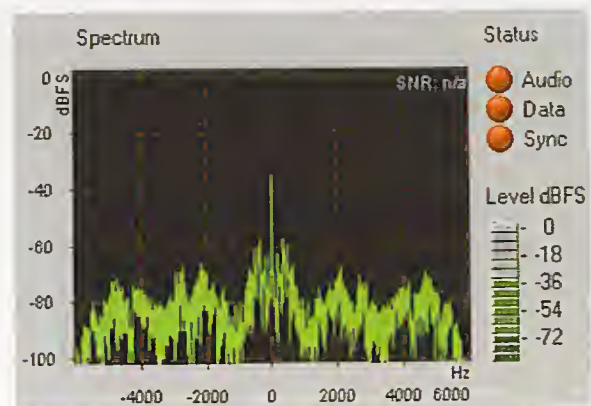

Figure 8. Using an AM broadcast station carrier as a frequency reference.

Decoder software

In addition to the tuning program DRM.exe (supplied by Elektor on disk or as a Free Download) you will require DRM demodulation/decoding software that works in combination with your PC soundcard. Two products are available on the market.

DRM Software Radio produced by the German Fraunhofer IIS (currently version 2.034) may be obtained at a cost of 60 Euros (approx. £43) from an online shop facility at www.drmtx.org. Payment for your order is by credit card. The download information and a software key arrive by email. The latest version supports the new MP4-based DRM standard introduced on 15 December 2003. Nearly all DRM stations now broadcast in stereo and achieve excellent sound quality using the new format.

The **DREAM** open-source project from Volkert Fischer and Alexander Kurpiers (a former Elektor author) of the Darmstadt University Institute for Communications Technology is currently available as version 1.0. The program is only supplied in the form of a C++ source code file because the authors have employed third-party modules that have to be obtained from the respective owners. The DREAM code itself may be found at

<http://sourceforge.net/projects/drm/>

The project may be compiled for Windows as well as Linux. If you are less than conversant with a C++ compiler, ask around for assistance with the creation of the files. DREAM_V1.0 has evolved into a serious alternative to the DRM Software Radio package. The program is stable and now presents less of a CPU load than before.

Meanwhile, the reception of pictures has become possible and the program is also capable of writing a log file containing reception reports. DREAM is very tolerant in respect of the exact frequency of the DRM baseband and will faithfully scan the complete range from 0 to 24 kHz. AM reception has been added as an extra mode, allowing the DRM receiver to be used for classic broadcast reception on the long- medium and shortwave bands.

In a future issue we will return to the DRM software decoder in greater detail. The DRM programs mentioned above are compatible with Windows 98 and up (i.e., 98, 2000, NT and XP).

ferred frequencies and they are saved in the setup file. The file is editable using a word processor. So, if you (against sound advice) decide to overclock your DDS at 60 MHz, the new frequencies may be entered here.

Control using Visual BASIC

The PC-controlled tuning of the DRM receiver opens a lot of potential, including, for instance, labelled preselect buttons for your favourite stations, or timer-driven tuning to certain scheduled broadcasts. Moreover, the DDS may be used for measurement purposes. To give all readers maximum freedom in further experiments, the DDS control is explained here using a small example. The user interface produced by the example program is shown in **Figure 9**. The program employs one slider control, quick tuning buttons and two boxes for free tuning. Calibration facilities are not provided for the end user, the calibration being performed by constants hidden in the program.

The two decisive procedures of the program are shown in **Listing 1**. Using output (Data), 16 bits are shifted into a register inside the AD9835. The procedure LO computes the frequency and the required register contents of the DDS component. The output frequency is adjusted through a 32-bit value, the step size being $50 \text{ MHz}/2^{32} = 0.01164 \text{ MHz}$. The allocation of these registers and their addressing in the upper part of the 16-bit control word is detailed in the AD9835 datasheet. The program example shows the seven essential register contents needed to actually set the DDS frequency. A frequency 'word' is divided into four bytes conveyed to four partial registers.

Near the top of the source code you'll find two constants that have to be adapted to enable frequency to be calibrated. The necessary data are taken from the ready-made user program for the receiver. XTAL = 50000 stands for the exact clock oscillator frequency, while IF1 = 455 defines the intermediate frequency. At a frequency of 466.3 kHz the IF becomes $466.3 \text{ kHz} - 12 \text{ kHz} = 454.3 \text{ kHz}$. The software controlling the RS232 traffic is a BAS module already described in [3].

(030055-1)

For further reading:

- [1] 'Digital Radio Mondial', Elektor Electronics December 2002.
- [2] 'An Experimental DRM Receiver', Elektor Electronics December 2003
- [3] PC Serial Peripheral Design, parts 1-7, Elektor Electronics September 2000 – March 2001

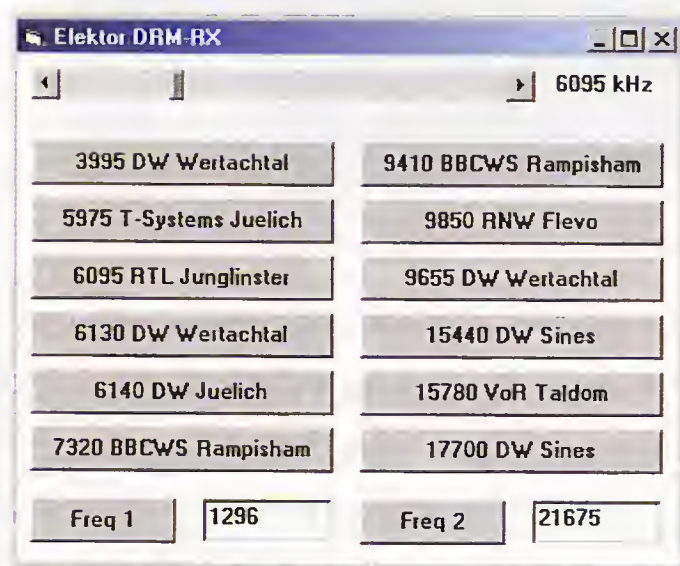
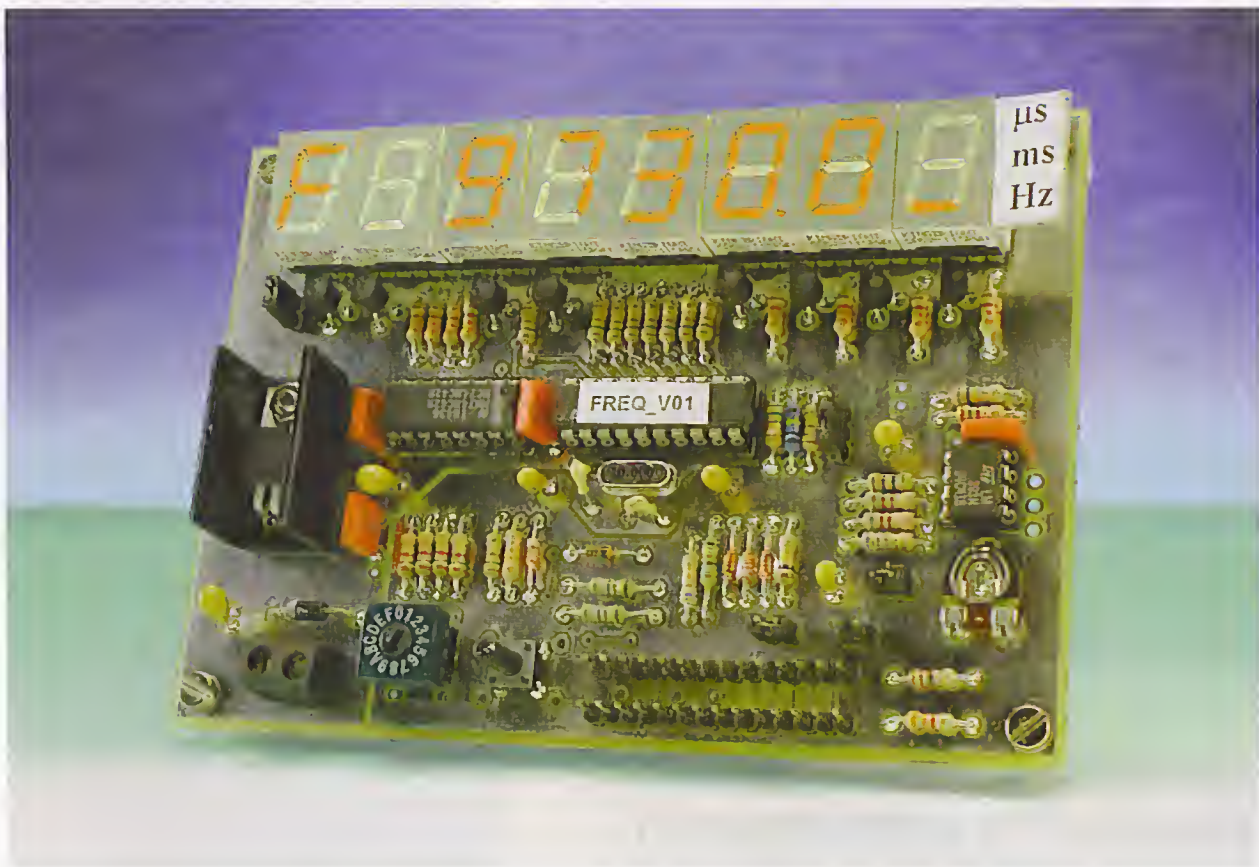

Figure 9. GUI produced by the Visual BASIC example program written for the receiver tuning and station preselect functions.

Multifunction Frequency Meter

For all time-related measurements

Design by R. Zenzinger



Despite its surprisingly simple hardware design and construction, the superb frequency meter / event counter described in this article couples ease of use to a plethora of measurement options. The successful combination is mainly due to the use of a microcontroller running some really ingenious software. The keywords in the general design of the instrument were noise immunity, reliability and functionality.

Main Specifications and Functions

- Frequency measurement using 3 gate times
- Period duration measurement in milliseconds and microseconds
- Pulse duration measurement of positive and negative half cycles in milliseconds and microseconds
- Event counter up to 10^7 events
- Stopwatch with lap time function; resolution 10 ms
- 8-digit 7-segment LED readout
- Selectable pause of 1-5 s or manual restart
- Resolution 0.1 microsecond or 0.1 second
- 4 MHz maximum input frequency
- 1 microsecond minimum pulse length
- 1,000 s maximum pulse length
- 10 mV – 5 V input voltage range protected up to 30 V (higher swings possible by adding an external voltage divider)
- Overflow indication; leading-zero suppression; measurement error signalling
- Tried, tested and approved by the Elektor design laboratory

A frequency meter / event counter is an indispensable instrument on the electronics laboratory workbench. In general, the basic circuit of the instrument is not particularly complex. Digital integrated circuits have been available for quite some time that are capable of performing frequency and time measurements, as well as pulse counting. The same ICs also cheerfully handle the job of displaying measurement results on an LC or LED display. These days, counters are just 'add-ons' to function generators and get the matching amount of attention!

So what should a multi-purpose frequency meter be capable of doing for you? Absolute priority, we feel, should be given to the measurement accuracy, which you should be able to rely on for many years ('long-term stability'). Of course, a wide frequency range is desirable, without breaking the bank! Also, the instrument should be suitable for a good

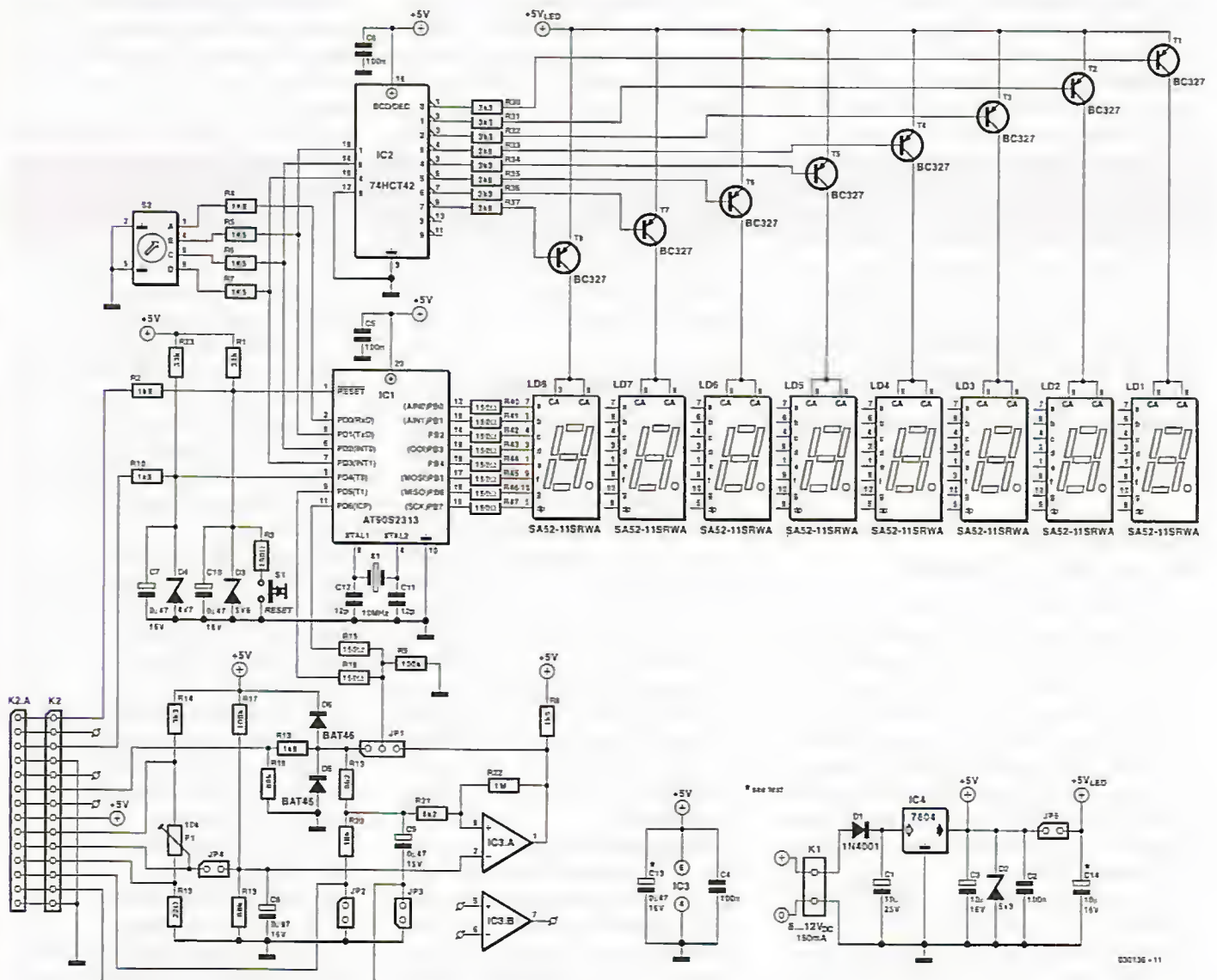

Figure 1. Circuit diagram of the Multifunction Frequency Meter designed around an AT90S microcontroller.

many measurement functions while being easy to control. Add to that the sensitivity and noise immunity issues, and you'll appreciate that it will be hard, if not impossible, for all these requirements to be fulfilled without the odd compromise.

So what does our instrument have to offer? To begin with, we have a frequency range of DC to 4 MHz. This may look a bit measly, but it does strike a good compromise. On the one hand, higher frequencies should not occur that often (unless you are into radio amateurism or RF design in general). On the other hand, a measurement range extending into the megahertz or even gigahertz ranges poses considerable problems in the design and realisation of preamplifier and prescaler units which serve to shape and reduce (i.e., divide) the measured frequency down to values that can be handled by a microcontroller like the one we've in mind. The same design effort could be used to implement high measurement accuracy for our instrument. The measurement error is ± 100 ppm ± 1 digit. The description 'multi-function' would be misleading if our instrument were able to measure just frequencies. In fact, it is capable of capturing pulses with a minimum duration of 1 μ s and pulse / period durations of up to 1,000 seconds. The input signal level may lie between 10 mV and 5 V. In order to measure larger signals, external voltage dividers may be added to your requirements. Likewise, the frequency range of the instrument may be extended by the addition of an external prescaler. The measurement function is selected using a 16-position BCD rotary switch, and the measurement result appears on a bright 8-digit LED display. A complete overview of all functions offered by the instrument may be found in the **Table**.

Microcontroller and peripheral circuitry

A block diagram of the multifunction frequency meter would be superfluous at this point. After all, the functional elements that make up the circuit — microcontroller, read-out, mode switch, signal conditioning and voltage supply — are easily spotted in the actual circuit diagram shown in **Figure 1**. Let's have a look at the practical realisation of each of these blocks before discussing the available measurement modes and the associated software.

The heart of the circuit is an AT90S2313 microcontroller from Atmel. The micro is clocked at a frequency of 10 MHz and offers no fewer than 15 configurable I/O lines divided across two ports. The lines in Port B are all programmed as outputs, driving the

individual segments of the 7-segment displays. By contrast, the lines in Port A have different functions, acting as inputs or outputs. Only PD0 and PD4 are invariably output lines with their internal pull-up resistor (approx. 50 k Ω) activated. PD.1, PD.2 and PD.3 are only active after a reset or when a different measurement mode is selected on the rotary switch. During operation, output mode is selected in order to drive the display.

Port lines PD.5 are configured without internal pull-up resistors. However, with an open-circuited input these lines should be at '0'. This is achieved with the aid of R9. Inputs PD.5 and PD.6 are effectively connected in parallel through decoupling resistors R15/R12. This is necessary because PD.5 has a special function in directly driving the internal timer/counter, without making use of the cyclic program. This is particularly useful in the case of relatively high frequencies. PD.6 triggers an interrupt routine and responds immediately to the input signal. This is essential for period / pulse measurements on very short-lived signals. In Clock mode, when PD.5 and PD.6 are configured as outputs, resistors R12 and R15 limit the current to a safe level.

Signal conditioning

A 14-way pinheader, K2, carries the link between the measurement signal as well as the signals to and from the external control elements. The measurement signal arrives at the measurement amplifier input by way of K2.6. Resistor R11 ensures a stable Low level when the input is open-circuited. R13 and fast Schottky diodes D5/D6 protect the input against damage caused by voltages exceeding about 30 volts. A zener diode in this position would cause too much attenuation of high frequencies, or rounding off of fast pulse edges.

The measurement signal is now ready to be taken to pins 9 and 11 of the microcontroller, via **jumper JP1**. This is particularly useful when you are dealing with TTL signals having a swing of 0/5 V, whose frequency is too high for conditioning by the comparator. The circuit around compara-

tor IC3.A only acts when the jumper is in the other position, when the signal is fed to the non-inverting input of the LM393 via R19 and R21. The inverting input is held at a fixed level (threshold) of 2 V by R17/R18. If the input voltage at pin 3 exceeds this level, the comparator toggles and with it the logic state of port lines PD.5 and PD.6. By the addition of R22, the comparator is given some hysteresis to prevent slow pulse edges causing spurious oscillation.

So far, we have assumed that neither jumpers JP2, JP3 or JP4 are fitted, nor connections have been made to pins K2.8-K2.13. **Jumper JP4** actuates voltage divider R16/P1/R14. These resistors are clearly smaller than R17/R18, preventing the voltage divider from having an effect on the adjustable threshold set at the inverting comparator input by means of P1. The potentiometer, by the way, may be relocated to the instrument front panel. In that case, preset P1 is omitted from the board and pins K2.9, K2.10 and K2.11 are used to connect the potentiometer through wires. With the values shown in the circuit diagram, the span ranges from about 10 mV to 3.7 V, which nicely matches the realistic operating range of an LM339 opamp at a supply of 5 V.

Jumper JP2 (or an external connection of K2.12 to ground) brings R13+R19/R20 into circuit, causing the measurement voltage to be halved. As a matter of course, an external voltage divider will allow higher voltage swings to be accommodated.

Jumper JP3 (or a link to ground via K2.13), finally, actuates damping capacitor C8, whose effect is beneficial if you're faced with noisy signals or when driving the input by a contact.

Besides the measurement input, there are two more connections from K2 to the microcontroller. K2.3 is a digital control input leading to PD.4. The input protected by R10 and zener diode D4 may be used for additional functions. C7, finally, serves to debounce signals supplied by an external contact.

Pushbutton S1 is the Reset or Start control. Debouncing and damping is effected by R1 and C10. R3 protect the sensitive contacts on S1.

Optionally, a second pushbutton may be connected to pin K2.1. This connection is protected up to 30 V by means of R2/D3.

The instrument mode is selected by the user on rotary BCD switch S2. The four BCD lines A-D are taken to microcontroller port lines PD.0-PD.3 by way of R4-R7. Port lines PD.1, PD.2 and PD.3 have double functions. In operation, these lines are configured as outputs, multiplexing the displays. This is also the reason for the presence of current limiters R4-R7, which prevent damage caused by short-circuits.

The readout

A 74HCT42 IC decodes the three BCD lines required for an 8-digit readout to decimal format. Transistors T1-T8 enable all display digits in succession at a refresh rate of about 80 Hz, each transistor carrying a current of about 160 mA when switched

on. The display turn-off delay should be as short as possible (less than 1 microsecond) to prevent overlap in the display-enable signals occurring and causing undesirable visual effects on the readout. In this circuit, this effect is eliminated by software, allowing 'not too fast' transistors to be used.

All identically named segments of the 8-digit readout are taken together and driven directly via Port B. The current limiting needed for the LED segments is realised by resistors R40-R47.

Power supply

The 8-12 VDC supply voltage for the instrument is applied via PCB terminal block K1, with diode D1 acting as a reverse polarity protection. The voltage regulator, a 7805 (for 1 A) is fitted with a small heatsink if it is to handle rather high input voltages (up to 15 V). If a much lower voltage

is used, then the PCB ground plane will provide sufficient cooling. Capacitors C1, C2 and C3 are the usual reservoir and decoupling components. Zener diode D2 limits the circuit supply voltage to a maximum level of about 5.6 V in case too much current flows into the supply circuit as a result of the input over-voltage protection. In addition, all integrated circuits are locally decoupled with 100-nF caps (C4, C5, C6).

On the board, the supply tracks to the display are routed separately to prevent noise owing to the multiplex signals. After all, a pulsed current of about 160 mA flows through these tracks. Depending on the ripple voltage on K1 two more electrolytic caps, C13 and C14 may be fitted on the board.

Operation

Despite the low overall cost of the components used, the instrument offers a comfortable, simple operation employing the 8-digit 7-segment display. As shown in Table 2, eleven modes are available and three auxiliary functions (settings, really). Any one of

S2	LED readout								Mode/Function
	7	6	5	4	3	2	1	0	
0	—	—	—	—	—	—	—	—	None (spare)
1	8.	8.	8.	8.	8.	8.	8.	8.	All segments and DP on (display test)
2		V6	V5	V4	V3	V2.	V3	—	Pulse duration of positive half cycle in microseconds
3		V6	V5	V3	V3	V2.	V1	—	Pulse duration of positive half cycle in milliseconds
4		V6	V5	V3	V3	V2.	V1	—	Pulse duration of negative half cycle in microseconds
5		V6	V5	V4	V3	V2.	V1	—	Pulse duration of negative half cycle in milliseconds
6		V6	V5	V4	V3	V2.	V1	—	Period duration in microseconds
7		V6	V5	V4	V3	V2.	V1	—	Period duration in milliseconds
8		V6	V5	V4	V3	V2	V1	0	Frequency, gate time 0.1 s
9		V6	V5	V4	V3	V2	V1	—	Frequency, gate time 1.0 s
10		V6	V5	V4	V3	V2.	V1	—	Frequency, gate time 10.0 s
11		V6	V5	V4	V3	V2	V1	.	7-digit Event Counter
12		V6	V5	V4	V3.	V2	V1	.	Stopwatch with lap time function, resolution 0.01 s
13	—	—	—	—	—	—	—	—	None (spare)
14		C	F	C	—	1.5	—		Pause before next measurement (1-5 s) manual restart
15		C	F	C	—				Select positive / negative pulse edge

V6-V1: value or count.

When the measured value or count exceeds 6 digits, digit 7 is automatically added. The instrument function is then no longer displayed.

Digit 7 flashes during measurements.

Decimal point in digit 7 indicates overflow / limit value.

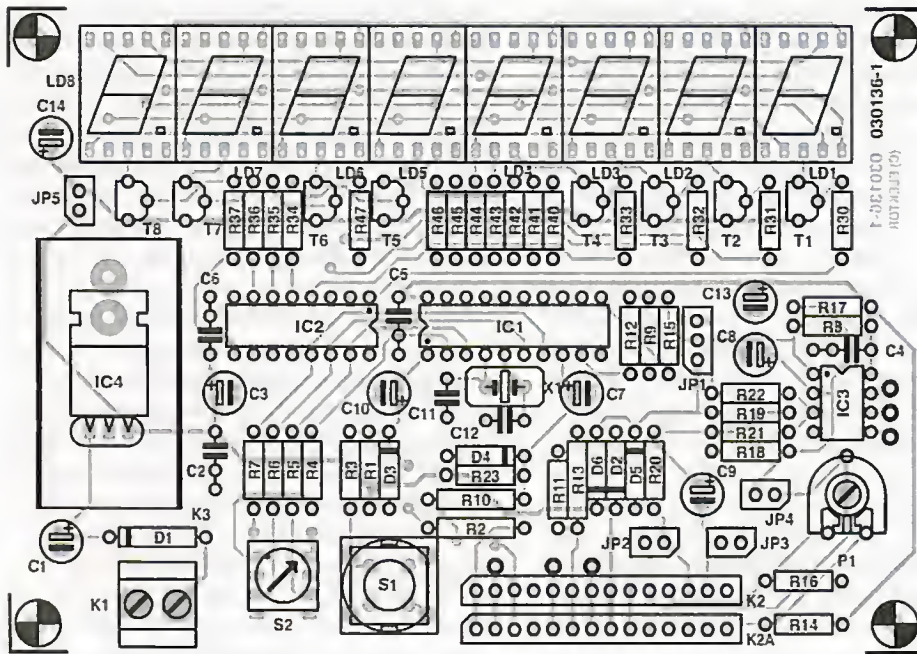

Figure 2. This double-sided board allows the versatile instrument to be built in a very compact way.

these may be selected at any time with BCD switch S2.

At power-on, a number of default settings are loaded (e.g., pause = 3 s; count edge = positive). If necessary, these settings may be modified via switch positions CONFIG1 and CONFIG2. Simply select the CONFIG you want to change and press the reset key until the desired setting appears on the display. Next, determine the desired mode of operation.

Each time the instrument function is changed or switched on, a new measurement cycle is launched. The displays will flash during the delay leading up to the trigger instant, as well as during the actual measurement. When the measurement is finished, the decimal point of digit 0 (DP0) lights briefly. This is a valuable indication about the status of the measurement process, particularly in the case of short measurements and 'display refresh on end of measurement'. Depending on the values entered into CONFIG1 a new measurement is automatically started after a fixed delay, allowing you to read the value from the display. This pause can be anything between 1 and 5 seconds in length, while it is also possible to select manual starting.

The separate gating input (K2.3 or PD.4) allows various functions to be realised for example, intermediate value displaying while in frequency meter or event counter mode. When the gating input is pulled Low, the

readout will be frozen. If it is permanently Low, the measured value is only refreshed at the end of the measurement cycle, in other words, it remains visible during the entire measurement. The gating input allows a start/stop/reset facility to be realised in Stopwatch mode.

Overflow is indicated by the decimal point in digit 7. Normally, the measured value will be displayed across display digits 1-6. When digit 6 overflows, the measured value also appears on digit 7, instead of the function indicator. When digit 7 overflows, too, the condition is flagged by the decimal point coming on and the digit starting to flash. The overflow indicator is also actuated with pulse duration measurements if you are applying pulses with a duration less than 1.6 microseconds, or a frequency greater than 300 kHz. In these cases, the display will act as a warning device.

The circuit features **automatic leading-zero suppression**. Only in 'refresh at end of measurement' mode, the zeroes will appear on the display in accordance with the progress of the measurement. When the measurement is finished, the readout is refreshed. The zeroes are retained when subsequent measure-

COMPONENTS LIST

Resistors:

- R1, R23 = 33k Ω
- R2, R10, R13 = 1k Ω 8
- R3, R12, R15, R40-R47 = 150 Ω
- R4-R8 = 1k Ω 5
- R9, R17 = 100k Ω
- R11, R18 = 68k Ω
- R14, R30-R37 = 3k Ω 3
- R16 = 22 Ω
- R19, R21 = 8k Ω 2
- R20 = 10k Ω
- R22 = 1M Ω
- P1 = 10 k Ω preset H (with spindle, see text)

Capacitors:

- C1 = 10 μ F 25V radial (optionally tantalum)
- C3 = 10 μ F 16V radial (optionally tantalum)
- C2, C4, C5, C6 = 100nF
- C7-C10 = .47 μ F 16V radial (optionally tantalum)
- C11, C12 = 22pF
- C13, C14 = 10 μ F 16V radial (optionally tantalum) (only if required)

Semiconductors:

- D1 = 1N4001
- D2, D3 = zener diode 5V6, 500 mW
- D4 = zener diode 4V7, 500 mW
- D5, D6 = BAT46
- T1-T8 = BC327-25
- IC1 = AT90S2313-10PC, programmed, order code 030136-41
- IC2 = 74HCT42 or 74HC42
- IC3 = LM393 (8-pi DIP)
- IC4 = 7805

Miscellaneous:

- JP1 = 3-way jumper
- JP2-JP5 = 2-way jumper
- K1 = 2-way PCB terminal block, lead pitch 5mm
- K2, K2A = 14-way SIL pinheader
- S1 = pushbutton, 1 make contact (small model)
- S2 = BCD switch (16 positions)
- X1 = 10MHz quartz crystal
- LD1-8 = SA52-11SRWA (Kingbright)
- IC sockets: 6-way, 8-way, 16-way, 20-way
- Heatsink for IC4 (U25, 30K/W)
- PCB, order code 030136-1
- Disk, project software, order code 030136-11 or Free Download

ments yield smaller values (clearing is possible by means of a RESET). With intermediate results on the readout (display refresh halted by separate input) the leading zeroes will be visible on the display as the counting operation progresses. After re-enabling the gate, the display (showing, for example, the stopwatch or the event counter) is immediately refreshed.

Functions

The function **Pulse/Period Measurement** is self-evident. As you can see on the photograph, the three horizontal segments in digit 0 are switched to indicate μs , ms or Hz units. Also on the photograph, the symbol for the actual function appears in digit 7. The decimal point appears in position 2. When the measurement is started, the instrument is triggered by the next (and, depending on the setting) valid pulse edge. With period measurements, triggering always takes place on a positive pulse edge. Optionally, a trigger threshold may be set using a comparator. This will be needed particularly with pulse duration measurements on non-rectangular signals.

In **Frequency Meter** mode you have gate times of 0.1 s, 1 s and 10 s to choose from. The lower horizontal segment for 'Hz' will be indicated by digit 0, and an 'F' (for 'frequency') will appear on digit 7. The decimal point only appears on digit 2 when 10-s gating has been selected. With the other gate times, display digits 0 or 1 will show a fixed 0.

In **Event Counter** mode the decimal point will light in display digit 0, while digit 7 indicates if positive or negative pulse edges are used to increment the counter. The selection is made using CONFIG2 (the default is 'positive'). Pulses with a frequency of up to 4 MHz are counted and displayed. Intermediate result viewing is possible by pulling the counter gate input low, which is flagged by DPO starting to flash.

The **Stopwatch** has an accuracy of 0.01 s. Its control, (start, intermediate value display, reset) only takes place via the separate pushbutton or input K2.3. The stopwatch defaults to the value '0.00 ms' on the display.

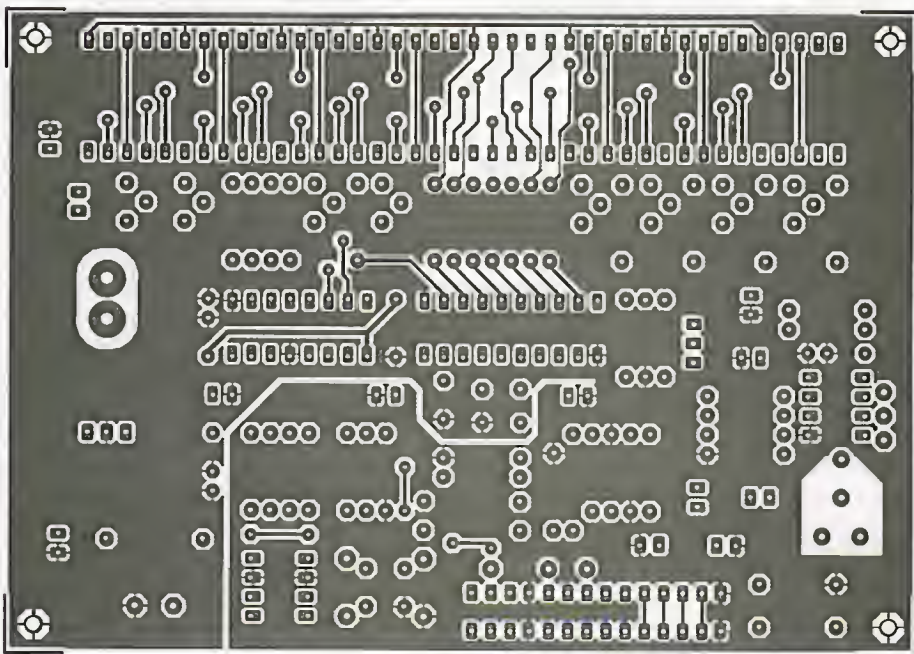
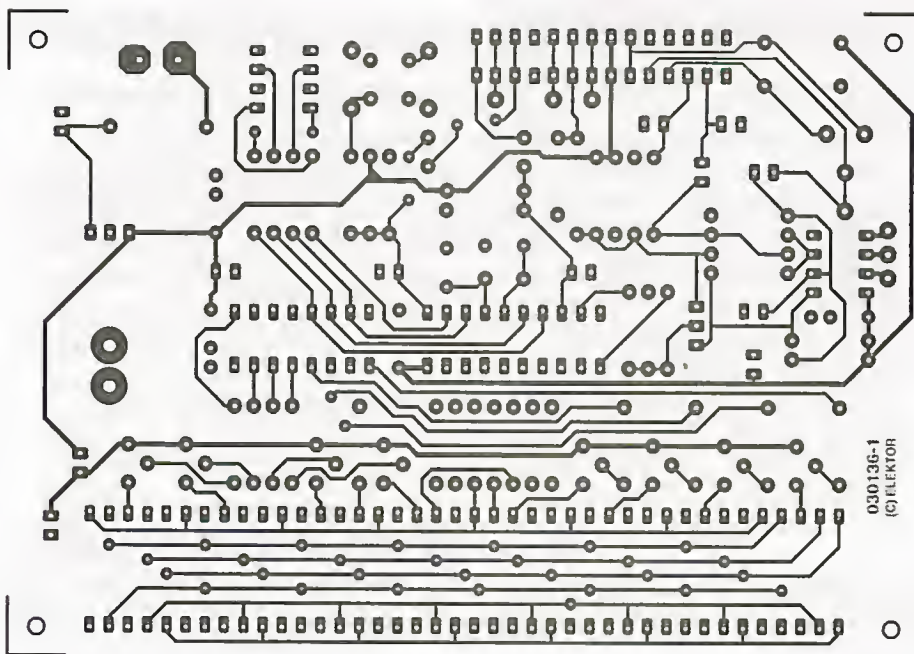

In digit 0, the central horizontal segment for 'ms' lights and a 'C' (for 'clock') will appear in digit 7. DPO is switched off. The stopwatch is started when the pushbutton is briefly pressed. The elapsed time will be displayed and DPO will light continuously. Intermediate (lap) and finish times may be requested by briefly pressing the pushbutton again. The display will freeze and DPO flashes to indicate the ongoing measurement. When you actuate the

pushbutton again, the display will be refreshed and DPO lights again. This sequence may be repeated as many times as you like. The stopwatch is reset by keeping the pushbutton depressed longer than about 2 seconds, or by pressing the Reset switch.

Construction

Figure 2 shows the double-sided printed circuit board designed for the Multifunction Frequency Meter. Despite its small size there are no dreaded SMD components to fit — all com-

DIY Programming

The microcontroller used in this circuit is available ready-programmed through our Readers Services. If you have the means and wherewithal to do your own programming, there's nothing to stop you as the HEX and source code files for this project may be obtained as Free Downloads from our website. Simply look for file number 030136-11 under month of publication or order a disk with the same number.

DIY programmers should know that

LB1 = 1 (unprogrammed)

LB2 = 1 (unprogrammed)

SPIEN = 0 (default, serial programming allowed)

FSRT = 1 (default)

ponents are of the normal 'leaded' type. Construction on a ready-made PCB obtained through our Readers Services (order code 030136-1) is not expected to cause problems if you work carefully. While populating the board, guidance on the positioning of polarized components is obtained from the component overlay. All DIL ICs may be fitted in good-quality sockets.

With the soldering work on the board finished, we suggest running a visual inspection on all solder work, if necessary using a magnifying glass. Without the ICs and displays mounted on the board, apply a supply voltage of about 8 V, preferably using a bench supply with current limiting. Check if the supply voltage arrives on all relevant points in the circuit. At this stage the overvoltage protection at the input may also be subjected to a quick test.

When everything seems to work so far, you may start fitting the displays onto the board. It is suggested to use two wires for a test of all individual segments. One wire is used to connect pins 1-7 and 9 of display position IC2 to ground. The other wire is used to switch IC3 pins 12-19 to ground. This will enable every individual segment to be tested. If this test is also successful, the displays and the associated transistor drivers can be assumed to work properly, which means that all ICs may be fitted in their sockets (observing their orientation, of course). Finally, all functions may be checked. The accuracy of the instrument is totally dependent on the drift and tolerance of the crystal oscillator. If necessary and provided high-end test equipment is available, the oscillator may be calibrated by making small changes to C11 and C12.

Well before starting your solder work on the board you should make up your mind which enclosure will be used to house the

instrument. But even without a case, the board should be very much alive and ready for use with just four PCB spacers secured to the corners — just hook up an 8-12 VDC/0.3 A mains adapter to K1 and away you go.

When the instrument is built into a stylish ABS enclosure, its controls should be moved from the board to the front panel. A case with a transparent cover, for example a Teko type P3 or P4, saves a lot of tooling as no clearance has to be cut and trimmed for the LED display — all you have to do is mount the displays in stacked sockets. Basically, the same applies when a case with a normal (non-transparent) lid is used — the displays may be positioned at the correct height above the board by using wire-wrap sockets whose pins are cut to length.

The board is secured to the inside of the front panel using four small PCB spacers. Although the actuator spindle of S2 may simply protrude from the panel, the hole for Reset switch S1 requires a much larger hole to make sure the cap is easily accessible.

The functions of jumpers JP2, JP3 and JP4 have been discussed above. If you want to use switches instead, do rummage around in your junkbox in search for miniature pushbuttons that, with some luck, can be fitted onto the board at (more or less) the right position. If you're unlucky, you can still connect the switch of your choice to the relevant pins on K2 and K2a, which have identical pinouts. The same goes for the potentiome-

ter: it is not necessary to mount one onto the front panel and wire it to the board if you can find an equivalent type that fits on the board and comes with a removable spindle. Alternatively, a preset may be mounted on the board and a hole drilled in the front panel to allow a small screwdriver to pass.

The counter gating input is realised by a pushbutton switching to ground and a two-way socket in parallel with it. These elements allow the gating input to be operated manually or electronically (by an external circuit). The measurement input should be a BNC socket.

Noise immunity

The input circuit has been laid out to represent a relatively high impedance. Depending on the jumper settings the input impedance will be between 15 and 65 k Ω . When long, open measurement wires are used, or the measurement is performed in an electrically noisy environment, strong 50-Hz signals may stray into the instrument (for instance, emanating from a phase angle control circuit). Although it is great to see that the mains frequency can be measured without an (unsafe) electrical connection, it is better to stick to defined conditions.

Since the instrument should be suitable for frequencies up to 4 MHz, damping (parallel) capacitors at the input are inappropriate. The following rules of thumb should be observed in this respect: (1) the signals sources should exhibit a low impedance and (2) long measurement cables should be screened. If necessary, a termination resistor (< 10 k Ω) should be connected to the measurement input.

(030136-1)

Hands-on CPLDs (2)

Part 2: Altera 7000S hardware

By A. Rosenkränzer

In this second article in the series we take a closer look at some of the hardware features of the 7000S-CPLD from Altera, this should help explain the process of programming the rev counter circuit into the CPLD.

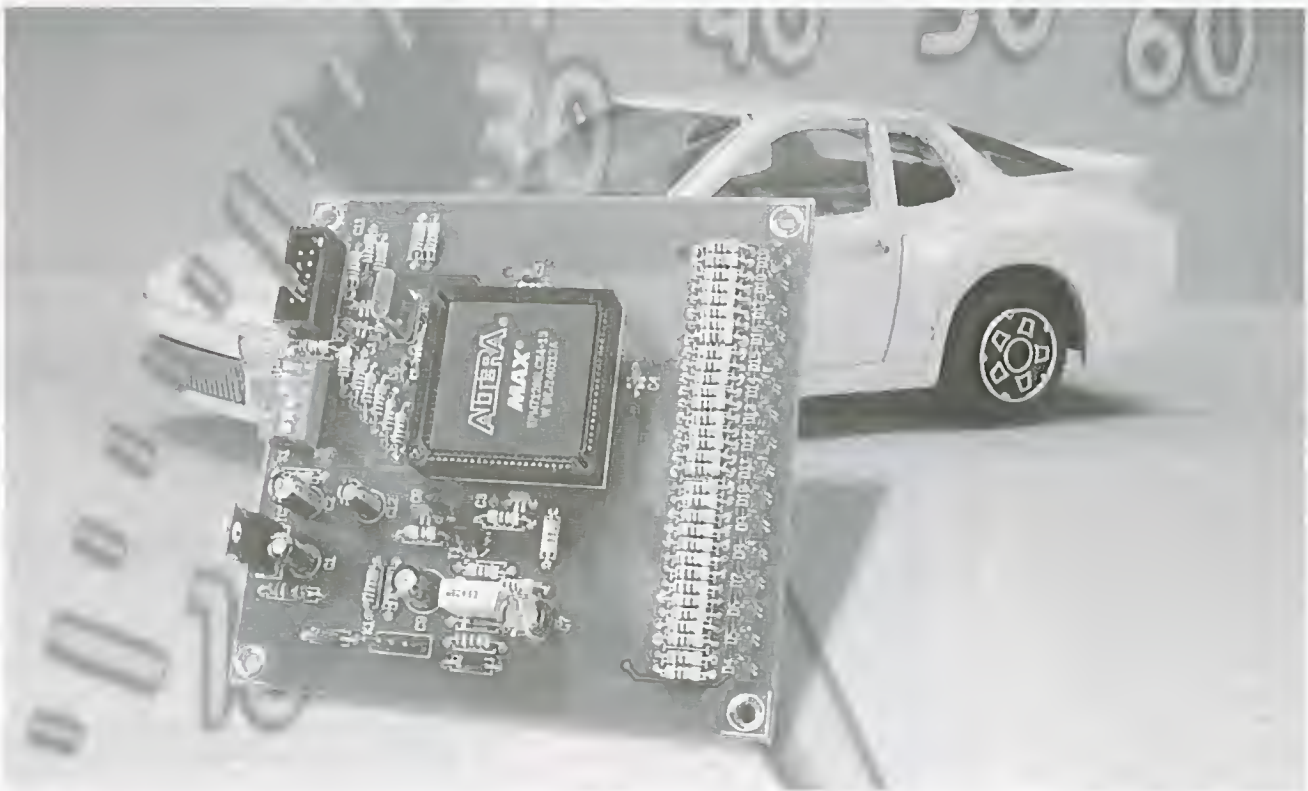

After last month's look at the rev counter circuit we now delve a bit deeper into the internal structure of a CPLD and use the Verilog hardware description software to configure the logic in a CPLD chip. For more in-depth information the Altera web site has a rich source of support documentation.

The smallest unit in the CPLD is the macrocell — it consists of a flipflop together with some peripheral logic. The logic can be

wired to 36 inputs. Both true and inverted versions of these 36 inputs are available internally. These signals can then be selectively AND gated to provide up to five product terms per macrocell. The resultant signals can now be connected to the inputs of OR or XOR gates and used as a data input to a flipflop. They can also be routed to other macrocells

via a configurable expander path. The type of flipflop implemented in each macrocell can be defined as a D, T, JK or SR type. The flipflops can also be bypassed if a purely combinational logic function is required from the macrocell.

The flipflop can be clocked from either of two global clock signals or a product term from some on-board

combinational logic. Generally speaking a synchronous design (where all registers clock signals are referenced from a common clock) is preferred to an asynchronous design. It is more problematic (especially for complex circuits) if a clock pulse is generated asynchronously within the circuit. In principle it is possible to use both rising and falling edges of the clock to move data simultaneously but this should only be employed if there is no other solution because it reduces the maximum usable clock rate. It is better to gate enable signals together with the appropriate clock edge. Each flipflop has a SET and RESET input (these are effective immediately and are not gated by the clock signal). Both of these signals can be supplied from logic outputs or any RESET can be tied to the Global-clear-Signal and its input pin.

Altera-CPLDs have 16 macrocells in each LAB (Logic Array Block). Each LAB has 36 input signals connected to a PIA (Programmable Interconnect Array). This arrangement can put some limitations on logic operations e.g. it is not possible to compare two twenty-bit words in one LAB because it would require 40 inputs. In practice 36 signals are sufficient for the vast majority of applications. All outputs from each macrocell together with special input pins and all I/O pins are connected to the PIA.

The different designation numbers in the 7000S series indicate the amount of logic available on the chip. The 7032S is the smallest in the family and has just two LABs i.e., 32 macrocells. The two numbers following the 7 therefore indicate the number of macrocells in the chip. The package outline and pin-count defines if all or only a few macrocells can have an I/O pin.

The file containing chip programming information is transferred from the PC to the chip over the JTAG interface connector. The ByteBlaster adapter links the JTAG port with the parallel port of the PC. The newer ByteBlasterMV runs in a wider range of computer operating systems and can accommodate a wider range of operating voltages (the original could only handle 5 V). Earlier still was the BitBlaster adapter, this

Table 1

```

/*
=====
Function   : PAL for AR rev counter
=====
Chip Type  : 7128S PLCC84
Manufacturer: Altera
Project    : Rev counter with freely programmable LEDs
PC Board   : Prototype
Reference  : Rev counter
Language   : Verilog, Quartus 3.0
Author     : AR
Company    : Myself
=====
Version  Date      Modification/Reason
-----
V 1.0    13.10.02   Initial Version
-----
V 2.0    08.11.02   Clock at 455kHz, ceramic Resonator
-----
V 2.1.   10.11.02   Bar mode only, no individual LED
-----
V 3.0    28.11.02   7128, 4.915MHz xtal, thousands readout
-----
V 3.1    28.12.02   External Reset
-----
V 4.0    16.04.03   DZ_IN_B for Schmitt trigger
-----
V 4.1    25.05.03   Reduced brightness with lights on
-----
V 5.0    09.10.03   Converted to Verilog
=====
*/

```

```

module drehzahl
(
    CLK,
    RESET,
    ZYL,
    MODE,
    LICHT,
    MRES,
    C4_IN,
    C4_OUT,
    DZ_IN,
    DZ_IN_B,
    LED_R_OA,
    LED_R_OB
);

    input          CLK;
    input [2:0]    ZYL;
    input [2:0]    MODE;
    input          LICHT;
    input          C4_IN;
    input          RESET;
    input          DZ_IN;

    output        MRES;
    reg           MRES;
    reg           Next_MRES;

    output        C4_OUT;
    reg           C4_OUT;

    output        DZ_IN_B;
    reg           DZ_IN_B;

    reg [8:0]     M;

```

plugged into the computer serial interface. More recently a USB version has been released. It is however not too important which path the data takes to get to the JTAG interface.

Programming

Many different software packages from as many different manufacturers are available. Altera offer both MAX2PLUS and QUARTUS.

MAX2PLUS is a relatively old software package. The free web version only allows the circuit connectivity to be entered using circuit schematics or an AHDL text file. Verilog and VHDL input can only be used on the licensed version of the software. Altera have announced that this package will not be supported in the future.

QUARTUS offers the language Verilog and VHDL in its free web edition and it can be used for large FPGAs but it does require more processing power from your computer and also more memory. These requirements should not pose a problem for any modern-day home PC. Quartus will therefore be used for the development of this project. Version 3.0 of the software is currently available for download from Altera. Once installed it is necessary to accept the terms of a *License File* via email. You will need the number of your hard drive or network adapter. The reply should only take a few minutes.

QUARTUS allows the design information to be entered in several different formats. Designs can be organised hierarchically or in a mixed format. For this project we will use a text-based input file and keep the design simple by using a flat hierarchy (only one layer). The program language VERILOG will be used throughout the development. VERILOG is not so hardware-near as AHDL but it is simpler to use. AHDL would be a better choice for applications where you are trying to squeeze maximum performance from the chip in as small as possible package outline.

The design file (XXX.v) can in principle be produced and read by any text editor program. The editor supplied by QUARTUS however uses coloured text to differentiate parts of the file (reserved words are blue, comments green etc) this makes it much easier to spot syntax errors such as a missing END statements and also makes it simpler to read the comments.

The file header

Table 1 shows the first part of the .v-file for the rev counter project that we described last

```

reg    [8:0]   Next_M;

reg    [10:0]  V;
reg    [10:0]  Next_V;

reg    VRES;
reg    Next_VRES;

reg    DZ_IN_1D;
reg    Next_DZ_IN_1D;

reg    DZ_IN_2D;
reg    Next_DZ_IN_2D;

reg    TOR;
reg    Next_TOR;

reg    TOR_D;
reg    Next_TOR_D;

reg    TOR_NF;
reg    Next_TOR_NF;

reg    [15:0]  LED;
reg    [15:0]  Next_LED;
reg    [15:0]  LED_R;
reg    [15:0]  Next_LED_R;

reg    [15:0]  LED_Z;

output [15:0]  LED_R_OA;
reg    [15:0]  LED_R_OA;

output [15:0]  LED_R_OB;
reg    [15:0]  LED_R_OB;

reg    [15:0]  MASK;

reg    [4:0]  i;

/*=====*/

```

month. The comment field starts after the /* symbols and ends with the */ symbols. The file has a large file header written as commentary giving a short history of the file along with the version numbers. A good tip here is to ensure you always make a back up before any major changes are made to the file.

Following the header the next line begins with the key word *module* followed by the module name (*drehzahl* for 'rev counter'). The inputs and outputs are now defined. It is not strictly necessary to separate all the inputs from all the outputs, they can all be mixed up but it does help to organise the file a bit better if they are kept separate. A comment can be added to the end of each line to give a short description of the signal. Later on the pin numbers can be added in the comment field for infor-

mation. The actual pin out information is produced in one of the other files.

Inputs and outputs

DZ_IN Ignition input from the vehicle coil. The signal will be filtered and level shifted to TTL signal thresholds.

CLK Global clock input driven from the crystal oscillator output C4_OUT.

C4_IN The crystal oscillator input.

MODE[2..0] The three signals from the three-way DIP switch used to select the different display modes. When there are several signals they can be grouped together under the same name they can then be

Table 2

```

/*=====*/
/* FlipFlops */
always @ (posedge CLK or negedge RESET)
begin
    if (RESET == 0)
    begin
        M           <=    9'd0;
        MRES        <=    1'b0;
        V           <=   11'd0;
        VRES        <=    1'b0;
        DZ_IN_1D <=    1'b0;
        DZ_IN_2D <=    1'b0;
        TOR         <=    1'b0;
        TOR_D       <=    1'b0;
        TOR_NF      <=    1'b0;
        LED         <=   16'd0;
        LED_R       <=   16'd0;

    end
    else
    begin
        M           <=   Next_M;
        MRES        <=   Next_MRES;
        V           <=   Next_V;
        VRES        <=   Next_VRES;
        DZ_IN_1D <=   Next_DZ_IN_1D;
        DZ_IN_2D <=   Next_DZ_IN_2D;
        TOR         <=   Next_TOR;
        TOR_D       <=   Next_TOR_D;
        TOR_NF      <=   Next_TOR_NF;
        LED         <=   Next_LED;
        LED_R       <=   Next_LED_R;

    end
end
/*=====*/

```

Table 3

```

/*=====*/
/* Clock oscillator */
always @ (C4_IN)
begin
    C4_OUT = !C4_IN;
end
/*=====*/

```

Table 4

```

/*=====*/
always @ (M or ZYL)
begin
    if (
        (M == 9'd478) && (ZYL == 3'd0) ||
        (M == 9'd238) && (ZYL == 3'd1) ||
        (M == 9'd158) && (ZYL == 3'd2) ||
        (M == 9'd118) && (ZYL == 3'd3) ||
        (M == 9'd78) && (ZYL == 3'd4) ||
        (!M == 9'd58) && (ZYL == 3'd5) ||
        (M == 9'd38) && (ZYL == 3'd6) ||
        (M == 9'd28) && (ZYL == 3'd7) )
        Next_MRES = 1'b1;
    else
        Next_MRES = 1'b0;
end
/*=====*/

```

referred to individually or as a group: MODE[1] is just one signal, MODE[1..0] is the two lowest bits and MODE[2..0] will be all three bits.

ZYL[2..0] These three inputs from the DIP switch allow the cylinder count of the engine to be selected. This allows the circuit to be used on different engines without the need to reprogram the CPLD.

LICHT reduces the brightness of the LEDs when the vehicle headlights are switched on.

RESET input for the Power-on-Reset network.

C4_OUT The crystal oscillator output.

MRES Debug output pin.

LED_R_OA [15 to 0] The first set of 16 outputs for the LEDs.

LED_R_OB [15 to 0] The second set of 16 outputs for the LEDs.

The output pins can only sink 12 mA so each LED has two outputs connected in parallel to increase the current.

DZ_IN_B The buffered input signal DZ_IN. The two external resistors produce a Schmitt trigger.

All outputs and internal signals are also defined as **reg** (register), but this does not necessarily mean that the signals will be produced by a flipflop.

All the flipflops used in the design are listed in **Table 2**. The signals in the *sensitivity list* (in the brackets after *always*) are the conditions that cause the output signals to change i.e. the positive edge of the clock or the negative edge of the RESET signal. All flipflops outputs are cleared to zero during reset. At the rising clock edge the signals will be updated to the values in the *NEXT_State*. The code for the *NEXT* state assignments is separated from the output logic assignments. This is not essential but is recommended by many Verilog design guides especially for modelling State machines.

The logic functions

The quartz oscillator is defined first; it consists of just a single inverter (**Table 3**).

The lines of equals' signs serve no other purpose than to visually separate each function block. One line of description is sufficient to describe the oscillator. The output signal C4_OUT is simply equal to the inverted input signal C4_IN. The exclamation mark indicates

signal inversion.

In the next description the clock frequency is divided down according to the settings of the 3 DIP switches Z0,Z1 and Z2. A four-stroke engine produces one ignition impulse per cylinder for every two revolutions of the crankshaft (assuming single spark ignition). A four cylinder engine therefore produces two impulses per revolution and an eight cylinder four impulses. To count the input pulses it would be possible to divide them down but this can produce display flicker so it is better to divide the clock frequency.

The statements in Table 4 describe the timing conditions necessary to generate the reset signal MRES for the 9-bit counter M. Altogether there are eight possible counter values that can generate MRES. Looking at the expression in brackets on the left-hand side the counter output M is compared to a decimal value on the right side of the brackets. The value of this expression will only be 1 when the counter output equals the decimal value otherwise it will be 0. Then comes two ampersands indicating the AND operator and another set of brackets containing the description of three inputs from the 3-way ZYL (CYL.) DIP switches. The value of the switches is compared with three bits representing the decimal number in the range 0 to 7. Only when the statements in both brackets are true will a 1 be generated. Each line has two vertical lines indicating that it is OR'ed with the next line so it only needs the statement on one of the lines to be true before the reset pulse MRES is set to a 1 otherwise it will be 0.

Line 4 for example will be '1' when counter reaches 118 and the DIP switch has the value 3. At the next rising edge of CLK the counter increments to 119 and MRES will change to a '1'. At the next clock the counter will be reset to zero and this will make MRES return to '0'. The counter is now ready to start counting up again at the next clock edge. It therefore counts from 0 to 119 which is 120 clocks altogether.

The behaviour of counter M is defined by the values in Table 5. When MRES is High, the next value of M will be 0 otherwise it will have the value M + 1. On the next positive clock edge the counter value will either be incremented or reset to zero, depending on the state of MRES.

Table 6 indicates that the input signal from the ignition coil DZ_IN is simply buffered and output as DZ_IN_B. Two external resistors use the buffered output to build a Schmitt trigger for DZ_IN.

The ignition input signal will not be synchronised to the internal clock frequency. It is necessary to re-clock this signal so that it can be

Table 5

```

/*=====*/
/* Counter M, Reset using MRES, else count up */
always @ (M or MRES)
begin
    if (MRES ==1'b1)
        Next_M = 9'd0;
    else
        Next_M = M + 1'b1 ;
end
/*=====*/

```

Table 6

```

/*=====*/
/* Input signal, counter gating, etc. (TOR = gate) */
always @ (DZ_IN)
begin
    DZ_IN_B = DZ_IN;
end
/*=====*/

/*=====*/
always @ (DZ_IN)
begin
    Next_DZ_IN_1D = DZ_IN;
end
/*=====*/

/*=====*/
always @ (DZ_IN_1D)
begin
    Next_DZ_IN_2D = DZ_IN_1D;
end
/*=====*/

/*=====*/
always @ (DZ_IN_1D or DZ_IN_2D or TOR)
begin
    if (DZ_IN_1D & !DZ_IN_2D)
        Next_TOR = !TOR;
    else
        Next_TOR = TOR;
end
/*=====*/

/*=====*/
always @ (TOR)
begin
    Next_TOR_D = TOR;
end
/*=====*/

/*=====*/
always @ (TOR or TOR_D)
begin
    Next_TOR_NF = !TOR & TOR_D;
end
/*=====*/

/*=====*/
always @ (TOR_NF)
begin
    Next_VRES = TOR_NF;
end
/*=====*/

```

Table 7

```

/*=====*/
/* Counter V */
always @ ( V or VRES or MRES or TOR)
begin
    if (VRES == 1'b1)
        Next_V = 11'd0;
    else
        if (!VRES & MRES & TOR)
            Next_V = V + 1'b1;
        else
            Next_V = V ;
end
/*=====*/

```

Table 8

```

/*=====*/
/* LEDs */
/* Mode 0    1000 to 6000 rpm, res. 333 */
/* Mode 1    750 to 4500 rpm, res. 250 */
/* Mode 2    4125 to 6000 rpm, res. 125 */
/* Mode 3    2500 to 10000 rpm, res. 500 */

always @ (LED[15] or MODE or VRES)
begin
    if (    LED[15] && (V == 204) && (MODE == 0) ||
        LED[15] && (V == 272) && (MODE == 1) ||
        LED[15] && (V == 204) && (MODE == 2) ||
        LED[15] && (V == 122) && (MODE == 3) )
        Next_LED[15] = 1'b0;
    else
        if (    VRES & !LED[15])
            Next_LED[15] = 1'b1;
        else
            Next_LED[15] = LED[15];
end
/*=====*/
.
.
/*=====*/
always @ (LED[0] or MODE or VRES)
begin
    if (    LED[0] && (V == 1228) && (MODE == 0) ||
        LED[0] && (V == 1637) && (MODE == 1) ||
        LED[0] && (V == 297) && (MODE == 2) ||
        LED[0] && (V == 491) && (MODE == 3) )
        Next_LED[0] = 1'b0;
    else
        if (    VRES & !LED[0])
            Next_LED[0] = 1'b1;
        else
            Next_LED[0] = LED[0];
end
/*=====*/

```

Table 9

```

/*=====*/
/* Copying into output register */
always @ (LED_R or LED or TOR_NF)
begin
    if ( TOR_NF )
        Next_LED_R[15:0] = LED[15:0];
    else
        Next_LED_R[15:0] = LED_R[15:0];
end
/*=====*/

```

used in the CPLD. The input signal is sampled by the flipflop DZ_IN_1D the first time and then DZ_IN_2D the second time. TOR toggles only if DZ_IN_1D is high and DZ_IN_2D is low which occurs at the rising edge of the input signal. The circuit operates like a digital differentiator. TOR therefore toggles between high and low for every rising edge of the ignition input signal. TOR_D is the TOR signal delayed by one clock period. TOR_NF detects the negative edge of TOR and is used to control the counter and registers.

Table 7 defines an 11-bit counter V[10..0]. A synchronous reset is generated by the VRES signal. The counter only increments when both MRES and TOR are high. The MRES pulse is one clock period wide and is used to reset the clock divider. M[] is one clock period wide. V[] does not count at every clock edge but only those gated by MRES. The frequency of MRES is defined by the 3 way DIPswitch ZYL[]. VRES is the signal TOR_NF delayed by one clock period.

The display

Table 8 indicates that each display LED has a flipflop assigned to it that is set to 1 by VRES. The DIP switch setting MODE [] controls the counter value at which the flipflop will be reset. The comments indicate displayed rev ranges and resolution (revs per LED). Thanks to the adjustable prescaler these settings are independent of the type of engine in use. To avoid repetition only LEDs 15 and 0 are shown. Table 9 shows that at the negative going edge of TOR (TOR_NF goes high) the contents of flipflops LED [n:0] are transferred into the LED_R[n:0].

To sum up

DZ_IN is the impulse from the ignition coil and is sampled twice. The positive edge triggers the TOR toggle flipflop. During the high phase of TOR the counter V[] counts using MRES as the clock source. M[] is a selectable divider which is adjusted to accommodate different engine types. The FF LED[] is reset when counter V reaches a user-defined maximum count. The negative edge of TOR loads the data from LED[] to LED_R[]. One clock period later V[] and LED[] are set to 1. As soon as TOR goes high again the whole process begins again and repeats.

From this description it can be seen that the time period between every other ignition pulse is counted to work out the engine speed, the period between counting is used to latch data and reset the circuit. LED display data is stored in an intermediate latch so

that it simply gets overwritten by the latest value at the falling edge of TOR. An earlier version of this circuit did not store the data so the LEDs flickered.

The circuit described so far simply displays the engine speed on a row of LEDs but there are also a couple of features that we have not yet explored. Firstly the LEDs brightness is automatically reduced when the vehicle lights are switched on. This is achieved by the first two lines of the FOR loop in Table 10. When the lights are off the first line of the expression is true and LED_Z[i] is the same as LED_R[i]. When the vehicle lights are switched on the second line is now true and bit 3 of the M counter output is included in the expression so the LEDs are now switched by this square wave and their brightness is reduced.

Secondly, there are eight possible display modes each with a different range of engine speeds so without any markers it can be difficult to interpret the display. To make the display more readable each LED representing a thousand revs on the scale glows constantly. As the engine speed increases and reaches these markers they switch to full brightness. The masks for these marker LEDs is included in the CASE declaration where the row of 16 LEDs is represented by a line of ones and

Table 10

```

/*-----*/
/* LEDs for thousands should light dimly, M0, M1 und M2 create Duty
Cycle */
/* M0 and M1 = 1/4, for lights off, M0, M1 and M2 = 1/8, for lights
on */
/* Mode 0 1000 to 6000 rpm, res. 333, LED 0,3,6,9,12,15 */
/* Mode 1 750 to 4500 rpm, res. 250, LED 1,5,9,13 */
/* Mode 2 4125 to 6000 rpm, res. 125, LED 7,15 */
/* Mode 3 2500 to 10000 rpm, res. 500, LED 1,3,5,7,9,11,13,15 */

always @ (LED_R or LICHT or M or MODE)
begin
    case (MODE)
        0:          MASK = 16'b1001001001001001;
        1:          MASK = 16'b0010001000100010;
        2:          MASK = 16'b1000000010000000;
        3:          MASK = 16'b1010101010101010;
        default:    MASK = 16'b0000000000000000;
    endcase

    for (i=0;i<=15;i=i+1)
        begin
            LED_Z[i] = LED_R[i] & !LICHT
                    | LED_R[i] & LICHT & M[2]
                    | MASK[i] & !LICHT & M[0] & M[1]
                    | MASK[i] & LICHT & M[0] & M[1]
            & M[2];
        end
    end
end
/*-----*/

```

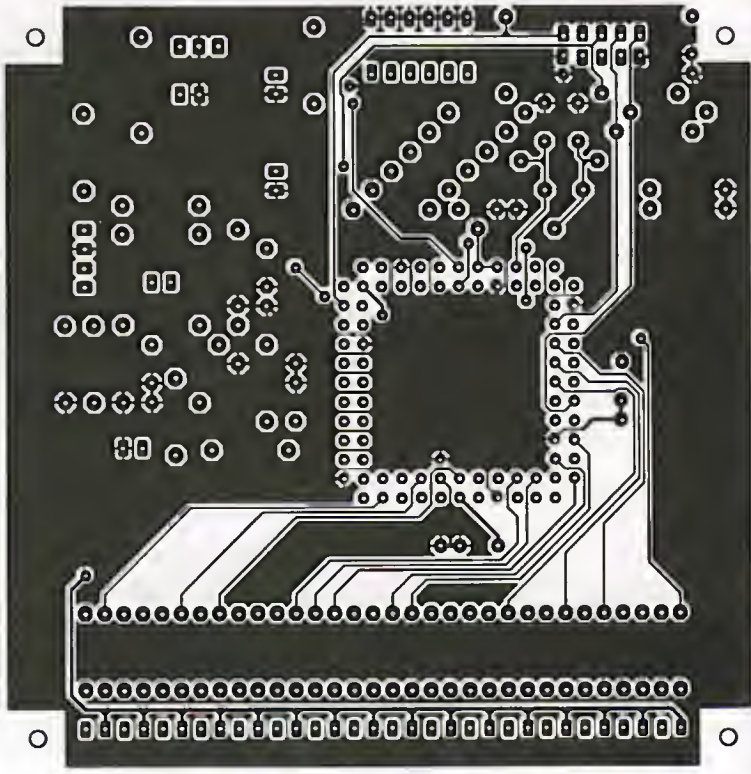
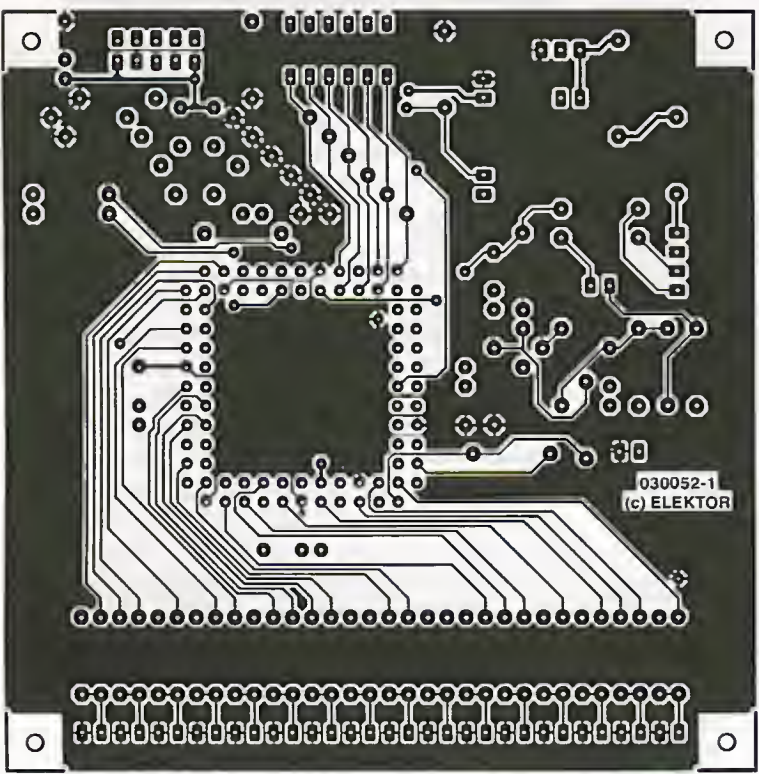

Figure 1. The double-sided PCB layout for the CPLD rev counter.

Table 11

```

/*-----*/
always @(LED_Z)
begin
  for (i=0;i<=15;i=i+1)
  begin
    if (LED_Z[i])
      LED_R_OA[i] = 1'b0;
    else
      LED_R_OA[i] = 1'bz;
    end
  end
end
/*-----*/

```

Table 12

```

/*-----*/
always @(LED_R or LICHT)
begin
  for (i=0;i<=15;i=i+1)
  begin
    if (LED_R[i] & !LICHT)
      LED_R_OB[i] = 1'b0;
    else
      LED_R_OB[i] = 1'bz;
    end
  end
end
/*-----*/
endmodule

```

zeroes, each 1 indicates a marker LED. The bit pattern from the three MODE inputs is used to select the correct mask. The mask is included in the last two lines of the FOR loop in table 10 to control the markers according to the state of the vehicle lights (LICHT).

In the expression in Table 11 the open-collector outputs LED_R_OA[i] are assigned to the output signals LED_Z[i]. Open-collector outputs can only sink current to ground; they cannot supply any output current to the load. Connecting two outputs in parallel effectively shares the current between the two outputs.

Finally, Table 12 defines the function of the second row of outputs LED_R_OB[i]. These outputs are driven directly from LED_R[i], they do not output any thousand rpm markers. These outputs are also switched off completely when the vehicle lights are switched on. The key word *endmodule* is used to indicate the end of the design files.

If this short introduction to CPLD programming has whetted your appetite you will be pleased to know that we have more QUARTUS and Verilog workshops planned. Also in the pipeline is a fully-fledged CPLD evaluation board ideal for prototyping new designs.

(030052-2)

See your design in print!
Elektor Electronics (Publishing)
are looking for
Freelance Technical Authors/Designers

If you have

- * an innovative or otherwise original design you would like to see in print in Europe's largest magazine on practical electronics
- * above average skills in designing electronic circuits
- * experience in writing electronics-related software
- * basic skills in complementing your design with an explanatory text
- * a PC, email and Internet access for efficient communication with our in-house design staff

then do not hesitate to contact us for exciting opportunities in getting your designs published on a regular basis.

Elektor Electronics
K. Walraven, Head of Design Dept.
P.O. Box 75, NL-6190-AB Beek, The Netherlands, Fax: (+31) 46 4370161
Email: k.walraven@segment.nl



Multi-channel Failsafe for Radio Controlled Models

Happy landings!

Design by Lex Cunningham

If you do not want your expensive R/C model to crash or disappear forever when the radio link fails or is subject to heavy interference, you need to preload your model with servo settings that 'take over' under adverse radio or battery conditions ensuring a landing that's as gentle and safe as possible. This circuit does it all, and more!

The Multi-Channel Failsafe was developed to prevent damage to radio controlled models when the on-board radio control receiver starts to receive erratic control information, or when the craft supply voltage drops below a predefined 'safe' level. Detection of corrupt frames in the received signal is handled by a microcontroller. At a certain level of insecurity, the micro loads a number of servo settings from an EEPROM that (hopefully) result in a safe landing, or at least, minimum damage to the model. The most important setting in these cases is, without doubt: cut off the engine (i.e., get it to idle)!

While such 'failsafe' facilities are available on high-end radio control systems, the cost is prohibitive to many occasional and weekend modellers. Many failsafe circuits have been published and commercial units are available, however these are only for a single channel and do not detect low voltage of the on-board battery. Setting up these units is also fiddly with the failsafe position set with a potentiometer.

Advantages and basic functionality

The Multi Channel Failsafe described in this article is flexible and easy to use, fits between the receiver and servos, provides up to eight

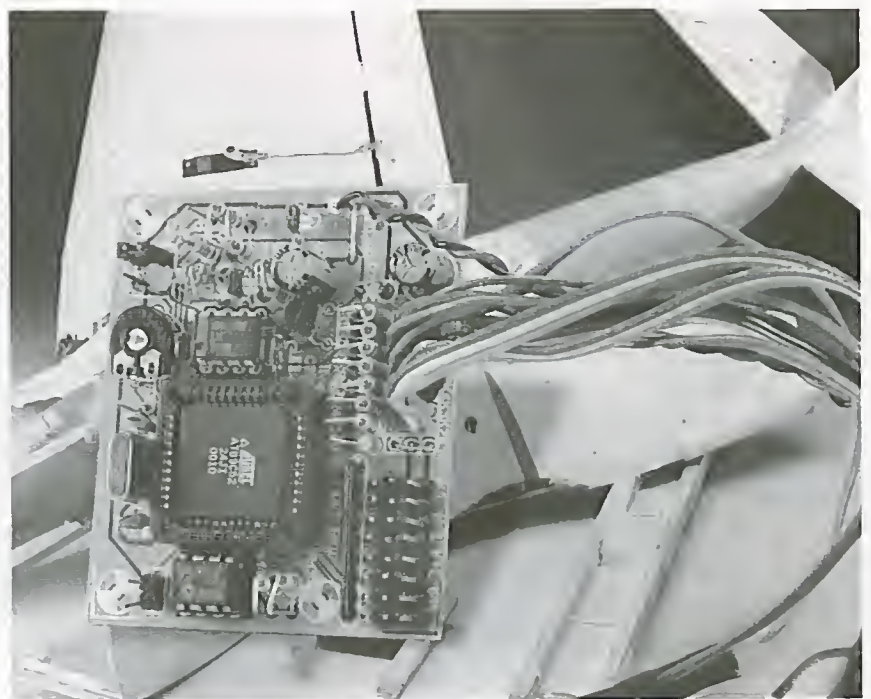

simultaneous channels, monitors the battery voltage and is switch selectable for use with four or five cell battery packs. It will continually measure and compare each servo pulse, as well as the entire frame and also

provide a 'lost model' alarm.

The failsafe state is entered if one of the following three conditions is detected by the microcontroller software in conjunction with suitable hardware:

- an entire frame is missing due to complete loss of received signal;
- a distorted-pulse counter reaches a threshold — this is useful when the model is near the edge of radio range;
- a low battery voltage is detected — this causes a repeated cycle of one second of failsafe positions, followed by five seconds of normal control. The resulting motions of the model are easily seen and heard from a distance and represent rather compelling reasons to get your expensive model back ashore, on the ground or in the pit!

The failsafe state is left, and the circuit acts as a bypass again for received servo signals when one of the following conditions is detected:

- a valid frame is received;
- the distorted-pulse counter drops below the threshold;
- the battery voltage returns to normal.

Programming the failsafe positions consists of setting the desired 'safe' positions using the RC transmitter, i.e., throttle to idle and other controls (rudder, aileron, steering, etc.) to neutral, and then pressing the Store button.

This causes the desired servo positions to be stored in EEPROM, from where they can be retrieved by the micro, but only when failsafe action is required. In all other cases, the circuit 'does nothing' to the servo commands you transmit to your model.

Circuit description

The failsafe unit is based on an AT89C52 microcontroller in a PLCC case. The circuit diagram in Figure 1 shows a typical application of a microcontroller. The main thing to understand about the circuit is that it is totally transparent to signals travelling from the eight IN connectors to the associated OUT connectors as long as no problems exist with the radio link and/or the on-board battery.

Having stated that the circuit is a standard microcontroller application, we should hasten to add that some analogue circuitry has been thrown in! A Low Battery condition is detected by a comparator circuit around IC3.A. The circuit supply voltage is normally stabilized to 5 volts by the circuit around IC4 — after all, five NiCd cells can supply anything between about 5.5 volts and 6.75 volts when exhausted or fully charged respectively.

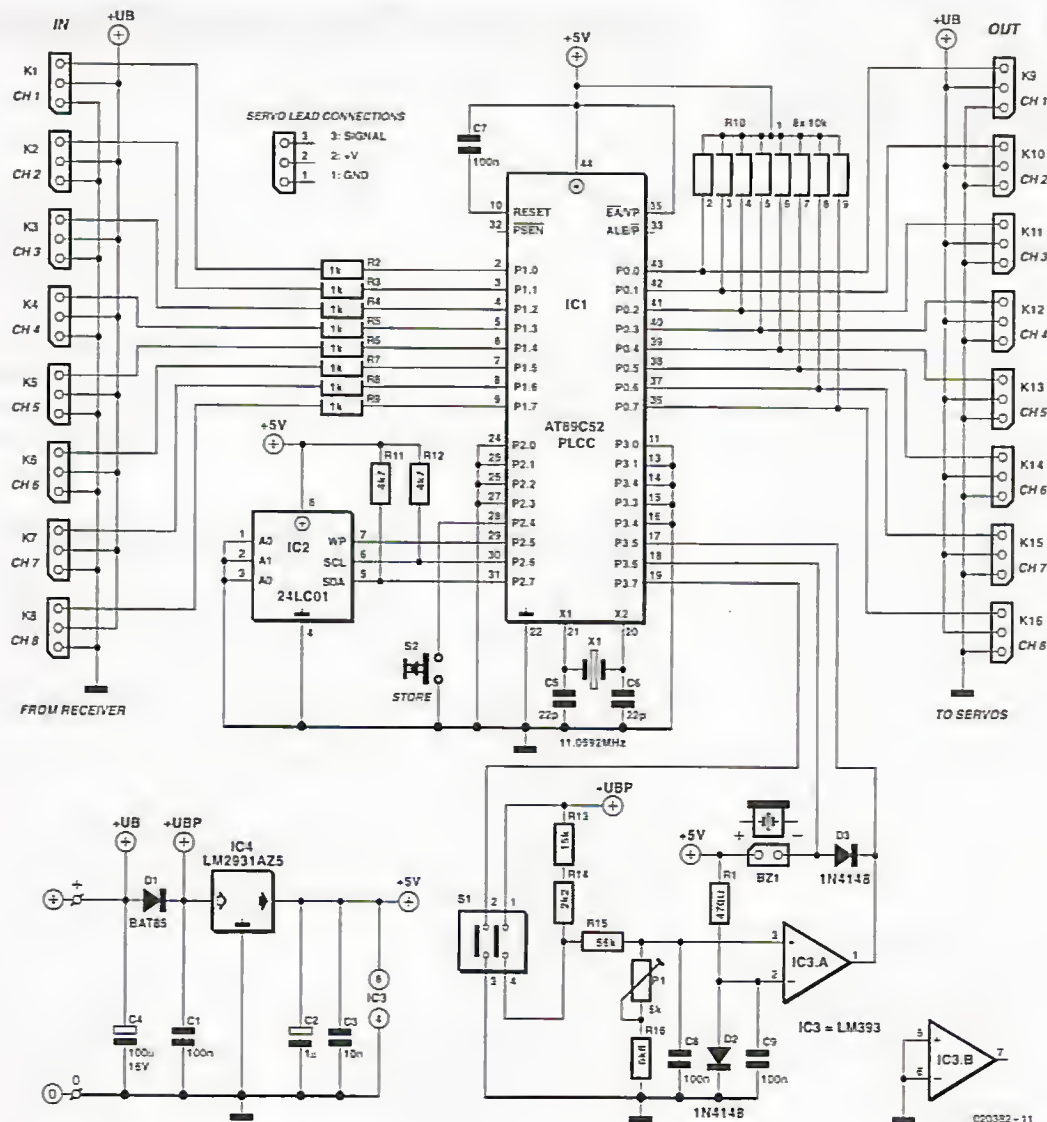

Figure 1. Circuit diagram of the Failsafe for R/C Models.

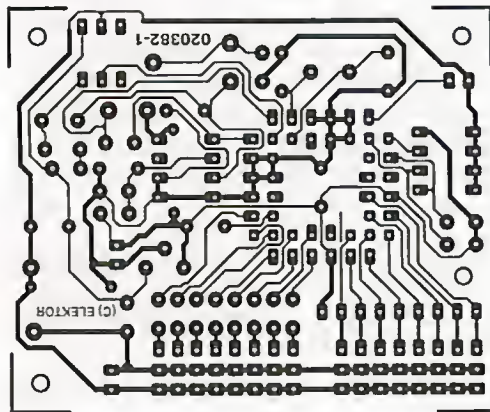
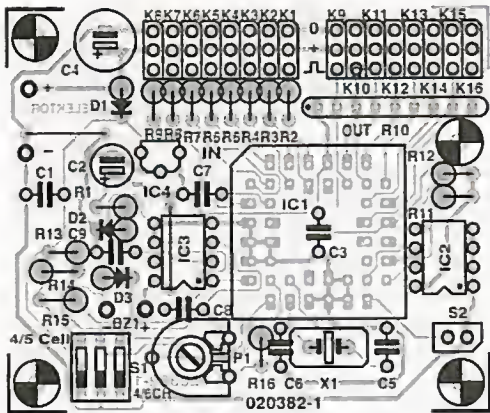

Figure 2. Printed circuit board layout (board available ready-made).

The LM2931A was chosen for its very low quiescent current, low voltage drop (max. 0.6 V), short-circuit and overload protections.

One switch in DIP switch block S1 allows you to select between operation from four or five NiCd cells. The setting you'll want to use for your particular model boat, car, helicopter or plane is picked from Table 1. When a four-cell NiCd battery pack is used, voltage regulator IC4 will not be able to regulate as its input voltage will be just 4.4-5.4V less the drop across D1 (approx. 0.2 V). Adding the drop across the (inactive) regulator itself, the supply voltage to the microcontroller may well become as low as 3.25 V and vary in proportion with the battery voltage. That is why we recommend the five-cell variety unless it is absolutely mandatory to use a four-cell battery pack for the model involved.

The 'battery-low' voltage level is accurately adjusted by means of preset P1. When the desired threshold is reached, that is, the battery voltage you consider unsafe for your model, buzzer Bz1 will sound. The 'battery-low' condition is also noticed by the microprocessor via port line P3.5.

The micro can also actuate the buzzer via P3.6 which is programmed to act as an out-

COMPONENTS LIST

Resistors:

- R1 = 470Ω
- R2-R9 = 1kΩ
- R10 = 8-way 2kΩ SIL array
- R11, R12 = 4kΩ
- R13 = 15kΩ
- R14 = 2kΩ
- R15 = 56kΩ
- R16 = 6kΩ
- P1 = 5kΩ preset H

Capacitors:

- C1, C7, C8, C9 = 100nF
- C2 = 1μF 16V radial
- C3 = 10nF
- C4 = 100μF 16V radial
- C5, C6 = 22pF

Semiconductors:

- D1 = BAT8S

D2, D3 = IN4148

IC1 = AT89C52-24J1, programmed, order code 020382-41 (see Readers Services page)

IC2 = 24LC01 (2V7)

IC3 = LM393

IC4 = LM2931AZ5 (Farnell # 412480)

Miscellaneous:

- BZ1 = active (DC) buzzer, SV
 - K1-K8 = 3-way servo plug
 - K9-K16 = 3-way SIL pinheader
 - S1 = 2-way DIP-switch (3-way optional, one contact not used)
 - S2 = pushbutton, 1 make contact
 - X1 = 11.0592MHz quartz crystal
- PCB, order code 020382-1 (see Readers Services page)
- Disk, microcontroller source code, order code 020382-11 (see Readers Services page) or Free Download.

Table 1 DIP switch functions

Switch contact on S1	On/Off	Function
S1-1 (pins 1-4)	On	Supply = 4 NiCd cells (4.8 V nom.)
	Off	Supply = 5 NiCd cells (6.0 V nom.) (recommended)
S1-2 (pins 2-3)	On	S-8 servo channels with failsafe
	Off	4 servo channels with failsafe

put line. The buzzer will sound when the model is 'lost' and may help you to recover your prized model aircraft from a corn field, tree branches or a

swimming pool.

Port line P3.7 reads the state of contacts 2 and 3 in DIP switch block S1. The available options are again

Figure 3. Extract from the C source code listing showing how the pulse width is measured in software.

```

unsigned char get_input_pulse_widths(unsigned char *seq_ptr,
unsigned int *sav_ptr, unsigned char *ft)
{
    /* get_input_pulse_widths measures the input pulse widths and
    /* stores the results in an array. 0 is returned when the frame */
    /* appears within a predetermined time. 1 is returned if there is */
    /* a frame timeout. */

    bit timer_flag, first_flag;
    unsigned char fail, int_hi, int_lo;
    unsigned int input_timer;

    timer_flag = 0;
    first_flag = 1;
    fail = 0;
    fail_int = 0;
    int_hi = INT_HI_FRAME;
    int_lo = INT_LO_FRAME;
    while (*seq_ptr != 0xFF && !fail) {
        if (!timer_flag) {
            set_int_timer(int_hi, int_lo);

```

given in Table 1.

When pushbutton S2 (STORE) is pressed, the failsafe settings for the CH1-CH8 servos on the corresponding connectors K9-K16 are copied from the transmitter (i.e., read from K1-K8) and stored in a 24LC01 I²C EEPROM (IC2). The microcontroller software contains a special routine to do all the talking with the 24LC01 using just three port lines. Two of these have been programmed to act as the SDA (serial data, P2.7) and SCL (serial clock, P2.6) lines, the other, to control the Write Protect (WP) function of the 24LC01. Note that a low-voltage (2.7 V) version of the 24LC01 is specified for this circuit.

One more point to note is the use of an 11.0592 MHz crystal. Although this is a dead common frequency in MCS51/52 land, we should not forget to mention that it was deliberately chosen so that any oscillator harmonics would not fall within the 27, 29, 35, 36, 40, 50, and 72 MHz R/C bands allowed in the UK.

Construction

As usual, Elektor's renowned PCB design department has succeeded in producing an extremely compact printed circuit board. What's more, the board is **single-sided** hence relatively cheap and easy to make yourself. Even better, the board can be supplied ready-made through our

Readers Services, the order code being 020382-1.

The PCB artwork is shown in Figure 2. Start the construction by fitting the two wire links so they are not forgotten later. SIL resistor array R10 is a polarized component whose 'common' terminal is usually identified by a dot on the body. This dot is also shown on the component overlay. Still on polarised components, the microcontroller is seated in a 44-pin PLCC socket — note the bevelled edge at one of its corners. Many parts are mounted upright. The areas where the two groups of eight (maximum) servo cables are connected to the board are quite crowded. If you do not want to use pinheaders, the servo wires may be soldered directly to the board. Either way, you need to get the servo wires connected the right way around, so if necessary consult the manufacturer's data in this respect. The location of the 'pulse' pins is clearly marked on the overlay, as well as by the inset drawing in the circuit diagram. The other two pins of each servo plug are ground and the positive supply (+UB).

Software

The software executed by the AT89C52 micro in this circuit was written in C using the freeware SDCC C compiler. The source code is

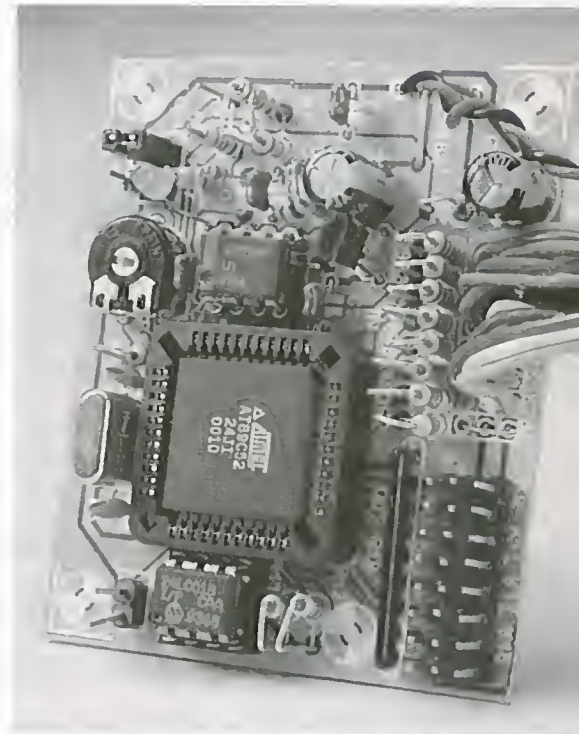

Figure 4. A close-up of our finished and tested prototype. As you can see, we soldered the servo wires directly to the board.

available on diskette (order code 020382-11) or a Free Download from our website (same number, see month of publication). Those of you without access to an assembler or a programmer for the Atmel AT series can buy the microcontroller ready-programmed through our Readers Services under order code 020382-41.

The source code has been extensively commented. The main parts of the code are the input sequencing and pulse width measurement functions. The latter is illustrated by the code snippet in Figure 3. Lex tells us that some innovative techniques have been developed to achieve correct framing of the input signals. By making the software freely accessible, Lex and *Elektor Electronics* jointly encourage readers to modify and extend the code.

(020382-1)

```

        j = *seq_ptr;
_asm
        mov    a,_j
00001$:
        cjne  a,p1,00002$
        sjmp  00003$
00002$:
        jnb  _fail_int,00001$
00003$:
_endasm ;
        set_start_timer(8);
        if (first_flag) {
            *ft = TIMER_2_HI;
            first_flag = 0;
            TIMER_2_LO = 0x00;
            TIMER_2_HI = 0x00;
        }
    }
    else {
        timer_flag = 0;
    }
    if (fail_int) {
        fail = 1;
        fail_int = 0;
    }

```

Free Downloads

Microcontroller source code. File number:
020382-11.zip.

PCB layout in PDF format. File number:
020382-1.zip.

www.elektor-electronics.co.uk/dl/dl.htm,
select month of publication.

The content of this note is based on information received from manufacturers in the electrical and electronics industries or their representatives and does not imply practical experience by Elektor Electronics or its consultants.

AVR450 Battery Charger

Multi-standard battery charging

By A. Riedenauer

Atmel's AVR450 reference board described in this article has just about everything you would expect from a high-end multi-standard battery charger. With suitable programming of the microcontroller, one and the same board and hardware allow you to implement a wide range of charger systems. Another unique feature of the circuit is its compatibility with Li-ion, NiMH, NiCd as well as lead-acid batteries.

Features

- Comprehensive charging system
- Modular C source code and extremely compact assembly code
- Inexpensive
- Support for all current battery technologies
- Fast charging algorithm
- 10-bit A-DC for high measurement accuracy
- Optional serial interface
- Simple adaptation to different charging parameters
- EEPROM for storage of battery characteristics

The AVR450 board introduced by Atmel contains two independent charger circuits, one built around the AT90S4433 and the other, around the much cheaper 8-pin ATtiny15. However, other AVR microcontrollers may be used, to, provided they have an A-D converter, a PWM output and enough program memory to hold the desired charging algorithms.

Ongoing research and development in battery technology constantly requires improved algorithms to enable batteries to be charged quickly and safely. While guarding the charg-

ing process, a higher accuracy is needed in order to reduce charging time while always exploiting the maximum cell capacity without causing damage to the cells.

Atmel's AVR microcontrollers are efficient 8-bit RISC machines offering Flash, EEPROM and a 10-bit A-D converter, all on one chip. The EEPROM memory is perfect for storage of calibration data and battery charge/discharge characteristics. Besides, the EEPROM allows the charge history of the cells to be permanently stored, hence their capacity to be fully exploited. The 10-bit A/D converter ensures excellent resolution during the measurements, enabling the charge response to be matched exactly to the cells while obviating the need for an external opamp acting as a voltage comparator. Another great thing about these 8-bit microcontrollers is that they have been designed for compatibility with higher programming languages such as industry standard 'C'. Not surprisingly, the software for the complete AT90S4433 is supplied in the form of 'C' code. The reference design for the ATtiny15 was written

in assembly language to make sure the highest possible code density could be achieved.

Both charger circuits are, of course, rather different when looking at their specifications. For example, the AT90S4433 may be used for voltage and temperature monitoring using a UART PC interface for the data logging function. The ATtiny15 design, on the other hand, has an advantage in being one of the heaviest integrated and at the same time cheapest battery charger circuits on the market today. The main differences between the two reference circuits are listed in Table 1.

Different battery types

Most portable equipment for the consumer market employs one of four battery technologies: Lithium-ion (Li-ion), Nickel Metal Hydride (NiMH), Nickel-Cadmium (NiCd) or sealed lead-acid (Pb).

Although these four battery types have widely different charging algorithms, for safe and complete charging of a cell, without the risk of overcharging or damage, it is a require-

Table 1. Differences between the charger circuits.

	AT90S4433	ATtiny15
Programming language	C	Assembly
Code size	approx. 1.5 kBytes	< 350 bytes
Current measurement	external opamp	internal difference amp
PWM frequency	14 kHz, 8-bit resolution	100 kHz, 8-bit resolution
Clock	external 7.3 MHz quartz crystal	internal 1.6 MHz oscillator
Serial interface	yes	no
In-system programming	yes	yes

ment for modern fast chargers (charge time less than 3 hours) to feature at least accurate measurement of the cell voltage, cell current and cell temperature.

The four battery technologies are briefly discussed below.

Pb cells are charged with a constant voltage, with a current limiter 'in the wings' to protect against overheating during the first phase of the charge cycle. In principle, Pb batteries may be left on charge indefinitely provided the cell voltage does not rise above the value specified by the manufacturer (usually 2.20 V).

NiCd cells are charged with a constant current. When discharging a battery pack it may happen that one of the series connected cells in the cluster is reverse polarized. To prevent damage, the cell voltage needs to be watched accurately and the load on the battery disconnected when the cell voltage drops below 1.0 V.

NiMH cells appear to be the most frequently used these days, possibly because of the higher energy density as compared with their predecessors the NiCd cells. Just like NiCd cells, NiMH cells are charged with a constant current. They are, however, sensitive to overcharging and that is why the cell voltage needs to be monitored closely during the entire charging process. NiMH cells, too, can be damaged by accidental reverse polarisation.

Li-ion cells have the higher energy density and resemble Pb cells in that they are charged with a constant voltage. Charging is halted the instant the charging current drops below a certain value. Li-ion cells are sensitive to overcharging and may even explode under adverse conditions.

Charging methods

Without exception, the charging current is dependent on the capacity (C) of the battery in question. The value of C is stated by the battery manufacturer. If a battery is charged with a current equal to $1C$ (i.e., one time the nominal capacity in mAh) then it will be fully charged in one hour. Trickle charging is often done at a (safe) current of $C/40$, that is, the battery capacity divided by 40.

We have to take into account that once the battery is fully charged, all further charging current is turned into heat (thermal energy). With a fast charger, rapid heating of the battery may cause irreversible damage if the charging current is not interrupted in time. Hence temperature monitoring is crucial to battery life.

Depending on the type of cell and its application, there are several methods of determining when a cell is fully charged, or the charging current has to be cut for any reason whatsoever. In the case of the AVR450 the first criterion used is the familiar voltage drop that occurs at the end of the charging cycle ($-dV/dt$), while battery temperature and absolute cell voltage are treated as secondary criteria. None the less, the hardware supports all four methods discussed below.

T (time)

One of the simplest methods to stop the charging process in time. With fast chargers, a timer is often used as an extra safety measure. With normal chargers (14 to 16 hours charging time), this is the most commonly used method. Applicable to all battery types.

V (voltage)

Charging is ended when the cell voltage rises above a certain value. This is often applied when charging with a constant current. In the case of Pb cells, the maximum value is defined as just above the charging voltage, resulting in constant charging. With Li-ion cells, this method is used to interrupt fast charging at a certain instant and then continue with a safe (much smaller) current to 'top up' the cells to 100% capacity. Also suitable as an extra safety precaution with NiCd and NiMH cells.

$-dV/dt$ (voltage droop)

Use is made of the slight decrease in cell voltage that occurs when the cell is fully charged. This method is applied in combination with a constant charging current in the case of NiCd and NiMH batteries and cells, although the latter should see their charge current disconnected when the voltage is no longer 'on the rise' (see $dV/dt = 0$).

I (current)

When charging with a constant voltage, the process is often stopped if the charging current drops below certain value. With Li-ion cells, the second charging phase after fast charging is ended in this way.

T (temperature)

Switching off the charging current above a certain critical (absolute) cell voltage is usually applied as a protection and not, as you might expect, as a primary criterion.

dT/dt (temperature rise)

With fast chargers the rise in cell temperature as a function of time may serve as a switch-off condition. The temperature rise will differ from battery to battery, but in general will be around 1 degree Celsius per minute for NiCd batteries. Suitable for use with NiCd and NiMH cells and batteries.

dT

(temperature above ambient temperature)

This is generally more reliable than the absolute temperature measurement, particularly in relatively cold environments. Usually, ambient temperature is measured by the same sensor as the one used for the cell temperature, and the measurement is performed at the start of the charging cycle. Applicable with NiCd and Pb cells and batteries as a primary criterion or a safety precaution.

dV/dt (delta zero voltage)

Much like the $-dV/dt$ method, with the only difference that the charger is switched off when the cell voltage is no longer rising. Suitable for NiCd and particularly for NiMH cells.

Hardware

As already said, the reference board contains two complete battery chargers. Functionally, the printed circuit board may be divided in three main sections as illustrated in **Figure 1**.

The large section at the left comprises a number of discrete components like LEDs, switches, a power supply, a reference voltage source and the PC interface. The power supply is a run of the mill 5-volt regulator built around an LM7805. The voltage source consists of another old faithful, the TL431 plus a couple of resistors. The PC interface is connected to the UART interface on the AT90S4433 and may be used to log battery data during the charging cycle. These data may fill a spreadsheet that allows you to examine the charge characteristic on a PC display. By the way, the AT90S4433 may double as a datalogger when the ATtiny15 charger is being used.

The sections at the right in **Figure 1** reflect the two processors whose PWM outputs are connected to a Buck converter, creating (in both cases) the actual charging circuits. The ATtiny15 sports an internal current amplifier capable of raising the voltage difference that exists between the two A/D channels. The AT90S4433 has an extra opamp for the same purpose. Moreover, the charger circuit is designed such that all battery types can be handled, while it may be adapted to suit all charging algorithms thrown at it.

Buck converter

The Buck converters used in the two charger circuits are largely similar in design,

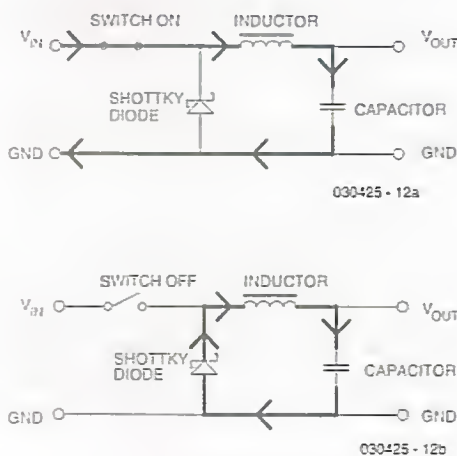

Figure 2. The main ingredients of a Buck converter are a switch, an inductor and a capacitor.

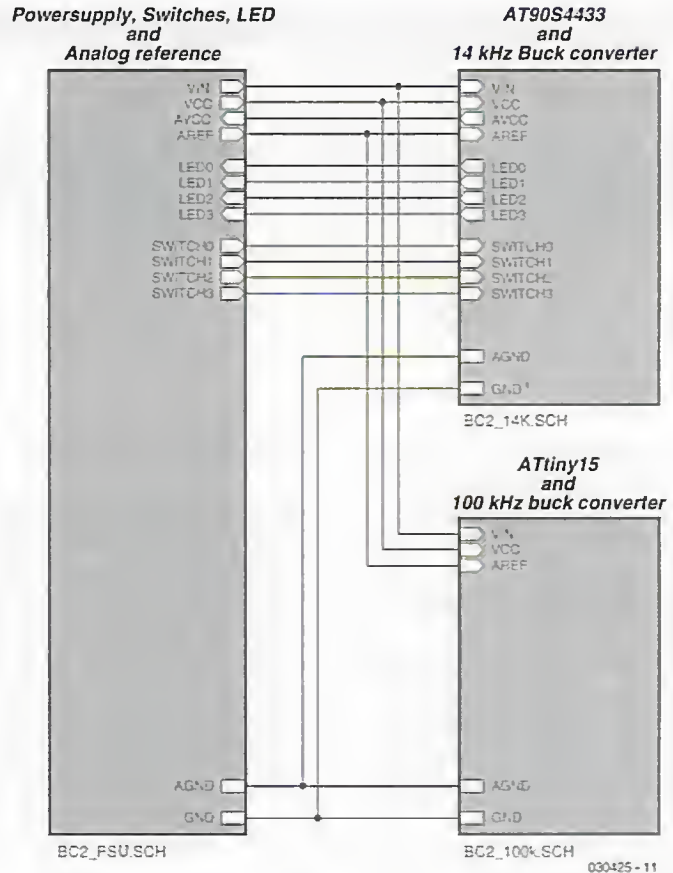

Figure 1. The three functional blocks that make up the AVR450.

comprising a p-channel MOSFET as the switching element driven by an n-p-n bipolar transistor which, in turn, is controlled by a micro-processor port line. The switching transistor is connected to an inductor, a diode and a capacitor (see **Figure 2**). A further diode prevents current flowing back into the battery when the supply voltage is switched off.

When the switching transistor is driven into conduction, current will flow as sketched in **Figure 2a**. The capacitor is charged by the input voltage by way of the inductor. When the switch is opened (**Figure 2b**) the inductor will attempt to maintain the current flow by inducing a voltage. By way of the diode and the inductor, the resulting current charges the capacitor to a higher voltage. The higher the duty cycle of the switching signal, the higher the output voltage. The maximum output voltage equals $V_{in} + 0.6$ V. The converter efficiency peaks at a duty cycle of 50%.

The AT90S4433 charger

The complete circuit diagram of the AT90S4433 charger may be seen in **Figure 3**. At the left you find the processor, at the right, the Buck converter. The serial interface is the sub-circuit in the lower part of the drawing.

The charger voltage is monitored by opamp U1B, whose inputs have been connected in parallel with the battery to be charged. Before the measurement for the opamp can be selected, the system will first have to determine the number of cells in the battery, as well as the battery type. Next, a suitable input voltage may be selected and resistors dimensioned to suit.

Resistor R1 acts as a sensor for the amount of charging current. The voltage drop across this resistor is amplified by opamp U1A in order to improve the measurement accuracy before the voltage is fed to the micro-controller's A/D converter.

The calculations required for the voltage and current measurement

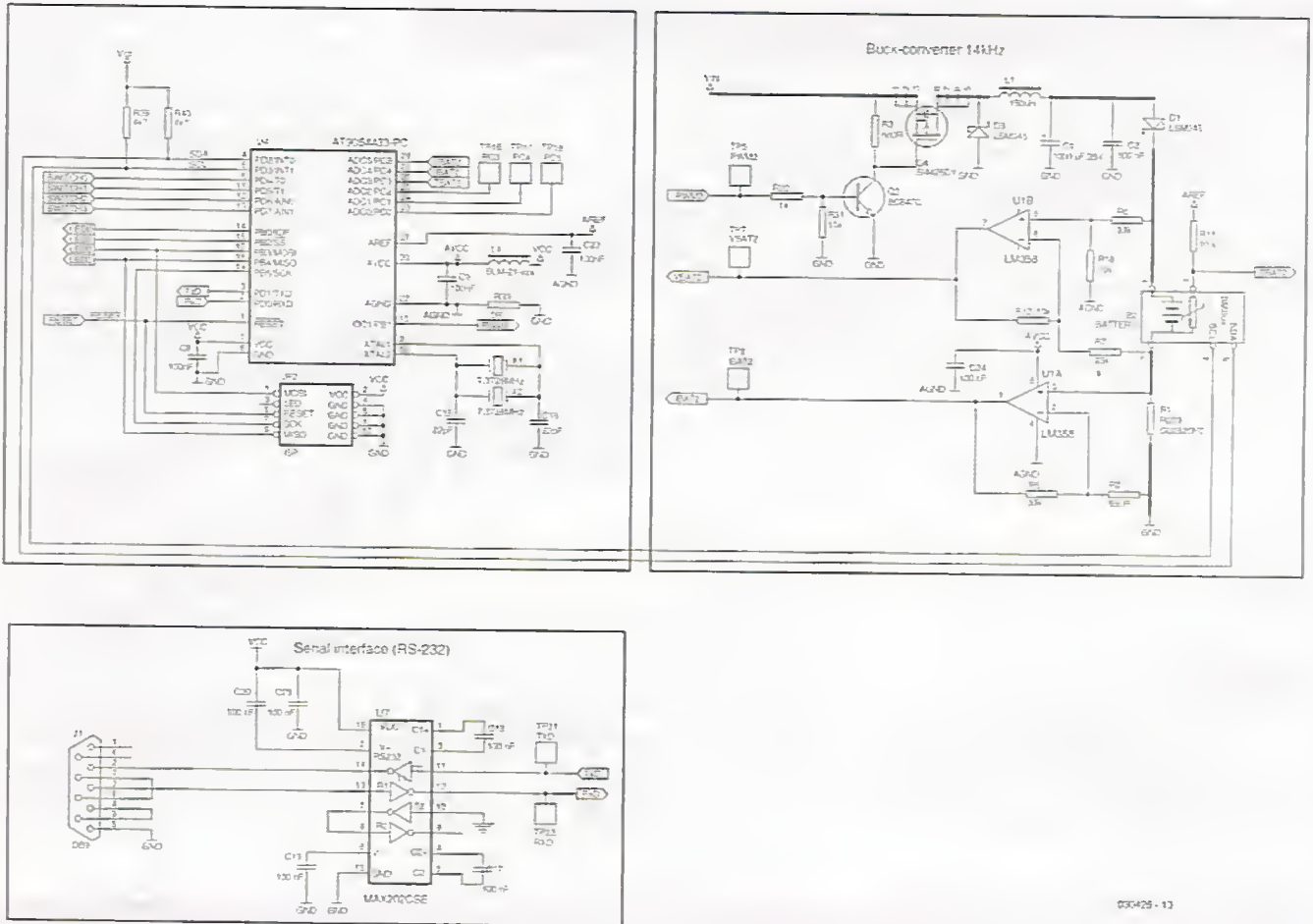

Figure 3. Circuit diagram of the AT90S4433 charger circuit employing a 14-kHz Buck converter.

Table 2. 'C' source code files		
Name	Description	Size
lo4333.h	Header containing symbolic names (for AT90S4333)	
cstartup.s90	Start-up files for C compiler	
Lnk0Lxcl	Command file for linker, specially for AT90S4433	
B_def.h	Defines cell type, cell voltage, cell capacity and voltage steps	
Bc.h	Header for bc.h, constants and macro definitions	
Bc.c	Main program, identical for all cell types	474 bytes
SLA.h	Header for lead-acid cells, charger parameters and function descriptions	
SLA.c	Source code for lead-acid cells	446 bytes
NiCd.h	Header for NiCd cells, charger parameters and function descriptions	
NiCd.c	Source code for NiCd cells	548 bytes
NiMh.h	Header for NiMH cells, charger parameters and function descriptions	
NiMh.c	Source code for NiMH cells	514 bytes
Liion.h	Header for Li-ion cells, charger parameters and function descriptions	
Liion.c	Source code for Li-ion cells	690 bytes

are discussed at length in the AVR450 datasheet published by Atmel.

The ATtiny15 charger

The hardware for this charger circuit being the spitting image of the one for the AT90S4433, we decided not to print it in this article. The oscillator frequency, 25.6 MHz, is generated by an on-chip PLL clocked by a 1.6-MHz signal supplied by an internal RC oscillator. A noticeable difference with the other charger circuit is the absence of the opamps in the Buck circuit — they have been replaced by two resistor ladder networks, one across the battery and the other across the shunt resistor. The necessary resistors are not part of the AVR450 board, but may be dimensioned to your requirements, depending on the battery voltage and the desired charging circuit.

The voltage difference measured across the battery or cell also supplies the necessary information on the charging voltage, and the resulting voltage is raised by the microcontroller's on-chip 20x amplifier. For the charge current information, the same happens to the

Table 3. Assembly code files

Name	Description	Size
bc.inc	Include file for register definitions, A/D channel definitions and global constants	
tn15def.inc	Include file for ATtiny15	
NiCd.inc	Include file for NiCd-cells, charger parameters	
NiCd.asm	Source code for NiCd cells	324 bytes
NiMh.inc	Include file for NiMH cells, charger parameters	
NiMh.asm	Source code for NiMH cells	328 bytes
Liion.inc	Include file for Li-ion cells, charger parameters	
Liion.asm	Source code for Li-ion cells	340 bytes

voltage drop developed across the shunt resistor connected in series with the battery.

Software

Not surprisingly, everything to do with the charging protocols is handled in software. In this respect, nearly all options you can think of are possible. Table 2 provides a list of the relevant 'C' source code files and Table 3, of the assembly code files.

The software may be adapted to support the charging of one or more cells. This is easiest done by charging cells alternately. Lead-acid and Li-ion batteries may be connected in parallel during charging, provided the packs consist of an equal number of cells! Both the charging current and the charge voltage per cell are limited for each battery.

The header 'Battery Characteristics' (b_char.h) contains definitions of all values together with the associated scaling factors. These values are defined in the Include files, calculated during compilation and subsequently used as constants when the program is executed. All measurement values supplied by the A/D converter may be instantly compared with these constants, hence no time is wasted on recalculating values while the program is being executed. Arguably, this

approach saves time and memory capacity.

With NiCd batteries, the charging current is started only when the battery temperature is within the range designated 'safe' by the manufacturer. Charging is ended if an error report indicates that either the temperature exceeds the maximum value, the maximum cell voltage is exceeded, or the maximum time allowed for fast charging is reached.

The standard way of establishing whether or not a battery is fully charged is to employ the above mentioned dT/dt or dV/dt methods. This is achieved by taking a temperature sample every minute, and a voltage sample every second. The values of these samples are constantly compared with those of previous samples. When the battery is fully charged, the charging mode automatically changes to trickle charging, all under control of software (i.e., the microcontroller program). Figure 4 shows a simplified flow diagram of a regular charging function.

In trickle charge mode, the program executes a loop structure, checking changes in the charging status and temperature while also keeping a close eye on the measured charge voltage and current. In case the maximum temperature or battery voltage is exceeded, an error flag is set and the relevant function is terminated. With no errors produced by the system, or the charging status changed by the user, trickle charging will continue indefinitely (in principle).

There is far more to say about the Atmel AVR450 battery charger system than can be fitted within the pages reserved for this Application Note. Readers interested in all the ins and outs are referred to the extensive Application Note no. 1659B-AVR-11/02 that may be downloaded free of charge from the Atmel website. In the not too distant future we hope to publish a practical battery charger based on the AVR450. This may take a while, however, so don't hold your breath.

(030425-1)

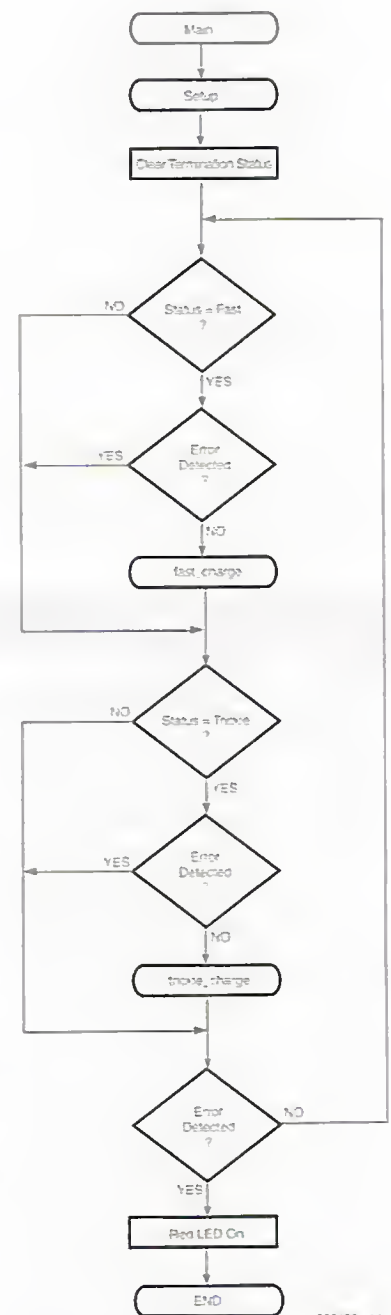

030425 - 14

Figure 4. Flow diagram of the charger's main function.

AT90S4433 Discontinued

Just before this issue was printed, we learned that Atmel have discontinued their AT90S4433 micro. The pin-compatible follow-up type is called ATMEGA 8. The Application Note describing the change from the AT90S4433 to the ATMEGA 8 is entitled 'AVR 081' and may be found at http://www.atmel.com/dyn/resources/prod_documents/doc2515.pdf

Data Storage on CompactFlash (CF) Cards

using BASCOM AVR

By F.-J. Vögel

In this article we show you how BASCOM AVR enables the Compact Flash Interface for our 89S8252 Flash Micro Board to be employed for DOS-compatible data storage in systems based on AVR microcontrollers.

The author's aim was to be able to use the Compact Flash Interface on an Atmel development board (RIBU ATMEGA103 Test Board) as well as in combination with BASCOM-AVR software, taking into account that the Atmel Test Board does have a lot of port lines, but no CPU-ish pins like RD, WR and ALE which are normally needed to connect external RAM.

Compact Flash interface

As shown in **Figure 1**, the hardware-wise connection to a microcontroller is possible without 'major surgery'. The eight datalines D0 through D7 are taken to a controller port. The remaining control lines occupy six pins of a further port. Address lines A0, A1 and A2 are connected to pins 0, 1 and 2. The WR (write) and RD (read) lines are connected to pins 3 and 4 of the control port. The chip enable input of the CompactFlash card is addressed by way of an address decoder, which pulls CE1 low when an address within the range F000 - FFFF is applied in external RAM mode.

However, using the solution proposed here, the CE1 input will have to be activated by a dedicated output pin. To this end, pin 5 of the control port is taken to A12 (an input of the NAND gate). The remaining the inputs A13, A14 and A15 of the NAND gate are tied to V_{CC}, so that outputting a High level at CE causes the output of the NAND gate to change from High to Low, thereby activating the CF card. The process as outlined above requires a total of 14 CPU I/O pins. Because the CF card is only activated through the CE input, at least a part of the other 'occupied' pins is available for use in

combination with additional peripherals like an LCD.

Compact Flash drivers

A software driver for a CompactFlash card should be able to read and write sectors of 512 bytes each, as well as initialise all required I/O pins (port lines). In as far as the interface is not capable of performing its own Power-On Reset, the driver should look after the resetting of the CF card. Also, the software should be able to establish whether the CF card in the system is available or not. Summarizing, the driver's functionality for a CF card or another storage medium (SmartCard, MultiMedia card) boils down to these routines:

DriveReadSector

Read a sector.

Drive WriteSector

Write a sector.

DriveReset

Reset a storage device.

DriveInit

Initialise the CPU peripherals including a reset for the storage device.

DriveCheck

Check if the storage device is available and ready for access.

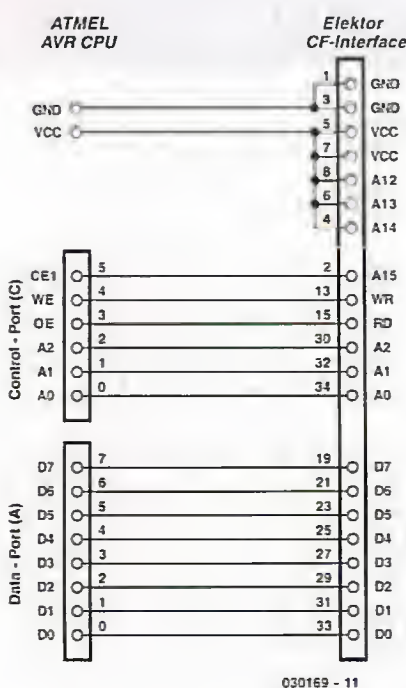

030169 - 11

Figure 1. Connecting the Elektor CF Interface to an AVR microcontroller system.

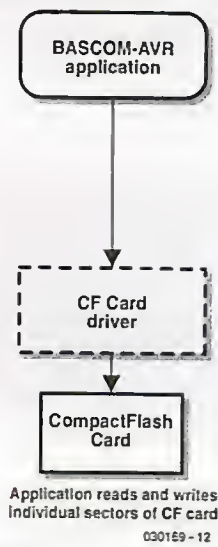

Figure 2. The application reads and writes individual CF card sectors.

DriveGetIdentify

Read the CF card's internal parameter blocks.

The names printed in **bold type** are the labels of the functions implemented in the current version of BASCOM-AVR. Explanations of the call parameters as well as exact function descriptions may be found in the Help file [1], which may be downloaded free of charge from the MCS Electronics website. Prices of CF cards having plummeted these past few months (a 128 MB card will now set you back less than 35 pounds), these software functions allow you to add an enormous amount of storage capacity to your microcontroller system.

If the data are to be copied onto a PC system for processing at a later time, the question arises how it should be organised on the Flash card to ensure compatibility between the microcontroller and the PC. If the MCU continuously writes data into the card's sectors, the PC program is forced to read the card sector by sector and by way of an adapter, interpreting the data all the time.

Another possibility is to use the PC to write a largish file containing nothing but blank data to a freshly formatted CF card. This would require the microcontroller to write its data line by line in ASCII format

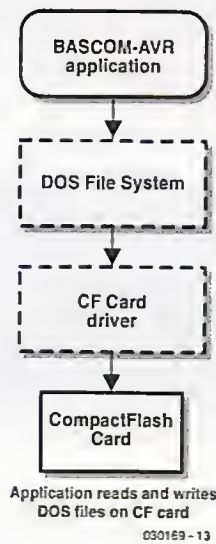

Figure 3. The application reads and writes DOS files.

into the occupied sectors. Once the data storage process is finished, the PC would be able to read the data under the previously given file name, using, for example, Excel. In any case, special programs would not be required.

The third and by far most elegant method is represented by a DOS system for BASCOM-AVR. Such a system puts all functions like creating, opening, reading and writing files in ASCII as well as binary format at the disposal of the microcontroller system, using a DOS formatted CF card.

DOS File System

The development of a DOS file system for BASCOM-AVR first started with an Internet search for information describing the way DOS and Windows manage files on a hard disk. A few very extensive and graphically well-presented websites were found [2]. In some cases, however, the information presented on the sites did not reflect personal experience, while in other cases discrepancies were found between certain bits of information. At the end of the day, the author found *Microsoft's Extensible Firmware Initiative, FAT32 File System Specification* [3] the most authoritative source. The document not only originates from the inventors of the DOS file system, but also was also found to contain

valuable information on data formats for use in *embedded systems*. Despite the document's title, FAT12 and FAT16 are also covered in depth.

During the further development of the project, the following essential points were noted:

DOS FAT16 File System

DOS FAT16 is the standard file system for storage volumes from 32 MB up to 512 MB, the theoretical limits ranging from 2 MB to 4 GB, covering the complete range of currently available CF cards. FAT12 and FAT32 pose heavier demands in terms of cluster management within the FAT.

Short DOS names (8.3 format)

Broadly speaking, a microcontroller system will not have the resources (i.e., input/output devices) to enable long file names to be handled with ease. Consequently a restriction to short file names only is unlikely to cause major problems, if you know that existing long file names may be addressed by means of their alias.

Files in Root Directory only

Using the standard formatting method, the Root directory is able to manage 512 files. This, we feel, should be sufficient for most, if not all, microcontroller systems, even really big ones. On the CF card, files may be stored in subdirectories, although they cannot be opened from there.

Sector size 512 bytes

Because the CF card can only transfer data on a sector-by-sector basis, and the sector size is a direct factor in the SRAM size requirements, AVR-DOS was designed for the standard sector size of 512 bytes, although other sizes like 1 kB, 2 kB, 4 kB and so on are supported by the Microsoft operating systems.

LBA sector addressing

The sector addressing on the CF card employs LBA Mode (Logical Block Address), which means that each sector is assigned a unique, linear address. The C/H/S (Cylinder/Head/Sector) method used in the early days of the hard disk is not supported. The file system was entirely written in AVR assembly code.

Configuration options

The DOS system is configurable with regard to the number of files that can be open at the same time. The open files are managed using file handle buffers. Besides the actual sector buffer, these contain the file number, directory

pointer and cluster number, and have a size of 534 bytes each. The number of possible file handles thus depends on the available RAM space and may be extended (if necessary) with external RAM. The DOS system contains measures to ensure a file can be opened multiple times in read mode (INPUT) only. Attempts at opening file several times over in read or write mode are signalled and rejected.

One further configuration option concerns the way the directory and FAT information is processed. This information may be saved either in a common buffer (saving RAM space and allowing faster file handling), or is separate buffers. In the second case, the sector is already saved in RAM when access is changed from FAT to Directory or the other way around, obviating the need to reload data from the CF card.

Implementation in BASCOM-AVR

The routines developed were integrated into the latest version of BASCOM-AVR in such a way that they can be called from an application using the syntax familiar from QBASIC/VBA/VB when it comes to file handling. This allows data input/output routines written in one of these dialects of BASIC to be copied and used without too many problems. The implemented commands listed in the Table show that size largely exceeds the minimum requirements for data logging

Unfortunately, a detailed discussion of all commands is beyond the scope of this article, although we should hasten to add that all you might want to know on the subject of command functionality may be found in the Help file [1].

Two simple examples should help to provide insight into the workings of the AVR-DOS system. **Example 1** shows how the values at three A/D inputs are logged over a period of about ten hours. First, the file system is initialised. Only if BASCOM-AVR was able to read the file system, the program returns '0' as an Error Code. The value '0' generally indicates that the DOS routine was able to complete its function as expected.

In **Example 2**, five command lines are used to read the 'contents page'. All files with the extension 'DAT' are looked up and their file names, dates, modification dates and file lengths get copied to the serial output line using the PRINT command.

Simulation

The BASCOM package contains an easy to use Simulator which allows a newly written program to be run on the PC before flashing

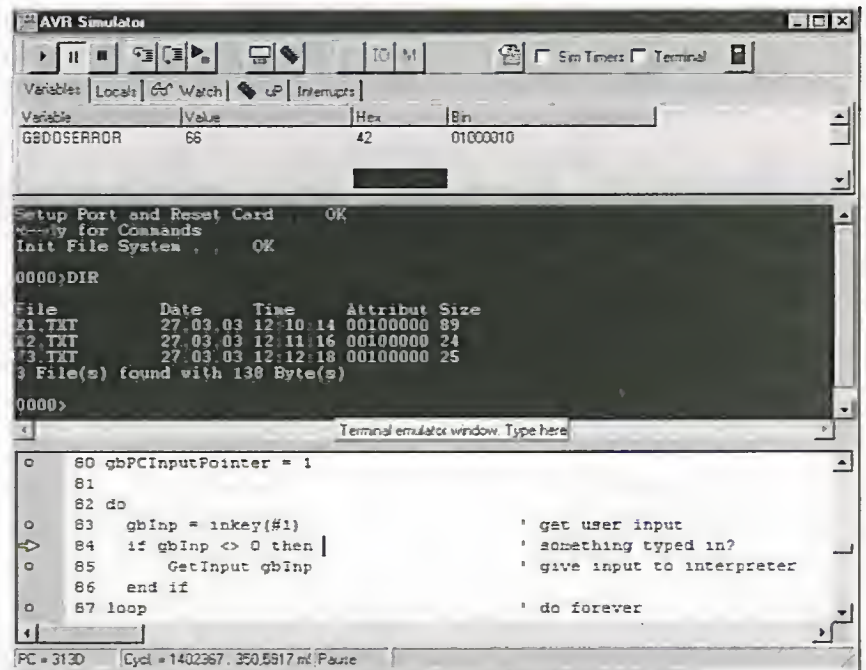

Figure 4. Screenshot showing Example 2 being run in the AVR Simulator.

Example 1. Recording the values supplied by A/D converters

```
Dim bError as Byte
Dim wValue1 as Word, wValue2 as Word, wValue3 as Word
Dim wsecond as Word

' initialise file system
bError = InitFileSystem(1)
If bError <> 0 then
    Print "No valid file system found"
End
End If

' Configure and start AD converter
Config ADC = Single, Prescaler = Auto
Start ADC

' Create file to write
Open "AD1.txt" For Output As #10
For wSecond = 1 to 36000 ' seconds counter for 10 hours
    wValue1 = GetADC(1) ' 1. read analogue value
    wValue2 = GetADC(2) ' 2. read analogue value
    wValue3 = GetADC(3) ' 3. read analogue value
    ' use seconds counter to write values into file
    Write #10, wSecond, wValue1, wValue2, wValue3
    Wait 1 ' wait 1 second
Next
Close #10
End
```

Example 2. Contents page of a CF card.

```
Dim strFileName as String * 12
strFileName = Dir("*.dat") ' 1. Find file
While strFileName <> "" ' File found?
    Print strFileName; " "; FileDate(); " "; FileTime(); _
        " "; FileLen()
    strFileName = Dir() ' find next file
WEnd
```

[1] BASCOM-AVR Help file

www.mcselec.com/download/avr/beta/bashtml.zip

[2] Information on DOS FAT

www.beginningtoseethelight.org/fat16/index.php

www.win.tue.nl/~aeb/linux/smartmedia/SmartMedia_Format.pdf

[3] Microsoft Extensible Firmware Initiative, FAT32 File System Specification

<http://www.microsoft.com/hwdev/download/hardware/FATGEN103.doc>

it. The CF card also allows this to be done — in a way. This was achieved with the aid of a driver simulating a CF card (admittedly with just 59 kB

and a largest directory size of just 16 files) in the AVR's extended RAM range. To this end, a so-called XRAM Driver is linked instead of the normal

CF card driver. Here, too, the modular driver concept pays off because it allows storage media to be swapped by changing a single statement. This not only allows the behaviour of application software in a DOS environment to be tested, but also the actual data storage on a storage medium in the external RAM range. According to the Microsoft recommendations, a disk size of 59 kB should be managed using FAT12 (up to 4 MB) and not FAT16. However, as this 'partition' is virtual only and intended for test purposes, this departure from the rules remains without negative consequences.

(030169-1)

Table I. Command List

• GetFileSystem	Reads required data from Master Boot Record (MBR) and Partition Boot Record (PBR) of the CF card in order to initialise the file system (not contained in QBASIC/VBA/VB syntax).
• DISKSIZE	Overall CF card storage capacity in bytes.
• DISKFREE	Available CF card storage capacity in bytes.
• KILL <FileName>	Wipes a file from CF card.
• DIR([<FileName>])	Searches for the first or second matching file name on the CF card.
• FILELEN([<FileName>])	Size of a file in the Root directory matching file name or file last found using DIR.
• FILEDATETIME([<FileName>])	Date and time of a file in the Root directory matching file name or file last found using DIR.
• FILEDATE ↵([<FileName>])	Date of a file in the Root directory matching file name or file last found using DIR.
• FILETIME ↵([<FileName>])	Time of a file in the Root directory matching file name or file last found using DIR.
File creation, opening, writing and reading	
• Open <FileName> FOR INPUT/OUTPUT/APPEND/BINARY AS #<File#>	Opens/creates a file at INPUT in read mode, at OUTPUT/APPEND in write mode, at BINARY in read/write mode.
• FREEFILE()	Returns a free file number, this may be used for the OPEN functions.
• CLOSE <File#>	Closes a file and releases the file handle.
• FLUSH [<File#>]	Writes the current data buffer(s) into RAM on the CF card and updates the contents (not contained in QBASIC/VBA/VB syntax).
• PRINT #<File#> , Variable1 ; Variable2; ...	Writes data in text format into a text file that was opened with OUTPUT or Append
• WRITE #<File#> , Variable1 , Variable2, ...	Writes data in text format into a text file that was opened with OUTPUT or Append. Individual data files are separated with a comma and character strings are enclosed in quotation marks.
• INPUT #<File#> , Variable1 , Variable2, ...	Reads data from a from a text file into program variables, mostly data written into a file using a WRITE command. Data files to be comma-separated and character strings enclosed in quotation marks if they contain commas.
• LINE INPUT #<File> , StringVariable	Reads a line from a text file into a string character variable.
• GET #<File#> , <Variable> [, Position]	Reads binary format data into any program variable from a file opened in BINARY mode.
• PUT #<File#> , <Variable> [, Position]	Writes any program variable in binary format into a file opened in BINARY mode
• SEEK #<File#> [, <New Position>]	Returns the file position of the next read/write access. The additional parameter <New Position> allows the position to be changed with files in binary mode also.
Status information on opened files	
• EOF #<File#>	Returns the status End of File.
• LOC #<File#>	Indicates the file position of the last read/write access.
• LOF #<File#>	Indicates the file length.
• FILEATTR #<File#>	Returns file opening mode.
Miscellaneous	
• BLOAD <FileName> , <SRAM Address>	Writes the contents of a microcontroller RAM range, starting at SRAM address.
• BSAVE <FileName> , <SRAM Address> , <Length>	Saves a microcontroller RAM range into a file.

Voltage & Continuity Tester

for direct and alternating voltages up to 60 V

Design by B. Kainka

Unless it reaches really high levels, what we refer to as 'voltage' is totally invisible, so test and measurement equipment is a must in every electronics lab. However, in many cases you'll just want to know if a voltage is present at or not a certain point. The tester described as this month's Mini Project is an unusual one because it can work with just one test lead — all you have to do is use the single probe to touch the point you want to check.



So where's the other test lead connected to, after all, a voltage always exists between two points? The answer is: the voltage is measured against 'ground' connected to the metal enclosure of the test instrument. In this way, it is defined by the person holding the test probe in his/her hand. With each voltage test, a safe current of just a few microamperes flows through the person's body. The tester will amplify this current to a level where it can be indicated by an LED.

Construction and principle

The narrow PCB (Figure 1) has been designed to fit into a metal tube together with two miniature batteries. If you do not object to a slightly larger construction, you may want to use two AA (penlight) batteries. The diameter of the metal tube depends on the width of the battery holder

used for the project. The isolated probe tip is then mounted at the front side of the tube. A so-called low-current LED should be used to ensure as little power as possible is wasted in the indication, yet making it sufficiently bright. An on/off switch is not required because the tester does not consume power when it is not used. Thanks to their low self-discharge current, a pair of alkaline batteries should last for many years.

The tester's principle of operation should be familiar to most of you, as it is also used for those screwdriver-type voltage testers you can use to check if the 230-VAC voltage is present on the 'L' (live) line of a mains socket. Most of these tools contain a small glow lamp and series resistor. A metal cap at the end of the screwdriver handle acts as the ground terminal, establishing the connection with the user's body. Unfortunately, glow discharge lamps do not work at voltages below about 100 V.

With electrical safety in mind, the instrument described in this article must never be connected to a mains voltage or any point that can be expected to be directly con-



Figure 1. The narrow board and the two miniature batteries together fit into a metal tube to make a probe-like enclosure for the tester.

ected to mains supply. For this purpose, use approved testers only, for example the screwdriver type described above.

The tester described in this article is intended for low voltages up to 60 V. As a bonus, it will also function as a continuity tester and an audio signal tracer.

The circuit

The circuit diagram in Figure 2 shows a simple Darlington amplifier based around two BC548C transistors. Each of these offers a current gain of at least 420 times, so the Darlington configuration is good for a gain of 420^2 or about 170,000 times! The maximum collector current is reached at just 1 mA already. Consequently an input current of less than 0.01 mA or 10 nanoamperes is sufficient to make the LED light. An added passive piezo sounder (transducer) enables the circuit to act as a tracer for audio signals. When an alternating voltage is applied to the input, the LED will also light and the signal is audible through the transducer.

In practice, there are two ways of defining the ground connection:

Ground (case) to negative battery terminal

The tester is suitable as a 'voltage present' indicator for input voltages from +1 V, which makes it ideal for faultfinding in circuits. Simply hold the tester in one hand and use the other to touch the ground rail of the circuit under investigation. By touching the measurement point with the probe tip, you can find out for sure if a voltage greater than about 1 Volt is present. Our little instrument is also suitable for use as a simple battery tester or polarity tester simply by moving the free hand to the other battery terminal. Besides, alternating voltages with a peak level greater than 1 V are reliably indicated as well as reproduced by the piezo sounder.

Ground (case) to positive battery terminal

The test instrument is tuned into a continuity tester, where 'continuity' should be taken to mean 'very high impedance connection'. A connec-

tion with a resistance as high as 1 MΩ is already seen as an electrical conductor! Also, small capacitances with just a few 100 pF may be tested by noticing their charge and leakage currents. The use of the tester can be extended to burnt out bulbs and fuses, where it is especially convenient because you only have to touch the 'other connection'.

The circuit diagram shows a changeover switch (a small slide or rocker switch) that allows you to select between the above two modes of operation. When only one mode is required or envisaged, the switch is superfluous and the metal case of the instrument is connected directly to the desired battery terminal of the equipment under test.

More applications

The extreme sensitivity of the tester opens up possibilities for rather special applications. For example, the tester may be used as a locating aid for mains wiring in conduit buried in walls. At just a few centimetres distance from the invisible Live (L) wire, sufficient capacitive coupling is obtained to make the LED light up.

The little instrument is also great for proving the presence of static charges. Simply hold the tester in your hand at some distance from your body, and walk over a synthetic carpet wearing shoes with rubber soles. The LED will light brightly with each step.

Other applications will exist for the instrument and we leave it up to your imagination to find out. If you do, tell us about it!

(020056-11)

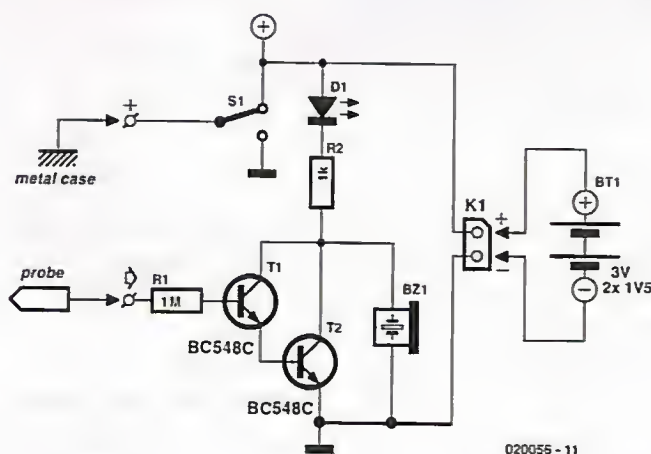

020055 - 11

COMPONENTS LIST

Resistors:

- R1 = 1MΩ
- R2 = 1kΩ

Semiconductors:

- D1 = LED, low current, red
- T1, T2 = BC547C, BC548C or BC549C

Miscellaneous:

- BZ1 = miniature piezo transducer (passive)
- K1 = 2-way pinheader, lead pitch 2.5mm (0.1 in) or two solder pins
- S1 = single-pole changeover switch (optional, see text)
- Battery holder for two LR03 (AAA) or LR6 (AA) batteries
- Enclosure: suitable metal tube (see text)
- PCB, available from **The PCBShop**

Figure 2. The circuit consists essentially of a Darlington stage with very high current gain.



Figure 1. The narrow board and the two miniature batteries together fit into a metal tube to make a probe-like enclosure for the tester.

ected to mains supply. For this purpose, use approved testers only, for example the screwdriver type described above.

The tester described in this article is intended for low voltages up to 60 V. As a bonus, it will also function as a continuity tester and an audio signal tracer.

The circuit

The circuit diagram in Figure 2 shows a simple Darlington amplifier based around two BC548C transistors. Each of these offers a current gain of at least 420 times, so the Darlington configuration is good for a gain of 420^2 or about 170,000 times! The maximum collector current is reached at just 1 mA already. Consequently an input current of less than 0.01 mA or 10 nano-amperes is sufficient to make the LED light. An added passive piezo sounder (transducer) enables the circuit to act as a tracer for audio signals. When an alternating voltage is applied to the input, the LED will also light and the signal is audible through the transducer.

In practice, there are two ways of defining the ground connection:

Ground (case) to negative battery terminal

The tester is suitable as a 'voltage present' indicator for input voltages from +1 V, which makes it ideal for faultfinding in circuits. Simply hold the tester in one hand and use the other to touch the ground rail of the circuit under investigation. By touching the measurement point with the probe tip, you can find out for sure if a voltage greater than about 1 Volt is present. Our little instrument is also suitable for use as a simple battery tester or polarity tester simply by moving the free hand to the other battery terminal. Besides, alternating voltages with a peak level greater than 1 V are reliably indicated as well as reproduced by the piezo sounder.

Ground (case) to positive battery terminal

The test instrument is tuned into a continuity tester, where 'continuity' should be taken to mean 'very high impedance connection'. A connec-

tion with a resistance as high as 1 MΩ is already seen as an electrical conductor! Also, small capacitances with just a few 100 pF may be tested by noticing their charge and leakage currents. The use of the tester can be extended to burnt out bulbs and fuses, where it is especially convenient because you only have to touch the 'other connection'.

The circuit diagram shows a changeover switch (a small slide or rocker switch) that allows you to select between the above two modes of operation. When only one mode is required or envisaged, the switch is superfluous and the metal case of the instrument is connected directly to the desired battery terminal of the equipment under test.

More applications

The extreme sensitivity of the tester opens up possibilities for rather special applications. For example, the tester may be used as a locating aid for mains wiring in conduit buried in walls. At just a few centimetres distance from the invisible Live (L) wire, sufficient capacitive coupling is obtained to make the LED light up.

The little instrument is also great for proving the presence of static charges. Simply hold the tester in your hand at some distance from your body, and walk over a synthetic carpet wearing shoes with rubber soles. The LED will light brightly with each step.

Other applications will exist for the instrument and we leave it up to your imagination to find out. If you do, tell us about it!

(020056-11)

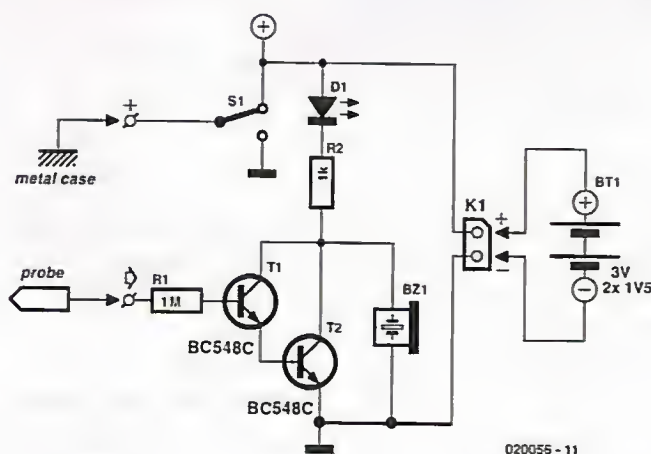

Figure 2. The circuit consists essentially of a Darlington stage with very high current gain.

COMPONENTS LIST

Resistors:

- R1 = 1MΩ
- R2 = 1kΩ

Semiconductors:

- D1 = LED, low current, red
- T1, T2 = BC547C, BC548C or BC549C

Miscellaneous:

- BZ1 = miniature piezo transducer (passive)
- K1 = 2-way pinheader, lead pitch 2.5mm (0.1 in) or two solder pins
- S1 = single-pole changeover switch (optional, see text)
- Battery holder for two LR03 (AAA) or LR6 (AA) batteries
- Enclosure: suitable metal tube (see text)
- PCB, available from **The PCBShop**

causes incrementing or decrementing numbers (0 to 9) to scroll across the display depending on the direction of rotation. The dial is pressed to select the number on the display and the number now scrolls downwards. Once the correct code sequence is entered a relay is activated for a few seconds.

The code sequence can be changed by keeping the dial pressed down when the last number of the current code is entered. The display now flashes to indicate that a new four-digit code can be entered. Once again when the last digit is entered, the dial is held down to signal the end of the new code sequence. The display now shows the code again. Should you forget the code it can be displayed by shorting out the pins of JP1 and resetting the circuit. The code sequence will now be shown and the display will be switched off after about one minute of no switch activity.

The controller

The circuit diagram in Figure 2 shows the PIC16F84 as the central component of the circuit. The

encoder push button contact is connected to RB0 while the encoder contacts A and B are connected to pins RB1 and RB2. These pins are configured as inputs and the necessary pull-up resistors are integrated on-chip. Port pin RB3 is only used during reset to read the value of jumper JP1.

Pins RB4, RB5 and RB6 are configured as outputs and drive the demultiplexer IC1. This device has open-collector outputs and drives the matrix display rows via transistors T1 to T7. The five columns of the display matrix are driven directly from port pins RA0 to RA4 via current limiting resistors R15 to R19. Port pin RB7 switches the relay via transistor T8. Diode D1 is necessary to prevent back-emf from destroying T8 when the relay is switched off. The relay specified does not have mains rated contacts and is only suitable for switching 125 VAC with a maximum load of 1 A.

The circuit draws 12 mA quiescent current rising to around 50 mA when the display is active and 180 mA with the relay pulled in. A 78L05 (IC3) voltage regulator is included on board to produce 5 V for

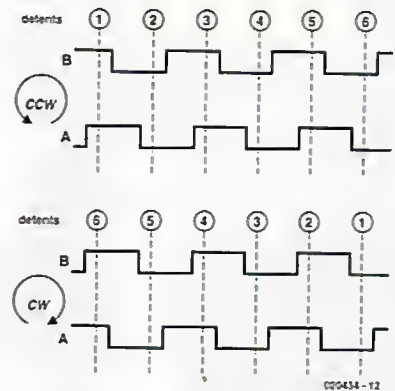

Figure 1. Output waveform of the rotary encoder.

the circuit. To avoid excessive dissipation the input supply voltage should not be any greater than 12 V.

Component placement

The circuit components all fit on a single-sided PCB. The majority of the resistors are mounted upright to save space. Ensure that the 12 V power supply leads are correctly connected to the '+' and '0' pads on the PCB. IC2 should be fitted to the PCB via a socket to ensure that it can easily be removed for reprogramming if a software update is

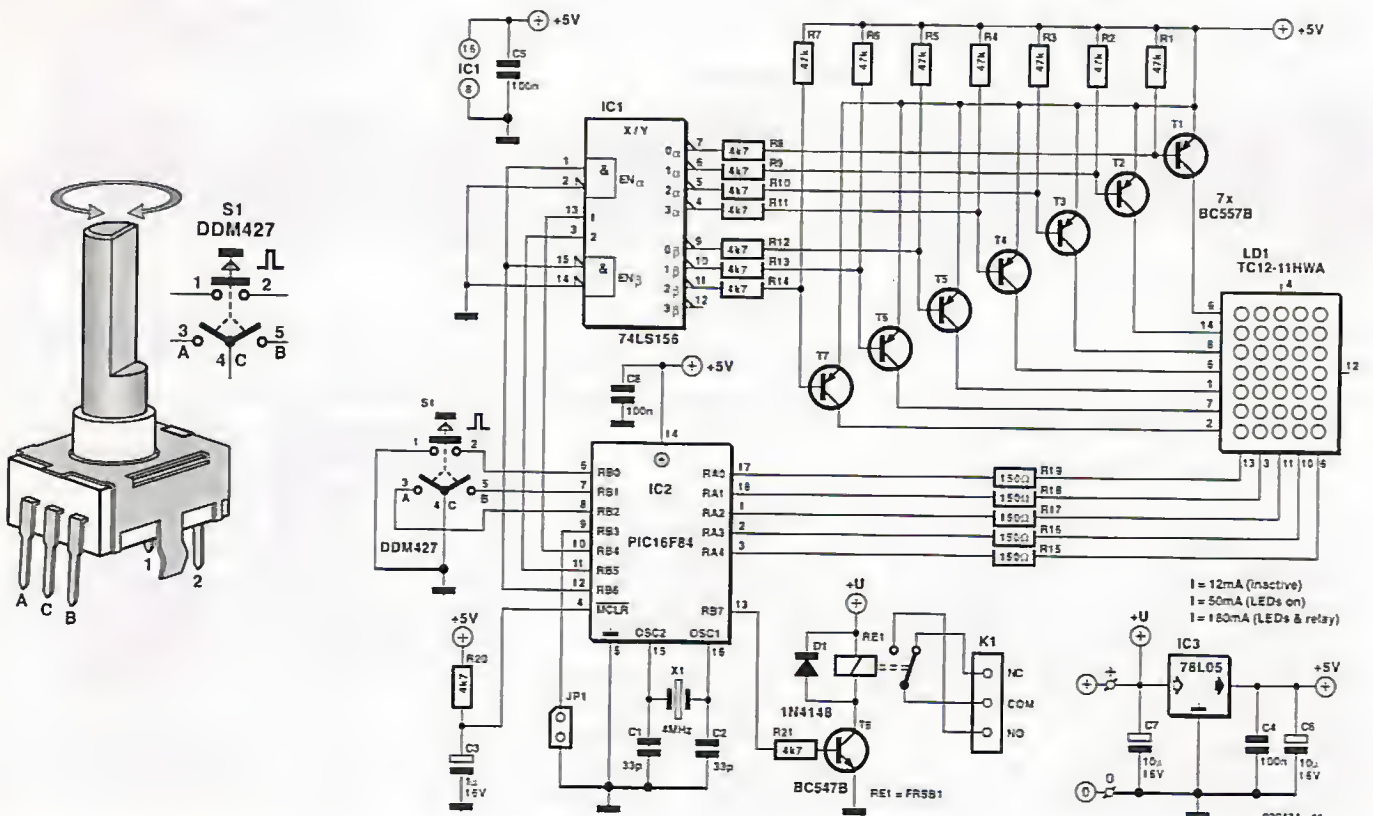

Figure 2. The code lock circuit diagram.

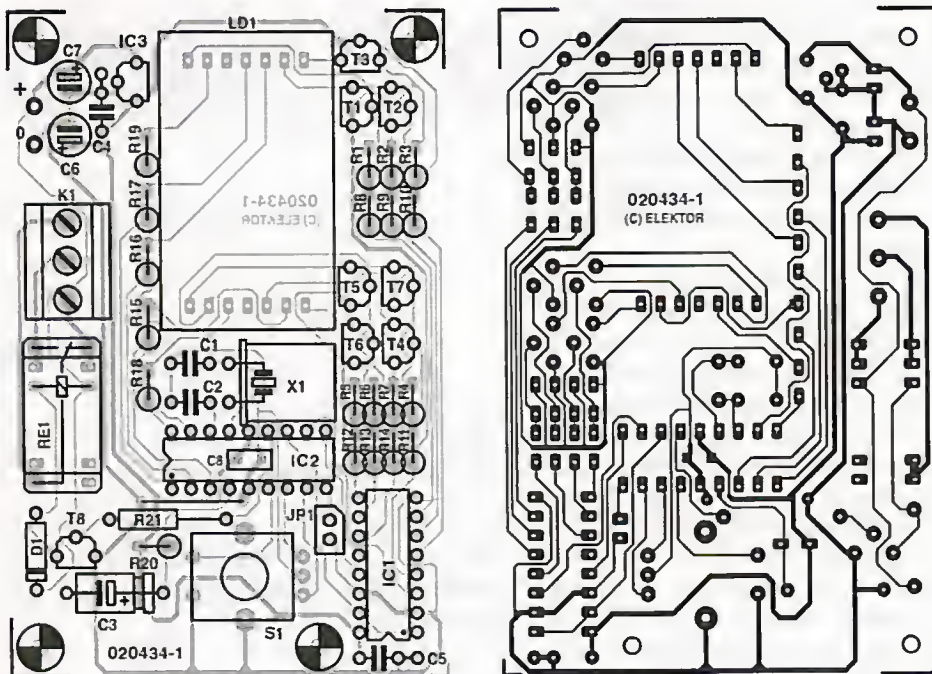

Figure 3. The single-sided PCB is quite tightly packed and does not use any SMD components.

required in the future.

Once all the components have been fitted and the board has been given a thorough inspection the 12 V input supply can be connected. The circuit should take around 50 mA and the number '0' should be displayed if everything is in order. If the circuit does not seem to be working it will be necessary to investigate a little further. Disconnect the power source and remove IC2 from its socket. Reconnect power and test the display multiplex circuitry by using a wire link to connect pins RA0 through RA4 one after another to ground (pin 5 on IC2 socket) while linking pins RB4, RB5 and RB6 to ground in a binary

sequence, this will illuminate and test each individual LED in the display. The voltage level at the reset input \overline{MCLR} should be 5 V and finally the crystal oscillator can be checked with an oscilloscope.

Software

All the software was written in assembler using MPASM. The complete software development environment can be downloaded freely from the Microchip website. The software for this project consists of two source files:

Display.asm contains the display character generator for the numbers 0 to 9.

Codelock.asm The main code-lock program.

These can be either freely downloaded from the *Elektor Electronics* website or supplied on a diskette (see Readers Services). At reset the microcontroller checks if it is the first time that the circuit has been used by reading the first memory location in EEPROM. The microcontrollers EEPROM is always supplied from the factory with 0xFF written to

COMPONENTS LIST

Resistors:
 R1-R7 = 47k Ω
 R8-R14, R20, R21 = 4k Ω
 R15-R19 = 150 Ω

Capacitors:
 C1, C2 = 33pF
 C3 = 1 μ F 16V
 C4, C5 = 100nF
 C6, C7 = 10 μ F 16V radial

Semiconductors:
 IC1 = 74LS156 or 74HC(T)156
 IC2 = PIC16F84 or PIC16C84A-4/P programmed, order code 020434-41
 IC3 = 78L05
 DI = IN4148
 T1-T7 = BC557B
 T8 = BC547B

Miscellaneous:
 X1 = 4MHz quartz crystal
 LD1 = 5x7 matrix display (Conrad Electronics # 160490)
 S1 = Rotary encoder type 427 (small model) (Conrad Electronics # 705594)
 RE1 = FRS1B-5, 12V, 1 x changeover (Conrad Electronics # 505196)
 JPI = 2-way PCB terminal block with jumper
 K1 = 3-way PCB terminal block, lead pitch 5mm
 2 solder pins
 PCB, order code 020434-1
 Disk, source and hex code, order code 020434-11 or Free Download

Free Downloads

PIC software. File number: 020434-11.zip, contains:

- CODELOCK.HEX
Hex code for the PIC
- CODELOCK.ASM
Source code (Assembler)
- DISPLAY.A5M
Source code (Character set)

PCB layout in PDF format.
 File number: 020434-1.zip
www.elektor-electronics.co.uk/dl/dl.htm,
 select month of publication.

each memory location. Whenever the unlock code sequence is changed the value 0x3D is written to this first byte. If this value is not present the microcontroller knows that it is the first time the circuit has been used and will write the default code sequence 1234 into its EEPROM.

When initialisation is complete the program enters its main loop where it takes care of display multiplexing and reading the input port. The contents of the bit-variable MODE indicate display scroll direction, input switch debounce period, relay switching time and new code is entry.

(020434-1)

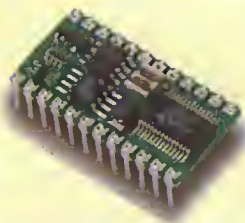

BS2-IC

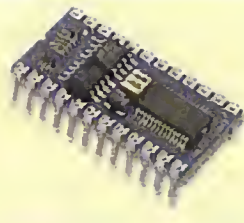

BS2-SX

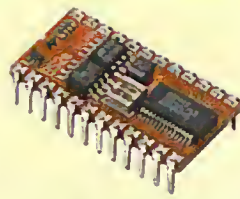

BS2E-IC

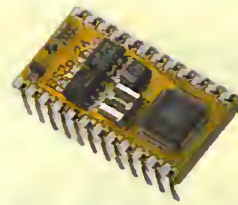

BS2P/24

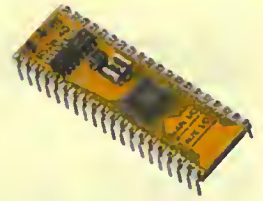

BS2P/40

Parallax BASIC Stamps - still the easy way to get your project up and running!

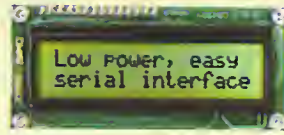
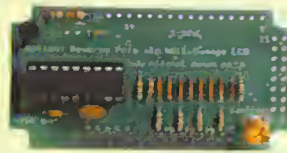

**Serial Alphanumeric and Graphic Displays,
Mini-Terminals and Bezel kits**

www.milinst.com



Animoted Head

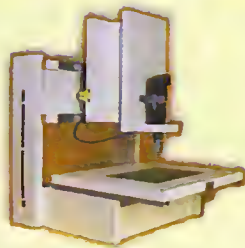

3-Axis Mochine



Six-Legged Walkers



Robotic Arms



Bipeds

Robotic models for both the beginner and the advanced hobbyist



Servo Drivers

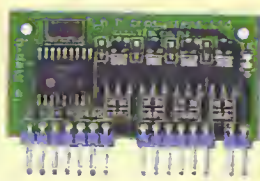

Motor Drivers

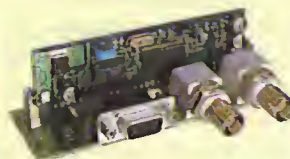

On-Screen Displays



DMX Protocol



U/Sound Ranging

Animatronics and Specialist Interface-Control Modules



Quadravox
MP3 & Speech Systems



SensoryInc
Voice Recognition



Parallax
Ubiicom Tool Kits

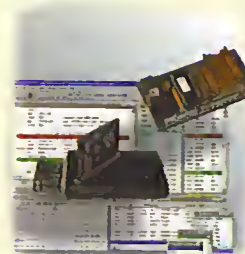

Tech-Tools
PIC & Rom Emulators

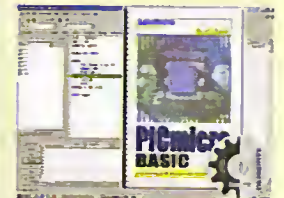

BASICMicro
PIC BASIC Compilers

Development Tools

Milford Instruments Limited Tel 01977 683665, Fax 01977 681465, sales@milinst.com

Wind Power

Wise move or waste of time?

By Gregg Grant

greg@grantg52.fsnet.co.uk



The UK Government recently announced the world's biggest ever expansion in wind energy. So how realistic is this scheme? What are the pitfalls, technical and otherwise, and how viable is it economically? It's time to look at wind generation in the round.

Wind is simply air in motion, with mass and energy. It has been used for centuries, the most obvious example being windmills. In 1850 the American Daniel Halliday developed the 'multi-bladed' farm windmill, a relatively simple device that inspired the first attempts to convert wind into a form of energy that could be either stored for future use, or applied elsewhere.

As electrification gradually spread to rural areas in both Europe and America, windmill-driven generators became fairly common in the more remote areas of both continents.

By 1890 Denmark — a nation without natural energy resources such as coal or waterfalls — had some 7000 of these windmill generators in operation, they delivering around a quarter of the country's power requirements. Consequently, the Danish government of the day decided to further develop wind-powered electric generators.

By the turn of the last century, some 72 generators, the first of their kind, had been built. They comprised a 25-metre high tower, which supported a four-bladed rotor some 22 metres in diameter, which was cou-

pled by a drive system to a ground-based generator. These wind driven devices continued to feed power into the Danish national grid system until 1968, when the last working machine was shut down, for economic reasons.

In America meanwhile, on-going wind power developments were mainly a matter of manufacturing and marketing what was termed 'wind chargers.' These were two-occasionally three-bladed propellers, some four metres in diameter, capable of supplying sufficient electricity to power a couple of lights, a radio and (perhaps) a washing machine or refrigerator.

Some 500,000 of these power sources were delivering power across the Midwest until, in 1960, the Rural Electrification Administration, the REA, finally connected the region to the national grid.

In Europe too a number of engineers and inventors were attempting to discover efficient ways of harnessing the energy of the wind. In 1922, the Finnish engineer Sigurd Savonius developed the rotor named after him. It comprised semi-circular blades, built from two sec-



030370 - 11

Figure 1. UK windforce distribution chart.

tions of an oil drum, cut in half along its vertical axis, and welded together with an offset from the axis to form an 'S' shape. In the 1970s, a modern version of this wind device was set to work in America, it generating some 5 kW of electricity in a 12-metre/second wind.

Nine years after Savonius, the French power engineer Georges Darrieus patented a wind turbine design whose blades were manufactured from twisted metal strips, which were attached to the top and bottom of the shaft and bowed out in the middle, rather like the blades of a food processor. This device however had a drawback: it was not self-starting. Nevertheless an example of this arrangement, with aluminium blades, was built at the Sandia National Laboratory in America and, during trials, generated around 60 kW of electricity in a wind blowing

at slightly more than 12 metres/second.

However, the most effective wind generators appeared to be those based on the classic 'Dutch' propeller, for it was the Dutch who carried out much of the early technical investigation into wind power. Indeed it was just such a system that the Americans opted for when they created their first major wind generator project in 1939.

Palmer Puttnam, the engineer in charge, chose a windswept hill in Vermont as the location for the generator, which was driven by two, eight-ton stainless steel blades, some 53 metres in diameter. Completed in 1941, this generator began to feed some 1500 kW into the national grid. Four years later however disaster struck when one of the blades flew off the shaft and ended up in a crumpled mess, some 240 met-

res away. The project was later abandoned.

The technological advances of the last half-century however have made wind power a viable alternative to fossil fuels and by the mid 1990s, a number of designs were being investigated in the United States (US), Europe and the United Kingdom (UK).

Wind Generation

There are three factors governing the conversion of wind into electrical power. They are wind speed, the conversion factor and the form and size of the turbine blades.

Wind Speed

The UK is in an enviable position where wind speed is concerned, as a glance at **Figure 1** illustrates. The highest winds occur along the Atlantic-facing coasts of the British Isles, giving the UK some 40% of Europe's total realisable wind energy potential.

Wind power is related to the cube of the wind's speed or, put another way, if windspeed doubles, wind power increases eight-fold. In fact during gale or storm force winds, windspeed can be as much as five times greater than the average windspeed for which the turbine was designed. This means that the stress acting on it rises way beyond the standard operating value.

Conversion Factor

The faster the wind, the speedier the movement of the turbine and therefore the greater the electrical energy generated. In short, power output increases with windspeed, although there is obviously no power delivered when the wind is too low.

The majority of commercial devices begin to provide a small output in windspeeds of about four metres/second. As the windspeed increases, so also does the power delivered until the rated power output is reached.

Turbine Form and Size

Two-bladed turbines are more common as they produce a higher maximum speed, although the three-bladed design of **Figure 2** makes for greater stability and so more vibration-free operations. The power produced is proportional to the square of the blade diameter which means that - for a standard horizontal axis turbine - doubling the area of the circle traced by the rotating blade tip, doubles the power generating potential.

Currently, blade manufacture is much influenced by aeronautical technology in particular sailplane wings. Blades are arranged so that the forces generated thrust the rotor around in a circular path, thus achieving a balance between maximum lift and

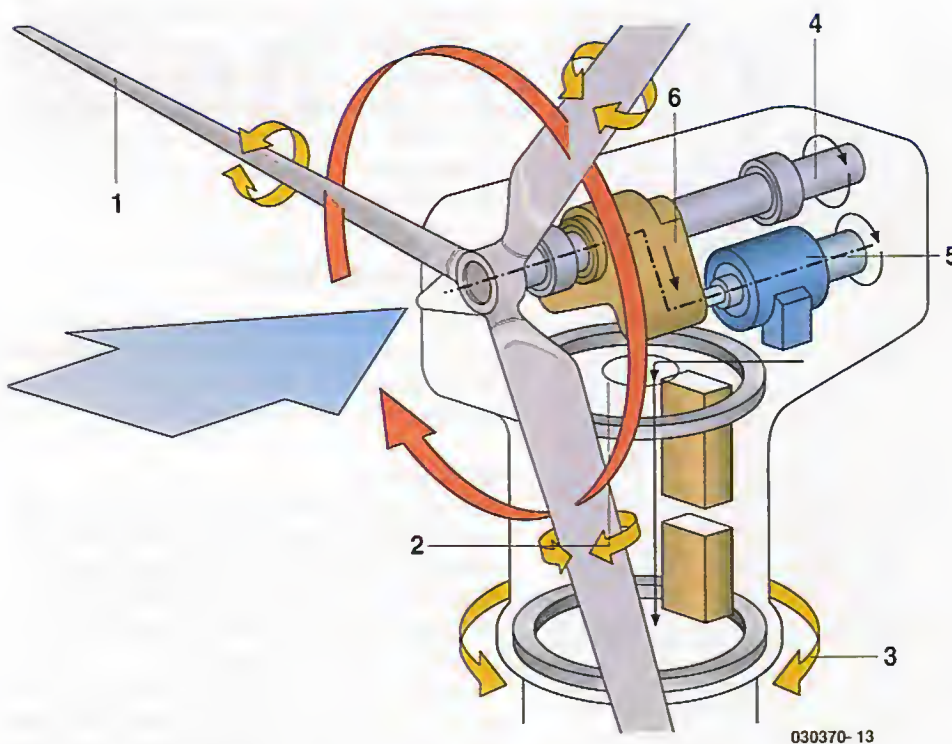

Figure 2. Basic design of a 3-blade turbine.

minimum drag. Presently, modern turbine blades rotate around 10 times faster than the basic windspeed.

The Equipment

Current turbine designs are twice as efficient as the designs of 20 years ago and the cost of these machines has been reduced by a factor of three over the same period. Presently, some designs are rated in hundreds of kilowatts, and shortly larger devices — sometimes referred to as aerogenerators — capable of delivering 20 megawatts and with turbine blades some 50 metres in diameter are coming on-stream.

In Figure 2, the three-blade turbine (1) can have the attitude of its blades altered. By changing the pitch (2) the blades can operate at maximum efficiency in changing wind conditions.

As the entire rotor assembly (3) moves into the wind, the blades turn the prop shaft (4), which is coupled to the generator (5) via the gearbox (6). The three-blade, variable pitch arrangement has proved to be the most efficient design and the largest wind farms comprise thousands of such turbines, linked together, and capable of generating as much electricity as a fossil fuel power station.

The UK's first commercial wind farm, made up of ten Danish wind turbines rated at 400 kW each and able to supply electricity to

some 3000 homes, was connected to a part of the national grid in December 1991. At the same time, some 500 Megawatts of power were being generated on the continent, the majority of it in Denmark.

By far the largest rise in wind power generation took place in the US, throughout the 1980s. Generous federal tax incentives created around 1500 megawatts of installed capacity; again much of it generated on Danish machines. The Danes are one of the few nations with a viable wind generator manufacturing industry, which exports its products worldwide. During the upturn in wind power generation in the US, the Danes were earning some £130 million per annum in export sales.

Although there is enough wind circulating day and night to supply the entire planet's energy requirements — despite the fact that only some 2% of the sunlight falling on the Earth is converted into wind energy — this potential power is spread thinly. That said, wind power is expanding at 20% per annum and has been for the last decade. Indeed as a growth industry it has few rivals, not even gas or oil. In the US for example, the states of Texas and

North and South Dakota have sufficient usable wind to meet the present electrical power requirements of America as a whole.

Drawbacks

Firstly there is the no small matter of constancy, secondly the interference wind turbines cause to radar and thirdly, no one has yet produced a cost-effective method of storing the excess energy that builds up when the wind does blow. Finally, one of the more astonishing drawbacks is the objection of the environmental lobby.

They — it seems — have four principal gripes firstly excessive noise, secondly the detrimental effect on the landscape, thirdly the impact on local flora and fauna and finally the huge amount of land taken up by wind farms.

Noise is the least of the above concerns as Figure 3 illustrates. For example, a person standing some 43 meters from a wind turbine would experience a noise level no greater than that she or he would be subjected to in an average house throughout a normal day. Furthermore a wind farm of 30, 300-kW turbines produces only 45 dB of noise, some 500 meters from the nearest turbine. This is little more than half of the figure considered damaging to the human ear i.e. 80 dB.

Even in terms of the detriment to the landscape the environmental lobby are hardly on solid ground. Wind turbines are no more unsightly than electricity pylons, structures that have long been accepted, even by the eco lobby. Once set up, around 98% of the land used for a wind farm can return to its natural state, thus encouraging (perhaps) a wider variety of flora and fauna to the area than had been there formerly. As to their effect on wildlife, the environmentalists do have a point. Wind turbines, for obvious reasons, are located in open areas, frequently on high moorland, exactly the sort of territory birds of prey frequently hunt in.

The radar problem is something else again and is one of the biggest hurdles faced by the industry, according to the British Wind Energy Association. The Ministry of Defence, the MOD, for example opposes some 34% of all new propo-

sals for wind farms.

Turbines can be as high as 180 metres which, coupled with their method of rotation, means that radar signals reflected by them can be as much as 1000 times stronger than those reflected from a light aircraft. They are also difficult to filter out, since a radar can pick up different blades with successive scans, interfering with the echoes from aircraft flying above the wind farm.

The problem can be reduced by manufacturing blades that are virtually invisible to radar, thus reducing the signal strength such that it can be filtered out in the same way as echoes from a building for example. The trick is to do this without either increasing manufacturing costs or reducing the strength of the blades.

The Costs Involved

Table 1 gives a comparison – for the early 1990s - of the cost of electricity generated from wind power compared to the three other major energy-

generating technologies. Since that time of course, technology shares — and hence profits and finances generally — have taken a battering.

However, from April through to July this year, technology stocks have been doing moderately well, those that survived the crisis that is. Yet they only attracted £9 million in new money in March, compared with the massive £879 million they pulled in during March 2000.

Given the above, what convinced the UK government and to a certain extent the City, that wind power was the way ahead in terms of energy? Furthermore, what should we read into the fact that the government has actually put up money for investment and support of wind power development?

Two things: the UK's commitment to the Kyoto Protocol, in which the planet's industrialised nations have agreed to cut carbon dioxide emissions by 10% by 2010, and the government's idea that wind power is capable of providing electricity to one in every six British homes.

Table 1: Power Generation Costs.	
Technology	Cost (Pence/ kilowatt/hour)
Coal	3.5 to 4.0 pence
Gas	2.3 to 2.8 pence
Nuclear Power	5.0 to 7.5 pence
Wind Power	2.9 to 5.2 pence

Whilst the government may be enthusiastic about wind power, the City remains cautious, for the subject involves what money men term 'early-stage' investment, which makes forecasting the return on capital expenditure problematical to say the least.

They also perceive a technological risk for although wind energy, both on-shore and off-shore, has a considerable amount of research and development behind it, no one has done it before on the scale the government's planning. The question for the City is this: will offshore wind generators deliver over the long haul?

Presently, the two biggest organisations providing wind-generated power in the UK are Power Gen Renewables and National Wind Power. The former generates some 120 Megawatts (MW) from its 16-unit Bowbeat Hill wind farm near Peebles. Currently the UK's largest such installation, it provides half the power required by homes in the Borders region. National Wind Power has 14 on-shore units generating around 160 MW.

However, the perceived detrimental effect of such installations on the landscape – touched on earlier – has led to the industry moving off-shore, and National Wind Power is scheduled to complete the UK's first offshore wind farm on the North Wales coast, later this year. Power Gen Renewables too has opted to move offshore, and its new installation off Great Yarmouth is due to go on-line in autumn 2004.

The UK government regards offshore wind power generation as capable of providing electricity to one in every six British homes. This is one aspect of its £6bn plan to make the UK the world's largest offshore wind farm developer. If this seems a great deal of money it's not surprising, for offshore wind farms are some 30% to 40% more costly to operate than on-shore ones.

Nevertheless, both companies are of the view that offshore installations will enable the UK to meet its commitments under the Kyoto agreement. Whether they will be able to deliver sufficient power to one sixth of the nation's homes at a competitive price, is another matter entirely.

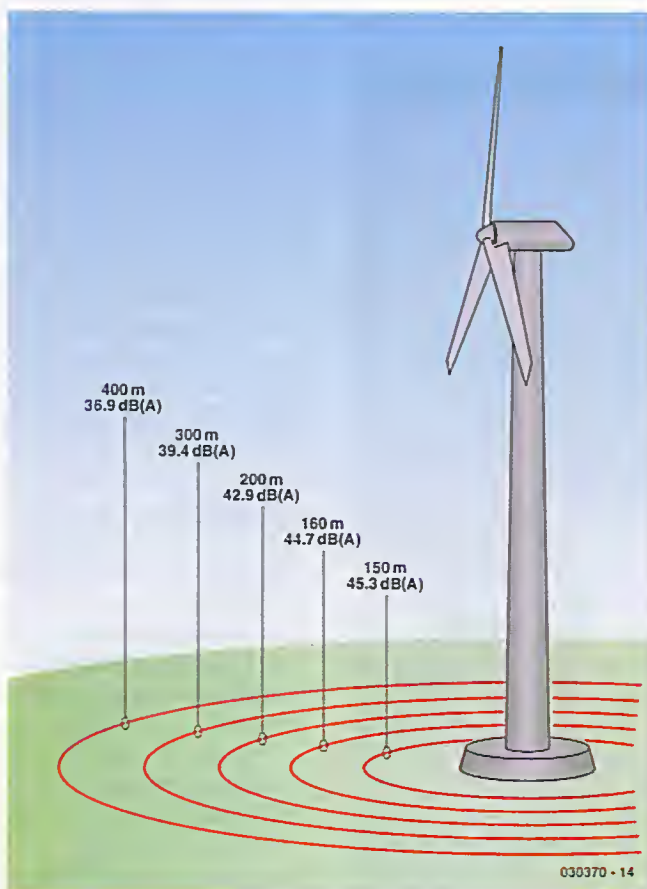

Figure 3. Noise footprint of a typical 3-blade wind turbine.

Blackfin DSP Development Kit

Messing about with DSPs

By Paul Goossens

Experimenting with DSPs is a fascinating pastime, but it can be difficult to find a good place to start. Generally speaking, DSP circuits use very high frequencies, which makes the PCB layout quite critical. In addition, DIY soldering of these components is almost impossible, because they are packaged in so-called Ball Grid Arrays (BGAs). How then, can we overcome these difficulties?



A large number of problems can be avoided by using a ready-built development kit. An additional advantage is that these kits are usually supplied with a comprehensive development environment and plenty of examples.

There is currently ample choice in DSP development kits. In this article we will take a close look at one such board and introduce it to you: the ADSP-BF533-EZ-KIT Lite from Analog Devices.

Contents of the kit

The kit contains the following items:

- PCB
- CD-ROM with the development environment Visual DSP++ (demo) including examples and documentation
- System manual
- Power supply
- USB cable

At the heart of the PCB is a DSP type ADSP-533. This DSP is a member of the Blackfin family of devices from

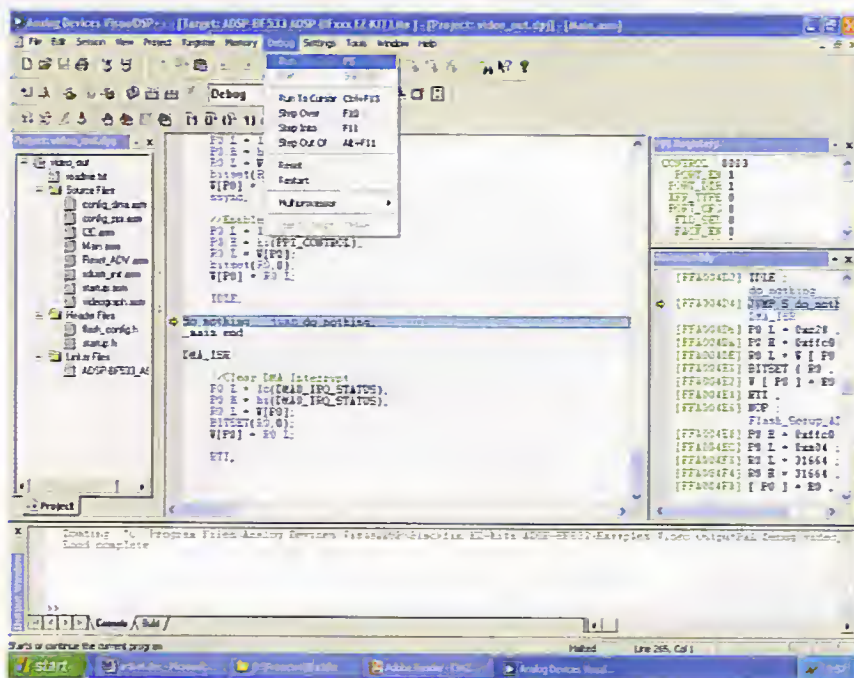

Analog Devices. In addition, the PCB is abundantly provided with relevant I/O and memory chips. As such, there is a 32 MB SDRAM (16 M x 16 bit), two Flash memories, each containing 1 MB primary and 64 kB secondary Flash memory, 32 kB SRAM and 256 bytes of configuration registers. These chips (PSD4256 from ST) really deserve an article by themselves, considering how versatile they are; in fact, we will return to this PSD family in detail in a future issue.

Concerning the audio interfaces, this board is provided with four analogue inputs and six analogue outputs. These can be driven with a codec that can simultaneously drive all these connections at 48 kHz. If you choose to use only half the number of inputs and outputs then a sample rate of 96 kHz can be obtained.

The DSP used here is powerful enough for video processing to fall within its capabilities. This is the reason that this board has a video interface as well. The video interface consists of three analogue inputs and three analogue outputs. This video interface will be described in detail a little further on.

A programming interface is indispensable on a development kit. This kit gives you the option of a JTAG interface or — and this is very interesting — a USB connection. This USB connection is not only used for programming but for real-time

debugging as well!

Finally, we should mention the RS232 interface, as well as the four pushbuttons (debounced!) plus six LEDs controlled from the I/O. This board is also complete with a power supply, which generates the necessary voltages from the adapter connection. On the back of the circuit board all the relevant signals are accessible for expansion purposes.

Software

Every development kit succeeds or fails depending on the included software. The Windows software in this kit is very comprehensive. It has to be noted that this software is a 'Lite' version containing a number of limitations compared to its larger sibling. These limitations are not too much of an issue in practice, however. For example, the maximum size of the program is limited to 20 kBytes and the simulator and emulator sessions are not accessible. In addition, this version allows only one DSP board to be connected at a time. And finally, the software will run only when the kit is connected to the PC and is powered on.

The supported programming languages are assembler, C and C++. These last two in particular are very interesting in order to quickly test the functionality of your own algorithms. If need be, the algorithm can

then be re-programmed in assembler to obtain the best possible performance. An important consideration here is that the assembler syntax is very clear and that programming in assembler is a lot less cryptic than with DSPs from other manufacturers. This is not only a significant advantage for the beginner, but even advanced programmers will appreciate the clear syntax.

The development environment is very complete and contains all the relevant components to enable you to write your own software, debug and upload it to the DSP board. A number of useful tools are integrated, such as a picture viewer, which can display an image (or a frame from the video signal) in the DSP memory. The contents of the internal registers of the DSP, as well as the external memory can be viewed and modified too, of course.

The DSP

The DSP that has been used here has many on-board peripherals. That is obvious from the datasheet that amounts to 936 pages and which details the hardware aspects of the DSP. We will only summarise the salient points.

As a result of all the built-in peripherals, the instruction set is quite remarkable for a DSP. This chip contains alongside the usual DSP instructions a complete set of 'normal' CPU instructions such as simple bit manipulation etc., which makes the move from microcontroller to DSP much easier from the programming perspective. This is not to say that an experienced DSP programmer won't appreciate these instructions either...

With a DSP, the calculating abilities are ultimately the most important. As with most other DSPs, this DSP also contains two very optimised arithmetic units, which will carry out one calculation per clock cycle, irrespective of whether this is a multiplication, an addition or a shift. At an internal clock frequency of 600 MHz this results in a computing power of 1.2 GMACs! This should be more than enough for most existing multimedia applications.

The operating speed can be increased by another factor when only 8-bit video instructions are used. We can hear you think already: 8 bits, that is now ancient history, isn't it? But nothing is further from the truth, because most video algorithms (such as the MPEG standard) make frequent use of 8-bit data.

The data stream

Such computing power is very nice, but it is only useful if data can be provided fast enough. Here is where the DAGs (Data Address Generators) come into play. They

can be considered as pointers that can be programmed with an offset, automatic increment/decrement and optionally generate bit-reverse-addressing (for the connoisseur: very helpful when doing an FFT analysis). These functions require a fast connection to the memory. In addition to the internal L1- and L2 cache memory, the DSP is also fitted with an SDRAM controller, which allows up to 128 MB of SDRAM to be addressed, without any additional components.

Other types of memory can also be addressed. This requires the programmer to indicate which type of memory is being used and how fast this memory can be accessed. This allows the use of standard memory devices. There is provision, in addition to SDRAM, for SRAM, Flash and ROM to be controlled, without the need for external logic. To enable a smooth flow of the data, there is a 12-channel (!) DMA controller, which is connected to the various interfaces. This makes it possible to move large amounts of data while the processor just continues to calculate.

Several interesting interfaces

As if all of this is not enough, the DSP also contains a USB controller. Using this, an interface to an external computer can easily be realised. For the more advanced among us it is interesting to know that the DSP also contains an actual PCI interface on board, which can function both as host and as slave in a PCI system!

Finally, we would like to mention the PPI. This is a very comprehensive parallel interface, which is capable, on its own, to transmit or receive video images and generate all the necessary synchronising signals, if required.

Examples

It goes without saying that the development kit is supplied with a number of examples, which work straight off on the evaluation board. These examples can form the basis for your own applications. One example concerns the generation of a test pattern with the aid of the video encoder. This example, unfortunately, generates an NTSC signal while PAL is the standard in most European countries. However, modern TV sets happily handle either signal.

Nevertheless, we found this to be an annoying limitation so we decided to adapt the example so that it would generate a PAL signal instead. At the same time, this is a very good exercise to familiarise yourself with the DSP and video encoder. The datasheet for the video encoder informed us that the chip

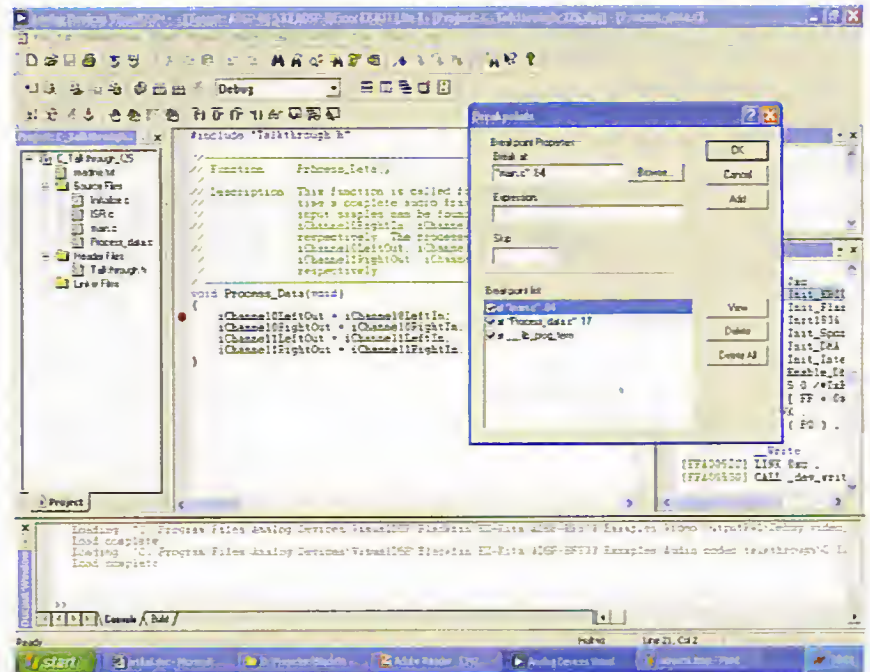

has to be configured via the I²C interface, so we first wrote a few simple I²C routines. At the back of the datasheet is a list with the configurations for the various TV standards. Unfortunately our modification didn't work immediately, because we had overlooked some minor details. In the list with I²C-registers and corresponding values, two registers are missing that are intended for future versions of the chip.

When you are configuring the video encoder yourself for your own application, keep in mind that in the list the two registers at sub-address 5 and 6 are not mentioned. You have to either write zero to these registers or (even better) just skip them. So look out when just sending the published list to the chip!

Our example for generating a PAL video signal can be downloaded, free of charge, from the *Elektor Electronics* website at www.elektor-electronics.co.uk, the file number is 030439-11.

Expansion

In the event that the on-board peripherals fail to satisfy all your needs, it is always possible to expand the hardware using the three connectors on the back of the board. All the necessary signals can be found on these connectors.

In addition, Analog Devices supplies a number of ready-made expansion boards for this kit, so that those who would prefer not to design and build their own hardware can still expand the capabilities of this kit. These expansion boards are along the lines of an external camera connection, fast A/D and D/A converters, etc. Typical I/O for a DSP, in other words.

Finally

The processor, as mentioned previously, is equipped with many features that cannot all be described here in detail. Otherwise, this issue would no longer fit in your mailbox! The I/O chips on the board are also certainly worth a closer look.

This kit is unfortunately not all that cheap (\$245 ex factory), but the price is still reasonably attractive, certainly considering the options it offers.

After an extensive introduction with the 'ADSP-BF533-EZ-KIT Lite' we come to the conclusion that this is a very powerful design, with not too complex programming. Of course, this kit is not intended for beginners, but you do not need to be a DSP expert either, in order to successfully realise a whole bunch of nice projects. This kit is certainly recommended to the curious boffins!

(00439-1)

FRUSTRATED!

Looking for ICs TRANSISTORS? A phone call to us could get a result. We offer an extensive range and with a world-wide database at our fingertips, we are able to source even more. We specialise in devices with the following prefix (to name but a few).



2N 2SA 2SB 2SC 2SD 2P 2SJ 2SK 3N 3SK 4N 6N 17 40 AD
ADC AN AM AY BA BC BD BDT BDV BDW BDX BF
BFR BFS BFT BFX BFY BLY BLX BS BR BRX BRY BS
BSS BSV BSW BSX BT BTA BTB BRW BU BUK BUT BUV
BUW BUX BUY BUZ CA CD CX CZA DAC DG DM DS
DTA DTC GL GM HA HCF HD HEF ICL ICM IRF J KA
KIA L LA LB LC LD LF LM M M5M MA MAB MAX MB
MC MDAJ MJE MJF MM MN MPS MPSA MPSH MPSU
MRF NJM NE OM OP PA PAL PIC PN RC S SAA SAB
SAD SAJ SAS SDA SG SI SL SN SO STA STK STR STRD
STRM STRS SVI T TA TAA TAG TBA TC TCA TDA TDB
TEA TIC TIP TIPL TEA TL TLC TMP TMS TPU U UA
UAA UC UDN ULN UM UPA UPC UPD VN X XR Z ZN
ZTS + many others

We can also offer equivalents (at customers' risk)
We also stock a full range of other electronic components
Mail, phone, Fax Credit Card orders and callers welcome

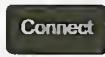

Cricklewood Electronics Ltd

40-42 Cricklewood Broadway London NW2 3ET
Tel: 020 8452 0161 Fax: 020 8208 1441

PCB-POOL®

SERVICING YOUR COMPLETE PROTOTYPE NEEDS

- Prototypes at a fraction of the cost
- Industry standard quality
- Tooling and setup included
- Follow up series runs
- Any contour
- CAM / CAD consulting
- Fr4 1.6mm, 35µm Cu

PRICE EXAMPLE:
1 EUROCARD D5.PTH

+ Tooling
+ Photoplots
+ VAT
= £ 29.89*

*Sterling rates may vary Price = €49



FREE



Beta
CIRCUIT

Tel: +353 (0)141 701170
Fax: +353 (0)141 701144
E-Mail: sales@beta-byout.com

Freephone
0800-389 8560

Simply send your files and order ONLINE:

WWW.PCB-POOL.COM



SOFTWARE TOOLBOX VOLUME 2

NEW

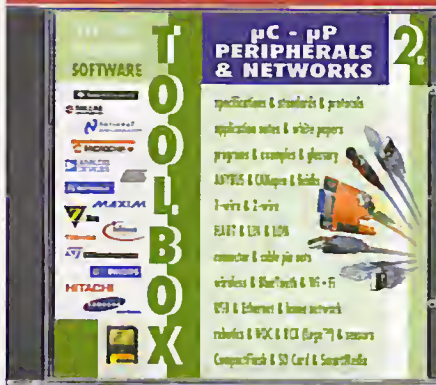

£12.05 (US\$ 21.25)
ISBN 90-5381-171-1

The second Toolbox CD-ROM again contains a vast collection of carefully selected software tools for the electronics enthusiast.

In your profession or hobby, how often did you experience that your project failed to reach the target in time because essential information was missing? Toolbox 2 offers new inroads to obtain information you just can't do without. This new CD-ROM contains software tools for, and information about, microcontrollers. However, just being aware of the existence of a microcontroller is often not sufficient — available data often needs to be extended with facts and figures about the right memory devices and communication channels.

That's why this CD-ROM gives specific attention to technical documentation (specifications, application notes, standards) about protocols (DiSEqC — Digital Satellite Equipment Control), field buses (including LON and HART), as well as modern information carriers (Smart Media, CompactFlash, SD card, etc.) which find increasing use. The hardware side of things is not forgotten either — Toolbox 2 contains data on connectors, cables and adapters (audio/video, GSM, memory, networks, parallel, serial, keyboard/mouse).

The CD-ROM also contains a large number of useful Internet addresses.

Order now using the Order Form in the Readers Services section in this issue

Elektor Electronics (Publishing) • P.O. Box 190 • Tunbridge Wells TN11 7WY
• England. Telephone +44 (0) 1580 200 657 • Fax +44 (0) 1580 200 616

**ELEKTOR
ELECTRONICS**
THE ELECTRONICS & COMPUTER MAGAZINE

See also
www.elektor-electronics.co.uk

calculation wonder chip offering lots of possibilities.

Today, the user is offered a dazzling number of options to choose from, including the number of I/O pins, memory size, Flash or conventional memory for program code and non-volatile data, speed compromised by power economy — you mention it, the silicon industry has it all. Nearly all microprocessor manufacturers boast a number of types with extra functionality as compared with other, lesser, family members. These functions may include A/D and D/A converters, various communication interfaces (like I²C and RS232), extra connections for hooking up an LCD and even in-built sensors to measure, say, temperature.

Not surprisingly, microcontroller manufacturers were among the first in the entire electronics industry to employ the Internet as a medium to offer not only complete datasheets but also application notes on their products, all free of charge. Today, the Internet is the first resource to dive into if you're after detailed information on a certain micro. Fair enough, but in addition to these sites there's such an overwhelming number of others containing, 'less official' but equally useful information you're soon lost and can't see the wood for the trees.

The two websites discussed in this month's instalment of Electronics Online put 500 links to microcontroller-related information literally at your fingertips. The links come properly grouped and sorted by the kind and bright souls that put these web pages together. The main orientation is by controller family, with further sub-classification according to the type of information offered in the case of extremely popular controllers.

The first website we'd like to tell you about is ePanaorama [1], an electronics portal site offering a massive number of linked neatly organised in categories. That makes ePanorama a great resource for 'all things electronic', that is, not just microcontrollers, and we feel it deserves a place in your browser's Favourites folder! A click on the subject 'microcontrollers' takes you to an index page showing sub-topics like general information, software and microcontrollers. The last subject is

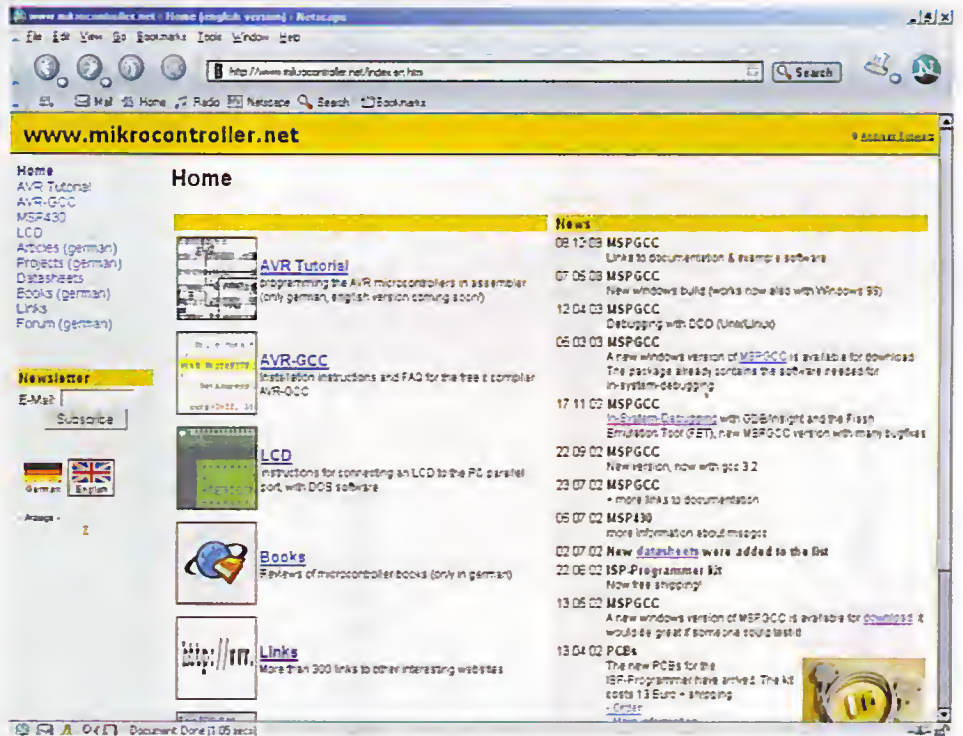

again divided to reflect today's most popular controller types:

PICs
Intel 8051/8052
x86 processors
Basic Stamp
Motorola 68HC11
Scenix microcontrollers
SGS-Thomson microcontrollers
ARM
PowerPC
Atmel microcontrollers
Hitachi
Zilog
Picaxe
Rabbit controllers

Each family is given a general introduction followed by a number of links complete with short descriptions of what to expect at the page you'll end up by following the hyper-link!

The second website we'd like to mention is called Mikrocontroller.net (no typo) [2]. It is available in two lan-

guages, German and English. Unfortunately some parts have not yet been translated into English but that is unlikely to be a problem for most links on the site. A click on the 'Links' button takes you to an overview of more than 300 links, all neatly arranged by controller family:

8051 & compatible types
AVR
PIC
68HCxxZ80
MSP430
M16C
Various controllers

Next, there's a number of links to allied subjects like prototyping, soldering, FPGA, CPLD, GAL, DSP and ARM.

Although the descriptions with the links are limited, most of them succeed in making clear what to expect on the hyperlinked pages. A smart addition to the website, national flag symbols indicate the language(s) in which the information is presented.

(045019-1)

Internet addresses

- [1] ePanorama: www.epanorama.net/index.php
[2] Mikrocontroller.net:
www.mikrocontroller.net/index.en.htm

One web site: 3 PCB services

On www.ThePCBShop.com you can now access three services: Eurocircuits, Europrint and Elektor. Together they supply a vast range of high quality printed circuit boards at very attractive prices. Come and visit us at www.ThePCBShop.com.

English



The PCBShop helps you to select the right production service for your PCB-needs.

On-Line: price calculations, order entry, order tracking and other communication.
Elektor boards.



EUROPRINT >

EUROCIRCUITS >

ELEKTOR >

BACK STAGE

PRESS & MEDIA

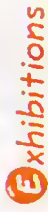

and streamlined through e-business.

New company platform: Eurocircuits available with even more services under www.ThePCBShop.com

Mechelen, Belgium, 20.11.2003 -

www.ThePCBShop.com offers up to 6-layer multi layers in quantities from 1 to 1.000 pieces.

Login Here

User Name:

Password:

Forgot Password?

Help

PRICE
CALCULATOR

COMPARISON
TABLES

TERMS

CONTACT US

LINK

EUROPRINT

EUROCIRCUITS

ELEKTOR

BACK STAGE

EURO
CIRCUITS



Verified



Value for Money

Attractive Prices

PCB-prototypes

Always Available

Up to 6 layer boards

Eurocircuits offers you up to 6-layer Printed Circuit Boards from 1 to 1000 pieces. The web site handles all communication: calculate your own quotes by just clicking on the price calculator, place or track orders after you have activated your login.

Eurocircuits Eurocircuits is available, on your desk, 24 hours a day and minimizes administrative actions. Our standardized service allows us to economize on production means and costs. The benefits of our lean business process are shared with you through our attractive prices.

Please Note

Software items marked @ are available from the Free Downloads page of the Publishers' website at www.elektor-electronics.co.uk. Diskettes are supplied for the convenience of readers without Internet access.

EVERGREENS

Elektor Electronics Help Disk

	£	US \$
986022-1 Disk, Windows version	8-15	14.45
Elektor Electronics Item Tracer 1985-2002		
036003-11 contents database (disk, Windows version)	8-15	14.35
Medium power HEXFET amplifier (December 1993)		
930102-1 PCB	10-90	19.25
Universal Prototyping Boards		
UPBS-1 PCB	2.45	4.30
UPBS-2 2 PCBs	-10	7.25
UPBS-4 4 PCBs	6-55	11.55

No. 330 MARCH 2004

Build Your Own DRM Receiver

@ 030365-1 PCB	9-10	16.10
@ 030065-11 Disk, DRM.exe program	4-90	8.65

Code Lock

@ 020434-1 PCB	9-60	16.95
@ 020434-11 Disk, source & hex code files	4-90	8.65
020434-41 Pic16F84A-4P, programmed	14-70	26.00

Multichannel Fallsale for Radio Controlled Models

@ 020382-11 Disk, source code file	4-90	8.65
020382-41 AT89C52-24JL, programmed	6-70	15.40

Multifunction Frequency Meter

@ 030136-1 PCB	9-35	16.55
@ 030136-11 Disk, project software	4-90	8.65
030136-41 AT90S2313-10PC, programmed	7-95	14.05

No. 329 FEBRUARY 2004

Digital Alarm Clock

@ 030096-11 Disk, PIC source and hex code	4-90	8.65
030096-41 PIC16F84-04P, programmed	15-20	26.90

iAccess

@ 020163-11 Disk set, source code and control software	7-50	13.30
020163-41 AT89S8252-12PC, programmed	13-90	24.60

Simple 12-Vo-230V Power Inverter

@ 020435-1 PCB	8-50	15.05
----------------	------	-------

Touch-controlled Switch

@ 030214-11 Disk, PIC source code	4-90	8.65
030214-41 PIC12C508A04-S08, programmed	6-15	10.90

No. 328 JANUARY 2004

64-K 80C552 Flash Board

@ 030042-1 PCB	9-35	16.55
@ 030042-11 Disk, misc. project software	4-90	8.65
030042-21 29F010, programmed	10-00	17.70
030042-31 GAL 16V8015Q, programmed	6-10	10.60

Climate Logger

@ 030076-1 PCB	7-75	13.70
@ 030076-11 Disk, Windows software	4-90	8.65

FMS Flight Simulator Encoder

@ 030066-1 PCB	10-20	18.05
030066-41 67LPC767BN, programmed	17-05	30.15

LED Roulette

@ 030168-1 PCB	17-90	31.60
@ 030168-11 Disk, source and hex files	4-90	8.65
030168-41 89C2051-12PC, programmed	8-05	14.25

Multi-event Alarm Clock

@ 020304-11 Disk, C (source) hex files	4-90	8.65
020304-41 AT89C2051-12PC, programmed	6-10	10.60

Stepper Motors Uncovered

020127-41 PIC16F873-20-SP	19-10	33.60
---------------------------	-------	-------

No. 327 DECEMBER 2003

FM Remote Control Transmitter & Receiver

@ 034044-1 PCB	10-20	18.05
----------------	-------	-------

LED Christmas Decoration

@ 030157-1 PCB	7-55	13.35
----------------	------	-------

P87LPC76x Programmer

@ 030313-11 Disk, project software	4-90	8.65
------------------------------------	------	------

Project Timekeeper

@ 020350-11 Disk, source & object code files	4-90	8.65
020350-41 PIC16F84-10P, programmed	13-15	23.25

Stepper Motors Uncovered (2)

@ 020127-11 Disk, source code file	4-90	8.65
------------------------------------	------	------

Universal Clock Generator

@ 020395-11 Disk, source code file	4-90	8.65
------------------------------------	------	------

Wireless RS232 Link

@ 030204-1 PCB	8-70	15.40
----------------	------	-------

No. 326 NOVEMBER 2003

Rev Counter for R/C Models

@ 024111-1 PCB	17-50	31.00
024111-11 Disk, source and hex code	4-90	8.65

GENERAL

Printed-circuit boards (PCBs), self-adhesive front panel foils, ROMs, EPROMs, PALs, GALs, microcontrollers and diskettes for projects which have appeared in Elektor Electronics may be ordered using the Order Form printed opposite. The form may also be used to order books (private customers only).

- The artwork for making a PCB which is not available ready-made through the Readers Services may be found in the relevant article.

- EPROMs, GALs, PALs, (E)PLDs, MACHs, PICs and other microcontrollers are supplied ready-programmed.

Prices and item descriptions subject to change. The publishers reserve the right to change prices without prior notification. Prices and item descriptions shown here supersede those in previous issues. E. & O E

PAST ISSUES

Past issues, if available, should be ordered from Worldwide Subscription Service Ltd, Unit 4, Gibbs Reed Farm, Pashley Road, TICEHURST TN5 7HE, England, telephone (+44) 1580 200657, fax (+44) 1580 200616, email wsss@wsss.demon.co.uk. Prices of past issues (except July/August and December), including postage for single copies, are £4.75 (UK and Eire); £5.30 (air mail Europe); £6.10 (airmail outside Europe). Prices of past July/August and December issues, including postage for single copies, are £6.65 (UK and Eire); £7.35 (airmail Europe); and £8.45 (airmail outside Europe).

PAST ARTICLES

For information on past articles, please contact our Editorial and Administrative Offices, telephone (01530) 200657, fax 200616, email sales@elektor-electronics.co.uk.

	£	US \$
024111-41 89C2051-12PC, programmed	8-65	15.65

Running Text Display

@ 020407-11 Disk, source and hex code	4-90	8.65
---------------------------------------	------	------

USB Analogue Converter

@ 020374-1 PCB	7-65	13.50
@ 020374-11 Disk, hex code and Windows software	4-90	8.65
020374-41 PIC16C765, programmed	13-25	23.45

No. 325 OCTOBER 2003

DDS RF Signal Generator

@ 020299-1 PCB, generator	11-60	20.55
@ 020299-2 PCB, control/supply	12-10	21.45
020299-41 AT90S8515-8PC, programmed	30-55	54.05

Minimalist Induction-Balance Metal Detector

@ 020290-1 PCB	8-95	15.65
----------------	------	-------

Xilinx PROM Programmer

@ 010109-11 Software	4-90	8.65
----------------------	------	------

No. 324 SEPTEMBER 2003

ATV Picture Generator

@ 020295-11 Disk, source & hex code files	4-90	8.65
020295-41 AT90S8515-8PC, programmed	15-20	26.90
020295-42 AT90S1200-12PC, programmed	13-90	24.60

DTMF Remote Telephone Switch

@ 020294-1 PCB	11-65	20.60
@ 020294-11 Disk, project software	4-90	8.65
020294-41 PIC16F874-20P, programmed	14-70	26.00

LC Display with I²C Bus

@ 030060-2 PCB	7-35	13.00
----------------	------	-------

PICProg 2003

@ 010202-1 PCB	9-05	16.00
@ 010202-11 Disk, Windows software	4-90	8.65
010202-41 PIC16F874-20P, programmed	23-55	41.65

Polyphonic Doorbell

@ 020354-11 Disk, project software	4-90	8.65
020354-41 PIC16F84A-10P, programmed	14-45	25.55

Precision Measurement Central

030060-91 Ready-assembled & tested board	69-00	112.50
--	-------	--------

Valve Preamplifier (1)

@ 020383-1 PCB, amplifier board	11-55	20.40
@ 020383-2 PCB, power supply board	11-40	20.20
@ 020383-3 PCB, I/O board	10-10	17.80

No. 323 JULY/AUGUST 2003

Add a Sparkle

@ 020293-11 Disk, HEX and source files	4-90	8.65
020293-41 PIC12C509A-04/SM, programmed	7-40	13.10

AT90S2313 Programmer

@ 034036-1 PCB	9-05	16.00
----------------	------	-------

Hard Disk Selector

@ 034050-1 PCB	9-45	16.75
----------------	------	-------

Mini Running Text Display

@ 020365-11 Disk, source code file	4-90	8.65
------------------------------------	------	------

Mini Test Chart Generator

@ 020403-11 Disk, PIC source code	4-90	8.65
-----------------------------------	------	------

Programming Tool for ATiny15

@ 030030-1 PCB	7-55	13.35
@ 030030-11 Disk, project software	4-90	8.65

Dual Bridge Car Amp

@ 034039-1 PCB	6-70	15.35
----------------	------	-------

Remote Light Control with Dimmer

@ 020337-11 Disk, HEX and source files	4-90	8.65
020337-41 AT89C2051-12, programmed	6-25	11.05

No. 322 JUNE 2003

AVR TV Tennis

@ 030026-1 Main PCB	6-70	15.40
@ 030026-2 Pushbutton PCB	6-60	15.25
@ 030026-11 Disk, AVR source code	4-90	8.65
030026-41 AT90S515, programmed	15-20	26.90

	£	US \$
Electronic Knotted Handkerchief		
Ⓢ 020308-11 Disk, PC and controller software	4.90	8.65
020308-41 AT90S2313-10PC, programmed	12.60	22.30
Low-Cost LCD Controller (2)		
Ⓢ 020114-1 PCB	8.70	15.35
Ⓢ 020114-11 Disk, project software	4.90	8.65
Night Light Control		
Ⓢ 020115-11 Disk, hex and source code	4.90	8.65
020115-41 AT90S2313-10PC, programmed	12.65	22.75
Universal XA Development Board		
Ⓢ 010103-1 PCB	13.20	23.35
Ⓢ 010103-11 Disk, GAL code, EPROM hex files, X-DEV	4.90	8.65
010103-21 EPROM IC8, 27C256-90, programmed	10.00	17.70
010103-22 EPROM IC9, 27C256-90, programmed	10.00	17.70
010103-31 GAL 16V8, programmed	4.80	8.50

No. 321 MAY 2003

Countdown Timer		
Ⓢ 020296-11 Disk, source and hex code	4.90	8.65
020296-41 AT90S1200, programmed	13.90	24.60
USB Audio Recorder		
Ⓢ 012013-11 Disk, EPROM hex code	4.90	8.65
012013-21 EPROM 27C512, programmed	12.60	22.30
Valve Final Amp (2)		
Ⓢ 020071-1 Amplifier board (one channel)	15.10	26.75
Ⓢ 020071-2 Power supply board	10.05	17.75

No. 320 APRIL 2003

8-Channel Disco Light Controller		
Ⓢ 010131-1 PCB	13.10	23.15
010131-41 87C750 or 87C71, programmed	23.00	40.70
Pico PLC		
Ⓢ 010059-1 PCB	18.70	33.10
Ⓢ 010059-11 Disk, test program	4.90	8.65
Single-Chip Tone Control		
Ⓢ 020054-4 PCB	10.90	19.30
Switched-Outlet Power Bar with RS232 Control		
Ⓢ 020298-1 PCB	10.80	19.10
Ⓢ 020298-11 Disk, project software	4.90	8.65
Temperature Indicator for the PC		
Ⓢ 020380-11 Disk, source and compiled code	4.90	8.65
020380-41 AT89C2051, programmed	10.25	18.15

No. 319 MARCH 2003

17 V / 10 A Switch-Mode Power Supply		
Ⓢ 020054-3 PCB	9.45	16.65
Add-on Switch unit for R/C Models		
Ⓢ 020126-1 PCB	8.95	15.85
Ⓢ 020126-11 Disk, hex and source files	4.90	8.65
020126-41 PIC16C712-041/SO, programmed	15.20	26.90
AVRee Development System		
Ⓢ 020351-1 PCB	13.20	23.35
Ⓢ 020351-11 Disk, example programs	4.90	8.65
Guitar Effects Switchbox		
Ⓢ 020181-1 PCB	13.15	23.30
Intelligent Fan Timer		
Ⓢ 020170-11 Disk, project software	4.90	8.65
020170-41 MSP430F1121, programmed	11.30	20.00
SAA3049 Replacement		
Ⓢ 020085-1 PCB	13.05	23.10
Ⓢ 020085-11 Disk, source and hex code	4.90	8.65
020085-41 87LPC764BN, programmed	9.90	17.55

Two-Colour Running Light		
Ⓢ 010134-1 PCB, controller board	8.25	14.60
Ⓢ 010134-2 PCB, LED board	10.65	18.80
Ⓢ 010134-11 Disk, project software	4.90	8.65
010134-41 AT89C2051-12PC, programmed	7.15	12.65

No. 318 FEBRUARY 2003

20/40 MHz Logic Analyser		
Ⓢ 020032-1 PCB	15.20	26.85
Ⓢ 020032-11 Disk, demo program	4.90	8.65
020032-41 AT90S8515-8PC, programmed	15.10	26.70
Active Loudspeaker System (2)		
Ⓢ 020084-2 PCB	7.95	14.05
Autoranging Capacitance Meter		
Ⓢ 020144-1 PCB	7.35	13.00
Ⓢ 020144-11 Disk, source and hex files	4.90	8.65
020144-41 PIC16F84A-20/R, programmed	15.20	26.90
Dimmer with D-10 V Control Input		
Ⓢ 010125-1 control PCB	9.60	17.00
Ⓢ 010125-2 dimmer PCB	8.95	15.85

Electronic Hourglass		
Ⓢ 020036-1 PCB	18.55	32.65
Ⓢ 020036-11 Disk, project software	4.90	8.65
020036-41 PIC16F84-04/R, programmed	15.20	26.90
Optimise your PC Soundcard		
Ⓢ 020184-11 Disk, Excel spreadsheet	4.90	8.65

No. 317 JANUARY 2003

Active Loudspeaker System (1)		
Ⓢ 020054-1 PCB	6.90	12.20
Electronic RPG Dice Roller		
Ⓢ 020005-1 PCB	10.65	17.75
Ⓢ 020005-11 Disk, source code file	4.90	8.65
020005-41 AT90S4433-8PC, programmed	30.60	54.50
Rodent Deterrent		
Ⓢ 020110-1 PCB	12.05	21.30
SMS-Controlled Mains Sockets		
Ⓢ 020157-1 PCB	12.90	22.65

No. 316 DECEMBER 2002

DCI PLC		
Ⓢ 010113-1 PCB, converter board	8.40	14.65
Ⓢ 010113-2 PCB, terminal board	12.50	22.10
Ⓢ 010113-11 Disk, project software & source code	4.90	8.65
010113-41 AT90S8515-8PC, programmed	21.20	37.55
Port Line and ADC Extension		
Ⓢ 020307-11 Disk, BASCOM-51 programs	4.90	8.65
Programmable Dial-Out Blocking Device		
Ⓢ 020106-1 PCB	12.20	21.55
Ⓢ 020106-11 Disk, project software	4.90	8.65
020106-41 AT89C2051-1, programmed	8.50	11.50
USB Audio Codec with S/PDIF		
Ⓢ 020178-1 PCB	11.10	19.60

No. 315 NOVEMBER 2002

Audio Level Check for Line Input		
Ⓢ 020189-1 PCB	9.25	16.35
EPROM Emulator		
Ⓢ 024066-1 PCB	9.35	16.50
Ⓢ 024066-11 Disk, GAL JEDEC listing	4.90	8.65
024066-31 GAL 16V89, programmed	5.00	8.65
LED Torch		
Ⓢ 012019-11 Disk, project software	4.90	8.65
012019-41 PIC12C672-04/SM, programmed	10.40	18.40
Stand-Alone EEDTS Pro		
Ⓢ 020125-1 PCB	15.35	27.15
Telephone Baby Monitor		
Ⓢ 012016-1 PCB	10.00	17.70
Ⓢ 012016-11 Disk, source and hex files	4.90	8.65
012016-41 AT90S1313-10PC, programmed	10.40	18.40
Vehicle Diagnostics Adapter		
Ⓢ 020138-1 PCB	9.25	16.35

No. 314 OCTOBER 2002

AT90S8535 Programmer		
Ⓢ 024051-1 PCB	9.05	16.05
Digital RF Wattmeter		
Ⓢ 020026-1 PCB	12.85	22.70
Ⓢ 020026-11 Disk, source code files	4.90	8.65
020026-41 PIC16F876-04/SP	19.90	35.20
Motorcycle Theft Alarm		
Ⓢ 000191-1 PCB	9.90	17.50
Ⓢ 000191-11 Disk, source code files	4.90	8.65
000191-41 PIC16F84-04/SO	19.90	35.20
000191-42 PIC16F84-04/P	14.70	26.05
Sound Pressure Level Meter		
Ⓢ 020122-1 PCB	19.70	34.85

No. 313 SEPTEMBER 2002

20-Metres Band Receiver		
Ⓢ 010097-1 PCB	14.30	25.30
Capacitor ESR Tester		
Ⓢ 012022-1 PCB	16.15	28.60
Continuity Tester		
Ⓢ 020002-1 PCB	4.60	8.10
EEDTS Pro Super Loco Decoder Upgrade		
Ⓢ 020094-41 PIC for super loco decoder	19.90	35.25
020095-41 PIC for return signaller	17.25	30.55
Firmware Update for EPROM Emulator		
Ⓢ 024107-11 Disk, hex file	4.90	8.65
024107-41 AT89C2051-12P, programmed	7.95	14.10
High-Speed Controller Board		
Ⓢ 020183-1 PCB	11.95	21.15
Parallel JTAG Interface		
Ⓢ 020093-1 PCB	8.75	15.45

No. 312 JULY/AUGUST 2002

4-Bit Decimal Display		
Ⓢ 024072-31 GAL22V10D-25LR, programmed	6.90	12.20

Products for older projects (if available) may be found on our web site
<http://www.elektor-electronics.co.uk>

ORDERING INSTRUCTIONS, P&P CHARGES

Except in the USA and Canada, all orders, except for subscriptions (for which see below), must be sent BY POST or FAX to our Tunbridge Wells address using the Order Form overleaf.

On-line ordering: <http://www.elektor-electronics.co.uk>

Readers in the USA and Canada may (but are not obliged to) send orders, except for subscriptions (for which see below), to the USA address given on the order form. Please apply to Old Colony Sound for applicable P&P charges. Please allow 4-6 weeks for delivery.

Orders placed on our Tunbridge Wells office must include P&P charges (Priority or Standard) as follows:

UK:	£3.50
Europe:	£5.00 (Standard) or £7.00 (Priority)
Outside Europe:	£8.00 (Standard) or £12.00 (Priority)

HOW TO PAY

Unless you have an approved credit account with us, all orders must be accompanied by the full payment, including postage and packing charges as stated above.

Payment may be made by cheque drawn on a London clearing bank (but see para. 4 below), postal order, VISA, Access, MasterCard or EuroCard (when paying by credit card, the order must go the cardholder's address). Do not send cash through the mail. Cheques and postal orders should be crossed and made payable to 'Elektor Electronics (Publishing)'. Payment may also be made by direct transfer from a private or business Giro account to our Giro account No. 34 152 3801 by completing and sending to the National Giro Centre, in a National Giro postage paid envelope, a National Giro transfer/deposit form. Do not send Giro transfers direct to us, as this will delay your order.

If you live outside the UK, payment may also be made by Bankers' sterling draft drawn on a London clearing bank, Eurocheque made out in pounds sterling (with holder's guarantee card number written on the back), or US or Canadian dollar cheque drawn on a US or Canadian bank.

If you pay by Bankers' sterling draft, make clear to the issuing bank that your full name and address MUST be communicated to the London clearing bank. Our bankers are NAT WEST PLC, 1 St James's Square, Wadhurst, East Sussex TN5 6BH, England. Our account number is 3512 5225, Sorting Code 60-22-15.

IBAN code : GB40 NWB K6 022 15 3512 5225

BIC code : NWB KGB 2L

COMPONENTS

Components for projects appearing in *Elektor Electronics* are usually available from certain advertisers in this magazine. If difficulties in the supply of components are envisaged, a source will normally be advised in the article. Note, however, that the source(s) given is (are) not exclusive.

TERMS OF BUSINESS

Delivery Although every effort will be made to dispatch your order within 2-3 weeks from receipt of your instructions, we can not guarantee this time scale for all orders.

Returns Faulty goods or goods sent in error may be returned for replacement or refund, but not before obtaining our consent. All goods returned should be packed securely in a padded bag or box, enclosing a covering letter stating the dispatch note number. If the goods are returned because of a mistake on our part, we will refund the return postage.

Damaged goods Claims for damaged goods must be received at our Tunbridge Wells office within 10 days (UK); 14 days (Europe) or 21 days (all other countries).

Cancelled orders All cancelled orders will be subject to a 10% handling charge with a minimum charge of £5-00.

Patents Patent protection may exist in respect of circuits, devices, components, and so on, described in our books and magazines. Elektor Electronics (Publishing) does not accept responsibility or liability for failing to identify such patent or other protection.

Copyright All drawings, photographs, articles, printed circuit boards, programmed integrated circuits, diskettes and software carriers published in our books and magazines (other than in third-party advertisements) are copyright and may not be reproduced or transmitted in any form or by any means, including photocopying and recording, in whole or in part, without the prior permission of Elektor Electronics (Publishing) in writing. Such written permission must also be obtained before any part of these publications is stored in a retrieval system of any nature.

Notwithstanding the above, printed-circuit boards may be produced for private and personal use without prior permission.

Limitation of liability Elektor Electronics (Publishing) shall not be liable in contract, tort, or otherwise, for any loss or damage suffered by the purchaser whatsoever or howsoever arising out of, or in connexion with, the supply of goods or services by Elektor Electronics (Publishing) other than to supply goods as described or, at the option of Elektor Electronics (Publishing), to refund the purchaser any money paid in respect of the goods.

Law Any question relating to the supply of goods and services by Elektor Electronics (Publishing) shall be determined in all respects by the laws of England.

January 2004

Subscription rates from January 2004 issue

	Standard	Plus
United Kingdom	£39.50	£45.50
Economy Mail		
Rest of the World (excluding Europe)	£51.30	£57.30
Priority Airmail		
Europe & Eire	£52.50	£58.50
Middle East, Africa, Southwest Asia,		
Central & South America	£64.00	£70.00
Australia, New Zealand,		
Far East & Pacific Territories	£66.00	£72.00
Airfreight		
USA & Canada only	US\$88.00	US\$96.50

Payment should be made by:

- Cheque or bankers' draft in sterling drawn on a London clearing bank (except in the USA and Canada — see below); Eurocheques must have the holder's guarantee card number written on the back.
- USS cheques drawn on a US or Canadian bank — only by subscribers in the USA or Canada.
- Direct transfer to our bank (NAT WEST PLC, 1 St James's Square, Wadhurst, East Sussex TN5 6BH, England). Our account number is 3512 5225, Sorting Code 60-22-15.
- Postal order.
- Credit card: VISA, ACCESS, Euro/MasterCard, JCB Electron or Switch.
- Transfer to our Giro Account number 34 152 3801. Giro transfers should be

made by completing and sending the appropriate transfer/deposit form to the National Giro Centre (UK) or to your national Giro Centre.

Cheques and postal orders should be made payable to Elektor Electronics (Publishing). Do not send cash through the mail.

Subscription conditions

The standard subscription order period is twelve months. If a permanent change of address during the subscription period means that copies have to be despatched by a more expensive service, no extra charge will be made. Conversely, no refund will be made, nor expiry date extended, if a change of address allows the use of a cheaper service.

Student applications, which qualify for a 20% (twenty per cent) reduction in current rates, must be supported by evidence of studentship signed by the head of the college, school or university faculty. A standard Student Subscription costs £31.60, a Student Subscription-Plus costs £37.60 (UK only).

Please note that new subscriptions take about four weeks from receipt of order to become effective.

Cancelled subscriptions will be subject to a charge of 25% (twenty-five per cent) of the full subscription price or £7.50, whichever is the higher, plus the cost of any issues already dispatched. Subscriptions cannot be cancelled after they have run for six months or more.

January 2004

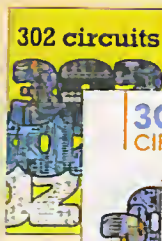

302 Circuits
Summer Circuits compilation 1982, 1983, 1984
£ 10.35/US\$ 21.00

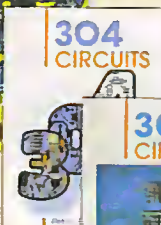

304 Circuits
Summer Circuits compilation 1988, 1989, 1990
£ 13.45/US\$ 27.00

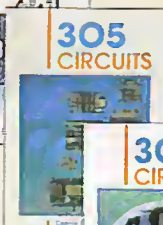

305 Circuits
Summer Circuits compilation 1991, 1992, 1993
£ 15.55/US\$ 31.00

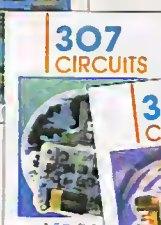

307 Circuits
Summer Circuits compilation 1997, 1998, 1999
£ 18.20/US\$ 37.00



308 Circuits
Summer Circuits compilation 2000, 2001, 2002
£ 18.20/US\$ 37.00



Build your own Audio Valve Amplifiers
This book proves that the thermionic valve is making a come-back.
£ 15.55/US\$ 31.00

Designing Audio Circuits
How does speech, music, or, indeed, any sound get from the record, CD, or cassette tape to the loud-speaker? This book endeavours to give a comprehensible answer.
£ 20.75/US\$ 42.00

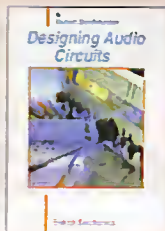

Handbook for Sound Technicians
A book on the technical aspects of the recording studio.
£ 20.75/US\$ 42.00



Build your own High-End Audio Equipment
For those who cannot pay high prices for high end equipment, a solution offered in this book: build your own at considerable cost savings.
£ 15.55/US\$ 31.00



Modern High-end Valve Amplifiers
Valve amplifiers based on toroidal output transformers combine of classical technology and modern components. The result: excellent sonic quality and a revival of the valve amplifier.
£ 25.95/US\$ 52.00



Lasers: Theory and Practice
A valuable book on the practical use of lasers.
£ 20.75/US\$ 42.00

Build your own Electronic Test Instruments

For good reasons (cost, challenge) many researchers, enthusiasts, and experimenters like to build test instruments themselves.
£ 16.60/US\$ 33.00



Microcontrollers

Order now using the Order Form in the Readers Services section in this issue



Matchbox Basic Computer
This book describes a miniature controller system using a programming language called MBL (MatchBox Language), which has its origins in BASIC and Pascal.
£ 25.95/US\$ 52.00



ST62 Microcontroller
Practical programming of the ST62 series of microcontrollers from SGS Thomson.
£ 24.95/US\$ 50.00



PICs in Practice
The PIC16C5x family is a series of microcontrollers that lend themselves to a broad variety of applications.
£ 24.95/US\$ 50.00



Short Course 8051/8032 Microcontrollers
A course describing the hardware and software (assembler code) to make a complete microcontroller system based on an MCS-51 controller.
£ 9.95/US\$ 20.00

Computers

See also www.elektor-electronics.co.uk



Dictionary of Monitor Technology
A pioneering book of unsurpassed range which clearly documents all aspects of the development of computer monitors.
£ 25.95/US\$ 52.00



Faultfinding in Computers and Digital Circuits
This book covers faultfinding not just in microprocessor systems, microcontrollers and industrial PCs, but also in consumer items such as personal computers, multimedia devices, digital television and so on.
£ 31.15/US\$ 63.00



The I2C Bus
This book deals extensively with the technical specifications of the I2C bus.
£ 25.95/US\$ 52.00



PC Service and Repair
This book provides the information you need to be able to deal with computer system faults whenever they occur.
£ 31.15/US\$ 63.00



SCSI
This book comes with a CD-ROM and will prove invaluable when you want to sort out a problem in a SCSI system.
£ 24.95/US\$ 50.00



PC Interfaces under Windows
Measurement and control using standard ports. PC Interfaces can be used for more than just the printer, mouse, modem and joystick!
£ 25.95/US\$ 52.00

To book your website space contact **Bernard Hubbard**

Tel 00 44 (0)1242 510760 Fax: 0044 (0)1242 226626

BETA LAYOUT

www.pcb-pool.com

Beta layout Ltd Award-winning site in both English and German offers prototype PCBs at a fraction of the cost of the usual manufacturers' prices.



BURN TECHNOLOGY LTD

<http://www.burntec.com>

Distributors of a wide range of device programmers, package adaptors, test and soldering equipment. Order online and get free delivery on all orders over £30.00.

COMPUCUT

<http://www.compucutters.com>

Computer Numerical Control from your home PC. Great for tricky jobs, and accurate repetitive work. We supply: - Software - Interface - Manual - Support
Price £250 plus postage.

CONFORD ELECTRONICS

<http://www.confordelec.co.uk>

Lightweight portable battery/mains audio units offering the highest technical performance. Microphone, Phantom Power and Headphone Amplifiers. Balanced/unbalanced signal lines with extensive RFI protection.

CROWNHILL ASSOCIATES LTD

<http://www.crownhill.co.uk>

tel 01353 666709 fax 01353 666710

- Manufacturers of production quality device programmers
 - PIC Programmers
 - PIC Development tools
 - Manufacturers of Smart Cards
 - Smart Card Programmers
 - Design & Development Services
- Crownhill Associates Limited
32 Broad Street Ely, Cambridge CB7 4AH
Tel: 01353 666709 Fax: 01353 666710



DANBURY ELECTRONICS

<http://www.mc-h.demon.co.uk/transformers.html>

Here you will find our mains and output transformers in Mike Holme's range of valve/tube amplifiers (PP & SE). Also circuits, parts lists, chassis, advice.

DEBUG INNOVATIONS UK

<http://www.debuginnovations.com>

Introducing hassle free prototyping

- RF / Analogue
 - High speed digital
 - Surface mount
 - 0.1" grid
 - Power planes
 - Unique patch architecture
- Forget custom PCBs, start your project now!



EASYSYNC

<http://www.easysync.co.uk>

EasySync Ltd sells a wide range of single and multi-port USB to RS232/RS422 and RS485 converters at competitive prices.



ELM ELECTRONICS

<http://www.elmelectronics.com>

Offering a variety of unique and low cost integrated circuits for the experimenter. Secure ordering via the web site with worldwide shipping.

ELNEC

www.elnec.com

- device programmer manufacturer
- selling through contracted distributors all over the world
- universal and dedicated device programmers
- excellent support and after sale support
- free SW updates
- once a months new SW release
- reliable HW
- three years warranty for most programmers

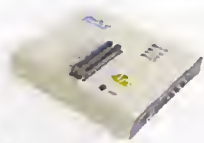

ERVAN INTERNATIONAL Co.

<http://www.ervan-int.com>

Power Electronics and Solar Energy Design and Consultants. Also offers;

- Discount prices of:
- Ultra Bright LEDs
 - PCB LED Cluster Kits
 - Laser Pointers
 - Solar Modules
 - Batteries

FOREST ELECTRONIC DEVELOPMENT

<http://www.fored.co.uk>

FED supply PIC programmers, Basic modules, and development software including a PIC C Compiler, Prog 'n Drop Visual Development and a well featured debugging environment.

FUTURLEC

<http://www.futurlec.com>

Save up to 60% on

- Electronic Components
- Microcontrollers, PIC, Atmel
- Development Boards, Programmers

Huge range of products available on-line for immediate delivery, at very competitive prices.



FUTURE TECHNOLOGY DEVICES

<http://www.ftdichip.com>

FTDI designs and sells USB-UART and USB-FIFO interface i.c.'s.

Complete with PC drivers, these devices simplify the task of designing or upgrading peripherals to USB



HAMMOND ELECTRONICS

<http://www.hammondmfg.com>,

sales@hammond-electronics.co.uk

tel: 01256 812812.

Small die-cast, plastic and metal enclosures for the hobbyist and professional. Widely available from major distributors.



MQP ELECTRONICS

<http://www.mqpelectronics.co.uk>

Leaders in Device Programming Solutions.

- Online shop
- Low Cost Adapters for all Programmers
- Single Site and Gang Programmers
- Support for virtually any Programmable Device

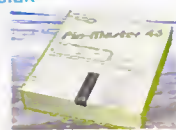

NEW WAVE CONCEPTS

<http://www.new-wave-concepts.com>

Software for hobbyists:

- Livewire circuit simulation software, only £29.36
- PCB Wizard circuit design software, only £29.36

Available from all Maplin Electronics stores and www.maplin.co.uk



PEAK ELECTRONIC DESIGN LIMITED

www.peakelec.co.uk

Cool component test gear for your passives and semis. Instant identification, measurement and validation. Connect anyway round. The Peak Atlas family starts from £59.



PICBASIC

<http://www.picbasic.co.uk>

- Pic basic & Pic Basic Pro
- Fast efficient powerful compilers
- Parallax stamp compatible code
- Write in basic-compile to hex
- 12c, 14c, 16c(f) and 17c pic's



POND ELECTRONICS

<http://www.pond.ie>

tel +353-1-821-5060

fax +353-1-820-9384

Innovative systems for PIC development & embedded applications.

- µFlash876
- PIC C Compilers & Programmers
- MicroStack • Basic Stamp
- Custom development Service



QUASAR ELECTRONICS

www.QuasarElectronics.com

Over 300 electronic kits, projects and ready built units for hobby, education and industrial applications including PIC/ATMEL programming solutions. Online ordering facilities.
Tel: +44 (0) 870 246 1826
Fax: +44 (0) 870 460 1045
Email: sales@QuasarElectronics.com



ROBOT ELECTRONICS

<http://www.robot-electronics.co.uk>

- Ultrasonic rangefinders
- Motor H-Bridge controllers
- Magnetic Compasses
- RC servos and controllers
- PIC programmers and components
- Electronic Design/Development and Manufacturer to industry



SPICEAGE AND SPICYCLE

<http://www.spiceage.com>

Spicycle circuit design program (schematic drawing, well-featured PCB drawing, SpiceAge simulation). SuperFilter digital and analogue filter synthesis and optimisation. Download a free working evaluation and enjoy software renowned for its high quality at prices that make it seem like Christmas all year round. Make contact with Those Engineers (020 8906 0155), real engineers, who will understand your needs.



The World is getting onto Spicycle

TECHNOBOTS

<http://www.technobots.co.uk>

Welcome to Technobots - the one stop shop especially for the remote operated robot builder, radio control and engineering hobbyist.



TELNET

<http://www.telnet.uk.com>

The site shows graphically Telnets wide range of quality second-user test and measurement equipment, including oscilloscopes and spectrum analysers.



ULTRALEDs

<http://www.ultraleds.co.uk>

tel: 0871 7110413
Large range of low cost Ultra bright leds and Led related lighting products. Major credit cards taken online with same day despatch.

USB INSTRUMENTS

<http://www.usb-instruments.com>

USB Instruments specialises in PC based instrumentation products and software such as Oscilloscopes, Data Loggers, Logic Analysers which interface to your PC via USB.

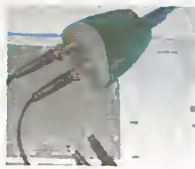

VIEWCOM

<http://www.viewcom.f9.co.uk>

tel: 020 8471 9338 fax: 020 8552 0946

- Mail Order supplier of:
 - Integrated Circuits and Components.
 - Kit and parts for Elektor projects.
 - Transistors, FETs, Capacitors, Resistors, Crystals, etc and hard to find devices.
- Viewcom Electronics, 77 Upperton Road West, Plaistow, London E13 9LT

PROMOTE YOUR WEBSITE HERE

Elektor Electronics have a feature to help customers to promote their websites. Net Links - a permanent feature of the magazine where you will be able to highlight your site on a regular basis.

- For just £120 + VAT (£10.90 per issue for eleven issues) Elektor will publish your company name, a 25-word description and your website address.
- For £300 + VAT for the year (£27.27 per issue for eleven issues) we will publish the above plus run a 3cm deep full colour screen shot from your site.

Places are limited and spaces will go on a strictly first come, first served basis. please fax back your order today!

I wish to promote my company. please book my space:

- Text insertion only for £120 + VAT
- Text and photo for £300 + VAT

NAME:..... ORGANISATION:.....

JOB TITLE:.....

ADDRESS:.....

..... TEL:.....

PLEASE COMPLETE COUPON BELOW AND FAX BACK TO 00-44-(0)1242 226626

COMPANY NAME

WEB ADDRESS

25-WORD DESCRIPTION

.....

.....

.....

.....

.....

ELECTRONIC ENTHUSIASTS

Only one magazine tests its projects and circuits in its own lab before publication -



ELEKTOR ELECTRONICS

THE ELECTRONICS & COMPUTER MAGAZINE

Contact: Worldwide Subscription Service Ltd, Unit 4 Gibbs Reed Farm, Pashley Road, Ticehurst TN5 7HE Telephone: (+44) (0) 1580 200657 Fax: (+44) (0) 1580 200616
Or visit our Website: www.elektor-electronics.co.uk

DIGITALLY CONTROLLED PREAMP

Sure, there are many designs for high-end preamplifiers but these are almost invariably marked by complex and expensive circuits when you look at the volume control section. This project closes the gap, offering not only a good many functions but also an opportunity to adapt these functions to personal requirements. Using technical idiom, you're looking at a super-accurate volume and balance control based around the PGA2311 analogue opamp operating under digital control of a PIC micro.



VHF-LOW EXPLORER

The radio frequency range between 68 and 87 MHz is usually referred to as the 'VHF-low' or 'Four-Metres' Band.

It is home to lots of services including (government) PMR and radio amateurs, the latter being active between 70.000 MHz and 70.500 MHz (in the UK).



NOT AN APRIL SPOOF!

- The April 2004 issue of Elektor Electronics will be marked by a major makeover including
- restyled magazine cover and masthead (logo)
- restyled article layouts
- new columns and regulars including News & New Products, iTech, eTech, Inside Out, Mailbox and Reviews.

CURIOUS? ORDER YOUR COPY NOW!

RESERVE YOUR COPY NOW!

The March 2004 issue goes on sale on Friday 26 March 2004 (UK distribution only). UK subscribers will receive the magazine a few days before this date. Article titles and magazine contents subject to change.

NEWSAGENTS ORDER FORM

SHOP SAVE / HOME DELIVERY

Please save / deliver one copy of *Elektor Electronics* magazine for me each month

Name:
 Address:
 Post code:
 Telephone:
 Date:
 Signature:



Please cut out or photocopy this form, complete details and hand to your newsagent. *Elektor Electronics* is published on the third Friday of each month, except in July. Distribution S.O.R. by Seymour (NS).

INDEX OF ADVERTISERS

Beta Layout, Net Links	www.pcb-pool.com	63, 72	MQP Electronics, Net Links	www.mqpelectronics.co.uk	72
Burn Technology LTD, Net Links	www.burntec.com	72	Net Links		72, 73
CMS	www.cms.uk.com	9	New Wave Concepts, Net Links	www.new-wave-concepts.com	72
CompuCut, Net Links	www.compu-cutters.com	72	Number One Systems	www.numberone.com	7
Conford Electronics, Net Links	www.confordelec.co.uk	72	Observant Electronics	www.observantworld.com	75
Cricklewood		63	PAGM	www.pagm.co.uk	2
Crownhill, Net Links	www.crownhill.co.uk	72	Peak Electronic, Net Links	www.peakelec.co.uk	72
Danbury, Net Links	www.mc-h.demon.co.uk	72	Picbasic, Net Links	www.picbasic.co.uk	72
Debug Innovations, Net Links	www.debuginnovations.com	72	Pico	www.drdaq.com	10
Display Electronics	www.distel.co.uk	27	Pond Electronics, Net Links	www.pond.ie	72
Easysync, Net Links	www.easysync.co.uk	72	Quasar Electronics, Net Links	www.quasarelectronics.com	6, 73
ELM Electronics Net Links,	www.elmelectronics.com	72	Robot Electronics, Net Links	www.robot-electronics.co.uk	73
Eltec, Net Links	www.eltec.com	72	Spiceage and Spicycle, Net Links	www.spiceage.com	73
Ennovi	www.ennovi.co.uk	9	Stewart of Reading	www.stewart-of-reading.co.uk	45
Ervan, Net Links	www.ervan-int.com	72	Technobots, Net Links	www.technobots.co.uk	73
Eurocircuits	www.thepcbshop.com	65	Telnet, Net Links	www.telnet.uk.com	73
Forest, Net Links	www.fored.co.uk	80	Ultraleads, Net Links	www.ultraleads.co.uk	73
Future Technology Devices, Net Links	www.ftdchip.com	72	USB Instruments, Net Links	www.usb-instruments.com	73
Futurtec, Net Links	www.futurtec.com	72	Viewcom, Net Links	www.viewcom.f9.co.uk	73
Hammond Electronics, Net Links	www.hammondmg.com	72			
Hitex www.hitex.co.uk/bigchip		8			
ITP	www.itp101.com	9			
Labcenter	www.labcenter.co.uk	76			
Matrix Multimedia Ltd	www.matrixmultimedia.co.uk	8			
Milford Instruments	www.milinst.demon.co.uk	55			

ADVERTISING SPACE for the issue of 20 April 2004 may be reserved not later than 24 March 2004 with Elektor Electronics (Publishing) Advertisement Office - 3 Crescent Terrace - Cheltenham GL50 3PE - England - Telephone 01242 510 760 - Fax 01242 226 626 - e-mail: bernardhubbard@ukonline.co.uk to whom all correspondence, copy instructions and artwork should be addressed.

PROTEUS

The Complete Electronics Design System

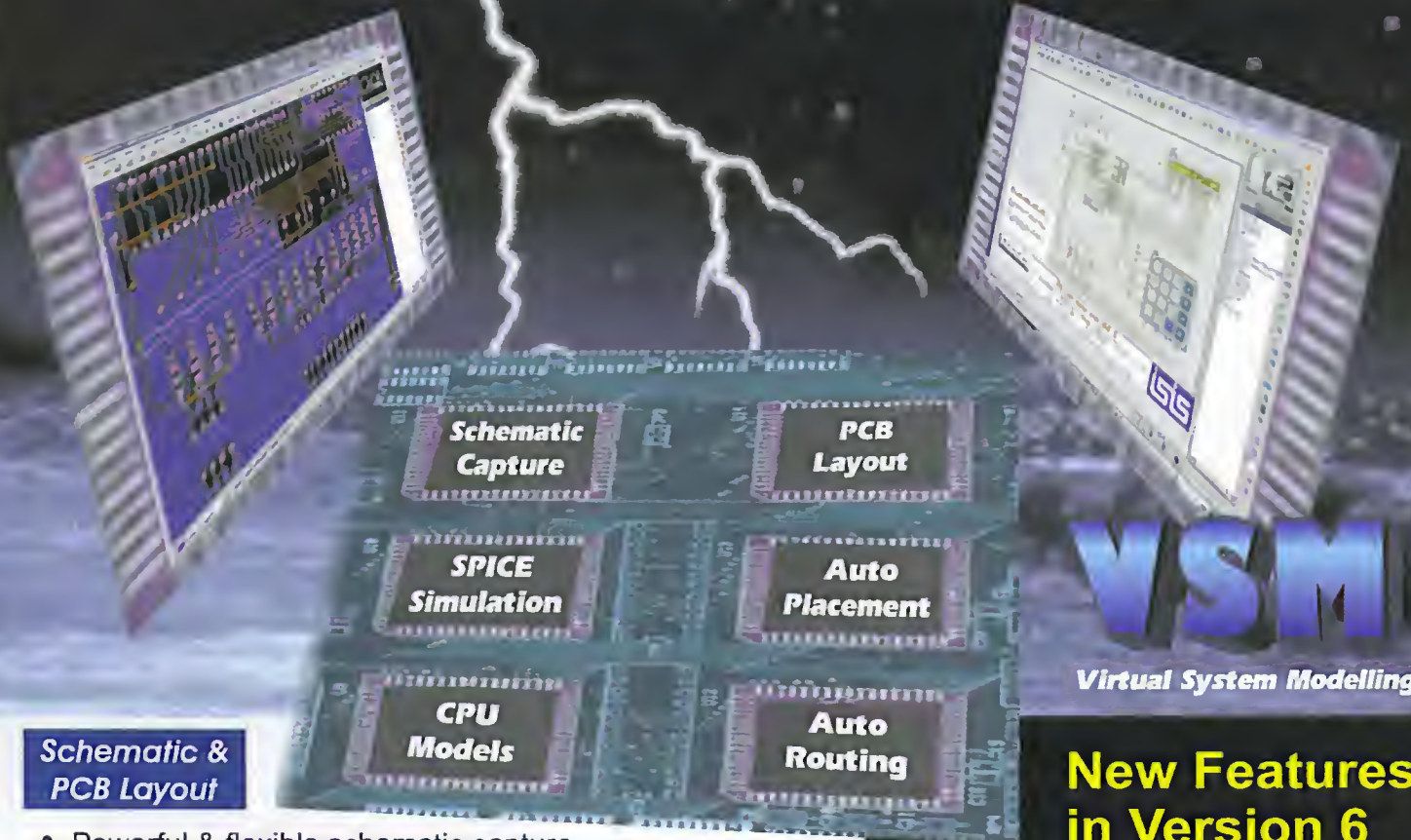

Schematic & PCB Layout

- Powerful & flexible schematic capture.
- Auto-component placement and rip-up/retry PCB routing.
- Polygonal gridless ground planes.
- Libraries of over 8000 schematic and 1000 PCB parts.
- Bill of materials, DRC reports and much more.

Mixed Mode SPICE Circuit Simulation

- Berkeley SPICE3F5 simulator with custom extensions for true mixed mode and interactive simulation.
- 6 virtual instruments and 14 graph based analysis types.
- 6000 models including TTL, CMOS and PLD digital parts.
- Fully compatible with manufacturers' SPICE models.

Proteus VSM - Co-simulation and debugging for popular Micro-controllers

- Supports PIC, AVR, 8051, HC11 and ARM micro-controllers.
- Co-simulate target firmware with your hardware design.
- Includes interactive peripheral models for LED and LCD displays, switches, keypads, virtual terminal and much, much more.
- Provides source level debugging for popular compilers and assemblers from Crownhill, IAR, Keil, and others.

New Features in Version 6

- Drag and drop toolbars.
- Visual PCB packaging tool.
- Improved route editing.
- Point and click DRC report.
- Multiple design rules (per net).
- Multiple undo/redo.

Call Now for Upgrade Pricing



labcenter

Electronics
53-55 Main Street, Grassington. BD23 5AA

Tel: 01756 753440
Fax: 01756 752857

Contact us for
Free Demo CD

www.labcenter.co.uk
info@labcenter.co.uk

DataStation™

The universal I/O solution

DataStation's 16 configurable channels provide 391 different I/O configurations and >500 samples per second, allowing it to adapt to virtually any application.

With up to:

- 6 Analogue Inputs
- Selectable ADC resolution
- 2 PWM Outputs
- 16 Digital Inputs
- 16 Digital Outputs
- RS-232 interface

Typical Applications:

- Machine control
- Industrial automation
- Environmental monitoring
- Robotics

This unrivalled flexibility allows designers to meet the needs of most applications with just one product, reducing development costs and time-to-market significantly.

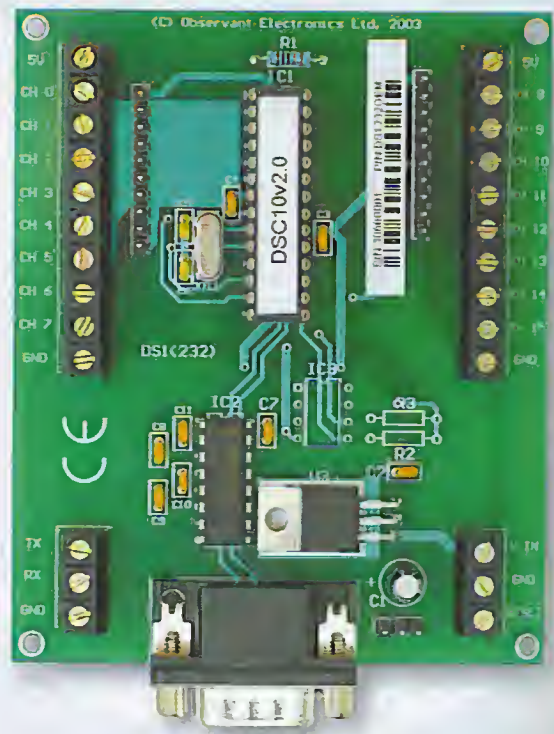

£89.00
plus VAT

(OEM pricing available)

To find out more or buy online visit: www.ObservantWorld.com



Unit F2b, Avonside Business Park,
New Broughton Road, Melksham,
Wiltshire. SN12 8BS. U.K.
Telephone: 01225 704631
Facsimile: 01225 708618
www.ObservantWorld.com
Email: enquiries@ObservantWorld.com