

MEASURE IT!

Hardware

22



OSCILLOSCOPES REVIEWED

Software

-LabView:
steep & comprehensive

-Profilab:
cheap & no frills

**Poor Man's
1-GHz Probe**
DIY = great savings

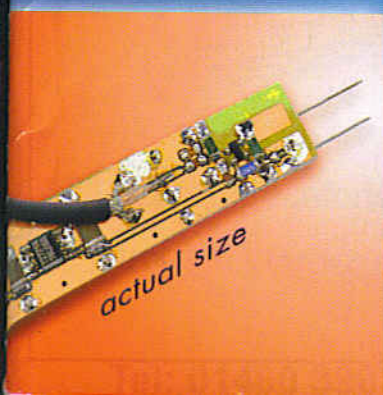

PAGM

The leaders in PIC development

FROM

£99



EASE OF USE

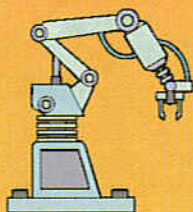

AUTOMATION



SCRIPTABILITY

- ◆ All you need to get started with PIC
- ◆ Industry standard/quality board
- ◆ Open the box and get coding
- ◆ Available with C compiler or use our PicScript to write programs using simple commands...

**NO ASSEMBLER,
NO COMPILER,
JUST WRITE AND RUN**

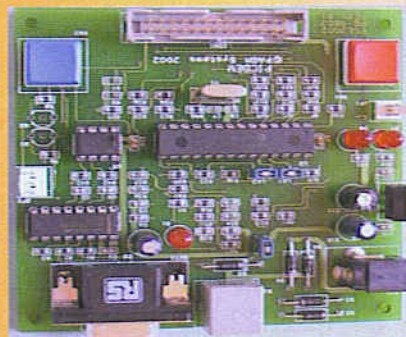

PicDev Board with PicScript

£99.00 (plus p+p)

This is a complete development suite for the novice or non programmer.

It is shipped with:

- PicDev Board
- PicShell and PicScript software
- Breakout board
- Cables
- Example scripts

PicDev Board with C Compiler

£165.00 (plus p+p)

This is a complete development suite for the more advanced programmer.

It is shipped with:

- PicDev Board
- PicShell and PicScript software
- C compiler
- Breakout board
- Cables
- Example scripts
- ICD1

Both items require

- PC with serial port available
- Power supply adapter

To order:

www.pagm.co.uk

sales@pagm.co.uk

Tel: +44 (0)1792 891927

DrDAQ Data Logger

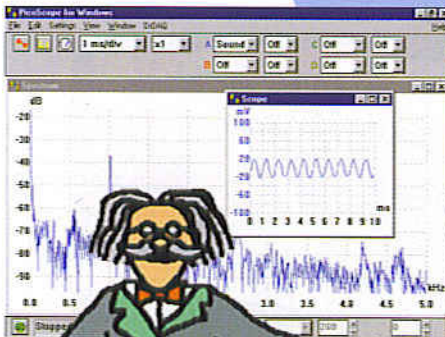

Experiments for DrDAQ

(and writing up one of these experiments, please get in touch, info@picotech.com for more information.)

- **Light sensor** Look at table lights, computer monitors and TV Screens. Use PicoScope oscilloscope to show the fluctuations produced by someone lighting a cigarette or the spectrum analyser to see the frequency components - who's frequency who can afford the loudest?
- **Sound** Record a sound source with a constant level and get how it decays with distance.
- **Musical Instruments** Look at the scope waveform and FFT spectrum of different instruments.

Practical Ideas

- **Light insulation** Experiment with different materials to see how much heat is lost.
- **Acid Base Titration** Measure the pH and Temperature.
- **Acid Rain** Measure the pH of collected rainwater. Needs careful calibration.
- **Exothermic Reactions** Measure the temperature and pH as sodium hydroxide is dissolved in water.
- **Fruit Fly** Measure the temperature and humidity over a 24 hour period.
- **Temperature of Grass** Measure the temperature of grass cuttings or a compost heap.
- **Component Values** Measure the resistance of different components.
- **Power** Measure the power of a photo-diode to see the effects.
- **Diode** Measure the forward and reverse voltage and power available.
- **Capacitors** Measure the time constant of different insulating materials. Compare wet and dry insulation.
- **Leads** Measure the resistance of different leads to see the effect of length and cross-section.

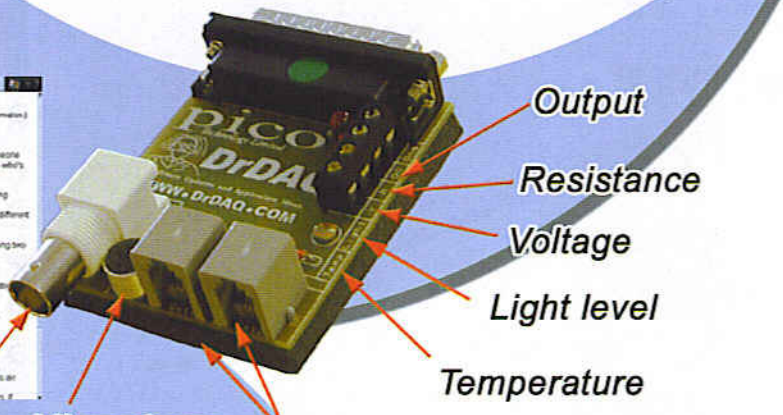

- Low cost - under £60
- Built in sensors for light, temperature and sound (level and waveforms)
- Use DrDAQ to capture fast signals
- Outputs for control experiments
- Supplied with both PicoScope (oscilloscope) and PicoLog (data logging) software

For more information on DrDAQ, please visit:

www.picotech.com/drdaq106

PC Oscilloscopes

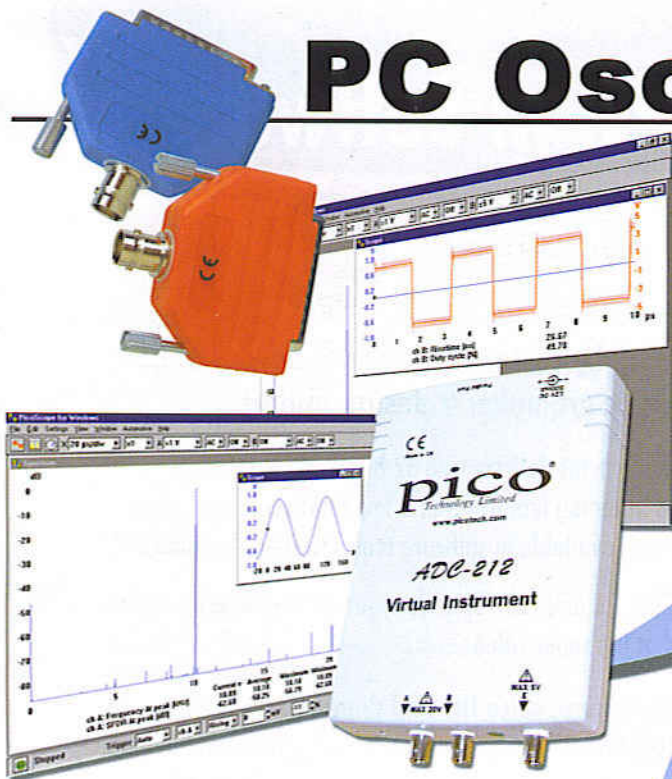

- Scope and spectrum analyser functions
- A fraction of the cost of benchtop scope
- Save multiple setups, for ease of use
- Save, print and e-mail your traces
- FREE technical support for life
- FREE software and upgrades
- Automated measurements

For more information on our scopes, please visit:

www.picotech.com/scope211

USBInstruments
www.usb-instruments.com

"Swordfish" PS40M10 Hand Held USB Oscilloscope

A unique hand held device that combines the functions of oscilloscope, data logger, spectrum analyser, volt meter and frequency meter in a single instrument. PS40M10 features a user replaceable precision spring loaded probe tip which can be used to probe even small smd components. The probe cap can be removed to allow PS40M10 to connect to standard oscilloscope probes or BNC cables if required. PS40M10 comes complete with oscilloscope and data logging software. The supplied Windows DLL's allows 3rd party applications to interface to it. Example code in several popular programming languages are provided. Windows CE and Linux drivers are also available on request.

"Swordfish" PS40M10 Features

- 10 Bit ADC Resolution
- 1G S/s sampling rate (repetitive) 40M S/s native
- Maximum input voltage +/- 50V
- AC / DC Coupling
- Edge, min/max pulse width and delayed trigger modes
- Analog Bandwidth 5MHz
- Self Powered USB Interface - no external PSU required
- Precision spring loaded probe tip or standard BNC connection
- 3rd Party application software support provided
- Hardware upgradeable over USB

£149
+ shipping & VAT

£125
+ shipping & VAT

"Stingray" DS1M12 Dual Channel Oscilloscope, Signal Generator & Multi-Function Instrument

Stingray DS1M12 is the value for money dual channel oscilloscope with signal generator, data logger, spectrum analyser, volt meter and frequency meter capabilities. Despite its low cost, DS1M12 offers a wealth of features including 1M S/s sampling with 12 bit conversion, advanced digital trigger modes, AC / DC coupling and an inbuilt signal generator with 10 bit resolution.

Technical Information
For detailed technical specifications, information and downloads please visit
www.usb-instruments.com

Sales Information
USB Instruments - a division of
EasySync Ltd
373 Scotland Street, Glasgow G5 8QB, U.K.
Tel : 0141 418 0181 Fax : 0141 418 0110
E-mail : sales@easysync.co.uk
Web : www.easysync.co.uk

"Stingray" DS1M12 Features

- Dual Channel standard BNC input connectors
- 12 Bit simultaneous ADC sampling on both channels
- 20M S/s sampling rate (repetitive) 1M S/s native
- Signal Generator Output / External Trigger Input
- Maximum input voltage +/- 50V
- AC / DC Coupling
- Edge, min/max pulse width and delayed trigger modes
- Analog Bandwidth 200KHz
- Self Powered USB Interface - no external PSU required
- 3rd Party application software support provided
- Hardware upgradeable over USB

FREE
Layout Software

EASY To Use!
Very **LOW** Cost!
Extremely **FAST**
Turnaround!

- 01 **DOWNLOAD** our free CAD software
- 02 **DESIGN** your two or four layer PC boards
- 03 **SEND** us your design with just a click
- 04 **RECEIVE** top quality boards in just days

expresspcb.com

Easy-PC for Windows

World Beating Value in PCB Design Software

from **£97**

High performance Windows based PCB Design Capture, Simulation and Layout software at prices you'd expect from your local computer store!

NEW! in Easy-PC 7

- Library Databook
- Step and repeat plotting
- Swap Connection Mode
- Dimensioning
- Copy to Metafile
- plus much more.....

Stop press... by customer demand, now with Tsien Boardmaker 2 design import...

Number One Systems delivers true 32 bit Windows software applications including features that a few short years ago would only have been available in software tools priced in the thousands!

Test drive Easy-PC and Easy-Spice for yourself and be prepared to be amazed at the super value...

Call for a brochure, price list and demo CD
on +44 (0)1684 773662 or email sales@numberone.com

or download from
www.numberone.com

No.1 Number One Systems
Number One Systems
Oak Lane, Bredon
Tewkesbury, Glos GL20 7LR
United Kingdom

Tour de force

About a year ago the editorial and in-house design team cheerfully planned 'measurement technology and measurement software for PCs' as the central theme for the October 2004 issue — blissfully unaware of the arrival, on 1 May of this year, of our new International Editor Mat Heffels.

In one of our June meetings, while perusing the theme plan for the year 2004, Mat, who has the gift of the gab, surprised us with the seemingly harmless question "so what does everyone use to test and measure circuits, and can we publish a grand test?" The answer was quickly given: an oscilloscope because that's every engineer's, designer's and editor's (!) most trusted and highly valued bit of test equipment on the workbench.

Next came the inevitable 'how many' question and after some brainstorming the answer was straightforward yet demanding: 'as many as possible'. David Daamen, our youngest editor in the Dutch editorial department, accepted the challenge. He called in the help of a few fellow students and other cronies from his former University to lobby for the short-term use of a professional test laboratory complete with qualified engineers 'to press the buttons'. The result of this remarkable *tour de force* is printed in this issue: 'Scope for Scopes, a review of 22 oscilloscopes ranging from 10 MHz to 2.5 GHz (and representing rrp values of just 109 right up to a whopping 22,000 pounds), with up to date technology backgrounders thrown in as a bonus. Personally, I am happily using an old HP 100-MHz 'scope picked up for 25 pounds at a radio rally.

Also reviewed, though by different authors and with a different slant from the Scope for Scopes article are two programs, LabView and ProfLab-Expert, that cover measurement software for PCs at widely different cost. Further articles that cover the theme we set out to explore include David Jewsbury's 'Poor Man's 1-GHz Probe' (directly related to oscilloscopes), the E-Online instalment 'Soundcard as Test Instrument' and 'Air Quality Sensor'.

Of course, other subjects are covered as well besides test & measurement. This month's instalment of the popular 'start here' feature has four designs presented in the usual compact way, all aimed at triggering your inspiration.

From readers' feedback we know that the 'kitchen table' feature is now particularly popular with youngsters and other beginners. I'm sure this month's subject, an add-on for digital cameras, will not turn out to be a flash in the pan.

For more amusement there's Steve Teal's electronic version of the Four in a Line game and to cap it all, professor Ohsmann's Quizz'away page presenting a mysterious hyper-active amplifier.

Jan Buiting, Editor



Volume 30, Number 336, October 2004 ISSN 0268/4519

Elektor Electronics aims at inspiring people to master electronics at any personal level by presenting construction projects and spotting developments in electronics and information technology.

Elektor Electronics is produced and published by Elektor Electronics (Publishing), P.O. Box 190, Tunbridge Wells TN5 7WY, England. Tel.: (+44) (0)1580 200657, fax: (+44) (0)1580 200616. Email: sales@elektor-electronics.co.uk.

The magazine is available from newsagents, bookshops and electronics retail outlets, or on subscription.

Elektor Electronics is published 11 times a year with a double issue for July & August.

Under the name *Elektor* and *Elektuur*, the magazine is also published in French, German and Dutch. Together with franchised editions the magazine is on circulation in more than 50 countries.

International Editor: Mat Heffels

Editor: Jan Buiting (editor@elektor-electronics.co.uk)

International editorial staff: Harry Baggen, David Daamen, Rolf Gerstendorf, Ernst Krempelsauer, Guy Raedersdorf.

Design staff: Karel Walraven (head of design), Ton Giesberts, Paul Goossens, Luc Lemmens (techdept@segment.nl)

Editorial secretariat: Hedwig Hennekens (secretariaat@segment.nl)

Graphic design / DTP: Ton Gulkers, Giel Dols

Managing Director / Publisher: Paul Snakkers

Circulation Control: Margriet Debeij (m.debeij@segment.nl)

Subscriptions

Worldwide Subscription Service Ltd., Unit 4, Gibbs Reed Farm, Pashley Road, Ticehurst TN5 7HE, England. Telephone: (+44) (0)1580 200657, Fax: (+44) (0)1580 200616. Email: wwss@wwss.demon.co.uk. Rates and terms are given on the Subscription Order Form.

Head Office:

Segment b.v. P.O. Box 75 NL-6190-AB Beek The Netherlands. Telephone: (+31) 46 4389444, Fax: (+31) 46 4370161

Distribution: Seymour, 86 Newman Street, London W1P 3LD, England

UK Advertising

Bernard Hubbard, 3 Crescent Terrace, Cheltenham GL50 3PE, England. Telephone (+44) (0)1242 510760, Fax: (+44) (0)1242 226626. Email: bernardhubbard@ukonline.co.uk. Advertising rates and terms available on request.

International Advertising

Klaas Caldenhoven, address as Head Office. Email: advertenties@elektuur.nl. Advertising rates and terms available on request.

Copyright notice

The circuits described in this magazine are for domestic use only. All drawings, photographs, printed circuit board layouts and article texts published in the editorial section of the magazine are copyright Segment b.v. and may not be reproduced or transmitted in any form or by any means, including photocopying, scanning or recording, in whole or in part without prior written permission from the Publishers. Such written permission must also be obtained before any part of this publication is stored in a retrieval system of any nature.

Patent protection may exist in respect of circuits, devices, components etc. described in this magazine. The Publisher does not accept responsibility for failing to identify such patent(s) or other protection.

The submission of designs or articles implies permission to the Publishers to alter the text and design, and to use the contents in other Segment publications and activities. The Publishers cannot guarantee to return any material submitted to them.

© Segment b.v. 2004

Printed in the Netherlands

14

28 & 32

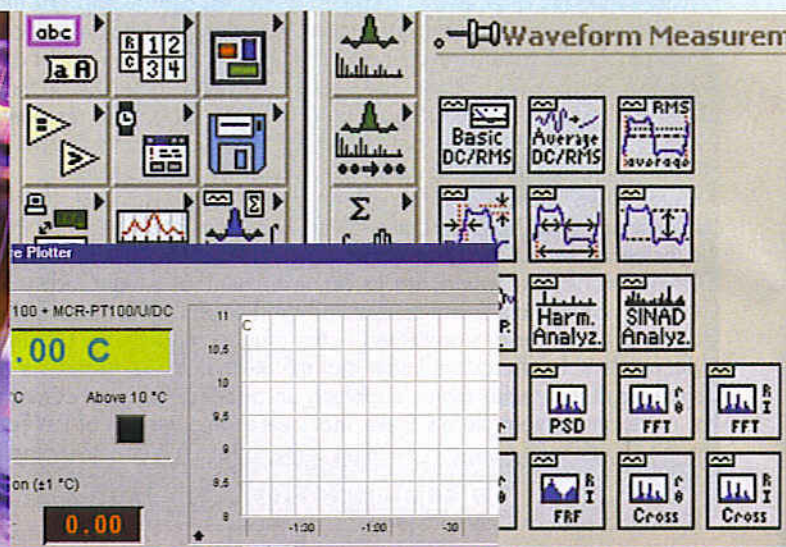
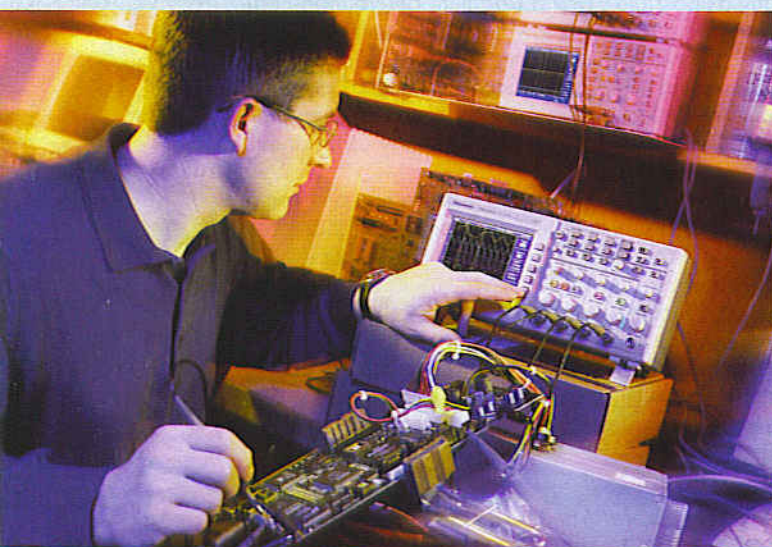

'Scope for Scopes — 22 oscilloscopes tested

If you don't already have an oscilloscope, or if you're looking to acquire a new one in the near future, our survey of 22 (actually, 23) instruments currently on the market will help you select the proper one. Apart from instrument reviews and specifications, the article contains valuable information on the latest digital technology applied to oscilloscopes.

'Soft' Measurements — LabVIEW and Profilab-Expert

Sure, these two programs play in different leagues: LabVIEW is now virtually an industry standard, its 4th generation programming language being tailored to just about any measurement & control task you can throw at it. Although Profilab-Expert is much cheaper, it excels in compactness and ease of use particularly when linked to PC measurement cards.

Informative Articles

- 14 Scope for 'Scopes: 22 oscilloscopes tested
- 28 Virtual Soldering (LabVIEW)
- 32 Profilab-Expert
- 40 Soundcard as Test Instrument
- 46 Air Quality Sensor
- 62 Goodbye '16, Welcome PIC18F
- 74 inside out: USB Memory Stick

Regulars

- 5 Foreword & Colophon
- 8 Mailbox
- 10 News: YEDA & Young Engineers for Britain
- 12 New Products
- 79 Quizz'away
- 82 Readers Services
- 84 Sneak Preview
- 84 Index of Advertisers

CONTENTS

Volume 30
October 2004
no. 336

36

58

66

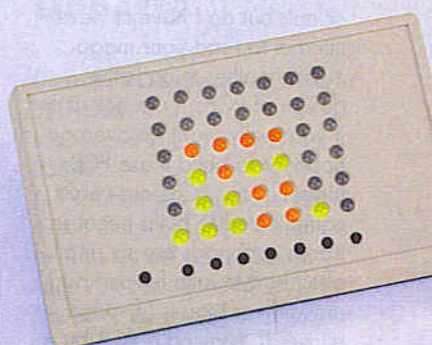
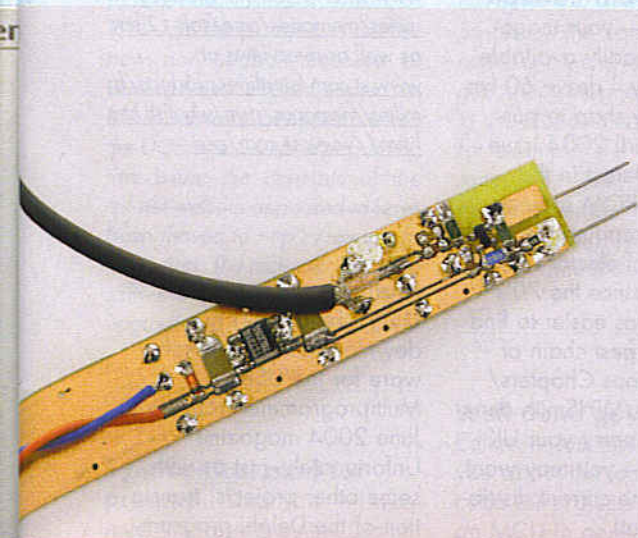

Poor Man's 1-GHz Probe

When it is required to make a measurement at a node of an RF circuit, connecting to the circuit using a normal oscilloscope probe, even on the x10 setting can change the behaviour of the circuit. For those difficult cases, you need a special probe. David Jewsbury's clever design saves a lot of money as compared with a commercial product.

Slave Flash for Digital Cameras

Although most digital cameras have a built-in flash, a connection for an external flashlight is rarely seen. Still, on some occasions it's useful to have just a tad more light and that's why this month's kitchen table pages present a simple add-on.

Four in a Row

With ordinary (board) games there is always the possibility that some parts get lost over time, such as playing pieces, cards or dice. An electronic version of the game obviously doesn't suffer from this. But this is not the only advantage that modern technology offers us...

Construction Projects

- 36 Poor Man's 1-GHz Probe
- 50 ClariTy 2 x 300 W Class-T Amplifier (3)
- 58 kitchen table:
Slave Flash for Digital Cameras
- 66 Four in a Row
- 76 start here:
One-component metal detector;
Ultra low-profile IC socket;
Line-2-mic for notebook;
RF control interface

Come see us at

electronica 2004

9 - 12 November 2004

New Trade Fair centre, Munich, Germany
Booth A5.164

Impossible PCB designs

Hello Jan, if you check the June 2004 issue, PCB boards section, you will see that left side of Rail Router is sort of cut off — it seems that one portion of layout is missing. The same applies to the Multi Programmer (left side). I don't know if pdf files in the Free Downloads section are correct or not, but do I have to have Internet to read your magazine? Another thing is the design of PCBs. I am not sure if you really want an average hobbyist to build those PCBs himself. Your PCBs are very complicated to build because traces and pads are so small. I often had to take felt-pen and make them bigger (if space allowed). Making a PCB by a machine is one thing, making it in a garage shop is totally different thing. I am just looking at some pads on Multi Programmer of June issue and tell you what, I don't have that small drill size to make the holes. Another thing, double-sided board means you have some vias involved. No hobbyist (or at least most of them) has the ability to tin plate through holes. That means that some of the components have to be soldered on both side of PCB. I don't see any vias marked up on any of your double-sided PCBs. It sometimes seems to me that you want to force readers to buy a PCB, not to build it. Another thing, instead of putting out 20 projects in one issue, it would be better to see two, but quality ones. I don't really care about quantity. Anyway, don't think about this as an attack on you, but rather as a friendly advice. We lost Poptronics here in the US, thus Elektor is one of rare electronics magazine that is available here.

Ben (USA)

Thanks for your comments. It's very nice to get the odd email

from the US of A. Regarding the two layouts on the PCB Layouts page, the artwork was accidentally trimmed as a result of a printing error. Our website has the complete layouts in pdf format, see Free Downloads, June 2004. Since you are on email, I can only assume you can access the Internet as well.

Readership surveys indicate that about 65% of our readers are professionals or semi-professionals, so we're not publishing just for hobbyists as you seem to assume. We believe this is reflected by the consistent design as well as the quality of the ready-made boards we sell. Sure, some boards are almost impossible to make yourself hence we sell them ready-made. The times when boards were hand designed using mask up tape are about 15 years behind us and we would not like think of a project like the Multi Programmer on USB mounted on a board twice the size now achieved by careful designing. You may have missed some of the developments in PCB design and manufacturing, as very small drill sizes are available from Farnell, RS Components and others. Similarly, a method for through contacting PCB holes in the home workshop was described in the April 2004 issue (Start Here section).

Printing two articles of heavy content as opposed to, say, ten of smaller size has the proven disadvantage of narrowing readership down to a few die hard enthusiasts and cannot be defended as being in the interest of a commercially operating publishing house like ours. The July/August and December magazines with their Small Circuit Collections have consistently been the best selling issues these past 30 years so lots of short, to the point articles are highly valued, as are full-size articles covering technical intricacies in great depth. No electronics magazine has more circuits and ideas per year than Elektor Electronics, and the most frequently heard positive point we hear

about our magazine is that it has such a wide range of articles.

Message from Canada

Dear Editor — your magazine is not readily available in my country. I drove 60 km to a specialty shop to purchase the April 2004 issue due to my interest in the Pandora CD-ROM project. I have been reading the occasional copy of *elektor* (sic) publications since the 70's (and yes it was easier to find then). The largest chain of magazine shops Chapters/Indigo/Coles/WHSmith deny you exist yet carry your UK competitors — you may want to speak to the current distributor about that!

Dave Lag

Readers in Canada and (a part of) the USA experiencing problems finding copies of Elektor Electronics in Canadian and US newsstands and bookshops should contact Customer Service at LMPI, 8155, Larrey Street, Anjou (Quebec), H1J 2L5, Canada. Phone (514) 355-5610, Fax: (514) 355-5676. Stores stocking copies of Elektor Electronics may be found using LMPI's website: www.lmpi.com. Email: lmipi@lmipi.com Freephone 1-800-263-9661

Hard to find

Dear Jan — in Soeren Petersens's excellent article 'Drop-in Microcontroller Board' (April 2004, Ed.) you mention that PSDsoft Express may be obtained free of charge from the STMicroelectronics website, www.st.com. After searching for the program for about an hour, also using various search engines, I gave up and decided to drop you an email. Will you spill

the beans?

Alex Rehling

You are right, the link should have been more accurate. Here is the one for PSDSoft-Express: www.st.com/stonline/products/families/memories/psm/soft_c2.htm as well as overviews at: www.st.com/stonline/products/families/memories/psm/whatisitl.htm <http://www.st.com/psd>

Multiprogrammer on USB

Hi Jan — I have downloaded the free software for the USB Multiprogrammer from the June 2004 magazine. Unfortunately, just as with some other projects, translation of the Delphi program reveals that components are missing, for example, the hex editor. Can you supply the relevant components? And another question: will the project support the AT89C55WD?

Edgar Schachler

The author, Andreas Oyrer, replies: Here are the links that should enable you to download the components:

*HID component: www.soft-gems.net/Controls.php
Hexeditor: <http://www.mirkes.de/de/delphi/vcls/hexedit.php>
Regedit: www.saturnlaboratories.co.za/download.php?filename=regedit.zip*

DIY moving-coil scales

Dear Editor — I am once again faced with having to design a case for a power supply unit and one recurring aspect is making a custom scale for moving-coil meters. Do you know of software that produces a graphic image of

a scale when I enter some parameters like size, start and fsd values? To be honest, I have become weary of tinkering with Autocad.

Tom Lengerer

Well Tom the problem is neither new nor oddball because at www.qsl.net/wb6bld/index we found software that goes back to the DOS age. Just before printing this issue, the contents of the qsl.net website appeared to have been moved to <http://tonnesoftware.com>. The meter scale design software is still free and has been upgraded to run under Windows!

Symmetrical mod for preamp

Dear Jan — I was much impressed by the Digital Controlled High-End Preamp published in the April 2004 issue and wondered if you have any plans to do a version with symmetrical outputs?

M. Ciop

*There no firm plans but as always we might be persuaded if sufficient interest is expressed by other readers. Meanwhile, why not use an existing circuit from our massive archive, for example, *Balanced/Unbalanced Converters for Audio Signals* from the March 1998 issue.*

MC input on Valve Preamp

Dear Elektor — I would like to know if it would be possible to connect an MC (moving-coil) pickup element to the input of your Valve Preamplifier (September 2003, Ed.)

R. Gollon

The existing phono (MD) input is not easily modified or adapt to MC elements because of insufficient gain and a too high noise

level. There exist MC-to-MD matching transformers (for example, Ortofon). The same function is obtained from our Ultra Low Noise MC Amplifier published in December 1998. The high-end electronic circuit may solve your problem if the transformer alternative is expensive or difficult to get. Another suggestion would be to use a dedicated MC preamp, for example, the one from the June 1999 issue, although we realize that may defeat the purpose of using valves for their characteristic sound.

Well done guys

Dear Editor — last time I wrote to you about the lack of source code for projects comprising an MCU in general and your PICProg 2003 project in particular (existing correspondence refers, Ed.).

I guess that if I can complain when I find something to be below my expectations, then I should also be prepared to communicate praise when a subject brings more than I anticipated. This is how I find the Multi Programmer on USB published in the June 2004 issue. Not only is the source code publicly available but the programmer in itself is more versatile than the PICProg 2003 ever was.

I very much like the adoption of the USB as the communication interface, and I find the possibility to keep the object code in a serial EEPROM to be simply brilliant! I know that this is a feature of the chosen MCU but since I didn't know about this beforehand I was very pleased to have it brought to my attention.

Despite my pleasure with the design I do not plan on building the Multi Programmer. I have purchased a PICStart Plus Programmer which once and for all has solved all of

my problems with burning Microchip MCUs.

Klaus Klug Christansen

About nine out of ten MCU-based projects published in Elektor Electronics now come with the source code freely available from our website or on a disk (at nominal cost). In the case of the PICProg 2003, the author receives royalty payments for every copy sold of the MCU, hence the source or hex code could not be made publicly available. We will endeavour to avoid such situations in the future, but can not rule out that a project containing 'closed' software is so good that we feel it deserves publication. The response to the PICProg 2003 project, by the way, was beyond our expectations.

Image tracking

Dear Jan — I always look forward to the July/August edition of your magazine with its circuit ideas. They remind me of the Engineers Notebook section of McGraw Hill's Electronics in the 1970s. It was also nice to see a much brighter cover than of late. So much easier to find on the magazine rack.

The TV Commercials Killer project was most impressive and although I would like to use it, as you know terrestrial TV in this country doesn't have these logos. However you should consider the possibility of making it into a more general purpose image processor. Take a look at <http://www-2.cs.cmu.edu/~cmucam> which uses the same hardware for image tracking in a robotic application.

Keep up the good work and keep a tight reign on your graphic designers. White-out text on pictures is particularly difficult to read.

Peter Cottrill

The design should be suitable for many stations broadcasting via satellite. Image tracking in robots is a hot item, perhaps other readers have further information that would help us design a project.

CORRECTIONS & UPDATES

Canon EOS Cameras go Wireless

July/August 2004, p. 102-14, 030432-1.

A 9-V battery is shown in the circuit diagram of the transmitter. This should be a pack of three AAA batteries (4.5 V). The parts list should be amended to read: BT1 = 4.5 V, 3 AAA batteries with holder.

Atmel Programmer

September 2001, p. 52, 010005-1.

The author has supplied yet another update for the Windows software. The latest version now reads signature bytes correctly in all cases. Free Download, file number 010005-11, September 2001. The firmware in controller no. 010005-41 remains unchanged.

MailBox Terms

- Publication of reader's correspondence is at the discretion of the Editor.
- Viewpoints expressed by correspondents are not necessarily those of the Editor or Publisher.
- Correspondence may be translated or edited for length, clarity and style.
- When replying to Mailbox correspondence, please quote Issue number.
- Please send your MailBox correspondence to: editor@elektor-electronics.co.uk or Elektor Electronics, The Editor, P.O. Box 190, Tunbridge Wells TN5 7WY, England.

Young Engineers for Britain and YEDA combined Annual celebration of engineering awards announced



Prize winner Alexander Warren and science and engineering TV personality Gareth Jones.

The results of the first combined industry-sponsored Young Engineers for Britain and YEDA (Youth, Electronics, Design, Applications) Awards under the 'Annual Celebration of Engineering Awards' have been announced at the Old Royal Naval College, Greenwich.

Open to students up to age 19 from across Britain, the event also featured the Junior Engineers for Britain K'Nex Challenge final and best Young Engineers Clubs of the year.

The Annual Celebration of Engineering is organised by Young Engineers, the national network of engineering, elec-

tronics and technology clubs in schools and colleges, who proudly announced during the Awards that His Royal Highness The Duke of York has become Patron. His Royal Highness has been Patron of the YEDA Trust for the past ten years and has welcomed this organisation's recent merger with Young Engineers, which has brought an added dimension to the Clubs network by virtue of its electronics and technology industry sponsors, and created one major Awards event in the Annual Celebration of Engineering in place of the previously separate YEDA Awards and Young Engineer for Britain events.

More than £50,000 worth of prizes was on offer at the Annual Celebration of Engineering with the two top prizes being Young Engineer for Britain 2004 and the Duke of York's Award for the most creative use of electronics technology. In addition to the £2,000 and £1,000 prize money (respectively) for each of these winners and prestigious trophies, they each received an all expenses trip to Phoenix, Arizona in 2005 to take part in the Intel International Science and Engineering Fair.

The prize winners

The Duke of York's Award for the most creative use of electronics technology:

Alexander Warren, (18) John Hampden Grammar School, High Wycombe — Fire Fighter Helmet Range Finding Sensor.

Young Engineer for Britain 2004:

Alexander Warren, (18) John Hampden Grammar School, High Wycombe — Fire

Fighter Helmet Range Finding Sensor.

Class A 10-14 years awards

Winner: Alex Cartey, Alex Cook, Alex Waters, St. Anthony's RC Girls School, Sunderland — A mechanical toy for year 6 Students.

Runner Up: Oliver Jackson and Matthew Tuck, Silverdale School, Sheffield — Hydro Electric Plumbing System.

Class B 15-16 year awards

Winner: Jamie Gordon, Merchiston Castle School, Edinburgh — Manual Snow Plough.

Runner Up: Andrew Nowell, Nottingham High School — The Dirt Thrasher.

Class C 17-19 years

Winner: Richard Entwisle, Canford School, Wimbourne — Wheelchair Seat Height Adjuster.

Runner Up: Jason Lowe, Lancaster Royal Grammar School — Paint Roller Cleaner.

Class D awards —



Alexander Warren — Fire Fighter Helmet Range Finding Sensor.

Working in Industry

Winner: Matthew Benning, Darchem Engineering Ltd. — The Autocropper.

Runner Up: Rosie Singleton, Jonathan Waring, Joseph Rees and Ian Hardy, St Mary's High School, Chesterfield — A Pipe Testing Nut Cracker.

Young Engineers Club of the Year

The Community College, Bishops Castle: Ruth Watson, Rebecca McIntock, Esme Hicks and Edward Middleton.

Junior Engineers Club of the Year

Uplands Junior School, Wolverhampton: Naomi Hopkins, Gurmes Kaur Dhinsa, David Allen and Anthony Pearce.

Most Innovative Club of the Year

Coopers Technology College, Chislehurst: Danielle Langley, Amy Orr, Melissa Miles and Aron Mayer.

Best Supporting Young Engineers Club Leader

Glen Harrison, Baltasound Junior High School.

Young Engineers — Best Supporting Company/Individual IEE.

Young Engineers - Best Supporting Network/Organisation

Geoff Clack, Education and Training Manager, The Engineering Employers Federation, Northern.

Royal Navy Award for Engineering Success through Teamwork

Brighton College Preparatory, Brighton: Marco Gonzalez, Thomas Smallwood, Anya Caister and Jana Majevalida.

Best Project that Meets a Disability Need

Winner: Richard Entwisle, Canford School, Wimbourne — Wheelchair Seat Height Adjuster.



Alex Cartey, Alex Cook, Alex Waters — A mechanical toy for year 6 Students.



Oliver Jackson and Matthew Tuck — Hydro Electric Plumbing System.



Jamie Gordon — Manual Snow Plough.

Best School Entering for the First Time with the Most Innovative Project

Winner: St Anthony's RC Girls School, Sunderland

Innovation Solutions for a Sustainable Environment Award

Winner: Jason Lowe, Lancaster Royal Grammar School — Rolla Clean

Most Innovative Use of Technology

Winner: John MacMorland, The Sandon School, Chelmsford — Integrated Car Hinge.

Most Innovative Electrical Engineering Application

Winner: Hilda Mansukhani, Nichola Byrom, Joanna Wong and Winnie Leung, St Swithun's School, Winchester — Satellite Antenna Test Cap.

Best Project for the Built Environment

Winner: David Hogg, Fan Court School, Esher — Autonomous Gutter Cleaner.

Award for Engineering Craftsmanship

Winner: Mark Hylands, Portadown College — The Helicopter.

Junior Engineers for Britain K'Nex Challenge

Winner: Megan Thomas and Simon Bentley, Ysgol Deiniol, Wrexham.

Runner Up: David Kelly and Nicholas Roberts, Charlton Kings Junior School, Cheltenham.



Andrew Nowell — The Dirt Thrasher.



Richard Entwisle — Wheelchair Seat Height Adjuster.



Jason Lowe — Paint Roller Cleaner.

More information can be found at www.youngeng.org and www.yeda.org.uk

(047162-1)

Ultra low power GPS modules enable portable tracking systems

A new family of GPS modules from Line One offers designers an ultra low power solution for obtaining high accuracy position, speed and time information from the Global Positioning System (GPS).

The XE1610-OEMPVT from Xemics is a fully autonomous GPS receiver suited to applications such as automotive GPS systems, asset management/ tracking and portable appliances.

The XE1610-OEMPVT uses an ultra low power IC design, with optimised RF and DSP architectures. It features a current consumption of under 20 mA at 3.3 V, when operating at full power, with three additional low power modes also available. On-board RAM handles storage for the GPS navigation data and temporary configuration changes while on-board Flash provides a non volatile storage for the GPS almanac, ephemeris and permanent profile changes. Based on the Trimble FirstGPS architecture, the XE1610-OEM-

PVT provides a high level of sensitivity (to -143 dBm tracking) and positional accuracy (less than 5 m CEP without SA, in the horizontal axis). The XE1610-OEMPVT can provide time and positional information under 12 seconds, in hot start operation, and under 40 seconds from a warm start.

Designed for simple integration into embedded systems, the XE1610-OEMPVT has a direct digital interface that supports standard bidirectional NMEA-0183 data sentences via a logic level serial port, as well as XEMICS vendor specific sentences. Trimble's FirstGPS solution includes GPS software libraries which, in the XE1610-OEMPVT, run on a low power ARM7TDMI microcontroller from Atmel.

The XE1610-OEMPVT helps conserve the system power budget even further via the provision of three simple power saving modes. These modes are: Power Save mode, in which both the RF section and GPS engine are powered down; Stand-by mode, whereby the MCU clock is also turned off while the main power supply remains on, with the real-time clock (RTC) running; and



Power Down mode, in which the main power supply is also turned off, leaving the RTC running on the back-up supply. Ideal for any handheld or battery operated equipment requiring high accuracy time or positional information.

**Xemics, Maladière 71, PO Box 31,
2007 Neuchâtel, Switzerland. Tel.
(+41) 32 720 5511.
www.xemics.com**

(0471 47-1)

Instant pin-point heat for IC testing

Thermo-Probe from Micro Technical Industries lets you heat-test integrated circuit components with ease and accuracy. Easily accessible for test bench or production line testing and no ovens or heat chambers required!

The instrument applies heat with an accuracy of ± 1 degree Centigrade and can be used on ICs, IC diodes, resistors, transistors, etc. It takes just seconds to bring the probe from ambient to 160 degrees C. An internal controller continuously monitors heat.

An analogue output on the

Thermo-Probe allows heat recording to all types of instrument. The instrument is said to be ideal for design engineers, QPL managers, technicians and trouble-shooters.

**Micro-Technical Industries, 505 N.
Tustin Avenue, Suite 156, Santa Ana
CA 92705, USA. Tel. (+1) 714 547-
9900. www.thermoprobe.com**

(0471 47-4)



A hot look for a cool logger

Lascar Electronics has launched the EL-USB-1, the world's first battery powered temperature data logger with a direct USB interface.

Using the Windows compatible software supplied, the EL-USB-1 can be configured to measure temperatures from -25 to $+80^{\circ}\text{C}$ (-13 to $+176^{\circ}\text{F}$). User selectable logging intervals from 10 seconds to 12 hours and a memory capacity of more than 16,000 readings make this data logger ideal for many temperature dependant industrial and consumer applications. The logger's housing provides an IP67 rated waterproof seal enabling the product to be used in harsh environments.

The EL-USB-1 has user programmable high and low temperature alarms, which are shown locally by a bright red LED and can be set to remain active once an

alarm level has been triggered. Additional green and amber LEDs inform the user of other logger conditions, including memory capacity and battery status. All readings are stored in non-volatile memory ensuring important data is never lost.

Simply plug the EL-USB-1 into a USB socket on a PC for instant download and graphing of logged data. Once the data has been downloaded, the logger can be instantly reconfigured to begin the next application.

The EL-USB-1 is available immediately from Lascar Electronics Ltd. at a price of £35 + VAT. Discount is available for volume orders.

Lascar Electronics Limited,
Module House, Whiteparish,
Salisbury, Wiltshire SP5 2SJ.
Tel. (+44) (0)1794 884567,

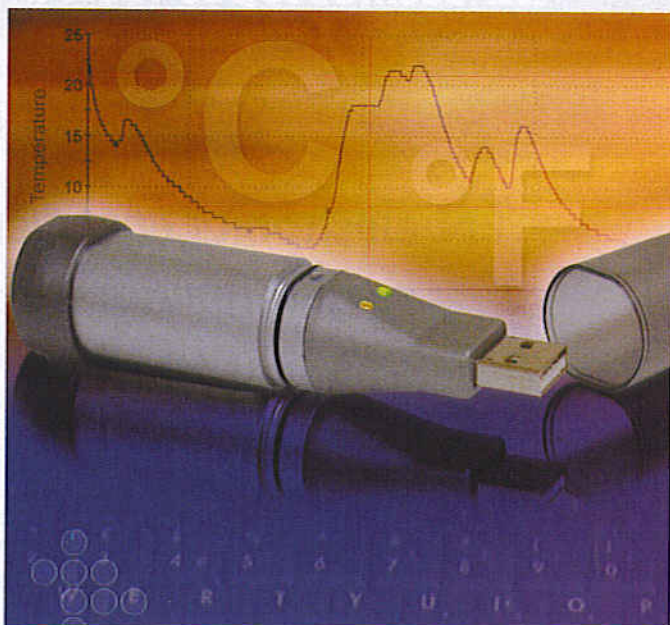

Fax (+44) (0)1794 884616.
 Internet: www.lascarelectronics.com

(047147-5)

Drop-in Bluetooth product family

SMART Modular Technologies, Inc. announces its new line of fully integrated 90191 Bluetooth modules. Designed to reduce development time and speed time-to-market for Bluetooth-enabled products, these innovative modules can be easily integrated into new or existing product designs to provide Bluetooth functionality.

This product family includes board-to-cable modules and board-to-board modules measuring $17.65\text{mm} \times 32.5\text{mm} \times 4.9\text{mm}$ and $17.65\text{mm} \times 32.5\text{mm} \times 4.2\text{mm}$, respectively. Available configurations include universal asynchronous receiver transmitter (UART) and universal serial bus (USB) interface modules supporting open host controller interface (OHCI) and upper host controller interface (UHCI). Featuring an integrated onboard antenna, these Class 2 products offer low power consumption and are equipped with six programmed

input/output (PIO) lines. The 90191 product family complies with the newly-released Bluetooth specification v1.2.

SMART's 90191 product line is a certified modular solution designed for ease of integration and "drop-in" Bluetooth functionality.

Based on a single-chip design, the 90191 product family includes Bluetooth firmware up to the Host Controller Interface (HCI) level, which allows customers to add their own upper-level stacks, and a serial port profile (SPP), which enables the modules to serve as cable replacements.

Ideal for use in consumer electronic, telematic, medical, telemetry, and industrial applications, the Bluetooth modules in SMART's 90191 product family allow OEM/ODMs to focus resources on their core competencies instead of expending valuable time and resources to implement wireless technology.

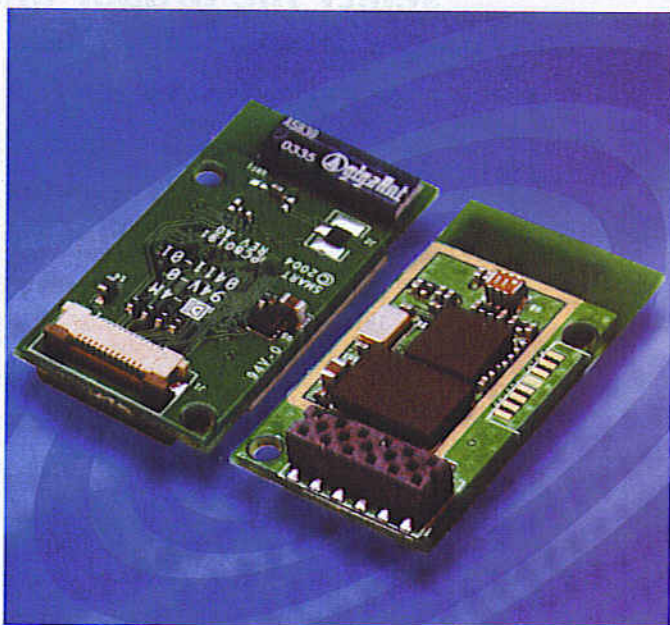

Smart Modular Technologies,
4211 Starboard Dr, Fremont,
CA 94538-6427, USA.
www.smartm.com

(047147-8)

Scope for 'S

22 oscilloscopes tested

For electronics engineers and technicians, the benchtop oscilloscope is an indispensable tool. If you don't already have a 'scope', or if you're looking to acquire a new scope in the near future, our survey will help you select the proper one.

**Test engineers:
Arjan Floris
Marcel Koenders
Henny Kuipers
Geert-Jan Laanstra
Stefan Lenk
Harald Profijt**

**Text and
project supervision:
David Daamen**



oscilloscopes

from 109 to more
than 22,000 pounds

At first glance, the number of different makes and models of oscilloscopes currently available appears to be too large for a comprehensive survey. Even making a reasonable choice when purchasing an oscilloscope appears to be practically impossible. However, the product range of most manufacturers actually consists of only a few basic types, which are available in models having different specifications. If we assume that the members of such a product family are more or less the same with regard to design, construction and basic functionality, the problem is considerably simplified.

Selection

That is thus more or less the method we used in selecting the oscilloscopes for our survey. From manufacturers and dealers that actively offer equipment, we requested demo models that are representative for a particular family or brand. However, not all product families of all brands are represented here, largely due to limitations related to the scope of the test. Nevertheless, we are confident that the present selection gives a good impression of what is available in the area of oscilloscopes and how the various brands generally score.

Preliminary remarks

Before introducing the instruments to you, we have several general comments.

The firm Chauvin-Arnoux, which manufactures the Metrix brand, was invited to participate in the test but declined. As they will soon be introducing new models, they decided not to participate in this test.

If you examine the list of selected instruments, you will probably notice that several other brands are missing. For example, Philips is missing, but they no longer make oscilloscopes. Hewlett-Packard is also not represented, since the 'test and measurement' division of Hewlett-Packard is now called Agilent – and Agilent is indeed represented here. Other big names, particularly in the digital segment (such as LeCroy and Tektronix), are also included.

For some brands, such as Iwatsu, Protek and Kenwood, we were unable to find a dealer who was prepared to make a demo instrument available.

We had also originally planned to examine the Voltcraft 320 (GW Instek GDS830). However, the screen remained blank after the unit was switched on, so it was not included in the results.

We also made a few interesting discoveries. For instance, certain brands turn out to be 'rebadged' Asian products. This is not particularly surprising, since as you doubtless already know, some vendors sell a lot of equipment under house brands, such as Conrad with Voltcraft. The same is true of Peaktech and Dynatek.

What is actually interesting is the following: we found one instrument (EZ Digital OS-5030) that is offered under these three brand names at three distinctly different prices. Depending on the label on the front, you can pay anywhere from £227 (€329) to £400 (€579). The difference can thus be as much as £172 (€250). That's something we thought you'd like to know.

Also, many Goodwill Instek oscilloscopes are also available under other brand names, for example Voltcraft. All of the selected participants are listed on the following pages.

Technospeak

Bandwidth	The frequency range within which the signal level (amplitude) has not dropped more than 3 dB.
Z _{in}	Input impedance, a combination of resistive and capacitive components.
Y range	Range of the vertical scale. Indicates the amplitude of an externally applied signal.
X range	Range of the horizontal scale. Indicates time. Normally controlled by timebase.
X-Y-mode	Both the horizontal and the vertical scale is controlled by an externally applied signal.
Z-modulation	Light intensity variation under the control of an externally applied signal.
Rise time	Minimum time required to move the electron beam from 10 % to 90 % of screen height.
Trigger	Signal indicating readiness to start writing to the screen.
auto	Trigger automatically reset by next trigger.
normal	As with auto, however electron beam quenched in the absence of a trigger.
single	Trigger is no longer reset. With memory oscilloscopes, the triggered waveform remains on the screen.
edge	Triggering takes place on signal edges.
pattern	Triggering takes place on measured signal.
pulse width	Triggering takes place on a certain pulsewidth found in the measured signal.
TV	Triggering takes place on a video signal.
Delay range	The range available for delaying write actions to the screen (post-trigger). If a delay line is available, negative times are also possible. A part of the waveform for triggering may then be displayed (pre-trigger).
Sample rate	Rate (frequency) at which samples of the input signal are taken.



Voltcraft 610-3

Brand	Voltcraft / Goodwill Instek
Model	610-3 / GOS310
Display and type	CRT, analogue
Channels	1
Bandwidth	10 MHz (-3 dB, DC)
Z_{in}	1 MΩ, 30 pF ±5 %
Y range	5 mV - 5 V / div (≤ 5 %)
Modes	X-Y via additional input
Max. input	400 V
Rise time	unknown
X range	0.1 μs - 0.1 s / div (≤ 5 %)
Triggering	auto, norm, TV
Trigger inputs	internal, power, external
Miscellaneous	-
Dimensions	135 x 200 x 300 mm (W x H x L)
Weight	approx. 3 kg
Including	user manual, measurement cable with two croc clips, power cord
Price (rrp)	£109 (€159) (Conrad)



Digimess MO10

Brand	Grundig Digimess
Model	HUC70-01 MO10
Display and type	CRT, analogue
Channels	1 (second channel for x-y mode only)
Bandwidth	10 MHz (-3 dB, DC)
Z_{in}	approx. 1 MΩ, 30 pF
Y range	5 mV - 5 V / div (3 %)
Modes	X-Y via separate input
Max. input	400 V
Rise time	≤ 35 ns
X range	0.1 μs - 0.1 s / div (3 %)
Triggering	auto, norm, TV
Trigger inputs	int, line, ext
Miscellaneous	-
Dimensions	220 x 90 x 270 mm (W x H x L)
Weight	approx. 3 kg
Including	user manual, power cord, measurement probe
Price (rrp)	£119 (€172.49) (Digimess), £132 (€191.32) (ex. VAT, Farnell)



Digimess MO20

Brand	Grundig Digimess
Model	HUC70-02 MO20
Display and type	CRT, analogue
Channels	2
Bandwidth	20 MHz (-3 dB, DC)
Z_{in}	approx. 1 MΩ (3 %), 25 ±5 pF
Y range	5 mV - 5 V / div (3 %)
Modes	ch1, ch2, add, alt, chop, invert ch2, x-y
Max. input	400 V
Rise time	≤ 17.5 ns
X range	0.2 μs - 0.5 s / div (3 %)
Triggering	auto, norm, TV, auto PP
Trigger inputs	int, ch1, ch2, alt, line, ext
Miscellaneous	z-modulation
Dimensions	320 x 130 x 418 mm (W x H x L)
Weight	approx. 6.5 kg
Including	user manual, power cord, two measurement probes
Price (rrp)	£305 (€442.48) (Digimess), £332 (€480.79) (ex. VAT, Farnell)

(from the same series: MO40, MO60; both 40 MHz)



GW Instek GOS620

Brand	Goodwill Instek (also sold as Isotech and Voltcraft)
Model	GOS620
Display and type	CRT, analogue
Channels	2
Bandwidth	20 MHz (-3 dB, DC)
Z_{in}	approx. 1 MΩ, 25 pF
Y range	5 mV - 5 V / div (3 %)
Modes	ch1, ch2, add, chop, invert ch2, x-y
Max. input	300 V
Rise time	17.5 ns
X range	0.2 μs - 0.5 s / div (3 %)
Triggering	auto, norm, TV-h, TV-v
Trigger inputs	ch1, ch2, alt, line, ext
Miscellaneous	z-modulation, ch1 output
Dimensions	310 x 150 x 455 mm (W x H x L)
Weight	approx. 8 kg
Including	user manual, power cord, two measurement probes
Price (rrp)	£350 (€508) (Havé-Digitap)

(from the same series: various 20-, 30- and 50-MHz instruments)



B+K Precision 2120B

Brand	B+K Precision
Model	2120B
Display and type	CRT, analogue
Channels	2
Bandwidth	30 MHz (-3 dB, DC)
Z_{in}	1 MΩ (± 2 %), 22 ± 10 pF
Y range	5 mV - 5 V / div (3 %)
Modes	ch1, ch2, add, alt, chop, invert ch2, x-y
Max. input	400 V
Rise time	12 ns
X range	0.1 μs - 2 s / div (3 %)
Triggering	auto, norm, fix, single, TV-h, TV-v, variable holdoff
Trigger inputs	ch1, ch2, alt, line, ext
Dimensions	370 x 180 x 440 mm (W x H x L)
Weight	7.8 kg
Including	user manual, power cord, spare fuse, two measurement probes
Options	various probes, carrying case
Price (rrp)	£322 (€466.65) (Printec)

(from the same series: various 30-, 60- and 100-MHz instruments, some including an internal frequency counter and component tester)



Hameg HM303-6

Brand	Hameg
Model	HM303-6
Display and type	CRT, analogue
Channels	2
Bandwidth	35 MHz (-3 dB, DC)
Z_{in}	approx. 1 MΩ, 20 pF
Y range	5 mV - 20 V / div (3 %)
Modes	ch1, ch2, add, chop, invert ch2, x-y
Max. input	400 V
Rise time	< 10 ns
X range	0.1 μs - 0.2 s / div (3 %)
Triggering	auto, norm, TV
Trigger inputs	ch1, ch2, line, ext
Miscellaneous	component tester
Dimensions	285 x 125 x 380 mm (W x H x L)
Weight	approx. 5.6 kg
Including	user manual, power cord, two measurement probes
Price (rrp)	£455 (€659.26) (DDS Electronics), £485 (€702.91) (Conrad)

(from the same series: a 50-MHz model)



EZ-digital OS-5030

Brand	EZ-digital (formerly Goldstar / LG Precision) / Dynatek / Voltcraft / Peaktech
Model	OS-5030 / 8300 / 630-2 / 2035
Display and type	CRT, analogue
Channels	2
Bandwidth	30 MHz (-3 dB, DC)
Z_{in}	approx. 1 MΩ, 30 pF
Y range	5 mV - 20 V / div (± 3 %)
Modes	ch1, ch2, add, dual, chop, alt, x-y
Max. input	400 V
Rise time	approx. 12 ns
X range	0.2 μs - 0.2 s / div (± 3 %)
Triggering	auto, norm, TV-v, TV-h
Trigger inputs	vert. (dual/alt), ch1, line, ext
Miscellaneous	z-modulation, ch1 output, blanking input
Dimensions	316 x 132 x 410 mm (W x H x L)
Weight	approx. 7.8 kg
Including	user manual, spare fuse, power cord
Price (rrp)	£227 (€329) (Conrad), £399 (€579) (DDS Electronics)

(from the same series: various 20-, 40-, 60- and 100-MHz instruments. Also digital up to 250 MHz/200 MSa/s)



Hameg HM1004-3

Brand	Hameg
Model	HM1004-3
Display and type	CRT, analogue (microprocessor controlled)
Channels	2
Bandwidth	100 MHz (-3 dB, DC)
Z_{in}	approx. 1 MΩ, 15 pF
Y range	1 mV - 2 mV (5 %), 5 mV - 20 V / div (3 %)
Modes	ch1, ch2, add, chop, invert ch2, x-y
Max. input	400 V
Rise time	< 3.5 ns
X range	50 ns - 0.5 s / div (3 %)
Triggering	auto, norm, TV
Trigger inputs	ch1, ch2, line, ext
Miscellaneous	second timebase, component tester, configuration memory, cursor measurements, autose, RS232 interface
Dimensions	285 x 125 x 380 mm (W x H x L)
Weight	approx. 5.9 kg
Including	user manual, power cord, two measurement probes, PC software
Price (rrp)	£1008 (€1463.70) (DDS Electronics), £1032 (€1497.02) (Conrad)

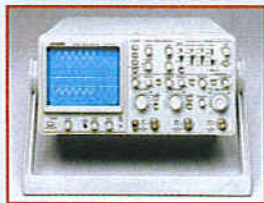

Leader LS8105A

Brand	Leader
Model	LS8105A
Display and type	CRT, analogue
Channels	3
Bandwidth	ch1, ch2: 20 MHz @ 1 mV/div, 100 MHz @ > 1 mV/div; ch3: 100 MHz (-3 dB, DC)
Z_{in}	1 MΩ (±1%), 20 pF
Y range	1 mV - 2 mV / div (5%), 5 mV - 5 V/div (2%)
Max. input	400 V (ch3 50 V)
Rise time	3.5 ns (5 mV - 5 V/div), 17.5 ns (1 mV - 2 mV/div)
X range	50 ns - 0.5 s / div (3%)
Triggering	auto, norm, fix, single, TV-h, TV-v, variable holdoff
Trigger inputs	ch1, ch2, ch3, alt, line, ext
Miscellaneous	z-modulation
Dimensions	300 x 150 x 400 mm (W x H x L)
Weight Including	8.8 kg
Options	user manual, power cord, spare fuse, two measurement probes
Price (rrp)	rackmount adapter, probe case, front cover, various probes £1148 (€1665) (elQuip)
	(From the same series: 20- and 50-MHz instruments and 100-MHz with cursors)



GW Instek GOS6103

Brand	Goodwill Instek (also sold as Isotech and Voltcraft)
Model	GOS6103
Display and type	CRT, analogue (microprocessor controlled)
Channels	2
Bandwidth	100 MHz, 20 MHz @ 2 mV/div (-3 dB, DC)
Z_{in}	1 MΩ (±2%), approx. 25 pF
Y range	2 mV - 5 V / div (≤3%)
Max. input	400 V
Rise time	3.5 ns (17.5 ns @ 2 mV/div)
X range	50 ns - 0.5 s / div (3%)
Triggering	auto, norm, TV, holdoff (1 μs - 5 s)
Trigger inputs	ch1, ch2, line, ext
Miscellaneous	z-modulation, trigger output, auto-range (time/div)
Cursor measurements	frequency, period, pulsewidth, duty-cycle
Dimensions	310 x 150 x 455 mm (W x H x L)
Weight Including	approx. 9 kg
Options	user manual, power cord, two measurement probes
Price (rrp)	£948 (€1376) (Havé-Digitap)
	(from the same series: various 50- and 200-MHz instruments)



Voltcraft 650AD

Brand	Voltcraft / Goodwill Instek
Model	320 / GRS6052A
Display and type	CRT, analogue & digital
Channels	2
Bandwidth	50 MHz (-3 dB, DC)
Z_{in}	1 MΩ (±2%), approx. 25 pF
Y range	1 mV - 20 V / div (±3%)
Max. input	400 V
Rise time	approx. 7 ns (5 mV - 20 V/div)
X range	analogue: 0.2 μs - 0.5 s / div (±3%), digital: 0.2 μs - 100 s
Triggering	auto, normal, TV, variable holdoff
Delay range	unknown
Trigger inputs	ch1, ch2, line, ext
Sample rate	8 bits @ 100 MSa/s (real-time)
Memory	16 kB (per channel)
Acquisition	sample, peak detect (> 25 ns), average, envelope, persistence
Cursor measurements	ΔV, Δt, 1/Δt
Miscellaneous	autoset, waveform-save/recall, configuration memory, RS232 interface, z-modulation, ch1 output
Dimensions	275 x 130 x 370 mm (W x H x L)
Weight Including	8.5 kg
Price (rrp)	user manual, power cord £699 (€999) (Conrad)
	(from the same series: a 30-MHz version from GW-Instek)



Hameg 1507-3

Brand	Hameg
Model	1507-3
Display and type	CRT, analogue & digital
Channels	2
Bandwidth	150 MHz (-3 dB, DC)
Z_{in}	approx. 1 MΩ, 15 pF
Y range	1 mV - 2 mV/div (5%), 5 mV - 20 V / div (±3%)
Max. input	400 V
Rise time	< 2.3 ns
X range	analogue: 50 ns - 0.5 s / div (3%), digital: 0.1 μs - 100 s / div (3%)
Triggering	auto, normal, single, TV, time delay/event delay, edge, pulse width
Delay range	approx. 70 ns
Trigger inputs	ch1, ch2, line, ext
Sample rate	8 bits @ 200 MSa/s (real-time)
Memory	2 kB (per channel)
Acquisition	sample, peak detect (> 5 ns), average, single, roll, envelope
Cursor measurements	ΔV, Δt, 1/Δt
Miscellaneous	second timebase, autoset, component tester, RS232 interface
Dimensions	285 x 125 x 380 mm (W x H x L)
Weight Including	approx. 6.5 kg
Options	user manual, software, two probes
Price (rrp)	multifunction interface, optical interface £1413 (€2049) (Conrad), £1446 (€2098) (DDS Electronics)
	(From the same series: 200-MHz variant)



Wittig 22-300

Brand	Wittig Technologies
Model	22-300 (Bench Scope)
Display and type	LCD (monochrome, 320 x 240 pixels), digital
Channels	2
Bandwidth	20 MHz (-3 dB, DC)
Z_{in}	1 MΩ, 20 pF
Y range	1 mV - 4 V / div (±2 %)
Max. input	40 V
Rise time	approx. 3.5 ns
X range	200 ns - 200 ms / div (±0.5 %)
Triggering	auto, int., line, TV
Trigger inputs	ch1, ch2, ext
Sample rate	8 bits @ 100 MSa/s (real-time)
Memory	16 kB (per channel)
Miscellaneous	second timebase
Dimensions	300 x 138 x 70 mm (W x H x L)
Weight	approx. 1.35 kg
Including	user manual, power cord, probe, PC software (via RS232 or USB; incl. FFT)
Options	-
Price (rrp)	£482 (€699) (Conrad)

(from the same series: a 4-channel version)



Voltcraft 6150C

Brand	Voltcraft / Goodwill Instek
Model	6150C / GDS820C
Display and type	LCD (colour, 320 x 240), digital
Channels	2
Bandwidth	150 MHz (-3 dB, DC)
Z_{in}	1 MΩ (±2 %), approx. 22 pF
Y range	2 mV - 5 V / div (±3 %)
Max. input	300 V
Rise time	approx. 7 ns (5 mV - 20 V/div)
X range	1 ns - 10 s / div (±0.01 %)
Triggering	auto, normal, single, TV, time delay/event delay, edge, pulse width
Delay range	100 ns - 1.3 ms / 2 - 65000 events
Trigger inputs	ch1, ch2, line, ext
Sample rate	8 bits @ 100 MSa/s (real-time)
Memory	125 k (per channel)
Acquisition	sample, peak detect (> 10 ns), average, FFT
Cursor measurements	ΔV, Δt, 1/Δt
Miscellaneous	autoset, save/recall, waveform trace save/recall, RS232, probe-calibration
Dimensions	254 x 142 x 310 mm (W x H x L)
Weight	4.1 kg
Including	user manual, power cord, 2 measurement probes
Price (rrp)	£896 (€1299) (Conrad)

(From the same series by GW-Instek: various 100-, 200-MHz instruments, also with colour display)



LDS Sigma 60-4

Brand	LDS Test and Measurement
Model	Sigma 60-4
Display and type	LCD (colour touchscreen, 800 x 600), digital
Channels	4
Bandwidth	200 MHz (-3 dB, DC)
Z_{in}	approx. 1 MΩ, 9 pF
Y range	2 mV - 5 V / div (±1 % ±2 LSB)
Max. input	400 V
Rise time	unknown
X range	50 ns - 100 s / div (±25 ppm)
Triggering	auto, pre- and post trigger, edge, pulse width and misc. adv. trigger options
Delay range	399 s
Trigger inputs	ch1, ch2, ch3, ch4, ext
Sample rate	8/10 bits @ 200 MSa/s (real-time)
Memory	200 k (per channel, cascade with fewer channels)
Acquisition	+, -, *, ÷, invert filter, FFT, averaging
Cursor measurements	2 vertical cursors, 2 horizontal cursors
Miscellaneous	VGA, RS232, Centronics, Ethernet, USB, PS2, soundcard, HD recording
Dimensions	378 x 254 x 302 mm (W x H x L)
Weight	approx. 8.2 kg
Including	user manual, power cord
Options	Enhanced Analysis, Synchroscope, Direct to disk
Price (rrp)	£5045 (€7316) (Abtronix)

(From the same series: 5 MHz/10 MSa/s and 25 MHz/100 MSa/s models)



Tektronix TDS2024

Brand	Tektronix
Model	TDS2024
Display and type	LCD (colour, 320 x 240), digital
Channels	4
Bandwidth	200 MHz (-3 dB, DC)
Z_{in}	1 MΩ (±2 %), 20 ±3 pF
Y range	2 mV - 5 mV / div (±4 %), 10 mV - 5 V / div (±3 %)
Max. input	450 V (≤ 100 ms), 300 V _{rms}
Rise time	< 2.1 ns
X range	2.5 ns - 10 s / div (±0.001 %)
Triggering	auto, edge, video, pulse width (glitch), holdoff (500 ns - 10 s)
Delay range	-4 div x s/div - 20 ms
Trigger inputs	ch1, ch2, ch3, ch4, ext
Sample rate	8 bits @ 2 GSa/s (real-time)
Memory	2500 samples per channel
Acquisition	normal, average, peak detect (> 12 ns)
Cursor measurements	ΔV, Δt, 1/Δt
Miscellaneous	set-up and waveform save/recall, trigger output
Dimensions	323.8 x 151.4 x 124.5 mm (W x H x L)
Weight	3.6 kg
Including	user manual, two measurement probes
Options	GPIO and RS232-interface, rackmount kit, programmer and service manual, various carrying cases
Price (rrp)	£2020 (€2930), TDS2022: 2 channels, £1731 / €2510 (ex. VAT, CN Rood)

(From the same series: various 60-, 100- and 200-MHz models)



Yokogawa DL1740EL

Brand and Model Display and type Channels Bandwidth

Yokogawa DL1740EL
LCD (colour), digital
4
500 MHz @ 10 mV - 10 V/div, 400 MHz @ 2 mV - 5 mV/div (@50 Ω, -3 dB, DC)
1 MΩ (±1%) / 50Ω (±1%)
2 mV - 10 V / div (±1.5% • 8 div)
400 V @ 1 MΩ / 10 V @ 50 Ω
700 ps (=0.35 / Bandwidth)
1 ns - 50 s / div
auto, normal, single, event/time-delay, edge, pattern, pulse width, (HD)TV, I²C, SPI
0 - 4 s

Delay range Trigger inputs Sample rate Memory Acquisition

ch1 - ch4, line, ext
8 bits @ 1 GSa/s (real-time)
4 MW (per channel) 8 MW (interleaved)
normal, envelope, average, +, -, *, binary operations, inverted, differentiate, integrate, FFT

Miscellaneous Dimensions Weight Including

I²C, CAN, SPI-analysis, USB, VGA, GPIB
220 x 265.8 x 264.1 mm (W x H x L)
approx. 5.4 kg
user manual, one probe per channel, floppy or card interface

Options

RS232 and Ethernet, inbuilt printer, probe power supply, various probes approx. £5862 (€ 8500) (Yokogawa Europe)

Price (rrp)

(From the same series: comparable models with fewer Memory/other options)



LeCroy Wavesurfer 424

Brand and Model Display and type Bandwidth Channels

LeCroy Wavesurfer 424
LCD (colour, 800 x 600), digital
200 MHz (-3 dB, DC)
4

Z_{in} Y range

1 MΩ / 16 pF, 50Ω (±1%)
1 mV - 10 V / div (±1.5% value + 0.5% full scale)

Max. input Rise time

400 V @ 1 MΩ / 5 V_{rms} @ 50 Ω
175 ns

X range Triggering

1 ns - 1000 s / div
auto, normal, single, stop, edge, glitch, pattern, pulse width, TV, line
2 ns - 20 s

Delay range Trigger inputs Sample rate

ch1, ch2, ch3, ch4, ext
8 bits @ 1 GSa/s (real-time) (2 GSa/s real-time interleaved)

Memory Acquisition Miscellaneous

250 kpts @ 3-4 ch, 500 kpts @ 1-2 ch
normal, envelope, average, FFT, math set-up and waveform save/recall, auxiliary- and DC output, e-mail, Centronics, Ethernet, USB, VGA, RS232

Dimensions Weight Including

322.6 x 172.7 x 317.5 mm (W x H x L)
6.82 kg
user manual, measurement probes, software

Options

additional memory, advanced triggering, extended math

Price (rrp)

£3070 (€4450) (ex. VAT, EMV Benelux)
(From the same series: various 200-, 350- and 500-MHz instruments)



Agilent 54642D

Brand and Model Display and type Bandwidth Channels

Agilent 54642D
CRT (monochrome), digital
500 MHz (-3 dB, DC)
2

Z_{in} Y range

1 MΩ (±1%) / 50Ω (±1%)
2 mV - 5 V / div (±2% full scale)

Max. input

400 V @ 1 MΩ / 5 V_{rms} @ 50 Ω

Rise time

approx. 700 ps (=0.35 / Bandwidth)

X range

1 ns - 50 s / div (±0.005% value / ±0.1% screenwidth / ±20 ps)

Triggering

auto, normal, single, edge, pattern, pulse width, TV, duration, sequence, I²C, SPI, CAN, LIN, USB

Delay range

60 ns - 10 s

Trigger inputs

ch1, ch2, ext

Sample rate

8 bits @ 1 GSa/s (real-time) (2 GSa/s real time interleaved)

Memory Acquisition

4 MB per channel
normal, envelope, average, peak detect (1 ns), math, binary operations, FFT

Miscellaneous

16 dig. inputs, set-up and waveform save/recall, RS232, Centronics, trigger out 322.6 x 172.7 x 317.5 mm (W x H x L)
6.82 kg

Dimensions

Weight

Including

user manual, various probes, software & RS232 cable

Options

screening, rackmount kit, cover, printer, carrying case, GPIB interface

Price (rrp)

£6436 (€9332) (£4614 / 6691 without digital inputs, prices ex. VAT, Agilent)

(from the same series: various 60-, 100- and 350-MHz instruments. Also 600-MHz and 1-GHz models)



Tektronix TDS7154B

Brand and Model Display and type

Tektronix TDS7154B
LCD (col. touchscreen, 1024 x 768), dig.

Bandwidth Channels

1.5 GHz (-3 dB, DC)
4

Z_{in}

50 Ω (±2.5% @ 25 °C)

Y range

2 mV - 1 V / div (±2.5% - 3%)

Max. input

1 V_{RMS} @ < 100 mV/div,
5 V_{RMS} @ ≥ 100 mV/div

Rise time

approx. 200 ps

X range

50 ps - 10 s/div

Triggering

auto, edge, glitch, div. adv. triggers

Delay range

5 ns - 250 s

Trigger inputs

ch1 - ch4, line, ext

Sample rate

8 bits @ 1 ch @ 20GSa/s, 2 ch @ 10GSa/s, 3-4 ch @ 5 GSa/s (real-time)

Memory Acquisition

4M @ 1 ch, 2M @ 2ch, 1M @ 3-4 ch
normal, envelope, average, peak detect (> 400 ps), math, spectrum analysis

Miscellaneous

set-up and waveform save/recall, trigger-reference and ch3 output, Centronics, Ethernet, GPIB, USB, 2 x VGA, RS232
455 x 287 x 435 mm (W x H x L)
17.7 kg

Dimensions

Weight

Including

incl. manual, two probes, software, SMA- and BNC input modules

Options

incl. memory, probes, trigger functionality, software modules

Price (rrp)

£18034 (€26150) (ex. VAT, CN Rood)

(from the same series: various 500-MHz, 1-, 2.5-, 4- and 7-GHz instruments)



LeCroy WavePro 7200

Brand and Model Display and type

Bandwidth Channels

Z_{in} Y range Max. input Rise time X range Triggering

Delay range Trigger inputs Sample rate

Memory Acquisition Miscellaneous

Dimensions Weight Including Options

Price (rrp)

(from the same series: 1- and 3-GHz models)

LeCroy WavePro 7100
LCD (colour touchscreen, 800 x 600), digital
1 GHz (-3 dB, DC)
4
1 M Ω / 11 pF, 50 Ω (± 1 %)
2 mV - 1 V / div (± 1 % typical)
100 V @ 1 M Ω / 5 V_{rms} @ 50 Ω
approx. 225 ps
20 ps - 10 s / div
edge, slope, line, glitch, pattern, width, state, logic, hold-off (20 s)
-hor. timescale - 10000 divisions
ch1 - ch4, line, ext.
8 bits, 1-2 ch @ 20 GSa/s, 3-4 ch @ 10 GSa/s (real-time)
1 Mpts @ 3-4 ch, 2 Mpts @ 1-2 ch
normal, envelope, floor, averaging
auto set-up, auxiliary input and output, floppy drive, Centronics, Ethernet, USB, VGA, RS232
397 x 264 x 491 mm (W x H x L)
18 kg
user manual, cover, power cord
incl. additional memory, probes, advanced triggering, extended math, fixing material, GPIB
approx. £15835 (€22950) (ex. VAT, EMV Benelux)



Agilent 54843A

Brand Model Display and type

Bandwidth Channels

Z_{in} Y range Max. input Rise time X range

Triggering

Delay range Trigger inputs Sample rate

Memory Acquisition

Miscellaneous

Dimensions Weight Including Options

Price (rrp)

(From the same series: 2-, 4- and 6-GHz instruments)

Agilent
54843A Infiniium
LCD (colour, 640 x 480), digital
2.5 GHz (-3 dB, DC)
4
50 Ω (± 1 %)
1 mV - 1 V / div (± 2 % full scale)
5 V_{rms} @ 50 Ω
approx. 168 ps
10 ps - 20 s / div (timebase accuracy: 1 ppm)
auto, normal, single, edge, glitch, line, state, delay, pulse width, transition
80 ns - 320 ms
ch1 - ch4, line, ext
8 bits @ 20 GSa/s (real-time per channel)
262 k per channel
normal, average, peak detect, +, -, *, /, invert, differentiate, integrate, FFT
set-up and waveform save/recall, RS232, Centronics, GPIB, trigger and timebase output, VGA, VGA (waveform)
437 x 216 x 440 mm (W x H x L)
13 kg
user manual, power cord, software
incl. rackmount kit, various software extensions
£19488 (€28259) (ex. VAT, Agilent)

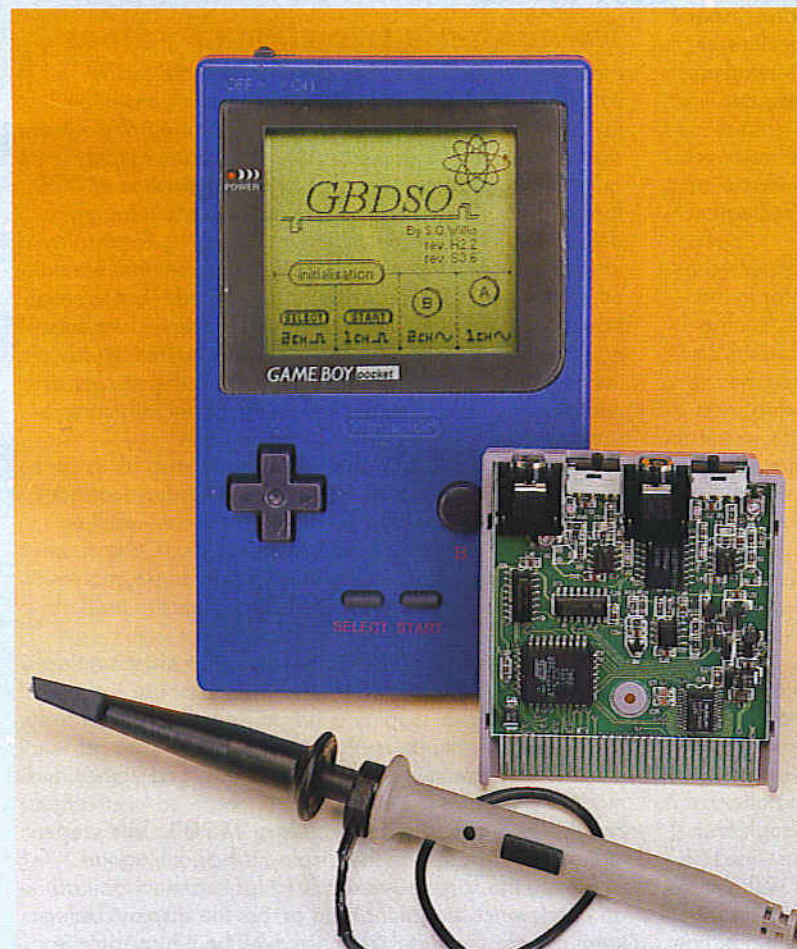

Gameboy oscilloscope

Did you know Elektor Electronics supplies a homebrew digital memory oscilloscope? A brilliant design by Steve Willis, the GBDSO (Gameboy Digital Sampling Oscilloscope) was published in the October and November 2000 issue. It is an extension card that turns the Gameboy Classic, Pocket, Colour or Advanced into a digital 'scope. The GBDSO rocked the electronics hobby world and that's why we continue offering ready-built GBDSO modules for just £90 plus P&P. Of course, the GBDSO is no match for any of the digital oscilloscopes discussed in this article, but it is and remains a useful little instrument with an excellent price/performance ratio. For those who do not remember the above articles, the main GBDSO specs are:

- Dual trace display
- Bandwidth 100 kHz
- Sample-rate max. 1 MSa/s
- Timebase 5 μ s - 100 s/div
- X-Y recorder
- Real-time FFT-mode with dB scale
- Adjustable persistence in X-Y mode
- PC link for image and or date transfer
- 5-hour operation from NiMH battery pack
- Averaging and auto-trigger functions
- Reference trace storage
- Available ready-built and tested from Elektor Electronics

About the selection

Elektor Electronics has attempted to make a selection of relevant products that is representative for the current market situation while including the availability factor. We realise this overview is not complete — space restrictions for printed articles had to be observed. For completeness' sake the table shows an overview of brands and websites of associated manufacturers, importers or national representatives. Not all brands and models are available in the UK or other countries where Elektor Electronics is published. A list showing a complete overview of all current models supplied by the manufacturers participating in this test may be found on our website.

Manufacturer	Website	Representative
Agilent Technologies	www.agilent.com	www.agilent.co.uk
B&K Precision	www.bkprecision.com	www.metrix-electronics.com
Chauvin Arnoux (Metrix)	www.chauvin-arnoux.com	www.chauvin-arnoux.co.uk
EZ Digital (Goldstar, LG Precision)	www.ezdgt.com/eng	www.sjelectronics.co.uk *
		www.conrad.com *
Grundig-Digimess	www.digimess.co.uk	www.digimess.co.uk , www.telonic.co.uk
GW Instek	www.goodwill.com.tw	www.sjelectronics.co.uk
		www.conrad.com *
Hameg	www.hameg.com	www.sjelectronics.co.uk
Hitachi Denshi	www.hitachi.com	www.sjelectronics.co.uk
Iwatsu Test Instrument	www.iti.iwatsu.co.jp/e/	
Kenwood (Tecstar)	www.tecstar.co.uk	www.tecstar.co.uk
Leader Instruments	www.leaderusa.com	www.elquip.nl
LDS Nicolet	www.lds-group.com	www.gould-nicolet.co.uk
LeCroy	www.lecroy.com	www.lecroy.co.uk
PeakTech	www.peaktech.de	www.peaktech.de
Protek (Hung Chang)	www.protektest.com	
Tektronix	www.tektronix.com	www.tektronix.co.uk
Voltcraft	www.conrad.nl	www.conrad.com
Wittig Technologies	www.wittigtechnologies.com	
Yokogawa	www.yokogawa.com/tm/	www.yokogawa.co.uk

* some models under different brand names

Test method

Due to the nature of the selection, in this comparison the emphasis by definition cannot lie on the 'standard' specifications. We thus didn't verify any input sensitivities or bandwidths. However, that's not strictly true — we were indeed curious with regard to a few instruments, but more about that later.

In the context of a test such as this, there's also not much point in comparing specs. That's because manufacturers in this segment think twice before stating a specification they can't prove.

So how did we actually do the survey? We connected a PAL video signal (from the Test Pattern Generator in the September 2003 issue of *Elektor Electronics*) to each of the oscilloscopes. This is a relatively complex signal, so we had to spend some time with each instrument before obtaining an image on the screen. That proved to be a good way to quickly obtain an impression of the general quality and usability of the instrument in question. In the following descriptions, we give our opinions regarding image quality, ease of use and triggering performance, as well as our general impression of the instrument's reliability.

The pipsqueaks

Let's start at the bottom end of the selection with two single-channel 10-MHz oscilloscopes, the **Voltcraft 610-3** and the **Digimess MO10**. In all honesty, we must admit that we had certain preconceptions here. We assumed these instruments wouldn't have all that much to offer. That turned out to be only partly justified. Although their miniature screens are far too small for making serious measurements, they accepted the video signal without any complaints. They are thus suitable for quickly obtaining an impression of a signal, but not anything more than

that. In this regard, their prices are an excellent match to their performance.

No-nonsense two-channel scopes

Next we have a set of five 20- and 30-MHz oscilloscopes. The **GW Instek GOS620** has a convenient layout and is very pleasant to use. The image of the test signal is especially stable and sharp, but the display is quite a bit less bright than that of the **Digimess MO20**, for example. The latter also has an adjustable trigger delay ('holdoff' function). This can be handy for displaying complex signals, since it allows an event that would otherwise generate a trigger to be skipped. That's a nice bonus for a scope in this price class. However, we must note that this instrument makes a somewhat less sturdy impression than its direct competitor, and the display of the test signal is somewhat less steady than with comparable scopes.

The **Hameg 303-6** is also very easy to use, although it is annoying that the focus setting also changes (considerably) when the intensity is changed. Most of the other instruments suffer far less from this problem. Other than that, this model is especially sturdy; it gives the impression that it will never break. It also includes the holdoff function.

The **EZ Digital OS-5030** does not have trigger holdoff, but it is still an excellent instrument. Ease of use is right on, and the signal display is bright and clear. As already mentioned, this scope is also available from Conrad, Dynatek and Peaktech under their own brand names and model numbers.

Finally there is the **B+K Precision 2120B**. This scope looks quite robust, and the display is basically good. However, the sample we received for examination had an interference signal that ran across the display. Unfortunately, we were unable to discover the cause, but we



assume it was something particular to this specific unit. In other respects, this instrument is just as good as the others with regard to features and operation.

More megahertz

Next we have three analogue oscilloscopes with a bandwidth of 100 MHz. As expected, all three perform a good deal better than the less expensive instruments. This shows once again that it's too simple to just compare specifications. We'd like to reiterate that it's quite probable that the models of the brands in the previous group with bandwidths of 100 MHz (or more) would also perform much better.

The larger bandwidth increases the quality of the displayed test signal. Not only is the image sharper, which makes it easier to distinguish rapid changes, but the writing speed of these instruments is also quite a bit higher. The display is refreshed more often, making the image considerably more steady on the screen.

The **Hameg 1004-3** and **GW Instek 6103** are microprocessor-controlled. The advantage of this is that certain settings can be stored in memory. In situations where a number of similar signals must be regularly measured, that can save a considerable amount of time. However, it also has drawbacks. For instance, it sometimes takes a bit of searching to find out exactly how the instrument is configured, and displaying the various settings on the screen affects the displayed waveform. The latter factor is sometimes annoying with the 6103.

The Hameg and GW Instek instruments also allow measurements to be made on the displayed waveform using cursors. We think that once you've worked with cursors, you'll miss them if your scope doesn't have this feature. If your budget permits it, this function is thus to be recommended.

The **Leader LS8105A** does not have cursor capability,

but a 100-MHz scope with cursors is also available under this brand name. With regard to the LS8105A, we noted that it is pleasantly easy to use, solidly built and has outstanding image quality. The accompanying manual is not brilliant, but that's actually the only criticism.

Digital or analogue?

The **Voltcraft 650AD** and **Hameg 1507-3** are combined instruments. They are actually 'normal' 50- or 100-MHz scopes (respectively) with additional digital storage scope capability. This directly overcomes one of the most significant drawbacks of digital scopes, which is that a purely digital oscilloscope can never display the actual waveform. What it displays is always a reconstruction of a sampled signal. As a result, it can happen that the image on the screen has no resemblance at all to the measured signal. With a combined scope, you can always quickly check whether the digital result is accurate.

In this regard, we must note here that the digital capability of the combination models included in this test is only limited. They have several cursor functions for making measurements and

can be operated via a PC, but the sampling rate is actually too low for good reproduction of a signal such as our test signal. In practice, the specified bandwidth is thus only usable in the analogue mode. Another factor is that the noise contribution from the A/D converters is generally rather large. This causes the traces of digital oscilloscopes to be 'fatter', so details more quickly become literally lost in the noise.

Other than that, there are no remarkable differences or details to be reported with regard to these combined instruments, and the performance of the analogue portion is good.

Digital storage oscilloscopes

The **Wittig 22-300**, the simplest instrument in the 'pure digital' category, is limited with regard to more than just its bandwidth and sampling rate. Its operation, measurement capabilities and display fall short of qualifying it for serious use. This is offset by its modest price. However, you would be wise to consider purchasing a good analogue instrument for the same money. If you specifically need storage capability, it's worth giving thought to saving up for an instrument with greater capability.

The same feeling prevails with the **Voltcraft 6150**, although it has significantly more extensive features. It has a variety of measurement functions, including spectral analysis using fast Fourier transform (FFT), that can be used via a clear, well-organised menu. Nevertheless, we could not obtain a good display of the test signal, but as already noted, that can't be expected from an instrument with such a limited sampling rate.

The next instrument, the **LDS Sigma 60-4**, is somewhat unique. Although the sampling rate of this instrument is 200 MSa/s, which cannot be considered to especially high, it does have several unusually useful features. The Sigma is particularly suitable for long-term

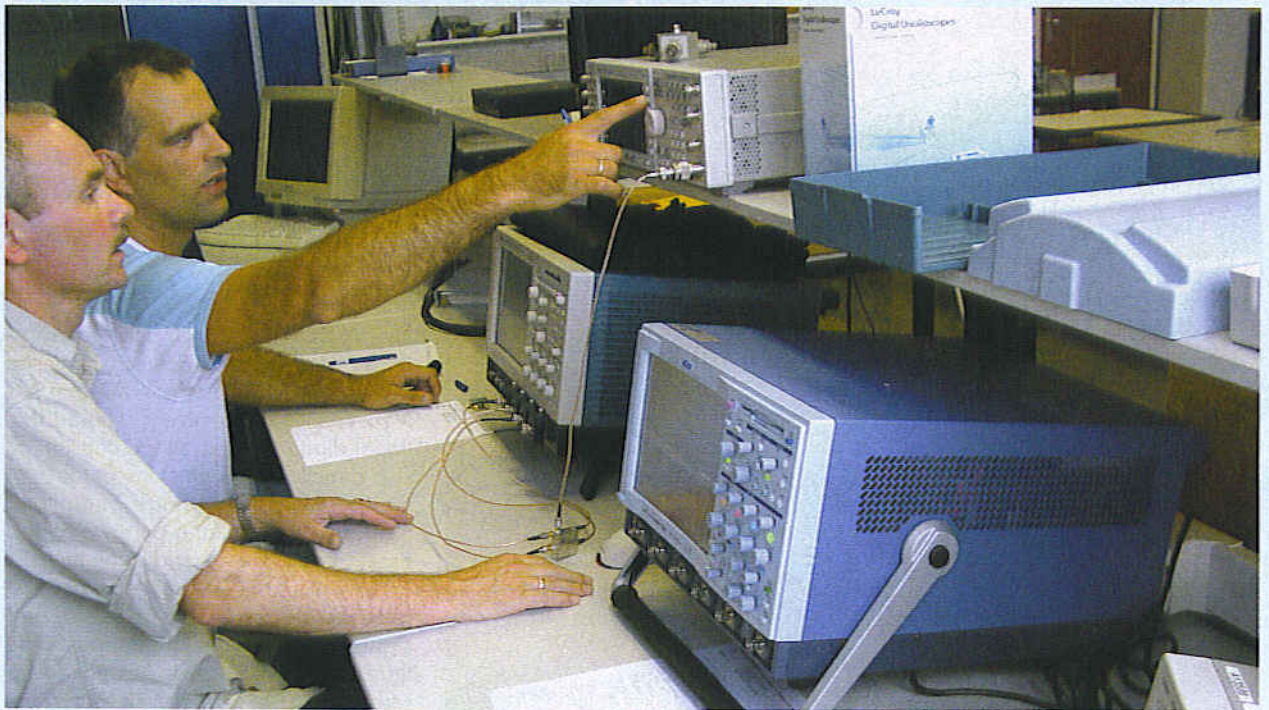

signal analysis. This is demonstrated by features such as hard-disk recording, extensive triggering options, analysis functions and report-generation options. This is also the first instrument in this test that is built on a PC platform. 'Standard' MS Windows is used as the operating system, so data from the measurement programs can be easily transferred to other programs (including user-written programs).

Despite the fact that the acquisition software runs under Windows, a non-standard menu structure has been chosen. We don't consider this to be a logical choice, since it costs significant extra effort to become adept at operating the scope. This is further complicated by the fact that only a few real knobs are present for changing settings. These knobs are constantly assigned different functions, depending on the menu selected using the touch screen (or the keyboard and mouse). We don't consider this convenient.

The **Tektronix 2024** is the first digital scope in this test with a serious sampling rate — no less than two gigasamples per second. This is where the concept 'digital' starts to become attractive. All of its functions — triggering, measurement options, etc. — are just right. This full-grown digital scope is also packaged in an especially small housing. However, you should bear in mind that with regard to screen resolution, this instrument is far from being the equal of a good analogue scope.

Next we have the **Yokogawa DL1740EL**. This scope is also packaged in an unusual enclosure with an attractive colour screen. In addition, the sample we received was equipped with a built-in thermal printer. Like the Sigma 60-4, this instrument is based on a PC platform and has its own operating system. Although some of the knobs are also assigned different functions depending on the menu selection, it has dedicated knobs for the basic settings (unlike the Sigma scope). It is thus possible to quickly learn how to use the instrument, despite its extensive features.

This instrument is also distinguished by extensive triggering options. For instance, it can be triggered on a specific I²C pattern, which allows the values of the bits to be viewed directly. Triggering on the test signal did not present any problems. With regard to technical aspects, this

instrument is perfectly in order.

Actually, that's true of all of the brands at this level and above — the technical aspects are not the issue. The most significant differences among the various instruments lie in their housing, operation, features and display quality, among other things.

The **Agilent 54642D** has remarkably good display quality for a digital scope, despite the fact that it uses a relatively small monochrome screen. However, the on-screen menu could have been made a bit smaller; we found it rather obtrusive. In contrast to the -A version of this Agilent model, the -D version has a full sixteen digital inputs in addition to two analogue inputs. Besides standard triggering, this scope can also work with I²C, SPI, CAN, LIN and USB signals.

The final member of this group is the **LeCroy Wavesurfer 424**. We are enthusiastic about this instrument, although it also has its own peculiarities. For instance, the automatic calibration feature often 'gets in the way', although the frequency of automatic calibration does decrease after the instrument reaches its operating temperature. In addition, it can be switched off for measurements where accuracy is not important. We were pleased that we could quickly figure out how to do this, without using the manual. That's probably in part due to the fact that a 'Windows-like' user interface was chosen for this instrument. As a result, using the Wavesurfer is generally reasonably intuitive. The display is excellent and generously sized. Using the extra functions, such as zooming in on a portion of the signal, is thus a real pleasure. The instrument could handle our test signal without any problems, although when we experimented with the mathematical functions we noticed that everything slowed down. That's hardly surprising when you consider how much data has to be processed every second. Ultimately, all of the instruments in this group suffer more or less from this problem. If you're considering purchasing an oscilloscope in this price class, we recommend making comparative tests of several different instruments using your own specific measurement setups. This advice is certainly applicable to the final three instruments in this test: the **Agilent Infinium 54843A**, **LeCroy Wavepro 7100** and **Tektronix TDS7154B**.

More than 35 gigasamples per second

The three top-end models in the test collectively achieve a sampling rate of no less than 35 GSa/s. The Agilent Infiniium 54843A, LeCroy Wavepro 7100 and Tektronix TDS7154B are all high-quality instruments that are typically used in research and development environments, such as in universities and the high-tech industry. The fact that these instruments are intended to be used for specific measurements on very broadband signals can for example be seen from the fact that the standard versions of the Agilent and Tektronix instruments have only 50- Ω inputs. This means that normal probes cannot be connected to them. You should pay attention this when purchasing an oscilloscope, as good probes can take up a significant portion of the budget – as much as 20 per cent or more. In this area, DIY pays off, see Poor Man's 1-GHz Active Probe design elsewhere in this issue.

With the rest of the scopes we did not check any of their specifications, but with these instruments we couldn't restrain our curiosity. After all, bandwidths on the order of several gigahertz are not a matter of course, even with modern technology. However, our measurements showed that all three of these instruments easily meet (or even surpass) their specifications.



Agilent Infiniium 54843A

This instrument has the smallest housing of them all, its design is relatively simple, and the front panel has a good, well-organised layout. It's a pity that the screen is too small for the opening in the front panel, so the metal surround is visible. This may not matter to its performance, but it's still a bit untidy for an instrument in this price class. The screen has the lowest resolution of the three, but it is the brightest. The user interface, in which a lot of the 'Windows look' can be seen, does not give the impression of being particularly well thought through. The response time is short, and the most important settings are readily accessible. However, it is often necessary to use the mouse to adjust the settings.

The triggering options are not especially extensive, but they should be adequate for most applications. Several standard automatic measurement functions are present, such as measuring and analysing amplitude, time, frequency, eye patterns and jitter. Besides the standard mathematical functions that can be used for signal processing, several analysis options are available for this instruments.

Signals can be displayed in up to four separate grids (multi-grid), or in a maximum of two grids using the megazoom function.



Tektronix TDS7154B

The housing of 'the Tek' is significantly larger, and the layout of the front panel is rather crowded. The knobs appear sturdy, but they are somewhat difficult to operate. The display is large, but unfortunately the reproduction of the waveform does not match the high resolution of the screen. All functions can be controlled using the touchscreen. The response time is reasonably good, but it sometimes takes a rather large effort to adjust even simple settings. The instrument can also be operated using an optional mouse and keyboard. Besides the usual connectors, this instrument has a display output for the scope image, in addition to the normal VGA output. The triggering options are quite extensive, as are the automatic measurement functions. Besides the standard mathematical functions,

four functions can be entered as formulas for manipulating signals, functions, measurements or data in the memory. The signals are shown together in a single grid, and the zoom functions appear together in a larger grid.



LeCroy WavePro 7100

This instrument is packaged in the largest enclosure of all three, and its front panel also has a rather busy layout. However, this does mean that many functions are directly accessible. The knobs appear simple, but they are quite pleasant to use. The user interface is well organised and appears to be carefully thought through, down to the last detail. The screen is large, and the display is well matched to the screen resolution. All functions can be readily controlled using the touch screen. The ultimate result is very nice. Once you've gotten accustomed to it, you won't want to use anything else. The scope can also be operated using an optional mouse and keyboard. Just like its little brother, the Wavesurfer, this instrument occasionally has a somewhat long

response time due to constant recalibration. This can of course be disabled, but by default it is enabled. This approach is different from the other instruments, for which automatic calibration is disabled by default. LeCroy clearly assumes that you want the measurement results to be accurate!

Just like the other two scopes, this instrument runs on a PC platform with Windows. This works quite well, but we do consider a working memory of 256 MB for this LeCroy to be on the meagre side.

The input channels are suitable for 1 M Ω as well as 50 Ω . This means you have a bit more choice in your connection options. The triggering options are quite extensive, with a particularly notable feature being that the Aux input can be used as an extra channel for all triggering. The automatic measurement options are also very extensive, and they are divided into amplitude, time, custom, disk, eye, jitter, power, pulse, statistical and miscellaneous measurements. The mathematical functions provide extensive options for manipulating signals, functions, measurements, or data in the memory. This signals are displayed in up to eight separate grids.

Conclusion

It's clear that all three instruments have both positive and negative aspects. The Agilent is quite fast with regard to bandwidth relative to the number of channels and sampling rate, but it falls short of the other two with regard to features, ease of use and finish. The Tektronix is fast in operation and has an especially large number of features. Our only real complaint is that touchscreen operation could be improved, and it's a pity that the instrument doesn't do justice to the resolution of the screen. Finally, the LeCroy is sometimes somewhat slow, but has more flexible features and is more nicely finished than the other two.

We'd like to again emphasise that these three instruments are more analysis instruments than oscilloscopes. They are intended to be used to quickly execute highly complex measurements and calculations. There is a comparable instrument in the lab of one of our test engineers, and even a year after acquiring it they are still discovering new functions! The descriptions of these instruments in this article are thus only intended to serve as an initial introduction. We recommend that you allow yourself to be thoroughly informed by the importer of manufacturer if you contemplate purchasing such an instrument.



Although even more expensive oscilloscopes are available, for this test we considered them to be the top end of the normal market. For this reason, we gave more attention to them than to the rest of the selection. The results are presented in a separate inset.

Recommendations

To start with, it is important to determine how much bandwidth and how many channels you need for the measurements you will be making – both now and in the future. After all, an oscilloscope's bandwidth and number of channels cannot be upgraded later on. The next thing to consider is that an oscilloscope cannot be 'interfaced' to the object to be measured without the proper probes and adapters. You are thus well advised to reserve a portion of your budget for such items.

It is also important to pay attention to the 'lifetime' of the instrument, with regard to the availability of spare parts. The question of whether you should select an analogue scope or a digital scope depends on what it will be used for. Digital instruments suffer from noise, which can cause waveform details to be lost. However, a good digital instrument can have quite extensive memory and triggering functions, while analogue instruments are clearly limited in this regard.

If you decide on a digital storage oscilloscope, when determining the required sampling rate you should bear in mind that many of these instruments can measure in two different modes. The real-time mode is specifically intended to be used for making single-shot measurements up to the physical sampling rate limit of the A/D converters. In the repetitive mode, a periodic signal can be sampled at a higher rate than what the A/D converters can actually handle. This involves making repeated real-time measurements at intervals that are successively offset by a small fraction of the period of the waveform. As the signal is repetitive, the results of these measurements can be combined. As a result, it appears that the signal was sampled at a (much) higher sampling rate.

But note that this is strictly limited to repetitive signals. Some manufacturers are occasionally inclined to advertise this higher sampling rate, although the true physical

rate is significantly lower.

You also have to pay attention to the memory depth. The larger the memory, the higher the sampling rate can be for a relatively long time interval (time base range). But a large memory is not always necessary, and sometimes it can even be undesirable, since processing an enormous amount of data generally slows down the operation of the oscilloscope.

You should also pay attention to the trigger options, and with digital oscilloscopes in particular, the functions that allow infrequent events (glitches) to be detected. Here the instrument's performance also depends on the sampling rate and resolution in relatively large time intervals.

Finally, you should also consider the (mathematical) analysis functions and report-generation features. Several basic functions are present with most of the manufacturers, and it is often possible to use supplementary software modules to expand the available features.

Both the analysis software and the firmware of most digital oscilloscopes are often subsequently upgraded, so it's a good idea to keep track of these updates.

Incidentally, in the more expensive instruments all of the options are often already present, and they only have to be activated using the appropriate software keys. With digital oscilloscopes that run on a Windows platform, it is often possible to also run 'normal' software, such as Matlab, on the same platform. This can also form a way to add extra functions.

Conclusion

We don't want to claim that choosing an oscilloscope is an easy task, even with this survey to help you. As already mentioned, it's a good idea (or even essential) to base your choice on your specific measurement tasks, taking future wishes into account as well. This survey and the reported results should then help you to more quickly sort through the available options.

The test results show that in particular, all of the relatively simple digital oscilloscopes are still surpassed by practically all analogue instruments with regard to display capabilities. To start with, in our view buying a digital oscilloscope is only justified if you have a particular need for specific triggering and/or memory functions. This will in particular be true if you have to make measurements on signals in which relatively infrequent special events occur, or if you want to use the oscilloscope for automated measurements and reports, possibly even operating under remote control.

For 'garden variety' applications, if you'll pardon our use of the term, buying a combined oscilloscope is worth serious consideration.

Regardless of which instrument you're interested in, if at all possible you should first try it out in your own measurement setup. With the more specialised instruments, this is practically unavoidable, since the suppliers will be only too pleased to demonstrate all the features to you. We certainly consider this to be a good idea, since it should now be clear that although most oscilloscopes are handy and versatile instruments, each one has its own particular faults and shortcomings.

(040274-1)

Elektor Electronics would like to thank the University of Twente, the Netherlands, and in particular the Chair of Signals and Systems and the Scintilla study association, for their cooperation and contributions to this project. Naturally, we would also like to thank all of the participating manufacturers, importers and suppliers for making the oscilloscopes available.

**Thought you couldn't use a
microcontroller in your design?
Think again!**

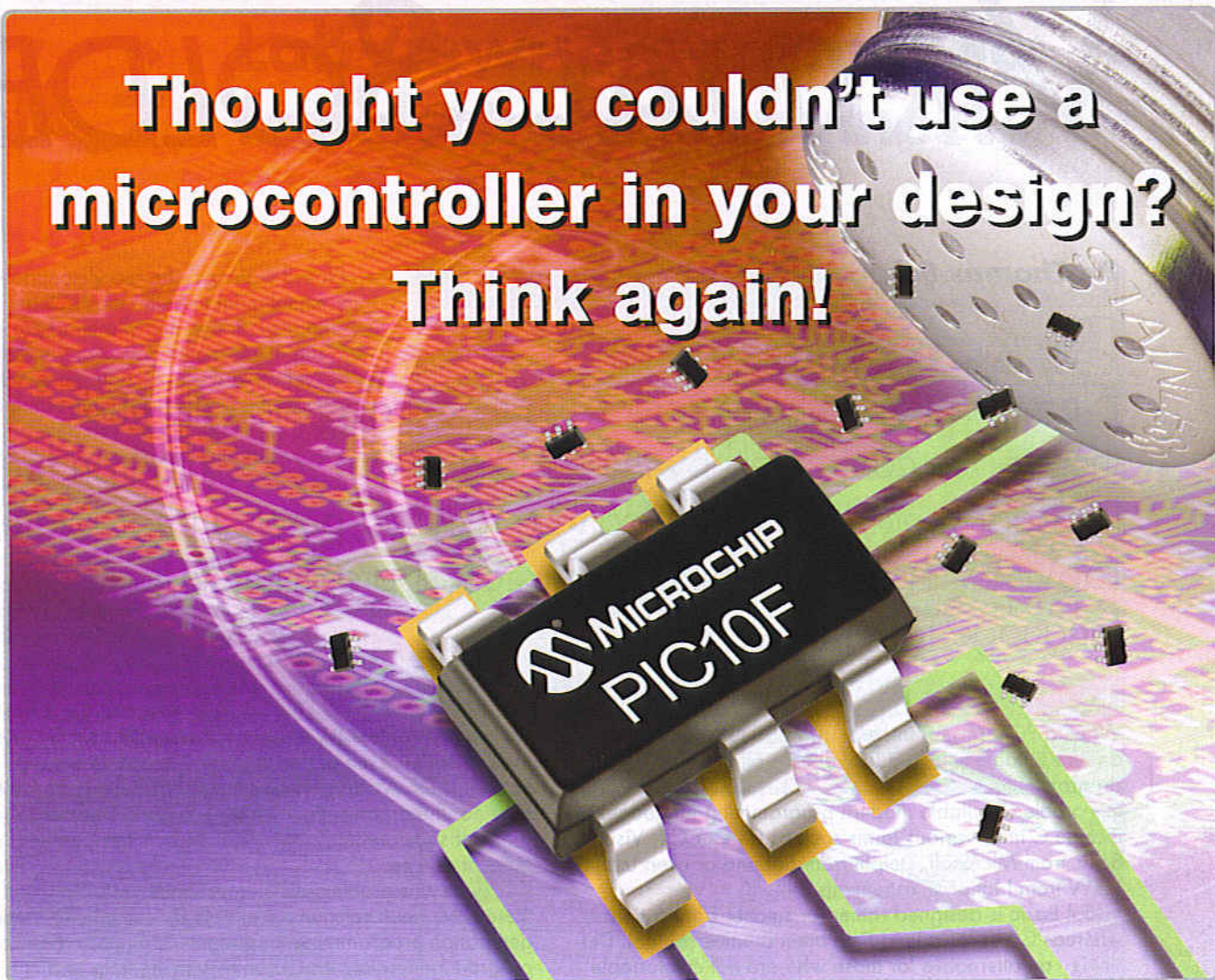

The World's Smallest 8-Bit Microcontroller - The Microchip PIC10F Family

Product	Memory	Bytes	RAM	Pins	Comparators	Timers/WDT	Packages	Internal ICSP™	OSC
PIC10F200	Flash	384	16	6	0	1-8 bit, 1-WDT	SOT-23	yes	4 MHz
PIC10F202	Flash	768	24	6	0	1-8 bit, 1-WDT	SOT-23	yes	4 MHz
PIC10F204	Flash	384	16	6	1	1-8 bit, 1-WDT	SOT-23	yes	4 MHz
PIC10F206	Flash	768	24	6	1	1-8 bit, 1-WDT	SOT-23	yes	4 MHz

Thought you couldn't use a microcontroller in your design? Think again! Microchip has packed a high-performance 8-bit PIC® microcontroller into a tiny 6-pin SOT-23 package. The PIC10F solves cost or board space problems in your applications. Fully code-compatible with larger PIC microcontrollers, you can start developing today with Microchip's existing

development tools, including the MPLAB® Integrated Development Environment (IDE) that can be downloaded FREE from the Microchip website. First choose the PIC10F and then create your design!

Go to buy.microchip.com or contact your local distributor today.

**buy.
MICROCHIP**
www.buymicrochip.com

Arrow
Electronics
Tel: 01279 626777
Fax: 01279 455777

**FARNELL
in one**
Farnell In One
Tel: 08701 200200
Fax: 08701 200201

**FUTURE
ELECTRONICS**
Future Electronics
Tel: 01753 763000
Fax: 01753 767745

Memec
Memec Unique
Tel: 01296 332376
Fax: 01844 210929

MICROCHIP
www.microchip.com/pic10F

VIRTUAL SOLDER

Dr. Thomas Scherer

Even experienced electronics engineers occasionally find themselves confronted by the need to swap soldering iron for keyboard: not all projects can be realised purely in hardware. LabVIEW makes an excellent choice of programming language for engineers!

When a PC forms an integral part of a technical solution and no suitable software is available off the shelf, some programming is required. There are various solutions to this problem: suitable modern programming languages include C in its various forms such as C++ or C#, Visual Basic from Microsoft, Delphi from Borland or even LabVIEW from National Instruments (NI).

Visual Basic is designed rather for smaller applications, whereas C has for a long time been a universal tool. Delphi is an alternative for those who are not comfortable with C's idiosyncrasies and prefer the structured style of Pascal. The majority of all large applications and all modern PC operating systems are written in C: and with good reason. This gives rise to the generally-held opinion that 'real programming' should be done in C, since C, of all the third-generation languages, produces the most elegant and fastest solutions. So what about LabVIEW?

Fourth-generation language

First, all the arguments that persuaded Microsoft, Apple, Linus Torvalds and many other professional programmers to use C as the basis for various operating systems are quite beside the point for the casual programmer. What counts is only how much effort it takes to write a good program. And by 'good program' we mean one that does not just function correctly in principle, but one that is above all else reliable and easy to use.

When you consider that, when you buy a PC today, you have to download some 100 MB of patches and extensions from the Internet in order to bring Windows XP up-to-date, perhaps you might think twice before using C. Every month Microsoft issues updates to fix bugs and close security holes. And this is not just to question the abilities of the Microsoft software engineers: the situation is no different for OS X or Linux. The complexity of the software is not solely to blame for the problem. Also at fault is the programming language. C does not make it easy to find errors, and nor does it help to avoid them in the first place. C is just text, and typing errors can easily creep into text files. Modern software consists of incredi-

ble amounts of text (Windows, for example, is millions of lines of code). Even understanding it in outline is a science in itself. A casual programmer has neither the know-how nor the organisational means to get a complex piece of software into a usable state in a reasonable amount of time.

Of course this problem did not just arise yesterday, and there have been solutions available for some time: fourth-generation programming languages. Essentially these are program generators that, usually with the help of a graphical user interface, create the actual code according to the abstract arrangement of functional blocks and control units. This high level of abstraction makes development much faster, since there is no need constantly to reinvent the wheel.

This is akin to developments in electronics where integrated circuits are now used instead of discrete components. It is clear that integrated circuits, which offer ready-made professionally-optimised subsystems, allow an individual to solve more complex problems than before, and with a drastically reduced likelihood of making a mistake. In software this is analogous to a program generator that produces code which has been optimised and thoroughly tested by professionals.

Of course there are also disadvantages. The consequence of a higher level of abstraction is an inevitable loss of flexibility. Solutions can no longer be tailored so precisely to particular problems. The programs do not run as quickly as those written in C, and the files generated are considerably larger, in the same way as the number of transistors in an integrated circuit has grown explosively. However, in view of the sizes of hard disks and memory available today, the large files do not present a problem. The difference in speed is relatively small these days (and an assembler program is generally faster than one written in C). The limited flexibility, however, definitely makes a difference: program generators are not equally good in all applications. They are more or less specialised to certain application areas such as databases, data capture, or measurement, control and regulation.

LabView: programming for electronics engineers

Unfortunately our analogy now breaks down: ICs from different manufacturers are generally compatible with one another: this is not the case with program generators. A piece of code from one manufacturer cannot be combined with one from another (as if one had to buy a complete set of ICs from a single manufacturer). This also goes for LabVIEW.

Besides factors such as the comprehensiveness and the range of functions provided, an important selection criterion is the level of maturity of the included modules. Another factor that should not be underestimated is the size of the user community for support. It is also important to consider the field in which the programming language is to be used. Ultimately one is going to sell a product, and if the prospective customer's technical department turns up its nose (justifiably or not), then you have a small problem.

In this regard LabVIEW presents no great difficulties. In the car industry the use of LabVIEW for measurement and testing is standard from Alfa Romeo to Volvo. LabVIEW can be found somewhere in practically every field of scientific endeavour. And, as product cycles get shorter, the sheer flexibility of LabVIEW is becoming more and more highly valued in the production environment.

Overall, then, LabVIEW offers the most mature fourth-generation language code base and the largest developer community in the fields of measurement, test and control. However, LabVIEW is no software jack-of-all-trades: you could not, for example, write an office suite using it, although it is perfect for instrumentation data processing. The most important limitation is that LabVIEW may not, according to the manufacturer, be used in safety-critical applications. NI is covering itself here from a legal point of view: it is hard to find any practical reasons not to use it.

What is LabVIEW?

The first version of LabVIEW (1.0) appeared in 1986, initially only for the Apple Macintosh computer. At that point the Mac itself was already two years old and represented a revolution in user-friendliness in the history of personal computing. Text-based entry was replaced by graphical metaphors, including a desktop with windows, waste basket and mouse. High-resolution bit-mapped displays replaced the chunky graphics we were accustomed to from DOS and its cousins. NI translated this metaphor into the field of measurement and test.

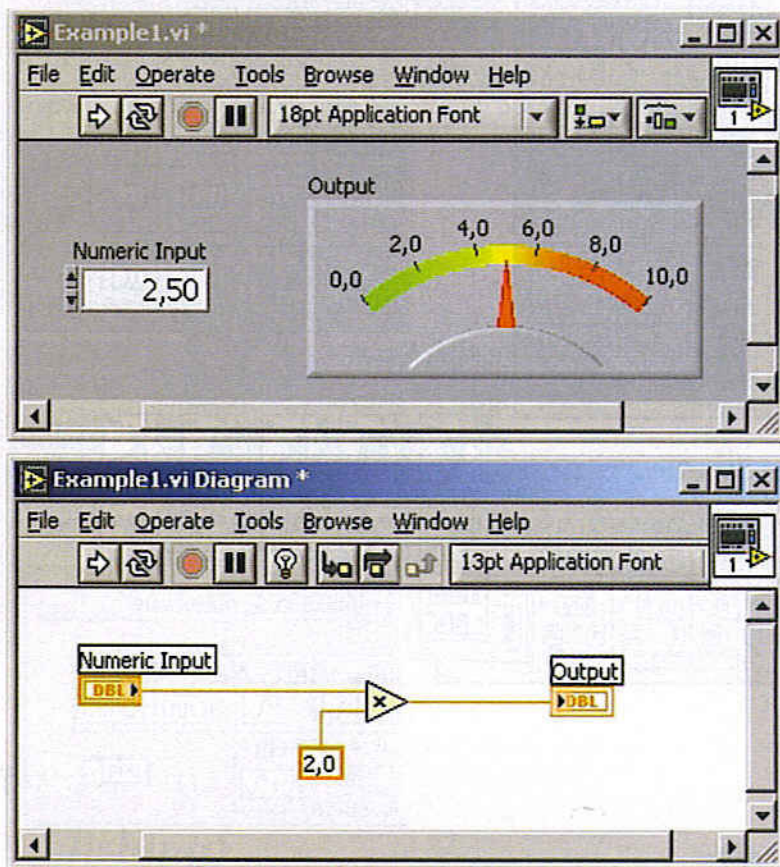

Figure 1: Front panel for the example program and (below) its 'code'.

At that time various computer-controlled instruments had already been available for some time, although they were very expensive. They were based on the GPIB (general purpose interface bus). The essence of NI's idea was to create a graphical programming interface where these instruments were represented by icons. In addition, mathematical functions, input units (such as switches) and output units (such as LEDs or oscilloscope displays) were also represented using graphical symbols. The icons were linked not by a couple of lines of code, but by a kind of 'wire'. Following the metaphor, the corresponding tool is represented in the user interface by a wiring pen, as frequently used in prototyping.

Figure 1 shows the appearance of a very simple arrangement of data source, data processing and data display units, forming a 'wired circuit'. The program does simply this: the input value entered on the control panel (2.5) is multiplied by a factor (2), and the result (5) is displayed on the scale of a simulated analogue meter. The function is displayed in the diagram using an amplifier symbol with the factor 2 shown. Wires run from the numeric input unit and the constant to the two inputs of a multiplier unit, and from the output of the multiplier to the input of the output unit.

Data and numeric values, rather than currents, flow

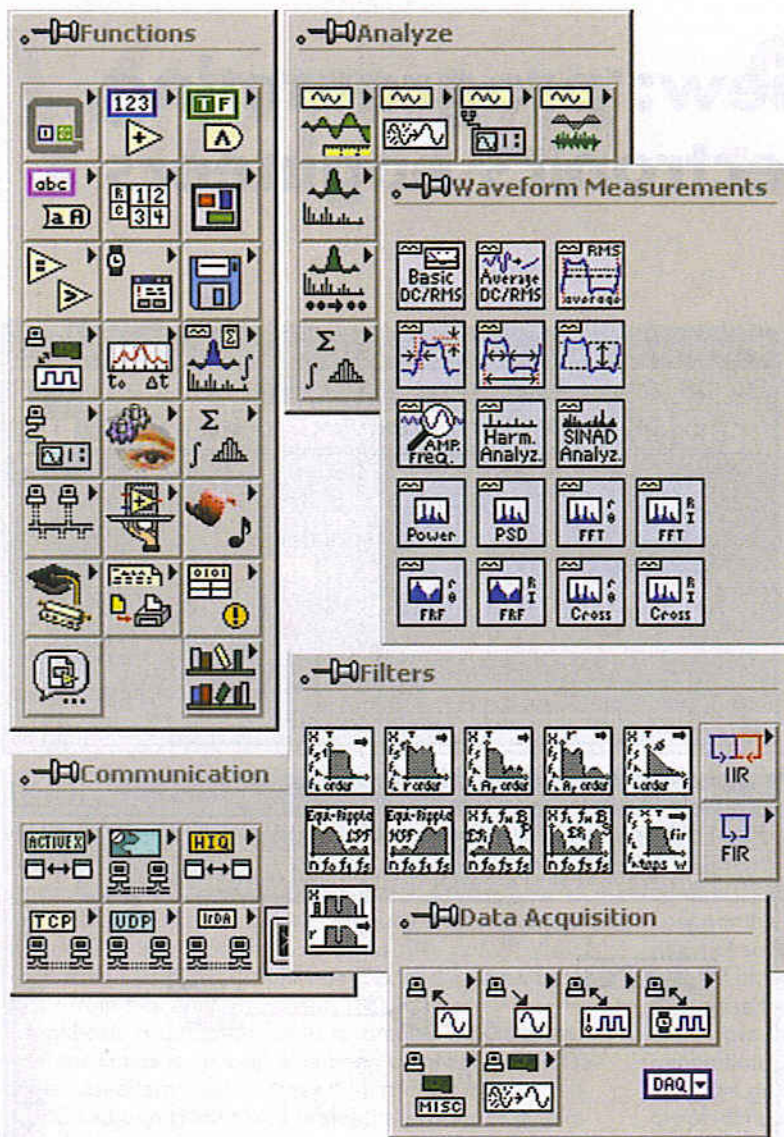

Figure 2: A selection of the LabVIEW tool palettes gives only an approximate impression of the enormous range of functions available. Most of the icons are in other palettes, with hundreds of VIs in total.

through these virtual wires, in this example from left to right. A module or icon executes its function when data are present at all its inputs. The sequence of processing operations is therefore not like that in normal programming languages where the flow of the text is followed from top to bottom (except where jumps occur), but depends instead on the flow of data. This is called a *data flow driven* architecture and gives great flexibility. NI generally refers to the individual modules as Virtual Instruments (VIs). An important further consequence of the architecture is that a number of independent (that is, not interconnected) VIs can be placed in a diagram and they will be processed in parallel: multitasking is thus a built-in feature of LabVIEW.

Further, it is possible to select either a part or the whole of such a module, along with its wiring, and with the click of the mouse bring it into a new module which can have its own icon. In this way code can be written once and then easily reused. This process is analogous to the organisation of code in normal programming languages into functions and procedures. In LabVIEW, by comparison, things are much more transparent.

From our example we can clearly see that programming in this style is the most natural process imaginable. It is very similar to drawing a circuit diagram, where the individual VIs represent electronic components. It is an easy intuitive step to go from constructing

electronic circuits to programming in LabVIEW. For classically-trained programmers and computer scientists, on the other hand, accustomed to the traditional methods of writing software, this technology takes some getting used to. A completely new way of thinking is required. Perhaps they would find it worth changing?

What can LabVIEW do?

LabVIEW has practically everything one would expect from a normal programming language: all the usual variable types from bits through double-precision floating-point to arrays and compound types. Even complex numbers are available. It can in some cases calculate directly with physical units. The usual constants from e to the gas constant R are available to high accuracy. Of course, all the usual control structures can be implemented using various types of loops and other commands: it is not compulsory simply to execute everything in parallel.

Debugging is possible using single-stepping and semi-automatically. Values of selected variables can be displayed at any time using so-called 'probes' (analogous to test points in electronics). Memory allocation can also be controlled.

The most outstanding feature of LabVIEW, however, is the incredible number of ready-made VIs for practically any application. There is the full range of usual mathematical operations including trigonometric and logarithmic functions, as well as an arsenal of VIs for string and array processing, and for file I/O. Of particular interest to electronics

engineers will be the wealth of filtering functions offering all the usual filter characteristics with adjustable parameters. There are also VIs for spectrum analysis (FFTs) and complex waveform-related functions such as peak detection. Results can be displayed using two-dimensional display units (analogous to an oscilloscope) or in three dimensions. Simple database and statistical functions are also available.

The importance of integrated support for communications protocols and various types of bus should not be underestimated. Not only are GPIB, CAN and serial ports supported, but there is also a complete set of Internet protocols. It is therefore straightforward to implement remote measurement and control applications, without having to learn a great deal about network technologies. Last but not least we should mention the large number of data acquisition cards available with PCI or PXI interfaces. There is no major vendor of such cards that does not offer a driver for LabVIEW, allowing one to configure and use a card in a hardware-independent fashion using abstract VIs. **Figure 2** shows some of the typical LabVIEW tool palettes with their corresponding VIs.

If the functions built in to LabVIEW are not sufficient, there are many software companies that offer optimised 'tool sets' for specific areas, such as the chemical industry, electronics for the construction industry, quality control, automotive technology, vibration analysis, image

processing, video monitoring etc. It is possible to write your own low-level VIs in C and integrate them: examples and support are available.

On the subject of support: early versions of LabVIEW came with about half a metre of manuals, but today all the documentation is provided on CD or in the form of context-sensitive help, so that with a little experience you will practically never need to look anything up.

What else can LabVIEW do?

Any program created using LabVIEW can be stored as a collection of VIs in an individual file which can then be run (within the development environment) with a double-click. There is also a compiler which can generate EXE or DLL files, protecting your ideas from being copied.

For those hardy souls who want to integrate fragments of LabVIEW code in their projects written in C there is a special version of LabVIEW available in the form of a C code library. A further version is available to run code generated by LabVIEW on dedicated single-board 19-inch rack computers, making it possible to build real-time instrumentation systems.

There is little else to note: LabVIEW is available for all the main operating systems (Windows, Mac OS 9, OS X, Linux, Solaris and HP/UX) and changing between platforms is straightforward. LabVIEW is also available for PDAs and FPGAs and in foreign languages. However LabVIEW is not cheap: a standard licence costs in the

region of seven hundred pounds, and the complete package including compiler and other functions costs around three thousand pounds. In view of the range of functions provided and the possible time savings, this seems reasonable. Research suggests that a threefold increase in productivity can be obtained, which the author can confirm from his own experience.

A significantly cheaper version, LabVIEW Express 7, is available to school pupils and students. It costs around twenty pounds and offers full functionality, but of course may not be used for commercial purposes.

Special prices are also available to universities buying a number of licences.

If you wish to try out LabVIEW, a free demonstration version, offering full functionality but time-limited to thirty days, is available from NI.

(040237-1)

Web pointers

<http://encyclopedia.thefreedictionary.com/4th%20Generation%20Language>

<http://www.ni.com/labview>

<http://www-w2k.gsi.de/labview/document.htm>

See your design in print!

Elektor Electronics (Publishing)

are looking for

Freelance Technical Authors/Designers

If you have

- * an innovative or otherwise original design you would like to see in print in Europe's largest magazine on practical electronics
- * above average skills in designing electronic circuits
- * experience in writing electronics-related software
- * basic skills in complementing your design with an explanatory text
- * a PC, email and Internet access for efficient communication with our in-house design staff

then do not hesitate to contact us for exciting opportunities in getting your designs published on a regular basis.

Elektor Electronics

K. Walraven, Head of Design Dept.

P.O. Box 75, NL-6190-AB Beek, The Netherlands, Fax: (+31) 46 4370161

Email: k.walraven@segment.nl

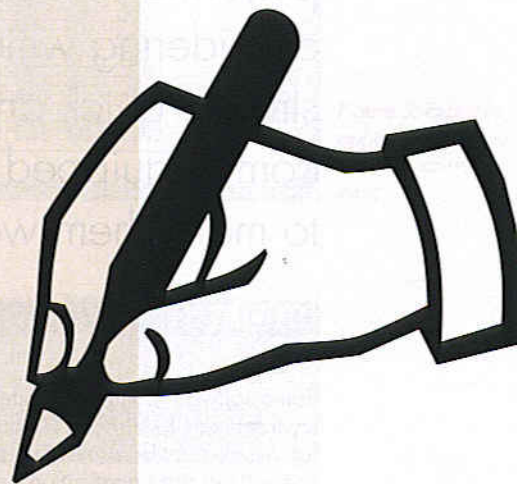

PROFILAB-EXPERT

Applications for PC data acquisition cards

Hans Koerfer, Kolter Electronic

The field of measurement, control and process technology is now dominated in the professional arena by PC-based data acquisition cards. The spectrum of applications is covered by digital I/O cards, relay cards, A/D and D/A converter cards, as well as cards offering a combination of these features. The cards are available in a range of variants from a number of different manufacturers. Although the selection of a card on the basis of its suitability for the project and price-performance ratio is straightforward, the problems start when considering which software will provide the most economical, simple, quick and flexible solution. Data acquisition cards come equipped with only the minimum 'intelligence' required to make them work as universally as possible.

Some software companies offer suitable programming environments for driving PC data acquisition cards and for visualising the results. There is a small number of very specialised data acquisition applications that demand particularly powerful and hence very expensive development systems, but for everyday requirements there are generally programming environments available that are not too costly and that do not make any sacrifices in terms of user-friendliness or flexibility. A graphical program development environment, such as that offered by ProfiLab-Expert, is essential. As well as being reasonably priced, it also offers the further advantage that the programming environment is easy to understand and free of exotic functions. The user can quickly find their way around the component library and tools available, and rapidly become familiar with the software.

A powerful programming environment

At around one hundred Euro (about sixty pounds) ProfiLab-Expert is an inexpensive and yet powerful programming environment that can be used in a multitude of data acquisition projects, whether they involve analogue measurements, digital controls, or some combination of the two. Almost any monitoring, regulation or control function can be realised without having to write a single line of program code. Given its features and price, the programming environment should also be of interest to schools: the program offers an easy-to-use simulation function which allows the construction of virtual logic circuits (**Figure 1**).

The program offers a graphical programming environ-

EXPERT

ment with a symbolic display. For example, a circuit can be wired up on the screen as a block diagram. Items can be selected from an extensive library of electronic functional units from switches and various logic functions to complete data acquisition cards, placed in the work area using 'drag and drop', and then wired up.

If a particular component requires configuration settings, these can be entered on a component-by-component basis using the 'Properties' dialogue accessed from the context menu.

The controls and monitor points of the circuit are placed in an additional window (Figure 2) imitating a front panel. The layout of the individual control and display elements can be freely chosen, and can be annotated if required. The characteristics (appearance and range) of the elements can be configured if desired or as needed. Using the front panel the simulation or actual application can be started and then monitored and controlled using the various elements.

Despite the complexity of the software, it is very simple to use: after just a little familiarisation operation soon becomes intuitive. The components needed for the project can be found in the extensive library, which includes all the logic and arithmetic elements needed to combine and process signals. The library includes not only logic components such as gates, flip-flops, counters, registers, ROMs and RAMs, but also instrumentation components such as trigger circuits, formula boxes, sample-and-hold units, comparators and so on. A wide range of modules for displaying results is also available: from light-emitting diodes, analogue meters, digital displays and tables for showing measured values all the way up to X-Y plotters and oscilloscopes.

Data acquisition cards from various manufacturers can be incorporated into the component library. Each of these data acquisition cards appears as a normal component (Figure 3) with all its connections: the user just needs to wire up the desired inputs and outputs. The PC will now simulate the circuit in real time at the click of a button. Incoming measured values are processed or displayed, and outgoing signals are generated. Incorporating a data acquisition card just requires entering the I/O address, adding the desired control and monitor components and wiring the external connections (Figure 4). Developing the project is just like drawing a circuit diagram. The needed components are simply dragged from the library into the working window and then wired up as required. The individual components can be combined in any way desired.

The simulation can then be started to test the function in real time. It is possible to interact directly with the system using the front panel controls. Also, the current state of the components (for example whether a switch is open or closed) and signal flow can be superimposed on the cir-

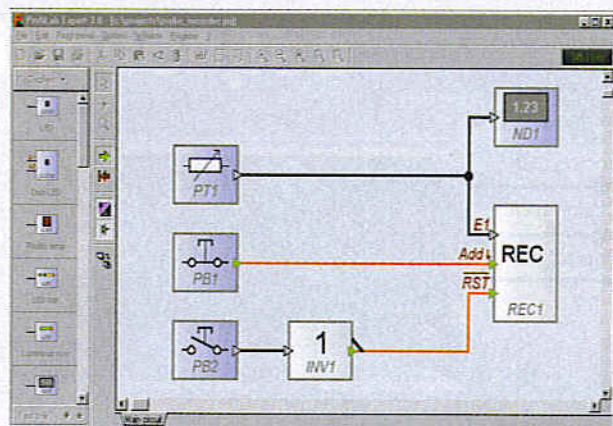

Figure 1. Simulating a data logger using ProfiLab-Expert.

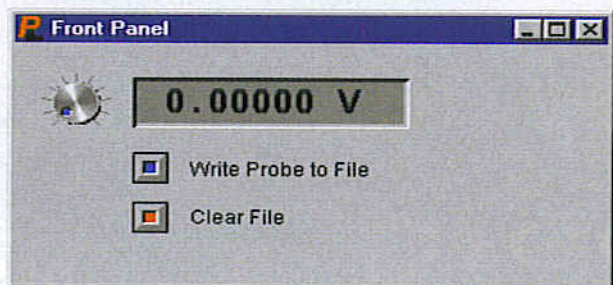

Figure 2. Front panel layout for control and visualisation of the data logger.

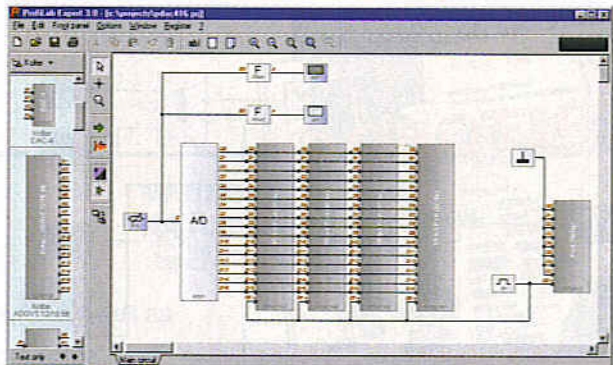

Figure 3. Example application using a PCI D/A converter card.

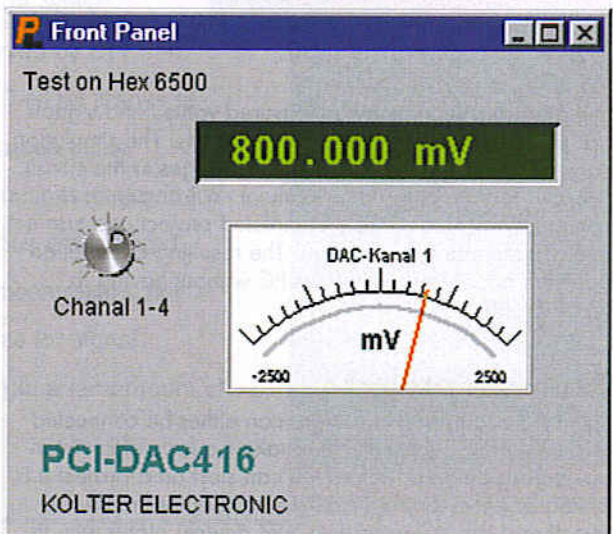

Figure 4. Front panel design for the digital-to-analogue converter card.

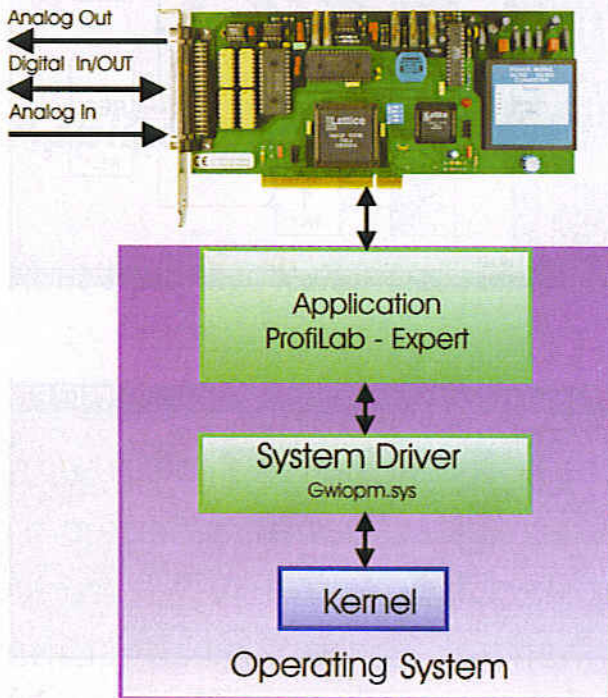

Figure 5. This block diagram shows how the data values are transferred from the data acquisition card to the appropriate software module and vice versa.

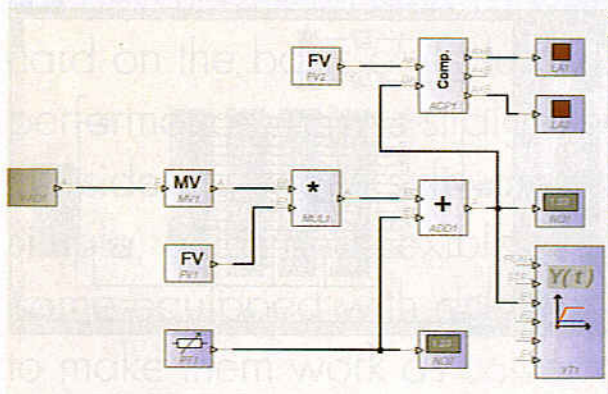

Figure 6. Circuit block diagram for the example project.

circuit diagram. All incoming measured values and signals are processed and displayed immediately. The simulation can be halted at any time to make changes to the circuit. A bonus feature of the development environment is a compiler which can take a completed project and turn it into a stand-alone application. The resulting application can then run on any Windows PC without having to install ProfiLab.

Example project

The data acquisition hardware can either be connected to one of the PC's ports or can take the form of an internal expansion card. Before we can start on a project it is of course necessary to install the acquisition hardware (whether it is a PCI card or a USB device) along with its

software, as well as ProfiLab-Expert.

In this example we are going to measure the temperature of a process and display how it changes over time. We want to be able to calibrate the measurements in 1 % steps to ± 1 °C. We also want a direct indication of when the temperature goes above or below a threshold of 10 °C.

We will use a Pt100 platinum resistance thermometer with a signal conditioner connected to the analogue input of the data acquisition card (Figure 5).

Start ProfiLab-Expert and create a new project. Select the acquisition card from the component library and drag it to the work area. In the 'Properties' dialogue (reached via the context menu) enter the port number and A/D range.

Next the circuit must be entered into ProfiLab-Expert as shown in the example circuit diagram (Figure 6). The input signal digitised by the data acquisition card is first taken to an averaging unit (MW1) to smooth the value. Then it is scaled by a fixed value (FW1) by a multiplier (MUL1). The scaled signal is now taken to an adder to allow for calibration: using potentiometer PT1 a positive or a negative offset can be added to the scaled value to correct the measured value. At the same time the offset value is displayed on the application's front panel using ND2. The parameters for the offset adjustment and for the offset value display can be configured using the 'Properties' dialogues. The signal at the output of the adder (which is the measured temperature plus or minus the offset) is displayed using digital display ND1; its changes over time are recorded using the Y(t) plotter. The measured signal is also taken to a comparator. This switches two lights according to whether the temperature is above or below preset value FW2. FW2 thus represents the desired temperature threshold.

The circuit can be tested in simulation. The settings of various parameters (such as offset voltages and fixed values) can be altered while the simulation is running.

If the application is to run in stand-alone mode on another computer the project must be compiled. Adjustment of port settings may be needed when running on another machine.

Conclusion

The example shows how simply, quickly and economically a data acquisition project can be realised. Even though, for reasons of clarity, we have chosen a relatively simple scenario, it should be enough to give a clear idea of how to approach solving problems of a similar nature. Using ProfiLab-Expert is definitely an alternative to consider for tackling a range of measurement, regulation and control problems.

(040166-1)

Web pointer

www.abacom-online.de/wk

PicoScope 3000 Series PC Oscilloscopes

The PicoScope 3000 series oscilloscopes are the latest offerings from the market leader in PC oscilloscopes combining high bandwidths with large record memories. Using the latest advances in low power electronics, the oscilloscopes draw their power from the USB port of any modern PC, eliminating the need for mains power.

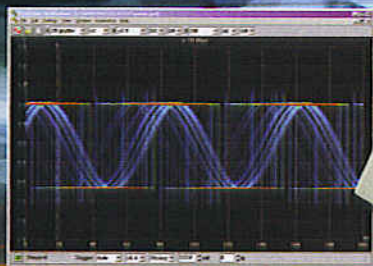

- High performance: **10GS/s sampling rate & 200MHz bandwidth**
- **1MB buffer memory**
- **Advanced display & trigger modes**
- **Compact & portable**
- **Supplied with PicoScope (oscilloscope/spectrum analyser) & PicoLog (data acquisition) software.**

PicoScope	3204	3205	3206
Bandwidth	50MHz	100MHz	200MHz
Sampling rate (respective)	2.5GS/s	5GS/s	10GS/s
Sampling rate (single shot)	50MS/s	100MS/s	200MS/s
Channels	2 Ext. trigger	2 Ext. trigger/Sig. gen	2 Ext. trigger/Sig. gen
Oscilloscope timebases	5ns/div to 50div/div	5ns/div to 50div/div	1ns/div to 50div/div
Timebase accuracy	50ppm	50ppm	50ppm
Spectrum ranges	0 to 25MHz	0 to 50MHz	0 to 100MHz
Record length	955k	912k	1MB
Resolution accuracy		8 bits / 9%	
Ranges		10mV to 2V/div	
PC Connection/Power supply		USB 2.0 (USB 1.1 compatible)	

Tel: 01480 396395

www.picotech.com/scope210

pico
Technology Limited



New CD-ROM Robotics

In Robotics, electronics meets information technology as well as mechanical engineering. The meeting results in a boundless experimental field. Do you want to explore it?

For beginners the shortest way is along the kits line, while experienced users and programmers are best served by DIY construction. Both options are available on this CD-ROM thanks to a large collection of datasheets, software tools, tips en tricks, addresses, Internet links to assorted robot constructions and general technical information. All aspects of modern robotics are covered, from sensors to motors, mechanical parts to microcontrollers, not forgetting matching programming tools and libraries for signal processing. Robots built from LEGO® bricks also get a fair amount of attention.

RRP £12.05
(US\$ 21.25)



Enter the fascinating world of robotics!

Order now using the Order Form in the Readers Services section in this issue.

Elektor Electronics (Publishing)
P.O. Box 190
Tunbridge Wells TN5 7WY England
Telephone +44 (0) 1580 200 657
Fax +44 (0) 1580 200 616

See also
www.elektor-electronics.co.uk

Poor Man's 1-GHz

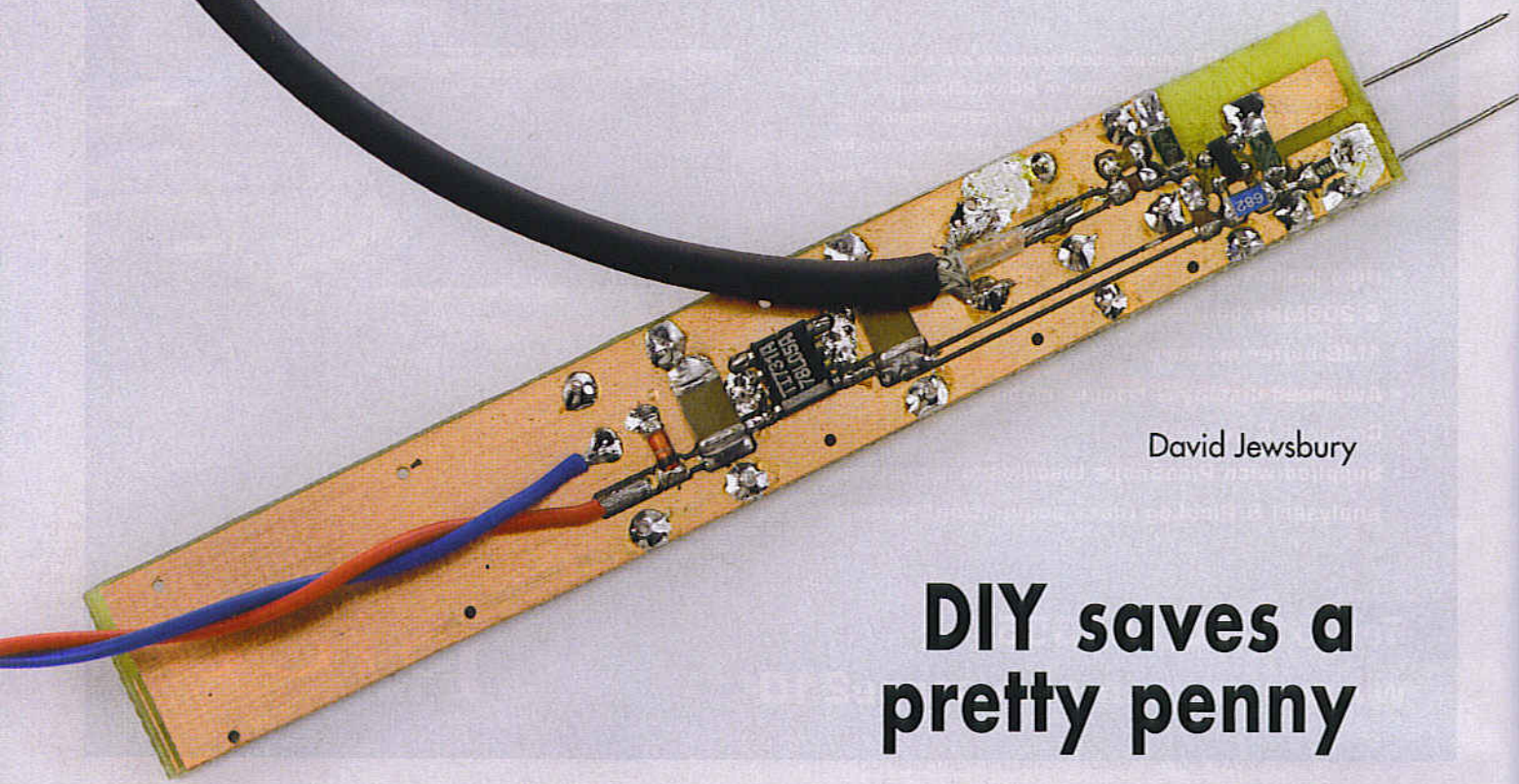

David Jewsbury

DIY saves a pretty penny

When it is required to make a measurement at a node of an RF circuit, connecting to the circuit using a normal oscilloscope probe, even on the x10 setting can change the behaviour of the circuit. For those difficult cases, you need a special probe like the one described here.

Any probe presents extra impedance for the circuit to drive, usually consisting of some resistance and stray capacitance, resulting in reduction in gain, or in extreme cases, causing instability.

The loading effect of the resistance and stray capacitance can be largely removed by using an active probe. The major manufacturers in the oscilloscope market all offer suitable models (see also 'Scope for Scopes' elsewhere

in this issue), but costing over a £1000 they are too expensive for amateur use. This article describes a probe that can be constructed at home, for very little money and has useful performance.

Specifications

This probe has some compromises in performance, as you would expect. In **Table 1** it is compared to a commonly available commercial probe, the type 85024A from Agilent.

Admittedly the commercial probe, with 0 dB loss, is more convenient to work with, but for most applications a homebrew probe is no disadvantage.

Circuit Description

The circuit is shown in **Figure 1**. It is hard to imagine anything simpler. A dual gate MOSFET, T1, is used in a source-follower configuration. This provides a low output impedance to drive the coax cable and test equip-

Active Probe

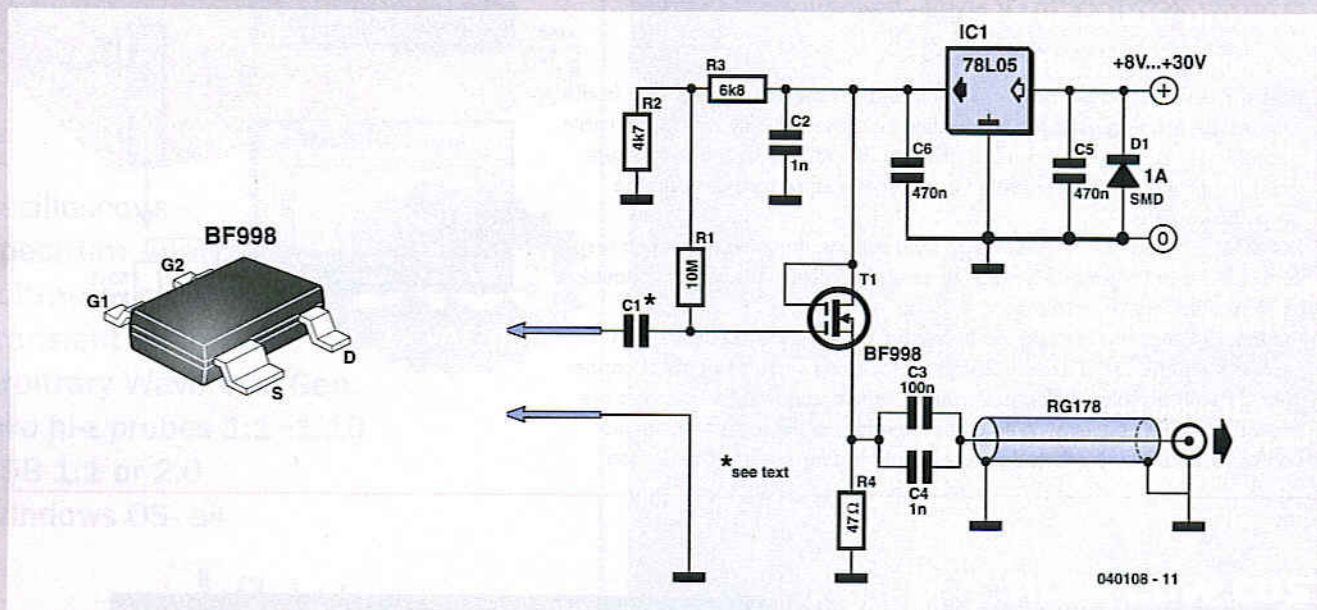

Figure 1. Circuit diagram of the DIY active probe. A dual-gate MOSFET guarantees light, uniform loading of RF signals over a frequency range extending well beyond the 1 GHz mark.

ment. The signal at the probe tip is applied to gate 1. The impedance at gate 1 is a very high resistance shunted by a few picofarads of capacitance. The choice of MOSFET used in the circuit is not critical, any one of the types listed in Table 2 and housed in a SOT143 case can be used with impunity. Be sure however to steer clear of '-R' suffix devices because they have a differ-

ent pinout and will not work on the proposed PCB.

Capacitor C1 has a value of about 0.5 pF, and is made by patches of copper on each side of the board. The gain of the buffer itself is a little less than one, but because of the voltage divider action of C1 and the input capacitance of T1, the overall loss of the probe is approximately 20 dB, or the input volt-

age is divided by 10.

IC1 regulates the supply voltage to a stable 5 volts. D1 protects the probe in the event of the supply leads being reversed.

Construction

The PCB artwork is shown in Figure 2. The board has been designed to allow fitting in a metal tube. All

Table 1.
Commercial / homebrew comparison

	Agilent 85024A	Homebrew probe
Input Impedance	0.75 pF // 1 MΩ	0.75 pF // 10 MΩ
Bandwidth	300 kHz to 1 GHz (± 1.5 dB), or 1 GHz to 3 GHz (± 2.5 dB)	100 kHz to 1.5 GHz (± 2.5 dB)
Gain	0 dB nominal	-20 dB nominal
1-dB compression point	0.3 V RMS	not measured

Table 2.
MOSFET selection guide

Type	C _{iG1} (pF)	Noise figure (dB)
BF990	2.6	2
BF991	2.1	1
BF992	4	1.2
BF998	2.1	1

Masterclass

It is important to realise that the probe is measuring RF voltage, but the displayed quantity is usually the power that the probe is delivering to the spectrum or network analyser. The voltage at the probe tip is given by:

$$V = \sqrt{\frac{10^{\left(\frac{P-L}{10}\right)}}{20}}$$

Where P is the displayed power in dBm, and L is the loss in the probe in dB. If the probe is being used for faultfinding purposes or only an approximate measurement is needed, L can be taken as 20 dB. For accurate measurements the probe can be calibrated over its frequency range, using the setup shown here.

The 50-Ω load can be a 51-Ω 0805-style surface mounted metal film resistor, soldered at the end of a piece of semi-rigid coax. The resistor should be reasonably non-reactive up to 1 GHz.

The loss of the probe is designed to be slightly less than 20 dB so that if needed it can be set to exactly 20 dB by trimming small amounts of copper from C1 with a scalpel. After calibration, very accurate measurements are available in 50-Ω systems. With other impedances there is an additional small error due to the unavoidable residual loading effects of the probe.

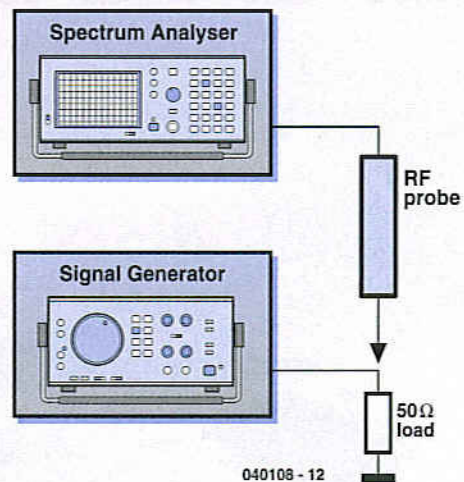

the components are surface mounted (SMD), but assembly by hand is reasonably easy with a fine tipped soldering iron and tweezers. The parts are assembled on one side of a double sided 1.6-mm thick PCB. Connections are made between the ground plane on each side of the board with solid wire soldered on each side. Flying leads take the power to the probe and a length of coax ending with a BNC plug take the output to the test instrument. Heat shrink coax is used to strain relieve the leads. The RF and Ground probe are made from steel pins filed to a point. Pins 'borrowed' from the family's clothes repair kit are excellent.

Testing and use of the probe

After connecting the probe leads to a suitable power supply, the probe should draw between 10 and 30 mA. If all is in order, connect the probe to a spectrum analyser. Applying an RF signal to the probe should result in an output seen on the spectrum analyser. To get accurate results it is important that the ground probe contacts an RF ground close to the probed point on the circuit. It is also important to hold the board by the edges to prevent stray effects from fingers on the circuit. If the impedance at the probed point is 50 Ω,



Figure 2. The PCB has been designed with compactness and low input capacitance in mind — hence the use of SMD parts.

COMPONENTS LIST

All resistors and capacitors:
SMD, '0805' case

Resistors:
R1 = 10MΩ
R2 = 4kΩ7
R3 = 6kΩ8

R4 = 47Ω

Capacitors:
C1 = PCB capacitor
C2, C4 = 1nF
C3 = 100nF
C5, C6 = 470nF

Semiconductors:
D1 = 1A diode, SMD
T1 = BF998 in SOT143 case
(see Table 2)
IC1 = 78L05 in SO-8 case

then the peak on the spectrum analyser should be about 20 dB less than the power at that point in the circuit. Commercial probes were notoriously sensitive to electrostatic discharge, but seem more robust these days. Although T1 has internal diodes to protect against ESD it is wise to take normal precautions against unwanted static, while using the probe, as for any sensitive electronics.

(040108-1)

Handyscope HS3 2 ch

Resolution Menu - 12, 14 or 16bits
Sample Rates - 5,10,25,50,100 Ms/s models



- ✓ Oscilloscope
- ✓ Spectrum Analyzer
- ✓ Voltmeter plus!
- ✓ Transient Recorder
- ✓ Arbitrary Waveform Gen.
- ✓ Two hi-z probes 1:1~1:10
- ✓ USB 1.1 or 2.0
- ✓ Windows OS- all

5 Ms/s Model
£435
ex VAT/pp

iTp Ltd

28 Stephenson Road, Industrial Estate, St Ives, Cambs. PE27 3WJ
Telephone: 01480 300695 Fax: 01480 461654

info@itp101.com www.itp101.com www.tiepie.com

A QUANTUM LEAP IN
EMBEDDED CONTROLLERS

Quick FIRE

SUPERCONTROLLERS

Our range provides:-

- The fastest 68000 based Core up to 66 Mhz.
- Extensive I/O:- Serial, IrDA, SPI, I²C, Analogue, Timers/Counters, RTC, etc.
- Large Memory Capacity Flash, SRAM, DRAM.
- Supports:- Mono & Colour LCD's, Touch Panels & Keypads, Very Low Power.

ALSO LOW COST

DEVELOPMENT

- Target easily & quickly.
- Full ANSI 'C' compiler, assembler & linker all Windows32 based.
- Source Level Debug.
- Full Driver Support with Libraries.
- Real Time Multitasking OS with a free run time licence.
- FREE Unlimited email support.

www.cms.uk.com

see our web site for full details

CAMBRIDGE MICROPROCESSOR SYSTEMS LTD



Unit 17-18 Zone 'D' Chelmsford Rd. Ind. Es
Great Dunmow, Essex CM6 1XG
Telephone: **01371 875644**
email: sales@cms.uk.com

PCB-POOL[®]

SERVICING YOUR COMPLETE PROTOTYPE NEEDS

- Prototypes at a fraction of the cost
- Tooling and setup included
- Any contour
- Fr4 1.6mm, 35µm Cu
- Industry standard quality
- Follow up series runs
- CAM / CAD consulting

PRICE EXAMPLE:
1 EUROCARD 82.5PTH
+ Tooling
+ Photoplots
+ VAT
= £ 29.89*

*Sterling rates may vary. Price = €49

€49



FREE
with first order
(while stocks last)
may differ slightly
to model shown

Beta
Tel: +353 (0)41 701170
Fax: +353 (0)41 701164
E-Mail: sales@beta-lyout.com

Freephone
0800-389 8560

Simply send your files and order ONLINE:

WWW.PCB-POOL.COM

TARGET Protel orcad GraphiCode PROTELS Electronics

E-ONLINE

SOUNDCARD AS TEST INSTRUMENT

Perfect for audio frequency measurements!

Harry Baggen

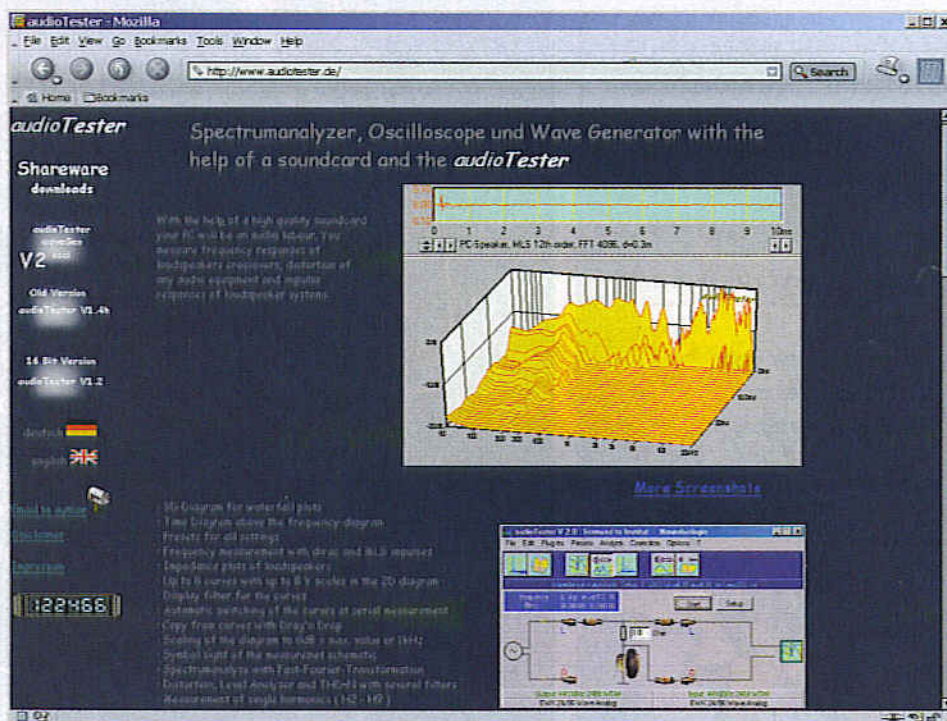

It's safe to say that every modern PC for home or office use has an internal soundcard. In general, the quality of the PC's sound subsystem is sufficient to allow measurements in the audio frequency range. With software in abundance on the Internet, nothing to keep you from turning your PC into an oscilloscope or a function generator.

These days it's hard to find a new PC without an internal soundcard or a sound chip integrated on the motherboard. Whatever the configuration, the 'sound' hardware in the PC often offers advanced features like 5.1-surround sound. Although such 'bells and whistles' will not be used by everyone, technical developments in PC sound technology have resulted in much improved audio reproduction characteristics as compared with a few years ago. Not only do we have a wide frequency range available, there's also a good signal/noise ratio and low distortion. All in all, the perfect behaviour to enable you to perform the occasional measurements in the audio range, especially if you do not want to splash out on a real oscilloscope or an external PC 'scope. Today, advanced soundcards are available at reasonable prices from, among others, Creative, Hercules and Terratec. These products offer 24-bit resolution and 192-kHz sampling. An excellent starting point for a modest PC-based measurement system!

As far as software is concerned, lots of programs are available that give the PC the functionality of an oscilloscope, a spectrum analyser or a function generator, all relying on the specifications of the soundcard. Lots of software comes as freeware or shareware, so there's really no reason why electronics engineers and hobbyists should not have a go at PC-based test & measurement. If you are satisfied with displaying just a few waveforms on your PC screen, you're perfectly served by Konstantin Zeldovich's **Oscilloscope for Windows** [1], a program that's not only small (90 kB, how's that) but also free. The program may be found on the University of Moscow's website.

David Taylor's **Audio Sweep Generator** [2] is a good add-on for the above mentioned oscilloscope program. David's software is easy to operate, yet offers all necessary ingredients to produce a single frequency or a sweep. The start and end frequencies may be set, as well as the sweep rate, a linear or logarithmic sweep and the output signal levels. A few extra programs are available, too, like a toneburst generator and a vectorscope.

The **Daqarta Signal Generator** (DaqGen) [3] is another signal generator for the PC soundcard, but one with lots of bells and whistles. It allows you to choose from different waveforms like sinewave, triangular wave, sawtooth, square wave and even custom defined ones. Various modulation types may be added like PWM, AM and FM, while swept frequency ranges are also possible — of the latter, the program will also display the waveform and the Fourier analysis.

Software Oscilloscope [4] is a free program by Toshio Iwata that does more than just display the signal applied to the soundcard input — one window shows the time domain and the other, the frequency domain. This website also has lots of other interesting software in store, including advanced filter calculations.

On the website published by **Thimo Esser** [5] we found a variety of small audio-related programs of which

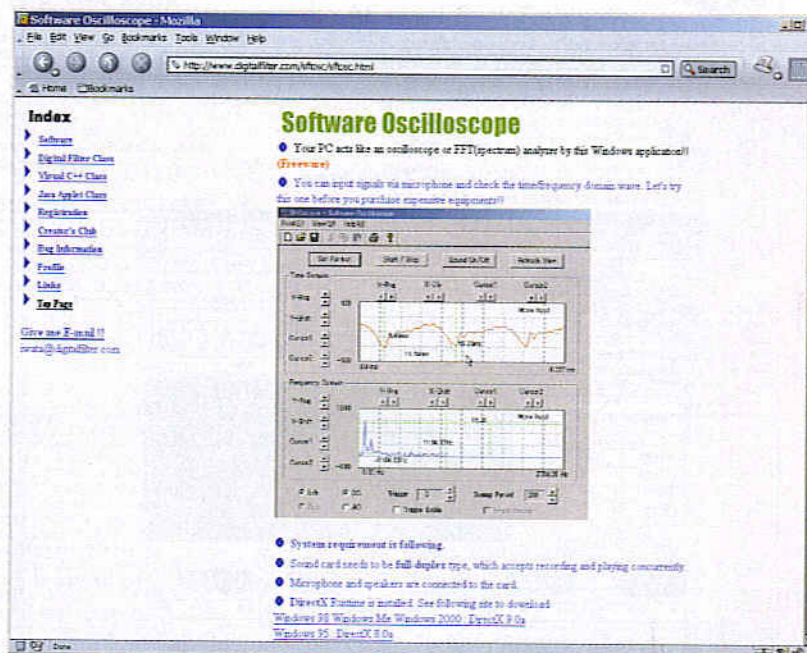

evaluation versions may be downloaded. The available utilities include a test tone generator, a multitone generator and — quite uncommon — a Home Audiometer that allows you to evaluate your own hearing ability. All programs can be bought at low cost if you want to continue using them.

VUMeter [6] by Joachim Michaelis and Lass Tassing is also a rather specialised program. Besides the two usual bar-type level displays we all know from traditional VU

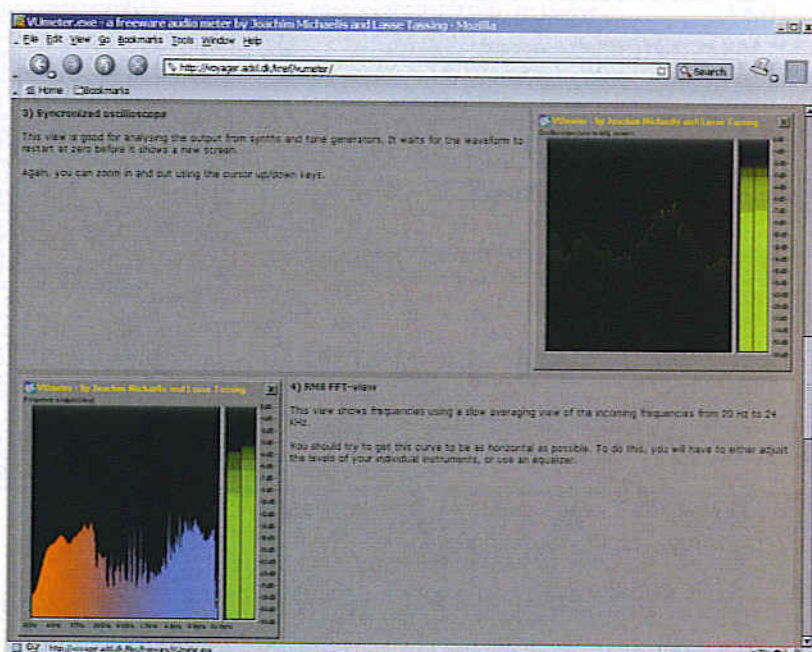

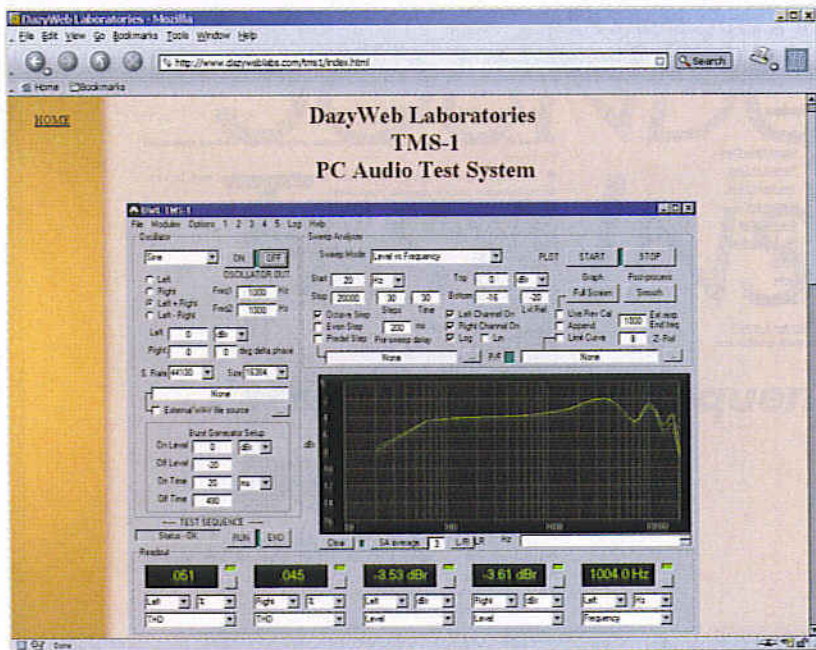

eters, the program offers a separate window where you can select the phase difference between the two channels, the waveforms (oscilloscope), an RMS, peak or stereo phase FFT image. Very useful to watch soundcard input signal levels, or analysed them.

The **Dazyweb Laboratories** website [7] offers a whole range of free PC-hosted instruments for test & measurements: oscilloscope, spectrum analyser, function generator, frequency meter, sine generator, a complete

audio test system and various utilities for audio calculations. Most programs are written in Visual Basic 6 and the author normally makes the source code files of his programs freely available.

If you do not have too much experience with Fourier analysis, you may want to play around with **Sound Frequency Analyzer** by Reliable Software [8]. This little program employs a FFT (fast Fourier transform) to perform real-time analysis of the signal at the soundcard input, for example, a speech signal picked up by a microphone. This supplies a beautifully coloured 'landscape' providing a good impression of the signal's composition in terms of frequency.

Ulrich Müller's **AudioTester** [9] comprises several instruments like an extensive spectrum analyser, a signal generator and an oscilloscope. This software suite allows you to do measurements on loudspeaker boxes with the aid of so-called MLS pulses, which largely eliminate the room effects. Distortion, spectrum analysis and even a 3-D waterfall spectrum are within the possibilities. The program is not free but may be given a try as shareware. For just 28 euros (approx. 20 pounds), the full version is certainly worth buying.

The **AtSpec Spectrum Analyzer** [10] is more aimed at pure Fourier analysis, offering lots of specialised control and analysis options. A built-in generator allows tones or noise to be generated. This is also shareware (the lite version costs \$29).

Finally, at **The Sonic Spot** [11] we found an interesting collection of programs and utilities for measuring and processing audio signals. Well worth exploring.

(045067-1)

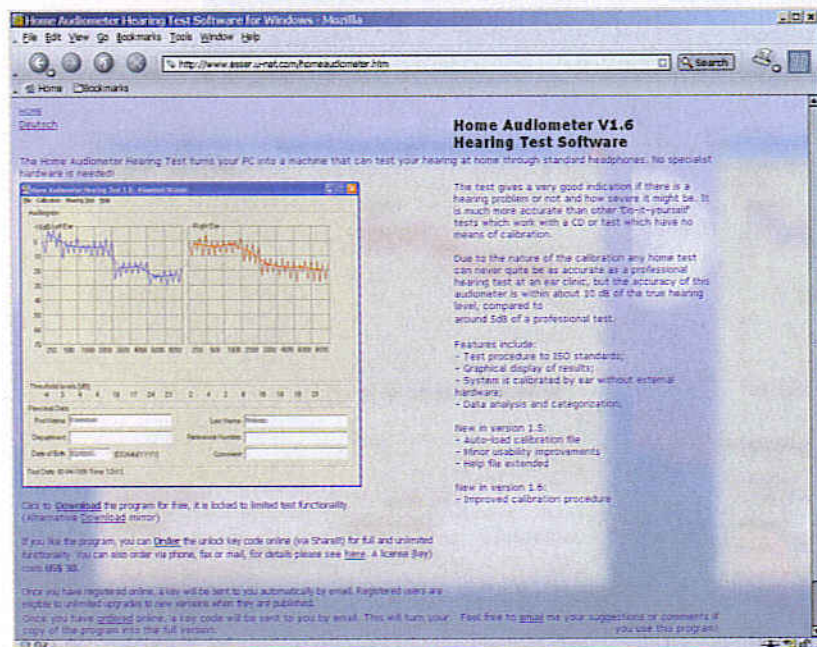

Internet addresses

- [1] Oscilloscope for Windows: <http://polly.phys.msu.ru/~zeld/oscill.html>
- [2] Audio Sweep Generator: www.david-taylor.pwp.blueyonder.co.uk/software/audio.html
- [3] Daqarta Signal Generator: www.daqarta.com/DGINTRO.HTM
- [4] Software oscilloscope: www.digitalfilter.com/sftosc/sftosc.html
- [5] Thimo Esser's Audio Software: www.esser.u-net.com/home.htm
- [6] VUmeter: <http://voyager.adsl.dk/knef/vumeter/>
- [7] Dazyweb Laboratories: www.dazyweblabs.com/shannonsoft/page3.html
- [8] Sound Frequency Analyzer: www.relisoft.com/freeware/index.htm
- [9] AudioTester: www.audiotester.de/
- [10] AtSpec Spectrum Analyzer: www.taquis.com/atspec.htm
- [11] The Sonic Spot: www.sonicspot.com/utills.html

Visit our website
www.distel.co.uk

THE ORIGINAL SURPLUS WONDERLAND!

THIS MONTH'S SELECTION FROM OUR VAST EVER CHANGING STOCKS

Surplus always
wanted for cash!

GIANT 10" 7 SEGMENT DISPLAYS

A bulk purchase enables us to bring you this GIANT 10" 7 segment digit displays at a now affordable price! The 10" character size gives exceptional readability at long distances and enables a host of applications including score boards, digital clocks, counters, event timers etc. As the units are a simple electromechanical device and operate from 12V DC, simple switching via switches, relays, PIC or PC may be used to control single or multiple digits. Units feature integral Zero Power memory which greatly simplifies design. For an excellent DIY practical article, see the May issue of "Everyday & Practical Electronics" magazine. Ideal School / College construction project. Supplied in good RFE condition, complete with data sheet.



Less than 30% of makers price!
Only £29.95 (B) or 4 / £99.00 (D)
Order RW44 Order PH26

THE AMAZING TELEBOX



TV SOUND &
VIDEO TUNER
CABLE COMPATIBLE

Converts your colour monitor into a QUALITY COLOUR TV!

The TELEBOX is an attractive fully cased mains powered unit, containing all electronics ready to plug into a host of video monitors or AV equipment which are fitted with a composite video or SCART input. The composite video output will also plug directly into most VCR or SCART inputs. The composite video output will also plug directly into most VCR or SCART inputs. The composite video output will also plug directly into most VCR or SCART inputs.

TELEBOX ST for composite video input type monitors £36.95
TELEBOX STL as ST but fitted with integral speaker £39.50
TELEBOX MB Multiband VHS/UHF/Cable/Hyperband tuner £69.95
For overseas PAL versions state 5.5 or 6 mhz sound specification.
*For cable / hyperband signal reception Telebox MB should be connected to a cable type service. Shipping on all Teleboxes, code (B)

NEW

State of the art PAL (UK spec) UHF TV tuner module with composite 1V pp video & NICAM hi fi stereo sound outputs. Micro electronics all on one small PCB only 73 x 160 x 52 mm enable full tuning control via a simple 3 wire link to an IBM pc type computer. Supplied complete with simple working program and documentation. Requires +12V & +5V DC to operate.
BRAND NEW - Order as MY00. Only £39.95 code (B)
See www.distel.co.uk/data_my00.htm for picture & full details

HARD DISK DRIVES 2 1/2" - 14"

2 1/2" TOSHIBA MK1002MAV 1.1Gb laptop (12.5 mm H) New £59.95
2 1/2" TOSHIBA MK4313MAT 4.3Gb laptop (8.2 mm H) New £105.00
2 1/2" TOSHIBA MK6409MAT 6.1Gb laptop (12.7 mm H) New £98.00
2 1/2" TOSHIBA MK1814GAV 18 Gb laptop (12 mm H) New £149.95
2 1/2" to 3 1/2" conversion kit for PCs, complete with connectors. £15.95
3 1/2" COMPAQ 313706-B21 (IBM) 9 gb ULT/SCSI3 New £199.00
3 1/2" FUJI FK-309-26 20mb MFm I/F RFE £59.95
3 1/2" CONNER CP3024 20 mb IDE I/F (or equiv.) RFE £59.95
3 1/2" CONNER CP3044 40 mb IDE I/F (or equiv.) RFE £69.00
3 1/2" QUANTUM 40S Prodrive 42mb SCSI I/F, New RFE £49.00
3 1/2" MINISCRIBE 3425 20mb MFm I/F (or equiv.) RFE £49.95
5 1/4" SEAGATE ST-238R 30 mb RLL I/F Refurb £69.95
5 1/4" CDC 94205-51 40mb HH MFm I/F RFE tested £99.00
5 1/4" HP 97548 850 Mb SCSI RFE tested £195.00
6" NEC D2246 85 Mb SMD interface. New £99.00
6" FUJITSU M2322K 160Mb SMD I/F RFE tested £195.00
6" FUJITSU M2392K 2 Gb SMD I/F RFE tested £345.00
Many other floppy & H drives, IDE, SCSI, ESDI etc from stock, see website for full stock list. Shipping on all drives is code (C)

TEST EQUIPMENT & SPECIAL INTEREST ITEMS

MITSUBUSHI FA3445ETKL 14" Ind. spec SVGA monitors £245
FARNELL 0-60V DC @ 50 Amps, bench Power Supplies £995
FARNELL AP3080 0-30V DC @ 80 Amps, bench Supply £1850
KINGSHILL CZ4031 0-50V @ DC 200 Amps - NEW £3950
1kW to 400 kW - 400 Hz 3 phase power sources - ex stock EPOA
IBM 8230 Type 1, Token ring base unit driver £760
Wayne Kerr RA200 Audio frequency response analyser £2500
INFODEC 1U, 24 port, RJ45 network patchpanels. #TH93 £49
3COM 16670 12 Port Ethernet hub - RJ45 connectors #LD97 £69
3COM 16671 24 Port Ethernet hub - RJ45 connectors £89
3COM 16700 8 Port Ethernet hub - RJ45 connectors NEW £39
IBM 53F5501 Token Ring ICs 20 port loba modules EPOA
IBM MAU Token ring distribution panel 8228-23-5050N £45
AIM 501 Low distortion Oscillator 9Hz to 330kHz, IEEE 10 £550
ALLGON 8360.11605-1880 MHz hybrid power combiners £250
Trend DSA 274 Data Analyser with G703(2M) 64 I/O EPOA
Marconi 6310 Programmable 2 to 22 GHz sweep generator £4500
Marconi 2022C 10kHz-1GHz RF signal generator £1550
HP1650B Logic Analyser £3750
HP3781A Pattern generator & HP3782A Error Detector EPOA
HP6621A Dual Programmable GPIB PSU 0-7 V 160 watts £1800
HP6264 Rack mount variable 0-20V @ 20A metered PSU £475
HP54121A DC to 22 GHz four channel test set EPOA
HP8130A opt 020-300 MHz pulse generator, GPIB etc £7900
HP A1, Ad 8 pen HPGL High speed drum plotters - from £550
HP DRAFTMASTER 16 pen high speed plotter £780
EG+G Brookfield 95030 Precision lock in amp £1500
Keithley 590 CV capacitor / voltage analyser EPOA
Racal ICR40 dual 40 channel voice recorder system £3750
Fiskers 45KVA 3 ph On Line UPS - New batteries £4500
Emerson AP130 2.5kVA Industrial spec UPS £1499
Mann Tally MT645 High speed line printer £2200
Intel SBC 486/133SE Multibus 486 system. 8Mb Ram £945

IC's - TRANSISTORS - DIODES

OBSOLETE - SHORT SUPPLY - BULK
10,000,000 items EX STOCK
For MAJOR SAVINGS
CALL or see web site www.distel.co.uk

COMPUTER MONITOR SPECIALS

Legacy products
High spec genuine multisync.
CGA, EGA, VGA, SVGA

Mitsubishi FA3415ETKL 14" SVGA Multisync colour monitor with fine 0.28 dot pitch tube and resolution of 1024 x 768. A variety of inputs allows connection to a host of computers including IBM PC's in CGA, EGA, VGA & SVGA modes. BBC, COMMODORE (including Amiga 1200), ARCHIMEDE and APPLE. Many features: Etched facelplate, text switching and LOW RADIATION MPR specification. Fully guaranteed, in EXCELLENT little used condition. Tilt & Swivel Base £475

VGA cable for IBM PC included. Only £129 (E) Order as CG73
External cables for other types of computers available - CALL

Generic LOW COST SVGA Monitors

We choose the make, which includes Compaq, Mitsubishi, IBM, etc. Supplied ready to run with all cables. Standard RTB 90 day guarantee.

14" £59.00 order TD84	15" £69.00 order TG21	17" £79.00 order TJ66
--------------------------	--------------------------	--------------------------

Supplied in good used condition. Shipping code (D)

VIDEO MONITORS

PHILIPS HCS35 (same style as CM8833) attractively styled 14" colour monitor with both RGB and standard composite 15.625 KHz video inputs via SCART socket and separate phono jacks. Integral audio power amp and speaker for all audio visual uses. Will connect direct to Amiga and Atari BBC computers. Ideal for all video monitoring / security applications with direct connection to most colour cameras. High quality with many features such as front concealed flap control, VCR correction button etc. Good used condition - fully tested - guaranteed
Dimensions: W14" x H12 1/2" x 15 1/2" D. Only £99.00 (D)
PHILIPS HCS31 Ultra compact 9" colour video monitor with standard composite 15.625 KHz video input via SCART socket. Ideal for all monitoring / security applications. High quality, ex-equipment fully tested & guaranteed (professional mirror screen burns). In attractive square black plastic case measuring W10" x H10" x 13 1/2" D. 240 V AC mains powered. Only £79.00 (D)

INDUSTRIAL COMPUTERS

Tiny shoebox sized industrial 40 Mhz 386 PC system measuring only (mm) 266 x X 88 x H 272 d. Ideal for dedicated control applications running DOS, Linux or even Windows! Steel case contains 65 to 265 V AC 50 / 60 Hz 70 Watt PSU, a 3 slot ISA passive backplane and a Rocky 318 (PC104) standard, single board computer with 8 MByte NON VOLATILE solid state 'Disk On Chip' RAMDISK. System comprises: Rocky 318 (PC104) SBC ISA card with 40MHz ALU 386SX CPU, 72 pin SIMM slot with 16 MByte SIMM, AMI BIOS, battery backed up real time clock, 2 x 9 pin D 16550 serial ports, EPP/CF printer port, mini DIN keyboard connector, floppy port, IDE port for hard drives up to 528 MByte capacity, watchdog timer and PCI/104 bus socket. The 8 MByte solid state 'disk on a chip' has its own BIOS, and can be disked, formatted & booted. Supplied BRAND NEW fully tested and guaranteed. For full data see featured item on website. Order as QG36

100's of applications inc: firewall, routers, robotics etc
Unless marked NEW, items in this section are pre owned. Only £99.00 (D)

19" RACK CABINETS

Europe's Largest Stocks of quality rack cabinets, enclosures and accessories. Over 1000 Racks from stock

Save £££'s
This month's special
33 / 42 / 47 U - High Quality
All steel Rack Cabinets

Made by Eurocraft Enclosures Ltd to the highest possible spec, rack features all steel construction with removable side, front and back doors. Front and back doors are hinged for easy access and all lockable with five secure 5 lever barrel locks. The front door is constructed of double walled steel with a 'designer style' smoked acrylic front panel to enable status indicators to be seen through the panel, yet remain unobtrusive. Internally the rack features fully slotted reinforced vertical fixing members to take the heaviest of 19" rack equipment. The two movable vertical fixing struts (extras available) are pre-punched for standard 'cage nuts'. A mains distribution panel internally mounted to the bottom rear, provides 8 x IEC 3 pin Euro sockets and 1 x 13 amp 3 pin switched utility socket. Overall ventilation is provided by fully louvered back door and double skinned top section with top and side louvres. The top panel may be removed for fitting of Integral fans to the sub plate etc. Other features include: fitted castors and floor levelers, prepunched utility panel at lower rear for cable / connector access etc. Supplied in excellent, slightly used condition with keys. Colour Royal blue, some grey available - CALL - Can be supplied in many other configurations.



33U Order as BC44 External dimensions mm=1825H x 635D x 603 W. (64" H x 25" D x 23 3/4" W) Only £245	42U Order as DT20 External dimensions mm=2019H x 635D x 603 W. (79.5" H x 25" D x 23 3/4" W) Only £345	47U Order as RV36 External dimensions mm=2235H x 635D x 603 W. (88" H x 25" D x 23 3/4" W) Only £410
--	--	--

Call for shipping quotation

COLOUR CCD CAMERAS

Undoubtedly a miracle of modern technology & our special buying power! A quality product featuring a fully cased COLOUR CCD camera at a give away price! Unit features full auto light sensing for use in low light & high light applications. A 10 mm fixed focus wide angle lens gives excellent focus and resolution from close up to long range. The composite video output will connect to any composite monitor or TV (via SCART socket) and most video recorders. Unit runs from 12V DC so ideal for security & portable applications where mains power not available. Supplied BRAND NEW & fully guaranteed with user data, 100's of applications including Security, Home Video, Web TV, Web Cams etc.

Order as LK33 ONLY £79.00 or 2 for £149.00 (B)

SOFTWARE SPECIALS

NT4 WorkStation, complete with service pack 3 and licence - OEM packaged. ONLY £89.00 (B)
ENCARTA 95 - CDROM, Not the latest - but at this price! £7.95
DOS 5.0 on 3 1/2" disks with concise books & QBasic £14.95
Windows for Workgroups 3.11a - Dos 6.22 on 3.5" disks £55.00
Windows 95 CDROM Only - No Licence £19.95
Wordperfect 6 for DOS supplied on 3 1/2" disks with manual £24.95
shipping charges for software is code B

SOLID STATE LASERS

Visible red, 670nm laser diode assembly. Unit runs from 5 V DC at approx 50 mA. Originally made for continuous use in industrial barcode scanners, the laser is mounted in a removable solid aluminium block, which functions as a heatsink and rigid optical mount. Dims of block are 50 x 50 x 15 mm. Integral features include over temperature shutdown, current control, laser OK output, and gated TTL ON / OFF. Many uses for experimental optics, comms & lightshows etc. Supplied complete with data sheet.

Order as TD91 ONLY £24.95 (A)

DC POWER SUPPLIES

Virtually every type of power supply you can imagine. Over 10,000 Power Supplies
Ex Stock - Call or see our web site.

RELAYS - 200,000 FROM STOCK

Save £££'s by choosing your next relay from our Massive Stocks covering types such as Military, Octal, Cradle, Hermetically Sealed, Continental, Contactors, Time Delay, Reed, Mercury Wetted, Solid State, Printed Circuit Mounting etc... CALL or see our web site www.distel.co.uk for more information. Many obsolete types from stock. Save £££'s

Display
-ELECTRONICS-

ALL MAIL TO
Dept EK, 29 / 35 Osborne Rd
Thornton Heath
Surrey CR7 8PD, UK
Open Mon - Fri 9.00 - 5.30

18 Million Items On Line Now!
Secure Ordering, Pictures, Information
www.distel.co.uk
email = admin@distel.co.uk

ALL ENQUIRIES
0208 653 3333
FAX 0208 653 8888

All prices for UK Mainland. UK customers add 17.5% VAT to TOTAL order amount. Minimum order £10. Bondi Fide account orders accepted from Government, Schools, Universities and Local Authorities - minimum account order £100. Cheques over £100 are subject to 7 working days clearance. Carriage charges (A)=£3.50, (B)=£6.50, (C)=£10, (D)=£15.00, (E)=£18.00, (F)=CALL. Allow approx 3 days for shipping - faster CALL. All goods supplied to our Standard Conditions of Sale which can be viewed at our website and unless stated guaranteed for 90 days. All guarantees on a return to base basis. All rights reserved to change prices / specifications without prior notice. Orders subject to stock. Discounts for volume. Top CASH prices paid for surplus goods. All trademarks, tradenames etc acknowledged. © Display Electronics 2002. E & O E.





Would
rather
what

*Read elektor
electronics.
leading the way*

Don't you ever know what's inside?



Take out an 18-month subscription to **elektor electronics** and receive a free 128-MB USB Memory Stick*.

Please fill out the Order Form with this issue.

Subscription rates and conditions may be found at the back of this issue.

* Offer available to Subscribers who have not held a Subscription to Elektor Electronics in the last 12 Months. Offer Subject to Availability.

AIR QUALITY S

Christian Voit – Unitronic AG



A CO₂ sensor has been developed for specialist applications in air quality monitoring and control, offering good long-term stability, high selectivity, and a low humidity dependence.

The concentration of CO₂ can be used as a good indicator of air quality in the office or in the home. Until now, an obstacle to the widespread adoption of control systems based on CO₂ concentration measurement has been the lack of stable, accurate and yet economical sensors for this unreactive gas. Now, however, with the introduction of new solid electrolyte sensors, rapidly-reacting measurement systems for air quality control can be produced. The concentration of CO₂ in fresh air is generally around 350 ppm (parts per million), although this is of course subject to variations due to natural as well as artificial causes. These variations are nevertheless of low amplitude and take place over long periods. In inhabited living and working spaces the CO₂ concentration can quickly rise to many thousands of parts per million as a result of respiration, smoking for other reasons. **Figure 1** shows the evolution over time of CO₂ concentration in a test room holding between 10 and 80 people. Of course many other substances have an influence on air quality (and in particular on the percep-

tion of odours). Research has shown, however, that CO₂ is the key indicator for determining air quality. Subjective perceptions of air quality certainly correlate with a gradual rise in the level of CO₂, especially bearing in mind that CO₂ is an odourless gas. If one goes into a room with a high CO₂ concentration, one immediately feels the need for fresh air (the so-called 'meeting room effect'). **Table 1** shows the effect of various levels of CO₂ on humans.

A range of sensor technologies

The most widely-used technique for CO₂ measurement is by NDIR (non-dispersive infra-red) absorption. This exploits the physical property of CO₂ that it absorbs infra-red light at a wavelength of 4.27 µm. The CO₂ partial pressure can be measured very selectively and accurately using this method (especially in the case of high absolute concentrations of CO₂, even up to 100 %). Unfortunately, for measuring lower concentrations a long optical path through the gas is required in

SENSOR

New CO₂ sensors for air quality monitoring

order to obtain a sufficiently significant absorption effect. The infra-red method is stable over long periods of time and has no moving parts. It is, however, bulky and requires precision optics and is therefore correspondingly expensive.

There are a few CO₂ sensors employing liquid electrolytes on the market. A decisive disadvantage of these cells is their limited life, the poor stability of their outputs and hence the lack of reproducibility of readings. There is also a general risk of leakage with cells that contain a liquid: this can lead to damage to the sensor or to nearby components. These sensors have therefore not been used in ventilation control systems.

Certain solids possess the property that ions can move within them. This makes them ideal to function as the electrolyte in a gas sensor. Particularly well suited to detecting gaseous oxides such as CO₂ or NO_x are materials based on a sodium (i.e., sodium) super-ionic conductor, or NASICON, structure. NASICON materials, which have been known for some time, are ceramics capable of conducting sodium ions. The chemical formula is Na_{1+x}Zr₂Si_xP_{3-x}O₁₂, with 0 < x < 3. The highest ion conductivity is exhibited when x=2. Many studies have sought to find an arrangement whereby an electrochemical cell is constructed from NASICON material together with chemically active layers, giving an electrical voltage which depends on the ambient gas concen-

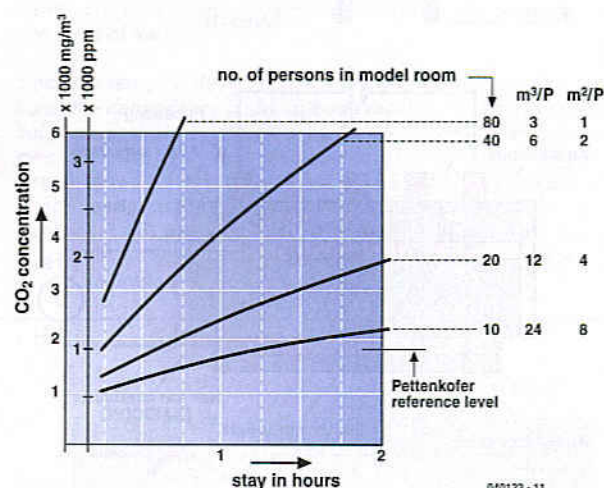

Figure 1. CO₂ concentration in a 240 m³ test room.

tration. The principal obstacle to commercial mass production was the lack of stability and reproducibility of the solid electrolyte CO₂ sensors, and their high humidity dependence. The Japanese semiconductor gas sensor manufacturer Figaro has now managed to develop a process for making long-term stable CO₂ sensors as standard components with reproducible properties and low humidity dependence.

% by volume	Concentration
0.022	Concentration in air in glacial ice from 18000 years ago
0.026	Concentration worldwide in pre-industrial age (before 1850)
0.035	'Fresh air' concentration today, rising by approximately 0.5 ppm per year
0.04	Onset of noticeable effects indoors: cranial pressure, feeling of stuffiness
0.07	Concentration in open air in cities
0.08	Heightened olfactory sensitivity
0.1	Maximum value according to Pettenkofer (1858)
0.14	Urban air in dwellings, maximum value for office buildings
0.3	Peak concentration during Dortmund bunker occupation experiment (1964)
0.4	Maximum value in classroom after lesson

0.5	Maximum workplace concentration: 5000 ppm or 9100 mg/m ³
0.7	Maximum value in cinema after film
2.0	Physiologically tolerable value for short periods
2.5	Intoxication-like effects on divers
3.0 to 4.0	Increased difficulty breathing
4.0 to 5.2	Exhaled air
5.0	Mixed with oxygen (95%) for use in artificial respiration apparatus
6.0 to 8.0	Paralysis effects similar to those of curare
8.0 to 10.0	Lethal dose if inhaled for long periods
10.0	Extinguishes a candle
~10.0	Blood concentration in marine mammals
~10.0%	Short-term maximum value in artificial CO ₂ -bath air, lethal if inhaled for even a short period

Table 1. CO₂ concentrations (0.03 % by volume = 300 ppm)

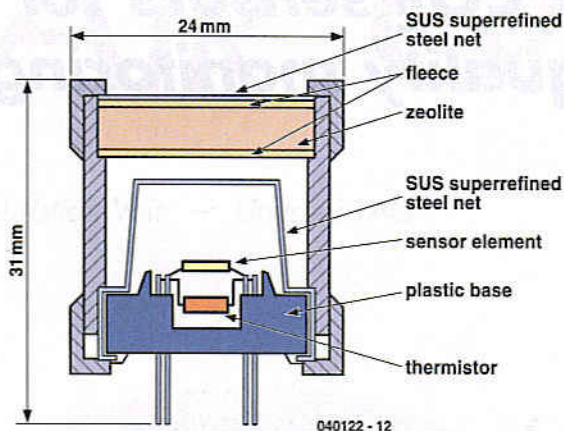

Figure 2. Cross-section through the TGS4160 and the sensor element itself.

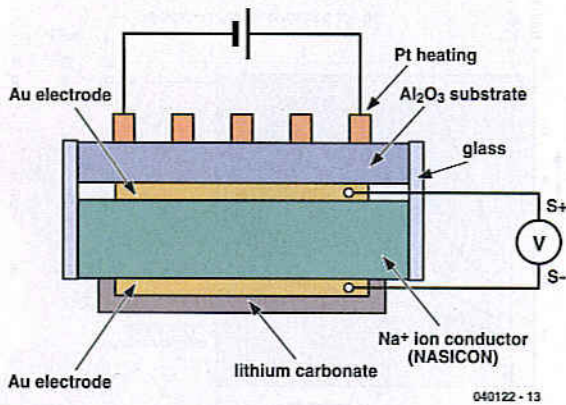

Figure 3. The sensor element must be connected to an extremely high-impedance input circuit.

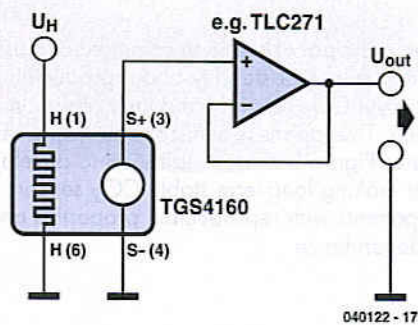
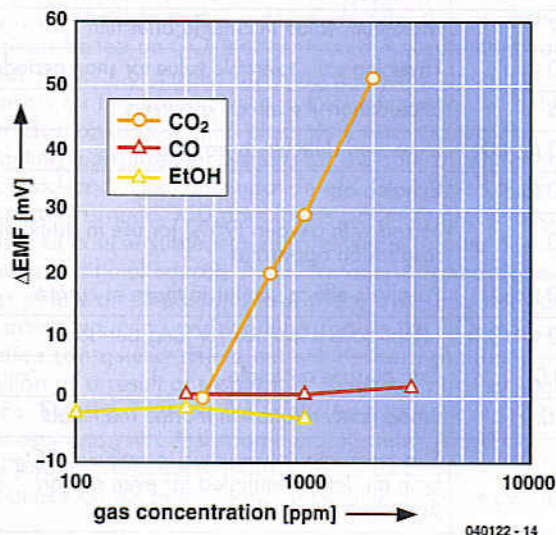

Figure 4. CO₂ sensitivity of the TGS4160 (and insensitivity to CO and ethanol)



The TGS4160 gas sensor

The TGS4160 consists of a CO₂-sensitive solid electrolyte cell with an internal thermistor for temperature compensation. Figure 2 shows the construction of the sensor and a cross-section through the sensor element. A NASICON disc with a diameter of 4 mm and a thickness of 0.7 mm is printed with gold electrodes on each side. A layer of lithium carbonate (Li₂CO₃) is added on the cathode side and then calcined at 600 °C. A thin disc of aluminium oxide ceramic, carrying a printed platinum heating element, is laminated onto the anode side. The edges of the sensor are sealed with glass. Platinum wires are bonded to the sensor element and spot-welded to the connection pins on the sensor base. The sensor base is made from glass fibre reinforced polybutylene terephthalate, and over it a mounted a two-layer stainless steel mesh as a flame retardant. The external enclosure is made from reinforced polyamide and includes a zeolite adsorption filter to prevent ingress of interference gases such as ethanol.

Signal conditioning

For good sensor performance and long life it is important to measure the cell voltage using as high an impedance as possible. The cell has a high internal resistance and so a low impedance measurement would give a false reading, and furthermore a significant external current would flow, causing a continual flow of ions in one direction. Over a long period this would damage the sensor. The input impedance of the measurement circuit should therefore be at least 100 MΩ and the bias current should be less than 1 pA. A typical basic circuit is shown in

Figure 3.

The output EMF is relatively stable as long as the sensor is heated. Long unheated storage, however, especially at high humidity, can lead to a significant drop in EMF. Nevertheless, the difference EMF (ΔEMF) between the value at 350 ppm CO₂ and the value at higher atmospheric CO₂ concentrations remains very stable. The ΔEMF of the TGS4160 shows a linear dependence on the logarithm of the CO₂ concentration (Figure 4) and only at higher humidities (over 60 %) does it start to show a slight humidity dependence. Because of these properties, the sensor is suitable for use in rapidly-reacting CO₂ air monitoring systems.

Because of the drift that can occur, the sensor is not suitable for measuring absolute CO₂ concentrations, but only the CO₂ concentration relative to the 'natural' concentration in fresh air. Special signal conditioning is thus required on the cell output voltage, which is carried out in software using a dedicated microcontroller running an application-specific algorithm (Figure 5). To evaluate the ΔEMF the reference level corresponding to 350 ppm CO₂ must first be determined. To do this we assume that the natural concentration of CO₂ in fresh air never falls below 350 ppm and that there will be fresh air in the measured environment at least from time to time. Given these assumptions we can take the highest EMF measured over a specified period (of say 24 hours) to be the reference EMF for 350 ppm. If during a 24 hour period the current reference level is not reached, the algorithm automatically reduces the stored reference value by a set amount, until the measured EMF once again exceeds the stored reference value. In this way a drift in either direction is automatically compensated for: the measuring system is self-calibrating.

Principles of operation

The sensor element is heated to about 450 °C by the heating element. The equilibrium point of the cathode reaction depends on the CO₂ and O₂ partial pressures. The cathode reaction is as follows:

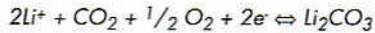

and the anode reaction is:

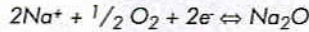

Since the anode is sealed from the atmosphere, the equilibrium point of the anode reaction depends only on the O₂ partial pressure in the small volume between the NASICON disc and the aluminium oxide disc. Each reaction gives rise to a particular electron concentration in the corresponding electrode. The charge difference can then be measured as a voltage between the two electrodes. The exact nature of the processes within the sensor cell, and in particular the interactions at the cathode boundary layers, are to a large extent not understood. Empirical research has established, however, that the behaviour of the cell accurately follows the Nernst equation:

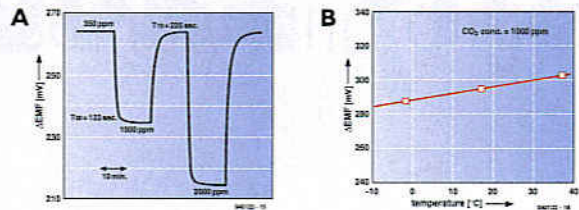

$$\text{EMF}[\text{mV}] = E_C \cdot (R \cdot T) / (2 \cdot F) \cdot \ln[P(\text{CO}_2)]$$

where $P(\text{CO}_2)$ is the CO₂ partial pressure, E_C is a constant for the cell, R is the ideal gas constant, T is temperature in Kelvin, F is the Faraday constant, and EMF is the electromotive force of the cell.

Since the sensor is designed for use in atmospheric conditions, the dependency of the cathode reaction on the O₂ partial pressure can be neglected, as the O₂ concentration only ever deviates slightly from the value of 21 % by volume. **Figure A** shows the step response of the TGS4160 to changes in gas concentration. The sensor has a linear temperature dependence as shown in **Figure B**, which can be taken into account in the signal conditioning circuit with the help of the built-in thermistor.

TGS4160s have been in continuous testing since 1996. So far no noticeable changes in performance or sensor failures have been observed.

Example circuit

The algorithm described above has been optimised in the light of practical experience and programmed into a microcontroller, which is available as a standard component. **Figure 6** shows the TGS4160 along with the ready-made AM4 module, which includes all the electronics required for a ventilation control system apart from the power driver stage. The sensor has already been successfully used in ventilation control applications, and its suitability for mass production has been demonstrated.

(040122-1)

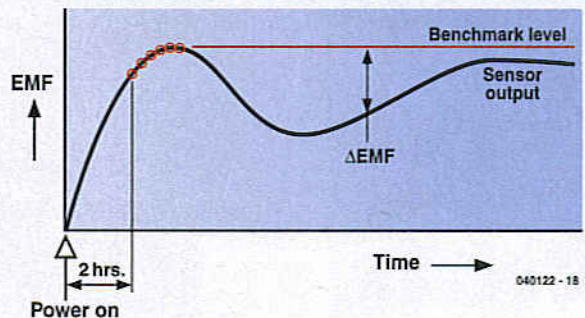

Figure 5. Determining the reference level in software.

Data sheet: www.unitronic.de/CO2
(German website, data sheet in English)

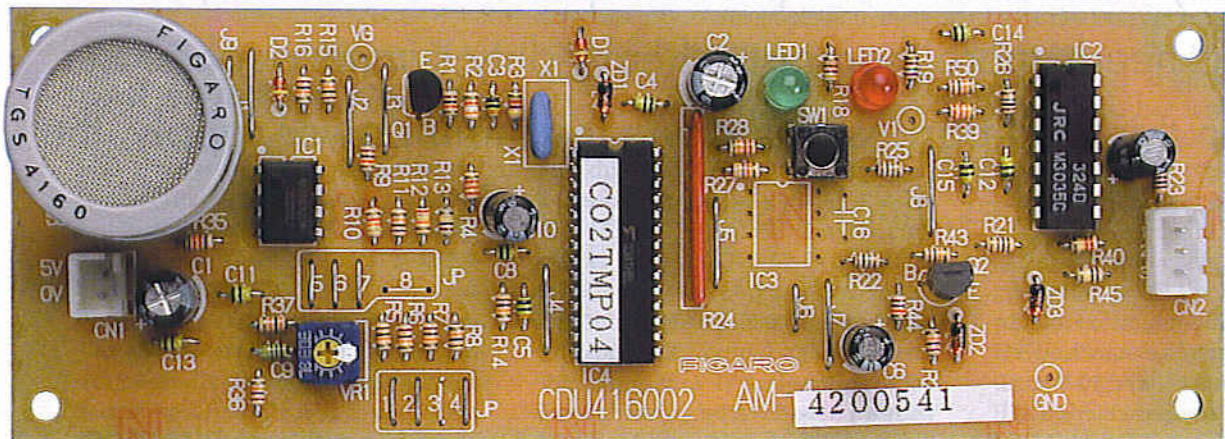
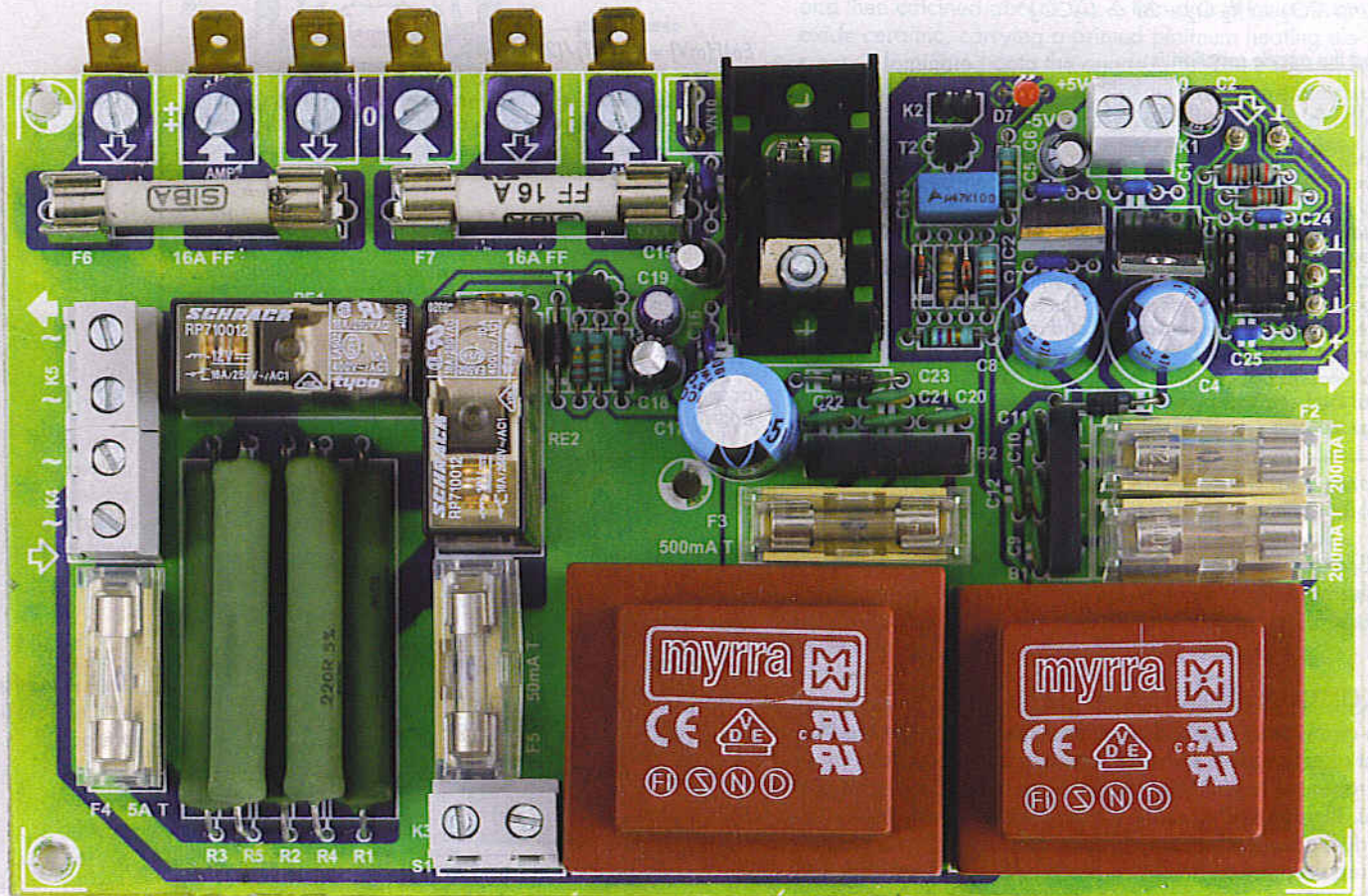

Figure 6. For experimentation and application: the AM4 module.

Clarity 2x300W Class-T



Ton Giesberts

As already mentioned in the previous parts of this article, this final amp needs more than just a heavy-duty symmetrical power supply. In this final part, we examine the main power supply, the other power supplies, final assembly and alignment.

The analogue input portion of the TA3020 operates from a stabilised 5-V supply voltage. A stabilised 10-V auxiliary voltage is also needed for driving the MOSFETs. The power supply board

also has a switch-on delay for the mains voltage (current limiting). An additional feature is a buffer circuit with a phase inverter, which allows the two channels to be easily operated

in a bridge configuration without requiring any modifications to the amplifier board. Naturally, the required mains power indicator and mute signal are also present.

Amplifier

Part 3: power supply, assembly and alignment

Analogue power supply and mute circuit

The analogue 5-V power supply has its own transformer (TR1, 2×9 V). A small, discrete-component circuit for generating a well-defined mute signal is added here (see **Figure 1**). The supply voltage for this circuit is taken directly from the output of the bridge rectifier (B1), filtered by a small capacitor (C14), so the amplifier can be switched to mute mode as quickly as possible when the mains voltage drops out.

The mute circuit is the height of simplicity: after C13 has been charged, T2 has enough voltage to fully drive the optocoupler on the amplifier board. C13 is slowly charged via R11 until it reaches the level defined by voltage divider R9/R10. D2 limits the voltage at the mute output, but the ultimate value is not especially critical. When the mains voltage drops out, C13 is quickly discharged by D3. The mute signal can be connected to the amplifier board via pin header K2.

The negative supply voltage is only needed for powering the phase inverter. Standard positive and negative voltage regulators are used for the ± 5 -V supplies. The +5-V supply can be connected to the amplifier board via K1.

The negative voltage is also available on a solder pin, so it is also available for user-defined applications.

Auxiliary voltage and switch-on delay

The 10-V supply for the output stage is also powered by a separate transformer (TR2). After rectification and filtering, the voltage is stabilised using a standard positive 10-V regulator. If a 10-V regulator is difficult or impossible to obtain, a 9-V type can also be used. Two different types of transformer are shown on the schematic diagram for this supply. The PCB is designed to accommodate a transformer with two

separate windings (2×6 V) or one with a single winding (1×12 V). In either case, a 12-V ac voltage is thus made available. Just as with the analogue supply, the filter is placed after an extra diode, rather than directly following the bridge rectifier.

The voltage provided by rectifier B2 is used to power the relays of the mains switch-on delay circuit. This voltage also has minimal filtering (C19). This causes the relays to disengage as quickly as possible when the mains voltage drops out.

The switch-on delay circuit consists of two relays. The first relay (RE1) switches on power to the amplifier via a set of high-power resistors in order to limit the magnetising current of the transformer and the charging current for the electrolytic capacitors of the main power supply. These high-power resistors consist of five 10-W, 220- Ω resistors connected in parallel. Two of them are mounted above the other three, separated by a certain amount. The peak load capacity must be taken into account in dimensioning these resistors. The transient power dissipation is around 1200 W, and the absolute peak dissipation is actually more than 2 kW!

The second relay (RE2) shorts out the resistors and connects the main power supply transformer (a 1000-VA type in our prototype) directly to the main voltage. This allows the amplifier to manage with a relatively small mains switch (6-A rating). With the delay circuit, the effective value of the switch-on current does not exceed 5.2 A.

The drive circuit for the switch-on delay is a standard design. Voltage divider R6/R7/R8 ensures that the voltage at the base of T1 is not high enough for it to conduct enough current to energise RE2 until the supply voltage has reached two thirds of its nominal value. The time required for this voltage to be reached is delayed by the charging time of C20. The value

of C20 can be kept to a minimum by using equal values for R6 and R7 to set the delay time. When the mains voltage drops out, D5 causes C20 to be rapidly discharged. With this arrangement, the delay time remains as nearly as possible constant if the supply is switched off and then quickly switched on again.

The required mains power indication is provided by LED D7. It must therefore be clearly visible on the front of the amplifier.

Main power supply

The compactness of the amplifier is offset by the sheer mass of the power supply. Of course, we could have also developed a switch-mode power supply, but it would have to be a supply that could deliver a good 40 A at a bit less than ± 60 V. That would be a challenge, to put it mildly. It should thus be clear why we choose to use a conventional design.

In consideration of the current levels involved here, we selected a heavy-duty rectifier that can handle a rated current of 46 A and a peak current of 90 A. For the electrolytic capacitors in the power supply, we selected types that can handle strong ripple currents. Normal power-supply electrolytics are not intended to be used in such severe applications. From the BCcomponents 2222 154 line, we selected a capacitor that can handle ripple currents of around 11 A at 10 kHz (or 20 A at 100 Hz) and has low values of self-inductance and ESR (a tall electrolytic capacitor with a small diameter). A long service life is ensured by connecting four capacitors in parallel for each half of the power supply. Here we can give you a small tip: if you order ten capacitors in a single lot from Farnell, it will cost you less than buying eight of them at the single-quantity price.

If you think the power supply is perhaps somewhat over-designed with the

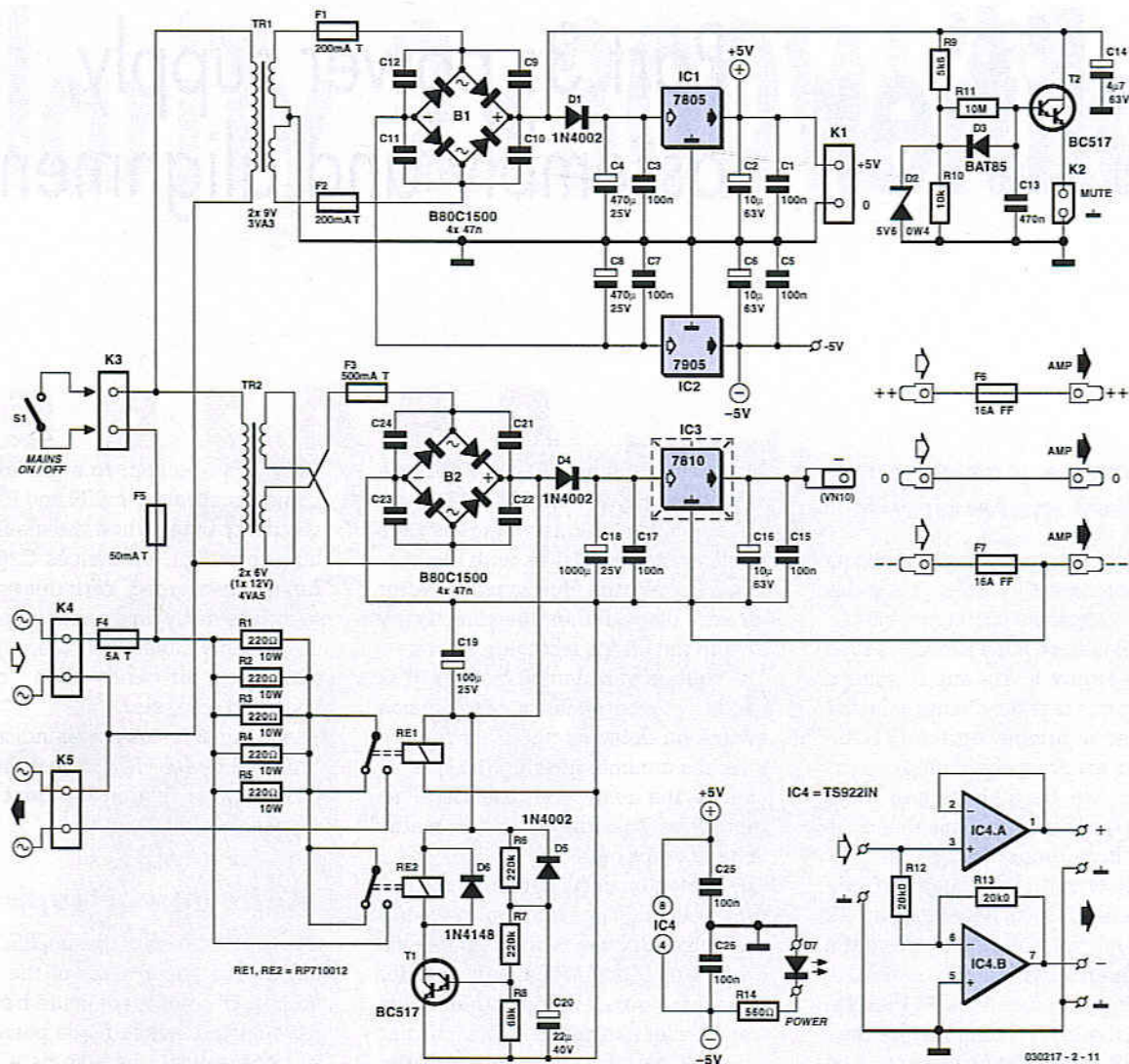

Figure 1. Besides the auxiliary supply voltages, the power supply board provides the switch-on delay, the mute signal and a phase inverter for bridge-mode operation.

COMPONENTS LIST

power supply board

Resistors:

R1-R5 = 220Ω 10W (e.g. AC10 BCcomponents)
 R6, R7 = 220kΩ
 R8 = 68kΩ
 R9 = 5kΩ6
 R10 = 10kΩ
 R11 = 10MΩ
 R12, R13 = 20kΩ 1%
 R14 = 560Ω

Capacitors:

C1, C3, C5, C7, C15, C17, C25, C26 = 100nF ceramic
 C2, C6, C16 = 10μF 63V radial
 C4, C8 = 470μF 25V radial
 C9-C12, C21-C24 = 47nF ceramic
 C13 = 470nF
 C14 = 4μF 7 63V radial
 C18 = 1000μF 25V radial
 C19 = 100μF 25V radial
 C20 = 22μF 40V radial

Semiconductors:

D1, D4, D5 = 1N4002
 D2 = zener diode 5.6V 0.4W
 D3 = BAT85
 D6 = 1N4148
 D7 = LED, red, low-current
 T1, T2 = BC517
 IC1 = 7805
 IC2 = 7905
 IC3 = 7810
 IC4 = TS922IN ST (Farnell # 332-6275)

Miscellaneous:

B1, B2 = B80C1500, straight case (- ~ + ~ -) (80V piv, 1.5A)
 K1 = 2-way PCB terminal block, lead pitch 5mm
 K2 = 2-way pinheader
 K3, K4, K5 = 2-way PCB terminal block, lead pitch 7.5 mm
 F1, F2 = fuse, 200mA/T (time lag) with PCB mount holder
 F3 = fuse, 500mA/T (time lag) with PCB mount holder
 F4 = fuse, 5A/T (time lag) with PCB mount holder
 F5 = fuse, 50mA/T (time lag) with PCB mount holder
 F6, F7 = fuse, 16A/FF (very fast), 6.35x32 mm (Farnell # 534-699 with

fuse clips # 230-480)
 RE1, RE2 = RP710012 16A/12V/270Ω (Schrack, Farnell # 388-312)
 TR1 = mains transformer, 2 x 9V/3.3VA (e.g., Myrra 44200, 2 x 1VA6)
 TR2 = mains transformer, 2 x 6V (or 1 x 12V)/4VA5 (e.g., Myrra 44235, 2 x 2VA5)
 1 x spade terminal, PCB mount, 2-way, straight
 6 x spade terminal, PCB mount, 3mm screw/bolt mounting
 Heat-sink 15 K/W for IC3 (ICK35SA Fischer)
 S1 = mains on/off switch rated for 6 A

main supply

Mains transformer 1000VA, 2 x 42V/11.9 A (e.g., Amplimo/Jaytee Z8022)
 Bridge rectifier 140V/50A (e.g. Diotec Semiconductor KBPC 5002FP, Farnell # 393-5292)
 8 electrolytic capacitors, 63V/15,000μF (e.g. BCcomponents # 2222 154 18153, Farnell # 248-022)
 4 mounting clamps for 35-mm diameter electrolytics (Farnell # 306-526)
 IEC mains appliance socket, chassis mount PCB, order code 030217-2

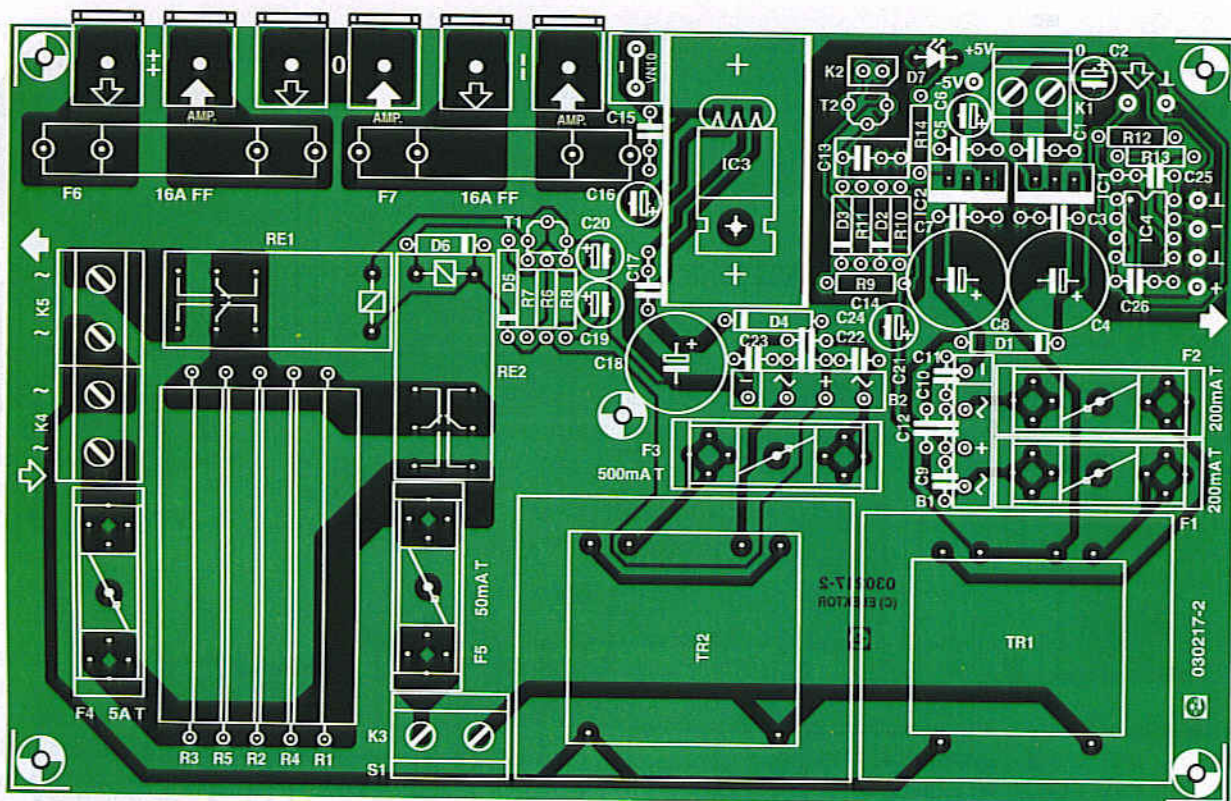

Figure 2. The power supply board also has room for several fuses, which provide good protection for the amplifier.

specified component values, we wouldn't immediately disagree. However, you should bear in mind that at 2×200 W sine-wave power, the output voltage of this supply already drops by 5 V!

Protection

The mains voltage is routed to the power supply board via K4. The primary fuse for the main transformer (F4) is also fitted here, so it isn't necessary to use a mains connector with a built-in fuse. The mains voltage for the auxiliary voltages is tapped off after the fuse for the main transformer. If the primary fuse blows, power will also be removed from the rest of the amplifier. In the opposite case, a similar situation exists. If the fuse for TR1 and TR2 blows, the supply voltage for the mains switch-on delay circuit will drop out, and power will be removed from the entire amplifier. A situation in which only part of the amplifier is without power can occur if F1 and/or F2 blows. In this case, at most the +5 V supply voltage will be lost, and there will no longer be any signal. That will not have any further detrimental effects; the most that can happen is that a small 'pop' will be heard from the speakers.

For additional safety, the main supply voltage for the final amp is protected using two 16-A FF fuses in 32-mm cases. This ensures that the voltage decays as quickly as possible in case of a short circuit, rather than requiring the power supply capacitors to first be discharged. These fuses are also fitted on the power supply board, and they are connected between the large power supply capacitors and the amplifier board using screw-mounted flat connectors (car connectors). The advantage of using separate fuse holders is that the PCB-mount fuse clips used here can handle a continuous current of no less than 15 A (with adequate copper area on the circuit board). Most PCB fuse holders are only rated at 5 A continuous current.

Assembly

For our prototype, we chose the 'not so quick-and-dirty' method and fabricated our own enclosure from a sheet of aluminium. This results in an unconventional design, whose shape and proportions are determined by the dimensions of the heat sink, toroidal transformer, power-supply capacitors and power supply board (Figure 2). The heat sink forms the front of the

unit. The mains entry, input sockets and speaker connectors are fitted at the rear. Of course, you are free to package everything into another type of (standard) enclosure.

In our design, we tried to keep the power supply connections as short as possible, and we fitted the power supply board above the large toroidal transformer. The four fastening holes for this board are far enough apart to allow it to be secured to the base with ample clearance from the transformer. The two rows of four electrolytic capacitors each are placed next to each other in a single group. Their terminals are connected together using small 2-mm aluminium plates. Be sure to provide adequate separation between the plates for the +, 0 and - polarities. We recommend fitting screw-mounted flat connectors to the plates, to simplify wiring and maintenance.

The capacitors can be adequately secured using four mounting clamps. Where necessary, one mounting tab must be broken off of each clamp. The wiring diagram is shown in Figure 3, which also shows the filter boards. These still have to be described.

The two centre taps of the transformer (neutral/ground) are connected to one

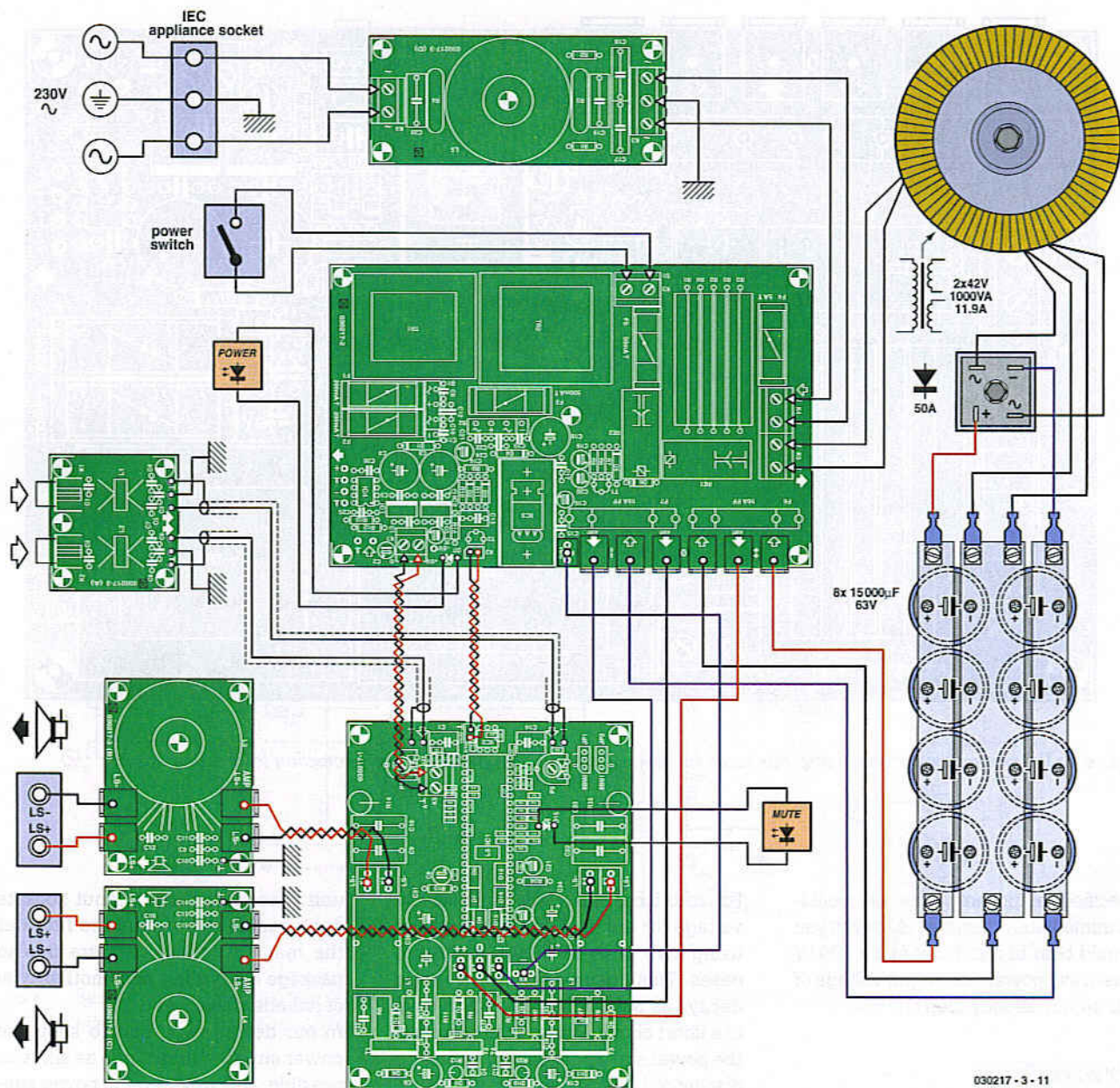

030217 - 3 - 11

Figure 3. The wiring diagram also shows the filters. Be sure to keep the connections as short as possible!

side of the common ground plate for the electrolytic capacitors, between the plus and minus leads from the bridge rectifier. In our design, the bridge rectifier is fitted to the side panel, which provides it with an adequate cooling surface.

On the opposite side of the electrolytic capacitors, the three power supply terminals (including neutral) are connected to the terminals on the power supply board marked with 'input' arrows. The four terminals for the supply voltages are thus available on the power supply board. The path to the amplifier board must be as short as possible. This also applies to the 10-V auxiliary voltage!

For the main supply voltage, stranded wire with a cross section of at least 4 mm^2 must be used. The mute signal for the amplifier is generated on the power supply board. It is connected to the amplifier board using a twisted pair of small-diameter stranded wires. The analogue supply voltage is connected to the amplifier board using a twisted pair of stranded wires (1.5 mm^2).

The mains voltage output from the power supply board is connected directly to the large toroidal transformer.

There is room to fit a small fan on the rear panel for internal cooling, if so desired. Try to route the cables for the

input signals as far away from the transformers as possible. The loudspeaker leads must be wired as a twisted pair for each channel to counter the effects of interference fields.

Alignment

The only alignment that is required is to adjust the dc offsets of the outputs, which can be done after the amplifier is assembled but should preferably be done during testing before final assembly. Naturally, the dc offset voltages must be set to zero. The offsets must be adjusted (using P1 and P2 on the amplifier board) with the amplifier

Two channels in bridge mode

If a stereo amplifier is to be used in bridge mode, the two channels must be supplied with signals having the same amplitude and opposite phases. To avoid having to change any connections or components on the amplifier board, a simple buffer circuit is provided on the power supply board. IC4a is wired as a voltage follower, and IC4b is configured as an inverting amplifier. This means that besides two decoupling capacitors for the supply voltages, only two opamps and two resistors are necessary. Since balanced supply voltages are used, no decoupling capacitors are required for any dc offsets that may be present at the inputs or outputs. Due to the simple design, small offset voltages may be present at the outputs, but the final amplifier is ac coupled and thus totally immune to such offsets.

For proper operation and low distortion, careful attention must be given to the polarity of the loudspeaker filter connections when the final amplifier board is operated in bridge mode. In this case, the amplifier is wired exactly the same as for stereo operation. Naturally, it's only necessary to build the input filter for a single channel. The output from the input filter goes to the buffer circuit on the power supply board (IC4). Two signals go from the buffer to the inputs on the final amplifier board. It goes without saying that these connections must be made using good-quality, screened audio cable. The two LS+ outputs from the loudspeaker filters form the speaker terminals of the bridge amplifier. As the return currents from the filters would have nowhere to go if the LS- outputs were left open, the two LS- outputs must be connected together. If the amplifier is used in bridge mode, it is essential to ensure that the amplifier outputs are not accidentally shorted together (due to incorrect wiring, for example).

switched on and operating in normal mode (not muted), with its rated load but without any drive signal.

In the mute mode without any load, the amplifier has an output impedance of approximately 10 k Ω . In this situation, there will be a small voltage on the output, but this does not have to be adjusted.

Besides adjusting the offset, the only other alignment is the dead-time setting for the MOSFET drive circuitry. This is determined by the positions of jumpers JP1 and JP2 (or BBM0 and BBM1). Set the dead time to 80 ns by setting JP1 to '1' and JP2 to '0'. There's no point in experimenting with other values. Using a larger value causes increased distortion, and using a

JP2 BBM1	JP BBM0	t ns
0	0	120
0	1	80
1	0	40
1	1	0

smaller value causes short-circuit currents to flow through the MOSFETs, which can be fatal for them.

All possible settings are listed in Table 1. The component overlay on the amplifier board also clearly indicates the proper positions of the jumpers.

Final remarks

There are a couple of things we still have to tell you. The first is that the amplifier can be used bridge configuration, as explained in the 'Two channels in bridge mode' text box. Another essential aspect is the measured performance, which is also described in a separate box. The measurements were made using the complete amplifier, which means including the filters. Unfortunately, there is not enough room to describe the filter circuits in this article. For the time being, you can also use the amplifier without the filters, but we strongly recommend including them in the overall system.

(030217-3)

Measured performance

The results described here were measured using a 1000-VA power supply transformer with two windings rated at 42 V / 11.9 A, together with two sets of four 15,000- μ F / 63-V electrolytic capacitors. The measurements were made using the fully assembled prototype. An additional 40-kHz passive second-order Butterworth filter with an air-core inductor was used for measuring intermodulation distortion and dynamic IM distortion.

Input sensitivity (2 \times 300 W / 4 Ω)

Input impedance

Sine-wave power (1 kHz / THD+N = 0.1 % / B = 22 Hz - 22 kHz)

Sine-wave power (1 kHz / THD+N = 1 % / B = 22 Hz - 22 kHz)

Sine-wave power in bridge mode

(1 kHz / THD+N = 1 % / B = 22 Hz - 22 kHz)

Bandwidth (via 9th-order elliptic filter with B = 180 kHz)

SNR (B = 22 Hz - 22 kHz)

Harmonic distortion (1 kHz)

(B = 22 Hz - 22 kHz)

1.13 V (THD+N = 1.5 %)

18.9 k Ω

2 \times 266 W / 4 Ω

2 \times 156 W / 8 Ω

2 \times 291 W / 4 Ω

2 \times 167 W / 8 Ω

600 W / 8 Ω

735 W / 6 Ω

2.4 Hz - 98 kHz (4 Ω / 1 W)

2.4 Hz - 122 kHz (8 Ω / 1 W)

> 68 dB (referred to 1 W / 4 Ω)

> 71 dB (referred to 1 W / 8 Ω)

< 0.04 %

< 0.03 %

< 0.02 %

2 \times 1 W / 4 Ω

2 \times 1 W / 8 Ω

2 \times 200 W / 4 Ω

2 nd harmonic alone	2 × 100 W / 8 Ω	< 0.02 %
	2 × 1 W / 4 Ω	< 0.01 % (THD+N = 0.037 %)
	2 × 10 W / 4 Ω	< 0.02 % (THD+N = 0.023 %)
	2 × 25 W / 4 Ω	< 0.025 % (THD+N = 0.026 %)
2 nd and 3 rd harmonics	2 × 100 W / 4 Ω	< 0.013 % (THD+N = 0.017 %)
	2 × 200 W / 4 Ω	< 0.015 % (THD+N = 0.018 %)
	1 W / 4 Ω	< 0.1 %
	1 W / 8 Ω	< 0.1 %
Intermodulation distortion (50 Hz : 7 kHz = 4 : 1)	300 W / 4 Ω	< 0.06 %
	150 W / 8 Ω	< 0.0 %
	1 W / 4 Ω	< 0.035 %
	1 W / 8 Ω	< 0.03 %
Dynamic IM distortion (3.15-kHz square wave with 15-kHz sine wave)	300 W / 4 Ω	< 0.025 %
	150 W / 8 Ω	< 0.01 %
	> 140	
	200 W / 4 Ω / 1 kHz	> 94 dB
Damping (8 Ω / 1 kHz)	100 W / 8 Ω / 1 kHz	> 100 dB
	200 W / 4 Ω / 20 kHz	> 77 dB
	100 W / 8 Ω / 20 kHz	> 77 dB

Besides these 'clinical' measurement figures, we have also recorded several curves. They probably give a better picture of the character of the amplifier, although ultimately only a listening test can provide a reliable conclusion.

Figure A shows the effect of the output filter (on the final amplifier board) on the amplitude response. The upper curve is measured with an 8-Ω load and shows a rise of +0.7 dB at 20 kHz and +4.6 dB at 70 kHz. Comparison with the measurement for 4 Ω clearly shows that the filter is optimised for 4 Ω, for which it exhibits an exemplary straight-line characteristic. The sudden sharp drop-off in the curve at the end of the measured range is due to the ninth-order elliptic filter used for this measurement.

Figure B shows THD+N versus output level for a bandwidth of 22 Hz to 22 kHz with a 4-Ω load. The rise in the middle of the curve (around 20 W) is partly due to the influence of the other channel (additional noise). All in all, the distortion over the entire output power range up to 200 W can be considered to be nicely constant. At levels above 200 W, distortion increases due to the additional modulation applied to the amplifier output. Here the amplifier exhibits behaviour that resembles soft clipping, but true limiting only occurs at around 300 W into 4 Ω. This is also strongly dependent on the strength of the power supply. An additional second-order filter was used for this measurement to slightly smooth the curve. Without this filter, the distortion is somewhat lower (e.g. 1 % at 291 W).

Figure C shows the maximum output power for loads of 2 × 4 Ω and 2 × 8 Ω. For 4 Ω, the distortion was held constant at 1 %, and for 8 Ω it was held constant at 0.5 %. Both measurements were made over a bandwidth of 22 Hz to 22 kHz. The power appears to increase starting at around 6–8 kHz, but this is naturally due to the fact that the filter suppresses harmonics above these frequencies. The curves should be drawn with a slightly dropping line starting at 5 kHz. The maximum power is slightly greater at low frequencies than at high frequencies. At 50 Hz it is approximately 163 W into 8 Ω or 306 W into 4 Ω, while at 1 kHz it is approximately 160 W into 8 Ω or 291 W into 4 Ω. The effect is thus slightly greater at lower impedance, but this is not perceptible in actual practice.

Finally, **Figure D** shows the frequency spectrum of a 1-kHz signal for 1 W into 4 Ω. This was measured using an additional 40-kHz second-order Butterworth filter in order to prevent HF noise in the A/D converter from affecting the FFT analysis. The second harmonic thus actually lies slightly below 80 dB (< 0.01 % distortion). No power-supply ripple or other irregularities are visible here. Despite the fact that a portion of the pulse-width modulation can be seen with 1 W at the output of the amplifier, the spectrum within the audio band can be considered to be quite clean. The small bump at 50 kHz does not require any comment.

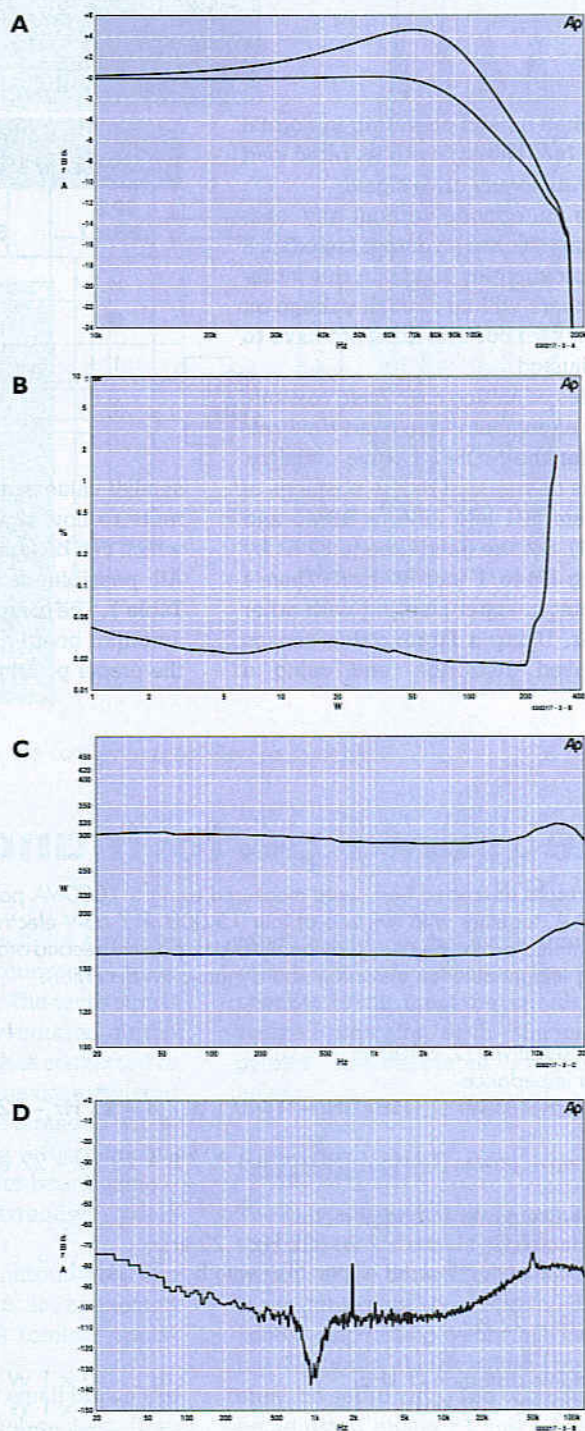

For rapid development of electronic systems...

EBLOCKS™

E-blocks are small circuit boards each of which contains a block of electronics typically found in an electronic system. E-blocks can be programmed in C, Assembly and are tightly integrated with Flowcode - which instantly converts flow charts into PICmicro code.

NEW



Low cost USB PIC programmers
(Starting at £27, model shown £55)

..plus a wide range of add-on boards and accessories...

.....plus incredibly easy to use software based on flow charts...

...equals extremely rapid system development: like this mobile text messaging system built from E-blocks.

...and solutions for learning and development...

Hands on training courses



training courses in PICmicro(R) programming, CPLD programming and ECAD

Resources for learning CPLD programming



Complete courses in electronics and programming



Equipment for datalogging, control and PC 'scopes

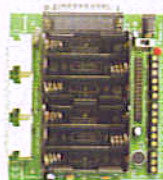

...and more at:



...see www.matrixmultimedia.co.uk

Matrix Multimedia Limited
sales@matrixmultimedia.co.uk
t. 0870 700 1831 f. 0870 700 1832

elektor
electronics
leading the way

New 2x300W Amplifier board with SMDs pre-fitted

This top-end amplifier proves that high power does not have to mean a large, heavy design. Although this amplifier is highly efficient (and thus compact), its specifications easily surpass those of quite a few conventional designs.

This 2 x 300 watt amplifier board has modest dimensions thanks to the use of SMD parts fitted at the underside. *Elektor Electronics* greatly simplifies building this project by offering the stereo amplifier board with all SMD parts already mounted, for just £34.50 (or US\$55.70)! Also included are the two toroid cores for the output filters.

More information on this powerhouse may be found in the June and September 2004 issues of *Elektor Electronics* magazine.

RRP £34.50
(US\$ 55.70)

A must-have for audio enthusiasts!

Order now using the Order Form in the Readers Services section in this issue.

Elektor Electronics (Publishing)
P.O. Box 190
Tunbridge Wells TN5 7WY England
Telephone +44 (0) 1580 200 657
Fax +44 (0) 1580 200 616

See also
www.elektor-electronics.co.uk

kitchen table

Slave Flash for Digital

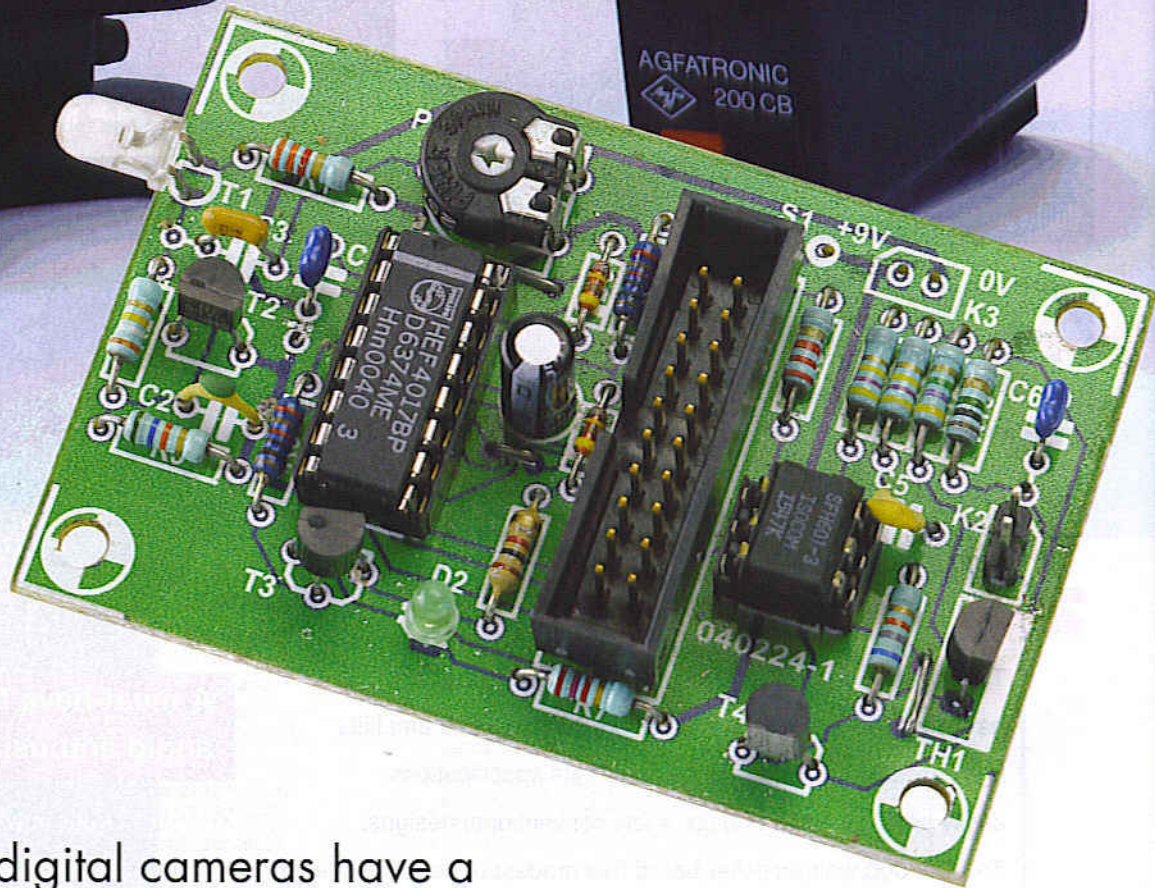
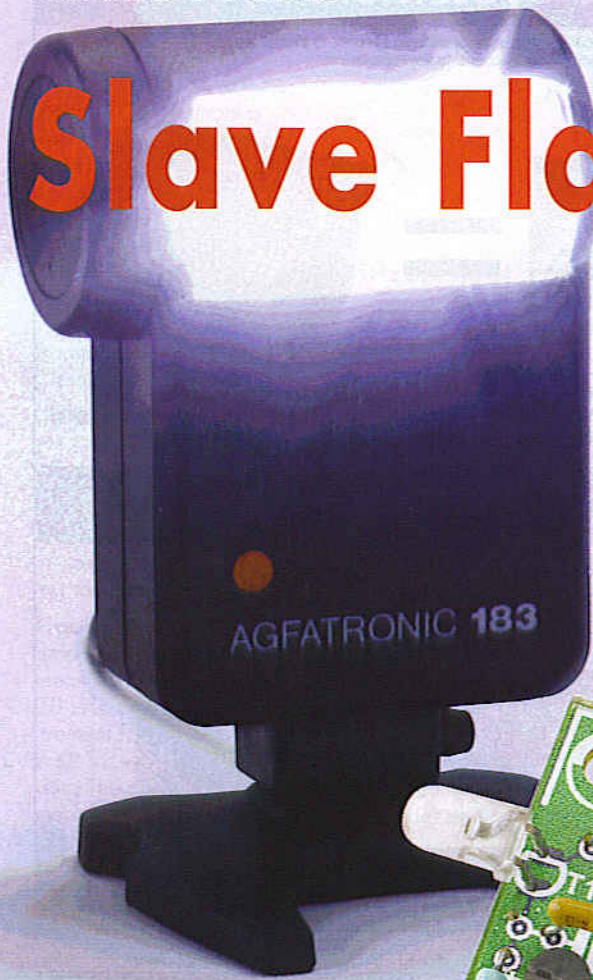

Udo Burret

Although most digital cameras have a built-in flash, a connection for an external flashlight is rarely seen. Still, on some occasions it's useful to have just a tad more light and that's why we propose a simple add-on.

Cameras

Don't throw away your old flashlight!

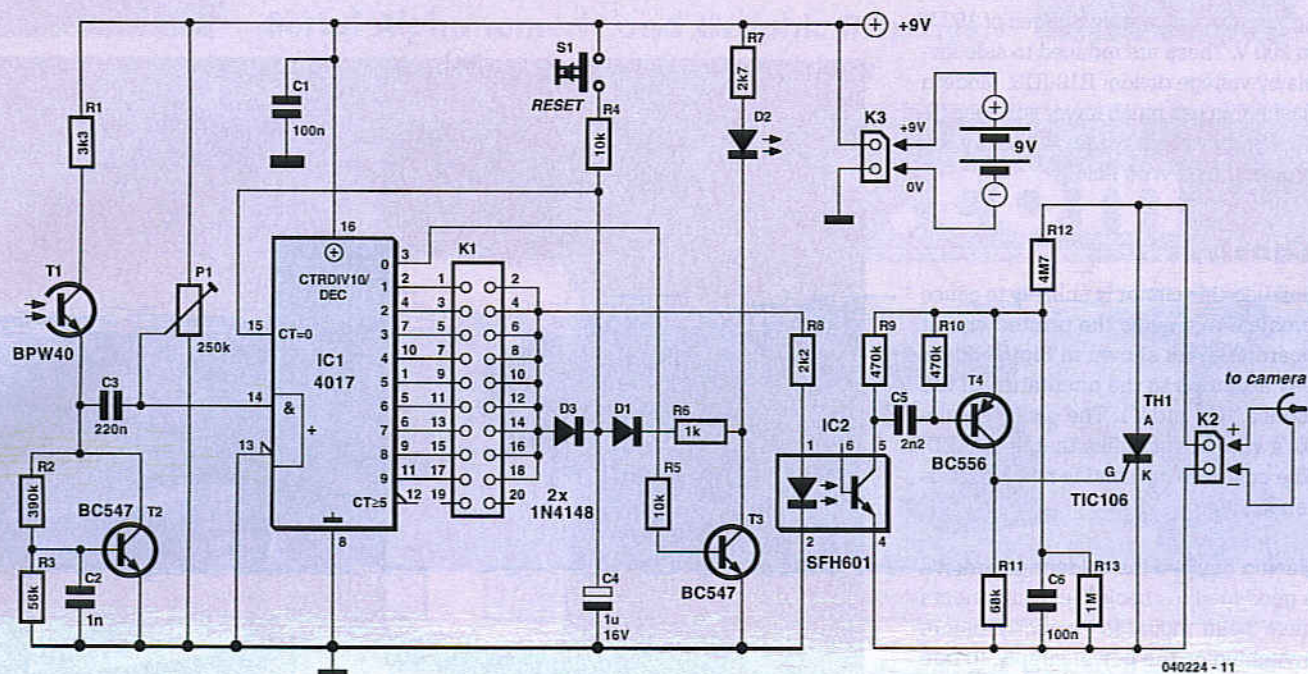

Figure 1. The circuit counts a user-defined number of flashes before firing a powerful external flashlight.

As many of you will be able to avow, the light capacity of the flash facility on low-cost digital cameras is often marginal if not insufficient. Problems typically occur where the object to be photographed is too far away, or if a (very) short shutter time is required. In those difficult cases, the slave flash we're about to describe may come in really useful.

The idea is simple: detect the flash from the camera and use it to trigger a powerful external flashlight with the aid of a thyristor.

A cursory look at the circuit diagram in **Figure 1** reveals that the practical side of things is rather more complex than you might have expected. In many cases, a digital camera supplies a short 'pre-flash' that serves, among

others, to adjust the white balance of the internal CCD (charge-coupled device) chip. Lots of cameras also feature 'red eye correction' where several pre-flashes cause the pupils of humans and certain animals to close to some extent. Some cameras supply just one pre-flash, others a whole series. Of course we do not want our slave flashlight to respond to these pre-flashes, else it would be triggered too early! This problem has been taken into account in the circuit design, which is in stark contrast with many off-the-shelf slave flash controllers.

Counting flashes

The author of the circuit employed an almost antediluvian design from Elek-

tor's 1979 Summer Circuits issue. With reference to Figure 1, phototransistor T1 detects the camera's flashes. The resulting pulses across C3 are applied to the clock input of decade counter IC1.

The circuit around T2 operates as a kind of zener diode, with C2 preventing instability owing to too rapid fluctuations of the 'zener' voltage. Without this precaution, the counter would run the risk of missing the odd pulse. The capacitor also eliminates any 100-Hz hum that may be picked up.

Switch S1 enables the circuit to be reset, causing output Q0 to go high and transistor T3 to switch on LED D2. With the LED on, the slave flashlight is ready for use. T3 also ensures that capacitor C4 is discharged and the

reset input of IC1 is returned to Low. At each light pulse on T1, the next output of IC1 will go high — Q1 on the first flash, Q2 on the second, and so on. A jumper or wire link on K1 allows you to select the flash that should actually trigger the slave flashlight. The LED in optoisolator IC2 is then switched on and C5 causes T4 to conduct briefly. This in turn causes thyristor Th1 to be fired and the terminals of connector K2 to be short-circuited briefly.

The optoisolator ensures that the flashlight voltage remains isolated from the (battery) supply of the rest of the circuit. The connections of older flashlights may well carry voltages of 150 V to 200 V. These are reduced to safe levels by voltage divider R12-R13. Modern flashlights use much lower voltages (5-10 V), in which case R12 may be replaced by a wire link.

Construction

Building this circuit is unlikely to cause problem if you use the printed circuit board artwork shown in **Figure 2**. Do pay attention to the orientation of the diodes, ICs and T1. The phototransistor's case is not unlike that of an LED. The collector terminal is near the flattened side.

Having finished the soldering work it's a good idea to check if all components have been mounted correctly before switching on the power supply. In rare cases D2 will light immediately when the supply is switched on as IC1 will randomly activate one of its outputs. However, D2 must come on in response to S1 being pressed briefly. Preset P1 allows the input signal for the decade counter to be adjusted. Some experimentation may be required before you find the optimum setting for P1:

- turn the wiper to the 'ground' extreme position.
- press S1
- slowly advance the wiper of P1
- stop when LED D2 goes out
- back off a little in the 'ground' direction

Finally, a note on hooking up the external flashlight: pin 1 of K2 — connected to the anode of Th1 and resistor R10 — should be taken to the centre contact of the flashlight socket.

(040224-1)

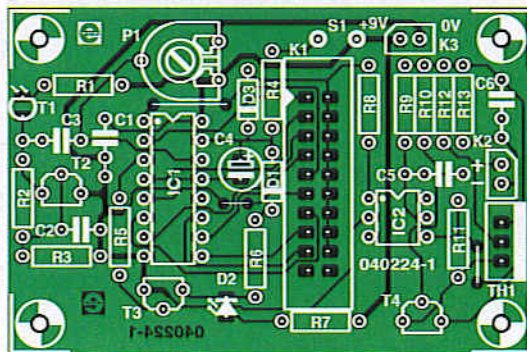

Figure 2. Once built up the circuit's sensitivity may be adjusted with the preset.



COMPONENTS LIST

Resistors:

R1 = 27k Ω
 R2 = 390k Ω
 R3 = 56k Ω
 R4, R5 = 10k Ω
 R6 = 1k Ω
 R7 = 2k Ω
 R8 = 2k Ω
 R9, R10 = 470k Ω
 R11 = 180k Ω
 R12 = 4M Ω
 R13 = 1M Ω
 P1 = 250k Ω preset

Capacitors:

C1, C6 = 100nF
 C2 = 1nF
 C3 = 220nF

C4 = 1 μ F 16V
 C5 = 2nF2

Semiconductors:

D1, D3 = 1N4148
 D2 = LED, 3 mm, low current
 T1 = BPW40
 T2, T3 = BC547
 T4 = BC557
 Th1 = TIC106
 IC1 = 4017
 IC2 = SFH601

Miscellaneous:

Bt1 = 9-V battery with clip-on lead
 S1 = pushbutton with 1 make contact
 K1 = 20-way boxheader with jumper, or a double-row pinheader (2 x 9) with jumper
 PCB, available from The PCBShop, ref. 040224.

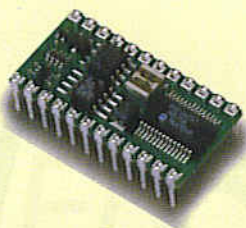

BS2-IC

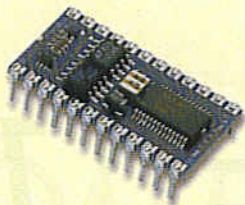

BS2-SX



BS2E-IC

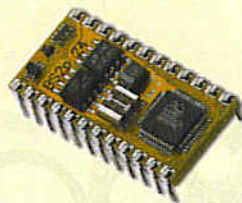

BS2P/24

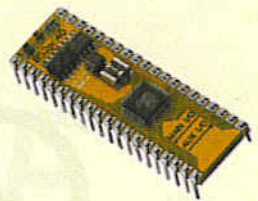

BS2P/40

Parallax BASIC Stamps - still the easy way to get your project up and running!

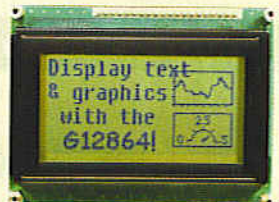
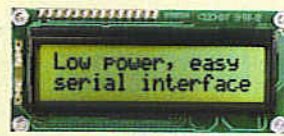
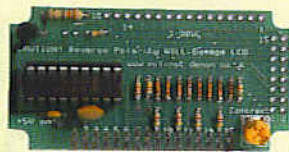

Serial Alphanumeric and Graphic Displays, Mini-Terminals and Bezel kits

www.milinst.com



Animated Head

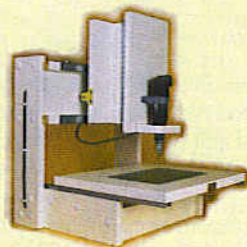

3-Axis Machine



Six-Legged Walkers

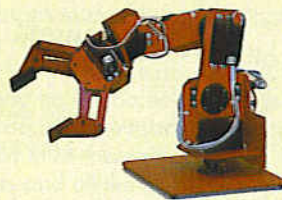

Robotic Arms



Bipeds

Robotic models for both the beginner and the advanced hobbyist

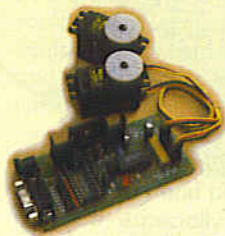

Servo Drivers

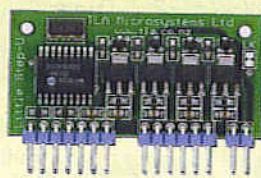

Motor Drivers



On-Screen Displays



DMX Protocol

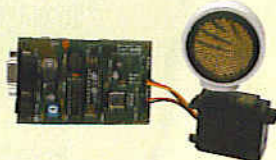

U/Sound Ranging

Animatronics and Specialist Interface-Control Modules



Quadvox MP3 & Speech Systems



SensoryInc Voice Recognition



Parallax Ubicom Tool Kits



Tech-Tools PIC & Rom Emulators



BASICMicro PIC BASIC Compilers

Development Tools

Milford Instruments Limited Tel 01977 683665, Fax 01977 681465, sales@milinst.com

200 CB

GOODBYE '16, V

meet the PIC18F series (part 1)

Ron Coates

MICROCHIP

PIC16F870/871

28/40-Pin, 8-Bit CMOS FLASH Microcontrollers

Devices Included in this Data Sheet:

- PIC16F870
- PIC16F871

Microcontroller Core Features:

- High performance RISC CPU
- Only 35 single word instructions to learn
- All single cycle instructions except for program branches which are two-cycle
- Operating speed: DC - 20 MHz clock input
DC - 200 ns instruction cycle
- 2K x 14 words of FLASH Program Memory
128 x 8 bytes of Data Memory (RAM)
64 x 8 bytes of EEPROM Data Memory
- Pinout compatible to the PIC16CXXX 28 and 40-pin devices
- Interrupt capability (up to 11 sources)
- Eight level deep hardware stack
- Direct, Indirect and Relative Addressing modes
- Power-on Reset (POR)
- Power-up Timer (PWRT) and Oscillator Start-up Timer (OST)
- Watchdog Timer (WDT) with its own on-chip RC oscillator for reliable operation
- Programmable code protection
- Power saving SLEEP mode
- Selectable oscillator options
- High performance CMOS FLASH

Pin Diagram

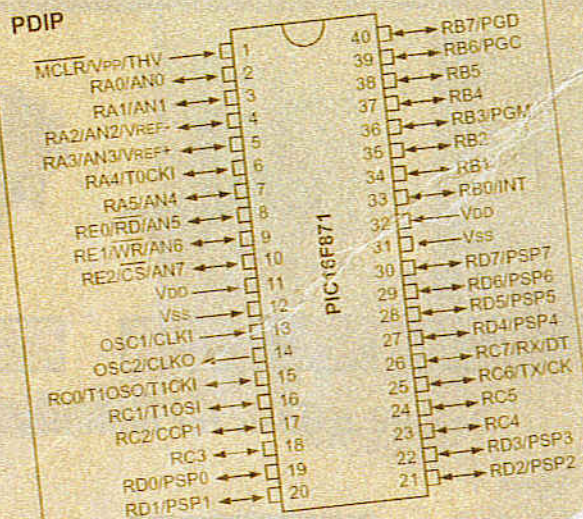

Peripheral Features:

- Timer0

Several articles using the PIC16 series of Microchip microcomputers have appeared in this magazine but so far there has been little or no

practical use of their more powerful cousins in the 18F series. The devices in the 18Fxx2 series of microcontrollers that has been recently introduced are pin for pin compatible with their predecessors from the 16F87x series and incorporate some significant improvements.

WELCOME PIC18F

In this first of two article instalments we look briefly at the main differences between the 16F and 18F series and in detail at the changes to the structure of the RAM (Data Memory). **Table 1** summarises the key features as compared to the 16F series.

There is an increase in ROM and large increase in RAM and this alone will justify their use for some people. But there are lots of other improvements too:

- Up to 40 MHz clock (compared to 20 MHz).
- Single cycle hardware multiplier.
- Long look up tables.
- Ability to write to Flash ROM during program operation.
- Many new instructions.
- Much improved addressing for both RAM and ROM.

Memory and its access

Among the main improvements over older PIC series is not only the larger amount of ROM and RAM but also the methods of addressing it. Before discussing this in detail we need to clear up some of the terms Microchip uses.

EEPROM is straightforward since it is never referred to as anything but EEPROM. EEPROM is non-volatile, and its contents may be modified not only during chip programming but also by the code executed by the PIC. EEPROM is also the area of memory that is best employed for the storage of user preferences. An example would be the display of a temperature measuring system that could be in Centigrade or Fahrenheit. If the variable that controls this is held in EEPROM, the user can change it and it will then be remembered, even when the power is turned off.

RAM and **Flash ROM** are referred to by Microchip as data memory and program memory respectively. Confusing, sure, especially on the PIC18F series as large blocks of data in the form of lookup tables would be stored in ROM. Data stored in RAM is lost when the PIC supply voltage is switched off. ROM data, on the other hand, is retained. Both RAM and ROM data may be changed by the running program. In the first application the author used an 18 series chip for, 12 k of ROM was used for data and less than 1 k for program. In this two-part article we will use the terms RAM and ROM for these areas of memory.

Table 2 shows the memory map for the RAM. When we access RAM directly, we only have one byte (the 'address byte') available to identify the location (address). Typically you would give your RAM locations — usually called registers — a name that relates to their general function and defines them at the start of your program, for example:

```
COUNT EQU 0x24
```

The 0x24 is the location (in hex) in the RAM and you only have a range of 256 possible locations. Since there

are far more than 256 bytes of RAM, a banking scheme has to be used to access them all. This was also the case in the PIC16 series but the arrangement in the PIC18 series is completely different.

There are potentially sixteen banks available, numbered from 0 to 15. Only banks 0, 1, 2 and 15 are implemented in the '242 or '442. The '252 and '452 have banks 3, 4 and 5 implemented as well. Bank 15 is used by the *Special Function Registers* so either three or six banks (768 or 1536 bytes) are available for general purpose registers. These banks can be selected using the *Bank Select Register BSR* but as we shall see, we would not normally need to worry about this.

Direct addressing

Direct addressing is much easier than with the PIC16F series and we've reasons to doubt if most programs will need to use banking commands at all.

As you will see from the memory map, the first half of bank 0 and the second half of bank 15 have been designated as the *Access Bank*. From reading the Microchip data sheet, you would think that this gave you 128 General Purpose Registers and all the Special Function Registers which you could access directly without using banking commands.

This would be good, but the reality is even better, since you can, in practice, use all 256 registers in bank zero and all the Special Function Registers without using banking commands and without running into conflicts. Since we just said above that you could only ever access 256 bytes without a banking command, how does this work? It works by using the access bit (a) to select either the access bank or the bank selected by the BSR.

Suppose we define a register call TESTREG as follows

```
TESTREG EQU 0x84
```

A look at the Special Function Register map will show you that 84 in the Access bank is Port E. You would think that a conflict would then exist between these, and indeed it could but for the way Microchip have defined the default value of the access bit.

Consider the following code:

```
MOVLW 02  
MOVWF TESTREG
```

```
MOVLW 04  
MOVWF PORTE
```

Although we have not used the access bit, these lines will be translated by the compiler as if we had written:

```
MOVLW 02  
MOVWF TESTREG, 1
```

```
MOVLW 04
```

Table 1. PIC16 vs PIC18F quick comparison

Type Code	Package	I/O (lines)	RAM (bytes)	FLASH ROM (bytes)	EEPROM (bytes)
16F873	28 pin DIL	22	192	4 k	128
16F874	40 pin DIL	33	192	4 k	128
16F876	28 pin DIL	22	368	8 k	256
16F877	40 pin DIL	33	368	8 k	256
18F242	28 pin DIL	22/23 *	768	8/16 k **	256
18F442	40 pin DIL	33/34 *	768	8/16 k **	256
18F252	28 pin DIL	22/23 *	1536	16/32 k **	256
18F452	40 pin DIL	33/34 *	1536	16/32 k **	256

* The extra output pin (RA6) can be implemented in place of the OSC2 pin where an external clock is used.
 ** See description of the Flash ROM for the explanation of these dual figures.

MOVWF PORTE, 0

For the first MOVWF command the access bit is 1 which means use the bank specified by the BSR, the default value of which is zero. The 02 will thus be put in location 0x084.

For the second MOVWF command the access bit is 0 which means use the access bank. The 04 will then be stored in 0xF84.

The clever bit is that we don't have to think about this at all, the compiler does it all for us, provided, of course, all the necessary 'declarations' (label and/or function statements) are present at the start of the program code. Don't worry if you don't fully understand all of the above, all that matters is that you can use all the General Purpose Registers you want from 00 to FF, and all the Special Function Registers that you need to, without having to worry about banking at all. If you need more than 256 registers, you should probably be using indexed addressing anyway.

Indirect addressing

If you thought, direct addressing was good, things get even better with indirect addressing. This is because we have a 12-bit number to use for addressing, giving us direct access to all 16 banks. After all, both 2^{12} and 16×256 equal 4,096.

First of all, there are now three FSR registers, FSRO, FSR1 and FSR2. Associated with these are three INDF registers.

For the purpose of this explanation we shall only talk about FSRO and INDF0 but exactly the same rules apply to the other two.

The big difference is that there is now an FSR0L (L= low) register which is an 8-bit register and is equivalent to the FSR register in the 16F series. We now also have an FSR0H (H= high) register of which only the lowest four bits are available, as these are all that are needed to address the sixteen banks.

By using these two registers together we can point to anywhere in the RAM memory space. Better still, if we are incrementing FSR0L, then when we get to 0FF and increment FSR0L again, FSR0L changes to 00 and FSR0H is automatically incremented so we can move seamlessly from, say, FF in bank 2 to 00 in bank 3. It gets better still because additional ways of manipulating indirect addressing have been introduced.

These are: (where *n* is 0, 1 or 2)

- INDF_n** Carries out the command to the indirect register and does nothing else. The same as the 16 series INDF.
- POSTDEC_n** As above, but after carrying out the command, the FSR is automatically decremented.
- POSTINC_n** After carrying out the command the FSR is incremented.
- PREINC_n** The FSR is incremented before carrying out the command.
- PLUSW_n** The value in the W register is used as an offset to the FSR. After the command both the FSR and W registers remain the same.

An example of the last of these commands would be:

```
INCF PLUSW0
```

If the value in FSRO was 0x023 and the value in W was 04, then the effect of the above command would be to increment the value in location 0x027. After the command the values in FSRO and W would be unchanged. Consider the following pieces of code which you should always use in the initialisation part of any program to clear the RAM.

Table 2. PIC18F RAM memory map

Bank no. /name	Address Range	Comment
0	000 – 0FF	00 – 7F is Access Bank
1	100 – 1FF	
2	200 – 2FF	
3 - 5	300 – 5FF	where implemented
6 -14	600 – EFF	not used
15	F00 – F7F	not used
Special Function Registers	F80 – FFF	(Access Bank)

All Greek to me

We can well imagine that this article is daunting to beginners. Much of the difficulty in making sense of articles on micro-controllers is the perplexing number of abbreviations used by manufacturers and died-in-the-wool programmers.

PIC	originally thought to mean Programmable Interface Controller but Microchip have since advised that the abbreviation is meaningless.
RAM	random access memory
ROM	read-only memory
DIL	dual-in-line
F	in PIC IC type codes, usually 'Flash'
EEPROM	electrically erasable programmable read only memory
BSR	bank select register
REG	register
SFR	special function register
GPR	general purpose register

For the 16F series we would have written:

```
        MOVLW    0x20
        MOVWF    FSR
NEXT    CLR      INDF
        INCF     FSR
        BTFSS   FSR, 7
        GOTO    NEXT
```

This segment of code starts at RAM location 0x20 (after the Special Function Registers) and clears each RAM location until 0x7F i.e. the whole of bank 1. Because 0x80-0x9F are Special Function Registers, you would have had to write similar separate segments for banks 2, 3 and 4.

For the PIC18F devices we can write

```
        LFSR     FSR0, 0x000
NEXT    CLRF    POSTINC0
        BTFSS   FSR0H, 0
        GOTO    NEXT
```

Examining this line by line, line 1 starts with a new instruction LFSR. You can put values in FSR0L and FSR0H separately using the normal MOVLW and MOVWF commands. However you can also initialise both registers at once using the LFSR command, followed by FSRO (or 1 or 2), then a comma followed by a three digit hex number. The first digit will go into the low byte of FSR0H and the other two into FSR0L. So the effect of our first line is to ensure that the FSR is pointing to the first register in our

RAM space.

The next line is a label, NEXT, followed by the familiar CLRF. The POSTINC0 operand would result in the register at location 000 being cleared and the FSR0 register then being incremented.

After the

```
GOTO NEXT
```

instruction the value in 0x001 will be cleared and this sequence will be continued until the

```
BTFSS     FSR0H, 0
```

command causes the program to jump out of the loop when the value in FSR0 reaches 0x100. The last memory location to be cleared will be 0x0FF.

With the PIC18F series, only four lines of code have cleared all 256 bytes of bank 0. To clear this much memory on the PIC16 series we would have had to repeat the six lines shown twice more for banks 1 and 2 making a total of eighteen lines.

Next month...

The next instalment will look at the improvements to ROM addressing and the implementation of long look up tables.

(040036-1)

Web pointer

PIC18F242/252/442/452 datasheet at
<http://www1.microchip.com/downloads/en/DeviceDoc/39564b.pdf>

Advertisement



Prototypes and small series up to 1000 pcs

Value for Money

Up to 6 layer boards

Always Available

Attractive price

www.ThePCBSHOP.com On-line Printed Circuit Boards

Double Sided, 1.6 mm,
Plated Through,
Green Solder mask,
Hot Air Level,
1 White Legend.
Price including
tooling + plotting + VAT

100 mm x 160 mm
1 pc = 45.74 Euro

100 mm x 80 mm
5 pcs = 68.97 Euro

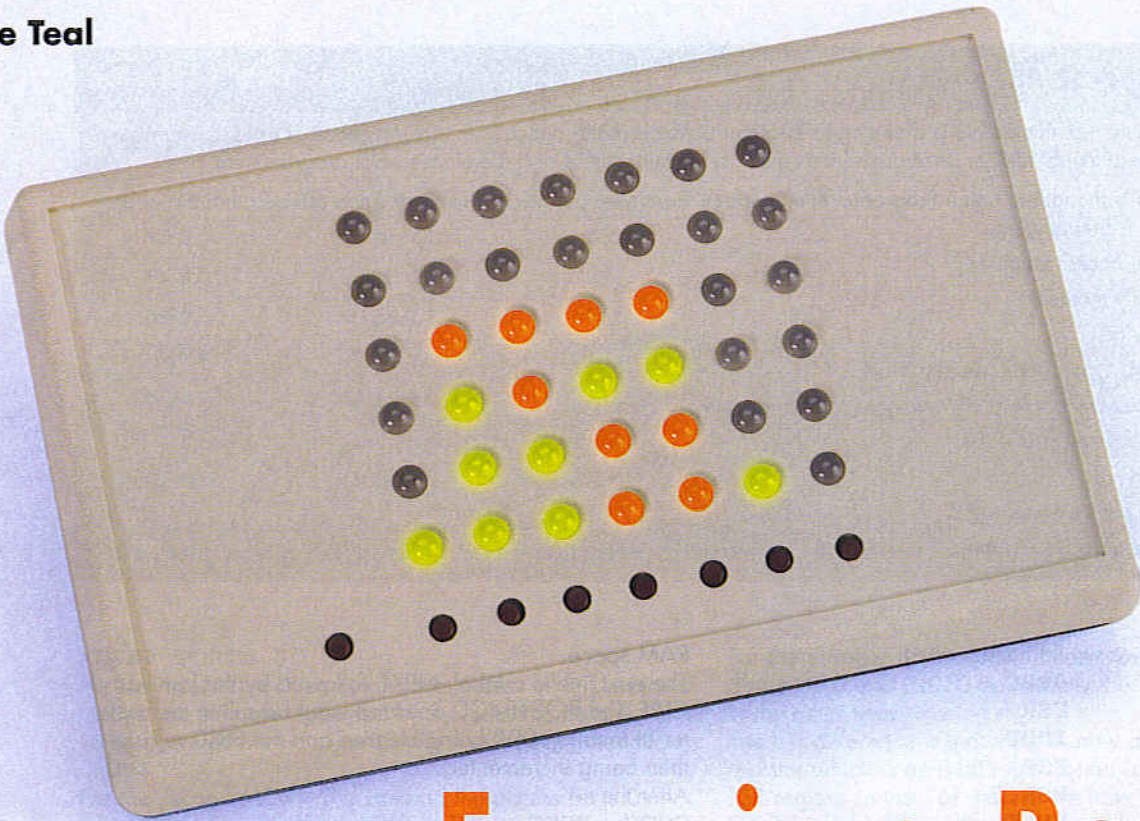

Four in a Row

Play against each other or against the micro!

With ordinary (board) games there is always the possibility that some parts get lost over time, such as playing pieces, cards or dice. An electronic version of the game obviously doesn't suffer from this. But this is not the only advantage that modern technology offers us.

Apart from playing against another human opponent you can also play against the microprocessor. A handy 'undo' function is included, which lets you correct any mistakes you made (usually some silly move!).

The game

First we'll explain the rules, just in case you're not familiar with them. Four in a row is normally played with two players, who each use different coloured discs. The players take it in turn to drop a disc into any of the columns of a frame. The first one who manages to get four of his discs in a row (horizontally, vertically or diagonally), wins. In

this instance the game can also be played against the microcontroller. There are several methods that can be used to implement an automatic opponent. A large number of examples can be found on the Internet. Most of these are based on Alpha-Beta algorithms and there is even one that uses an enormous table to search for the best move. The algorithm in our version isn't quite an Alpha-Beta one, but it still makes a very capable opponent. The automatic opponent can be turned on at any time. The micro will then make the next move. The play area is represented by a matrix of 42 bi-colour LEDs. The players drop a disc down a column using

the switches that are underneath each column. When 'four in a row' are detected the winning line will flash and the game is over. Every move made is also stored, so it is always possible to go back. This even works when a winning line flashes.

The circuit

The game is built round an AT90S2313 microcontroller by Atmel, which runs at 10 MHz. The circuit diagram is shown in **Figure 1**. As you can see, the LED matrix takes up most of the board. The 12 cathode lines are driven by IC2. This is a HEF4894B, a relatively new addition to the 4000B CMOS family. It

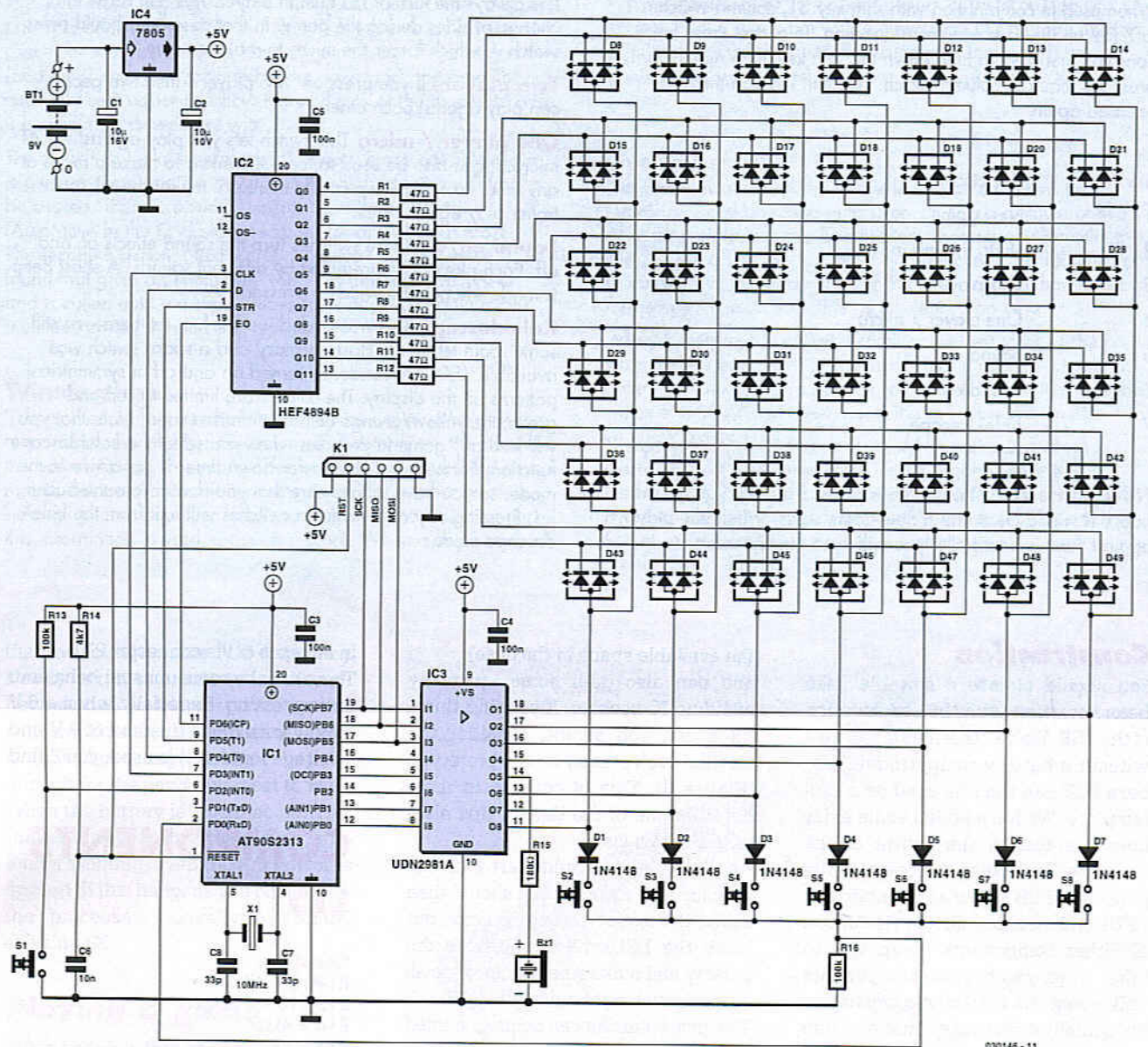

Figure 1. The circuit contains 42 bi-colour LEDs for the play area.

is a 12-channel serial to parallel shift register with open drain outputs. This IC was specifically designed as a LED driver and is therefore particularly suitable for our application. With this IC the use of common anode LEDs was the logical choice.

The LEDs are multiplexed. The columns are activated in turn, while the right rows are activated at the same time, making the required LEDs light up. The LEDs aren't very bright, but it's sufficient for indoor use. The current through the LEDs is limited to 20 mA, because the HEF4894B cannot sink more than that. Since they are multiplexed at a ratio of 1:7, the average current is only about 2 to 3 mA.

The anodes are driven by IC3, an 8-channel source driver that is connected to port B of the microcontroller.

The software goes through all the columns. Pin PB3 is skipped because this connects to the piezo buzzer. During the scanning of the columns a check takes place to see if a switch is pressed (see the sidebar). This uses a common return signal, which is connected to PD0 of the microcontroller. The extra diodes prevent more than one column becoming active when several switches are pressed.

The circuit contains a voltage regulator, so the power source can either be a 9 V battery or mains adapter. The maximum current consumption is

about 150 mA, so we would recommend that you use a 300 mA mains adapter.

The idle current of the circuit is 800 μ A. This is a bit too much to leave the circuit permanently powered by batteries, so an on/off switch is recommended. The circuit will also work with four AA cells and a diode instead of IC4. The idle current without a voltage regulator is only 1 μ A and an on/off switch is no longer necessary. This is feasible since the circuit goes into a sleep mode automatically when it hasn't detected any activity for a certain length of time. The memory contents are saved in this state and it is possible to resume a game again at any time.

Operation

When used in combination with shift key S1, column switches 1 to 7 (S2 to S8) have a different function. To access these functions you first have to hold down the shift key, then momentarily press the required column switch. The shift key can then be released again.

Switch	Function
1	New game
2	Undo the last move
3	Two players
4	One player / micro
5	Sound off
6	Sound on
7	Kaleidoscope

New game When this switch is pressed during a game, the board is wiped clear and a new game starts. When you play against the microcontroller you will have the first move.

Undo the last move Every move can be undone. If you press this switch repeatedly it is even possible to go right back to the beginning of a game. After you have gone back a move, it is always the turn of the human player. This can result in a change of sides during the game. In that case you should press switch 4, which forces the micro to make a move.

Two players If you press on 'two players' then two people can play against each other.

One player / micro This switch lets you play against the AT micro. It can also be used to force the micro to make a move at any time. Pressing it repeatedly therefore makes the microcontroller play against itself.

Sound on/off These switches turn the sound effects on and off. Each player is represented by different sounds. A short beep is made whenever a switch is pressed.

Kaleidoscope This was added just for fun, as there was still some room left in the Flash memory and a spare switch was available. LEDs are randomly turned on and off in symmetrical patterns on the display. The colours are limited to red and green; the yellow/orange combination isn't used. Note that you will lose any game in progress when you select the kaleidoscope function. Furthermore, the power-down timer is not active in this mode, so you have to take care that you don't drain the batteries. Pressing any of the column switches will exit from the kaleidoscope mode.

Construction

You should choose a suitable case before starting with the construction of the PCB. We've chosen a Pactec case without a battery compartment. The bare PCB can then be used as a drill template. We have added some extra holes for this in the centre of the switches. Try to keep the height of the populated PCB as low as possible. The LEDs and switches should rise above all other components. Keep this in mind when you buy the components and mount the electrolytic capacitors horizontally if necessary (first measure

the available space in the case).

You can also gain some space by avoiding IC sockets. If you find this a bit scary, you should consider the method we've used in our prototype (Figure 3). This is covered in more detail in one of the design tips elsewhere in this issue.

As always, you should start with the wire links on the PCB. You should then solder the rest of the components, but leave the LEDs till last. Check the polarity and make sure that they are all at the same height above the PCB.

The microcontroller can be programmed

in advance or via connector PL1.

There may be some unusual behaviour during testing. Especially when a 6 V supply with diode (instead of 9 V and a voltage regulator) is used, you'll find

COMPONENTS LIST

Resistors:

R1-R12 = 47Ω
R13, R16 = 100kΩ
R14 = 4kΩ
R15 = 180Ω

Capacitors:

C1, C2 = 10μF 16V radial
C3, C4, C5 = 100nF
C6 = 10nF
C7, C8 = 33pF

Semiconductors:

D1-D7 = 1N4148
D8-D49 = bi-colour LED (red/green) with common anode
IC1 = AT90S2313-10PC, programmed, order code **030146-41**
IC2 = HEF4894BP
IC3 = UDN2981A
IC4 = 7805 or 1N4004 *

Miscellaneous:

S1-S8 = miniature pushbutton, 1 make contact
BZ1 = 6V DC (active) buzzer
X1 = 10MHz quartz crystal
K1 = 6-way SIL header
Case, e.g., PacTec type HP
PCB, order code **030146-1**
Disk, contains source and hex code files, order code **030146-11** or Free Download

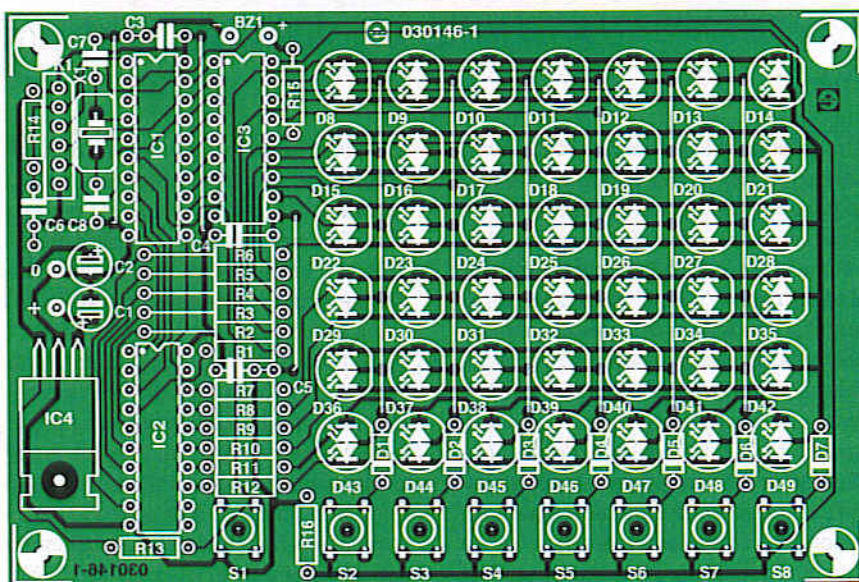

Figure 2. During construction you should keep in mind the limited height available in the case.

Algorithm

The 'best move' algorithm is the intelligence behind the computerised opponent. The algorithm that finally found its way into the processor was first tested extensively on the PC. The program (and the C code) are included in the download package. This code makes it easier to follow the workings of the algorithm and it is simpler to experiment with.

The algorithm looks several moves ahead. Every possible move is given a score and the move with the highest score will finally be chosen. There are two important functions: AVRMove (AutoMove in the C version) searches for any obvious moves. The second function, NextSearch, is called when no move is found that gives an immediate win. This function is recursive and is called until a winning move is found or a certain maximum search depth has been reached.

Winning lines

When a search has reached the maximum depth without finding a winning move, the NextSearch routine determines the state of the board. During this process the board is not considered as a matrix, but as 69 potential winning lines. The number of discs belonging to each player is counted for every possible line and this information is used to assign a score. When a line has discs

from both players, and can therefore never be a winning line, it is allocated a score of zero. The total score for player 1 is calculated by adding the scores of all possible lines and then subtracting the scores of the lines of player 2. The score for player 2 is the same, but with a minus sign in front of it. Next a small random value is added to the scores to give a bit of chance to the game and to reduce the possibility of identical games.

Optimisation

The search depth is limited to five levels, which means that NextSearch will be called recursively up to a maximum of five times after AVRMove has been called. Theoretically something like 20,000 discs can be played and removed. This requires a fair amount of processing power and time, and we have therefore made the search routine as efficient as possible.

When NextSearch is called it receives the best score of the previous search level. After NextSearch calculates a new score for a certain column, the scores are compared. Should the result be worse than the current best score, this search is broken off.

The danger here is that a move could be arrived at which is worse than the calculated score would suggest, since this method doesn't look at every possible combination of moves. To avoid a bad move as much as possible, the search is never broken of as long as it is at the first search depth.

that the voltage on the PCB drops very slowly after the battery is disconnected, due to the very low current consumption. One consequence of this is that the voltage doesn't drop far enough for the power-up reset to work when the battery is reconnected. This makes it appear as if the circuit is no longer working, even though power is applied. If this happens you could reset the processor manually by briefly shorting C6.

Playing a game

When power is first applied a diagonal line of burning LEDs moves across the play area. The default setting is for one player to play against the microcontroller.

When one of the switches underneath a column is pressed, a dropping disc is simulated. Next it is the micro's turn and after about a second it will make its move using the other colour.

Then it is the first player's turn again and this continues until one of the players has 'four in a row' (horizontally, vertically or diagonally), or until the board is full. Flashing LEDs shows a winning line. This is shown for about 12 seconds, after which a diagonal line of LEDs clears the board and a new game can be started.

When the playing field is completely full, without there being a winner, it becomes a draw. The game will stay in this state until a new game is started or the last move is undone.

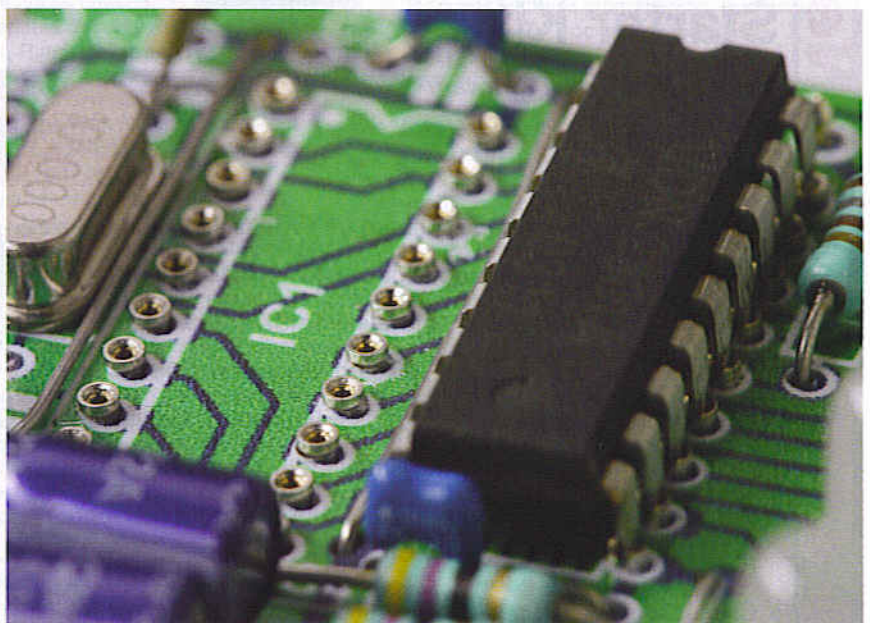
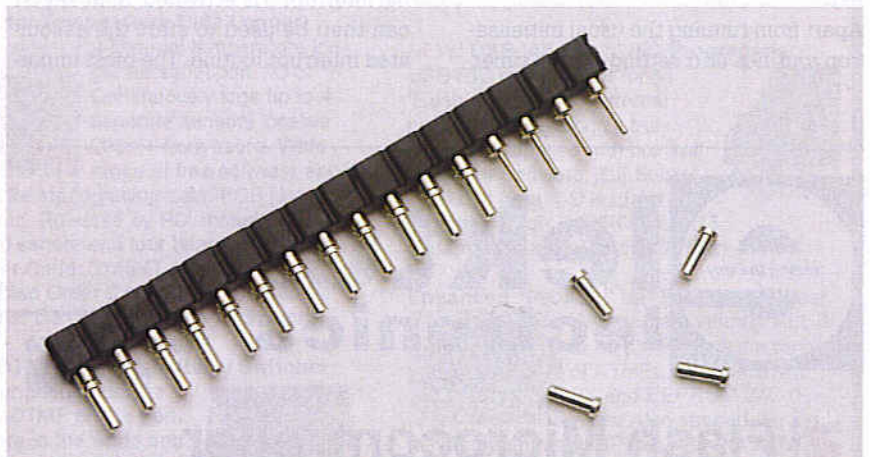

Figure 3. Homemade IC sockets keep the height limited.

If no switch is pressed for about a minute, the processor turns itself off. The shift key (S1) should then be used to turn the game on again. The game then carries on from where it left off previously. Should there be no active game in the memory the diagonal line moves across the board, indicating the start of a new game.

Software

The software for the microcontroller is written in assembler and developed using AVR Studio from Atmel. This is freely available from the manufacturer's website. Apart from the source code (found in the file 'inaline.asm'), you will also need an include file (2313def.inc), which is included as standard with AVR Studio.

Unfortunately, there is not enough room here to explain the workings of the software in detail, but we can give an overview of the more important routines. There is also a further explanation of the search algorithm in the sidebar.

Apart from running the usual initialisation routines and setting up the timer,

the processor also checks at switch-on if a game was still in progress. This is easily done by inspecting the value of the variable NEXT_MOVE. The value here holds the number of moves made, starting at zero. Therefore any value other than zero means that a game is still in progress.

The program checks continuously how many times the timer, which was set up at the start, has overflowed. Every time a switch is pressed the counter will be reset. This is how the program determines if it is time to turn itself off automatically.

Before the device is turned off, the processor first checks if a winning line is flashing. If that is the case, the board is cleared using the moving diagonal line of LEDs and the game is reset. The timer then has to run its course again before finally turning off.

Once the microcontroller is in its sleep mode there is not much that can wake it up again. It so happens that all internal clocks have been stopped. But just before the sleep mode is started, external interrupt 0 is activated. Shift key S1 can then be used to start the associated interrupt routine. The most impor-

tant task of this routine is of course to clear the bit for sleep mode in the control register of the microcontroller.

Strength of play

We've compared our program to several others on the Internet and of course to some human players as well. In general we found that our device plays quite well, especially when you compare the processor speed to that of a typical PC platform!

And finally we would like to draw your attention to the website of Keith Pomakis, www.pomakis.com/~pomakis/c4. Although there are numerous other sites about games such as four in a row and artificial intelligence, this site is one of the few which has a great example of a true Alpha-Beta game called 'connect 4'. Furthermore, the fully documented source code is freely available.

(030146-1)

Internet

www.atmel.com (AVR Studio)

Advertisement



£ 69.00 / US\$ 112.50
(plus postage)

New Flash Microcontroller Starter Kit

Elektor Hardware & Software

Contents of Starter Kit:

89S8252 Flash Microcontroller board (ready-assembled and tested PCB), 300-mA mains adapter, serial cable for COM port and a software bundle on CD-ROM. Article compilation on CD-ROM:

- 89S8252 Flash Microcontroller Board (December 2001)
- Microcontroller Basics Course parts 1-6 (January through June 2002)
- Microcontroller Basics FAQ (September 2002)
- Port Line and ADC Extension for 89S8252 Flash Micro Board (December 2002)
- Chess Computer using the Flash Micro Board.

Step into the fascinating world of microcontrollers

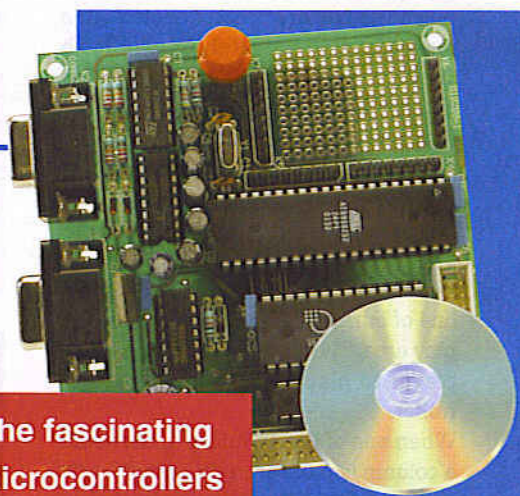

Order now using the Order Form in the Readers Services section in this issue.

Elektor Electronics (Publishing) P.O. Box 190
Tunbridge Wells TN5 7WY England
Telephone +44 (0) 1580 200 657
Fax +44 (0) 1580 200 616

See also
www.elektor-electronics.co.uk



Quasar Electronics Limited
PO Box 6935, Bishops Stortford,
CM23 4WP
Tel: 0870 246 1826
Fax: 0870 460 1045
E-mail: sales@quasarelectronics.com

Add £2.95 P&P to all UK orders or 1st Class Recorded - £4.95,
Next Day (Insured £250) - £7.95, Europe - £5.95, Rest of World - £9.95
(order online for reduced price UK Postage).
We accept all major credit/debit cards. Make cheques/PO's payable
to Quasar Electronics. Prices include 17.5% VAT.
Call now for our FREE CATALOGUE with details of over 300 kits,
projects, modules and publications.
MAIL ORDER ONLY.



QUASAR
electronics

0871

**CREDIT CARD
SALES**

717

7168

Helping you make the right connections!

Motor Drivers/Controllers

Here are just a few of our controller and driver modules for AC, DC, unipolar/bipolar stepper motors and servo motors. See website for full details.

DC Motor Speed Controller (5A/100V)

Control the speed of almost any common DC motor rated up to 100V/5A. Pulse width modulation output for maximum motor torque at all speeds. Supply: 5-15VDC. Box supplied. Dimensions (mm): 60Wx100Lx60H. Kit Order Code: 3067KT - £12.95
Assembled Order Code: AS3067 - £19.95

NEW! PC / Standalone Unipolar Stepper Motor Driver

Drives any 5, 6 or 8-lead unipolar stepper motor rated up to 6 Amps max. Provides speed and direction control. Operates in stand-alone or PC-controlled mode. Up to six 3179 driver boards can be connected to a single parallel port. Supply: 9V DC. PCB: 80x50mm. Kit Order Code: 3179KT - £9.95
Assembled Order Code: AS3179 - £16.95



PC Controlled Dual Stepper Motor Driver

Independently control two unipolar stepper motors (each rated up to 3 Amps max.) using PC parallel port and software interface provided. Four digital inputs available for monitoring external switches and other inputs. Software provides three run modes and will half-step, single-step or manual-step motors. Complete unit neatly housed in an extended D-shell case. All components, case, documentation and software are supplied (stepper motors are NOT provided). Dimensions (mm): 55Wx70Lx15H. Kit Order Code: 3113KT - £15.95
Assembled Order Code: AS3113 - £24.95



NEW! Bi-Polar Stepper Motor Driver

Drive any bi-polar stepper motor using externally supplied 5V levels for stepping and direction control. These usually come from software running on a computer. Supply: 8-30V DC. PCB: 75x85mm. Kit Order Code: 3158KT - £12.95
Assembled Order Code: AS3158 - £26.95



Most items are available in kit form (KT suffix) or assembled and ready for use (AS prefix).

Controllers & Loggers

Here are just a few of the controller and data acquisition and control units we have. See website for full details. Suitable PSU for all units: Order Code PSU445 £8.95

Rolling Code 4-Channel UHF Remote

State-of-the-Art. High security. 4 channels. Momentary or latching relay output. Range up to 40m. Up to 15 Tx's can be learnt by one Rx (kit includes one Tx but more available separately). 4 indicator LED's. Rx: PCB 77x85mm, 12VDC/6mA (standby). Two and Ten channel versions also available. Kit Order Code: 3180KT - £41.95
Assembled Order Code: AS3180 - £49.95



Computer Temperature Data Logger

4-channel temperature logger for serial port. °C or °F. Continuously logs up to 4 separate sensors located 200m+ from board. Wide range of free software applications for storing/using data. PCB just 38x38mm. Powered by PC. Includes one DS1820 sensor and four header cables. Kit Order Code: 3145KT - £19.95
Assembled Order Code: AS3145 - £26.95
Additional DS1820 Sensors - £3.95 each



NEW! DTMF Telephone Relay Switcher

Call your phone number using a DTMF phone from anywhere in the world and remotely turn on/off any of the 4 relays as desired. User settable Security Password, Anti-Tamper, Rings to Answer, Auto Hang-up and Lockout. Includes plastic case. 130x110x30mm. Power: 12VDC. Kit Order Code: 3140KT - £39.95
Assembled Order Code: AS3140 - £49.95



Serial Isolated I/O Module

PC controlled 8-Relay Board. 115/250V relay outputs and 4 isolated digital inputs. Useful in a variety of control and sensing applications. Uses PC serial port for programming (using our new Windows interface or batch files). Once programmed unit can operate without PC. Includes plastic case 130x100x30mm. Power Supply: 12VDC/500mA. Kit Order Code: 3108KT - £54.95
Assembled Order Code: AS3108 - £64.95



Infrared RC Relay Board

Individually control 12 on-board relays with included infrared remote control unit. Toggle or momentary. 15m+ range. 112x122mm. Supply: 12VDC/0.5A
Kit Order Code: 3142KT - £41.95
Assembled Order Code: AS3142 - £51.95

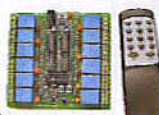

PIC & ATMEL Programmers

We have a wide range of low cost PIC and ATMEL Programmers. Complete range and documentation available from our web site.

Programmer Accessories:

40-pin Wide ZIF socket (ZIF40W) £15.00
18V DC Power supply (PSU010) £19.95
Leads: Parallel (LEAD108) £4.95 / Serial (LEAD76) £4.95 / USB (LEADUAB) £2.95

NEW! USB 'All-Flash' PIC Programmer

USB PIC programmer for all 'Flash' devices. No external power supply making it truly portable. Supplied with box and Windows Software. ZIF Socket and USB Plug A-B lead not incl. Kit Order Code: 3128KT - £29.95
Assembled Order Code: AS3128 - £39.95



Enhanced "PICALL" ISP PIC Programmer

Will program virtually ALL 8 to 40 pin PICs plus a range of ATMEL AVR, SCENIX SX and EEPROM 24C devices. Also supports In System Programming (ISP) for PIC and ATMEL AVRs. Free software. Blank chip auto detect for super fast bulk programming. Requires a 40-pin wide ZIF socket (not included). Available in assembled format only. Assembled Order Code: AS3144 - £54.95



ATMEL 89xxx Programmer

Uses serial port and any standard terminal comms program. 4 LED's display the status. ZIF sockets not included. Supply: 16-18VDC. Kit Order Code: 3123KT - £29.95
Assembled Order Code: AS3123 - £34.95



NEW! USB & Serial Port PIC Programmer

USB/Serial connection. Header cable for ICSP. Free Windows software. See website for PICs supported. ZIF Socket/USB Plug A-B lead extra. Supply: 18VDC. Kit Order Code: 3149KT - £29.95
Assembled Order Code: AS3149 - £44.95



www.quasarelectronics.com

Secure Online Ordering Facilities • Full Product Listing, Descriptions & Photos • Kit Documentation & Software Downloads

**No.1
3KITS**

FRUSTRATED!

Looking for ICs TRANSISTORS? A phone call to us could get a result. We offer an extensive range and with a world-wide database at our fingertips, we are able to source even more. We specialise in devices with the following prefix (to name but a few).



2N 2SA 2SB 2SC 2SD 2P 2SJ 2SK 3N 3SK 4N 6N 17 40 AD
 ADC AN AM AY BA BC BD BDT BDV BDW BDX BF
 BFR BFS BFT BFX BFY BLY BLX BS BR BRX BRY BS
 BSS BSV BSW BSX BT BTA BTB BRW BU BUK BUT BUW
 BUW BUX BUY BUZ CA CD CX CXA DAC DG DM DS
 DTA DTC GL GM HA HCF HD HEF ICL ICM IRF J KA
 KIA L LA LB LC LD LF LM M M5M MA MAB MAX MB
 MC MDAJ MJE MJF MM MN MPS MPSA MPSH MPSU
 MRF NJM NE OM OP PA PAL PIC PN RC S SAA SAB
 SAD SAJ SAS SDA SG SI SL SN SO STA STK STR STRD
 STRM STRS SVI T TA TAA TAG TBA TC TCA TDA TDB
 TEA TIC TIP TIPL TEA TL TLC TMP TMS TPU U UA
 UAA UC UDN ULN UM UPA UPC UPD VN X XR Z ZN
 ZTS + many others

We can also offer equivalents (at customers' risk)

We also stock a full range of other electronic components
 Mail, phone, Fax Credit Card orders and callers welcome

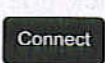

Cricklewood Electronics Ltd

40-42 Cricklewood Broadway London NW2 3ET
 Tel: 020 8452 0161 Fax: 020 8208 1441

PicoServ provides all that is required to enable an Internet web server to be integrated into your system or product, providing remote control and remote access via the Web or mobile phone



Simply Embed the Internet with PICO SERV

Creating a web browser or mobile phone based interface is simple using the modular PicoServ system.

The PicoServ web module takes care of

- Network interfacing
- Internet protocols
- Web page storage

PicoServ I/O modules provide simple analogue and digital interfaces to the real world and the SMS gateway module allows remote access using a mobile phone.

Basic HTML programming is all that is required for you to be rapidly in control of your system from anywhere!

Compulogic

Find out more...

www.compulogic.info

info@compulogic.co.uk

or call +44 (0) 1234 756048

- HOME AUTOMATION
- INDUSTRIAL AUTOMATION
- REMOTE SENSING
- REMOTE CONTROL
- ENVIRONMENTAL MONITORING
- ALARM MONITORING
- EMERGENCY CALL
- LOW COST
- LOW POWER
- SMALL SIZE



ECD (Edition 2)

Elektor's Components Database

RRP £12.95
 (US\$ 22.90)

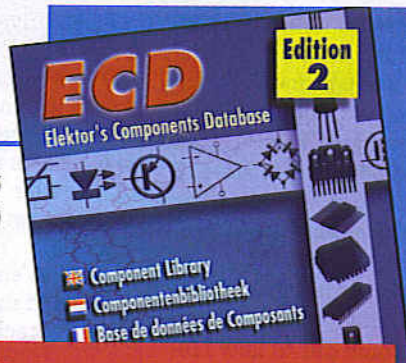

Now extended with even more ICs, transistors, FETs, thyristors and triacs!

The program package consists of four databanks covering ICs, transistors, diodes and optocouplers. A further nine applications cover the calculation of, for example, zener diode series resistors, voltage regulators, voltage dividers and AMVs. A colour band decoder is included for determining resistor and inductor values.

The ECD gives you easy access to design data for over 5,700 ICs, more than 35,000 transistors, FETs, thyristors and triacs, just under 25,000 diodes and 1,800 optocouplers.

All databank applications are fully interactive, allowing the user to add, edit and complete component data.

This CD-ROM (Windows XP compatible) is a must-have for all electronics enthusiasts.

Order now using the Order Form in the Readers Services section in this issue.

Elektor Electronics (Publishing)
 P.O. Box 190
 Tunbridge Wells TN5 7WY England
 Telephone +44 (0) 1580 200 657
 Fax +44 (0) 1580 200 616

See also
www.elektor-electronics.co.uk

USB Memory Stick

An ideal memory device

Harry Baggen

In no time at all, the USB Flash Drive or Memory Stick has become one of the most popular memory devices: small, robust, large capacity, no battery. Now that Elektor Electronics are offering a 128-MB USB Memory Stick as a welcome gift to new subscribers, it's high time your favourite electronics magazine told you how it works.

Really useful, such a USB Flash drive. It will fit in your trouser pocket, does not eat batteries and holds lots and lots of computer data. Around for a number of years already, this memory device has become incredibly popular.

So what's inside a Flash Drive and how does it work? Using our welcome gift to new (18-month) subscribers we'll tell you, with a note that the description is applicable to other brands and types, too. The photograph shows that there's precious little inside

a Flash drive. The main components are the Flash memory (the big back slice at the top side) and the controller (with this type, at the underside). There are also a couple of smaller SMD parts, a quartz crystal and an indicator LED signalling data access. A small slide switch is fitted at the side to provide write protection.

Two ICs

The block schematic structure of the two large ICs is shown in **Figure 1**. The Flash disk controller (here, an OTi-2168) is specially designed for this

sort of application. It contains a fast RISC core that handles the complete communication with the Flash memory, enabling the computer connected to the Flash drive to 'think' that a ordinary hard disk is connected to one of its USB ports. Furthermore, the OTi chip contains an integrated fast UB2.0 interface allowing the highest possible data speed of 480 Mbit/s to be achieved.

You may wonder why so much computing power is necessary. The answer is we're not just looking at serial/parallel

conversion but also at all the protocols that apply to accessing the Flash memory. Complying with a protocol and thus establishing communication with the Flash memory device over a number of I/O pins is radically different from driving a set of address and data pins on conventional RAM or EEPROM. The Flash memory is a 1024 Mbit (128 Mbyte) 'NAND' type from Samsung driven via eight I/O lines. The controller issues commands for reading, writing or erasing while also supplying the relevant addresses and data.



Changing the drive letter

Normally, Windows XP will automatically assign the next available drive letter in the system when a memory stick is plugged into a USB port for the first time. However, problems may arise in a network environment where access is granted to drives on another computer (like a server). In such cases, it may happen that the memory stick is assigned the same letter as one of the network drives, or is not 'visible' at all. Such problems may be prevented by assigning a

different drive letter to your memory stick. In the Start menu, go to **Settings/Control Panel/Administrative Tools**, and open **Computer Management**. In the left-hand area of the window, click on **Storage - Disk management**, this will make all available drives show up in the right-hand area. Find the USB memory stick and right-click on its symbol. Select **Change Drive Letter and Paths**, and assign a free letter to the drive, for example, Z.'



The block diagram gives a fair impression of the memory chip complexity — a lot of intelligence lurks inside the memory to make sure all processes run properly.

One of the main points to note with any Flash memory is reliability. Flash memory cells do not have eternal life as the odd cell may malfunction during operation. That's why an extensive internal error checking system is available (ECC, error correction code). With all operations, (read, write, but also erasure), the data integrity is checked. In case an error is found, it is corrected and the contents of the entire 'block' containing the error is copied to another, free, block in the memory.

The manufacturer claims a lifetime of 100,000 erasure and write cycles to the device. Data is held in the memory cells for at least 10 years.

How does a Flash memory work?

The basic construction of Flash memory is derived from

the EPROM. Each memory cell consists of MOSFET with two gates (Figure 2). A floating gate is 'inserted' between the control gate and the substrate of the FET. This floating gate employs an extremely thin layer of silicon dioxide hence forms a nearly perfect isolation, preventing electrons injected into the gate from leaking away when the supply voltage is switched off. The number of electrons present on the floating gate determines if a logic High or Low level is being stored. Cell programming and erasure is effected by applying a relatively strong field between gate and substrate, allowing electrons to travel across the isolation barrier. This process is called Fowler-Nordheim tunnelling. In the mean time, millions of USB memory sticks and cards have proved the reliability of Flash-based memory devices — they can be relied upon to keep your data secure for many years.

(040273-1)

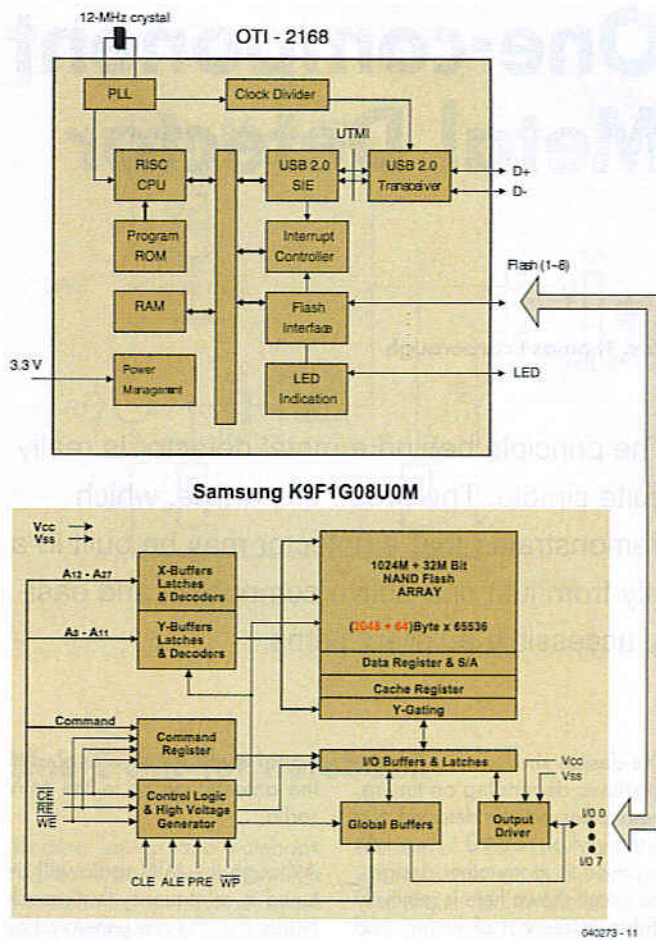

040273 - 11

Figure 1. Two complex ICs rule in a USB Flash drive: a dedicated microcontroller and a NAND Flash memory.

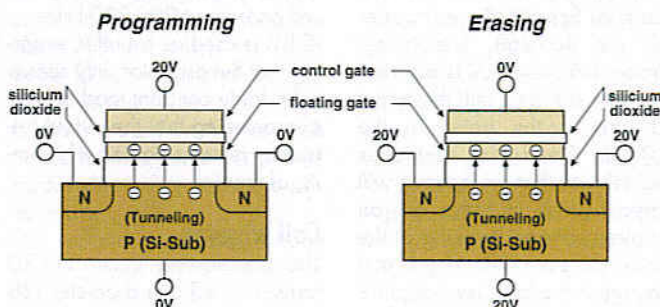

040273 - 12

Figure 2. Basic operation of a Flash memory cell (source: Toshiba).

One-component Metal Detector

Rev. Thomas Scarborough

The principle behind a metal detector is really quite simple. The proof: this article, which demonstrates that a detector may be built in a jiffy from just one active component and easily accessible auxiliary items.

The design shown here is quite sensitive: depending on tuning, metal coins may be detected at a distance of 80-90 cms. As opposed to many other designs, the circuit shown here is relatively stable in respect of tuning and therefore easy to use.

Operation

Just as with many other metal detectors, this instrument employs the BFO (beat frequency oscillator) principle. A tone is produced whose frequency is the difference between a variable and a reference oscillator. In this circuit, a pocket medium-wave radio is used for the frequency reference. The variable oscillator in the detector is built around a hex (six-fold) Schmitt trigger inverter IC, the 40106B. The homemade detection coil is inserted between the input and the output of one of the gates in the 40106. Electronics textbooks will tell you that an inductor will oppose fast changes in an applied voltage. Looking at the circuit diagram shown here, any change in the logic level at pin 2 of IC1.A will be delayed before it is copied to input pin 1. This delay will cause the circuit to start oscillating, and the resulting

signal is inductively coupled to the antenna on or in the MW radio.

Although the MW radio will be tuned to a frequency that's much higher than the one generated by the 40106 gate, the BFO principle works equally well with oscillator harmonics.

If metal is present in the vicinity of the coil, the inductance of L1 will increase or decrease, causing the oscillator frequency to drop or rise respectively. This effect is made audible via the radio's loudspeaker.

Depending on the make of the 40106 you're using the oscillator will operate at 200-300 kHz. IC1.B is used as a buffer, ensuring that the oscillator only sees a light, fairly constant load and so guaranteeing that the output frequency remains stable (within limits, of course).

Coil winding

The detection coil consists of 70 turns of 0.35 mm diameter (28 SWG) enamelled copper wire on a former with diameter of 120 mm. The construction of the coil is not critical. As you wind,

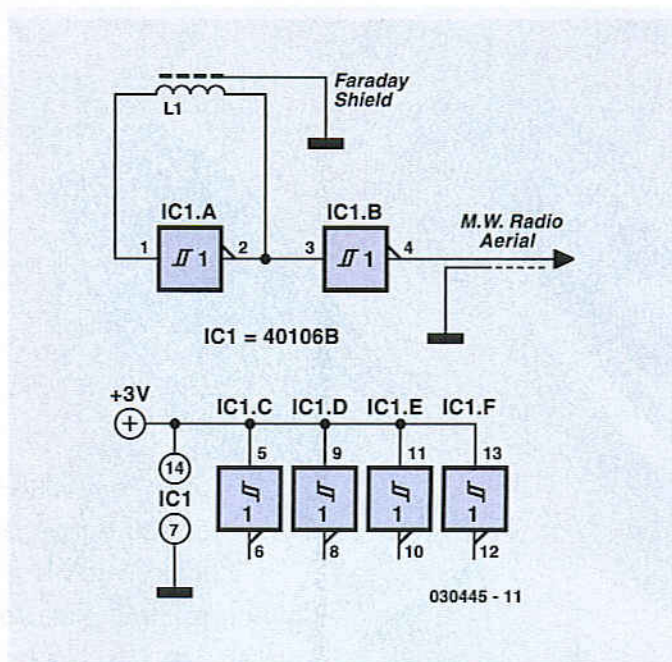

the turns may be held together with small pieces of sticky tape. Once the winding is complete, the coil has to be fully isolated with electrical tape. Keep the two inductor ends free, however.

Screening and connecting

Next, the coil has to be screened using a couple of strips of thin sheet metal. First wind approximately 100 mm bare copper wire around the isolated coil. This wire will be in electrical contact with the screening later.

The metal strips are now fitted around the coil, covering the bare copper wire. Although the screening has to cover the full circumference of the coil, a small gap of about 10 mm has to be allowed for, in other words, the start and end of each metal strip may not touch. Secure the screening with electrical tape.

Next, connect the coil ends to the circuit by means of screened microphone cable of undisputed quality. The order of the connections is not important, as long as you make sure the coil screen is connected to the cable screen (braid) and the circuit ground. Of course, the detection coil may

be given a professional look and finish using, for example, a disc and a handle.

Detection

Pin 4 of the 40106 IC has to be connected to the radio by way of screened cable. If the radio does not have a separate antenna input, feed the metal detector output to the whip antenna by means of a small croc clip.

Switch on the metal detector power supply, then the radio, and select the MW (medium-wave) range. Tune the radio until a loud whistle is heard.

The detector can distinguish between ferrous and non-ferrous metals. The first will cause the frequency to rise, the latter, to drop. There's room to experiment with the oscillator output frequency. This is easiest done by raising the supply voltage (max. 15 V).

(030445-1)

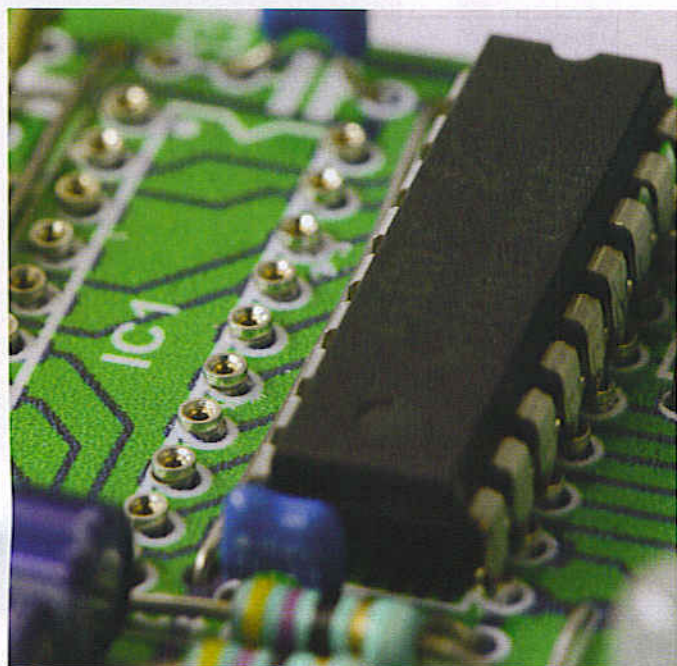

Ultra low-profile IC socket

Even if you have made something yourself you often want it to have a professional look. Also, if you know space constraints well before starting out on a project, it is perfectly possible to achieve nice looking results.

Size of a finished project often equates to 'as small as possible' so in many cases it is sufficient to make sure a circuit board takes up as little space as possible. SMD parts are then a logic choice but unfortunately not always. For example, devices may be available in conventional leaded cases only. Even more problematic are relatively expensive ICs like microcontrollers. To prevent damage during soldering, these precarious parts are preferably fitted in an IC socket, which will also prove invaluable when the IC needs to be replaced or programmed. Still, conventional IC sockets increase the height of the finished PCB and are therefore omitted in many cases.

Fortunately there's a relatively simple solution to this dilemma as with a bit of skill you can make an IC socket that adds very little

height indeed. The DIY socket employs individual receptacles supplied on a carrier strip, for example order code 739049 from Conrad Electronics. These are not the same as the SIL socket strips you can buy to make your own IC sockets. The device used here consists of a carrier with pins onto which round receptacles are secured. The carrier only serves to keep the receptacles aligned with the grid for IC pins.

The carrier is cut to size and the receptacles pushed into the PCB holes before they are soldered. Next, the carrier can be pulled off leaving the receptacles firmly seated in the board and acting like a very low profile IC socket. The empty strips are best discarded straight away as they can not be used to make further IC sockets. As we learned the hard way, ICs will not fit...

(040269-1)

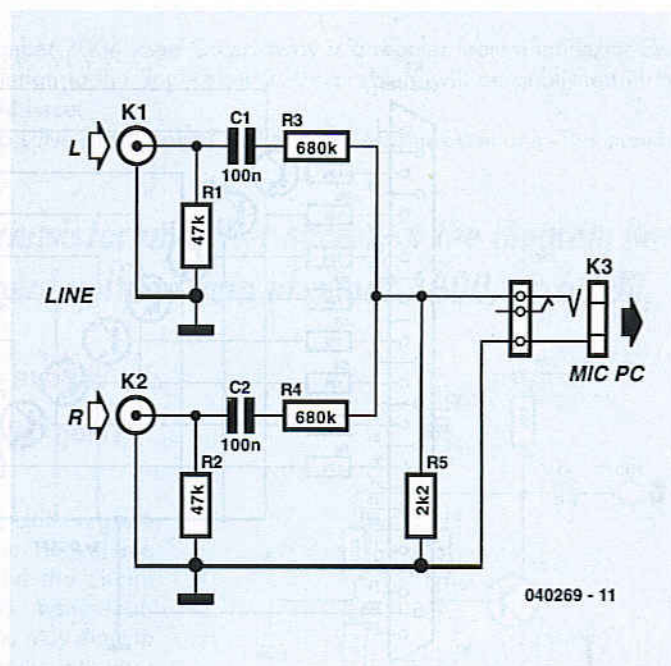

040269 - 11

Line-2-mic for notebook

Modern laptop and notebook PCs almost invariably come with a microphone input but not a line input for audio signals. A reader asked us for a simple circuit that would enable him to connect an audio line signal to the microphone input. We do like the easy ones! Because the microphone input is usually monaural, a stereo line signal requires not only attenuating but also summing to turn stereo into mono. A voltage divider comprising just three resistors (R3, R4, R5) does the job. A couple of measurements on a Creative SB Live! Soundcard showed that the microphone input can handle input signals up to about 15 mV when the 'Mic-boost' function was enabled. Levels exceeding 15 mV or so cause clipping. Based on this research we can only assume that soundcards in laptops respond in a similar way.

The calculation of the voltage divider is based on a line level of $2 \times 2 \text{ V}$ (as, for instance, from a CD player). R5 takes a value of $2.2 \text{ k}\Omega$ for a reasonable microphone impedance simulation. This results in an associated series

resistor of $680 \text{ k}\Omega$ which even affords some headroom to cope with slightly higher line levels. Two capacitors, C1 and C2, have been added to the circuit to afford decoupling of any bias voltages that may be supplied by the mic input for condenser microphones, as well as to prevent plops when the plug is inserted. R1 and R2 serve to keep the capacitors discharged as well as to lower the input impedance to the standard value of about $47 \text{ k}\Omega$.

For the inputs you may apply cinch sockets or a 3.5-mm stereo jack. If the microphone input on your PC is considerably less sensitive without Mic-boost of about 20 dB, (i.e., 10 times less) then the resistor values may be adapted. R3 and R4 take 10 times smaller values while the opposite applies to C1 and C2. To maintain a nominal input impedance of $47 \text{ k}\Omega$ R1 and R2 then need to be increased to $150 \text{ k}\Omega$.

This circuit is of course also perfect if you want to add an extra line input to a soundcard in a desktop PC.

(040269-1)

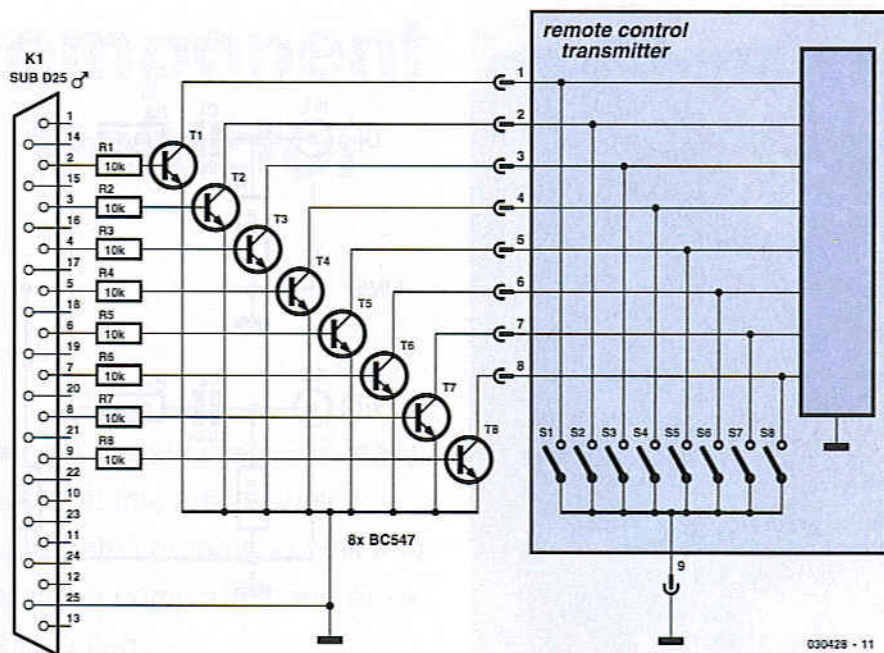

Figure 1. Eight resistors and eight transistors fit comfortably into the 25-way connector housing.

RF Control Interface

Parallel interface for remote appliance switching

Karl Köckeis

There are a number of 'home automation' systems available that use a hand-held RF control unit to switch household electrical appliances remotely. This article describes some simple interface hardware to link the control unit to your computer's parallel port and allow automatic control from your PC.

The vast majority of printers manufactured today connect to the USB port on your computer. This means that the parallel printer port is often left just gathering dust. The interface described in this article connects to the parallel port and uses very simple and inexpensive hardware to convert a commercially available RF appliance controller for automatic

control from a PC. The computer parallel port has an eight-bit wide data bus (D0 to D7) available on pins 2 to 9 of the 25-pin sub-D printer port socket. Each of these eight signals is used in this circuit to independently switch eight transistors. These transistors are in open-collector configuration and wired in parallel to the pushbuttons on a

commercially available control unit so that when the control software switches one of the transistors for approximately 0.5 s, it has the same effect as if that button were pressed manually. Resistors R1 to R8 serve to limit the transistor base drive current.

A standard printer cable (make sure the connectors are not the moulded-on type) is adapted to connect the PC to the remote control handset. The 25-way sub-D connector housing is first dismantled and each wire connection desoldered. Any cables not required can be clipped off to give more space inside the housing for the eight transistors and resistors. With reference to the circuit diagram, solder the eight resistors and transistors between the 25-way connector and the cable. Ensure that the finished assembly will fit inside the connector housing without shorting when it is reassembled. Next solder the 9-way sub-D connector at the other end of the cable. After testing, the connector covers can be reassembled.

It is necessary to fit a 9-way connector to the hand-held unit to provide a connection to the computer cable. Whenever manual operation is required it is a simple matter to just unplug the unit from the PC cable and use it as normal. The unit must be opened-up to fit the 9-way sub-D connector as shown in the circuit diagram. First locate the earth track on the PCB (the battery minus connection) and solder a wire connecting this point to pin 9 on the connector. Next identify the connections for the eight switches in the unit and solder eight wires to the PCB pads to connect these with the correct pins on the connector. The unit will be ready for use once the cables have been tidied and the unit reassembled. The connector will now be accessible via the battery compartment.

So much for the simple hardware, control software for the unit is also available and will be featured in an upcoming edition of *Elektor Electronics* so be sure not to miss out!

(030428-1)

QUIZZ'AWAY

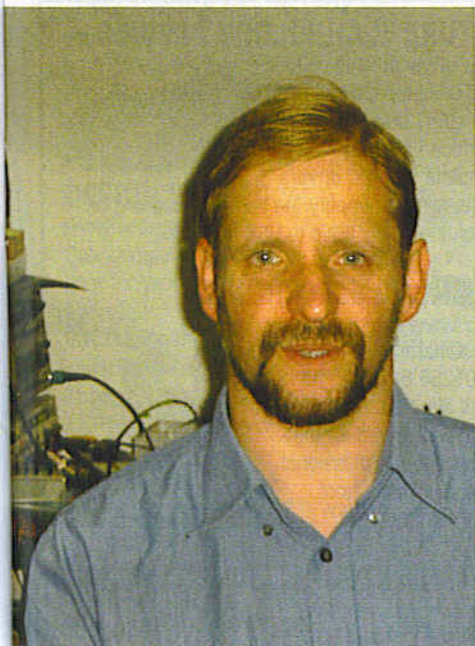

Martin Ohsmann is a Professor of Electrical Engineering and Information Technology at FH Aachen and a long-time contributor to Elektor Electronics. Through Quizz'away he aims at stimulating thought, speculation, construction and simulation as well as raise interesting questions.

As of the September 2004 issue Quizz'away is a regular feature in Elektor Electronics. The solution to the September 2004 problem will be published in the November 2004 issue.

The problems to solve are supplied by Professor Martin Ohsmann. This month's problem is:

The two-transistor amplifier shown in the diagram has a small-signal voltage gain of about 1800, or 65 dB.

How do you explain this extremely high gain?

If you doubt the claim regarding the high gain, do feel free to actually build the circuit and check its behaviour. Alternatively, you may want to enter the schematic into your electronics simulation program. Why is the gain so high, considering that a classic combination of a common-emitter and common-collector circuit typically supplies a gain of up to 200?

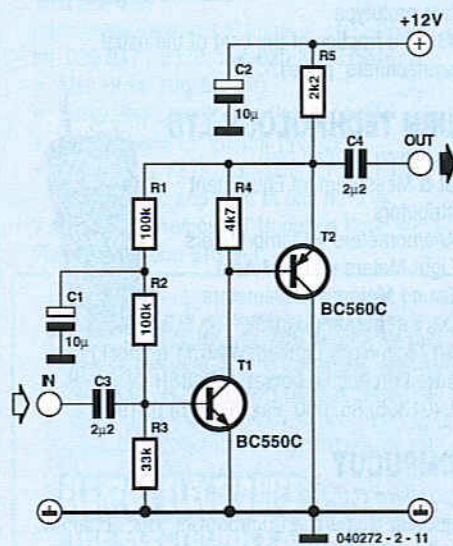

Quizz'away and win!

Send in the best answer to this month's Quizz'away question and win this **Flexipanel Bluetooth Module** worth \$100 (www.flexipanel.com).

All answers are processed by Martin Ohsmann in co-operation with Elektor editorial staff. Results are not open to discussion or correspondence and a lucky winner is drawn in case of several correct answers.

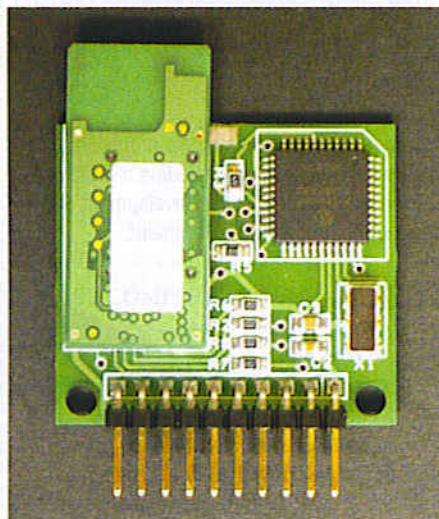

Quizz'away conditions

Please send your answer to this month's Quizz'away problem by email, fax or letter to:

Quizz'away, Elektor Electronics, PO Box 190, Tunbridge Wells TN5 7WY, England.

Fax (+44) (0)1580 200616.

Email editor@elektor-electronics.co.uk, subject: 'quizzaway 10-04'.

The closing date is 22 October 2004.

The outcome of the quiz is final. The quiz is not open to employees of Segment b.v., its business partners and/or associated publishing houses.

NET LINKS

To book your website space contact **Bernard Hubbard**

Tel 00 44 (0)1242 510760 Fax: 0044 (0)1242 226626

ALLGOOD TECHNOLOGY

www.allgoodtechnology.com

Low-medium volume sub-contract assembly. SMT specialist since 1990. Customers include military, aerospace etc. 0402 to BGA capabilities, automatic assembly and hand built prototypes.

BETA LAYOUT

www.pcb-pool.com

Beta layout Ltd Award-winning site in both English and German offers prototype PCBs at a fraction of the cost of the usual manufacturers' prices.



BURN TECHNOLOGY LTD

<http://www.burntec.com>

Test & Measurement Equipment Distributors

- Anemometers • Clamp Meters
- Light Meters • LCR Meters
- Sound Meters • Multimeters
- Device Programmers

Burn Technology Limited, Winfrith Technology Centre, Dorchester, Dorset, DT2 8DH
Tel: (01305) 852090 Fax: (01305) 851940



COMPUCUT

<http://www.compucutters.com>

Computer Numerical Control from your home PC. Great for tricky jobs, and accurate repetitive work. We supply: - Software - Interface - Manual - Support
Price £250 plus postage.

CONFORD ELECTRONICS

<http://www.confordelec.co.uk>

Lightweight portable battery/mains audio units offering the highest technical performance. Microphone, Phantom Power and Headphone Amplifiers. Balanced/unbalanced signal lines with extensive RFI protection.

DANBURY ELECTRONICS

<http://www.mc-h.demon.co.uk/transformers.html>

Here you will find our mains and output transformers in Mike Holme's range of valve/tube amplifiers (PP & SE). Also circuits, parts lists, chassis, advice.

DEBUG INNOVATIONS UK

<http://www.debuginnovations.com>

Introducing hassle free prototyping

- RF / Analogue
- High speed digital
- Surface mount
- 0.1" grid
- Power planes
- Unique patch architecture



Forget custom PCBs, start your project now!

EASYSYNC

<http://www.easysync.co.uk>

EasySync Ltd sells a wide range of single and multi-port USB to RS232/RS422 and RS485 converters at competitive prices.



ELEXOL PTY LTD

<http://www.elexol.com>

Developer and manufacturer of

- USB Development Modules.
 - USBMOD Series.
 - USBIO24 Digital Input/Output Module.
 - MP3 Solutions.
 - MP3MOD4 Module.
- Distributor inquiries welcome.



ELNEC

www.elnec.com

- device programmer manufacturer
- selling through contracted distributors all over the world
- universal and dedicated device programmers
- excellent support and after sale support
- free SW updates
- once a months new SW release
- reliable HW
- three years warranty for most programmers



ERVAN INTERNATIONAL CO.

<http://www.ervan-int.com>

Power Electronics and Solar Energy Design and Consultants. Also offers;

- Discount prices of:
- Ultra Bright LEDs
 - PCB LED Cluster Kits
 - Laser Pointers
 - Solar Modules
 - Batteries

FOREST ELECTRONIC DEVELOPMENT

<http://www.fored.co.uk>

FED supply PIC programmers, Basic modules, and development software including a PIC C Compiler, Prog 'n Drop Visual Development and a well featured debugging environment.

FUTURLEC

<http://www.futurlec.com>

Save up to 60% on

- Electronic Components
- Microcontrollers, PIC, Atmel
- Development Boards, Programmers

Huge range of products available on-line for immediate delivery, at very competitive prices.



FUTURE TECHNOLOGY DEVICES

<http://www.ftdichip.com>

FTDI designs and sells USB-UART and USB-FIFO interface i.c.'s.

Complete with PC drivers, these devices simplify the task of designing or upgrading peripherals to USB

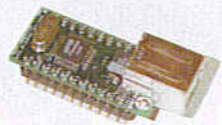

HAMMOND ELECTRONICS

<http://www.hammondmfg.com>,

sales@hammond-electronics.co.uk

tel: 01256 812812.

Small die-cast, plastic and metal enclosures for the hobbyist and professional. Widely available from major distributors.



IPEVA LIMITED

<http://www.ipeva.com>

IPEVA sell low cost USB FPGA development boards. IPEVA provide Design Consultancy for Embedded Systems, OpenCores-IP, FPGA, ASIC, HDL translation and migration. Tel. 0870 080 2340



KOMCARD

<http://www.komcard.com>

Learn how to design a PCI card, and write a PCI device driver. We lead you step by step with practical PCI projects you build.

LONDON ELECTRONICS COLLEGE

<http://www.lec.org.uk>

Vocational training and education for national qualifications in Electronics Engineering and Information Technology (BTEC First National, Higher National NVQs, GCSEs and Advanced Qualifications). Also Technical Management and Languages.

MQP ELECTRONICS

<http://www.mqpelectronics.co.uk>

Leaders in Device Programming Solutions.

- Online shop
- Low Cost Adapters for all Programmers
- Single Site and Gang Programmers
- Support for virtually any Programmable Device



NEW WAVE CONCEPTS

<http://www.new-wave-concepts.com>

Software for hobbyists:

- Livewire circuit simulation software, only £29.36
- PCB Wizard circuit design software, only £29.36

Available from all Maplin Electronics stores and www.maplin.co.uk



PCB WORLD

<http://www.pcbworld.org.uk>
World-class site: Your magazine project or prototype PCB from the artwork of your choice for less. Call Lee on 07946 846159 for details. Prompt service.

PEAK ELECTRONIC DESIGN LIMITED

www.peakelec.co.uk
Cool component test gear for your passives and semis. Instant identification, measurement and validation. Connect anyway round. The Peak Atlas family starts from £59.



PHYZX

<http://www.phyzx.co.uk>
Automatically NC Drill PCBs yourself

- Accurately
- Repeatably
- Mains operated
- Robust Steel Construction
- Directly from file
- Full XYZ RS232 Control
- Including Accessories
- Complete system Under £500

PICDOS™

<http://www.picdos.com>
Hard disk, DOS & files on PIC16F877. SmartMedia™ based. No complex hardware just wires. Run-Debug existing PIC code & interrupts. Free schematics, software, debugger



QUASAR ELECTRONICS

www.QuasarElectronics.com
Over 300 electronic kits, projects and ready built units for hobby, education and industrial applications including PIC/ATMEL programming solutions. Online ordering facilities. Tel: +44 (0) 870 246 1826 Fax: +44 (0) 870 460 1045 Email: sales@QuasarElectronics.com



ROBOT ELECTRONICS

<http://www.robot-electronics.co.uk>

- Ultrasonic rangefinders
- Motor H-Bridge controllers
- Magnetic Compasses
- RC servos and controllers
- PIC programmers and components
- Electronic Design/Development and Manufacturer to industry



TECHNOBOTS

<http://www.technobots.co.uk>
Welcome to Technobots - the one stop shop specially for the remote operated robot builder, radio control and engineering hobbyist.



TELNET

<http://www.telnet.uk.com>
The site shows graphically Telnets wide range of quality second-user test and measurement equipment, including oscilloscopes and spectrum analysers.



ULTRALEDS

<http://www.ultraleds.co.uk>
tel: 0871 7110413
Large range of low cost Ultra bright leds and Led related lighting products. Major credit cards taken online with same day despatch.



USB INSTRUMENTS

<http://www.usb-instruments.com>
USB Instruments specialises in PC based instrumentation products and software such as Oscilloscopes, Data Loggers, Logic Analysers which interface to your PC via USB.

VIEWCOM

<http://www.viewcom.f9.co.uk>
tel: 020 8471 9338 fax: 020 8552 0946

- Mail Order supplier of:
- Integrated Circuits and Components.
- Kit and parts for Elektor projects.
- Transistors, FETs, Capacitors, Resistors, Crystals, etc and hard to find devices.

Viewcom Electronics, 77 Upperton Road West, Plaistow, London E13 9LT

ELECTRONIC ENTHUSIASTS

Only one magazine tests its projects and circuits in its own lab before publication -

ELEKTOR ELECTRONICS
THE ELECTRONICS & COMPUTER MAGAZINE

SUBSCRIBE TODAY!

Contact: Worldwide Subscription Service Ltd,
Unit 4 Gibbs Reed Farm, Pashley Road,
Titchhurst TN5 7HE
Telephone: (+44) (0) 1580 200657
Fax: (+44) (0) 1580 200616
Or visit our Website:
www.elektor-electronics.co.uk

PROMOTE YOUR WEBSITE HERE

Elektor Electronics have a feature to help customers to promote their websites, Net Links - a permanent feature of the magazine where you will be able to highlight your site on a regular basis.

- For just £120 + VAT (£10.90 per issue for eleven issues) Elektor will publish your company name, a 25-word description and your website address.
- For £300 + VAT for the year (£27.27 per issue for eleven issues) we will publish the above plus run a 3cm deep full colour screen shot from your site.

Places are limited and spaces will go on a strictly first come, first served basis, please fax back your order today!

I wish to promote my company, please book my space:

- Text insertion only for £120 + VAT • Text and photo for £300 + VAT

NAME: ORGANISATION:

JOB TITLE:

ADDRESS:

TEL:

PLEASE COMPLETE COUPON BELOW AND FAX BACK TO 00-44-(0)1242 226626

COMPANY NAME

WEB ADDRESS

25-WORD DESCRIPTION

.....

.....

Please Note

Software items marked @ are available from the Free Downloads page of the Publishers' website at www.ellektor-electronics.co.uk. Diskettes are supplied for the convenience of readers without Internet access.

READY-BUILT PROJECTS

	£	US \$
Clarity 300-W Class-T Amplifier		
030217-91 Amplifier board with SMDs pre-fitted; cores for L1 & L2	34.50	55.70
Flash Microcontroller Starter Kit		
010208-91 ready-assembled PCB incl. software, cable, adapter & related articles	69.00	112.50
Gameboy Digital Sampling Oscilloscope (GBDSO)		
990082-91 ready-assembled board, incl. the PC software and related articles	90.00	160.00
Micro Webserver with MSC1210 Board		
030060-91 Microprocessor Board, ready-assembled	69.00	112.50
044026-91 Network Extension Board, ready-assembled	41.95	73.95
044026-92 Combined package (030060-91 & 044026-91 & related articles)	103.5	184.95

EVERGREENS

Elektor Electronics Help Disk		
966022-1 Disk, Windows version	8.15	14.45
Elektor Electronics Item Tracer 1985-2003		
046003-11 contents database (disk, Windows version)	8.15	14.35
Universal Prototyping Boards		
UPBS-1 PCB	2.45	4.30
UPBS-2 2 PCBs	4.10	7.25
UPBS-4 4 PCBs	6.55	11.55

No. 336 OCTOBER 2004

Clarity 300-W Class-T Amplifier		
@ 030217-2 PCB	15.90	28.10
Four in a Row		
@ 030146-1 PCB	13.15	23.25
@ 030146-11 Disk, source & hex code	4.90	8.65
030146-41 AT90S2313-10PC, programmed	7.40	13.10

No. 335 SEPTEMBER 2004

Rolling Dice		
@ 040248-1 PCB set (6 sides)	13.75	24.30
@ 040248-11 Disk, source & hex files	4.90	8.65
@ 040248-41 AT89C2051-12PI, programmed	8.70	15.40
Swiss Army Knife		
@ 030448-1 PCB set: MCU, RS232, USB	9.50	16.80
@ 030448-11 Disk set (a+b), all project software	6.50	11.50
030448-41 AT89S8252-24PC, programmed	25.65	45.75

No. 334 JULY/AUGUST 2004

IR Servo Motor Interface		
@ 020356-11 Disk, RCX program and PIC source & object code	4.90	8.65
020356-41 PIC16F628, programmed	10.00	17.70
020356-42 PIC16F628, programmed	10.00	17.70
Micro Webserver with MSC1210 Board		
@ 044026-1 Network Extension Board, PCB only	10.45	18.50
R/C Analyser		
@ 030178-11 Disk, PIC source code	4.90	8.65
030178-41 PIC16F627-4/CP, programmed	10.25	18.15
USB Converter Controlled via HTML		
@ 044034-11 Disk, example programs	4.90	8.65
Working with ActiveX		
@ 030431-11 Disk	4.90	8.65

No. 333 JUNE 2004

Multi Programmer		
@ 020336-1 PCB	8.80	15.60
@ 020336-11 Disk, firmware & source code	4.90	8.65
Pocket Pong		
@ 030320-11 Disk, PIC software	4.90	8.65
Rail Router		
@ 030403-1 PCB	10.80	19.15
@ 030403-11 Disk, PIC & PC software	4.90	8.65
030403-41 PIC16F877-20/P, programmed	21.45	37.95
Smooth Operator		
@ 030209-11 Disk, PIC software	4.90	8.65
030209-41 PIC16F84-10P, programmed	14.70	26.00

No. 332 MAY 2004

Design Your Own IC		
@ 030385-1 PCB	15.65	27.70
High-End Preamp		
@ 020046-1 PCB — main board	8.45	14.95
@ 020046-2 PCB — relay board	7.50	13.30
@ 020046-3 PCB — PSU board	6.70	11.85
@ 020046-11 Disk	4.90	8.65
020046-41 PIC18LF452-V/L, programmed	28.20	49.90

GENERAL

Printed-circuit boards (PCBs), self-adhesive front panel foils, ROMs, EPROMs, PALs, GALs, microcontrollers and diskettes for projects which have appeared in *Elektor Electronics* may be ordered using the Order Form printed opposite. The form may also be used to order books (private customers only).

• The artwork for making a PCB which is not available ready-made through the Readers Services may be found in the relevant article.

• EPROMs, GALs, PALs, (E)PLDs, MACHs, PICs and other microcontrollers are supplied ready-programmed.

Prices and item descriptions subject to change. The publishers reserve the right to change prices without prior notification. Prices and item descriptions shown here supersede those in previous issues. E & OE

Wind Speed & Direction Meter

@ 030371-11 Disk, project software	4.90	8.65
030371-41 PIC16F871, programmed	17.55	31.05

No. 331 APRIL 2004

Drop-in Microcontroller Board		
@ 020148-1 PCB	8.60	15.20
@ 020148-11 Disk, sample project file	4.90	8.65

Pandora's Sound & Music Box

@ 030402-1 PCB	10.60	18.75
@ 030402-11 Disk, source and hex code files	4.90	8.65
030402-41 PIC16F871/R, programmed	20.55	36.40

VHF-Low Explorer

@ 020416-1 PCB	8.80	15.50
----------------	------	-------

No. 330 MARCH 2004

Build Your Own DRM Receiver		
@ 030365-1 PCB	9.10	16.10
@ 030365-11 Disk, DRM.exe program	4.90	8.65

Code Lock

@ 020434-1 PCB	9.60	16.95
@ 020434-11 Disk, source & hex code files	4.90	8.65
020434-41 Pic16F84A-4P, programmed	14.70	26.00

Hands-on CPLDs (2)

@ 030052-1 PCB	8.90	15.75
@ 030052-11 Software	4.90	8.65
030052-41 EPM7126SLC84-15, programmed	33.40	59.10

Multichannel Failsafe for Radio Controlled Models

@ 020382-11 Disk, source code file	4.90	8.65
020382-41 AT89C52-24JL, programmed	8.70	15.40

Multifunction Frequency Meter

@ 030136-1 PCB	9.35	16.55
@ 030136-11 Disk, project software	4.90	8.65
030136-41 AT90S2313-10PC, programmed	7.95	14.05

No. 329 FEBRUARY 2004

Digital Alarm Clock		
@ 030096-11 Disk, PIC source and hex code	4.90	8.65
030096-41 PIC16F84-04/p, programmed	15.20	26.90

iAccess

@ 020163-11 Disk set, source code and control software	7.50	13.30
020163-41 AT89S8252-12PC, programmed	13.90	24.60

Simple 12-to-230V Power Inverter

@ 020435-1 PCB	8.50	15.05
----------------	------	-------

Touch-controlled Switch

@ 030214-11 Disk, PIC source code	4.90	8.65
030214-41 PIC12C508A04/S08, programmed	6.15	10.90

No. 328 JANUARY 2004

64-K 80C552 Flash Board		
@ 030042-1 PCB	9.35	16.55
@ 030042-11 Disk, misc. project software	4.90	8.65
030042-21 29F010, programmed	10.00	17.70
030042-31 GAL 16V8D15QP, programmed	6.10	10.80

Climate Logger

@ 030076-1 PCB	7.75	13.70
@ 030076-11 Disk, Windows software	4.90	8.65

FMS Flight Simulator Encoder

@ 030066-1 PCB	10.20	18.05
030066-41 87LPC767BN, programmed	17.05	30.15

LED Roulette

@ 030168-1 PCB	17.90	31.60
@ 030168-11 Disk, source and hex files	4.90	8.65
030168-41 89C2051-12PC, programmed	8.05	14.25

Multi-event Alarm Clock

@ 020304-11 Disk, C (source) hex files	4.90	8.65
020304-41 AT89C2051-12PC, programmed	6.10	10.80

PAST ISSUES

Past issues, if available, should be ordered from **Worldwide Subscription Service Ltd, Unit 4, Gibbs Reed Farm, Pashley Road, TICHEURST TN5 7HE, England, telephone (+44) 1580 200657, fax (+44) 1580 200616, email wwss@wwss.demon.co.uk**. Prices of past issues (except July/August and December), including postage for single copies, are £4.75 (UK and Eire); £5.30 (air mail Europe); £6.10 (airmail outside Europe). Prices of past July/August and December issues, including postage for single copies, are £6.65 (UK and Eire); £7.35 (airmail Europe); and £8.45 (airmail outside Europe).

PAST ARTICLES

For information on past articles, please contact our Editorial and Administrative Offices, telephone (01580) 200657; fax 200616, email sales@ellektor-electronics.co.uk.

	£	US \$
Stepper Motors Uncovered 020127-41 PIC16F873-20/SP	19-10	33.80
No. 327 DECEMBER 2003		
FM Remote Control Transmitter & Receiver 034044-1 PCB	10-20	18.05
LED Christmas Decoration 030157-1 PCB	7-55	13.35
P87LPC76x Programmer 030313-11 Disk, project software	4-90	8.65
Project Timekeeper 020350-11 Disk, source & object code files 020350-41 PIC16F84-10P, programmed	4-90 13-15	8.65 23.25
Stepper Motors Uncovered (2) 020127-11 Disk, source code file	4-90	8.65
Universal Clock Generator 020395-11 Disk, source code file	4-90	8.65
Wireless RS232 Link 030204-1 PCB	8-70	15.40
No. 326 NOVEMBER 2003		
Precision Measurement Central 030060-4 PCB	8-70	15.40
No. 326 NOVEMBER 2003		
Rev Counter for R/C Models 024111-1 PCB 024111-11 Disk, source and hex code 024111-41 89C2051-12PC, programmed	17-50 4-90 8-85	31.00 8.65 15.65
Running Text Display 020407-11 Disk, source and hex code	4-90	8.65
USB Analogue Converter 020374-1 PCB 020374-11 Disk, hex code and Windows software 020374-41 PIC16C765, programmed	7-65 4-90 13-25	13.50 8.65 23.45
No. 325 OCTOBER 2003		
DDS RF Signal Generator 020299-1 PCB, generator 020299-2 PCB, control/supply 020299-41 AT90S8515-8PC, programmed	11-60 12-10 30-55	20.55 21.45 54.05
Minimalist Induction-Balance Metal Detector 020290-1 PCB	8-95	15.65
Xilinx PROM Programmer 010109-11 Software	4-90	8.65
No. 324 SEPTEMBER 2003		
ATV Picture Generator 020295-11 Disk, source & hex code files 020295-41 AT90S8515-8PC, programmed 020295-42 AT90S1200-12PC, programmed	4-90 15-20 13-90	8.65 26.90 24.60
DTMF Remote Telephone Switch 020294-1 PCB 020294-11 Disk, project software 020294-41 PIC16F84A-20/P, programmed	11-65 4-90 14-70	20.60 8.65 26.00
LC Display with I²C Bus 030060-2 PCB	7-35	13.00
PICProg 2003 010202-1 PCB 010202-11 Disk, Windows software 010202-41 PIC16F874-20/P, programmed	9-05 4-90 23-55	16.00 8.65 41.65
Polyphonic Doorbell 020354-11 Disk, project software 020354-41 PIC16F84A-10/P, programmed	4-90 14-45	8.65 25.55
Precision Measurement Central 030060-91 Ready-assembled & tested board	69-00	112.50
Valve Pre-amplifier (1) 020383-1 PCB, amplifier board 020383-2 PCB, power supply board 020383-3 PCB, I/O board	11-55 11-40 10-10	20.40 20.20 17.80
No. 323 JULY/AUGUST 2003		
Add a Sparkle 020293-11 Disk, HEX and source files 020293-41 PIC12C509A-04/SM, programmed	4-90 7-40	8.65 13.10
AT90S2313 Programmer 034036-1 PCB	9-05	16.00
Hard Disk Selector 034050-1 PCB	9-45	16.75
Mini Running Text Display 020365-11 Disk, source code file	4-90	8.65
Mini Test Chart Generator 020403-11 Disk, PIC source code	4-90	8.65
Programming Tool for AtTiny15 030030-1 PCB 030030-11 Disk, project software	7-55 4-90	13.35 8.65

	£	US \$
Quad Bridge Car Amp 034039-1 PCB	8-70	15.35
Remote Light Control with Dimmer 020337-11 Disk, HEX and source files 020337-41 AT89C2051-12, programmed	4-90 6-25	8.65 11.05
No. 322 JUNE 2003		
AVR TV Tennis 030026-1 Main PCB 030026-2 Pushbutton PCB 030026-11 Disk, AVR source code 030026-41 AT908515, programmed	8-70 8-60 4-90 15-20	15.40 15.25 8.65 26.90
Electronic Knotted Handkerchief 020308-11 Disk, PC and controller software 020308-41 AT90S2313-10PC, programmed	4-90 12-60	8.65 22.30
Low-Cost LCD Controller (2) 020114-1 PCB 020114-11 Disk, project software	8-70 4-90	15.35 8.65
Night Light Control 020115-11 Disk, hex and source code 020115-41 AT90S2313-10PC, programmed	4-90 12-85	8.65 22.75
Universal XA Development Board 010103-1 PCB 010103-11 Disk, GAL code, EPROM hex files, XADEV 010103-21 EPROM IC8, 27C256-90, programmed 010103-22 EPROM IC9, 27C256-90, programmed 010103-31 GAL 16V8, programmed	13-20 4-90 10-00 10-00 4-80	23.35 8.65 17.70 17.70 8.50
No. 321 MAY 2003		
Countdown Timer 020296-11 Disk, source and hex code 020296-41 AT90S1200, programmed	4-90 13-90	8.65 24.60
USB Audio Recorder 012013-11 Disk, EPROM hex code 012013-21 EPROM 27C512, programmed	4-90 12-60	8.65 22.30
Valve Final Amp (2) 020071-1 Amplifier board (one channel) 020071-2 Power supply board	15-10 10-05	26.75 17.75
No. 320 APRIL 2003		
8-Channel Disco Light Controller 010131-1 PCB 010131-41 87C750 or 87C71, programmed	13-10 23-00	23.15 40.70
Pico PLC 010059-1 PCB 010059-11 Disk, test program	18-70 4-90	33.10 8.65
Single-Chip Tone Control 020054-4 PCB	10-90	19.30
Switched-Outlet Power Bar with RS232 Control 020298-1 PCB 020298-11 Disk, project software	10-80 4-90	19.10 8.65
Temperature Indicator for the PC 020380-11 Disk, source and compiled code 020380-41 AT89C2051, programmed	4-90 10-25	8.65 18.15
No. 319 MARCH 2003		
17 V / 10 A Switch-Mode Power Supply 020054-3 PCB	9-45	16.65
Add-on Switch unit for R/C Models 020126-1 PCB 020126-11 Disk, hex and source files 020126-41 PIC16C712-041/S0, programmed	8-95 4-90 15-20	15.85 8.65 26.90
AVR Development System 020351-1 PCB 020351-11 Disk, example programs	13-20 4-90	23.35 8.65
Guitar Effects Switchbox 020181-1 PCB	13-15	23.30
Intelligent Fan Timer 020170-11 Disk, project software 020170-41 MSP430F1121, programmed	4-90 11-30	8.65 20.00
SAA3049 Replacement 020085-1 PCB 020085-11 Disk, source and hex code 020085-41 87LPC764BN, programmed	13-05 4-90 9-90	23.10 8.65 17.55
Two-Colour Running Light 010134-1 PCB, controller board 010134-2 PCB, LED board 010134-11 Disk, project software 010134-41 AT89C2051-12PC, programmed	8-25 10-65 4-90 7-15	14.60 18.80 8.65 12.65
No. 318 FEBRUARY 2003		
20/40 MHz Logic Analyser 020032-1 PCB 020032-11 Disk, demo program	15-20 4-90	26.85 8.65

Products for older projects (if available) may be found on our web site
<http://www.elektor-electronics.co.uk>

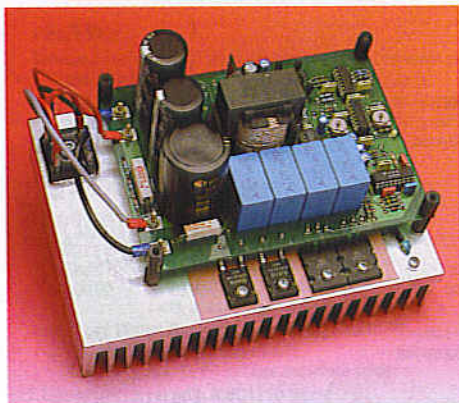

Cuk Converter

The Cuk converter is a type of electrical inverter converting power at one DC voltage to power at a different voltage. Unlike most other types of converter which use an inductor, it employs a capacitor as its main energy-storage component. The converter is named after Slobodan M. Cuk of the California Institute of Technology, who first presented the design in the early 1990s. In good Elektor tradition we describe the theory as well as a practical design in the form of an adjustable 0-50V, 0-5A power supply unit.

Solutions to Counter Electronic Waste

In 2006 European legislation on electrical and electronic waste comes into full force. As any electronics enthusiast who has recently tried to repair a consumer product will know, it is more likely to be cheaper to dispose of and replace an item than to repair it. The EU estimates that 4% of household waste consists of electrical and electronics products and this figure is increasing at a rate of 16-28% every five years. A glance at the statistics and listening to green organizations would suggest a depressing future. There exists however, a movement to exploit the electronics waste problem where a positive attitude and creativity results in novel solutions.

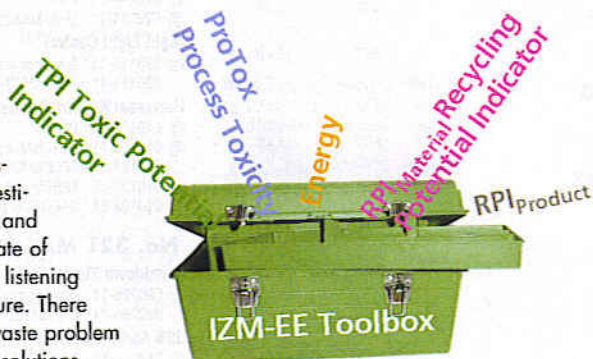

Also...

PICXEX18 Operating System, 12-volt Dimmer, Body Fat Meters, Filter Boards for the ClariTy Amp, Thermoelements, Whistle Beacon, Automatic Preselector for DRM Receiver.

RESERVE YOUR COPY NOW!

UK subscribers will receive the magazine a few days before this date.

The November 2004 issue goes on sale on Friday 15 October 2004 (UK distribution only).

Article titles and magazine contents subject to change.

NEWSAGENTS ORDER FORM

SHOP SAVE / HOME DELIVERY

Please save / deliver one copy of *Elektor Electronics* magazine for me each month

Name:
 Address:
 Post code:
 Telephone:
 Date:
 Signature:



Please cut out or photocopy this form, complete details and hand to your newsagent. *Elektor Electronics* is published on the third Friday of each month, except in July. Distribution S.O.R. by Seymour (NS).

INDEX OF ADVERTISERS

Allgood Technology, Net Links www.allgoodtechnology.com	80	Matrix Multimedia Ltd www.matrixmultimedia.co.uk	57
Beta Layout, Net Links www.pcb-pool.com	39, 80	Microchip www.microchip.com	27
BK Electronics www.bkelec.com	87	Milford Instruments www.milinst.demon.co.uk	61
Burn Technology LTD, Net Links www.burntec.com	80	MQP Electronics, Net Links www.mqpelectronics.co.uk	80
CMS www.cms.uk.com	39	Net Links	80, 81
Compucut, Net Links www.compucutters.com	80	New Wave Concepts, Net Links www.new-wave-concepts.com	80
Compulogic www.compulogic.info	73	Number One Systems www.numberone.com	4
Conford Electronics, Net Links www.confordelec.co.uk	80	PAGM www.pagm.co.uk	2
Cricklewood	73	PCB World, Net Links www.pcbworld.org.uk	81
Danbury, Net Links www.mc-h.demon.co.uk	80	Peak Electronic, Net Links www.peakelec.co.uk	81
Debug Innovations, Net Links www.debuginnovations.com	80	PHYZX, Net Links www.phyzx.co.uk	81
Display Electronics www.distel.co.uk	43	Picdos, Net Links www.picdos.com	81
Easysync, Net Links www.easysync.co.uk	4, 80	Pico www.drdaq.com	3, 35
Elexol, Net Links www.elexol.com	80	Quasar Electronics, Net Links www.quasarelectronics.com	71, 81
Eltec, Net Links www.eltec.com	80	Robot Electronics, Net Links www.robot-electronics.co.uk	81
Ervan International, Net Links www.ervan-int.com	80	Stewart of Reading www.stewart-of-reading.co.uk	72
Eurocircuits www.thepcbshop.com	65	Technobots, Net Links www.technobots.co.uk	81
ExpressPCB www.expresspcb.com	4	Telnet, Net Links www.telnet.uk.com	81
Forest, Net Links www.fored.co.uk	80	Ultraleds, Net Links www.ultraleds.co.uk	81
Future Technology Devices, Net Links www.ftdchip.com	80	USB Instruments, Net Links www.usb-instruments.com	81
Futurlec, Net Links www.futurlec.com	80	Viewcom, Net Links www.viewcom.f9.co.uk	81
Hammond Electronics, Net Links www.hammondmfg.com	80			
Ipeva Limited, Net Links www.ipeva.com	80			
ITP www.itp101.com	39			
Komcard, Net Links www.komcard.com	80			
Labcenter www.labcenter.co.uk	88			
London Electronics College, Net Links www.lec.org.uk	80			

ADVERTISING SPACE for the issue of 16 November 2004 may be reserved not later than 20 October 2004 with Elektor Electronics (Publishing) Advertisement Office – 3 Crescent Terrace – Cheltenham GL50 3PE – England – Telephone 01242 510 760 – Fax 01242 226 626 – e-mail: bernardhubbard@ukonline.co.uk to whom all correspondence, copy instructions and artwork should be addressed.

ORDERING INSTRUCTIONS, P&P CHARGES

Except in the USA and Canada, all orders, except for subscriptions (for which see below), must be sent BY POST or FAX to our Tunbridge Wells address using the Order Form overleaf. On-line ordering: <http://www.elektor-electronics.co.uk>

Readers in the USA and Canada may (but are not obliged to) send orders, except for subscriptions (for which see below), to the USA address given on the order form. Please apply to Old Colony Sound for applicable P&P charges. Please allow 4-6 weeks for delivery.

Orders placed on our Tunbridge Wells office must include P&P charges (Priority or Standard) as follows:

UK: £4.00 Europe: £5.00 (Standard) or £7.00 (Priority) Outside Europe: £8.00 (Standard) or £12.00 (Priority)

HOW TO PAY

Unless you have an approved credit account with us, all orders must be accompanied by the full payment, including postage and packing charges as stated above. Payment may be made by cheque drawn on a London clearing bank (but see para. 4 below), postal order, VISA, Access, MasterCard or EuroCard (when paying by credit card, the order must go the cardholder's address). Do not send cash through the mail. Cheques and postal orders should be crossed and made payable to 'Elektor Electronics (Publishing)'. Payment may also be made by direct transfer from a private or business Giro account to our **Giro account No. 34 152 3801** by completing and sending to the National Giro Centre, in a National Giro postage paid envelope, a National Giro transfer/deposit form. Do not send Giro transfers direct to us, as this will delay your order. If you live outside the UK, payment may also be made by Bankers' sterling draft drawn on a London clearing bank, Eurocheque made out in pounds sterling (with holder's guarantee card number written on the back), or US or Canadian dollar cheque drawn on a US or Canadian bank. If you pay by Bankers' sterling draft, make clear to the issuing bank that your full name and address MUST be communicated to the London clearing bank. Our bankers are **NAT WEST PLC, 1 St James's Square, Wadhurst, East Sussex TN5 6BH, England. Our account number is 3512 5225, Sorting Code 60-22-15. IBAN code: GB40 NWB K6 022 15 3512 5225 BIC code: NWB KGB 2L**

COMPONENTS

Components for projects appearing in Elektor Electronics are usually available from certain advertisers in this magazine. If difficulties in the supply of components are envisaged, a source will normally be advised in the article. Note, however, that the source(s) given is (are) not exclusive.

TERMS OF BUSINESS

Delivery Although every effort will be made to dispatch your order within 2-3 weeks from receipt of your instructions, we can not guarantee this time scale for all orders. **Returns** Faulty goods or goods sent in error may be returned for replacement or refund, but not before obtaining our consent. All goods returned should be packed securely in a padded bag or box, enclosing a covering letter stating the dispatch note number. If the goods are returned because of a mistake on our part, we will refund the return postage. **Damaged goods** Claims for damaged goods must be received at our Tunbridge Wells office within 10 days (UK); 14 days (Europe) or 21 days (all other countries). **Cancelled orders** All cancelled orders will be subject to a 10% handling charge with a minimum charge of £5.00. **Patents** Patent protection may exist in respect of circuits, devices, components, and so on, described in our books and magazines. Elektor Electronics (Publishing) does not accept responsibility or liability for failing to identify such patent or other protection. **Copyright** All drawings, photographs, articles, printed circuit boards, programmed integrated circuits, diskettes and software carriers published in our books and magazines (other than in third-party advertisements) are copyright and may not be reproduced or transmitted in any form or by any means, including photocopying and recording, in whole or in part, without the prior permission of Elektor Electronics (Publishing) in writing. Such written permission must also be obtained before any part of these publications is stored in a retrieval system of any nature. Notwithstanding the above, printed-circuit boards may be produced for private and personal use without prior permission. **Limitation of liability** Elektor Electronics (Publishing) shall not be liable in contract, tort, or otherwise, for any loss or damage suffered by the purchaser whatsoever or howsoever arising out of, or in connexion with, the supply of goods or services by Elektor Electronics (Publishing) other than to supply goods as described or, at the option of Elektor Electronics (Publishing), to refund the purchaser any money paid in respect of the goods.

Law Any question relating to the supply of goods and services by Elektor Electronics (Publishing) shall be determined in all respects by the laws of England.

January 2004

SUBSCRIPTION RATES

FROM JANUARY 2004 ISSUE

	Standard	Plus
United Kingdom	£39.50	£45.50
Economy Mail		
Rest of the World (excluding Europe)	£51.30	£57.30
Priority Airmail		
Europe & Eire	£52.50	£58.50
Middle East, Africa, Southwest Asia, Central & South America	£64.00	£70.00
Australia, New Zealand, Far East & Pacific Territories	£66.00	£72.00
Airfreight		
USA & Canada only	US\$88.00	US\$96.50

Payment should be made by:

- Cheque or bankers' draft in sterling drawn on a London clearing bank (except in the USA and Canada — see below);
- US\$ cheques drawn on a US or Canadian bank — only by subscribers in the USA or Canada.
- Direct transfer to our bank (NAT WEST PLC, 1 St James's Square, Wadhurst, East Sussex TN5 6BH, England). Our account number is 3512 5225, Sorting Code 60-22-15. IBAN code: GB40 NWB K6 022 15 3512 5225 BIC code: NWB KGB 2L
- Postal order.
- Credit card: VISA, ACCESS, Euro/MasterCard, JCB Electron or Switch.
- Transfer to our Giro Account number 34 152 3801. Giro transfers should be made by completing and sending the appropriate transfer/deposit form to the National Giro Centre (UK) or to your national Giro Centre.

Cheques and postal orders should be made payable to Elektor Electronics (Publishing). Do not send cash through the mail.

SUBSCRIPTION RATES

FOR 18-MONTH SUBSCRIPTION

	Standard	Plus
United Kingdom	£59.25	£65.25
Economy Mail		
Rest of the World (excluding Europe)	£76.95	£82.95
Priority Airmail		
Europe & Eire	£78.75	£84.75
Middle East, Africa, Southwest Asia, Central & South America	£96.00	£102.00
Australia, New Zealand, Far East & Pacific Territories	£99.00	£105.00
Airfreight		
USA & Canada only	US\$132.00	US\$140.50

SUBSCRIPTION CONDITIONS

The standard subscription order period is twelve months. If a permanent change of address during the subscription period means that copies have to be despatched by a more expensive service, no extra charge will be made. Conversely, no refund will be made, nor expiry date extended, if a change of address allows the use of a cheaper service.

Student applications, which qualify for a 20% (twenty per cent) reduction in current rates, must be supported by evidence of studentship signed by the head of the college, school or university faculty. A standard Student Subscription costs £31.60, a Student Subscription-Plus costs £37.60 (UK only).

Please note that new subscriptions take about four weeks from receipt of order to become effective.

Cancelled subscriptions will be subject to a charge of 25% (twenty-five per cent) of the full subscription price or £7.50, whichever is the higher, plus the cost of any issues already dispatched. Subscriptions cannot be cancelled after they have run for six months or more.

January 2004



Try us for Tivoli Radio
 Tivoli Radio 1 Just **£91.95 Carriage £8.00**

OMP MOS-FET POWER AMPLIFIERS
HIGH POWER, TWO CHANNEL 19 INCH RACK

10,000's
 SOLD
 TO PRO
 USERS



THE RENOWNED MXF SERIES OF POWER AMPLIFIERS

FOUR MODELS:- MXF200 (100W + 100W) MXF400 (200W + 200W)
 MXF600 (300W + 300W) MXF900 (450W + 450W)

ALL POWER RATINGS ARE R.M.S. INTO 4 OHMS, WITH BOTH CHANNELS DRIVEN
 FEATURES:- * Independent power supplies with two toroidal transformers
 * Twin L.E.D. Vu Meters * Level controls * Illuminated on/off switch * Jack / XLR inputs *
 * Speakon Outputs * Standard 775mv inputs * Open and Short circuit proof * Latest Mos-Fets
 for stress free delivery into virtually any load * High slew rate * Very low distortion * Aluminium
 cases * MXF600 & MXF900 fan cooled with D.C. Loudspeaker and thermal protection

USED THE WORLD OVER IN CLUBS, PUBS, CINEMAS, DISCOS ETC

MXF200	W19"	D11"	H3 1/2"	(2U)
MXF400	W19"	D12"	H5 1/2"	(3U)
MXF600	W19"	D13"	H5 1/2"	(3U)
MXF900	W19"	D14"	H5 1/2"	(3U)

PRICES:- MXF200 **£175.00** MXF400 **£233.85**
 MXF600 **£329.00** MXF900 **£449.15**
SPECIALIST CARRIER DEL £12.50 Each



ABSOLUTE HIGH END CLASS D AMPLIFIER

The OMP MFD600 can be used as a stand alone monoblock amplifier or fitted into existing loudspeakers to make them active

- Compact design due to switch mode P.S.U.
- 90% Efficient high switching frequency
- Small size, fits in a 110mm x 92mm opening
- Neutrik® Combi input balanced / unbalanced
- Output fully protected
- Status LEDs - Presence / Clip / Protect
- 600W / 2 Ohm - 500W / 4 Ohm - 300W / 8 Ohm
- All powers in R.M.S.
- Volume control. Input sensitivity 775mV
- Freq. Response 2Hz-20kHz
- Light weight 3kg

For further information please look at our website at www.bkelec.com and click on the modules and hybrids button

Special quantity pricing and customised artwork for OEM's.

Price **£281.12** Inc Vat Each or **£499.00** Per Pair when quoting this advert

Carriage UK Mainland Only **£8.00**

Stunning performance
 Audiophile Quality



50W to 500 WATT ACTIVE SUB BASS AMPLIFIER PANELS



Model Shown:- BSBP200

The BSB Range of Sub Bass Amplifiers consists of 5 panels with power outputs of 50W to 500W to suit most of the DIY enthusiasts needs. All panels are airtight and come equipped with both high and low level inputs with separate gain controls, frequency adjust and 0-180 Deg. continuous phase control adjustment. A full connection lead pack included

MODEL	PRICE	IMP.	* Please
BSBP50	£89.95	8 Ohm	State 4
BSBP100	£117.44	*4/8 Ohm	or 8 Ohm
BSBP200	£149.50	*4/8 Ohm	when
BSBP300	£184.50	4 Ohm	ordering
BSBP500	£219.50	4 Ohm	

SPECIFICATIONS:- * POWER 200W RMS @ 4 or 8 OHMS * FREQ RESP. 10Hz 15kHz
 -3dB * DAMPING FACTOR >200 * DISTORTION 0.05% * S/N A WEIGHTED >100dB *
 SUPPLY 230V A.C. * WEIGHT 5.0Kg * SIZE H254 X W254 X D95mm

THERE ARE 2 VERSIONS OF THE ABOVE PANEL AVAILABLE :-BSB200/8
 8 OHM VERSION BSB200/4 4 OHM VERSION CHECK WEBSITE FOR PANELS UP TO 500W

XLS 200 Subwoofer Sytem
 Save £100's buying factory direct



We have combined the famous Peerless XLS10 with our renowned BSBP200/4 sub bass panel in a compact MDF cabinet that measures only D390 x H295 x W295 to produce a truly awesome sub woofer system suitable for both Hi-Fi and AV use.

Customer Comment:- It sounds excellent, how did I live without one before. Its opened up the sound on the whole system and given it a more "full" sound. I thought my speaker set up was good before but now it's awesome.

Features:- *High and low level inputs *Frequency adjust *Continuous phase control *200W RMS *Separate control of high and low level gain *Automatic Speaker Protection. Comes complete with mains lead, 5m stereo phono lead, 10m High level lead and Spikes

Available in Silver or Black, for further information please look on our website at <http://www.bkelec.com>

£279.00 Each plus £8.00 carriage within the UK mainland. International carriage charges to Germany, France, Belgium, Luxembourg and Holland at only £16.00 per XLS200

MXF1200D 600W Per Channel Class D Price:- **469.95 Inc. V.A.T. Carriage £8.00**



The MXF1200D is not only a must for PA and Disco use, but it's stunning performance lends itself readily to Studio and High Power AV Cinema installs, it is also suitable for Hi-End Hi-Fi use. Can be driven direct from a CD player and has balanced XLR input, unbalanced jack input.

The latest in high-tech Class D amplifiers coupled to two independent switch-mode power supplies. **Front Panel:-** Presence Led's, Clip Led's, Independent volume controls and power On/Off switch with cool blue illuminated surrounds. **Rear Panel:-** Mains IEC input, Neutrik Speakon outputs and Neutrik Combi inputs

Golf Ball Height



Specification:- Output power 600W RMS into 2 Ohm, 500W RMS into 4 Ohm, 300W RMS into 8 Ohm Frequency response 2 Hz to 22kHz, Input sensitivity 775mV, Input Imp.7.5k Ohms, T.H.D. 0.1%, S/N 85dB, Power Supply 230V AC 50Hz, Switching Freq. 450kHz, Weight 8.0kg, Size H44 x W482 x L376mm

OMP MOS-FET POWER AMPLIFIER MODULES

SUPPLIED READY BUILT AND TESTED

These modules now enjoy a world-wide reputation for quality, reliability and performance at a realistic price. Four models are available to suit the needs of the professional and hobby market i.e. Industry, Leisure, Instrumental and Hi-Fi etc. When comparing prices, NOTE that all models include toroidal power supply, integral heatsink glass fibre P.C.B. and drive circuits to power a compatible Vu meter. All models are open and short circuit proof

THOUSANDS OF MODULES PURCHASED BY PROFESSIONAL USERS



OMP/MF 100 Mos-Fet Output Power 110 watts R.M.S. into 4 ohms, frequency response 1Hz - 100kHz -3dB, Damping Factor >300, Slew Rate 45V/uS, T.H.D. typical 0.002%, Input Sensitivity 500mV, S.N.R. 110dB, Size 300 x 123 x 60mm.
Price:- £43.85 + £4.00 P&P

OMP/MF 200 Mos-Fet Output Power 200 watts R.M.S. into 4 ohms, frequency response 1Hz - 100kHz -3dB, Damping Factor >300, Slew Rate 50V/uS, T.H.D. typical 0.001%, Input Sensitivity 500mV, S.N.R. 110dB, Size 300 x 155 x 100mm.
Price:- £67.35 + £4.00 P&P

OMP/MF 300 Mos-Fet Output Power 300 watts R.M.S. into 4 ohms, frequency response 1Hz - 100kHz -3dB, Damping Factor >300, Slew Rate 60V/uS, T.H.D. typical 0.001%, Input Sensitivity 500mV, S.N.R. 110dB, Size 330 x 175 x 100mm.
Price:- £84.75 + £5.00 P&P

OMP/MF 450 Mos-Fet Output Power 450 watts R.M.S. into 4 ohms, frequency response 1Hz - 100kHz -3dB, Damping Factor >300, Slew Rate 75V/uS, T.H.D. typical 0.001%, Input Sensitivity 500mV, S.N.R. 110dB, Fan Cooled, D.C. Loudspeaker Protection, 2 Second Anti Thump Delay, Size 385 x 210 x 105mm.
Price:- £137.85 + £6.00 P&P

OMP/MF 1000 Mos-Fet Output Power 1000 watts R.M.S. into 2 ohms, frequency response 1Hz - 100kHz -3dB, Damping Factor >300, Slew Rate 75V/uS, T.H.D. typical 0.001%, Input Sensitivity 500mV, S.N.R. 110dB, Fan Cooled, D.C. Loudspeaker Protection, 2 Second Anti Thump Delay, Size 422 x 300 x 125mm.
Price:- £264.00 + £12.00 P&P

NOTE: MOS-FET MODULES ARE AVAILABLE IN TWO VERSIONS. STANDARD - INPUT SENS 500mV/BANDWIDTH 100kHz OR PEC (PROFESSIONAL EQUIPMENT COMPATIBLE) - INPUT SENS 775mV/BANDWIDTH 50kHz. ORDER STANDARD OR PEC

Peerless XLS10 Sub Woofer Driver



The renowned Peerless XLS10 Drive unit is possibly one of the best 10 inch sub woofer drivers available today. Made in Denmark by Peerless, a company synonymous with quality and craftsmanship. This drive unit is ideal for inclusion into small enclosures of around 17 litres and will give a tight controlled deep bass output. To further enhance the qualities of this unit greater output and deeper bass can be achieved by coupling the XLS10, with it's companion passive radiator the XLS10P

Peerless XLS 10 **£89.00.** Peerless XLS10P **32.90**
 Carriage **£8.00**

For full specification and prices goto our website at <http://www.bkelec.com> and try our new shopping basket facility

B.K. ELECTRONICS REF EL2

UNIT 1 COMET WAY, SOUTHEND-ON-SEA, ESSEX, SS2 6TR.
 TEL.: 01702-527572 FAX.: 01702-420243
 Web:- <http://www.bkelec.com> E-Mail sales@bkelec.com



DELIVERY CHARGES:- PLEASE INCLUDE AS ABOVE. A MINIMUM CHARGE OF £8.00 TO A MAXIMUM AMOUNT OF £30.00. OFFICIAL ORDERS FROM SCHOOLS, COLLEGES, GOVT. PLCs ETC. PRICES INCLUSIVE OF V.A.T. SALES COUNTER. CREDIT CARD ORDERS ACCEPTED BY POST PHONE OR FAX.



PROTEUS

The Complete Electronics Design System

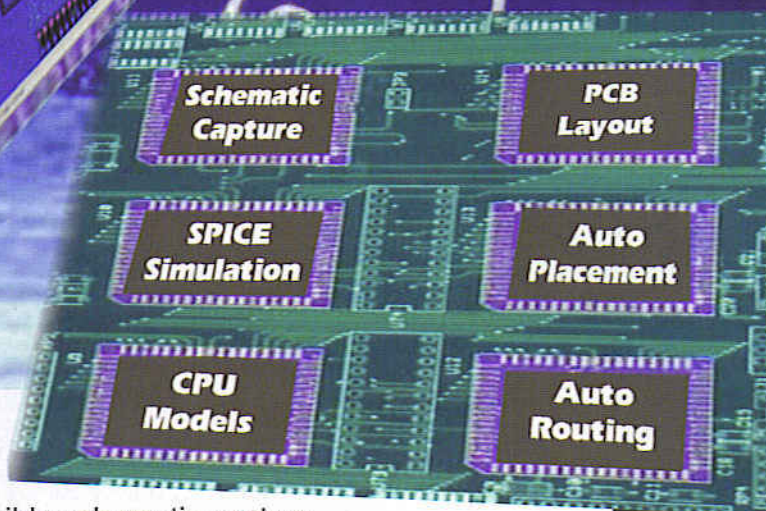
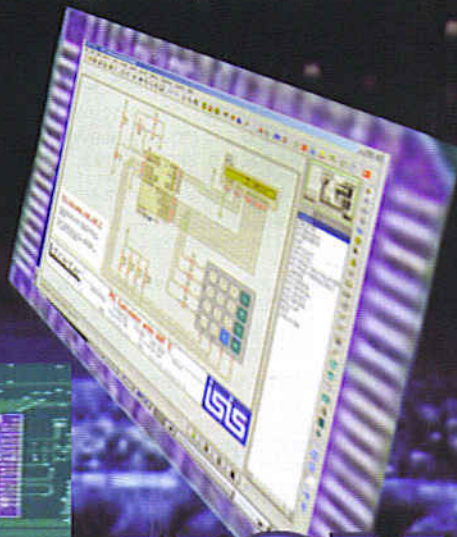
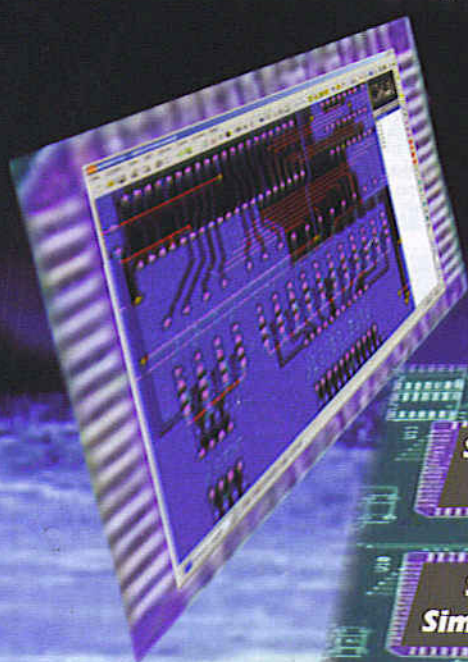

VSM

Virtual System Modelling

Schematic & PCB Layout

- Powerful & flexible schematic capture.
- Auto-component placement and rip-up/retry PCB routing.
- Polygonal gridless ground planes.
- Libraries of over 8000 schematic and 1000 PCB parts.
- Bill of materials, DRC reports and much more.

Mixed Mode SPICE Circuit Simulation

- Berkeley SPICE3F5 simulator with custom extensions for true mixed mode and interactive simulation.
- 6 virtual instruments and 14 graph based analysis types.
- 6000 models including TTL, CMOS and PLD digital parts.
- Fully compatible with manufacturers' SPICE models.

Proteus VSM - Co-simulation and debugging for popular Micro-controllers

- Supports PIC, AVR, 8051, and BASIC STAMP micro-controllers.
- Co-simulate target firmware with your hardware design.
- Includes interactive peripheral models for LED and LCD displays, switches, keypads, virtual terminal and much, much more.
- Compatible with popular compilers and assemblers from Microchip, Crownhill, IAR, Keil, and others.

New Features in Version 6.5

- Textual library part search.
- User defined keyboard map.
- CAD/CAM output to ZIP file.
- Bitmap import function.
- Truetype fonts on PCBs.
- Enhanced printer output.

Call Now for Upgrade Pricing

**NEW
ELECTRA
SHAPE BASED
AUTOROUTER
NOW AVAILABLE**

labcenter

Electronics
53-55 Main Street, Grassington. BD23 5AA

Tel: 01756 753440
Fax: 01756 752857

Contact us for
Free Demo CD

www.labcenter.co.uk
info@labcenter.co.uk