

76
August
1989

elektor **INDIA**

Rs. 10.00

electronics

THE MAGAZINE FOR PROFESSIONALS

The invisible invader,
ELCOM stems it.

Sunder Singh

Tracking tester

Multi-layer PCBs

Floppy disk monitor

Test pattern generator



Publisher: C.R. Chandarana
Editor: Surendra Iyer
Circulation / Advertising: J. Dhas
Production: C.N. Mithagari

Volume-7, Number-8
 August 1989

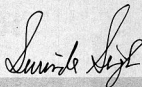

CONTENTS

Address:
 ELEKTOR ELECTRONICS PVT. LTD.
 52, C Proctor Road, Bombay-400 007 INDIA
 Telex: (011) 76661 ELEK IN

OVERSEAS EDITIONS

**Elektor Electronics
 (Publishing)**

Down House, Broomhill Road,
 LONDON SW18 4JQ

Editor: Len Seymour

Elektor sarl
 Route Nationale, Le Seau; B.P. 53
 59270 Baillieul - France

Editors: D R S Meyer;
 G C P Raederdorf

Elektor Verlag GmbH
 Süsterfeld-Straße 25
 5100 Aachen - West Germany
Editor: E. J. A Krempelsauer

Elektor EPE
 Karaiskaki 14
 16673 Voula - Athens - Greece
Editor: E Xanthoulis

Elektuur B.V.
 Peter Treckpoelstraat 2-4
 6191 VK Beek - the Netherlands
Editor: P E L Kersemakers

Electro-shop
 35 Naseem Plaza
 Lasbella Chawk
 Karachi 5 - Pakistan
Manager: Zain Ahmed

Ferreira & Bento Lda.
 R.D. Estefania, 31-1°
 1000 Lisboa-Portugal
Editor: Jeremias Sequeira

Ingelek S.A.
 Plaza República Ecuador
 2-28016 Madrid - Spain
Editor: A M Ferrer

Electronic Press AB
 Box 5505
 14105 Huddinge - Sweden
Editor: Bill Cedrum

The Circuits are domestic use only. The submission of designs or articles implies permission to the publisher to alter and translate the text and design and to use the contents in other Elektor Publications and activities. The publishers cannot guarantee to return any material submitted to them. Material must be sent to the Holland address (given above). All drawings, photographs, printed circuit boards and articles published in elektor publications are copyright and may not be reproduced or omitted in whole or part without prior written permission of the publishers.

Patent protection may exist in respect of circuit devices, components etc. described in this magazine.

The publishers do not accept responsibility for failing to identify such patent or other protection.



Printed at : Trupti Offset Bombay - 400 013
 Copyright © 1989 Elektuur B.V.

Editorial	
A testing time	8.05
Special Features	
The invisible invader, ELCOM stems it	8.08
Components	
Lin CMOS circuits	8.22
Practical filter design (7)	8.32
Computers	
Floppy disk monitor	8.26
Electronics	
Universal MIDI Keyboard interface	8.35
General Interest	
Multi-layer PCBs	8.45
DC-AC power converter	8.46
The digital model train (5)	8.49
Science & Technology	
The versatile cable that tells a tale	8.39
Test & Measurement	
Test pattern generator	8.18
Tracking tester	8.40
Information	
Telecom News	8.12
Industry News	8.13
Electronic News	8.14
Appointments	8.65
Guide lines	
Classified ads	8.66
Index of advertisers	8.66

A TESTING TIME

Our society has become highly dependent on technology. We have nearly become slaves of the technology. Or so it seems, when we visualise a scenario where no satellite is in the sky for the benefit of the Indian people. The latest mishap to the Indian National Satellite, INSAT-1D has put us in such a crisis situation.

Both the indigenous rockets and the foreign-made satellites have been dogged with problems successively, though not by design but by mere accident. While the launching of the intermediate range missile, Agni, may appear as a bright spot on the dark space screen, the crippled INSAT-1C and the stillborn INSAT-1D, coupled with INSAT-1B, nearing the end of its life, put our television, communication and weather services in vulnerable position. Even if INSAT-1D had been launched as per schedule it would not have given any additional service but would have substituted INSAT-1B.

Though INSAT-1C is giving partial services, to make up for INSAT-1B, the Indian Space Research Organisation has sought the services of foreign satellites and hopefully, the crisis can be overcome with this.

Now, ISRO is banking on INSAT-2 series, which will be indigenous unlike the INSAT-1 series. The decision to invest on the indigenous satellite programme, was delayed a bit. Had it been taken much earlier, the time lag could have been avoided.

As ISRO reassures us, by mistakes, Indian space scientists have learnt a lot and the damage to satellites does not mean financial loss as they have been insured.

Having realised that there is no substitute for self-reliance, India is keen on building its own rocket for launching satellites in the geosynchronous, orbit. If the cryogenic technologies for this project are not available abroad, India will do it by herself, though it may take couple of years more.

As Prof U.R. Rao, chief of ISRO says: Indian space programme is on a steady orbit. The only thing that can stop us is our lack of determination.

TEST PATTERN GENERATOR

A. Rigby

A programmable digital pattern generator for all of you who do not have access to specialized equipment for faultfinding in digital circuits.

The operation of many digital circuits is, in principle, not simpler or more complex than that of analogue circuits, but the dependency of certain signals on others gives digital faultfinding a labyrinth effect. Furthermore, it is often impossible to isolate a particular section of the circuit for a stand-alone test. The omission of a single control signal, whose function may not be known at all initially, may cause the whole circuit to 'stall', making it impossible to track the cause of the malfunction.

In synchronously operating digital circuits, state changes take place only as a result of clock signal transitions. This makes the operation of this type of circuit relatively simple to follow, especially if

the clock signal or signals can be generated by external means. By contrast, a level change at a particular point in an asynchronous digital circuit is taken over by the rest of the circuit. This means that a spurious pulse at any point in the circuit can easily disrupt the normal operation of the entire digital equipment.

A test pattern generator as described here enables programmed data to appear in a predefined order at the input of the circuit under test. An oscilloscope is used to check whether the circuit gives the correct response to the applied test patterns.

Patterns for testing

The generator is capable of supplying up

to 255 8-bit test words, or a sequence thereof. The number of test words can be set by the user. A short sequence therefore takes hardly time to program, and need only be programmed once. A sequence of, say, five test words simply corresponds to five bytes loaded into the memory of the test generator. The remaining 250 memory positions are not used and need not be loaded.

The block diagram in Fig. 1 shows that the heart of the circuit is formed by a RAM memory. Two 8-way DIL switch blocks serve to program the test words and the length of the test word sequence. The memory locations are addressed by a counter, which counts from 0 to 255. The generated address (A) is compared to the preset length of the sequence (B). When A and B are equal, output $A=B$ of the word comparator is actuated. Depending on the position of the mode selection switch, the test pattern is either stopped or repeated. When the switch is set to CONTINUOUS, the output signal of the comparator causes the address counter to be reset and to start counting from 0 again. When the mode switch is set to SINGLE, the oscillator is inhibited, so that the last counter state is 'frozen'.

There are three more switches in the circuit. One of these serves to select either the 'single step' or the 'run' mode. In single-step mode, the clock pulse for the circuit is generated by a push-button, while in run mode it is generated by means of a clock generator. Switch OC enables the outputs to be switched to high-impedance (three-state). The last switch, marked RUN/PROG causes the WE (write enable) input of the memory to be connected to the clock signal (program), or to the positive supply voltage (run). In the run mode, the memory is made 'read-only'.

Circuit description

The circuit diagram of Fig. 2 shows how the previously discussed functions are given their practical form. The test generator is composed of only six integrated circuits.

Since only 256 of the 2,048 memory locations in RAM ICs are used, address lines A8, A9 and A10 are connected to ground. The Type 6116 2Kx8 CMOS static RAM is used here because it is currently

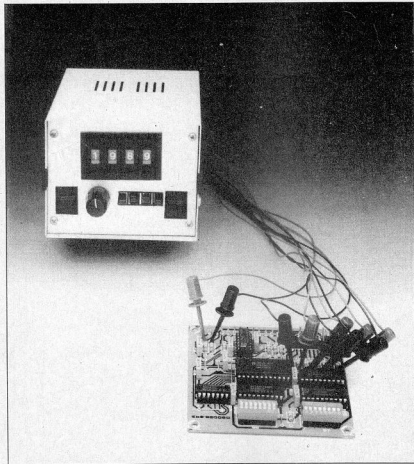

cheaper and more readily available than any 256-byte type.

The counter that drives the eight remaining address lines of the RAM is formed by IC₂, a Type 74HCT393. This 8-bit bistable counts continuously from 0 to the value set with switch block S₄. IC₄ compares the current counter state at inputs Q_n with the preset word at inputs P_n. When the words are equal, output P=Q goes low. Depending on the position of S₄, either the outputs of N₃ and N₄ are blocked, or the counter is reset. After being reset, the counter starts at state 0 again.

The memory databus is connected to an input buffer with three-state outputs, IC₁, and an output buffer, IC₃. When the memory is read out, RAM input WE is logic high, and IC₁ is switched to high-impedance mode. The output buffer is transparent, and latches the data from the databus on the negative edge of the clock signal. The buffer passes all data applied to its D inputs as long as input C is logic high. When C is made logic low, the negative clock pulse transition causes the data at the D inputs to be latched in the buffer's internal registers. The data remains there and on the outputs, until input C is made high again. The OC input allows the output drivers in the buffer to be switched to high-impedance, so that the test generator is effectively disconnected from the circuit under test without the need of leads to be unplugged or wires to be removed.

Manual or automatically?

As already discussed, the circuit can be controlled either by a clock generator or with the aid of the SINGLE STEP switch, S₁. R-C network R₁-C₁ suppresses bounce pulses generated when the SINGLE STEP button is actuated. Schmitt-trigger gate N₃ gives the switch signal a digital shape and level.

Gate N₄, capacitor C₂ and resistors P₁ and R₃ form an adjustable clock generator. One input of N₃ and N₄ is connected to switch S₄, which enables the gates to be blocked. When S₄ is set to CONTINUOUS, one input of both gates is taken high via R₂, so that the clock oscillator is enabled. The span of potentiometer P₁ is fairly large at 1:100, allowing the user to set the optimum test frequency for many types of digital circuit.

External push-button S₆, with associated debouncing network R₉-C₃, makes it possible to reset the counter. The enable inputs of IC₁ and the WE input of IC₃ are logic high as long as S₅ is open. The input buffer is in high-impedance mode, and IC₃ behaves as a read-only memory. The circuit is thus set to the 'run' mode.

When S₅ is closed, input WE is pulled low during the active part of the clock pulse, and the input buffer is enabled. The circuit is in 'program' mode because the databus set on S₇ is stored into the memory during the rising edge of the clock pulse. The clock signal at the pole of S₂ is applied to the clock input of bistable FF₁

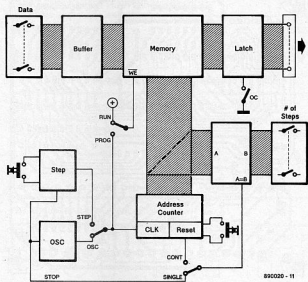

Fig. 1. Block diagram of the test pattern generator for digital circuits.

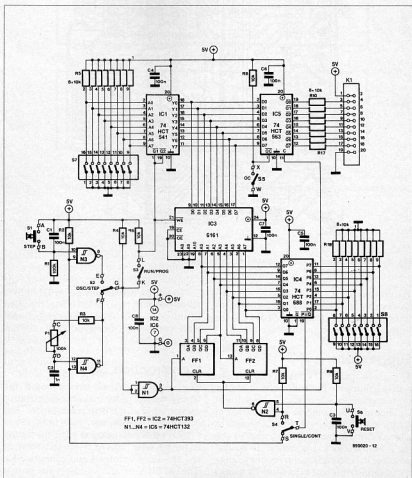

Fig. 2. Circuit diagram of the tester.

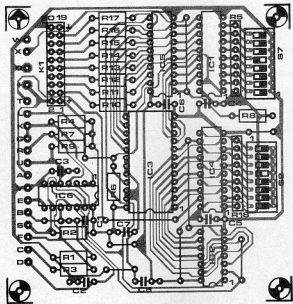
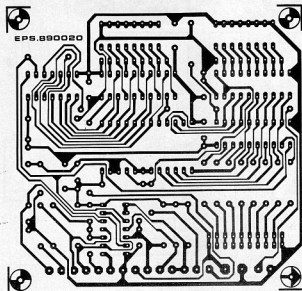

Fig. 3. Track layout and component mounting plan.

via inverter N1. Output Q4 of FF1 in turn clocks a second bistable, FF2. The bistables (there are actually four in each device) are thus cascaded to form an 8-bit counter.

Suggestions

The clock frequency has been chosen rather arbitrarily but will be suitable for most applications. If required, the value of C2 should be adapted to give a different frequency. A larger value of C2 results in a lower clock frequency, and a smaller one in a higher clock frequency. It is also possible to create a larger frequency range by selecting different capacitors by means of a rotary switch.

Toggle switch S2 may be replaced by a three-position type. In that case, the third position is used for selecting an external clock source, e.g., one available in the circuit under test.

Construction

The compact printed-circuit board designed for the tester makes construction a matter of routine. The track layout and component overlay are given in Fig. 3.

Start the construction with the fitting of the ten wire links on the board. Next, fit the 18 solder terminals and connector K2. The HCT ICs are all low-cost types, so that sockets are not strictly required. Although

Parts list

Resistors ($\pm 5\%$):

R1 = 100k
 R2; R3; R4; R6-R17 = 10k
 R5; R18 = S1L resistor array 8x10k
 P1 = potentiometer 100k linear

Capacitors:

C1; C3-C8 = 100n
 C2 = 1n0

Semiconductors:

IC1 = 74HCT541
 IC2 = 74HCT393
 IC3 = 6116 or 8416
 IC4 = 74HCT688
 IC5 = 74HCT563
 IC6 = 74HCT132

Miscellaneous:

S1; S6 = SPST push-to-make button.
 S2; S3; S4 = miniature SPDT switch.
 S5 = miniature SPST switch.
 S7; S8 = 8-way DIP switch or hex thumb-wheel-switch.
 K1 = 20-way pin header.
 PCB Type 890020

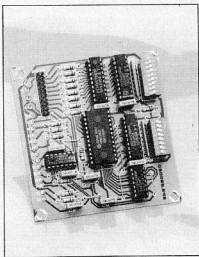

the board allows the fitting of two 8-way DIL switch blocks, it is better, in many cases, to use switches that can be mounted on to the enclosure. Hexadecimal thumb-wheel switches are convenient in the practical use of the test generator and are, therefore, suggested as an more ergonomic and simple-to-connect alternative to DIP switch blocks.

The power supply is purposely not accommodated on the board because a regulated 5 V source will nearly always be available as part of the circuit under test. The digital test generator draws about 30 mA.

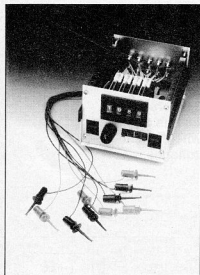

Fig. 4. Prototype of the test generator housed in a compact enclosure with the word configuration and word number switches mounted on to the front panel.

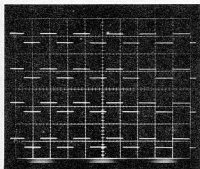

Fig. 5. Bit pattern displayed on a logic analyser.

Programming

The memory has to be loaded with the desired bit-patterns (test words) before the circuit can be used to test a digital system. Fortunately, programming is straightforward:

- Set the number of test words as a hexadecimal value on S_6 (00H–FFH).
- Set S_3 to PROGRAM, S_2 to STEP and S_4 to SINGLE. Set the desired bit pattern on S_7 .
- Press STEP to store the bit pattern in memory.
- Set the next bit pattern.

When S_4 is set to SINGLE, the circuit will not accept further data when the number set with S_6 is reached. After loading all bit patterns, S_3 is set to RUN to sequentially feed the data to the circuit under test. Depending on the position of S_2 , this feeding out takes place automatically or ma-

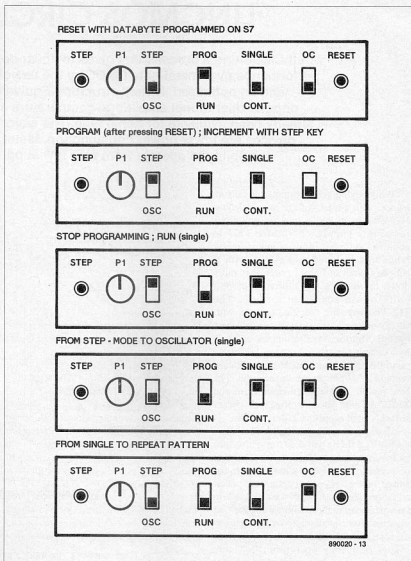

Fig. 6. Overview of the programming and loading operations using the front panel controls.

nually.

Timing and level measurements may start after the digital outputs of the tester have been connected to relevant points in the circuit under test. The tester does not provide a strobe pulse, but this is fairly simple to implement by programming, say, bit 8 accordingly. In that case, the test word is 7-bits wide, and the sequential data stream has a maximum length of 128 samples because the strobe bit must toggle in between samples.

Finally, one interesting application of the test generator should not be left unmentioned here. It is fairly simple to use the instrument for driving a D-A (digital-to-analogue) converter. This combination creates a simple programmable waveform generator.

LINCMOS CIRCUITS

LinCMOS™ is a process that gives to linear devices a superior performance over metal-gate CMOS by the use of polysilicon gates and an optimized 'N well' structure. Equivalents of many popular operational amplifiers, comparators and timers have already been available for some time. The major benefits of these devices are lower power consumption, faster switching and the ability to operate from very low supply voltages.

While giving good \pm supply rail performance, with a total voltage not exceeding 16 V, the input and output are optimized for single supply operation. This is achieved with an input common mode range that included GND ($-V_{DD}$ with \pm supplies) and an output range that pulls down to within a few millivolts of GND (with a load connected to GND). The TLC27x range are specified to work with supply voltage down to 3 V and will thus operate with the supplies that are commonly available for TTL and HCMOS. For maximum dynamic range, single rail operation with 16 V supplies should be used. For low power and battery operation, the TLC25x range are specified to operate with 1 V total supply voltage.

High bias mode gives a wider bandwidth (2.3 MHz) and faster slew rate (4.5 V/ μ s) than standard bipolar opamps (especially single-supply devices) for the same order of supply current. The enhanced bandwidth gives an increase in the open-loop to closed-loop gain ratio at a particular frequency improving accuracy of, for example, filter circuits, or allowing higher frequency operation. Slew rate enhancement gives a wider large-signal bandwidth and generally allows the implementation of faster circuits.

Medium bias mode gives standard bipolar opamp performance at roughly a tenth of the supply current.

The main advantage of the low bias mode is the low power consumption with sufficient bandwidth and slew rate for basic sensor interface and audio applications.

Low bias and offset currents allow circuit simplification through the elimination of bias current balancing resistors, higher impedance circuits for greater accuracy (for instance, smaller, higher tolerance capacitors) and circuit current defined only by feedback components. Another advantage is insignificant noise due to bias current (shot noise); noise is dominated by noise voltage and resistor noise—see Fig 3.

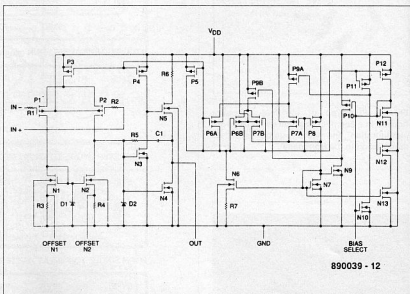

Fig. 1. Circuit diagram of a typical LinCMOS operational amplifier.

TECHNOLOGY	BIPOLAR*	BIFET*	LinCMOS (bias levels)		
			LOW	MEDIUM	HIGH
V_{CC} MAX REC	± 15	± 15	16	16	16
V_{CC} MIN REC	± 5	± 5	1	1	1
V_{CC} SPECIFD	± 15	± 15	10**	10**	10**
V_{IO} mV	1-10 ¹	3-20	2-10	2-10	2-10
ΔV_{IO} μ V/degC	5-20*	10	0.7	2	5
I_{IO}	2-750nA	5p-2nA	1-300pA	1-300pA	1-300pA
I_{IQ}	20-800nA	30p-10nA	1-600pA	1-600pA	1-600pA
V_{ICM} V	± 13 or ± 12	± 12	-0.2 to 9	-0.2 to 9	-0.2 to 9
V_{OS} IN 10kohms	24-26 or $V_{CC}-1.5$	24-77	0-7.8	0-7.8	0-7.8
A_{VOL} V/mV	15-200	15-200	20-500	15-280	7.5-40
CMRR dB	70-90	70-76	70-88	70-88	65-82
I_{CC}	0.5-3.3mA	1.4-2.8mA	10-40 μ A	150-400 μ A	1-2.2mA
B, MHz	0.7-1	3	0.1	0.7	2.3
SR V/ μ S	0.5	13	0.04	0.6	4.5
e_n nV/Hz	22*	18	70	38	30
@ 1kHz					
i_n pA \sqrt Hz	0.55*	0.01	0.013*	0.013*	0.013*
@ 1kHz					

1) bipolar: μ A741 / MC1458 / LM324

2) BIFET: TL080-series

* typical value (not specified)

** TLC25X types are also specified at 1V

890039 - 11

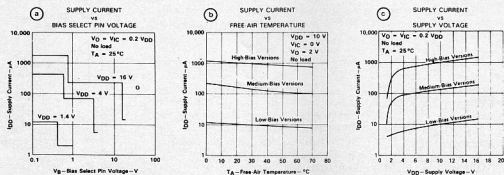

DEVICE FEATURES				
Typical @ VDD = 5 V, TA = 25°C				
BIAS-SELECT MODE				
	HIGH	MEDIUM	LOW	UNIT
F _D	3375	525	50	μA
S _{RI}	0.6	0.4	0.03	V/μs
V _{TA}	25	32	68	mV/°C
f ₁	1.7	0.5	0.06	MHz
A _{VD}	23	170	480	V/mV

Parameter Bias	Low	Medium	High
Offset voltage drift (Typ)*	0.1 μV/month	0.1 μV/month	0.1 μV/month
Offset temp coef (Typ)	0.7 μV/°C	2 μV/°C	5 μV/°C

890039 - 13

Fig. 2. The voltage at the bias-select pin of a LinCMOS operational amplifier influences the characteristics of the device.

Operational amplifiers

The operational amplifier is the most popular of all LinCMOS circuits. In fact, the first devices available in the new technology were the now well-known opamps Type TLC251/271 (single), TLC252/272 (dual), and TLC254/274 (quad). These are intended as replacements for the standard Types 741/3140, MC1458/CA3240, and LM324.

A close examination of the TLC271 reveals that the opamp, apart from the usual inputs, output and supply connec-

tions, has a so-called bias-select pin. The voltage at this pin determines the current drawn by the device—see Fig. 2. In the low-bias mode (bias-select pin connected to the +ve supply voltage), the current is only (typically) 10 μA. The price to be paid for this low current is a poor slew rate of only 0.04 V/μs and a unity-gain bandwidth of a mere 100 kHz.

The speed is determined largely by the device's internal capacitances. When the supply current is small, the charge and discharge currents through these capacitances will assume a larger importance, whence

the lack of speed. However, there are a number of applications in which the low slew rate is of no importance.

In the medium-bias mode, the current is about 15 times higher, but the slew rate and unity-gain bandwidth are correspondingly better: 0.6 V/μs and 0.7 MHz respectively). These values are comparable to those of, for instance, a standard 741. Note however that the latter draws a current of 1.7 mA.

In the high-bias mode, the current rises to 1 mA, but for that you get a very fast opamp with a slew rate of 4.5 V/μs and a

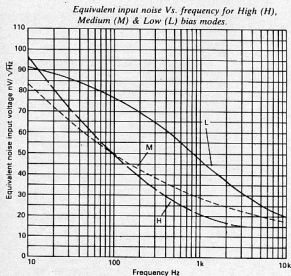

Fig. 3. Equivalent input noise voltage vs. frequency for high (H), medium (M) and low (L) bias modes.

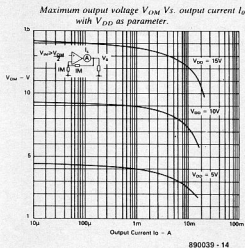

Fig. 4. Maximum output voltage V_{OM} vs. output current I_O at various supply voltages.

unity-gain bandwidth of 2.3 MHz.

The dual versions TLC252/272 and the quad Type TLC254/274 are not provided with bias-select pins (for which they have no space in any case). In these versions, the bias mode is permanently set internally. The type number indicates which bias mode the device provides. For instance, a TLC27L2 is a low-bias type; a TLC272 is a high-bias version; and the TLC272M2 is a medium-bias type.

Power supply and load

As mentioned briefly already, to obtain maximum dynamic range, LincMOS opamps are optimized for single-rail operation from supplies not exceeding 16 V.

The output voltage vs output current characteristic for loads connected to earth is given in Fig. 4. An open-circuit output, or one with the load connected to earth, can be pulled to within a few millivolts of 0 V. The output can only be pulled to the +ve supply level if the load is connected to the +ve supply level if the load is connected to the +ve rail or an external pull-up resistor is added. Such a resistor has, however, the disadvantage of resulting in a relatively large power consumption at low output voltages. Also, the open-loop amplification drops sharply when the output voltage gets close to the +ve supply voltage. This is caused by N5—see Fig. 1—switching off.

When relatively heavy loads are used, it should be noted that the sinking rate may exceed the sourcing rate; in other words, that the output current is greater than can be provided. If, therefore, large output currents are required without additional components, it is recommended that the load is connected to the +ve supply rail as shown in Fig. 5b.

Frequency compensation

In low-power applications, the current

will be determined largely by the resistances in the feedback loop and by the load. The value of these resistance will, therefore, be normally quite high. As far as DC signals are concerned, that presents no problems. When AC signals are involved, however, more account must be taken of input and other stray capacitances (C_{stray} in Fig. 6) than in conventional opamp circuits. To obtain a sufficiently wide bandwidth, it may in some cases be necessary to use a compensating capacitor as shown in Fig. 6 to reduce the feedback at high frequencies.

Comparators

A number of comparators available in LincMOS technology are shown in Table 2. The TLC372 and TLC393 are pin-compatible replacement of, for instance, double comparator Type LM393. Quad comparator Type LM339 may be replaced by the TLC339 or TLC374.

As with opamps, the current consumption of LincMOS comparators is substantially lower than that of bipolar equivalents, while the input current is very low (typically 5 pA). There is not much difference in the input offset voltages.

The outputs of most comparators are of the open-drain type, enabling logic functions to be produced by interlinking them. Normally, a pull-up resistor will also be required, but not with the TLC3702 and TLC3704, since these have totem pole outputs.

Unlike some opamps, comparators do not offer a choice of three bias modes. The bias mode is inherent in the type. For instance, the TLC393 draws 22 μA (typical) compared with the 0.8 mA drawn by an LM393, but it is slightly slower (2.5 μs against 1.3 μs). A TLC372 has a higher power consumption, but is much faster (650 μs)

COMPARATORS

Table 2

	INPUT OFFSET VOLTAGE (mV)	INPUT OFFSET CURRENT (pA)	INPUT BIAS CURRENT AT 25°C (pA)	RESPONSE TIME (μs)	SUPPLY CURRENT (μA)	SUPPLY VOLTAGE RANGE (V)		OUTPUT TYPE
						Min	Max	
Dual								
TLC372	12.0	1	5	0.65	750	3	16	Open Drain
TLC393	10	1	5	2.10	50	3	16	Open Drain
TLC3702	10	1	5	2.30	50	3	16	Totem Pole*
Quad								
TLC374	12.0	1	5	0.65	1000	3	16	Open Drain
TLC339	10	1	5	2.10	100	3	16	Open Drain
TLC3704	10	1	5	2.30	100	3	16	Totem Pole*

*Totem Pole Outputs are HCMOS and TTL compatible

890039 - 21

Table 2. Some LincMOS comparators and their main parameters.

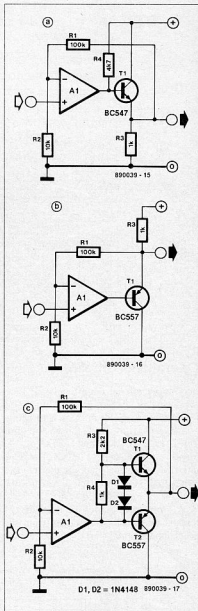

Fig. 5. Circuit adaptations for obtaining a larger output current in a load connected (a) to earth, (b) to the +ve supply rail, and (c) symmetrically.

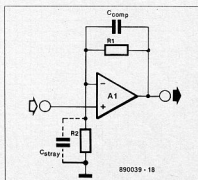

Fig. 6. Input and other stray capacitances may be countered by a compensating capacitor.

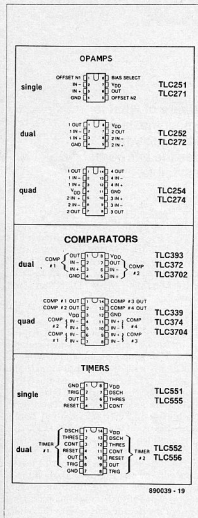

Fig. 7. Pinouts of the various LinCMOS circuits discussed in this article.

TIMERS

Table 3

	SUPPLY CURRENT (μ A)	POWER DISSIPATION (mW)	SUPPLY RANGE (V)		MAX FREQUENCY (MHZ)	MAX TIMING PERIOD	MAX TIMING ERROR	OUTPUT CURRENT (mA)
			Min	Max				
Single	TLC551	1	1	18	2.1	Hours	3%	+10/-100
	TLC555	1	2(3)*	18	2.1	Hours	3%	+10/-100
Dual	TLC552	2	1	18	2.1	Hours	3%	+10/-100
	TLC556	2	2(3)*	18	2.1	Hours	3%	+10/-100

*Indicates for industrial Temp Range

890039 - 22

Table 3. A variety of LinCMOS timers and their main parameters.

It should be noted that Texas Instruments is not consistent in their recommendations on maximum supply voltage voltage. In some data sheets they mention 16 V and in others, 18 V. It is, perhaps, wise to be on the safe side and stick to 16 V.

Timers

As might be expected, there are equivalent LinCMOS ICs for the renowned 555 series of timers. In fact, there are four: the TLC555 (single) and TLC556 (dual) to replace the standard (LM/NE)555 and 556 for supply voltages from 2 V to 18 V and the TLC551 and TLC552 for operation from low voltages (down to 1 V).

Apart from the much reduced power consumption, the great benefit LinCMOS timers offer is the greatly extended frequency range. The maximum frequency is about ten times higher than that of a standard 555 (2.1 MHz against 200 kHz), because the saturation normal transistors have to cope with has no or negligible

effect in the new technology. Even at relatively low frequencies (from 20 kHz to some hundreds of kHz), the TLC555 has a major advantage in that the frequency can be defined much more precisely by external components. Note that the frequency range is extended also at its lower end.

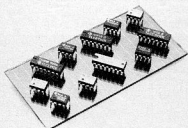

Since the input impedance and input leakage current are much smaller than in a bipolar 555, the RC networks that are connected to these timers can have a much higher value. This makes realization of very long time delays (up to hours) possible.

ELECTRONICS NEWS

MODI XEROX POINT

India's first retail outlet chain for computers, Computer Point, is to be acquired by Modi Xerox Ltd. Set up in 1984 by a group of technocrats, Computer Point initiated a new trend as several computer retail outlets sprang up in different parts of the country following its success.

Computer Point opened four outlets in Bombay, Delhi, Madras and Bangalore where small buyers could visit the shop, see the products and purchase their choice.

Initially, Computer Point sold imported home computers of Spectrum and computer stationery and then it became a public limited company. Computer Point was appointed sole distributor for Lotus products and it also diversified into selling products of other Indian manufacturers. The company embarked on an ambitious target of opening 40 outlets in the country by 1990 but this could not be achieved following serious cash flow problems. Subsequently, manpower problems also compounded the crisis. Lotus joined hands with Tata Consultancy Services, and Computer Point lost a major chunk of its business.

The promoters of the company, Mr B.M. Ghia and Indian Organic

Chemicals Ltd. chose to sell their shares in Computer Point. For Modi Xerox, Computer Point's outlets would provide the much needed infrastructure for selling its own office automation equipment, in addition to computers.

FLOPPY DISK MONITOR

M. Noteris

It often happens that PC users are left completely unaware of what is actually happening to the floppy disk inserted in the machine. Is the machine reading, attempting to read, or writing, and if so, to which track? This simple monitor circuit for IBM PCs provides the answers by making the control signals of the disk drives visible.

The drive select LED on a floppy disk drive does just what it is supposed to do: indicate drive activity. Many PC users have, therefore, no idea whether the floppy disk they have just inserted is read from or written to. Clearly, this is an unacceptable situation in this day and age of data security and a few bits on a disk determining access to files that represent many hours of work. While the present

circuit can not restore data on a corrupted floppy disk, it helps to prevent the most serious of mishaps because you witness how they come about!

The principle

The floppy disk monitor works on the simple principle of visually indicating the status of the various control signals used

for the floppy disk drives in a PC. Practically all user manuals supplied with PCs give a disk-drive wiring diagram that indicates the signals **Drive Select** (DS0 to DS2, and, in some cases, DS3), **Read Data**, **Write Enable**, **Step**, **Direction** and **Track 0**.

The movement of the head in the disk drive is fairly simple to monitor by clocking a counter with the Step pulses, driving the up/down input of the same counter with the Direction signal, and driving its reset input with the Track 0 signal. The visual indication function is assumed by a Type 4543 IC that decodes BCD data supplied by a counter Type 4510. The 4543 is capable of supplying the required 20 mA segment current for a Type 7760 LED display, of which two show the current track number.

Since the maximum number of tracks supported by the floppy disk monitor is 80 (0-79), two counter/display circuits are cascaded by driving the CARRY IN input of the decade driver with the CARRY OUT signal of the unit driver.

Signals Read Data and Write Enable are visualized with the aid of the decimal points on the LED displays. These indications are referred to as DPR (*decimal point read*), and DPW (*decimal point write*) in this article.

The circuit

The circuit diagram shown in Fig. 1 may cause some readers to wonder why two

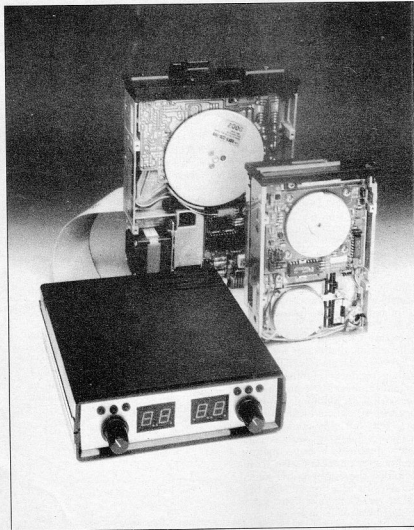

- monitors all floppy disk drives available for PC/XT, PC/AT and compatible PCs: 5¼-inch, 3½-inch, single/double sided, double or quadruple density
- static display of head position (current track number)
- read and/or write indication for selected drive
- read indicator shows data flow resulting from pulses induced in the head by the magnetic carrier
- monitors two floppy disk drives simultaneously

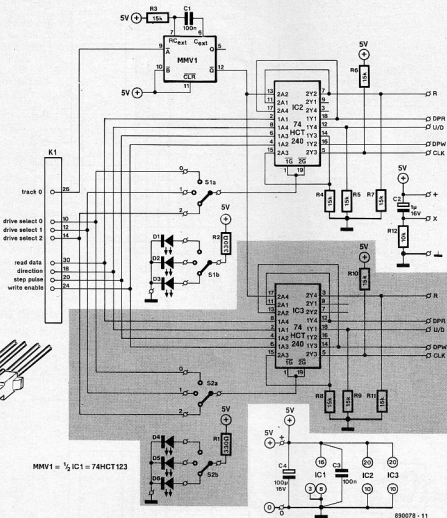

Fig. 1. Circuit diagram of the driver section of the floppy disk monitor. Shown inset is the pinning of the cable socket for powering disk drives.

Type 74HCT240 bus buffers are used. The six signals used for controlling all disk drives in a PC are carried in parallel between the disk controller board and the disk drives, so that the signals for the actuated drive must be selected before they can be directed to the associated indicator circuit. This directing of control signals is accomplished with the aid of the drive select lines, DS0, DS1 and DS2, which enable the bus buffers depending on the position of switches S₁ and S₂.

Since all control signals involved are active low, they are inverted by the 74HCT240s to enable driving the display units. A number of bus buffer inputs are connected to outputs to make sure they are properly terminated.

With S₁ in the position indicated in the

circuit diagram, signal Drive Select 2 enables bus buffer IC₂ with a low level at inputs 1G and 2G. Pull-up and pull-down resistors are fitted on the output lines of the bus buffers since these are switched to high-impedance when the device is disabled via the 1G and 2G inputs. Output lines R (reset) and U/D (up/down) are pulled low, and CLK (clock) is pulled high.

The Track 0 signal guarantees that the displays are always correctly reset to zero, which is useful when, for one reason or another, the counter loses track of the step pulses. Monostable multivibrator MMV1 shapes the Track 0 signal supplied by a slotted optocoupler in the disk drive. The arm on which the head is mounted interrupts a light beam when it is in the extreme outer position with the head(s) over

track 0 of the disk. The monostable lengthens the track 0 signal to about 1.5 ms to make sure that the display counter is properly reset even with drives that use the fastest step rate, 3 ms. Edge-triggering is used to cope with tolerance on the track 0 detection circuit and associated mechanical parts. In certain disk drives, the signal is still active even when the head is half way between tracks 0 and 1.

R-C network R₁₂-C₂ resets the counter circuits to zero at power-on by supplying a brief 'high' pulse via line x.

More about drive selection

Although the cable from the disk controller board has four drive select wires, DS0-DS3, the practical number of floppy disk

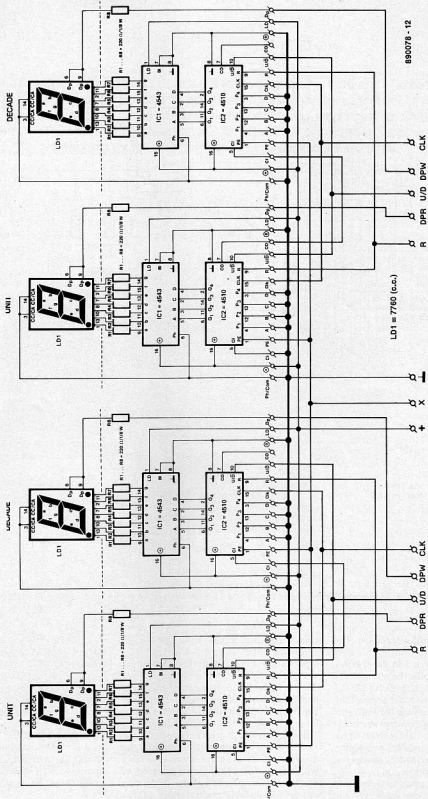

Fig. 2. Circuit diagram of the counter/display module.

drives supported in IBM PCs and compatible machines is usually limited to two. This is because each floppy disk drive requires two signals, one to control the motor, and one to control the actual selection of the drive. Thus, the motor in drive A is energized under the control of a low level on line D50, while the drive proper is enabled under the control of a low level on line D52.

It should be noted that the above functions of D50 and D52 are the other way around on some PC compatibles of Far Eastern make. The floppy disk monitor solves a potential problem arising from this oddity by virtue of rotary switches S1 and S2.

Another noteworthy point is that signal Write Enable is fed to the display unit. The use of Write Data would appear more logical at first. The background to the use of Write Enable is that some disk controller boards, for instance, those of Western Digital, generate clock pulses on the Write Data line except when actually writing to the disk drive. This clock pulse stream can not be used by the display circuits, and would cause these to light the WRITE indication (DRW) continuously.

Counter and display module

The counter/display circuit is based on an earlier design published in Ref. 1. Figure 2 gives the circuit diagram. The module is composed of four identical combinations of a synchronous BCD counter Type CD4510, a latching BCD-to-7 segment display driver Type CD4543, and a common-cathode LED display Type 7760. Cascading is achieved by connecting

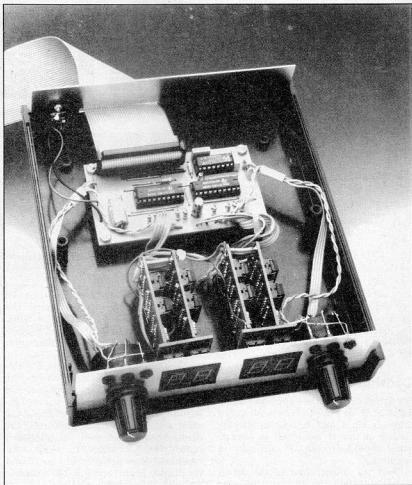

Parts list

DRIVER BOARD

Resistors (±5%):

R1, R2 = 330Ω
R3-R11 = 15k
R12 = 10k

Capacitors:

C1, C3 = 100n
C2 = 1μ0; 16 V; radial
C4 = 100μ; 16 V

Semiconductors:

D1-D6 = LED; red; 3 mm
IC1 = 74HCT123
IC2, IC3 = 74HCT240

Miscellaneous:

S1, S2 = two-pole, three-way rotary switch.
K1 = 34-way pin header.
PCB Type 890078

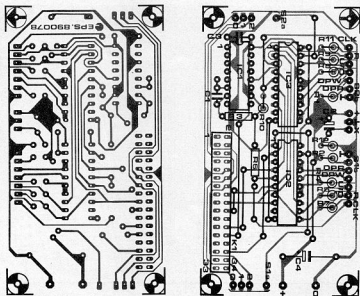

Fig. 3. Track layout and component mounting plan of the driver board.

Parts list

COUNTER/DISPLAY BOARD

Resistors (±5%):

R1-R8 = 220Ω

Semiconductors:

IC1 = 4543

IC2 = 4510

LD1 = 7760

Miscellaneous:

PCB Type 85019

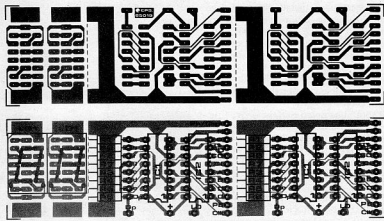

Fig. 4. Track layout and component mounting plan of the counter/display board.

the CARRY OUT (CO) output of each of the two units counters to the CARRY IN (CI) input of the associated decade counter. The functions of the U/D (up/down), and R (reset), Ph, BI, PE and LD are covered in Ref. 1.

Construction

The driver circuit of the floppy disk monitor is built on the printed-circuit board shown in Fig. 3, and the counter/display module on that shown in Fig. 4. Neither board should present any difficulty in populating.

Start the construction of the driver board by fitting the 12 insulated wire links. Continue with the resistors, of which most are fitted upright, the capacitors, the soldering terminals, IC sockets, and, finally, the 34-way pin header, in that order.

Each display board accommodates two displays and two driver circuits. The ready-made printed-circuit board must, therefore, be cut into three along the two dotted lines printed at the component side.

The fitting of the parts is carried out as usual. The interconnection between the two control boards to the display circuit requires further detailing, however. Taking one pair of displays as an example, the construction is started by populating the display board, and then the associated control circuit. Resistors R1 through R8 are mounted between the control board and the display board, and give the complete assembly the required rigidity.

Proceed with connecting paired points Ph/COM, R, 0, U/D, PE, CLK, + and LD. The CO output of the units display driver is connected to the CI input of the decade display driver, as shown in the circuit

diagram of Fig. 2 (note the mirrored position of the displays in this drawing).

The completed counter/display units are connected to the driver circuit via the 6 signal lines and the 2 supply lines. In the standard version of the floppy disk monitor, there are two counter/display units and one driver unit.

The remaining connections are those for the LEDs and the rotary switches. Install the wiring as shown in the circuit diagram.

Power supply

The circuit is conveniently powered from the 5 V rail provided by the computer's power supply. The prototype of the floppy disk monitor is a stand-alone unit that is powered via a small socket as used on portable cassette recorders. The PC is fitted with a similar socket, and the two units are interconnected by a 30 cm long 2-wire supply cable.

If the circuit is installed permanently in the PC, the ground and +5 V connections may be made at appropriate points on the motherboard. Another, more practical, solution is shown in Fig. 7. A cable should be made to enable the supply voltage to be taken from one of the disk drives.

Cables

The floppy disk monitor is connected to the disk controller board via a home-made flat ribbon cable. This cable is crucial to the operation of the circuit and is, therefore, drawn in Fig. 5.

The job is almost done if the right parts are to hand: 50 cm or so of flat-ribbon cable, two 34-way IDC (insulation displacement) sockets, and one 34-way IDC header. The sockets and the header may be types with or without a strain relief clip. The two sockets are mounted at the cable ends, and the IDC header at about 15 cm from one of the sockets. Do not twist the cable in between the header and

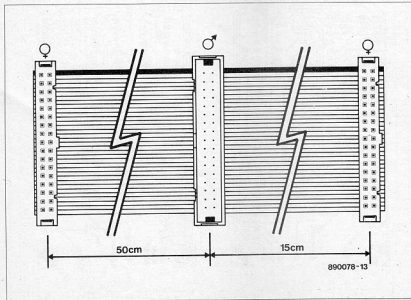

Fig. 5. The home-made 34-way flat-ribbon cable.

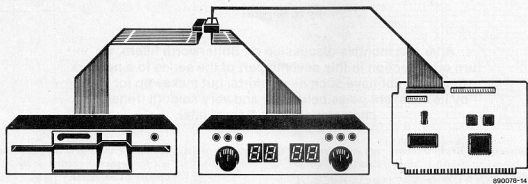

Fig. 6. Interconnection between the floppy disk drive, the monitor and the disk controller card in the PC.

the sockets: use the coloured wire in the cable to mark pin 1 of the connectors.

The existing cable between the floppy disk drives and the controller board must be disconnected at the side of the controller board. Figure 6 illustrates how the sockets at the ends of the previously described cable are connected to the disk controller board and the floppy disk monitor. The free end of the cable to the floppy disk drive is connected to the header on the home-made flat cable.

The connection as detailed is not affected by the number of floppy disk drives monitored with the present circuit. All activity on one, two or even three floppy disk drives may be watched closely from now on.

Modifications

As already noted, the basic version of the circuit is intended for monitoring the control signals of two floppy disk drives. It is, however, possible to realize a version for a single drive. In that case, only one universal counter module is used, while one of the two bus buffers on the driver board may be omitted.

A three-drive version of the monitor simply requires a third universal counter module, and, in addition, the shaded part of the circuit in Fig. 1. It is possible to mount the additional 74HC240 on top of IC₂ or IC₃, soldering pins 2, 4, 6, 8, 10, 17 and 20 to the IC below, and bending the remaining pins away from the IC body for wiring as indicated in Fig. 1.

Unfortunately, IBM PCs and compatibles do not normally allow the use of more than two floppy disk drives. There are ways to overcome this limitation, but these fall outside the scope of this article. In an IBM environment, therefore, the floppy disk monitor can not keep an eye on more than two drives.

For computers that do support more than two floppy disk drives, the monitor

circuit can be modified as required by using rotary switches with the corresponding number of positions.

The floppy disk monitor is not suitable for use with hard disks because these have a much higher number of tracks and heads.

In practice, the floppy disk monitor is a simple, yet effective aid for the PC user. It obviates, for instance, the use of a software utility to find out on which track a program or file is started, or how it is arranged on the disk.

Reference:

1. *Versatile counter circuit. Elektor India*, April 1985.

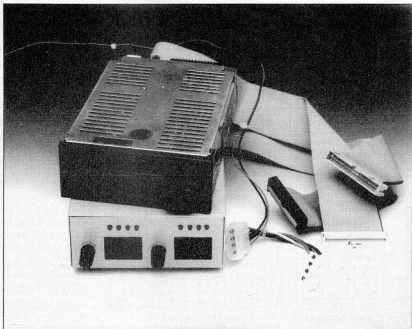

Fig. 7. The circuit is also perfect for use with 3 1/2-inch disk drives.

PRACTICAL FILTER DESIGN - PART 7

by H. Baggott

After last month's discussion on Butterworth filters, we turn our attention in this seventh part of the series to a network that does not have such steep skirts, but makes up for that by its excellent pulse behaviour and very smooth transition characteristic: the Bessel filter.

The major advantage of Bessel sections is their phase behaviour, which is more linear than that of any other type of filter — see Fig. 38. If the Bessel amplitude characteristic is projected on a linear scale, it is a straight descending line. It is only because of its usual projection on a logarithmic scale that the characteristic looks like a typical filter skirt. The transfer characteristic of a Bessel filter is, therefore, moderate. A roll-off of 60 dB per octave is not attainable: the curve is particularly poor around the cut-off frequency and this is

not dependent on n (n is the order of the filter).

Bessel tables

The tables giving the data for the computation of Bessel filters are compiled similarly to those for Butterworth sections, described in detail last month, and they should therefore not present any problems.

Again, the component values are given for a cut-off frequency of 1 Hz. Table 6 gives the pole locations of Bessel filters from the 2nd to the 10th order, while

Tables 7, 8 and 9 give the component values for a passive section under different operating conditions.

Bessel characteristics

The characteristics in Fig. 37–39 show the plus and minus points of a Bessel filter. For instance, the roll-off is noticeably less steep than that of a Butterworth filter. Also, the knee is virtually the same for all orders of the filter. One of the positive qualities of the Bessel filter is seen in Fig. 38. The delay vs frequency characteristics

CORRECTION

Tables 2 and 3 in last month's instalment contained some errors. The drawings inset in those tables included the descriptions 'even order' and 'odd order'. These should have read 'even order' and 'odd order' respectively.

n	real part - α	imaginary part - β
2	1.103	0.8368
3	1.0509	1.0025
4	0.9877	1.2478
5	0.9606	1.4756
6	0.9318	1.664
7	0.9104	1.8375
8	0.8955	2.0044
9	0.8788	2.1509
10	0.8688	2.3002
11	0.8535	2.4396
12	0.8419	2.5724
13	0.8327	2.7000
14	0.8253	2.8224
15	0.8193	2.9400
16	0.8144	3.0536
17	0.8103	3.1636
18	0.8069	3.2696
19	0.8041	3.3720
20	0.8018	3.4712
21	0.8000	3.5668
22	0.7986	3.6594
23	0.7975	3.7488
24	0.7967	3.8356
25	0.7961	3.9196
26	0.7957	4.0016
27	0.7954	4.0812
28	0.7952	4.1584
29	0.7951	4.2332
30	0.7950	4.3056
31	0.7950	4.3756
32	0.7950	4.4432
33	0.7950	4.5084
34	0.7950	4.5712
35	0.7950	4.6316
36	0.7950	4.6896
37	0.7950	4.7452
38	0.7950	4.7984
39	0.7950	4.8492
40	0.7950	4.8976
41	0.7950	4.9436
42	0.7950	4.9872
43	0.7950	5.0284
44	0.7950	5.0672
45	0.7950	5.1036
46	0.7950	5.1376
47	0.7950	5.1692
48	0.7950	5.1984
49	0.7950	5.2252
50	0.7950	5.2496
51	0.7950	5.2716
52	0.7950	5.2912
53	0.7950	5.3084
54	0.7950	5.3232
55	0.7950	5.3356
56	0.7950	5.3456
57	0.7950	5.3532
58	0.7950	5.3584
59	0.7950	5.3612
60	0.7950	5.3624

Table 6. Pole locations of Bessel filters.

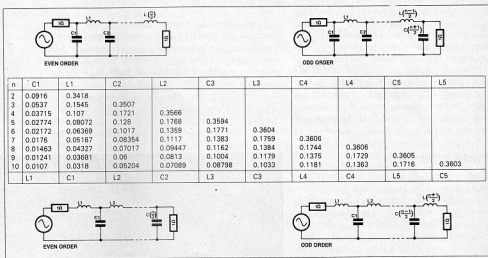

Table 7. Normalized component values for passive low-pass filters with identical input and output impedances.

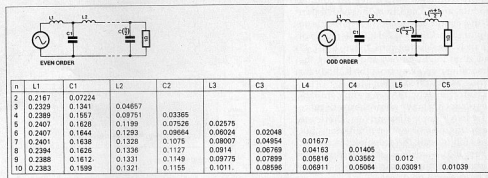
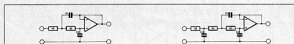

Table 8. Normalized component values for passive low-pass sections with negligible source impedance.



n	C1	C2	C1	C2	C3
2	0.1443	0.1082			
3			0.2265	0.1572	0.04039
4	0.1611 0.117	0.006207 0.1047			
5	0.1657	0.04934			
6	0.1708 0.115 0.1011	0.04076 0.07696 0.09708	0.1607	0.1387	0.04926
7	0.1751 0.1154	0.03444 0.06607			
8	0.1776 0.1155 0.09693 0.09029	0.02956 0.05714 0.07737 0.08917	0.1358	0.124	0.04818
9	0.181 0.1163 0.09626	0.02591 0.05025 0.06926			
10	1.1832 0.1166 0.09549 0.08613 0.08231	0.02287 0.04444 0.06201 0.07482 0.08104	0.1204	0.1125	0.04538

Table 9. Normalized component values for active filters with a single feed-back path.

are highly linear up to the cut-off frequency (from about the 3rd order onwards). With higher orders, the delay remains linear for some time beyond the cut-off frequency. This linear behaviour is also found in the step response in Fig. 39: there is virtually no overshoot or sign of ringing.

Some examples

Example 1.

Third-order low- and high-pass Bessel filters are required for a loudspeaker system with a nominal impedance of 8Ω. The cut-off frequency is required to be 2500 Hz.

Solution.

It is assumed that the source impedance is negligibly small and that the required filter is a passive one. The computation of the low-pass section is simplicity itself. We take a standard passive low-pass filter and insert the component values for a 3rd-order section from Table 8—see Fig. 40a. Subsequently, those values are transferred to the real load impedance (8Ω) and the actual cut-off frequency (2500 Hz):

$$C' = C / (fR)$$

$$L' = LRf$$

The resulting section is shown in Fig. 40b.

Next, the high-pass filter. All capacitors in the low-pass filter are replaced by inductors and all inductors by capacitors. In Part 3 we have seen that normalized filter values of a high-pass section are found by 'inverting' the normalized values of a low-pass filter. For the present example, this has been done in Fig. 40c with the addition of a factor $4\pi^2$, which is necessary because the formulas $1/C$ and $1/L$ apply to normalized values for $\omega = 1$ rad/s, whereas in the tables in these articles the standard values are given for $f = 1$ Hz, whence the correction factor. The formulas thus become:

$$C_h = 1/(4\pi^2 L_1)$$

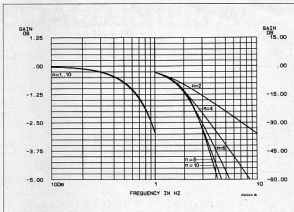

Fig. 37. Gain vs frequency characteristics of a Bessel filter.

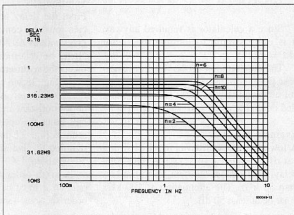

Fig. 38. Delay time vs frequency characteristics of a Bessel filter.

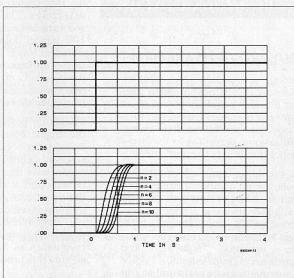

Fig. 39. Step response of a Bessel filter.

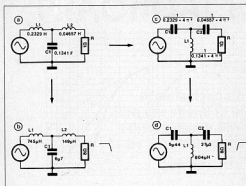

Fig. 40. Dimensioning a passive low- and high-pass filter: load impedance is 8Ω and cut-off frequency is 2500 Hz.

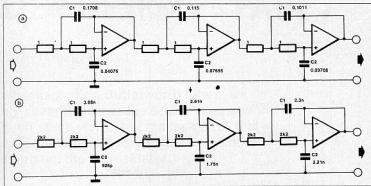

Fig. 41. An active Bessel filter of the sixth order; cut-off frequency is 20 kHz.

$$L_h = 1/(4\pi^2 C_l)$$

Since a calculator is required anyway, it is quite simple to include the factor $(4\pi^2 = 39.48)$.

The computation of the resulting high-pass filter terminated into 8Ω and having a cut-off frequency of 2500 Hz is then carried out in the usual way—see Fig. 40d.

Example 2.

A low-pass Bessel filter is required with a cut-off frequency of 20 kHz. The time delay must remain constant up to not less than 30 kHz. The attenuation at 100 kHz must be at least 50 dB.

Solution.

First, the delay and attenuation frequencies must be converted to 1 Hz and this gives values of $30/20=1.5$ and $100/20=5$. Next, we ascertain which order of filter meets the requirements.

In Fig. 38 we see that a filter of about the sixth order is required to keep the delay constant up to around one-and-a-half times the cut-off frequency. It is then seen in Fig. 37 that a sixth order filter is required to give an attenuation of at least 50 dB at $5\omega_c$.

A sixth-order filter is an even-order one, so it must be constructed from 2nd-order sections—see Table 9. The capaci-

tor values for the three sections may be taken direct from Table 9. Next, choose a suitable value for the resistors. The actual capacitor values and the wanted cut-off frequency are then computed with the aid of the formulas used in the first example—see Fig. 41b.

Two calculations for the first section:

$$C_1 = 0.1708/(20,000 \times 2200) = 3.88 \times 10^{-9} = 3.88 \text{ nF.}$$

$$C_2 = 0.04076/(20,000 \times 2200) = 926 \times 10^{-12} = 926 \text{ pF.}$$

Next month: Chebishev filters.

ELECTRONICS NEWS

BUYING SOFTWARE FIRMS

Indian companies can acquire software companies abroad by paying for such acquisitions out of 30 per cent of excess export earnings made over and above their export obligations, according to the latest policy decision of the government.

A condition imposed under this policy is an additional export obligation of 15 per cent of the foreign exchange released. Under the previous policy, the software exporters were allowed to import computer systems, software and hardware subsystems, office equipment, spare parts and so on. This facility is now modified to include the purchase of a company abroad.

Though the potential is enormous. Software exports in 1988-89 were

worth only about Rs 80 crores and the target fixed for 1989-90 is Rs 300 crores. The world demand for software is currently estimated at 100 billion dollars and it is projected to touch 300 billion by the turn of the century. The decision of the government to allow purchase of software companies abroad is to be seen in this context.

Marketing problems were among the major constraints which affected the export of Indian software. Only a few large companies have their branches abroad. Others find it difficult to market their products as it involves continuous monitoring and substantial expenditure. The industry suggested acquisition of foreign companies as one of the ways of solving this problem.

But, the condition that the companies should pay from the excess 30 per cent of the earning for such acquisitions may not help many as few companies are anywhere near exceeding their export earnings by

30 per cent of the obligation. To evoke an enthusiastic response from the industry and to accelerate the growth of the software industry this condition may have to be diluted, it is felt.

Transposition switch S1 must be not be installed direct on to the board because its pinning does not correspond to that of the solder terminals (the centre contact must be wired to point c). The MIDI connector is a 5-way DIN type for mounting at the edge of the printed circuit board.

Decoder boards

The number of decoder boards required depends on the keyboard type. One decoder board, of which the design is shown in Fig. 8, scans up to 16 keys, and is configured to address a particular group of keys with the aid of a jumper, J1, which goes to point A, B, C, D, E, or F as shown in Fig. 6. Each of the cascaded decoder boards has a different jumper installed. Jumper A is always used for the decoder board connected to the lowest key group. If the total number of keys on the keyboard is not a multiple of 16, as, for instance, in the case of a 72-key type, only the *extreme right-hand* decoder board may be cut in two. The track design of the decoder board allows this to be done fairly easily to the right of contact S5.

Connections

The controller board is connected to one of the decoder boards with the aid of a 16-way flat-ribbon cable. Both ends of this



cable must be fitted with an IDC-type 16-pin DIP header. As shown in Figs. 6a and 6b, the cable connects socket K1 on the controller board to socket K3 on the nearest decoder board. The decoder boards are interconnected in ascending order with cables between sockets (or pin headers) K2 and K1. These are shown in dotted lines on the component overlay, and must, therefore, be installed at the track side of the board. Wire-wrap sockets or pin headers should be used to make sure that the pins can be soldered properly to the tracks. Wire-wrap sockets mate with 16-way IDC

Parts list

CONTROLLER BOARD

Resistors ($\pm 5\%$):

R1;R2 = 1K0
R3;R4 = 470R
R5;R6 = 220R
R7 = 10K
R8;R9;R10 = 100K
R11-R14 = 1K0 (8-way SIL array)

Capacitors:

C1;C2 = 22p
C3 = 100p
C4 = 10n
C5 = 1 μ 0; 16 V; tantalum
C6 = 10 μ ; 16 V
C7-C11 = 2 μ 2; 16 V; tantalum
C9 is not fitted when ICs is mounted with a heat-sink.

Semiconductors:

D1;D4 = LED
D2;D3 = 1N4148
D5 = 1N4001
IC1 = E510*
IC2 = EPROM 2764 (ESS575; see Readers Services page)
IC3 = 74HC00 or 74HC132
IC4 = 74HC138
IC5 = 7805
IC6 = 74HC688
IC7 = 74HC273
IC8 = 74HC04 or 74HC14
Note: HCT equivalents may be used, but HC and HCT types must not be mixed in this circuit.

Miscellaneous:

X1 = quartz crystal 4 MHz.
S1 = miniature toggle switch with centre-off contact.
S2 = push-to-make button.
K1 = 16-way DIL socket or 2 8-way pin headers.
K2 = PCB mount socket for 3.5 mm supply plug.
K3 = PCB mount 5-way DIN socket.
Heat-sink for ICs.
PCB Type 890105-2

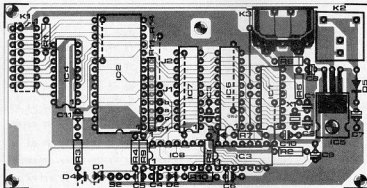
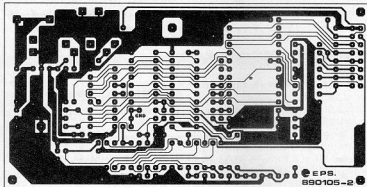

Fig. 7. Track layout and component overlay of the main controller board. The unregulated supply voltage is applied via K2.

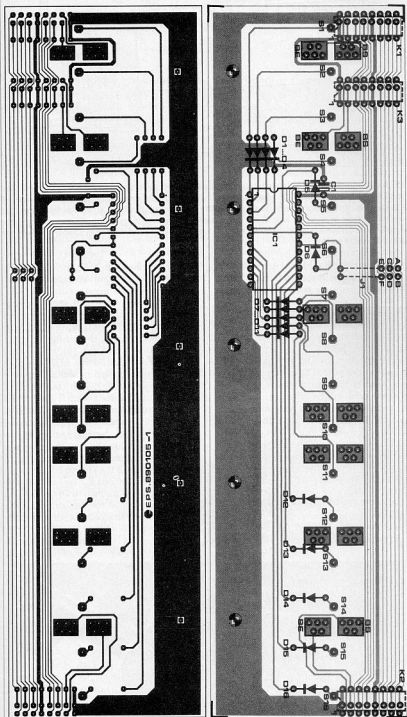

Fig. 8. Track layout and component mounting plan of a keyboard decoder. The BE and BS bars are fitted on to solder terminals, for which five possible positions are provided. Sockets or pin headers K1 and K2 are mounted at the track side of the board.

Parts list

DECODER BOARD

Capacitors:

C1 = 1 μ 0; 16 V; tantalum

Semiconductors:

D1-D16 = 1N4148

IC1 = 74HC154 or 74HCT154

Miscellaneous:

K1; K2; (K3) = 16-way pin header or wire-wrap socket.

16-way flat-ribbon cable with IDC or DIP connectors.

Solder terminals as required.

PCB Type 890105-1

DIP headers, and pin headers with IDC sockets. It is also possible to do without flat-cable connectors altogether and use individual wires. With 3, 4 or 5 decoder boards, and 16 wires per connection, however, this solution is rather time-consuming.

When a keyboard with fewer than 96 keys is used, and it is not desired to change the contents of the default EPROM (ESS575), study the configuration diagram of Figs. 6a, and find the decoder board and point S1-S16 to which the lowest key contact on your keyboard is connected. Figure 6a shows examples of how keyboards with 72 keys and 54 keys are 'fitted' into the available range of 8 octaves. Again, note that the *standard* EPROM is used (ESS575), so that programming is not required. Non-connected contacts may be left open or tied to the BE bus to simulate a closed rest contact.

Mechanical work

Since there are many types of new, used and otherwise ready-made keyboards around, the mechanical construction is not standard as is the electronic construction.

The choice of the keyboard and the contact type is fairly difficult, and the best way to avoid problems is, of course, to purchase a keyboard with integral switch-over keys. Unfortunately, such a device is probably hard to obtain, so that the keyboard and the contacts may have to be purchased separately. Gold-plated wire contacts are simply glued on to the decoder boards prior to soldering their contacts. Keyboards with wooden keys and spring-type contacts are probably the best you can get, but they require great care and precision in assembling successfully with the decoder boards.

Although the decoder boards (Fig. 8) have been designed to fit in line with the contacts and the keys themselves, they are also suitable for use with wooden keys

and separately installed contacts, as shown in the accompanying photographs. The BS and BE lines are constructed as bus bars that run along the full length of the cascaded decoder boards. The spiral springs touch the upper bar when the keys are pressed. The bars are made from silver-plated wire fitted on to solder terminals.

Each decoder board has holes to enable it to be secured on to the keyboard with screws and PCB spacers. The BE and BS bus bars or the contacts must not be used for keeping the boards in place. At least 3 of the 5 screw holes must be used: the two at the edges and the one in the centre of the board. The cross-sectional drawing of Fig. 9 gives a suggested construction of a keyboard with wooden keys and spiral spring contacts.

Horizontal bus bars

To begin with, do not install the solder terminals for the BE and BS bus bars, or the contacts. Use an unpopulated decoder board to mark its position on to the rear of the keyboard. Wood screws may be used in some cases, and metal screws with PCB spacers in others, depending on the construction, size and material of the rear side and the base plate or frame of the keyboard.

The decoder boards allow 5 positions for the solder terminals that hold the bus bars. As will be recalled from Part 1 of this article, the keyboard processor measures the player's strike force as the time that lapses when the pole of the actuated key travels from the rest contact to the work contact. The key release time is established in a similar manner by measuring the work-to-rest time. Since all rest contacts are connected to bus bar BE, and all work contacts to bus bar BS, it will be evident that the 5 positions of the bars allow the constructor to gear the velocity characteristic very accurately to the player's preference (are you the constructor and the player? Good!).

While fitting the solder terminals and the bus bars, it is important to observe the distance between them, and the distance between the key contact (the spiral spring) and the BS bus bar. These distances must be uniform over the full length of the bars. A vernier slide gauge or a micrometer must be used to check this. In practice, it was found that a bar distance of 3 mm gave optimum results with the prototype keyboard shown in the photographs. Position errors of less than 0.5 mm were clearly noted by experienced players.

To find the optimum position of the bars on your particular keyboard, fit only 2 solder terminals on a single decoder board, that is provisionally secured on to the keyboard. Experiment with the bus distance until you are satisfied with the velocity response of the keyboard, then install the bars permanently and check for uniform spacing. The use of silvered wire is a must to prevent corrosion of the contacts. Silver-plated wire is usually sold in diameters from 1 to 2 mm.

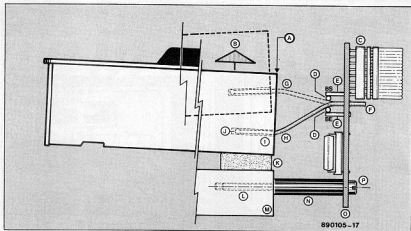

Fig. 9. Suggested construction using wooden keys and spiral springs. A: wooden key. B: key travel. C: wire-wrap socket. D: silver-plated bus bar. E: solder terminal. F: spring end soldered at track side of decoder board. G: spiral spring in actuated position. H: spiral spring in rest position. I: hole in wooden key. J: spring secured in key with super-glue. K: support strip for keys. L: hole drilled in keyboard base plate. M: keyboard base plate. N: PCB spacer. O: decoder board. P: metal screw.

The key pole should not reach the work contact, i.e. the BS line, until the key is fully down. This requires accurate positioning of the decoder boards, and is best achieved by making the screw holes slightly oval at the top with the aid of a small round file. Do not make the holes in the keyboard itself any larger.

The position of the BS bus bar with respect to the pole is fairly critical. If the pole reaches the work contact too early, adjacent keys will be actuated along with the wanted ones while playing rapidly. Also take into account the relatively large inertia of wooden keys, which take quite some time to return to the rest position. In general, if the work contact is not located at the very end of the pole travel, notes will blend (no NOTE OFF message) during rapid, but still *staccato*, playing. The problem in this case is common to all mechanical keyboards: the limit of the repetition rate is reached.

In conclusion, the work contact as well

as the rest contact must be actuated neatly and reliably at the end of the pole travel, and at all times.

The drawing of Fig. 9 shows a suggested construction on the basis of wooden keys and spiral spring contacts. It is recommended first to glue the spring in a hole in the key, and then solder the other end to the decoder board. After the glue has hardened, the spring is pulled gently just before soldering it at the track side of the relevant decoder board. This is done to make sure that the spiral remains straight when the associated key is struck. Spring movement, however small, is unacceptable in the rest position. When movement is noted, heat the solder joint and carefully pull the spring a little to get more tension. Try out the feel of the keys by playing a few notes within the octave. Do not fit or adjust the remainder of the keys until the results of this test are satisfactory.

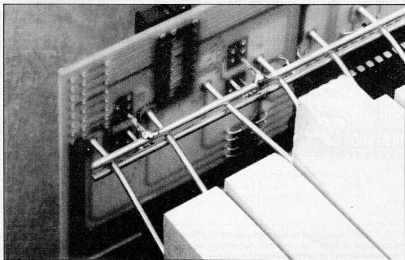

SCIENCE & TECHNOLOGY

The versatile cable that tells a tale

by Dennis Moralee

A new pressure-sensitive cable with important security possibilities, developed as part of a British naval research project, is about to open up a whole range of military, industrial and domestic applications.

Vibetek, the new sensing cable, incorporates a rugged piezoelectric polymer that allows it to respond directly to applied pressures, impacts, stress and strain, vibration and even sound. Compared to traditional piezoelectric sensing devices, using single crystals or microchip thin films that are limited to sensing at a single point location, Vibetek provides continuous sensing along cable runs of over several hundred meters. It also offers a much more sensitive response, is robust and competitively priced.

The new cable may be used simply to replace existing pressure-sensitive lines in, for example, traffic monitoring applications, where it can be buried just below a road surface in order to count the number of vehicles passing over it.

Its high sensitivity makes it possible for the cable to be put about 30 cm or more below the road surface, protecting it from physical damage while still providing accurate and reliable detection of passing vehicles. Its rugged construction will ensure that it survives for two years or more where conventional cables would last only a small part of this time.

Highest vibration frequencies

Moreover, it can detect not only the large applied pressures of road vehicles but the lighter loads as well. And because its response is highly linear and its electrical output precisely proportional to the applied pressure, different forms of road traffic can be distinguished and accurately weighed, proving the facilities of a dynamic weighbridge.

It is also sensitive over a wide range of frequencies, which in traffic-sensing applications can stretch from the near-static loads of slow-moving vehicles to the high-

est vibration frequencies transmitted through the road surface. Linked to an electronic signal processing instrument, the cable can provide information about a passing vehicle's weight, speed, load-distribution, acoustic noise level, and even its engine condition. In suitable circumstances, it can also monitor the conversation of passing pedestrians.

The capabilities of the Vibetek cables are even more important in military and civilian security applications. For example, in one military situation, an army patrol, camping overnight in rough terrain, used the new cable as a trip wire along a lengthy security perimeter that included not only roads, farm tracks and fields, but

even pick up intruders' conversations, providing the perfect antidote to nimble-fingered thieves of artworks and security safes.

Raychem Ltd⁽¹⁾ of Swindon, the original developer of Vibetek, has set up a subsidiary company to develop the market both for the cable and complete electronic systems incorporating its use. Called FOCAS⁽²⁾, the new firm is staffed mainly by former Raychem personnel. Raychem is a minority shareholder with the majority owned by security specialists, Cookson Group PLC⁽³⁾.

FOCAS has already built up considerable interest in Vibetek among many British companies, particularly in the security field, and new commercial uses for the cable are expected to reach the market soon.

It is currently being supplied in two forms: an extremely sensitive premium grade called Vibetek 20, and a more rugged, cheaper version, Vibetek 5. Both use a piezoelectric layer of polyvinylidene fluoride (PVDF), formed coaxially between inner and outer electrodes.

In the case of Vibetek 20, these are made from a special alloy and silver respectively as part of a unique co-extrusion process. In Vibetek 5, however, the PVDF layers are conventional copper compo-

nents surrounded by an extra rugged protective jacket. Both forms of cable allow easy connection through conventional cabling techniques, yet have very impressive technical characteristics.

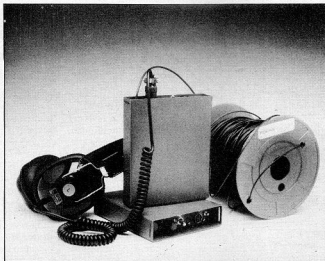

also sections of running streams.

Through monitoring, the patrol could detect and track the movements of every type of intruder sent against it—ranging from a single infantryman to a whole platoon and wheeled and tracked vehicles.

Security functions

In everyday life, the security provided by Vibetek's capabilities is noteworthy. A length of cable attached to a perimeter fence around an industrial site, for instance, can pinpoint all attempts to tamper with it.

Buried in a floor or wall or even simply run under a carpet, it will detect all movements in a protected building, and may

References:

1. Raychem Ltd • Faraday Road • Dorcan • SWINDON SN3 5HH • Telephone (0793) 28171.
2. FOCAS • Faraday Road • Dorcan • SWINDON SN3 5HH • Telephone (0793) 28171.
3. Cookson Group PLC • Clements House • 14 Gresham Street • LONDON EC2V Telephone 01-606 4400.

TRACKING TESTER



This high-grade piece of test equipment, designed by ELV GmbH, can be used for tape speed calibration, wow, flutter and drift measurements on reel-to-reel tape recorders, cassette recorders and video recorders.

A close study of the tape tracking characteristics, together with signal-to-noise and frequency response measurements, is of undisputed importance for aligning audio and video tape recording equipment, and for quality assessment. Tracking errors are caused by irregular tape transport, and are manifest as frequency deviations in the played back signal.

At least two standards are available for tape tracking measurements. One is the DIN standard (*Deutsche Industrie Norm*), which is based on a test frequency of 3150 Hz. The other standard has been defined by the CCIR (*Comité Consultatif Internationale de Radio*), and is based on a test frequency of 3000 Hz. The tracking tester described here supports both standards by providing either test frequency at the flick of a switch.

Tests and procedures

A basic distinction is made between two test procedures:

Speed deviations and drift

This measurement requires a test cassette with a prerecorded reference signal of 3150 Hz (DIN) or 3000 Hz (CCIR). The accuracy of the frequency of this reference tone is adequate for all practical purposes, and enables measuring absolute tape speed deviations as well as drift. The latter is particularly noticeable at the beginning and the end of the tape, when the reel motor(s) have to compensate relatively rapid changes in the load and torque. The operation of the tracking tester for this type of measurement is detailed below.

Wow and flutter

These tracking errors consist of slow frequency variations in the range from 0.3 to

6 Hz (*wow*), and as faster modulation effects up to 100 Hz, which results in a fluttering sound. The tracking tester has three ranges for wow and flutter measurements.

Depending on the selected mode and range, the tracking tester measures the relative deviation of the instantaneous tape speed (*wow* and *flutter*), or the relative deviation of the average tape speed (*drift*). The relative deviations are expressed as a percentage of the relevant standard values. As already mentioned, drift measurements require a test cassette.

Operation

The tracking tester is powered by a 9 VDC/200 mA mains adaptor connected to a socket on the rear panel of the enclosure.

The power on/off switch is found at the right on the front panel. A light-emitting diode (LED) above the switch indicates whether the instrument is in operation.

The required test standard, CCIR (3000 Hz) or DIN (3150 Hz), is selected with the aid of a single switch at the centre of the front panel, near the top cover of the enclosure. The signals to and from the tape recorder are connected to the tracking tester either separately via phono sockets or combined via a 5-way DIN socket.

Wow and flutter measurement

Measurements without a test cassette first require recording the test frequency on to a tape inserted in the apparatus under test. The tracking tester supplies a stable reference frequency of 3000 Hz or 3150 Hz for this purpose. This frequency is obtained from a quartz crystal oscillator and a fairly complex filter that together guarantee a stable sine-wave signal with

a distortion smaller than 1%.

After recording the test signal, the tape is rewound and played back. The *wow* and *flutter* measurement can then be carried out either with the reference tape or the previously recorded tape. Playing back the home-made recording will, in general, result in readings that are about 40% higher than those obtained with a proprietary reference tape. This difference is caused mainly by the fact that tracking fluctuations are also taken into account during the recording.

Toggle switch TEST/MEASURE is set to the MEASURE position, and the range switch to '1%'. The CALIBRATE control has no effect at this stage.

The *wow* and *flutter* percentage is read from the 1%-scale on the large moving-coil meter. High-quality and top-of-the-range recorders with very low *wow* and *flutter* may require the tracking tester to be set to the lower ranges of 0.3% or 0.1% full-scale deflection.

Speed deviation and drift

These measurements invariably require a proprietary test tape to provide a sufficiently accurate reference tone of 3000 Hz or 3150 Hz.

- For absolute speed measurement, the TEST/MEASURE switch is set to TEST.
- Set the range switch to position 'Drift 5%'.
- Turn the CALIBRATE control until the meter indicates 0% at the centre of the scale.

With the TEST/MEASURE switch set to MEASURE, the meter indicates the absolute tape speed deviation in a range of 5%.

The service documentation with the

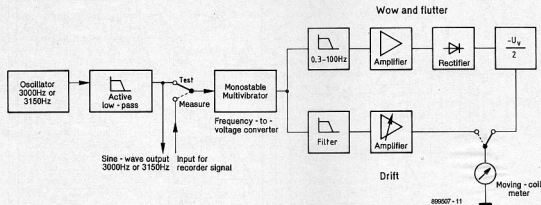

Fig. 1. Block diagram of the tracking tester.

tape recorder may be consulted to find out how the tape speed can be adjusted to obtain the lowest possible deviation (less than 0.5% is acceptable in most cases).

Following the absolute tape speed measurement, drift should be checked against the data supplied by the manufacturer. Rewind the test tape, and select the MEASURE mode. Calibrate the instrument for a reading of 0%. Play the test tape back to see how the long-term behaviour of the mechanical assembly affects average tape speed. Tape pull, determined by the varying effective diameter of the pulling reel is also a major cause of drift. Careful mechanical adjustments as outlined in the maintenance manual may give the required improvements.

Principle of operation

The principle of measurement used in the tracking tester is illustrated in the block diagram of Fig. 1. The quartz crystal oscillator and a number of dividers supply a rectangular signal at 3000 or 3150 Hz. A low-pass filter converts this signal into a sinusoidal shape with a distortion smaller than 1%. This is adequate for the measurements in question, because accuracy and stability are the prime aims.

When set to TEST, the mode selection switch supplies the generated reference signal to a monostable multivibrator which functions as a frequency-to-voltage (f-V) converter in conjunction with the filters that follow it.

The pulse ratio is such that the centre of the meter range can be set with the calibration control during drift measurements.

When the mode switch is set to the MEASURE position, the f-V converter is driven with the output signal of the recorder under test. When the absolute tape speed is higher than the standard speed, the input frequency of the converter is

higher than the reference frequency (3000 Hz or 3150 Hz). This means that the MMV receives more trigger pulses within a unit of time, so that the low-pass filter at the output supplies a higher voltage. The needle of the moving-coil meter deflects to the right, and the relative deviation can be read from the scale as a percentage. Likewise, the needle deflects to the left of the centre when the tape speed is too low.

Wow and flutter measurements work on a similar basis. The only difference with drift measurement is the use of an additional rectifier that records short-term frequency changes which are the result of relatively fast tracking errors in the tape mechanism as discussed earlier. Since this measurement need not discriminate between positive and negative deviations, the full scale, starting at 0, is available for the read-out (a centre indication is not required). A differential amplifier is used for this purpose.

The circuit in detail

The circuit diagram is given in Fig. 2. The quartz crystal oscillator set up around gate N1 supplies a 3.2768 MHz signal to divider IC2, a Type CD4040. The divisor is either 1040 or 1092 as decoded by gates N5, N6 and N7, and selected by switch S1 (CCIR/DIN). In the first case, the output frequency at pin 14 of IC2 is 3150 Hz, in the second case, 3000 Hz.

A first-order passive low-pass filter is formed by R4, R5, R6 and C3, and a third-order active low-pass filter by R7, R8, R9, C4, C5, C6 and opamp OP1. The active filter is dimensioned for a roll-off frequency of about 3.5 kHz to achieve sufficient suppression of harmonics. A clean 3000 Hz or 3150 Hz sine-wave is available at pin 7 of OP1. A further opamp, OP2, raises this signal to a level of 0 dBm, or 775 mV_{rms} (2.2 V_{pp}) into 600 Ω. This level may be set by adjusting preset R11. ▶

The sinusoidal test signal is used for recording purposes by feeding it to the output terminals (pins 1 and 4 on the DIN socket, and the phono-type recording socket) as well as for use as an internal reference during drift measurements.

Toggle switch S2 selects either the tape signal or the internal reference signal. Either of these is applied to the input of amplifier OP3 via C9 and R13. Comparator OP4 converts the output signal of OP3 into a rectangular waveform.

The monostable multivibrator around N3, N4 and IC5 is triggered at each rising pulse edge applied via C12 and R25. Counter/oscillator IC6 forms part of the MMV to ensure that the drift of the instrument itself can not affect the meter readings in the most sensitive range.

Each positive pulse transition at pin 12 of gate N3 causes the output, pin 11, to change from high to low. This state is latched because of the bistable configuration of the two gates, and counter IC6 is enabled via pin 12. The oscillator in the CD4060 starts to operate at a frequency determined by R28, R29 and C18. Ripple counter output pin 7 goes high after 8 clock cycles, which resets bistable N3-N4 via pin 2. The output of N3 disables IC6 and resets the MMV to its initial state.

Pin 3 of gate N4 is high for the duration of the oscillator activity. This pulse is used for further processing, and is marked by high stability in respect of the pulse width.

That the instrument is capable of measuring tape tracking errors down to 0.1% is mainly by virtue of the third-order active filter around R27, R41, R42, C20, C21, C22 and OP6, in combination with first-order low-pass section R43-C23.

Opamps OP7 and OP8 are configured to provide further amplification, while S3b forms the range selector.

A peak rectifier is set up around OP9 and D11-C29. The reference level of the rec-

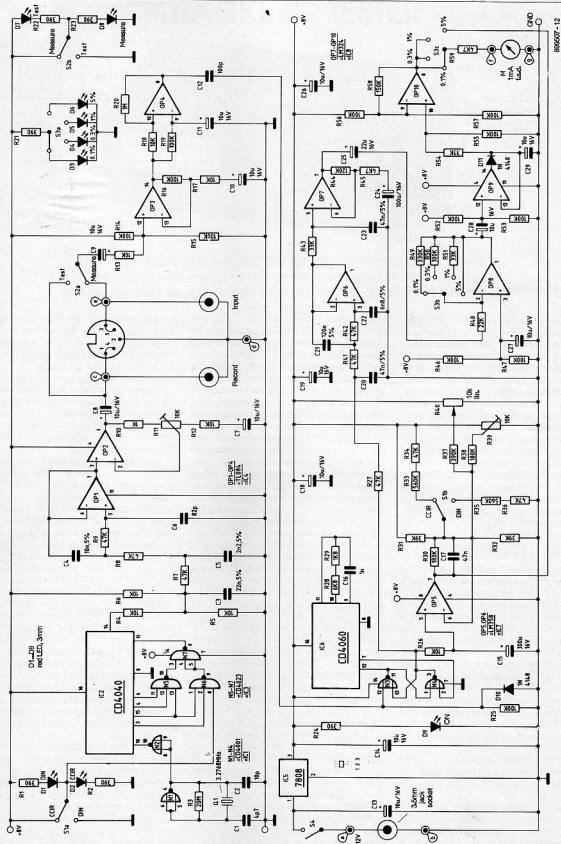

Fig. 2. Circuit diagram of the tracking tester.

tified signal is shifted from half the supply potential to ground by OP10, so that tracking measurements can use the full meter scale starting at 0%.

The centre-zero indication for absolute tape speed measurements is obtained with the aid of integrating network R26-C15 and an amplifier based on OPs. In the TEST mode, the meter is set to the centre indication with R39 (coarse) and R40 (fine). The measuring range is $\pm 5\%$.

Setting up

The tracking tester can be adjusted with a frequency meter and an oscilloscope.

To begin with, preset R11 is set for an output level of 775 mV_{rms} at pin 1 of OP2. Other reference levels may be set where these are required.

The CALIBRATE control is set to the centre of its travel. Switch S2 is set to TEST, and preset R39 is adjusted until the meter indicates 0% at the centre of the scale. Range switch S3 is set to 'Drift 5%' for this adjustment.

When the centre indication can not be achieved by turning preset R39, the deviation of the oscillator frequency generated by IC6 is too large. This frequency should be 49.2 kHz nominally with a maximum tolerance of $\pm 10\%$. It can be measured at pin 9 of IC6, while pin 12 of gate N3 is provisionally made logic high with the aid of a short wire to the +8 V supply rail. Make small changes to R29 and/or R28 to pull the frequency within the acceptable range. Two series-connected resistors are used here for this setting instead of the more usual trimmer capacitor, which would magnify the effect of stray capacitance. The minimum equivalent resistance of R28-R29 must not be made lower than 6.8 k Ω , and not higher than 22 k Ω . The wire connection at pin 13 of N3 is removed after the necessary corrections have been made.

When a frequency meter is not available, R28 and R29 may be changed in 1 k Ω increments until the centre-zero indication is achieved within the range of R39.

The above corrections are not likely to be necessary in most cases, since the circuit is dimensioned such that R39 covers the required control range. The frequency correction with the oscillator components around IC6 is described for the sake of completeness.

No other adjustments are required.

Construction

The circuit is built on two printed circuit boards, the main board and the oscillator board. The component overlays in Fig. 3 and the Parts List are given as an aid for populating the boards, which should be started with the low-profile components. All soldering is done at the track sides.

The main board has some components that are mounted at the track side: voltage regulator IC5, electrolytic capacitors C15, C24, C25 and all solder terminals.

After a thorough check of the com-

pleted boards, the oscillator board may be mounted upright on to the main board in a manner where the copper surfaces at the side of D10 line up with the associated surfaces on the main board. The copper surfaces are then joined with plenty of solder to secure the oscillator board at right angles on to the track side of the main board. The oscillator board is relatively small and light, so that additional mechanical support is not required.

The two phono sockets and the DIN socket are secured on to the front panel, which also serves to hold the main board by means of the nuts on the threaded shafts of the switches. One nut is first turned on to each of the shafts, followed by a locking washer, after which the spindles are inserted into the holes provided in the front panel. Finally, the PCB assembly is secured to the front panel by one additional nut for each protruding switch shaft.

The spindles of the potentiometer and the range switch are then cut to length and fitted with the associated knobs.

Finally, the wiring is installed in accordance with the circuit diagram. This includes the connection of the moving-coil meter and the supply voltage. The latter is applied to the circuit via a 3.5 mm jack socket on the rear panel of the enclosure. The recommended input voltage is 9 VDC.

The meter is secured to the inside of the front panel. This requires removing a part of the rims at the inside of the top and bottom halves of the enclosure to ensure that the face of the meter is flush with the front panel. The meter is carefully secured with a some two-component adhesive or super-glue applied at the corners.

Parts list

Resistors:

R1; R2; R21-R24=390K
R10=1K0
R29=1K8
R45; R59=4K7
R26=6K8
R4; R5; R6; R12; R13; R17; R18; R26=10K
R48=22K
R43; R51; R54=33K
R31; R32=39K
R7; R8; R9; R27; R34; R36; R41; R42=47K
R14; R15; R16; R19; R25; R46; R47; R50; R52;
R53; R55; R56; R57=100K
R44=120K
R58=150K
R30; R38=180K
R49=330K
R37=390K
R33; R35=560K
R20=1M0
R3=20M
R11; R39=10K preset H
R40=10K linear potentiometer; spindle dia. 6 mm

Capacitors:

C1=4p7
C2=10p
C6=82p
C12=100p
C16=1n0
C5=2n2; 5%
C22=6n8; 5%
C4=10n; 5%
C3=22n; 5%
C17; C20; C23=47n; 5%
C21=120n; 5%
C7-C11; C13; C14; C18; C19; C26-C28=10 μ ; 16 V
C25=22 μ ; 16 V
C15; C24=100 μ ; 16 V

Semiconductors:

IC4=TL084
IC6=LM324
IC7=LM358
IC1=CD4001
IC3=CD4023
IC2=CD4040
IC5=CD4060
IC5=7808
D10; D11=1N4148
D1-D9=LED; 3 mm; red

Miscellaneous:

Q1 = 4 MHz quartz crystal.
S3 = 3-pole, 4-way rotary switch for PCB mounting.
S1; S2 = miniature DPDT switch.
S4 = miniature SPDT switch.
10 solder terminals.
30 cm screened wire, single core.
20 cm screened wire, 2-core 0.4 mm².

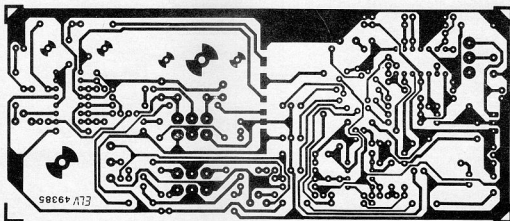
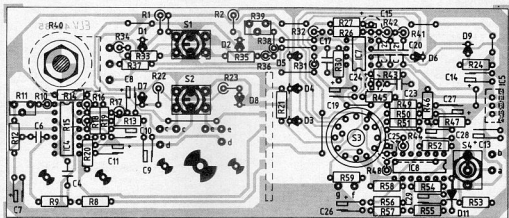
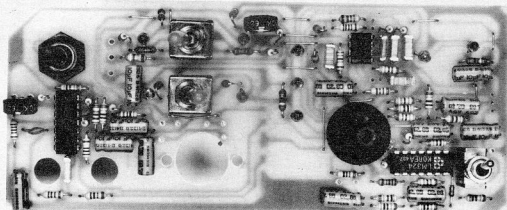
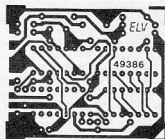
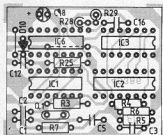
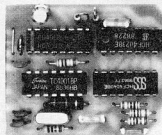

Fig. 3. Top views and component overlays of the oscillator board and the main board of the instrument.

MULTI-LAYER PCBS

by A.J. Kool (ULTimate Technology, Norcross, USA)

The introduction of multi-layer printed-circuit boards challenged designers in their creativity to use these additional layers efficiently. One of the ways to increase the area left for actual wiring is the use of buried vias. Buried vias connect copper layers in layer pairs. They are not drilled through the entire board, leaving more space for routing on the other layers. Since the advent of surface mount technology – SMT – these buried vias have become more popular with designers. The increased use of these vias, however, presents the designers with a new set of problems that only few CAD systems are able of coping with.

What are buried and blind vias?

The idea of creating buried and blind vias comes from the manufacturing of the printed-circuit board. A multi-layer board is built from a set of (thin) double-sided boards. The copper layers of these thin boards form the copper layers of a multi-layer board. They are all etched and then stacked together, separated by insulation layers. This is the lamination process illustrated in Fig. 1.



Fig. 1. The layers are laminated together as thin boards.

Buried vias are created by drilling and metallization of the thin boards before the lamination process. By doing this, the layers of the thin boards are connected with vias. At this point, the whole set of thin boards is laminated, the vias in the middle layers are buried (not visible from the outside) and the vias in outer layers are blind (visible from one side only) – see Fig. 2. For the designers, there is no differ-

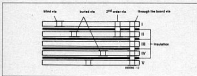

Fig. 2. Buried and blind vias are located in the board.

ence between buried and blind vias.

When the idea of drilling and metallization is taken one step further, we may laminate boards I and II, drill and metal-

lize the resulting board and complete the rest of the lamination process – see Fig. 3.

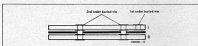

Fig. 3. Layers I and II are drilled and metallized before laminating the other layers.

Vias created like this are called 2nd order buried vias. By using 2nd, 3rd or higher order vias, we obtain a complicated lamination and metallization sequence that increases the routeability of printed-circuit boards, but also their cost.

Using a CAD system

Until recently, CAD tools would only handle the buried vias between layer pairs. No provisions were available to have vias through more than two layers. Now SMT is used more extensively, more designers are looking for CAD tools that handle buried and blind vias in a highly automated way. To have a CAD system automatically handle these vias, it must first know how the designer is planning to laminate the PCB. Are 2nd, 3rd and higher order buried vias allowed? These are the things a CAD system must know before vias can be used. When this is known by the system, a via placed between the TOP layer and Inner 3 can be computed to be 'through the board' or a 2nd order (if this was possible in the lamination sequence).

Another aspect the CAD system must deal with is the size of the drill hole. A multi-layer board with 10 layers is not (much) thicker than a 2-layer board. A single layer-pair of the 10-layer composite board is very thin. The via drill diameter may be smaller for these thin boards than for the through-the-board vias. The CAD system must compute the number of layers

the drilling hole will cross and select the drill diameter accordingly.

If the designer wants to extend 1st order buried vias to a higher order, the drill diameter may need to be changed. To be able to manufacture the board, the PCB manufacturer needs to have a drill file for each layer-pair and each half-product that has buried vias. Finally, a drill file for the complete board is needed for the through-the-board vias and component pins. The 10-layer board of Fig. 4 needs 8 drill files: 5 for the layer-pairs, 2 for the half-products and 1 for the complete board.

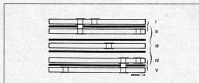

Fig. 4. Example of a lamination sequence specification for a 10-layer board in the ULTIboard PCB system: $[(I+II)+III+(IV+V)]$. This specification means: first handle (drill and metallize) the layer pairs I through V individually, then laminate I and II together and IV and V and handle these half-products. Then laminate III to the half-products and process the through-the-board vias. You might consider this sequence for a dense SMT board with components mounted on both sides. The layers of layer-pair III (inner 4 and 5) would be the power and ground planes. The others (TOP, INNER 1, 2, 3, 6, 7, 8 and BOTTOM) will be signal layers.

Conclusion

Currently available CAD systems are sufficient for handling boards with 4 signal layers. In a few years' time, when the need arises for a board with 6 or more layers, all CAD systems will almost certainly have to be able to support the higher order buried vias to some extent.

DC-AC POWER CONVERTER

J. Ruffell

Holidaymakers, do not forget this low-cost power converter when you are packing for this year's camping tour. The converter works from the car battery, is simple-to-build from standard components, and provides you with up to sixty watts to power mains-operated loads such as a shaver, a small fluorescent tube, and (dare we suggest it?) a soldering iron.

There is nothing to beat the good old camp fire, candles, or pale moonlight to light holidaymakers gathered for the evening barbecue on the camping site. An electric light source, on the other hand, is the thing you want when tentpegs are to be driven in the ground in the middle of the night, somewhere, in the dark, on an unfamiliar site. An AC converter is also handy for the daily shave, for the portable TV set, a small fluorescent tube, a radio, oscilloscope or computer.

Circuit description

The circuit diagram of Fig. 1 shows that the DC-AC power converter is built from commonly available and inexpensive parts. Circuit IC1, a CMOS Type CD4047, is used as an astable multivibrator whose outputs, Q and \bar{Q} , supply a square wave signal that has a frequency of about 50 Hz. To prevent excessive loading of the chip outputs, the complementary signals are fed to the gates of Type BS170 low-power MOSFETs. These transistors are capable of switching at high speed, they guarantee low turn-on and turn-off times, and provide sufficient drive for the bipolar power stage composed of drivers T₃-T₄ and power devices T₅-T₆. Like the MOSFETs, the transistors used in the power stage are selected for their switching speed, with an aim to keep dissipation in T₅ and T₆ as low as possible. Zener diodes D₂ and D₃ protect the power transistors against voltage peaks generated by the transformer, which forms an inductive load.

The power transformer is a standard type, i.e., not a toroid, and is used 'the other way around' to step up the low voltage to the mains voltage. The low-voltage winding with its centre tap forms the primary. The centre tap is not connected to ground as usual in most power supplies, but to +12 V. The power transistors, T₅ and T₆, alternately take the outer connections of the primary to ground, passing considerable current. This, in turn, induces a voltage in the secondary, which is the mains winding in this case. A fuse completes the AC-DC converter.

50 Hz quartz-controlled

Most radio alarm clocks use the frequency



of the mains voltage as the timing reference. A small extension circuit enables the DC-AC converter to supply the mains voltage at a constant and accurately defined frequency of 50 Hz. The printed-circuit board of the converter is provided with a connection for accepting the 50 Hz signal.

Figure 2 shows that the 50 Hz reference signal is derived from a 3.2768 MHz quartz crystal. The circuit uses only two CMOS ICs, and operates from 12 V. The quartz crystal is an inexpensive type commonly used in clock timebase circuits. The frequency of oscillation is trimmed with C₂. A fixed, ceramic, 12 pF capacitor may be preferred over the trimmer in some cases, and results in a frequency deviation that is perfectly acceptable for the application in question. When the trimmer is used, it is adjusted for a frequency of 204.8 kHz at test point TP. The 50 Hz signal available at point 3 of the timebase is connected to point 2 of the DC-AC converter. In this configuration, a wire link is installed between points 5 and 6. When

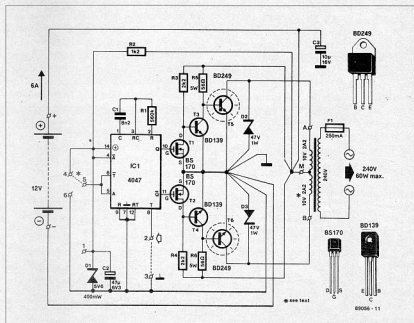

Fig. 1. Circuit diagram of the DC-AC power converter. The wire links enable the use of an optional 50 Hz timebase.

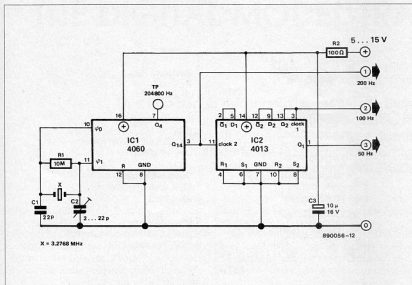
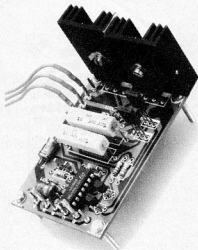

Fig. 2. This quartz-crystal controlled timebase is an optional extension of the power converter.



the external timebase is not used, the wire link is installed between points 4 and 5, while point 2 is grounded via a link to point 3.

Construction and practical use

There is little to say about the construction of the power converter because the population of the printed circuit board (Fig. 3) is entirely straightforward. By virtue of the high overall efficiency, the power transistors can do with a relatively small heat-sink. When the unit is mounted in a

metal enclosure, the transistors are conveniently bolted on to a side panel. Do not forget to use insulating washers and a touch of heat-conducting compound. The introductory photograph shows the prototype in a sturdy metal enclosure with a shaver-type output socket and

heavy-duty wander sockets for connecting the battery cable.

The low-voltage winding of the transformer is switched to achieve high efficiency. As a result, the generated high voltage is a fairly clean square wave, which remains largely rectangular with

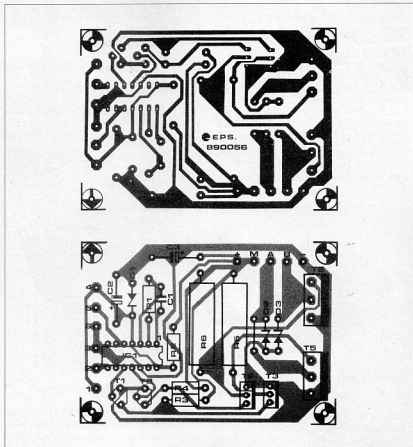

Fig. 3. Printed-circuit board for the DC-AC power converter.

Parts list

Resistors:

R1 = 560k
R2 = 1k2
R3; R4 = 2k2
R5; R7 = 56Ω; 5 W

Capacitors:

C1 = 8n2
C2 = 47µ; 6V3
C3 = 10µ; 16 V

Semiconductors:

D1 = zener diode 5V6; 400 mW
D2; D3 = zener diode 47 V; 1 W
T1; T2 = BS170 (Cricklewood Electronics)
T3; T4 = BD139
T5; T6 = BD249
IC1 = 4047

Miscellaneous:

F1 = fuse 100 mA; slow.
TR1 = mains transformer 2x10 V; 2.2 A.
Heat-sink for T5 and T6; max. 4°C/W.
Insulating washers and bolts for T5 and T6.
PCB Type 890056

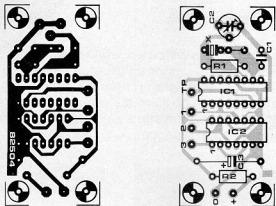

Fig. 4. Printed-circuit board for the optional timebase circuit.

some overshoot even when an inductive load, such as a mains transformer, is powered.

Regulation of the output voltage is purposely not implemented to keep the overall cost of the converter as low as possible. This means that the open-circuit output voltage is higher than the loaded output voltage, an effect which is caused mainly by the copper losses of the transformer windings.

It will be evident that the output voltage is also dependent on the battery voltage. At a battery voltage of 14 V, the output voltage is about 10% higher than at 12 V. When the power converter is frequently used with relatively heavy loads (between 40 and 60 W), such as a portable

TV, it is recommended to use a 2x9 V transformer rather than a 2x10 V type.

At an input voltage of 12.0 V, and loaded with a light bulb, the prototype gave the following results (the transformer was a 240 V/2x10 V type):

Bulk wattage	U_o (Vrms)
0	261.5
25	242.1
40	222.2
75	187.2
100	165

The power converter gave no problems when used to power the ohmic-inductive load formed by an electric shaver. Encour-

Parts list

Resistors (15%):

R1 = 10M
R2 = 100Ω

Capacitors:

C1 = 22p
C2 = 22p foil trimmer (green)
C3 = 10μ; 16 V

Semiconductors:

IC1 = 4060
IC2 = 4013

Miscellaneous:

X1 = 3.2768 MHz quartz crystal.
PCB Type 82504

aged by this result, we connected a Commodore C64 computer plus monitor (40 VA). Although the output voltage dropped to about 210 V, the computer worked all right. In the case of equipment not functioning owing to a too low voltage, it is best to resort to the use of a 2x9 V transformer in the converter.

An experiment with a cassette recorder deck gave less satisfactory results: the heads picked up harmonics of the converter's output signal, so that the equipment produced unacceptable background noise. The same cassette deck was known to be sensitive in this respect, however, since it produced almost the same background noise when installed near the light dimmer in the living room at home.

In many cases, it is advisable to use a mains filter between the power converter and the load when this is mainly inductive and rated at more than about 30 W. Such a filter may be purchased ready-made, but a common suppressor choke as used in dimmer circuits, in combination with a 470 nF/400 V capacitor will also do the job.

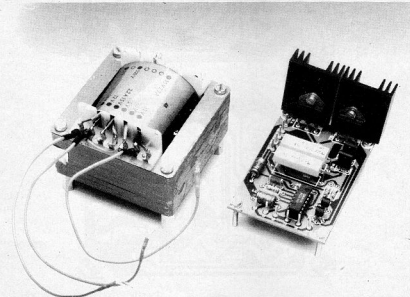

THE DIGITAL MODEL TRAIN – PART 5

by T. Wigmore

This fifth part in the series discusses the Elektor Electronics Digital Train System, which makes possible the independent control via the rails of many locomotives, turnouts (points) and signals. It also makes provision for storing monitoring signals and contains as standard an RS232 interface.

Some mention was made in the previous five articles of digital train control systems with particular reference to the Märklin system and also the Elektor Electronics Digital Train System. From now on the articles will deal specifically with the latter.

The Elektor Electronics system is intended primarily for home construction, which makes it considerably cheaper than proprietary systems, and also gives you the opportunity of making it as simple or as complex as you like. At present, our system offers more facilities and possibilities than any other system we have seen.

The Elektor Electronics system is of modular construction—see Fig. 34. Table 4 compares it with the Märklin system.

Design considerations

The main PCB of our system plus at least one booster unit (to be published next month) and a power supply form the most basic configuration of the control system. This will accommodate sixteen controllers each consisting of a simple slide potentiometer. These alone will save the home constructor a lot of money, since, for instance, a Märklin controller costs about £60–£70. Multiply that by sixteen and you arrive at a tidy sum. The sixteen slide potentiometers will probably cost you little more than just one Märklin controller.

Each controller is paralleled by two switches. One of these serves to select the correct locomotive decoder (Märklin or Elektor Electronics), while the other provides the additional function required by the Märklin decoders.

Each controller enables one of the possible 81 addresses to be set by a diode matrix. To keep the wiring to a minimum, address setting is carried out on the main board by mounting a number of diodes. A spartan but inexpensive solution if you do not use more than 16 locomotives. The setting may be carried out in a somewhat more flexible manner with the aid of DIL switches or jump leads, or in a very convenient manner by means of thumb-wheel switches. The latter is possible because the locomotive addresses are written in BCD format. Yet another possibility is a hybrid system in which thumb-wheel switches are used for a couple of controllers and diodes for the others. How you implement the

addresses depends therefore on the money you are prepared to spend on it.

An even more de luxe solution is still being contemplated. This entails setting the addresses fully electronically and includes a two-digit seven-segment display for each locomotive.

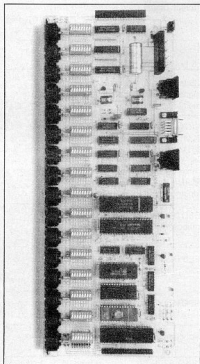

Fig. 32. Evolution of the main board of the Elektor Electronics Digital Train System—at the top the very first prototype and underneath it the final design.

Although only sixteen controllers can be connected to the main board, it is possible to operate 81 locomotives simultaneously. Just as in the Märklin system, any controller may set the speed of a given locomotive and then be switched to another locomotive. The first locomotive will, of course, continue to move at the set speed.

It is also possible to control locomotives that are not connected to a controller via the RS232 interface.

A third possibility is accessing the controllers by the host computer via the RS232 interface. The host computer processes the data and retransmits them to the control system. In this way, several locomotives may be operated via one controller (for instance, when two or more are pulling heavy goods trains).

It is also possible to simulate the inertia of trains or to restrict trains to a certain maximum speed.

The main board contains a dead-man's switch, which, when pressed, instantly stops the data transmission to the rails so that all rolling stock comes to a standstill.

Booster

The Märklin Central Unit contains an integral power amplifier (booster) that can deliver up to 3 A. Our system provides rather more power, since each locomotive draws 0.5–1.0 A.

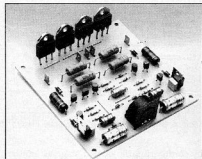

Fig. 33. A separate booster stage supplies ample power to the track.

Our booster is designed as a separate unit and provides a voltage-stabilized output. It may be used with the Märklin system. Stabilization of the output is obtained

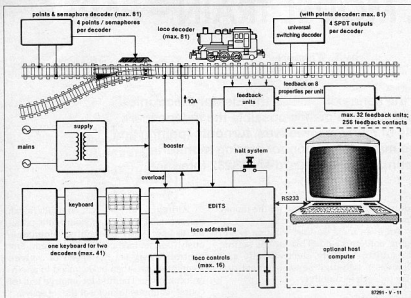

Fig. 34. Block schematic of the complete Elektor Electronics Digital Train System.

EEDTS	Märklin	Remarks
Turnout (points) decoder (Feb 1989)	Turnout (points) decoder (K83)	Suitable for four turnouts (points) or signals or for eight sorting or marshalling sidings
Locomotive decoder for d.c. and a.c. systems (Mar/Apr 1989)	Locomotive decoder. C80 for a.c. C81 for d.c.	
Two-rail adapter (Mar/Apr 1989)		Märklin has announced a separate locomotive decoder for two-rail systems
Universal signals and switching decoder (May 1989)	Switching decoder K84	EEDTS offers various output configurations: darlington's or relays
Main PCB (June 1989)	Central unit + Control 80 + interface	EEDTS PCB has integral RS232 and 16 locomotive controllers
Booster (10 A) (July 1989)	Booster (2.5 A)	EEDTS booster is stabilized
Keyboard(s) (Sept 1989)	Keyboard(s)	Not compatible
Monitoring unit for 8 sensors (Oct 1989)	Monitoring unit for 16 sensors	Not compatible
	Memory	

Table 4. Brief comparison of the Elektor Electronics Digital Train System and the Märklin system.

by configuring the output stage as emitter follower. This has the advantage that the output voltage is independent of the input voltage and will therefore remain stable, even under heavy load conditions.

On the track this is manifested by truly constant lights and well-defined maximum speeds of the locomotives.

The booster output is proof against

short-circuits to prevent fires in case of a derailment or other accident. When the output current exceeds 8-10 A, the protection circuits are automatically switched on. If the short-circuit is of short duration, the protection circuits are switched off again automatically. When a short-circuit persists, the dead-man's switch is operated. This effectively prevents overheating of the

booster and a possible fire hazard on the track. If you have a very large track, you can, of course, use a number of boosters.

Keyboards

In principle, it is possible to use our system for the independent control of locomotives only, while signals and turnouts (points) are operated in a conventional manner. The system has, however, been designed to control not only locomotives, but also signals, turnouts (points), sorting sidings and any other switching functions you may have. You do, of course, need a number of relevant decoders as described in previous articles, although Märklin units may also be used. For every two decoders one small keyboard containing 16 keys is required. Therefore, if your system has the maximum 81 locomotives, you need 41 keyboards.

The 16 keys on the keyboard serve to operate the eight signals or turnouts (points) that are connected to the decoders associated with the keyboard. The keyboards provide a visual answer-back signal in the shape of LEDs to keep you informed of the actual position of signals and turnouts (points).

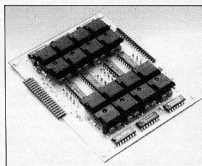

Fig. 35. The Elektor Electronics Digital Train System may be expanded with keyboards: how many depends on the number of signals and turnouts (points) the track contains.

Each keyboard has a 20-pole connector at each of its sides to enable a number of them to be interlinked without any wiring. The extreme right-hand keyboard is plugged into the relevant connector on the main PCB.

You are not tied to the layout of a keyboard: it is perfectly possible to incorporate the switches in an operating panel.

The advantage of controlling signals and turnouts by means of decoders and not in a conventional manner was already discussed in the first article in this series. The advantage of switching them via the present system is that they may be managed centrally. The actual position of the various signals and turnouts (points) may be ascertained via the serial RS232 connection. Moreover, switching instructions may be given via this route, that is, by-passing the keyboards. These features are indispensable if you want to operate a software-controlled protection system or timetable

via the host computer. Thanks to the system, your computer does not need a (parallel) output for every signal and turnout (points): it is all done via that one RS232 connection.

Monitoring units

Apart from keyboards and controllers, the system can also incorporate a number of monitoring units. These units make it possible, for instance, to locate a locomotive anywhere on the track. Each monitoring unit has provision to accept up to eight sensors. A number of units may be connected in parallel via a five-way cable. The units may be located along the track in a decentralized manner. Note, however, that our monitoring units are not compatible with those of Märklin.

The signals from the monitoring units may be written into the computer via the system on command. Since each of the units has its own local memory, even very short switching pulses will not be missed. The writing and processing of monitoring signals can take place only via the RS232 interface. The host computer connected to the interface can be programmed in a manner to cause certain monitoring signals to result in predetermined switching operations.

RS232 interface

The RS232 interface fitted as standard on the main board offers a multitude of possibilities. It is, unfortunately, not possible to give a detailed description of these, because at the time of writing the software for the control program (which must, of course also interpret the RS232 commands) was still in development. At present we can therefore only say that we intend to give the RS232 interface the following facilities:

- giving control commands to locomotives (speed; forward; reverse; additional function of Märklin locomotive decoder);
- obtaining information on the position of connected locomotive controllers and the associated locomotive addresses;
- releasing or otherwise of certain locomotive controllers;
- giving switching instructions for the control of turnouts (points), signals and sorting sidings;
- actuating switches operated via the decoders;
- releasing or otherwise of keyboards: in fully automatic operation the keyboards, like the controllers, may be locked by the program;
- obtaining information on the position of signals and turnouts (points);
- obtaining information from the monitoring units;
- reset: all locomotives at standstill although power to the track is maintained;
- emergency stop: power is removed from track (this may be an optional facility);
- setting of the baud rate of the RS232

interface;

- setting of duration of actuation of turnouts (points) (when these are controlled via the keyboards, they are actuated as long as the key is depressed; when they are controlled via the RS232 interface, a fixed actuation period must be set to prevent their coils burning out);
- loading of application programs from the host computer—real enthusiasts can write their own application programs in Z80 machine language and load them in the RAM of the system; the programs can be started via separate instructions.

This is all we can say about the RS232 interface, but the subject will be reverted to later in the series.

Response time

The data flow in the system is primarily serial. Because of the uncertain contact between locomotives and rails, control instructions to the locomotives are transmitted constantly, but only to those locomotives that are in operation. Unused controllers are recognized by the system and ignored. The associated locomotive addresses are defined as out of service, except if they are in use via the RS232 interface. Only the data of actually operating locomotives are sent out via the rails.

The result of this procedure is that the response time of the system depends to a large extent on how many locomotives are in operation at any one time. When all 81 locomotives are in use, the response time will be of the order of 0.8–1 second.

Switching instructions for decoders along the track are always transmitted, however, in between the locomotive commands, ensuring that they have a response time not exceeding about 10 ms. Each switching instruction is transmitted only twice, but since the decoders are connected to the track permanently the information transmission is reliable.

Control program

The Elektor Electronics Digital Train System is based on a Z80 microprocessor. The control program is being developed in assembler and will become available through our Readers' Services in due course.

Although it is not necessary for the user

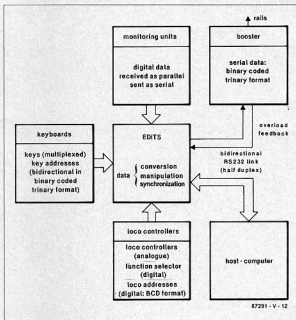

Fig. 36. Signal flow diagram showing the various data formats used.

to know exactly what the program does, it is, of course, interesting to know at least the basics of it, if only to get a better insight of how the system works.

The main task of the program is communication. Information is obtained from, and transmitted to, a number of locations and the system must be able to co-ordinate this flow of information and transform it into switching instructions that are passed to the locomotives, signals and turnouts (points) via the rails.

Control instructions are transmitted via the locomotive controllers, keyboards, monitoring units and the RS232 interface. These instructions are of different format: they may be analogue (locomotive controllers, for instance) or digital. The digital data may be parallel (locomotive addresses in BCD format, keyboard addresses in binary coded trinary format) or serial. The serial data representing voltage levels, baud rates and protocols are all different from one another.

The first task of the system is, therefore, the translating and conversion of these different data formats.

Another aspect is that the data are asynchronous, that is, they are obtained or transmitted at different times. However, the serial output can handle only one instruction at a time. Synchronization and allocating priorities to control and switching instructions are, therefore, another vital task of the control program.

Program and data structure

The control program consists, strictly speaking, of two different modules that are vying for attention on an interrupt basis. The Elektor Electronics system is, therefore, a multi-tasking system. The main task

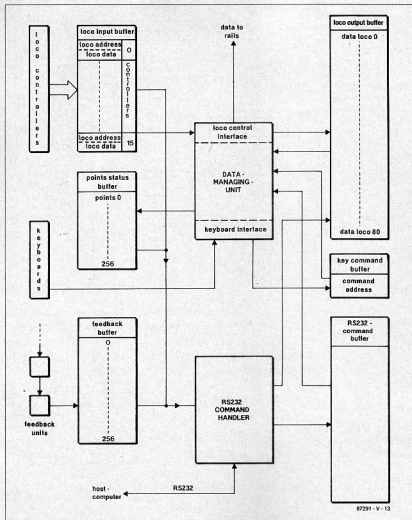

Fig. 37. Internal data structure of the control program. Two separate modules handle the data processing: the data managing unit and the RS232 command handler.

is performed by the data managing unit. This part of the program carries out the loading and processing of the controller and keyboard data and ensures that these are transmitted via the rails in good time.

The second module, the RS232 command handler, interrupts the data managing unit as soon as RS232 instructions appear on the line. It interprets the received commands and ensures that the system undertakes correct action for each instruction.

All incoming data are collected, processed if necessary and put into sequence before they are retransmitted via the rails. In this respect, the system resembles a post office. In the RAM a number of buffers have been reserved for sorting data. Other buffers merely collect incoming data and yet others hold data ready for transmission.

The internal data structure is shown in Fig. 37, which also shows the position of the two modules and to which buffers they have access.

As already mentioned, the data managing unit performs the routine tasks. It loads the controller and keyboard data in the locomotive output buffer and key command buffer respectively. It also carries out any required data conversions and, for instance, adaptation of Elektor Electronics or Märklin locomotive data formats. Moreover, it retransmits data via the rails, including any stored in the RS232 command buffer.

The RS232 command handler takes care of the communication with an external host computer. On the one hand it contains module routines with which the RS232 interface is realized (the system does not use a special RS232 chip) and on the other hand it contains a decoding routine to decipher incoming commands.

Incoming locomotive control instructions are placed direct into the locomotive output buffer. This means, in effect, that the data managing unit loses control of the associated locomotive address until this is released again by the RS232 interface.

Switching instructions are loaded into a separate buffer. Yet other buffers are used by the RS232 command handler for monitoring or ascertaining the position of signals or turnouts (points).

The RS232 command handler has access also to the locomotive input buffer for monitoring and ascertaining the position of controllers and set locomotive addresses.

The monitoring (feedback) buffer is accessible only via the RS232 interface. If it is necessary that a given monitoring signal requires a certain action, this has to be programmed via the host computer. This means that if you do not intend to connect the system to a computer, there is no sense in using monitoring units.

Cost aspects

Before you start work on a complete and far-reaching digitization of your model railway, you would, no doubt, appreciate what sort of outlay you may expect.

A first glance at the main PCB may make you hesitate even to begin thinking about starting, but, although it looks complex (and therefore expensive?), we believe that the proposed system is very inexpensive for what it offers.

The main expenditure will almost certainly be the main PCB (for price, see Readers' Services section), which is double-sided and through-plated (not easy to make yourself or even to have made). But almost all the components used on this board are fairly, or very, cheap.

Also bear in mind that the locomotive addresses may be set with the aid of cheap diodes. More sophisticated means (DIP switches, for instance) are entirely your own choice.

Another point worth remembering is that connecting the locomotive controllers via DIN connectors is, strictly speaking, an unnecessary luxury.

The main expense in the booster lies in the mains transformer and the heat sink, but even for a non-digital track you need at least one transformer. Here, it is worth bearing in mind that it is invariably much cheaper to buy an appropriate transformer from an electronics retailer than to insist on a proprietary "model train transformer".

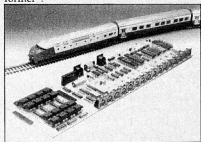

The keyboard circuits, as well as those for the monitoring units, have been kept as simple and inexpensive as feasible, particularly since we realize that most users will want (or need) a number of these units.

NEW PRODUCTS

Photoelectric Switch

Electro Arts have developed a Photo electric with a range of 10 m for diverse industrial applications. The unit works on a modulated infrared beam and is not affected by vibrations, ambient light and weather condition. Working on 220 V AC, the unit is available in light sensing or Dark sensing modes.

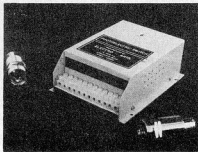

M/s. Electro Arts • 4, Vaishali • Gangapur Road • Nashik-422 005.

PCB Inspection Projector

A PCB Inspection Projector (Model 175) for inspection of PCB artworks, negative, films etc is being marketed by Dynascan Inspection Systems Company. The projector has a screen size of 175 x 175 mm, with a magnification of 10 x and can accommodate a PCB of maximum size 450 x 375 mm. Lighting is provided by

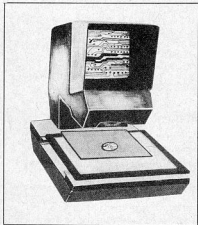

means of three halogen bulbs. A stereo microscope is available for Inclined/straight viewing for through holes inspection. A Digital Readout Systems can also be provided for measuring track widths, lengths, pad diameters, hole diameters etc.

M/s. Dynascan Inspection Systems Company • Plot No. 1 • Benningana Halli • Old Madras Road • Bangalore-560 016.

Programming Module (PGM-8540)

Professional Electronic Products is offering a PAL Programming Module (PGM-8540) for programming Programmable Array Logic (PAL) devices of MMI, National Semiconductors and Texas Instruments. This device is an attachment to PEP's Univer PROM Programmer PP-85, and is supplied along with the necessary software. This software runs on a PC/XT checking of trace waveforms and simulations can be done on the PC itself. A large number of PAL devices can be programmed through this.

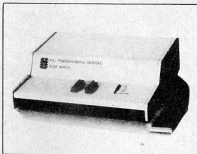

M/s. Professional Electronic Products • Opp. Old Octroi Post • Delhi Road • P.B. No. 316 • MEERUT-250 002. • Tel: 20159, 20460.

Automatic Light Switch

Electronics Hobby Centre has brought out a solid state Automatic Light Switch which does not use a transformer and relays. This switch puts the light 'ON' at dusk and 'OFF' at dawn. Working on 220 V AC, it is available in ratings of 300 and 600 W. The circuit is encased in plastic ABS cabinet and is available in both wall mountings or plugging type models.

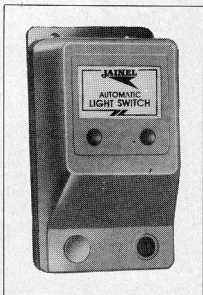

M/s. Electronics Hobby Centre • F-32, Nand Dham Industrial Estate • Marol • Bombay-400 059 • Ph: 636 6123.

PCB Racks

Circuit Aids, Inc., has developed FRP moulded PCB Racks designed to hold PCBs of any thickness vertically. The maximum card length that can be accommodated is 18" and each rack can hold 25 cards. The racks can be mounted on a trolley for easy transportation.

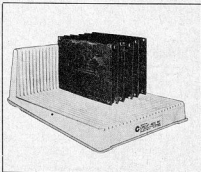

M/s. Circuit Aids Inc. • Nom 451, II Floor, 64th Cross • V Block, Rajaji Nagar • Bangalore-560 010. • Tel: 359694.

NEW PRODUCTS

Plug-In-Timer

Pla has introduced Series PT Plug-in Electronic Timer suitable for 8 pin base. Compact and light these timers have a range from 0.1 seconds to 60 minutes with ON/OFF delay action. Contact rated at 6 A at 24 V DC/240 V AC.

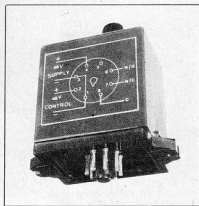

M/s. SAI Electronics • (A Divn. of Starch & Allied Industries) • Thakor Estate • Kurla Kiron Road • Vidyavihar (W) • Bombay-400 086 • Ph: 5113094/5113094/5136601.

Ribbon Stuffing Machine

Track Engineers have developed a ribbon stuffing/refilling machine for computer printer ribbons. The machine is useful for filling the new ribbon from ribbon rolls into the cassette. The machine consists of a variable speed drive at 250 rpm with a precise speed controller and an electronic counter. As the ribbon is filled into the cassette, the counter provides the length in meters. The speed controller facilitates the use of same

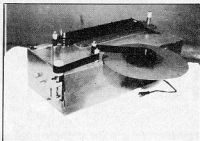

machines with all the cassettes. The operation is very fast with one cassette require about 2-3 minutes to fill. Different sized ribbons can also be filled by the machines. These machines are suitable for new ribbon manufacturers as well as dealer providing refilling services.

M/s. Track Engineers • 209, Devendra Industrial Estate • Lokmanya Nagar • Pada No. 2 • Thane (W)-400 606 • Tel: 509446.

Data Wall Outlet

PRIMA INDUSTRIES has introduced a Data Wall Outlet for terminating Rs 232 and BNC connectors for LAN installations. This is manufactured from high grade ABS plastic and comprises of three parts viz, the wall mounted enclosure, the connector mounting plate and the dust cover. Useful for computer installations and other electronic based systems. The Wall outlet provides for neat installations by eliminating untidy cabling and connectors lying on the floor.

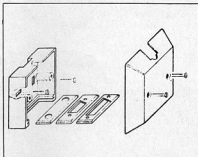

M/s. Prima Industries • 16, Sargent House • Allana Road • Bombay-400 039 • Tel No. 242086.

Power Supply Analyser

ATE Ltd is offering Chroma 600 Switching Power Supply Analyzer, manufactured by Chroma ATE Taiwan. The analyser can simulate a wide variety of static, dynamic, transient load condition in order to determine the stability and response of the power systems. Suitable for testing power supply variable in R&D, production and QC application. Available in 4 models.

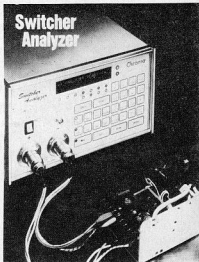

M/s. A.T.E. Limited • Electronic Division • 36, SDF 2, SEEPZ • Andheri (E) • Bombay-400 096.

Grommet Ring

Grommet Ring used for protecting wires, Cable cords against damage from sharp panel edges, have been developed by Novoflex. These rings are highly flexible and have good resistance to fluids, mineral oils, alkalies etc. They are self extinguishing with good insulating properties. Available for Panel hole diameter 5 mm to 30 mm. These rings are used in a wide number of industries.

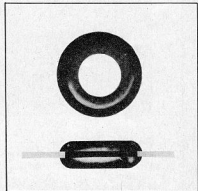

M/s. Novoflex Cable Care Systems • Post Box No. 9159 • Calcutta-700 016 • Tel: 299-4382, 29-5939, 299-3991.

NEW PRODUCTS

Emergency Light

Prolite is offering a wide range of Emergency Fluorescent tube lights. The range includes mini tube light (of 8W/9W/22W) and standard tube lights. (10W/20W/40W). Powered by Sealed Dry Maintenance Free Rechargeable Batteries, each unit consists of

- a battery charger
- High frequency inverter.
- solid state switching circuit
- Auto cut-off circuit

Useful in a number of places like banks, hospitals, factories, offices, homes etc., the units are available in both desk top/wall mounting versions.

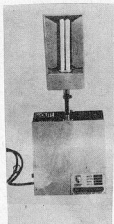

M/s. Professional Lighting Industries • 25, Singh Industrial Estate No. 3 • Ram Mandir Road • Goregaon (W) • Bombay-400 104 • Tel: 672 35 21.

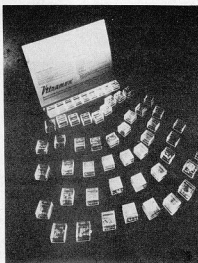

M/s. A.T.E. Limited • (Electronics Division) • 36, SDF 2, SEEPZ, Andheri (E) • Bombay-400 096.

Digital Frequency Counter

Vasavi Electronics is marketing a compact digital frequency counter VDC 18. Features include Mains/Battery operations, 7 digit LED display, 500 MHz frequency range, light weight, resolution selection etc.

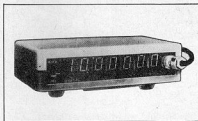

M/s. Vasavi Electronics • M-8, Cheno Trade Centre • Parklane • Secunderabad-500 003 • Ph: 70995.

Ceramic Capacitor Kit

A.T.E. Ltd. is marketing a Multilayer Ceramic Chip Capacitor kit manufactured by Vitramon Ltd. of U.K. It comprises of a box containing 54 individual containers of chip capacitors totalling over 5000 pieces in 0805, 1206, 1210 and 1812 sizes with Nickel Barrier Terminations. A wide range of capacitive values ranging from 0-47 pF upto 220 nF is included. The chip kit is useful for prototyping and design engineering applications.

Soldering Iron Bits

Soldering Iron Bits 30 W-24 V are being offered by Khanchandani Industries. Manufactured from high conductivity Copper Rods of 99.99% purity, these are Nickel plated for enhancing their life and easier solder flow.

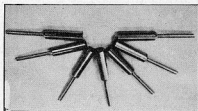

M/s. Khanchandani Industries • 36, Shanti Indl. Estate • Sarojini Naidu Road • Mulund (West) • Bombay-400 080.

Key Switch

Integral Systems have introduced Key Switches 1 K 9 in various sizes. Made of ABS or acetal, the contacts are rated at 0.1 A, 30 V.D.C. The Switch has an operating life of 2 million times with the contact mechanism comprising of a gold plated rotating ball which offers a fresh surface as contact, each time the plunger is depressed. This ensures a longer life compared to conventional switches where the sheet metal contacts suffer from problems of distortion, fatigue etc.

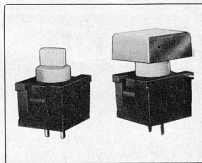

Integral Systems and Components Pvt. Ltd. • 45/7 A, Gubbanna Indl. Estate • 6th Block • Rajajinagar • Bangalore-560 010 • 35 42 47.

NEW PRODUCTS

ANTISTATIC ELECTRO STATIC DISCHARGE BAGS.

Marvel Products have introduced reusable economical P.V.C material E.S.D semi transparent bags for storing P.C.B & Electrostatic sensitive components these bags are available in various sizes (As per specifications) with printed caution warning sign.

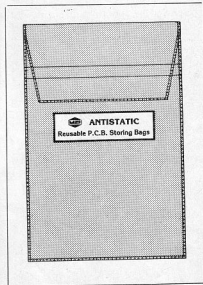

For further information contact:-
Marvel Products • 208, Allied Industrial Estate,
Mahim • Bombay-400 016.

Also available with additional card holders for use in factory production line wherever a system incorporates inter-laced PCB wiring.

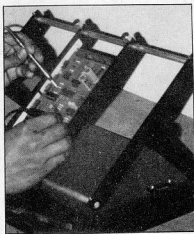

Contact: • M/s. Electro-Links • Plot No. 49,
• Shop No. 9, • New Link Road,
• Behram Baug • Jogeshwari (West) •
Bombay-400 102.

M/s. Professional Lighting Industries •
25, Singh Industrial Estate No. 3 • Ram Mandir Road, Goregaon (West) • Bombay-400 104 • Ph: 672 35 21.

Spectrum Analyser

THE spectrum analyser FSB by Rohde & Schwarz is claimed to be the first spectrum analyser in the 100 Hz to 5 GHz (5.2 GHz) range with intrinsic noise below -145 dBm (6 Hz); on a colour screen with a usable display range of 105 dB in a measuring range > 170 dB. Thanks to its measuring characteristics, user-oriented expert functions, and automatic test routines it is suitable for complex testing to CEPT regulations as well as for microwave link applications. The low phase noise of < -110 dBc (1 Hz) 1 KHz from the carrier and the wide intermodulation free range > 100 dB make high dynamic range measurements possible. The large resolution band width range of 6 Hz to 3 MHz (typ., quassianalog setting) and the span from 10 Hz to 5.2 GHz make the FSB indispensable for all selective level measurements.

UPS

Prolite has recently introduced a solid state Uninterruptible Power Supply Systems for various industrial and consumer applications. Rated at 400 VA, it incorporates Rechargeable Maintenance free Batteries of 24V, 18AH. The system also has a pulsed boost-cum-trickle charger to monitor and control the battery charging. This unit is also available in the OFF LINE Mode.



PRINTED CIRCUIT CARD FIXTURE

The PCF-10 is a handy PCB fixture unit for every electronic assembly and maintenance workshop. A pair of adjustable card guides allow the user for holding PCB's of various sizes at any convenient position, either horizontal or vertical. It incorporates a unique arrangement to hold PCB's in a vertically locked position for providing easy access to both sides of printed circuits and especially for removing IC's without damaging the printed circuit board. The PCF-10 is light in weight and can be used as a table top fixture. It has working dimensions of 240mm x 300mm to cover most requirements of every electronic workshop.



M/s. Rohde & Schwarz • Liaison Office India • B-Block, Ground floor • 9, Prithviraj Road • New Delhi-110 011.

DO IT YOURSELF

THE

**JUNIOR
COMPUTER**

BOOK

**LEARN-BUILD-
PROGRAM**the practical introduction
to a powerful systemPrice
Rs. 50.00
Available at
all leading
book shops.

The Junior Computer book is for anyone wishing to become familiar with microcomputers, this book gives the opportunity to build and program a personal computer at a very reasonable cost.

The Indian reprint comes to you from

elektor India

Send full payment by
M.O./I.P.O./D.D. No Cheque Please.
Packing & Postage free

to: **elektor ELECTRONICS pvt ltd.**
52-C, Proctor Road, Grant Road (E),
Bombay-400 007.

