

71  
March  
1989

# elektor **INDIA**

Rs. 8.00

# electronics

THE MAGAZINE FOR PROFESSIONALS

**ELECTRONICS ON THE RAILS & WHEELS**



*Sunder Singh*

**CATCHING  
THE COMPUTER THIEF**

**INDUSTRIAL ELECTRONICS  
& HIGH-TECH USA '89**

**MOLECULAR ELECTRONICS**

*Towards an advanced form of computer technology*

**VIDEO CARDS FOR  
PERSONAL COMPUTERS**

**"NEW"  
ON THE 555**

**Publisher:** C.R. Chandarans  
**Editor:** Surendra Iyer  
**Technical Adviser:** Ashok Dongre  
**Circulation:** Advertising: J. Dhas  
**Production:** C.N. Mithagari

**Address:**  
 ELEKTOR ELECTRONICS PVT. LTD.  
 52, C Proctor Road, Bombay-400 007 INDIA  
 Telex: (011) 76661 ELEK IN

**Overseas editions:**

**Elektor Electronics**  
 I, Herlaquin Avenue  
 Great West Road, Brentford TW8, SEW U.K.  
 Editor: Lou Seymour

**Pulltron Publicações Técnicas Ltda**  
 Av Espirito Santo, 1100, 8° andar CEP-01040 São Paulo - Brasil  
 Editor: Juliana Borsari

**Elektor eest**  
 Pöate Nõukogu, La Saue, B P. 93  
 102270 Tallinn - France  
 Editors: D.R.S Meyer,  
 G.C.F. Raadema

**Elektor Verlag GmbH**  
 Sauerhoff-Strasse 75 100 Aachen - West Germany  
 Editor: E.J.A. Krompeltzer

**Elektor EPE**  
 Kamefokki 14 16573 Voula - Athens - Greece  
 Editor: E. Koutoulas

**Elektuur B.V.**  
 Peter Treckpoelstraat 24  
 1191 VK Beek - The Netherlands  
 Editor: P.E.L. Kerssebaumer

**Ferreira & Bento Ltda**  
 R.D. Estrela, 32 1° 1000 Lisboa - Portugal  
 Editor: Jorge Dantas

**Ingeniök S.A.**  
 Plaza Republica Ecuador 2.26019 Madrid-Spain  
 Editor: A.M. Ferrer

**Ele Part**  
 Kitchener Holdings Pty Ltd Cor. Fox Valley Road &  
 Kings Street Wehrange NSW 2075 - Australia  
 Editor: Roger Harries

**Electronic Press AB**  
 Box 63  
 182 11 Danderyd - Sweden  
 Editor: Bill Cedron

The Circula see domestic use only. The submission of designs or articles implies permission to the publisher to alter and translate the text and design and to use the contents in other Elektor Publications and activities.

The publisher cannot guarantee to return any material submitted to them. Material must be sent to the Holland address (given above). All drawings, photographs, printed circuit boards and articles published in Elektor publications are copyright and may not be reproduced or imitated in whole or part without prior written permission of the publishers.

Patent protection may exist in respect of circuit devices, components etc. described in this magazine.

The publishers do not accept responsibility for failing to identify such patent or other protection.



MEMBER

Printed at: Trupti Offset  
 Bombay - 400 013

Ph. 4922261, 4921354

Copyright © 1989 Elektuur B.V.

*Elektor*

# CONTENTS

## Special Features

Industrial Electronics & High-Tech USA '89 .....	3.10
Electronics on the rails & wheels .....	3.14

## Audio & Hi-fi

PROJECT: MOSFET hi-fi power amplifier .....	3.28
Tweeter protector .....	3.62

## Automotive electronics

PROJECT: Car service module .....	3.33
-----------------------------------	------

## Components

More application for the 555 .....	3.40
Practical filter design-2 .....	3.56

## Computer

Catching the computer thief .....	3.16
SPECIAL FEATURE: Computers — an overview .....	3.45
Molecular Electronics .....	3.51

## General Interest

PROJECT: The digital model train-1 .....	3.47
--	------

## Science & Technology

Recognizing speech in noise .....	3.53
-----------------------------------	------

## Information

Industry News .....	3.24
Telecom News .....	3.25
Electronics News .....	3.26
New Products .....	3.66

## Guide-Lines

Classified ads .....	3.74
Index of advertisers .....	3.74

# "INDUSTRIAL ELECTRONICS & HIGH-TECH USA '89"

USA and India: Touching tomorrow together. That is the theme of an exhibition of advanced technology, electronics and computer systems. The exhibition, after successful week long exposition in New Delhi moves to Bombay.

"Industrial Electronics & Hi-Tech USA '89", organised by the United States Department of Commerce and the American Consulate General-sponsor this show in Bombay from March 8 to 11, at Bangalore from March 16 to 18 and at Hyderabad on March 29 and 30.

Computer hardware, peripherals, specialised software packagers, process control instruments, electronic industry production and test measurements, electronic components, CAD/CAM system, laboratory and scientific instruments, electronic medical equipment, microprocessor based pollution control instruments, electronic desk top publishing systems, engineering and design equipment and other high technology products designed to enhance productivity and efficiency in office and industry are being displayed.

Some of the high quality American companies participating in the trade show include AT and T, Digital Electronics, Hewlett Packard, Tektronix, Texas Instruments, Tata-Unisys and Citicorp Software.

Mr David Hughes, commercial consul at the American Consulate, Bombay, speaking to "Elector India" outlined the broad features of the trade show.

Technology import becomes essential for development. In the absence of a hi-tech show like this, hundreds of entrepreneurs and industrialists may have to visit the United States on their own to get the first hand information on the state of the art products available for commercial production. Instead of taking the people in large numbers to the US, we bring the products here. This is a cost effective method of bilateral trade promotion.

"United States is the largest trading partner of India, apart from being a big investor. Ready market is avail-

able here from the point of view of both the countries."

Having explained why this exhibition, Mr Hughes recounts the success of a similar exhibition in India in 1987 which reinforces the importance of the hi-tech trade show.

"The 1987 electronics trade show attracted over 70,000 visitors. Two products which were never shown in any exhibition anywhere in the world were brought to the Indian show. Six other products which had not been shown outside the US before were also displayed in the Indian exhibition.

"A company that never sold even a single product to India before, now sold more than a million dollars worth of products, directly as a result of the 1987 exhibition.

"Interface, a Michigan-based NRI firm is proud of the fact that the company built itself from the scratch through successful sales of products to India".

Mr Hughes also cites the new joint ventures by the Digital Electronics and Tektronix with Indian firms as a symbol of the emerging trend.

On the query, what new products are likely to be on display this time, says Mr Hughes: "Products come out in the US market daily. The products change within a few days. Thus, always an element of surprise exists in the display of the products. The equipment and instruments to be displayed in Hi-Tech '89 will be worth 12 million dollars.

Mr Hughes describes India as a gateway to the International market. Of the entire supplies made to India by the US, electronic products alone account for 60 per cent. Indian export to the US has also shown an upward trend, by about 20 per cent. Further, the familiarity of languages between India and the US makes the people of both countries feel at home and this is a significant advantage in the Indo-U.S. commercial cooperation.

The US computer equipment industry has entered an era of

heightened foreign competition, increasing product standardisation, aggressive pricing and shorter product cycles. The effects of these factors are evident in the industry's declining trade surplus and employment. Mergers and consolidations have begun and are likely to increase, because none of these factors is likely to abate, according to "U.S. Industrial Outlook", an authentic publication on the U.S. commerce.

By the early 1990s, some observers forecast, a growing movement from silicon to gallium-arsenide based semiconductors. This development will help computer system performance surpass the highest levels now attainable.

The U.S. software industry must deal with the continuing shortage of skilled programmers and the escalating cost of producing software, to retain its leadership in the world market. By 1995, demand for computer programmers and systems analysts in the United States is expected to be nearly the 1984 level, reaching 1.1 million professionals, according to the Bureau of Labour Statics projections.

Electronic components are the building blocks of all commercial and military equipment. Technological advancement in electronic components increase the performance and reliability of computers, telecommunications, consumer electronics, robotics, aerospace and defence equipment.

The American electronic components industry experienced a shakeout of manufacturers in 1986 and 1987. Joint ventures, mergers, and acquisitions characterised conditions in many product sectors, including semiconductors, capacitors, resistors, and connectors.

U.S. shipments of semiconductor devices will increase at an average annual rate of 12 per cent through 1993. Future growth will depend on continued expansion of semiconductor applications. The U.S. industry is expected to continue the lead in design technology.

# ELECTRONICS ON THE RAILS & WHEELS

Indian Railways provide faster transport than the Indian Airlines. There is some truth in this statement, even if we ignore the frequent delays in flight schedules. If proportionate weightage is given to the railways for the number of passengers transported in a train, with much less sophisticated technology than in an aircraft, rail travel will turn out to be faster.

The desire for moving fast inspired the invention of wheel. The urge for faster movement is fraught with the danger of derailments and collisions. But, the iron wheel on rails has been gaining momentum steadily and safely as well.

The era of high-speed rail travel has entered the Indian Railways. The Shatabdi Express, flagged off in mid-February, is the fastest train in the country today. This train running between Delhi and Bhopal, overtakes the Rajdhani Express introduced 30 years ago between Delhi and Calcutta. Rajdhani runs

at a maximum speed of 130 kmph while Shatabdi runs at 140 kmph.

Speed and safety necessarily involve induction of modern technology. No modern technology can be devoid of electronics. But, the role of electronics is not widely felt by the ordinary passenger, except for the red and green signals or the time indicators and moving advertisements in the platforms. Of course, we have closed circuit TV in the railway stations, nowadays.

Going by the pace of modernisation elsewhere, one may visualise a science fiction like situation where trains run automatically on the press of a switch, sense obstacles on the way, stop and proceed, entirely based on the remote control computer workstations. It is almost a driverless train. Even, the fully computerised railway systems abroad have led to collisions, and hence, Indian Railways are very cautious in introducing solid state chips in operating the trains.

Running of a train calls for the coordination of a variety of services. The locomotive, the coach formation, electric traction, maintenance, line clearance, interlocking of tracking and signals and so on. When simultaneously dozens of trains run on the same track, to control their movement without any mishap an expert controller is indispensable. The controller can be a man or a machine. The man now increasingly uses the machine to "control and operate" the moving trains.

Communication is the life line of today's railway network, comprising nine zonal railways covering different parts of the country. Unless the message of an incoming train or outgoing train is communicated from station to station, there will be chaos. A controller used to draw a chart, plotting the movement of trains manually. This is impossible now with the increasing number of trains, moving in quick succession. The control panel is now

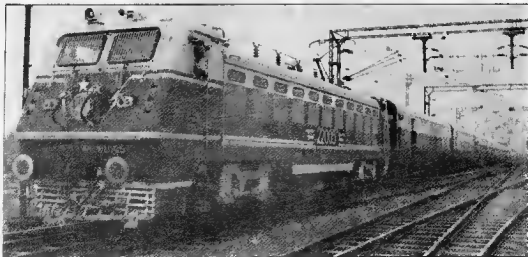

THE SHATABDI EXPRESS

modernised with the indicators, activated by what are known as "relays". Millions of switches get activated and de-activated in the process of monitoring the train movements on various routes, in-different sections of a railway division.

Communication channels are required not only for train and track control but also for administrative control. Headquarters of the nine zonal railways and 52 divisions of the Indian Railways are all linked with microwave communication network. From any station in the country, one can speak to another station through the decided communication channels of the railways.

The railways have telephone exchanges of nearly 90,000 lines. The trunk phone channel runs 3.80 lakh kilometers. The telegraphic and teleprinter lines work out to 140,000 km. The VHF microwave link has about 16,000 route kilometers. The underground cable communication accounts for about 8,000 km.

Apart from the real time control of operating trains, similar sub-controls exist for electric traction, locomotives and wagon formation. The reliability of railway communication services is 99.1 per cent. In communications, the railways have kept pace with latest in introducing the optical fibre communication system. The country's first optical fibre railway communication system was commissioned in February, 1989, between Churghate and Virar near Bombay on the Western Railway. The optical fibres cover a length of 60 km. The next major optical fibre communication systems will be commissioned over a length of 900 km between Itarsi and Nagpur of the Central Railway.

The railway have chalked out a perspective plan for establishing an "Operating Information System", incorporating digital data communication. The plan envisages an outlay of Rs. 1,100 crores.

Data communication is an integral part of the railway system. There are about 9,500 steam, diesel and electric locomotives. The coaches, both conventional and passenger

electromotive units, number about 38,000. There are nearly 200,000 covered wagons and 100,000 open wagons, not to speak of over 48,000 special type wagons and about 12,000 department wagons. These locomotives and wagons are scattered on railway tracks which measure 107,000 km, criss-crossing the country.

On an average, daily about 3000 EMUs, 900 mail or express trains and 3,000 ordinary and mixed trains run on the Indian railway network. There is little doubt that a computerised data base and dynamic exchange of information through computer networking is the only scientific method available for utilising the rolling stock optimally and efficiently.

The philosophy of safety followed by the railways aims at reducing the human element in controlling the train operations. Modern signalling systems, panel interlocking, remote relay interlocking, centralised traffic control, automatic signalling and mechanisation of marshalling yards are some of the steps taken by the railways in recent years.

Still, the Indian Railways have not gained the confidence to introduce solid state electronics in interlocking systems because a chip failure can mean a major disaster. Though, such a system has been introduced on an experimental scale at Srirangam in Tamil Nadu, intervention of human element still continues in the interest of ultimate safety. Two computers, in parallel, control the traffic in any typical modern network. What if one computer, which compares notes with its parallel computer fails. The system will collapse. Experts now feel a standby third computer can be provided. Why not a fifth one, some way ask. It is still a technology in evolution and India, with its highly-populated rail network cannot hastily jump into the futuristic ideas, says a seasoned railway communication engineer.

Yet the railways can speak of many innovative techniques now in use. The most popular technique is the one used to prevent a train from jumping red signal. A sensor will switch off the locomotive when the

engine tries to go past the red signal.

Track to train control is a new concept being introduced. An equivalent on the train transmits a signal at a given frequency. The wheel has a receiver. When the train runs at a speed more than the prescribed limit, the wheel moving faster will miss the signals. The disturbance in the frequency will alert the driver that the train is exceeding its speed. If this warning is not acknowledged within a few seconds, the system gives a command for activating the brakes and the train will come to a halt automatically.

An axle counter system blocks movements of a train in the same track where another train is already stalled or moving. An oscillator coil on the tracks, counts the number of wheels which pass through and transmits the number of "dips" to its counterpart at the end of the block. The line clear signal will be available only if the second oscillating counter records the movement of the same number of wheels which originally entered the block.

A last Vehicle Check Device has been developed by the railways in collaboration with the Bharat Electronics Ltd. This system will avoid accidents caused due to parting of trains in blocks of tracks.

Similarly, train actuated warning to level crossings are being introduced. This system uses radio, solar power panels for signalling and microprocessor based axle counters. For detecting flaws in the tracks and to detect invisible rail fracture, ultrasonic rail flaw detectors are used. To ensure that the width of the tracks does not alter, accelerometers are used.

Finally, what affects the people most directly is the reservation of tickets. The success of the computerised train reservation system, introduced in the four major cities of Delhi, Bombay, Madras and Calcutta, has become well known. Again, a comparison with the airlines booking is inevitable. Railway reservation systems are too complicated to be compared with the

airlines. Still, the computer systems of the railways withstand the rigours.

The most perceptible impact of the computerised reservation system is that a person normally gets his ticket in 30 minutes, under manual booking system, the person might have stood in the queue for several hours. One can take any ticket for any destination for any date in any computer. Following cancellations, waitlist positions automatically get updated, reducing the possible tampering with the reservation chart.

Besides being one of the largest railway networks in the world, Indian railways offer services which

are nearly unparalleled. There are seven types of classes like first air-conditioned class, second air-conditioned class, first class, second class sleeper and so on. There 60 types of coaches. The railways offer as many as 90 types concessions to travellers. The rates of cancellation vary. The fare structure are mind boggling. The options of permutations and combinations available before deciding on a journey ticket is stupendously large. Nothing but a computer can do the job in a trice.

In Bombay, the main Victoria Terminus, Churchgate and Bombay Central have been linked and tickets for both the Central and West-

ern Railways are available. Soon the computers of major cities would be linked in a network and booking of return tickets will be as easy as the purchase of the first journey ticket.

While purchasing the computer printed tickets, in the cozy air-conditioned atmosphere, we also find a sea change in the persons behind the counter, tapping keyboard and watching the console. These were the same reservation clerks who exhausted themselves in the drudgery of issuing tickets manually.

## CATCHING THE COMPUTER THIEF

How easy is for anyone to find out the foreign account holding of an individual? Going by the information available from a series of media disclosures of Fairfax agencies of the U.S., it should be easy. And, pray, how does the agency get the requisite information? Thereby lies the whole world of computer code break-in and the growing insecurity of stored data.

The villainy of hackers has been sufficiently highlighted and how they squeeze information from a computer is commonplace. But as

hackers get busy, so do the agencies offering security systems. Computer security is a big and growing field. Several locking systems have been developed to keep interlopers out and it is a battle of wits between these who devise safety and the ones who find ways of breaking them. Be that as it may, just as the clever policeman may set a thief to catch a thief, a computer specialist is often used to counter a computer fraudster. A detective agency trying to get the foreign account holdings, for instance, will work through a 'plant' or a 'Man in Place'. This plant is

nursed for long and is used for strategic information retrieval. And costs for services can be pretty high because the risks are considerable. Whether it be defence information, bank transactions, drug trafficking, the modus operandi is to use a plant. And the security of the stored information is sought to be safeguarded by a variety of systems of which locking devices are only a sample. Some information is in code so that even a retrieval is harmless. Certain software packages are beyond the access of people. Those entitled to run specific programmes are frequently

changed so that a nexus is never formed between the operator and the outsider. Passwords are not only changed from time to time but also coded so that the birthday and anniversary reference are removed. Such references in password codes are relatively easy to determine.

A disgruntled employee or a highly ambitious and get-rich-quick staff is a hazard for security of information. Such people oblige with the requisite information or, in a more vicious role, bung a spanner into the works. They could cause a computer virus by altering and hacking the stored data. One of these Smart Alecs in the U.S. when thrown out of his job hacked the software in such a way that each month a database would be wiped out. Records that thus began to vanish, the company lost track of its dues and faced liquidation. The computer programmers can take it out on their employers if badly treated. A disabled programme is hard to reassemble. The hacker managed hitherto to go unscathed but not anymore. Some of the states in the US already regard the offence as a felony and the judges mete out severe punishment.

Over 75 per cent of the security breaches in a computer is caused internally. People who have access to data are in an eminent position to trade information either for pecuniary consideration or to avenge a severe treatment by a boss. Disabling a computer or a communication is considered as easy as snapping a power line. And once the computer support is lost, the owner-company is virtually paralysed without computers, plants cannot be run, bills remain uncollected, and a planning for production and inventory rendered negatory. The potential for trouble is even greater in banking industry. One estimate places the daily transactions in US through computer networks at \$ one trillion, an amount equal to 25 per cent of the gross national product of that country. Of this amount the fraud is believed to account for some \$ five billion annually. The white collar computer fraud is a big business. And the one who is in a posi-

tion to commit it is often a small-time clerk. The computer related heist involve vast sums and it is often too late when the mischief comes to light.

To protect the vast systems therefore elaborate security is introduced through extra-thick concrete walls and ceiling to house the mechanical facility. The protective barbed wire is said to have not just voltage deterrent but a retina scanner that locates the unwanted guest through sensors that read the blood vessels in eyeballs.

Protecting the hardware and software of computers has itself become a big business worldwide. The growth in demand for computer security has surpassed the larger computer hardware and software manufacturers. The current series of computers come with some safety devices but the earlier ones are still susceptible to unauthorised access. The assessment for market to providers of computer security services is an impressive \$ 554 million by 1992, \$ 340 million more than what is currently spent. The leading security software packages mentioned in the European press include RACF from IBM and ACF2 and Topsecret from Computer Associates of Slough. Software houses such as Cap Gemini Sogeti and Logica also offer systems.

The computer rooms in future will be like elaborate fortress with security guards. And the guard will both be physical man and mechanical code. The first function of the software is to check the legitimacy of each attempt at access. Users identify themselves by name or initials and are then authenticated.

The system checks through passwords, magnetic tokens or biometric methods which aim at identification by physical features including finger prints. In some of the systems the user has to place a hand below a sensor for the computer to verify the authenticity of the person planning to sit before a terminal. Once in through the fortress, the software must ensure

that the person's activity is limited to appropriate applications. This is done by careful allocation of the data for access.

The password itself is in future designed to be based on completely different lines. Currently, these are determined on the basis of their pet's name or that of a dear departed. Such associations are vulnerable and hacker or more seriously the insider-groper could easily locate those banal passwords. Numbered codes provide little protection because many use their birth dates or anniversary references. Some of those in charge of computer software suggest frequent change of passwords and job changes. The passwords also need to be of a certain number of words. One hacker's programme can crack a four-letter password in less than a day while a five-letter one can take months. Both the stored information and the users must be graded and assigned specific rolls. Some could have authority to alter and update data while others could only scan selectively created files.

Sensitive documents can be individually coded so that even if an unauthorised user gains access to a file, it remains impossible to read. Although encryption codes can be broken down the information could still remain classified for a period of time because it takes time to break the codes. Most information is time sensitive and the encryption therefore has some value and merit for the computer operator.

Although inadequate or weak security had severely undetermined the business viability of several service industry units, a computer-using company is still not too sure if the safeguard systems are worthwhile. Unquestionably, there is value for such security in defence and other strategic areas but a corporate entity prefers to ponder. The re-thinking on introducing computer security is because of the high cost of the requisite packages. The reluctance to introduce the safeguards stems mainly from the feeling that these do not add to profits. At best they may protect profits but this perception is not too often

realised. Since there is no direct advantage in using a security package, the decision is invariably deferred.

One other fear of a computer security safeguard is that it might get too complex to safely operate on a day-to-day basis. If the system is oversecure, the users might have to put down their passwords in sheafs of paper. Which, of course, is too much risk in itself. The main area of concern is about the security of national secrets. The extensive use of computers in the US has jeopardised military secrecy. Who knows if it is a hacker upto a harmless prank or an international spy ring getting access to national secrets. Espionage and counter-espionage is done through breaks into computers. The U.S. security agencies receive signals from Soviet spy satellites, decode information and simultaneously ensure the opposite camp does not do the same. The Soviets, in their own ways, set up international electronic telecommunications, a fact evidenced by the presence of antennae. Phone conversations and data transmissions relayed by cellular radio and microwave links are picked up routinely. In Cuba, giant dishes pull in signals beamed down from satellites to any point in the lower 48 states. Soviet ships monitor both coasts along the US. One estimate places the Soviet interception of American calls at one half of the latter's aggregate traffic.

Any traffic can be intercepted and one method of securing the information is to safeguard lines of fiberoptic cables buried deep under the ground. There are no connections to outside phones, so no hacker can gain access. If a spy cuts a pipe to tap the cable, the drop in gas pressure would alert watchers by sounding an alarm. However, buried cables are no good when it comes to communicating with ships and planes. To ensure secrecy in this area, the US agencies use cryptographic ciphers which turn English into gibberish. It will be impossible to make sense from a typical English text with unfamiliar and non-existent words. The cipher is changed

frequently so that if 'U' stood for 'U' now, it might stand for 'V' tomorrow. The decode requires a keyboard command which instructs the computer to say how it must recast a message so that it made sense to the ordinary mind.

As in the private computer, so in the government even if it involved a top secret agency. The worst enemy to a code is the person inside. Turncoats could make a fortune selling crypto details only because the stakes in international diplomacy are high. Such is the extent of risk and fear of insecurity that the names used to classify information are themselves classified. The possession of crypto code could mean access to top national secrets. As more and more is stored in computers, as more intelligence is gathered through gropers, the need for securing the systems and the hardware assumes urgency. There can never be an ideal because the insider or the know-all could spill the beans and mar the effect.

The rewards for information are attractive indeed. The knowing persons are vulnerable before the tempting offers. When the demand for information is high and the supply prospect is restricted because of the intensified security, the price offered is attractive. Such offers trigger perverted minds to work overtime and find methods of eaves dropping data.

What really has made computer vulnerable to hackers and gropers is the network diversification. The PCs have developed enormous reach as more data is brought within networks. The hackers, oriented entirely for mischief and fast buck, find ways of using their PCs to break into networks. Some are at it for pranks but an increasing number for rewards.

In some places the employees permitted limited access are given micro-processor-based smart cards. Each card is designed to provide a set information package. These cards are hard to duplicate and safe enough to ensure that the right person has the right access to data in the stomach of the compu-

ter. The flaw with the card, however, is the risk of their being stolen. It is for this reason that the biometric access devices are mentioned. Machines can scan voice inflexions, hand prints and even typing habits!

Why computer frauds are increasing has intrigued people. It may have little statistical significance if one went by the cases reported. What is relevant is not the number of cases but the huge sums and stakes behind each of them. An electronic bank heist runs into something like tens of millions of dollars. Just five of these bring about the closure of a large bank. Also, the victims are less inclined to report a white-collar fraud with the use of a computer. If a bank case were to be reported, it could be a disaster in terms of public confidence in the institutions. Managements of banks are known to have cordially parted company with unscrupulous employees, giving them a terminal gift only to ensure the matter did not come before the public. Elsewhere also, even the detected cases are kept under wraps, lest it should turn out to be a public relations disaster.

The most insidious of the computer misuses is the spread of virus. The whole data bank is wiped out or altered beyond recognition. This is done by releasing a software to infect a genuine package. Over period of time the 'intruder' package undermines the original package. Some quarter million outbreaks involving 40 large American corporations have been reportedly tak nill with the virus. Some of the viruses make a passage over wide distances through the globe. Some versions of a virus are created by mischief mongers along the way and they have taken their virus to such countries as Israel, Europe and the U.S. That passage itself, if it is suspected, was through the networks.

Among the steps to check the spread of virus are not only the appropriate vaccines but also tighter laws and also tax incentives for investment in sophisticated safeguard programmes. The



American companies have been spending large sums on the computer chasticity belts with some software copies selling for as much as \$ 35,000. These are also agencies which keep backup in case a set is lost through fire, flood or any other 'Act of God'. These are often stored in remote places with armed personnel guarding the tapes.

The ingenuity of the hackers and gropers and other mischief mongers keeps increasing as the protectors develop defences. It is battle unlikely to stop. The international dependence on computers for data storage is expected to force people in other countries too to face up to bad elements in the trade. Since India has also embarked on a phased computerised programming, the devices would now have to be prepared to prevent the disasters which western countries faced.

The computers might produce an environment exactly the opposite of the one it set about achieving. The purpose of the computer was to guarantee secrecy. That was also the reason for the popularity of the gadget with the blackmoney hol-

ders in the country. With hackers around, there is a threat to the secrecy. Too much of sophisticated technology is becoming too commonplace. There might well be an open society with the computers and hackers. Secrets, if any, will become open. Will that make a computer redundant? There is a growing body of opinion which feels that computers cannot eternally be relied upon as capability make it seem there is a rebirth of Man Friday.

From the time Alibaba discovered the 'Open Sesame' code, secrets are hard to keep. There indeed are attempts at keeping secrets under the hat but they have the uncanny habit of getting away thanks to the hackers.

Be that as it may, the controversial retention of Hershman as a provider of vital information on illegal account holding of Indian politicians appears to strengthen the view that secrets are sought even in this country. The only access to such information in developed countries, and specifically in the closely-guarded banking systems

of Switzerland is through plants in the financial institutions. It is believed to be easy to cultivate plants and secure from them vital tax evasion information. It is not uncommon for the American private investigation agencies to look for those opportunities. And the way to do it is of course to follow the many methods described in the course of this article.

Every account in every bank of Europe is in the computer. If a way could be found to retrieve it from there, the information is common knowledge. The only ones capable of getting it out is any employee enjoying the trust of the employer. Since the rewards are large, the incentive is good.

As the retrieval of data through gropers become easy, the user begins to think more seriously of installing security systems. There are many user worldwide who are currently evaluating the various security packages and wondering which, if any, of those should be requisitioned. This is giving the security package writers a good prospect of business in the times to come.

95% of TV reception problems are caused by faulty antennas.

Don't take chances with cheap fakes.

## INSTALL A YAGINA TV ANTENNA TODAY

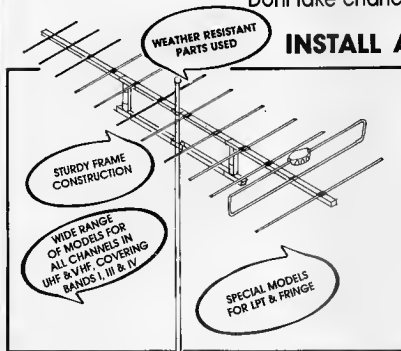

YAGINA Antennas are designed and manufactured by experienced electronic engineers to ensure the required quality, performance, reliability & weather resistance.

Manufactured by:



**YABASU  
GRAPHICS  
PVT. LTD.**

103, Shanti Industrial Estate, Sarojini Naidu Road, Mulund (W) Bombay-400 080.  
Ph. 561 6519

**DEALERS WANTED**

# MOSFET HI-FI POWER AMPLIFIER

A quality 160-watt hi-fi output amplifier based on the Siemens BUZ series MOSFETs.

Until not so long ago, the BUZ series of MOSFETs from Siemens were hard to come by and very expensive. That was a pity, because these devices offer a very good specification. Fortunately, the situation has improved considerably, although the transistors are still only available as n-p-n types. However, n-p-n types can be used just as well as complementary pairs as the present circuit proves.

A power amplifier, whether it uses bipolar devices or MOSFETs, needs a drive circuit. When MOSFETs are used, that circuit can be kept pretty straightforward. This means that any modifications in respect of power handling, bandwidth and distortion may be brought in fairly easily.

The device chosen for the present circuit is recommended by Siemens for use as a power opamp in control engineering, which indicates that it is a very stable component. None the less, to prevent any mishaps, the amplifier is provided with protection circuits against short-circuits and overheating.

## The circuit

The circuit diagram in Fig. 2 shows the highest-power version of the amplifier: this delivers 160 W into 4 ohms. Modifications to reduce the power output will be discussed later in the article.

The circuit is based on the two series-connected MOSFETs,  $T_1$  and  $T_2$ , being driven in anti-phase by a differential amplifier. Since the input resistance of MOSFETs is of the order of  $10^9$  ohms, the drive power needs to be only very small. The MOSFETs are thus voltage-driven.

The drive circuit consists essentially of  $T_1$ - $T_2$  and  $T_3$ - $T_4$ . Negative d.c. feedback from the output amplifier is provided by  $R_{22}$  and negative a.c. feedback by  $R_{23}$ - $C_1$ . The a.c. voltage gain is about 30 dB. The lower cut-off frequency depends on the values of  $C_1$  and  $C_2$ .

The operating point of the first differential amplifier,  $T_1$ - $T_2$ , is set by the current flowing through  $T_1$ . The collector current of  $T_1$  determines the reference current for current mirror  $T_3$ - $T_4$ . To ensure

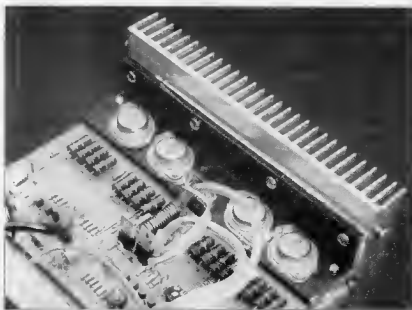

Fig. 1. The completed MOSFET power amplifier.

that the reference current is stable, the base voltage of  $T_3$  is stabilized by diodes  $D_1$ - $D_2$ .

The output of  $T_1$ - $T_2$  drives a second differential amplifier,  $T_3$ - $T_4$ , whose collector currents generate the gate potential for the output transistors. The level of that potential is determined by the operating point of  $T_3$ - $T_4$ . Current mirror  $T_3$ - $T_4$  and diodes  $D_1$ - $D_2$  have the same function as  $T_1$ - $T_2$  and  $D_1$ - $D_2$  in the first differential amplifier. The magnitude of the reference current depends on the collector current of  $T_3$ , which in turn is set by  $P_1$  in the emitter circuit of  $T_3$ . This arrangement sets the quiescent (bias) current in the absence of an input signal.

## Stabilization of quiescent current

The MOSFETs have a positive temperature coefficient when their drain current is small, so that the quiescent (bias) current is only kept stable by appropriate compensation. This is provided by  $R_{17}$

D.C. operating voltage	
( $P_{out} = \max$ )	$\geq \pm 46$ V
( $P_{out} = 0$ )	$\leq \pm 55$ V
Current drawn	
( $P_{out} = \max$ )	3 A
( $P_{out} = 0$ )	$\geq 0.2$ A
(Output short-circuited)	$\leq 1.5$ A
Max. power output	
( $f = 1$ kHz; $R_L = 4$ ohms)	160 W
Music power output	
( $R_L = 4$ ohms)	$\leq 240$ W
Distortion (20 Hz-20 kHz)	$\leq 0.05\%$
Intermodulation	
(250 Hz, 8 kHz; 4:1)	$\leq 0.07\%$
Input resistance	$\leq 33$ k
Voltage amplification	31 dB

Frequency response (-3 dB)	$\geq 2$ Hz- $\leq 250$ kHz
( $R_L = 4$ ohms, $P_{out} = 15$ W)	
Power bandwidth	
(THD = 0.5%, $P_{out} = 80$ W)	$\leq 5$ Hz- $\geq 70$ kHz
Damping factor	
( $R_L = 4$ ohms $f = 40$ Hz)	$\geq 200$
Signal-to-noise ratio (unweighted)	
( $P_{out} = 50$ mW)	$\geq 73$ dB
( $P_{out} = \max$ )	$\geq 108$ dB
Output impedance	4 $\Omega$

Table 1. Technical specification of the MOSFET amplifier.

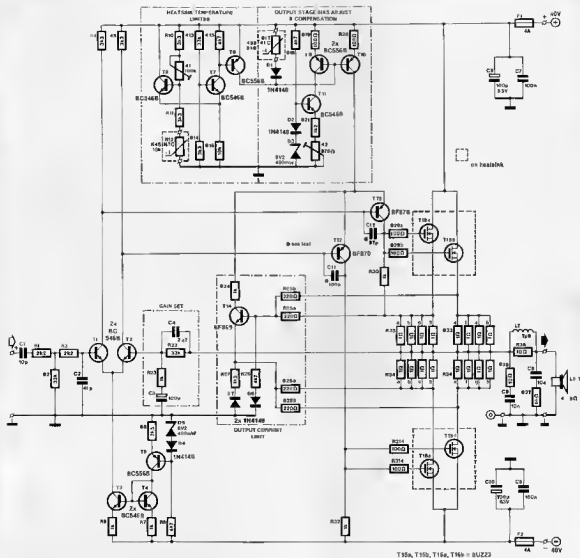

Fig. 2. Circuit diagram of the 160-watt version of the MOSFET power amplifier. Changes for lower-power versions are given in Table 2.

across current mirror  $T_9$ - $T_{10}$ , which has a negative temperature coefficient. When this resistor heats up, it draws a slightly larger portion of the reference current through  $T_9$ . This causes a reduction in the collector current of  $T_{10}$  and this, in turn, causes a decrease in the gate-source voltage of the MOSFETs, which effectively compensates the increase caused by the PTC of the MOSFETs. The thermal time constant, which is dependent on the thermal resistance of the heat sinks, determines the time it takes for stabilization to be effected. The quiescent (bias) current set by  $P_1$  is stable within  $\pm 30\%$ .

### Overheating protection

The MOSFETs are protected against overheating by thermistor  $R_{12}$  in the base circuit of  $T_8$ . When a certain temperature is reached, the potential across the thermistor causes  $T_8$  switch on. When that happens,  $T_8$  draws the larger part of the reference current through  $T_9$ - $T_{10}$ , which effectively limits the output power of the MOSFETs.

The temperature threshold is set by  $P_1$  and is equivalent to a heat sink temperature of  $\leq 72.5^\circ\text{C}$ . This assumes a thermal resistance of  $0.5\text{ K/W}$  and an ambient temperature of  $25^\circ\text{C}$ .

### Short-circuit protection

If the output is short-circuited in the presence of an input signal, the reduction in voltage across resistors  $R_{13}$  and  $R_{14}$  causes  $T_{14}$  to be switched on. This results in a decrease of the current through  $T_9$ - $T_{10}$  and, consequently, of the collector currents of  $T_{12}$  and  $T_{13}$ . The dynamic range of the MOSFETs is then severely restricted, so that the power dissipation is kept low.

Since the permissible drain current is dependent on the drain-source voltage, more information is needed for the correct setting of the current limiting. This

## Parts list

### Resistors:

- R1, R3 = 2k2  
R2, R13, R22 = 33 k  
R4, R5, R10, R11, R14 = 3k3  
R6, R7, R23, R24, R30, R32 = 1 k  
R8 = 7k5  
R9, R15, R18, R20 = 4k7  
R12 = 10 k (NTC)\*  
R16 = 10 k  
R17 = 6k8 (NTC)\*  
R19, R20, R29a, R29b, R31a, R31b = 100R  
R22 = 1k2  
R25a, R25b = 330R  
R27 = 1k8  
R28a, R28b = 220R  
R33a, R33b, R33c, R33d, R33e, R33f, R33g, R33h = 1R; 1 W  
R35, R37 = 10R  
R36 = 10R; 1 W  
P1 = 100 k preset  
P2 = 470R preset

\* Siemens Type K45 or equivalent

### Capacitors:

- C1 = 10 $\mu$ F (MKT)  
C2 = 47pF  
C3 = 100 $\mu$ F; 16 V  
C4 = 2p2  
C5, C6 = 10nF  
C7, C8 = 100nF  
C9, C10 = 100 $\mu$ F; 100 V  
C11 = 100 $\mu$ F; 100 V  
C12 = 47pF; 100 V

### Semiconductors:

- D1, D2, D3, D5, D7 = 1N4148  
D4, D6 = BV2; 0.4 W (zener)  
T1, T2, T3, T4, T6, T7, T11 = BC546B  
T5, T8, T9, T10 = BC556B  
T12, T13 = BF870  
T14 = BF869  
T15a, T15b, T16a, T16b = BUZ23

### Miscellaneous:

- L1 = 15 turns enamelled copper wire 0.2 mm dia, wound on R36  
F1, F2 = miniature fuse, 4 A on PCB holder  
Right-angle aluminium extrusion as shown in Fig. 4.

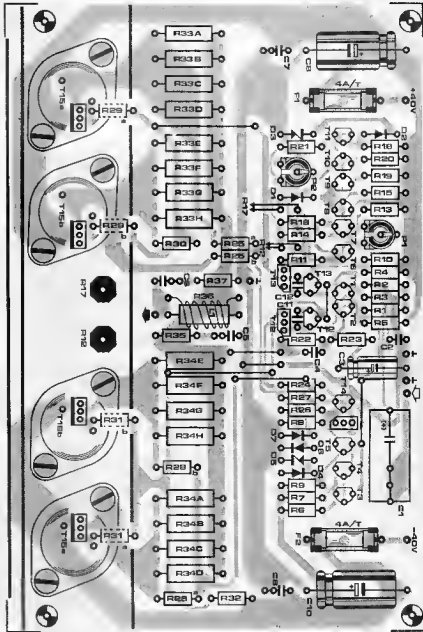

Fig. 3. The printed-circuit board for the MOSFET power amplifier. The associated parts list is intended for the 160-watt version. Changes for lower-power versions are given in Table 2.

information is provided by the voltage drop across resistors  $R_{16}$  and  $R_{17}$  (positive and negative output signals respectively). If the load is  $>4$  ohms, the base-emitter voltage of  $T_{14}$  is reduced to a value that results in the short-circuit current being limited to 3.3 A.

## Construction

The amplifier is best built on the PCB shown in Fig. 3. However, before construction is started, it has to be decided which version is wanted. Fig. 2 and the parts list of Fig. 3 are for the 160-watt version. Changes for the 60 W, 80 W, and 120 W versions are shown in Table 2.

As shown in Fig. 4, the MOSFETs and NTCs are mounted on a right-angled. The pin connections are shown in Fig. 5. The NTCs are screwed directly into M3-size, tapped (tapping drill = 2.5 mm), holes: use plenty of heat conducting paste.

Resistor  $R_{33}$  and  $R_{31}$  are soldered direct to the gates of the MOSFETs at the track side of the board.  
Inductor  $L_1$  is wound on  $R_{36}$ ; its well-insulated, pre-tinned terminals are soldered to the holes adjacent to those for  $R_{36}$ .  
Capacitor  $C_1$  may be an electrolytic type, but an MKT type is preferable. The faces of  $T_1$  and  $T_2$  should be glued

together to ensure that their body temperature remains equal.

Do not forget the wire bridges. The power supply for the 160-watt version is shown in Fig. 6; changes for the other versions are shown in Table 2. An artist's impression of its construction is shown in Fig. 7.

Once the power unit has been built, the open-circuit operating voltages may be measured. The d.c. voltages should be not greater than  $\pm 55$  V, otherwise there is a danger that the MOSFETs will give up the ghost on first power-on. If suitable loads are available, it is, of course, preferable that the supply is tested under load conditions.

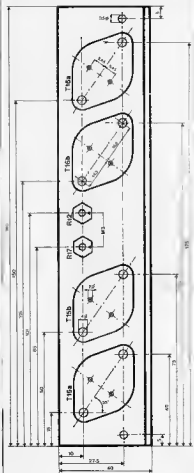

Fig. 4. The right-angle aluminium bracket on to which the MOSFETs and NTCs are mounted. The bracket itself is fitted on to the printed-circuit board.

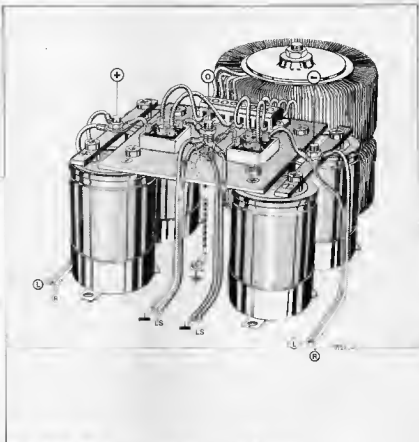

Fig. 5. Artist's impression of the construction of the power unit.

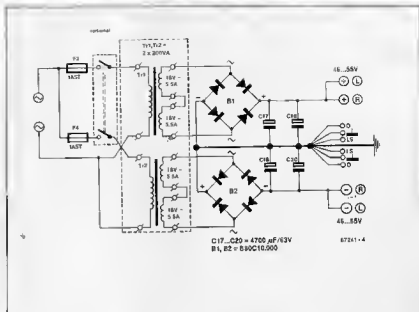

Fig. 6. Circuit diagram of the power unit for the MOSFET amplifier.

Parts list

B1, B2 = bridge rectifier 100 V; 25 A

C17; C18; C19; C20 = 4700–10,000  $\mu$ F; 63 V

F3; F4 = miniature fuse 1.5 A

T1; T2 = mains transformer with 2 x 18 V, 5.5 A (200 VA) secondary

When the power supply is found OK, the aluminium MOSFET assembly is screwed on to a suitable heat sink. Fig. 8 gives an impression of the size of the heat sinks and of the complete assembly of a stereo version of the amplifier. For clarity, only the position of the components of the power supply is shown.

The areas where the heat sink and the aluminium MOSFET assembly (and, possibly, the rear panel of the amplifier enclosure) meet should be given a good coating of heat conducting paste. Each of the two assemblies should be screwed to the associated heat sink with at least six M4 (4 mm) size screws.

The wiring should follow the guide lines in Fig. 8 faithfully. It is best to start with the supply lines (heavy gauge wire). Next, make the earth connections (star-shaped) from the power unit earth to the PCBs and the output earth. Subsequently, make the connections between PCBs and loudspeaker terminals and those between the input sockets and the PCBs. The input earth needs to be connected only to the earth terminal on the PCB - no more!

## Calibration and testing

Instead of fuses  $F_1$  and  $F_2$ , connect 10-ohm, 0.25 W, resistors in their position on the PCB. Preset  $P_2$  must be set fully anticlockwise, while  $P_1$  is set to the centre of its travel. The loudspeaker terminals remain open, and the input must be short-circuited.

Switch on the mains. If there are any short-circuits in the amplifier, the 10-ohm resistors will go up in smoke! If that happens, switch off immediately, find the fault, replace the resistors, and switch on again.

When all appears correct, connect a voltmeter (3 V or 6 V d.c. range) across one of the 10-ohm resistors. There should be no voltage across it. If there is,  $P_2$  is not turned fully anticlockwise. The voltage should rise when  $P_2$  is slowly turned clockwise. Set  $P_2$  for a voltage of 2 V: the current is then 200 mA, i.e.: 100 mA per MOSFET.

Switch off, and replace the 10-ohm resistor by the fuses. Switch on again, and measure the voltage between earth and amplifier output: this should be not greater than  $\pm 20$  mV. The amplifier is then ready for operation.

A final point. As already stated, the switching threshold of the overheating protection circuit must be set for about 72.5 °C. This can be ascertained by heating the heat sink with, e.g., a hair dryer and measuring its temperature. However, this is not strictly necessary:  $P_1$  may be left set at the centre of its travel. Its position should only be adjusted if the amplifier switches off too often. None the less, its position should never be far from the mid position. ■

Power transistors*	2 x BUZ 20	2 x BUZ 23	4 x BUZ 20	Unit	
DC operating voltage ( $P_{out} = \max$ )	$\pm 33$	$\pm 36$	$\pm 40$	V	
	( $P_{out} = 0$ )	$\pm 38$	$\pm 42$	V	
Current drawn ( $P_{out} = \max$ )	0,1	0,1	0,2	A	
	( $P_{out} = 0$ )	1,7	2	2,3	A
	(output short-circuited)	1	1	1,8	A
Power output (max) ( $f = 1$ kHz; $R_L = 4\Omega$ )	60	80	120	W	

## Transistors required

Transistors	80 W	80 W	120 W	
T <sub>1</sub> , T <sub>2</sub>	BC 414 C	BC 414 C	BC 546 B	
T <sub>3</sub> , T <sub>4</sub>	BC 237 B	BC 237 B	BC 546 B	
T <sub>5</sub>	BC 307 B	BC 307 B	BC 558 B	
T <sub>6</sub> , T <sub>7</sub>	BC 237 B	BC 237 B	BC 546 B	
T <sub>8</sub> , T <sub>9</sub> , T <sub>10</sub>	BC 307 B	BC 307 B	BC 307 B	
T <sub>11</sub>	BC 237 B	BC 237 B	BC 546 B	
T <sub>12</sub> , T <sub>13</sub>	BC 558 B	BC 558 B	BF 870	
T <sub>14</sub>	BC 546 B	BC 546 B	BF 869	
T <sub>15a</sub> , T <sub>15b</sub>	BUZ 20	BUZ 23	BUZ 20	
T <sub>15c</sub> , T <sub>15d</sub>	—	—	BUZ 20	

Resistors for short-circuit protection	R25a,b	R28a,b	R26	R27	Unit
60/80 W	330	120	2,7 k*	1 k*	$\Omega$
120/160 W	330	220	4,7 k*	1,8 k*	$\Omega$

\*) The onset of the short-circuit protection is determined by these values and must be adapted for each and every individual amplifier.

Table 2. Changes and variations for lower-power versions of the MOSFET amplifier.

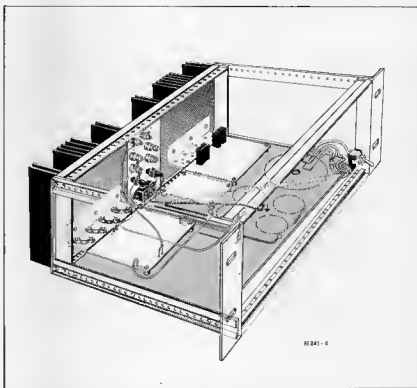

Fig. 7. Artist's impression of the assembly of a stereo version of the MOSFET power amplifier. It also gives an idea of the size of the heat sinks.

# CAR SERVICE MODULE

A compact unit that measures speed of a petrol engine in revolutions per minute, and the dwell angle of the ignition.

by A. Rigby

The car service module is composed of two units: a circuit for measuring dwell angle and engine speed on one printed circuit board, and an associated liquid crystal display (LCD) read-out on another board. The units are connected by a cable terminated in 9-pin D-type connectors. The compact LCD readout is purposely kept separate to enable it to be used in other applications also.

## Electronics and the petrol engine

Engine speed and the ignition dwell angle are both physical quantities which are to be converted to a voltage that can be shown on a display. Figure 1a shows the basic elements of an ignition system in a petrol engine. The primary of the ignition coil is connected between the positive pole of the car battery and the contact breaker, which is shunted by a capacitor and indirectly operated by the camshaft. When the camshaft revolves, the contact breaker opens periodically. A magnetic field is built up in the ignition coil when the contact breaker is closed. When the contact opens very briefly as it is pushed open by the rotation of the camshaft, the magnetic field causes an electrical pulse because of resonance of the tuned circuit formed by the ignition coil and the capacitor. The alternating voltage is boosted to 15,000 to 30,000 volts by the high-impedance secondary winding of the coil. The high voltage is then directed, via the distributor, to one of the 4 spark plugs (it is assumed here that the service module is used for 4-cylinder cars). Obviously, the spark rate depends on the speed at which the engine runs.

The dwell angle is the angular displacement of the contact breaker shaft that determines how long the contact breaker remains closed. A correctly adjusted dwell angle is essential for two reasons: first, for correct timing of the sparks in the cylinders, and, with it, the highest possible engine efficiency; and second, for enabling the ignition coil to build up

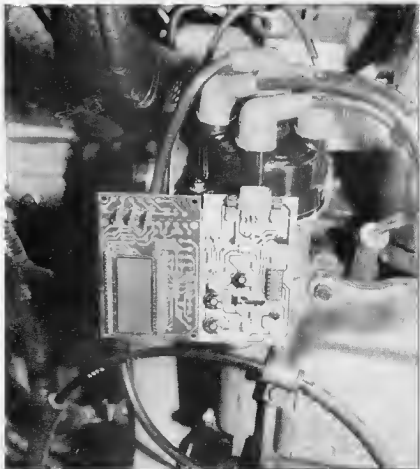

enough energy for the spark-over voltage.

The timing diagrams in Fig. 1b show how electrical pulses are obtained from the contact breaker. The top diagram shows the voltage typically developed across the contact breaker. This voltage is clipped and shaped to obtain digital compatible 5 V pulses that can be processed by the service module. The first negative pulse edge triggers a monostable multivibrator (MMV), which pulls its output low for a fixed period,  $T_{MMV}$ . The output of the MMV thus supplies a rectangular signal of which the 'low' time,  $T_L (=T_{MMV})$ , is constant in each period, while the 'high' time,  $T_H$ , is a function of engine speed: the trigger frequency rises with engine speed, while  $T_H$  becomes shorter. The average voltage,  $U_{av}$ , available at the output of the MMV is approximated with the equation

$$U_{av} \approx U_0 T_H / (T_H + T_L)$$

Since the period of the contact breaker,  $T_0$ , is simply  $T_H + T_L$ , it follows that

$$T_0 = 1/f_0$$

where  $f_0$  is the contact breaker frequency, which is a function of engine speed. From the above, it can be deduced that  $U_{av}$  is a function of engine speed:

$$\begin{aligned} U_{av} &= U_0 (T_0 - T_{MMV}) / T_0 = \\ &= U_0 [1 - (T_{MMV} / T_0)] = \\ &= U_0 (1 - f_0 T_{MMV}) \end{aligned}$$

To understand how the dwell angle,  $\Phi$ , is measured, it must first be defined as

$$\Phi = T(T_c / T_0) (360/n)$$

where  $n$  is the number of cylinders.

A NAND gate is used to combine the shaped, digital signal (second drawing in Fig. 1b) with the MMV signal (third drawing). The result is the signal drawn in the last diagram in Fig. 1b. The combining is necessary to get rid of the noise at the start of each period of the input signal. The average value of the voltage

at the output of the NAND gate is written as

$$U_{av} = U_b [1 - (T_1 / T_0)]$$

Since, in a four-cylinder, four-stroke, engine,

$$\Phi = 90T(T_1 / T_0)$$

it is evident that  $U_{av}$  is directly proportional to  $\Phi$ , so that it can be used to measure the dwell angle.

## Circuit description

Figure 2 shows that the circuit of the meter section of the service module is fairly simple, and essentially based on only one integrated circuit, the CMOS Type 4011. The 5 V regulator, IC<sub>2</sub>, is fed from the 9 V battery in the display circuit described below. A zener diode, D<sub>1</sub>, and a series resistor, R<sub>1</sub>, reduce the amplitude of the contact breaker signal to a value suitable for applying to a CMOS NAND gate, N<sub>1</sub>. Capacitor C<sub>1</sub> in the input network shunts any high-frequency components to ground.

Gate N<sub>1</sub> functions as a pulse shaper as already discussed with reference to Fig. 1b. Parts R<sub>2</sub> and C<sub>2</sub> form a differential network that supplies a very brief, active low, needle pulse with every negative pulse transition from N<sub>1</sub>. The monostable multivibrator set up around N<sub>2</sub> and N<sub>3</sub> is triggered on the first of these needle pulses as shown in the timing diagrams in Fig. 3. In the non-triggered state, the MMV output (N<sub>3</sub> pin 10) as well as the input (N<sub>2</sub> pin 5)

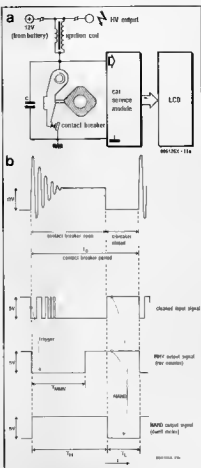

Fig. 1. Basic ignition system in a petrol engine (a) and timing diagrams of the car service module (b).

are logic high. Since the output is connected to pin 6 of N<sub>2</sub>, pin 4 of this gate is logic low. This condition is stable with no voltage across C<sub>2</sub>. Following a negative-going needle pulse at the input of the MMV, the output of N<sub>2</sub> toggles from low to high. The resulting charge current through C<sub>2</sub>, shown in Fig. 3c, causes a quickly rising and a slowly, logarithmically decreasing, voltage drop across R<sub>3</sub> and P<sub>1</sub>. Consequently, N<sub>3</sub> toggles: its output, and with it the second input (pin 6) of N<sub>2</sub>, goes low, so that a stable situation is obtained for as long as the voltage across R<sub>3</sub> and P<sub>1</sub> does not exceed the toggle threshold of N<sub>3</sub>.

When, at a voltage level of about  $\frac{1}{2}U_b$ , the input voltage of N<sub>3</sub> falls below the toggle threshold, the gate supplies a high level again. The monotime T<sub>MMV</sub> is over, and both inputs of N<sub>2</sub> are logic high again. In other words, the stable standby state is restored until the next trigger pulse occurs.

VMOSFET T<sub>1</sub> blocks during the monotime. As soon as this ceases, however, the transistor conducts and effectively shunts P<sub>1</sub> and R<sub>3</sub> with a relatively low resistance, R<sub>4</sub>. This causes C<sub>2</sub> to be discharged much faster, so that the monotime of the MMV remains constant even with relatively high trigger frequencies (= engine speeds). A VMOSFET Type BS170 is used here because its high input impedance ensures that N<sub>3</sub> is not overloaded. Moreover, the transistor has a very low drain-source saturation voltage, so that it does not affect the operation of in-

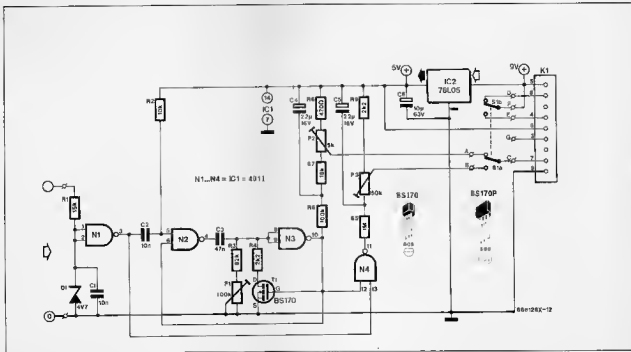

Fig. 2. Circuit diagram of the rev counter/dwell meter circuit in the car service module.



regulator  $R_5-C_4$ . This network serves to convert the rectangular signal at the output of  $N_3$  into a direct voltage that is directly proportional to the average voltage of the rectangular signal, and, therefore, to the engine speed. The capacitor,  $C_4$ , is connected to the positive supply line because  $U_{av}$  is obtained from the active-low output of the MMV, so that it is actually an *inverse* function of engine speed (refer back to Fig. 1b). With  $C_4$  connected to the positive supply rail, this inversion is inverted again, since the voltage on the capacitor increases when  $U_{av}$  decreases.

Dwell angle measurement uses integrating network  $R_5-C_5$  at the output of  $N_4$ . As shown in Fig. 1b, this NAND gate combines the cleaned input signal with the MMV signal, so that the voltage on  $C_5$  is directly proportional to the dwell angle.

Finally, potential dividers  $R_6-P_2-R_7$  (rev counter) and  $R_8-P_3$  (dwell meter) provide the drive voltages for the LCD readout. The presets are used for calibrating the two functions of the module. Toggle switch  $S_{1a}$  selects between the revolution counter and the dwell angle meter functions, while  $S_{1b}$  selects the correct position of the decimal point on the display (DP2 for the rev counter, and DP1 for the dwell meter).

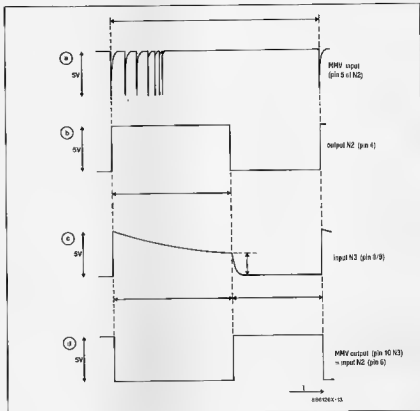

Fig. 3. Basic operation of the monostable set up around  $N_2$  and  $N_3$ .

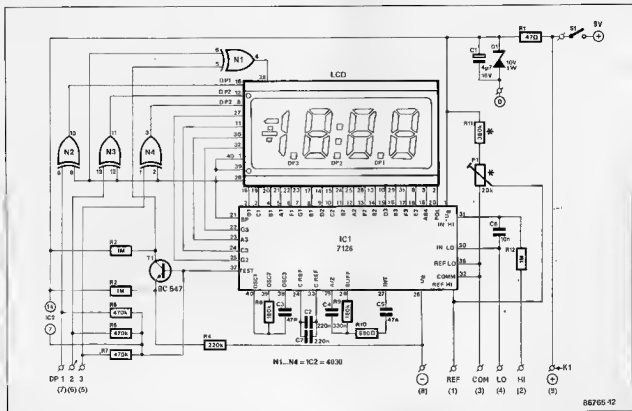

Fig. 4. Circuit diagram of the LCD readout.

## A universal LC display module

The circuit diagram of Fig. 4 shows that the 3½-digit liquid-crystal display with the car service module is a standard application of the ICL7126 from Intersil (the ICL7126 is a CMOS version of the familiar ICL7106 which may also be used here). Transistor T<sub>1</sub> is added to actuate the LO BAT indicator on the display when the 9 V battery is exhausted ( $U_b < 7.2$  V). The auto-zero function of the ICL7126 obviates any null adjustments. The display unit is calibrated by interconnecting its LO and COM inputs, applying a variable voltage between 0 and 200 mV to LO (-) and HI (+), and adjusting preset P<sub>1</sub> until the read-out is in accordance with the actual value of the applied voltage, which is measured simultaneously with a digital voltmeter.

### Construction and alignment

Building the two circuits that together form the car service module on the PCBs shown in Figs. 5 (meter section) and 6 (LC display) is straightforward. Angled 9-pin D-connectors for PCB mounting are used for interconnecting the circuits by means of a length of 9-

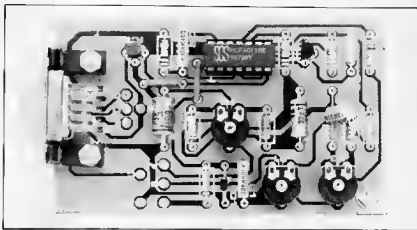

Completed meter circuit on PCB 886126.

way cable. The size of the PCBs is such that the units can be housed in identical, transparent, enclosures, from which the 9-pin connectors protrude. The input to the meter circuit is made by 2 wander sockets, a red and a black one, which accept plugs fitted on heavy-duty, heat-resistant test wires with insulated croc clips at the other end for connecting to the contact breaker on the car engine. For the following description of the alignment of the service meter, it is as-

sumed that the digital read-out has been calibrated as detailed above.

First, build the 50 Hz source shown in Fig. 7. The alternating voltage it supplies simulates the contact breaker pulses, and is applied to the input of the car service module. Since, in a four-cylinder, four-stroke, engine, ignition in a cylinder takes place every fourth revolution of the crankshaft, 50 contact breaker pulses per second simulate  $50 \times 60 = 3000$  sparks per minute, or 750

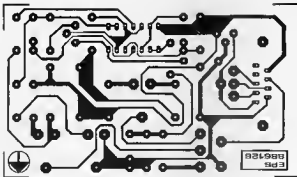
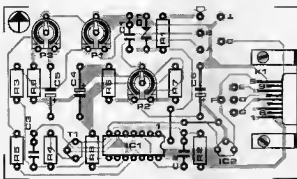

#### Parts list

##### METER BOARD. CIRCUIT DIAGRAM: FIG. 2.

#### Resistors (±5%):

R<sub>1</sub> = 15K  
 R<sub>2</sub> = 10K  
 R<sub>3</sub> = 82K  
 R<sub>4</sub>/R<sub>9</sub> = 2K2  
 R<sub>5</sub> = 1MΩ  
 R<sub>6</sub> = 470R  
 R<sub>7</sub> = 18K  
 R<sub>8</sub> = 100K  
 P<sub>1</sub> = 100K preset H  
 P<sub>2</sub> = 5KΩ preset H  
 P<sub>3</sub> = 50K preset H

#### Capacitors:

C<sub>1</sub>/C<sub>2</sub> = 10n  
 C<sub>3</sub> = 47n  
 C<sub>4</sub>/C<sub>5</sub> = 22μ, 16 V; axial  
 C<sub>6</sub> = 10μ, 16 V; axial

#### Semiconductors:

D<sub>1</sub> = zener diode 4V7; 400 mW  
 T<sub>1</sub> = BS170  
 IC<sub>1</sub> = 4011  
 IC<sub>2</sub> = 78L05

#### Miscellaneous:

K<sub>1</sub> = 9-way mini-D connector for PCB mounting  
 S<sub>1</sub> = miniature double-pole toggle switch (DPDT)  
 PCB Type 886126

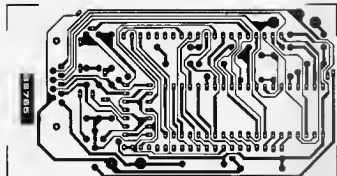
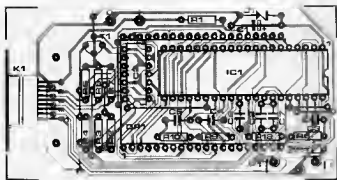

Fig. 6. Printed-circuit board for the LC display unit.

per minute per cylinder. Since one spark is generated per two revolutions, the simulated engine speed is 1500 rpm. With a 60 Hz mains, this becomes 1800 rpm.

In most cases, the maximum engine speed will be about 6000 rpm, corresponding to a contact breaker frequency of 200 Hz. This means that the monotime of MMV in the circuit should be set to about  $0.8(1/200) = 4$  ms. Connect a high-impedance DVM across  $C_4$ ,

and adjust  $P_1$  for a reading of 0.19 V. This sets the monotime with sufficient accuracy.

Make sure that the function switch,  $S_1$ , is set to rev counter, and adjust  $P_2$  until the LCD readout indicates 1.5, which corresponds to 1500 rpm (60 Hz: 1800 rpm). Now switch on the dwell meter function and adjust  $P_3$  for an LCD reading of  $45.0^\circ$ . In practical use of the instrument, it should be borne in mind that integrator R8-C4 is purposely

Parts list

LC DISPLAY UNIT. CIRCUIT DIAGRAM. FIG. 4

Resistors ( $\pm 5\%$ ):

- $R_1 = 47R$
- $R_2, R_3, R_{12} = 1M\Omega$
- $R_4 = 220K$
- $R_5, R_6, R_7 = 470K$
- $R_8, R_9 = 180K$
- $R_{10} = 680R$
- $R_{11} = 390K$

Capacitors:

- $C_1 = 4\mu F, 16 V$
- $C_2, C_7 = 220n$
- $C_3 = 47p$
- $C_4 = 330n$
- $C_5 = 47n$
- $C_6 = 10n$

Semiconductors:

- $D_1 =$  zener diode 10 V; 1 W
- $IC_1 = ICL7126$  (Intersil)
- $IC_2 = 4030$
- $T_1 = BC547B$

Miscellaneous:

- LCU = general-purpose 3½ digit LC display with LO BAT indication.
- $K_1 =$  9-way female D connector for PCB mounting.
- $S_1 =$  miniature on/off slide switch.
- PCB Type 86765

dimensioned to give a stable readout, at the cost of a fairly slow meter response to engine speed variations. Also, since the input signal is combined with the MMV signal, dwell angle measurements can only be made at engine speeds lower than 3000 rpm.

The meter is also suitable for six-cylinder engines. Since these generally run at a lower speed than 4-cylinder types, no changes are, in principle, required to the previously detailed adjustment of  $P_1$ . The signal supplied by the test circuit of Fig. 7 then simply corresponds to 1000 rpm (60 Hz: 1200 rpm) and a dwell angle of  $30^\circ$ .



This compact, ICL7126-based LC display unit can be used in many applications.

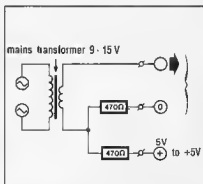

Fig. 7. A simple signal source for adjusting the car service module.

# MORE APPLICATIONS FOR THE 555

There are probably few integrated circuits that have been with us for as long as timer type 555. This article does not add to the seemingly endless list of AMV and MMV applications of this chip, but discusses some less familiar designs derived from these. In addition, a brief introduction is given to the new CMOS and LinCMOS versions of the 555.

by T. Wigmore

One explanation of the popularity of the now 17-year-old timer type 555 may be that the chip is inexpensive, and contains a fairly unique combination of sub-circuits. Looking at the internal structure shown in Fig. 1, these are a bistable (a digital circuit), two comparators (analogue circuits) and some discrete parts, a resistive potential divider and a transistor. Added to the versatility of these interesting building blocks come the abilities of the chip to supply a relatively high output current, and to work from a wide range of supply voltages. Pin assignments of the 555 and the dual version of it, the 556, are given in Fig 2. Every electronic engineer or student is bound, at some time, to deal with the 555 in its standard configuration as a monostable or astable multivibrator. These applications are so numerous by now that it is often forgotten, or not even known, that the 555 can be used in a number of other, less well known, configurations. To understand how these work, however, it is useful to first look at the basic operation of the chip.

## Some fundamentals

Judging from the internal diagram of the 555 (Fig. 3), the relatively high number of components is typical of chip technology of the early 1970s. Fortunately, the internal diagram is still fairly simple to analyse. A trigger comparator (block

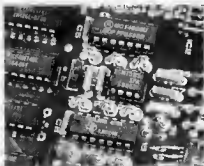

A) and a threshold comparator, block B, are clearly recognized as difference amplifiers. The bistable, block C, is, perhaps, less conspicuous. In rest, transistors  $Q_{15}$  and  $Q_{17}$  are off, while  $Q_{16}$  and  $Q_{20}$  conduct. When the trigger voltage drops below one-third of the supply voltage,  $Q_{16}$ ,  $Q_{14}$  and, therefore,  $Q_{15}$ , also start to conduct. Transistor  $Q_{15}$  removes the base drive of  $Q_{16}$  and so causes this to block. By virtue of  $R_{10}$  and diode  $Q_{18}$ ,  $Q_{17}$  starts to conduct. As the trigger voltage rises again,  $Q_{15}$  is allowed to turn off again without causing instability of the new state —  $Q_{16}$  is

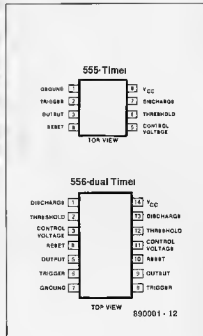

Fig. 2. Pinning of the 555 and the 556

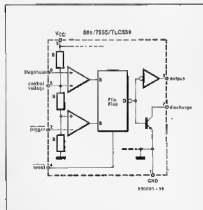

Fig. 1. Basic internal structure of the 555.

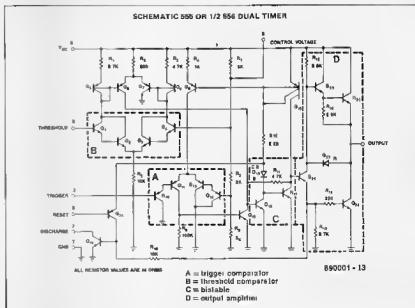

Fig. 3. Detailed internal circuit diagram of the 555.

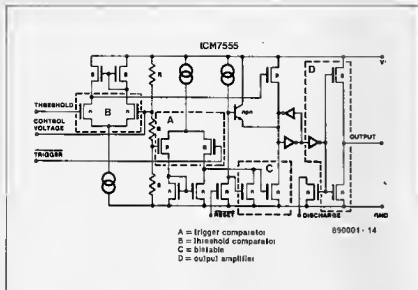

Fig. 4. Internal structure of a CMOS version of the 555, the ICM7555 from Intersil.

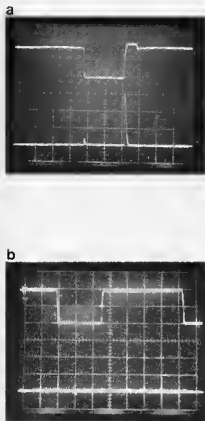

Fig. 5. A standard 555 briefly draws a high current when its output changes from low to high. This is so because  $Q_{24}$  is briefly driven into saturation, and takes a while to actually turn off. As soon as  $Q_{23}$  and  $Q_{22}$  conduct, a short, non-current limited, short-circuit of the supply arises. It is for this reason that the 555 requires particular attention to be paid to decoupling of the supply voltage (see Fig. 5a). Output switching from high to low causes fewer problems because  $Q_{21}$  and  $Q_{22}$  are not driven into saturation; hence, the switch-off time is short relative to that of  $Q_{24}$ . CMOS versions of the 555 generally do suffer from this annoying effect.

then inhibited from conducting via  $R_{11}$ . The normal procedure is that the threshold voltage exceeds two-thirds of the supply voltage. This results in  $Q_1$  and  $Q_2$  starting to conduct. The increase in their collector currents is amplified by  $Q_4$  and  $Q_6$ , so that  $Q_{16}$  starts to conduct again. This transistor, in turn, causes  $Q_{17}$  to block, but only if  $Q_{15}$  is actually off. If this is not so — in other words, if the threshold input and the trigger input are both actuated — the bistable remains reset. Because the collector current of  $Q_6$  is limited by  $R_2$ ,  $Q_{15}$  pulls the base of  $Q_{16}$  harder to ground than  $Q_6$  can pull it to the positive supply rail.

An all-overriding method to reset the bistable is to drive its reset input low. This results in  $Q_{25}$  conducting, so that the base drive of  $Q_{17}$  is removed. Since diode  $Q_{18}$  creates additional voltage drop during resetting, the base voltage of  $Q_{17}$  is sufficiently low to actually turn this transistor off. When the bistable is in the reset state, output transistors  $Q_{20}$  and  $Q_{23}$  and, via  $R_{16}$ , discharge transistor  $Q_{14}$ , conduct.

The 555 briefly draws a fairly high current when its output changes from low to high. This is so because  $Q_{24}$  is briefly driven into saturation, and takes a while to actually turn off. As soon as  $Q_{23}$  and  $Q_{22}$  conduct, a short, non-current limited, short-circuit of the supply arises. It is for this reason that the 555 requires particular attention to be paid to decoupling of the supply voltage (see Fig. 5a). Output switching from high to low causes fewer problems because  $Q_{21}$  and  $Q_{22}$  are not driven into saturation; hence, the switch-off time is short relative to that of  $Q_{24}$ . CMOS versions of the 555 generally do suffer from this annoying effect.

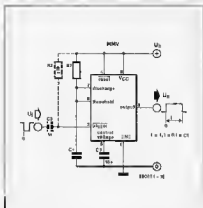

Fig. 6. Standard application of the 555 in MMV configuration.

## Applications

In 9 out of 10 applications of the 555, the chip is used as a monostable or astable multivibrator (AMV or MMV respectively). In MMV configuration, the pulse time is determined by the time needed to charge the timing capacitor from 0 V to  $\frac{2}{3}U_b$ , the threshold voltage. In general, the charge voltage,  $U_c$ , on a capacitor, C, charging through a resistor R, from a supply voltage,  $U_b$ , is equal to  $\frac{2}{3}U_b$  when

$$U_c(t) = U_b(1 - e^{-t/RC})$$

from which,

$$\tau = (-\log_e \frac{2}{3})RC = 1.1RC$$

The charge voltage also determines the monotime, provided the trigger pulse is shorter than the monotime. A longer trigger pulse also results in a longer output pulse, but this may be prevented by driving the trigger input with an AC-coupled signal only (add  $R_2/C_3$ , with  $(R_2C_3) < (R_1C_1)$ ).

The MMV circuit is turned into an AMV simply by making it self-triggering. Capacitor  $C_1$ , via  $R_1$  and  $R_2$ , is charged to  $\frac{2}{3}U_b$  in time interval  $t_1$ :

$$t_1 = (-\log_e \frac{2}{3})(R_1 + R_2)C_1 - (-\log_e \frac{1}{3})(R_1 + R_2)C_1 = 0.694(R_1 + R_2)C_1$$

and is then discharged again, this time only via  $R_2$ . The discharge time,  $t_2$ , equals

$$t_2 = 0.694R_2C_1$$

This means that the voltage on the capacitor toggles between  $\frac{1}{3}U_b$  and  $\frac{2}{3}U_b$ . The total period, T, is calculated as

$$T = t_1 + t_2 = 0.694(R_1 + 2R_2)C_1$$

and the frequency,  $f_0$ , as

$$f_0 = 1/T = 1.44/(R_1 + 2R_2)C_1$$

It should be remembered, however, that  $C_1$  has to be charged from 0 V when power is first applied, or when the reset input is made high. The first part of the first output period, therefore, has a period of  $1.1R_1C_1$ .

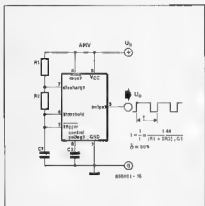

Fig. 7. Standard application of the 555 in AMV configuration.

One of the nice features of the 555 as an MMV or AMV is that the pulse time is, in principle, independent of the supply voltage,  $U_b$ . When this drops, the trigger and threshold voltages, as well as the charge- and discharge currents, drop accordingly, resulting in no change overall. A disadvantage of the AMV circuit shown in Fig. 7 is its inability to supply an output signal of duty factor greater than 0.5: this is because the charge resistance,  $R_1+R_2$ , is always greater than the discharge resistance,  $R_2$  by itself. The basic circuit in Fig. 8 shows how this can be resolved with the aid of a diode,  $D_1$ . During charging, it bypasses  $R_2$ , so that the charge current can become smaller than the discharge current. Another diode,  $D_2$ , is optional if  $R_2$  alone is to determine the charge current. It should be noted that the above use of diodes sacrifices, at least partly, the 555's independence of the supply voltage level — when the supply voltage is changed,

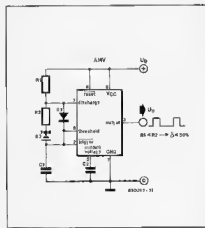

Fig. 8. Non-standard AMV configuration that allows duty factors lower than 0.5 to be achieved.

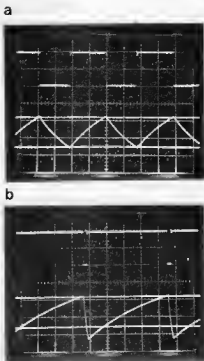

Fig. 9. Frequency deviation of a 555 in AMV configuration is a function of a number of parameters, including the duty factor. The effect shown by these oscillograms is mainly on account of the recovery time of the trigger comparator and discharge transistor. Upper trace: output signal; lower trace: voltage on timing capacitor. The horizontal traces show the trigger and comparator threshold levels.

the fixed drop across the diode results in a non-proportional change of the charge and discharge current of  $C_1$ . The control voltage input, pin 5, of the bipolar 555, is normally decoupled to ground with a 10 nF capacitor for noise protection. According to the manufacturers, this capacitor is no longer required with the new CMOS versions of the 555.

### Timing errors

It is not so simple to express the inaccuracy of a timing interval produced by a 555 as a single error-percentage. A large number of factors should be taken into account here, but many can be forestalled by correct dimensioning and/or selection of the most appropriate type of 555 for a particular application. Tolerance on the internally generated reference voltages, in combination with input-offset voltages of the trigger- and threshold comparators, introduces timing errors of the order of 2%. Internal reaction and recovery times also form a factor to be taken into account. The oscilloscope photographs in Fig. 9 illustrate the behaviour of a 555-based AMV at a relatively high output frequency. Figure 9a shows the AMV set to

a duty factor of about 0.6. The frequency, 29 kHz, already deviates considerably from the calculated 25 kHz. Fig. 9b shows the output signal of the same circuit, this time dimensioned for a much greater duty factor. Since the total resistance  $R_1+2R_2$  is equal in both cases, it might be expected that the output frequency remains unchanged. It is seen, however, that  $C_1$  is actually discharged to below the trigger level (which, like the threshold level, is marked by a horizontal trace). This effect is caused partly by the relatively quickly falling voltage on  $C_1$ , and partly by the slowness of the trigger comparator in combination with the recovery time of the discharge transistor. Because of the excess discharge of  $C_1$ , the output frequency of the 555 will be significantly lower than calculated: 20 kHz in this case.

The essence of all this is that the accuracy of relatively high output frequencies depends largely on the duty factor.

When the 555 is configured as an MMV, due account should be taken of the saturation voltage of the internal discharge transistor. The level of this saturation voltage is inversely related to the value of the charge resistor, and, at relatively short monomites, causes the output pulse to be shorter than calculated.

At very low output frequencies, factors such as the leakage current of the timing capacitor, that of the discharge transistor, and the input current of the threshold comparator, become increasingly significant.

In general, the lower the frequency, the higher the values of the charge and discharge resistors. As the charge current decreases, the importance of various leakage currents increases. Also remember that the use of an electrolytic capacitor with high leakage and tolerance in position  $C_1$  will cause a much higher timing error.

### Using the control input

The control voltage input, pin 5, affords a number of interesting, yet little used,

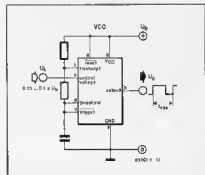

Fig. 10. By using the control voltage input, a 555-based AMV can be turned into a VCO.

applications, whose background is discussed below.

The internal diagram shows that pin 5 is connected to the internal voltage divider. When not externally loaded, this carries a voltage of  $\frac{1}{3}U_b$ . According to the manufacturers, this voltage may be varied between 45% and 90% of the supply voltage. When the control voltage is made too high, however, the threshold comparator will cease to work correctly, while a too low voltage at the control input upsets the bias point of the trigger comparator (refer to the internal diagram in Fig. 3).

The most evident application of the control voltage input is, of course, the 555 as a voltage-controlled oscillator (VCO), as shown in Fig. 10. The 555 itself is configured as an AMV whose output frequency can be varied over about  $\pm 50\%$ . In practice, especially when the supply voltage is relatively high, a value considerably lower than  $0.45U_b$ , but with a minimum of about 1.5 V, is permissible for the control voltage. The frequency so achieved becomes up to 2fa.

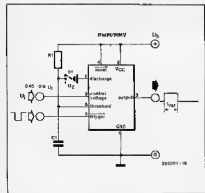

Fig. 11. Voltage-controlled monostable multivibrator.

The basic circuit of Fig. 11 shows that the control voltage input may also be used for making an MMV with adjustable monotime. When, however, the standard monostable configuration is chosen, the output pulse can never become too short. Assuming an input voltage,  $U_1$ , at pin 5 of  $0.45U_b$ , the voltage on  $C_1$  will be kept at virtually 0 V by the internal discharge transistor. When a relatively large control range of the output pulse is desired, the lowest voltage on  $C_1$  may be raised with the aid of a zener diode, or a number of series-connected, forward-biased, diodes, in the collector line of the discharge transistor. To obtain a well-defined minimum voltage on  $C_1$ , the quiescent current through  $R_1$ ,  $I_{R1}$ , must be just high enough to achieve the correct zener voltage,  $U_z$ . This current is calculated from

$$I_{R1} = (U_b - U_z) / R_1$$

In practice, a few mA will suffice to

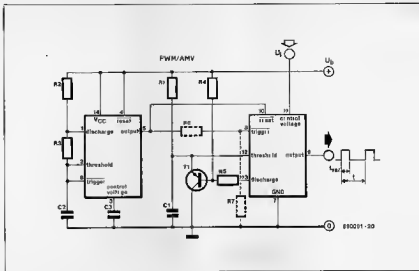

Fig. 12. Two 555's, or, in this case, a single 556, make an excellent fixed-frequency pulse-width modulator for low-loss power control systems.

achieve the zener effect.

The circuit of Fig. 11 does not provide a linear relationship between control input voltage and output pulse-width. Such linearity can be achieved, however, by replacing  $R_1$  with a current source. A practical example and a detailed explanation of this interesting configuration is given in Ref. 1.

It is fairly simple to change the basic voltage-controlled monostable into a pulse-width modulated oscillator — see Fig. 12. All that is required is another AMV-based oscillator, set up around the other 555 contained in the 556 chip. The resulting circuit is an excellent, low-loss, pulse-width modulator for use with a power-transistor driver stage.

There are a few more interesting details in the circuit shown in Fig. 12. The first has to do with  $C_1$ , which is not discharged to 0 V, but to a level set with p.d.  $R_1$ - $R_2$ , plus the base-emitter drop of  $T_1$ . Similar to the previously discussed 'zener-trick', this arrangement considerably magnifies the span of the output pulse-width.

The second interesting point of the circuit entails the simultaneous resetting and triggering of MMVs: to ensure an accurately defined voltage on  $C_1$  at the start of each period. In the absence of the trigger signal, a curious phenomenon would take place when the duty factor is, theoretically, as close as possible to 1. During the first period, the threshold voltage is not reached, so that  $C_1$  is not discharged. Immediately after the start of the second period, however, the threshold level is reached, so that the output goes low. The result of this sequence would be the halving of the output signal frequency, and a reduction of the duty factor from almost 1 to about 0.5.

As already said, this effect is prevented by resetting the MMV at the start of

each period. Referring back to the internal diagram, the bistable is actually set and reset at the same time. Reliable triggering is, however, still ensured by virtue of the internal reset circuit switching off faster than the trigger circuit ( $Q_2$  has been driven into saturation, and has a longer recovery time). Incidentally, the recovery time of the trigger circuit can be shortened by using a potential divider that provides a trigger level just lower than  $\frac{1}{3}U_b$ .

In the concept discussed here, the duty factor can never become 1, because the output is invariably low for the duration of the reset signal of the MMV. This is why  $R_3$  is generally made small relative to  $R_2$ .

The control voltage input of a standard 555 forms a fairly low resistance ( $5 \text{ k}\Omega // 10 \text{ k}\Omega = 3.3 \text{ k}\Omega$  typ.). CMOS versions of the 555 have a much higher input resistance thanks to an internal voltage divider composed of three  $100 \text{ k}\Omega$  resistors. In general, tolerance on these input resistance values is relatively high, so that a voltage source driving the control input should be designed to have a low output impedance...

## Long-interval timers

As already hinted at in the section on timing errors, configuring the 555 as a long-interval timer may pose problems because of the inevitable role of leakage currents in the timing components, i.e., the high-value resistor(s) and the capacitor. A further aggravating effect is that the leakage current of an electrolytic capacitor is age- and temperature-dependent. In practice, the maximum interval that can be achieved with a 555 in standard configuration is 10 to 30 minutes long, taking a fairly high tolerance for granted.

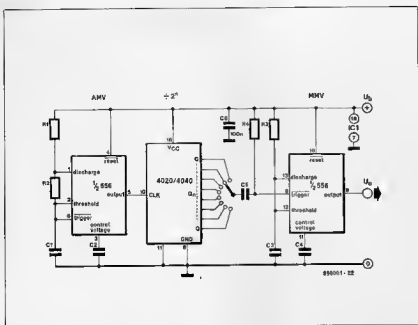

Fig. 13. Long-interval timers are best realized with the aid of a ripple-cascade divider.

One solution to obtain better-defined and longer intervals would be the cascading of 555s, so that each is triggered by the previous one. This is not a very neat solution to the problem, however, since all timing errors of individual timers in the cascade simply add up (accumulation effect). Moreover, the duration of the interval rises only linearly with the number of 555 stages. The increase can be made exponential by following one 555 in AMV mode with a divider as shown in Fig. 13. Depending on the application, the  $n$ -th output of the divider can trigger a further 555, this time in MMV mode. In this set-up, the 555 in AMV mode is conveniently dimensioned for optimum accuracy (average values for  $R_2$  and  $R_3$ , and a low-leakage capacitor for  $C_1$ ), while cascaded dividers afford timer intervals of hours, days or even weeks.

### CMOS versions: 7555 and TLC555

Intersil was the first to introduce the 7555, a CMOS version of the 555. A little later, Texas Instruments, in line with its consistent and successful policy of producing LinCMOS (linear CMOS) versions of 'bipolar bestsellers', came up with the TLC555. As with a number of well-established opamps and comparators, the TLC555 and TLC556 from TI were an instant success.

In general, current consumption of the CMOS versions has been drastically reduced with respect to the bipolar 555 — from 10 mA to 100  $\mu$ A, while the minimum supply voltage has been lowered to 2 V. Obviously, these features are of great importance for the design of

battery-powered circuits. The CMOS versions do not suffer the large peak current at output switch-over, while the input bias current of the threshold comparator, and the leakage current of the discharge transistor, are also significantly reduced. These features of the new devices are advantageous because they allow a higher charge resistance for the capacitor, bringing longer timing intervals within reach.

Thanks to the virtual absence of saturation effects commonly associated with bipolar transistors, speed of the new CMOS 555's has also increased. In a laboratory test, a standard 555 gave up

at about 180 kHz, whereas a 7555 scored 1.1 MHz, and a TLC555 even 2.4 MHz (test conditions: AMV configuration with  $R_1=R_2=220 \Omega$  and  $C_1=100 \text{ pF}$ ). As far as output current is concerned, however, the bipolar 555, with its sink and source capability of 200 mA, is still superior to the CMOS versions. The 7555 supplies a maximum of 5 to 50 mA, depending on the supply voltage (10 mA at 10 V). The TLC555 has a symmetrical output with a source and sink capability of 10 mA and 100 mA respectively. Ergo, where the replacement of a standard 555 with a CMOS type is considered, the current requirement of the load should be taken into account (a standard 555s is often used to power a relay direct).



Table 1

	555			7555			TLC555			unit
	min.	typ.	max.	min.	typ.	max.	min.	typ.	max.	
V <sub>CC</sub> /V <sub>EE</sub>	4.5		18	2		18	2		18	V
Supply current										mA
2V										0.28
5V		3	5	0.08		0.4		0.17	0.35	mA
10V		10	12	0.12		0.6		0.35	0.60	mA
Output Current										mA
load		200		8		80		100		mA
source		200		1		20		10		mA
Threshold current		100	250			10		0.01		nA
Discharge state-off current		20	100			10		0.1		nA
MMV timing error		1	3		2			1	3	%
Temp. drift			500		250					ppm/°C
V <sub>CC</sub> drift			0.5		0.3	1		0.1	0.5	%/V
Output										
rise-time		100	300		75			20		ns
fall time		100	300		75			75		ns
f <sub>max</sub>			0.5		1			2		MHz

data valid at T<sub>a</sub> = 25 °C



# COMPUTERS: AN OVERVIEW

by K.A. Roberts, BA

## Early machines

It takes a far cry from the first automatic computer, the Automatic Sequence Controlled Calculator—ASCC. Yet, it is not quite half a century ago that this machine, the result of a collaboration between Dr Aiken of Harvard University and IBM, was presented to Harvard University in 1944.

Dr Aiken based much of his design on the Analytical Engine conceived in 1832 by Charles Babbage. Like Babbage's brainchild, the ASCC used sets of wheels as registers to store numbers. The machine was composed of no fewer than nearly 800,000 parts and almost 900 km of wire.

## The first electronic computer

The first digital electronic computer came close on the heels of the ASCC: it was in full operation in 1946. Named ENIAC, acronym for Electronic Numerical Integrator and Calculator, it was designed by Dr J. Eckert and Dr J. Mauchly of the University of Pennsylvania.

Where the ASCC was a mechanical monster, the ENIAC was an electrical one: it contained some 18,000 electronic valves and consumed around 150 kW of electric power.

Not long after the ENIAC had been taken into operation at the University of Pennsylvania, a course of lectures was delivered at the same university that formed the mould for today's electronic computer. The lectures, *The Theory and Techniques of Electronic Digital Computers*, contained the principles for the design of electronic computers that had been worked out by a group of mathematicians and electrical engineers headed by a, now famous, Hungarian professor of mathematics working at Princeton, Johann von Neumann.

From then on, computer technology advanced at an accelerating pace. So much so that as early as 1956 Sir George Thomson, the eminent physicist, declared that

'the electronic computer has not made the headlines in the same way as nuclear energy, but I believe it is comparable in importance. The ability to apply precise reasoning to very large amounts of data in a reasonable time

is something new, and the introduction of computers into science may prove not much less important than the introduction of mathematics in the seventeenth century'.

## The mainframe era

During the 1950s and 1960s, the electronic computer evolved into a useful, but expensive tool. Scientific research, defence organizations, large accounts departments, and educational establishments had all begun to use some kind of computer.

The advent of time-sharing systems saw an even greater degree of computer penetration. The obvious advantages of allowing many users within a single company or organization to make simultaneous use of a central computer were quickly spotted by commercial entrepreneurs who set up commercial time-sharing services. Time sharing was for many the only way of making use of computer power: computers were still very expensive. Their cost lay not only in the initial outlay, but also in terms of operational staff, space and power requirements.

## The minicomputer

Because of the high cost of computers, manufacturers realized the need for a smaller, relatively less complex (and thus less expensive) machines. The first manufacturer to bring one of these machines on the market was Digital (in 1963). In comparison with the mainframes then current, it was a limited machine: it ran only one program at a time, processed data in 12 bit-words and had only 4 k of memory. None the less, its advantages were obvious: it was not much larger than a domestic freezer, did not require an army of trained support staff, and its cost was only about 5—10% of the mainframe computers of the day when it was announced. Since it sold extremely well, penetrating not only new, but also existing, markets, its price rapidly came down, so that even more customers were attracted. By the early 1970s, no fewer than 70 US firms were manufacturing the so-called minicomputer.

## Personal computers

Whereas the minicomputer came about for sound economic reasons, the microcomputer, perhaps better known as the personal computer, was, like radio in its early days, developed by amateurs. It should be noted that the industry at that time did not think a personal computer would ever cotton on (and this is only 15 years ago!). It was in 1974 that the July edition of *Radio Electronics*, an American hobbyist magazine, carried an article for the home construction of a small computer. The Mark 8, as it was called, used an Intel 8008 microprocessor, had 256 bytes of RAM (expandable up to 16 k) and had no ROM.

Despite its limitations, interest in the Mark 8 was phenomenal and sales of parts for it far exceeded expectations. This interest, coupled with the introduction of Intel's 8080 microprocessor, prompted MITS, a small US electronics company, to introduce the Altair 8800. This design was also aimed at the hobbyist and designed for another American amateur publication, *Popular Electronics*. The project was published as a series of constructional articles, the first of which appeared in the January 1975 edition.

The computer was offered to readers of *Popular Electronics* for \$650 fully assembled or \$395 in kit form.

## Apple Computers is born

Interest in the Altair 8800 caused the setting up, all over the USA, of 'computer clubs', run by, and for, amateur enthusiasts. A member of one such club in California, Stephen Wozniak, a self-taught computer engineer, got the idea of designing and manufacturing a similar kind of small computer, based on the newly-introduced 6502 microprocessor.

Wozniak designed a small computer, which was received enthusiastically by his fellow club members. However, when he approached his employers, Hewlett Packard, to try to interest them in manufacturing his computer, he met with a bland refusal. Hewlett-Packard did not think there was a sufficiently large market for the machine!

A friend of Wozniak's, Stephen Jobs, thought differently. He approached a number of potential buyers and eventu-

ally got a contract for a quantity of the Wozniak boards. Jobs and Wozniak thereupon went into business for themselves and formed what is now one of the largest computer companies in the world: Apple Computers. They have never looked back!

All this happened only 15 years ago. Today, the personal computer market far outstrips the mainframe and minicomputer markets, and tens of millions of PCs are in use the world over for a multitude of applications.

## Parallel processing

It was stated earlier on that von Neumann's model formed the mould for today's computer. That was true until the arrival of the transputer. The processor in traditional computers can handle only a single instruction at a time. This is true even in multi-user and multi-tasking systems such as UNIX and concurrent MS-DOS, where the processor appears to be engaged in several tasks at a time, but in reality assigns time slots to portions of the relevant tasks. Obviously, the faster the processor, the less users are aware of the time-sharing process.

The transputer is a radical departure from the von Neumann concept. It is normalized for true concurrency. Parallel processing of data and instructions is achieved by synchronized very fast point-to-point communication channels between processes as well as individual transputer modules. There is, in principle, no limit on the number of transputer modules that can be connected to form a computer.

In contrast to other processors, transputers enable defining the speed of the system simply by adding as many modules as required. The IMS T800 transputer from Immos, the designers and manufacturers of the transputer, in its 20 MHz version outperforms all of its 32-bit competitors, including the National Semiconductor NS32332-32081 and Motorola's MC68020-68881.

The calculation performance of the IMS T800 is equal to that of the VAX 8600 scientific computer from DEC, while a network of ten IMS T800 modules offers the speed and processing power of the Cyber 205 supercomputer from Control Data Corporation.

Because of their ability to work cooperatively in parallel on a number of different but related tasks, transputers are well suited for use in so-called parallel processing. By designing computers that work on a number of tasks simultaneously, instead of doing everything in sequence, designers aim to mimic more closely the workings of the human brain. Transputers are also being assigned to less futuristic applications, including desk top supercomputers, laser printers and what have been nicknamed turbo-

chargers where the transputer is used as an add-on unit to an existing system to upgrade its performance. High-performance graphics, engineering workstations, and robotics are other areas where the transputer has already begun to make an impact.

## The optical computer

Beyond the transputer, research is going into photonic and molecular-based computers. Basically, the heart of a computer is the transistor (although there may be thousands of them on one IC). A transistor is nothing but a switch that can flip backwards and forwards between two states. Therefore, computers are chains of switches. They treat sequences of ons and offs to denote numbers (in which case ons and offs are read as the ones and zeros of binary counting) or to denote true or false (in which case chains of switches may be used as the building blocks of algebraic logic). Researchers at AT&T's Bell Laboratories and at Edinburgh's Heriot-Watt University have invented a device that does for light what the transistor does for electrons. This switch, known as a Bistable Optical Device—BOD—or transphosor, is essentially an optical transistor. Light emerges from it as a strong beam (on) or a weak one (off). Put a bunch of transphosors together, shine laser beams through them, and you have the basic ingredients of an optical computers.

## The chemical computer

Even more advanced is the chemical computer that will operate in the same way as the human brain. The Science and Research Council—SERC—a few years ago set up a multi-million pound research project, called MERI—Molecular Electronics Research Initiative—that is intended to keep Britain in the forefront of advanced computer technology.

The idea of a molecular computer was first suggested by an American scientist, Forrest Carter, as a means of overcoming heat dissipation problems in electronic computers. Living organisms are made up of carbon-based compounds, better known as organic compounds that interact to make possible, among many other things, such functions as thinking. Under the MERI, biologists and electronics experts will work side by side to engineer carbon-based chemicals that can replace electronic components now made from silicon. These chemicals will be able to interact at molecular level and will, therefore, provide enormous computing power in a very small space. Since molecules are interconnected in three dimensions, the computer based on them would be able to use parallel processing (like the transputer), making it very fast.

It would also be better at pattern recognition than conventional computers.

## Some newcomers

Back to today, one of the most exciting PCs to have come on the market in the past 18 months is undoubtedly the Archimedes. It is the first PC equipped with a 32-bit wide bus at a very reasonable price. Its processor is an Acorn Risc Machine—ARM—that is cheap and very fast. The high processing speed of 4 MIPS (million instructions per second) is the result of RISC (Reduced Instruction Set Computer) technology. The philosophy behind this technology is that it is better for the processor to work very fast from simple instructions than slowly from complex and often little-used instructions. Already, some versions of ARM have operated, under laboratory conditions, at processing speeds approaching 20 MIPS. It is noteworthy that although the ARM is comparable to Intel's 80836 chip in performance, its price is only about 1/100th of that of the 80836!

Another interesting introduction just over a year ago was from the man they can't keep down: Sir Clive Sinclair. His Z88 portable computer is cheap, small (smaller than a size A4 sheet of paper) and weighs just about 2 lb (less than 1 kg). All software is in ROM and it is not compatible with anything. The Z88 is intended as an end-product and comes, therefore, with all necessary software. Its ROM, apart from a number of tools, also contains a spreadsheet, a diary, a word processor and the well-known BBC BASIC. The programs may be used simultaneously. There is, of course, a serial connection for a printer so that texts from the word processor may be sent straight to the printer.

## Finally

With all the kerfuffle about computers speeds, peripherals of a thousand kinds, software of unimaginable variety, it is sometimes well to reflect on the fact that a computer can really do only two things: carry out sequences of relatively unimportant operations like adding or copying, and choose between alternative sequences.

# THE DIGITAL MODEL TRAIN — PART 1

by T. Wigmore

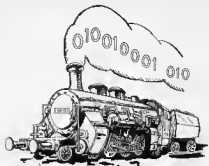

As every railway modeller knows, the control of model railways is being transferred inexorably from the heavy-duty switches and relays of yesteryear to the digital computer. In a new series of articles, we describe a number of units based on the new technology, culminating in a fully electronic model railway. The series commences with a description of the Marklin control system in which all commands to the signals, locomotive and points (turnouts) are given via the rails.

Although in this and some future articles reference will be made to the Marklin system, it should be noted that a number of units will be described that may not only replace the relevant Marklin circuit, but can be used in a variety of DC railways of other manufacturers.

## Rails: a serial bus

In any model railway, there are a number of operations that must be under full control at all times. Points (turnouts) and signals may be operated independently of one another in a simple manner, because they all have their own power and control connections. The drawback of this type of parallel control is the ensuing complexity of the wiring. It is far more complicated to control locomotives independently, because their only contact with the "driver" is via the rails. There are control systems that provide a number of high-frequency command signals. Each locomotive is then fitted with a special filter that allows it to be operated on one specific frequency only. Even these systems are limited to 10 or 15 independent locomotives, because the operating frequencies must be spaced fairly widely to ensure complete freedom from interference. However, time has already caught up with these systems.

The Marklin system is unambiguously based on computer technology. It makes use of a two-wire bus (communication channel) that is already present in any model railway: the rails. Each item to be controlled is connected to the rails (from which it is also powered) and given an address. When a given item, be it signal, locomotive or point (turnout), is to be

operated, the relevant address is entered on to the bus followed by a data stream that contains the operating command. It is clear that each item needs an address decoder that will indicate when it is being addressed. The data stream contains a certain measure of redundancy to obviate erroneous operations. This is particularly useful with locomotives, because the frequently bad contact between wheels and rails is a real source of trouble.

The command signal is entered on to the rails by the central control computer in

packets of nine bits (strictly speaking, the supply voltage is being modulated). Of the nine bits, the first four (in locomotive decoders) or five (in point—turnout—decoders) are accepted as address bits and the remainder as data bits. It is noteworthy that the so-called trinary system is used for the address bits. In this system, a bit can have three states: logic 0, logic open, and logic 1. The protocol of these states is shown in serial format in Fig. 2. It is because of these three possible states that a fairly large number of addresses

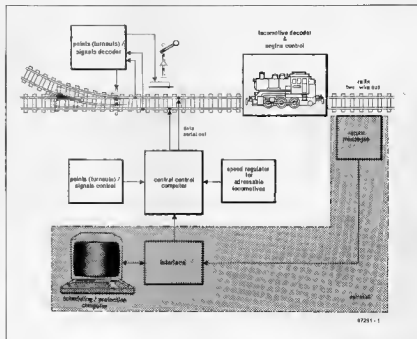

Fig. 1. Block schematic of a digital model railway as designed by Marklin. The rails are used as a two-wire bus.

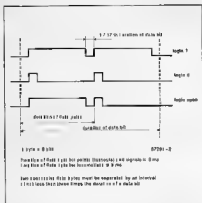

Fig. 2. The serial data format. The short pulses serve as markers. The three states of the trinary system are: 00 = logic 0; 10 = logic indeterminate; 11 = logic 1.

may be obtained with relatively few bits (i.e. connections): 81 for locomotives and (theoretically) 243 for points (turnouts).

Furthermore, the baud rate of the locomotive control signal is half that of the signals and point control signal. Apart from ensuring a more reliable data transmission to the locomotives, the use of different baud rates enables extending the address range. It should be noted that the decoders for locomotives and points (turnouts) operate in the same address range (except, of course,

bit 5 which is a data bit for locomotives and an address bit for points). The decoder merely ignores signals with a baud rate different from that for which it is designed.

### A practical circuit: point/signals decoder

We have chosen a relatively simple circuit to describe the Marklin system. The decoder in Fig. 4 may be used for the control of up to four points (turnouts) or signals. The serial data extracted from the supply voltage via  $R_7$  and the clamping diodes on board IC<sub>1</sub> are decoded by IC<sub>1</sub>. The first five bits are accepted as address bits. However, input A<sub>5</sub> is connected to ground, so that only one third of the address range is reserved for the points and signals, i.e., theoretically, 81 decoders may be connected. Each decoder is given a trinary address with the aid of shorting plugs or wire bridges (see also Table I).

The total number of points (turnouts) is restricted to 256, because not more than 16 switching boxes (each with switches for 16 points) can be connected to the central computer. Evidently, not all trinary addresses are used.

In each decoder, three of the four data bits are used to form a sort of sub-address that serves to select one of eight possible magnet coils. This is done with

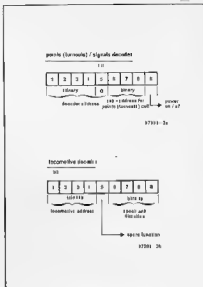

Fig. 3. Construction of the 9-bit data words that control points (turnouts) and signals (a) and locomotives (b). The address bits operate with three logic states.

the aid of a 3-to-8 decoder, IC<sub>2</sub>, which, on the command of the last data bit, connects one of the darlington inputs to the positive supply line via  $R_2$ . In the circuit, use is made of the darlings contained in a ULN2001A, because this device is relatively cheap. It also contains

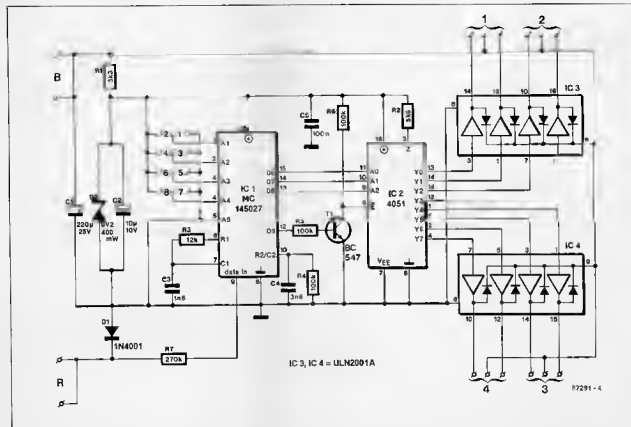

Fig. 4. Circuit diagram of the decoder for points (turnouts) and signals.

a number of indispensable freewheeling diodes. These diodes prevent the high voltage peaks generated by the on and off switching of inductive loads being superimposed on the supply voltage. A little more detail about IC1: see Fig. 5. Network  $R_3C_3$  is used to differentiate between short and long received pulses. The short ones may be considered as "markers"; the trinary information is contained in the intervening long pulses. Time constant  $R_4C_4$  serves to separate sequential data words. If the received address, i.e., the first five bits of a data byte, matches its wired-in address, the decoder will transfer the received data to a 4-bit shift register. They are not yet available at the outputs. Only when a second, identical, data word is received are the data transferred to the output register. This arrangement ensures a large degree of freedom from interference.

### Price/performance considerations

It may not be clear what the advantages are in using points (turnouts) decoders instead of conventional wiring and relays. After all, the saving in wire does not compare with the cost of a decoder. The main advantage of a decoder is that it affords the possibility of "intelligent" control of points (turnouts). The "intelligence" may take the form of pre-programmed switching of combinations of points (turnouts) or of computer-controlled scheduling and protection. It is, of course, not possible to power each and every locomotive via separate wires. The advantage of a decoder is here, therefore, much clearer.

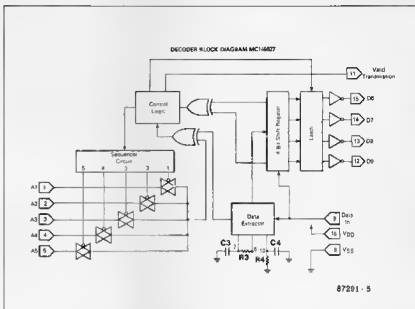

Fig. 5. Block diagram of the MC145027.

In principle, a locomotive decoder works in a similar fashion as that for signals and points (turnouts). Four bits are used to address a locomotive (up to 81 may be used). Bit 5 is used for special functions and the remaining four bits serve to control speed and direction.

Since locomotive power is present on the rails at all times, permanent train lighting presents no problems. It would be feasible to power other aspects, such as station lights, via the rails, but in view of the maximum current the central unit can provide, it is wise to power equipment not directly connected with the rolling stock from a separate supply.

### The practical side

Constructing the points (turnouts)/signals decoder on the printed-circuit board shown in Fig. 6 should not present any difficulties. Connecting it to the track is no problem either. There are two connections: red and brown and these are connected to the corresponding terminals of the Marklin system. Table 1 shows how the short-circuiting jump wires are to be located for setting the various addresses.

Each point (turnout) or signal has three terminals. The central one of these is used for the common wire of the two

#### Parts list

##### Resistors ( $\pm 5\%$ ):

- R1 = 3K3
- R2 = 5K6
- R3 = 12K
- R4; R5; R6 = 100K
- R7 = 270K

##### Capacitors:

- C1 = 220 $\mu$ ; 25 V; axial
- C2 = 10 $\mu$ ; 10 V; radial
- C3 = 1n8
- C4 = 3n9
- C5 = 100n

##### Semiconductors:

- D1 = 1N4001
- D2 = zener diode 8V2; 400 mW
- IC1 = MC145027 (Motorola)
- IC2 = 4051
- IC3; IC4 = ULN2001A

##### Miscellaneous:

- PCB Type 87291-1

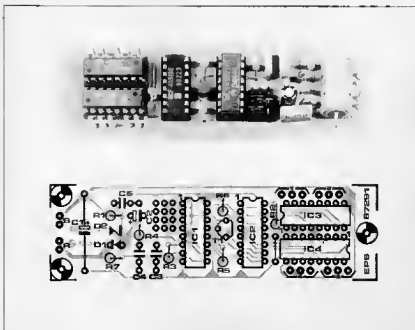

Fig. 6. The printed-circuit board for the decoder.

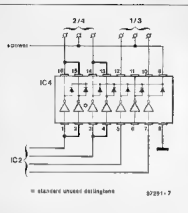

Fig. 7. The maximum current at an output may be doubled by connecting the two relevant darlington in parallel with the aid of two short wire bridges.

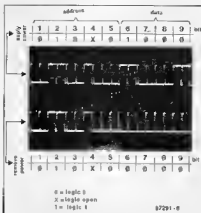

Fig. 8. Actual data streams. The one at the top is generated when bit 9 is set (power applied); the other when the data bits are reset (power removed).

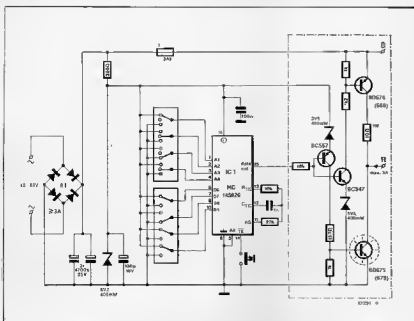

Fig. 9. Circuit diagram of an encoder based on Motorola's MC145026 that enables the Marklin decoder to be used independently.

solenoids. The darlington's are capable of switching up to 500 mA per coil. If points (turnouts) are connected in parallel, this maximum current must be borne in mind. Since not all the darlington's in IC3 and IC4 are used, it is possible to increase the current from some outputs by a factor 2. To do this, two darlington's connected to the relevant output (see Fig. 7) are connected in parallel with the aid of two short wire bridges. If Marklin points (turnouts) with lights are used, these lights are powered by disconnecting the yellow wire from the central terminal of the solenoids and connecting it instead to the central rail. The same may be done with the signal lights. This arrangement will cause the lights to be on permanently. It is worth considering connecting the wire, perhaps via a switch, direct to the yellow AC con-

nection on the transformer. This has the added advantage that the load on the central unit is decreased so that more power becomes available for the trains.

### Testing

For testing at least a Marklin central unit, a keyboard, and a "control 80" are needed. When every unit has been connected, a red LED on the central unit will light (it may be necessary to press the go key on the "control 80" unit first). The connected points (turnouts) may be operated via the keyboard. It is, of course, essential that all addresses are set on the decoder as well as on the DFL switches at the rear of the keyboard (see Table 1).

Every time a key is depressed, two se-

keyboard number	keyboard switches on	decoder	
		points (turnouts) number	pump wires placed at
1	---	1, 2, 3, 4	2-2-B-7
		5, 6, 7, 8	3-5-7-
		9, 10, 11, 12	1--4-5-7-
		13, 14, 15, 16	2-4-6-7-
2	1---	1, 2, 3, 4	4-5-7-
		5, 6, 7, 8	1--6-7-
		9, 10, 11, 12	2--5-7-
		13, 14, 15, 16	--5-7-
3	-2-	1, 2, 3, 4	1-3--6-7-
		5, 6, 7, 8	2-3--6-7-
		9, 10, 11, 12	--3-6-7-
		13, 14, 15, 16	1--4-6-7-
4	12--	1, 2, 3, 4	2-4-6-7-
		5, 6, 7, 8	--4-6-7-
		9, 10, 11, 12	1--6-7-
		13, 14, 15, 16	2--6-7-
5	-3-	1, 2, 3, 4	--8-7-
		5, 6, 7, 8	1-2--7-
		9, 10, 11, 12	2-3--7-
		13, 14, 15, 16	--3--7-
6	1-3-	1, 2, 3, 4	2-4-7-
		5, 6, 7, 8	1--4-7-
		9, 10, 11, 12	--4-7-
		13, 14, 15, 16	1--4--7-
7	-23-	1, 2, 3, 4	2--7-
		5, 6, 7, 8	1--7-
		9, 10, 11, 12	1-3-6-8
		13, 14, 15, 16	2-3-6-8
8	123-	1, 2, 3, 4	1--8-8
		5, 6, 7, 8	1--8-8
		9, 10, 11, 12	2-4-8-8
		13, 14, 15, 16	--4-8-8
9	--4-	1, 2, 3, 4	1--5-8
		5, 6, 7, 8	2--5-8
		9, 10, 11, 12	1--5-8
		13, 14, 15, 16	1-3--8-8
10	1--4-	1, 2, 3, 4	2-3--8-8
		5, 6, 7, 8	3--8-8
		9, 10, 11, 12	1--4-8-8
		13, 14, 15, 16	2-4-8-8
11	-2-4-	1, 2, 3, 4	1--8-8
		5, 6, 7, 8	1--8-8
		9, 10, 11, 12	2--8-8
		13, 14, 15, 16	1--8-8
12	12-4-	1, 2, 3, 4	1-3--8-8
		5, 6, 7, 8	2-3--8-8
		9, 10, 11, 12	3--8-8
		13, 14, 15, 16	1-4--8-8
13	--34-	1, 2, 3, 4	2-4--8-8
		5, 6, 7, 8	--4-8-8
		9, 10, 11, 12	1--8-8
		13, 14, 15, 16	2--8-8
14	1-34-	1, 2, 3, 4	1-2-8-8
		5, 6, 7, 8	1-2-8-8
		9, 10, 11, 12	2-2-8-8
		13, 14, 15, 16	3-8-8
15	-234-	1, 2, 3, 4	1-2-8-8
		5, 6, 7, 8	2-4-8-8
		9, 10, 11, 12	--4-8-8
		13, 14, 15, 16	1--8-8
16	1234-	1, 2, 3, 4	1-2-8-8
		5, 6, 7, 8	2-8-8
		9, 10, 11, 12	1-3--8-8
		13, 14, 15, 16	2-2--8-8

Table 1. Address settings for the Marklin keyboard and the present decoder.

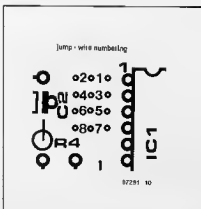
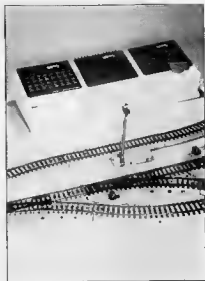

Fig. 10. Jump wire numbering.

quential pulse trains are put on to the rails. Each of these trains contains two identical data bytes. One pulse train would, therefore, be sufficient, because the decoder needs only two data bytes, but for absolute security of operation two trains have been arranged. Bits 1 to 4 constitute the relevant decoder address; bit 5 is always 0; bit 6 to 8 form the sub-address of the appropriate solenoid; and bit 9 is 1 so that power is applied. When the key is released, four bytes are again put on to the rails, but this time with the data bits reset to cause power to be removed.



5 is connected to earth. The trinary decoder address must be placed on inputs 1 to 4 and the solenoid sub-address (binary) on inputs 6 to 8. The power is removed or applied by bit 9. In the cir-

cuit, switches are shown for setting the addresses, but the inputs may just as well be controlled by the output port of a computer. Note, however, that these inputs are not TTL compatible (not even if the decoder would operate from a 5 V supply). Furthermore, for each address bit a third logic state (high impedance) must be available. This means that an interface is required between the output port and the encoder.

A short pulse at the TE input (transmit enable) results in the set byte being sent twice in succession. If the TE input is kept low permanently, the encoder sends continuously.

When one central power supply is used (as in the Marklin system), the data are superimposed on the supply voltage which is effected by the boxed section at the right in Fig. 9. It is, however, also possible to give each decoder a separate supply, so that only earth and a signal line have to be provided. The boxed section in Fig. 9 is then not required. The output of the encoder and earth are then connected direct to R and the data input respectively (it may be necessary to remove R7).

### Alternative control circuit

The points (turnouts) decoder may also be used independent of the Marklin system, not only with model railways, but also as a two-wire remote control unit. This is made possible by Motorola's MC145026 encoder. This IC makes it possible to construct a substitute for the Marklin control with only a few additional components (see Fig. 9). The encoder has 9 address/data inputs. Input

## MOLECULAR ELECTRONICS

### Towards an advanced form of computer technology

by John Delin

Smell sensors, paper-thin television screens, moving holograms and bio-computers using living organisms are all the stuff of fantasy. But so was the silicon chip or the seemingly incredible notion that a million pieces of information could be stored in a grain of dust, only a few decades ago. Today's microprocessors are hardly obsolete but they are already revealing limitations in terms of size and other physical constraints. Where then can scientists turn to complement existing technologies while providing an exciting springboard into the fantasies and realities

of the future? Molecular electronics, designed to harness the molecule itself as an information processor, show considerable promise. Gathered together from disparate research over a range of disciplines, this line of thought has attracted considerable interest in Britain and has now been selected as one of the major areas of the Department of Trade and Industry's new Link<sup>(1)</sup> programme of collaborative research between universities and industry. At least £20 million is to be allocated to molecular electronics, half from government

sources and half from industry, to cover the so-called pre-competitive stage of development, delving into fundamental principles and the feasibility of devices. The programme aims to provide the platform from which industry and industrially sponsored research can later develop exploitable products.

#### Practical application

Molecular electronics uses organic molecules to process information. It goes beyond the digital processing of conventional electronics and adds new dimensions—for example struc-

tures and shapes—to its vocabulary. Conventional electronics are analogous with the nerves in the body that trigger when a certain electrical threshold is reached. Molecular electronics resemble the white corpuscles that react to the shape, density or temperature of a bacterial invader. They are conceptual in action rather than computational.

One familiar example of molecular electronics in action is the liquid crystal display seen in watches and calculators that respond vigorously to electrical or heat signals. These are already in use in a number of

applications such as the head-up displays where an array of indicators is visible in the wind-screen to aircraft pilots or railway locomotive drivers. The operator is not distracted by having to search for gauges but can absorb vital information such as engine speed or temperature without moving his head.

Unfortunately today's liquid crystals are sluggish in action and not very sensitive. The race is on to improve them and the newer ferro-electric crystals already being tested are more flexible and responsive. Displays are now envisaged that will reproduce four-colour signals on a flat screen — an obvious precursor to wallpaper television.

### Cheap mass memories

Using the ultra-thin films of one molecule thickness now being produced, coupled with photo-electronics, one could envisage quickly changing holograms, no more than a short step conceptually from genuinely three dimensional moving pictures.

Britain's Link programme defines molecular electronics as "systematic exploitation of molecular, including macromolecular, materials in electronics and related areas such as photo-electronics". Liquid crystalline substances apart, it proposes to investigate organic metals and semiconductors, non-linear optical materials, and photochromic, electrochromic, piezo-electric and pyro-electric substances. Applications to be studied include information storage and transmission, signal processing and thin film technology.

Experts see the envisaged molecular electronic systems as compact, flexible, cheap and efficient. According to Professor John Barker of Glasgow University, a leading worker in the field, the smallness of molecules make possible very dense circuits leading to cheap mass memories.

Molecules are much more noise stable and thermally stable than conventional semiconductors. Metallic, semiconducting, insulating molecular components to be built into switches and circuits would be the very least one might expect.

### Artificial intelligence

Compared with the paucity of good solid-state electronic materials, molecular materials have a rich variety of possibilities ranging from simple small molecules, polymers and molecular crystals to complex macromolecules bordering on biologically significant structures not far removed from natural organisms. Many of the techniques employed in synthetic organic chemistry could provide the means of building useful additional properties into such materials.



Will an "electronic nose" ever replace the wine expert's experience and discrimination?

A significant example of the last technique is illustrated in the electronic nose project being conducted jointly at Glasgow University and Warwick University. By varying the structures of a range of polymers it has been possible to devise a machine that can smell. It converts the responses of a range of sensors into signals related to specific smells.

In modern science it has apparently been the most simple senses such as taste, smell and

sight, particularly visual recognition, that have been most difficult to reproduce in their true complexity. Such advances as these will offer important insights into the way the brain works and the development of artificial intelligence.

Many scientists see the way ahead as grafting molecular electronics on to the conventional variety, possibly using thin films as an interface and producing, in effect, conventional microprocessors with a much wider range of sen-

sitive structures, linking the animate and inanimate and producing living intelligences—the bio-computers of the future. It does not follow that these will be human brain analogs.

In fact, part of the excitement will be the construction of different types of intelligence to supplement the human variety. We are already familiar with such variations, as for example, the collective intelligence of an insect colony as compared with the more isolated individuality of the human brain.

These distinctions are already accepted by most scientists working in molecular electronics. The theory of molecular computing differs radically from the now conventional digital computing which, strictly speaking, is no more than advanced counting. On paper at least, researchers are already producing new structures and simulations that presage many fresh approaches to artificial and natural intelligence.

### Hope and prejudice

The universities and industrial groups collaborating in the Link molecular electronics programme aim to produce exploitable hardware within the next few years and expect to achieve consistent rather than dramatic development within this time. Professor David Bloor of Queen Mary College<sup>(1)</sup>, London, who is the Link programme coordinator for molecular electronics, is quite clear on the point.

"Molecular electronics is not a replacement for the silicon chip", he said. "We are prejudiced by silicon technology and people must be encouraged to take different attitudes. Molecular electronics, if it comes to fruition, will be as different from today's electronics as semiconductors are from the valve technology of 40 years ago."

stivities.

### Insect colony

For example, today's industrial robots are firmly based on the digital principle, essentially by measurement and counting. The concept of a robot that could compare, sense and feel brings in an almost occult dimension.

The logical conclusion to this development, as some scientists see it, will be to bridge the gap between molecular and

(1) Link Secretariat, Department of Trade and Industry, Room 237, Ashdown House, 123 Victoria Street, London SW1E 6RB.

(2) Professor David Bloor, Department of Physics, Queen Mary College, Mile End Road, London E1 4NS.



# SCIENCE & TECHNOLOGY

## Recognizing speech in noise

by Dr William Ainsworth, Department of Communication and Neuroscience, University of Keele

Few people have any experience of communicating verbally with computers and even fewer have ever done so in a noisy environment. Yet in a factory or when using a telephone in a busy office, recognizing and decoding speech is a familiar problem. But it will take many years of research before the most efficient form of man-machine interface will be evolved, though the task has to be tackled if we are to be able to talk to computers against a background of machinery, in a motor car or on a flight deck. Headway is already being made in analysing the difficulties and outlining ways to overcome them.

Speech dominates human communication. If we want people to do something, or we need certain information from them, we simply speak to them. If they are far away we may write them a letter, but most people prefer to pick up a telephone, perhaps because reading and writing seem much more complicated than speaking and listening. That is hardly surprising, for it takes years of practice at school to become proficient in the skills needed to read and write.

When we want to communicate with a machine we have to learn new skills. We need to know how to poke at a keyboard with our fingers and to watch the effect it has on a screen. How much easier it would be if we could simply speak into a microphone to get the machine to do what we wanted!

This dream occurred to speech technologists many years ago, and for the last 20 years or so they have been trying to devise techniques for getting machines to respond effectively to speech signals.

Speech communication appears to be a simple process. It is learned by every healthy child with little or no effort. In reality it is not simple: it is a most complex process. An idea in the mind of the speaker must first be expressed as a sentence in a language understood by both him and the listener. It must then be articulated. We do it by modulating the airstream from the lungs by the vocal cords to produce a sequence of pulses whose frequency determines the intonation. The pulses excite the resonances of the vocal tract and then radiate from

the lips as a sound wave. The meaning of the sentence is coded in this wave by subtle movements of the tongue, jaw and lips. These complex movements are known intuitively by everyone who has learned the language.

But this is only half the story. The sound wave passes through the outer ear of the listener and causes the eardrum to vibrate. These vibrations cause the ossicles, a series of small bones attached to the eardrum, to move and pump fluid in the cochlea, or inner ear. In the cochlea is the basilar membrane which oscillates at various places along it which depend upon the frequencies present in the input signal. So, the structure of the inner ear begins the process of decoding the speech wave. Attached to the basilar membrane are a large number of hair cells, some 30,000 of them, which actuate nerve cells when they bend. These cells are the first stage in a complex system which leads up the brainstem and eventually to the auditory cortex.

### Automatic recognition

So far, the processes by which the speech signals are decoded by the brain are not well understood, so programming a computer to recognize speech in the same way that the brain operates is obviously impossible. Nevertheless, for many practical purposes a machine which recognizes just a few words can be very useful. For example, consider a program that displays the choices available to the user by means of numbered menus. If the machine can

just recognize the spoken digits the user can complete his task by voice.

Most practical speech recognizers work by pattern matching. The user speaks all the words in the machine's vocabulary and the machine analyses them and stores the result. These stored patterns are often known as templates. When an unknown word is spoken, the machine compares this new utterance with each of the stored templates and chooses the one which gives the best match.

Several techniques have been employed to analyse speech signals. We know that speech is encoded in terms of frequencies and that the human auditory system begins its analysis of sounds by separating them into their component frequencies, so spectral analysis is a popular technique. The upper of the two illustrations shows a sound spectrogram, or sonagram, of the word 'recognition'. Frequency is represented by the blackness of the picture. The dominant frequencies, known as the formants, can be seen as the black horizontal bands. These reflect the resonances of the vocal tract.

### Problems

Speech recognizers built on these principles alone are not very successful for three reasons:

- (1) Every time we utter a word we speak at a different rate, so some patterns are spread out in time compared with others.
- (2) Different people have different sized vocal tracts, so the formants occur at different frequencies when they say the

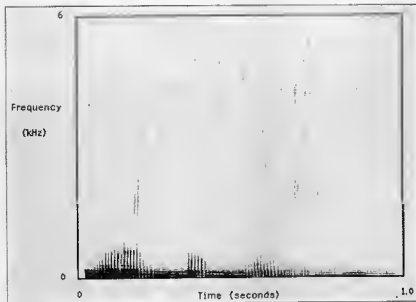
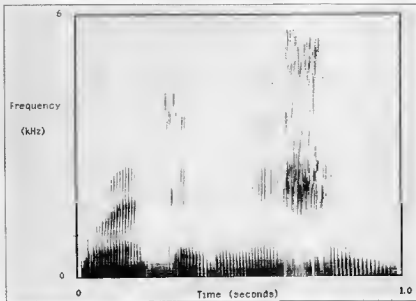

Sonagrams of the word 'recognition'. At the top it is spoken against a quiet background, and above with a signal-to-noise ratio of  $-6$  dB.

same word.

(3) Most speech communication takes place not in isolation, but against a background of other noises.

Various techniques have been devised for dealing with these problems. The first problem can be dealt with by so-called dynamic time warping. This enables the stored templates to be expanded or compressed in such a way that the optimum match is obtained. Alternatively the problem can be dealt with by building statistical models of each word which incorporate the variability of the utterances.

Usually the multi-speaker problem has been circumvented by training the system

with the voice of the user but there have been some attempts to cope with it by building transformations for each new speaker that enable his voice to be transformed into one like that of the person who originally trained the system. Here, statistical modelling of the variability has again been used.

The problem of recognition in noise has not yet been solved. John Bridle and his colleagues at the UK Royal Signals and Radar Research Establishment in Malvern some years ago showed that a speech recognizer which worked well in the quiet recognized only about 50 per cent of spoken digits correctly when the signal-to-noise ratio was  $+3$  dB (decibels). This is far worse than human performance. It has been known for

many years that spoken digits can be recognized with almost complete accuracy with a signal-to-noise ratio as poor as  $-6$  dB, which means the intensity of the speech is much less than that of the noise. A sonagram of the word 'recognition' with a signal-to-noise ratio of  $-6$  dB is shown in the lower of the two illustrations.

## Auditory modelling

The superior performance of people in recognizing speech in noise has led to the suggestion that speech analysers which operate on the same principles as the human auditory system might work better than those based on conventional techniques. Preliminary experiments by Dr Ghitzza at the Bell Laboratories in the USA and others elsewhere have shown promising results.

Our Department of Communication and Neuroscience comprises a number of research groups which investigate the mechanisms of vision, hearing and speech. Professor Ted Evans, the head of the department and leader of the Auditory Physiology group, has developed an electronic model of a single channel of the auditory system. It gives responses similar to those obtained by inserting micro-electrodes in the auditory systems of cats.

Professor Evans' model consists of a filter with characteristics that simulate those of the inner ear, a half-wave rectifier and logarithmic compressor to represent the action of the hair cells, and what is called a probabilistic spike generator to simulate the production of action potentials in nerve cells.

Our Speech and Auditory Physiology groups are collaborating with Dr Pat Wilson of the Auditory Psychophysics group to produce a computational model of the auditory system with 100 or more channels. This work is made possible by a grant from the UK Science and Engineering Research Council to install a fast computer that will enable the model to process signals, especially speech, in a reasonable time.

The first stage of the model consists of a bank of bank-pass filters which simulate the signal processing as far as the auditory nerve. The characteristics of these filters are estimated by a process known as reverse correlation. A random noise signal is applied to the auditory system and responses are recorded from the auditory nerve by means of a microelectrode. The noise signal causing the nerve fibre to respond is also recorded. By a process similar to cross correlation between the noise input signal and the response of the nerve fibre, the impulse response (the response of a filter to a single impulse) of the auditory filter is found (in practice the impulse response is reversed in time; hence the term reverse correlation). Several ex-

periments have to be done with a number of nerve cells, each tuned to respond to different frequencies, to develop the impulse responses of a bank of filters. These impulse responses can be programmed on the computer and used to simulate the filtering characteristics of the auditory system. The other stages of auditory processing, logarithmic compression and rectification by the hair cells and the generation of spikes according to a probability function, can also be programmed. The result is a computational model which allows the signals generated at each level in response to speech sounds to be studied. The auditory system is more complicated than I have already outlined. Recent physiological studies have shown that there are interactions between the channels: if there is activity in one channel, the activity in neighbouring channels is suppressed. This mechanism might be responsible for reducing the effects of noise while enabling speech signals to be transmitted to the higher regions of the auditory system. We intend to build lateral suppression into our model and to investigate what effect it has on speech processing.

## Speech synthesis

Techniques for speech synthesis were developed about 20 years ago. In a typical system a sentence is first translated into a sequence of phonetic units, which represent the way in which each sound is pronounced. This can be done by looking up each word in a phonetic dictionary or by applying a set of context-sensitive rules (for example *p* followed by *h* is pronounced *f*, otherwise *p*). The phonetic units are then translated into acoustic parameters which represent the physical characteristics of the sounds. The acoustic parameters are the frequencies of the formants (see left-hand illustration), their intensities, and their durations. They are used to control a speech synthesizer consisting of a set of resonators excited by a sequence of pulses.

Although such a system produces intelligible speech, the output sounds rather mechanical. Moreover, it has been found that when it is heard against a background of noise it is a great deal less intelligible than equally loud natural speech. We are collaborating with the IBM Scientific Centre in Winchester to try to discover why this is so. One possibility is that whereas this system faithfully models the resonances of the vocal tract it does not employ realistic excitation pulses. A technique known as inverse filtering is being used to measure the shapes of the excitation pulses in human speech. In this technique the characteristics of the vocal tract filter are estimated, and then the characteristic of the filter is inverted. If speech signals are passed through the 'inverted' filter, only the excitation pulses remain. Using the technique we are able to study the variation in shape of the excitation pulses. This knowledge can be applied to speech synthesis. We expect that speech synthesized in this way will be more intelligible in the presence of background noise.

## User interface

When the captain of a ship gives a compass course for the helmsman to steer, the helmsman repeats it back to confirm that he has heard it correctly. When a telephone operator is asked to obtain a number she repeats the number back. Communicating with a machine in a noisy environment is somewhat similar. The noise may corrupt the speech signal and cause an error in recognition. The user will be unaware of the mistake unless the words are displayed on a screen or the machine is equipped with a synthesizer to speak back to him. If the user is communicating over a telephone line, or if his eyes are busy with another task, the latter course may be the only one that is practicable.

The question arises as to whether the response of the recognizer should be checked after each word has been spoken

to it or whether it should be checked later, for example, at the end of each sentence. Compass courses always consist of three digits and they are repeated back as a group. Telephone numbers, on the other hand, vary quite widely in the number of digits they contain. They are often checked after three digits, but on a bad line digits may be checked one by one.

Here at Keele we are interested in communicating with computers in a noisy environment where it is likely, in spite of advances in recognition from auditory modelling and in synthesis from realistic excitation pulses, that occasional mistakes will be made. So we are interested in finding the most efficient ways of detecting and correcting errors. We have developed a mathematical model of the user interface, which enables us to arrive at the optimum number of words which should be spoken before any checking is done. This model predicts, as might be expected, that as the noise level rises and the frequency of errors increases, the number of words spoken before a check is made should be reduced. Experiments have shown that the specific predictions of the model are borne out in practice.

## Future plans

Our research is by no means completed. We have only recently acquired computers powerful enough for us to carry out the work. When even more powerful computers come into use, progress will be faster.

Advances are continually being made in understanding the physiology of the auditory system. We intend to incorporate these developments in future auditory models and to test their utility in automatic speech recognizers. Our programme in speech synthesis has been hampered by a lack of knowledge as to how the shape of the excitation pulses varies in natural speech. We are gradually acquiring this knowledge and in due course it will be transferred to our speech synthesis system.

## ELECTRONICS NEWS

### Japan threatens U.S.

Japanese are rapidly moving ahead of the U.S. in the development of a crucial new X-ray technology that will be used to manufacture computer chips in mid-nineties.

Major American electronic firms and scientists have cautioned the U.S. administration that American competi-

tiveness is at stake in a number of vital areas from military technology to consumer electronics.

The most advanced commercial chips available now can store on million bits of information, approximately 62 typed pages. Experts say that the limit to such chips is 16 million bits.

The developing technology called X-ray lithography, can make denser chips that scientists think will ultimately enable storage of 1000 times more data. Such computing power is

now available only with the largest IBM mainframe computer, which occupies several refrigerator-sized cabinets. The new chips would be about the size of a finger nail.

The Japanese have set up a joint industry-government venture on X-ray lithography at a cost of one billion dollars. Since, the technology is too expensive for any single company to develop, the IBM has approached other companies to share the equipment cost for the X-ray lithography studies.

# PRACTICAL FILTER DESIGN (2)

by H. Baggott

Each filter has its own typical properties and these can be laid down in a few parameters. The second part of this series explains what these parameters are and what they mean

There are a number of parameters that characterize the properties of a filter. One of these is the frequency response characteristic or curve. The designer, having drawn up a target specification for the ripple in the pass-band and the slope of the filter skirt, will have to make a choice from several possibilities. The type of filter, whether it is a high-pass or band-pass, and so on, is not of importance at this stage.

Any type of filter can be converted into a standard low-pass with a cut-off frequency of 1 Hz. The target requirements must be translated into a normalized low-pass filter specification. After that, they may be compared with available standard curves with a 1 Hz cut-off point.

After a choice has been made, the required filter is simply reconverted and dimensioned for the required frequencies.

The designer has a choice of the following filter types:

- Butterworth
- Bessel
- Chebyshev
- transition
- linear-phase
- synchronous-tuned
- elliptic-function.

Apart from those of elliptic-function filters, the frequency characteristics of all these types are normalized for a -3 dB cut-off point at 1 Hz. The curves may be scaled to the desired frequency with the aid of standard multipliers.

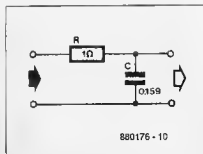

Fig. 6. A simple RC network with its -3 dB cut-off point at 1 Hz.

## Filter parameters

As an example of the operation of a filter, we will consider the simplest type: an RC network as shown in Fig. 6. This network is terminated into an infinitely high impedance and powered by a voltage source that has an internal resistance of zero ohms. The capacitor is the frequency-dependent element and it introduces a phase shift.

The transfer function of the filter is

$$T(j\omega) = 1/(1 + j\omega CR) \quad [4]$$

The absolute value of the function is

$$|T(j\omega)| = 1/\sqrt{1 + (\omega CR)^2} \quad [5]$$

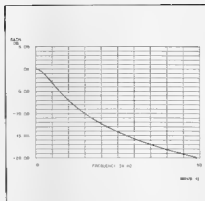

Fig. 7. Gain vs frequency curve of the sample filter drawn on a linear scale.

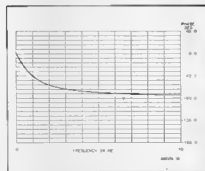

Fig. 8. The linear X-axis on the phase shift curve gives a good idea of the time delay caused by the filter.

The resulting phase shift is

$$\phi = -\arctan(\omega RC) \quad [6]$$

Equations [5] and [6] enable the gain vs frequency and the phase shift vs frequency characteristics to be computed and these are shown in Fig. 7 and Fig. 8 respectively. It should be noted that these curves are drawn on linear coordinates and that, therefore, particularly the gain curve is not the nearly straight line usually encountered. This is because the curves are normally drawn on a logarithmic abscissa (X-axis).

None the less, the phase characteristic in Fig. 8 shows how well the filter function approaches the condition not to

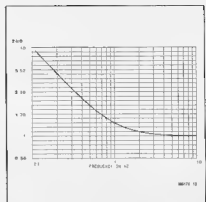

Fig. 9. The input impedance of the sample network is not constant but increases at low frequencies.

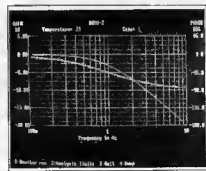

Fig. 10. The phase shift and gain characteristics are normally shown on the same illustration.

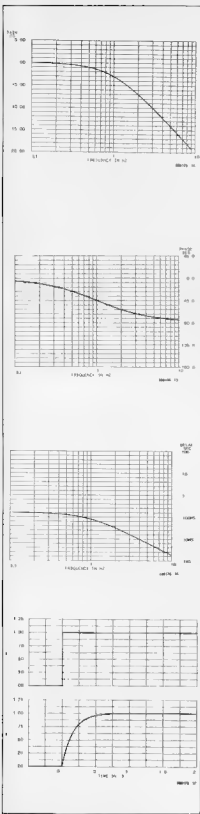

Fig. 11. The standard curves that will be used for all the filters that will be discussed in forthcoming articles in this series.  
 a. gain vs frequency;  
 b. phase shift vs frequency;  
 c. time delay vs frequency;  
 d. step response.

introduce delay distortion ( $\Phi/f = \text{constant}$ ). On a linear scale, the curve should be a sloping straight line. This aspect is difficult to judge when a logarithmic scale is used.

The input impedance of the filter is, of course, also a point to be considered. It is not possible, as many of us have found by bitter experience, to connect a number of filters in cascade to obtain a sharp cut-off response. Since the reactance of some filter components is frequency-dependent, the input impedance will also vary with frequency. This may be seen from Fig. 9, which illustrates the input impedance of our sample RC network.

Furthermore, a filter is always computed for a fixed ohmic termination. If that load is replaced by another filter presenting a frequency-dependent impedance, neither of the two filters will behave as originally designed.

As already stated, since the frequency and phase characteristics are normally drawn on a logarithmic X-axis (and quite often shown together as in Fig. 10), it is difficult to ascertain the time delay from them. For that reason, the time delay characteristic (computed from the frequency and phase characteristics) is often added on the same illustration.

For some applications, it is important to know the step response of the filter. This is a measure of the reaction of the network to a sudden rise in input voltage.

The four parameters just discussed give virtually all the information the designer normally requires.

### Standard curves

The standard curves of our sample RC network are shown in Fig. 11. Such curves will also be given for all types of filter in forthcoming articles in this series. We will endeavour to give them all on the same scale so that a direct comparison may be made. All curves have been computed with the aid of a network analysis program to obtain representative characteristics that are as accurate as possible. All of them have been normalized on a cut-off frequency of 1 Hz.

Reverting to Fig. 11, a and b show the gain vs frequency and the phase shift vs frequency respectively. Fig. 11c is the time delay vs frequency curve computed from curves a and b. Fig. 11d gives the step response of the network; the upper part of the illustration shows the sudden increase in input voltage from 0 to 1 V, and the lower part the resulting change in output voltage. Curves in future articles in this series will not show the upper part again, because the rise in input voltage is always taken as shown here. The step response of our sample filter does not mean much, of course, because the network is so simple. In the

case of more complex networks (of the second and higher orders), the step response will show at a glance whether there is any ringing, how long this lasts, and the extent of the overshoot.

### A sample computation

To end this second part of the series, we will give a sample computation to show how a filter is dimensioned in line with the foregoing discussion. Assume that we need an RC network as shown in Fig. 6 that is powered from a low-impedance voltage source and is terminated into a fairly high impedance ( $>1 \text{ M}\Omega$ ). The cut-off point is required to be at 3 kHz (the multiplier,  $m$ , is thus 3,000). We choose a standard value for  $R$ , say 10 k $\Omega$ . The value of the capacitor is divided by the value of the resistor and the multiplier. If the network had contained an inductance instead of a capacitor, the value of the inductor would be multiplied by the value of the resistor and the result divided by the multiplier. In the RC network:

$$C = 0.159/mR =$$

$$C = 0.159/3000 \times 10000 =$$

$$C = 5.3 \times 10^{-9} = 5.3 \text{ nF}$$

The time delay at a given frequency may be calculated by reading the delay at that frequency in Fig. 11c and dividing that value by  $m$ . The same applies to the time scale of the step response curve. ■

# VIDEO CARDS FOR PERSONAL COMPUTERS

by H. Stenhouse

In recent years a bewildering variety of video cards for PCs has come on to the market. This article attempts to remove much of the confusion caused by the different specifications and monitor requirements.

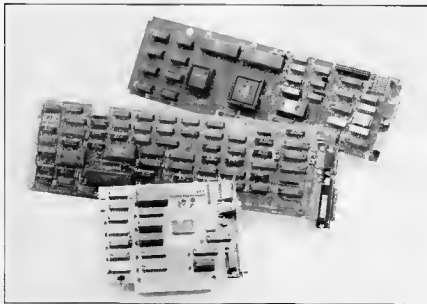

Functionally, the video card in a personal computer is an output device. Over the past few years, as PCs grew more sophisticated and users more demanding, the video card has become more than the fairly simple text display circuit of yesteryear. At that time, no provision was made for displaying, say, a graph on the screen. Fortunately, this was corrected with the introduction of the Colour Graphics Adaptor (CGA), which did allow, at least partly, for integration of text with simple graphics. The main disadvantage of the CGA was, however, its limited resolution for text. The well-known Hercules card, developed by the company of the same name, overcame this shortcoming at least for monochrome text applications. A few years later, the EGA card (EGA = Enhanced Graphics Adaptor) and the PGC card (Professional Graphics Adaptor) were introduced to satisfy more demanding users wishing to work with high-resolution colour screens. But the evolution of the videocard did not stop with the PGC: the introduction of the new series of PS/2 computers from IBM called for even higher resolution and speed: the answer was provided in the form of a range of MCGA and VGA cards.

The evolution from the basic video card to the highly sophisticated graphics adaptor available now has caused great confusion among many PC users. This is mainly because the systems are often incompatible as far as the monitor, horizontal and vertical scanning frequency, and even the interconnecting cables are concerned. The CGA (8 colours) and the EGA card (16 colours), for instance, supply output signals at TTL level, usually combined with an intensity signal, whereas other videocards, such as the PGC and VGA have linear video outputs that allow a very high number of displayable colours. Owing to the structure of the on-board RAM, the VGA and PGC work with video modes in which a limited number of colours — say, 256 — can be active at a time. These cards offer an indirect choice of nearly a quarter of a million shades via a palette structure.

Computer display manufacturers have traditionally supported each new PC video card with an appropriate display. An exception to this is formed by the so-called *multisync* monitor, which is available in many types from, for instance, NEC (Multisync-2), Eizo (Flexscan 8060S and 9070S) and Taxan. The

electronics in this advanced type of display is capable of automatic adjustment to the internal line and raster frequency detected in the applied video signal. In addition to this extremely useful feature, the display often has inputs for linear as well as digital video signals, so that it can be used with virtually all current videocards.

Unfortunately, a CVBS (Chroma, Video, Blanking and Sync) input to the PAL (or NTSC) standard is rarely found on high-resolution colour monitors for computers. Such an input is, admittedly, not very useful in the PC environment, but may, on the other hand, give interesting opportunities for use of the high-resolution display in conjunction with cameras, VCRs, video digitizers, and some types of home computer.

## The monochrome scene

The Monochrome Display Adaptor (MDA) fitted in the earliest of IBM PCs provided only text display. This card, which is now obsolete, had a screen memory of only 4 Kbyte (4,000 characters), and displayed text as 25 lines of 80 characters. None the less, the resolution of the MDA is relatively high at

720x350 pixels. The character font is 7x11 pixels in a 9x14 raster, resulting in a clear text display. The card provides 256 characters, which are stored in an on-board ROM. No provision is made for the user to define his own characters. The Hercules card replaces the MDA, and adds a graphics option in the form of a monochrome graphics interface with a resolution of 720x348 pixels. Text display is basically the same as with the MDA, and requires no special software. Graphics software, however, can only be run with the aid of software utility INT10, since IBM, and, therefore, the Disk Operating System (DOS), does not support the Hercules card. After an initial shortage of graphics software for the Hercules card, this is now supported in the majority of programs from leading software companies. The use of the Hercules card is also boosted by programs such as MG-2 (MultiGraph-2) that allow it to emulate the CGA mode with the aid of grey shades. Currently, the Hercules card is probably the widest used video adaptor for PCs running word-processing and other text applications. As a useful boon, the card provides a parallel printer output port, LPT1.

## Colour and graphics: the CGA

The CGA was the first card introduced by IBM that allowed the connection of a colour display to a PC. On board the CGA is a 16 Kbyte memory. The card can operate in two modes: text and graphics. In text mode, two sub-modes are available: 40 or 80 characters per line, at 25 lines per screen in both cases. The available memory allows 8 or 4 screens to be stored in 40 and 80 charac-

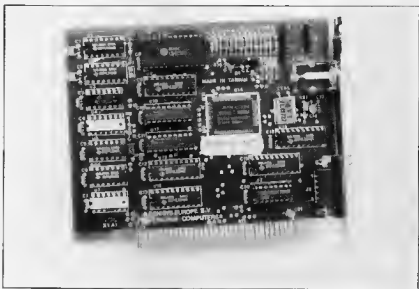

Fig. 1. Half-length Colour Graphics Adaptor.

ter mode, respectively, so that fast scrolling can be achieved. The graphics mode also affords a number of sub-modes, including one with 640x200 pixels at two colours, and 320x200 pixels at four colours. In graphics mode, characters with an ASCII value greater than 127 can be shaped by the user. Since characters are formed in an 8x8 matrix, the CGA is less suitable for text display. In many cases, a CGA and a Hercules card can be used alongside in the computer, but only if the Hercules card is not used in the so-called *full-size mode* (64 Kbytes of screen memory). Switching between the two cards can be done in software, so that monochrome text can be combined with colour graphics on separate screens.

The CGA double-scan card is an improved version of the standard CGA. This type of video adaptor is available in the form of an emulated mode on some EGA cards, and enables software written for the CGA to be run on a display with much higher resolution. This is mainly by virtue of the double-scan principle, which provides an interlace function that effectively doubles the vertical resolution. Unfortunately, this interesting mode is not available in the form of a separate card.

## Enter the EGA

The cost of an Enhanced Graphics Adaptor (EGA) was, for a time, prohibitive for the average PC user, but that, fortunately, changed with the availability of good-quality products from the Far East. The EGA has a large, 256 Kbyte, on-board memory, and offers a graphics resolution of 640x350 pixels, at 16 possible colours per pixel (a 256-colour extension for the EGA is described in Ref. 1). Pixel colour selection is from a 64-colour palette. Depending on the resolution, two or four screens can be held in the memory.

The character set of the EGA is ROM-resident, and uses an 8x14 matrix to guarantee excellent text display capabilities. Provision has been made for the user to shape up to 1024 characters at a height of 8 to 32 pixels. Many manufacturers of EGA cards have come up with useful extensions to the basic capabilities, often in the form of emulation modes. In many cases, software is supplied with the card that allows it to switch to the CGA, MDA and CGA double-scan mode. The EGA-Wonder card from ATI takes compatibility even further by its ability to adapt the outputs to the display used. Other EGA cards

Table 1

Horizontal frequency kHz	Vertical frequency Hz	display adapter	Resolution
15.75	60	CGA	320 x 200 640 x 200 640 x 350
18.2	50	EGA-mono	640 x 350
18.4	50	MDA	720 x 350
18.8	51	Hercules	720 x 348
21.9	60	EGA	640 x 350 1056 x 352
31	60	EGA+	640 x 480
32	60	CGA double frequency	320 x 400 640 x 400

Table 2

pin	MDA	CGA	EGA	PGC	MCGA	VGA mono	VGA colour
1	ground	ground	ground	R	R-out		R-out
2	ground	ground	R'	G	G-out	M-out	G-out
3		R	R	B	B-out		B-out
4		G	G	Com. Sync			
5		B	B	mode		test	test
6	intensity video	intensity	G'	R-ground	R-in	key	R-in
7			B'	G-ground	G-in	M-in	G-in
8	HSYNC(+)	HSYNC(+)	HSYNC(+)	B-ground	B-in		B-in
9	VSNC(-)	VSNC(-)	VSNC(-)	ground	key		
10				ground		G (dig)	G (dig)
11				type 0			G (dig)
12				type 1		G (dig)	
13				HSYNC	HSYNC	HSYNC	HSYNC
14				VSNC	VSNC	VSNC	VSNC
15							

can be used in conjunction with a CGA-compatible monitor, with the obvious advantage of going round investing in a new, high-resolution, monitor.

### PGC: professional at a professional price

The Professional Graphics Adaptor (PGC) was developed and introduced to convince PC users of the fact that CAD software need not necessarily be run on a professional workstation. Unfortunately, the PGC has remained relatively expensive, and has, therefore, failed to become popular. Aimed at the CAD market, the PGC was designed to provide an aspect ratio of 4:3, and to generate up to 256 colours. The multisync monitor mentioned earlier makes it possible to run PGC-based CAD software in the EGA+ mode available on the latest multi-mode EGA cards. That the PGC is bound to be forgotten soon is also caused by the fact that the Video Graphics Array (VGA), introduced with IBM's line of PS/2 computers, is in principle capable of taking over all its functions... as a subset!

### New standards: MCGA and VGA

In an attempt to put an end to the widespread confusion about videocard in PCs, IBM recently introduced two new types of display adaptor, the Video Graphics Array (VGA) and the Multi-Color Graphics Array (MCGA), for use in their Series PS/2 computers. Both adaptors are complete, versatile, and expected to stay with us for quite some time. The MCGA is essentially a 'low-budget' version of the VGA. It comes as standard with the Model 30 computer in IBM's PS/2 line, and has 64 Kbyte of on-board RAM. The maximum resolution of 640x480 pixels is achieved in the two-colour mode. At the lower resolu-

tion of 300x200 pixels, 256 colours are available from a total of 262,144 in the colour palette. The MCGA can display up to 64 grey shades on a monochrome monitor. Downwards compatibility is ensured at least partly by a CGA emulation mode. Other cards such as the EGA or MDA can not be emulated.

The second new card, the VGA, is fitted in PS/2 Models 50, 60 and 80. It can be used with colour as well as monochrome monitors with an analogue (linear) input. Screen memory is 256 kByte for a standard graphics resolution of 640x480 pixels, or 720x400 pixels in the text modes. In the low resolution graphics mode, each of the 320x200 pixels can be assigned one of 256 colours. In the high-resolution mode, this is reduced to 16 colours. The number of available colours in the palette circuit is equal to that in the MCGA. Depending on the selected screen mode, up to 8 screens can be held in memory. Characters are built in a matrix of 9x16 pixels in text mode, or 8x16 pixels in graphics mode. The VGA is capable of emulating all previous

standards, ensuring software compatibility with MDA, CGA, EGA and MCGA. Characters in these subsets have a maximum height of 32 pixels.

### Wanted: monitors!

Selecting a videocard is one thing, finding a suitable monitor for it is another. Table 1 summarizes the vertical and horizontal scanning frequencies of a number of PC videocards. In general, the requirements of the cathode ray tube (CRT) used in the monitor rise with sync frequency. Excellent resolution on a flicker-free display is achieved thanks to high raster and line frequencies (up to 80 Hz and 50 kHz respectively), and non-glare screens.

Obviously, investing in an expensive videocard is useless if the monitor has insufficient resolution. In the case of the monochrome monitor, the maximum resolution is usually determined by the bandwidth of the video amplifier. This means that the design and production of a monochrome monitor are simple compared with those of a colour monitor with equal specifications in respect of resolution. For optimum convergence in a colour picture tube, the electron beams must be controlled with great accuracy to ensure the actuation of only one phosphor element at a time. The size of these elements varies from 0.62 mm in a standard colour TV tube to 0.29 mm in a multisync high-resolution colour monitor. For most graphics applications, a dot pitch of 0.31 mm is sufficient.

The large differences in respect of line and raster frequency between the various videocards give rise to monitor incompatibility. A standard CGA display, for instance, can not be used in conjunction with a Hercules card. Some monochrome, Hercules compatible, monitors, however, are capable of dual-frequency operation so that CGA pic-

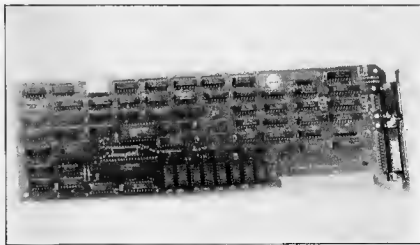

Fig. 2. Hercules card for combined medium-resolution monochrome graphics and text applications. The card shown here is a relatively old, full-length model.



Table 3.		
Videocard	Resolution	Colours
Hercules	720 x 348	2
CGA	320 x 200	2
CGA	320 x 200	4
CGA	640 x 200	2
EGA	320 x 200	16
EGA	640 x 200	4
EGA	640 x 200	16
EGA	640 x 350	2
EGA	640 x 350	4
EGA	640 x 350	16
VGA	320 x 200	256
VGA	640 x 400	16
VGA	640 x 480	2
VGA	640 x 480	16

tures can be displayed by means of shades of grey. Similar dual-sync colour monitors are aimed at users of PCs with a CGA and/or EGA card. The EGA and PGC also require their own monitor type. Apart from a specific line and raster frequency, some videocards supply only digital or analogue signals. Potential buyers of a video card are, therefore, well advised to take all these different specifications into account before deciding on a particular type. Always remember the monitor!

A great effort is constantly being made by monitor manufacturers to provide the widest possible range of products to meet the requirements of customers as well as of the videocards they use.

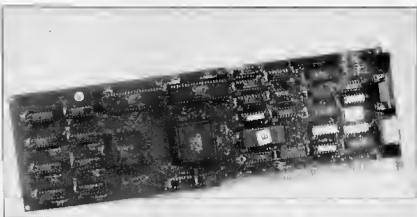

Fig. 3. The widely used EGA card affords good colour graphics and text capabilities at a reasonable price.

Again, the multisync monitor (monochrome as well as colour) is the overall winner here, although VGA and MCGA compatibility is not always guaranteed.

### Cables and plugs

Combining a videocard with an appropriate colour or monochrome monitor is a problem that is even further complicated by the cables and plugs needed for each combination. Table 2 shows an overview of connections for various type of video card. It will be noted that the

MDA, CGA, EGA and PGC make use of a 9-pin D-connector, while the new cards, MCGA and VGA, need more wires and work with a 15-pin connector. In principle, horizontal and vertical sync signals are sent over separate wires; only the PGC uses a combined sync line. Fortunately, this card is of no significance to today's PC user.

## ELECTRONICS NEWS

### New Status for NIC

The National Informatics Centre (NIC), responsible for linking the entire country with a computer network status be given a special status, according to a high-level expert panel. NIC is now a cell of the Planning Commission. It has been set up at a cost of Rs. 180 crores.

The expert panel observed that most of the government departments and ministries are not using the facilities created by NIC. Even the Department of Electronics, which originally set up the centre, does not make use of its computer and other facilities. The

panel set up under Mr. P.S. Deodhar, chairman of the Electronics Commission, submitted its report recently.

The panel has opined that a number of ministries like agriculture, home, science and technology and others have dedicated computer systems at district level. If NIC is given a special status and treated as a part of the government, the multiplicity of investment by various ministries can be avoided. The annual budget of about Rs. 40 crores given to NIC will be sufficient to meet all the data collection requirements of the entire government machinery.

NIC has so far entered into a memorandum of understanding with all the states, excepting Nagaland. So far, it has created the computer network for 300 districts. Of these, 170 district data network systems are fully operational and 130 are in the final stage of testing. It has created information system for 27 sectors such as

agriculture, scheduled castes and tribes, family welfare, health, treasury accounting, education and so on.



# TWEETER PROTECTOR

by K. Baumotte

Tweeters, the high-frequency drive units in a loudspeaker system are often damaged by a properly matched and rated power amplifier. This happens because many modern power amplifiers are direct-coupled to the loudspeakers, i.e., they do not use a transformer. Such amplifiers have the nasty property of producing square-wave signals when they are (even slightly) overdriven. The ensuing harmonics lie chiefly in the frequency range of the tweeter. This considerable spectral shift of the audio signal was, of course, not taken into account during the design stages. This is because during the standard (DIN) testing of the loudspeaker system, the tweeter is required to handle only 1% of the total applied power. In other words, when 100 W of audio power is applied, to a loudspeaker system, the tweeter needs to handle only 1 W. Even if the tweeter is rated well above the standard test specification requirements, during loud music passages, when clipping occurs (and square-wave signals are generated) it may well have to handle too much power. This may happen before any distortion of the sound is heard. Tone controls and equalizers can hasten the demise of the tweeter: a 6-dB lift at 4 kHz doubles the power applied to the tweeter, i.e., makes the unit twice as vulnerable.

## Protection circuit

A relatively simple circuit as shown in Fig. 1 is all that is required to prevent damage to the tweeter, especially if it is frequently used at high volume levels. It can not be a coincidence that most

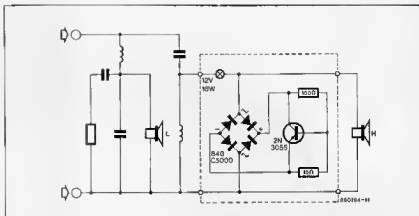

Fig. 1. Circuit diagram of the proposed tweeter protector. The resistance of the lamp increases with rising input power. At the same time, the 2N3055 short-circuits the tweeter during the high power peaks. The circuit is suitable for all tweeters with a cross-over frequency of 5 kHz.

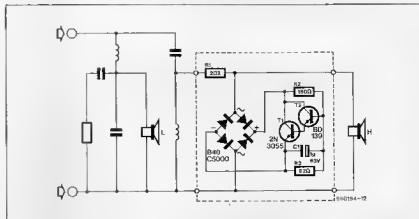

Fig. 2. This is an improved version of the circuit of Fig. 1. Its starting time and time constant may be varied to individual taste. Moreover, it keeps distortion down to an acceptable level.

leading suppliers of disco and public-address systems fit a similar protection circuit in their equipment.

A useful side effect of the circuit in Fig. 1 is that the lamp used as a positive-temperature coefficient resistor gives a visible warning if the sound level is too high. The lamp begins to glow when the power reaches a certain level. When the voltage drop across it reaches about 5.5 V, the lamp severely limits the level of the applied signal. At the same time, the transistor begins to conduct and short-circuits the tweeter. If this situation is allowed to continue, the transistor dissipates enough heat to warrant the use of a small heat sink.

## Distortion

Overloading the tweeter also causes severe distortion: when the voltage at the input to the circuit is 12 V, the level of

distortion is likely to be around 10%. This may be improved very considerably by the use of the circuit shown in Fig. 2. Under the same conditions, the level of distortion is only about 0.2%.

The time constant R3-C1 enables single pulses to pass through the circuit unhindered. Only when the overloading continues do the darlington pair of transistors begin to conduct and short-circuit the drive unit. The time constant may be altered by changing the value of C1 up to 470  $\mu$ F. Slight alterations in the values of R2 and R3 allow the toggle time of T2 to be set to individual needs.

## Finally

Although the circuits in Fig. 1 and Fig. 2 are extremely useful, it should be noted that they are not intended for use with good hi-fi equipment: they are designed primarily for use with disco and public-address equipment.

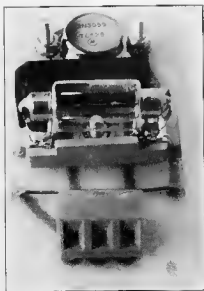

## NEW PRODUCTS

### Oscilloscope Multiplexer

Thurlby Electronic Ltd., UK, have introduced the OM358 Oscilloscope Multiplexer, a self-contained instrument which allows up to 8 channels to be displayed using just one trace of a conventional oscilloscope. Typical application areas included microprocessor-based products, data transmission systems, analog-digital converters, PLLs, frequency dividers, etc.



M/s. MiniATE System • B-7, Pamposh Eclave • New Delhi-110 048 • Tel: 6418470 •

### Digital Temperature Indicator

Instrol's digital temperature indicators, single and multipoint types, are measure temperature in ovens, oil/water baths and furnaces of ceramic industries, process temperatures of chemicals, fertiliser plastic, cement, food-processing and solvent industries. They are available in portable or panel mounting forms with LED/LCD digital displays and for temperature range from ambient to 1999°C with cold-junction compensation for K/J/T thermocouples. Digital temperature Indicators for RTDs are also available. The accuracy is  $\pm 1\%$  or better and resolution is 0.1°C. Thermocouples and

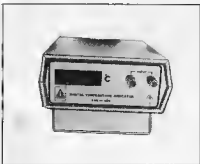

RTD assemblies in standard design or as per specifications are supplied with the temperature indicators.

M/s. Instrol (India) Pvt. Ltd. • A-37, G.I.D.C. Electronics Estate • Gandhinagar-382 016 (Gujarat) • Phone: 21551 •

### Ultrasonic Hardness Tester

The Ultrasonic Hardness Tester model 8701 for metals working the principle of ultrasonic contact impedance has a range of applications due to its independence of fixed testing locations and testing of hard-to-reach points, surfaces, installed parts eg. teeth, bearings, shafts etc., including testing on flat surfaces, curved surfaces etc. The tester probe can be used in any position horizontal, slanted, vertical downwards or vertical upwards and requires no correction; reading can be on huge parts or thin sheets.

The tester is simple to operate. By gently applying the probe against the test object, the hardness of the metal is indicated on the meter. Anyone can measure the metal hardness accurately with ease and fast.

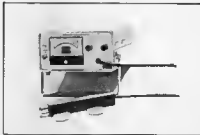

M/s. Mahisa Electronics • H-204, Ansa Industrial Estate • Saki Vihar Road • Saki Naka • Bombay-400 072 •

### Time Switch

GELCO Time Switch Type-101, based on latest IC technology, gives more accurate time for switching off the lights of sign boards, display boards, hoardings,



etc. at set time interval. Pushbutton, LED and time selection switch are provided. Time interval can be selected from 1 to 8 hours. System voltage is 230 V, 50 Hz current capacity 10 A resistive. The device measure 115 mm x 105 mm x 75 mm and weights 0.95 approx.

M/s. Gujarat Electronics & Controls • 9, Advani Market • Outside Delhi Gate • Ahmedabad-300 004 • Phone: 23117 •

### Electronic Safety Guard

The Electronic safety Guard from Electro-Arts works on infrared techniques and ensures safety in dangerous operating areas on automatic machines, power presses, shears, bending machines, etc.. It consists of a set of parallel beam infrared transmitter and receiver which forms invisible curtain in between the operator and the machine. When any of the beam is interrupted the same is sensed and the machine is stopped immediately preventing possibility of accident.

Various models are available covering a height of 100 mm to 1000 mm and up to a range of 4000 mm. The unit works on 220 VAC and is unaffected by vibration and ambient light conditions. It is designed for continuous use.

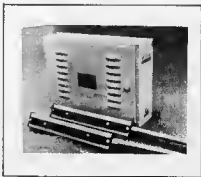

M/s. Electro-Arts • 4, Vaishali • Ganagapur Road • Nashik-422 005 • Ph: 6253-78452 •

## NEW PRODUCTS

### In-Circuit Microprocessor Emulator.

SIIMPLETECH Instruments offer a stand-alone in-circuit microprocessor Emulator for software debugging and hardware integration. The CPU in the circuit can be replaced with the emulator for the various operations involved in locating software errors and hardware faults. The portable, table-top instrument is suitable for field servicing, production testing, and R&D testing. It is totally transparent to the user. A feature is that the CPU can run at its full speed. Break-point allows real time program execution at full speed to a present address. When the breakpoint is encountered the emulator will enter the step Mode in which the VPU status is displayed and makes it possible to examine or alter memory locations, I/O ports and registers. The user can step through and locate the programme, error or circuit faults. The DMA Read/Write, I/O Read/Write, Register Read/Write features help to see what is happening in the CPU and in the circuit. Emulators for 8085 and Z 80 are available; emulators suitable for other processors also can be considered.

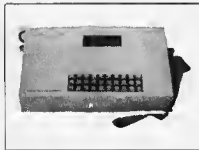

M/s. Simple Tech I-nstruments • M.E.S. Road • Jallahalli • Bangalore-560 013.

### FM Linear Director

THE AK5507B/AK5508B FM linear detectors from Ando Electric Co. of Japan are for measuring the modulation characteristics of FM mobile radio transmitters. They are suitable for a range of applications, including evaluation of data or design and prototype analysis of transmitters and signal generators, as well as adjustments in the testing of such equipment. The AK5507B's frequency range is from 7 to 520 MHz and that of

AK5508B is from 7 to 1000 MGz. Both models can read peak voltage or peak-to-peak/2 voltage. The indications appears in 3 digit decimal LED as well as on the meter. A minimum range of  $\pm 1$  KHz is provided for the modulation factor meter to enable simple measurement of low level modulation. The inductively tuned local oscillator provides stable measurement of S/N ratio even in the presence of external noise and vibration. The use of an external local oscillator allows the enhancement of S/N measuring accuracy by using a very stable crystal oscillator or other signal source. The AK5508B features a residual AM measurement function as well.



M/s. Murugappa Electronics Ltd. • Agency Division • 299, Kamaraj Avenue • Second Street • Adyar • Madras-600 020. • Phone: 41 33 87.

### Conductivity Meter.

A modified AC wheatstone bridge circuit provides alongwith CMOS devices an advancement to NCS 3000 series of industrial conductivity meter from NAINA. This is a low cost single range electrical conductivity meter which can be supplied with a range of 20 micro siemens, 200 micro siemens, 2 mini siemens or 20 mili siemens. The reading is displayed on  $3\frac{1}{2}$  digit LED display of 12.5 mm or 20 mm height. Cell constant compensation is the inbuilt feature however temperature compensation, 4-20mA output, printer output, temperature indication, audio-visual alarms with set points are optionally available. A small



panel mounting cabinet of 96 mm X 96 mm size is used. Selection of dip type cells, flow type cells of Glass, PVC or SS 304 can be made with proper cell constant. Equipment can be used by DM/DI water supply units, boilers, electroplating units, swimming pools, fisheries ponds, chemical industry, cooling towers, pollution studies etc.

Naina Electronics P. Ltd. • 181/6, Industrial Area • Chandigarh 160 002.

### Automatic Coil-Winding Machines

M/s. Tekma Kinomat of Italy have been manufacturing coil-winding machines since 25 years.

These machines are available in several models, with or without CNC system, and having a range of production for wire dia. from 0.02 mm. to 1.5 mm. The production of bimetallic coils too is carried out with the relevant models. The production capacity ranges from 600 to 2000 coils/hour, depending also on the number of spirals.

The production from these machines has application in various products and industries like : Electrical coils; Electrolytic capacitors, Resistors; Coils for Magnetic Cards; Tape-Reading Heads; Data Processors; Electronic Office Machines; Quartz Watches; Dashboard Instruments; Magnets for Starter Motors; Bimetallic coils for Remote-Controls and overload relays; T.V. and Radio industry; Washing Machine and Refrigerator motors and relays; Toy motors etc. The Import of these machines is under O.G.L. for Actual-Users.

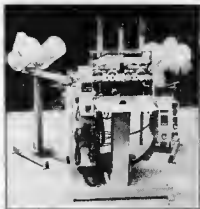

Precision International • D-7, Green Park (Main) • New Delhi-110 016.

## NEW PRODUCTS

### Printed Circuit Board

Besides PCBs for almost every application, including flexible PCBs, Grafica offer PCBs with conductive silver/carbon for telephones, remote control switches, etc. They propose to manufacture touch membranes, keyboard switches, conductive silicon rubber keypads and double sided PTH PCBs.

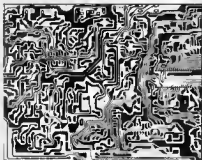

M/s. Grafica Display Co. • 86, Mathuradas Vasanji Road • Near Darpan Cinema • Andheri (E) • Bombay-400 093 •

### DIGITAL TIMER

The PLA Compatible mounting and quartz controlled 30 minutes timer for maximum Demand indicator is available with 1 C/O output contact, accuracy better than 0.1% supply voltage 240/VAC and 110/VAC.



M/s. Sai Electronics • (A Divn. of Starch & Allied Industries) • Thakor Estate • Kurla Kiroli Road • Vidyavihar (West) • Bombay-400 086 • Ph: 5136601/5113094/5113095 •

### Precision Brass Parts

Khanchandani Industries manufacture Precision brass parts as per specification and/or drawings/samples. The brass parts are used in electronics, automobile, electrical, instrument, computer and other industries.



M/s. Khanchandani Industries • 36, shanti industrial estate • Sarojini naidu road • Mulund West • Bombay-400 080

### Digital Multimeter

The PLA DM-20 AR digital auto/manual multimeter features: 4d digit display, fast auto ranging audible continuity tones, frequency/dB measurement facility (only in manual mode), and Auto battery test and auto polarity.



M/s. Pla Electro Appliances Pvt. Ltd. • Thakor Estate • Kurla Kiroli Road • Vidyavihar (West) • Bombay-400 086. •

### Earth Leakage Circuit Breaker

GELCO offer the ELCB (Shock Guard), a static relay that disconnects the supply on the detection of leakage current. On removal of the fault, current relay can be reset manually. The device has fixed leakage current 30mA (adjustable leakage current of 7mA-30 mA and 30 mA-100 mA available on request). It

is available in single phase, 16 A, 30 A, and 60 A. The device measures 170 x 165 x 70 mm.



M/s. Gujarat Electronics & Controls • 9, Advani market • Outside Delhi Gate • Ahmedabad-380 004.

### Torque Gauge

Waters Manufacturing Inc. of U.S.A. Offer the Torque Watch - Torque Measuring Gauges in Three ranges - Low, Medium, and High-from 0.2 g-cm to 14 kg-cm. Torque measurement is easy requiring no special set-up or tools. The gauge is attached to the shaft and rotated by hand to give direct readings on a clear easy-to-read dial. It is useful as a production or laboratory tool as well as inspection instrument in application such as micromotors, small clocks, computer peripherals, small geared drives, potentiometers, measuring instruments industry, and research.

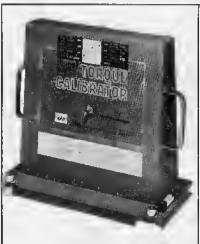

M/s. Universal Automation • 47, Mitra Mandal • Pune 411 009 •

## NEW PRODUCTS

### Electronic Thermal Wire Stripper

Reliance Electronic have developed an electronic thermal wire stripper to remove the insulation of PTFE, PVC and any other insulation. The Device leaves wire free of oxide, nicks or deformations of any kind, high gauge wire. Diameter of wire to be stripped should not be more than 1.6 mm. However cutting of insulation can be done up to 3 mm DIA. The stripper can be used for single and multistrand wires.

A pushbutton switch provided in the handle enables the special alloy blades to heat up to 1500°F in less than 10 seconds allowing the current to pass instantaneously only. The compact solid-state temperature control unit controls the temperature of the blades ranging from 1000 F to 1500°F. The unit will operate single phase, 230 V  $\pm$  10% with out put of 3.5 V, 25 W.

LEG operated wire-stripper, electronically temperature controlled soldering station, solder bath, soldering repairing station and IC remover are also available.

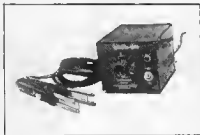

M/s. M.R.K. & Brothers Engineers •  
310-A, Commerce House • N.M. Road  
• Fort • Bombay-400 023 •

### Time Switch

The MIL 2008 Q series time switch is fitted with a quartz Electronic drive control and a step motor. The quartz frequency is 4.19 million hertz; the quartz stabilisation ensures the exact running of the driving mechanism. These time switches are designed for the accurate control of oil heating installations, electric heaters, airconditioning plant, water processing plant, streetlights, traffic signals, etc.

The MIL 2008 Q is available with contact rating of 16 A, 250 VAC, and with daily

and weekly programme dial. Operating on mains supply is, however, continues to run for 150 hour after power failure on a battery back-up.



M/s. Sai Electronics • (In association  
with cupwud Arts) • Thakkore Estate •  
Kurta Kirod Road • Vidyavihar (West) •  
Bombay--400 086 • Ph: 5136601/5113094

### Digital Ohmmeter

ECONOMY offer a bench type instrument for measuring the various resistors in the manufacturing process of electrical heaters, coils and relays. The instrument can also be used by electronic industries for inspection of proper values of resistance.

Features include: 3a digit, 7 segment red LED, 7 measurement ranges with lowest range of 2 ohm with 1 millionohm resolution and highest range of 2 Mohm with Kohm resolution; other ranges of 20 ohm, 200 ohm, 2 Kohm, 20 kohm, and 200 Kohm; 4 wire measurement; and Accuracy  $\pm$  0.1% of range  $\pm$  0.1% of reading  $\pm$  1 digit.

Cabinet size: 240 mm depth x 193 mm width.  
Weight 3 Kg.

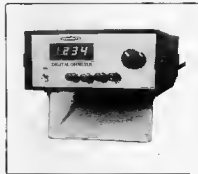

M/s. Economy Electronics • 15, Sweet Home • Plot No. 442 • 2nd floor • Pitamber Lane • Off. Tulsi Pipe Road • Mahim • Bombay-400 016 •

### PCB TESTING SYSTEM

THE PCB System from Struers of Denmark is a complete system for the preparation of PCB cross sections for microscopic examination and testing. The system comprises equipment for all preparation steps from sampling and drilling of reference holes to final grinding and polishing. The object of the system is to facilitate and rationalise control with a single, but frequent source of failure; defects in the through-plated holes in double-sided and multilayer printed circuits PCB System produces 36 or more specimens automatically and reproducibly. The specimens are sectioned with high precision along the centre line of the through-plated holes and mounted in the sample holder with all the holes positioned at the same level. The PCB sampler is a routing/drilling tool for highly accurate and deformation-free sectioning of samples from any given area of a printed circuit board. At the same time it provides the two reference holes ensuring that the inspection holes will be located at the same level in the mount. The mounting device is designed for convenient and troublefree insertion of disposable positioning pins in the reference holes up to 6 samples. The samples are automatically spaced evenly, ready for embedding. The sample holder fits struers Planopol/Pedemax and the three abra machines, which give the user a wide choice of grinding and polishing equipment. Each sample is held by a clip and may be removed individually for microscope inspection between preparation steps. The illustration below shows the marks A, B and C for adjustment of the stop screws for coarse grinding, fine grinding and polishing, respectively.

M/s. Mukund Iron & Steel Works Ltd •  
L B Shastri Marg • Kurla • Bombay-400  
070 • Phone: 512 0180 - 88.

## NEW PRODUCTS

### Programmer Controller

JELTRON Model 814A Programmer Controller is a self contained microprocessor based set point programmer and a single loop industrial controller combined in one compact case. The 814A accepts directly process variable inputs from TCs, RTDs, transmitter voltages and currents and Optical Radiation Temperature Detectors. All temperature inputs are linearized and direct reading in degrees F or C, switch selectable. All transmitter units are field configurable in engineering units, from 999 to 9999 with full decimal point positioning. All program parameters such as Range Limits, Set points, Ramp Times and Soak Times are entered in full engineering units. Times are user configurable from 0.0 to 99.9 hours or minutes. The 814A is a single channel instrument that can store a maximum of 30 segments. Individual programs can be fully independent or linked. A loop instruction allows the segment or any combination of segments to be repeated upto 99 times. Complete program configuration is stored in solid state non volatile EAROM. The 814A is available in wide choice of Control outputs. Reverse acting or direct acting control action is switch selectable. Integral Auto/Manual Station standard with bumpless transfer from auto manual. Remote/Local set point operation is standard. The remote set point input is automatically sealed to the field configured range of the controller. Optionally, RS-232C or RS 422 communication interface is available for supervisory control applications. Set Point, Control output and Configuration of parameters are viewed using the main display. Segment number as well as Set Point are continuously displayed. Program security is assured using a front key lock.



Jeltron Instruments (India) Private Limited. • 6-3-198/2, Road No. 1 • Banjara Hills • Hyderabad-500 034.

### Temperature Indicator Controller

HOSHAKUN has developed Digital Temperature with double thumbwheel type Digital Controller. It is a rugged, compact panel mountable instrument. The bright red 12.5 mm LED Display enables one to read the temperature from a long distance. Set temperature is all the time visible on the front panel by the use of thumbwheel switches. Broken sensor protection and automatic cold junction compensation is standard feature for thermocouple input. Most of the assemblies used in this instrument are plug in which offers simplicity in assembly as well as dismantling for servicing purpose. This instrument can be used for furnaces having heaters in delta/star connection such that during the start up the furnace is heated with heaters in delta form upto a certain temperature (set low) and after than it gets connected into star form up set high around which control action will take place. In other words during start up, furnace is in "MORE HEAT" mode and after exceeding first control point it goes into "LESS HEAT" mode which then controls the temperature of the furnace around the second control point. This also can be used for oil fired furnaces (MORE HEAT mode equivalent to both main and pilot burners on and less heat mode equivalent to only pilot burner on and main burner off).



HOSHAKUN • Vivek Apartments • Plot No. 15 • Tulshibagwale Colony • Sahakarnagar No. 2 • PUNE-411 009.

### Programmable Batch Counter Controller

Micronix offers an ideal instrument for applications where counting, controlling and sequencing operations are involved. The Unit is based on 8085 microprocessor with battery backed memory to retain data during power failures.

The front panel consists of an interactive 4 digit display and hermetically sealed membrane keyboard for entry of parameters. The display is used to indicate event count as well as Jobs done depending on the selected mode. It also indicates to system status on LED indicators. The number of counts per sequence is 999 and no. of sequences is 8 both expandable as per user request. The unit accepts a variety of inputs such as microswitch, optical or proximity switch etc. It provides a change over contact for controller action.

The unit works on 230VAC and is housed in DIN standard enclosure suitable for panel mounting or bench top models.



Micromix • D-74, Angol Industrial Estate • Udyambag • Belgaum-590 008, Karnataka State.

### New Open-Type Terminal Connectors

"IEC" has introduced a new range of Open Type Terminal Connectors - TBM Series. They are presently available in 12 ways, 10 ways and 8 ways. The Connectors are rated at 15 Amps, 250 V AC with a insulation resistance of more than 1000 Mohms and can withstand H.V. test of 2000 V for 1 minute. The Terminals are of Brass with Nickel plating and the housing of electrical grade bakelite or melamine on order.

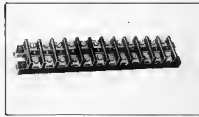

M/s. Asia Electric Company • Katara Mansion • 132A, DR. A. Besant Road • Worli Naka • Bombay-400 018.

## NEW PRODUCTS

### Desoldering Station

Zevac Ausltsysteme GMBH. (WEST GERMANY) manufactures desoldering tools, desoldering station and machines. Zevac Tools are sturdy and designed for high efficiency. ALS desoldering stations consist of vacuum unit desoldering iron and stand, controlled by a foot-switch with 220/24 Volts-supply. PVS-60 is a desoldering system with an integrated vacuum transducer mounted on the soldering iron handle with a finger operated control to enable complete single handed operation with a supply of 220 or 24 Volts. Zevac Desoldering machines are used for desoldering standard integrated components, multilead connectors as well as chips, capacitors, flatpacks etc.

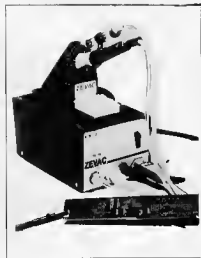

M/s. Arun Electronics Pvt. Ltd. • 2 E, Court Chambers • 35 New Marine Lines • Bombay 40 020. Tel: 252160/259207.

### Digital Multimeter

Ledtron Electronics has introduced autoranging Digital Multimeter Model DT 860A using latest American LSI Technology. Its unique features are autoranging/manual mode, memory for relative measurements, transistor HFE/diode check, datahold, razor sharp LCD with automatic range/function display,

10-ohm range for in circuit resistance measurements etc. It can measure DC/AC voltage up to 1000 V/750 V, DC/AC current up to 15 A, resistance upto 20 megohm and audible continuity check by buzzer. It is housed in compact, portable high impact plastic case with till stand for table top as well as field applications.



Ledtron Electronic • 170 Lohar Chawl • Bombay. 400 002.

### Preset Counters

Micronix offers a range of Digital preset counters for counting and controlling applications. The counters find applications in Machine tools, Pharmaceuticals and food processing industries. Press operations, process control panels, plastic and rubber moulding industries, automobile industries etc.

These counters use CMOS technology. Modular construction makes servicing very easy. The presetting is done through a set of Thumbwheel switches. The actual count is displayed on a 0.5 inch seven segment LED display. It accepts a variety of input sensors such as proximity switch, microswitch or optical sensors.

It gives a set of changeover contacts for control applications. These counters are

housed in DIN standard panel-mountable enclosures. Working voltages are user selectable.



M/s. Micronix • D-74, Angol Industrial Estate, • Udyam bag • Belgaum • Karnataka-590 008.

### Temperature Controller

The ARTECH series 101 Temperature Controller is a simple, rugged and accurate instrument which can find applications in all area of Temperature Control. The unit is fully solid state, selectivity using integrated Circuits. The circuitry can withstand normal machine vibration without adverse effects. Automatic cold junction protection, lead resistance compensation and open sensor protection are standard features. The dimensions are suited for flush panel mounting in a 92 x 92 mm cutout as per DIN 43700.

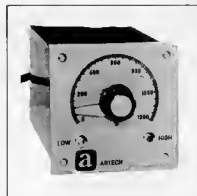

Artech Labs • A-3 Udyog Sadan No. 3 • Central Road • M I D C • Andheri (East) • Bombay 400 093.



# HAVE YOU MISSED OUR ANNUAL NUMBER?

The September 88

## CIRCUITS SPECIAL

With Over Hundred Exciting Circuits

### Special Offer

Send a 3 years subscription

To **elektor** INDIA

and get this Annual-88

**FREE**

This offer is valid for payment  
received between 1st March 1989  
to 31st August 1989

or Send Rs 16/- by M.O. only to:  
**ELEKTOR ELECTRONICS PVT Ltd.**  
52-C Proctor Road, Bombay-400 007

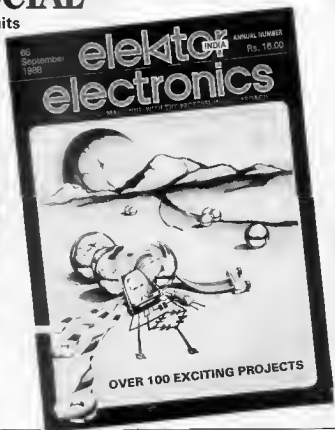

**Chemswab™**  
IPA Saturated  
Foam Swab



**Freez-It® - 65°F**  
Variable Control  
Tracks Intermittents



**Ultrajet® Dusters**  
Precision Filtered  
to < 0.2 Microns



**Flux-Off®**  
CO<sub>2</sub> Propelled  
No Scrubbing



**Konform®**  
UL Listed  
UV Detectable



**Gold Guard™**  
Preserves Precious  
Metal Contacts



**Chempad™**  
IPA Saturated  
Cleaning Pad



**Chem-Wik® Lite**  
Desolders  
50% Faster



**Twillwipes™**  
Textured Cotton  
Lint Free



## Performance you can count on.

The electronic service industry's most popular chemicals and cleaning products for over 30 years.  
Call or write today for a free catalog, samples or technical assistance.

Manufactured by:

 **Chemtronics**  
NEW YORK, USA

For further details write:

**Accra Pac (India) Pvt. Ltd.**

917, Raheja Chambers, Nariman Point, Bombay-400 021.  
Telex 011-5771 APIB IN