

70
February
1989

elektor **INDIA**

Rs. 8.00

electronics

THE MAGAZINE FOR PROFESSIONALS



Sunanda Singh

HIGH DENSITY
TV

COMMAND A COMPUTER
CONSTRUCT A HOUSE

PRACTICAL FILTER
DESIGN (1)

SOFTWARE
WITHOUT TEARS

OVER-VOLTAGE
PROTECTION

THIRD GENERATION
CD PLAYERS

DEVELOPMENT SYSTEM
FOR M6805

LCD
LUXMETER

Publisher: C.R. Chandarana
Editor: Surendra Iyer
Technical Adviser: Ashok Dongre
Circulation & Advertising: J. Dhas
Production: C.N. Mithagari

Address:
 ELEKTOR ELECTRONICS PVT. LTD.
 52, C Proctor Road, Bombay-400 007 INDIA
 Telex: (011) 76661 ELEK IN

Overseas editions:

Elektor Electronics
 1, Harlequin Avenue,
 Great West Road, Brentford TW8, SEW U.K.
Editor: Len Seymour

Pultron Publicações Técnicas Ltda
 Av Espingola 1100, 3º andar CEP 01040 Sao Paulo - Brazil
Editor: Juliano Barsali

Elektor erli
 Route Nationale, Le Sesa; B.P. 53
 592270 Baillieu - France
Editors: D R S Meyer;
 G C P Raedersdorf

Elektor Verlag GmbH
 Susterfeld-Str. 25 100 Aachen - West Germany
Editor: E J A Krempelsauer

Elektor EPE
 Karaiskaki 14 16673 Voula - Athens - Greece
Editor: E Xanthoulis

Elektuur B.V.
 Peter Treckpoelstraat 2.4
 6191 VK Beek - the Netherlands
Editor: P E L Kersemakers

Ferraris & Bento Lda
 R.D. Estefania, 32-1º 1000 Lisboa - Portugal
Editor: Jorge Goncalves

Inglask S.A.
 Plaza Republica Ecuador 2.28016 Madrid-Spain
Editor: A M Ferrer

In Part:
 Kerdhorn Holdings PTY Ltd Cnr Fox Valley Road &
 Kiole Street Wahroonga NSW 2078 - Australia
Editor: Roger Harrison

Electronic Press AB
 Box 63
 182 11 Danderyd - Sweden
Editor: Bill Cedrun

The Circuits are domestic use only. The submission of designs or articles implies permission to the publisher to alter and translate the text and design and to use the contents in other Elektor Publications and activities.

The publishers cannot guarantee to return any material submitted to them. Material must be sent to the Holland address (given above). All drawings, photographs, printed circuit boards and articles published in elektor publications are copyright and may not be reproduced or imitated in whole or part without prior written permission of the publishers.

Patent protection may exist in respect of circuit devices, components etc. described in this magazine.

The publishers do not accept responsibility for failing to identify such patent or other protection.



MEMBER

Printed at: Trupti Offset
 Bombay - 400 013
 Ph. 4923261, 4921354
 Copyright © 1989 Elektuur B.V.

Surendra Iyer
CONTENTS

Editorial

Gallium-arsenide a bright future? 2.23

Special Feature

High density television a costly dream come true 2.10
 Command a computer construct a house 2.14

Audio & Hi-Fi

Decoding ICs for CD players 2.28

Components

Practical filter design: a new series 2.45

Computers

PROJECT: Autonomous I/O controller (final part) 2.34
 A low cost development system for M6805 microprocessors 2.39

General Interest

Overvoltage protection 2.24
 PROJECT: Thyristor speed control 2.32
 Improving automotive wiring systems 2.47
 PROJECT: LCD luxmeter 2.54

Science & Technology

Software without tears 2.51

Test & Measurement

REVIEW: Part 13 - Power supplies (I) 2.49

Information

Industry news 2.18
 Telecom news 2.20
 Electronics news 2.22
 New Products 2.66
 Appointments 2.73

Guide-Lines

Classified ads 2.74
 Index of advertisers 2.74

GALLIUM-ARSENIDE: A BRIGHT FUTURE?

Mainly because of the needs of the satellite TV business, but also those of the automobile industry, the demand for gallium-arsenide (GaAs) devices is growing at a rate not foreseen by many only a year or so ago. Pundits now reckon that the world market for GaAs devices will be worth in excess of £2 billion by 1992. The main requirements will be for monolithic microwave integrated circuits (MMICs), field-effect transistors (FETs), and high electron-mobility transistors (HEMTs).

Gallium-arsenide devices have some important advantages over silicon devices. First, they exhibit far greater electron mobility, which means that considerably faster circuits can be realized than with silicon. Second, they have far better thermal stability and greater resistance to radiation, which is of particular importance for the production of very fast and highly integrated memories.

On the other hand, silicon has better uniformity, purity, and surface smoothness, which results in better control, and thus greater efficiency.

As far as the state-of-the-art is concerned, much larger and more complex ICs can at present be fabricated with silicon. In general, gallium-arsenide technology is still well behind silicon technology, but the industry expects that it will have caught up by the early to mid 1990s.

From this, it is clear that the applications for GaAs devices will remain, at least for the time being, in those areas where the physical properties of GaAs are superior to those of silicon. These areas include the military sphere, aerospace industry, aviation, satellite television, and automotive engineering. Initially, the use of gallium-arsenide will be confined to small and medium scale ICs, but in the not too distant future it will also be possible to use the material for VLSI circuits.

The United Kingdom, through Plessey, has a good lead in Europe in GaAs technology—in fact, there is no other European supplier. But competition from Japan and the USA is strong. Such an important lead is, of course, worth preserving and it is, therefore, encouraging that the Government has recently authorized a £25 million GaAs research programme.

There are, however, quite a few opponents to the GaAs research programme who say that this money would be better spent on research into silicon technology. Indeed, a number of these researchers believe that within a relatively short time silicon circuits will have been developed for speeds up to 25 GHz. Not unnaturally, many industry insiders take a very sceptical view of these beliefs.

The government programme for GaAs research has staunch supporters, among them the chairman of BICC, Sir William Barlow. During a recent lecture at the Institute of Electrical Engineers, Sir William called for a vast fibre-optic cable network across the UK for the distribution of satellite TV and data services. Such a scheme would provide a massive demand for GaAs devices for use in the necessary decoders and allied equipment. It would also create many thousands of jobs over a long period. Alas, it is only a plan that will probably never come to fruition owing to the absence of firm, co-ordinated policies.

Front cover

The Olympus thermal model in the satellite assembly hall of British Aerospace. Olympus 1, the world's largest and most powerful civil three-axis stabilized telecommunication satellite, has already completed solar simulation tests and is now undergoing final environmental testing prior to launch on Ariane III in a few months' time. Olympus 1 is 2.9 m wide, 5.6 m long, and has a solar array of over 25.6 m². It has been built under contract to the European Space Agency. It carries a 20-30 GHz payload, suitable for video teleconferencing and other business applications.

OVER-VOLTAGE PROTECTION

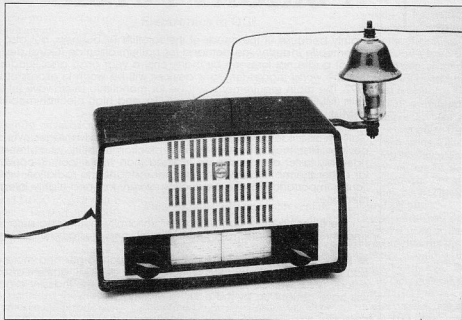

The use of some form of over-voltage protection in electronic equipment is often not contemplated until a huge voltage surge has caused considerable damage. Since it is invariably better to be safe than sorry, this article looks at two over-voltage protection devices (*surge arresters*), the varistor and the gas-filled conductor, and discusses their operation and application.

Over-voltage is basically any voltage that exceeds the nominal value plus the stated tolerance. Over-voltage can be generated by various sources, of which lightning is probably the best known. A thunderstorm, even while it is several miles away, can give rise to voltage peaks of considerable amplitude on the mains network. The switching on and off of relatively heavy loads connected to long wires or conductors, which form a considerable self-inductance, also causes such peaks. The mains network is, however, not the only large self-inductance where over-voltage protection is required: model railway systems, telephone and computer networks are also prone to picking up interference and surges with a disastrous effect.

A number of components are available for over-voltage protection. In electronic circuits, much use is made of conventional diodes, suppressor diodes and zener diodes. The varistor is an interesting component that has already been used in a number of projects recently featured in *Elektr India*.

Figure 1 shows a comparison between the 4 most commonly used types of over-voltage protection device, in respect of

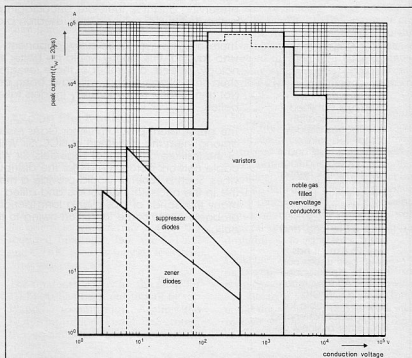

Fig. 1. This chart shows maximum peak current ($t=20 \mu\text{s}$) as a function of conduction voltage for four types of over-voltage protection device.

0.1 mA when the varistor does not conduct. In the rounded part at the low side of the curve, the internal resistance is mainly determined by R_v , which is much smaller than R_z , but still larger than R_{in} . At large currents, the resistance of the ideal varistor is practically nought. The ohmic resistance of the metal-oxide parts (R_n) then determines the internal resistance. Capacitor C is relatively large (100 to 4000 pF). Without additional components, such as series-connected variable capacitance diodes, varistors are, therefore, unsuitable for high-frequency applications. Related to over-voltage protection, however, the internal capacitance is useful because it provides some smoothing of voltage surges. Inductor L represents mainly the self-inductance of the varistor's wires. For optimum speed of the varistor, these wires should be kept as short as possible.

At less common nominal voltages, a suitable varistor may be made from series-connected varistors individually specified for a lower nominal voltage. When this is done, care should be taken to use varistors from the same series. Parallel connection of varistors is not possible owing to tolerance on the effective surface area. In the worst case, this tolerance may cause currents in parallel-connected varistors to differ by as much as a factor 1,000. Selecting matched types is particularly difficult for high peak currents, since measuring and generating these require specialized equipment.

The electrical behaviour of a varistor in overload conditions depends on the type of overload. A too high peak current causes the varistor to explode, so that the connection is broken. A long-term, light, overload gives rise to mixing of the metal-oxide granules, so that the varistor changes gradually into a low-value resistor.

Evidently, there exist no maximum values for voltage and current surges, so that a correctly selected varistor may still be overloaded. With this in mind, it is clear why varistors are typically mounted at some distance from other components, especially when used for suppression of interference on low-impedance networks, such as the mains.

Which varistor?

In general, the choice of varistor for a particular application is made on the basis of the datasheets supplied by the manufacturer. First, the operating voltage is determined, taking care not to confuse the DC and AC specifications. Next, the tolerance is added to the nominal voltage, and the result is rounded off to the next higher value in the series. For most applications with 240 V and 220 V mains networks, a

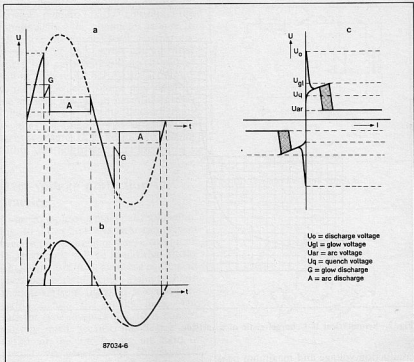

Fig. 6. Current/voltage response of a noble-gas filled surge arrester to a sinusoidal voltage.

250 V varistor is adequate. Maximum peak current and energy absorption are then determined, and a suitable type is selected. The U-I characteristic of the varistor shows the maximum voltage across the varistor when this conducts. If this voltage is higher than the maximum permissible voltage for the protected circuit, a different varistor with a more appropriate U-I characteristic will have to be found.

Noble-gas filled surge arresters

This type of over-voltage protection device is based on the gas discharge principle, as illustrated in Fig. 6. Once the sinusoidal voltage has reached the discharge level, U_d , a glow discharge takes place that brings the voltage down to 70 to 150 V. Current is then 0.1 A to 1.5 A. If the current rises, an arc discharge takes place that brings the voltage down

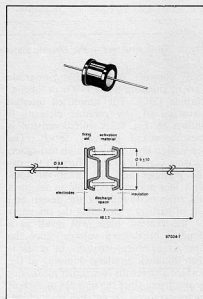

Fig. 7. Internal structure of a noble-gas filled surge arrester.

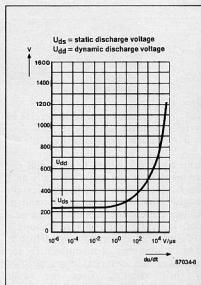

Fig. 8. Conduction voltage, V, of a noble-gas filled surge arrester as a function of the rate of rise, du/dt , of the over-voltage pulse.

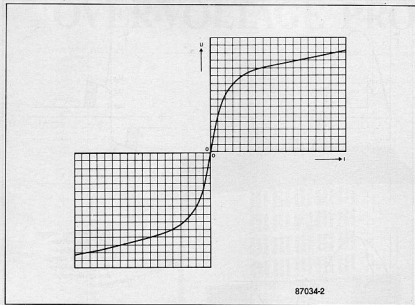

Fig. 2. Symmetrical U-I characteristic of a varistor.

conduction voltage and maximum peak current during conduction. This article mainly focuses on varistors and gas-filled surge arresters.

Conducting ceramics

The varistor, also called VDR (voltage-dependent resistor), is comparable, to some extent, to the zener diode. The difference is mainly that the U-I characteristic of the varistor is symmetrical, i.e., the zener effect occurs with positive as well as negative current. The curve in Fig. 2 is obtained from

$$I = KU^\alpha$$

or

$$U = CI^\beta$$

where

I = current through varistor

U = voltage across varistor

K; C = a constant dependent on size of

varistor element; $K=1/C^\beta$

α ; β = material constants; $\alpha=1/\beta$.

Both constants, α and K (or β and C), are taken from the manufacturer's data sheets. Depending on the application range, additional data is provided. Among these is the maximum peak current, I_{max} . The graph in Fig. 3 shows a so-called 8/20 μ s current surge, which is used by a number of manufacturers for specifying the electrical characteristics of their varistors. Even for small varistors, the value of I_{max} is expressed in kilo-amperes (kA).

The disc-shaped ceramic element in a varistor is typically made from a metal-

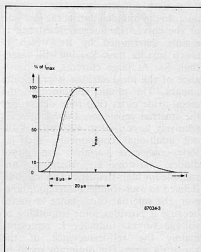

Fig. 3. Shape definition of the so-called 8/20 surge used for measuring the maximum peak current capability of over-voltage protection devices. The repeat rate of this pulse is 30 seconds or 3 minutes, depending on the test method adopted.

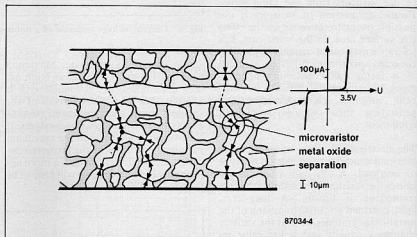

Fig. 4. Basic structure of the ceramic material used in a varistor.

oxide powder — usually zinc-oxide (ZnO), titanium-oxide (TiO) or silicon-carbide (SiC). The simplified internal structure of the ceramic element is shown in Fig. 4. A micro-varistor is created where granules touch. The separation layer forms a high resistance, causing current to flow through the oxide granules and the micro-varistors. This fact makes it possible to set up a few rules of thumb for the design and use of varistors. Doubling the thickness of the ceramic plate will result in a doubled breakdown voltage, since the number of micro-varistors in series is then doubled. Similarly, doubling of the surface area results in a higher maximum peak current since the number of current paths arranged in parallel is doubled. Lastly, doubling the volume results in double the amount of energy that can be absorbed.

The equivalent circuit of a varistor is drawn in Fig. 5. R_v is an ideal varistor. R_z causes a leakage current of less than

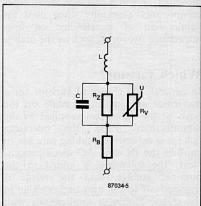

Fig. 5. Equivalent circuit of a varistor.

to 10 to 20 V. As the current becomes smaller, the arc will extinguish at 10 to 100 mA. After a short glow phase, the surge arrester reverts to its normal state. Combination of the voltage and current curves yields the U-I characteristic shown in Fig. 6c. It is seen that the voltage across the conductor decreases rapidly when ignition occurs. This is in contrast to the varistor, which maintains a largely constant voltage.

The internal structure of the noble-gas filled surge arrester is illustrated in Fig. 7. The device is hermetically sealed to prevent ambient parameters, such as gas type, gas pressure, relative humidity and pollution, from changing its carefully defined electrical characteristics. The electrodes are covered in a material that facilitates electron emission. A firing aid may be mounted at the inside of the insulator to speed up reaction time. The electrical characteristics of the noble-gas filled surge arrester are determined mainly by the type of gas, gas pressure, and electrode activation material.

Figure 8 shows that the discharge voltage rises if the rate of rise of the interfering voltage exceeds a certain value. As already seen in Fig. 6, the noble-gas filled surge arrester is not extinguished until the instantaneous voltage falls below the quench voltage, U_q . This is not a problem with alternating voltages, but direct voltages higher than the quench voltage may give rise to difficulties. Everything is fine as long as the internal resistance of the voltage source is so high as to cause the voltage at the relevant current to drop below the quench voltage. A problem arises, however, if the internal resistance of the voltage source is so low that the surge arrester is not quenched. Fortunately, quenching can still be ensured by connecting a varistor in series with the gas-filled surge arrester as shown in Fig. 9. Since, after the interfering pulse

has disappeared, the voltage across the varistor remains fairly constant, the voltage across the surge arrester is sure to fall below the quench level. Further applications of this series circuit arise where low capacitance (1 to 10 pF) as well as high resistance ($>10^{10} \Omega$) are required, but where voltage dips down to the arc level are just as harmful as over-voltage surges. Following the discharging of the gas-filled surge arrester, the varistor ensures that the voltage remains within safe limits (see Fig. 9b).

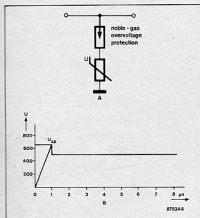

Fig. 9. Series connection of a noble-gas filled surge arrester and a metal-oxide varistor. The graph shows the voltage across the combination.

Over-voltage protection in practice

As an example of a practical application, Fig. 10 shows how a varistor can prevent over-voltage damaging, say, a computer. In practice, it will be found that fitting small varistors in all available equipment gives better results than a single, high-energy, varistor fitted at a central location across the mains lines. The varistor type given in Fig. 10 is conservatively rated because the degree and nature of the interference are hard to predict. In general, the choice of a suitable varistor is not critical in protection circuits for low-power equipment — in this case, the nominal voltage is the main criterium.

Provided there is room to fit them, varistors may also be used to prevent arcing on the collector of small DC motors — see Fig. 11. For AC as well as DC model railway systems, it is recommended to use varistors on motors and track sections.

Source:

Gas-filled over-voltage conductors, metal-oxide varistors (SIOV). Siemens Publication.

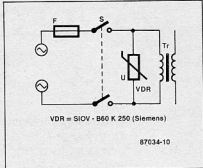

Fig. 10. Typical varistor application.

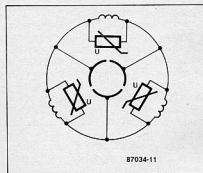
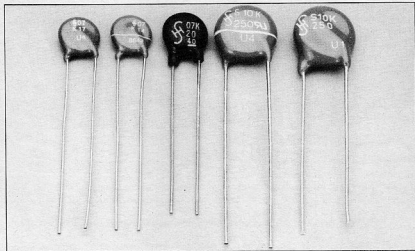

Fig. 11. Arcing at the collector of a DC motor can be prevented by fitting three varistors on the rotor.

Component availability note:

A range of Siemens SIOV varistors, including the Type S10K250 used in recent *Elektronics* projects, is available from ElectroValue Limited • 28 St Judes Road • Englefield Green • Egham • Surrey TW20 0HB. Telephone: (0784) 33603. Telex: 264475. Fax: (0784) 35216. Northern branch: 680 Burnage Lane • Manchester M19 1NA. Telephone: (061 432) 4945.



On Siemens' range of varistors, S stands for disc-type (B=block type); the following two-digit number indicates the diameter of the varistor element; K indicates a tolerance of 10% (J=5%; S=special); the last number indicates U_{nommax} . SIOV (Siemens metalOxide Varistor) is a registered trademark.

DECODING ICs FOR CD PLAYERS

Although the majority of popular compact-disc players on the market offer 16-bit \times 4 times oversampling, it is by no means certain that this is the standard for the future. Philips-Valvo have introduced new decoding chips that may herald the third generation compact-disc player offering 1-bit \times 256 times oversampling.

Figure 1 of *Pitch Control for CD Players*¹³ showed the block schematic of a typical second-generation compact-disc player. The signal processing (decoding) section of that diagram is repeated in Fig. 1 of this article. It consists of four special CD ICs and a standard DRAM. For the third-generation CD player, the four special CD ICs have been replaced by two new ICs as shown in Fig. 2.

The current SAA7220 is a phase linear, 4 \times oversampling digital filter with 120 filter coefficients. Its frequency response is shown in Fig. 3. In conjunction with the Type TDA1541 16-bit digital-to-analogue converter and the Type

TDA1542 third-order analogue filter, it has a ripple of only 0.02 dB in the pass band and an attenuation of >50 dB outside the pass-band. It is not ideal for use with de-emphasis circuits.

The SAA7220 also interpolates the values of missing or uncorrectable samples. It can estimate up to eight such samples as shown in fig. 4. The figure also shows that the SAA7210 decoder provides a basic interpolation function prior to the SAA7220.

For good sound quality, both efficient error correction and good linearity of the Type TDA1541 digital-to-analogue converter are vital. This IC contains two complete 16-bit D-A converters that, like

the earlier TDA1540, operate on the well-known current division principle. Since each of the stereo channels has its own converter, there is no time delay between their signals. The conversion time is shorter than 2 μ s, so that data rates of more than 6 Mbit/s can be processed. By periodic overlapping of the two D-As on one chip, it is possible to achieve a sampling rate of 380 kHz per channel. As a matter of fact, in some CD players the TDA1541 provides 16-bit \times 8 times oversampling.

The SAA7220 is connected to the TDA1541 via a so-called I²S (Inter-IC-Sound) bus. This consists of a clock line, a serial data line, a control line, and a

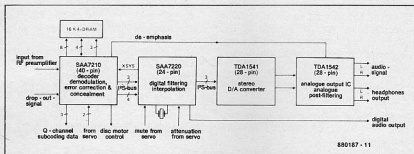

Fig. 1. Block diagram of the decoder and digital-to-analogue converter in a typical second-generation CD player.

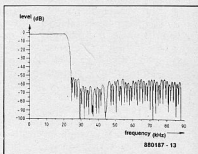

Fig. 3. Frequency response of the digital filter in the SAA7220.

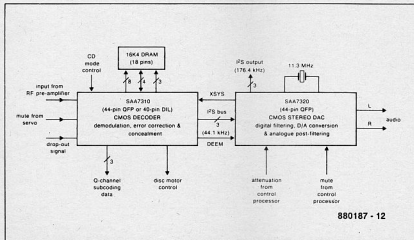

Fig. 2. Block diagram of the decoder and digital-to-analogue converter stages in a third-generation CD player: five chips have been reduced to three.

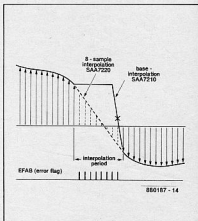

Fig. 4. The SAA7210 provides basic interpolation of uncorrectable sample values. The SAA7220 then equalizes up to 8 sequential sample values by linear interpolation.

line that connects the system clock in the SAA7220 to the SAA7210 (where the clock is connected to the disc motor servo). The control line serves to indicate whether the data pertain to the left-hand or right-hand channel.

The Type TDA1542 third-order low-pass filter also has provision for a matching amplifier and a driver stage for headphones output.

The internal circuit of the TDA1542 and the external components required to form it into a Thomson-Butterworth third-order low-pass filter are shown in Fig. 5. Its frequency response is shown in Fig. 6. Without de-emphasis, the cut-off frequency is about 45 kHz, so that in the CD transmission range up to 20 kHz ripple and phase shift are very small. When the sound reproduction has de-emphasis, the TDA1542 is provided by the SAA7210 with an appropriate control signal that actuates the de-emphasis elements via opamps A₂ and A₃. The response is then as shown by the dashed line in Fig. 6. It has a number of lower cut-off frequencies which cause a noticeable phase shift. The equalizing characteristic and the equality of the two channels is then determined largely by the tolerance of the external resistors and capacitors, so that fairly large deviations from the nominal values may result. This fact is normally ignored during the testing of CD players. It would be interesting to see the frequency response of CD players that have de-emphasis. It must be admitted that there are not many of these, however. It is even so that, for instance, Cambridge Audio Systems have removed the de-emphasis circuits from their latest high-end CD player.

Network L₁-C₃ forms a notch filter for appropriate attenuation of the 156.4 kHz harmonics at the output of the D-A converter.

A complete circuit diagram of a typical decoder circuit found in many popular CD players is given in Fig. 7. Instead of the not yet widely used TDA1541, two dual opamps Type NE5532 are used to form the analogue filter. The de-emphasis circuits are actuated by relay contacts K₁ and K₂. The relays are energized by driver T₂ at the DEEM output of the SAA7210.

The stereo signal is available at outputs a and d. There is no provision for headphones outputs.

It is worth noting that in this circuit, as well as in that of Fig. 5, electrolytic capacitors are used in the signal path. This was also the case in the Philips CD players used for the research of this article. It only goes to show that if you don't know there are electrolytic capacitors in the signal path, you don't hear their presence! None the less, Walter Jung, who, as Matti Otala, became well known in the 1970s by his articles on a.f. opamps and amplifier

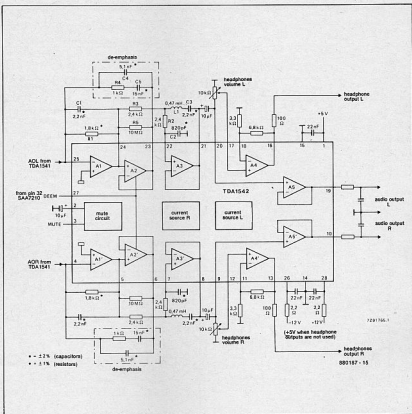

Fig. 5. Internal circuit of the TDA1542 together with the external components required to make it into a third-order low-pass filter.

techniques, gives his recommendations for reconstructing these circuits without the use of electrolytic capacitors in the January 1988 issue of *The Audio Amateur*.

Third generation CD

As already shown in Fig. 2, in the next generation CD player, the SAA7310 performs the same functions as the current SAA7210: demodulation, full error correction, and basic interpolation of uncorrectable audio samples. In addition, it controls the new data interpolation inhibit and the data concealment process. The SAA7320, which replaces the SAA7220, the TDA1541 and the TDA1542, includes a phase linear digital low-pass filter, two newly designed high-linearity D-A converters and opamps for analogue post-filtering. Like the SAA7220, it has facilities for attenuating the audio output by 12 dB, which can be used at the start of *fast forward/fast reverse* commands and a search for a track, for instance. In addition, the soft mute facility that can be used when moving to another track and during pauses is retained.

As already stated, the data format between the SAA7310 and SAA7320 is according to the inter-IC sound specification, I²S. The I²S bus is a 3-line bus comprising clock, serial data line, and a

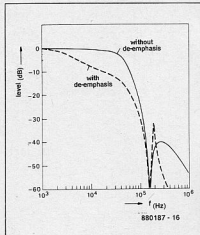
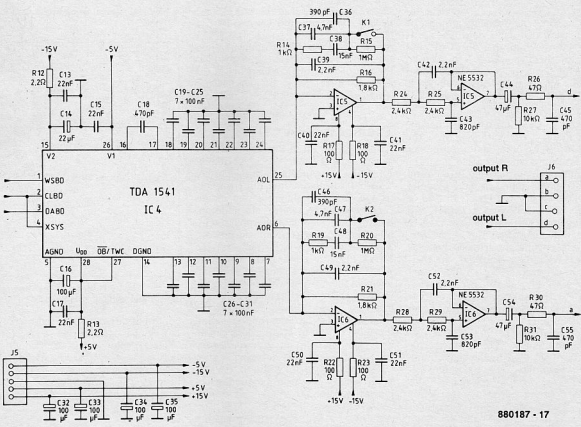
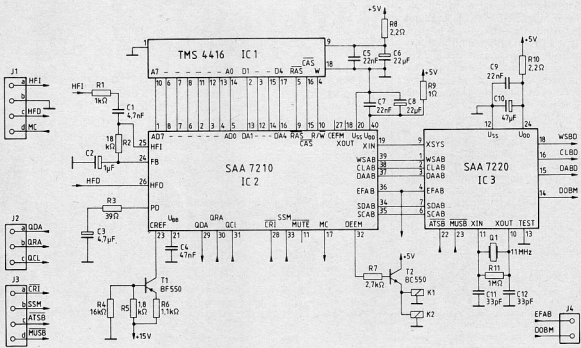

Fig. 6. Transfer function of the filter in Fig. 5 with and without de-emphasis.

control line used to select right-hand and left-hand channel words. The I²S format allows combinations of second- and third-generation ICs to be used in a CD player, giving the player manufacturer maximum design flexibility.

Apart from having fewer ICs, the third-generation players draw a much smaller current, since the new chips are all made in CMOS technology and intended for surface mount production. The SAA7310 is, however, also available in a DIL package. The new chips should,



880187 - 17

Fig. 7. Circuit diagram of the decoder and digital-to-analogue converter stages in a typical second-generation CD player.

Table 1.
Decoding ICs for CD players

	de-modulation	error correction	interpolation basic	interpolation enhanced	digital-filtering	D/A conversion	application
1st generation	SAA7010	SAA7020	SAA7000	—	SAA7030	2 x TDA1540 plus discrete analogue low-pass filter	home players
2nd generation		SAA7210		SAA7220		TDA 1541 plus TDA1542	home and full-performance players
3rd generation		SAA 7310		—	SAA 7320		portable and home players
2nd & 3rd generation		SAA 7310		SAA 7220		TDA1541 plus TDA1542	full-performance players

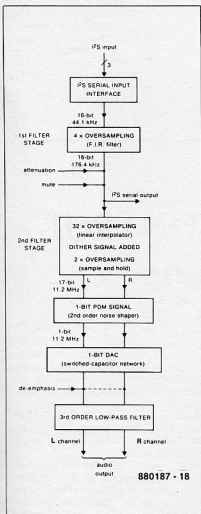

Fig. 8. Block schematic of the data flow in an SAA7320.

therefore, make possible the production of inexpensive, high-quality portable and mobile CD players. The possible combinations of current and new-generation chips are given in Table 1. The data flow in the SAA7320 is given in block schematic form in Fig. 8. The first filter stage corresponds to that in the current SAA7220, but has 128 filter coefficients instead of 120. The filter is followed by an I²S output so that operation with a TDA1541 as D-A converter is possible. The remainder of the IC is then not used.

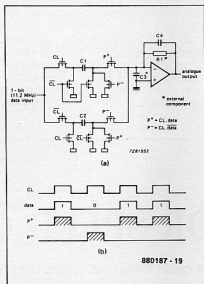

Fig. 9. Circuit diagram of the 1-bit digital-to-analogue converter in the SAA7320.

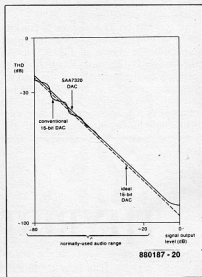

Fig. 10. At low signal levels, the linearity of the 1-bit system is better than that of a conventional 16-bit D-A converter.

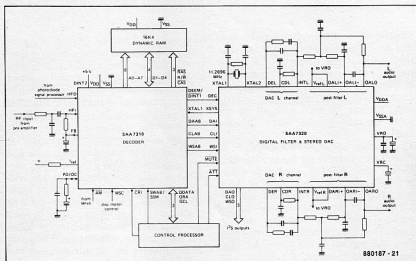

Fig. 11. Schematic diagram of the decoder, D-A converter and analogue filter in a third-generation CD player. Compared with second-generation circuits, as in Fig. 7, it has far fewer components.

The 4x oversampling filter is followed by a further oversampling filter (64x; first 32x by linear interpolation and the 2x by sample-and-hold). An internally generated noise resembling dither signal is added to the signal to reduce quantization distortion at low signal levels.

This increases the amplitude, however, so that after interpolation 32-bit wide samples ensue.

The 256x oversampling process therefore provides 17-bit words at a sampling frequency of 11.28 MHz (≈ 191.76 Mbit/s). A 1-bit quantizer reduces the 17

bits to 1 bit per sample. (A quantizer is a circuit that selects the digital subdivision into which an analogue quantity is placed, i.e., a sort of A-D converter). The resulting rounding-off error is fed back to the input of the quantizer, whose correcting action reduces the quantization noise so that only a minute part remains in the audio range. In practice, this technique works so well that the signal-to-noise ratio with 1-bit \times 256 times oversampling corresponds to that of a conventional 16-bit D-A converter without oversampling.

The actual 1-bit D-A converter consists of a very simple circuit with switched capacitors as shown in Fig. 9. During the first half of the sampling period, depending on the logic state of the data input, capacitor C_1 is charged (drawing current from the inverting input of the opamp) or C_2 discharges (sending current into the inverting input of the

opamp). During the second half, the process is reversed.

The linearity of such a 1-bit converter can be superior to that of a conventional D-A converter. On the one hand, there are fewer converter stages and thus fewer tolerances, and on the other, the LSBs become more accurate. These LSBs normally cause non-linearity and thus distortion at low signal levels—see Fig. 10. Because of the superior linearity at small signal levels, the 1-bit system may well offer advantages (acoustically speaking) over the less-precise 16-bit D-A converter.

The opamp in Fig. 9 that serves as a current-to-voltage converter and also as a first-order low-pass (6 dB/octave) filter is followed by an opamp for each channel. Each of these opamps forms a second-order filter with external components—see Fig. 11.

These opamps operate from 5 V and

have a slew rate of 30 V/ μ s and a signal-to-noise ratio of more than 100 dB.

A further, third-order (18 dB/octave) filter in each channel ensures an optimum flat frequency response over the audio range of 2 Hz to 20 kHz and a high (60 kHz) cut-off frequency. Furthermore, there is no phase shift at frequencies below 20 kHz.

THYRISTOR SPEED CONTROL

This low-cost circuit gives excellent speed and torque control of series motors rated up to 3500 W as used in electric drills, saws and grinding machines. Built from only seven components, the speed controller is suitable for fitting into a compact ABS enclosure with mains input and output.

Electric tools with electronic speed control are invariably more expensive than tools without this useful facility. If the purchase of several tools is considered, it is, therefore, a good idea to decide on the construction of a single speed control unit that can be used with all electric tools, including the ones already available.

The thyristor speed control circuit is, of course, also suitable for loads other than electric tools. Intensity control of a normal bulb, for instance, is possible when it is remembered that the maximum output power of the circuit is only half the nominal power consumption of the load. This is so because the circuit uses only half periods of the sinusoidal input voltage. The insertion of a bridge rectifier, rated at 400 V/10 A, between the mains and the input of the speed control circuit, affords regulation over the full power range. For the application discussed here (speed control of series motors), however, the bridge rectifier should not be used.

The circuit diagram of the speed control unit is given in Fig. 1. Capacitor C_1 and inductor L_1 form a filter for suppres-

sion of interference on the mains, generated when the control circuit is triggered during the conduction phase. Since diodes D_1 and D_2 do not conduct during the negative half period of mains voltage, potential divider R_1 - P_1 supplies only positive voltage to the gate (G) of thyristor Th_1 . This means that the load is only powered during the positive excursions of the mains voltage — hence, the maximum power that can be supplied is half the nominal power consumption of the load, so that the maximum speed of the motor in the tool is reduced also. In most cases, this is not a problem since speed regulation is useful for relatively low speeds only. The power reduction even has an advantage in that it gives greater accuracy of speed control because the full range of the potentiometer is available for a relatively small speed range.

Circuit description

The speed control circuit is based on power regulation with the aid of a thyristor, Th_1 , which conducts only at a user-defined phase angle of the positive

half cycle of the alternating mains voltage. The difference between the gate potential of the thyristor and the reverse electromotive force (EMF) supplied by the motor determines when Th_1 is fired. Firing takes place when the gate is a few volts positive relative to the voltage across the motor.

The reverse EMF generated by the motor rises with the speed this runs at. This means that the thyristor will be fired less frequently as the motor runs free (i.e., non-loaded) at the set speed — the reverse EMF is then virtually equal to the gate potential. In that case, the total energy consumption of the motor is, in principle, only due to compensation of internal mechanical and electrical losses. When the motor is loaded, however, its speed, and with it its reverse EMF, decreases, causing the thyristor to be fired earlier. Consequently, more energy is fed to the motor, so that its speed is corrected until the set level is reached.

The type of speed control described above works well at relatively low speeds only because it requires a fairly large drive margin. Evidently, full speed compensation for a heavy load becomes

more difficult to achieve as the set speed approaches the maximum speed (in this case, about 50% of the real maximum).

Construction

The printed-circuit board shown in Fig. 2 has been designed to ensure that the speed control circuit can be built in a simple, yet safe, manner. The size of the completed board is such that it is readily fitted in an ABS power-supply enclosure with moulded mains plug. Since the circuit is connected direct to the mains, and carries lethal voltages, it should NEVER be used until the enclosure is properly closed.

Although the stated thyristor can control loads up to 3,500 VA, it is recommended to fit it with a TO-220 style heat-sink when loads over 800 VA are connected. The connections between PCB and mains pins of the enclosure, and those between PCB and the load, are made with the aid of PCB-mount terminal blocks. For 240 and 220 V mains networks, it is imperative that C_1 has a AC voltage rating greater than 250 V, or 400 VDC. Inductor L_1 is a ready-made suppressor choke for thyristor circuits. Its inductance is fairly uncritical, and can be any value between 20 and about 100 μ H. Potentiometer P_1 must be a wire-wound type with a plastic shaft.

Parts list

Resistors:

$R_1 = 8K2; 5 W$

$P_1 = 1K0; 1 W; \text{ wirewound potentiometer with plastic shaft}$

Capacitor:

$C_1 = 100n; 400 VDC (250 VAC)$

Semiconductors:

$D_1; D_2 = 1N4004$

$Th_1 = TIC126M$

Inductor:

$L_1 = 40\mu H; 10 A \text{ suppressor choke (Omni Electronics)}$

Miscellaneous:

$K_1; K_2 = \text{PCB mount terminal block}$

Heat-sink for Th_1 .

ABS PSU enclosure (e.g., Maplin FG41U or ElectroMail 503-571).

PCB Type 87200

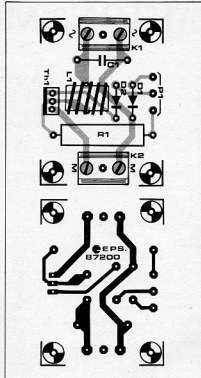

Fig. 2. Track layout and component overlay of the printed circuit board for the speed controller.

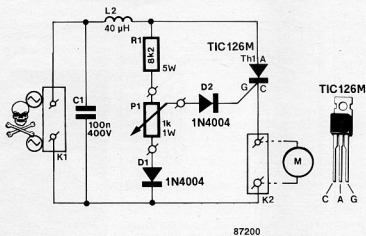

Fig. 1. Circuit diagram of the low-cost, thyristor-based, speed control circuit.

AUTONOMOUS I/O CONTROLLER

This concluding instalment of the article deals with serial interface hardware at the host computer side, and software command descriptions.

Final Part

The RS232-to-current loop converter shown in Fig. 12 is the same as that used in the microcontroller-driven power supply. A discussion of its operation and application can be found in Ref. 1. Constructional details are shown in Figs. 13 (printed-circuit board) and 14 (practical version, ready for fitting inside the hood of a male D-25 connector). Pins 4 and 5 of non-used D9-connectors should be interconnected to prevent breaking the current loop. The adaptor allows up to 6 instruments to be connected to the bus, but only if the host computer supplies ± 12 V at its RS232 outlet. Some computers supply only 5 V, which limits the number of instruments that can be connected to 2 or maybe 3.

Selective addressing

The bus structure designed for the autonomous I/O controller and the microcontroller-driven power supply (Ref. 1), allows individual addressing of equipment with the aid of selection codes, which are in the range from 128 to 155. When an instrument selection code is sent via the bus, the central processor in each bus-connected instrument is in-

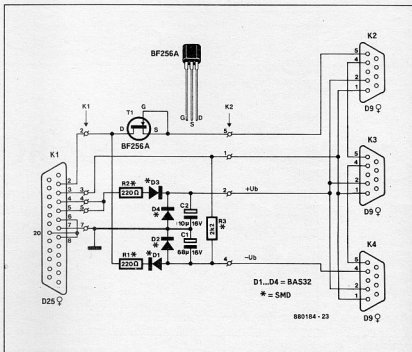

Fig. 12. Circuit diagram of the RS232-to-current loop converter.

Parts list

ADAPTOR BOARD. CIRCUIT DIAGRAM: FIG. 12

Resistors (SMA types):

R1; R2 = 220R
R3 = 2K2

Capacitors:

C1 = 68 μ ; 16 V; miniature axial.
C2 = 10 μ ; 16 V; miniature radial.

Semiconductors:

D1; D2; D3 = BAS32 (=SMA version of 1N4148)
T1 = BF256A

Miscellaneous:

K1 = 25-way female sub-D connector with hood.
K2 = 9-way male sub-D connector with hood.
PCB Type 880016-4

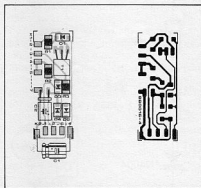

Fig. 13. True-size track layout and component mounting plan of the RS232-to-current loop adaptor. The circuit is built mainly in surface-mount technology. To facilitate soldering, the component overlay is not actually printed on boards supplied through the Readers Services.

errupted to compare the current code with its own identification code. As shown in Table 2 (see Part 1) each type

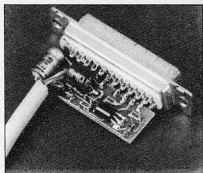

Fig. 14. The adaptor circuit is so small that it can be housed in the hood of a female D25 connector plugged into the host computer's RS232 outlet.

of instrument can be assigned one of four addresses. This is done to enable the use of up to four instruments of a particular type (in this case, an I/O controller or a microcontroller-driven power supply).

When the I/O controller recognizes its identification code on the bus, LED REMOTE CONTROL lights to indicate that the serial interface is available for transmission and reception of commands and data to or from the host computer.

Figure 2 in Part 1 of this article shows that the serial interface in the I/O controller is based on a pair of optocouplers to ensure complete electrical insulation from other bus-connected devices. It should be noted that production tolerance on the optocouplers is relatively high. In certain cases, therefore, the values of R20 and R22 may have to be changed to ensure a sufficiently low digital level.

Serial interface commands

The serial data format and speed is 9600 baud, 1 start bit, 8 data bits, 2 stop bits and no parity bit.

General:

Three types of command are available:

- Identification codes to enable serial communication with an instrument, after interrupting its 'off-line' operation. Reserved codes are 128 to 255. The autonomous I/O controller can be assigned an address between 144 and 151.

- Commands to read data from the I/O controller. These commands are given in lower-case letters. The controller's response is a parameter in decimal notation (or in hexadecimal in certain cases). Voltage readings are expressed in volts (V), preceded by non-significant leading zeroes where applicable.

- Single-character commands, e.g., N<CR> to switch to the NO LOCAL mode. The I/O controller sends nothing in return (except, in certain conditions, the echoed command). When ECHO ON is selected, the I/O controller returns all received commands. Incorrect characters or syntax errors, however, are returned in the form of a question mark.

Identification code

Each bus-connected instrument is configured to recognize a particular odd-numbered and an even-numbered address. The first effectively switches the instrument 'off-line', the second 'on-line' (see Table 2).

Even-numbered address (on-line; listen)

The host computer can select the I/O controller, i.e., switch it 'on line', by sending the address (between 144 and 150)

that corresponds to the configuration of diodes D₁ and D₂ on the main PCB. Provided the I/O controller is in ECHO ON mode, the selection code is returned to the host computer. Also, LED REMOTE CONTROL on the front panel is turned on, and remains on until the 'off-line' (quit) code is received.

Odd-numbered address (off-line; quit)

Serial communication with the I/O controller is terminated by the host computer sending the 'off-line' (quit) address immediately after the 'on-line' address. Assuming that the instrument identification code is 144, reception of address 145 disables serial communication with the host computer. Listen and quit codes need not be followed by a <CR>. The I/O controller never echoes the quit code when this is recognized and accepted, even when ECHO ON is selected. The instrument can only be brought on-line again by the host computer sending the appropriate even-numbered address.

Status byte request

To prevent the computer sending inappropriate or improperly timed commands to the I/O controller, this supplies a status byte of configuration shown in Table 3. The computer can call up the status byte by sending command NUL (control-@ or 00h, not ASCII 0), which is never echoed.

Table 3

STATUS BYTE		
Bit	1	0
B0	echo on	echo off
B2	ready	not ready
B3	outputs disabled	outputs enabled
B4	local	no local
B1 = 1; B5 = B6 = B7 = 0		
shaded areas denote default settings		

The host computer should always read the status byte, and wait until bit b2 is high (ready) before sending a new command to the I/O controller. Command NUL itself is never echoed. Instead, NUL prompts the I/O controller to immediately send the status byte. Example:

00h command received by the I/O controller

16h status byte returned by the I/O controller.

With reference Table 3, this means that the I/O controller is in LOCAL mode

and ready to accept a new command, the digital outputs are enabled, and ECHO is turned off.

Note: in the ECHO ON mode, reception by the host of the echo of the CR used for ending each command does not guarantee the actual execution of this command. When the command returned has been subject to normal echoing (i.e., characters are sent back in their true form, not as '?'), the echo of the CR merely indicates that the command has been received correctly, and is executable. Whether or not the command has actually been executed can only be ascertained by calling up the status byte.

The highest value of the status byte sent by the I/O controller is 1Fu (ECHO ON mode; ready; digital outputs disabled; LOCAL control). The lowest value is 02h (ECHO OFF mode; not ready; digital outputs enabled; NO LOCAL mode).

General-character commands

■ CR and CANCEL (ctrl-X; 18h)

Each command, with or without parameters, should be ended with a CR (carriage return; 0Dh), not a CR-LF (carriage return followed by line feed 0Ah), which will not be accepted by the I/O controller. CANCEL can be sent at any time in the string, but before the closing CR, to prevent an erroneous command being executed. CANCEL is echoed just like any other character.

Error message sent by the I/O controller

■ ?

When the I/O controller is in ECHO ON mode, it replaces incorrect characters with a question mark, i.e., the incorrect character sent by the host computer is not echoed. The returning of a '?' means that the command that contained the incorrect character has been cancelled. For example, when the I/O controller receives string U1,10,1A, it returns U1,10,1?, and does not execute command U1,10,1. The I/O controller does not accept any new command until it has received a CR or a CANCEL command.

Commands without parameters

■ R<CR>

R stands for RESET. The result of this command is the same as switching the I/O controller off and on again. Note that the serial interface is then switched off-line, so that the last character received on the host computer is the echoed CR following R (provided, of course, ECHO is ON).

N<CR>

N stands for NO LOCAL. This command inhibits the push-button on the front panel of the I/O controller until

the reception of command LOCAL (L) or RESET (R). Following the reception of the quit code (odd-numbered instrument address), LED REMOTE CONTROL remains on when the I/O controller is in NO LOCAL mode. This is so arranged to provide an indication when the push-button on the front panel is effectively disabled. The LED goes out when either one of the above mentioned reset conditions is met, or when the unit is switched off and on again, which automatically resets it to the default configuration.

L<CR> L stands for LOCAL. This command enables the push-button on the front panel. The I/O controller defaults to LOCAL after power-up.

X<CR>
This command selects ECHO ON mode. It is particularly useful when the I/O box is controlled by means of a terminal, or a computer acting as a terminal. The I/O controller defaults to ECHO ON after power-up.

Y<CR>
This command selects ECHO OFF mode. ECHO is best turned off when the host computer executes a program that simultaneously uses several instruments on the bus. ECHO is effectively turned off after the command itself, Y<CR>, has been echoed. This means that the question mark (syntax or transmission error) is not echoed afterwards.

C<CR>

This command forces all digital outputs of the I/O controller to logic low. Note that the digital outputs are of the open-collector type: a logic low level, therefore, turns off the output transistor, so that its collector voltage is almost the supply voltage.

D<CR>

This command forces all digital outputs of the I/O controller to logic high. Note that the digital outputs are of the open-collector type: a logic low level, therefore, turns on the output transistor, so that its collector voltage is practically nought.

Commands with parameters

General note: although the decimal point in the syntax of the parameters is only processed as a delimiter by the microcontroller in the I/O controller, it is essential, and facilitates programming the host computer because it makes the parameter syntax compatible with that of BASIC (in particular, instruction PRINT USING).

The analogue outputs are numbered 0 to 3; the analogue inputs 0 to 7. The digital outputs are numbered 0 to 31 in 4 blocks of 8; the same goes for the digital inputs.

Contrary to the protocol used for the microcontroller-driven power supply, the autonomous I/O controller does allow two-parameter commands, e.g., output number followed by logic level, or out-

put number followed by analogue voltage. The default for the second parameter is nought. Data for the digital input and output channels on the I/O controller can be sent in decimal or hexadecimal. The latter format is useful when the unit is controlled direct by a terminal. Decimal notation, on the other hand, is advantageous when BASIC is being used.

Syntax verification is automatic and works on a character-by-character basis while commands are being loaded. Parameters in hexadecimal notation should be preceded, not followed, by the letter h or H.

Single-parameter commands

The parameter is the number of the output, or the block of outputs.

a<n><CR>

Parameter *n* is given either in decimal (0 to 31) or hexadecimal (H0 to H1F). This command enables reading the state of a logic output. The I/O controller returns a 0 when the output is logic low, and a 1 when the output is logic high.

Examples:

a7<CR>
reads the state of the last output line in block 0;

a8<CR>
does the same for the first output line in block 1.

b<0 to 3><CR>

This command enables reading the state of the eight digital outputs in a block.

Table 4

Command	Parameter 1	Parameter 2	Answer	Command description
[144 . . . 150] [141 . . . 151]	—	—	—	even-numbered address enables serial communication odd-numbered address disables serial communication
R	—	—	—	initialization
L	—	—	—	mode LOCAL
N	—	—	—	mode NO LOCAL
X	—	—	—	mode ECHO ON
Y	—	—	—	mode ECHO OFF
C	—	—	—	all digital outputs to logic 0
D	—	—	—	all digital outputs to logic 1
a	(0 to 31)	—	(0 or 1)	read digital output level
b	(0 to 3)	—	(0 to 255)	read block configuration byte (8 outputs)
e	(0 to 31)	—	(0 or 1)	read digital input level
f	(0 to 3)	—	(0 to 255)	read block configuration byte (8 inputs)
g	(0 to 3)	—	(0 or 1)	read block interconnection status (0 = off; 1 = on)
v	(0 to 3)	—	(0 to 10.23)	read programmed analogue output voltage
u	(0 to 7)	—	(0 to 10.23)	read analogue voltage applied to input
G	(0 to 3)	—	—	interconnection in block enabled
H	(0 to 3)	—	—	interconnection in block disabled
A	(0 to 31)	(0 or 1)	—	write logic level to output line
B	(0 to 3)	(0 to 255)	—	write byte to block of output lines
U	(0 to 3)	(0 to 10.23)	—	write voltage to analogue output

The I/O controller returns data in the form of 4 characters.

Examples:

b0<CR>

reads the state of the output lines in block 0. Assuming that these are all logic 1, the I/O controller answers:

0255

Similarly, in hexadecimal, command

bh0<CR>

would result in answer

HOFF

The answer represents the programmed, not the actual, levels on the outputs. This means that the answer to command b does not take the DISABLE OUTPUTS function into account.

e<n><CR>

Parameter n is given either in decimal (0 to 31) or hexadecimal (H0 to H1F). This command reads the logic level applied to a digital input (see command a above for syntax and answer descriptions).

f<0 to 3><CR>

This command enables reading the state of the eight digital inputs in a block (see command b above for syntax and answer descriptions).

g<0 to 3><CR>

The answer to this command informs the host computer whether or not inputs and outputs of identical number in the stated block are interconnected (answer: 1) or not (answer: 0).

The interconnection is a software function of the I/O controller, which is capable of detecting falling pulse edges (transition from 1 to 0), on digital inputs in the interconnected block. The software arranges for the corresponding output to toggle, and remain in the new state until a further high-to-low transition is detected. Key debouncing (max. 5 ms) is also ensured by the program, making it possible to have push-buttons, connected direct to the inputs of an interconnected block, control loads (LEDs; relays) on the corresponding outputs.

Example command:

g2<CR>

Answer:

1
indicates that block 2 is in interconnected mode.

u<0 to 3><CR>

This command reads the set output voltage relevant for the stated analogue output.

Example:

Assuming that analogue output 0 has been programmed to supply 9.99 V, commands

u0<CR> and

uh0<CR>

both prompt the I/O controller to answer

This means that the answer is always in decimal notation.

v<0 to 7><CR>

This command reads the voltage applied to the stated analogue input.

Example command

v6

returns

09.10

to indicate that input 6 is driven with an analogue voltage of 9.1 V.

G<0 to 3><CR>

This command results in interconnection of corresponding lines in the stated block. The interconnection works even in the NO LOCAL mode, but not when the digital outputs are disabled manually by pressing key DISABLE OUTPUTS (LED is turned on).

Example command

G1<CR>

H<0 to 3><CR>

This command effectively ends the interconnection of corresponding inputs and outputs in the stated block.

Example: command

H2<CR>

Two-parameter commands

The two parameters involved are separated by a comma. The first parameter is the number of the output, or block of outputs. The second parameter is the desired logic level, combination of logic levels, or analogue output voltage.

A<n>,<0 or 1><CR>

Parameter n is given either in decimal (0 to 31) or hexadecimal (H0 to H1F). This command programs a logic level (0 or 1) on the stated output (n).

Examples: command

A,<CR>

```
10 REM ***** TEST PROGRAM 2 DEVICES *****
20 PWR = 132: IO = 144: REM device addresses
30 CLS
40 :
50 REM If any file open, close it
60 CLOSE
70 :
80 REM Open communication port 'COM1:' (9600Bd, no parity, 8 bits, 2 stopbits)
90 REM as file number:
100 OPEN "com1:9600,n,8,2" AS 1
110 :
120 REM Delay (minimal .2s) to get correct interface voltage.
130 FOR DELAY=0 TO 1000: NEXT
140 :
150 REM Initialize and close all devices.
160 FOR ADDR = 128 TO 254 STEP 2
170 PRINT#1, CHR$(ADDR);CHR$(SH10);"R";CHR$(SHD);
180 NEXT ADDR
190 :
200 REM Clear host RxD-buffer.
210 WHILE NOT(EOF(1)):DUMMYS=INPUT$(1, #1): WEND
220 :
230 :
500 REM ***** MAINPROGRAM *****
510 ADDR=PWR: CMNDS="U": NROFVARS=1: VARI=500: GOSUB 1000: REM SV
520 ADDR=PWR: CMNDS="I": NROFVARS=1: VARI=0: GOSUB 1000: REM 100mA
530 ADDR=PWR: CMNDS="D": NROFVARS=0: GOSUB 1000: REM 0 V output
540 X=1:
550 WHILE X=128
560 REM set one output of block 0
570 ADDR=IO: CMNDS="B": NROFVARS=2: VARI=0: VAR2=X: GOSUB 1000
580 REM test value of analog input 0, loop if < 1.5V
590 ADDR=IO: CMNDS="V": NROFVARS=1: VARI=0: GOSUB 1000: VOLTAGE = I
600 LOCATE 1,1: PRINT"Analog input 0: U=";PRINT USING"###.##";VOLTAGE
610 IF VOLTAGE < 1.5 GOTO 580
620 X=X*2: REM select next output
630 WEND
640 ADDR=IO: CMNDS="C": NROFVARS=0: GOSUB 1000: REM all outputs 0
650 ADDR=PWR: CMNDS="C": NROFVARS=0: GOSUB 1000: REM 0V out
660 END
670 :
680 :
1000 REM ***** OUTPUT COMMAND *****
1010 REM
1020 REM Open device 'ADDR', check status, transmit command if ready and
1030 REM close device.
1040 REM On exit 'I' contains the requested value (if any).
1050 REM
1060 PRINT#1, CHR$(ADDR); REM open device 'ADDR'
1070 PRINT#1, CHR$(0);: STATUS=ASC(INPUT$(1, #1));: REM get status
1080 IF (STATUS AND 4)=0 GOTO 1070: REM loop if not ready
1090 REM ***** Transmit command and variables (if any) *****
1100 PRINT#1, CMNDS;
1110 IF NROFVARS >= 1 THEN PRINT#1, VARI;: REM first variable
1120 IF NROFVARS >= 2 THEN PRINT#1, ", ", VAR2;: REM second variable
1130 PRINT#1, CHR$(SHD); REM (CR)
1140 REM ***** Get variable if requested *****
1150 IF (CMNDS = "Z") AND (CMNDS >= "a") THEN INPUT#1, I
1160 PRINT#1, CHR$(ADDR+1);: REM close device
1170 RETURN
```

80104 - 20

Fig. 15. Sample GWBASIC listing that illustrates the way in which one microcontroller-driven power supply and one autonomous I/O controller may be operated with the aid of commands sent via the instrument bus.

or
A0,0<CR>
programs a logic low level on digital output 0. Command
A1,1<CR>
programs a logic high level on digital output 1.

B<0 to 3>,<n><CR>
Parameter *n* is given either in decimal (0 to 255) or hexadecimal (H0 to HFF). This command enables simultaneous programming of all 8 outputs in a block. The first parameter is the block number, the second the desired 8-bit pattern (in decimal or hexadecimal).

Examples: command

B,<CR>

or
B0,0<CR>
sets all output lines in block 0 to logic low. Command

B1,HA0<CR> results in binary pattern 1010 0000 on the output lines in block 1.

U<0 to 3>,<n><CR>

Parameter *n* is either 0 to 1023, or 0 to 10.23. This command programs the desired output voltage on the stated analogue output. The first parameter is the number of the output, the second a value between 0 and 10.23 (V) or 1023 (mV).

Examples: commands

U,<CR>

and
U0,00.00
both result in 0 V on analogue output 0.

Commands

U1,.23<CR>

and

U1,00.23<CR>
both result in 230 mV on analogue output 1. Commands

U2,3.40<CR>

and

U2,03.40<CR>
both result in 3.4 V on analogue output 2.

Note that the 0 following 4 in the previous example is significant:

command

U2,3.4<CR>

is the same as

U2,.34<CR>

and both result in 340 mV, not 3.4 V, on analogue output 2.

Finally, command

U3,10.23<CR>

results in 10.23 V on analogue output 3.

Sample program and final remarks

The GW-BASIC listing in Fig. 15 is given here to aid programmers getting started with developing application-oriented software for the host computer. The sample program enables an IBM PC or compatible to control two bus-

connected instruments: a microcontroller-driven power supply (Ref. 1) and an I/O controller as described in this article.

At the end of this article we once more advise readers that the control program in the Type 8751 microcontroller is protected by copyright. Listings can, therefore, not be made available. Ready-programmed, copy-protected, 8751's are available through the Readers Services.

References mentioned here can be found at the end of Part 1.

NEWS

Distributing TV by millimetre Wave Radio

British Telecom's Research Laboratories have successfully demonstrated the use of short-range millimetre-wave radio for delivering programmes into viewers' homes.

If the system were licenced by the Government, it could prove a quick and economic supplement to broadband cable networks. It could bring multi-channel TV to millions of homes that are unlikely to be cabled before 2000. The system uses a frequency of about 30 GHz to beam four satellite TV programmes plus the four broadcast services to a number of homes in a town fitted with special antennas capable of receiving the transmissions. Commercial systems would be capable of carrying between 15 and 25 channels.

British Telecom's system is made economically possible by the use of gallium-arsenide ICs. These microchips allow the receiving equipment to be built at a cost many people could afford.

Martlesham already has an established

worldwide reputation for the fabrication of optoelectronic components from gallium-arsenide and is now pioneering the design and fabrication of circuits operating in the more challenging millimetre-wave bands.

They have produced Monolithic Millimetre-Wave ICs (MMWICs) on a single semiconductor wafer, which in production can contain hundreds of individual microcircuits. They have also harnessed the properties of high dielectric constant ceramic resonators to achieve cost-effective stabilization of the millimetre-wave oscillators.

Martlesham research workers estimate that, with the economies of large-scale production, receivers would be produced for about a few hundred pounds. These receivers use a dish only 15 cm in diameter, much smaller and more environmentally acceptable than the 30-100 cm dishes needed to receive TV programmes direct from satellites. They are capable of receiving a mix of programmes drawn from:

- TV receive-only or direct broadcasting satellites at several orbiting positions;
- off-air UHF broadcast channels;
- cable TV programmes;
- taped programmes injected at the

head end;

- high definition or extended-definition TV when available;
- local interest and community programmes.

In addition, the system may be easily configured for either PAL or MAC formats. Also, it would allow different satellite programmes to be viewed on different sets.

A LOW-COST DEVELOPMENT SYSTEM FOR M6805 MICROPROCESSORS

by Peter Topping

Development systems for single-chip MCUs can be complex and expensive, dissuading potential users of this type of microprocessor from designing them into new applications. This article describes a low-cost 'entry' development system for debugging hardware and software for Motorola's M6805 range of microprocessors.

The M6805 range includes both CMOS and NMOS parts, all but one of which are single-chip devices which include mask-programmable ROM, RAM, I/O and a timer function. The exception is the CMOS MC146805E2, which has no on-chip ROM but has a multiplexed data/address bus that enables it to use external memories and peripherals.

The development system described uses the MC146805E2 processor, and can be used to develop applications intended for the MC146805G2, MC146805F2, or the E2 itself. It can also be used for applications intended for NMOS variants such as the MC6805P, U and R families, or the more recent CMOS devices such as the MC68HC05C4 and the MC68HC05B4/6, but does not emulate all the features of these devices, since without the addition of external chips, there is no A-D (R&B families) or SCI/SPI (HC05s).

There is an EPROM or EEPROM version of most M6805 devices. These versions allow prototyping or limited volume production without the need for mask programming. They can be used to check the operation of the software in the final application PCB without the additional hardware required for an emulator.

An example of software and hardware developed with the system can be found in Ref. 1.

Introducing the MC146805E2

The MC146805E2 has a multiplexed bus which requires an address latch to interface with non-multiplexed RAMs, ROMs, and EPROMs. Even with this type of bus it only has sufficient pins to provide two I/O ports. The MC146805G2 includes a further two ports. With an MC146805E2, these can be supplied by a PIA such as the MC146823. Alternatively, the latch, additional ports and the address decoding

M6805 DBUG05 Development System

- Inspection/modification of RAM locations.
- Inspection/modification of all registers.
- Up to three breakpoints.
- Tracing (through RAM or EPROM).
- Relative offset calculation.
- Program save/load using cassette tape.
- Real-time clock routines.
- 24-key keyboard and 6-digit display (which can be used from user software).
- Example software shows how to debug programs introduced on EPROMs as an alternative to using the cassette interface.
- All-CMOS (battery operation).

logic can all be provided by an MC68HC25.

The MC146805E2 can thus be used with an MC68HC25 to build a system of only three chips (E2, HC25 and EPROM). Such a system would be most cost-effective in small volume applications not justifying a mask-programmed single-chip MCU. For software development, however, RAM and a monitor system have to be incorporated so that memory locations can be examined and changed. The 6116 2 Kbyte static RAM is used here, while the DBUG05 EPROM fulfills the monitor requirement.

Circuit description

The circuit diagram of the development system is given in Fig. 1. The 6116 2 Kbyte RAM is placed between \$0000 and \$07FF. This means that the 128 bytes from \$0000 to \$007F are not used, as they are mapped over the

E2's I/O and RAM space. This mapping was chosen to fully utilize the address space in which the direct addressing mode of the MC146805E2 can be used. It has the disadvantage, however, that there is a conflict at addresses \$0002, \$0003, \$0006 and \$0007 where the MC68HC25 adds ports C and D (ports 3 and 4 in the MC68C25). This can be resolved by decoding out the bottom half of page zero in the RAM chip-select/output-enable logic as shown in the circuit diagram. The 74HC32 in conjunction with the 74HC00 inverts the data strobe supplied by the E2, disabling the RAM when the address is in the range \$00 to \$7F.

RAM in the top half of page zero provides enough directly accessible memory to emulate the MC146805G2 (112 bytes). This is not the case without adding RAM, as DBUG05 uses 41 bytes of the E2's RAM (also 112 bytes). The 6116 RAM extends up to \$07FF; the space between \$0080 to \$00EF is used to emulate the G2 RAM, and from \$0100 to \$07FF for the software under development. The second block of RAM will not be required when the software has been debugged, and therefore does not conflict with the recommendation that the space between \$0100 and \$06FF should not be used with the MC68HC25. MC74HC00s provide the address decoding and the R/W and output enable signals for the RAM, the low-order addresses being demultiplexed by AS using the MC68HC25.

A 27C16 2 Kbyte EPROM is selected by CS2 from the MC68HC25 between \$0800 and \$0FFF, and can be used to introduce software which has been entered and cross-assembled on a PC, or manually by an EPROM programmer. The address range between \$1000 and \$17FF is not used except for the (optional) MC146818 real-time clock (RTC), which is required to be at \$1700 if the DBUG05 RTC routines are to be used.

An MC74HC138 can be used to decode the RTC at \$1700. Alternatively, if nothing else is required between \$1000 and \$17FF, a 74HC00 can be used to select an address range of \$1000 to \$17FF, as the RTC chip will still appear at \$1700.

The DBUG05 monitor EPROM uses the memory range from \$1800 to \$1FFF, and can be selected by the MC68HC25's CSI chip select line. Figure 4 shows a memory map of the development system. The DBUG05 EPROM, like the user software EPROM, is shown as a 27C16, but could also be a 27C64 (or a 2716 or 2764 if the low-power capability is not required).

The monitor display is a 6-digit, 4-backplane LCD (e.g. Hamlin Type 4200, or the 8-digit GE Type LXD69D3F09KG) which is driven by an MC145000 display driver. The driver is controlled by a 2-line serial link from the microprocessor. In this case, the static LC display shown in Fig. 2 can be used as an alternative. Three MC144115 driver chips are used, along with a transistor inverter to supply the additional latch enable signal required by these drivers. This circuit requires many more connections to the LCD, but allows the use of a commonly available display.

The MC68HC25 has a RESET IN pin intended as a system reset, and a RESET OUT pin to reset the processor. For this to work, a clock is required. As the clock is supplied by the MC146805E2, a low at RESET IN will not wake the E2 from a STOP instruction, so a diode has been added between RESET IN and RESET OUT to ensure that a low on RESET IN always forces a low at RESET OUT.

The DBUG05 monitor includes routines to transfer 6805 code to and from a cassette tape. When the PUNCH (P) key is used to record a program, the output is taken from PA6 as shown in Fig. 1. When the L key is used to load a previously saved program, the output from the cassette should be applied to the interrupt pin of the MC146805E2. This signal should be between 2 and 5 V_{pp}, and be AC-coupled to the microprocessor. When this is being done, it is advisable to disconnect all other components from the IRQ pin.

MC68HC25

The MC68HC25 has many modes of operation allowing it to work with the MC6801 and MC68HC11 as well as with the E2. It can also operate with different sizes of memory map. Mode selection for the MC68HC25 is effected with the aid of data at address location \$1FBB. The byte used here is \$F4. Table 1 shows the options available, where 'X' indicates those used. The byte is read after RESET goes high, but before the HC25 RESET OUT goes high to start the processor.

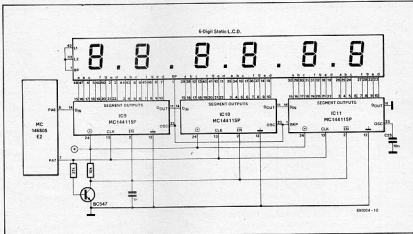

Fig. 2. Circuit diagram of the alternative, static, LC display.

If additional ports are not required, a 74HC373 octal latch can be used instead of a MC68HC25. In this case, the EPROM select logic can be provided by a 74HC00. A circuit employing a 74HC373, strobed by the AS signal from the MC146805E2, and a 74HC00 for chip select, is shown in Fig. 3. Note that the use of this simple unstrobed chip select circuit requires that the EPROM output enables (pin 20) are strobed by the inverted data strobe from the MC146805E2. If the MC68HC25 is not used, the 74HC32 can be omitted (pin 13 of the 74HC00 should be connected to pin 12), as can be the mode byte at \$1FBB.

If the EPROMs used are of the CMOS type, the whole system is in CMOS, and consumes only a few milliwatts when active, and a few microwatts in stand-by (with the E2 in STOP mode). In order to achieve this low stand-by dissipation, the

multiplexed databus, timer pin and other uncommitted high-impedance lines should be grounded via 100 kΩ resistors. In DBUG05, port A has 4 input lines grounded through 10 kΩ resistors, and 4 output lines. Port B, however, is not configured, so all eight bits are inputs, and will increase stand-by dissipation unless held low (or high), or assigned as output in software. This also applies to ports C and D on the MC68HC25. If the final code is to be used without DBUG05, it should also configure port A's I/O lines.

System monitor DBUG05

The DBUG05 EPROM comprises a monitor specifically written to enter and debug 6805 code. Input is via a 24-key keyboard. The functions available are listed in Table 2.

The MC146805E2's vectors are within the address space of the DBUG05 EPROM. They operate via extended jumps in RAM. This gives the user access to the vectors if these jumps are written to from within the user's program. The interrupt jumps are at \$40 for IRQ, \$43 for timer, and \$46 for timer (wait). An example of how these are used is shown on lines 17 to 20 in Fig. 5. Clearly, the RESET vector can not be altered in this way, so during debugging, user software should be started using the GO facility in DBUG05.

Example software

The example software listed in Fig. 5 has been assembled to reside in RAM starting at address \$0100, but is introduced into the system in the EPROM at \$0800. The code includes a routine to move itself into RAM where it can be executed and debugged using DBUG05. This provides an alternative to the cassette routine in DBUG05 intended for loading software to be debugged.

Table 1. MC68HC25 Mode Selection

The mode selection byte contains the following bits:

Bit	Function	Options	
7,6	CS2 address size	1,1: 2 Kbytes 1,0: 4 Kbytes 0,1: 8 Kbytes 0,0: 16 Kbytes	X
5,4	CS1 address size	1,1: 2 Kbytes 1,0: 4 Kbytes 0,1: 8 Kbytes 0,0: ---	X
3	CS1 zone shift	1: shifted 0: not shifted	X
2	CMOS/TTL	1: CMOS 0: TTL	X
1	Memory map size	1: 64 Kbytes 0: 8 Kbytes	X
0	Port displace	1: displaced 0: not displaced	X

Table 2. DEBUG05 functions.

Function	Key	Description of function	Function	Key	Description of function	Function	Key	Description of function
PC	0	Display program counter.	TR	B	Trace one instruction.	V	V	Verify tape. If OK, prompt '□' is displayed, otherwise incorrect address, or 'err' for a checksum error.
BP	5	Enable breakpoints. Breakpoint one is displayed if enabled, or text 'boff' if it is not. Enter new breakpoint address followed by ENTER to change or enable and move to next one. Three breakpoints are available.	STOP	C	Put the E2 into STOP mode. Clock stops, display clears.	ENTER	ENTER	Enter keyed-in address or data (and move to next address in 'M').
BCL	6	Clear breakpoints. ENTER clears all breakpoints. Entering a number followed by ENTER clears that breakpoint only.	CC	D	Display/change Condition Code register. New data is followed by ENTER. ESC returns to '□' prompt without changing contents.	ESC	ESC	Escape from current function, except STOP, V, L, and P.
DT	8	Display time from (optional) MC146818.	XR	E	Display/change Index register. New data is followed by ENTER. ESC returns to '□' prompt without changing contents.	GO	GO	Begin or continue program. When pressed, current PC is displayed.
ST	9	Set time on the (optional) MC146818 (P for PM, AM is default).	AR	F	Display/change Accumulator. New data is followed by ENTER. ESC returns to '□' prompt without changing contents.	M	M	To proceed from that location, press ENTER. To proceed from a different address, enter the address followed by ENTER.
OFF	A	Calculate branch offset. The address of the branch instruction, and that of the destination, are requested. If a valid branch is calculated, it is written into memory, and displayed. If not valid, then text 'or' (for out of range) is displayed. A branch of -128 through +127 relative to the start address of the next instruction is allowed.	P	P	Record tape. On pressing P, text 'ba' (for begin address) is displayed. Enter first address (followed by ENTER), then last address when text 'ea' is displayed. A second ENTER starts the recording.	SP	SP	Display/change a location in RAM. When pressed, last address is displayed. Press ENTER to display the contents of the address, or enter a new address followed by ENTER. New contents can be entered if required. ENTER moves to next address, M moves to previous address. Display stack pointer.
			L	L	Load tape. Press L, then play tape. Valid load displays '□', bad memory displays address. Checksum error displays 'err'.			

To achieve low dissipation in STOP mode, it is desirable to execute the STOP instruction in EPROM. This is achieved during debugging by the extended JMP on line 22. Alternatively, there is a STOP instruction followed by a branch back to this instruction at address \$1FF3 in DEBUG05. This is intended for use by a program in RAM, as the execution of a STOP instruction in RAM will not result in low dissipation (the RAM will be left selected when the microprocessor goes into STOP mode).

If the debugged software is required to run in EPROM without the DEBUG05 EPROM, then the code should be re-assembled at \$1800, and the MC68HC25 mode byte and the reset and interrupt vectors added.

In the example software, lines 10-11, 17-20, 22 and 51-56 should be deleted as they are only relevant when the program is in RAM. The ORG statements on lines 6 and 9 should be changed from \$0080 to \$0010, and from \$0100 to \$1800. The EPROM should be decoded at \$1800 instead of \$0800 (CS1 from the MC68HC25), and the DEBUG05 monitor EPROM removed. If the target system uses only two ports — and can thus use a 74HC373 rather than an MC68HC25 — it may be necessary to change the port allocation to make port A available.

Clearly, the use of port A can not be debugged, but as long as the DDRs and the hardware are also changed this should not be a problem.

In the example software, the reset vector (\$1FFE) should point to START (line 14), and the external interrupt vector (\$1FFA) to IRQ (line 12). The MC68HC25 mode byte (\$F4) should be added at address \$1FFB.

If the E2's 112 bytes of RAM are sufficient for the relevant application, the 6116 RAM can also be removed. Care should be taken to leave enough RAM for the stack, which starts at \$7F. Two bytes are used for each level of subroutine, and five bytes for each level of interrupt. The simple example program shown uses 7 bytes (one interrupt and one level of subroutine). More complicated programs will use more (up to a maximum of 64 bytes), but it would be unusual to use more than 20 bytes. This would leave 92 bytes of RAM available for other uses. During debugging, the stack is in the E2 at \$7F, and 128 bytes of RAM in the 6116 (\$80 to \$FF) were available for data storage.

The monitor uses the timer and its vector for breakpoints and tracing, so if the timer is used in the application, these facilities can not be used. The timer WAIT vector is not used, and an appli-

cation using it can make use of all the monitor's features except when the timer is actually running. In practice, this is not a major restriction if the timer part of the application is debugged after the rest of the software is working.

Example hardware

The previously discussed software was developed for use with the MC145157-based radio synthesizer described in Ref. 1. The divide ratio is entered into locations SMEM and SMEM+1, and is transferred to the synthesizer chip when the microprocessor is interrupted. This method allows the MC146805E2 to be in STOP mode when it is not actually sending a frequency. This arrangement eliminates any risk of RFI in the receiver. In the simple example shown, the divide ratio has to be manually converted and entered into RAM. In the complete control program for the synthesizer (see Ref. 1), this would of course be done automatically when the required frequency was entered into a keyboard. After, say, 1265 (kHz) is converted to hexadecimal (\$04F1), the bits must be moved left by one place to allow for a control bit to be sent to the MC145157 after the frequency. This control bit determines whether the ratio is intended for the ref-

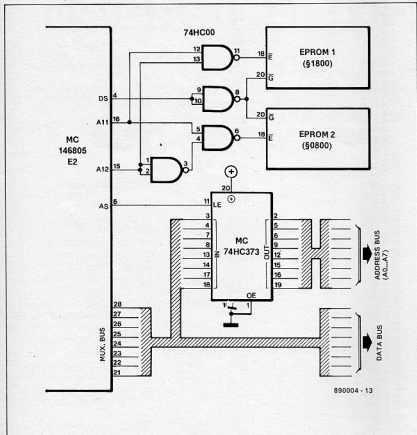
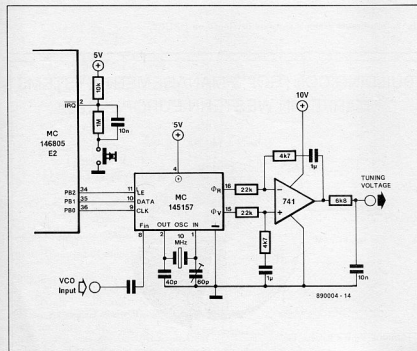

Fig. 3. This simple latch circuit provides an alternative to the MC68HC25 in applications where additional ports are not required.

Port A data	\$0000
Port B data	\$0001
Port C data direction	\$0002
Port D data direction	\$0003
Port A data direction	\$0004
Port B data direction	\$0005
Port C data	\$0006
Port D data	\$0007
Timer data register	\$0008
Timer control register	\$0009
not used	\$000A
not used	\$000F
not used	\$0010
MC146805E2 RAM (inc. STACK at \$7F)	\$007F
MC65116 data RAM	\$0080
-----	\$00FF
6116 program RAM	\$0100
-----	\$07FF
Program EPROM (CS2N)	\$0800
-----	\$0FFF
not used (optional)	\$1000
MC146818 at \$1700	\$17FF
-----	\$1800
DEBUG5 EPROM (CS1N)	\$1FFF

Fig. 4. Memory map of the system monitor, DEBUG5.



Basic synthesizer circuit that works in conjunction with the program listed in Fig. 5.

reference divider or the LO (local oscillator) divider. A zero is required for the LO divider, so SMEM and SMEM+1 contain the hexadecimal number 509E2 for a LO frequency of 1265 kHz. The fixed reference divide ratio of 10,000 can be seen in the software listing on lines 26 and 28. The number \$214E is the hexadecimal equivalent of 10,000, again moved left by one bit, but this time the control bit is a logic one.

To maximize the usefulness of the development system, a home computer capable of assembling 6805 code, and programming EPROMs, should be available. Motorola's AS5 assembler for IBM PCs and compatibles is available for this purpose. This program, and the listing of DEBUG5, can be obtained free from *Elektronics* by sending a formatted 5¼ inch, 360 kByte, diskette, and a self-addressed, stamped return envelope, to our Brentford office. Overseas readers please include 3 IRCs to cover the return postage.

1 P			OPT	CMOS	
2 P					
3 A	0001	PORTB	EQU	\$01	
4 A	0005	DDRB	EQU	\$05	
5 F					
6 A	0080		ORG	\$80	Data RAM
7 A 0080	0002	SMEM	RMB	2	MCI45157 freq.(e.g. 810kC=E2,09)
8 A					
9 A	0100		ORG	\$0100	Program RAM
10 A 0100	CC0847	MOVE	JMP	MOV+\$700	start at \$800 to load into RAM
11 A 0103	CC0109	RST	JMP	START	start at \$103 to run in RAM
12 A 0106	CC011D	IRQ	JMP	SQRT	interrupt starts here
13 A					
14 A 0109	A607	START	LDA	#507	setup bits 0 - 3
15 A 010B	B705		STA	D0RB	as outputs
16 A 010D	B701		CLR	PORTB	and clear
17 A 010F	A601		LDA	#501	DBUG05
18 A 0111	B741		STA	\$41	interrupt
19 A 0113	A606		LDA	\$506	vector
20 A 0115	B742		STA	\$42	extended jump
21 A					
22 A 0117	CC081A		JMP	STP+\$700	execute STOP in EPROM
23 A 011A	8E	STP	STOP		
24 A 011B	20FD		BRA	STP	RTI returns here
25 A					
26 A 011D	A64E	SQRT	LDA	#\$4E	10 MHz/10,000 = 1 kHz
27 A 011F	AD15		BSR	SQU	send reference MSB
28 A 0121	A621		LDA	#\$21	
29 A 0123	AD11		BSR	SQU	and LSB
30 A 0125	1401		BSET	2,PORTB	latch
31 A 0127	1501		BCLR	2,PORTB	it
32 A 0129	B681		LDA	SMEM+1	local osc. MSB
33 A 012B	AD09		BSR	SQU	
34 A 012D	B680		LDA	SMEM	and LSB
35 A 012F	AD05	SQU2	BSR	SQU	
36 A 0131	1401		BSET	2,PORTB	latch
37 A 0133	1501		BCLR	2,PORTB	it
38 A 0135	80		RTI		go back into standby (STOP)
39 A					
40 A 0136	AE08	SQU	LDX	#8	
41 A 0138	48	S1	LSLA		move 1 bit into 'C'
42 A 0139	2402		BCC	S2	zero?
43 A 013B	1201		BSET	1,PORTB	no
44 A 013D	1001	S2	BSET	0,PORTB	clock
45 A 013F	1101		BCLR	0,PORTB	it
46 A 0141	1301		BCLR	1,PORTB	
47 A 0143	5A		DECX		
48 A 0144	26F2		BNE	S1	any more?
49 A 0146	81		RTS		
50 A					
51 A 0157	AE00	MOV	LDX	#00	move
52 A 0149	D60800	T8	LDA	\$800,X	program
53 A 014C	D70100		STA	\$100,X	program
54 A 014F	5C		INCX		EPROM (\$800)
55 A 0150	26F7		BNE	T8	to RAM (\$100)
56 A 0152	CC0109		JMP	START	
57 A					
58 A			END		
**** TOTAL ERRORS		0-			890004 - 16
**** TOTAL WARNINGS		0-			

Fig. 5. Synthesizer example software developed on DBUG05.

NEWS

Intelligent buildings in Europe

The skyscrapers of Europe will have brains by 1992 says a report from Frost & Sullivan, *Building Control and Management in Europe*. It continues to say that the incorporation of an integrated system of telecommunications, office automation, and building services management is "on the horizon" and that there has been a recent and accelerated trend towards integrating such disparate things as heating, ventilation and air conditioning (HVAC), fire alarms or controls, and access controls. The report forecasts that the highest growth rate will occur in the UK, closely followed by West Germany.

BUILDING CONTROL & MANAGEMENT SYSTEMS MARKET IN WESTERN EUROPE - 1992

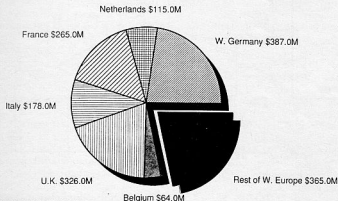

SOURCE: Frost & Sullivan, Inc.

Report #E981

PRACTICAL FILTER DESIGN (1)

There are still many electronics constructors who are not fully au fait with the operation and calculation of filters. This often results in not always fully correct standard solutions and difficulties when it comes to tracing faults. This new series of articles will attempt to explain the operation of the most frequently encountered types of filter and to make the design of them accessible to everyone.

It is hard to think of any piece of electronic equipment, be it audio, HF, radar, television, or computing that does not contain some kind of filter.

Filters, also called networks, consist essentially of a number of impedances connected together to form a system the behaviour of which depends on the values of the resistances, capacitances, and inductances from which they are made up.

Networks may be classified according to their configuration: T, π , L, ladder or lattice, some of which are shown diagrammatically in Fig. 1.

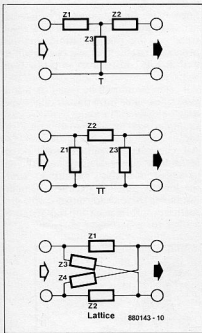

Fig. 1. Diagrams of some basic filter.

They may also be categorized as **passive** (*LC, LR, RC*, or *LCR* filters, strip lines or ceramic resonators) or **active**, in which a device, normally an opamp, plays an active role.

These categories are based on physical parameters, however, whereas we are normally more interested in the way a

filter functions. In this series, all networks will be classified according to their mode of operation.

Basic types of filter

There are five basic types of filter, whose pass-bands are shown in Fig. 2.

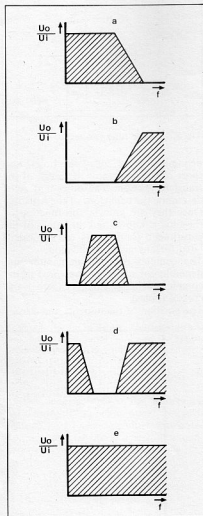

Fig. 2. Pass-bands of the five basic types of filter.

1. **Low-pass**, which passes all signals from d.c. to a certain frequency called the **cut-off** frequency. Above that frequency, all signals are attenuated or suppressed altogether.

2. **High-pass**, in which all signals below a given frequency, again called cut-off frequency, are attenuated or suppressed.

3. **Band-pass**, which passes all signals between two given frequencies, called the lower and higher cut-off frequency respectively. This is the most commonly used filter in electronic engineering.

4. **Band-stop**, which attenuates or suppresses all signals between two given frequencies. Outside those frequencies, all signals are passed.

5. **All-pass**, which passes all signals of whatever frequency, but introduces a phase shift that is a function of the network parameters. Strictly speaking, this is, therefore, not a filter in the true sense of the word.

Except for the all-pass type, all filters may be calculated from the parameters of a low-pass network as will be seen later in the series.

The ideal filter

An ideal filter is a network that passes all signals between two frequencies without altering them in any way and suppresses all others completely. The **skirt** of the pass-band of such a filter is a vertical line—see Fig. 3.

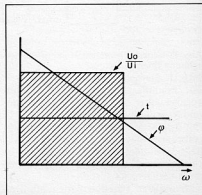

Fig. 3. Pass-band of an ideal filter.

An ideal filter will introduce a time delay between its input and output that is constant for all frequencies—this is shown by the horizontal line in Fig. 3.

From these two (straight) lines, it follows that the ideal phase shift θ , is also a straight line.

The time delay, t , at an angular velocity, $\omega = 2\pi f$, of frequency f is derived from the phase shift at every frequency:

$$t = \theta / f$$

in which θ is the phase shift in degrees, or

$$t = \beta / \omega$$

in which β is the phase shift in radians. Note that the frequency axis in Fig. 3 is linear; when this is shown, as is usual, logarithmically, the phase characteristic will, of course, look quite different.

The ideal filter can not be realized, so that practical network characteristics are not the straight lines shown in Fig. 3. Also, the time delay in a practical filter does not remain the same for each frequency. The deviations from the ideal characteristic curves have an important bearing on the step and pulse behaviour of the network.

Some network theory

Figure 4 shows the general representation of a terminated filter. The voltage source at the input has an internal resistance R_i , while the output termination consists of resistance R_o .

The two resistances have an important bearing on the functioning of the filter. If buffers are used at the input and output of the filter, however, these resistances no longer affect the operation of the network. Their value must be known when the filter is being designed.

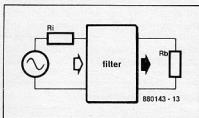

Fig. 4. General representation of a terminated filter.

For example, in the case of a loudspeaker filter, R_i will be virtually zero and R_o will have a value of, say, 6 Ω . In the case of a high-frequency filter, both resistances may have a value of 60 Ω . These examples show that the design of these networks must be approached from different angles.

The transfer function (attenuation vs frequency characteristic) of a filter may

be expressed as a vulgar fraction of two complex quantities. For example, the transfer function of the simple filter in Fig. 5 is:

$$T(j\omega) = 1 / (j\omega)^3 + 2(j\omega)^2 + 2(j\omega) + 1$$

Since the denominator consists of a 3rd order equation, the filter is said to be a 3rd order network. The roots of the

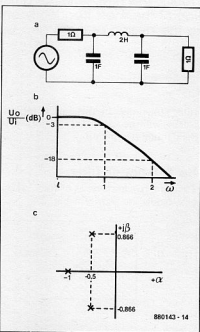

Fig. 5. A basic filter (see text).

denominator are called the poles, and those of the numerator the zeros, of the transfer function. The poles and zeros determine the behaviour of the network. Once they are known, the function of the filter is known and the values of the constituent components can be calculated for any given application.

The complex roots of numerator and denominator may be represented in the complex plane by noughts (zeros) and crosses (poles).

The positions of the noughts and crosses

in the complex plane determines the stability and practicability of the filter. It is interesting to note that normally the poles and zeros are conjugate pairs. Only poles and zeros that lie on the real axes can exist on their own. Also, poles may lie only to the left of the y coordinate.

The slope of an n -th order filter is, in general $n \times 6$ dB per octave. This is, however, only a guideline and depends on the type of filter.

Similarly, the phase shift at the cut-off frequency is, generally speaking, $n \times 45^\circ$, but this may be quite different in some types of filter.

Modern network theory has produced a number of standard filters, each with its own specific parameters, e.g., Chebyshev and Bessel. Since with higher-order transfer functions it becomes tedious to calculate the poles and zeros of a given filter, use may be made of standard tables that give the values for a number of filters.

Further in the series...

In this series, we will deal with a number of filter topologies, passive as well as active, and various filter types. In all cases, the most important characteristics will be given, as will tables for the poles and component values for the various networks.

For passive filters, values of source impedances will be given that are either equal to the output terminating impedance or zero. This will enable a.f. as well as h.f. constructors to profit from the series.

All calculations will be based on a low-pass filter, since from this all other types may be derived. In many cases, worked examples will be used to illustrate the text.

All characteristic curves used in the series have been calculated with the aid of a network analysis program to ensure the highest possible accuracy. In many instances, these characteristics will give sufficient information for the design of a filter for a particular purpose. ♦

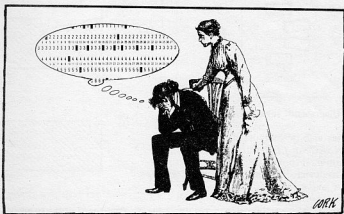

IMPROVING AUTOMOTIVE WIRING SYSTEMS

by Alan Baker, BSc(Eng), ACGI, CEng, FIMechE

One of the most outstanding aspects of automotive progress in the post-World War II era has been the proliferation of electrical services. Pre-1939 cars had electric starting, lighting, screen wiping, horns and semaphore-type turn indicators but little more, unless one includes a handful of such developments as Auburn's electric raise-and-lower system for the hood of a convertible. Innovative but, at that time, not adequately reliable.

After the war, though, came a succession of electrically actuated ancillaries aimed at enhancing safety, comfort or convenience. Stop, fog and spot lights, heating/ventilation fans, cigarette lighters, screen washers, rear-window heating and (with the advent of the hatchback) rear wash/wipe, headlamp wash/wipe, central door locking and powered windows, in-car entertainment (as it has come to be called) and the power sourcing for the growing electronics content — ignition, on-board computer, cruise control, engine and transmission management, anti-lock brakes and anti-wheelspin devices.

And there is more to come as four-wheel drive and steering gain favour and suspension is improved through automatic damper-rate variation or, in the longer term, fully active systems.

Small wonder, then, that conventional electric harnesses have been becoming ever more complex, bulky and costly. For a well equipped car the loom may now involve thousands of wires and weigh many kilograms, as well as impose significant installation and maintenance problems. Some easing of the situation was gained from reducing individual insulation thicknesses, but this was just a palliative — the cure demanded a more drastic approach.

University advice

That approach, now called multiplexing, has existed as a concept for some years but it has raised many practical difficulties that have only recently been overcome. In ideal multiplexing, every service on the vehicle would be supplied with electricity via a sort of ring-main—as in a building—with local intelligence or logic to decide what should be on and what off.

Such a scheme would have a major snag, though. It would have to be entirely of heavyweight 60 A cable to carry the current. A major compromise was clearly essential.

One of Britain's major electrical suppliers, the Volex Group, latched on to the possibilities of multiplexing some eight years ago and soon became aware of this and other associated problems. Volex's wiring specialists reckoned that the computer might help them towards a solution, so they consulted Professor Michael Hampshire, then head of the Department of Electrical and Electronic

was formed jointly with the General Electric Company of England, and a new factory was built for it at Rugeley. The time since the formation of Salplex in 1980 has been devoted to evolving fully practicable automotive systems.

Levels of multiplexing

The main technical problems had all been solved by 1984, since when the company has been refining its designs and developing the appropriate production techniques in readiness for the rush that looks about to start. It became apparent relatively early that any attempt to evolve a panacea multiplex system was doomed to failure since it would be over-sophisticated for some duties and too primitive for others.

One organization to recognize this fact was the United States Society of Automotive Engineers (SAE) which, in consultation with the country's auto manufacturers, established three levels of multiplexing.

Salplex's lowest level, corresponding to the SAE's Class A, is that suitable for vehicle body electrical systems where the requirement is for simple on/off switching of each service. Class B caters for shared information and communication, message sending and handling. Class C is a higher tech and often higher speed (and consequently much more expensive) system including in car diagnostics, anti-lock braking, engine management and the control of automatic transmission.

Integrated multiplexing for a car therefore has to be a combination of Classes A and B. The two elements cannot be discrete, though, but have to have an interface since, in some areas, communication between the two types of function is essential. Salplex has developed a combined system of this kind, carrying the Series 4000 designation.

The system handles not only the communications function but also the inter-related switching one as, for example, when headlamps have to be controlled by the ignition switch, the high/low-beam switch and the headlamp-flash switch. This functionality, as it is called, is programmed into the master unit and is not dependent on complex switches or

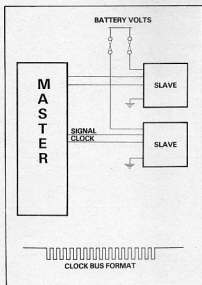

Schematic layout of Salplex multiplexing system, based on a master unit and the appropriate number of slave units.

Engineering at nearby Salford University.

This is not the place for a detailed evaluation of the consequent work at Salford, but its end-product was a rational computer-based system for converting an automotive customer's wiring drawings into a viable multiplexing scheme based on a plurality of feed cables rather than the single conductor of the idealized ring-main.

The manufacture of hardware of this innovative type was outside Volex's operational ambit. To meet the situation, therefore, a new company, Salplex Ltd,

relay logic.

A working system

The essence of multiplexing is time division, which ensures that each service gets its share of the conductor (known as a bus) without interference from the others using it. Several techniques have been evolved for time division and that chosen by Salplex for the Series 4000 is known as time-slot assignment, based on the maximum acceptable time delay between an input event (a switch closing) and the related output event (a lamp lighting). This time interval is divided

into a number of time slots, each of which is available for moving the data or commands allocated specifically to it. In brief, the Series 4000 is based on a central master module and a number of slave modules distributed about the vehicle. While the master module is responsible for power and signal distribution and all logic functions and timing, the slave modules service the complement of loads and switches either directly or through sub-harnessing. Many of the world's major motor manufacturers are currently evaluating the Salplex system, along with comparable equipment from the handful of

other companies that have succeeded in negotiating the many obstacles on the multiplex road. In the meantime, the company continues its research and development in collaboration with its parent firms, being determined to build on its sound foundations and to be in a position to supply proven and practicable hardware when the multiplexing bandwagon begins to roll.

NEWS

Satellite communications

Since INTELSAT I ("Early Bird") was launched more than 23 years ago, dozens of commercial communications satellites have gone into orbit—overcrowding the C-band (4-6 GHz) and forcing migration to the Ku-band (11-14 GHz), which is now also becoming overcrowded. Next in line is the Ka-band (20-30GHz).

Satellite Communications in Developing Countries, a report from Frost & Sullivan, estimates that, on average, 20 commercial satellites will be launched worldwide each year through 1995. About four fifths of these will be for communications and about 40% of them will be for use by developing countries.

Over the past 20 years, satellites have become more complex, more powerful, and considerably larger. Early Bird was 1.37 m high, whereas the latest INTELSAT VI, due for launch later this year, will stand almost 12 m high and will be several times larger than a private car. Large, powerful satellites make possible smaller, less complex, and thus cheaper, earth stations. The report estimates that at present just over 3,000 earth stations with antenna diameters of less than five metres are installed in developing countries, but that by 1992 that number will have grown to almost 35,000.

The end of morse

Morse code, the radio message system used by ships at sea and thousands of radio amateurs the world over, is to become a thing of the past, at least as far as professional services are concerned. The International Maritime Organization in London has given the go-ahead to the introduction of a more advanced digital replacement. The global maritime distress and safety system will be introduced in 1999. Messages will be handled automatically, mostly by satellite. Any distress signal will be coded to

SHARE BY REGION OF TOTAL EARTH STATION MARKET FOR DEVELOPING COUNTRIES - 1992

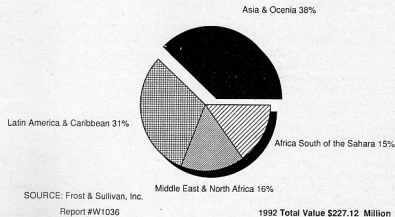

identify the ship automatically.

IBC beats all records

IBC88 was even larger than IBC86 which in itself was a record-breaking convention. There were over 20,000 participants from 62 countries at the International Broadcasting Convention held at Brighton from 23 to 27 September last. The well attended Technical Programme generated interesting, informed and lively discussions with 114 papers presented by authors from 14 countries.

As was expected, the chief interest was in High Definition Television—HDTV, digital handling of television signals and satellite broadcasting; the keynote was set in the opening session with a discussion of HDTV. Other aspects of broadcasting were not neglected, however, and the Technical Programme as a whole was one of the fullest and most varied ever.

The IBC88 award was presented to Professor Henri Mertens, Assistant Director, Technical Centre, of the European Broadcasting Union (EBU), in recognition of his major contribution to broadcasting over a period of many years.

TEST & MEASURING EQUIPMENT

Part 13: Power Supplies (1)

by Julian Nolan

Farnell LT30/1 Power Supply

Farnell are a large and well-established electronics company who, over the years, have gained a good reputation, especially in meeting the instrumentation requirements of the educational sector. Farnell has a wide range of products in its T&M range, from synthesized r.f. signal generators to low-cost oscilloscopes.

The LT30/1 is a dual 0—30 V, 1 A power supply that retails at £230+VAT. The LT30/1 is one of a large range of power supplies that includes such units as the TSV70 which provides 0—70 V at up to 10 A output.

The unit is characterized by its use of twin analogue output meters instead of the more common dual, often quad-ripple, digital meters that accompany some power supplies. Constant-voltage or constant-current operation is possible, while the output is protected against overloads and short circuits.

Connection to the mains is by a fixed lead. The mains input voltage may be set to 110 V, 130 V, 220 V, or 240 V a.c.

Operating characteristics

Line regulation is good at less than 0.01% output change (constant current or constant voltage) for a $\pm 10\%$ change in mains voltage. Load regulation is also good, with a 0.01% change in output for a zero to maximum change in the load. These specified conditions were matched on the review model. This facility, together with the low temperature coefficient of 0.01% per °C, enables accurate output levels to be set at switch-on, irrespective of load variations or operating time. Initial drift was also low on the review model and should not be significant. None the less, as a safeguard, a separate output switch is provided. This enables the supply to be adjusted in circuit and left in stand-by prior to supplying the load. This arrangement provides good regulation without a warm-up delay.

Ripple and noise do not present any undue problems: they are below 1 mV_{pp} (constant voltage $f_D=80$ kHz) under full-load conditions.

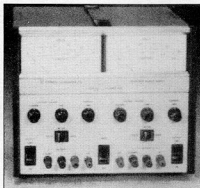

Table 19

TECHNICAL SPECIFICATION

Line voltage:	110 V; 130 V; 220 V; 240 V $\pm 10\%$
Line regulation:	<0.01% of max. output for a $\pm 10\%$ change in mains voltage
Output impedance:	<0.1 Ω at 100 kHz
Temperature coefficient:	0.01% per °C (typical)
Transient response:	<25 μ s for output to recover within 50 mV following a 10% to 100% change in load
Ripple and noise:	<1 mV (typical)
Voltage control:	coarse and fine controls
Current control:	single control only
Protection:	against full overload and short circuits
Metering:	twin analogue meters (30 V and 1 A f.s.d.)
Meter accuracy:	not known
Output terminations:	4 mm terminals
Sensing:	remote current sensing only
Other features:	output switching; dedicated current source mode
Dimensions:	226 x 254 x 249 mm (H x W x D)
Weight:	8.4 kg

The transient response time is also good: the output recovers to within 50 mV in 25 μ s following a 10%—100% load change of 1 μ s rise time.

The current limit is continuously variable over the full current output range of 1 A: the trip temperature coefficient of

0.02% enables this to be known accurately at all times.

The LT30/1 in use

In use, the LT30/1 scores highly: clear indications are provided of current overload and output current/voltage. The use of analogue instead of digital meters has, of course, a cost advantage and also allows trends such as, for instance, the current drawn to be seen more easily. On the other hand, analogue meters do not offer the resolution of digital meters, although on a power supply this is not really a critical factor. None the less, it would have been useful to have the option of switching the meters, for instance, to have constant-current and constant-voltage metering on a single output rather than the obligatory one meter per output switching arrangement. Both meters can be switched between current and voltage monitoring.

The constant-current facility should find many applications from providing a reference for a DAC to charging NiCd cells, for instance. A current-sense input enables the constant-current output to be set with high accuracy.

Since voltage sense inputs are not provided, no automatic compensation can be made for the potential drop across the supply leads, although with a 1 A supply this is not of great importance with commonly used leads.

The outputs may be paralleled to increase the maximum output current to 2 A, while a maximum output voltage of 60 V is available if the outputs are connected in series. These arrangements work well, but it would have been useful if an internal switching network instead of the necessary reconfiguration of the output terminals had been provided.

Construction

The external construction is based on a steel chassis and a stove-enamelled steel enclosure. The neat front panel consists largely of aluminium, as does the back panel. Heat sinks are mounted on the

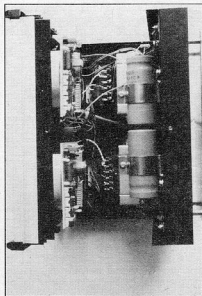
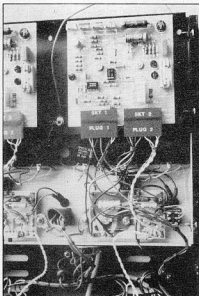
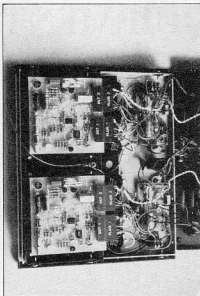

Table 20

	Unsatisfactory	Satisfactory	Good	Very good	Excellent
Voltage control					*
Current control			*		
Regulation				*	
Meter accuracy			*	*	
Overall accuracy				*	
Output impedance			*		
Internal construction					*
External construction					*
Overall specification				*	
Ease of use				*	
Manual				*	
Additional features				*	

back panel. The construction gives the instrument a justifiably solid appearance.

The internal construction is of the same high standard. The unit consists basically of two single power supplies housed in a single enclosure. Each supply is based on a separate transformer and printed circuit board. Access is good, so servicing should not present undue problems.

Heat dissipation is low even at high output currents.

Overall, the power supply should be able to withstand use in most environments and should not be damaged easily.

Manual

The manual provided with the instrument contains fairly detailed operating instructions, together with a full range of applications. There is also a full circuit description, components list and a circuit diagram.

Conclusion

The analogue meters of the LT30/1 may initially cause concern to some users, but they have advantages over digital types. This small point is, however, offset by the LT30/1's high standard of construction and a range of facilities that are well above average.

The constant-current mode is particularly useful, as are the current-sense inputs where high accuracy is required. Given the accuracy and resolution of the good-quality analogue meters, the absence of remote voltage-sensing should be not too significant.

The high-grade construction should make the instrument appeal to a wide range of users, especially in the educational and business sectors where Farnell already has a good market.

In perspective

At an RRP of £230, the LT30/1 may appear to be overpriced when compared

with other power supplies offering a similar specification and quadruple digital meters for, typically, another £20. However, if the dual analogue meters are acceptable, the LT30/1 represents good value. Farnell have earned a good reputation in the test equipment market.

The LT30/1 was supplied by Farnell Instrument Ltd, Sandbeck Way, Wetherby, West Yorkshire LS22 4DH, Telephone (0937) 61961.

Some other PSUs from Farnell

Owing to the large range of power supplies available from Farnell, only a brief outline of specifications can be given.

L series: single (0–30 V at 1 A and 0–30 V at 5 A); and dual (0–30 V at 1 A and 0–30 V at 2 A). Prices from £121 + VAT to £282 + VAT.

D series: various models from other ranges (mostly L) but with digital meters.

5000 series: a range of low-cost units, including 0–15 V at 1 A and triple output models. Typical RRP around £45 + VAT.

E30 series: 0–15 V at 2 A or 0–30 V at 1 A; other versions available. Typical RRP around £110 + VAT.

Triple output: various output voltages available at different current ratings; RRP from £114 to £250; some models include digital meters.

A heavy-duty range is also available with 3 kW maximum output; prices up to £2,450.

SCIENCE & TECHNOLOGY

Software without tears

by Dr Hugh Porteous, Department of Mathematical Sciences, Sheffield City Polytechnic

Many firms that are not big enough to employ professional computer systems analysts run into trouble when embarking on the task of programming. A great deal of money is often wasted in this way, but it need not happen if someone on the staff takes a short, home course prepared by academic mathematics departments and a large computer manufacturer in the UK. The course is now available through the Institution of Electrical Engineers.

Most people associate computers and mathematics. For many, mathematics means 'sums', amounting to addition, subtraction, multiplication and division and, because they see computers as big machines that do number calculations with great speed and complete accuracy, they think mathematicians are virtually redundant. Others, more aware of the limitations of computers, still see a role for the mathematician but see the relationship between a mathematician and a computer as that of a master who wishes to perform some task and a servant who does all the dirty work.

And most people who work with computers know that the vast majority of jobs handled are not complicated numerical calculations but more mundane tasks such as keeping records of stock in a warehouse, producing labels of names and addresses for mailing purposes or handling a company's payroll. The level of mathematics required is elementary arithmetic. For example, if I have five boxes of a particular part and I sell one, I have four boxes left. If I then order two more, I have six. Mathematics seems remote and irrelevant.

While people wrote simple programs to deal with simple tasks, all was well. Usually, programs worked and if they did not the author of the program would quickly discover what was wrong and put it right. As programs grew more complicated, the programmers grew with them, gaining more and more skill at circumventing the limitations of the machines they were using and the languages with which they communicated with the machines. Programming had become a 'craft'.

Too complicated

At about this stage things started to go wrong. Tasks tended to become too complicated for a single programmer and attempts were made to patch together the work of several people. Often this worked very well, but sometimes one part of a program reacted on another in a way that none of the programmers could have anticipated and the computer produced incorrect results. Sometimes that would be cured by modifying the program in a suitable way — until, that is, another programmer came along, interpreted the modification as a 'mistake', and put it 'right' again.

In seeking to solve this problem, the industry has evolved from the craft discipline of programming to the engineering discipline of software engineering. This involves building up programs in a modular function, with each module independently tested to make sure that it performs as required. The final program should have a relatively simple structure so that it is easy to check that it is correct. The result should be error-free software, or at least software where errors can be put right without creating a whole host of new ones. The key to such a strategy is specification. There is no point in writing large numbers of modules for programs if the other members of the team cannot understand what they do. It is important to realise that what matters, once a module has been written, is *what* it does, now *how* it does it. The specification of a program module should declare what inputs the module will accept, the sort of output to be expected and a statement of

how the input and output are related. Just how to obtain the output from the input is important to the writer of the module, but may not be so to the user.

Off the shelf

All this has taken us a long way from mathematics. Yet it is not so far. For the analogy with other engineering disciplines is deliberate. If we are designing a new machine we may well construct it with parts 'off the shelf' and they too will be built to a specification. Critical parts will be built to certain sizes, strengths and weights, and it will be not at all surprising if these are expressed in a mathematical form. With software, similarly, mathematics is the language used for specifying program modules.

The reason why many find this surprising, even impossible to accept, is that their view of mathematics is too limited. Mathematics is not just about numbers. It is about any formal, logical system with precise rules of operations. The mathematics of the software engineer is not the mathematics that most people used to learn at school. There is no need to solve differential equations, compute logarithms, sines or cosines or even to use that most famous of all mathematical symbols, the number π . Instead we use the calculus of propositions, evaluate expressions in Boolean algebra and collect objects together into sets.

For much of the time only two numbers suffice, the numbers 1 and 0, which can be interpreted as the equivalents of 'true' and 'false'. Many of the concepts are exceedingly simple and are now taught in primary schools; but to the uninitiated,

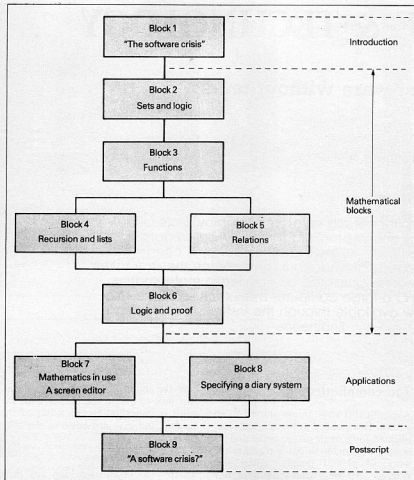

The structure of the course.

$p \wedge q - r$ is easy to understand once you know the language, but is incomprehensible otherwise. Unfortunately many very competent computer programmers have never met this sort of mathematics. For them, software engineering is a closed book.

It was for this sort of person that we wrote the training package *Essential Mathematics for Software Engineers*. It consists of three programmed learning texts, each having three blocks; a fourth volume contains a glossary; there is a bibliography and a guide to the course and a video cassette, which introduces each of the blocks and explains some of the concepts in a more graphic way than is possible in a straight text. The first and last blocks are an introduction and postscript to the other seven; blocks two to six introduce the various mathematical concepts, while blocks seven and eight are extended case studies.

Block two looks at sets and logic. The purpose of this is to provide a framework for writing down the essential facts about a problem in an unambiguous way and with the structure

clearly visible. What we need is to find simple ways to put together sentences so that it is easy to check whether they are true or false, and to specify sets in such a way that if we take any particular object we can tell easily which sets it belongs to.

We may well ask why, when most of the ideas are so simple, we cannot just write specifications in ordinary English. The answer is that often we can, but English has a number of peculiarities that can lead to ambiguities. The simplest of these is the use of the word *or*. If you are asked at breakfast in a hotel whether you would like cereals or orange juice, which of the following do you state as your choice?

- Cereals
- Orange juice
- Both
- Yes please

Here is another example:

"Peter and Andrew were fishermen". The statement can be paraphrased as (Peter was a fisherman) and (Andrew was a fisherman) but "Peter and Andrew were brothers",

although of exactly the same grammatical appearance, cannot be paraphrased as (Peter was a brother) and (Andrew was a brother). Once again our everyday language is not precise.

The next example is a little more subtle. An advertisement for a used car proclaims "only one careful driver." Let us try to be precise. Let D be the set of all drivers of the car. Let CD be the subset of this consisting of all careful drivers of the car. Then we wish to say that the set CD has only a single element. That, at least, is what it seems to mean. But is that what is really intended? Would you buy a car which had had only one careful driver, and not worry about all the other, careless drivers which the car had had? Or does the advertisement imply that the set D has only one element, and that that driver was careful? I suspect that most people would assume that the second interpretation was the correct one.

Contrast this with the assertion "The car has had only one serious accident." The grammatical structure is identical, yet most people would take the other interpretation, namely that the number of serious accidents suffered by the car is one, but that there may have been other, non-serious ones. Where the same grammatical structure can mean quite different things according to the context, there is a clear indication that the language we are using to specify the structure is not good enough for the purpose.

Block three looks at functions. These correspond to an idealised computer program which has the structure:

Input — Process — Output

In the block we look at how the input and output are specified and how the process relates the two. Functions themselves can be put together in different ways and this provides valuable insight into how programs can be structured using smaller modules.

Recursion and list

Block four brings us to the related concepts of recursion and list. A list is rather like a set, except that the elements of it are in a specific order instead of merely being somewhere in the set. It is possible to insert and delete elements and to sort and merge lists. Recursion is involved because it turns out to be more convenient to define a list in terms of other, shorter, lists. The definition of a concept in terms of itself is called a recursive definition. At first sight it looks like cheating, but it is quite respectable if properly used and often leads to much shorter, easier programs that leave much less scope for error.

For example, suppose we have two lists of people, both sorted alphabetically, and we wish to merge them into one list. Using recursion we start by comparing the first elements of the two lists.

Whichever one comes first alphabetically we write down and remove it from its list. Now merge (this is the recursive step) the two remaining lists by repeating the process and write the merged list after the element we have written down already. That is all, or nearly all. We also explain what happens if one of the lists to be merged is empty. In fact it is easy: we just write down the other. The next block is to do with relations. This is not about brothers and sisters, aunts and uncles, though these are used as an example to explain the idea. The point is that mathematics is concerned not primarily with objects, but rather with the relationships between them. Programming too is about relationships, especially between the inputs to a program and the associated outputs. Relations are at the heart of the specification process, just as functions relate to the implementation of the program, and

it is vital to have a clear understanding of these two concepts.

Proofs

The final mathematical block deals with proofs. Part of the reason for using mathematics for program specification is that it not only helps to eliminate errors in programs, but even holds out the hope that we could prove our programs to be correct. This subject is still very much in its infancy, but the fundamental notions that would be needed in any such project are well known to mathematicians.

Blocks seven and eight, as I have mentioned, are extended case studies. One common example that was used to illustrate many of the ideas in blocks two to five was the monitor screen of a computer. In block seven much of this material is pulled together to show how to design a simple text editor, specifying

its properties using the mathematical language already developed. It falls far short of a full wordprocessor, but it does illustrate the techniques which could be used to design one. Block eight is a quite different problem. It is the design of an electronic diary system for a small organisation that holds meetings at regular intervals and needs to find when the people who matter are free.

The package has been produced with financial assistance from the Alvey Directorate in the UK and was written by a team from Sheffield City Polytechnic; the Hatfield Polytechnic; the University of Technology, at Loughborough, and ICL. The video cassette, which is of exceptionally high quality, was produced by the Open University and the BBC. Publishers of the complete package are the Institution of Electrical Engineers, whose address is P.O. Box 26, Hitchin, Hertfordshire SG5 1SA, England.

NEW PRODUCTS

Earth Leakage Circuit Breaker.

ELCB from PR Electronics is used to detect the leakage current which occurs due to man touching to or bad insulation. By switching off Electrical Power it prevents electrical shock & fire hazards & damage of equipment because of excess leakage current.

The device senses leakage current by special transformer which is compared with set value & if it exceeds i.e. when fault occurs the relay operate & audio visual indication is given.

The test key is used to check whether the device is working normally. ELCB's are available for 16A, 30 Amp. & for 30MA/100MA leakage current.

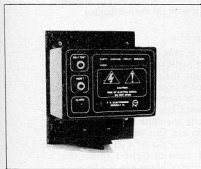

M/s. P. R. ELECTRONICS • 53/C, Raut Wadi, Mogal Lane • Mahim • Bombay-400 016.

LCR Meter

ANDO ELECTRIC CO of Japan offers a 3-1/2 digit LCR meter with a built in comparator. It can be used to measure accurately inductance, capacitance, resistance, dissipation factor, quality factor, ESR and conductance. Four measurement frequencies of 100 Hz, 120 Hz, 1 KHz and 10 KHz are available. The test signal level can be varied from 10 mV to 1V. The AB4305 also features automatic offset "Zero" adjustment function. Series or parallel parameter can be selected. The ranges can be selected automatically or manually. The built in comparator compares the measured value with a preset value and passes if it is within the stipulated range. GP-1B interface is available as standard. DC bias can be applied to the specimen upto $\pm 35V$ or 100 mA.



M/s. Murugappa Electronics Ltd., • Agency Division • 29, Second Street • Kamaraj Avenue • Adyar • Madras 600 020.

Conductivity Indicator Controller

JNM's DCIC - 400 Conductivity indicator-controller comes in two parts - a) Field mountable signal condition/transmitter and b) Panel mountable indicator controller. Remote signal conditioner is

in a rugged, NEMA IV housing. The usual problem associated with cable capacitance errors in conductivity measurement is avoided by processing the signal in the remote transmitter only. Distance between the cell and the panel instrument could be upto 1000 ft. The transmitter can be mounted close to the cell on any pipe, horizontal or vertical. The panel indicator is withdrawable without disturbing the panel wiring giving ease of servicing and replacement. It also has a membrane keyboard with splash-proof front panel capable of taking considerable operational abuse.

Inputs and output signals are galvanically isolated from each other and from the indicator-controller electronics. High Alarm, Low Alarm, Setpoints Hi & Lo and span-Zero for current outputs are all programmable through simple key stroke. Alarm outputs are available on relays.

Calibration of the instrument is extremely simple, connect two known value resistors successively in 'CAL' mode and 'ENTER' the equivalent conductivity data. Instrument takes care of the rest. Liquid temperature value can be manually set or will be automatically taken care of by an independent temperature sensor.

Build-in self diagnostics checks the health of all the electronics. Should any fault occur, a fault relay operates and the error code is indicated on the front panel display.

J. N. Marshall Pvt. Ltd. • Bombay Poona Road • Kasarwadi • POONA-411 034

illumination
indicated
digitally

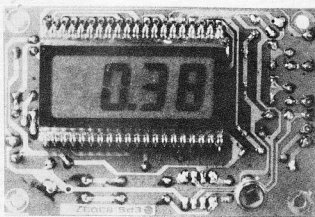

This is a new and up-to-date measuring instrument; it is convenient, compact and digital: the DLM. The digital luxmeter is the latest member of our growing family of digital measuring instruments with simple construction, thanks to a high level of integration. It is intended for accurate measurement of illumination, in two ranges: 0.1 ... 200 lux and 10 ... 20,000 lux. Its low current consumption of only 2 ... 4 mA makes the instrument independent of the mains and useful for portable applications.

LCD luxmeter

Table 1. Illumination figures for natural light sources and guide values for artificial lighting.

Table 1

Natural light	Illumination (lux = lx)
Clear night, full moon	0.3
Winter's day in December with overcast sky	900 ... 2,000
Summer's day in June with overcast sky	4,000 ... 20,000
Winter's day in December with clear sky	up to approx. 9,000
Summer's day in June with sunlight	up to approx. 100,000
Artificial lighting	
Candle light at 1 m distance	1
Side roads	4
Main roads	16
Staircases, railway platforms	30 ... 60
Secondary rooms such as basement, hall, etc.	120
Living-rooms and offices	250
Classrooms, shops, work- shops	500
Drawing offices, precision engineering workshops	1,000

be adhered to. Some of these guide values are listed in table 1, and the table also indicates the illumination levels of natural light sources. The illumination levels quoted in table 1 for artificial light sources are only average values.

The luxmeter presented here measures the amount of illumination. It consists of three units: the sensor and light-to-current converter; the analogue-digital converter with reference voltage source, counter, latch, BCD to 7-segment decoder and LCD driver; and finally, the liquid crystal display.

The sensor

A luxmeter is only useful if it 'sees' the illumination just like the human eye and for this reason the spectral sensitivities of the two sensors (eye and photodiode) should be as similar as possible. So far, no photosensitive device has been made available having exactly the same spectral sensitivity as the human eye. One which comes fairly close, however, is the BPW 21 photodiode. The dashed curve in figure 1 shows the relative sensitivity of the eye as a function of the wavelength of light. The solid curve represents the relative sensitivity of the BPW 21 photodiode and it can be seen that both the eye and the photodiode are relatively sensitive to visible light with a wavelength of approximately 555 nm. The radiation range of visible light is approxi-

Table 2	Optical requirement	Example	Recommended light intensity lx
	Orientation in closed rooms	Corridor lighting	100
	Normal vision handling medium-sized objects	Living-room lighting; manufacture of cases for electronic equipment	400
	Increased visual requirement, small details	Study of tech. literature; fitting components to a p.c.b.	800
	Very great optical requirement, very tiny details	Detailed drawing-work; constructing a miniature device with high component density	1,500
	Extremely great optical requirement, minute details	Repairing mechanical watches	3,000

Table 2. Recommended values of light intensity with changing optical requirements.

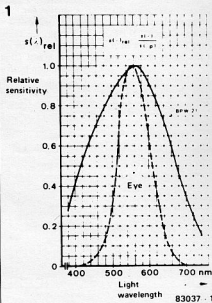

Figure 1. Both sensors, the photodiode and the human eye, have almost the same sensitivity for the range of visible light with wavelengths from 400 nm to 700 nm.

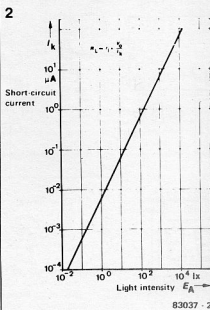

Figure 2. The short-circuit current for the BPW 21 photodiode is linear over a wide range.

mately 4000 - 700 nm and within this region the sensitivity varies considerably according to colour. This applies both to the eye and the photodiode. The curves in figure 1 also show that the sensitivity of the eye is relatively narrowband, whilst that of the photodiode is broad-band. The photodiode responds to violet light with a wavelength of 430 nm and to red light with a wavelength of 650 nm with greater sensitivity than the human eye. However, they both reach their maximum at a wavelength of 555 nm (yellow-green light). In other words, if a light source emits red light and yellow-green light with the same radiation intensity, the yellow-green light appears considerably brighter to both the eye and the photodiode. The two curves in figure 1 do not exactly coincide but are fairly close to each other and the colour correction filter in the photodiode is used to obtain compatibility. For both sensors, no perception is possible outside this radiation range. Radiation under 400 nm is in the ultraviolet region and that over 700 nm is in the infrared region.

Another favourable characteristic of the BPW 21 photodiode is its excellent linearity as shown in figure 2. The short-circuit current I_k is perfectly linear over an illumination range from 0.01 lx to 10,000 lx. In the region of interest, this results in good linearity as regards the absolute sensitivity which is typically 7 nA/lx, (4.5 nA/lx min., 10 nA/lx max.) and a linear scale readout.

The circuit

Circuit operation is straightforward: light is converted to current which is then used to produce a directly proportional voltage followed by a digital readout. There we have a brief description of the circuit shown in figure 3; it does however warrant a more detailed description.

Photodiode D1 is connected in 'current source' mode so that the linear portion of its characteristic curve is used where current is directly proportional to light intensity over a wide range, in the region of several decades. A virtual short circuit is obtained relative to the diode, which bridges the inverting and non-inverting inputs of IC1. This improves linearity and eliminates the otherwise negative influence of the photo-

diode's leakage current. Further information on this subject and photodiode parameters along with various circuit configurations, is given elsewhere in this issue ('O, IC!').

The photocurrent is converted to a proportional voltage by means of IC1 in conjunction with R1/R2 and preset potentiometers P2/P3. In this circuit the opamp's output voltage must be equal to the voltage drop across R1/P2 or R2/P3. This voltage drop is directly proportional to the current through the photodiode and the resistor values used. The resistors therefore determine the measuring range. Since the voltage amplification of the light-to-current-to-voltage conversion circuit is relatively low, capacitor C2 must be added to prevent oscillation.

Once the first stage has converted the light intensity into an equivalent voltage, this can be applied to the measuring input 'IN HI' of IC2. A low-pass filter (R11/C4) is included to smooth out the 50 Hz component in artificial light.

IC2 contains all the functions required in order to obtain counting pulses from the

analogue input voltage, and feed them to the 7 segment decoder which is followed by the LCD driver stage. The DVM chip also provides a 2.8 V reference voltage, which shares a common zero reference with the potential divider R9/R10 and the light sensor D1 ('REF LO' and 'COMM', pins 35 and 32 of IC2). A voltage of 100 mV is present across R10 of the potential divider and is applied to the 'REF HI' input (pin 36) to ensure that the luxmeter gives full scale deflection for a measuring voltage of 199.9 mV at the 'IN HI' input (pin 31). The digits 1999 then appear on the display. T1 serves the function of inverting the BP (blackplane) signal of IC2 (pin 21) so that the decimal point DP1 or DP2 is switched on, depending on the setting of switch S2.

Construction

All components except for the battery and switches can be mounted on the printed circuit board (figure 4). Components are mounted on both sides of the p.c.b., which results in a compact design that will fit into a small case. It is advisable to solder the

Figure 3. Complete circuit of the luxmeter. The change-over facility of the current/voltage converter provides the luxmeter with a range of 0.1 lx to 20,000 lx. This roughly corresponds to a range of illumination extending from a clear night with new moon, up to a summer's day in June with overcast sky.

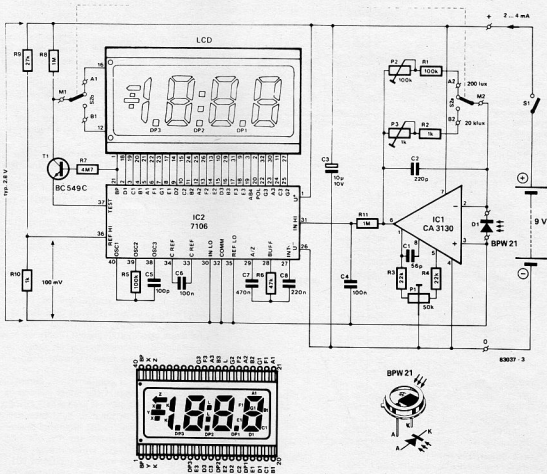

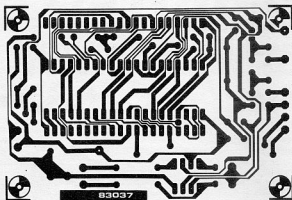

Parts list

Resistors:
 R1, R5 = 100 k
 R2, R10 = 1 k
 R3, R4 = 22 k
 R6 = 47 k
 R7 = 4M7
 R8, R11 = 1 M
 R9 = 27 k
 P1 = 50 k (47 k) preset
 P2 = 100 k
 P3 = 1 k 10-turn presets

Capacitors:
 C1 = 56 p
 C2 = 220 p
 C3 = 10 μ /10 V
 C4, C6 = 100 p
 C5 = 470 n
 C8 = 220 n

Semiconductors:

T1 = BC 549C
 D1 = BPW 21
 IC1 = CA 3130
 IC2 = 7106
 LCD: 3½ digit, digit height 13 mm
 For example:
 Hamlin 3901 or 3902;
 LXD 43D5R03;
 Hitachi LS007C-C,
 H1331C-C

Miscellaneous:

S1 = single-pole on/off switch
 S2 = double-pole change-over switch
 Battery clip for 9 V battery.

Figure 4. Printed circuit board and component layout for the luxmeter. The liquid crystal display and the photodiode are situated on the copper track side, resulting in a compact design.

BPW 21 photodiode directly to the copper track side of the p.c.b. Ensure that it is correctly connected! The LCD display should also be fitted to this side of the p.c.b. If pin 1 is not marked on the display, the decimal points can be used for orientation. They are visible when the display is viewed at an angle. The display is correctly positioned on the p.c.b. when the decimal points are on the same side as the light sensor. All other components are fitted to the component side.

Calibration and alignment

A 40 W and 100 W bulb are required for calibration; they are inserted in sequence into a reflectorless socket with no other light source switched on. No mirrors or reflecting surfaces should be in the vicinity, and brightly coloured walls or ceilings should also be avoided before commencing to calibrate.

- The offset alignment is done before mounting the photodiode D1(!). Set the display to 000 with P1. In exceptional cases it may prove necessary to modify the values for R3, R4 and P1 (R3 = R4 = 10 k and P1 = 100 k).

- Mount the photodiode, set switch S2 to the 20,000 lx range and position the luxmeter 30 cm from the bulb (100 W). Make sure that the bulb is directly above the sensor. Now adjust preset potentiometer P3 to obtain a reading of 1.00 (klx) on the display (i.e. 1,000 lux).

- Change to the 40 W bulb and increase the distance to 50 cm, then select the 200 lx range. Adjust P2 to obtain a reading of 150.0 (lx)

The luxmeter is now ready for use and we suggest checking the illumination levels quoted in Table 1.

NEW PRODUCTS

Universal Eprom Programmer

PR Electronic offer an intelligent Universal EPROM Programmer (PP-100), which is used along with ZX spectrum computer. The basic unit contains hardware and software cassette to program the entire range of EPROM from 2716 to 27512 and its subfamilies. Various other intelligent programming algorithms have been used to reduce the programming time. The programming voltage, time and various other parameters are user selectable by software. Features are: Blank checking, Copy EPROM into RAM, Verify, Entry and Edit of Data, Programming, Loading/Saving of data into cassette, and Identify mode/Manual selection of EPROM.

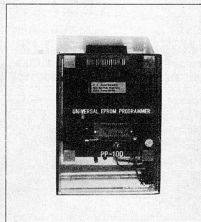

M/s. P. R. ELECTRONICS • 53/C, Raut Wadi, Mogal Lane • Mahim • Bombay-400 016.

Electronic PCB Drill

INSTROL have developed a high speed high power PCB drilling machine that can drill holes of 0.2 to 2.6 mm in printed circuit boards. The PCB drill is a mini version with base and stand so designed to accommodate a big-sized PCB with a width of 400 mm. The spindle height is adjustable. The speed can be adjusted by an electronic speed controller to maximum of 14,500 RPM. The AC series motor can draw upto 300 watts. The highly balanced rotor furnishes the rotational power to the drill bit for precise drilling operation. The drill can also

be used for drilling holes in soft metal sheets made of aluminium bakelite and fibre.

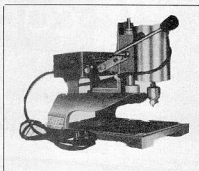

M/s. Instrol (India) Pvt. Ltd. • A-37, Electronics Estate, GIDC • Gandhinagar-382 015.

Insulation Tester

SCR Elektroniks manufacture the Digimeg, a portable digital megger in two basic versions - The LED model (suitable for 230 V, 12 V optional) LCD model which works on 9 v battery. Low cost and portability are said to be the two basic features which make the Digimeg suitable for applications on the field, in the shop floor and in any sophisticated test lab.



SCR Elektroniks • Opp. Fatima High School • Kirod Road • Vidyavihar • Bombay-400 086.

Electronic Phase Sequence Indicator

THE Electro-Arts Solid-State phase sequence indicator is powered through test point R and does not require any separate supply. Output indications are given by LED and the green LED is ON when phase sequence is correct. The instrument has its own R and Y terminals with the EARTH terminal. Connect the

Earth terminal to actual Earth/Ground and R and Y terminals to respective phases. The green LED will glow (ON) only if the phase sequence is correct.



M/s. Electro-Arts • 4, Vaishali • Gangapur Road • Nashik-422 005 • Phone-0253-78452.

Mixed Connectors

THE Type M mixed connectors, manufactured by ERNI Elektroapparate gmbh of Fed Republic of Germany, meet DIN 41612 specifications. Besides the signal contacts for loads of up to 4 A, it is possible to fit high-current contacts up to 40 A and/or coaxial contacts. This range is said to considerably increase the field of application of these multi-pin connectors in the telecommunication and data processing fields. Both the male and female connector halves can be equipped with 2, 4, 6 or 8 special contacts spaced on a 0.1" (2.54 mm) grid. High current contacts are available for either solder or crimp connection. Co-axial contacts, with a very low reflection factor, are available in various attens. They have excellent electrical transmission qualities and are insensitive to disturbing electromagnetic fields.

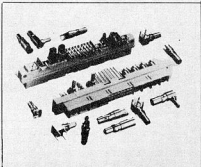

M/s. A.T.E. Pvt. Ltd. • Electronics Division • 36 SDFP 2, SEEPZ • Andheri (E) • Bombay-400 096.

NEW PRODUCTS

Epabx Upgraded

L&T manufacture C-DOT's Version 3 electronic private automatic branch exchange (EPABX), designated ELTEX-112. The upgraded EPABX incorporates fully digital technology comprising time division multiplexing pulse code modulation (TDM-PCM) technique with stored program control (SPC). It is equipped with 128 ports enabling connections of 16 trunks or P&T lines and 96 user extensions which includes two operator console connections.

The Version-3 can be upgraded to 256 ports enabling connections of 32 terminals and 192 user extensions with a maximum of four operator consoles. Features such as fully non-blocking, duplicated control scheme and extensive self-diagnostics make the system dependable. Designed to operate in a non-airconditioned atmosphere, the exchange is positivity suitable for Indian environmental conditions. Voice and data switching capability is integrated into the system to make it fully suitable for complete office automation.



M/s. Larsen & Toubro Limited, TCOM Division • 563, Anna Salai • Madras 600 018 •

Digital Pocket Thermometer

ECONOMY have introduced a digital pocket thermometer with a 10 mm LED fluorescent display that ensures clarity of readout. The unit is provided with dry batteries and intended for use with K-type thermocouples. Advanced electronic in the meter offer linearisation of the K-type thermocouples over a range of -50 to +1200°C. The precision cold junction is compensated with a permanently calibrated circuit.

Interchangeable thermocouple with standard miniature male connector are

offered for air, water, oil and gas temperature in engines, surface temperature of motors, pumps, bearings, extruders, ovens and furnaces; and other applications in process industry.

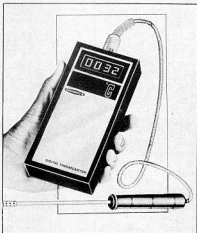

M/s. Economy Electronics • 15, Sweet Home • Plot No. 442 • 2nd floor • Pitamber lane • Off Tulsii Pipe Road • Mahim • Bombay-400 016 • Phone: 2862360 - 461482 •

Real Time Clock

The RTC-72421 is a Real Time Clock designed for use in direct bus-compatible microprocessor applications. It features a built-in quartz oscillator, time and date function, and C-MOS circuitry for low power consumption. The built-in crystal eliminates the need for external components and allows for easy design. Three control registers provide Stop, Hold, Reset, 30 Sec Adjust, and Interrupt Masking Auto. Leap year and 12 and 24 HOUR format are also provided.

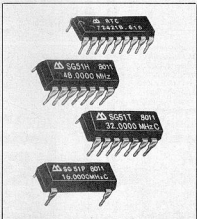

M/s. Sai Electronics • (IN Association with Copwud Arts) • Thakore Estate • Kurla Kirod Road • Vidyavihar (W) • Bombay-400 086 • Ph: 5136601/5113094/5113095 •

Oscilloscope

The Tektronix 300 MHz digital oscilloscope combines B-bit vertical resolution with 500 megasample per-second, dual-channel, and simultaneous acquisition. The combination of high resolution and high sampling rate gives users noticeably more horizontal and vertical waveform detail. The result is the ability to capture very fast single-shot events with significantly improved accuracy, it is said. The 2440 enhances all the built-in automation features pioneered by the other 2400 digital oscilloscopes, in a compact, GPIB-compatible package. Besides the 2440's familiar front-panel controls, set-up and measurement functions can be initiated by an ID button on the head of Tektronix new P6137 350 MHz passive voltage probe. Up to 21 automatic measurements including amplitude, frequency, risetime, falltime, pulse width and propagation delay can be made simultaneously. The 2440 provides built-in pass/fail decision making for unattended testing. known good waveform templates can be generated or downloaded into the scope and automatically compared to a live waveform. Violations of the template are automatically captured. A direct printer/plotter output provides automatic, time-stamped documentation.



M/s. Hinditron Services Pvt. Ltd. • Test & Measurement Division • 69/A, L. Jagmohandass marg • Bombay-400 006. •

NEW PRODUCTS

Modular Test & Measuring Instruments.

Scientific offer a range of high precision professional grade test and measuring instruments in modular form. The main-frame has a built-in power supply to accommodate any two modules of the 8000 Series. The enhanced features and high accuracy of the modules makes them useful for calibration checks as well. Features include 20 MHz generator with highly stable amplitude, 3 ns Rise and Fall time pulses, distortion measurement up to 0.01%, frequency counting with period measurement, and event counting facility at a measurement rate of 300 ms, etc.

The range includes 6 modules: Frequency counter HM 8021-(0.1 Hz to 1 GHz with period measurement and event counting facility, 300 ms); Pulse generator HM 8035 3 ns rise 20 MHz frequency range separate +ve and -ve output facility; Function generator HM 8030 + (0.01 Hz to 1 MHz, FM input and DC-off-set facility); Sine wave generator HM 8032. (20 Hz to 20 MHz); Distortion meter HM 8027-(20 Hz to 20 KHz for measuring distortion to within 0.01%; and milli-ohm-meter HM 8014 - (Resolution 100 microohms, Range 200 m ohms to 20 K ohms, audible fault locator and diode testing facility).

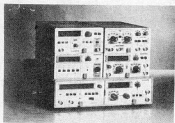

Scientific Mes-Technik Pvt. Ltd. • B-14, Pologround • Industrial Estate • Indore-452 003.

CABLE TIES

The Novoflex Cab-lok cable tie is a versatile method of binding hardwiring and fixing cables. The tie is self-locking and cannot work loose. The one-piece cable tie can be used in virtually any bundle configuration and available in a variety of sizes to cover bundling diameter of 1.6

to 106 mm. Novoflex Cab-lock ties system is immensely strong and virtually indestructible.

Each tie incorporates a non-return, cam-action locking device which ensures that once in place the tie will never come off or slacken. It maintains holding strength over a temperature extreme of -60°C to +110°C.

It is available in natural translucent and black for indoor use. Black ties are suitable for outdoor use, including underground, since they are resistant to ultraviolet radiation.

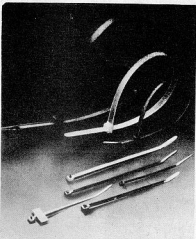

For further details to contact:

NOVOFLEX CABLE CARE SYSTEMS

- Post Box No. 9159 • Calcutta-700 016.
- Phone: 290482, 295939, 293991 •
- Gram: SAFTDUCT •

LCR Meter with Comparator

Ando Electric Co. of Japan offer the AG4304, 4 1/2-digit LCR meter with a built-in comparator, which can be used to measure inductance, capacitance, resistance, dissipation factor, quality factor, ESR and conductance. Four measurement frequencies of 100 Hz, 120 Hz, 1 KHz are available. The test signal level can be varied from 10 mV to 1 V. The AG4304 also features automatic offset Zero adjustment function. Series or parallel parameter can be selected. The ranges can be selected automatically or manually. The built-in comparator compares the measured value with a preset value and passes if it is within the stipulated range. GP-IB interface is available as standard. DC bias can be applied to the specimen upto ± 35 V or 100 mA.

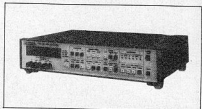

M/s. Murugappa Electronics Ltd. • Agency Division • 29, Second street • Kamaraj Avenue • Adyar • Madras-600 020. • Phone: 41 33 87 •

Photoelectric Proximity Switch

Electro-Arts manufacture a range of photoelectric proximity switches. The self-contained photoelectric scanner combines a modulated beam infrared light source and receiver in a single housing which can be easily installed. The unit detects objects by sensing reflections of light source from object surface. These switches detect diffusely a reflecting surfaces or objects including metal or non-metals paper cloth plastics etc. These are applicable in non-contact sensing, switching, controlling, and regulating various processes, plants, machines etc. for factory automation.

The switches are available in a standard brass plated housing of 18 mm dia as well as in a rectangular size. These work on 10-24 VDC, output is available from NPN or PNP transistors with 100 mA output current.



M/s. Electro-Arts • 4, Vaishali • Gangapur Road • Nashik-422 005 • 0253-7852 •

NEW PRODUCTS

Tube Axial Cooling Fans

Manufactured by Ralliwolf, these have already found acceptance with all leading manufacturers of computers, photocopiers and others. The 120x120x38mm model seen in the photograph is the first of cooling fans planned by the company and is presently available in 230V and 115V AC. This cooling fan is guaranteed to deliver an airflow above 95 cfm free air and develop a static head of 9.5 mm of water. Fitted with imported miniature ball bearings, the life of the cooling fan is assured to last much beyond 30,000 hours.

The model IMA-15 has successfully withstood tests such as shock and vibration, salt spray, dust and rain that are stipulated for defence use.

The configuration of the frame of this cooling fan has been so designed as to facilitate one-to-one replacement of many imported cooling fans.

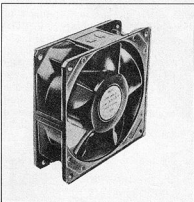

MAC ELECTRONICS • 405 Hill view industrial estate • Off L.B.S. Marg, Ghatkopar (W), Bombay 400 086

Thermocouples/RTD Sensors

Chemitronics India offers full range of thermocouple sensors for chromel alumel, copper constant, iron constant, Pt-Pt 13% Rh, Pt-Pt 10% Rh, and RTD Pt 100. These sensors are available in different shapes and sizes depending on application. The range includes surface temperature probes (exposed junction) up to 800°C for solid surface hot plate, furnace, etc; gas probe up to 500°C; bow type probe up to 600°C, mainly for moving rollers, pipes and circular hot junction application; penetration probe up to

800°C for semi-frozen type materials, resins, cold storage frozen material; needle probe up to 800°C for flat surfaces; mineral insulated probes with Monel metal sheath or Inconel sheath for special applications such as hazardous chemicals, acids, furnace oils, etc. Also offered are compensating cables and thermocouple wires for all these thermocouples.

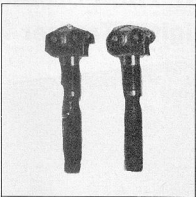

Chemitronics India • Block 4 • Plot 10 • Society Road • Above IOB • Bombay 400 060

Potentiometers

Sakae of Japan offers a range of potentiometers, dials and servo components. The range covers multi-turn, single-turn, low torque, non linear, linear motion, multi-elements, trimming, oil filled, A.C. and contactless potentiometers. Servo components include motorised potentiometers, servo amplifiers, switching amplifiers, D.C. power supplies, helical switches, etc. Application includes consumer, professional, defence, machine tool, robotics and medical electronics.



M/s. Universal Automation • 47, Mitra-mandal • Pune- 411 0099

Computer Ribbon Re-inking Machine

The Track Inker for computer electronic typewriter ribbons is basically used for reinking of used/new computer ribbons at user's location. The tabletop device supports all types of fabric ribbons cartridges and ribbon width varying from 6 to 30 mm. The machine consists of a base with an electrical drive and ink reservoir. The ribbon is rotated by the drive and as it passes around the reservoir, ink is transferred to the ribbon via a capillary mesh which ensures even ink distribution. The ink used is a special type called dot matrix ink and supplied with the machine. Automatic timers are also available for auto shut-off of the drive.

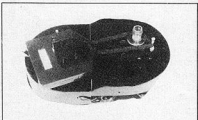

M/s. Track Engineers • 187/5225, Sanmati • Pantangar • Ghatkopar (E) • Bombay-400 075 • Ph: 362111, 381989 (Shashank) •

Desktop Semiconductor Device Tester

Scientific Test Inc. of USA manufacture the Model 5150 desktop, automatic discrete semiconductor test system which can set electrical parameters of triacs, SCRs, transistors, MOSFETS, Zeners, MOVs, diodes etc. Suitable for original equipment manufacturers for incoming inspection of semiconductor devices, the system features as standard a self test diagnostic routine which functionally tests the complete system in under 5 seconds.



M/s. A.T.E. Pvt. Ltd. • (Electronics Division) • 36, SDFP II, SEEPZ, • Andheri (E) • BOMBAY-400 0996 • 6300195 •

DO IT YOURSELF**THE****JUNIOR
COMPUTER****BOOK****LEARN-BUILD-PROGRAM**the practical introduction
to a powerful system

Price
Rs 50.00
Available at
all leading
book shops.

The Junior Computer book is for anyone wishing to become familiar with microcomputers, this book gives the opportunity to build and program a personal computer at a very reasonable cost.

The Indian reprint comes to you from

elektor

Send full payment by
M.O./I.P.O./D.D. No Cheque Please.
Packing & Postage free

to: **elektor ELECTRONICS PVT LTD.**
52-C, Proctor Road, Grant Road (E),
Bombay-400 007.

