

64
August
1988

elektor **INDIA**

Rs. 8.00

electronics

THE PRACTICAL MAGAZINE WITH THE PROFESSIONAL APPROACH

Microprocessor - Controlled radio synthesizer

Fuel Economiser

Proximity Detector

Electrometer

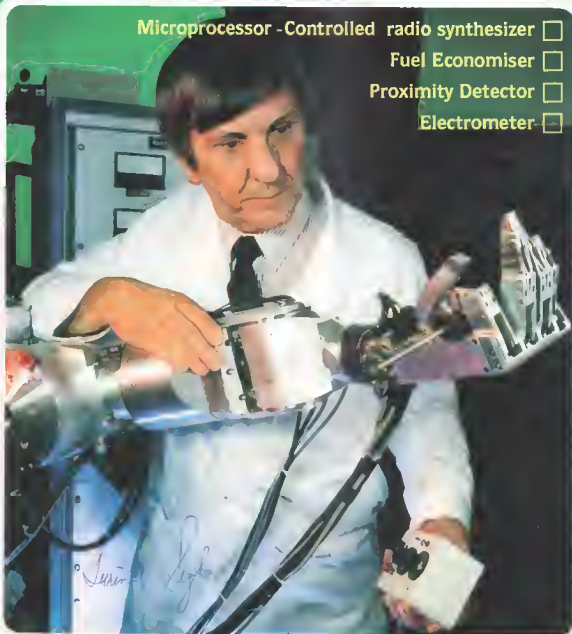

Publisher: C.R. Chandarana
Editor: Surendra Iyer
Technical Adviser: Ashok Dongra
Circulation: J. Dhas
Advertising: B.M. Mehta
Production: C.N. Mithagari

Address:
 ELEKTOR ELECTRONICS PVT. LTD.
 52, C Proctor Road, Bandra - 400 007 INDIA
 Telex: (011) 76661 ELEK IN

Overseas editions:

Elekto Electronics
 1, Harlequin Avenue,
 Great Wind Road, Brentford TW8, SEW U.K.
 Editor: Len Seymour

Pulltron Publicações Técnicas Ltda
 Av Ipiranga 1106, 3° andar CEP 01040 São Paulo - Brasil
 Editor: Juliano Baraldi

Elekto rasl
 Raslka Naberezhje, Le Seou B P 53
 592270 Sevastopol - Russia
 Editors: D R S Meyer,
 G C P Riederwaldorf

Elektoer Verlag GmbH
 Sauerlandstraße 25 100 Aachen - West Germany
 Editor: F J A Krempelbauer

Elekto EPE
 Karagözek 14 16673 Yozla - Athens - Greece
 Editor: E Xanthoulis

Elektuur B.V.
 Postbus Tweedeplaat 2 4
 6191 VK Beek - the Netherlands
 Editor: F E L Kerskenslaer

Ferreira & Bento Lda
 R D Palmária, 32 1° 1000 Lisboa - Portugal
 Editor: Jorge Gonçalves

Ingtek S A
 Plaza Republica Ecuador 2.28016 Madrid-Spain
 Editor: A M Pérez

In Part
 Kerthen Holdings PTY Ltd Cnr Fox Valley Road &
 Koogh Street Wairoanga NSW 2076 - Australia
 Editor: Roger Harrison

Electron Press AB
 Box 53
 162 11 Danderyd - Sweden
 Editor: Bill Cedrum

The Circuits are for domestic use only. The submission of designs of articles of Elekto India implies a permission to the publishers to alter and translate the text and design and to use the contents in other **Praktik** publications and journals. The publishers cannot guarantee to return any material submitted to them. All drawings, photographs, printed circuit boards and articles published in Elekto India are copyright and may not be reproduced or imitated in whole or part without prior written permission of the publishers.

Patent protection may exist in respect of circuits, devices, components etc. described in this magazine. The publishers do not accept responsibility for failing to identify such patent or other protection.



MEMBER

Printed at : Trupri Offset
 Bombay - 400 013
 Ph. 4923261, 4921354
 Copyright © 1988 Elektuur B.V.



Volume-6 Number-8
 August 1988

Editorial

Video theatres 7.05

General Interest

PROJECT: Fuel economiser 8.24
 PROJECT: Door bell memory 8.46
 New Computer System enhances textile production 8.54
 PROJECT: Proximity detector 8.56

Radio & Television

PROJECT: Chrominance-locked clock generator 8.20
 PROJECT: Microprocessor controlled radio synthesizer - Part 1 8.28
 PROJECT: Direct-conversion receiver for 80 metres. 8.38
 PROJECT: Frequency read-out for short-wave receiver 8.41
 PROJECT: Reception and transmission of radio teletype 8.47

Test & Measurement

PROJECT: Electrometer 8.35

Information

Telecommunication news 8.16
 Electronics news 8.17
 New products 8.62
 Corrections 8.73

Guide lines

Classified advertisements 8.74
 Index of advertisers 8.74

Selex-37

Battery operated tube light 8.59

Optic Fibre Lab

The quality assurance circle of the Department of Telecommunications will set up a Rs. 6 crore optic fibre and systems laboratory in Bangalore during 1988-89.

Two quality assurance centres are proposed to be set up at Bangalore and Bhopal where production of optical fibres will begin shortly. The ITI and Hindustan Cables Ltd., will set up a project in the joint sector at Naini for production of optical fibre cables. This project will be in collaboration with the Danish firm NKP.

The Madhya Pradesh State Electronics Corporation will set up a Rs. 50 crore unit at Bhopal for the manufacture of both optical fibre cables and systems in collaboration with the Japanese firms Fujitsu and Furokawa. The first phase of production is scheduled to begin in 1989-90.

To develop expertise in handling the sophisticated equipment, the International Telecommunication Union and the United Nations Development Programme are sponsoring training programmes, according to Mr. U.R.G. Acharya, general manager, Telecom QA circle.

In 1987-88, the Telecom QA circle had evaluated telephone instruments produced by six manufacturers in the private sector—Swede India Telectronics, Bangalore, Rajasthan Telephone Industries Ltd., GCEL, Ahmedabad, Keltron Telephone Instruments Ltd, Telematics Systems Ltd., and Bharat Telecom Ltd. About 66,000 instruments, mostly produced by the first three firms, had been approved.

Reviewing the circle's achievements in 1987-88, Mr Acharya said that more than 700 cases of prototype approval had been processed and finalised. About 25 publications for helping Telecom QA personnel and telecom industries had been brought out, which included 16 quality manuals. New QA test centres have been established at Goa and Mysore, while additional centres will be opened shortly at Madras and Hyderabad.

Testing facilities in all test centres, particularly at the Components Approval Centre for Telecommunication and the Telecom Testing Laboratory, both in

Bangalore, would be augmented.

As per the agreement with the ITU and UNDP, telecom experts from the developed countries would organise programmes for Indian participants and senior Indian telecom officials would be trained abroad in latest telecom technologies.

Telecom Plan

To provide telephone connection to anyone on demand by the year 2000, five more electronic switching factories, in addition to the existing one, are needed.

According to a perspective plan drawn up by the Department of Telecommunications for 1990-2000, an investment of Rs. 47,700 crores should be made during these 10 years if the targets are to be achieved. The targets are provisions of telephone on demand, a public telephone in every village, and installation of eight lakh voice and data communication circuits to meet the demands of the business and industry.

In the seventh plan, 1985-90, the expected expenditure on telecommunications is Rs. 8,100 crores. The perspective plan requires at least six times this investment in the next 10 years.

According to Mr Satya Pal, secretary to the Department of Telecommunications the department had spent Rs. 3000 crores in 1985-88, installed 10.23 lakh lines of local switching capacity, 1.81 lakh lines for replacement and 9.04 lakh lines of direct exchange lines, besides providing STD facilities for 107 district headquarters.

During the last three years, the department, established 2000 rural exchanges, 16 trunk automatic exchanges, 5,085 long distance public telephones and 60 telephone exchanges. Besides providing 11,356 telex connections, the department set up 36 satellite earth stations. The department has been authorised to spend Rs. 1700 crores for the current financial year, 1988-89 though its demand was for Rs. 2400 crores.

According to a DOT review, against the seventh plan target of creating 21 lakh lines of local switching capacity, 4.81 lakh lines for replacement and 16 lakh direct exchange lines, it could create only 10.23 lakh lines, 4.81 lakh lines and 9.04 lakh lines respectively in 1985-88. The department hopes to fulfill the target in the remaining two years.

The DOT has engineered remote area satellite network with a capacity of 1000 subscribers and has invested Rs. 15 crores. The system, likely to be operational by 1989, will provide the users with their own microwave earth stations. Over 300 industrial units have registered with the department for this facility.

On the Cellular or car telephone system, Mr Pal said, in Bombay 1200 car telephones would be installed in the first phase and 5000 more would be installed in the second phase. The categories of telephone would include those fixed in cars, hand-held apparatus and transportable units. Initially some imports would be made and later they would be manufactured locally, even in the private sector.

Kiss Phone

Telephones are undergoing a lot of change in their names, appearance and action. No wonder, some manufacturers catalogue their telephone instruments as "Telemoon" and "Kiss Phone", thus making the phone more of a personal fashion piece.

Japanese stores display over 500 types of telephone instruments making it difficult for shoppers to make a simple choice. Telemoon and Kiss Phones are meant for personal use rather than for the whole family.

Telephone answering machine is increasingly gaining popularity. This machine tapes messages from callers when there is no one at home to answer the phone. Today's telephones come with a variety of features - phone number pre-setting; one-touch dialling; automatic redialling; call waiting; call rejection; screen display of dialled number for confirmation; volume and tone adjustment and so on.

Most of the high-tech phones are push button types. Push button phones and dial phones differ in the way dialled numbers are transmitted. In the dial phone, each number is represented by a series of current breaks that is transmitted to the switchboard. In push button phones, each number signal is transmitted as a pair of audio frequencies one of which is the same for four horizontal rows of buttons and the other same for three vertical rows.

Cordless phone is another item becoming popular. Using this, a person can carry on the conversation staying within 20 metres of the main set. A wireless handset functions as a cordless phone. The phone is made up of a built-in miniature transceiver, with a wireless base unit. It uses weak electrical signals for communication. The negative feature of the cordless phone is that only a limited range of frequencies is available for this facility. If all houses use the cordless phone, there is a likelihood of mixed transmissions and "wave tapping".

Mobile phone or car phone is another type of cordless phone. It paves way for a two-way communication. They are basically powered by car battery. Mobile phones are also known as cellular phones. This name is derived from the fact that many cell-like zones, each

with a radius of two to 10 kilometres, are marked off for mobile phone service. In each zone, a radio base station is constructed to send voice signals over electric waves of certain frequencies through a dedicated base station. When a car moves from zone A to zone B, the frequency of the transmission is automatically switched. The key station controls this change of frequency while tracking the target car.

Radio paging is another popular form of one-way communication. This system makes use of "beepers" which are carried by construction supervisors, salesmen and doctors so that they can be notified when someone is trying to reach them.

New paging devices are appearing in the market. One new pager, the size of a pack of cigarettes, is capable of display-

ing numerals on its liquid crystal display. During operation, the caller is able to use a push-button phone to send a code indicating his own number which the holder of the page is to call. The system can also be used to transmit simple coded messages.

Improvements in the messages-receiving functions of pagers have prompted many new service companies to provide real-time information on foreign exchange rates, stock prices and other applications for customers who need up to the minute data.

Though these gadgets have come on the Japanese scene, like many other technologies and services, it won't be long before they invade the Indian market.

ELECTRONICS NEWS • ELECTRONICS NEWS

Face Competition

The Electronics Commission has suggested that the electronics industry should be exposed to international competition to bring down prices.

The commission at a meeting held recently discussed the high prices of computer peripherals such as floppy drives, terminals and printers and noted that despite concessions such as steep cut in the customs duty on the imported inputs, the industry had failed to bring down prices. Domestic prices of these items were still three to four times higher than the world prices. The slight drop in prices was not in proportion to the concessions given to the industry.

The commission has asked the Department of Electronics to conduct systematic studies on cost-price structure of the items. If the industry failed to cut production costs due to inefficiency, the solution should be to allow imports of these items and expose the local industry to world competition. If the problem was traced to disproportionate marketing costs or the smaller units facing a severe marketing constraint, the department should take remedial measures. It has been suggested that an organisation like

the ET & T should make bulk purchases and sell the items at fixed price throughout the country.

The public sector units engaged in the manufacture of defence electronics had gained strength in several areas and all out efforts should be made to exploit the potential.

India has massive deposits of ferrites in Madhya Pradesh and the commission felt that the studies relating to the export potential ferrites should be taken up. Schemes should be developed to Make Madhya Pradesh a "Ferrite Valley" like the Silicon Valley.

The thrust of the commission's last meeting was on how to increase the use of electronics in improving the standard of living of the people, to increase its use in the industrial sector, and to improve reliability and quality of the Indian products.

Matkem Silican

The Department of Non-conventional Energy Sources has sanctioned Rs. 1 crore to Matkem Silicon Ltd., for its proposed research and development centre. A further soft loan of Rs. 50 lakhs is extended for upgrading the

existing plant and equipment.

Efforts are underway to scale up the plant technology to bring down the production cost of indigenously produced silicon wafers. The company is now wholly owned by Mettur Chemicals Ltd, a private sector firm. Negotiations are in progress to provide equity to the government in this plant.

The quality of polysilicon produced at Matkem was satisfactory and was meeting international standards, according to Mr Maheshwar Dayal, secretary to the department. The 25-tonne plant was now meeting the demands of the country. The production can be scaled up to 150 tonnes per annum.

Polysilicon crystals and wafers had a growing market with the increased utilisation of photovoltaic cells. Currently, Matkem is supplying polysilicon wafers to the BHEL and the Central Electronics Ltd. The government has set a target of one megawatt power to be produced annually through photovoltaic cells. The primary technological goal of Matkem would be to reduce the cost of production by cutting down energy input.

By June, 1989, a pilot plant for the manufacture of amorphous silicon would be ready near Delhi. Seven research groups in the country were studying this material and developing the production technology. Amorphous silicon has a potential to reduce the costs of photovoltaic cells.

A new financing body called Indian Renewable Energy Development Agency has been set up recently to finance both producing and purchase of renewable energy sources.

An expert panel on photovoltaics has been set up with representatives from leading research institutions and industries to review the development of this technology in the country. The DNES has submitted a proposal to set up a chain of solar energy stations of 30 MW capacity each and the proposal is under the consideration of the planning commission.

Shortfall of Silicon

A latest report of the Department of Electronics on the industrial promotion and research and development in silicon has found that there is a gap of about 1.5 million silicon wafers between demand and supply for photovoltaic applications.

Apart from Metkem, two other indigenous companies, Super Semiconductors private limited, Calcutta and Siltronics, Bangalore, are in the silicon business. They buy polysilicon from the market, pull single crystals and slice wafers from them.

When all the expansion plans of the three companies come through, the total installed capacity for conversion of polysilicon into wafers, would be over one million wafers which is equivalent to 20 tonnes of polysilicon. The existing shortfall is expected to be made up within one year. The DOE does not feel the need to invest in creating additional capacities immediately. The three manufacturers, in the current year, are slated to supply 640,000 wafers, of which the share of Metkem is 480,000.

Photovoltaic industry uses only 10 cm diameter wafers and until last year the total wafering capacity was 300,000 against the total consumption of 1.4 million wafers, corresponding to a total poly consumption of six tonnes. Though Metkem's annual poly production could yield close to 1.25 million wafers, lack of

adequate pulling and wafering capacity resulted in shortage of indigenous wafers.

The solar cell manufacturers, the CEL and the BHEL, expect to create a higher total capacity of 1.6 MW peak solar power in 1988-89 to meet the additional markets generated outside the requirement of the DNES. From this, the DOE has projected a demand of two million wafers for 1988-89 for the PV industry. The CEL alone has recently floated global tenders for 1.7 million wafers. Taking the indigenous supply position, then the shortfall may be around 1.3 million. Thus, there is actually a demand for more than 25 tonne per annum of poly if enough wafering capacities can be created. Till then, wafers will continue to be imported.

For semiconductors, hardly any supply is being made by local suppliers. Substantial import of silicon is taking place in the form of diffused wafers and chips. In 1987, close to 3000 kg of undiffused wafers were imported. About 50 per cent of semiconductor devices are produced on indigenous diffusion. If all the devices were to be made with indigenous diffusion, the estimate for silicon consumption for the semiconductor industry would be around 6000 kg.

Computer Hacker

A 24-year old man in West Germany gained access to over 50 military and industrial computers in the United States and Japan, using a home computer and a telephone, thus creating a sensation in the history of computer crimes.

Sitting in Hanover, the hacker who is called David Keller (not his real name) operated the national computer security centre in Fort Mead, Maryland, which is a data protection facility; the SRI network information centre in Nebraska; an air force control system in California; a naval coastal system command centre; the Optimus data base of the Pentagon; the gas turbine laboratory in Pasadena; the Boeing security computer in Seattle; the Anniston army depot in Alabama; and a system at the Fort Buckner American army base in Okinawa, Japan, to name a few.

The story of the discovery, the investigation and the identification of the Hanover hacker illustrates both complexity and susceptibility of the high-tech world as well as the clashing in-

terests of the main players.

In August, 1986, Cliff Stoll, a 37 year-old systems manager at the Lawrence Berkeley Laboratory in California discovered that an unknown person was using his laboratory computer. His laboratory is associated with the Star Wars project of the Lawrence Livermore Laboratory. Stoll is also processing nuclear arms information.

Computer systems of Livermore and Berkeley labs, in addition to the computer systems of many universities and research institutions in many parts of the world, are interconnected. Berkeley is also connected to Milnet, which is linked to military and a number of computers.

Stoll's surveillance showed that Keller hacked into about 450 different military computers. In one system, he got through a security hole which gave him the status of a super user, a privilege which got him access to all stored data which he could then either read or alter.

Stoll followed the hacker day and night and the pursuit through the computers remained a secret. The hunted hacker used the trial and error method, like walking along a street, pressing every door bell, without using force. If the front door did not open, the attempt was made at the back door or side window and then he moved onto the next house.

The hacker was present only for a few minutes and it posed a problem in tracing him. But, false information was lured before him and more details about him were gathered. The hacker was interested in catchwords like nuclear and SDI, Strategic Defence Initiative.

A breakthrough came in the investigation when the hacker was traced across the Atlantic in a German post office network. He was using the Bremen university computer as a springboard to America. The FBI alerted the German authorities and the hacker was being watched both from America and Germany. Then a lure was dangled in the form of a false Star Wars project and the hacker got hooked to it. He remained at the screen until he was traced through the Bremen computer to his home at Hanover.

A few months later, the laboratory received a request for more information about the decoy project from an arms dealer in Pittsburgh who was known to

have ties with Saudi Arabia. It is not known how he got the information about the project.

In June, 1987, the hackers home and office were searched. His machine was confiscated. But, hacking alone was not an offence and the evidence was insufficient to prosecute him under West German law. The legal committee of the government said hackers who simply burrowed their way into systems and did not obtain data illegally should not be prosecuted.

The FBI maintained a news blackout. Stoll wrote an article about the episode in a computer magazine in May, 1988 and the news appeared everywhere. Time magazine and New York Times began a research in this case.

A lot remains unknown. What, for example, are the chances of foreign powers getting information through their secret services hacking into computer systems? Though claims were made that the hacker had not seen any secret material, the problem is that no one knows exactly which data the Hanover hacker had seen or not seen.

Clifford Stoll emerged as a victorious hacker hunter. But the question remains: How many hackers, apart from the Hanover hacker, have gained entry to strategically important computer systems? Have hackers altered programmes without anyone knowing? How near is this episode to the film "War Games" in which a young hacker set in action the war programme in the Pentagon computer just to impress his girlfriend?

The Chaos Computer Club, a hacker club in Hamburg, sees the world as being more and more automatised and controlled by strange forces through machines, computers and robots. It has become necessary to analyse the work of hackers to improve computer security. Meanwhile, the Hanover hacker has been offered a new job with double pay.

Mega Bubbles

Incredibly small magnetic bubbles are emerging as the new generation, ultra-dense memory storage systems. These systems are rugged, resistant to radiation and non-volatile. They retain the data when the power is switched off and they need few moving parts.

Bubble-memory devices in which the

presence or absence of bubbles denotes the 1s and 0s of computer language already exist. They are used in robot memories, portable instruments, specialised computers and many more places where ruggedness and reliability are needed. But the bubbles in these systems are elephantine in size compared with the bubbles now under study in the laboratories of Carnegie Mellon, USA, Japan's Hitachi and Fujitsu and a US firm, Mem Tech.

The shrinking bubbles, ten times smaller than the ones used today, combined with modern technologies like ion implantation may enable developers in less than a decade to cram as many as a billion bits of information on a chip of the size of a thumbnail. Today's state of the art bubble chips and silicon semiconductor chips hold four million bits.

These super-high density bubbles, as a result of the price drop, will find applications in areas where bubble memory is now too expensive. These include ordinary personal computers, automobiles that remember your destination, digital audio players with no moving parts and filmless cameras.

Before bubble technology reaches store shelves, however, specialists say that more basic research is needed. The stability of bubbles in new devices must be evaluated, faster ways of moving the bubbles around inside chips must be found, and the bulky electronic components for detecting bubbles need to be more compact.

In bubble-memory systems, as in semiconductor memories, information must be written, moved around, retrieved and read. The underlying difference is that in bubble-memories, information is represented by tiny magnetic regions, or bubbles. The bubbles are formed on the surface of a garnet crystal made up of magnetic domains pointing in opposite directions. As a magnetic field is applied perpendicularly to the crystal surface, those domains pointing in the direction opposite to the field begin to shrink into snakelike patterns and eventually, into smaller circular spots or bubbles.

MICRON TECHNOLOGY

The Electronics Commission has cleared the import of 1.5 micron technology from the US.

The 1.5 micron technology will be used for the manufacture of telecommunication equipment. This will enable India upgrade its existing miniaturisation of the integrated circuits. The Semiconductor Complex Ltd., Chandigarh and the Bharat Electronics Ltd. have the capabilities to manufacture these micron chips. SCL is working towards achieving two microns capability before the end of the year.

One micron is ten-thousandth of a centimetre and 1.5 micron technology implies that at this level of integration of circuits on the silicon chip, each component will have dimensions roughly of this order. Such high level integration corresponds to somewhat beyond what is termed as Very Large Scale Integrated circuits. The VLSI regime begins at two microns: VLSI corresponds to integration of close to about a million components on a standard size semiconductor chip.

The Indian Telephone Industries has sought transfer of technology from an American firm, VLSI Technology, California, for the 1.5 micron technology. When the technology becomes available, ITI will be able to fabricate devices for defence applications, digital for cipher codes and echo cancellers for telecommunication and so on.

Microelectronics production in India forms hardly 0.6 per cent of the total electronics production in the country or it is worth Rs. 7 crores. The target set for 1995 is Rs. 1000 crores.

The Application Specific Integrated Circuits are the fastest growing segment of the microelectronics family which are ideal for low volume production and known for their competitive edge in cost and functions. India has just made entry in the production of VLSI ASICs. Production for 1988 has been estimated at Rs. 50 lakhs whereas it should be around Rs. 2.50 crores for an electronics systems market of Rs. 75 crores.

SCL has approached the AMI of USA for upgrading its two micron technology into three micron technology. Ultimately, SCL may transfer this technology to the ITI. However, ITI seems to have preferred a collaboration with the VLSI Technology Inc.

CHROMINANCE-LOCKED CLOCK GENERATOR

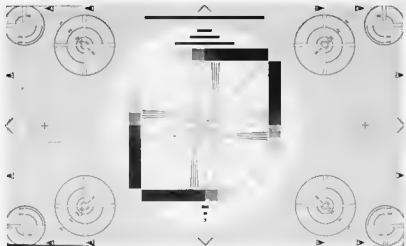

A remarkably simple solution is offered to a problem almost any constructor of a test card or call sign generator, lagamat, graphics card, or any other video equipment must have been faced with at same time: phase synchronicity between clock pulses in the system and the chrominance subcarrier.

A PLL circuit is described that enables deriving the TV line and field frequency, and a number of other useful signals, from the chrominance frequency, 4.433 MHz. A mystery unravelled!

by J. C. Stekelenburg PE1FYZ

In video equipment, the beneficial effects of phase-locking the central clock oscillator to the chrominance subcarrier are mainly the elimination of annoying digital interference and colour cross-patterning. The improvement can be noticed in the well-known colour bar test chart, in which colour transitions become sharply defined rather than blurred with bands of spurious lines and randomly moving coloured spots while longer lines are moving slowly and diagonally or horizontally across the screen.

In professional video systems and studios, complex equipment is available to ensure that all TV synchronization signals have a fixed phase relationship with the chrominance frequency, as set forth in the relevant CCIR specifications.

This article demonstrates how some thinking on the technical background of the PAL (*Phase Alternation Line*) and NTSC (*National Television System Committee*) TV systems, and a comparison between these in respect of possible interference, leads up to simple computer-assisted arithmetic and, finally, the design of a circuit that achieves the above objective of providing chrominance-locked, standard clock frequencies for digital video generators.

Choice of the chrominance subcarrier frequency

The PAL TV system is based on double-sideband modulation of the picture colour information onto a subcarrier of 4.433 MHz. This system is basically

similar to that used for NTSC TV. The Y (luminance) signal is obtained by adding the three primary colours, red (R), green (G) and blue (B), in proportion, as

$$Y = 0.3R + 0.59G + 0.11B$$

The degree of luminance of each individual pixel determines its brilliance, black corresponding to minimum, and white to maximum luminance. For a monochrome TV set, the luminance signal is sufficient for producing a picture. A colour receiver, however, needs the three primary colours for mixing to give each pixel on the screen the correct colour. The colour receiver finds two modulated signals, R-Y and B-Y adjacent to the 4.433 MHz subcarrier. From these, the R, G and B signals are obtained by means of a number of

simple operations involving subtraction and addition. The R-Y and B-Y signals are quadrature-modulated on the 4.433 MHz carrier, so that the instantaneous phase provides a measure for the colour of a pixel, and the amplitude for the colour saturation. Since the colour subcarrier is found within the luminance band (0...5 MHz), its sidebands will become visible as a pattern of thin lines. In the NTSC TV system, this undesirable effect is minimized by using a colour subcarrier frequency that is an odd multiple of the line frequency. This gives rise to a dot pattern which is far less conspicuous and annoying than the line pattern that would be formed in the PAL picture (see Fig. 1).

In the PAL system, the phase of the modulated R-Y signal is inverted for every line in the picture. This causes two sidebands adjacent to the 4.433 MHz

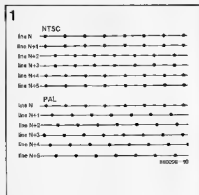

Fig. 1. Comparison between PAL and NTSC: luminance patterns caused by chrominance information.

subcarrier, at an offset corresponding to half the line frequency. When the subcarrier frequency is chosen such that it is an odd-numbered multiple of half the line frequency, B-Y information will result in a dot pattern, and R-Y information in a line pattern. To avoid this, the chrominance subcarrier frequency is an odd multiple of the line frequency divided by four (quarter-offset). Time-averaging of the remaining interference on a raster-by-raster basis is further achieved by adding 25 Hz (raster frequency) to the colour subcarrier, so that cross-interference between luminance and chrominance is least noticed. Summarizing the above, the optimum frequency of the above, the optimum frequency of the chrominance subcarrier, f_{con} , becomes:

$$f_{\text{con}} = (15,625/4) \cdot 1135 + 25 \\ = 4,433,618.75 \text{ Hz}$$

corresponding to the line frequency multiplied by 283.7516. The deriving of the line frequency from the chrominance frequency would, therefore, require dividing this by 283.7516. This is impossible by electronic means, which only

Table 1.

```

1 REM chrominance-locked clock generator
5 REM successive approximation of clock divisors
10 K=4433618.75
20 INPUT "Enter output frequency ",F
30 H=K/F
40 P=H/(H-1)
50 B=1
60 FOR X=1 TO 1000
70 Y=PX
80 A=ABS(Y-RND(Y,-1)/X)
90 IF A>=B; NEXT X
100 IF A<B; B=A : D=RND(X*P,-1) : E=D-X : PRINT X,D,E
110 R=K/D*E : U=K/D
120 S=R/256-15625
130 PRINT R,S,U
140 NEXT X

```

Table 2.

Objective: $f_0 = 4 \text{ MHz}$

x	divisor d	divisor e	real output frequency [Hz]	deviation from 15,625 [Hz]	phase comparator frequency [Hz]
1	10	9	3,999,256.875	-38.05908	443,361.875
3	31	28	4,004,558.871	17.80809	143,019.9597
4	41	37	4,001,070.579	4.1819501	108,137.0427
5	51	46	3,998,950.245	-4.1006052	88,933.70098
9	82	83	3,999,895.177	-0.4084664	48,191.60815
31	317	286	4,000,047.2	0.1843761	13,986.17902
40	409	369	4,000,013.004	0.0507978	10,840.14364
49	501	452	3,999,991.367	-0.0337217	8,849.638423
89	910	821	4,000,001.092	0.0042657	4,872.108516
227	2321	2094	3,999,998.993	-0.0039341	1,910.219194
316	3231	2915	3,999,999.584	-0.0016247	1,372.21255
405	4141	3736	3,999,999.916	-0.0003293	1,070.683789
899	9192	8293	4,000,000.032	0.000125	482.3345028

allows dividing by integers. Subtraction of 25 Hz, division by 1135 and subsequent multiplication by 4 is also very complex in terms of electronics. Reasonable accuracy is, however, obtained by approximation of the denominator, 283.7516.

Wanted: two denominators

Many digital video circuits have a central clock oscillator that runs at a multiple of 1 MHz. This is so arranged because the line frequency is then readily obtained with the aid of binary counters/dividers. For instance, when a clock of 4 MHz is available, 15,625 Hz is obtained by division by 256 (=2⁸). The question is now: how can we relate 4,433,618.75 Hz to 4,000,000 Hz? The answer can be provided by a computer, programmed to find two integer denominators: one, d , for the chrominance frequency, and another, e , for the clock frequency. In other words, if the chrominance frequency is divided by d , and the result of

this division is multiplied by e , 4,000,000 MHz should be obtained.

The BASIC computer program listed in Table 1 gave the results summarized in Table 2. Denominators 910 for d and 821 for e were found to yield a reasonable approximation of the target frequency whilst giving a practicable operating frequency for the phase comparator in the PLL to be designed. Also, these denominators allow relatively simple divider circuits to be used. The final deviation from 4,000,000 MHz is virtually negligible at +1.092 Hz.

Practical circuit

The above considerations lead up to the block diagram of Fig. 2. It is seen that 4 MHz is divided by multiples of 2 to obtain commonly used frequencies in digital video circuits. The chrominance frequency is multiplied by two to give 8.86 MHz, which is frequently required as a clock signal for IC-based colour generators.

Figure 3 shows the circuit diagram of the chrominance-locked clock generator, which is essentially a discrete phase-locked loop, designed around commonly available parts.

The 4.433 MHz crystal oscillator is set up around gate N_5 , whose output signal is fed to buffer N_1 and counter IC₃. This, together with bistable FF₁, divides the chrominance frequency by 910 to give 4.8721085 kHz. IC₃ counts 909 periods of the clock signal, while FF₁ delays 1 period (approx. 226 ns) during the resetting of the counter, giving the required divisor and allowing sufficient time for IC₃ to reset all internal bistables.

The 4 MHz L-C oscillator is a varicap-controlled Colpitts type set up around T₁, with T₂ and Schmitt-trigger gate N₄ acting as a buffer to obtain a digital compatible output signal.

Division by 810 in IC₄ is achieved in a manner similar to that in IC₃-FF₁ as discussed.

Gate network N₂-N₆-N₇-N₈ forms the phase comparator, while R₄-C₃ forms the loop filter with a roll-off of 7.2 Hz. The natural frequency of the PLL is 12.96 Hz, while the hold range is of the order of 150 kHz.

Construction and setting up

The circuit is fairly uncritical in respect of construction, and is simple to build on a small piece of Veroboard. Connections in the 4 MHz and 4.433 MHz oscillators should be as short as possible though, and due attention should be paid to decoupling of the positive supply line.

The only component that requires further discussion here is L₁. In the prototype, good results were obtained with a Neosid Type 7A0 inductor assembly. The required inductance of about 22 μH was achieved by winding 60 turns of 0.2 mm dia. enamelled copper wire onto the former. Do not use ready-made 4.433 MHz inductors with a built-in parallel capacitor, since this is often too large to ensure the relatively high L-C ratio required in this application. The 4.433 MHz crystal was a type salvaged from a colour TV chassis.

After building the circuit, it is recommended to commence testing the 4 MHz oscillator by temporarily breaking the PLL control loop. Disconnect R₄ from pin 4 of N₅. This enables checking the operation of the 4 MHz oscillator with the aid of an external tuning voltage obtained from the wiper of a po-

2

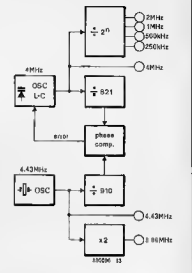

Fig. 2. Block diagram of the chrominance-locked clock generator for video systems.

Parts list

Resistors (±5%):

R₁ = 10M
R₂ = 120K
R₃, R₇, R₁₁, R₁₂ = 10K
R₄, R₆ = 100K
R₅ = 560K
R₈ = 12K
R₉ = 1KΩ

Capacitors:

C₁ = 100p
C₂ = 40p trimmer
C₃ = 220n
C₄, C₅, C₆, C₁₀, C₁₃ = 47p
C₈ = 68p
C₇, C₉, C₁₁ = 100p
C₁₂ = 1n0
C₁₄, C₁₅ = 100n

Inductors:

L₁ = winding details are given in the text.
Neosid Type 7A0 (Neosid Limited • Icknold Way West • LETCHWORTH SG6 4AS, Telephone: (0452) 481000, Telex: B26405 Control Mr. E. Adcott, Neosid Inductors are also available from C-I Electronics.
L₂ = 12μH with centre tap (see text)
L₃ = 7μH with centre tap (see text).

Semiconductors:

D₁, ... D₁₁ incl = 1N4148
D₁₂ = 88105
D_{13a}, D₁₄ = AA119
IC₁ = 4093
IC₂ = 4001
IC₃, IC₄ = 4040
IC₅ = 4013
IC₆ = 4516
T₁, T₂ = BF199

Miscellaneous:

X₁ = quartz crystal 4.433 MHz.

It is regretted that a printed-circuit board for this project is not available.

3

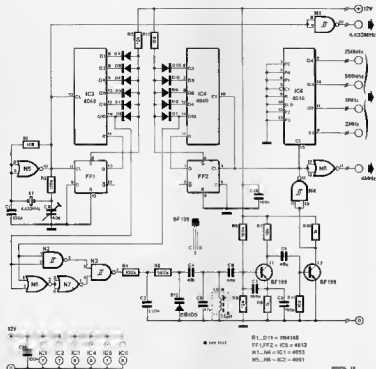

Fig. 3. The clock generator is essentially a discrete phase-locked loop.

tentiometer connected between +12 V and ground. To begin with, adjust L_1 so that oscillation is achieved around 4 MHz. Check that the oscillator can be tuned with the potentiometer. The output of N_2 should supply CMOS-compatible clock pulses. It is essential that these pulses have the full CMOS swing of about $12 V_{DD}$ when the oscillator is tuned around 4 MHz. Do not add too much capacitance to the parallel tuned circuit when its resonance frequency is found to be too high; instead, ensure more inductance by increasing the number of turns on L_1 .

Next, adjust trimmer capacitor C_2 to give 4.43362 MHz at the buffered output. Measure the frequency at pin 2 of N_2 — this should be 4.8721085 kHz. Similarly, measure the frequency at pin 1 of N_2 to check the operation of IC-FF₂. Tune the oscillator to obtain about 4.8 kHz here.

When these tests check out, it is time to close the loop by removing the potentiometer, and connecting R_4 to the output of N_2 . Connect the frequency meter to the 4 MHz output. Some re-adjustment of L_1 may be required to get the PLL to lock.

The oscilloscope photographs of Fig. 4 may be used as guidance if difficulties are encountered in the setting up. The upper two traces show the 4.8 kHz signals at the inputs of the phase comparator, i.e., pins 1 and 2 of N_2 (or N_4), the lower trace the phase comparator output (pin 4 of N_2). Although the latter signal is different in the photographs, the PLL was locked in both conditions, with only L_1 set differently within the hold range of the oscillator. It is clearly seen that the phase comparator is essentially an exclusive NOR function: the output goes low only when the two input signals are different.

The operation of the PLL can be checked by carefully adjusting L_1 while monitoring the phase comparator output with an oscilloscope. It will be found that the PLL loses lock when the pulses become significantly narrower than those in the lower trace of Fig. 4b. When the PLL is locked, L_1 can be adjusted over a small span while the output frequency remains stable at 4.000002 MHz (7-digit resolution).

Finally, switch the power to the circuit on and off a few times to verify that the PLL starts and locks properly. All drift on the 4 MHz output is, of course, caused by drift of the quartz crystal frequency. It is, therefore, recommended to make the final adjustment of C_2 and L_1 after a warming-up period of about 10 minutes.

Multiplier for TEA1002

The circuit described is used by the author as part of a digital test chart and call-sign generator for amateur tele-

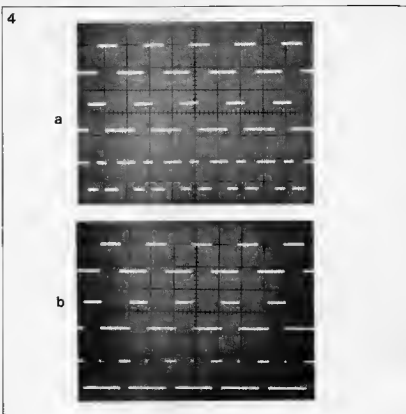

Fig. 4. Oscillograms showing the operation of the XNOR phase comparator.

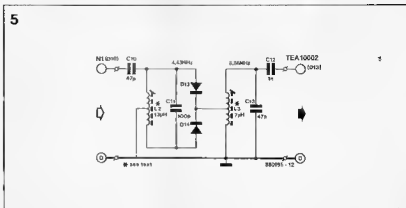

Fig. 5. Frequency multiplier circuit for driving the Type TEA1002 colour generator.

vision. The system incorporates a TEA1002 colour generator chip (Ref. 10) which requires an input signal of 8.86 MHz. The circuit of Fig. 5 multiplies the buffered crystal oscillator output of the chrominance oscillator by two to obtain this frequency. The multiplier is essentially a double-phase rectifier with a parallel-resonant LC output filter. Suggested diode types are AA119 or OA95 (in any case, germanium types should be used). L_2 and L_1 are wound as 30 and 20 turns respectively of 0.2 mm dia. enamelled copper wire, with a centre tap. It is also possible to use ready-made inductors provided they are

known to have a centre tap and the correct inductance (use a grid-dipper to check the in-circuit resonance frequency). Both L_2 and L_1 are simply peaked for maximum amplitude of the 8.86 MHz output signal. *Bu*

Reference:

¹⁰ Video combiner. *Elektor India*, March 1984.

For further reading:

Principles of PAL Colour Television. H. V. Sims, London Iliffe Books Ltd. 1969. *Phase-lock techniques*. F. M. Gardner, John Wiley & Sons Inc. 1966.

an R.P.M. indicator as an economy guide.

fuel economiser

A car engine is at its most efficient when the amount of energy it produces is closest to the amount consumed. This occurs at an engine speed that produces the maximum torque output. Outside of this quite small speed range energy is wasted. The fuel economiser provides both an optical and an acoustical guide to enable the driver to change gear at the optimum time and thereby keep the engine within its most efficient range.

Although an r.p.m. counter is a useful instrument, it is not very helpful in terms of saving petrol. If it was to be used for this purpose it would have to be watched far too carefully to be effective and this would be too demanding on the driver. The circuit described here does not provide a complete r.p.m. indication but rather an indication of when to change gear in order to keep the engine speed at its most efficient. It also gives a warning when the maximum engine speed is approached and would therefore be of use to drivers of high performance cars as well.

The circuit has been designed to demand as little attention as possible

from the driver. As well as giving a visual indication in the form of coloured LED's, it is able to produce an audible indication of the correct gear change times.

How an r.p.m. counter can help save fuel.

It is often underestimated how much a person's driving style will affect fuel consumption. Figure 1 shows the factors which are involved. The consumption of a car without any technical defects has been set at 100%. The 'extra's piled onto that block should be avoided, and it is the 'driving style' section which depends exclusively on the driver.

As far as driving economically is concerned, this is easier said than done. Usually, we drive 'by ear' which is not always an objective method. An r.p.m. counter is highly objective and can help break some bad habits.

The amount of energy consumed by the engine is largely dependent on the engine speed and the torque. Figure 2 shows the torque/revs curve of a typical engine with the energy consumption as a function of the r.p.m. The engine will produce the maximum amount of torque at a certain number of revs. (The exact amount will of course depend on the engine). At this speed, the engine will be running at its highest efficiency. When engine speed is increased significantly above this figure however, much more fuel will be consumed, with a progressive decrease in actual power output per 100 r.p.m. From the graph the following guidelines for an economical driving style may be deduced:

When accelerating (particularly in town traffic) the engine speed in every gear should reach the point at which the maximum torque occurs. As soon as this

speed is exceeded, the driver should change gear.

- When accelerating depress the accelerator smoothly and not too quickly.
- The key to success is to accelerate smoothly and change gear on time.

When the car is not accelerating, it will be apparent that the higher the gear, the lower the fuel consumption. (For in a high gear the number of revs will be lower and as figure 2 shows, fuel consumption is at a minimum at low engine speeds).

The number of revs should not exceed the level at which the maximum amount of torque is produced. Unfortunately, prevailing these measures will be affected by traffic conditions. However, any attempt at saving fuel and whenever possible must be better than no attempt at all. This is where the Fuel Economiser becomes really effective.

Which r.p.m. counter?

Of course any r.p.m. counter can be used to save energy. Unfortunately, as mentioned previously, the 'ordinary' type using a dial or, even worse, a digital display demand too much of the driver's attention. An r.p.m. counter which is meant to save fuel should only provide relevant information when required and not in such a way that the driver is distracted. It is better for it to indicate ranges rather than exact values. In the Fuel Economiser these are indicated by LED's in the following manner;

- yellow: engine speed lower than at maximum torque
- green: engine speed about right for maximum torque
- red: engine speed higher than maximum torque

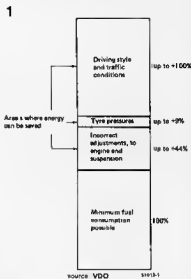

Figure 1. People underestimate how much their driving style can affect the fuel consumption. Even so, this has been known to differ by 100%.

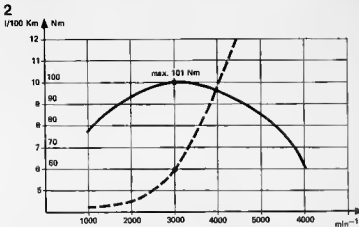

Figure 2. Consumption and torque as a function of the number of revs.

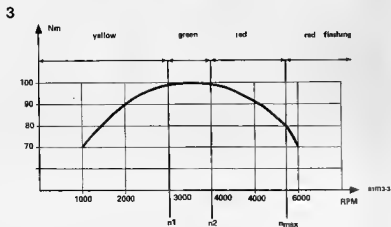

Figure 3. The fuel economiser does not indicate the exact number of revs, but gives a general idea of whether they are too low, too high or just right.

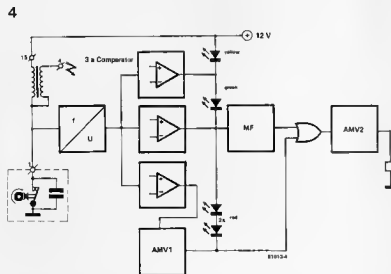

Figure 4. The block diagram.

red flashing: maximum permissible engine speed reached

Figure 3 shows how the display works in relation to the torque/rev curve. Three LED's are sufficient. An extra acoustic signal means you don't have to keep your eye on the LED's continuously. A short tone signals the transition from the green to the red range and indicates it is time to change gear. When the maximum number of revs is exceeded an intermittent warning note will be produced.

The fuel economiser itself:

The block diagram shows a frequency-to-voltage converter at the input to convert the contact breaker frequency into a linear, proportional DC voltage level. This is fed to three comparators which are used to switch the corresponding LED on when the measured engine speed complies with the preset threshold value. When the light switches from green to red, the monoflop MF sends a pulse to the tone oscillator AMV2, which then produces an acoustic signal with the aid of a loud-speaker.

When the threshold value for the maximum number of revs is reached, AMV1 is triggered and produces the flashing frequency for the red LED. At the same time this signal is used to switch the output of the tone oscillator via an OR gate.

As can be seen in the circuit diagram (figure 5), the frequency-to-voltage converter is a fairly simple circuit. Transistor T1 acts as a pulse shaper and IC1 is a 555 timer IC in a monoflop configuration. By integrating its output with the two RC networks R7/C6 and R8/C7, a DC voltage level that is proportional to the pulse frequency is obtained. This DC level will arrive at the non-inverting inputs of op-amps A1...A3. These three op-amps are used as comparators and, together with A4, combined in a single LM324 IC. The voltages to be compared are adjustable with preset potentiometers P2...P4. Until one of the threshold values is reached, (the number of revs being below the economical value) the outputs of the three comparators will be low. In this condition the yellow LED D7 will light and the others will remain unlit.

When the first threshold is reached (lowest limit of the maximum torque range) the output of A1 will be at the positive supply voltage (about 12 V); causing the green LED (D8) to light and D7 to go out. At the second threshold A2 will switch, the green LED will go out and the red LED's D9 and D10 indicate that the torque output is falling. The positive edge of this signal triggers the tone oscillator. Integration through C11 and R19 causes a tone with a descending pitch to be produced. This is to advise the driver to change to a higher gear.

D2...D4 = 1N4148
 D7 = LED yellow
 D8 = LED green
 D9, D10 = LED red
 A1...A4 = LM 555 + IC2

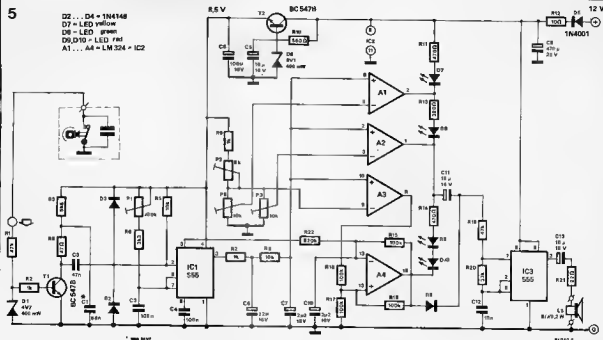

Figure 5. The circuit.

When the engine speed reaches the value set by P2, comparator A3 will switch on the astable multivibrator A4. This will cause the red LED's D9 and D10 to flash once every second and modulates the tone oscillator IC3 via D4 to give an intermittent warning signal. IC3 controls an 8 Ω /0.2 W loudspeaker. If a greater volume is required, a piezo tweeter can be used instead. If the volume is too loud, R21 can be increased.

To enable the fuel economiser to work efficiently in the car a voltage stabiliser is needed and this consists of zener diode D6 and transistor T2. Diode D11, resistor R12 and capacitor C5 serve to suppress transients.

Construction and setting up

Thanks to the printed circuit board shown in figure 6, construction should pose no problems. It is advisable to use sockets for the three IC's. It is also an advantage to use tantalum electrolytic capacitors for C7, C10 and if possible for C14 and C11 too.

Setting up requires a multimeter, a small transformer and a bridge rectifier. In addition, the following engine data should be obtained:

1. The highest acceptable engine speed in r.p.m. (n_{\max}). This can usually be found in the car manual but if in doubt, 5,500 r.p.m. will be close enough. To save the engine a slightly lower figure should be taken, say about 5,250.
2. The lowest (n_1) and highest (n_2) limits of engine speed are derived from the engine torque/rev curve (see figure 3). If this is not given in the manual, you should ask your car dealer.
3. The number of revs at a contact

breaker frequency of 100 Hz.

The following ratio exists between frequency f (Hz), number of revs

$$n \left(\frac{1}{\text{min}} \right) \text{ and the number of cylinders } Z:$$

$$f = \frac{n \cdot Z}{120} \quad (\text{for 4-stroke engines}) \text{ and}$$

$$f = \frac{n \cdot Z}{60} \quad (\text{for 2-stroke engines}).$$

From this it follows that for 100 Hz in a 4-cycle engine $n_{100 \text{ Hz}} = \frac{12000}{Z}$ is required.

Once these r.p.m. values have been calculated, the voltage value can be preset for n_{\max} at 5 V with P2 measured either at the rotor or at pin 9 of IC2). The following voltage for n_2 is then preset at the rotor of P3:

$$U_{p3} = 5 \text{ V} \cdot \frac{n_2}{n_{\max}}$$

Analogous to this the voltage for n_1 is preset at the wiper of P3:

$$U_{p4} = 5 \text{ V} \cdot \frac{n_1}{n_{\max}}$$

Finally, the frequency-to-voltage converter will have to be adjusted to the engine's r.p.m. For this the 100 Hz generator (figure 7) is connected to the rev counter and P1 is set so that the following DC level is measured at capacitor C7:

$$U_{C7} = \frac{n_{100 \text{ Hz}}}{n_{\max}}$$

The value of C1 is calculated for the maximum revs per minute (4 cylinder 4-stroke).

That covers regulation. Now for a practical example.

Engine data: 4 cylinder 4-stroke, maximum torque 101 Nm at 3800-4600 r.p.m., maximum power at 5800 r.p.m. and maximum r.p.m. 6600. Since the greatest power is already reached at 5800 revs, the maximum number of revs (5 V at P2) is set at 6000 r.p.m. Therefore U_{p3} should have a voltage of 3.8 V and U_{p4} 3.1 V. With 100 Hz at the input P1 is adjusted to a voltage of 2.5 V across C7.

Hints for building the circuit into the car

The circuit can be mounted in a standard plastic or aluminium case. The connection of the positive supply voltage is made at a convenient point on the ignition switch or the fuse box. The negative supply voltage (ground) is connected to the closest earth point (in cars with the negative of the battery to earth). The input of the circuit will be connected to the contact breaker side of the coil.

In cars where the connecting pins are according to the DIN 72652 standards, the positive supply voltage is derived from pin 15, the earth from pin 31 and the contact breaker from pin 1.

To avoid interference from radio, the connection between the contact breaker and the rev counter should be laid close to metal parts of the bodywork. Even better would be to use a cable with an earth shield. Make sure that the wiring does not touch any 'hot parts' of the engine.

If after fitting the display should 'jump' and the circuit shows a false alarm once or twice, the value of R1 may be

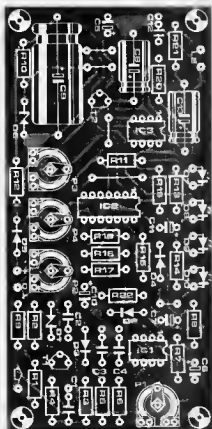

Figure 6. The component layout of the printed circuit board.

Parts list

Resistors:

R1,R19 = 47 k
R2,R7,R9 = 1 k
R3 = 5k6
R4 = 47 Ω
R5,R8 = 10 k
R6 = 3k3
R10 = 560 Ω
R11,R14 = 470 Ω
R12 = 10 Ω
R13 = 390 Ω
R14 = 470 Ω
R15,R16,R17,R18 = 100 k
R20 = 33 k

Capacitors:

C1 = 68 n
C2 = 47 n
C3,C4 = 100 n
C5,C11,C13 = 10 μ /16 V
C6 = 22 μ /16 V
C7,C10 = 2 μ /16 V
C8 = 100 μ /16 V
C9 = 470 μ /25 V
C12 = 10 n

R21 = 22 Ω
R22 = 820 k
P1 = 100 k preset
P2 = 5 k preset
P3,P4 = 10 k preset

Semiconductors:

T1,T2 = BC 547B
IC1,IC3 = 555
IC2 = LM 324, CA 324
D1 = zener diode 4V7/400 mW
D2,D3,D4 = 1N4148
D5 = 1N4001
D6 = zener diode 9V1/400 mW
D7 = LED yellow
D8 = LED green
D9,D10 = LED red

Loudspeaker:

LS = 8 Ω /0.2 W

lowered to a minimum of 4k7. It is also possible that P1 is incorrectly preset and so has to be readjusted.

Guarantee for economy

It is difficult to determine how much fuel an economiser circuit could save, because the consumption does not depend on the circuit, but on the driver. The circuit will merely give a helping hand. If the driver is prepared to be 'advised' then some reduction in consumption is bound to be achieved. Naturally, a driver who is converted from a 'quick-off-the-mark' speeder to an energy-heeder will save a great deal more than someone who drives economically anyway. In any case, much

7

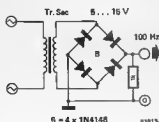

Figure 7. A very simple '100 Hz generator'.

more will be saved in town traffic than on the motorway.

One guarantee can be given for certain and that is that it is considerably cheaper to use a fuel economiser than the 'on-board computer' with which cars are likely to be equipped in the near future and which serves exactly the same purpose.

sources:

Dr. E. Spoerer, W. Thieme,
'The technique to drive economically'
VDO Vertriebsgesellschaft mbH,
Postfach 2220,
6232 Bad Soden 2.

MICROPROCESSOR-CONTROLLED RADIO SYNTHESIZER — 1

The addition of a microprocessor-controlled synthesizer to a continuously-tuned receiver greatly improves tuning accuracy and provides several additional facilities that have become available in recent years.

The versatile synthesizer described has a 6-digit LCD or LED display and a 16-position keyboard which allows direct frequency entry, channel or frequency increment or decrement, as well as the storing and recalling of 30 frequencies. The MW, SW and FM band are covered each with a choice of IF offsets.

by P. Topping

Most recently designed quality radios employ synthesized local oscillators controlled by a microprocessor. These complex designs should not discourage the advanced home constructor, however, as components are currently available which enable similar facilities to be either incorporated in individual designs, or added to existing radios. Synthesis of the local oscillator (LO) in a superheterodyne receiver provides many advantages over the more traditional mechanical tuning. The main benefits are improved tuning accuracy, stability and the possibility to store often used frequencies. Accuracy and stability result from the fact that the local oscillator is phase-locked to a reference crystal oscillator. Before synthesizers became available, crystals were used to obtain a good degree of accuracy. This

has the disadvantage of requiring a separate crystal for each frequency. Using a phase-locked loop (PLL) synthesizer, similar performance can be achieved at an unlimited number of frequencies from only one crystal. Accurate, drift-free, tuning is particularly important for stand-by use of a receiver when nobody is on hand to provide fine tuning.

A synthesizer can be incorporated into almost any receiver simply by replacing the tuning capacitor with a variable capacitance diode (varicap) as shown in Fig. 1. The voltage biasing this varicap is supplied by the synthesizer, which thus takes over the RF tuning. A simpler solution is to retain the RF function of the existing tuning control as a preselector to avoid tracking problems in multi-band designs. The current trend is to

eliminate front-end tuning altogether, and employ only a wideband filter between the RF input and the first mixer.

Synthesizer MC145157

The Type MC145157 CMOS synthesizer from Motorola is one of a series offering a variety of options including serial or parallel interfacing, and single or dual modulus prescaling. In the synthesizer described here, only single modulus

MULTIBAND RF SYNTHESIZER

Features:

- Coverage of MW, SW and VHF FM bands.
- Variable step size in accordance with station spacing.
- CMOS design allows battery back-up while minimizing power consumption and RF interference.
- 11 switch-selected bands with a variety of IF offsets, including none.
- Power-down mode for display and processor.
- Easy to operate keyboard.
- RIT (receiver incremental tuning) control provided.
- Choice of three 6-digit displays: 7-segment LED, static LCD or multiplexed LCD.
- Memory function for up to 30 often-used frequencies.
- Last used frequency automatically recalled at receiver power-on.
- Simple to incorporate in almost any general-purpose receiver.
- Direct synthesis up to 16 MHz without prescalers.
- Prescalers for up to 60 MHz and up to 150 MHz.
- IF offset can be customized to individual requirement.

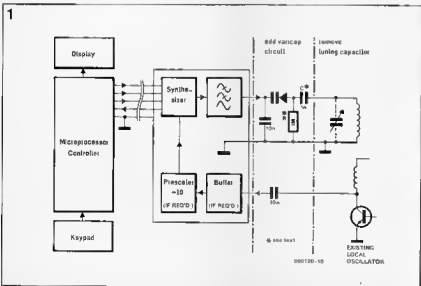

Fig. 1. A local-oscillator synthesizer can easily replace mechanical tuning to provide crystal-controlled accuracy and many other improvements in performance and convenience.

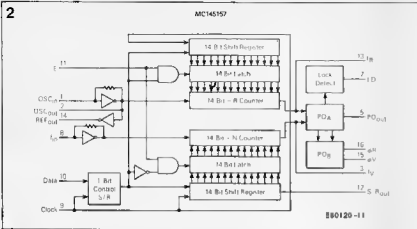

Fig. 2. The MC145157 synthesizer includes two 14-bit shift registers, one each for the reference divider (top) and the variable (LO) divider. Their loading is controlled by the value of a trailing 15th bit. The outputs of these dividers are compared in respect of phase to control the frequency of the local oscillator.

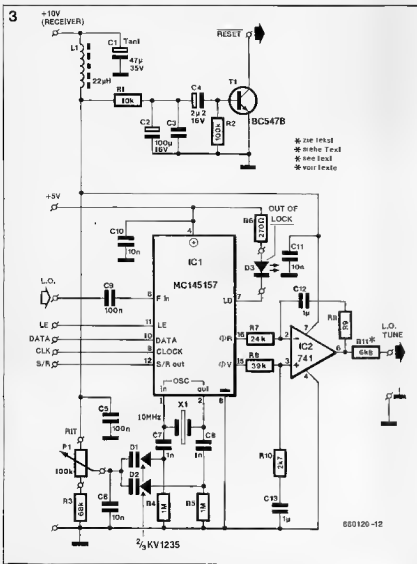

Fig. 3. The synthesizer module contains the MC145157 phase-locked loop chip and its opamp-based active low-pass filter. It also includes a RIT control and a microprocessor reset circuit, which makes it possible to resend the last used frequency in stand-by applications.

prescaling is used. Serial interfacing was chosen to minimize the number of interconnections between the synthesizer and the microprocessor.

The block diagram of the MC145157 is shown in Fig. 2. There are two 14-bit long counters, which are loaded by shift registers, starting with the most significant bit (MSB). After loading the 14 databits, a 15th control bit is loaded, and the information is transferred to the selected latch using LE (latch enable). If the control bit is a logic one, the reference divider latch is loaded; if it is a logic zero, the variable (LO) divider latch is loaded.

The reference counter divides the crystal oscillator down to the reference frequency (in this case 1 kHz), at which the comparison is made with the (also divided down) local oscillator frequency. The error signal from the phase comparator is filtered, and forms the tuning voltage for the local oscillator. The numbers chosen as the divide ratios determine the frequency at which this oscillator stabilizes. The equation below shows the relationship between the various frequencies, where P is the LO prescaler, N is the reference divider ratio, and Q is the LO divider ratio. The received frequency can be changed by altering the LO divide ratio. The microprocessor takes care of the decimal to binary conversion, IF offset, and the other required arithmetic.

$$f_{LO} = RF + IF = P(f_{Xtal}/N)Q$$

The practical application of the MC145157 is shown in the circuit diagram of Fig. 3. The output signal of the synthesizer's 10 MHz crystal oscillator is divided down by 10,000 to obtain the reference frequency at which the phase comparator operates. A compromise is required when deciding on this frequency. Filter design is relaxed by choosing a high reference frequency, but the disadvantage is that the minimum step size of the synthesizer is determined by the reference frequency, as the smallest change which can be made results from a change of 1 on the LO divide ratio (see the above equation). A reference of 1 kHz is a reasonable compromise for most broadcast receivers. The MC145157 is specified to operate up to 20 MHz, so prescaling is required on FM (VHF) and SW. Shortwave band divide-by-5 prescaling is used, and for FM divide-by-10. This increases the minimum step size to 10 kHz on FM, which is ideal for this band, and to 5 kHz on SW, which is suitable for most broadcast receivers but too large for some shortwave applications. Fortunately, however, this can be alleviated by the use of an RIT (receiver incremental tuning) control, formed by external potentiometer P_1 . The low-IF (455, 468 and 470 kHz) SW bands do not use prescal-

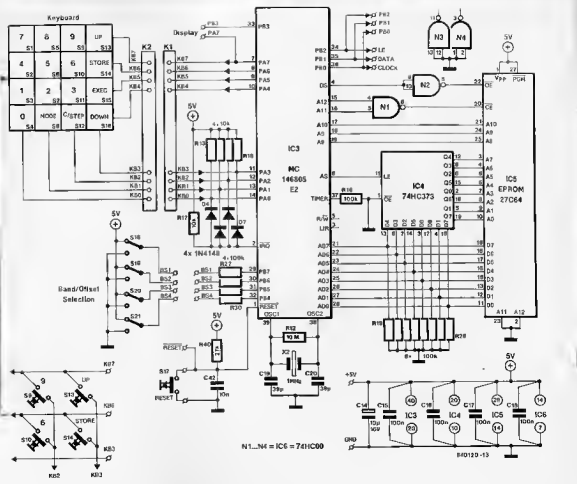

Fig. 4. Circuit diagram of the microprocessor-based controller and the keyboard.

ing, and thus have a step of 1 kHz, but a maximum frequency of just under 16 MHz. ($2^{14} - 1$).

Complex multiple loops are used in some commercial designs to achieve better resolution, but this can also be achieved with the previously mentioned RIT control. With reference to Fig. 3, the adjustment is made by slightly changing the synthesizer's reference frequency. This can be accomplished by replacing the usual combination of a fixed and a trimming capacitor on the crystal pins of the MC145157 with varicap diodes (D₁-D₂). Adjustment is thus by a direct voltage, taken from the wiper of potentiometer P₁, which can be fitted remote from the synthesizer.

This type of adjustment necessarily gives a control range which depends on the tuned frequency, but the relatively high IF ensures that this is not too significant. For instance, using an IF of 10.7 MHz, the circuit shown gives the required range of ± 2.5 kHz at the lower end of the SW band (1.6 MHz), and just over twice this range at about 15 MHz. If an RIT control is not required, pins 1 and 2

should have a 47 pF capacitor and a 30 pF trimmer to ground respectively, the trimmer being adjusted to provide a reference of 1 kHz. If a frequency meter is not available, this adjustment can easily be made by tuning into a strong broadcast of known frequency, and adjusting for optimum reception and symmetric off-channel response.

An important part of any phase-locked loop is the loop (low-pass) filter. The active filter set up around opamp IC₂ is driven from the double-ended phase detector output of the MC145157. An active filter has the advantage of increasing the available voltage swing beyond the supply rail (5 V) of the synthesizer chip. The supply voltage on the active filter determines the maximum voltage available to the varicap diodes in the RIT circuit — 10 V is suitable for the Type KV1235 triple varicap from Toko. The 10 V supply is conveniently taken from the receiver which incorporates the synthesizer.

The combination of active filter and double-ended phase detector outputs makes it simple to select the correct relationship between voltage and LO fre-

quency. Usually, one side of the varicap diode is grounded, so that increasing the reverse voltage on it increases the frequency of the local oscillator. In some oscillator designs, however, the fixed side may be taken to the supply rail, so that increasing the tuning voltage decreases the frequency. With the filter design shown, the choice can be made simply by interchanging the connections to pins 15 and 16 on the MC145157.

Resistors R₁...R₁₀ incl. may need to be adjusted empirically to stabilize the loop and eliminate any trace of the reference frequency from the output of the radio (remember that LO phase noise is demodulated together with the wanted signal).

Microprocessor and keyboard

The next module in the synthesizer is the microprocessor circuit — see Fig. 4. The microprocessor used is the CMOS Type MC146805E2 from Motorola, which offers powerful bit manipulation instructions, useful for this type of application. It also has a stand-by (*power-down*) mode in which the clock is stopped. This

has the double advantage of saving power in battery applications, and eliminating interference problems with the radio. When a key is pressed, the microprocessor 'wakes', performs the required function, and then goes back into the stand-by mode.

The MCI46805E2 has a multiplexed bus for data and low-order addresses. This arrangement saves pins but requires an external address latch, IC4, to interface with the system EPROM, IC3. This is a CMOS Type 27C64 so that the whole system consumes only a few milliwatts when active, and a few microwatts in stand-by. Although the control program in the EPROM could have been accommodated in a 27C16 (2Kx8) with room to spare, an 8 Kbyte EPROM was chosen because this is currently less expensive and generally better obtainable; the 2716, and its CMOS version, 27C16, is now rapidly becoming obsolete.

After performing the initialization routine at power-on, or following a reset, the microprocessor is programmed to switch lines PA4...PA7 of port A to output, and PA8...PA3 to input. The output lines are set logic low before the CPU is software-switched to the power-down state. Any subsequent action on one of the keys S1...S6 incl. drives the processor's interrupt request (IRQ) line logic low, ending the power-down state. Instructions in the EPROM cause the CPU to start scanning the keyboard with the aid of outputs PA4...PA7 and inputs PA8...PA3, to determine which key

was pressed, execute the appropriate command or load the pressed number on the keyboard, write serial data to the synthesizer via PB0, PB1 and PB2, and update the display read-out via PB3-PA7, PB0-PB2, or PB1-PB3-PA7 (the port lines used depend on the display type — this will be discussed later).

The EPROM-resident control program is located in address range 1800h to 1FFFh. This is the top of the CPU's address space (it can address 8 Kbyte of memory), and includes the reset and interrupt vectors. These vectors reside between 1FF6h and 1FFFh with the program itself starting at 1800h. The MCI46805E2 microprocessor has a 112-byte on-chip RAM area in page zero. The CPU bus is demultiplexed by octal latch IC4 using the address strobe (AS) pulse.

The 5 V supply to the controller should not be switched off if the station memories are to survive. The supply does not need to be regulated, and four 1.5 V zinc-carbon or Ni-Cd batteries will do. With the static LCD on, the current drawn in stand-by is about 50 μ A, without it, less than 1 μ A. Eight 100 k Ω pull-down resistors on the multiplexed bus lines of the CPU are used for ensuring minimum stand-by power dissipation. When the display is switched on, it will show random data, but will be written to when any key is pressed (use of the EXECUTE key restores the display to its previous data), or automatically by the reset circuit shown in Fig. 3.

Using the keyboard

The 16-key keypad performs the following functions:

0-9 These keys are used for both direct frequency entry and recalling (or storing) the ten frequencies available in each band.

UP Increment by one channel (5 KHz SW; 9 kHz MW; 50 kHz FM) or 1 kHz (10 kHz on FM, not applicable to 10.7 MHz SW).

DOWN Decrement by one channel (5 KHz SW, 9 kHz MW, 50 kHz FM) or 1 kHz (10 kHz on FM, not applicable to 10.7 MHz SW).

STORE Next key (0-9) stores current frequency at that key (indicated by a decimal point on the left-most digit).

CLEAR Clear display (direct frequency entry). Also toggles between channel steps and 1 kHz steps (indicated by a decimal point on the second digit from the right).

MODE Change between frequency and station mode.

EXECUTE Go to frequency, but stay in current mode.

The leftmost digit in the display indicates which mode is current:

- Display blank: *direct frequency entry mode*;
- Number: last station stored or recalled — *station mode*;
- Small square (LC display) or a single lit horizontal centre segment (LED

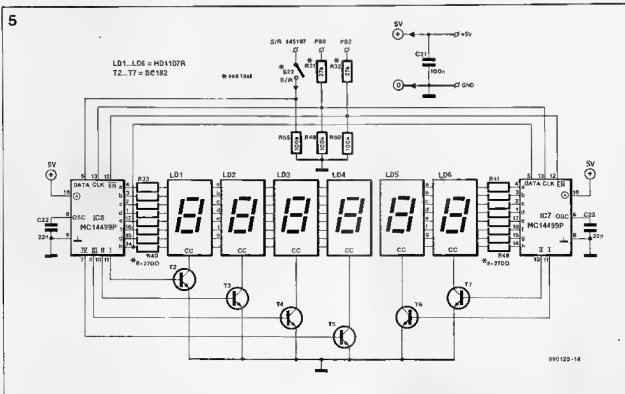

Fig. 5. Six-digit multiplexed LED display.

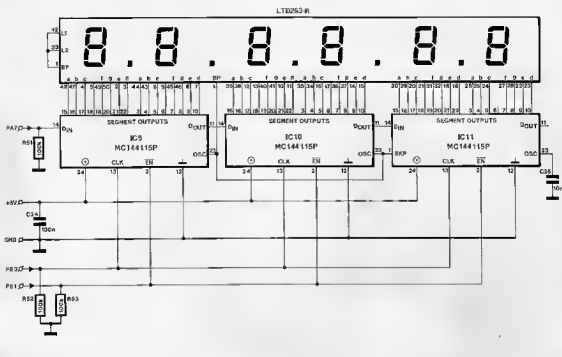

Fig. 6. Static liquid crystal display for the synthesizer.

display): the current frequency has not been written into or recalled from memory.

A choice of two modes permits the minimum number of keystrokes regardless of method of use. In the station mode, previously memorized stations can be recalled by pressing only the required key — there is no RECALL key. Storing a frequency requires two key actions, viz. STORE (indicated by a decimal point on the left-most digit) followed by the memory number.

If direct frequency entry is required, MODE is pressed followed by the frequency. There is now a choice: press MODE again to jump to the new frequency, and return to the station mode. Alternatively, press EXECUTE to jump to the selected frequency but stay in the frequency mode — new frequencies can then be selected with only the EXECUTE key required after each new frequency entered. The store facility also works in the frequency mode.

If it is desired to change back from frequency mode to station mode without retuning the radio, press STORE, then MODE, and to display current frequency press EXECUTE. In station mode, EXECUTE updates the synthesizer and the display with the current frequency. This can be used when the receiver is newly switched on to retune the frequency which was in use when it was switched

off, even if that frequency was not stored. Returning to the circuit diagram of Fig. 3, it is seen that this is achieved by T₁ resetting the microprocessor when the radio is switched on — when the 10 V supply rises, T₁ momentarily pulls the CPU's reset input low.

Bands and IF offsets

Port B lines PB4...PB7 incl. are used for providing band selection infor-

mation to the CPU. These lines can be tied to the appropriate logic level if only one band is required (one band can constitute all the bands which use the same oscillator, but select frequency range by switching inductors). If, however, more than one oscillator has to be tuned, or the step size has to be changed (e.g. between MW and SW), the port lines can be set to the appropriate logic level by means of a set of switches (as shown in

Table 1

Band	PB7 (S18)	PB6 (S19)	PB5 (S20)	PB4 (S21)	IF offset1 (kHz)	Step (kHz)	Memory	Use	Prescaler
0	0	0	0	0	455	5/1	1	SW	—
1	0	0	0	1	468	5/1	1	SW	—
2	0	0	1	0	470	5/1	1	SW	+5
3	0	0	1	1	10,700	5	1	SW	+5
4	0	1	0	0	-10,700	50/10	2	FM	+10
5	0	1	0	1	0	50/10	2	FM	+10
6	0	1	1	0	-70	50/10	2	FM	+10
7	0	1	1	1	10,700	50/10	2	FM	+10
8	1	0	0	0	455	9/1	3	MW	—
9	1	0	0	1	468	9/1	3	MW	—
10	1	0	1	0	470	9/1	3	MW	—
11	1	0	1	1	10,700	5	3	SW	+5

Table 2

0000:	2E 01 80 CD 18 4D 24 23 5F B7 28 A6 27 B7 2D A6
0010:	0E B7 2E D6 18 71 B1 28 27 0A A1 77 27 0D 5C 5C
0020:	5C 5C 20 EF 5C DD 18 71 CD 1A E2 80 A6 F0 B7 04
0030:	A6 0F B7 05 3F 01 3F 00 3F 2F A6 27 B7 2D A6 0E
0040:	B7 2E CD 19 63 10 2F CD 1A E2 BE 20 FD A6 F7 48
0050:	24 12 B7 00 2F F9 98 B6 00 AD 0C 2F 07 2E FE AD
0060:	06 2E FA 99 3F 00 81 AE FF 21 FE 21 FE 5A 26 F9
0070:	B1 EE CC 18 B1 DE CC 18 B1 DD CC 18 B1 DB CC 18
0080:	B1 0E CC 18 B1 8D CC 18 B1 BB CC 18 B1 7E CC 18
0090:	B1 7D CC 18 B1 7B CC 18 B1 ED CC 19 91 D7 CC 19
00A0:	3D E7 CC 19 12 EB CC 19 A2 B7 16 2F 01 77 CC 19
00B0:	05 9F 44 44 00 2F 1E 0E 2F 18 B7 24 05 2F 05 15
00C0:	2F CD 1A C2 CD 1A D9 BE 22 E6 01 F7 5C B3 23 26
00D0:	F8 B6 24 F7 81 97 B7 2E D6 1A CF B7 2D 9F 4C 0F
00E0:	01 04 AB 14 20 05 01 02 AB 0A 48 97 07 2F 0B
00F0:	B6 30 E7 38 B6 31 E7 31 17 2F B1 E2 38 B7 30 E6
0100:	31 B7 31 20 5E AD 1A 3C 30 26 02 3C 31 5A 26 F7
0110:	28 51 AD 0D 3D 30 26 02 3A 31 3A 30 5A 26 F5 20
0120:	42 AE 02 02 2F 0D AD A0 A1 03 27 07 AE 0A 0F 01
0130:	02 AE 12 81 B6 01 A4 78 44 44 44 44 44 44 00 2F 23
0140:	CD 19 B6 AE 10 BF 2B CD 1A 58 AD EB A1 03 26 10
0150:	AE 10 BF 2C CD 1A 58 AE 05 E6 0F E7 10 5A 26 F9
0160:	CD 1A 0B CD 1A 91 AD CC A1 03 26 19 AE 10 BF 2B
0170:	BF 2C AE 16 CD 1A 5B AE 16 BF 2B AE 10 CD 1A 5B
0180:	AE 10 CD 1A 5B CD 19 B6 AE 10 BF 2B 14 2F CC 1A
0190:	42 06 2F 02 AD A7 17 2F 01 2F 04 11 2F 20 86 10
01A0:	2F 81 00 2F 05 CD 1A C2 20 09 02 2F 04 12 2F 20
01B0:	02 13 2F 17 2F B1 CD 19 34 48 B7 22 48 BB 22 AB
01C0:	05 B7 23 A6 06 B7 2A BE 23 D6 19 DB 3A 23 BE 2A
01D0:	E7 15 3A 2A 26 F1 AE 16 BF 2C B1 01 00 00 00 04 05
01E0:	05 00 00 00 04 06 08 00 00 00 04 07 00 00 01 00
01F0:	07 00 00 09 09 08 09 03 00 00 00 00 00 00 00 09
0200:	09 09 09 09 03 00 00 01 00 07 00 3F 30 3F 31 5F
0210:	B6 30 48 B7 22 39 31 B6 31 B7 23 B6 22 48 39 31
0220:	48 39 31 B8 22 B7 30 B6 31 B9 23 B7 31 5C 0E 10
0230:	B8 30 B7 30 4F B9 31 B7 31 A3 05 26 D3 38 30 39
0240:	31 81 BF 26 BE 2C A6 06 B7 2A A6 09 0E 05 E7 05
0250:	5A 3A 2A 26 F5 3F 29 3C 29 20 04 3F 29 BF 26 A6
0260:	06 B7 2A BE 2B BF 2A BE 2C BF 25 BE 2A E6 05 3A
0270:	24 BE 25 EB 05 3A 25 BB 29 3F 29 AD 0F BE 26 E7
0280:	05 3A 26 3A 2A 26 E4 81 0A 0A 3C 29 A1 2A 24 F8
0290:	81 B6 31 B7 23 B6 30 B7 22 AE 1C BF 2B AD 25 3C
02A0:	21 AD 1F A6 0E B7 27 34 23 36 22 34 23 36 22 24
02B0:	06 AE 10 BF 2C AD A4 AE 1C BF 2C AD 9E 3A 26 FA 81
02C0:	EA 81 AE 10 A6 06 B7 2A 7F 5C 3A 2A 26 FA 81 EB
02D0:	60 C7 E5 6C AD AF 0E EF ED A6 10 B7 22 AB 05 B7
02E0:	23 81 AD F5 AE 1C AD DC BE 22 5A 5C B3 23 27 03
02F0:	F6 27 FB 5A BF 27 A6 05 B7 25 BE 23 F6 BF 26 97
0300:	D6 1A CF BE 25 E7 1C 3A 25 BE 26 5A B3 27 26 EC
0310:	0D 01 05 0E 01 02 18 1F B6 1C 01 2F 02 B6 2D 07
0320:	2F 02 AA 10 B7 1C CD 19 34 A1 03 27 05 03 2F 02
0330:	18 20 AE 05 E6 1C BF 24 1F 00 AE 08 44 24 02 1E
0340:	00 16 01 17 01 1F 00 5A 26 F2 BE 24 5A 2A E5 A6
0350:	FF B7 1F B7 20 B7 21 A6 0F B7 1D 3F 1F BE 23 F6
0360:	B7 22 CD 1C 05 B7 23 A3 15 26 04 B6 23 B7 1E A3
0370:	14 26 04 B6 22 B7 1D P6 21 A3 13 26 06 A4 F0 BB
0380:	22 B7 21 A3 12 26 06 A4 0F BB 23 B7 21 B6 20 A3
0390:	11 26 06 A4 F0 BB 22 B7 20 A3 10 26 06 A4 0F BB
03A0:	23 B7 20 5A B3 27 26 B7 0D 01 05 0E 01 02 10 1F
03B0:	01 2F 0E B6 20 A4 0F B7 20 B6 2E AD 48 BB 20 B7
03C0:	20 07 2F 02 16 1F CD 19 34 A1 03 27 05 03 2F 02
03D0:	1E 1D A6 FF AD 39 A6 FF AD 35 A6 FF AD 31 B6 31
03E0:	AD 28 B6 30 AD 29 14 01 15 01 5F E6 1D BF 24 AD
03F0:	1E BE 24 5C A3 05 25 F3 A6 4E AD 0E A6 21 AD 0F
0400:	14 01 3F 01 81 48 48 48 48 81 48 AE 07 20 02 AE
0410:	08 48 24 02 12 01 11 01 10 01 13 01 5A 26 F2 81
0420:	FF FF FF FF FF FF FF FF FF FF FF FF FF FF FF FF
07F0:	FF FF *FF FF FF FF 18 2C 18 2C 18 00 18 2C 18 2C
0800:	00

880120

Table 2. Hexadecimal dump of the EPROM contents. EPROM address range 0430h to 07F0h is purposely not shown because it is left unprogrammed (addresses read FFh), just as the remaining 6 Kbyte in the EPROM (0800h—1FFFh).

the circuit diagram), or, if available, spare contacts on the band selection switch in the receiver. Additionally, the local oscillator feed to the MC145157 synthesizer may need to be switched with the aid of RF relays or PIN diodes. The direct tuning voltage will not normally need to be switched as it can be fed to all varicaps in parallel.

The relationship between the bit combinations on the four MS lines of Port B and the selected band plus IF offset is shown in Table 1.

- Bands 0, 1 and 2: single-conversion SW receivers;
- Band 3: dual-conversion SW receivers (external prescaler $P=5$);
- Band 4: 'oscillator-low' FM receivers or front ends such as the LP1186 (external prescaler $P=10$);
- Band 5: FM band without IF offset; intended for seeing the actual oscillator frequency on display in experimental configurations using a purpose-built test oscillator (external prescaler $P=10$; no prescaler in band 13);
- Band 6: low IF (70 kHz) FM radio ICs (e.g. TDA7000);
- Band 7: 'oscillator-high' FM receivers or front ends such as the Toko 5803/4 or 5402, or Larholt 8319 or 7254;
- Bands 8, 9 and 10: single-conversion MW receivers (9 kHz steps);
- Band 11: dual-conversion SW receivers (external prescaler $P=5$).

It is seen that bit combination 011 in PB6, PB5 and PB4 will select 10.7 MHz IF shortwave regardless of the state of line PB7, so two banks (1 and 3) of memory giving a total of 20 stations can be used, provided that the third bank is not being used for medium wave. A front-panel button connected to PB7 is required to utilize this feature. This will also work for the low-IF shortwave options in which the raising of PB7 selects medium wave with the same IF offset. The IF offsets can be modified in EPROM if required. They are in 6-digit unpacked BCD format, starting at memory address 1E05h with negative offsets appearing in 10-complement form. FM offsets are in tens of kHz, all others in kHz. For medium wave, starting at band 8, the same series of offsets is used again starting at band 0's 455 kHz. Only the first three are meaningful for medium wave, and at band 11 the software automatically repeats a selection of band 3 as described above. Beyond this there are no useful bands except, perhaps, band 13 which, like band 5, has a zero IF offset.

The software does not include any restrictions on the frequencies which can be used in each band. This maximizes the versatility of the synthesizer. For example, the shortwave bands can be used for MW in the USA where the

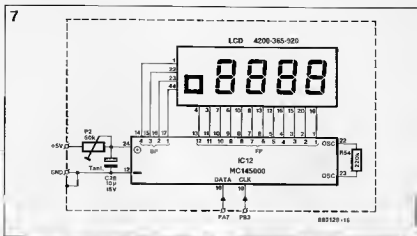

Fig. 7. Multiplexed liquid crystal display. P₂ is used for setting the contrast.

channel spacing of 10 kHz means that the SW step size of 5 kHz is more useful than the 9 kHz provided on MW for use in Europe.

Select your display

The display indicates the current frequency and memory number, and assists with the entry of commands and new frequencies. The user is offered a choice of three types of 6-digit display for the synthesizer:

1. LED display; this has the advantage of probably being the least expensive thanks to the use of common 7-segment LED displays. The disadvantage of this circuit is its relatively high current consumption.
2. Static liquid crystal display.
3. Multiplexed liquid crystal display.

All three displays are driven with only two or three lines from the processor board to simplify wiring, and they work without any change in the software. It is, of course, possible to omit the display altogether, or use two displays simultaneously.

The multiplexed LCD is definitely the most elegant of the three options available, since it enables building a compact display unit with only one driver chip and few connections between this and the LCD. Unfortunately, however, the display required in this application proved very difficult to obtain, and it was, therefore, decided not to sup-

port this option with a printed-circuit board. The circuit diagram will, however, be discussed below.

LED display

The circuit diagram is given in Fig. 5. In line with the rest of the design, the LED display driver is also based on low-power CMOS LSI chips from Motorola, in this case two Type MC14499 display decoders/drivers set up in a multiplexed circuit with four and two common-cathode 7-segment LED displays. The anode resistors, R₁...R₄₀ incl. and R₄₁...R₄₈ incl. should be dimensioned to give the required compromise between brightness and power consumption. IC₇ and IC₈ share their clock and latch enable (LE) lines with the synthesizer (IC), and receive their data from its shift register (S/R) output, pin 12.

As the current consumption of the LED display unit is of the order of 100 mA using 270 Ω anode resistors, the module cannot be left on with the microprocessor in battery-backed up applications, but should be switched off with the receiver. As the data to the drivers is supplied by the MC145157, the display should not be switched off while the MC145157 is still powered, unless the data line (SR) from this is also disconnected by opening S₂₂.

Static LC display

6-digit static displays are currently available with standard pin-outs from a number of manufacturers, with only

minor differences in the use of colons and other signs, which are not used here. Figure 6 shows the circuit diagram of the static LC display unit set up around drivers Type MC14415P. The suggested display from Philips Components (formerly Mullard/Vidolec) gives good contrast while requiring very little power — the total current consumption of this display module is about 50 μA. Non-used segments in the display are tied to the backplane.

Multiplexed LC display

The software can control a display unit composed of a 6-digit multiplexed LCD and a single driver chip as shown in Fig. 7. The benefits of a multi-plane display are immediately apparent from a comparison of the number lines between the controller and the display in this circuit diagram and that of Fig. 6. The controller, a Type MC145000, is fed serially with 48 bits corresponding to 6 digits of 8 segments, including the decimal point. It formats this data into the four backplane and 12 front-plane waveforms required to drive the LCD. Preset P₂ is used for setting the contrast. To avoid interference with the radio owing to multiplexing pulses, the complete display module should be fitted in a metal enclosure.

Part 2 of this article will deal with the prescalers and the construction of the synthesizer.

electrometer

It should be noted at the outset that this instrument is not intended to give a quantitative measurement of field strength, but only to indicate the presence, and fluctuations in the strength, of an electric field. It should also be noted that other factors such as magnetic fields may influence the instrument.

Principle of operation

When a body acquires an electric charge, then an electric field and a potential difference exist between it and earth and indeed between it and other (charged) objects. The geometry and strength of the electric field depend on the shape of the charged object, the potential difference, and the distance between the object and earth (or another object).

For example, consider the electric field between two large, flat parallel, conducting plates. The potential falls uniformly across the space between one plate and the other. It is possible to detect (or even measure) this so-called 'potential gradient' by inserting a pair of electrodes into the field and measuring the voltage difference between them.

Of course all this takes place in an insulating (dielectric) medium such as air, which has a very high resistivity, so any instrument used to measure the potential difference must have an extremely high input impedance. It is no use waving about the probes on one's multimeter and expecting to get a reading!

The input stage of the electrometer must therefore consist of a pair of electrodes feeding into an amplifier with a very high input impedance (figure 1). The amplifier output drives some form of indicator. As the present electrometer design is intended to give only a qualitative indication of field strength, it was felt that the expense of a meter was not justified, so an audible indication is provided.

The electrodes, which are etched on a piece of printed circuit board, are connected to the differential inputs of a FET input operational amplifier. The output voltage of the amplifier is used to control the frequency of a voltage-controlled oscillator (VCO), which

Researcher into psychic matters believe that electric fields often accompany or are the cause of unusual phenomena. For example, it has been conjectured that buildings having certain geometrical shapes, such as pyramids, have the ability to concentrate electric fields and thus preserve organic tissues (mummification). This claim seems partly to be borne out by recent experiments in the USSR, where strong electric fields have been used to preserve vegetables and shepen reazor blades.

It is also believed that electric fields accompany psychic manifestations. An instrument that will indicate the presence of an electric field is thus of considerable use when investigating such phenomena, and this is what the electrometer is designed to do.

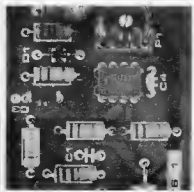

drives a loudspeaker. The VCO frequency is an indication of the field strength.

The smaller electrode between the two main electrodes serves as a balance electrode and a discharge path. Since the input impedance of the amplifier must be extremely high, it is not possible to reference the two inputs to zero or supply voltage by any resistive network. The input terminals are thus floating DC-wise with respect to the supply terminals, and it is possible that the common-mode range of the amplifier could be exceeded, even if the differential input voltage was quite small. The balance electrode is thus connected to half supply potential to provide a reference.

The balance electrode also serves as a discharge path for any static charges that may build up on the main electrodes. When using the electrometer the main electrodes should periodically be connected to the balance electrode to discharge them. Bridging the three contacts with a finger-tip will do the trick!

Complete circuit

The circuit of the electrometer is given in figure 2. The input amplifier is a CA 3140 FET op-amp. Negative feedback to define the closed-loop gain is provided to one of the offset inputs via R3. (Providing feedback to the inputs, as is more usual, would lower the input impedance!). C1 provides high-frequency rolloff to maintain stability and prevent any high-frequency pickup.

The VCO is built around a 741 op-amp. This is connected as a voltage comparator, with the reference voltage on the non-inverting input determined by R5, R6, R7 and the output voltage of IC1. When the voltage on pin 2 is higher than the voltage on pin 3 the output will go low and C3 will discharge through R8.

When C3 has discharged to such an extent that the voltage on pin 3 exceeds that on pin 2 then the output will go high and C3 will charge rapidly through D1. The output voltage will then go low and the cycle will repeat.

The output waveform of the VCO is thus a series of pulses having a very small duty-cycle, which keeps the cur-

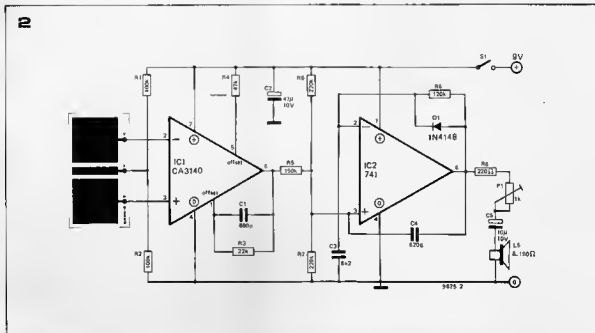
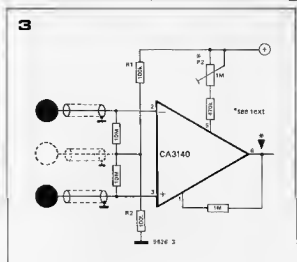
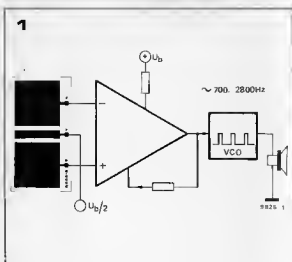

Figure 1. Block diagram of the electrometer, which consists of two sensor electrodes, a high input impedance differential amplifier, a VCO and a loudspeaker.

Figure 2. Complete circuit of the electrometer.

Figure 3. The input stage can be modified to monitor voltages generated by physiological changes such as muscle contraction.

rent consumption low and allows a 9 V transistor power pack battery to be used as the supply.

Potentiometer P1 in series with the loudspeaker provides some adjustment of the volume. For an 8 Ω loudspeaker P1 should be adjusted until the total resistance (P1 + R9) is around 390 Ω . The current consumption of the circuit will then be around 5 mA.

Printed circuit board and component layouts for the circuit and the sensor electrodes are given in figures 4 and 5.

Testing and applications

When the electrometer is switched on, in the absence of an electric field, the instrument will produce a fixed tone. If an insulator such as an ebonite rod or piece of acrylic (which has been charged by rubbing on fur or other material) is brought close to the electrodes the pitch will change.

The electrometer can now be used to investigate electric fields around other bodies.

The electrometer may also be modified to indicate voltages generated during physiological changes such as muscle contraction, or the voltages generated by plants. These modifications are detailed in figure 3. The electrode plate is dispensed with and 10 M input resistors are connected into the circuit as shown. New electrodes, preferably of silver, are attached to the subject and connected via screened leads. In this case the centre electrode is optional, but if connected to the subject midway between the other two it will reduce the susceptibility to common-mode interference. To use the instrument, P2 is first adjusted until the output of IC1 is at half supply. The electrodes are then connected to the subject, either by taping to the skin over a muscle when

4

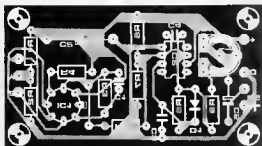

Parts list:

Resistors:

R1, R2 = 100 k
 R3 = 22 k
 R4 = 47 k
 R5 = 150 k
 R6, R7 = 220 k
 R8 = 120 Ω
 R9 = 220 Ω
 P1 = 1 k

Capacitors:

C1 = 680 p
 C2 = 47 μ /10 V
 C3 = 8n2
 C4 = 820 p
 C5 = 10 μ /10 V

Semiconductors:

IC1 = CA 3140
 IC2 = 741
 D1 = 1N4148

Miscellaneous:

S1 = SPST switch
 LS = loudspeaker
 8 = 150 Ω

5



Figure 4. Printed circuit board end and component layout for the electrometer. (EPS 9826-1)

Figure 5. The sensor electrodes, which are also etched on copper laminate board.

monitoring muscle contractions, or by taping to the leaves or stem of a plant. When the muscle is flexed the pitch of the VCO will change, or in the case of plants there may be a response to stimuli such as light, heat or even sound. Whatever application the electrometer is used in, it should be remembered that the instrument is fairly sensitive and has a high input impedance, and is thus very susceptible to interference such as mains hum. It should therefore preferably be used well away from such sources of interference. **M**

DIRECT-CONVERSION RECEIVER FOR 80 METRES

What better occasion to present an ultra-simple 80 m receiver than this month's issue devoted to amateur radio and TV? An ideal project for the holidays, this CW/RTTY/SSB receiver is inexpensive, yet has good sensitivity and selectivity. You will have it ready in no time, and it only requires headphones, a set of batteries and a long-wire aerial to bring in the 80 metres band, popular among hams around the world for its reliable propagation characteristics.

The tuning range of the receiver discussed here is about 3.5 to 4.0 MHz, a section of which is assigned to licensed radio amateurs. In most areas in the world, the 80 m amateur band extends from 3.5 MHz to 3.8 MHz. Predominant modulation methods are single-sideband (SSB), continuous wave (CW) and FSK RTTY (radioteletype based on frequency shift keying, using an SSB transmitter). The 80 m band has some interesting properties as regards propagation. Daytime range is usually of the order of a few hundred kilometres, while in the evening and at night field-strength increases, and stations up to 2,000 kilometres away can be heard. Occasionally, American stations are received in Europe in the early hours of the morning.

Direct-conversion receiver

The operating principle of the direct-conversion (or homodyne) receiver is simple: the received signal is mixed with that of a local oscillator to give a beat note, which is at once the AF output (see Fig. 1). In a direct-conversion receiver,

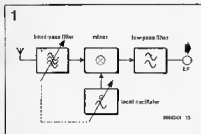

Fig. 1. Basic direct-conversion receiver.

the degree of selectivity is determined almost exclusively by the AF low-pass filter. The present design uses an active mixer which doubles as a linear detector, obviating the need for a prestage and providing the necessary high audio am-

plification thanks to a special feedback circuit.

The practical circuit of the receiver is shown in Fig. 2. The circuit looks relatively complex at first, but is basically not very different from the block diagram.

The aerial signal is fed via coupling capacitor C_1 to a parallel tuned circuit, $L-C_2-C_3-C_4$. This band-pass filter can be tuned by applying a direct voltage to variable capacitance diode (varicap) D_1 . Coupling capacitor C_5 feeds signals passed by the filter to operational transconductance amplifier (OTA) IC₁, a Type CA3080. An OTA differs from an operational amplifier in supplying an output current rather than an output

voltage. In the present application, amplification of the CA3080 is controlled by the feedback circuit and the voltage on pin 5, which is provided by the local oscillator, to achieve the desired mixing effect. The feedback network is composed of C_6 , C_{10} , C_{11} , T_1 , R_3 , R_6 , R_8 and C_8 . It is a relatively complex circuit because it functions as a current-to-voltage converter in conjunction with FET T_1 , and at the same time as a low-pass filter whose roll-off frequency is determined mainly by the capacitance across R_8 , i.e., C_{11} (100nF; CW/RTTY) or $C_{11}+C_{12}$ (570nF; phone). The oscillator set up around T_2 is a varactor-tuned Clapp type with polystyrene capacitors to ensure opti-

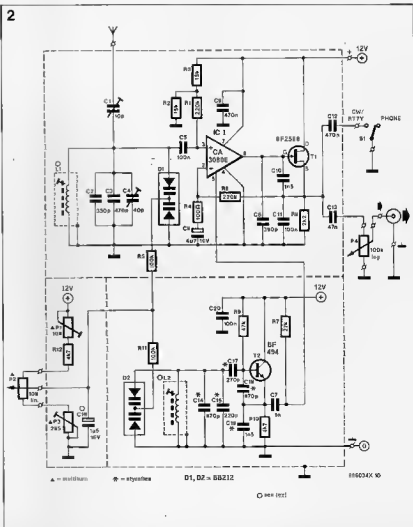

Fig. 2. Circuit diagram of the direct-conversion receiver for the 80 metres band.

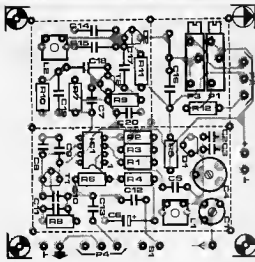

Fig. 3. Track layout and component mounting plan of the double-sided printed circuit board for the direct-conversion receiver.

Parts List

Resistors ($\pm 5\%$):

R1; R6 = 220K
R2; R3 = 15K
R4 = 100R
R5; R11 = 100K
R7 = 27K
R8 = 2K2

R9 = 47K

R10; R12 = 4K7

P1 = 10K multiturn preset

P2 = 10K linear multiturn potentiometer

P3 = 10K multiturn preset

P4 = 100K logarithmic potentiometer

Capacitors:

C1 = 10p trimmer
C2 = 330p

C3 = 470p

C4 = 40p trimmer

C5; C11; C20 = 100n

C6 = 4p7; 18 V

C7 = 1n0

C8 = 390p

C9; C12 = 470n

C10 = 1n5

C13 = 47n

C14; C18 = 470p⁺

C15 = 220p⁺

C16 = 1p5 MKT

C17 = 270p⁺

C18 = 1n5⁺

⁺ polystyrene (Siemens: styroflex[®]) capacitor
5% (available from Cricklewood Electronics).

Inductors:

L1; L2 = Neosid assembly 7A15; winding details are given in the text. Neosid part no.

06956500. Neosid Limited • Icknield Way West • LETCHWORTH SG6 4AS. Telephone: (0462) 481000. Telex: 826405. Fax: (0462) 481008 (contact) Mr. E. Adcoft. Neosid inductor assemblies are also available from C-1 Electronics • P.O. Box 22089 • 6360 AB Nuth • The Netherlands.

Semiconductors:

D1; D2 = BB212 IC/ik stock no. 12-02045

T1 = BF250B

T2 = BF494

IC1 = CA3030E

Miscellaneous:

S1 = miniature SPST switch.

PCB Type 686034X I

imum stability. The common tuning voltage for the oscillator and the input bandfilter is obtained from multiturn potentiometer P₂. Presets P₁ and P₃ form part of a potential divider, and enable accurate setting of the receiver's tuning range. Since the capacitance of a varicap is inversely proportional to the reverse voltage across it, the received frequency increases with the voltage on the wiper of P₂. With this in mind, it is readily seen that P₁ and P₃ set the upper and lower band limit respectively.

Construction

The direct-conversion receiver is constructed on the double-sided, but not through-plated, printed circuit board shown in Fig. 3. The component side of this board is left largely unetched to enable it to function as a ground plane. Commence the construction with soldering 15 mm high tin plate or brass screens onto the component side — the locations are shown in dashed lines on the overlay. Use soldering pins at the corners to aid in positioning and, if necessary, bending the screens. Drill holes to ensure access to the spindles of multiturn presets P₁ and P₃ later. Inductors L₁ and L₂ are home-made and identical. They are composed of 20 turns of 0.2 mm dia. enamelled copper

wire wound on the plastic former of a Type 7A15 inductor assembly from Neosid. Remove the three pins on one side of the base, and use the remaining two pins for connecting the winding. Scratch off the enamel coating with a pen-knife, pre-tin the wire end, remove solder flux by scratching again, and then wind the wire end two times around the pin. Tighten the winding and move it up towards the base to prevent a short-circuit with the ground plane. Solder fast to prevent the base melting and the pin being dislocated. Now close-wind 20 turns of the wire upwards on to the former, right up to the rim. Adjustment of the inductor is facilitated when the grounded ('cold') end of the inductor is near the rim on the former. Secure the winding with a few drops of glue or wax, and check continuity at the pins. Carefully mount the inductor on the board, and solder the pins at the track side. Fit the ferrite cup, and insert the core. Finally, mount the screening can, and solder the tabs to ground at both sides of the PCB.

The mounting of the remaining components on the board is a matter of routine. One terminal of the following components is soldered to ground at both sides of the PCB: R₂, R₃, R₁₀, C₂, C₃, C₆, C₉, C₁₄, C₁₅, C₁₉, C₂₀, D₁, D₂, P₂ and S₁. The two rotor terminals of foil trimmer C₄

and the two ground pins (supply and AF output), are soldered likewise. In the case of the trimmer, take care not to damage the PTFE material by overheating it with the iron. Unfortunately, there is a small error on the ready-made PCB for this project: facing the flat side of varicap D₁ (BB212), the right-hand side terminal of the device should not be inserted in the hole provided. Instead, it is soldered direct to the ground surface. PCBs supplied through our Readers Services are accompanied by a note advising of this design error.

Capacitor C₁₆ is preferably an MKT type. When this is not available, a low-leakage electrolytic type may be used instead. The photograph of Fig. 4 shows a prototype of the receiver. Note that a number of ceramic capacitors are fitted in positions that should have polystyrene types. Unfortunately, these were not available when the photograph was taken. The previously mentioned grounded terminal of D₁ is clearly visible to the left of the device. It is essential that the receiver is fitted in a metal enclosure. Figure 5 shows a suggested front-panel layout.

Setting up

The following items are required for set-

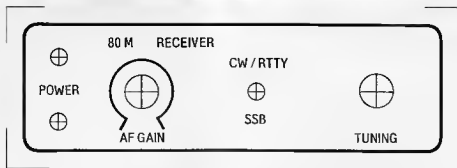
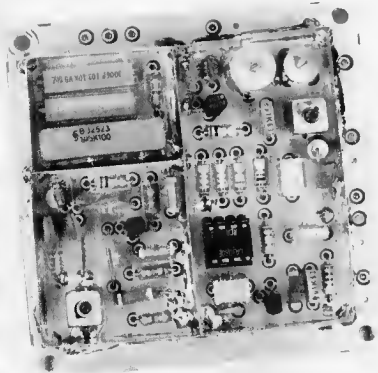

Fig. 5. Suggested layout of the front panel.



Prototype of the receiver board.

ting up the receiver: a nylon trimming tool, a multimeter and a frequency meter (or a good-quality 80 m receiver).

Temporarily power the completed receiver from a regulated 12 V supply. Connect the AF output to an amplifier. Turn P_2 to the centre of its travel, and measure the voltage at the wiper. Adjust P_1 and P_3 to obtain 4 V. Connect the frequency meter to the emitter of T_2 , and use the nylon trimming tool to adjust the core in L_2 until the oscillator produces 3.65 MHz. Turn P_2 fully counter-clockwise, and check that the oscillator frequency decreases. Exchange the wires to the outer connections of the potentiometer if the frequency increases.

Adjust P_3 until the frequency meter reads 3.4 MHz. Turn P_2 fully clockwise, and adjust P_1 for an oscillator frequency of 3.9 MHz. Turn P_2 to the centre of its travel, and check that the oscillator frequency is about 3.4 MHz. If necessary, re-do the adjustments of P_1 and P_2 until P_2 covers the full tuning range of 3.4 MHz to 3.9 MHz.

As a matter of course, the function of the frequency meter can be taken over by a calibrated 80 m receiver, which should have no difficulty picking up stray radiation from T_2 . The oscillator frequency can then be read from the dial of the auxiliary receiver.

Connect the aerial to the input of the

direct conversion receiver. Tune to a weak transmission at the lower band edge (3.4 MHz), and peak C_4 for optimum reception. Then tune to a station at about 3.9 MHz and similarly adjust the core in L_1 . Repeat the adjustment of C_4 and L_1 to optimize sensitivity across the band.

Power supply: beware of adaptors

The receiver is preferably fed from a well-regulated 12 V supply, or a set of batteries that gives the same voltage. In many cases, however, it will be convenient to power the receiver from an available 12 VDC mains adaptor. When this is used, it is likely to cause hum in the receiver, a problem which can often be solved by fitting an additional smoothing capacitor of 470 or 1000 μ F across the adaptor's output terminals. If hum persists, it is probably caused by capacitive coupling of the receiver and the mains. When the rectifier diodes in the adaptor are reverse-biased, they behave as capacitors. This is not normally a problem, but the oscillator signal, via the supply wires, can thus find a path to these diodes, which cause amplitude modulation of 50 (60) Hz (single-phase rectifier) or 100 (120) Hz (double-phase rectifier). This modulated signal is radiated by the mains wires, and is picked up again by the receiver. In this, the oscillator frequency equals the received frequency, so that hum is produced as the AF output signal.

The supply connections of the receiver should be decoupled by fitting chokes between the terminals of the 12 VDC input socket and the relevant soldering pins on the board. Both socket terminals are decoupled to ground with a 100 nF capacitor. The L-C networks prevent the oscillator signal being superimposed onto the supply lines. If hum still persists, try winding the supply wires through a ferrite ring core, or around a ferrite rod. A final tip is to solder a 100 nF capacitor across each rectifier in the mains adaptor.

FREQUENCY READ-OUT FOR SW RECEIVER

Although the circuit described here was designed as a frequency read-out for a short-wave receiver, it can also be used as a universal counter.

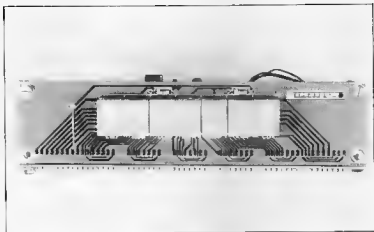

The text of this article will be described on the basis of the 'SSB receiver for 20 and 80 metres' (1).

The block schematic of the unit is shown in Fig. 1. The signal to be measured is first fed to a variable-gain amplifier and then applied to an up/down counter via a NAND gate. The value at which counting starts depends on the setting of a number of preset switches. The final count depends on the setting of the up/down switch and may be larger or smaller than the preset value. To obtain a stable read-out, a latch has been introduced between the counter and the LED display, which stores the outcome of the measurement. The timing section serves to ensure that the other sections operate in time and with the required accuracy.

The block schematic of relevant sections of the receiver is given in Fig. 2 to show how the read-out unit transfers the information to the display. The signal whose frequency is to be measured is the output of the oscillator in the receiver, which is available at test point 2. To display the received frequency, the counter must start from 900,000, i.e., the IF of the receiver. Note that the counter counts in steps of 10 Hz. That value is set with the preset switches. Whether the counter is to count up or down depends on whether the received frequency lies above or under the IF. In the 20-m band, the IF is lower than the received frequency, and the counter must then count up from 900,000. In the 80-m band, the IF is higher than the received frequency, and the counter must then count down.

Technical Data

Bandwidth of input amplifiers	1 kHz to 50 MHz
Input sensitivity	≥ 25 mV
Max. counter input frequency	25 MHz
Counter resolution	10 Hz
Gate time	0.1 s
Number of measurements per sec	5
Number of digits	7
Current drain	≤ 465 mA

Preamplifier and timing section

The circuit of the input and timing sections is shown in Fig. 3. The preamplifier ensures that the oscillator in the receiver is not loaded unduly and raises the oscillator signal to a level of about $1 V_{pp}$ at the collector of T_1 .

Preset P_1 serves to set the gain so that the counter operates in a stable manner, and also that T_1 does not go into saturation.

The amplified signal is fed to a Schmitt trigger, N_4 , via C_3 . Since the input of the trigger is at half the supply voltage level (R_3 - R_4), the gate toggles readily at an input of $1 V_{pp}$. Whether the output of N_4 is passed to the counter via clock N_3 is determined by the timing circuit, formed by IC_1 , IC_2 , and IC_3 .

Circuit IC_1 contains an oscillator and a 14-bit divider. The oscillator frequency is determined by crystal X_1 (6.5536 MHz). The oscillator output is divided in IC_1

and IC_2 by 2^7 to 50 Hz. This signal is divided by 10 in Johnson counter IC_3 . The shape of the final 5 Hz signal is shown in Fig. 6, together with that of the signals at the other outputs of IC_3 and the outputs of N_1 and N_2 .

The Johnson counter produces from each 50 Hz pulse five symmetrical square waves that have a PRF of 5 Hz and are separated from one another by 20 ms spaces.

After the first clock pulse, Q_1 goes high, and as long as it remains so (for 100 ms), the signal to be measured is passed from N_1 to the counter. Then N_1 transmits a pulse which ensures that the contents of the counter are passed to the latch, and thus to the display. To prepare the counter for the next measurement, N_2 transmits a pulse which is used to reset the counter, and this terminates the count cycle.

Table 1

Truth table Johnson counter IC3					
Q1	Q2	Q3	Q4	Q5	state
0	0	0	0	0	0
0	0	0	0	1	1
0	0	0	1	1	2
0	0	1	1	1	3
0	1	1	1	1	4
1	1	1	1	1	5
1	1	1	1	0	6
1	1	1	0	0	7
1	1	0	0	0	8
1	0	0	0	0	9

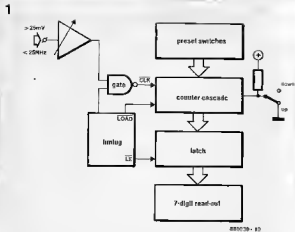

Fig. 1. Block schematic of the frequency read-out.

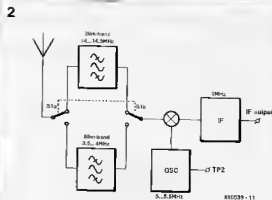

Fig. 2. Block schematic of the receiver parts relevant to the frequency read-out.

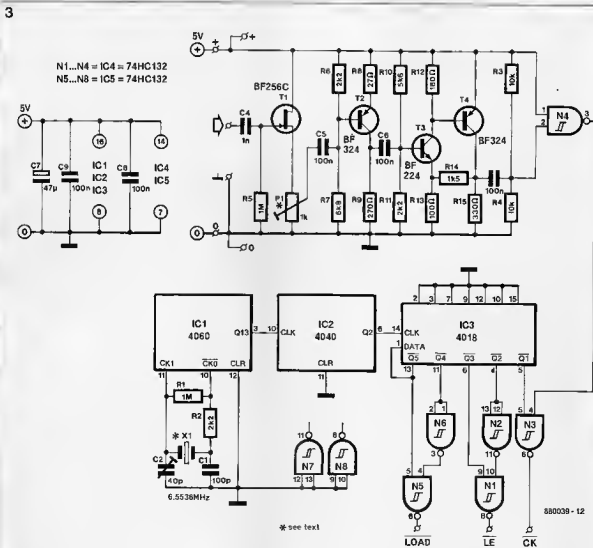

Fig. 3. Circuit diagram of the preamplifier and the timing section.

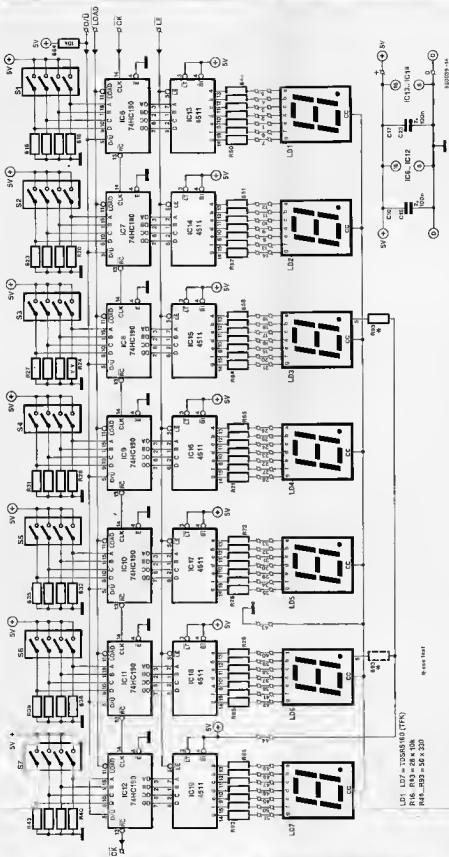

Fig. 4. Circuit diagram of the counter and display section, constructed from discrete components to reduce noise and other spurious emissions.

Parts list

Resistors ($\pm 5\%$).

- R1; R6 = 1MΩ
 R2; R6 = 2K2
 R3, R4; R10... R42 incl.; R94 = 10K
 R7 = 6K8
 R8 = 27R
 R9 = 270R
 R10 = 5K6
 R11 = 2K2
 R12 = 180R
 R13 = 100R
 R14 = 1K5
 R15; R44... R93 incl. = 330R
 P1 = 1KΩ preset H

Capacitors:

- C1 = 100p
 C2 = 40p trimmer
 C3; C6, C6; C6... C20 incl. = 100n
 C4 = 1n0
 C7 = 47μ; 10 V; tantalum

Semiconductors:

- T1 = BF256C
 T2; T4 = BF324 (Cricklewood)
 T3 = BF224 (Cricklewood)
 LD1... LD7 incl. = D350PK or TD5R516G (AEG-Telefunken; UK distributors are listed on InfoCard 502, *EE* February 1987). Suggested equivalents HD1133R (Siemens) or HDSP5303/5503/5603/5703/5733 (Hawlett-Packard).
 IC1; IC9 = 4060
 IC2 = 4040
 IC3 = 4018
 IC4; IC8 = 74HC132
 IC6... IC12 incl. = 74HC190
 IC13... IC18 incl. = 4611

ElectroValue Limited • 28 St Judes Road •
 Englefield Green • Egham • Surrey TW20
 OHB. Telephone: (0784) 33603 Telex.
 264475. Northern branch: 680 Burnage Lane
 • Manchester M19 1NA. Telephone: (061)
 4321 4945.

Miscellaneous:

- S1... S7 incl. = 4-way DIL switch block
 X1 = quartz crystal 6 5536 MHz.
 PCB 880039

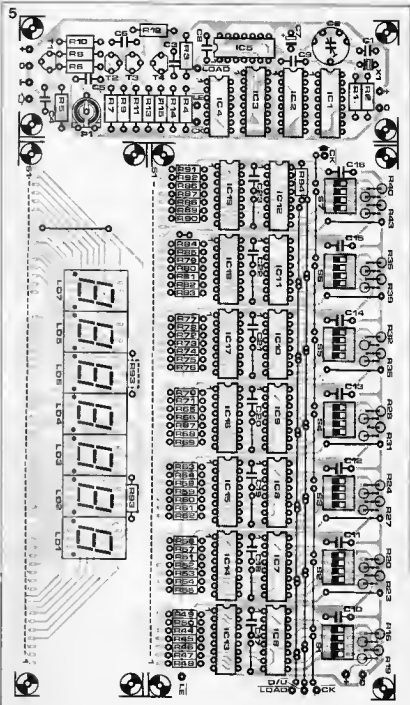

Fig. 5. The printed circuits of the three sections of the frequency read-out are contained on one board.

Discrete counting

The counter is constructed from discrete counter elements and display drivers (with built-in latch), as shown in Fig. 4. Each of the seven identical sections consists of four preset switches with pull-down resistors, a BCD counter, a BCD-to-seven-segment decoder/driver with latch, seven biasing resistors, and a seven-segment LED display. Preset switches S1 to S7 set the BCD code to a value at which the counter starts counting. The pull-down resistors

ensure that the preset inputs of the counter are provided with a 0 if the switch is open.

Counters IC3 to IC12 incl. are coupled asynchronously. This has the advantage that only the first counter (IC3) is supplied with a high clock frequency. The result of the measurement is stored in latches IC13 to IC18 incl. These ICs ensure that the measuring result is made visible on the display, because they also have the BCD-to-seven-segment-decoder and a display driver on board. The pos-

ition of the decimal point is determined by the location of Rs. If this is in the position shown solid, the display reads in kHz; in the position shown in dashed lines, the read-out is in MHz.

Construction

The three printed circuits are housed on one board, as shown in Fig. 5. The three sections should be cut off as required. The circuits are single-sided, which gives rise to a fair number of wire links. These

arc, of course, best put in place first. Construction is facilitated by Fig. 7, which shows the layout of the prototype. Several types of switch may be used for S_1 to S_7 . First, there are DIL switches, which are set according to the BCD code in Table 2. Note that the least significant bit is located at the left-hand side of the switch viewed from the display. Another, rather more luxurious, type is a BCD thumb-wheel switch: rather expensive, but very useful if the switches are set often. If the switches are used only once, they may be replaced by wire links. Resistors R_{16} to R_{43} and DIL switches S_1 to S_7 are then, of course, not required. Where a preset input must be 1, the wire link is fitted in place of the switch; if the preset input must be 0, the wire link takes the place of the relevant resistor. Take care that each preset input gets only one wire link — no more, no fewer.

Table 2

	BCD code			
	D	C	B	A
0	0	0	0	0
1	0	0	0	1
2	0	0	1	0
3	0	0	1	1
4	0	1	0	0
5	0	1	0	1
6	0	1	1	0
7	0	1	1	1
8	1	0	0	0
9	1	0	0	1

The calibration of the read-out is carried out by turning P_1 so that its wiper is at ground potential, and then turning it until a stable read-out appears on the display. Take care that T_4 does not go into saturation with differing input signals at high frequency, because this will affect the bandwidth which may lead to erroneous measurements. Once P_1 has been adjusted correctly, the frequency of the crystal oscillator must be set with the aid of C_2 . This is done most conveniently by tuning the receiver to a

strong station whose frequency is known accurately: C_2 is then rotated until that frequency is displayed.

Accuracy

The accuracy of the read-out unit is determined mainly by crystal X_1 . Without special precautions, the frequency of the received signal is measured with an accuracy of within 200 to 300 Hz. The short-term accuracy may be improved by

placing the crystal in polystyrene foam and tuning the oscillator (before any measurement) with the aid of a reference oscillator. This will guarantee good accuracy for up to an hour.

If greater accuracy and stability are required, a crystal with a temperature coefficient of 20 to 30 ppm should be used. Bear in mind that the effect of temperature becomes greater at high frequencies.

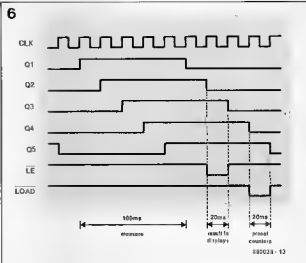

Fig. 6. Output signals of ICs, N_1 , and N_2 .

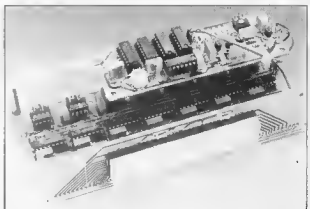
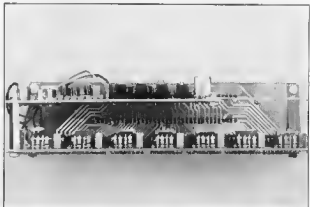
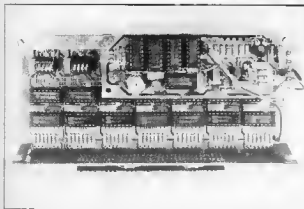
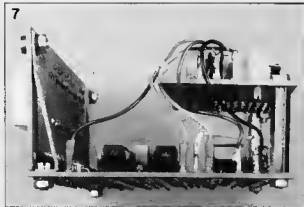

Fig. 7. Various views of the prototype frequency read-out.

Finally

The read-out lends itself readily to experimenting. It is, for instance, possible to use an external and very stable frequency source, such as the 'Intelligent Time Standard' (2) to enable measurements to be made with a resolution of 1 Hz. The (divided) external oscillator signal is connected across pins 6 and 8 (ground) of the socket for IC₁ (IC₁ and IC₂ and associated components are, of course, not required and may be omitted or removed). The frequency, f_s , of the (divided) external signal is determined by $f_s = 5/T_m$, where T_m is the measuring time (= 1 s for a frequency of 1 Hz). With these changes in the timing section, it may, of course, happen that it is no longer possible to place the decimal point at its correct position with R₉. In

that case, the resistor will have to be mounted on the display PCB (track side) between the +5 V track and pin 5 of the relevant display module. Speed is another aspect with which may be experimented. The maximum frequency the counter can handle is determined by the highest clock frequency to which IC₁ can react. The first thing to do is to try each of the seven modules in the IC₁ position: in the prototype one or two of the modules worked satisfactorily up to 25 MHz, although the data sheet indicated 17 MHz (Type 74190). The modules shown in Fig. 4 (Types 74HC190) can operate with clocks of up to 40 MHz. If even higher speeds are required, use a Type 74F190 in the IC₁ position, which is intended for operation with clock frequencies of around 90 MHz. The other ICs can remain HC

types, because they need not work at these high frequencies. It is also possible to use HCT types: these are essential, by the way, if it is required to drive the counter from a TTL circuit. It should be noted that the design of the counter circuit with discrete components is deliberate: a multiplexed integrated display unit is a source of noise and interference, which in a sensitive receiver is, of course, the last thing you want. None the less, it is still advisable to mount the read-out in a properly screened enclosure.

References:

- (1) *Elektron India*, December 1987
- (2) *Elektron India*, March 1988.

doorbell memory

On occasion it may be useful to know when a visitor has called in your absence. This is especially true in the case of an enforced absence when a visitor is expected. Confusion reigns supreme on these occasions. The circuit here helps to rectify the situation by providing a 'memory' for the doorbell. On your return a LED will advise you whether or not a visitor called. The circuit is powered by the bell transformer via diode D1 and capacitor C1. This provides a d.c. voltage level sufficient for the 'memory'. Under normal conditions (with no one ringing the doorbell) transistor T1 will be switched off and T2 will be conducting to provide a form of latch for T1. Obviously LED D3 will never light under these conditions! Now our visitor arrives! With a joyful cry of 'Avon calling' they press the doorbell — only to lapse into total embarrassment when there is no answer! However our circuit now leaps into action. Via D2 and R1, the doorbell switch S1 provides a base drive current to T1 which switches off T2 and, in passing, LED D3 on. Now the transistor

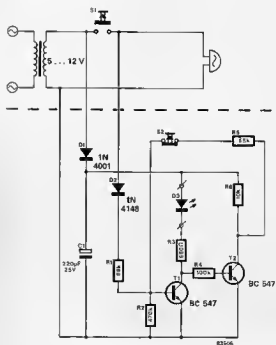

'latch' (T2) swings the other way and T1 is held on by the current path to the positive supply through S2 (normally closed) R5 and R6. The unfortunate visitor goes away totally deflated but the LED will indicate his 'past presence'! On your return the LED will be noted and the circuit 'reset'. This is carried out by simply pressing S2 which breaks the base current path holding T1 on causing this transistor to switch off. In doing so the LED will be switched off and T2 will be switched on. The 'latch' will be back in the original position where T1 is held off by the fact that R5 is effectively

in parallel with R2. A further refinement would be to provide an automatic reset when the front door is opened. In this case S2 is a switch operated by the opening door. However the LED must then be mounted outside the door (possibly in the doorbell switch housing) or the LED will be off by the time you get into the house to look! On the other hand a second circuit could be built as a 'memory' for the 'automatic' memory and then it would be no problem to open the door! This second circuit will of course require a reset switch!

RECEPTION AND TRANSMISSION OF RADIOTELETYPE

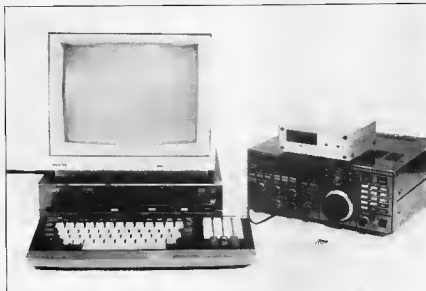

The results of our recent Readership Survey have confirmed the popularity of construction projects and informative articles on every aspect of modern telecommunications. In particular, RTTY is a well-liked subject; and for good reasons, because the combination of simple circuits and a computer offers many advantages over the mechanical telex machine. In addition to a low-cost telex converter plus tuning aid and powerful decoding software, we present a precision, phase-synchronous, AFSK generator for radio amateurs in possession of a licence to transmit RTTY.

If you have never worked with telex for fear of complex circuits, this is the time to take the decisive step into the fascinating world of long-distance communication where messages originate from press bureaus, radio amateurs, navigational, meteorological and utility stations in the shortwave bands. In this article it is assumed that the reader is familiar with the concept of RTTY, but just for convenience a short recapitulation is offered on the structure of the serial data format.

Baudot code and FSK

RTTY information is composed of characters that are transmitted sequentially to the format shown in Fig. 1. One dataword is composed of 7 bits:

- 1 start bit, which is always low;
- 5 data bits, which represent the character;
- 1 stop bit, which has a duration 1.5T rather than T used for the start and data bits.

Five databits offer 32 (2^5) possible combinations. There are, however, 26 letters in the alphabet, 10 numbers, and a number of punctuation marks and symbols, so that 32 positions would appear too few. A solution to this problem is offered by the Baudot system, which reserves a special code for distinguishing between letters on the one hand and figures, punctuation marks or signs on the other. This means that a number of available databit combinations can represent either a letter or a number, depending on the group selection code, which is transmitted after pressing the *Ltrs* or *Figs* key



Fig. 1. Serial transmission of an RTTY character.

on the teletype machine (*cp* the caps lock function on a typewriter).

The bit combinations in the Baudot system are listed in Table I for reference. It should be noted that there exist many other systems and standards for RTTY, with variations in transmission formats, pulse duration and bit combinations. The majority of telex stations, however, use the Baudot code.

The speed of the RTTY transmission is called the *baud rate*. This is defined as the number of bits transmitted per second. For instance, a 75 baud station can transmit nearly 11 characters per second. On the shortwave bands, the modulation used for RTTY transmission is usually frequency shift keying (FSK) — depending on the logic level of the bit (mark or space), frequency f_1 or f_2 is transmitted. The difference between these frequencies is called *shift*.

Figure 2 summarizes the above by showing the units required for over-air transmission of a telex message. This article will deal with the construction of the RTTY converter, AFSK generator and

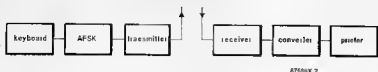

Fig. 2. Transmission and reception of radioteletype.

printer. The latter function is assumed by a computer running an advanced program that enables decoding RTTY at a number of standardized baud rates.

PLL-based RTTY converter and tuning aid

The function of the RTTY converter is to translate the mark and space notes received into the appropriate logic levels. To keep the circuit as simple as possible without compromising versatility, it was decided to set it up around an integrated phase-locked loop, the Type XR2211 from Exar.

3

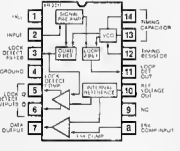

Fig. 3. Pinning of the Type XR2211 phase-locked loop from Exar.

The operation of the converter is best explained with reference to the internal circuit of the XR2211 shown in Fig. 4, and the circuit diagram in Fig. 5. Note that the small circles and numbers in Fig. 4 are the pins of the chip — the resistors and capacitors are external components. Basically, a phase-locked loop will attempt to make the frequency of the internal voltage-controlled oscillator (VCO) equal to that of the input signal. The two frequencies are compared by the quad and/or loop detector, and the error signal produced by one of these is used for controlling (i.e., tuning) the VCO until the difference between VCO frequency and input frequency is nought. The VCO control signal is, therefore, a measure of the frequency of the input signal provided by the shortwave receiver tuned to an RTTY transmission. In the present application of the XR2211, the on-board quad detector is not used.

The circuit diagram of the converter is

very similar to the block diagram of the XR2211. The input signal enters the IC via R-C network $R_1-C_1-C_2$, and is fed to an amplifier driving the loop detector, whose output signal is used for controlling the VCO via potential divider R_3-R_4 , and driving comparator 1 via R_5-C_3 . The comparator uses the input voltage to decide whether the received frequency is f_1 or f_2 (mark or space). Its output signal needs filtering, however, because the PLL is so fast that it also responds to interference in the input signal. Comparator 2, in combination with low-pass R_2-C_2 , ensures a filtered, rectangular output signal. The amplitude of the output signal of comparator 1 (fed to pin 3 via R_2-C_3) is much greater than that supplied by the quad detector, which is thus rendered ineffective. Comparator 2 has complementary outputs Q and \bar{Q} , which are useful for selecting between stations transmitting standard and inverted RTTY signals (logic high = f_2 ; logic low = f_1). This selection is accomplished by toggle switch S_1 .

It will be clear that the mark and space tones can only be decoded correctly when the receiver is accurately tuned to the telex transmitter. Figure 6 shows the circuit diagram of a bar-graph tuning indicator which will prove indispensable for RTTY reception. Based on a VU-meter IC, it indicates centre tuning as well as shift employed by the transmitter. The display indicates frequency of the

Table 1

bit	letters	figures
1 2 3 4 5		
1 1 0 0 0	A	—
1 0 0 1 1	B	.
0 1 1 1 0	C	(
1 0 0 1 0	O	who are you
1 0 0 0 0	E	3
1 0 1 1 0	F	optional
0 1 0 1 1	G	optional
0 0 1 0 1	H	optional
0 1 1 0 0	I	8
1 1 0 1 0	J	bell
1 1 1 1 0	K	(
0 1 0 0 1	L)
0 0 1 1 1	M	.
0 0 1 1 0	N	.
0 0 0 1 1	O	9
0 1 1 0 1	P	0
1 1 1 0 1	Q	1
0 1 0 1 0	R	4
1 0 1 0 0	S	,
0 0 0 0 1	T	5
1 1 1 0 0	U	7
0 1 1 1 1	V	=
1 1 0 0 1	W	2
1 0 1 1 1	X	/
1 0 1 0 1	Y	6
1 0 0 0 1	Z	+
0 0 0 1 0		carriage return
0 1 0 0 0		line feed
1 1 1 1 1		letters
1 1 0 1 1		figures
0 0 0 0 0		space
0 0 0 0 0		backspace

mark and space tones by means of LEDs to the right and left of the centre, respectively. The centre two LEDs are illuminated when the input signal from the converter has a frequency of 1500 Hz. When the receiver is correctly tuned, LEDs at equal distance from the centre will be seen to flash rapidly. The distance between the illuminated LEDs is a measure of the shift employed by the RTTY transmitter.

4

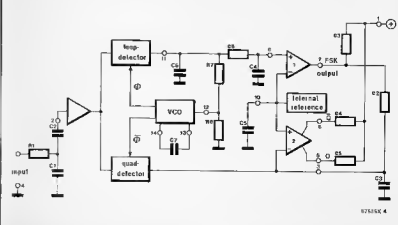

Fig. 4. Internal circuit of the XR2211.

5

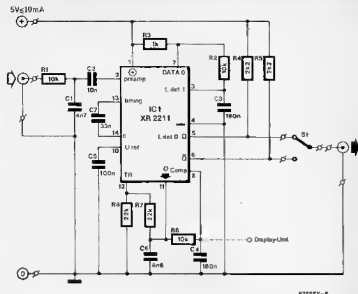

Fig. 5. Circuit diagram of the RTTY decoder.

6

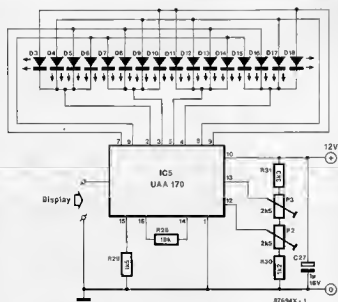

Fig. 6. Circuit diagram of the optional RTTY tuning aid, which is essentially a LED-based shift and tuning indicator.

Power supply and computer interface

It will be noted that the supply voltage for the RTTY converter is 5 V, whereas that for the display unit is 12 V. The latter is optional, so that the converter may be fed from the computer's built-in 5 V power supply. When the display is used in conjunction with the converter and a

computer, it is essential that the converter is fed from 12 V rather than 5 V. This can be done with impunity using the power supply of Fig. 7 and the simple computer interface of Fig. 8 (the latter reduces the converter's output voltage swing of 12 V_{pp} to 5 V_{pp}). The serial bitstream from the converter is applied to the computer's joystick port as shown in Fig. 9. To prevent

7

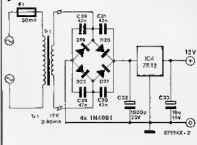

Fig. 7. Suggested power supply for the RTTY converter and tuning aid.

8

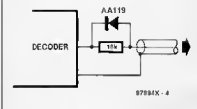

Fig. 8. Resistor-diode attenuator for reducing the logic swing at the output of the decoder from 12 V_{pp} to 5 V_{pp}.

9

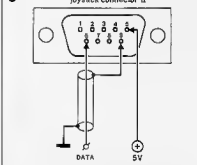

Fig. 9. Connection of the RTTY decoder to joystick connector #2 on an MSX 1 or MSX2 computer.

10



Fig. 10. Interference from the computer can be suppressed by winding the serial data and supply cables onto a ferrite core.

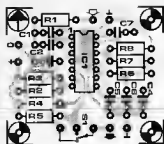

Fig. 11. Printed circuit board for the single-chip RTTY decoder.

Parts list
RTTY DECODER, CIRCUIT DIAGRAM: FIG. 5.

Resistors ($\pm 5\%$):

R₁, R₂, R₆ = 10K

R₃ = 1K0

R₄, R₅ = 2K2

R₇, R₈ = 22K

Capacitors:

C₁ = 4n7

C₂ = 10n

C₃, C₄ = 180n

C₅ = 100n

C₆ = 8n2

C₇ = 33n

Semiconductor:

IC₁ = XR2211 (Manufacturer: Exar. Listed by Mepln, Cricklewood Electronics, Universal Semiconductor Devices)

Miscellaneous:

S₁ = miniature SPDT switch.

PCB Type 87586X

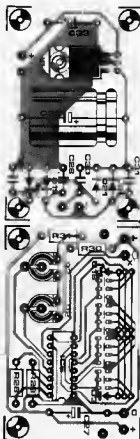

Fig. 12. Printed circuit board for the RTTY tuning aid and power supply.

digital interference from the computer entering the converter circuit, it is recommended to wind the cable between the converter and the computer onto a medium-size ferrite ring core as shown in Fig. 10.

Setting up

Apply the output signal of a sine wave generator to the converter. Adjust the generator between 1 and 2 kHz, and use a scope or a voltmeter to find the frequency at which the output of the converter toggles. Leave the generator set to this frequency, and adjust P₁ and P₂ in the display circuit until the two centre LEDs light. Then correct the settings until 1 kHz corresponds to the leftmost LED, and 2 kHz to the right-most LED. The preset adjustments will be found to interact, and care should be taken not to shift the centre frequency indication away from D₁₀-D₁₁. If necessary, repeat the adjustments.

When a sine wave generator is not available, connect the converter to the receiver, and tune to a station that transmits an unmodulated carrier.

Parts list
TUNING AID AND POWER SUPPLY
CIRCUIT DIAGRAMS: FIGS 6 & 7.

Resistors ($\pm 5\%$):

R_{2a} = 18K

R_{2b} = 1K5

R_{3a} = 1K2

R_{3b} = 3K3

P₁, P₂ = 2K5 or 2K2 preset H

Capacitors:

C₂₇ = 1 μ 0; 18 V

C₂₈ ... C₃₁ incl. = 47n

C₃₂ = 1000 μ ; 25 V

C₃₃ = 10 μ ; 18 V

Semiconductors:

D₃ ... D₁₉ incl. = rectangular LED

D₁₉ ... D₂₂ incl. = 1N4001

IC₄ = 7812

IC₅ = UAA170 (listed by Mepln, Cricklewood)

Miscellaneous:

F₁ = 250 mA fuse, delayed action, with chassis-mount holder.

T₁ = mains transformer, 15 V; ≥ 80 mA, PCB 88019

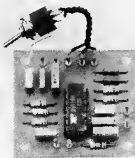

Switch to SSB, and tune the receiver until the output of the converter toggles. The note produced by the receiver then has a frequency of about 1500 Hz, and P₂-P₃ may be adjusted such that the centre LEDs light. Table 2 lists a number of meteorological services that use a shift of 1 kHz, enabling the maximum shift indication of the display to be set as discussed above.

Table 2

speed	frequency (kHz)	service
50	3038	Meteo
50	13530	Meteo
75	2474	Marine
75	4280	Marine
100	7980	Meteo

Enter the computer

An RTTY decoder program was written for MSX1 and MSX2 computers with a disk drive running under MSXDOS. This program can be obtained through the Readers Services by sending in a formatted 3½-inch diskette that contains MSXDOS.SYS and COMMAND.COM. The program has its own video drivers because those available under standard MSX software proved too slow to ensure correct interrupt servicing and picture scrolling given the speed of the pulses supplied by the RTTY converter. Further, the program boots up automatically when the disk is inserted in the machine at power-on. After some time, the main menu will appear, and the user is prompted to enter the required parameters — see Fig. 13.

Table 3

speed	frequency (kHz)	country	time (approx., GMT)
100	16048	USSR	9.00 — 13.00 h.
50	15633	N. Korea	12.00 — 13.00 h.
50	13780	N. Korea	12.00 — 13.00 h.
50	13524	Iraq	13.00 — 17.00 h.
75	13770	USA	13.00 — 17.00 h.
50	7960	Iran	19.00 — 24.00 h.
75	5460	USA	0.30 — 3.30 h.
75	6941	USA	0.30 — 3.30 h.

Although the menu is mostly self-explanatory, a short discussion will be given of the various options available.

■ **ASCII:** when this mode is selected, the computer switches to decoding 8 databits and 2 stop bits. Since this is a non-standard format, the mode is called ASCII rather than ASCII. It can be tried by tuning to the news bulletin of radio amateur station W1AW on 14.095 MHz in the 20 m band. This North-American station transmits at 140 baud, and is one of very few not to use the Baudot code.

■ **Shift:** It was already noted that the Baudot code has two special characters for switching between letters (*Lts*) and figures/punctuation marks/signs (*Figs*). When **SHIFT NORMAL** is selected from the menu, switching between these character sets takes place when the relevant code is received. When, owing to interference, the computer does not receive one of these codes, it will produce illegible text. To prevent this, select **Unshift On Space (UOS)**, to automatically switch to letters following the reception of a space character. This is particularly useful for

stations that transmit mainly text, e.g. press bureaux. The reverse is also possible: **Shift On Space (SOS)** causes the 'figures' set to be selected following a space, aiding in the reception of, for instance, meteorological data, which is mainly clusters of figures and signs.

■ **Invert data:** this is the software equivalent of operating the polarity switch, S_i, on the RTTY converter.

■ **Baud rate selection:** available speeds are arranged in order of frequency of use.

■ **Read Text buffer:** text read by the computer is stored in memory. When the computer is in the RX (receive) mode, the memory contents can be examined and, if required, sent to a printer. The text buffer mode is selected by pressing M on the keyboard. Decoding of incoming data is inhibited in this mode, which can be left by pressing a.

User-selected parameters are loaded by pressing the space bar to enter the receive (RX) mode. When the settings are correct, and the converter is properly aligned, text will appear on the screen. If there appears no text, or only garbled data, the parameters must be changed by returning to the menu — press RETURN.

An interesting feature of the MSX RTTY software is its ability to decode Russian stations using an extended version of the Baudot code. A number of additional shift characters are used in this to enable using the Cyrillic alphabet, which has more than 26 letters. The software translates these in characters that are relatively little used on computers. For instance, the ampersand sign, &, represents the sound /sj/ (Saša), while the exclamation mark, !, stands for /e/ (Elektrik). There are more replacement signs, but a discussion of all of these is beyond the scope of this article. Actually receiving Russian stations is the best way of getting accustomed to the special signs, since their sound and meaning can be learned fairly rapidly by deduction from the context. Recommended frequencies are around 8,350 kHz (evenings and night) and 12,500 kHz (daytime). Other useful frequency allocations are given in Table 3.



Fig. 13. Menu screen shown by the RTTY decoding program for MSX computers.

Finally, it will be understood that usable results are only obtained by using a good-quality SSB receiver connected to an outdoor aerial. Everything possible must be done to eliminate sources of interference, since these give rise to decoding errors even when the telex station received has sufficient field-strength locally.

the relevant RTTY standard. As a result, a poor signal-to-noise ratio is obtained, and there are station operators who attempt to cure this by switching over to AMTOR or other error-correcting systems, while the trouble originates clearly from their poorly designed AFSK generator.

The circuit described here is simple to build from a handful of fairly common parts, and can produce virtually any frequency used for AFSK at a resolution of a few hertz.

AFSK generator: principle of operation

The block diagram of Fig. 14 shows that a quartz-controlled 10 MHz oscillator clocks two counters/dividers, whose divide ratio can be preset to any value between 1 and 256. The counters are, of course, configured to give signals of different output frequency, which are applied to an electronic toggle switch composed of NAND gates. The position of this switch is controlled by the logic level of the signal applied to the TTL input. The frequency of the signal at the output of the electronic switch changes with every change in the logic level of the signal at the digital input. In this arrangement, phase disturbance will occur because of the abrupt switching between the output frequencies. The result is an annoying click, which is particularly troublesome when SSB is used, because it easily causes sideband splatter. These switching problems are also frequently encountered in PLL-based AFSK generators, where the oscillator is constantly on the verge of losing lock owing to the fast changing AFSK frequency. The present generator offers an elegant way round the above difficulties. The output signal of the electronic toggle switch is not fed direct to the circuit out-

put, but is first applied to a :64 divider. When, owing to the switching at its input, the :64 divider receives one pulse too many or too few, the toggling of the output will be delayed or speeded up by only 1/64th part of the period of the signal applied. This results in negligible pulse-width distortion whilst ensuring that the output signals of the divider are phase-synchronous. After filtering in a low-pass, an RTTY signal is obtained that is much cleaner than one produced by a PLL-based generator.

AFSK generator: circuit description.

The practical circuit diagram is shown in Fig. 15. The 10 MHz clock oscillator is set up around T_1 , which drives counters IC_1 and IC_2 . The divisor of each of these can be set by means of $S_{11} \dots S_{1n}$ and $S_{21} \dots S_{2n}$ respectively. The user is left free to use either (DIP-) switches or wire links in these positions. The previously mentioned NAND gates that form the electronic toggle switch are found in IC_3 , while IC_4 is the :64 divider. The circuit around T_2 and T_3 forms an interface between the TTL input and IC_3 . TTL signals are limited by D_1 and inverted by T_2 . T_3 once more inverts the signal. Switch S_3 allows selecting normal or reverse signal polarity. Harmonics and interference at the output of divider IC_4 are eliminated in low-pass filter L-L₂-C₁-C₂-C₃. The amplitude of the AFSK signal can be set with P_1 .

Construction and use

The AFSK generator is relatively easy to construct on Veroboard. In practice, it will be found that a number of configuration switches may be omitted because a fixed set of AFSK frequencies often suffices.

Standard AFSK frequencies and associated shifts are listed in Fig. 16. It is seen that the step size is 85 Hz. Formerly very popular frequencies were 2125 Hz and 2975 Hz. These multiples of 425 Hz, and those of 170 Hz, were long used by American telegraph companies. Dividing these frequencies reveals that they are all multiples of 17 Hz, which is important to remember for accurately setting the AFSK generator. The need for the new AFSK frequencies in Fig. 16 arose from the fact that amateur radio receivers incorporated AF filters too narrow to pass 2975 Hz, so that many RTTY hams were forced to use lower frequencies.

It should be noted that some stations use shifts other than those shown, e.g. 85 Hz or even shifts which are not a multiple of 17 Hz (70 and 240 Hz). When the AFSK generator is used with an SSB transmitter, the absolute frequencies are not important, only the shift. For FM

AFSK generator for VHF RTTY

Contrary to a good many other designs, the audio frequency shift keying (AFSK) generator described here is not only quartz-controlled, but also phase-synchronous, ensuring very high signal quality and accurate definition of the tone frequencies. Most AFSK generators used by radio amateurs incorporate R-C or L-C oscillators, which often suffer from poor stability and accuracy. Many PLL-based and computer-driven AFSK generators are also remarkable for their low signal quality and deviation from the prescribed mark and space frequencies, making it impossible to achieve proper decoding when the receiving station uses filters that are known to be accurately dimensioned to

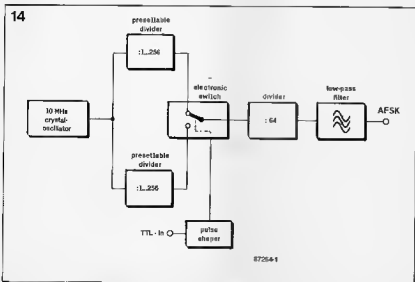

Fig. 14. Block diagram of the crystal-controlled AFSK generator.

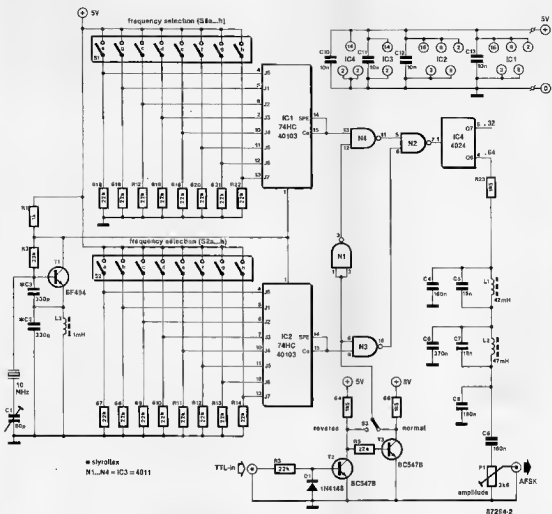

Fig. 15. Circuit diagram of the audio frequency shift generator for RTTY transmitters.

transmitters (VHF), however, it is desired to approach standardized AFSK frequencies as closely as possible. This can be achieved by setting IC₁ and IC₂ to the highest possible divisor, so that the output frequencies can be altered in small steps, and having IC₄ divide by 32 instead of 64 at the cost of a small increase in pulsewidth deviation.

The following example shows how to set the DIP switches in the AFSK generator to obtain mark/space frequencies of 1200 and 2400 Hz. Arithmetically, it makes no difference which of the divisors is defined first. To begin with, there is the fixed divisor at the output (IC₄): 10 MHz divided by 64 equals 156,250 Hz. This, in turn, must be divided down, with divisors between 1 and 256 available (IC₁; IC₂). For instance, in

Parts list

AFSK GENERATOR. CIRCUIT DIAGRAM:
FIG. 15.

Resistors (±5%):

R₁ = 1KΩ
R₂ = 33K
R₃; R₅; R₇... R₂₂ incl. = 22K
R₄; R₆; R₉ = 1K5
P₁ = 2K5 or 2K2 preset

Capacitors:

C₁ = 80p trimmer
C₂; C₃ = 330p polystyrene (styroflex) 5%
C₄; C₈ = 180n
C₅; C₇ = 15n
C₆ = 270n
C₉ = 150n
C₁₀; C₁₁; C₁₂; C₁₃ = 10n

Inductors:

L₁; L₂ = 47mH (e.g. Toko 181LY-473; Cirkit, Bonex)

Semiconductors:

D₁ = 1N4148
IC₁; IC₂ = 74HC40103
IC₃ = 4011
IC₄ = 4024
T₁ = BF494
T₂; T₃ = BC547B

Miscellaneous:

X₁ = 10 MHz quartz crystal (series resonance).
S₁; S₂ = 8-way DIL switch block.
S₃ = miniature SPST switch.
Veroboard as required.

the case of IC₁, the result should be as close as possible to 2400 Hz. Dividing 156,250 by 2400 gives 65.1042, which is rounded off to 65. Due to the internal structure of the 74HCT40103, the set divisor becomes 64 instead of 65. This means that binary code 0100 0000 is applied to inputs J₀...J₇ incl. (J₀=LSB, J₇=MSB). In other words, only J₀ is held logic high.

The decimal values with J₀, J₁, J₂, J₃, J₄, J₅, J₆ and J₇ are 1, 2, 4, 8, 16, 32, 64 and 128 respectively. Any divisor between 1 and 256 can, therefore, be set by closing one or more switches.

B

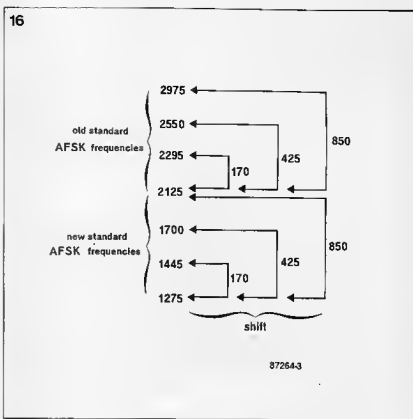

Fig. 16. Overview of 'old' and 'new' AFSK frequencies, and associated shifts.

NEW COMPUTER SYSTEM ENHANCES TEXTILE PRODUCTION

by Anna Kochan, BEng

An integrated computer system that can warn of production bottlenecks a year ahead and can be used by an operator with no experience of data processing has been on the market since late last year.

Made by McGuffie Brunton Northern[®], the first installation is at the northeast England textile manufacturing mill of the J.H. Walker Company, which collaborated in the design. Walker specializes in sliver pile fabric and jersey fleece.

McGuffie started as a partnership in 1981, became a limited company two years later and developed an annual turnover of £1.8 million by 1986. Its first products were the Trader 25 and Jobber 25 software packages for the wholesale and distribution industries, and make-to-order, finish-to-order and jobbing manufacture, respectively.

These are now installed in more than 250 businesses in the United Kingdom. The new package has evolved from these two earlier versions to suit the requirements of weavers, spinners, dyers, yarn extruders and finishers.

For the past years the firm has been licensed to sell certain ICL computers and it is the ICL System 25 range of business minicomputers that the new package for the textile industry has been chosen to run on.

Textile 25, as the new integrated company management control system is known, covers the needs of production control and costing, stock sales orders

and financial accounting with comprehensive management reporting.

Total control

The system is modular and can be installed progressively from a modest beginning. The modules are designed in such a way that they can be used by an inexperienced operator and the programs lead the operator through the systems by means of conversational English screen prompting.

Within the Textile 25 system, 27 different modules are included and they fall into six broad categories as follows:

* Sales order control: sales order pro-

cessing, telephone selling option, order intake analysis, production batch-to-sales allocation, despatch control and invoicing.

- * Stock control: stock recording, batch control and location control, stock movement audit, stock management and demand forecasting.
- * Production control: job and batch estimating, works order documentation, batch costing and labour analysis, production piece tracking, blending and recipe management, bill-off-resource management and requirements planning.
- * Buying control: buyer's information database and purchase order processing.
- * Financial control: sales ledger, sales analysis, purchase ledger, nominal ledger, fixed ledger, fixed assets, payroll and BACS (bankers automatic clearance system) link.
- * Data and security link: menu system and data management system.

Avoiding bottlenecks

J.H. Walker uses this new system in the manufacture of a range of high-quality knitted fashion fabrics for the clothing and upholstery trade. The company's two major manufacturing ranges are a jersey and a sliver fabric. The jersey fabric is knitted and stored in a 'grege' (natural) state, and then dyed and finished to individual customer orders. The sliver fabric is knitted and finished in one pass to individual customer requirements. This involves special fibre blending and very precise quality control.

So far, Walker has implemented the first phase of Textile 25 for production, order control and tracking system. A network of factory data collection terminals distributed throughout the production area and connected to the ICL system 25 minicomputer has been installed for this purpose.

As customers' orders are received they are entered on to the computer. The Textile 25 order processing module is

specialty adapted to handle the many thousands of quality and colour combinations that are possible without the need to store each one. Production batches can be planned and allocated to orders well in advance of start. The requirements planning module highlights potential bottlenecks and material shortages for up to one year ahead, allowing timely action to be taken to rectify the situation.

As work on a production batch is started, it is booked on to a knitting machine. Pieces coming off the machine are then weighed and measured. The system assigns a piece number and prints a bar-coded ticket immediately to identify the piece and accompany it around the factory. As operations are completed, the piece bar code is read and completion of the operation automatically recorded.

Accurate information

At the final inspection, extra information such as quality, net weight and net length are entered via the factory terminal, and a new bar code roll card is printed to accompany the completed piece into store.

Customer despatches are carefully controlled by the system. Each roll card being despatched is bar-code read and checked to be of the correct quality, shade and so on, for the order. Despatch documentation is printed instantly giving the customer full details of roll lengths. Invoicing then follows automatically, quickly and accurately.

At any time the firm can view the current state of a production batch and customer order. Reports highlight over-production and under-production or potential late delivery situations. Comprehensive yield analysis and raw material location control monitors costs and minimises waste.

The system has enabled Walker to improve its customer service levels in terms of meeting delivery deadlines and accurate despatches. Usage of raw materials stocks has been improved and stock holding has been reduced. The system operates 24 hours a day, six days a week and is proving to be reliable and resilient.

In the future, Walker plans to introduce enhancements to its system to cover fibre blending, time and attendance recording and automatic machine motoring.

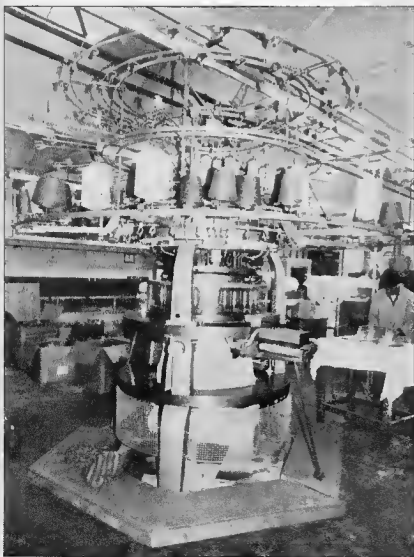

Before production begins, work is booked to specific knitting machines.

References:

1. J.H. Walker Ltd, Ravensthorpe Mills, Calder Road, DEWSBURY WF13 3SJ.
2. McGuffie Brunton Northern, The Granary, 50 Barton Road, Worsley, MANCHESTER M28 4PB.

proximity detector

There are many methods of detecting the presence of a person within a specified area, for example by using ultrasonic or microwave Doppler techniques, which are the methods frequently employed in intruder alarms. The approach adopted in this article is based on the fact that a person moving about in a room alters the geometry and strength of the electric field that invariably exists. The circuit detects changes in the electric field and produces an audible warning.

Natural and artificial electric fields exist practically everywhere. Their geometry and strength is influenced by the presence of objects, particularly conductors, that are in the field, but in a static situation, i.e. with no moving objects, field patterns will change only slowly, over a period of some hours. If a large conducting object such as a human body moves through an electric field then it will distort the field pattern. Due to the electric charges generated on clothing by friction these variations in the electric field can be very large. In a carpeted room, particularly if the carpets are of man-made fibre, the changes can be even more pronounced.

An electric field can be monitored by a sensor electrode connected to the input of a high impedance amplifier. The electrode will acquire a potential which is dependent on the field strength at the point where the electrode is mounted. Changes in field strength can also be detected very easily by using an analogue voltage comparator.

If the output of the sensor electrode amplifier is connected to one input of a comparator then the voltage at that input will consist of that due to the normal electric field with a changing voltage due to any variations in the field superimposed upon it. If the same signal is connected to the second input of the comparator via a lowpass filter with a very low cutoff frequency (~ 0.2 Hz) then the signal appearing at this input will consist only of the voltage due to the static component of the electric field. Whilst it can follow slow changes due to natural variations in the field over a period of time it will be unable to

follow voltage changes due to objects moving in the field. The voltage on the second input of the comparator thus provides a reference against which to measure changes in the field. Normally the voltage on both inputs of the comparator will be the same, but if the field changes then the voltage on the first input of the comparator will vary and the comparator output will change state.

Two problems must be solved before a practical field variation proximity detector can be built. The first is caused by the 50 Hz AC field which is invariably present in any building where there is mains wiring, and which the sensor would see as a rapid change in field strength. This problem can be overcome by using a second lowpass filter to remove the 50 Hz component from the signal picked up by the sensor plate. The cutoff frequency of the filter (1.8 Hz) is chosen so that the 50 Hz component is completely suppressed, but is still sufficiently high to pass the somewhat slower changes in voltage caused by movements in the field.

The second problem is that, since the amplifier connected to the sensor plate has a high input impedance (which it must have to detect electric fields) the voltage on the sensor plate cannot discharge. The sensor plate will therefore simply charge up to the highest voltage that it sees and any drop in voltage will not register. This problem is solved by periodically discharging the sensor plate through an (electronic) switch. To avoid possible spurious signals caused by beating between the 50 Hz AC voltage and the signal that controls the dis-

Figure 1. Block diagram of the proximity detector.

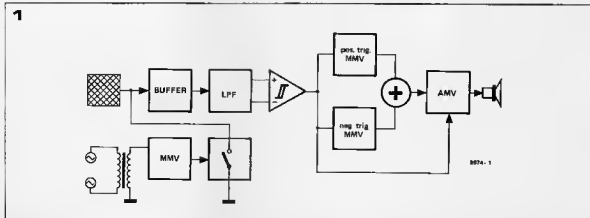

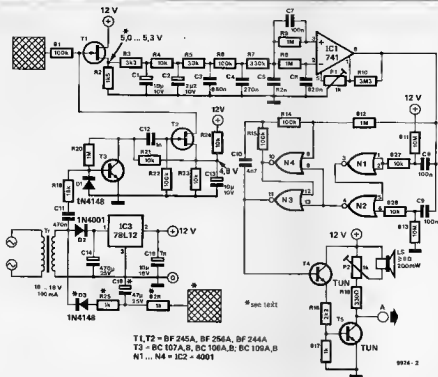

charge switch, it is essential that the plate should be discharged in synchronism with the mains frequency. This is achieved simply by having a 50 Hz mains signal control the switch.

Block diagram

Figure 1 shows a block diagram of the proximity switch. The sensor plate is connected to the input of a high impedance buffer amplifier. This is followed by a lowpass filter, which consists of two sections. The first is the 50 Hz filter; the output of this section connects to the first input of the comparator, i.e. the 'signal' input. A second filter section with a much lower cutoff frequency precedes the second input to the comparator, the 'reference' input. The signal arriving at the signal input of the comparator will thus consist of the total voltage picked up by the sensor plate, i.e. the static reference plus any variations caused by objects moving in the field, whilst only the (practically) unchanging reference voltage will get through the second filter section to the reference input of the comparator.

At the output of the comparator are connected two monostable multivibrators, one of which is positive-triggered, and the other negative-triggered, so that either positive- or negative-going transitions of the comparator output can be detected. The outputs of the two monostables are used to control an astable multivibrator, which drives a loudspeaker to give an audible warning. By using the output of the comparator to vary the frequency of

the astable a two-tone signal is provided, the frequency depending upon whether the comparator output is high or low.

Complete circuit

The complete circuit of the proximity detector is given in figure 2. The sensor plate is connected to the gate of T1, which is a FET connected as a source follower. This stage has an extremely high input impedance and a low output impedance. The gain is slightly less than unity. Resistors R3 to R7 and their associated capacitors form the lowpass filter which removes 50 Hz signals. The output of this filter is connected to the non-inverting input of the comparator, a 741 op-amp, via R9 and C7. A lowpass filter section with a very long time constant (R8-C6, approximately 800 ms) removes all but very slow variations from the voltage applied to the inverting input of IC1.

To obtain clean switching of the comparator output a small degree of hysteresis is introduced by applying positive feedback to one of the offset inputs via R10. Negative-going transitions or the comparator output cause the input of N1 to be pulled low via C8. The output of N1 therefore goes high and the output of N2 goes low. Positive-going transitions of the comparator output take the input of N2 high via C9, so that in this case also the output of N2 goes low. The length of time for which the output of N2 remains low depends on the time constant C8-R11 (or C9-R13). N3 and N4 are connected as an astable multivibrator, which drives a small audio amplifier consisting of T4 and T5. When

Figure 2. Complete circuit of the proximity detector.

Figure 3. Printed circuit board and component layout for the proximity detector (EPS 9974).

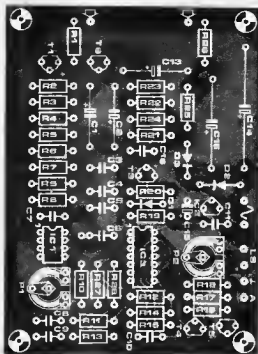

Parts list.

Resistors.
 R1, R6, R14, R15, R22 = 100 k
 R2 = 1k5
 R3 = 2k3
 R4, R21, R23, R24, R27, R28 = 10 k
 R5 = 33 k
 R7 = 330 k
 R8, R9, R12, R20 = 1 M
 R10 = 3M3
 R11, R13 = 10 M
 R16 = 2k2
 R17, R26, R26 = 1 k
 R18 = 330 Ω
 R19 = 18 k
 P1, P2 = 1 k preset

Capacitors.

C1, C13 = 10 μ/10 V
 C2 = 2μ/10 V
 C3 = 680 n
 C4 = 270 n
 C5 = 82 n
 C6 = 820 n
 C8, C9 = 100 n
 C10 = 4n7
 C11 = 470 n
 C12 = 1 n
 C14 = 470 μ/25 V
 C15 = 10 μ/15 V tantalum
 C16 = 47 μ/25 V

Semiconductors.

T1, T2 = BF 244A, BF 245A,
 BF 255A.
 T3 = BC 107A/5, 5C 108B/C,
 BC 109B/C
 T4, T5 = TUN
 D1 = 1N4148, 1N914
 D2, D3 = 1N4001
 IC1 = 741
 IC2 = N1 . N4 = 4001
 IC3 = 78L12

Miscellaneous.

15 V or 18 V/100 mA mains transformer

the output of N2 is low the multi-vibrator will oscillate. An input to the multivibrator from the comparator, via R12, alters the multivibrator frequency depending on whether the sensor output is high or low. The sensor plate is discharged every 20 ms by FET T2. Transistor T3 turns off at each negative-going zero-crossing of the mains waveform, at which point T2 conducts briefly and discharges the sensor electrode.

Power supply

Power for the circuit is obtained from a mains transformer with a 15 V or 18 V secondary rated at 100 mA or greater. The output voltage of the transformer is half-wave rectified by D2 and smoothed by C14 before being fed to a 12 V IC regulator. The mains transformer also provides the 50 Hz signal to switch T3 and T2.

For optimum sensitivity the 0 V rail of the circuit must be connected to an earth point such as mains earth or a metal water pipe. If no such earth is available then an 'artificial earth' must be used consisting of a second electrode connected to a negative supply voltage as shown in figure 2. However, if a true earth is used then R25, R26, C16 and D3 can be omitted.

Construction and use

A printed circuit board and component layout for the proximity detector are given in figure 3. All the components, with the exception of the loudspeaker and mains transformer, are mounted on this board. The electrode(s) may be

made from copper laminate board approximately 15 cm square. If two electrodes are used, they should be mounted about 1 metre apart. The sensor plate must be well-insulated from surrounding objects. Probably the best method is to mount it on the outside of the box in which the circuit is housed using nylon spacers. The unit should function immediately when switched on, and the only adjustments required are to vary P1 for the best sensitivity and to set the volume of the audible warning using P2.

Although intended mainly as demonstration of the principle, the circuit can also be used for practical applications such as intruder alarms, provided its limitations are known. The proximity detector is much less prone to false alarms than ultrasonic or microwave Doppler alarms, which can be triggered by flapping curtains or rattling doors and windows. However, the circuit may be falsely triggered by changes in field strength caused by switching on and off of electrical equipment. This is not such a problem if the unit is intended to protect unoccupied premises, provided care is taken not to mount it in the vicinity of equipment that switches on and off automatically, such as a refrigerator or freezer.

To trigger an external alarm or other circuit the signal from point (A) may be used. This is normally high, but when the audible warning sounds point (A) goes alternately high and low at the same frequency.

Battery Operated Tube Light

Many of you must have faced this situation when you would have liked to have a tube light operated from a car battery. The reasons for this need may be numerous, but the solution is one, and it appears here as a simple electronic circuit which can light up a small tube light from a 12 V car battery.

At the heart of the circuit is the voltage converter. A block schematic diagram is given in figure 1. Just one look at the diagram will make the operating principle clear. The 12 V DC voltage from the car battery is given to an astable multivibrator, which produces rectangular pulses — and converts the DC voltage to an AC voltage. Though it is not an AC sine wave, it will serve our purpose. Only one difficulty with this AC square wave is that its amplitude can never be more than 12 V, because of the battery voltage.

This difficulty is overcome by stepping up the voltage through a transformer. Also, as the current requirements is high we must use power transistors to boost the current output before feeding the 12 V square wave to the transformer. This task is accomplished by the block shown just before the transformer. The transformer is just a common stepdown transformer of 12-0-12 V/1A rating used in reverse direction so as to make it a step up transformer.

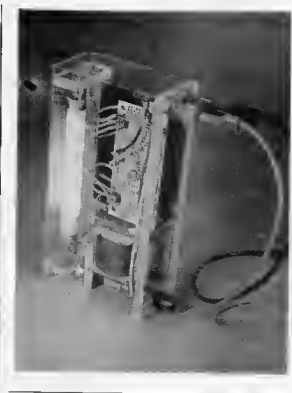

By connecting the 12 V AC square wave to the transformer, we can now get about 230 V AC at the output, under no-load condition. The voltage may drop to about 100 V after connecting the tube light, but this is sufficient to operate the small tube light. Just four transistors and a few passive components are enough to construct the circuit, which is shown in figure 2.

Transistors T1 and T2 form the astable multivibrator

which produces the square wave. The frequency of this square wave depends on R2, R3 and P1 as well as the capacitors C1 and C2. The frequency in the given circuit is about 220 Hz, with the potentiometer P1 on zero. The wave shape is a square wave with this combination. By increasing P1, the frequency can be reduced to about 125 Hz. The on/off ratio or the duty cycle of the wave will also change with this. The change in duty cycle affects the brightness of the glow

and thus P1 can be used to control the brightness level. The dim light of this fluorescent lamp can perhaps substitute the romantic atmosphere of a mild moon light....

The transistors T1 and T2 are too weak to deliver the required output current necessary to drive the tube light. Hence two power transistors are used to handle this current level. These are the transistors T3 and T4 which feed the current through the transformer Tr1. This is a stepdown transformer used in reverse way to serve as a step up transformer. It finally provides the high AC voltage required by the tube light. The transformer used here is a 10-0-10 V or 12-0-12 V transformer which has either two different windings on the lower voltage side or a center tapped winding. The center tap is connected to the + 12 V DC from the battery, and the two ends of the winding are connected to the power transistors.

The wave forms on the transformer are represented schematically in figure 3. The common terminal is connected to + 12 V. At terminals 1 and 3, the voltage is opposite of each other. If 1 is on 12 V, 3 is on 0 V and if 1 is on 0 V then 3 is on 12 V. These Voltage levels change in rhythm of the square wave delivered by the astable multivibrator. This drives the current once

through W1 and once through W2. Every time the current through the winding is interrupted, the magnetic field breaks and generates a high voltage on the winding connected to the tube light. This happens continuously as long as the astable multivibrator provides the square wave output.

Construction:

The electronics of the battery operated tube light takes very little time to construct - however, the mechanical construction will take the major part of your time and skill.

Figure 1:

The actual task of a converter circuit is to convert a DC level into an AC wave form. The power transistors are used to boost the current output. The high current then flows through the step up transformer and produces the desired high AC voltage.

Figure 2:

An astable multivibrator is at the heart of the circuit. The AC square wave produced by the AMV is further stepped up by the transformer being driven by the two power transistors. Diodes D1 and D2 protect the collector - emitter junctions of T3 and T4 from the high voltage spikes.

Figure 3:

Voltsages and wave forms present on the transformer windings.

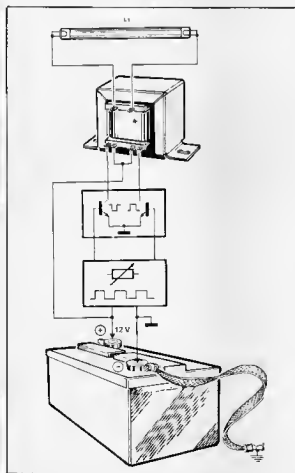

2

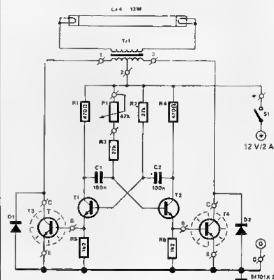

T1, T2 = BC140 16
 T3, T4 = 2N3055
 D1, D2 = 1N4007/1N4004
 Tr1 = 230V / 2 x 12 V, 1 A
 230 V / 2 x 10 V, 1 A
 La = Fluorescent Tube Light (4 to 12 W)

3

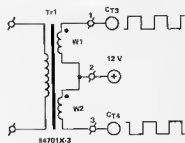

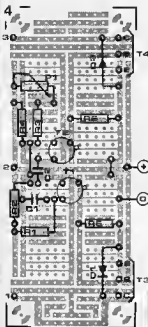

Figure 4:
The power transistors and the transformer are not mounted on the PCB. All other components can be accommodated on a small SELEX PCB of size 1.

Parts List:

- R1, R4 = 470 Ω
- R2, R3 = 27 K Ω
- R5, R6 = 1.2 K Ω
- P1 = 47 K Linear Pot.
- C1, C2 = 100 nF
- T1, T2 = BC 140-16/2N 2219
- T3, T4 = 2N 3055
- D1, D2 = 1N 4004 or 1N 4007

Other parts:

- Tr1 = 12.0-12 or 10.0-10/1 A Transformer (230 V)
- S1 = on/off switch
- La = Fluorescent Lamp 4 to 12 W (Tube)
- 1 heat sink for T3 & T4
- 2 Transistor mounting kits for T3 & T4
- Terminals, soldering pins, flexible wire, acrylic casing etc.

The component layout is shown in figure 4 as usual and is very simple to follow. All components can be accommodated on a small SELEX PCB of size 1, except for the transformer and the power transistors. The standard procedure for soldering must be followed, that is, first the Jumper wires, then resistors, diodes, capacitors, transistors etc. Even if you can find space to accommodate the power transistors on the PCB, do not mount them on the PCB as they must be mounted on a suitable heat sink. Do not forget to use the mica insulation and heat sink compound while mounting the transistors on

the heat sinks. The terminals of the power transistors can be connected to the PCB through flexible wires. The screws used for fitting the power transistors must not have contact with the heat sink and you must use insulating bushes with these screws. In case the screws come in contact with the heat sink, both the collectors of T3 and T4 will be shorted together through the heat sink.

After properly assembling the circuit and checking the circuit connections visually as well as with a multimeter, power can be applied to the circuit. Make sure that the collectors of T3 and T4 are not short circuited. If you



want to be very sure about the functioning of the circuit, do not connect the transformer first. Use a 9 V battery in place of 12 V and check the voltages on collectors of T1 and T2. The collector voltage of T1 should be around 3 to 4.5 V and that of T2 around 4 to 6 V. Some deviation can be expected depending upon the position of P1.

If this check is as desired, then you can be certain about the functioning of the circuit.

The fluorescent light is fed from an AC square wave in this case and requires higher power than in case it was driven by an AC sine

wave. The current consumption in this case is approximately 2 A. If the power is reduced and current restricted to about 1.2 A then an additional resistance of 4.7 Ω /10 W must be introduced in the collector lines of T3 and T4. We must also mention an undesired side effect here, the circuit makes a fuzzing sound - which can of course be interpreted as if a fly was humming around our lamp!

NEW PRODUCTS • NEW PRODUCTS • NEW

Insulation Testers.

Meco Instruments have introduced the new "FUSO" Hand driven, generator type Insulation Testers. These testers are housed in light weight ABS Plastic cases. The constant voltage AC generator is hand - driven via nylon gears. Cross coil ratio meters are used throughout the range.

All models incorporate spring loaded terminals, and are supplied complete with test leads.



Meco Instruments Pvt Ltd • Bharat Industrial Estate • T J Road • Sewree • Bombay-400 015.

Tin Plating

'Tinglo' process is a method of high speed bright acid Tin plating which gives bright uniform tin deposits. Besides, it gives better ductility, conductivity, strength, corrosion protection, brightness and does not tarnish or stain as compared to other methods of plating.

'Tinglo' is recommended for smooth ductile plating in the Electronics Industry for Terminals, Tags, Lugs, Semi-conductor devices, Electrical connectors and contacts, PCBs and other Electrical/Electronic components, due to its low contact resistance properties.



The 'Tinglo' process is simple to operate and maintain. The bath make-up includes Tinglo salt, Sulphuric acid C.P. (Sp. Gr: 1.84), Tinglo brightener "A" and Tinglo Brightener "B". Typical operating instructions and guidelines for the process are provided to the user. Various package sizes of the salt and brightness are available.

Dawat International • 167 A to Z Industrial Estate • Lower Parel • Bombay 400 013.

Milli Ohmmeter

This Digital Ohm Meter features 3 1/2 digit, 7 segment RED LED Display. 5 ranges with lowest range of 200 milli ohm with 0.1 milli ohm resolution and highest range of 2 K ohm with 1 ohm resolution. Other ranges are 2 ohm, 20 ohm, 200 ohm. Selection is by interlocked push button switches. 4 wire measurement avoids lead resistance error.



Economy Electronics • 15 Sweet Home • Plot No. 442 • 2nd floor • Pilamber lane • Off Tulsii Pipe Road • Mahim • Bombay 400 016.

Test Terminal Blocks

'Nelster Welcon' Test Terminal Blocks, are available in 3-phase 3-wires and 3-

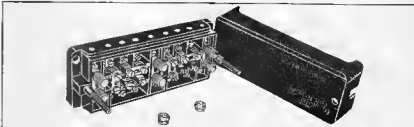

phase 4-wires for front or rear connection. Housed in a black moulding these brass terminals are of high current carrying capacity and have Ø 5 mm holes for cable. Brass shorting links/screws provide easy and positive operation. All metal parts are nickel plated.

Nelster Welcon • 6 Laxmi Woolen Mills Compound • Shakti Mills Lane • Off Dr. E Moses Road • Mahalaxmi • Bombay-400 011.

Time Totalizer

M/s. Controls & Equipments have recently introduced new Mini Time Totalizer series 622 having 6 digits counter with a range of 0 to 99999.9 hours or 0 to 9999.99 hours. This is also offered without Re-set facility so that the counter cannot be manually re-set to zero thereby ruling out any possibility of tampering with the recorded time.

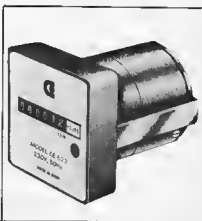

M/s. Sai Electronics • (A Div. of Starch & Allied Industries) • Thakor Estate • Kurla Kiroli Road • Vidyavihar (West) • Bombay-400 086. Telephone-5136601.

NEW PRODUCTS • NEW PRODUCTS • NEW

Static Eliminator

CIRCUIT AIDS INC offers ingeniously developed Static Area Eliminators having an effective area coverage of 0.75 Mtrs. The instrument works on a principle of high voltage corona generation through gold plated pins. The gold plating of pins ensure that no ozone is generated. Throws ionised air using a built-in propeller. The instrument is portable and weighs 2.75 Kgs. Rated for continuous use, the instrument consumes 30 watts of power.

The areas of applications of the instrument are Clean Rooms, Antistatic Work Stations, Semiconductor Manufacturers, Lens manufacturers, Pharmaceutical manufacturers etc.



Circuit Aids Inc. • No 451 64th Cross V Block • Rajajinagar • Bangalore-560 010 (Karnataka).

Liquid Dispensing System

The I & Jth Model LD1000B is a fully automatic dispensing system that allows a wide variety of dispensing applications to be performed such as solder mask and solder paste dispensing onto printed circuit boards, SMT chip bonding adhesive or solder paste dispensing onto SMT boards and one or two part epoxy encapsulation of electrical components. In addition, other materials such as form-in-place gasket material, conformal coating, cyanoacrylate, grease and other liquids can easily be dispensed.



Typical applications include dispensing a UV cure material to seal switches, dispensing a solder paste or SMT adhesive onto surface mount boards or to automate any application that requires accurate liquid dispensing and precision parts positioning.

I & J Fisnar Inc. • 2-07 Banta Place • Fair Lawn • NJ 07410 • USA.

Screwless Terminal Blocks

Wago Kontaktkechaik GMBH manufacture rail mounted terminal blocks of various types and sizes for use in power plants, telecommunication equipment, and applications requiring interconnection of power supplies.

These are suitable for all copper conductors from AWG 26 upto AWG 2.

The product range includes: PCB terminal blocks, connectors, electronic rail mounted terminal blocks, plug-in-modules, screw clamp connecting systems, terminals blocks, multicore connectors, of various types an assortment of side entry connectors, marker strips, and card connectors.

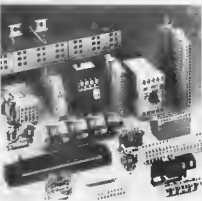

M/s. Arun Electronics Pvt. Ltd. • 2E, Court Chambers • 35 New Marine Lines Bombay 400 020 • Tel: 252160/259207.

High Voltage Op Amp Handles ± 45 V

Burr-Brown's new OPA445 monolithic operational amplifier operates from power supplies up to ± 45 V with

minimum 15mA output current. Its compact size and voltage-handling ability make it an excellent choice for a broad range of applications, including ATE pin drivers, power supplies, power controllers, and other programmable power sources.

OPA445 has FET input circuitry, and it's input bias current is only 50pA max at room temperature.

The device is unity gain stable and requires no external compensation components. The new op amp is available in TO-99 and 8-pin plastic DIP packages with standard industry pin-outs.



Oriole Services & Consultants Pvt. Ltd. • Post Box No. 9275 • 4 Kurla Industrial Estate • Ghatkopar • Bombay-400 086.

High Power Alternistor

Silicon Power Electronics, manufacturers of Power Semiconductors have introduced 80 Amp. Alternistor, a bidirectional device, used for application in reactive circuits and in high frequency instruments.

The 80 Amp. Alternistor will be useful in control panels, servo systems, magnetisors, variable speed controls etc.

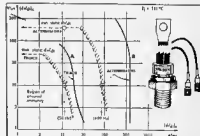

M/s. Silicon Power Electronics • Plot 29/3, D-2 Block, MIDC Telco Road • Chinchwad • Pune 411 019.

NEW PRODUCTS • NEW PRODUCTS • N

Timer

Multi - Controls have developed an electronic timer for control of varied processes which require time related control. The timer is offered in two types viz.:

- (1) Industry Standard Flush Panel Type and
- (2) Plug - in Type.

The Plug - in feature provides ease of maintenance and replacement. It is accommodated in a standard 8 pin/11 pin relay base. The timing range offered is 1 sec to 60 minutes in nine different forms. The operating voltages could be 12, 24, 110, 230, 440, AC/DC. All standard timer modes such as, "ON DELAY", "OFF DELAY", are offered.



Multi Controls • Shantaram Jagtap Building • Hingne Khurd • Vitthalwadi • Pune-411 009.

Burnishing Machine

M/s. O.R.T. of Italy have developed an external burnishing machine for finishing the external diameters of soft, cylindrical components.

This process is suitable for a wide variety of components, including fanshafts; piston-rods of shock-absorbers; crankshafts of compressors; needle-bar and presser-bar of sewing machines; etc. The burnished surface accepts electroplating as a finishing process.



Burnishing machines can be imported under O.G.L. by Actual-Users, and the import-duty is concessional.

M/s. O.R.T. are participating in the India International Trade Fair at New Delhi in Nov. 87.

Precision International • P.O. Box 3041 • New Delhi- 110 003.

Modular Computer

The Unit comes complete with two 5 1/4" Floppy Drive. Video monitor along with keyboard is all that is required to complete the system. This is available in standard 19" Rack with all Eurobus boards. A printer of required capacity and specification can be connected to the Rack. Additional 3 Slots are provided for user defined expansion, such a system can be used as development system for programme development and debugging.

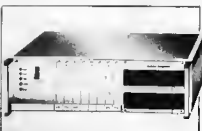

Arun Electronics Pvt. Limited • B/125-126 Ansa Industrial Estate • Saki Vihar Road • Bombay 400 072. Tel: 58 33 54/58 71 01.

Illuminometer

Upto India has introduced a very sensitive, portable, compact ILLUMINOMETER for measurement of light levels. This is suitable for all photometric measurements in science and research as well as quality testing labs. Its response meets with internationally accepted standard CIE observer's curve (equivalent to average human eye response) with cosine correction:

The ranges of the instrument is 0-3, 0-10, 0-30, 0-100, 0-300.

Agrawal Sales Enterprises • 34 Ganesh Bazar • Jhansi-284 002.



Cabinet Cooler

Electronics Consumer Durables Pvt. Ltd. has introduced a solid state cabinet Cooler - Elektra-Staykool.

Elektra-Staykool operates on solid state thermoelectric technology, with a closed-loop cooling system.

The cabinet cooler can be easily installed by screwing it onto the cabinet. It has a modular construction, is light-weight and compact. Operating costs are low due to low power consumption.

This product has wide applications - It is useful manufacturers of electronic control panels, electronic systems, and CNC controllers. It is also widely used in the field of defence, where, among other factors, high reliability, portability, and silent operation, are often prerequisites.

Elektra-Staykool is available for Rs. 2,500 plus taxes.



Electronica Consumer Durables Pvt. Ltd. • 12 Kaka Halwai Industrial Estate • Pune-Satara Road • Pune- 411 009.

NEW PRODUCTS • NEW PRODUCTS • N

Multiple Coil Winding Machine

Taga Manufacturing Co of Japan introduce single spindle type multiple automatic coil winding machine model 2085. This machine winds multiple number of coils simultaneously on one spindle. This model is most suitable for production of thin wire coils and with thin insulating paper. With this coil winder, ignition coils, vertical transformers, coils for cross bar switches, relay coils, choke coils, neon transformer coils etc. can be produced.

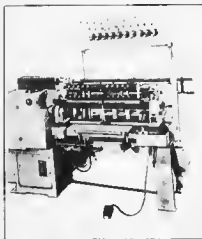

Murugappa Electronics Limited
• Agency Division • 'Parry House' • 3rd floor • 43 Moore Street • Madras 600 001 • Phone: 21019, 21003, 27531.

Darlington Module

SGS has added a new silicon to its TO240 family for high power D.C. applications. This high gain SGS 100DA0250 Darlington module can sustain 100A of continuous current in circuits which operate from up to 250V supply lines. Applications include high power regulated D.C. supplies, and D.C. motor control.

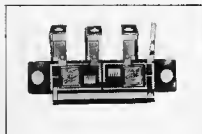

**SGS Semiconductors (Pte) Ltd • 28 Ang
Ko Kio Industrial Park-2 • Singapore-
2056.**

Controller

The GPC 02 card is a control and governing module in the standard Europe 100 x 160 mm size.

It operates on the ABACO (R) 16 bit BUS and exploits the wide outfit of industrial peripheries and intelligent modules of said bus. ABACO (R) BUS is compatible with SC 84 BUS.

The card operates through and is assembled with the CPU Intel 51 family in its different version with/without internal ROM/EPROM including the BASIC masked model.

The development and setup of programmes for this card can just start from the single GPC 02, since it is already provided with the minimum outfit necessary for a first approach, including the built-in EPROM programmer.

The completeness of GPC 02 card makes it suitable to meet on its own, control requirements of medium-complex units or automations. Where a more complex assembly is required, the performance are easy to increase using suitable cards to be assembled on the powerful ABACO (R) BUS.

On the contrary, when cost saving is required along with a card optimization, just beginning from small series, it is possible to order cards depleted from unnecessary functions.

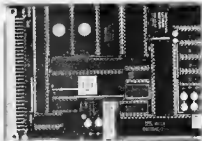

**Grifo Di Damino S. & C. S.N.C. • 40016
San Giorgio di piano (bologna) • Italy •
Via Dante 1 •**

Temperature Controller

Radix introduces LSC 260 featuring two to eight independently programmable set-points for a single input channel. This microprocessor based controller accepts B, E, J, K, R, S or T thermocouple and Pt 100 inputs. The instrument is housed in a 96 (H) x 192 (W) x 260 (D) mm, DIN size panel mounting case.



**M/s. Radix Elecsystems. • A/22,
Bonanza Indl. Estate • Kandivli (E) •
Bombay-400 101. • Phone: 69 95 89.**

Rotary Wire Stripper

Ajit Engineers, Bangalore have developed a semi-automatic Rotary wire stripper-cum-twister. It is ideal for use with PVC hook up wires, shielded wires, automobile cable and Industrial panel Wiring etc. It uses a unique, simple rugged stripping-cum-twisting mechanism which can be set for any desired wire diameter and strip length within seconds. It can strip lengths upto 75 mm and wires from 1.5 mm to 5 mm Ø.

The waste is collected in a bag leaving stripped and twisted wires ready for tinning, soldering and crimping operations.

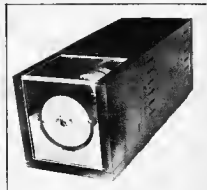

**Ajit Engineers • 70 S S I Area •
Rajajinagar • Bangalore-560 010.**

ATTENTION

elektor^{INDIA} electronics

**OUR SEPTEMBER '88
ISSUE WILL BE
THE
ANNUAL
CIRCUITS SPECIAL**

100+
CIRCUITS

WITH

**SPECIAL SUPPLEMENT
ON ELECTRONICS INDIA 88
EXHIBITION**

The International Exhibition on Electronics
being organised by the Trade Fair Authority of India
at Pragati Maidan New Delhi

**NOT TO BE MISSED
BY READERS & ADVERTISERS**

BOOK YOUR COPY NOW

Your Right Connection ...

Champion

The Champion Connectors!

- o Dual In-line IC Sockets.
- o Single In-line IC Sockets.
- o Pin Grid Array Sockets.
- o Socket Adaptors.
- o Cage Jacks.

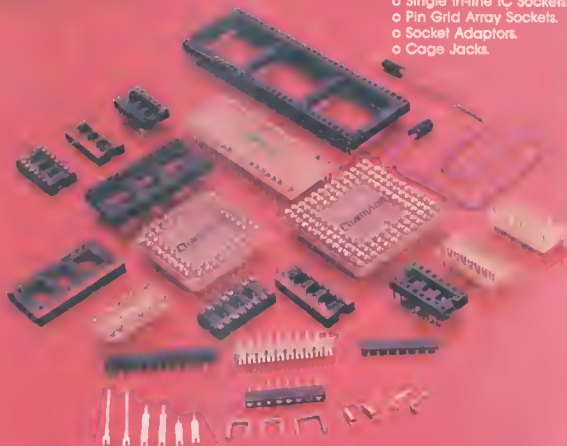

Champion Electronics, Pvt. Ltd.

S-17, M I D C, Bhojan, Pune 411 026 India (0212) 82582, 83791 Cable CHAMPION
Telex 0145-343 CHMP IN 0145-333 MCCI IN 0145-505 MCCI IN