

59

March  
1988

# elektor

INDIA

# electronics

154

Rs. 8.00

## TELECOMMUNICATIONS

ISDN • Satellites •  
Fibre Optics

Prescaler for multi-function frequency meter  
VAM-video/audio modulator  
Percolator Switch



Publisher: C.R. Chandarana  
 Editor: Surendra Iyer  
 Technical Editor: Ashok Dongra  
 Circulation: J. Dhas  
 Advertising: B.M. Mehta  
 Production: C.N. Mithagari

Address:  
 ELEKTOR ELECTRONICS PVT LTD  
 52, C Proctor Road, Bombay-400 007 INDIA  
 Telex: (011) 78661 ELEK IN

**Overseas editions.**

**Elektor Electronics**  
 1, Hallowin Avenue  
 Great West Road, Brentford TW6 4EW, U.K.  
 Editor: Lee Seymour  
**Publicis Publications Tecacas Ltda**  
 Av. Ipiranga 1100, 3º andar, CEP:01040, San Paulo, Brazil  
 Editor: Jairo B. Seel

**Elektor sat**  
 Route Nationale 1e Sss, B.P. 83  
 93220, Suresnes - France  
 Editors: R.R. & Meyer  
 G.C.P. Riederstein

**Elektor Verlag GmbH**  
 Supersfeld Straße 25, 100, Aachen - West Germany  
 Editor: F.J.A. Kneppelmeier

**Elektor EPE**  
 Kivimäki EA 16675, Vanta - Finland - Canada  
 Editor: E. Karttunen

**Elektuur B.V.**  
 Post: Tschopvishoek 2, 4  
 6161 VK Beek - The Netherlands  
 Editor: P.E.L. Krasmakers

**Fantaa & Baato Ltd**  
 P.O. Box 32, 1000, Lohja - Portugal  
 Editor: Jorge Gonçalves

**Ingels B.A.**  
 Plaza B. publico, Braxos 7, 28016 Madrid Spain  
 Editor: A.M. Pavez

**In Peil**  
 Keshavn Holdings PVT Ltd, Cst. Box Valley Road B  
 Kagle Street, Whitehorn NW6 2076 - Australia  
 Editor: Roger Harrison

**Electrona Press AB**  
 Box 64  
 187 11 Danderyd, Sweden  
 Editor: Bill Cadman

The Content is for domestic use only. The submission of request of articles of Elektor India implies permission for the publisher to edit and translate the text and design and to use the contents in other Elektor publications and so on. If a publisher desires permission to retain the material submitted to them. All drawings, photographs, printed circuit boards and articles published in Elektor, take the copyright and may not be reproduced or translated in whole or part without prior written permission of the publisher.

Printed permission may exist in form of circuits, device construction or directed to the magazine. The publishers do not accept responsibility for failing to identify such patents or other protection.



MEMBER

Printed at: Trupti Offset Bombay - 400 013

Fh 4923261, 4921354

Copyright © 1998 Elektuur B.V



*Surendra Iyer*

Volume-6 Number-3  
 March 1988

# CONTENTS

|  |      |
|--|------|
| <b>Components</b>  |      |
| Industry standard moves to CHMOS .....   | 3.22 |
| <b>Radio &amp; Television</b>  |      |
| Flat aerial for satellite TV reception .....                                     | 3.31 |
| <b>Computers</b>   |      |
| <b>PROJECT: VAM - video/audio modulator</b> .....                                | 3.26 |
| <b>Telecommunications</b>  |      |
| Geneva calling ISDN and satellites at Telecom, 87 .....                          | 3.33 |
| Optic fibre communication .....  | 3.38 |
| Computer and telecommunication revolution<br>will bring its legal problems ..... | 3.39 |
| <b>Test &amp; Measurement</b>  |      |
| <b>PROJECT: Prescaler for multifunction frequency meter</b> .....                | 3.41 |
| <b>PROJECT: Percolator switch</b> .....  | 3.46 |
| Dual-trace oscilloscopes (part 3) .....  | 3.48 |
| <b>Audio &amp; Hi-fi</b>   |      |
| <b>PROJECT: Microphone preamp.</b> .....   | 3.25 |
| <b>Information</b>   |      |
| Editorial .....  | 3.05 |
| Electronic news .....  | 3.18 |
| Telecommunication news .....   | 3.20 |
| New products .....   | 3.60 |
| Appointments .....   | 3.71 |
| <b>Guide lines</b>   |      |
| Switchboard .....  | 3.66 |
| Index of advertisers .....   | 3.74 |
| <b>Telex - 32</b>  |      |
| <b>PROJECT: Baby phone</b> .....   | 3.55 |



## CAR PHONES

Import of technology has become a very controversial topic in our country. Whether to import and perish or export and flourish is a difficult question for which no simple answer exists.

Elsewhere in this issue, we report on the proposed import of car telephones. The issue assumes significance not merely because it is a sophisticated technology but also because the Prime Minister of India has shown his interest in the technology, "out of the way" in Stockholm.

Sophisticated technology is certainly a welcome aspect. But, in a country where until the other day, even possessing a telephone was considered a "luxury", the idea of a car telephone cannot be sold easily.

There can be two opinions on the timing of introducing the mobile cellular communication system in India. That is either now or a few years hence. The reason advanced for delaying the car phones is that improving and expanding the existing telecommunication network was more important than bringing a fancy equipment for a chosen few.

A telecommunication expert, close to the Prime Minister, was himself opposed to the car telephones but interestingly the PM seems to have had a fresh thought on the issue.

If the car telephone technology is obtained without any strings that may strangle the other essential projects in the country, at least on an experimental basis, there can be no quarrel. If commercial interests alone prevail it would be a bad step.

### Front cover

Artist's impression of a communications satellite in orbit around the earth. Copyright Seth Shostak/Science Photo Library.

## Policy Review

The annual budget time is the time for a review and forecast. The electronics industry cannot escape this exercise. The inevitable change of policy and implementation in electronics is already upon us.

The liberal import policy and the associated "phased manufacturing programme" have not helped in the indigenisation of the industry as envisaged. What is derisively called the "screwdriver technology" has continued.

The Electronics Commission has proposed a three-tier duty structure for the electronics industry and a fiscal policy for a minimum period of three years. The strategy aims at boosting investment, upgrading technology through fiscal incentives and pushing up exports.

The commission has suggested that the raw materials should attract least amount of duty, if any and the components should be exempt from customs duty. However, the duty on the capital goods will continue and no concession is likely for this sector. Any concession to the capital goods imports only led to the import of second hand machinery and it also hampered investment in the capital goods sector.

The commission does not believe that higher duty on capital goods raises the prices of end products. The effect of high duties on capitals is not more than three percent on the end products.

This conclusion has been made after analysing the CTV and VCR industries which justify high duty structure on the capital equipment required. For example, a plant with an installed capacity for producing 700,000 CTVs per annum, when a 50 percent import duty is imposed on the capital goods costing Rs. 25 crores in foreign exchange, enhances the cost of the plant by Rs. 12.50 crores. If the plant produced 500,000 tubes per annum, the average cost increase due to higher duty will be Rs. 50 per tube.

Imports of SKD kits were also reviewed and the Electronics Commission was asked by Prime Minister's office to suggest measures to check this trend. The solution to this problem lies in rationalisation of the fiscal measures, according to the commission.

Commenting on the Phased Manufacturing Programme, the commission refers to the case of telephone instruments. For this simple product, several licences have been given to many vendors to go in

for foreign collaboration. This has proved to be a heavy drain on the foreign exchange and multiple technology imports affected standardisation. Too many Indian business groups chased too few foreign technologies and the country lost its negotiating lever.

To boost investment, the commission has suggested accelerated use of electronics to 3 percent of the GNP by 1990s, 5 per cent of the GNP by 1995 and 7 per cent by the year 2000. This can be achieved by increasing the usage of electronics in agriculture, industry, education, transportation, banking, communication and other public utilities.

A telephone exchange within 5 km hexagon by 1995, a local radio station in every district by 1995 and a radio in every home will be desirable. Instead of setting up electronic industrial complexes, the commission recommends setting up of TV and radio facilities to give a flip to downstream industries.

The commission underlines the need for optimising the existing investments through easy availability of spares and by giving facilities on par with manufacturers to maintenance services organisations. These organisations should be given the status of industry enabling them to import spares.

To encourage domestic production to meet the internal demand, preferential treatment may be given to the manufacturers of quality products. A target should be fixed that by 1990 roughly 80 per cent of the domestic demand should be met through domestic production.

Three-year user forecast of technology and quantity should be mandatory for issuing import clearance.

Despite the fact that the domestic market for electronic products in the country has gone up sharply in the last decade, the real share of domestic production in the total consumption of electronic products in the country has drastically come down. Similarly, the increased outlay of foreign exchange in this area has not been balanced with corresponding exports.

## World Bank's Tips

The World Bank has suggested that foreign collaborations in the electronic sector should be exempted from the Foreign Exchange Regulation Act. The bank has also called for the abolition of the 10 per cent price preference to the public sector units and greater freedom to the private sector to choose

technologies, collaborators and the volume of production.

The objective of the electronic policy should be to ensure techno-economic viability and production at international cost and quality. It should also ensure production efficiency and continuous technology upgradation through liberal access to foreign technologies.

The World Bank reports say that FERA restrictions should be removed from high-tech end products, industrial and telecommunication equipment, middle grade components, micro and mini computers and the software. Firms seeking high percentages of equity should be asked to emphasise on manpower training and technology transfer programmes rather than on the export obligation as contained in the existing electronics policy.

The report says that FERA regulation to locate the industry in the backward areas served as a disincentive and this should be removed. Rates of royalty, which were recently increased to eight per cent should be hiked further.

The bank feels that the encouragement given to the private sector recently should be further strengthened by placing the private and public sectors on the same competitive basis. Production levels of industries opened to the private sector should be regulated for sometime to allow the development of private sector competition.

The prices should be linked to the performance of the most efficient firms and not the least efficient ones. The inefficient production processes protected through policies also raise profit margins. The profit margins in India are 25 per cent to 35 per cent against the international norms of 10 to 15 per cent, according to the World Bank report.

The bank also suggests removal of protectionism slowly along with removal of import restrictions through gradual reduction in customs duties.

The report notes that unrestricted access to components of highly quality at low prices is necessary for efficient production of most end products and critical for efficient production of colour TV sets, microcomputers, printers and EPABX. Steps should be taken to reduce component costs by progressively lowering component import duties.

The duty on components should be brought down to 35 per cent from the present 75 per cent and this could be

done over seven years. Also, components such as digital ICs should be imported and not manufactured indigenously and a 20 per cent duty can be imposed on them, according to the World Bank.

The proposed policy changes suggested by the Electronic Commission and the contents of the World Bank report appear to be common on a number of points. This has given rise to a view point that the policy has been made under the World Bank pressure.

While the policy of the government and the World Bank may appear to be a coincident, the World Bank has, for the first time, offered credits worth US \$ 150 million for electronics sector. The bank has indicated that there should be "single window clearance" and a continued improvement in the policy areas of the electronic sector.

The attractive aspect of this credit offer is that the bank will not only finance fixed assets but also provide funds for working capitals.

## CSI convention

The world's largest computer communications network will become operational in India by August, 1988, connecting 430 districts, all state capitals and major cities. Mr Sam Pitroda, technology adviser to the Prime Minister and chief of the Centre for Development of Telematics, highlighted this aspect in his keynote address at the 23rd annual convention of the Computer Society of India at Madras on January 6.

Mr Pitroda, who has got the 'ears' of the PM, also heads the five special technology missions announced by the government. When Mr Pitroda said there would not be any large scale import of equipment or technology for computers, he should be taken seriously. He stressed that self-reliance would be achieved even if it was time consuming and took a generation to accomplish.

Mr Pitroda has suggested to the Planning Commission that equal emphasis should be laid on telecommunications, computers and energy.

Prof H.N. Mahabala, president of the CSI, told the convention that India could also export hardware if the government policies encouraged volume production and local R and D. It was high time that the government supported the R and D in the private sector. By 1990, India will have 100,000 personal computers and this would necessitate a national plan to

provide locally produced, quality software.

Mr Hemant Sonawala, vice-president of the CSI, said the convention was the first to have an interlinked electronic mail, an on-line query system and a special high-tech pavilion. Also, for the first time, the department of electronics announced an award for the best software package developed by an Indian Company.

India was negotiating with a big American company a proposal to export 100,000 computer systems to the U.S. this year and the systems would be supplied with specific software packages developed in India. Dr N. Seshagiri, additional secretary in the department of electronics, announced at the CSI convention.

Indian companies obtained orders worth Rs.20 crores to the US and Singapore in the last six months and the fact that the orders were for hardware indicated the potential for Indian hardware exports, Dr Seshagiri pointed out. Since IBM was getting out of the PC market as it developed new types, the older types of PC ranges were open for countries like India to exploit. Indian firms could supply both the hardware and software in this area.

The Indian government would support the fifth generation technology and R and D in a bid to catch up with the advanced countries. Consequently, emphasis would be laid on Artificial Intelligence and parallel processing systems, according to Mr K.P.P. Nambiar, secretary to the department of electronics.

Dr Nambiar said the government would set up a centre for advanced computing technology which would concentrate on new software and hardware procedures. Part of this effort could lead to the development of a supercomputer by India within three years. The supercomputer would initially work at 100 million floating point operations per second and would later be upgraded to one billion or giga operations per second. The department of electronics would also set up hardware design and testing centres in collaboration with major manufacturers like the ECIL, BEL, IIT, Keltron and Uptron.

## DEC in Delhi

Digital Equipment Corporation (DEC), one of the world's largest computer firms, has entered into a joint venture with the Indian firm, Hinditron Computers, to float a new company called Digital Equipment (India) Ltd. DEC will

make VAX-II range of supermini computers in India and this may help in avoiding the imports of the systems. DEC and Hinditron already share a software export facility at the Santacruz Electronics Export Processing Zone, Bombay and a similar facility will be set up in Bangalore.

The government has also approved a similar tie up between the Modi group and Italy's Olivetti.

Competition in the minicomputer markets will increase with the entry of DEC. Though IBM does not have any official tie up with India, Unisys has an Indian subsidiary called Tata Unisys; Wang Labs Inc. has a tie up with Digitron Computers; Hewlett Packard has links with Blue Star; Texas Instruments have joined with Zenith and Apple with Raba Contel Ltd.

## Control systems

Advani-Oerlikon Ltd. has signed a memorandum of understanding with two British companies, Oceantech Systems Ltd., and Vosper Thornycraft Controls for transfer of technology in electronic control systems.

The company will invest about Rs. 100 crores in the next five years in new areas of control systems for applications in offshore and on shore oil drilling projects and the Indian Navy's frigates and other vessels.

## ECIL Pact

While we talk of collaborations between Indian companies and international giants, for a change an Indian giant is having collaboration with another Indian firm. The state-owned Electronics Corporation of India has a tie up with the DCM Data Products. The coming together of a public sector and a private sector unit is significant.

DCM Data Products will market the Media series of mainframe computer systems, manufactured by ECIL, on a value-added basis. It will provide service and maintenance support besides some specific software.

## IBC Awards

The International Broadcasting Convention has invited nominations of candidates for its 1988 award. Together with a cheque for 3000 pound sterling, the award is given in recognition of a significant contribution over any period by a person or group of persons to all aspects of broadcasting technology and allied research, design, development, manufac-

# ELECTRONICS NEWS • ELECTRONICS N

ture, operational practice and management.

Nominations should be submitted by May 31, 1988 to IBC Award 1988, Institution of Electrical Engineers, Savoy Place, London WC2R 0BL, U.K. The award will be presented during the International Broadcasting Convention to be held in Brighton, from September 23 to 27, 1988.

## World semiconductor market to expand by 11%

A report from Benn Electronics, *Profile of the Worldwide Semiconductor Industry 1987-88*, forecasts that the industry is set to expand at a rate of 11% in 1988. This increase will take the total value of the market to \$36.6 billion, up from \$32.9 at constant 1986 values and exchange rates. Growth will be highest in the USA (14%), followed by Europe (11%), and Japan (7%). For Japan, the improvement represents a recovery from the performance in 1986 and 1987, when the market lost 5% of its value in real terms.

The report also highlights the fast-changing technological composition of the world market, with CMOS products expected to account for 44% of the IC sector value in 1991, compared with only 23.5% in 1986. In the discrete market, the changes are less dramatic, but Optoelectronics and Power devices are both expected to gain overall market share over the 1986-91 period.

**Benn Electronics Publications Ltd • Chiltern House • 146 Midland Road • Luton LU2 0BL • Telephone (0582) 421981.**

**World Semiconductor Market** (at constant 1986 values & exchange rates)

|            | 1986 | 1987 | 1988 | 1989 | 1990 | 1991 |
|------------|------|------|------|------|------|------|
| US\$ bn    | 30.7 | 32.9 | 36.6 | 38.6 | 42.1 | 47.4 |
| % increase | 1.2  | 7.1  | 11.2 | 5.5  | 9.1  | 12.8 |

Source: Benn Electronics Publications, Luton, UK

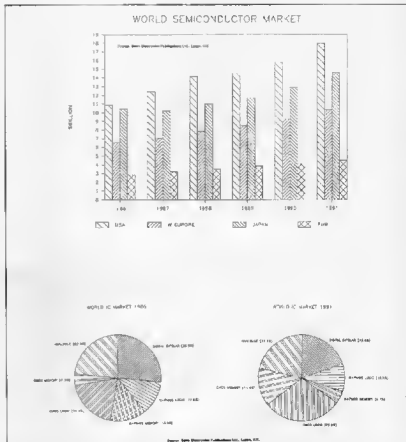

# TELECOMMUNICATION NEWS • TELECO

## An Exchange a day

The department of telecommunications is embarking on a programme of expanding its network in rural areas and the aim of this programme is to instal "one digital rural exchange a day". About Rs. 30 crores will be spent in 1988 for this mission.

Initially, the exchanges would be small ones with a capacity of 128 ports or roughly 80 lines each and all the equipment would be manufactured within the country. The average cost of putting up an exchange had been worked out to be Rs. 10,000 to Rs 15,000 per line. In 1988, 250 exchanges are expected to be installed in different parts of the country.

The location selected for setting up an exchange would have minimum population of 4000.

A 15-member committee has been set up by the Planning Commission to examine the ways in which different sectors could pool their resources allocated for development of telecommunication so that duplication of efforts can be removed

Mr Sam Pitroda, adviser to the Prime Minister, addressing members of the Confederation of Engineering Industry at Calcutta, opposed the scheme of mobile telephones or phones in cars as he felt that the efforts should be more on a national network. On parallel communication network for businessmen, Mr Pitroda said any such scheme should also serve the national interests. Import from different countries had resulted in lack of compatibility between various systems. While microprocessors and integrated circuits could be imported, the designs and software could be made in India, according to Mr Pitroda.

## Car Phones

The car phones project, opposed by many as a luxury and non-priority in the context, was shelved sometime ago but latest reports from abroad show that the project is not dead after all.

During his recent visit to Stockholm, the Prime Minister, Mr Rajiv Gandhi, showed interest in the activities of the Swedish telecommunication firm, Ericsson. Mr Gandhi dialled Mr D K. Sangal, telecommunication secretary in Delhi, using a mobile telephone manufactured by Ericsson from Stockholm. Two days after this episode, Financial Times, London, reported that Ericsson was close to winning a Rs. 100 million contract to supply a mobile phone system to India. The report said Ericsson, Motorola of the US and NEC of Japan have been short-listed to supply a mobile telephone system in Bombay for 5000 subscribers.

The city of Ericsson in mobile telephones may pave for others to come to "the expanding" Indian market. New Delhi has plans to set up mobile telephone systems in 14 major systems, it is learnt. Incidentally, the mobile telephone system may require re-writing of the existing software in digital electronic exchanges.

The changing perception on the advisability of car telephones has obviously raised many controversial points. More than commercial interests and the legitimate urge to become "modern" overnight, induction of sophisticated technology should be preceded by sane and sensible evaluation.

## Aword to TCIL

The Telecommunication Consultants India Ltd. has bagged the 1987 corporate

performance award given by "The Economic Times" and Harvard Business School Association of India.

Within 10 years, TCIL achieved overseas orders worth Rs. 350 crores, with its operations spreading across 22 countries of Asia and Africa. Recently, three developed countries in the field of telecommunication, the Netherlands, Sweden and the USA have sought the skills of TCIL in software development.

TCIL's recent achievement was in the area of satellite based communication network, engineered for the National Thermal Power Corporation.

A defence organisation has entrusted the TCIL with the job of establishing an integrated network for international communication services via a purpose designed satellite earth station.

## World Radio Conference

The world Administrative Radio Conference for Mobile Services which met in Geneva towards the end of 1987 took a number of decisions which could significantly affect key aspects of mobile satellite communications. The conference brought together about 800 delegates from 108 countries.

The most significant decision taken at the meet was regarding the Global Maritime Distress and Safety System. It specified that any equipment covered by the new chapter IX of the International Telecommunications Union Radio Regulations must be maintained on board ship by a qualified radio-electronic officer.

Existing regulatory provisions will continue to be followed until adequate measures have been taken to ensure safe communications.

While some nations objected to the unnecessary burden imposed on the maritime community, some others felt that perpetuation of outmoded systems could lead to inadequate safety standards.

Many countries like the US, UK, Canada, France, FRG, Norway, Liberia and Panama believe that the route to improved safety lies in the installation of modern equipment which can be operated as easily as a telex machine or a telephone. In the event of failure, the equipment has sufficient built-in diagnostic routes to help the ship personnel replace defective parts. This is the justification for doing away with certified radio officers on board.

The conference also made several mod-

ifications to L-band frequency allocation. While the maritime community will continue to have access to the entire 1530-1544 MHz band, the first three MHz 1530-1533 will be shared on a co-priority basis with land mobile services.

## Satellite Search:

The satellite aided distress alert detection and position locumun has emerged as a proven new earth bound application of satellite technology for humanitarian purposes.

In this system, a series of satellites in low, near-polar orbits listen to the distress signals and relay them to a network of dedicated ground stations. The ground station alerts the rescue coordination centre to rush to the site of emergency.

For providing distress alert transmission capability in the event of fire, explosion or sudden foundering of a vessel the float-free Emergency Position Indicating Radio Beacon is regarded as a key element in the future Global Maritime Distress and Safety System (GMDSS) by the International Maritime Organisation.

The first Indian ground station for receiving distress signals will be ready at Bangalore by 1989.

The agreement with various international parties for use has already been signed. The agreement envisages that the Bangalore local user terminal will receive 243 MHz signals as well as 121.5 and 406 MHz signals.

The search and rescue payloads will be incorporated on host satellites as well as on future Indian satellites. The first two of the second generation Indian National Satellite system, INSAT-IIA and IIB will carry 406 MHz payloads for detection of distress signals. The engineering model of this payload is under fabrication.

In 1986, Indian Space Research Organisation and the National Aeronautics and Space Administration of the USA concluded an agreement for cooperation in the development of 406 MHz geo-stationary search and rescue experience.

In August, 1987, the USSR expressed its interest in the establishment of a suitable terminal in the USSR to receive and process the 406 MHz distress signal relayed through INSAT-IIA and IIB.

Thus, a strong Indian inter-agency programme in satellite search and rescue programme is emerging.

# INDUSTRY STANDARD MOVING TO CHMOS

High CPU power and a very high level of integration have developed the Type 80186 and 80188 16-bit microprocessors into industry standards in the embedded control arena. Most systems in the automation and power engineering area, like CNC machines and robots, are based on the 80186/188 architecture.

by Bernhard Meier, Dipl. Inform. (FH)\*

INTEL's 80C186 is the newest member of the popular, high integrated 80186/188 microprocessor family. The chip provides full hardware and software compatibility with its NMOS predecessor 80186 and gives the design engineer additional opportunities via an integrated DRAM refresh unit, special power-saving logic and the new asynchronous numerics coprocessor (NPX) interface.

The 80C186 is manufactured with INTEL's CHMOS III process technology (the same process on which the 32-bit 80386 is based) and is specified for 10, 12.5, or 16 MHz operation.

## Two operating modes

The 80C186 supports two operating modes: *Compatible Mode* and *Enhanced Mode*. When running in *Compatible Mode*, the chip is fully hardware and software compatible with the NMOS 80186, with identical pin-out, timings, instruction set and driving levels on the I/O pins. Fig. 1 shows the block diagram of the new CHMOS component. It is seen that all 80186 peripheral functions are present:

- a clock generator
- two independent, high speed DMA channels
- one fully programmable interrupt controller
- three programmable 16-bit timer/counters
- user programmable memory and peripheral chip-select-logic
- a wait-state-generator
- and the local bus controller.

Enhanced Mode operation offers an even higher level of integration. Additional facilities are:

- the *DRAM refresh unit*. It is added to the bus interface unit of the 80C186 and automatically generates the refresh bus cycles for the system DRAM-banks. Additional costs and design effort for a separate refresh-controller now belong to history in 80C186-designs.
- *power-saving logic*. This unit is placed before the clock oscillator circuitry and provides the

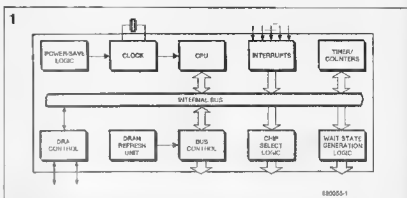

facility of internally dividing the clock frequency of the 80C186. Software determines the internal speed and power consumption of the total chip. Power savings of up to 94% can be achieved by this unique feature.

### • asynchronous numerics coprocessor interface

This asynchronous interface replaces the current synchronous 8087-interface, which is no longer supported on the 80C186. A 80287-type of numerics coprocessor can be interfaced without any TTL-glue in between. The current integrated bus controller (IBC) 82188 is no longer necessary either.

A detailed description of these new features will be given after the following brief overview of the 80186/80C186 internal architecture.

## 80186/80C186 Base Architecture

The 80C186 CPU provides full object code compatibility with the other members of the 8086-family (8086/186/286/386), but offers twice the 8086-CPU performance by virtue of a couple of architectural enhancements. The register- and base instruction set, as well as the segmented memory organisation, follows the 8086-standard. The chip offers (like its predecessor the 80186) up to 15 standard peripherals, thus reducing overall system cost dramatically. Fig. 2 shows the high level of integration in a

typical 80C186 based CPU-board, while additional hardware is only necessary for EPROM, RAM and special I/O functions, like disk-, winchester- or LAN-interfacing.

The on-chip DMA controller has two channels which can each be shared by multiple devices. At a speed of 12.5 Mbit each channel is capable of transferring data at up to 3.12 Mbytes per second. It offers the choice of byte and word transfers and can be programmed to perform a burst transfer of a block of data, transfer data per specified time interval, or transfer data per external request.

The on-chip interrupt controller responds to both external interrupts and interrupts requested by the on-chip peripherals such as the timers and the DMA channels. It can be configured to generate interrupt vector addresses internally like the INTEL microcontrollers or externally like the popular 8259A interrupt controller. In addition to that, it can also be configured as a slave controller to an external interrupt controller (RMX 86 mode) or as a master for one or two 8259As, which in turn may be masters for up to 8 more 8259As. When operating in this master mode, each channel can support up to 64 external interrupts giving a total of 128.

The three 16-bit timers are also integrated on the chip. Timer 0 and timer 1 can be programmed to be 16-bit counters able to count external events. If configured as timers, they can be started by software or by a specific external event.





## MEMORY PARTITION REGISTER



Bits 0-8 Reserved.  
Bits 9-15 M0-M4, are address bits A13-A19 of the 20-bit memory refresh address.

## CLOCK PRE-SCALER REGISTER



Bits 0-8 C0-C8, clock divider register. Holds the number of CLOCKOUT cycles between each refresh request.

Bits 9-15 Reserved

## ENABLE DRAM REGISTER



Bits 0-8 (T0-T8). These bits contain the refresh clock counter output.

Bits 9-14 Reserved

Bit 15 (E) Bit. Activation (E=1) and deactivation (E=0) of the DRAM refresh unit.

88005-3

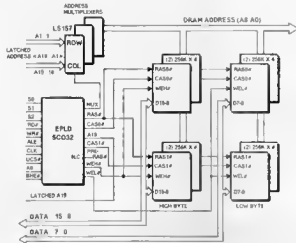

88005-4

are re-programmed when entering and leaving the power-saving mode. The power-saving mode is excited whenever an interrupt is processed or whenever the user clears the enable bit in the register PDCON.

### Asynchronous numerics coprocessor interface

The 80C186 is a general purpose 16-bit microprocessor, designed for a wide range of embedded control applications. Typically, these areas need fast, efficient data movement and a very short interrupt response time combined with a very high level of integration. Traditionally, the arithmetic on data values in these applications tended to be simple, so that the 80186/188 fulfilled these needs in a low-cost, effective manner.

However, more and more automation equipment requires extremely fast and

complex mathematical functions, which are not provided by the instruction set of a general purpose CPU. Such functions as square root, sine, cosine, and logarithms are not directly available in a general purpose processor like the 80C186. Software routines to get high speed numerics are too slow, so that special numeric coprocessors (NPX), like 8087/287/387 have been designed as a hardware extension to the corresponding CPUs.

For the NMOS 80186/188, numerics requirements can easily be fulfilled with the 8087 and the integrated bus controller (IBC) 82188. The 80C186 does not support this synchronous coprocessor interface in either Compatible Mode or Enhanced Mode. As a replacement, in Enhanced Mode the 80C186 has been equipped with an asynchronous numerics coprocessor interface, which is similar to the 80286/80287 interface and shows some advantage over a synchron-

ous one. For example, the clock frequency of the NPX is not limited by the CPU-clock rate. To get maximum floating point performance, the NPX clock frequency can be higher than the 80C186 system clock. Additionally, 80C186 DRAM refresh bus cycles can interrupt NPX-data transfers, for example during the NPX-commands FRSTOR and FSAVE. The new asynchronous interface also allows the full use of the 80C186 chip select, wait state generator and bus control logic for memory. The handshaking between the 80C186 and the NPX is accomplished with four dedicated pins: NPS#, ERROR#, PEREQ and BUSY#. To keep the 80C186 in the standard 68-pin form factor and yet accommodate these pins, it has been necessary to redefine three of the mid-range memory chip select lines according to the following table:

| Compatible Mode | Enhanced Mode |
|-----------------|---------------|
| MCS0#           | PEREQ         |
| MCS1#           | ERROR#        |
| MCS3#           | NPS#          |

The pin PEREQ means Processor Extension Request. This is used to signal to the CPU that numeric data transfers to and from the numerics processor have to be performed. The ERROR# pin is useful during ESCAPE instructions, where a low on this pin will vector to the INT 16 interrupt. Lastly, NPS# is the numerics coprocessor select line. For a 80C186-NPX CPU board design it is important not to use pins MCS0/1/3. An external decoder is recommended to replace their functions.

In addition to the four pins, four dedicated I/O port addresses are reserved for passing information between the 80C186 and the NPX:

| I/O address | Read definition | Write definition |
|-------------|-----------------|------------------|
| 00F8H       | status/control  | opcode           |
| 00FAH       | data            | DATA; CS:IP;     |
| 00FCH       | reserved        | DS:EA            |
| 00FEH       | opcode status   | reserved         |

Fig. 6 gives details of the asynchronous interface between the 80C186 and the numerics coprocessor (NPX). Note that there is no TTL-glue between the two chips. It should be mentioned at this point that the interface is not available with the 8-bit version 80C188.

### ONCE Mode and development tools

The 80C186 has an additional feature which allows the user to electrically isolate the device from the PC-board when it is soldered through hole or sur-

face mounted. This special test mode is called ONCE (ON Circuit Emulation) and provides an easy way of testing and inspecting devices that are fixed into a target system. During this mode, all 80C186 pins are placed in a high impedance state so that a board test can be accomplished without the need of removing the 80C186. The ONCE mode is selected by tying pins UCS# and LCS# low during RESET and is terminated by a normal RESET (UCS# and LCS# high).

The success of new board designs is more and more dependent on the availability of efficient hardware and software development tools. These tools are required to run on industry standard hosts. Because the 80C186 shows object code compatibility with the 8086 family, the current INTEL compilers, like C-86, FORTAN-86, PLM-86, PASCAL-86 and the standard 8086-Assembler, can be used. These software tools are available on a variety of hosts, including INTEL's MDS III/IV, INTEL's systems 310/320 and of course on the IBM PC XT/AT and its compatibles. For designs of up to 10 MHz in Compatible Mode, the 12ICE-186 is a comfortable hardware emulation vehicle also for the 80C186. To support new, true CMOS designs with the 80C186 and clock frequencies of up to 16 MHz, a new emulator, the ICE-186, has been developed. This new tool incorporates the 80C186 bond-out chip, which provides full access to all the new features of Enhanced Mode.

## Summary

The new features of the 80C186, the advantages of the CHMOS-process with speed selections of up to 16 MHz, and

5

Power-Save Control Register



Bit 0 - 1 Check-Division-Factor (1, A3 after 16).  
 Bits 2 - 14 Reserved.  
 Bit 15 Enable Power-Save-Mode.

88055-5

6

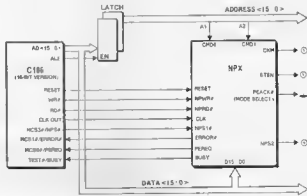

88055-4

the availability of powerful hard- and software development tools, make this new processor the ideal solution for many new embedded control applications. For current 80186-based products the 80C186 is a logical and efficient upgrade. All conditions are there for it to become the next embedded control microprocessor standard.

(2) 8088/8086/80188/80186 Hardware Reference Manual INTEL Corporation, 1986.

(3) 8088/8086/80188/80186 Programmers Ref. Manual INTEL Corporation, 1986.

\* Bernard Meier is with INTEL Semiconductor GmbH, Munich

## Literature:

(1) 80C186 Data Sheet, INTEL Corporation, 1987.

## microphone preamp

This preamp is specifically intended for use with low impedance microphones. Its advantages are high output level, large bandwidth and extremely low noise figure. The maximum gain of the preamp is approx 200. Depending upon the sensitivity of the microphone used the gain can be adjusted by altering the value of resistor R3 (for which a suitable typical value is around 2.2 k).

The low noise figure (virtually undetectable in the lab) is obtained by precise impedance-matching of the input. Optimal results are therefore obtained only with microphones of 500 to 600  $\Omega$  impedance. For 200  $\Omega$  microphones R4 should be reduced in value to 220  $\Omega$ , and C1 increased to 4 $\mu$ F.

Sound 'perfectionists may wish to use metal film resistors for R3. R6 and parallel-connected MKM capacitors in place of an electrolytic capacitor for C1. Further details with an input signal of 3.5 mVpp and maximum gain, an output signal of 800 mVpp was obtained. The maximum

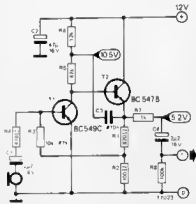

output level is approx 10 Vpp for an input of 50 mVpp. The frequency response was flat within 3 dB from 50 Hz. . . 100 kHz.

# VAM- video/audio modulator

colour  
pictures and  
sound from  
your personal  
computer

First of all, let us answer the question: What is a video modulator? This could be described as a kind of miniature TV transmitter which processes a video signal in such a way that it is suitable for application to the aerial input of a conventional TV set. It is an essential element in a TV games computer, for example, or a test pattern generator. It is also required by a Videotext decoder or TV terminal for a personal computer. Several video modulators have already been published in *Elektron*. However, the last design dates back to the October 1978 issue and is not suitable for colour applications. Moreover, it cannot be used for audio and the sound must be applied to a separate amplifier. This means that the sound section of the TV set remains silent, which is a pity. It is not an elegant solution from the technical point of view.

These various factors prompted the design of a new circuit which is suitable for modulating both video and sound. The circuit is of such universal design that it can be used for a wide number of applications.

## Design

The intention is for the user of the VAM to be able to convert the RGB signal generated by this hobby computer, test pattern generator or other source into a video signal of his choice. This was a basic requirement of the VAM in the development stage. The circuit was to be equipped with digital R(ed), G(reen), B(lue) inputs, a separate audio input, and a video output. After some reflection, the *Teletext Decoder* published in the November 1981 issue was

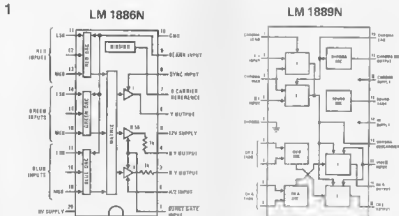

Figure 1. The two most important components for the VAM miniature colour TV transmitter: LM 1886N (video matrix) and D/A converter) and LM 1889N (video modulator).

62190 1

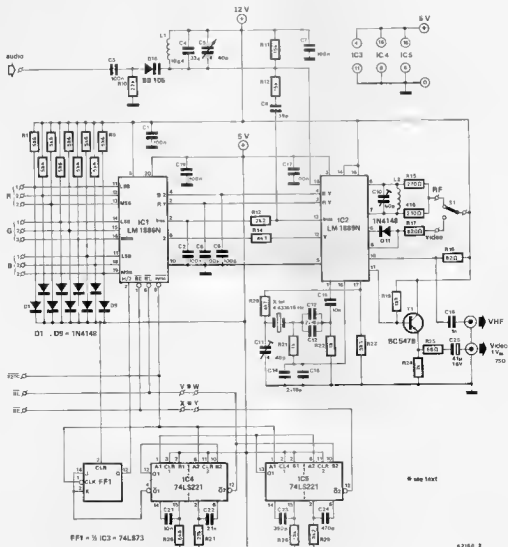

Figure 2. Circuit of the VAM — video/audio modulator. RGB and audio signals in, VHF or video signal out.

chosen as a suitable basis for our design. After minor modifications and a somewhat different arrangement, we achieved our objective — the VAM.

The circuit chiefly consists of two special ICs whose internal block diagram is shown in figure 1. The LM1889N is the heart of the circuit. This IC contains a complete colour modulator which is capable of 'composing' a colour video signal from a brightness (luminance) signal Y (at pin 13) and the R-Y and B-Y signals. The LM1889N also contains an oscillator for generating the sound carrier. This sound carrier is mixed with the video signal via pin 12.

The LM1886N integrated circuit serves as a converter. In addition to a matrix for generating the Y, R-Y and B-Y signals required by the LM1889N, this IC has inputs for colour modulation according to the PAL system. Three digital inputs are provided per colour (Red, Green and Blue), corresponding to 9-bit colour data; this is adequate for all possible applications.

#### The circuit

Figure 2 shows the combination of the two ICs into a 'miniature colour-TV power encoder'.

62/80 3

The different inputs can be seen on the left of the figure. The most important ones are the 9 RGB inputs, sync input and audio input. The VHF and video outputs are on the right of the figure. They can be optionally selected by means of S1. The LM 1886N and LM 1889N are designated here as IC1 and IC2 respectively and interconnected via lines B-Y, R-Y, bias and Y. ICs 3, 4 and 5 are needed to enable to obtain the burst-anable (burst) and H/2 (for the PAL switch) signals required for generating a PAL video signal. Additionally, a blanking pulse (BL) is generated with these ICs; this suppresses the picture information during vertical synchronisation.

However, the pulse is only required when no external BL signal is available. We shall examine this in more detail later.

The audio modulator in the upper part of figure 2 is a simple circuit. A resonant circuit (L1, C4, C5) at the intercarrier frequency (6 MHz) is frequency modulated by means of varicap diode D10. The audio signal serves as modulation signal. Since the circuit mentioned is a part of the oscillator contained in IC2, the sound is also modulated in this way. Input sensitivity of the audio modulator is approximately 1 V<sub>rms</sub>.

We shall now consider the signals in more detail.

### RGB

Three inputs are provided for each of the red, green and blue signals. Eight levels can therefore be realised per colour, resulting in a total of  $2^3 = 512$  different colour shades. The coding for the most common colours is listed in table 1.

For simple applications the three R, G and B inputs can be interconnected, so that only one input is available per colour. One pull-up resistor (R1, R4, R7) and one limiting diode (D1, D4, D7) is utilised per group of three in this case. The selection is thus restricted to six colours plus black and white. This may not appear to be much, but it is satisfactory in most cases, e.g. for microcomputers with digital RGB outputs.

Such microcomputers often supply an NTSC colour signal which is of little use in the UK and continental Europe. However, the VAM can be directly utilised as an 'adapter' between these computers and the

aerial or video input of a PAL colour television set. In these cases problems are sometimes encountered with the vertical synchronisation (60 Hz for NTSC). In general, however, the TV set can easily be readjusted.

One more comment: if the RGB inputs are driven by TTL, the pull-up resistors and limiting diodes can be omitted.

### Sync

The sync signal must be applied to the circuit without fail. For this reason it is also provided by every video signal source. Pulses (logic zero) which can be directly used as a sync signal are those with a width of about 4  $\mu$ s and a repetition frequency of 15625 Hz (64  $\mu$ s). Additionally, the pulse train must contain an interval of approximately 500  $\mu$ s (7.5 x 64  $\mu$ s, to be precise) every 20 ms for purposes of vertical synchronisation. During the interval, the synchronisation signals deliver a substitute signal which is inverted with respect to the original sync signal and which has twice the frequency. This doubled frequency is used in the VAM to suppress the burst pulse.

We shall examine the BE (burst enable) signal later. Incidentally, a combined (horizontal plus vertical) sync signal is not always available. In this case the horizontal (HS) and vertical (VS) components must be combined into a sync signal. Figure 3 shows a simple circuit: an AND gate (3a) or two tri-state buffers (3b) form the desired sync signal from the HS and VS.

### BL = blanking

The BL signal is not absolutely necessary. Its purpose is to suppress the input signals at the RGB inputs. In most cases this suppression already takes place in the computer or test pattern generator, thus making an external blanking signal superfluous. If necessary, the VAM can provide an external although 'primitive' rasterblanking signal. This will be discussed in the description of the BE signal.

When applying a BL signal, care should be taken to ensure that it is active during the logic zero periods.

3



Figure 3. If only one horizontal and a vertical sync signal are available, the two can be combined in this way.

## BE<sup>2</sup> burst enable

The sync signal is immediately followed by a short pulse (approximately 9 periods), to synchronise the TV set with the colour demodulator. The task of the BE signal is to establish the instant at which this pulse is emitted. To prevent the TV set from 'flipping out' during the raster-sync (vertical-sync) pulses, the BE signal is suppressed during this period.

On the one hand, the PAL flip-flop IC3 is prevented from reacting to the double sync-frequency by means of IC4 (Q1 - see figure 2); FF1 continues to follow the same rate. On the other hand, a blanking signal of approximately 600  $\mu$ s in duration is

generated as soon as IC4 signals this double frequency (when a new sync pulse appears within 40  $\mu$ s). This signal can serve for raster blanking via wire link V-W, instead of an external BL signal. However, this blanking signal is mainly required to suppress the BE pulse.

Here are two more points. Firstly, it should be noted that when the VAM is used as a monochrome modulator the oscillator connected to pins 1, 17 and 18 of IC2 becomes superfluous. In this case the BE signal is not required either, because it is normally employed to modulate the phase of this oscillator together with the RGB signals (converted to R-Y and B-Y). The second

**ATTENTION**

**PCBs  
& Set of COMPONENTS**

for projects are normally available with

**precious<sup>®</sup> ELECTRONICS CORPORATION**

52-C Proctor Road, Bombay-400 007 Phone: 367459/369478

## Parts list

### Resistors

R1...R9 = 5k $\Omega$   
R10 = 22 k  
R11, R12 = 15 k  
R13 = 2k $\Omega$   
R14, R20 = 4k7  
R15, R16 = 270  $\Omega$   
R17 = 820  $\Omega$   
R18 = 82  $\Omega$   
R19 = 1k $\Omega$   
R21, R23, R24 = 1 k  
R22 = 3k3  
R25 = 68  $\Omega$   
R26 = 6k8  
R27 = 27 k  
R28 = 18 k  
R29 = 8k2

### Capacitors

C1...C3, C7, C17, C19 = 100 n  
C4 = 33 p  
C5, C11 = 4 40 p trimmer  
C6 = 39 p  
C8, C9 = 100 p  
C10 = 10...60 p trimmer  
C12...C15 = 18 p  
C16, C21 = 10 n  
C18 = 1 n  
C20 = 47  $\mu$  16 V  
C22 = 27 n  
C23 = 390 p  
C24 = 470 p

### Semiconductors

D1...D9, D11 = 1N4148  
D10 = BB 105 (vertical diode)  
T1 = BC 547B  
IC1 = LM 1886 N (National Semiconductor)  
IC2 = LM 1889 N (National Semiconductor)  
IC3 = 74LS73  
IC4, IC6 = 74LS221

### Miscellaneous

L1 = 10  $\mu$ H  
L2 = 6 turns enamelled copper (0.8 mm  $\phi$ ) on 8 mm former  
S1 = changeover switch  
Xtal = 4,433619 MHz crystal

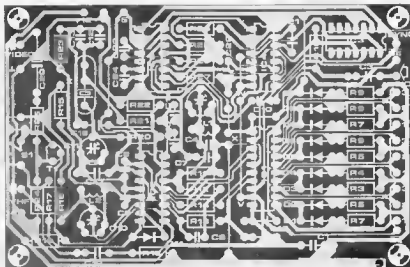

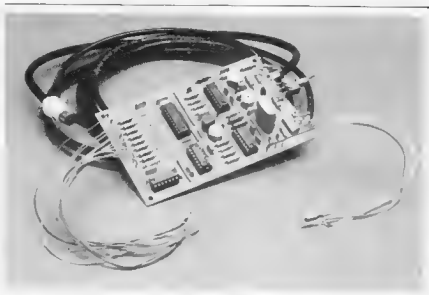

point, which may seem obvious, is that the BE signal can also be applied externally. In this case, X-Y remains open circuit.

### Practice

Construction of the VAM should present no problems using the printed circuit board shown in figure 4. All inputs are arranged at one edge of the p.c.b. Located at the other edge are the VHF and video outputs and the terminals for switch S1, which is used to select one of the two outputs. The supply voltage terminals are at one of the longer edges of the p.c.b.

Two different supply voltages are required: +12 V and +5 V. The 12 V rail must be capable of supplying approximately 60 mA and the 5 V rail approximately 10 mA. Since no other special demands are made on the power supply for the VAM, it is possible to use the teletext power supply from the February 1982 issue, for example.

When fitting the components to the p.c.b. it should be noted that a total of six wire links must be installed. Two of these wire links are alternatives: if an external BE signal is applied, wire link V-W is omitted. If an external BE signal is applied, link X-Y is omitted.

### Alignment

Alignment is fairly simple. It is merely necessary to adjust three trimmer capacitors, C5, C10 and C11. The oscillator circuit of the audio modulator is tuned to precisely 6 MHz by means of C5. This is easier than one might think. In practice the trimmer is set to minimum audible noise and maximum level.

C11 is used for fine adjustment of the colour carrier frequency. The range of adjustment is relatively narrow, because this is a crystal-controlled frequency. The colour TV set will display a good picture within a particular capacitance range of C11. The trimmer should therefore be set to the midpoint of this range.

|               |         | INPUT CODE |     |       |     |      |   |
|---------------|---------|------------|-----|-------|-----|------|---|
|               |         | RED        |     | GREEN |     | BLUE |   |
| Colour        |         | M          | L   | M     | L   | M    | L |
| Black         |         | 000        | 000 | 000   | 000 |      |   |
| Dark Grey     |         | 010        | 010 | 010   | 010 |      |   |
| Light Grey    |         | 101        | 101 | 101   | 101 |      |   |
| White         |         | 111        | 111 | 111   | 111 |      |   |
| Primary       | Red     | 111        | 000 | 000   |     |      |   |
|               | Green   | 000        | 111 | 000   |     |      |   |
|               | Blue    | 000        | 000 | 111   |     |      |   |
| Complementary | Cyan    | 000        | 111 | 111   |     |      |   |
|               | Magenta | 111        | 000 | 111   |     |      |   |
|               | Yellow  | 111        | 111 | 000   |     |      |   |
|               | Brown   | 011        | 011 | 000   |     |      |   |
|               | Orange  | 111        | 100 | 000   |     |      |   |
| Flesh tone    |         | 111        | 110 | 101   |     |      |   |
| Pink          |         | 111        | 110 | 110   |     |      |   |
| Sky Blue      |         | 101        | 101 | 111   |     |      |   |

This compact unit converts digital colour and tone signals to a clean 'composita video' signal. If desired, a UHF modulator can be added, so that the signal can be applied to an aerial input.

Table 1. Coding for the most common colours.

Last but not least, C10. The main purpose of this trimmer is to allow adjustment of the VHF output frequency. If switch S1 is set to the 'RF' position, the output signal can be tuned to VHF channels 2, 3 and 4. Fine adjustment can be made using the appropriate potentiometer in the TV set. Readers fortunate enough to have a TV set with a video input should connect it to the corresponding output of the VAM. Picture quality will probably be somewhat better.



# FLAT AERIAL FOR SATELLITE TV RECEPTION

Matsushita Electric Works (MEW) have recently introduced a flat, easy-to-install, 12 GHz aerial developed by Comsat Corporation. The new product is available in seven versions. Simple to install, unobtrusive, and complete with a low-noise down converter, the flat aerial is an attractive alternative to the conventional parabolic or off-set dish.

The flat aerial for satellite TV reception was developed by Comsat Corporation, known worldwide as one of the technical consultants of Intelsat and Inmarsat as regards microwave technology. Comsat's research and development laboratories recently succeeded in designing a 12 GHz aerial which forms a radical departure from the parabolic concept used for dishes of diameter between 50 cm and 1 m. The signals to be beamed down by the direct broadcasting satellites (TV-SAT), TDF-1, Olympus, Tele-X, and others, are strong enough to be picked up by relatively small—and,

therefore, easy to install—aerials, in combination with a low-noise block down converter (LNB or LNC). But even a so-called off-set dish of, say, 60 cm diameter may be difficult to install in built up areas. In many cases, a building permit is required before the aerial may be fitted onto the roof. Another important point is the total depth of the dish aerial including the pointing system at the rear, and the the LNB mounting system in front. Compared to a depth of 30 cm or so for a modern dish of the off-set type, the aerial introduced by MEW is truly flat at only 20 mm.

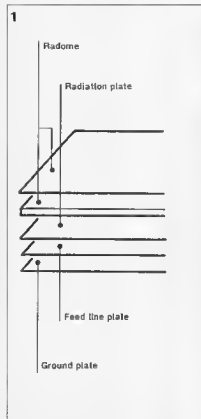

Fig. 1. The flat aerial is a multi-layer structure developed by Comsat Corporation.

|                              |  | R: Right-Hand Circular Polarization<br>L: Left-Hand Circular Polarization<br>D: Dual Polarization |                  |                        |  |
|------------------------------|--|---|------------------|------------------------|--|
| Tentative Performance        |  |   |                  |                        |  |
| MODEL NO.                    | PA33-R<br>PA33-L   | PA36 R<br>PA36-L  | PA66-R<br>PA66-L | PA66-D                 |  |
| FREQUENCY RANGE              | 11.7 - 12.5 GHz (Europe)<br>12.2 - 12.7 GHz (USA)<br>11.7 - 12.0 GHz (Japan)   |   |                  |                        |  |
| ANTENNA GAIN                 | 31.0dB   | 33.5dB  | 36.0dB           | 33.0dB<br>Both R and L |  |
| POLARIZATION                 | R or L (Right-hand Circular Pol or Left hand Circular Pol)                     |   |                  |                        |  |
| CROSS POLAR-CHARACTERISTIC   | 25 dB Frequency band dependent   |   |                  |                        |  |
| BEAM SQUINT ANGLE            | 0° or 12°  |   |                  |                        |  |
| IF-OUTPUT FREQUENCY          | 0.96 - 1.75 GHz (Europe)<br>0.96 - 1.45 GHz (USA)<br>1.022 - 1.322 GHz (Japan) |   |                  |                        |  |
| LNB CONVERSION GAIN          | 55 dB (Europe)<br>56 dB (USA)<br>48 dB (Japan)                                 |   |                  |                        |  |
| NOISE FIGURE                 | 2.3 dB   |   |                  |                        |  |
| IF-OUTPUT CONNECTOR          | F type connector   |   |                  |                        |  |
| SUPPLY VOLTAGE CURRENT DRAIN | 15 - 24 VDC <150 mA  |   |                  | 15 - 24 VDC<br><200 mA |  |
| SIZE (PANEL ONLY)            | 354 × 20mm   | 385 × 720 × 20mm  | 720 × 720 × 20mm | 720 × 720 × 20mm       |  |
| WEIGHT (PANEL ONLY)          | abt 1.3kg  | abt 5kg   | abt 9kg          | abt 9kg                |  |
| OPERATING TEMPERATURE        | -30° ~ 60°C  |   |                  |                        |  |
| WIND LOADING                 | 50m/sec  |   |                  |                        |  |

## Multi-layer structure captures received power

The operation of a dish aerial is based on reflection of the received microwave power to the focus, i.e., the feed horn or LNB input. This is in contrast to the flat aerial, which receives power direct on a multi-layer laminated structure as shown in Fig. 1. Power loss is minimized by virtue of the stacking system of radome, radiation plate, feed line plate and ground plate. The multi-layer laminated structure developed by Comsat is claimed to yield high efficiency (60–70%), and sufficient gain for DBS reception over a wide frequency band.

The flat aerial is much easier to point at the satellite than the dish. This is because of the greater half power beamwidth, which is typically 6–8° in the azimuth plane. With the exception of the "top of the range" model, the Type PA66-D, the flat aerials receive either right-hand or left-hand circularly polarized signals in the DBS band.

The accompanying table shows the main technical characteristics of the available models. Note the use of the standardized LNB intermediate frequency (IF) of 950–1750 MHz, which ensures ready connection to most types of indoor unit

via an F connector and a download cable that carries the RF signal and the supply voltage for the LNB. The noise figure and LNB conversion gain are also fairly standard at 2.3 dB and 55 dB, respectively.

The ease of use, and a number of installation options, of the new aerials is illustrated in Fig. 2. The smallest type has a size of 35×35 cm and weighs only 1.3 kg; it is, therefore, ideal for semi-portable applications.

The flat aerial from MEW is among the most important of new components introduced in support of individual reception of TV satellites. It is a rugged, easy to handle component that can even be mounted behind glass surfaces for experiments in the reception of audio programmes transmitted in narrow bandwidth pulse code modulation (PCM).

Matsushita Electric Works Limited  
International Trade Development Division  
1048 Kadoma-Shi • Osaka 571 • Japan  
Telephone: 06-906-1823  
Telex: 529-3319 MEW J  
Fax: 06-909-7053



2

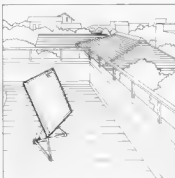

- Simple mounting for roofs or gardens

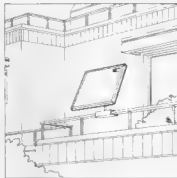

- For verandas

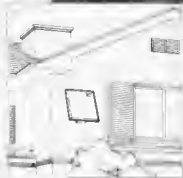

- On walls

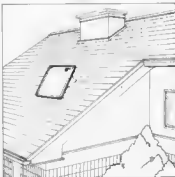

- On roofs

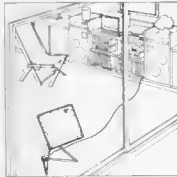

- For PCM music broadcasts

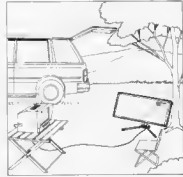

- Leisure

Fig. 2. Various applications of the new flat aerial for DBS reception.



# GENEVA CALLING: ISDN AND SATELLITES AT TELECOM 87

A brief look at some of the new technical concepts introduced at Telecom 87, the world's largest and most comprehensive telecommunications exhibition held in Geneva last October.

The main technical topic at Telecom 87 was *integrated services digital networking*, ISDN. The underlying principle of this far-reaching technical concept is the total integration of all electronic communication equipment in a network that allows continuous data transfer in all directions, at the highest possible speed. Ideally, wait times are eradicated, and every communication unit, whether this is an electronic typewriter, a telex, a grade-4 facsimile machine, or a voice synthesizer in a telephone exchange, can communicate direct to every other unit in the network. Communication is, therefore, interactive at all levels. An ISDN structure can only handle digital data, so that all types of analogue messages, including voice, require digitizing.

ISDN supports a multitude of communication services: telephone, videophone, telex, fax, videotext, slow-scan television, local area networks (LANs), videoconferencing systems, data terminals, personal computers, telephone exchanges, printers, payphones, and many more.

It is all very well for communication units to be part of an efficiently operating network, but can we connect two or more ISDNs to form an even larger network? In other words, can we connect an ISDN to the outside world? Satellites and fibre optic cables provide the answer. Digital signals in ISDN channels travel at 64 kbit/s, and processor-controlled central units (*concentrators*) regulate the multitude of data streams in accordance with the capacity of the lines in the system. Obviously, the higher the bandwidth of the channels, the more traffic can be carried at a relatively high bit-rate. The increasing use of fibre-optic technology is certain to bring the transmission of moving pictures in ISDNs within reach in the not too distant future. An important aspect of ISDN is that the routing and buffering of data in the system are completely invisible. This means that the user of, say, a personal micro can send out a data file to another computer user in the office building without having to wait for access if the "receiver" is engaged in other work: the data is automatically buffered and kept stored until the receiver is ready to accept them. Data from the ISDN in an office may be

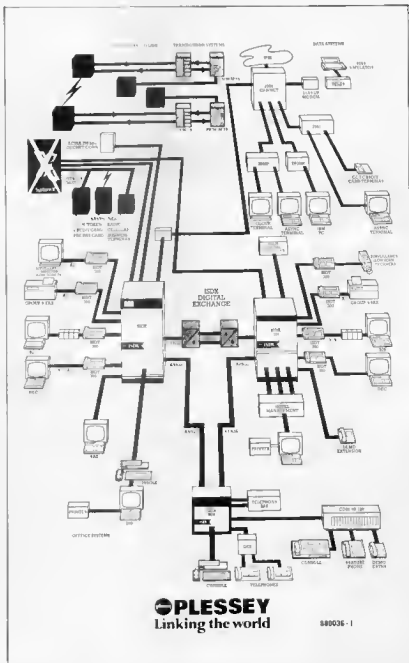

**PLESSEY**  
Linking the world

880036-1

Example of an integrated digital systems network (ISDN). Data flow is regulated and optimized by processor-controlled exchanges, which are completely invisible to the users of communication equipment connected (courtesy Plessey/GEC).

fed to a satellite uplink unit. It is then digitally transmitted to a geostationary transponder, which amplifies the signal, and beams it down to the receiving station, which may be thousands of miles away from the sending office. Both offices are equipped with transmit and receive equipment for access to a particular satellite, or even a network of satellites, so that high quality full-duplex communication channels are continuously available.

On the aerial grounds outside Telecom 87, a number of companies demonstrated new, transportable, satellite uplink equipment in various power ratings, geared to connection to an ISDN. Dish sizes varied from about 1.5 m to 10 m and more.

Companies actively engaged in building ISDN equipment include NEC, Siemens, Hewlett Packard, the Northern Telecom consortium, Philips/AT&T (Sopho-S system), IBM and Olivetti.

## ISDN in practice: System X

Plessey and GEC-Marconi are currently regarded as the leaders in the development of ISDN systems to CCITT standards. Their joint product is called System X. Although System X equipment has been in use for a number of years in British Telecom's main trunk exchanges, recent improvements as regards the achievable speed on the internal and external data links have aroused the interest of many national PTTs planning and building new data and voice communication networks. Recently, the data transfer rate of System X has been upgraded from 80 to 144 kbit/s, with full compatibility between old and new systems guaranteed.

At Telecom 87, Plessey/GEC demonstrated the versatility of the latest version of an ISDN compatible trunk exchange. The system installed on the stand was in

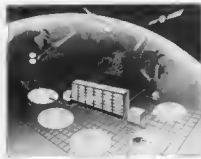

System X live at Telecom 87: London literally transferred to Geneva. With the co-operation of British Telecom, the Geneva based System X exchange from GEC/Plessey operates as an integral part of the UK telephone network. Two other companies exhibiting at Telecom 87, Comsat and STC, had access to the "London" exchange and its ISDN services (courtesy Plessey/GEC).

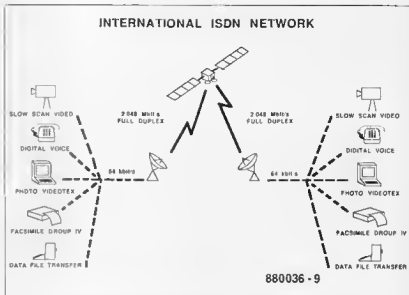

Example of communication equipment installed in 2 offices, and connected to an ISDN network with an uplink/downlink interface. A geostationary satellite puts the offices in contact with each other.

continuous operation, functioning as part of a telephone exchange situated in London. Two-way satellite links between Geneva and London had been set up for the occasion of Telecom 87 to show that part of the traffic carried by a main London telephone exchange could be transferred to the system installed on the System X stand. In fact, the public was invited to contact London extensions direct from the stand, without having to prefix calls with STD code 01. The ISDN exchange occupied relatively little floor space, yet carried fax, telex, slow-scan, computer, LAN, voice and videophone services for 5 companies simultaneously.

An interesting technical novelty developed specifically for use in ISDN systems is *dynamic line inductance balancing*. A computer simulation on the System X stand showed how an intelligent test and control system runs a fast and invisible check on the electrical characteristics of the telephone line. This takes place within a second or so after the line has been selected, and provides the basic settings for the active fork circuit that terminates the line at the ISDN side. The combined termination and source inductance of the fork is continuously adjusted to achieve optimum suppression of noise, pulse ringing, and line echoes. These are often troublesome effects in data transmission, causing distortion and, of course, a reduced bit rate (data speed). In short, the active fork circuit makes the best of every line, irrespective of the length, or the equipment connected to it. As such, it offers new ways to use existing telephone lines for high-speed modems.



The new ISDN compatible videophone from Philips Communication Industries.

The operator console coupled to an ISDN compatible exchange is a radical departure from the well-known "switchboard". The bulk of the work is now carried out automatically by a computer. A high-resolution screen gives an overview of all current and pending connections between internal and external extensions. Internal extensions do not have numbers, but easy to memorize letter codes, which are all displayed on the screen, complete with extension status information. Extensions can be called up with a single command from the keyboard. Automatic redialling, call diversion, automatic reminders, priority level assignment, interrupting calls, group extension calling, conferencing arrangements, extension scans to locate called up persons, and fully automated dialling of emergency services are among the many features of the new operator console, which records the day's activities on a printer. The speed at which the system works is unbeatable by even the most experienced and efficient of exchange operators.

# TEST + MEASUREMENT

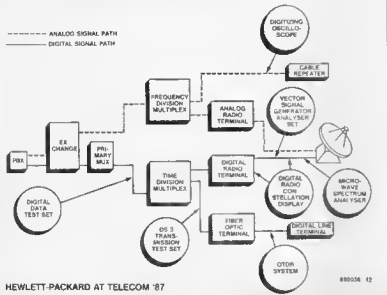

Hewlett Packard proposes to use ISDN structures for fast data throughput in complex automated test and measurement systems.

Large transparent panels allowed a glance at some of the latest electronics technology fitted into racks that together form the digital and voice compatible System X ISDN exchange. Plessey/GEC have relied mostly on their own expertise as regards the use of high density multi-layer PCBs, VLSI chips, SMA components, 8 Mbyte memory boards, multi-tasking processor systems, and fibre optic connections between modules, instead of complex and costly bus structures. The System X exchange is completely modular, and can be tailored

and programmed to customer requirements: it is, for example, possible to select a synthesized, male or female, voice, which upon request advises cost and duration of the call. Field technicians can also make use of the synthesized—but remarkably real—voice to obtain technical information on the line or exchange section brought into service. An array of lead-acid batteries provides the memory back-up function, enabling the complete exchange to be brought into service again within 2 minutes after a mains failure.

One of the most interesting demonstrations of the capabilities of ISDN was the full-duplex slow-scan link with one camera installed on the Plessey/GEC stand, and the other in an office in Manchester. A high-speed fax message was sent to this office via the System X exchange, and an office employee could be seen to collect it from his fax receiver. For reasons unknown, a demonstration of data file transfer to a UK-based bulletin board via the ISDN exchange was less successful.

## Satellites: competition and co-operation

Much excitement, optimism and good cheer at the stands of Eutelsat, Aero-Spafale, EuroSatellite, ArianeSpace, and many other companies and institutions involved in the building, launch, and operation of the first European direct broadcasting satellite (DBS), TV SAT-1. At long last, and after much negative publicity caused by the Columbia disaster and the launch failures of 2 communication satellites, ArianeSpace was hopeful again: the countdown for TV SAT-1 was the topic of the day. Mr



The Siornophone 6000 multilingual radio-telephone can prompt and instruct the user in 10 different languages.

|  | EUTELSAT I-F1 | EUTELSAT I-F2 and following | EUTELSAT II                                |
|--|---------------|-----------------------------|--|
| Stabilization                              | 3 axis        | 3 axis                      | 3 axis                                     |
| Mass at launch                             | 1 045 kg      | 1 160 kg                    | 1 700 kg ( 7 years)<br>1 800 kg (10 years) |
| Mass in orbit (1)                          | 510 kg        | 550 kg                      | 866 kg                                     |
| Span (with solar panel deployed)           | 13.80 m       | 13.80 m                     | 22 40 m                                    |
| Electrical power (1)                       | 900 W         | 900 W                       | 3 000 W                                    |
| Lifetime                                   | 7 years       | 7 years                     | 7 to 10 years                              |
| Frequency bands                            | 14/11 GHz     | 14/11 and 14/12 GHz         | 14/11 and 14/12 GHz                        |
| Number of transponders                     | 12            | 14                          | 16   |
| Number of transponder for simultaneous use | 10 (2)        | 10                          | 16   |
| Transmit power of each transponder         | 20 W          | 20 W                        | 50 W                                       |
| Antennas:                                  |               |                             |  |
| - receive/transmit                         | —             | 1                           | 1  |
| - receive only                             | 2 (3)         | 1                           | —  |
| - transmit only                            | 4             | 4                           | 1  |

(1) at end of life - (2) 6 only in eclipse - (3) one antenna as a back-up for the other

880036 - T

Comparison of the technical features of future Eutelsat Series-2 satellites to the "good old" Series 1 spacecraft Eutelsat I F1 (ECS-1) and Eutelsat I F2 (ECS-2). Not shown in the table is the recently launched Eutelsat I F4 (ECS-4; OP = 10° E), which is also a Series 1 type. ECS-3 was lost in an unsuccessful launch (courtesy Eutelsat).

Jean-Pierre Baudry of EuroSatellite received telex straight from the ESA launch site at Kourou, French Guyana, and faithfully added a tick to a long list of check items related to the preparations for the launch of the Ariane 2 rocket to carry TV SAT-1 into geostationary orbit. Now, almost 4 months after Telecom 87, it has evolved that the launch was successful, but that TV SAT-1 is unlikely to be taken into service as scheduled owing to technical difficulties with telemetry equipment and one of the solar panels. This was the last thing the German electronics industry had expected: a successful launch, but a defective satellite.

How does the American satellite industry regard the European efforts at putting high power TV satellites in orbit? Mrs Walda W Roseman, chief press officer of Intelsat, argued that the combined power of the European satellite industry is not, or not yet, a serious competitor to her company, simply because "the technology lacks the experience". She then went on to show the huge technical potential and the good financial results achieved by Intelsat, an international consortium renowned for its experience in operating tens of geostationary satellites for data communications and TV services. The 4-channel German and French DB services, TV SAT and TDF, are so heavily sponsored by the respective governments as to be economically unviable; in other words, they can not be, nor become, profitable simply because they have no channels available for leasing to commercial TV

stations. In this context, it is interesting to note that SES of Luxembourg have signed a contract with RCA for the construction of Astira, a 16-channel medium power satellite to be launched later this year.

Meanwhile, Eutelsat has started a program for the construction and launch of their Series-2 satellites in the early 1990s. These satellites will be considerably improved with respect to the current types in Series-1 (ECS-1, ECS-2, and, recently, ECS-4). Transmit power will be 50 W per transponder instead of 20 W. Again, it is interesting to note that Eutelsat has no intention whatsoever of building satellites with the power rating of the "heavy-weights" TV SAT, TDF or Olympus. Mr Michel Chabrol, operational planning engineer of Eutelsat, said that 50 W would be adequate, even for direct (individual) reception, considering the recent technical advances achieved in satellite receiver technology. Indeed, lowering the receiver's noise figure by about 0.5 dB is easier, and certainly less costly, than increasing the satellite transmit power by, say, 100 W.



Telecommunications has developed spectacularly since Alexander Graham Bell's invention of the telephone in 1876 (courtesy ITU).



Fuba's off-set parabolic dish aerial Type OAP120 for satellite TV reception (Fuba press photograph).

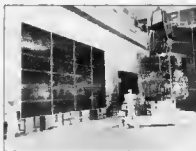

Better luck than TV SAT-1, we hope: engineers working on the French national DB satellite, TDF-1 (courtesy Aerospatiale).

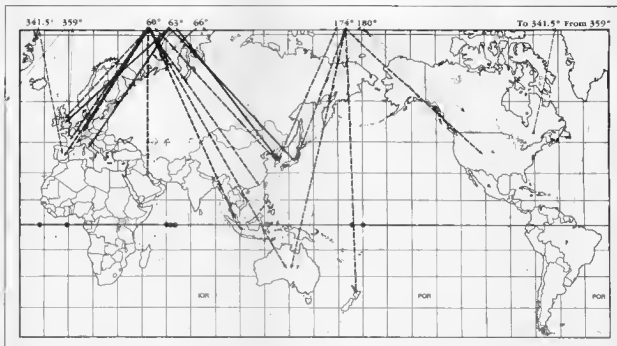

Proposed network of Intelsat geosynchronous satellites for coverage of this year's Summer Olympic Games in Seoul, Korea (courtesy Intelsat).

## D2-MAC: already a skeleton in the cupboard?

Not a single West-German company on Telecom 87 was able to show a working, D2-MAC compatible, satellite TV receiver for the consumer market. This was simply because IFF Semiconductors of Freiburg did not have the key component ready in time. Embarrassed press officers and engineers on the stands of Fuba, Hirschmann and Bosch had to admit that receive systems for TV SAT-1 were still incomplete without the Type DMA2270 transcoder chip.

Whether or not D2-MAC will succeed in becoming the new European TV standard, the professional world is ready for it: Matra Communication of France and Fuba of West Germany showed working prototypes of D2-MAC to PA1 /SFCAM transcoders. These systems are only intended for cable head-end stations, however, and come as a number of racks fitted in a 19 inch enclosure.

Plessey and Philips are also reported to have commenced a joint programme for the development of a MAC transcoder chip, but details of this were not known at Telecom 87.

The Japanese industry has simply skipped everything to do with MAC transcoders, and have come up with the far more powerful MUSE transmission standard, which is briefly discussed further on in this article.

## Inmarsat

The International Maritime Organisation (Inmarsat) had built an impressive and colourful stand. Inmarsat is totally dedicated to operating a network of geostationary satellites that carry data and voice communication between ships, shore stations, and, shortly, aeroplanes. The main topic was Inmarsat's new initiative to extend their services with land-mobile and aeronautical communication systems. In the not too distant future,



Motorcycle top box with Storno's "Silent Messenger" radio installed in a shock absorbent enclosure.

airlines will be able to offer passengers world-wide telephone and data transmission facilities. Before long, the businessman on board an aeroplane will be seen sending reports prepared on his lap-top computer to the head-office.

Inmarsat currently operates communication capacity on 9 satellites in geostationary orbit around the world. These are the Marecs A and B2 satellites, three MariSat spacecraft, and transponders leased on four Intelsat series-5 satellites. Inmarsat expects to satisfy the ever increasing demand for more communication capacity at higher speed by means of three Inmarsat-2 satellites currently being constructed by an international consortium headed by British Aerospace. Inmarsat will own, rather than lease, these new satellites.

STC, one of the companies that supply Inmarsat approved communications equipment for use on ships, demonstrated a new mechanically steered dish aerial that uses an electronic gyroscope to keep itself pointed at the satellite with an accuracy of tenths of a degree.

## Oriental power

Twenty-six Japanese organizations and telecommunications manufacturers participated in Telecom 87. Their collective stand was the third largest on the exhibition, following the United States and France. Japan Radio, Hitachi, Fujitsu, NEC, Sony, Panasonic, Matsushita, NHK (The Japanese broadcasting corporation), Canon, Ricoh, OKI and KDD made their presence as the most important companies.

One of the most interesting technical novelties on display was the HDTV (high definition television) equipment developed by NHK. This TV standard is based on 1,125 lines and a horizontal-to-vertical picture aspect ratio of 9:16, and is expected to revolutionize TV watching. Colour pictures of unparalleled brightness and resolution are displayed on 32 or 40 inch monitors, and the accompanying sound is to CD standards.

Since the Hi-vision picture contains about 5 times the information of a conventional PAL picture, NHK set out to develop the MUSE transmission system for use on satellites. MUSE means Multiple Sub Nyquist Sampling Encoding. Studio equipment has been developed to compress the HDTV bandwidth of more than 20 MHz to about 8 MHz, the standard uplink baseband, without reducing picture quality. NHK have already conducted many experiments in broadcasting Hi-Vision signals via the Japanese satellite BS-2B. The aim of NHK is to increase the number of lines in the TV raster to 2,200, while 3-dimensional television is also being studied. A HDTV video cassette recorder is already available, and was demonstrated successfully.

Further interesting new items on the Japanese stand were Ricoh's and Canon's fast, ISDN compatible G4 facsimile machines. The Canon fax Type 14003 is complete with a desk-top publishing system, a vertical A4 monitor, and a medium-resolution laser printer. At the speed of 64 kbits/s, the machine transmits a document in just 3 seconds. Who needs telex any longer? Hitachi presented its new HMAP-D system, which is a complete workstation for the design, storage and retrieval of map information. The system was demonstrated live on Telecom, using a satellite link to receive information from a central storage computer in Tokyo. Real estate listings and detailed maps complete with street names and traffic information were available almost instantly on a 58-inch high resolution colour display, and a colour printer. Colour coding, magnifying, reducing or scrolling of maps are among the many technical features of this powerful system.

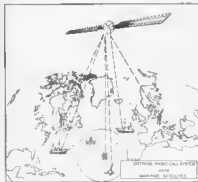

Geostationary satellites operated by Inmarsat can play an important role in the forming of a worldwide distress calling system for ships (courtesy DFVIR).

## IIIrd WORLD BOOK AND AUDIOVISUAL FAIR ON TELECOMMUNICATIONS AND ELECTRONICS

21-26 JUNE 20-22 OCT 1987

DIPLOMA

in recognition of the efforts of

Elektor Electronics

by RICHARD J. BUTLER

No way can the telecommunications industry go round informative books and magazines on the subject!

# OPTIC FIBRE COMMUNICATION

The development of the self-supporting aerial fibre optic cables *Fibrespan* and *Translite* has opened up enormous possibilities for improving and expanding communications systems at considerably less cost and effort by relying on existing electrical grid and railway networks.

by Bill Presdee, BSc, CEng, MIEE

The technology of fibre optics generally has been making rapid inroads into various areas of control and communications, replacing or supplementing traditional metal conductors and other methods.

In the aircraft industry when hydraulic and mechanical linkages were replaced by electric control cables, the technology was hailed as "fly-by-wire". With the introduction of fibre optic cables into aircraft, the term "fly-by-light" was coined. One can only wonder how earth-bound aerial optical fibre cables will be described.

The laying of subterranean trunk communication cables is an expensive undertaking and that of optical fibre cables is no exception. Despite their relatively low weight and ease of handling, they still have to be laid in ducting or other protective materials. The routing of the cables and the construction work, with all the related problems, constitutes a difficult and time-consuming task.

## Ready-made distribution network

However, in most countries, there are existing distribution systems with the potential for enhancement to provide comprehensive trunk communications at considerably less cost and effort. These are the electrical grid and railway networks which have established routes and carry their electrical power or signalling circuits, for the most part, via poles or pylons.

These systems naturally serve the major centres of population and industry, and embrace the secondary ones. Communications planners have, no doubt, considered for some time the possibility of using metallic cables on the electric pylons across the countryside, but the strong electromagnetic fields associated with high voltages have precluded their effective use as communications carriers.

When, in recent years, the development of lasers and fibre optic cables provided communication by light circuits unaffected by magnetic fields, a reappraisal of routing them together with electrical distribution became inevitable. However, the design of a self-supporting cable suitable for long spans and capable of withstanding a wide range of climatic conditions presented problems.

The first method to meet these requirements sought to use the electrical conductors as a bearer for the fibre optic communications. A composite cable was developed where the earth wire contained a core of fibre optics and, later, another type in which they were wrapped around the conductor.

But the dependence of the communications on the electrics was a hindrance. To maintain the fibre optics, an electrical circuit had to be de-energized and to restrung electrical conductors, the communications link had to be broken. These restrictions led Standard Telephone and Cables (STC) to develop *Fibrespan* as a self-supporting aerial fibre optic cable which could be strung between pylons, operated and maintained quite independently of electrical conductors and without interruption of electrical supplies. It has since been subjected to exhaustive tests at the Central Electricity Generating Board's laboratories at Leatherhead.

Its appearance on the market has been followed recently by the announcement of *Translite* as a fibre optic aerial cable of generally similar capability. This is manufactured by Telephone Cables Ltd (TCL) a subsidiary of the General Elec-

tric Company—which has undergone tests with England's East Midland Electricity Board.

## Fibrespan and Translite cable features

The cable design is based on a single rod of glass reinforced plastic (GRP) with a tensile strength of 65 kN, which is three times the design maximum for operation of 22.5 kN. The GRP rod has a longitudinal slot in which ribbons containing up to 24 fibres are laid in a thixotropic gel to cushion them against distortion of the rod through strains and stresses. The slot is covered by a polythene slot cap which restores the circular profile and the whole is covered by a binder yarn and outer sheath.

The single mode fibres used in the cable operate at 1300 nm with 0.5 dB/km attenuation or better and a pulse dispersion factor of not more than 3.5 ps/nm/km. The cable with an outer diameter of 13mm weighs 220 kg/km and has an operating temperature of -40°C to 70°C.

TCL offers two types of *Translite* cable self-supported by GRP rod; a

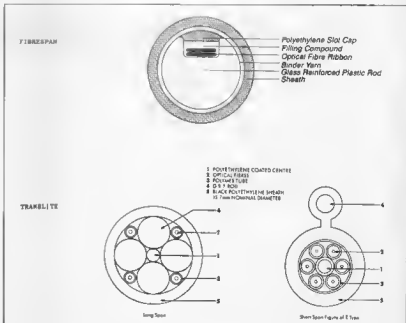

Sections for *Fibrespan* and *Translite* cables.



250 kg/km long span circular section cable, of 15.7 mm external diameter for installation on towers with spans up to 1000 m, and a 240 kg/km short span figure of eight cable of 12 mm x 22 mm, suitable for mounting on pole routes with spans up to 100 m. The long span type has a working tension of 25 kN, while that for the short span cable is 5 kN.

In the long span type, up to 24 optical fibres are carried in polymer tubes laid up with symmetrically disposed load bearing GRP rods, while for the short span a single GRP rod supports the optical fibres in their tubes. Attenuation of less than 0.5 dB/km at 1300 nm and dispersion of less than 6 ps/nm/km are quoted for single mode optical fibres. The standard drum length for both Fibrespan and Translite is 2 km but 4 km drums can be provided. The maximum span for Fibrespan cable on normal pylons in temperate climates would be 550 m, assuming the worst climatic condition to be 12.5 mm of radial ice and concurrent 88 km/h winds, although this could be extended to 720 m for a river or canyon crossing. In tropical climates with no ice hazard but a maximum anticipated wind speed

of 135 km/h, a normal span would be up to 800 m, extending to 1000 m for a river or canyon crossing. The location of the optical cable on the suspension towers is of course critical. It must ensure adequate ground clearance at mid-span while avoiding any clash with the electrical conductors under worst weather conditions.

### Arc fusion welding

A low cable site is preferred, centrally on the tower near the level of the bottom cross arm, or for asymmetric cross arms half way between the two bottom phase conductors. This enables installation to be carried out under live grid conditions while allowing a minimum ground clearance of 5.6 m.

A method of tension stringing appropriate to the new cable has been developed by STC and provides rapid installation with minimum interference to crops and activities on the ground. A full kit of installation devices including terminal clamps, suspension clamps, vibration dampers and joint housings, is available.

The fibres are jointed on the ground using arc fusion welding and this is fol-

lowed by a test of each joint by an optical time domain reflectometer, which provides a visual display of the optical attenuation through the splice. In a cable section of, say, 40 km, about 15 cable joint housings would be needed. The frequency of optical repeater stations would depend on the length of the trunk route and the type of optical line system employed. For a 565 Mbit/s single mode system, for instance, the spacing of stations could be up to 50 km apart.

With the relentless increase in the bit rate for optical line systems it would be inappropriate to designate a particular system for use with Fibrespan or Translite cable. The choice of system would depend, apart from the project budget, on current and projected traffic well into the future, especially as the life expectancy of the cable is over 25 years. One STC 565 Mbit system operating over two single mode fibres has the capacity of 7,680 telephone circuits each of 64 kbits (or a combination of telephone, television, and sound programme channels, or data up to 546,992 kbits). With Fibrespan and Translite offering up to 24 single mode fibres per cable, the potential traffic adds up to a considerable number of kbits along the pylons.

---

# COMPUTER AND TELECOMMUNICATIONS REVOLUTION WILL BRING ITS LEGAL PROBLEMS

By John McQueen

Since the early 1970's the development of computer and telecommunications technology has been taking place at a breathtaking rate. A world-wide revolution has taken place in the transmission of data within countries and between them.

In particular financial institutions of every type and variety have taken hold of the new developments in a very big way. It would be no exaggeration to say that the world banking system is now totally

dependent on the new technology in order to go about its business.

And the banking systems within most countries in the Western World are equally dependent upon the new technology. These changes have taken place almost overnight against a background of deregulation for financial dealings generally. Foreign financial transactions which used to be very strictly governed now have very few restrictions. And the recent "Big Bang" has brought about

large scale deregulation of all types of financial transactions within the UK.

We are now in a position where massive flows of money are being transmitted around the world and within countries without any kind of restrictions — a situation that would have been regarded as irresponsible just a decade ago.

The problems are already beginning to show through. Many experts have blamed the recent world-wide crash of the stock markets on unrestricted inter-

national transactions completed through the push button electronic communications network that now links all the world's stock markets. If these arguments are true then the unrestricted use of communications systems can be said to have precipitated a world-wide crisis. There are those who would argue that the cause of the collapse was due to factors other than instantaneous computer dealings — even so it cannot be denied that these dealings were an important factor in what happened.

But whatever the truth behind the stock market collapse there can be little argument that there are major risks involved in the application of computer and telecommunications technology in the financial field.

The amount of money being transmitted around the world and within countries can be measured in billions of pounds a day. The figures and the risks involved are frightening.

The financial field is the biggest and most obvious example of the impact of the new technology. But masses of other information is also being transmitted. Interpol, for example, now have a huge capacity to exchange information about criminals and suspects. Multi-National companies also have their own networks to transmit masses of commercial information.

And many government departments are becoming rapidly computerised. In the UK, Customs and Excise already have a sophisticated set up. The Inland Revenue are currently honing up a huge computer network that will eventually churn out tax forms and demands automatically.

Yet against this background of incredible rapid development there is virtually no international law in place to deal with the problems that may, and which must one day arise. What, for example, is the legal position if a deal involving many millions of pounds goes wrong between two financial institutions in different countries? How would any agreement be sorted out if the deal has been set up by the transmission of electronic messages? How would the problem be sorted out? More importantly, which country would have jurisdiction to sort the matter out? The answers at the moment are that there are no answers. If some gigantic financial accident happens then there are no international laws in force that can bring about a solution. And, if as usually happens in the nature of things, a series of accidents occurs then chaos on the financial markets could result.

These big nightmares are real enough, yet on the national front there are many domestic issues to cause concern. The transmission and storage of electronic data within the UK is now of gigantic proportions. Yet the laws that regulates this field are only in their infancy. The relevant Acts in the UK are the Data

Protection Act 1984 and the Telecommunications Act 1984. Both are relatively new Acts with the former barely implemented so most of the provisions remain untested in the courts.

The Telecommunications Act concerns itself more with the considerable technical and legal problems that face the industry in the day to day business of running a communication system establishing rights of access and so on to land and equipment. A complex Act, it deals with the nitty gritty of everyday practicalities.

But it does not really address itself to the important issues of the regulation of the transmission of huge amounts of information. It is left to the Data Protection Act to provide the necessary protections in this regard.

There are several main elements to the Data Protection Act. It contains the provision that anyone holding personal data on a computer must register their precise uses of their equipment with the new Data Protection Registrar, Eric Hove. Failure to register can bring about unlimited fines on those involved. Few people still realise that the provision applies to every computer user however limited their use of computers for personal data storage might be.

Some companies have still not registered and they face severe penalties if they are caught. Most companies have, however, now registered for every possible type of use from a list of options to be on the safe side.

And though discussion surrounding the Data Protection Act has largely centred on the question of privacy because of the sensitive implications, it is important to point out that the Act is also intended to ensure the physical security of information from possible destruction from fire, flood and terrorism.

In general terms there is a right of access to information held on a computer about any individual person who has a right to be supplied by any data user with a copy of any information held on that individual, so long as that request is made in writing.

If the information held is shown to be incorrect then compensation can be claimed as a result of any distress or damage caused by the holding of inaccurate information. However, it will be a defence for the data user to show they had taken all reasonable steps to store information they believed to be accurate. However, a large section of the Act gives itself over to exceptions. Most important government departments are excluded from the requirements to provide information and there are a whole host of other exceptions which are already giving rise to some considerable confusion about just what sort of information is covered by the Act. It is clear however that only a limited amount of information can be obtained. The UK has

been very slow to legislate in this field and the new Act has only come about because of a ruling by the EEC's Council of Europe that such an Act must be brought into force in all Member countries.

But at the very least the Data Protection Act, however limited its provisions, opened up the debate on the important subject of the issues involved in all this electronic transmission of information. Professional engineers and all those involved in the communications business are going to have to give more thought to the practical problems involved in providing for the proper security of sensitive equipment. Society generally is now beginning to wake up to the wider implications of this amazing new technology, and it is important that those actively involved in work in this field are also aware of the wider ramifications to their work.

The current electronic revolution has been equated in the scope of its implications with the industrial revolution of the eighteenth and nineteenth centuries. That revolution brought with it huge social, economic and political changes that transformed the world.

The real fear of the present electronic revolution is that it is proceeding at such an incredible pace that the social and legal structures are unable to keep up with it. And now that so many important financial and other institutions are so dependent on the new technology it may prove impossible to regulate and control its growth.

Certainly there is a general feeling about that some terrible disaster will occur in this field. Otherwise it is impossible to square the fact that the Data Protection Act only applies to data stored on electronic files and does not apply to manual files. It seems odd in logic that such a distinction should be made. But it is also an indicator of the very real fears beginning to open up in the minds of people about the uses that may be put to the transmission of all this information and of all the possible damages.

During December 1985 a congressional sub-committee in the United States learned that computer problems of the Bank of New York led to it accumulating an overdraft of 20 billion dollars in the course of a day. Without the intervention of The Federal Reserve there could have been disastrous implications for the whole domestic and international financial system.

Incidents like this not unnaturally make people worry about the dangers involved in computerising virtually all important information in government and society generally. Certainly this whole area is a fertile legal field that is bound to see major developments in the future.

# PRESCALER FOR MULTI-FUNCTION FREQUENCY METER

An add-on board that extends the usable frequency range of the instrument introduced 2 months ago from 10 MHz to well over 1.2 GHz.

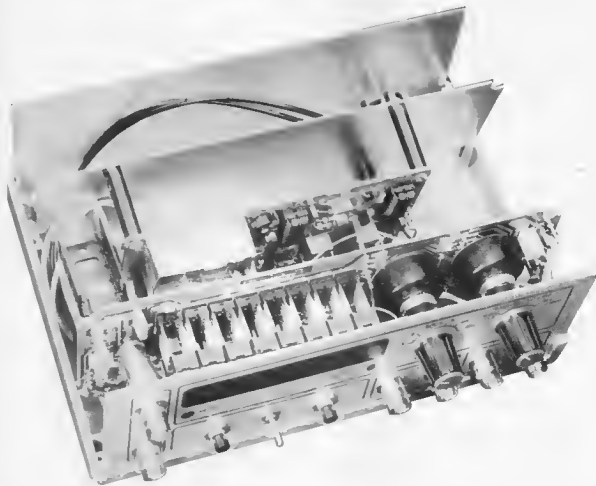

The pre-scaler described here is intended as an optional extension of the multi-function frequency meter introduced in reference (1).

There are various ways of adding a pre-scaler to an existing frequency meter. The simplest of these is based on the assumption that the instrument is mainly intended for measuring relatively low frequencies, indicated on a kilohertz (kHz) scale. Fitting a pre-scaler with a divisor of 1,000 to the input of such a frequency meter effectively changes the kHz scale into a MHz scale, obviating the need for changing the position of the decimal point. The main disadvantage of the above method is the reduction by 1,000 of the meter's resolution. A better approach entails increasing the

gate time of the counter by a factor 1,000. This results in more count pulses fed to the counter circuits, and hence retains the formerly available resolution.

The gate time of a frequency meter is determined primarily by the output frequency of the central clock oscillator, which is quartz-controlled in most cases. The oscillator frequency is scaled down internally to obtain the required gate time. Inserting, for instance, a binary scaler between the clock output and the internal divider cascade results in a doubling of the gate time, so that the measured signal must be passed through a  $\times 2$  divider also. These applications are often thought to be restricted to the use of decade scalers, while in practice any other divisor works equally well.

## Block diagram

The present pre-scaler was designed for ready connection to the multi-function frequency meter without compromising its usability in other, similar, instruments.

With reference to the block diagram of Fig. 1, electronic switches ES<sub>1</sub>, ES<sub>2</sub> and ES<sub>3</sub> select between 10 MHz, 2.5 MHz and 78.125 kHz at point  $\epsilon$ . The switches are controlled by signal detectors on the input channels. The existing 10 MHz input on the multi-function frequency meter is retained along with the 2 pre-scaler inputs, so that the complete instrument has 3 frequency ranges in all. A separate 10...40 MHz input is used in view of the reduced sensitivity of the

+64 prescaler in this frequency range. The sensitivity of the +64 prescaler is highest at around 250 MHz. The use of the 10.40 MHz input is also advantageous because it enables the use of relatively short gate periods.

With the greatest divisor, 128, the available gate periods are in the range from 0.14 to 140 s. Detector controlled switches ES<sub>5</sub> and ES<sub>7</sub> arrange the correct selection or disconnection of prescaler outputs on the 10 MHz input of the main frequency meter. ES<sub>5</sub> functions as an inverter, while ES<sub>7</sub> takes care of the "mode" settings, and the shifting of the decimal point.

The switch configurations for the 3 frequency ranges of the meter are as follows:

| Switch (ES) | 1 | 2 | 3 | 4 | 5 | 6 | 7 | B |
|-------------|---|---|---|---|---|---|---|---|
| Range (MHz) |   |   |   |   |   |   |   |   |
| 40 - 1250   | x |   | • | • | x | x | • | • |
| 10 - 40     | • | x | • |   | x | • | x | x |
| <10         | x | x | x | x | • | x | x | x |

x switch opened

• switch closed

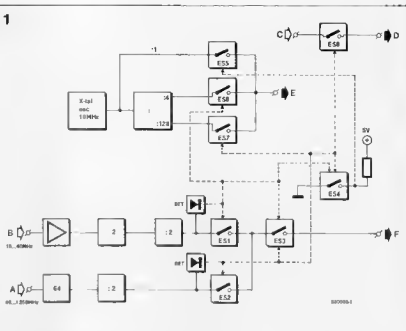

Fig. 1. Block diagram of the 1.2 GHz prescaler.

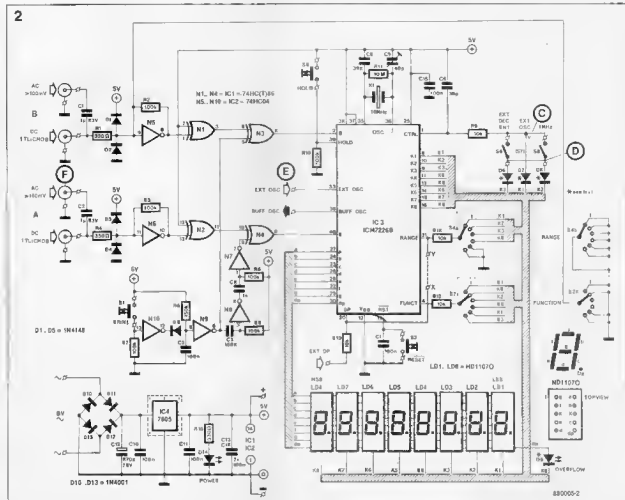

Fig. 2. Modifications to the multi-function frequency meter to enable using the prescaler extension.

### Preparing for the extension

A few simple modifications are required on the main frequency meter board before the prescaler extension can be used.

With reference to Fig. 2, power for the prescaler is available from terminals + and  $\perp$  at the output of the regulated 5 V supply on the frequency meter board. The AC coupled input of channel A on the frequency meter, point F, accepts the prescaler output signal. The divided or undivided clock signal from the pre-

scaler board is connected to the EXTOSC input of IC<sub>3</sub> (point E). Points X and Y are connected by a wire link as shown. Configuration switch S<sub>1</sub> is replaced by a wire link. Remove S<sub>4</sub> and S<sub>5</sub>, since their functions are taken over by ES<sub>1</sub> on the prescaler board. Connect the anodes of D<sub>5</sub> and D<sub>6</sub> to create point D. Point C in the prescaler circuit is connected to junction R<sub>5</sub>-A<sub>10</sub>. The 10 MHz crystal may be removed for re-use in the oscillator on the prescaler board. Figure 3 shows the locations of the various points and connections on the frequency meter board.

### Circuit description of the prescaler

The main functional blocks in the prescaler discussed under *Block diagram* are readily found back in the circuit diagram of Fig. 4. Crystal oscillator and buffer T<sub>1</sub>-T<sub>2</sub> ensures the required stability of the 10 MHz digital signal applied to counter IC<sub>1</sub> and electronic switch ES<sub>1</sub>. Binary ripple outputs Q<sub>2</sub> (+2<sup>2</sup>=4) and Q<sub>7</sub> (+2<sup>7</sup>=128) of IC<sub>1</sub> carry the 2.5 MHz and 78.125 kHz clock signal, respectively.

3

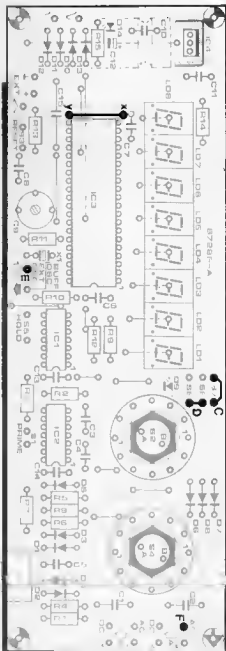
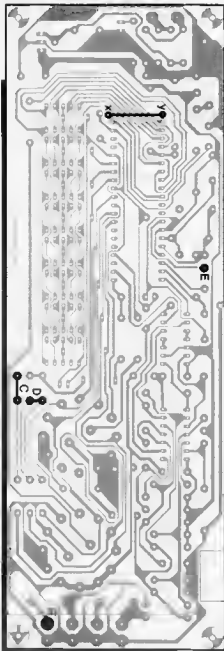

Fig. 3. Location of the wire links and terminals to be fitted on the main frequency meter board.

Signals applied to the 10...40 MHz input are amplified in fast opamp IC<sub>1</sub> and divided by 4 in bistables FF<sub>1</sub> (÷2) and FF<sub>2</sub> (÷2). Preset P<sub>1</sub> enables accurate setting of the bistable's switching threshold to 2.5 V. The rectifier (signal detector) for controlling the electronic switches as discussed is formed by diodes D<sub>1</sub>, D<sub>2</sub> and D<sub>3</sub>, together with R-C combination R-C<sub>1</sub>.

Signals in the frequency range of 40...1250 MHz are applied direct to ÷64 prescaler IC<sub>4</sub>, a Type U664B from AEG-Telefunken. Bistable FF<sub>3</sub> divides

by 2, so that the total divisor on this channel is 128. The function of the rectifier and the threshold preset is similar to that of the corresponding circuits in the 10...40 MHz channel. The dashed lines in the circuit diagram denote metal screens fitted to prevent stray radiation and erroneous meter readings caused by digital interference.

### Construction of the prescaler

The first components to be fitted on the prescaler board are leadless ceramic

capacitors C<sub>13</sub> and C<sub>14</sub>. Both disc and rectangular versions may be used in these positions. Cut the required slots in the PCB, push-fit the capacitors, and carefully solder the pretrinned sides to the relevant copper areas. Solder paste and accurately: leadless ceramic capacitors are relatively brittle components. The next somewhat unusual part is prescaler IC<sub>4</sub>. Use precision pliers to carefully bend the 8 pins of this IC over 180°, and mount the chip at the track side of the board, observing the orientation indicated on the component over-

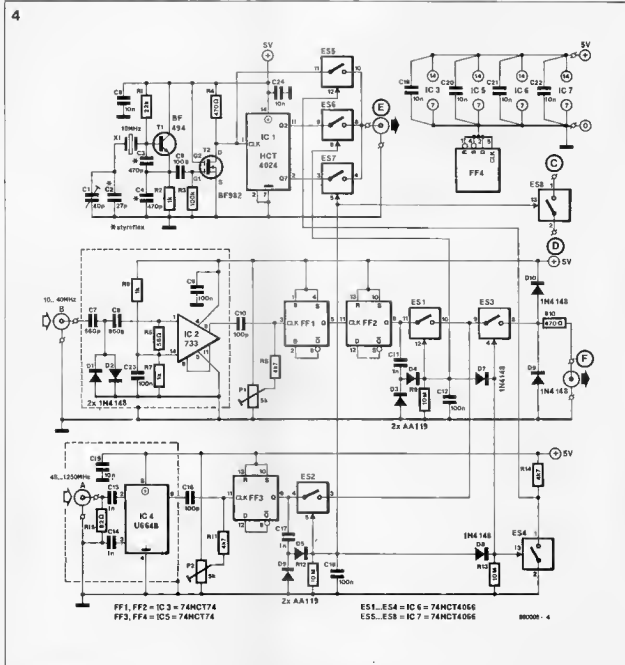

Fig. 4. Circuit diagram of the 1.2 GHz prescaler for the Elektor Electronics multi-function frequency meter. The dashed lines denote metal screens.

lay. If bending the pins is considered risky, it is also possible to mount the IC at the component side of the PCB, provided a suitable clearance is cut. Whatever mounting method is adopted, the connections to the prescaler pins should be as short as possible.

The fitting of the remaining components on the prescaler board is straightforward. It is recommended to use sockets for the 6 ICs. The screens at the component side of the PCB are made of 15 mm high brass or tin metal sheet, bent to shape and secured with the aid of

soldering pins—see Fig. 6. The screening of the VHF/UHF prescaler is "continued" at the track side of the PCB as shown in Fig. 7. The connections between the BNC sockets and the prescaler inputs are made in thin ( $\varnothing 3$  mm) coaxial cable, e.g. Type RG174/U. Keep the connection of the centre cores to the prescaler inputs as short as possible. The shielding braid of the 40...1250 MHz input cable is soldered direct to the screening plate at the track side. Use copper foil to shield the connections of the BNC sockets to the coax cables. It is

recommended to make the connections between the prescaler and the main frequency meter board in coaxial cable, with the exception of the supply wires.

The completed prescaler board is fitted vertically behind the main frequency meter board as shown in the introductory photograph of this article. Finally, make sure that the mains adaptor can handle the additional current drain of the prescaler board.

#### Parts list

##### Resistors ( $\pm 5\%$ ).

R1 = 22K  
R2, R6, R7 = 1K0  
R3 = 100K  
R4, R10 = 470R  
R5 = 56R  
R6, R11, R14 = 4K7  
R8, R12, R13 = 10M  
R9 = 82R  
P1, P2 = 5K0 or 4K7 preset H

##### Capacitors:

C1 = 40p trimmer  
C2 = 27p polystyrene or styroflex

C3, C4 = 470p polystyrene or styroflex  
C5, C15; C18, C20; C21; C22; C24 = 10n  
C6; C10; C16 = 100p  
C7; C8 = 560p  
C9; C12; C18, C23 = 100n  
C11; C13 = 1n0  
C13; C14 = 1n0 leadless ceramic (disc or rectangular, e.g. Cukit stock no. 04-10211)

##### Semiconductors

T1 = 8F494  
T2 = 8F982  
D1; D2, D7... D10 incl. = 1N4148  
D3... D6 incl. = AA119  
IC1 = 74HCT4024  
IC2 = 733 or  $\mu$ A733

IC3; IC6 = 74HCT74  
IC4 = U664B<sup>\*</sup>  
IC5, IC7 = 74HCT4066

<sup>\*</sup> AEG-Telefunken distributors in the UK are listed on InfoCard 502

##### Miscellaneous.

X1 = 10 MHz quartz crystal, 30 p series resonant  
PCB Type 880006 (see the Readers Services page).

5

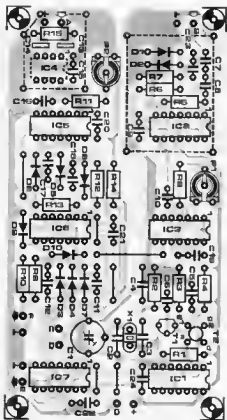

**ATTENTION**

**PCBs  
& Set of COMPONENTS**

for projects are normally available with

**precious** <sup>©</sup> ELECTRONICS CORPORATION

52, C Proctor Road, Bombay-400 007 Phones 367459/369478

Fig. 5. Track layout and component mounting plan for the prescaler PCB. READ THE TLXT BEFORE FITTING IC4, IC5 AND IC14.

## Setting up

The setting up of the extended frequency meter is fairly simple if a signal source of 10...40 MHz and 40...1250 MHz is available. To begin with, set the clock oscillator to 10,000 MHz precisely with the aid of a second, calibrated, frequency meter.

Apply a test signal at a frequency higher than 40 MHz to prescaler input A, and reduce the generator output until the read-out becomes unstable. Adjust  $P_2$  to restore the correct read-out, reduce the input signal, re-adjust  $P_2$ , and so on, until the optimum threshold setting is achieved. The sensitivity of the prescaler's B input is set likewise.

A carefully aligned prototype of the frequency meter achieved a sensitivity of about 400 mV<sub>rms</sub> at 1190 MHz. B

## Reference:

<sup>(1)</sup> Multi-function frequency meter. *Elektor India*, January 1988.

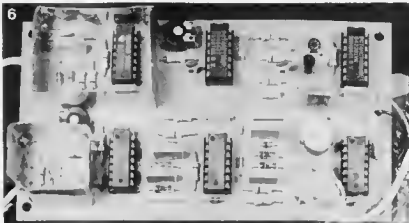

Fig. 6. Prototype of the prescaler board. Note the use of metal screens around the input sections.

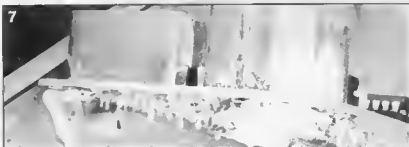

Fig. 7. Close-up photograph showing the screen around the VHF/UHF input at the track side of the board.

# percolator switch

Most of the timer ICs which are commonly available provide only relatively short timing intervals. If longer delays, of say, from several minutes up to a few hours, are required then one is faced with something of a problem.

The following circuit, which can be used in any number of possible applications (e.g. as a time switch for cookers, heaters, alarms, house lighting, etc.), permits delay times of up to approximately four hours.

The circuit was originally designed to automatically switch off a coffee percolator after a certain time, and as such has been functioning satisfactorily for quite a while here at the Elektor offices. The operating principle is simple:

After pressing the start button (S1), capacitor C2 is charged up to almost the full supply voltage, and the non-inverting input (pin 3) of IC1 is taken positive of the inverting input (pin 2), the latter being held low via the voltage divider R2/P1/R3. The output of IC1 therefore turns on T1, which in turn triggers triac Tri1. LED D3 will light up to indicate that the device in question (RL) is switched on.

As soon as the button S1 is released, C2 begins to discharge via the non-inverting input of IC1. After a certain interval, the length of which is determined by the value of C2 and R6 as well as the position of P1, the voltage across C2 will drop to below that at the inverting input (this being set by P1). The output of IC1 therefore drops to almost zero, turning off both T1 and Tri1, and the LED is extinguished, thereby indicating that the load device has been switched off.

If one wishes to switch off the device earlier than was originally intended, this can be done simply by pressing the stop button S2, which causes C2 to be discharged rapidly via R4.

Since C2 cannot have too high a value (it must be a low-leakage capacitor and therefore not an electrolytic), very long timing intervals can only be achieved by giving R6 an extremely high value.



Although this is not a major problem, it is slightly inconvenient, since such high value resistors cannot be obtained individually and one is forced to use a number of smaller resistors connected in series.

With the value of C2 as given in the circuit diagram (2μF), the maximum possible value for R6 is 40 MΩ. This gives a maximum timing interval (which is set by P1) of 4 hours. It should be mentioned that the exact delay time will depend upon the tolerances of some of the components. If very long times are in fact required, it may be necessary to choose a slightly higher value for C2. Times of up to 1 hour are possible when



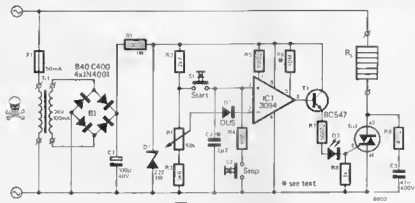

**ATTENTION**

**PCBs  
& Set of COMPONENTS**

for projects are normally available with

**precious** ELLECTRONICS CORPORATION

52-C Proctor Road, Bombay-400 007. Phones: 367450/365478

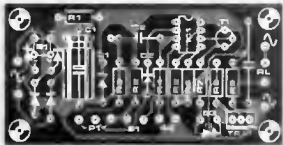

component values shown in the circuit diagram are used. The printed circuit board is designed to accommodate a CA 3094 in a mini-DIP package (a TO-version could also be used), whilst either a bridge rectifier or four discrete diodes may be used for B1.

The skull and crossbones beside the circuit diagram should be a clear enough indication that the circuit operates at dangerously high voltages, and therefore great care should be taken during construction. The circuit should be mounted in a fully insulating (plastic) case. If however a metal enclosure is used, then it should be connected to mains earth via a three core cable, and

the circuit itself insulated from the box. To further eliminate the possibility of electric shock, the pushbutton switches should be of a good quality type, suitable for mains use.

### Selecting a triac

The selection of the triac will depend on the intended application.

To avoid exceeding the PIV rating (peak inverse voltage) of the triac, a 400 V unit should be used. The current rating will depend upon the load which is to be switched. For loads such as lamps and heating elements, the switch-on

### Parts list.

#### Resistors:

- R1 = 330 Ω/1 W
- R2 = 2k7
- R3 = 5k6
- R4, R5 = 100 Ω
- R6 = 10 M (see text)
- R7 = 560 Ω
- R8 = 1 k
- R9 = 47 Ω

#### Capacitors:

- C1 = 100 µF/40 V
- C2 = 2µ2 (MKH low leakage)
- C3 = 47 nF/400 V

#### Semiconductors:

- IC1 = CA 3094 (RCA)
- T1 = BC 547
- Tr1 = 400 V triac (see text)
- D1 = zener diode 22 V/1 W
- D2 = DUS
- D3 = LED
- B1 = bridge rectifier B 40 C 400, or 4 x 1N4001

#### Miscellaneous

- Tr1 = mains transformer  
24 V/100 mA
- F1 = mains fuse 50 mA (iso blo)
- P1 = potentiometer 50 k lin.
- S1, S2 = pushbutton switch,  
adequately insulated

'surge current' is usually quite a bit larger than the steady operating current. Therefore, if a 2 A device is being switched, it is advisable to use a 100% (or more) over-rated triac (4 A). In this connection, it is interesting to note that there is often very little difference in price between triacs with a low current rating and those with a high rating. For this reason, it is wise to purchase one with a large current rating, say 8 or 10 A, and not have to worry about accidentally 'blowing up' an under-rated slightly cheaper triac. ■

# TEST & MEASURING EQUIPMENT

The 3rd part of Julian Nolan's review of dual trace oscilloscopes looks at the Philips PM3050 and the Kenwood CS1045 instruments.

## Part 1: dual-trace oscilloscopes (c)

### Philips PM3050

The Philips PM3050 is one of a range of high grade oscilloscopes ranging from the 15 MHz PM3206 at £320 to, for example, the new range of 400 MHz scopes. Other instruments manufactured by Philips include logic analyzers, multimeters, pulse generators, chart recorders and a comprehensive range of waveform analysers. Philips has a long standing reputation for the reliability of its instruments. The PM3050, which was launched in 1986, is no exception to this, selling in its first year to a wide range of both universities and companies such as GEC.

The modern styling and unconventional appearance of the PM3055 are brought about mainly by its use of a LCD panel and the use of 'softkeys' for the setting of most of the operating parameters. An Autoset key is also provided, allowing automatic setting of amplitude, timebase and triggering functions. These characteristics are combined with a Y-amplifier bandwidth of 50 MHz ( $-3\text{dB}$ ), a 16 kV tube and a IEEE option for £845 (3055) or £795 for the single timebase PM3050.

### Autoset and 'softkey' functions

These two features distinguish the PM3050 from other 50 MHz scopes and are unique in its price range, being aimed at providing ease of operation along with increased reliability. The 'softkeys' consist of a group of 21 keys, which control all oscilloscope functions with the exception of those which need to be continuously variable such as the trace position, triggering level and hold off controls. The state of these, some of which combine up to 5 functions, is continuously displayed on the LCD panel along with the range settings of the three up/down switches, controlling timebase and Y-amplifier coefficients. The 'softkeys' replace all the usual rotary or slider switches which are to be found on comparable scopes. On the whole, I found that operation in terms of time taken was

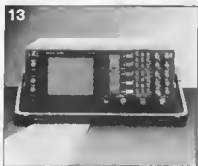

Fig. 13. The Philips PM3050 oscilloscope

on a par with that taken in more conventional scopes. In some cases, however, such as when changing the triggering (or X, when in X-Y mode) source, the time taken to, for example, change from triggering on CH B to CH A can be considerably longer than on most conventional scopes. This is largely because CH B is one of five different triggering source options available, so that to change back to triggering on the A channel a total of 3 key presses are required.

The LCD provides a clear alphanumeric readout of all settings and is also backlit for operation in low ambient lighting conditions. This is particularly advantageous for timebase, delayed sweep and Y-amplifier readouts, providing a very clear and unambiguous display. Its relevance is increased for the timebase sweep time when in the  $\times 10$  deflection magnification mode, showing the actual sweep time (down to 5ns/div) instead of the user having to manually multiply the sweep speed by 10, thereby eliminating any possible scaling error. An asterisk is also shown on the LCD when in  $\times 10$  mode. Unfortunately, a non-volatile memory is not used to store the front panel settings and as consequence they are reset to their default value should the instrument be turned off. This is 1V/div for the vertical deflection coefficient and 1ms/div for the timebase. Although there can be little doubt that the 'softkey' system is easier to use and less ambiguous in most cases than its analogue counterpart, this cannot be said of the speed of operation for the up/down range keys, which can be significantly



Fig. 14. Internal construction of the PM3050



Fig. 15. Front view of the PM3050 with the trace and LCD shown enlarged

slower, especially on the deflection coefficient settings when in manual mode. For example, to change from a timebase speed of 0.5 s/div to 50 ns/div takes approximately 5 seconds using softkeys, while speeds of typically under 1 second can be obtained with a standard rotary control. In practice, this may not be so noticeable as it is unlikely that such large changes in the deflection coefficients will be required, but the time required may still be longer than that in its rotary counterpart.

The use of a single chip microcontroller enables not only 'softkey' control, but also a full Autoset facility. This function is increasingly being introduced into a range of oscilloscopes, although at present the Philips PM3050 and 3055 are the only units to incorporate it in their class, i.e. 50 MHz and under £1000. The Autoset function allows the automatic setting of both Y-amplifiers, timebases and the triggering source. The total time required for one 'setting' is approximately 3 seconds, so continuous assessment and setting of the required and necessary parameters is not possible. Obviously, all continuously variable controls, including trigger holdoff remain unaffected.

In addition to this, the microcontroller also incorporates other functions, including a menu facility in which the functions of any one of the 'softkeys' can be displayed in a step-through function sequence, without affecting any of the operating parameters that have been previously set. A test routine is also provided, which provides a 6 step visual test of Y amplifier, triggering and timebase functions.

### Y-amplifiers

The maximum bandwidth of 50 MHz (-3dB) is only usable at sensitivities above 20 mV/div; below these a maximum bandwidth of 35 MHz can be observed. This lack of sensitivity at higher frequencies is rather disappointing for an oscilloscope in its range: some of its direct competitors maintain the full 50 MHz bandwidth down to 5 mV/div, although admittedly they do not have the advanced level of control of the PM3050, nor several of its other facilities. Deflection coefficients range from 2 mV to 10 V per division, the vernier control decreasing the minimum sensitivity to 25 V/div. Uncalibrated op-

Table 9 Specification

#### ELECTRICAL CHARACTERISTICS

Line voltage: 100 to 240 VAC continuous (SM power supply) Power: 50 Watts (max)  
Line frequency: 50-400 Hz

#### MECHANICAL CONSTRUCTION

Dimensions: W 387 mm, H 146 mm, D 455 mm  
Housing: steel sheet, chassis + front and rear panels plastic  
Weight: approx 7.6 kg

#### Y AMPLIFIER ETC.

Operating modes:  
CH A alone, CH B alone  
Inversion capability on CH B only  
Dual, alternate or chopped  
CH A + CH B  
Frequency response: 0 - 50 MHz (-3dB) to 20 mV/div; 35 MHz (-3dB) to 2 mV/div  
Risetima < 7 nsec, t<10 ns below 20 mV/div)  
Deflection factor: 12 steps:  
2 mV/div 10 V/div  $\pm 3\%$ , vernier control adjusts min sensitivity on 10 V/div range to approx 30 V/div (fully anti cwl)  
Input coupling: AC, DC or Gnd  
Input impedance: 1 M $\Omega$ /20 pF, Max input voltage: 400 V (OC + peak AC)  
Signal delay time: approx 20 ns on CRT screen

#### X-Y MODE

CH A or B X-axis and Ext Y-axis Bandwidth: DC to 2 MHz (-3dB) X-Y phase shift < 3° at 100 kHz

#### SWEEP

Type: A X Y  
Sweep time: 50 ns/div to 0.5 s/div,  $\pm 3\%$  in 22 ranges: 1-2-5 sequence. Vernier control slows sweep down by up to 3:1  
Sweep magnification:  $\times 10$ ;  $\pm 4\%$  (total error limit)  
Hold off: variable up to 10.1

#### TRIGGERING

Trigger modes: Auto (bright line); normal, single-rstet  
Trigger coupling: peak-peak, DC, TVL, TVF  
Trigger sources: CH A, CH B, Line, EXT, (AC or DC), Composite (all/mata)  
Triggering sensitivity: internal < 1 div at 50 MHz, external 0.15Vp-p at 50 MHz

#### MISCELLANEOUS

CRT: make Philips, measuring error 80  $\times$  100 mm, accelerating voltage 16 kV. Compensation signal for divider probe, amplitude approx 1.2 Vpp ( $\pm 3\%$ ), frequency 2 kHz.  
Z modulation sensitivity: 2 V detectable (intensity modulation)  
Covered by 1 year warranty.

#### PM3055 as PM3050 plus the following

Trigger View-Frequency (response)  
DC... >60 MHz (-3dB), via Ext Y, Yb.  
Deflection coefficient: 100 mV/div via Ext input, 2 mV... 10 V/div via Ya or YB.

Horizontal display modes  
MTB, MTB1, Alt TB, DTS, X-def.

Delay Timebase  
Time coefficient: 1ms/div... 50ns/div in 1-2-5 sequence  
Expansion:  $\times 10$  fastest sweep speed 5ns/div, Error limit 3%

(continued overleaf)

Delay Timebase Multiplier  
Resolution 1:10,000  
Error limit total 4% (\*10 magn.)  
Delay time jitter 1 > 20,000

Triggering (DTB)  
Starts, A, B, Composite (A, B), Ext (DC or AC), TVL

Other oscilloscopes available at under £1500

Rack mounted version of PM3050 and PM3065, at £995 + VAT and £1045 + VAT respectively

PM3206-Dual channel 15MHz bandwidth, Z-modulation, 2 kV acc. voltage, sweep speeds 100 ns/div to 200 ms/div\* £350 + VAT

PM3217-50 MHz dual trace, 2 mV sensitivity to full 80 MHz (-3dB), dual timebase and delayed sweep, automatic p-p triggering, trigger holdoff, 10 kV CRT: £1325 + VAT

Table 9. Specification

eration is indicated by a flashing '>' sign on the LCD. Provision is also made for automatic  $\times 10$  probe sensing when used with the recommended PM8936/09  $\times 1/\times 10$  switchable probes which come at £95 + VAT per pair. This enables the scaling on the LCD to be automatically divided by 10, minimizing any possible reading errors. Both Y-amplifiers performed reasonably well for a scope in this price range, possessing a dynamic range covering the full vertical deflection capability of 8 cm at 50 MHz. Both the risetime and base line jump were also within the specified limits at 7 ns (down to 20 mV/div) and 1 small division (variable) respectively. Overshoot, ringing and rounding were restricted to approximately 1.4 small divisions p-p for an input pulse of amplitude 5 divisions centred around the screen centre. One slightly odd cause of trace shift is the graticule illumination control, which has the effect of causing approximately 1/3 small division shift if the graticule illumination is varied from zero to maximum. In Autoset mode, vertical deflection coefficient selection is usually accurate, typically being set for a deflection of 4 cm. One inconvenient but inevitable result of this is the need to set the input coupling to AC, as obviously only the user can decide whether it is necessary to view any DC offset which may be present. The 'sofkeys' controlling the Y-amplifiers are neatly and logically grouped together opposite the appropriate section of the LCD, and include the usual alternate/chopped, add/invert functions. In common with some other scopes in this price range, only CH B can be inverted, which, although not restricting the range of possible algebraic functions, could entail the swapping of the CH A and CH B input leads.

Table 10

| CATEGORY                  | Unsatisfactory | Satisfactory | Good | Vary Good | Excellent |
|---------------------------|----------------|--------------|------|-----------|-----------|
| TRIGGER FACILITIES        |                |              |      | *         |           |
| TRIGGER PERFORMANCE       |                |              |      |           | *         |
| DELAYED SWEEP FACILITY    |                |              | N/A  |           |           |
| DELAYED SWEEP PERFORMANCE |                |              | N/A  |           |           |
| CRT BRIGHTNESS            |                |              |      |           | *         |
| CRT FOCUSING              |                |              |      | *         |           |
| Y-AMP ATTENUATION RANGE   |                |              |      | *         |           |
| INTERNAL CONSTRUCTION     |                |              |      |           | *         |
| EXTERNAL CONSTRUCTION     |                |              |      | *         |           |
| OVERALL SPECIFICATION     |                |              |      | *         |           |
| OVERALL PERFORMANCE       |                |              |      |           | *         |
| EASE OF USE               |                |              |      |           | *         |
| MANUAL                    |                |              |      | *         |           |

For an explanation of the table, see *Elektron India*, January 1988.

Table 10. Performance summary

### Triggering

The PM3050 is equipped with a wide range of triggering features which include peak to peak and composite, or alternate sourcing facilities. The triggering functions are, like the Y-amplifiers and timebase, under the control of the microcontroller when in Autoset mode. Perhaps not surprisingly, no great benefit appears to have come of this, however, as far as the automatic setting of the trigger coupling, mode and slope is concerned. These settings are largely user-dependent and inevitably set to their default values of p-p, auto and rising edge respectively when the Autoset key is pressed. The Autoset function has an effect on the triggering source in selecting either CH A or CH B, but not on the external input which might have been useful. The LCD gives an indication of whether the scope is triggered or armed in single shot mode. All other triggering functions, such as triggering slope, trigger coupling and mode are also displayed. When both Y-amplifiers are grounded, an automatic bright line is displayed irrespective of the operating mode in which the scope is set, i.e. single shot, triggered or auto. Triggering performance was good; signals of over 100 MHz were displayed stably, while the delayed holdoff control was effective against most complex pulse trains. When in peak to peak mode, the level control thresholds are automatically set for the peak values of the waveform, enabling both the triggering stability of a normal p-p automatic triggering circuit and versatility of the more usual auto mode to be combined. One noticeable absence from the facilities available is that of HF and LF filtering.

### Timebase

The timebase can also be set automatically by the Autoset control, with speeds ranging from 0.5 s to 50 ns, providing a total of 22 ranges. A clear indication of the speed is provided by the LCD, which also takes into account the  $\times 10$  increases in deflection speed which is brought about if the  $\times 10$  magnifier is operated. In Autoset mode, typically three cycles of the waveform are displayed where possible. The minimum timebase speed automatically set in this mode appears to be 20 ms/div. Sweep speed accuracy was well within the specified 3%, or 4% with the  $\times 10$  magnifier in operation. Linearity is also good. XY operation benefits from a versatile range of available sources: CH A, CH B and external, all of which can be independently selected and displayed in any combination.

### CRT

The PM3050 is equipped with a 16 kV CRT which enables it to give a good level of brightness even at its maximum deflection speed of 5 ns/div. The high level of intensity also allows easily definable traces to be obtained at the same deflection speeds in bright ambient light. The focusing could have been slightly sharper, although it is perfectly acceptable, especially at higher intensity levels. A small amount of defocusing occurs if the intensity is altered by a large coefficient, necessitating an adjustment in the focusing potential. Tube geometry was particularly good with the minimum of barrelling and pinchoff over the whole of its area. Overall, the CRT's performance was very good for a scope in the 'under £1000' price bracket, especially in

the brightness sector of its performance characteristics. A graticule illumination facility is also provided, although due to its very low level of illumination it is only really effective in correspondingly low levels of ambient lighting, or for photographic uses.

## Construction

The construction is perhaps the most revolutionary part of the PM3050: it is completely and drastically different from the more conventional oscilloscopes, which up to the PM3050's launch dominated the 50 MHz market. A one-piece moulded plastic chassis is the basis of the PM3050, housing all components, including the CRT and PCBs. This appears to be reasonably rugged, and in use should be as robust as the more usually encountered aluminium. Two of the oscilloscope's total of four screws are used to keep the two steel covers in place, which are free of ventilation slots. The PCBs, CRT and other components are secured by a system of customized plastic clips and slots. This system of snap-in components enables quick servicing, while apparently not affecting the robustness of the instrument. The CRT and Y-amplifier shielding are practically the only pieces of metal in the scope; the extensive use of plastic mouldings keeps the number of mechanical components to an absolute minimum and should increase MTBF.

The instrument itself is constructed around 7 PCBs, all of which are double sided, enabling a clear and uncluttered layout. The microcontroller, an 8052, and associated circuitry are mounted directly onto the front panel PCB, which also houses the 'softkey' switches, all of which are independently mounted and

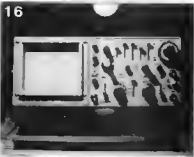

Fig. 16. The Kenwood CS-1045

should further help reliability. Obviously, many of the ICs are custom designed, making the return to Philips of a faulty board essential. For this reason, none of the boards is silk screened. The PM3050 has been designed, however, with ease of servicing very much in mind: each PCB is easily accessible for the minimum of down time. A switch mode power supply is also a feature of the PM3050, resulting in a weight of only 7.5 kg and enabling a non-switched line voltage range of 100 to 240 VAC at 50 to 400 Hz to be specified. Short IDC terminated ribbon cables provide the vast majority of internal connections, further improving the ease of servicing. Typical assembly time of the PM3050 is 20 minutes compared to 10 hours for a conventional scope.

## Interface facilities

The PM3050 is unique in its price range in that an IEEE interface is available as an optional extra. This is external to the scope, and is fitted by means of the 9-pin 'D' type connector provided at the rear of the scope. The external nature of the interface, which is priced at £349 + VAT allows it to be used with a large number

of other instruments where required, at a great saving in cost. The IEEE interface is capable of controlling all scope functions remotely, with the exception of the potentiometer settings. This makes its use valid for a wide range of applications, such as ATE and production line QC environments.

Other interfaces available include front panel memory backup, the PM 8998 at £54 + VAT. A number of output options such as Y-amplifier signal out are also available.

## Manual

The manual contains information on setting the scope up, performance characteristics and preventative maintenance. All of these are covered in some depth, but areas such as applications are not included, which, given the sector of the market the scope is aimed at, may not be surprising. A service manual containing circuit diagrams etc is available free of charge upon request.

## Conclusion

The Philips PM3050 represents a radical new approach to the design of an oscilloscope in its class. Only time will tell whether or not this new approach will increase the reliability of the instrument, but on the face of it, one must expect it to. Ease of use is greatly simplified by the use of 'softkeys' and the LCD, but this may be limiting so far as the speed of operation is concerned, which is worth bearing in mind if large range changes have to be made in situations where it would be inappropriate to use the Autoset function. This in itself can help to save a great deal of time compared to a conventional analogue oscilloscope, although it rarely sets the ideal setting in terms of input and trigger coupling. Despite this, it should still be of a value, even if in some situations it is restricted to an intelligent beam finder. As a 50 MHz oscilloscope, the PM3050 performs well, the high brightness tube being of particular benefit at higher frequencies.

The PM3050 should fit a large range of applications, from ATE to educational environments and this has been proved by the fact that its users so far range from building societies to calibration laboratories. Its particular strengths lie in its ease of use, price/performance ratio and construction characteristics. It does have one or two minor failings, such as its 20 mV maximum sensitivity at the full 50 MHz (-3dB) bandwidth, but on the whole its performance equates with what can be expected from a 50 MHz scope in its class. If the ease of use and additional features, including Autoset, are then added to this, together with the IEEE capability, the instrument becomes a good choice, whether its in-



Fig. 17. Detail of CS-1045 front panel

tended use is for the latest 007 film (the PM3050 was used in 'The Living Daylights'), or a servicing application.

## PM3055

The PM3055 incorporates a dual timebase and delayed sweep facilities, as well as trigger view. Both timebases have independent trigger level controls. The 16 kV tube allows high levels of magnification while maintaining a reasonable trace intensity. Highly accurate setting of the delay time multiplier is possible because of the incorporation of the LCD. Overall, the PM3055's additional features should be well worth the extra £50 for most users.

The Phillips PM3050 was supplied by Pye Unicam Ltd, York Street, Cambridge, CB1 2PX. Telephone (0223) 358866.

## Kenwood CS-1045

Trio, or Kenwood as it is now called, is a long-established Japanese company renowned for its products in the electronics sector, particularly communication receivers and oscilloscopes. The Kenwood CS-1045 is one of a new series of oscilloscopes, ranging in price from a competitive £319 (20 MHz) to £1695 for the top-of-the-range 150 MHz scope. The CS-1045 is a 40 MHz, 3-trace, delayed-sweep, dual-timebase oscilloscope retailing at £695 + VAT. Two high-quality  $\times 1/\times 10$  switchable probes are supplied with the CS-1045, as well as a set of spare fuses, covering the different line voltage options that are available on the instrument.

The CS-1045 is a relatively small unit, measuring 319 mm (W)  $\times$  132 mm (H)  $\times$  380 mm (D), although what it loses in size is made up in weight, which is 9.2 kg. A robust multiposition stand is fitted, which also has the appropriate fixing holes for an optional soft vinyl probe pouch. These two features should prove extremely useful if portability is required. Mains connection is by a standard IEC style socket; the line voltage is externally selectable from 100 VAC to 240 VAC.

The CS-1045 has several features which, although uncommon even on 'top-of-the-range' units a few years ago, are becoming increasingly popular, especially on medium-price oscilloscopes. In this case, they include 3 input channels, comprehensive TV triggering on both timebases and trigger holdoff facility. In common with several other ranges of oscilloscopes, a CH 1 output is provided along with the more standard Z-axis input, both of which are situated on the back panel. The mounting of these connections on the back panel is virtually common to all scopes, including the CS-1045. I feel that this is a pity

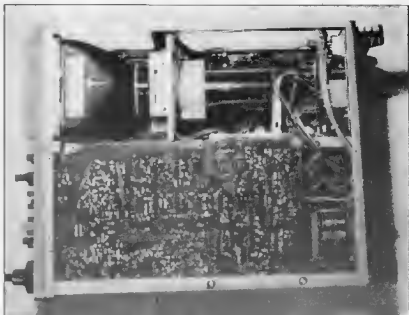

Fig. 18. Internal view of the CS-1045

### ELECTRICAL CHARACTERISTICS

Line voltage, 100, 120, 220, 240 VAC  $\pm 10\%$ , externally adjustable, Power 61 Watts, Line frequency: 50/60 Hz

### MECHANICAL CONSTRUCTION

Dimensions W 319 mm, H 132 mm, D 380 mm  
Housing: steel sheet  
Weight approx. 9.2 kg

### Y AMPLIFIER ETC.

Operating modes:  
CH 1 alone or CH 2 alone  
Inversion capability on CH 2 only.  
Dual: CH 1 and CH 2 (alternate or chopped) (250 kHz)  
Triple: CH 1, CH 2 and CH 3 (alternate or chopped)  
CH 1 + CH 2

Frequency response 0.1 - 40 MHz ( $-3$  dB);  
15 MHz 1 mV and 2 mV/div  
Rise time  $< 8$  ns, (23.4 ns 1 mV/div to 2 mV/div)  
Deflection factor 12 steps  
1 mV/div 5 V/div  $\pm 3\%$ , vernier control  
adjusts min sensitivity on 5 V/div range to approx 17 V/div (fully cwi - CH 1 and 2 only).  
Input coupling AC, OC or Gnd  
Input impedance 1 M $\Omega$ /20 pF, max input voltage 250 (DC + peak AC)  
Signal delay time: approx 20 ns on CRT screen.

### CH 3 only specifications

Sensitivity 0.5 V/div  $\pm 3\%$ ; input impedance 1 M $\Omega$ /20pF  
Frequency response: 40 MHz; rise time 8 ns  
Max input: 50 V (DC + AC peak)

### X-Y MODE

CH 1 Y-axis, CH 2 X-axis, X bandwidth OC to 1 MHz ( $-3$ dB); X Y phase difference  $< 3^\circ$  at 100 kHz

### SWEEP

Type A: A Sweep, Alt; A sweep (intensified for duration of B sweep) and B sweep (delayed sweep) alternating; B: delayed sweep; X-Y.

A sweep time 0.1 s/div to 0.5 s/div,  $\pm 3\%$  in 21 ranges, 1-2.5 sequence Vernier control slows sweep down by up to 3:1; B sweep 0.1 s/div to 50 ms/div,  $\pm 3\%$  in 18 ranges, 1-2.5 sequence.

Sweep magnification  $\times 10 \pm 5\%$  ( $\pm 8\%$  on 0.1 s/div to 0.2 s/div range)  
Hold off, variable up to 10:1  
Delay modes: continuous delay, Trigger Delay (TV), Trigger Delay (TV line), delay = zero  
Delay jitter: 1/20000

### TRIGGERING

Trigger modes: Auto (bright line), Normal, Fixed (automatic triggering), single reset  
Trigger coupling: AC, OC, HF reject, TV frame and line.  
Trigger sources: CH 1, CH 2, Line, Ext, or CH 3, Vertical (alternate)  
Triggering sensitivity Internal  $< 1$  div at 40 MHz, External  $< 0.5$  Vp-p at 40 MHz, Normal mode

### MISCELLANEOUS

CRT-make Trio-Kenwood, measuring area 80  $\times$  100 mm, accelerating voltage 12 kV, 00med-mesh type.  
Compensation signal for divider probe, amplitude approx. 1 Vp-p ( $\pm 3\%$ ), frequency 1 kHz, Z modulation Sensitivity 5 V (complete blanking)  
Vertical CH 1 output approx 50 mV/div into 50  $\Omega$ ; frequency response 100 Hz to 40 MHz except on 1 mV/div and 2 mV/div ranges (100 Hz to 15 MHz)  
Covered by 1 year warranty

Table 11. Specification

Table 12

| CATEGORY                  | Unsatisfactory | Satisfactory | Good | Very Good | Excellent |
|---------------------------|----------------|--------------|------|-----------|-----------|
| TRIGGER FACILITIES        |                |              |      | *         |           |
| TRIGGER PERFORMANCE       |                |              |      | *         |           |
| DELAYED SWEEP FACILITY    |                |              |      | *         |           |
| DELAYED SWEEP PERFORMANCE |                |              |      |           | *         |
| CRT BRIGHTNESS            |                |              |      | *         |           |
| CRT FOCUSING              |                |              |      | *         |           |
| Y-AMP ATTENUATION RANGE   |                |              | *    |           |           |
| INTERNAL CONSTRUCTION     |                |              |      | *         |           |
| EXTERNAL CONSTRUCTION     |                |              |      | *         |           |
| OVERALL SPECIFICATION     |                |              |      |           | *         |
| OVERALL PERFORMANCE       |                |              |      | *         |           |
| EASE OF USE               |                |              |      | *         |           |
| MANUAL                    |                |              |      | *         |           |

For an explanation of the table, see *Elektron India*, January 1988.

Table 12. Performance summary

since in some situations these connectors become almost inaccessible. The CS-1045 has a comprehensive set of functions, as can be seen from Fig. 17. As already mentioned, the CS-1045 possesses 3 input channels, 2 of which are variable, while the third is fixed at a convenient 0.5 V/div. The two main channels have a maximum sensitivity of 1 mV/div, which is, however, only usable to a bandwidth of maximum 15 MHz ( $-3\text{dB}$ ). A sensitivity of 5 mV/div can be sustained across the full 40 MHz ( $-3\text{dB}$ ) bandwidth. Input impedance is  $1\text{M}\Omega$  at 20pF and should be of considerable help in observing signals from very high impedance sources, especially if a  $\times 10$  probe is used. The performance of the Y-amps was good: the 1 mV/div and 2 mV/div ranges have a good response up to 25 MHz, while still maintaining a reasonable frequency dependent attenuation of just over  $-3\text{dB}$ . This kind of performance was repeated across the rest of the range: the attenuation at 40 MHz (5mV/div) was inside the quoted  $-3\text{dB}$  range. The triggering range of the unit extends well beyond the 40 MHz Y-amplifier bandwidth, and it is possible to stably trigger the main timebase with signals approaching 100 MHz. Both Y-amps have a continuously variable control, which can increase the maximum deflection amplitude, from the calibrated 5 V/div to approximately 15 V/div. To prevent any further cramping of the front panel layout, only one channel is invertible. The third channel's usefulness is limited by its fixed deflection factor of 0.5 V/div, but this can be increased to 5 V/div by the use of a  $\times 10$  probe, making it useful for digital measurements. It can also be used, for example, as a marker channel for both digital and analogue applications, when the bandwidth extends to the full 40 MHz band-

width ( $-3\text{dB}$ ). The third channel's input impedance is matched to channels 1 and 2, so that swapping of  $\times 10$  or  $\times 100$  probes across all three channels causes the minimum of trace distortion. No provisions are made for an internal trigger view, which would have been helpful in some instances. On the review model, it was noticeable that the DC balance on both channels was slightly out, necessitating the need for a readjustment of the horizontal position of the Y amps on the most sensitive ranges. A trace shift of approximately 3-5 mm occurred during the warm-up period of about 10 minutes, making accurate measurements within that period difficult.

The third channel can only be displayed in the tri-trace mode and not independently, but when the nature of channel is taken into account, this should hardly be important. In the tri- or dual-trace modes the channels can either be displayed in chopped ( $f=250\text{ kHz}$ ) or alternate mode, although only CH 1 and CH 2 can be added or subtracted.

The CS has a wide range of trigger functions, typical of an oscilloscope in its class. These include a fix mode, where the unit is automatically triggered from the centre of the waveform, and an alternate channel triggering mode (or vertical mode), which is vital for stable display of non-synchronized waveforms. Other features include TV line triggering on the second timebase (B), enabling the A timebase to be triggered on the frame frequency, and perhaps displaying one frame, while the B timebase is triggering on line frequency, perhaps displaying one line of information. This section, shown on the A timebase sweep by a bright spot, is selected by the delay time multiplier. When the correct section, such as a single line, has been selected, the B timebase sweep can be displayed on its own, centred on the original A

trace. Other features of the second timebase include the more common after-delay and zero-delay functions. Performance on the trigger side was on the whole good, triggering reliably on the vast majority of waveforms. The holdoff control contributed significantly to this, enabling irregular waveforms, which otherwise may have been a problem, to be stably triggered. An IIF reject trigger coupling facility is provided, but there is a notable absence of any such LIF function. I found, however, that this did not seriously affect the unit's triggering performance, as it is sometimes possible to compensate this function by very careful adjustment of the triggering threshold. There is usually no delay when locking onto a waveform in fix mode, although on signals of approximately  $\frac{1}{2}$  div amplitude, delays of up to about 10 seconds can be observed in certain circumstances. This can usually be corrected by increasing the vertical deflection to roughly 1 div. A single sweep facility is also available for non-repetitive waveforms etc.

Timebase A on the CS-1045 covers from 0.5 s/div to 0.1  $\mu\text{s}/\text{div}$ , while the second timebase, B, covers from a faster 50 ms/div to the same 0.1  $\mu\text{s}/\text{div}$ . Both these speeds are extendable to 10 ns/div deflection speed by the use of a  $\times 10$  magnifier control. The error over the deflection speed range of 10 ns to 20 ns is surprisingly specified as  $\pm 8\%$ , although on the review model these speeds appeared to be within the more normal  $\pm 5\%$  limit. Only timebase A has a continuously variable sweep time/div control. Incidentally, neither the Y-amplifiers nor the A timebase have uncalibrated indicators to show when these controls are in use. I found that this initially led to one or two measurement errors where these controls had been used for a previous reading. Horizontal modes cover the timebase sweeps being displayed separately or alternately and there is also the usual X-Y mode. These, coupled with the B timebase mode functions, cover a comprehensive range of input possibilities from the standard delayed sweep and magnified sweep to a triggered B sweep. An external accessible intensity control for the B trace would have been helpful in delayed sweep mode, especially at the higher sweep rates. The trace separation control only allows the separation of the B sweep in the downward position and, while this helps to avoid any confusion over which trace is which, it is also slightly limiting in that often the A trace has to be repositioned to accommodate the positioning of the B trace below it. The delay time itself is controlled by a continuously variable, fully calibrated, 10-turn control over 0.2 to 10 times the A timebase speed. The action of this is very smooth and consequently allows readings to be taken very accurately, for example, over

a pulse width measurement. Calibration accuracy is good, and there is the minimum of jitter. In most cases, the results obtained with the delayed sweep ( $\pm$  a few digits) typically corresponded to those obtained from a digital counter/timer. The timebase performance is very good, but it would have benefited from a maximum timebase speed of 50 ns/div, given the 40 MHz Y-amp bandwidth and the wide bandwidth of the triggering system.

The Trio Kenwood CRT is of the 12 kV, domed-mesh variety, and produces a very clear and well focused trace, as can be expected from a tube with a reasonably high accelerating potential. The brightness is also good, although, when used in dual timebase mode, magnification ratios of over 200 can be difficult to observe on the B sweep in average bright light. When, however, the unit is used in artificial light of fairly poor brightness, it is possible to observe ratios of over 1000 times. Front panel controls for astigmatism and also for the scale illumination are provided on the CS-1045. The graticule, which is fully marked with the appropriate risetime graduations, lights to a highly visible amber colour on maximum illumination, making measurements in subdued lighting conditions an easy task. A very sensitive Z-modulation input is provided at the back panel; it has a typical sensitivity of +3 V for complete blanking to -5 V for a large increase in trace intensity. The CH 1 output is AC coupled, providing a 50 mV/div output and a reasonable degree of calibration accuracy, enabling it to be used for voltage or frequency measurements, etc. The output is also consistent over the entire deflection range, in contrast to similar outputs provided by some other manufacturers, where clipping occurs if the total deflection exceeds approximately 6 divisions. A signal delay line is also fitted, enabling the viewing of the triggering edge of most waveforms.

Internal construction is centred around four main PCBs, all of which are silk screened and single sided. The component side is screened with the track layout and this should prove a great help if any servicing is necessary. The number of boards and external connections necessitates a large number of wire links, but I am satisfied that these will in no way affect the reliability of the instrument, although servicing may be rather time-consuming. The PCBs and other components are mounted on a steel frame, from which the external casing is also constructed. This should enable the scope to be used successfully in a variety of environments. All components and presets appear to be of a good quality, especially the mode and triggering selection switches which have a light, yet very positive, action, providing easy operation of the instrument. Front panel

layout is good and allows the unit's range of functions to be quickly operated. One minor point is, however, that some of the controls extend a good distance from the front panel, and may, therefore, be easily damaged.

The 31-page manual is good, providing particular emphasis on dual timebase operation, with shorter descriptions of the more standard operating modes. Detailed sections are included on a large number of dual timebase applications which also include the appropriate examples. No circuit diagram, or description is given, but a service manual is available separately.

## Conclusion

Overall, the CS-1045 is a highly specified instrument, and should meet most users' present requirements, as well as their future ones. The delayed sweep facility is particularly good, and has some useful, if perhaps specialized functions such as independent TV line triggering. Trigger performance is also good over and beyond the stated Y-amp bandwidth. The CRT provides a fairly high standard of performance, giving a well focused trace at the vast majority of timebase speeds and magnification ratios combined with a reasonable brightness range. One or two features, such as internal trigger view or comprehensive channel selection, are not included, and this is worth considering. To sum up, the CS-1045 gives a good allround performance and is well worth considering.

The Kenwood CS-1045 was supplied by Thurlby Electronics Ltd, New Road, St. Ives, Huntingdon, Cambs. PE17 4BG. Tel. (0480) 63570

---

Other scopes available under £1500 in the Kenwood range

### CS-1021

Dual trace, 20 MHz bandwidth, 1 mV/div to 10 MHz, 50 ns/div max sweep, alternate triggering, 2 kV CRT: £319+VAT

### CS-1025

Similar to CS-1021 + 6 kV CRT, 20 ns/div maximum sweep, scale illumination.

### CS-1044

Similar to CS-1025 + 40 MHz bandwidth, variable holdoff: £575+VAT

### CS-1045

Covered in review: £695+VAT

### CS-1065

Similar to CS-1045 + 60 MHz bandwidth, 5 ns/div maximum sweep + wider bandwidth probes supplied: £795+VAT

### CS-1100A

Similar to CS-1065 + 100 MHz bandwidth, 16 kV CRT, different physical appearance: £1195+VAT

### CS-2110

Similar to CS-1100A + independent triggering of second timebase, illuminated push-button switches, 4 channel capability, 20 kV CRT: £1395+VAT

### CS-8010

10 MHz sampling cursor measurement DSO, 2k memory (8-bit), full pen recorder facilities—will be covered in a later review: £1195+VAT



# BABY PHONE



A common baby phone used for supervising the sleep of an infant or child, allows only for one way communication. Also, it can be used for monitoring the general activity in the children's room during the day.

The circuit presented here, however, allows for two way communication. It is not exactly an Intercom, but quite near to it.

It allows also for one way communication from the secondary station to the master station. The master can decide whether to switch over to two way communication. The circuit is thus a combination of a normal baby phone and an intercom.

## The Circuit

As described earlier, the circuit

provides for both, one way as well as two way communication. The mode selection is possible through switch S1, S3, and the change over switch S2. These are shown in figure 1. Switch S1 and S2 belong to the master station (A) and S3 belongs to the secondary, or slave, station (B). The unit works as a baby phone when S1 and S3 are in released

position and S2 is in the S/H position. With the switch S2 in B position, the circuit functions as an intercom, and is ready for operation. If one now wants to speak from the master station, S2 must be switched over to S/H position and S1 must be kept pressed while speaking. After speaking is over, S1 can be released and an answer from the slave station can be received. At

Figure 1

Switch S2 determines the mode of operation. S1 and S3 are push to on Key Switches, with their locking mechanism removed. S2 in B position is the standby mode, whereas S/H position gives the Intercom mode, or baby phone-hear mode.

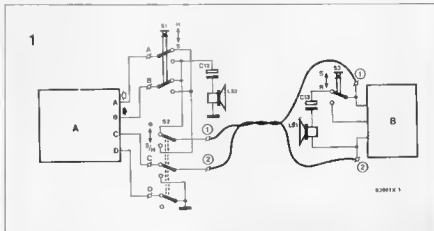

the end of conversation, S2 must be switched over to B position again.

When S2 is in S/H and S1 is in released position, there is one way communication from slave to master.

It is also possible for the slave station to request a communication with the master station. This is possible with S2 in B position (Stand by mode). When the switch S3 is pressed at the slave station, a call signal is sounded at the master station. There must be someone present at the master station to receive the call by putting the switch S2 in S/H position.

The actual circuit diagram is shown in figure 3, and is divided functionally into 6 blocks. The block diagram is shown in figure 2 and is easy to understand.

The transformer and the block A make the power supply for both the stations. The circuit uses two loudspeakers and has no microphones. The loudspeakers themselves function as microphones. In the baby phone mode, the audio signal coming from the slave station F is given to the preamplifier B in the

master station. It is then amplified and fed to the power amplifier C, which in turn sends it over to the loudspeaker LS2 in the master station.

In the intercom mode, when the master station wants to speak to the slave station the switch must be in S position. This connects the loudspeaker in master station as a microphone and feeds the audio signal to preamplifier B. The pre-amplifier amplifies it and

feeds the power amplifier C. It is then further passed on to the slave station F.

If during the standby mode, the slave station wants to communicate with the master station, the call tone generator E is activated by switch S3 (see figure 3). In the standby mode the switch in the master station is in H position, and thus enables the power amplifier C to amplify and pass on the call tone to

loudspeaker in the master station.

The block D functions as an AVC (Automatic Volume Control). It maintains the sound at a constant volume throughout the operation. This is achieved by a lamp and an LDR. If the sound level is too large, the lamp glows brightly and the LDR resistance is reduced. This drop in the resistance is used to reduce the gain of the preamplifier block B.

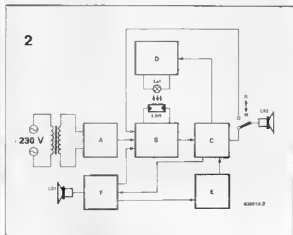
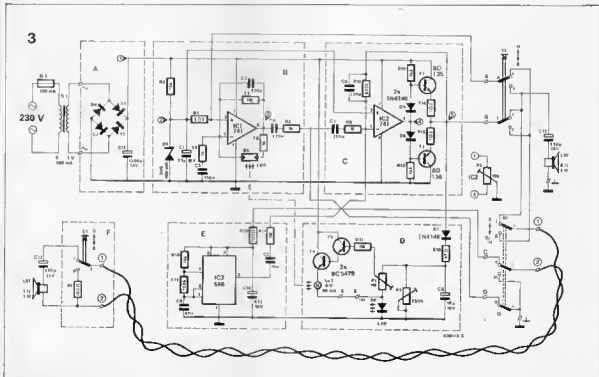

Figure 2:

The entire circuit is divided into six functional parts: Power Supply (A), Pre-amplifier (B), Power amplifier (C), Automatic Volume Control (D) and the Call tone generator (E). The slave unit is (F).

Figure 3:

The 6 functional blocks of figure 2 can be easily recognised here with their internal working details.



This avoids the overload of the power amplifier C and keeps the volume at a constant level.

Figure 3 shows all these functional blocks in greater detail inside the dotted lines, and can be easily identified as the functional blocks described above. The power supply is designed to give about 10V output. This can be achieved by using a step-down transformer of 230 : 8 V ratio.

The preamplifier consists of an op amp 741. The circuit of the preamplifier is designed in such a way that the LDR affects the gain between 2 and 1000. The resistors R4, R5 and R7 are fixed value resistors which decide the gain in combination with the LDR R6. C2 is used to limit the high frequency signals. R2 and D9 take care of the split voltage level required. Pin 6 of 741 thus lies on approximately 5 V DC. The capacitor C1 is used for suppressing the noise.

The power amplifier also uses a 741 Op amp. It also uses two transistors T1 and T2 to deliver the audio signal to the loudspeaker. The gain of this

stage is decided by resistors R8, R9 and R10, and is approximately 400. C4 is used to limit the low frequencies and C6 is used to limit the higher frequencies.

The audio output signal is rectified by D7, and is fed to the AVC section consisting of T3 and T4. C6 works as a filter capacitor. The DC voltage led to the combination of P1, P2 and D8 is thus directly proportional to the audio output. Potentiometer P1 decides the sensitivity of the AVC circuit. C8 bypasses the short duration peaks and smoothens the action of the AVC circuit. The sensitivity is also affected by adjusting P2. A break in the continuity at x - x makes the AVC ineffective.

When S2 is in B position, the unit is in standby mode.

If switch S3 is closed during the standby mode, point 1 in the slave unit gets connected to R1 and as the other end of R1 is connected to the connection point C of the call tone generator circuit, the voltage is connected through R20 to the 555 IC. The IC generates a square wave signal at pin 3 which is fed over C7 and

R11 to the output stage in master unit. The signal is reproduced through loud speaker LS2 and serves as a call tone. Communication can be established by the master station by changing over switch S2 in S/H position on hearing the call tone.

## Construction

Component layout of the main section of the circuit is shown in figure 4. This covers the master station of the circuit except the switches, power supply and the loudspeaker. The Slave Section consists of Loudspeaker LS1, Capacitor C13, resistor R1 and switch S3. These are to be wired separately.

As usual, the assembly should start with the jumper wires, then the resistors, potentiometers, diodes, capacitors and so on. The polarity for diodes and capacitors must be observed correctly. LED D8 also must be soldered with correct polarity. This LED shows when the AVC circuit is in operation, and must be fitted on the front panel of the enclosure.

## Component list

R1, R20, R21 = 100Ω  
R2 = 15 KΩ  
R3 = 8.2 KΩ  
R4, R5, R8, R9 = 1 KΩ  
R6 = LDR  
R7, R11, R17 = 1 MΩ  
R10 = 820 KΩ  
R12, R13 = 1.2 KΩ  
R14, R15 = 1.2 Ω  
R16 = 47 Ω  
R18 = 10 KΩ  
R19 = 100 KΩ  
P1 = 1 MΩ (Preset)  
P2 = 250 KΩ (Preset)  
P3 = 10 KΩ (Preset)

C1, C10 = 47 μF/16V  
C2, C6 = 220 pF  
C3 = 100 nF  
C4, C5 = 220 nF  
C7 = 10 nF  
C8 = 10 μF/16V  
C9 = 47 nF  
C11 = 1000 μF/16V  
C12, C13 = 220 μF/16V  
D1, D2, D3, D4 = 1 N 4001  
D5, D6, D7 = 1 N 4148  
D8 = LED (Red)  
D9 = Zener 5.6 V/400 mW  
T1 = BD 135 (or BD 139)  
T2 = BD 136 (or BD 140)  
T3, T4 = BC 547B  
IC1, IC2 = 741  
IC3 = 555

## Other parts:

1 Standard SELEX PCB, Size 2, (80 x 100 mm)  
1 Transformer 230 V/8 V (500 mA)  
1 Fuse (100 mA)  
1 Fuse holder

LS1, LS2 = 8 Ω/1 W loud speakers.  
S1, S2, S3 = Push button switches.

La 1 = 6V/50 mA lamp.  
Suitable enclosure  
Soldering pins, hook up wire, etc.

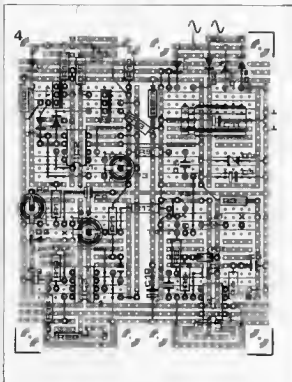

Figure 4:

Component layout for the main part of the circuit. The design is compact and soldering should be neat and clean. See text for details about installing the lamp and the LDR

The pin details of the transistors also must be followed correctly. The thick black line shown in the layout diagram is the heat sink fin of the transistors. The ICs are to be soldered in the end.

Be careful to solder the LDR in such a way that the light sensitive side of the LDR faces correctly in the direction of the lamp. The lamp is to be soldered directly without using a socket. Also important is the requirement that the LDR should be protected from external light, so that external light conditions do not affect the operation of the AVC circuit. After the soldering work is over, a black insulation tape can be wrapped around the combination of Lamp and LDR to protect them from external light. After wiring the PCB, all the external parts must be connected. These are the transformer, the switches and the loud speakers.

The testing should be done first without the ICs fitted into sockets. Keep P1 in middle position and the sliding contact of P2 in the earth position. As soon as the power is applied, D8 must glow. The voltages at various test points should be as follows.

- 1 = 10 V approx.
- 2 = 5.6 V approx.
- 5 = 5 V approx

The voltage at pin 7 of the connectors for IC1 and IC2 must be around 10 V. Now temporarily connect point B to point C and see the voltages at the pin 8 and pin 4 of socket for IC3. They must be about 5V. If they are OK, then remove the connection between B and C, and switch off the power. Now the ICs can be inserted if everything has gone all right up to this stage. The pin 1 marking on the ICs must be correctly followed.

If you switch on the power once again, after inserting the ICs, the voltages at point 3 and 4 must be now 5V.

P3 connected across the pins 1 and 5 of IC2 prevents a clicking sound coming from the loudspeaker, whenever any switch is pressed. Adjust P3 till the voltage between points A and B goes to a minimum.

Finally, disconnect the power again and install the capacitor C12 with Loud Speaker LS2. Also, connect B to C temporarily and then switch on power. A ringing tone must come from the loud speaker. Now disconnect B-C, the capacitor, loud speaker again.

The fitting inside the enclosures can now be started. S1 and S2 are similar push button switches, but the locking mechanism must

be removed from S1, so that it does not remain locked after releasing the push button. S3 is just a simple push to on type key switch. S1 and S2 connections are as shown in figure 5. Flexible hook up wire must be used for the interconnections, wherever necessary the loudspeakers are installed last inside the enclosures.

The slave station is relatively easy to construct. The components are directly mounted on the loud speaker. The key switch S3 is to be installed on the enclosure front panel. If a suitable key switch with only one pair of contacts is difficult to obtain, use same switch as S1 but use only one pair of contacts. Don't forget to remove the locking mechanism.

Use a two core shielded wire to connect the Master Station to the slave station.

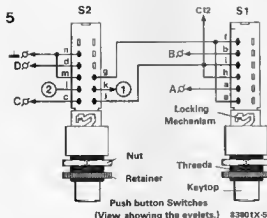

Figure 5:  
The connection details for the switches. The locking mechanism must be removed from switch S1.

# NEW PRODUCTS • NEW PRODUCTS • N

## Timer

Spradecom Electro Controls offers a range of Industrial Digital Timers for On Delay/Off Delay and Sequential operations. The elapsed time of the digital timers are displayed on four digit 1/2" LED display, which can be set with the help of thumb wheel switch.

These timers are available in standard 48H x 96W x 12 OD mm DIN size.



**SPRADECOM ELECTRO CONTROLS.** • 40, Bajson Industrial Estate, • Chakala, Andheri (E), • Bombay 400 099.

## Thermometer

RAOIX ELECTROSYSTEMS offers a pocket sized digital thermometer DIGIRAD 2000. The standard model is calibrated for Chromel/Alumel thermocouple and covers a range of -100°C to + 1200°C. The measured temperature is indicated on a 3 1/2 digit LCO display. DIGIRAD 2000 operates off a single 9



volt Eveready 216 battery. The instrument measures 75(W) x 125 (H) x 20 (D) mm.

**M/S. RADIX ELECTROSYSTEMS.** A/22, Bonanza Industrial Estate, • Kandivli (East), • Bombay 400 101.

## Wirewound Resistors

**CHESHIRE RESISTRONICS PVT. LTD.**, manufacture "CHESHIRE" Brand Wirewound Resistors in Axial, Radial and Direct PCB Mounting Types. The Resistors are available silicon coated, Ceramic encased or Vitreous Enamelled. These are available in Inductive & Non Inductive types. The Resistance range is from 0.01 to 750 K Ohms in 0.5 W to 500 W with a standard Tolerance of  $\pm 5\%$  and  $\pm 10\%$ . On request Tolerance upto  $\pm 0.1\%$  can also be provided. The Dielectric Strength is more than 700 V AC up to 1000 V AC and power rating is at 25 °C and 40 °C, derated at 0 to 300 °C and 350 °C depending on the type of Resistors. Higher Dielectric strength can be provided on request. Smaller size of Resistors in Beryllium oxide cores & Tubes are available. These Resistors are specially packed in Blisters packing for safety and easy handling.



**CHESHIRE RESISTRONICS PVT. LTD.**, • 210, Nahar & Seth Estate, • Cardinal Gracias Road, • Chakala, Andheri (E), • Bombay 400 093. • Telephone: 634 42 48. • TLX No.: 11-72395 CHES IN

## Terminal Blocks

'Nelster Welcon' offers Barrier Terminal Blocks in 5, 10 & 20 A ratings upto 22 ways in various terminal configuration with accessories to suit your requirements. Phenolic insulators are moulded in-house. Contacts are plated brass to ensure smooth contact and solderability. Screws are nickel plated brass.



**M/S. NELSTER WELCON**

• 6, Laxmi Woollen Mills Compound, • Shakti Mills lane, • Off. Dr. E. Moses Road, • Mahalaxmi, Bombay 400 011.

## Ding Dong Bell

The Rider range of electronic Fan Regulators, Light Dimmers and Musical Door Bell occupy number one position in the market today.

Ideally suited for modern homes and offices, the Rider Range is manufactured using carefully selected components and strict quality control tests. Rider offers the largest choice of designs and colours with elegant, strong reinforced plastic housing or attractive metallish finish.

The Rider Ding Dong Bell is the latest of a string of electrifying ideas from H.V. Industrial Electronics. Elegant and modern in design, it's special alloy steel plates gives a pleasing, melodious and resounding peal. It has a thicker copper coil for high durability. They are available in a choice of attractive designs and colours.

Rider also manufactures Fan Regulators, Light Dimmers, Musical Door Bells, Light Chasers, Voltage Stabilizers, Energy Lights, Disco Lights, Strobe Lights, Musical Car Reverse Horns and Musical two and three-wheeler Horns. The products are available widely throughout India at all electrical stores and automobile accessories retail stores.

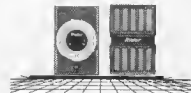

• H.V. Industrial Electronics Pvt. Ltd. • 223, Vyapar Bhavan • 49, P. O'Mello Road, • Bombay-400 009 • Tel 346022/379868

# NEW PRODUCTS • NEW PRODUCTS • N

## Z8 Microcomputer Has On-Board Eprom

ARGATE BZ-APRIL 1987-SGS has extended the popular Z8 microcomputer family with the introduction of the Z86E11, a complete single-chip microcomputer containing a powerful CPU, RAM, serial and parallel I/O ports, two counter/timers and a 4K UV EPROM. The Z86E11 can be configured as a stand-alone microcomputer, as a traditional microprocessor that manages up to 120 k bytes of external memory or as a processor element in parallel processing systems.

The Z86E11 contains a 144-byte RAM, organised as four I/O port registers, 16 control and status registers directly or indirectly via an 8-bit address field. In addition, the register file can be considered as nine 16-register workspaces and individual registers within the selected workspace can be addressed via a short 4-bit addressing mode. The workspace organisation leads to compact programs and also simplifies context switching during interrupt and subroutine calls.

The 4 K x 8 on-board EPROM can be programmed in three different ways, first using a conventional EPROM programming procedure, second using the self-programming mode that allows single bytes to be altered during normal program execution, and in addition an autoloading operation using a simple board.

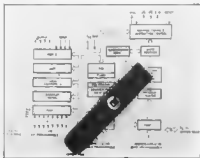

An important feature of the Z86E11 is the programmable readout protection facility which allows users to inhibit external access to proprietary program code. Readout protection is activated by programming two non-volatile transistors. Once set these security locks can be reset only by erasing the entire EPROM array.

M/S. SGS SEMICONDUCTORS (PTE) LTD., • 29, Ang Ko kio Industrial Park 2, • Singapore 2056.

## Clock Module

ION clock module F-C1 k/M6 is primarily meant for automobiles. F-C1k/M6 also finds application in UPS systems, emergency lights, battery panels etc.

The display used is 6mm vacuum fluorescent type with green glow. For variety, a transparent acrylic filter of amber, yellow, green, blue or violet can be used to change the display colour to individual taste. Time is shown in hours and minutes in the 12 hours format. An additional feature is the display of month & date in the calendar mode.



The module measures 45(H) x 81 (W) x 14 (D) mm. Four push button switches and a casing are required to complete the clock. Wiring and operating instructions are provided with every piece. To save the car battery from current drain, the display is connected through the ignition switch so that it glows only when the car engine is on.

PROMOTION, • Blk # 4, Flr # 1, • 10, Subash Cross Lane, • Bombay 400 057.

## Push Buttons & Indicators

Efficient Engineering have developed the Series 34 Lighted Push Buttons and indicators with rectangular bezel to DIN Standard 48 x 24 mm.



Two independent lamp circuits and one or two pole SPDT Self cleaning and snap acting microswitches, momentary or maintained action or any combination, offer 100% redundancy and a comprehensive functional range as shown.

Such comprehensive range, aesthetic look and ample provision for engraving on front face make these Lighted Push Buttons and Indicators ideally suitable for process Control Instrumentation, Supervisory remote Control Systems, Data Acquisition and Control Systems, Sequencing Logic Controls, Hierarchy Controls and Turn key Instrumentation.

M/s. SAI ELECTRONICS, A Div. of Starch & Allied Industries)

• Thakor Estate, Kurla Kiroli road, • Vidyavihar (West), • Bombay 400 086. • Phone : 5136601/5131219.

## Voltmeters Etc.

MECO manufactures a range of Portable Instruments for measuring various Electrical Parameters like Amps, Volts, Watts, Power Factor, Frequency, etc.,. Instruments are made in Moving Iron type, Moving Coil type, Moving Coil type, Moving Coil Transducer type & Electrodynamic type. The complete body is moulded from bakelite and the movement is placed in a separate compartment making it completely dust proof. Instrument conforms to BSS & ISS specification and is available in both Industrial Grade Accuracy & Precision Grade Accuracy.



MECO INSTRUMENTS PVT. LTD. • Bharat Industrial Estate, • T. J. Road, Sewree, • Bombay 400 015. • Phone: 4137423, 4132435, 4137253, • Telex: 11 7101 MECO IN.

# Your Right Connection... Champion

## The Champion Connectors!

- o Dual In-line IC Sockets.
- o Single In-line IC Sockets.
- o Pin Grid Array Sockets.
- o Socket Adaptors.
- o Cage Jacks.

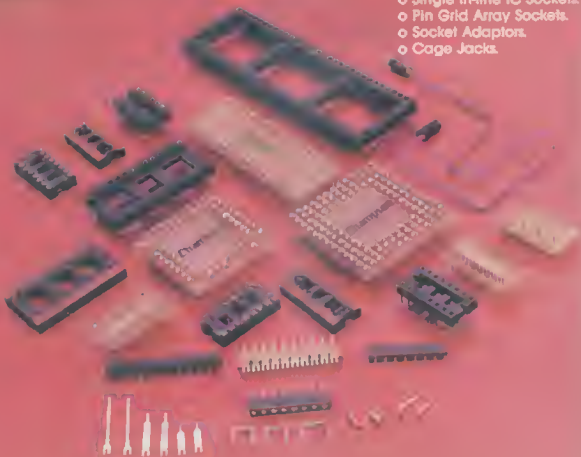

**Champion Electronics, Pvt. Ltd.**

S-17, MIDC, Bhosari, Pune 411 026, India. 212/82682-83791 Cable: CHAMPION  
Telex: 0146-343 CHMP N. 0145-333 MCCI IN. 0145-595 MCCI IN.