

49
May
1987



elektor

INDIA

144

Rs. 7.50

electronics

RIMS : COUNTING ATOMS

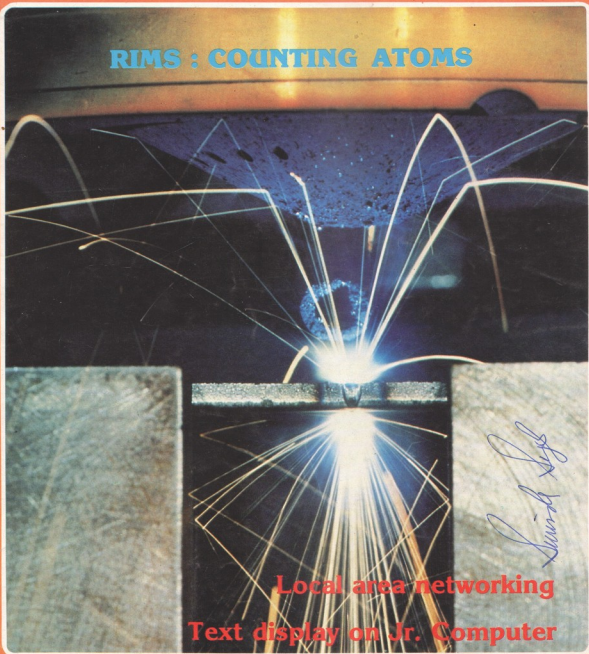

Sunil Singh

Local area networking
Text display on Jr. Computer

Publisher: C.R. Chandarana

Editor: Surendra Iyer
Editorial Assistance: Ashok Dongre
General Manager: J. Dhas
Advertising: B.M. Mehta
Production: C.N. Mithagari

Address:

ELEKTOR ELECTRONICS PVT. LTD.
52, C Proctor Road
Bombay - 400 007 INDIA
Telex: (011) 76661 ELEK IN

Overseas editions:

Elektor Electronics
Standfast House
Bath Place
High Street, Barnet
Herts EN5 5XE U.K.
Editor: Len Seymour

Publitor Publicacoes Tecnicas Ltda
Av Ipiranga 1100, 9º andar
CEP 01040 Sao Paulo - Brazil
Editor: Juliano Barsali

Elektor sarl
Route Nationale: Le Seau; B.P. 53
59270 Baillieux - France
Editors: D R S Meyer;
G C P Raedersdorf

Elektor Verlag GmbH
Susterfeld-Straße 25
100 Aachen - West Germany
Editor: E J A Krempelsauer

Elektor EPE
Karaiskaki 14
16673 Voula - Athens - Greece
Editor: E Xanthoulis

Elektuur B.V.
Peter Treckpoelstraat 2-4
6191 VK Beek - the Netherlands
Editor: P E L Kersemakers

Ferreira & Bento Lda
R.D. Estefania, 32ºº
1000 Lisboa - Portugal
Editor: Jorge Goncalves

Ingelek S.A.
Av. Alfonso XIII, 141
Madrid 16 - Spain
Editor: A. M Ferrer

In part:
Kedhorn Holdings PTY Ltd
Cnr Fox Valley Road &
Kiole Street
Wahroonga NSW 2076 - Australia
Editor: Roger Harrison

Electronic Press AB
Box 63
182 11 Danderyd - Sweden
Editor: Bill Cedrum

The Circuits are for domestic use only.
The submission of designs of articles of
Elektor India implies permission to the
publishers to alter and translate the text
and designed to use the contents in
other Elektor publications and activities.
The publishers cannot guarantee to
return any material submitted to them.
All drawings, photographs, printed
circuit boards and articles published in
Elektor India are copyright and may not
be reproduced or imitated in whole or
part without prior written permission of
the publishers.

Patent protection may exist in respect of
circuits, devices, components etc.
described in this magazine.

The publishers do not accept
responsibility for failing to identify such
patent or other protection.

Printed At:
Trupti Offset
Bombay - 400 013
Ph. 4923261, 4921354



Copyright © 1987 Elektuur B.V.
The Netherlands



Volume - 5, Number - 5
May, 1987

Sumit Singh

Electronics Technology

Electronic potentiometers	5.22
Secondary breakdown in power transistors	5.25
Linkwitz filters	5.30
RIMS : counting atoms	5.33
Where electronic messages have the edge	5.37
Local area networking	5.44
Schools equipment for tomorrow's scientists	5.45

Projects

Feedback in loudspeakers	5.19
Preset extension	5.28
MSX extensions - 5	5.40
Text display on junior computer	5.47

Information

News ● News ● News ●	5.17
New products	5.60
Info/Data sheets	5.73

Guide lines

Switch board	5.67
Classified ads	5.72
Index of advertisers	5.72
Corrections	5.72

Selex-23

Sound of the sea	5.50
Touch-Keys	5.53

FEEDBACK IN LOUDSPEAKERS

by R Conell

Electrical feedback is the backbone of many an electronic circuit. Acoustic feedback is not nearly so common, but R Conell suggests some ways of experimenting with it in a low-frequency loudspeaker.

Ever since Thiele and Small published their works on loudspeaker theory, it has been possible to calculate fairly accurately what the ideal enclosure is for a certain type of loudspeaker, or conversely how a loudspeaker will behave in a certain enclosure. According to Small, a closed box will behave as a second-order high-pass filter, while Thiele shows that bass reflex and transmission line boxes act as fourth- or sixth-order filters. From this it is clear that a closed box will give better bass reproduction than an open system.

The performance of a filter is determined by its quality factor Q and its resonance frequency f . This is also true of a complete loudspeaker system, including the enclosure, when the total Q is designated Q_{tc} and the resonant frequency f_c . In an ideal bass system, these quantities should have values as follows:

$Q_{tc} = 0.5$ to 0.7 , and

$f_c < 30$ Hz.

Moreover, the volume of the enclosure should preferably not exceed 100 litres; the frequency range should be greater than 300 Hz; and the dis-

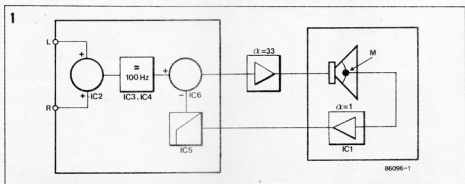

Fig. 1. Block schematic of proposed set-up with modified drive unit.

ortion should not exceed 1%. It is virtually impossible to meet these requirements with a passive speaker system, particularly as regards Q_{tc} and f_c . In an active system, it is far easier to approach the ideal. Frequency response equalization is one way to tackle the problem. Basically, it is better, however, to make use of a controlled system. Unfortunately, such a system is prone to spurious oscillations, which can, however, be obviated by negative feedback.

Basic controlled system

Control is possible by convert-

ing some of the acoustic output of the loudspeaker into an electrical signal and returning this to the input of the power amplifier. To this end, a low-mass acceleration pick-up has to be fitted to the cone of the drive unit.

The block schematic of a possible arrangement is shown in Fig. 1. The left-hand box contains the control electronics, followed by the power amplifier, which has a gain of about 30 dB, and the loudspeaker system.

The control electronics consist of an adder that combines the left- and right-hand signals, a low-pass filter with a cut-off frequency of 100 Hz, and a difference amplifier where the filtered input signal is reduced by the correction signal from the feedback loop.

The power amplifier can be of any type, but its gain should preferably be about 30 dB. A smaller gain would require some adjustment of the control loop, while a higher gain increases the tendency to oscillations in the loudspeaker system.

The loudspeaker system contains the drive unit, fitted with the acceleration pick-up, M, and an impedance converter, IC.

Impedance converter

The impedance converter—see Fig. 2—consists of a Type TL071 operational amplifier. Its pin-out is shown in Fig. 3. This stage should be fitted as close as possible to the acceleration pick-up, preferable direct onto the chassis of the drive unit as shown in Fig. 7.

Control circuits

Adder IC₂ in Fig. 3 combines the two stereo signals into a monaural signal. Potentiometer P₁ sets the input level for low-pass filter IC₃-IC₄. This Bessel filter has a cut-off frequency of 100 Hz and a roll-off of 24 dB/octave. A similar filter was described in the January 1986 issue of *Elektor India*.

The control amplifier proper is formed by IC₅; the values of R₃, R₁₁, and C₃ determine the transient response of the overall system. These values will be reverted to under *Setting up*.

The control signal is deducted from the filtered audio signal in subtractor IC₆. The output of this stage is fed to buffer IC₇ via two low-pass sections, R₁₂-C₁₁ and R₁₇-C₁₂. These sections further suppress any tendency to oscillation and are absolutely necessary.

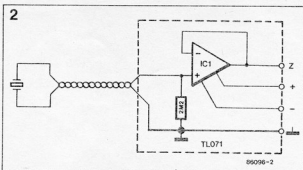
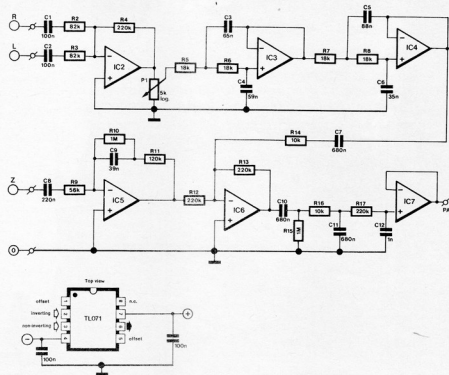

Fig. 2. Circuit diagram of the impedance converter. The pin-out of the TL071 is shown in Fig. 3.



86096-3

Fig. 3. Circuit diagram of the control electronics.

It is possible to omit impedance converter IC₅ and buffer IC₇, but the values of the low-pass sections between IC₆ and IC₇ should then be recalculated with due account of the input impedance of the power amplifier.

Modifying the drive unit

The acceleration pick-up is made from a piezo tweeter from which the chassis has been removed as shown in Fig. 4. The connexion wires have been cut

at the terminals, *not* at the crystal end. The remaining cone is then cut to the same size as the piezo disc.

The resulting acceleration pick-up may be fitted over or under the dust cap of the woofer. The latter method is preferable, but only possible if the dust cap has been fastened with a thermoplastic glue. The cap may then be removed quite easily with a heated knife as shown in Fig. 5. The removal of the cap should, of course, be carried out with the greatest care to avoid damage to the cone of the

drive unit or its speech coil.

Once the dust cap has been removed, it should be stiffened with a thin layer of epoxy resin and a piece of glass fibre cloth at its inside—see Fig. 6. The epoxy resin may be used at the same time to fix the pick-up in place. In the mean time, the woofer should be kept upside down to prevent dust entering the air gap.

After the epoxy resin has hardened, a thin flexible wire should be soldered to each of the two short connexions of the pick-up. These wires should

also be glued to the dust cap to prevent them vibrating in unison with the cone later.

Next, the dust cap can be fastened onto the cone again, preferably with thermoplastic glue to enable removal at a later stage if necessary. Before gluing it in place, however, pierce a small hole in the cone through which the flexible wires are fed. These wires should be glued to the cone in the same way as those to the speech coil. Finally, they should be connected to the impedance converter board as shown in Fig. 2 and

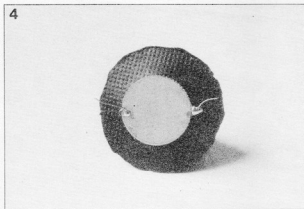

Fig. 4. Piezo tweeter after its chassis has been removed.

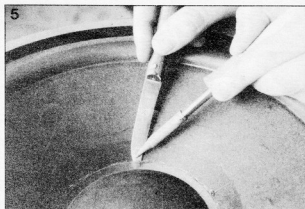

Fig. 5. Removing the dust cap from the cone of the bass drive unit.

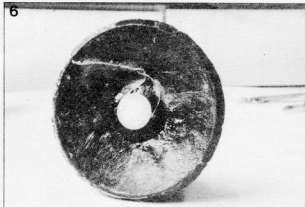

Fig. 6. the dustcap should be stiffened on its inside with a thin layer of epoxy resin, which can be used at the same time to fix the acceleration pick-up.



Fig. 7. The modified bass drive unit: note how the impedance changer is fixed to its chassis.

Table 1

Harmonic distortion at 96 dB at 1 m distance

Frequency (Hz)	30	40	70	100
Without feedback	4.5%	1.7%	0.65%	0.85%
With feedback	1.5%	0.6%	0.5%	0.65%

Maximum sound pressure at 40 Hz with different enclosure volumes

Volume (litre)	50	70	100
Without feedback	98 dB	100 dB	102 dB
With feedback	101 dB	103 dB	105 dB

System parameters measured in a 70 l enclosure

	Q_{tc}	f_c	f_3 dB
Without feedback	1.9	48 Hz	29 Hz
With feedback	0.6	17 Hz	20 Hz

Fig. 7. They should preferably be of about the same length as those to the speech coil. The drive unit is then ready for operational use—see Fig. 7.

Setting up

All the constituent parts of the system should now be interconnected as shown in Fig. 1. Short out R_{11} and C_8 with the aid of a switch to disable the control circuit. When the switch is opened momentarily, one of three things will happen:

- the loudspeaker remains quiet;
- the system oscillates at a low frequency (<100 Hz);
- the system oscillates at a high frequency (>1 kHz).

In the first case, everything is in order and the system can be

taken into use.

In the second case, the connections from the pick-up to the impedance converter board must be reversed.

In the third case, the oscillations must be damped by changing the values of a few components. First, increase C_{12} to 1n8 and, if this does not help, C_{11} to 1 μ F. If that still does not cure the problem, reduce the value of R_{11} and increase that of C_8 . Resistor R_{11} affects the lower cross-over frequency, while C_8 alters the Q_{tc} of the system. The author has built several of these systems and has never encountered oscillation problems. Do not forget to remove the switch from across R_{11} and R_9 .

Finally

The frequency characteristics in Fig. 8 show the results of the modification: it is quite evident that the lump between 30 and 100 Hz in the response of the system disappears when the feedback is introduced. The response between 20 and 30 Hz is also much improved.

A number of pertinent measurements are tabulated in Table 1.

The system with feedback was also compared with a number of top quality loudspeaker systems: in all cases, it performed equally well over the bass range, in spite of its cost being only a fraction of that of the competition.

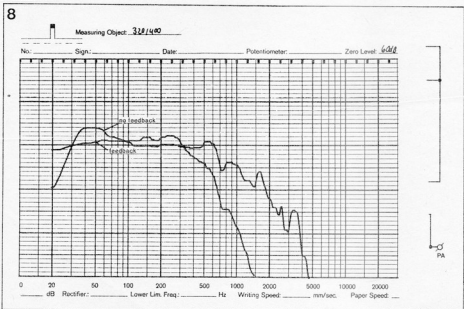

Fig. 8. The frequency response curves of the system with and without feedback.

ELECTRONIC POTENTIOMETERS

by T Scherer

An exploratory look at all-electronic replacements for potentiometers in high quality AF applications.

Potentiometers are, arguably, not the best way of controlling the volume and tone settings in an AF amplifier. We all know that they can cause scratching noises when operated, collect dust, and sometimes develop contact problems giving rise to troublesome discontinuities in the operative range. High quality potentiometers for AF applications are not only difficult to obtain, but also notoriously expensive. In the following sections we will briefly examine a

number of low-cost alternatives to potentiometers used in various circuit sections of AF equipment.

The carbon track potentiometer

This most commonly used voltage divider is generally composed of a carbon film deposit on a ceramic base arranged in a three-quarter circular form (270°). The poor contact definition of the wiper

on this thin carbon film readily gives rise to scratching noises made audible in the loudspeakers. Furthermore, dust and foreign particles can easily enter the potentiometer enclosure, and block certain sections of the carbon track, so that the amplifier falls still at particular volume settings, making the adjustment very difficult.

Stereo potentiometers of the carbon film type are a further source of trouble. With most inexpensive types, the tolerance

on synchronicity of the set resistance is often no less than 20%, even with linear law types. The voltages at the wipers of a logarithmic stereo potentiometer can also differ by some 20%, causing a volume difference between the channels of a maximum of 2 dB, which may be noticeable in listening. Potentiometers are generally mounted on equipment front panels, and are connected to the electronic circuit with the aid of shielded wires that often

1a Opto-couplers

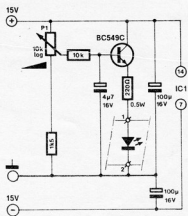
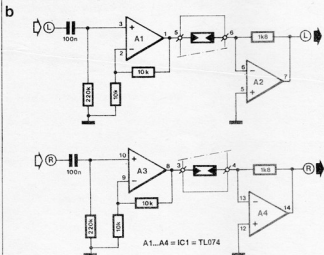
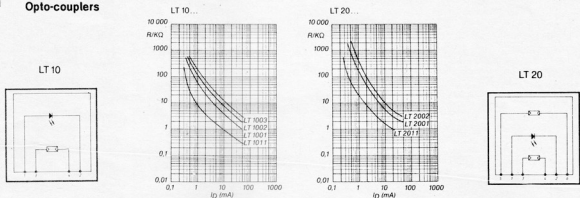

Fig. 1. Experimental stereo volume control circuit based on the use of a LED-LDR optocoupler.

carry very low signal level at relatively high impedance. This makes the amplifier susceptible to noise, hum and strong RF fields, which can still be picked up by the carbon track in the potentiometer (plastic enclosures!), and even in the cable shield.

In conclusion, it is reasonable to say that the standard carbon track potentiometer is unsuitable for a great many critical applications.

Stepping switches

Rotary (wafer) switches with fixed resistors at the contacts are, in principle, a good way to effect volume and tone setting in an amplifier. The tracking is adequate, and scratching noises due to spindle movement are effectively ruled out. However many rotary switches of suspect quality do develop contact problems after prolonged use. A major difficulty in the designing with stepping switches is the finding of types having the number of positions required to ensure a sufficiently smooth adjustment range.

Wire-wound potentiometers

Long ago in the history of electronics, all potentiometers and resistors were made from resistance wire. For a number of specific applications, the wire-wound potentiometer is still in use. Ganged types with motor drive units can be found in some of the most expensive types of amplifier. This application, however, requires sophisticated mechanical engineering on the one hand, and a fairly complex electronic control circuit on the other, making the whole set-up rather cumbersome and expensive at the same time.

An LDR-based potentiometer

The first attempts at making a fully electronic potentiometer were carried out with combinations of LDRs (light dependent resistor) and a small bulb. Although the results were quite satisfactory for AF equipment on the market in the early 1960s, we would nowadays reject the LDR-and-bulb control for incorporation in Hi-Fi equipment in view of the noise production,

2

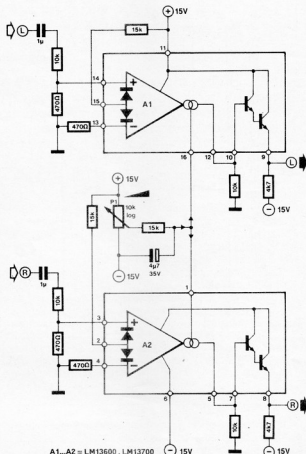

A1...A2 = LM13600, LM13700

87301-2

Fig. 2. OTAs in use as a Hi-Fi stereo volume control.

rumble sensitivity, and poor tracking characteristic of the stereo versions.

We all know that each and every electronic component remains subject to continuous enhancement by the joint force of manufacturers and their research laboratories. The German firm Heimann, for instance, took up the long forgotten LDR for further research, and used two of these devices together with a LED to make an optocoupler that has adequate features for Hi-Fi applications. The LDRs in their Types LT10xx and LT20xx optocouplers are of excellent quality, and especially the LT20xx should do very well as a stereo potentiometer with adequate tracking properties—see Fig. 1a for the pinning and R-I curves, and Fig. 1b for a suggested application circuit.

An OTA-based potentiometer

A fairly simple potentiometer replacement can be realized with the aid of an OTA (operational transconductance amplifier), which is essentially an amplifier with current-controlled gain. The gain range of about 80 dB, the extensive usable frequency range and linearity of the current-gain correlation, make an OTA such as the Type LM13600 eminently suitable for the applications we are concerned with here.

Those who want to experiment with these devices will find the suggested circuit in Fig. 2 of use for further experiments. The only drawback associated with OTAs is their limited dynamic range, which results in a maximum attainable signal-to-noise ratio of about 80 dB.

Analogue multiplexers

The circuit shown in Fig. 3 is a high-quality, all-electronic volume control featuring 16 dB and 2 dB steps as controlled from a 6-bit digital input. The ICs in this circuit are the well-known Type 4051 eight-channel analogue multiplexer/demultiplexer, which is in essence an electronic version of an 8-way, single pole rotary switch. The contacts are inputs 0-7, the pole is output Z, and the switch position is set with the 3 bits at the A-B-C inputs. Example: applying binary code 010 to the A-B-C inputs of the left-hand multiplexer connects input 2 (pin 15) to output Z. The input signal for opamp A₁ is therefore taken from the -32 dB contact on the resistor ladder. The resistors at the inputs of the second multiplexer driving A₂ are dimen-

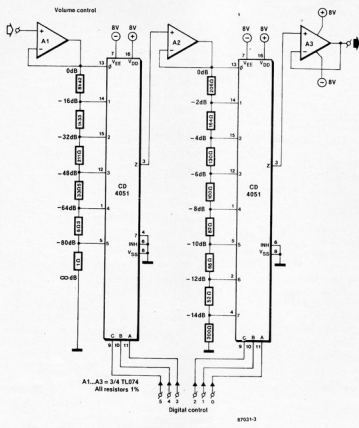

Fig. 3. A 6-bit high quality volume control circuit that uses CMOS analogue multiplexers.

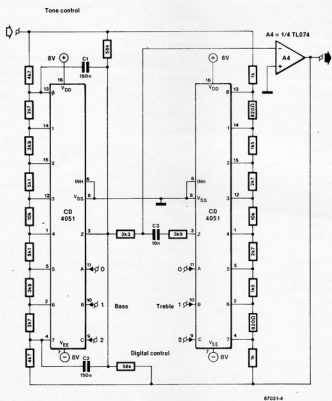

Fig. 4. Using electronic switches instead of a potentiometer in a tone control circuit.

Table 1

INPUT STATES				"ON"
INHIBIT	C	B	A	CHANNEL(S)
CD4051B				
0	0	0	0	0
0	0	0	1	1
0	0	1	0	2
0	0	1	1	3
0	1	0	0	4
0	1	0	1	5
0	1	1	0	6
0	1	1	1	7
1	X	X	X	NONE

sioned to give 2 dB attenuation steps, so that the overall range of this electronic potentiometer is from 0 to -96 dB as set with 6 bits. A balance control can be made with two of these circuits, operated on the basis of software.

The tone control section shown in Fig. 4 uses the same principle as the above volume adjustment. The resistors as part of the R-C filters in the feedback loop of A_4 are selected with 3-bit codes for bass and treble.

Use high-stability resistors and capacitors when constructing these circuits, and provide ample decoupling of the supply lines. The opamps should be low-noise types such as the TL074 indicated in the circuit diagram. The digital adjustment of the volume and tone control circuits is a matter we leave in your hands. You may want to use an up/down counter, a microprocessor port, or a special switch to arrange for the correct bit combinations at the multiplexer control inputs (consult Table 1).

SECONDARY BREAKDOWN IN POWER TRANSISTORS

by Sue Cain & Ray Ashmore *

This article examines the different types of secondary breakdown that occur in power transistors, and investigates the phenomena that cause them. It concludes that secondary breakdown is a function of transistor technology, and cannot always be improved without some trade-off in other parameters.

One of the basic failure mechanisms in power transistors is second breakdown.

This term includes various physical phenomena which are completely different. They depend on the different use of transistors in the circuits and have in common the electrical and thermal instability inherent in transistors themselves.

The conduction behaviour of an emitter base junction and the current gain of a transistor depend significantly on the temperature and increase as a function of the temperature. Electrical and thermal instabilities may act simultaneously within the device, thereby giving rise to destructive second breakdown mechanism.

An understanding of this mechanism is of great importance for a safer optimum application of a power transistor.

A distinction should be made between direct second breakdown ($I_{S/B}$) which is distinguished by a normal direction of base current I_B (entering into an NPN transistor) and inverse second breakdown ($E_{S/B}$), when I_B is in the opposite direction (extracted from an NPN transistor). The limits to which a transistor may be used without entering into $E_{S/B}$ are defined by the reverse bias safe operating area (RBSOA).

Direct second breakdown

It is important for the power circuit designer to know the locus of the I_C - V_{CE} points defining the boundary between stable and unstable operation of forward biased transistors. This locus defines the SOA safe operating area, that is, the area

of the $\log I_C$ - $\log V_{CE}$ plane which may be used without any risk in DC current conditions or with different width pulses at a known temperature. A typical SOA is shown in Fig. 1. The limits of this area are as follows:

- 1) The A-B section represents the upper limit of the collector current that may normally be used, generally limited by wire bonds. Operation at higher currents may cause damage to the wires of their bonding.
- 2) The B-C section is the -I slope curve section (i.e. the section with constant dissipation) defined by:

$$V_{CE} I_C = P_{max} = (T_{jmax} - T_c) / R_{\theta} \quad [1]$$

This section therefore indicates the maximum dissipable power of the device. T_{jmax} is the maximum temperature which the collector-base junction may reach, over which the device reliability may be compro-

mised. In power transistors, T_{jmax} varies between 125 and 200 degrees Celsius and generally depends on the metallurgy and the type of package. R_{θ} is the thermal resistance between the collector-base junction and the case, including all the silicon and package system. The increase in the maximum dissipable power when the pulse width decreases (Fig. 1) corresponds to the decrease of Z_{θ} with respect to R_{θ} .

3) Section C-D corresponds to the second breakdown phenomenon (or $I_{S/B}$) and limits the maximum power that the transistor can dissipate. This may occur even at relatively low V_{CE} voltages.

4) Section D-F is the limit due to the transistor's EV_{CE0} .

Second breakdown is generated by the electrical and thermal instability of the transistor. The main causes of this instability are:

- 1) The V_{BE} of a directly biased base-emitter junction, at constant current, decreases linearly with temperature, with a ± 2 to 2.5 mV/°C slope. The base current of the transistor may therefore be expressed by:

$$I_B = I_{C0} \exp(eV_{BE} - I^2 / kT) \quad [2]$$

and, when V_{BE} is kept constant, it increases with temperature.

- 2) The h_{FE} at the relevant voltage values increases as a function of temperature according to the law:

$$h_{FE} = h_{FE0} \exp(\Delta E_g / kT) \quad [3]$$

Where ΔE_g is an activation energy which is a feature of the transistor.

- 3) The thermal conductivity of silicon decreases when temperature rises, causing a worsening of the thermal resistance of the transistor.

When these three phenomena are taken into consideration, it may be observed that a pulse of power $P = V_{CE} I_C$ generates:

- a) an increase of the junction temperature, giving rise to an increase of I_B and h_{FE} , and therefore to an increase of I_C with a following increase of P and, therefore, a further temperature increase.

- b) a dissipation to the external environment, controlled by the thermal resistance $R_{\theta} = dT/dP$ which tends to stabilize the device.

The situation evolves towards stability when:

$$\frac{\Delta I_C}{I_C} = \frac{\partial I_C}{\partial T} V_{CE} R_{\theta}$$

is smaller than 1, or instability if > 1 .

In this way, a stability factor, S , may be defined that will be a function of V_{CE} and I_C :

$$S = R_{\theta} V_{CE} \frac{\partial I_C}{\partial T} \quad [4]$$

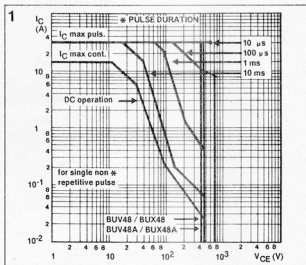

Figure 1. Safe operating areas which may be used without any risk in DC current conditions or with different width pulses at a known temperature.

When $S > 1$, so called "thermal runaway" occurs and the junction temperature increases without any limit, thereby degrading and possibly damaging the transistor. The failure generally occurs when the surface temperature becomes greater than the eutectic temperature between silicon and the contact metal (front aluminium) with a consequent melting of the alloy. A localized temperature increase may also damage the crystal, or the inner temperature of the device may reach values high enough to melt the silicon.

To understand $I_{c/b}$ phenomena which give rise to a reduction of the maximum power that the transistor can dissipate as V_{CE} increases (zone D-E), it is necessary to take into account that device operation is not homogeneous on all the dice area. There are disuniformities in the emitter base current density that may be due to junction disuniformities, crystal defects and, most of all, to the emitter edge concentration phenomenon.

The voltage drop due to the base current flowing through the cross resistance $r_{bb'}$ gives rise to a disuniformity of V_{BE} at the junction, and therefore to the disuniformity of the current density J_E (see Fig. 2).

A side drop of 26 mV reduces the injected emitter current by a factor $1/e$, where e is the base of the natural system of logarithms ($= 2.71828 \dots$).

A concentration of the current at the emitter periphery is therefore generated, so the active silicon area is reduced and hot spots occur, leading to an effective increase of the thermal resistance. As a result, the maximum dissipable power is decreased.

When V_{CE} is increased, the effect of the base-collector electric field is to increase the base current concentration.

Different techniques may be adopted to limit the $I_{c/b}$ phenomenon. Fundamentally, these consist of minimizing the mechanisms that trigger electrical and thermal instabilities in the transistor. The basic techniques are:

- 1) minimization of crystal damages, metal impurities, and doping disuniformities;
- 2) optimization of package and die attach techniques to minimize the thermal resistance

on which the stability factor S depends. Disuniformities of silicon die bondings to the case may give rise to adverse variations of R_{θ} as a macroscopic parameter for the dice as a whole, but also to significant variations between different points, giving rise to premature second breakdown;

- 3) increase of the base thickness to reduce the high current densities (due to emitter crowding) flowing through the collector base junction (where the electric field is localized), so that the density of the dissipated power is decreased. High base thicknesses, however, will result in lower cut off frequencies and slower switching times;
- 4) optimization of the horizontal geometry;
- 5) introduction of distributed

ballast resistances connected in series with the base, the emitter or both, which tend to give a negative feedback to thermal runaway, therefore stabilizing the device. The introduction of a ballast resistance in series with the base of the emitter may reduce from J_1 to J_2 the current density in the hot spot. The emitter ballast res-

istance is generally obtained by opening emitter contacts thinner than the emitter strip. In this way it is possible to limit the current density at the boundaries of the emitter. These resistances show the drawback of increasing the saturation voltage of the transistor by the amount $V_{CE(sat)} = REI_{C(sat)}$.

On the other hand, the base ballast resistance is obtained through a "N⁺ pocket" (in the case of NPN), around the emitter area. This N⁺ diffusion, being unbiased, cannot be traversed by the base current, so this is forced to flow below the N⁺ through a small section and, in the case of a diffused base, encounters a higher resistance on the way to the edge of the emitter. In this way it is possible to improve $I_{c/b}$ significantly.

It should be noted that the SOA limits are temperature dependent and suitable derating must be applied.

Reverse second breakdown

The reverse breakdown phenomenon ($E_{c/b}$) is also due to thermal and electrical in-

stability of the transistor. As already mentioned, it is distinguished from $I_{c/b}$ by the presence of a reverse I_B (i.e. with a direction opposite to the normal direction of a transistor operating in the active zone) and by high V_{CE} values of the transistor. The device may be in these working conditions during turn-off with an inductive load.

In Figure 3 the common emitter characteristic curves for a transistor are shown.

It is easy to understand the behaviour of these curves when the common emitter gain expression is considered:

$$h_{FE} = A_F / (1 - A_F) \quad (5)$$

for high V_{CE} values, A_F is replaced by MA_F .

For low V_{CE} values, M is an insignificant factor, being very close to 1: it increases when V_{CE} is increased according to the following expression:

$$M = 1 / [1 - V_{CE} / (BV_{CEO})] \quad (6)$$

From expressions (5) and (6) it is clear that h_{FE} depends on V_{CE} , becoming infinite when $MA_F = 1 / BV_{CEO}$.

The negative slope section, which is a feature of the curves with $I_B < 0$, is due to the fact that A decreases at low values of the emitter current.

During turn-off with an inductive load, the transistor has to operate with negative base current and a high value of I_C . It often has to reach a working area above V_{CEO} , remaining there all the time required for the inductance to be discharged. Fig. 4 shows the behaviour of I_C , V_{CE} , I_B and the power dissipated by the transistor during turn-off.

The area of the dissipated power corresponds to the energy stored by the inductance, $\frac{1}{2}LI^2$, which is discharged into the transistor and this is called second breakdown energy ($E_{c/b}$).

Like $I_{c/b}$, the voltage drop due to the reverse I_B flowing through the side resistance $r_{bb'}$ makes the centre of the emitter strip more biased than its periphery. In this way, a current concentration occurs at the emitter centre.

Let us analyse the case of an NPN transistor with diffused base and epitaxial collector, i.e. with constant concentration ND of donors doping particles.

Poisson's equation is:

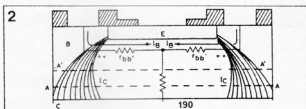

Figure 2. The voltage drop resulting from the base current flowing through the cross resistance $r_{bb'}$ gives rise to a disuniformity of V_{BE} at the junction, and so to the disuniformity of the current density J_E .

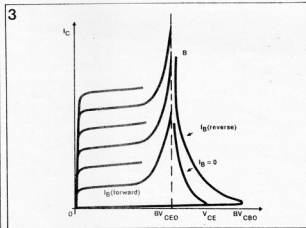

Figure 3. The common emitter characteristic curves for a transistor.

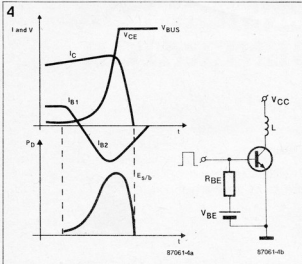

Figure 4. The behaviour of I_C , V_{CE} , I_B and the power dissipated by the transistor during turn-off.

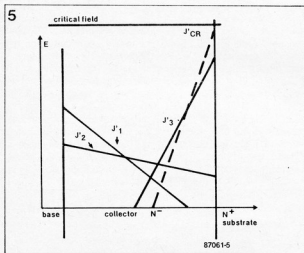

Figure 5. Typical electric field behaviour when the collector current is limited to low values.

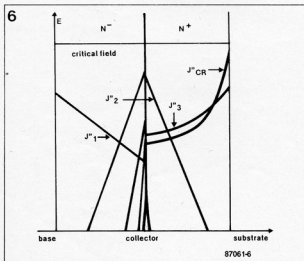

Figure 6. The condition created by the intermediate layer inserted between the collector and the substrate in order to obtain high $E_{s/b}$ values.

$$dE/dX = dV/dX = p(x)/\epsilon \quad [7]$$

The X axis is normal to the silicon dice surface, (x) is the charge per unit volume, E is the dielectric constant of silicon. When the collector current is limited to low values, expression [7] becomes (q being the electron charge):

$$dE/dX = qNo/\epsilon \quad [8]$$

and the electric field behaviour is similar to that shown in figure 5 for $J_C = J'_1$.

The voltage V_{CB} ($= V_{CE}$) is given by the area of the $E-X$ graph and is smaller than primary breakdown voltage due to the reaching of critical field E_{cr} . In the presence of significant values of current density J_C , the expression [8] is modified due to the concentration of electrons flowing at the speed V through the depletion layer.

$$dE/dX = [q(ND-n)]/\epsilon \quad [9]$$

where $n = J_C/qV$. At constant V_{CB} , the area limited by E has to remain constant. When J_C increases, the $E-X$ slope varies (J'_2) until its sign is changed (J'_3) and E_{cr} is reached (J'_{cr}). At this point avalanche local multiplication of electrons occurs with an uncontrolled current increase—and so a strip is formed with a very high temperature that gives rise to either crystal damage or silicon melting. Possible crystal defects, metal ions, and junction discontinuities further exaggerate this phenomenon. The avalanche multiplication is very fast and very localized so the device remains externally cold. The $E_{s/b}$ behaviour is not influenced by the die bonding quality. High $E_{s/b}$ values can be obtained with a proper geometric design to limit the current crowding and, most of all, by inserting a second epitaxial layer N of intermediate doping between the collector and the substrate.

The intermediate layer creates the condition shown in Fig. 6. When the current density increases (J'_2) the electric field at the interface N/N is increased. Before the critical field E_{cr} is reached at the interface, the contribution of layer N becomes significant in sustaining the voltage. A further density increase (J'_3) reduces the electric field at the interface

N/N and the breakdown is not triggered until the critical field is reached at interface N/N^+ . For a good power transistor with $V_{CE0/SUS} = 450V$, the current density J'_{cr} corresponding to E_{cr} is of the order of $20A/mm^2$, i.e., greater by a factor 10 when compared to the average current density given by the ratio between maximum saturation current and emitter area.

The $E_{s/b}$ behaviour is also influenced by the conditions outside the transistor, R_{BE} , V_{BE} , L . The base conditions are especially important, as they regulate the crowding phenomenon.

The system most commonly used by power designers to reduce the $E_{s/b}$ effect during turn off with inductive load is a clamping or 'snubber' circuit, that limits the voltage peak between collector and emitter.

The presence of the clamping circuit allows only a minimal amount of the energy stored in the inductance to be absorbed by the transistor, and $E_{s/b}$ becomes independent of the value of L and practical RBSOA limits may be defined.

The presence of high V_{CE} and negative base current, I_B , may give rise at high current to the previously described $E_{s/b}$ phenomenon, even in the presence of the clamping circuit. The multi-epitaxial transistors show a better behaviour even in the presence of a clamp.

The reverse bias safe operating area establishes the maximum switchable current with inductive load versus clamping voltage in very harsh base conditions that simulate the real base driving conditions in the circuits.

The temperature is not a major factor in the $E_{s/b}$ and so the RBSOA rating can be considered to be independent of temperature.

Conclusion

Second breakdown performance is a function of transistor technology and cannot always be improved without some trade-off in other parameters. The application conditions have a considerable effect on both $I_{s/b}$ and $E_{s/b}$ capability.

* Sue Cain is with BA Electronics and Ray Ashmore is with SGS.

PRESET EXTENSION FOR FUNCTION GENERATOR

by M Kistingner

A simple to build, ten-frequency preset unit for the Elektor Function Generator that features an adjustable sweep function, a LED indication, and much more at a very small outlay.

The AF Function Generator described in *Elektor India*, January 1985, has generated a lot of interest, which is mainly due to the instrument being versatile, relatively simple to construct, and sufficiently accurate for a great many applications. The preset extension proposed here is a separately housed, 10-way programmable ancillary intended to drive the generator's VCO input. Frequencies that are often used for test and measurement purposes can be called up at the click of a switch, and there is also a facility to successively select all ten of them at variable speed, providing a 10-frequency sweep function. Furthermore, the extension provides an output signal to trigger an oscilloscope with any one of the ten available frequencies.

Ease of control is the key word in this design. Once you have set the ten generator output frequencies with the aid of multitrans presets, you can select manual operation on the extension and press the SINGLE STEP key until the relevant frequency is enabled, as indicated by the associated LED. If the MAN/AUTO switch is in the AUTO position, the VCO voltages are successively output at a rate defined with the SPEED potentiometer and the FAST/SLOW push-button selector. A BCD (thumbwheel) switch is used to select the period of one of the 10 available VCO voltages for triggering an oscilloscope.

Standard components are used throughout this extension, which will quickly prove an indispensable add-on unit that can save you quite some time in setting the generator's output frequency.

Circuit description

The circuit diagram of the proposed extension is shown in Fig. 1. At the lower left is the power supply, which delivers +5 V for the logic circuits, and +10 V for the sweep oscillator, IC₁, and the VCO output drivers, T₁-T₁₀. The latter voltage is provided by a precision regulator Type LM317 (IC₂) to ensure the stability of the ten VCO drive levels. The +5 V supply is conventionally based on a Type 7805 regulator which can easily handle the 150 mA current demand of the (LS)TTL circuits.

With S₁ set to MAN, depression of SINGLE STEP push-button S₂ causes N₁ and delay network R₁₀-C₁ to provide a trigger pulse to the B input of monostable multivibrator IC₃, whose output period is defined with R₁₂-C₂. As S₁ is open, the pulse at output Q of IC₃ is passed through gates N₁₅ and N₁₇ and fed to the clock input of counter IC₁.

If S₁ is in the AUTO position, N₁₅ blocks the SINGLE STEP pulses from IC₃, and IC₃ is arranged to be clocked from oscillator IC₁ via level translator T₁₂. Potentiometer P₁ and FAST/SLOW push-button S₃ allow precise setting of the VCO sweep speed. Note that S₃ is actually part of the SPEED potentiometer, so that turning this fully counter-clockwise automatically enables manual selection of the direct voltage level from the preset extension, and hence of the function generator's output frequency.

Counter IC₁ is advanced by pulses from N₁₇, and the BCD code at its QA-QD outputs is applied to the XOR gates in IC₄, as well as to BCD-to-decimal decoder IC₅. The Type 74LS90

counter is set up to count from 0 to 9, and is reset to state 0 at power-on with the aid of C₃-R₁₄. The trigger signal for the oscilloscope is obtained from N₁₃-N₁₄ and N₁₈-N₁₉, which function as a 4-bit comparator in conjunction with IC₆ and a BCD switch for selection of the relevant trigger pulse. The output of N₁₉ goes high if the logic state of outputs QA-QD on IC₅ matches that of the A-D lines on the BCD switch.

Any one of the 10 outputs of decoder IC₅ can enable an associated driver stage, whose direct output voltage is defined

with a multitrans preset. If, for instance, output 9 of IC₅ goes low, the output of open-collector inverter N₁₂ goes high. Transistor T₁₀ is turned on, LED D₁₀ lights, and a portion of the emitter voltage is fed to the VCO input of the function generator, via the wiper of P₁₂ and summing diode D₁₀. The circuit around T₁₁ serves to raise the ground potential of the extension so as to increase the active range of the presets in the analogue output stages. It should be noted that this arrangement makes it impossible to feed the preset extension from the generator's

Parts list

Resistors (± 5%):

R₁, R₂ = 4K22; 1%
R₃ = 100K
R₄, R₅ = 5K6
R₆, R₇, R₈, R₉, R₁₀, R₁₁, R₁₂ incl. = 10K
R₆ = 1K5
R₁₃, R₁₄, R₁₅, R₁₆ incl. = 1K0
R₁₇, R₁₈, R₁₉, R₂₀ = 1K2
R₂₁, R₂₂ = 220R
R₂₃, R₂₄, R₂₅ incl. = 270R
R₂₆ = 100R
P₁ = 500K linear potentiometer with SPST switch (S₃)
P₂ = 5K0 preset
P₃ ... P₁₂ incl. = 4K7 multitrans preset

Capacitors:

C₁, C₂ = 100n
C₃ = 2µ2; 25 V
C₄ = 10µ; 10 V
C₅ = 1µ; 35 V
C₆ = 4µ7; 63 V
C₇ = 1000µ; 40 V
C₈ = 47µ; 63 V
C₉ = 10µ; 35 V
C₁₀ = 2µ2; 25 V
decoupling capacitors (100n) as required

Semiconductors:

B₁ = B80C1500
D₁ ... D₁₀ incl.; D₂₂ = 1N4148
D₁₁ ... D₂₁ incl. = LED
D₂₃ = 1N4007
IC₁ = 741
IC₂ = 74121
IC₃ = 74LS90
IC₄ = 74LS86
IC₅ = 74LS42
IC₆, IC₇ = 7405
IC₈ = 74LS02
IC₉, IC₁₀ = 74LS50
IC₁₁ = 7805 plus heat-sink
IC₁₂ = LM317T
T₁ ... T₁₀ incl. = BC549B
T₁₁ = BC237B
T₁₂ = BCY59

Miscellaneous:

F₁ = 100 mA; delayed action.
Fuseholder for F₁.
T₁ = 15 V; 200 mA.
S₁, S₂ = push-to-make button.
S₃ = part of P₁.
S₄ = SPST mains switch.
Suggested enclosure: Verobox Type 75 3007C (180 × 120 × 40 mm).
Prototyping board (Veroboard) as required.
BCD Thumbwheel switch

LINKWITZ FILTERS

A brief look at the theory and practice of passive and active Linkwitz cross-over networks.

An analysis by Siegfried Linkwitz in the January 1976 issue of the *Journal of the Audio Engineering Society* shows that conventional cross-over filters have a negative effect on the radiation pattern of a multi-way loudspeaker system as regards both directivity and amplitude. On the basis of his research, Linkwitz proposed a new type of network that gives a uniform radiation pattern and constant amplitude. This filter, which is essentially a Butterworth-derived type, was first described by Riley and is, therefore, sometimes referred to as a Linkwitz-Riley network.

For simplicity's sake, the following discussion is based on a two-way loudspeaker system. For optimum results, Linkwitz suggested that the filter must meet three requirements:

- there must be no phase shift between the outputs of the loudspeakers at the relevant cross-over frequency to prevent an upward or downward displacement of the radiation pattern;
- the signal attenuation at each filter output must be 6 dB instead of the usual 3 dB to prevent peaks in the sums of the signals;
- the phase shift between the output signals must be constant at all frequencies to retain the symmetry of the radiation pattern above and below the cross-over frequency; this condition is conveniently met by the use of symmetrical filters in both the low-pass and the high-pass sections.

Linkwitz found that these requirements can be met by cascading two identical second-order Butterworth filters. Higher-order types may, of course, be used, but in practical applications these are less interesting. It should be noted that in any case the filter must be an even-order type, since each order causes a phase shift of 45° at the cross-over frequency.

Fig. 1 shows the amplitude and phase shift behaviour of a Butterworth filter, and Fig. 2 those of a Linkwitz-Riley network. Note the 3 dB peak of the Butterworth filter. This can not be obviated by increasing the separation of the cross-over fre-

quencies of the low- and high-pass sections, because this would violate the first requirement of zero phase shift between the outputs. For clarity's sake, the two characteristics are combined in Fig. 3 to highlight the difference between them.

The Linkwitz curve is rather more rounded in the vicinity of the cross-over frequency, and starts falling off somewhat earlier. The slightly different phase shift of the two filters should also be noted.

The foregoing discussion is true only if the signals are sinusoidal. The pulse (or step) response of the Linkwitz filter causes the same problems as that of a Butterworth filter, assuming that both filters have separate low- and high-pass sections. Even a Linkwitz filter is therefore not perfect.

A practical filter

A Linkwitz filter may be designed as a passive or as an active type. The circuit diagram of an active design is shown in Fig. 4; this may be constructed on the printed-circuit board shown in Fig. 5. Note that this board is identical to that used for the electronic cross-over network published in the September 1984 issue of *Elektronik*.

The circuit of Fig. 4 is for a three-way loudspeaker system. The network has cross-over frequencies of 500 Hz and 5,000 Hz and roll-offs of 24 dB per octave. Stage A₁ serves as a buffer for the input signal before this is split three-way. The low-pass section is formed by A₃ and A₆; the middle-frequency section by A₇ and A₈ (high) and A₉ and A₁₀ (low); and the high-pass section by A₁₁ and A₁₂. Each section is provided with a potentiometer for setting the level of the output signal (P₁, P₂, and P₃ respectively), and a stage to buffer the output (A₂, A₅, and A₄ respectively). The power supply lines are stabilized by voltage regulators IC₁ and IC₂. The cross-over frequencies may be altered with the aid of Table 1 (any frequency) or Table 2 (the 17 most likely frequencies). The values in Table 2 have deliberately not been rounded off to the nearest

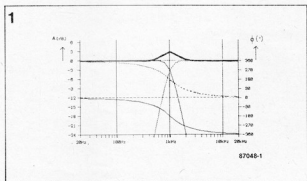

Fig. 1. Butterworth network: amplitude and phase characteristics over the audio frequency range. The fat line represents the sum of the outputs of the filters.

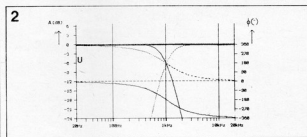

Fig. 2. Linkwitz network: amplitude and phase characteristics over the audio frequency range. The fat line represents the sum of the outputs of the filter sections.

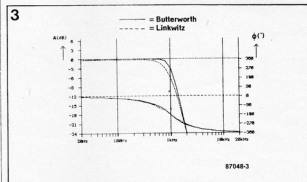

Fig. 3. Butterworth and Linkwitz characteristics combined to highlight their differences. The networks used had a slope of 24 dB per octave.

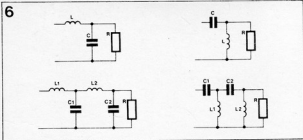

Fig. 6. Passive Linkwitz sections (a) with a 12 dB per octave slope, and (b) with a 24 dB per octave slope.

type. If the filters are given a 12 dB per octave slope, the connections to the middle-frequency loudspeaker (in a three-way system) or those to the tweeter (in a two-way system) should be reversed.

The loudspeaker impedance must be corrected in a manner that ensures that it is constant and ohmic at the cross-over frequency. The corrected impedance of the loudspeaker, R in Fig. 6a and 6b, should be

ascertained as detailed in *Loudspeaker Impedance Correction* (Elektor India, June 1986).

Table 1	low-pass section 12 dB/octave	low-pass section 24 dB/octave
	<p>$C_A = C_A / 2\pi f R$ where $R = 4.7 - 10 \text{ k}\Omega$</p>	<p>$C_A = C_C = \sqrt{2}/2\pi f R$ $C_B = C_D = 1/\sqrt{2}/2\pi f R$ where $R = 4.7 - 10 \text{ k}\Omega$</p>
	high-pass section 12 dB/octave	high-pass section 24 dB/octave
	<p>$R_A = R_B = 1/2\sqrt{2}\pi f C$ where $C = 4.7 - 10 \text{ nF}$</p>	<p>$R_A = R_C = 1/2\sqrt{2}\pi f C$ $R_B = R_D = \sqrt{2}/2\pi f C$ where $C = 4.7 - 10 \text{ nF}$</p>

Table 2		Low-pass 12 dB/octave	Low-pass 24 dB/octave	High-pass 12 dB/octave	High-pass 24 dB/octave
$R = 5k\Omega$		$R = 5k\Omega$		$C = 4n7$	
f (Hz)	$C_A = C_B$ (nF)	f (Hz)	$C_A = C_C$ (nF) $C_B = C_D$ (nF)	f (Hz)	$R_A = R_B$ (kΩ)
100	284	100	402 201	100	339
200	142	200	200 100	200	169
300	94.7	300	134 67	300	113
400	71.1	400	100.4 50.2	400	84.7
500	56.8	500	80.4 40.2	500	67.7
600	47.4	600	67 33.5	600	56.4
700	40.6	700	57.4 28.7	700	48.4
800	35.5	800	50.2 25.1	800	42.3
1,000	28.4	1,000	40.2 20.1	1,000	33.9
1,500	18.9	1,500	26.8 13.4	1,500	22.6
2,000	14.2	2,000	20 10	2,000	16.9
2,500	11.4	2,500	16.1 8.04	2,500	13.5
3,000	9.47	3,000	13.4 6.7	3,000	11.3
3,500	8.12	3,500	11.5 5.74	3,500	9.68
4,000	7.11	4,000	10.04 5.02	4,000	8.47
5,000	5.68	5,000	8.04 4.02	5,000	6.77
10,000	2.84	10,000	4.02 2.01	10,000	3.39
					$R_A = R_C$ (kΩ) $R_B = R_D$ (kΩ)
					100 239 478
					200 120 240
					300 79.8 159.6
					400 59.9 119.8
					500 47.9 95.8
					600 39.9 79.8
					700 34.2 68.4
					800 29.9 59.8
					1,000 23.9 47.8
					1,500 16 32
					2,000 12 24
					2,500 9.58 19.16
					3,000 7.98 15.96
					3,500 6.84 13.68
					4,000 5.99 11.98
					5,000 4.79 9.58
					10,000 2.39 4.78

RIMS: COUNTING ATOMS

by Dr Kenneth W. D. Ledingham, Department of Physics and Astronomy, University of Glasgow

Resonant Ionisation Mass Spectroscopy (RIMS) is a unique, ultra-sensitive analytic technique which can detect down to the level of a few atoms. It is applicable to any sample, whether solid, liquid or gas and can be used to assay every element in the periodic table apart from helium and neon, as well as any stable or radioactive isotope. It is likely to find important applications in fundamental and applied physics, and to become a valuable tool in the semiconductor industry and in diagnostic medicine.

The need to develop new analytic ways to measure ultra-trace quantities of elements in various substances is becoming urgent in many branches of science, engineering and medicine. There are already many sensitive analytic techniques, including neutron or photon activation analysis, inductively coupled plasma spectroscopy, atomic absorption and various kinds of mass spectroscopy, particularly secondary-ion mass spectroscopy (SIMS). The sensitivity of these techniques for trace analysis is usually limited to the order of parts in 10^7 or 10^8 . In the last few years problems have arisen that require ultra-trace analysis at the previously unheard-of sensitivities of parts in 10^9 to 10^{12} or even further. Already three areas which require such analysis have been identified and as techniques are developed many more applications are likely to become apparent.

Firstly, it is essential to reduce the minimum detection limit of impurities in silicon if improvement, especially in miniaturisation, of the semiconductor manufacturing process is to be maintained. Secondly, Professor M. Baxter of the Scottish Universities Research and Reactor Centre, near Glasgow, has speculated whether there is a health risk from the presence of very low-activity β emitters in the environment. They are very difficult to monitor because they are likely to be below the sensitivity range of conventional nuclear counter techniques.

Finally, the presence of trace

amounts of certain elements in human body fluids and tissues is considered to be essential to health. This is a poorly understood branch of biochemistry and widely divergent figures for trace metal concentrations in apparently healthy people have been published. But there is growing evidence that many of the studies are flawed by gross analytic inaccuracies and that new, reliable techniques are necessary at sensitivity levels of parts in 10^9 . During the middle and late 1970s the possibility of applying laser techniques of single-atom detection to ultra-trace analysis attracted interest. The technology had been pioneered largely by Professor V. S. Letokhov of the Academy of Sciences in Moscow and Professor G. S. Hurst of Oak Ridge National Laboratory, USA. Resonant Ionisation Spectroscopy, RIS as it has come to be known, can detect one atom of a specific type in a background of 10^{10} others in gaseous phase. The implications of this degree of sensitivity for many disparate fields of research are likely to be enormous.

Resonant Ionisation Spectroscopy

With the development of intense, tuneable, pulsed lasers the simultaneous absorption of several photons by a single atom or molecule to produce a free electron and a positive ion became experimentally feasible.

In the simplest RIS process, a pulsed laser is tuned precisely to the wavelength required to

excite the atom or molecule from its ground state of energy to an excited state that is unique to the element under study. A second photon, of the same wavelength and from the same laser pulse, interacts with the atom in its excited state and causes an electron to be released from it, thereby creating a positive ion. This process can be made more selective by adding further resonant steps in the excitation process, using a second laser tuned to another frequency. Five different laser schemes, represented in the first illustration, can ionise all the elements in the periodic table, except helium and neon. From left to right in the diagram they are:

(a) $A(\omega_1, \omega_1 e)A^+$

This reaction means that two photons of the same wavelength (that is, with angular velocity ω_1) create the ion pair.

(b) $A(2\omega_1, \omega_1 e)A^+$

The laser wavelength is frequency doubled into the ultra-violet and then mixed with the fundamental to create the ion pair.

(c) $A(\omega_1 \omega_2, \omega_1 \text{ or } \omega_2 e)A^+$

In this process three photons are absorbed with two colours being involved, indicated by ω_1 and ω_2 .

(d) $A(2\omega_1, \omega_1 \omega_2 e)A^+$

One colour is frequency doubled ($2\omega_1$) and another photon of a second colour is absorbed as well as one of the original photons.

(e) $A(\omega_1 \omega_2, \omega_1 e)A^+$

In this case usually three photons of the same colour are absorbed to create the ion pair.

The second diagram is the periodic table of elements with one of the five schemes being ascribed to each, after Professor Hurst. In the early days of the technology, the electrons created in the resonance process were detected by ionisation or proportional counters. Soon, however, it became obvious the ultra-trace isotopic selectivity was needed, too, so mass spectrometers were introduced to detect the positive ions. Although both magnetic sector and quadrupole mass spectrometers have been used by different research groups, the arrangement preferred now includes a time-of-flight mass spectrometer.

Resonant Ionisation Mass Spectroscopy

When laser techniques are used to detect ultra-trace amounts of elements or isotopes in a substance or matrix, three separate steps are involved. A typical laser time-of-flight mass spectrometer is shown in the third illustration, indicating the steps. Firstly, a pulsed, charged, argon beam or a neutral argon beam, ablates or creates neutral atoms from the surface of the solid sample to be assayed. Ideally, the atoms created should be accurately representative of the solid under analysis and to date argon ablation has been shown to be largely matrix-free. This technique is now considered to be superior to the laser ablation technique, which is a high-temperature method known to cause matrix problems because it favours the easily

vapourisable materials.

SIMS, already mentioned, also uses an ion beam to ablate the surface of the sample but analyses only the charged ions, which are created in numbers some two or three orders of magnitude fewer than the neutrals. Because they are charged, these ions are emitted at a rate that is a function of the chemical composition of the surface. RIMS and SIMS are made quantitative by making comparisons with well characterised standard samples, so if there are any matrix problems, any quantitative analysis is likely to be inaccurate.

Having created a cloud of vapour above the target, RIS lasers then selectively ionise atoms of the chosen element in the vapour cloud, which are subsequently accelerated into the time-of-flight mass spectrometer. Secondary ions created by the ablation process can be rejected by electrostatic fields or by varying the time between the ion-beam pulse and the RIS laser pulse. The normal laser arrangement to achieve total elemental coverage is an Nd:YAG laser powering two dye lasers, one of which has frequency doubling facilities. Typical lasers of this kind operate with pulse lengths of several nanoseconds at repetition rates of some tens per second. The transverse spatial dimensions of the beam are typically a few millimetres. One of the strengths of RIS is that the photo-ionisation process can be made almost 100 per cent efficient, that is, it reaches saturation. By saturation of the RIS process, we mean that every atom of a quantum selected species which was in its ground state before being subjected to the photon field of a pulsed laser is converted to a positive ion and a free electron during the short duration of the laser pulse. Because saturation occurs when laser fluences, by which we mean energy per unit area, are typically about 100 mJ cm^{-2} , conventional commercial lasers require modest focusing of a 3-mm beam. It is hoped that RIMS will become a routine ultra-trace analytic technique, so a short analysis time is desirable, of the order of minutes. For this purpose the low repetition rate of Nd:YAG lasers (30 sec^{-1}) is a limitation. Two of the severe limitations of

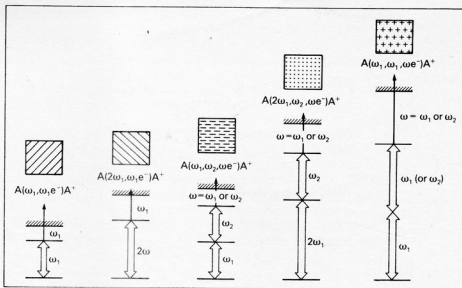

These five different schemes, using a pulsed laser or lasers to excite an atom or a molecule from its ground state of energy, can ionise all the elements in the periodic table except helium and neon.

I	II	III	IV	V	VI	VII	VIII	0
1H								
3Li	4Be	5B	+6C++	+7N+++	+8O++++			
11Na	12Mg	13Al		+15P++	+16S+++	+17Cl+++		
19K	20Ca	21Sc	22Ti	23V	24Cr	25Mn	26Fe	27Co
28Ni	29Cu	30Zn	31Ga	32Ge	33As	34Se	35Br++	+36Kr+++++
37Rb	38Sr	39Y	40Zr	41Nb	42Mo	43Tc	44Ru	45Rh
46Pd	47Ag	48Cd	49In	50Sn	51Sb	52Te	+53I++	+54Xe+++++
55Cs	56Ba		72Hf	73Ta	74W	75Re	76Os	77Ir
78Pt	79Au	80Hg	81Tl	82Pb	83Bi	84Po		
87Fr	88Ra							
57La	58Ce	59Pr	60Nd	61Pm	62Sm	63Eu	64Gd	65Tb
66Dy	67Ho	68Er	69Tm	70Yb	71Lu			
		92U			96Am		99Es	

Periodic table of elements, with one of the five schemes of the first diagram ascribed to each. (After Professor Hurst.)

conventional mass spectroscopy can be eliminated when tuned lasers are used to produce the ions for mass analysis. In a conventional mass spectrometer the ions to be analysed are normally electron-

beam induced, so molecular interferences and isobaric effects cannot be avoided. A mass spectrometer cannot easily distinguish between CO and N₂, for example. This is a phenomenon known as mol-

ecular interference. Nor can it distinguish between ⁴⁰Ca, ⁴⁰K and ⁴⁰Ar because they are isobaric; that is, they have similar masses. These ambiguities are avoided when RIMS is used. The final step of the RIMS tech-

nique is to count and measure the mass of the laser-induced ions, using a time-of-flight (TOF) mass spectrometer. A TOF instrument is a non-magnetic system in which the ions first accelerate through a series of closely spaced electrodes and then pass through a field-free region (D) of considerable dimensions, of the order of one metre, to be detected by an ion detector such as a channeltron. In its simplest form the transit time (t) of the ion in the field-free region is proportional to the length of the field-free region and to the square root of the ion mass (m).

For an accelerating voltage of 1000 V, with D equal to 1 m, t is about 20 μ s for a singly ionised mass of 100 atomic mass units. There are several advantages to be gained by using a TOF mass spectrometer: firstly, entire mass spectra can be accumulated in a very short time and an entire spectrum can be recorded for each laser pulse; secondly, TOF systems measure isotopic ratios very accurately, because they measure them under identical conditions; finally, the accuracy of a TOF spectrometer depends on electronic circuitry instead of extremely accurate mechanical alignment, so it is simpler to make. The time-honoured disadvantage of TOF instruments is low resolution due to the poorly defined spatial and temporal character of conventional ion formation. But that scarcely applies when the ions are formed by lasers, because the laser spot has a tight focus and the laser pulse is so short, between 5 and 10 ns.

In the last year a number of groups in the USA, the Soviet Union and Europe have been set up to exploit the sensitivity of RIMS. Already it is claimed that the technique is capable of detecting impurities at the level of 1 part in 10^{10} in a routine analysis time of 5 minutes.

Future Development

The design of the RIMS instrument so far described is by no means optimised. A number of promising lines of research have yet to be investigated which may lead to better sensitivity. Each of the three steps in the RIMS process will be considered, to see whether improvements are possible.

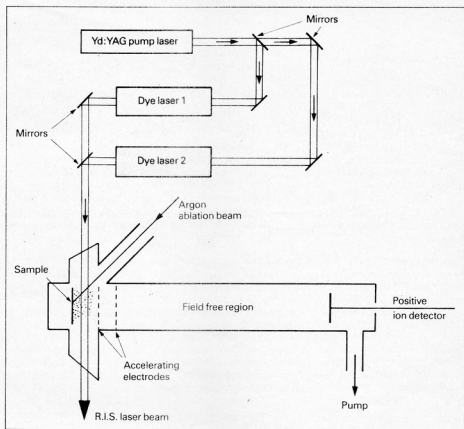

Block diagram of a TOF resonant ionisation mass spectrometer, outlining the three separate steps in its principle of operation.

During the past few years, a great deal of attention has been paid to photon, electron and ion ablation of solids. At present, argon ablation of the sample is the most popular technique, though recent developments in metal-ion beams such as those of gallium and caesium might increase the ion-sputtered yield per unit incident current. What is not in question is that these metal-ion beams can be focused to far smaller spots than an argon beam, down to sub-micron focal dimensions, so they are likely to be of great importance in future for precision scanning of sample surfaces.

Over the next few years, it is improvement of the RIS step that is likely to contribute most to greater sensitivity. While an Nd:YAG pumped dye laser system has a repetition rate of 30 pulses s^{-1} , copper vapour lasers have recently been developed, in particular by Oxford Lasers (UK) which have a repetition rate of 6500 pulses s^{-1} , capable of pumping dye lasers to provide saturation intensities. This is likely to increase the efficiency of RIMS considerably, especially in

detecting minute quantities of the actinides, recently demonstrated by Professor Kluge and Professor Trautmann of the University of Mainz. At present, however, there are electronic difficulties in handling data at such a large rate. The problems arise from not having enough storage capacity and from the transfer rates of available high-speed transient recorders.

One possible improvement in sensitivity may be understood by considering the stepped photo-ionisation process in the final diagram. In (a) an electron in its ground state absorbs a photon and is promoted to an excited state with a cross-section that is typically about 10^{-11} to 10^{-12} cm^2 . Another photon is absorbed and the excited atom is ionised. The photo-ionisation step is characterised by a small cross-section σ_{ion} of 10^{-17} to 10^{-18} cm^2 and therefore by a large laser fluence being needed to achieve saturation. The fluence is achieved by focusing, so that the volume of interaction with the ablation cloud is small. If, however, procedures (b) and (c) are adopted the probability of ionisation is

greater by two or three orders of magnitude. In process (b) the atom is excited to close to the continuum (a Rydberg state) and then finally ionised with high efficiency using a pulsed electric field.

Another possibility of improvement is shown in (c) where the final ionisation step is to a so-called auto-ionisation state, above the ionisation level but having a large cross-section. Considerable research is necessary to identify the auto-ionisation states in a number of elements before this powerful procedure can be adopted. If processes (b) and (c) can be used then the saturation fluences of the laser are greatly reduced, so that the beam need not be focused. The volume of interaction is then bigger.

Future Applications

One exciting aspect of this technology is that there are likely to be important applications in both fundamental and applied physics. In connection with fundamental physics, applications of RIMS to solar neutrino experiments, double

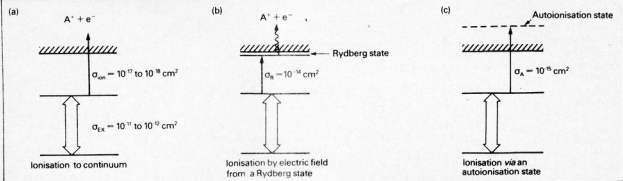

Stepped photo-ionisation process. (a) An electron in its ground state absorbs a photon and is raised to an excited state. (b) The atom is excited to a Rydberg state and finally ionised by a pulsed electric field. (c) The final step is to an auto-ionisation state, to give a large cross-section.

beta decay, baryon conservation and magnetic monopole searches as well as detection of quark atoms and superheavy atoms are being actively pursued. In particular, a detector based on the ^{81}Br (ν, e) ^{81}Kr to measure the ^7Be neutrino source in the Sun has been shown to be feasible because the long-lived (2×10^5 year) ^{81}Kr

can now be counted with RIMS. In applied and commercial science, the applications of RIMS are likely to be very far reaching. In the semiconductor and electronic industries RIMS can identify impurities that restrict performance of high-speed, high-density integrated circuits. The technique can extend downwards the present

minimum detection limits for contaminants by perhaps three orders of magnitude or greater. In the medical field, early diagnosis of certain diseases by using trace-element concentrations in body tissues and fluids is a very attractive possibility but must be carried out in a non-invasive way by using as small quantities of material as

possible. Finally, RIMS can assist in selecting sites for storing hazardous nuclear wastes by using ground-water dating techniques as well as allaying public concern by ensuring that environmental monitoring be made as sensitive as possible.

0314/6

NEWS • NEWS • NEWS • NEWS • NEWS

Advanced universal digital filter

A real-time universal digital filter, developed by Fern Developments for use in speech processing, audiology, psychoacoustics, electrophysiology, and geophysics, offers linear filtering capabilities which are said to be superior to those that can be achieved with conventional analogue techniques. The benchtop EP8, based on a design conceived by the Medical Research Council, is a 512-coefficient finite-impulse-response, non-recursive filter that offers an unlimited number of totally different filtering actions, the anti-alias (pre-process) and post-process sections use high-precision programmable low-pass filters. The filter unit has an operating bandwidth of 0-30 kHz, attenuation rates of typically 4000 dB per octave, and up to 512

weighting coefficients for symmetrical responses.

Fern Developments Ltd
7 Springburn Place
College Milton North
Glasgow G74 5NU

Grundig do it with robots

Helping Grundig on the road to success is a new robotic VCR production line which, the company says, is in advance of any other in the world today. Making VS400 machines, which will retail in the UK at around the £400 mark, the production line cost over £5 million to install. It was designed and built entirely by Grundig engineers and took a mere nine months to complete from putting pen to paper in the drawing office to the first complete machine coming off the 130-metre long production line.

When on full production, the automated plant is expected to produce at least one million VCRs per year: each one taking just 35 minutes to make plus another two hours in soak testing. Each machine goes through 87 work stations and through automatic quality tests on its way to completion. The new VCR line is just the first of a planned series of developments which will continue to radically change Grundig's approach to video production.

Grundig International Ltd
42 Newlands Park
London SE26 5NQ

SMA assembly of PCBs

The WS1500 combination workstation from Surface Mounted Production Systems Ltd is intended for the surface-mounted assembly (SMA) of printed-

circuit boards (PCBs). It incorporates a precision dispenser, vacuum pick-up, infra-red soldering unit, and a soldering iron. PCBs up to 7 x 4 inches can be accommodated. The WS1500 enables prototype design and development, single or small batch production and repair work on surface-mounted circuit to be carried out at one workstation. It is priced at less than £2000.

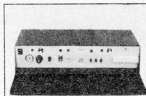

Surface Mounted Production Systems Ltd
Unit 5
Sandbank Industrial Estate
Dunoon PA23 8PB

WHERE ELECTRONIC MESSAGES HAVE THE EDGE

by Barry Fox

The new age of information technology is founded on one simple truth. It is quicker, easier, and cheaper to send pulses of electricity down a telephone wire or over a satellite link than it is to transport people or packages by road, sea or air. The telex service has until now been the standard means of sending text. Telex is a reliable war horse but has its own snags. The equipment is bulky and expensive, trained operators are needed to send messages, and the service relies on dedicated lines — that is to say special circuits designed to carry telex pulses rather than speech.

It is still not widely recognized that almost every personal computer, either desk top or portable, can be used for electronic mail through one of the available services. It is the modern alternative to sending correspondence by telex. Text is sent from one computer to another along a conventional telephone line via a central message-handling computer. Already script writers, translators, bankers, journalists, and lawyers are using electronic mail to send text from home to office. Sales teams use it to keep in touch with their headquarters while moving round the country. Musicians use it while on tour. Electronic mail terminals can work equally well from an office desk or a hotel room far away.

Digital pulses

In its simplest form, a home computer sends messages either to the screen or to a printer. If it

is programmed with additional communications software, it can send similar messages from its output — usually an RS-232 — socket. This output is in the form of a stream of digital pulses, similar to telex, but much faster. They can be sent down a short wire cable to a matching computer system. This is how several computers are networked in an office. The pulses will not travel reliably down a conventional telephone line so they must first be converted into audible tones which the telephone network handles like speech.

A special device called a modem — short for modulator/demodulator — is needed to convert the computer pulses into sound tones. It is connected between the computer output and the telephone line socket, while a com-

puter at the other end of the telephone line has a matching modem. This converts incoming tones back into digital pulses which are then displayed on the computer screen or printed on to paper.

Four services

Electronic mail provides a mail-box system into which messages can be dropped by one user to be picked up later by another. A host computer handles the messages with a system of passwords to ensure that messages can only be picked up by the people to whom they are addressed.

In Britain there are four electronic mail services. The most successful so far is Telecom Gold which is run by British Telecom and has around 30 000 subscribers. Rival services are

offered by Easylink—a subsidiary of Cable and Wireless; Comet from Istel—a subsidiary of British Leyland; and One-to-One—a private company now owned by United States Telecom's company Telesis. Each of these services offers a message drop facility.

When someone working from home or a hotel room wants to contact an office, he or she calls the relevant electronic mail telephone number and sends a message which is held in a message services computer. Later, the person at the office calls the same electronic mail number and reads the message off the computer. The text can be viewed on screen, stored on magnetic disk for subsequent word processing, or printed direct on to paper like a telex.

Any office wanting to use electronic mail should first find out what services are on offer. The Telecom Gold service in Britain is derived from the ITT Dialcom system developed in the United States of America. It is now used in over a dozen countries around the world, and is proving increasingly popular.

How to buy

Most businesses that decide to install an electronic mail system will find it cheaper in the long run to buy the hardware and software through a dealer whose purchase price includes the cost of installing the equipment, getting it up and running, and teaching the staff how to use it. Once a system has been installed, staff may very soon wonder how they ever lived without it.

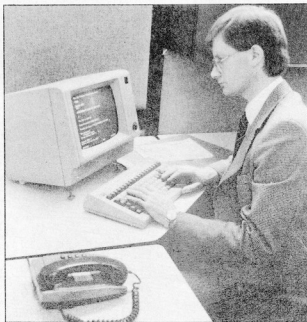

Alan Freeman, Britain's western region sales manager at Telecom Gold, uses his electronic mail-box to communicate with customers and colleagues.

Interactive EPROM programming

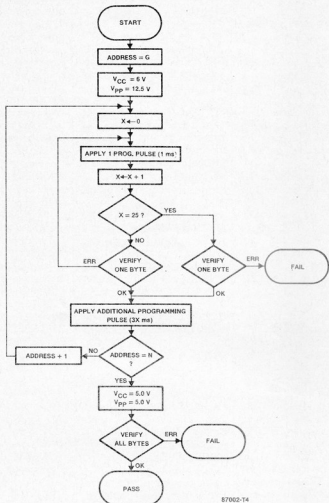

Table 4. Intelligent programming of EPROMs essentially entails applying no more pulses than strictly necessary for correct loading.

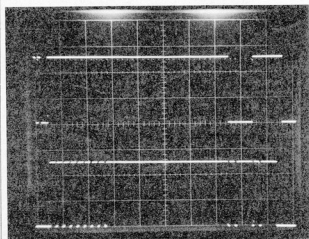

Fig. 8. This oscilloscope shows that addresses may differ in respect of the number of programming pulses required for loading a byte. Upper channel: address line Aa; lower channel: (8×1)+24 ms for the first byte, (1×1)+3 for the second and third.

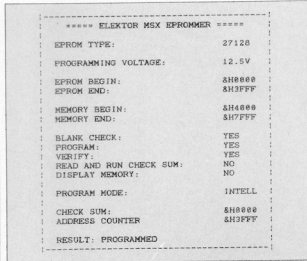

Fig. 9. Screenshot of the command input screen (settings are examples).

switched on and off by means of particular system commands, which will not be gone into in this article. Page 0 is usually reserved for the MSX BIOS (Basic Input/Output system), and page 3 for the system stack and scratch blocks, variables, the keyboard buffer, etc. At power-on, an MSX computer invariably examines pages 1 and 2 in all slots for the presence of (EPROM-resident) programs, which are immediately started if a particular identification code is found in the first 16 address locations. If such an identifier is not found, the BASIC ROM on page 1 is enabled, and the machine boots up accordingly.

The control program for the EPROM programmer comes in the form of a ready-programmed EPROM Type 27128 (16 Kbytes), available through our Readers' Services under number 552. This EPROM is inserted in the socket on the cartridge board for MSX computers, described in *Elektor* puters, described in *Elektor India*, March 1986. In the following section we will set out how to correct all add-on units to make a functional set-up.

The programmer software immediately runs from page 1 at power-on. After completing the necessary initialization routines, the program finds out which slot has RAM in pages 1 and 2 for use as the EPROM data area (32 Kbyte maximum size, 4000-BFFF), it copies part of itself into the highest possible RAM area on page 3, that is,

it inserts itself between the stack and string & scratch blocks. After all this has been done, control is returned to the computer's normal start-up procedure, which means in most cases that BASIC will be started. The EPROM software can now be run by typing CALL EPROMx, where x is the cartridge address area, 0, 1, 2, or 3. The program, when called, automatically selects the appropriate slot(s) for the RAM buffer, and then switches back to where it came from with the aid of routines on page 3. All switching between RAM and EPROM resident subroutines in the programmer is invisible to the user, and makes it possible for the proposed software to run on any MSX computer equipped with at least 64 Kbytes of RAM. Extensive use is made of vector-addressing, and all keyboard and screen input/output is routed via the BIOS on page 0. To make sure that data for or from the EPROM is not overwriting the system stack, or possibly the RAM-resident portion of the control program itself, it is a good idea to check whether there is enough room for your data by typing PRINT HEX\$(FRE(0)+H8000). The address returned should be higher than the top location you need, observing that part of the available memory is used for the string and stack blocks, which extend downwards. Those MSX users in possession of a computer with a disc drive may have to limit the DISK-BASIC workspace somewhat by holding down the CONTROL-key during power-up as a means of telling the system there is but one virtual disc drive available. Similarly, holding down the SHIFT key disables the disc unit altogether.

Command summary

Although the proposed program is extremely simple to use, it is none the less recommended to study this brief summary of the available functions, commands and options. After typing CALL EPROMx, you should see the welcome screen. Pass on to the help pages with EPROM data and program information by pressing any key. You can leaf through the help pages by

pressing the appropriate cursor movement keys. The command input screen can be called up at any time by pressing the space bar.

The following keys are used during the command input mode:

Cursor and select the item you wish to work on.

Key H returns you to the help pages.

Key P causes the screen contents to be dumped to a printer (make sure this is properly connected, else you will get a NO PRINTER error).

Key T runs a test program that causes all functions on the programmer to be successively enabled with aid of CTC interrupts, indicated by the flashing PGM LED. Make sure that jumper J₁ is not installed, and never run the test with an EPROM inserted in the ZIF socket.

The **space bar** selects the various options for the command items (toggle function).

Key S causes the program to start executing your set of commands. Always make sure that the command screen shows what you want before pressing S.

Key I enables the storing of BASIC programs in EPROM. The software automatically arranges for the correct initialisation of the memory begin & end, and EPROM begin & end addresses. Link addresses are automatically adapted to enable the BASIC program to be run from EPROM.

With reference to Fig. 9, these are the various parameters you need to define before the pro-

grammer does what you want it to do:

EPROM TYPE and PROGRAMMING VOLTAGE: consult Table 1 or the relevant help page and use the space bar to select the appropriate EPROM type; notice that **EPROM BEGIN & END** change in accordance with the holding capacity of the relevant EPROM type. It is possible to program part of an EPROM by keying in the relevant hexadecimal address range. The program accepts entries in hexadecimal only, and produces an error message if you try to define an impossible address range, or if the **EPROM BEGIN & END** entry is not in accordance with the **MEMORY BEGIN & END** entry. Example: you want to program the first half of a Type 2764 (8 Kbyte): **EPROM BEGIN = 0000; EPROM END = 0FFF; MEMORY BEGIN = 4000; MEMORY END = 4FFF.**

BLANK CHECK should be a fairly well-known facility; it checks, with the aid of **EPROM BEGIN & END** whether the specified address range contains only bytes FF, indicating that data can be loaded there. **PROGRAM** speaks for itself. This function uses both **EPROM BEGIN & END** and **MEMORY BEGIN & END**.

VERIFY checks whether the EPROM contents and the RAM buffer contents are the same, and evidently uses **EPROM BEGIN & END** and **MEMORY BEGIN & END** to determine what address ranges are to be compared.

READ AND RUN CHECKSUM loads the data from the EPROM

into the buffer and adds the values of all bytes to produce a 16-bit checksum.

DISPLAY MEMORY offers the user the possibility to load the EPROM contents into the computer for examination on the screen (hexadecimal and ASCII format, 8 bytes per line, preceding address). You can not alter the displayed bytes.

PROGRAM MODE simply selects normal, fast-1, fast-2, or intelligent programming as appropriate for the specific type of EPROM. Consult Table 1 or the relevant help page.

ADDRESS COUNTER at the lower end of the screen is a 16-bit counter that keeps track of the EPROM location currently read from or written to.

The **RESULT** line at the bottom of the screen can be used to display the following messages (H returns to the help pages):

ADDRESS ERROR is a general message to tell you to re-do the **EPROM BEGIN & END** and/or the **MEMORY BEGIN & END** entry before pressing S again. **BLANK** reports that the stated address area contains only bytes reading FF. The EPROM area is not copied into RAM.

NOT BLANK reports that one or more bytes in the specified EPROM area do not read FF. The address counter displays the first address encountered, and the program is halted.

READING COMPLETED speaks for itself. The contents of the EPROM are available for examination with **DISPLAY MEMORY**. For modification, you will probably want to resort to BASIC or a suitable utility package.

VERIFIED reports that the verification routine has completed without finding errors.

VERIFY ERROR indicates that one or more differences exist between the contents of the EPROM and that of the RAM. The address counter displays the first incorrect address encountered, and the program is halted.

REPROGRAMMABLE indicates that a verify error was found, but the relevant byte is reprogrammable, i.e., any of its bits reads logic 1 when it should be logic 0. Logic low levels in EPROMs can only be changed into logic high by exposing the chip to a dosage of ultra-violet light.

NOT PROGRAMMABLE re-

Table 5 Port C command data

EPROM	READ	VERIFY	WRITE
2716	0B	0B + V _{pp}	28 + V _{pp}
2732	0F	0C + V _{pp}	68 + V _{pp}
2764	0B	0B + V _{pp}	28 + V _{pp}
27128	0B	0B + V _{pp}	28 + V _{pp}
27256	0B	4B + V _{pp}	68 + V _{pp}
27512	0F	0C + V _{pp}	68 + V _{pp}
2516	0B	0B	68 + V _{pp}
2532	0B	0B	68 + V _{pp}
2564	0B	0B	48 + V _{pp}

All entries in hexadecimal.

V_{pp} = 5 V : 3. V_{pp} = 12.5 : 2. V_{pp} = 21 V : 1. V_{pp} = 25 V : 0.

MS bit on port C is programmed as input.

Table 5. Command bit configuration at the Port C input.

ports that the address indicated by the address counter can not be loaded correctly, even after applying 25 programming pulses (see Table 4, intelligent programming only).

EXECUTION STOPPED is displayed in response to the pressing of the RESET switch on the EPROM programmer.

DEVICE I/O ERROR indicates that the computer is not receiving interrupts from the cartridge, which is possibly set to the wrong I/O address.

NO PRINTER is a message that speaks for itself.

ILLEGAL COMMAND ORDER informs you to re-do the YES/NO setting of one or more commands. Note that it is allowed to choose YES for BLANK CHECK, PROGRAM and VERIFY; the program performs these steps in the correct order, without the need for intermediate command starting with S.

As already noted, it is advisable to think well before pressing the S key and so start the program. If you get an error report, do not get into a panic, but study the command screen to trace the fault and understand its nature. Once you have

worked with this EPROM programmer for some time, you will notice that it is highly user-friendly and easy to get going with the aid of the help pages, which are instantly available at the pressing of key H.

If you do not know how to program an EPROM which is not included in Table 1, simply begin with the lowest programming voltage, 12.5 V, to see if anything happens to the contents of the device; you can not damage it in this way, provided you do not select intelligent programming, as this causes the V_{cc} line to be raised to 6 V during the programming cycle. In conclusion of this section, a few more tips. When an EPROM is stated to be programmable in the normal (50 ms) mode, it is worth while to try out the effect of selecting fast-1 or fast-2 programming to save time. If you want to document the program settings for a specific EPROM, it is a good idea to use the screendump option for the recording of the checksum and other relevant data. Remember that a Type 27S12 (64 Kbyte) EPROM must be programmed in two 32 Kbyte passes. Press CONTROL-STOP

to return to MSX BASIC, and type CALL EPROMX to run the programmer again. Use an assembler or a machine language utility package to write bytes into the RAM buffer for loading into an EPROM, but make sure that data is not overwritten by stack or buffer usage of any program you run in combination with the EPROM programmer software.

Keep in mind that running BASIC programs that use PLAY commands require the computer to be reset and hence the EPROM programmer software to be re-initialized. This is because the proposed program locates its jump table and variable map in the voice queue area. In more general terms, do not use the EPROM programmer software before you are sure that there are no other programs, or remnants thereof, still around somewhere in the computer's memory. The best way to avoid trouble is to reset the machine with the EPROM cartridge inserted.

Finally, Table 5 shows the control words for the various EPROM types. These 7-bits words are specific to the EPROM type to be dealt with, and can be used by anyone contemplating the writing of his own version of the control software.

Getting started

Commence with fitting jumpers B, D, E and I on the EPROM cartridge board, then mount EPROM ESS 552 in the 28-way socket. Plug this cartridge into a slot of the MSX computer, and plug the I/O & timer cartridge either in a remaining slot, or in the one provided on the EPROM cartridge board. Connect the EPROM programmer to the I/O & timer cartridge via the 50-way flat ribbon cable, and you have the system ready for use—see Fig. 10. Please note that it is not possible to use the add-on busboard for MSX computers, in conjunction with the timer & I/O cartridge. Do not yet fit an EPROM in the ZIF socket, switch on the power, and call the program on completion of its initialisation. After viewing the welcome and copyright screen, go to the command screen and run the built-in test routine prior to working on any EPROMs. If all LEDs on the programmer's front

panel can be seen to go on and off at regular intervals, there is good reason to assume that the hardware and software functions satisfactorily, and it is high time to set the system to work on any EPROM that you may have available.

AR

We regret that we can not provide information on the use of this EPROM programmer with computers other than those in the MSX series.

Previous articles on MSX extensions have appeared in the following issues of *Elektor India*.

February 1986 (I/O bus, digitizer, I/O port);
March 1986 (EPROM cartridge board);
April 1986 (add-on bus board);
February 1987 (I/O and timer cartridge).

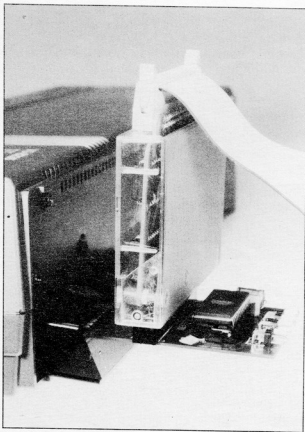

Fig. 10. One slot can hold both the EPROM and the I/O cartridge.

Local Area Networking

The proliferation of personal computers (PCs) as a business tool has driven the need for a distributed processing environment where many microcomputers can share expensive peripheral devices, such as printers and hard disk drives. The capability to network equipment also enables users to share files and programs and to centralize backup facilities and procedures.

Local Area Networking has two main requirements. It must be implemented in VLSI, to simplify design and lower the overall "per node" cost of connection to a network. Second, the LAN must also run standardized software and conform to an industry standard, so that end users can interconnect equipment from different vendors without worrying about protocols.

The IEEE 802.3 standard (Ethernet™) has gained wide acceptance by both large and small companies as a high-speed (10 megabit/second) LAN. However, because of its cable requirements, it can be relatively expensive to implement. In response to this drawback, Thin Ethernet, also known as Cheapernet™ — was developed. Thin Ethernet uses less expensive coaxial cable and features a "node-integrated" transceiver. Thin Ethernet maintains full compatibility with Ethernet's 10 megabit/second data rate.

Another network sponsored by the IEEE 802.3 committee is StarLAN™, a 1 megabit-per-second implementation that features a "star" configuration. Each node is connected to another central hub in point-to-point fashion.

Continuing development of LAN interface chips has driven the LAN connection cost per node down to new levels, making networks affordable at all business levels. Because of its cost-effectiveness, the personal computer connection segment of the LAN marketplace is forecast to grow faster than any other segment. According to Dataquest, revenues in 1990 will top US\$ 528 million. Revenues in 1985 totalled US\$ 181.7 million. The installed base of networked PCs will be 3.7 million in 1990, up from 438,000 in 1985.

Current Status

The decision by 3Com and Novell to port their LAN operating stems to National Semiconductor's DP8390 Network Interface Controller marks the first time a semiconductor supplier has taken an active role in making network software standard with their chips. This makes it easier for designers to use the chips in a network, rather than having to write software themselves. For original equipment manufacturers (OEMs), DP8390 compatibility with 3Com's 3+ network software and Novell's Advanced NetWare means an easy path to LAN design for IBM-compatible PCs. OEMs can use National Semiconductor's tool kit containing DP8390 LAN evaluation boards and 3Com 3+ network software to develop networking and workgroup computing products. Or they can use Novell's development kit and the DP8390EB, or the DP8390 LAN chip set, to design local area networks.

3Com and Novell are responsible for setting "de facto" stan-

dards in the PC LAN industry. 3Com is the leading vendor of LAN add-on boards for PCs, with a 19 percent share of the market, according to Dataquest. Novell's NetWare, with 60,000 installations, is the most widely used PC LAN operating system. It supports 35 local area network systems, including 3Com's Etherlink and Etherlink Plus, AT&T's StarLAN and IBM's PC Cluster and Token-Ring Network.

Support from two predominant LAN suppliers reflects the emergence of the DP8390 as the standard LAN chip set of choice among system designers.

National's Local Area Network Chip Set

Focusing specifically on the IEEE 802.3 local area network standard encompassing Ethernet, Thin-Ethernet (Cheapernet), and StarLAN compatible networks, National designers developed three integrated circuits: an Advanced Network Interface Controller (DP8390 NIC), a Serial Network Interface (DP8391 SNI) and a Coaxial Transceiver Interface (DP8392 CTI). The chip set was the first complete VLSI implementation to meet the entire IEEE 802.3 standard. Its availability makes National Semiconductor well positioned to provide the rapidly expanding PC LAN market with its cost-effective chip set. In particular, the DP8392 was the first monolithic chip implementation of a cable transceiver. The high level of integration saves users a significant amount of board space. In fact, the network chip set is the only one that fits on a short-slot PC card.

The DP8390 NIC features two 16-bit DMA channels that deliver all the data-link layer functions required for data packet transmission and reception. The DP8391 features a patented digital phase lock loop for most reliable data reception. The DP8392 CTI implements all driver, receiver, jabber and collision-detecting functions required by the IEEE 802.3 cable transceiver. In addition, the DP8392 exceeds the one million hour MTBF required in the 802.3 specification for transceivers.

Illustrating National Semiconductor's technological breadth, three distinct process technologies were used in fabricating the chips: microCMOS for the DP8390, a high-speed oxide isolated bipolar process for the DP8391 and a junction-isolated bipolar process for the DP8392. The DP8390EB evaluation board, containing the chip set, plugs into any IBM PC-compatible computer and incorporates all of the components required to provide a LAN interface to Ethernet or Thin Ethernet networks.

The entire LAN chip set and evaluation board are all currently in production.

Ethernet is a trademark of Xerox Corporation.

Cheapernet is a trademark of National Semiconductor Corporation.

StarLAN is a trademark of AT&T Bell Laboratories.

(Source: National Semiconductor)



APEX Microtechnology's latest power operational amplifier, the Type PA73M, offers operation up to ± 30 V; outputs of up to 5 A; a high-efficiency class C output stage; and MIL-STD-883C screening. Further details from APEX's UK representatives: Pascall Electronics Ltd • Saxon House • Downside • Sunbury-on-Thames TW16 6RY.

A new MSDOS emulator for Arcom's 80188 processor boards provides a low-cost PC-based development path. The package, called APPCOM, is supplied in an EPROM by Arcom Control Systems Ltd • Unit 8 • Clifton Road • Cambridge CB1 4WH.

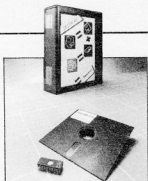

SCHOOLS EQUIPMENT FOR TOMORROW'S SCIENTISTS

by David Tawney, MA FInstP*

From magnifying glasses to microscopes, callipers to computer interfaces, pipettes to pH meters: the range of equipment in the catalogues of educational laboratory suppliers is vast and continually changing in response to technological and educational developments.

The introduction of micro-computers such as the BBC B and the RM 380Z to schools in the United Kingdom has been rapidly followed by the development of computer interfaces whose purpose is either to enable data from school laboratory experiments to be captured, processed and displayed, or to control simple devices.

Similarly, the rapid adoption by industry of biotechnological techniques has led Britain's major suppliers to sell kits by which these techniques can be simulated in schools. However, not all new equipment is stimulated by recent technological innovations: an educational concern to introduce science and technology to pupils aged five to 11 has led to much recent interest in construction kits. There are several reasons why the range of educational laboratory equipment is so wide. First, science is taught in British schools over the age range of five to 18. Secondly, as the emphasis is on giving pupils hands-on experience, suppliers have learned how to provide equipment that schools can afford in quantities sufficient for classroom work. Some of it is, of course, for demonstration by teachers but much is meant to be used by pupils working in groups



Using Griffin & George programmable scientific instruments.

of two and three. Pupil practical work is a cornerstone of education and so equipment must be strong and relatively inexpensive.

Higher education equivalent

The high degree of specialization by British pupils who stay on after 16, in many cases to pre-

pare for a course at a university or polytechnic, is sometimes criticized but it has advantages. The level reached by these pupils is typical of first or even second year university students in some countries and so equipment that is useful for higher education is produced in the quantities that schools need and at prices they can afford. Britain does not have a centralized educational system and schools are given extensive choices in

the courses they provide for their pupils. There are eight area boards offering examinations for the more academic pupils, and while procedures ensure comparability between these examinations, syllabuses do vary which increases the range of equipment needed. In the 1960s and 1970s, there was considerable in British schools, much supported by money from the Nuffield Foundation or from the government-funded Schools Council.

This stimulated corresponding innovations in equipment, another reason why the range is so wide.

In the late 1970s and early 1980s, most of the new courses were revised and these revisions, together with restrictions on money for education caused by falling school rolls and the worldwide slump, have eliminated from the suppliers' catalogues anything that has proved unpopular. Much of what is left — still very extensive — has been refined over at least a decade.

British schools tend to buy their laboratory equipment from three main general suppliers: Griffin & George (GG), Philip Harris (PH) and Irwin-Desman (ID). However, a number of specialist firms are also used. For example, interfaces for coupling equipment with microcomputers to capture data or demonstrate control are offered by all three of the major suppliers as well as the specialists.

Many functions

An example is the measurement module supplied by Educational Electronics (EE) which enables data from the outputs of a range of instruments — Hall probe for measuring magnetic fields, pH meter and so on — to be recorded and strikingly displayed in several forms on a television monitor. A range of sensors is being developed to go with this and other computer interfaces. One of the most interesting recent developments using micro-electronics is the GIPSI (Griffin Programmable Scientific Instrument). There is concern that much of the more sophisticated equipment used in education spends much of its time on the shelf and is used only when its turn comes round in the syllabus so this instrument has many functions and will measure current, voltage, resistance, magnetic field,

pH, light levels, and so on. The function wanted is selected by connecting a module containing an appropriately programmed read only memory (ROM) and fitting overlays over the control panel makes it easy to use.

Another current growth area is electronics teaching kits. There have for many years been small components of electronics in some school physics courses but such physics teaching has recently been modernized and separate school electronics courses developed. The emphasis has shifted from simple introductions to semiconductor diodes and triodes to a systems approach to digital electronics and to operational amplifiers.

There are currently many approaches to teaching electronics embodied in kits. The equipment for one very popular course, "Micro-electronics for All", intended for 11 to 13 year olds but in fact used for older pupils as well, is available from Unilab (U). Ideas underlying micro-electronics — or information technology as it is sometimes called — are learned through solving simple control problems. Other kits drawing interest are the Independent Schools Micro-electronics Centre (ISMEC) kits available from Griffin & George, Philip Harris, and Unilab. Unilab specializes in electrical and electronic equipment for education at competitive prices such as power supplies, meters, radiation counters, signal generators, and so on, all items that can, of course, be obtained from the general suppliers.

Move to plastics

It is easy to look just at recent major developments and forget that the bulk of purchases made by educational establishments are for consumables, notably glassware and chemicals, both supplied

by Griffin & George and Philip Harris. Another company that specializes is BDH Chemicals. A development over the last few years has been the slow acceptance by schools of plasticware in place of glassware. Early examples of plasticware stained too readily but recent products are more satisfactory and stand up to pupil use much longer than glass. Many of the top pan balances bought during the boom in science education in the 1960s and 1970s are now wearing out and schools are replacing them, as funds permit, with electronic balances with digital displays. These are very quick to use so that fewer are required for a class. Griffin & George, Philip Harris, and Irwin-Desman all supply balances but there are also several specialist suppliers, notably Oertling.

There are several ranges of microscope and specialist firms such as Prior have suitable instruments for the educational market. Recently, biologists have shown interest in kits for environmental studies containing meters that measure pH, conductivity, temperature, light level, and so on. An example is an enzyme kit which provides insight into the industrial use of biotechnology.

A recent growth point has been equipment for primary school science. The educational emphasis is on using what can be found in the home and the classroom with the minimum use of special equipment but some is needed, such as simple kitchen-type scales, magnifiers, thermometers, construction kits, and so on. Specialist primary school companies such as E.J. Arnold and Osmiroid have equipment suitable for primary science education.

Checking for safety

The School Science Ser-

vice provides information and consultancy on school science equipment and safety for the majority of British schools. Its task is to examine and test equipment and make recommendations to teachers. Copies of its reports can be obtained overseas through the British Council or through subscribing to the service as an overseas associate. Frequently the service is obliged to be critical of certain products but suppliers usually make modifications in the light of criticisms.

E.J. Arnold Ltd, Lockwood Distribution Centre, Parkside Lane, Leeds, West Yorkshire, England, LS11 5TD

BDH Chemicals Ltd, Broom Road, Parkstone, Poole, Dorset, England, BH12 4NN

Educational Electronics, 28 Lake Street, Leighton Buzzard, Bedfordshire, England, LU7 8RZ

Griffin & George Ltd, Bishops Meadow Road, Loughborough, Leicestershire, England, LE11 0RG

Philip Harris Ltd, Lynn Lane, Shenston, Staffordshire, England, WS14 0EE

Irwin-Desman Ltd, 294 Purley Way, Croydon, Surrey, England, CR9 4QL

Oertling, W. & T. Avery Ltd, Smethwick, Warley, West Midlands, England, B66 2LP

Osmiroid, E.J. Perry Ltd, Gosport, Hampshire, England, PO13 0AL

Prior Scientific Instruments Ltd, London Road, Bishops Cleeve, Herefordshire, England, CM23 5ND

Unilab Ltd, Clarendon Road, Blackburn, Lancashire, England, BB1 9TA

*David Tawney is director of the Brunel University-based School Science Service of Britain's Consortium of Local Authorities for the Provision of Science Equipment (CLEAPSE).

JUNIOR COMPUTER

FACTS

Hot ICs - no need for fear

It is perfectly normal for ICs particularly bipolar digital ICs such as TTL, to become very warm in operation. These ICs draw considerable power which is finally dissipated as heat. An example is the common TTL IC 74145. Typical dissipation for this device is 215 mW and approximately 360mW maximum; this is in the quiescent state with unloaded outputs. When these are loaded the dissipation is even higher. Since the area of the IC package is relatively small, the IC becomes very warm indeed. This is no problem, however; it is rated appropriately and operates perfectly even at ambient temperatures of upto 70°C. When the computer is installed in a housing, care should be taken to provide ventilation slots for the heat to dissipate. In the event of doubt regarding the temperature rise of ICs, the data sheet should be consulted; an IC with a maximum dissipation of 10 mW for instance, should not exhibit noticeable temperature rise.

The Microcomputer as a source of interference

Every microcomputer system operates with relatively fast logic ICs, such as Schottky TTLs. This means that the digital signals have rapid-rise slopes which produce harmonics extending far into the VHF/UHF region. This cause interference, and not only to FM stereo reception. The problem is not restricted to home made microcomputers; some commercially built microcomputers, particularly teaching and experimental systems, can unfortunately be classed as sources of electromagnetic pollution. The only solution is to install the microcomputer in a (metal) screened housing with an earth connection; it may also be necessary to fit a mains RF-suppression filter. Scree need (coaxial) cable should be used for connections between the computer and peripheral equipment. These precautions apply to all digital equipment using fast logic.

text display on the Junior Computer

As we know, the display of the Junior Computer is suitable for displaying both numerical and hexadecimal data. By utilising a seven segment alphabet it is also possible to display written texts. If the text is to be static, a total of six letters are available. If, however a longer message is required, this may 'run' along the display rather like the electronic news display at the top of tall buildings (dynamic text).

from an idea by U. Seyffert

This particular topic receives full attention in Junior Computer Book 2 (to be available shortly), but there is no harm in whetting the appetites of our readers even if it is a little premature.

How can the Junior Computer display words? Normally speaking, data and address information is displayed with the aid of the monitor routine SCANDS. This involves one of the hexadecimal numbers, 0...F, in each display. Where texts are concerned,

however, the monitor routines are no good. What is needed is the subroutine SHOW with the addition of a special look-up table which contains the corresponding seven segment pattern for each individual letter.

Table 1 provides a survey of letters and figures together with the corresponding data which has to be entered into port A for them to be displayed. This table has been partly based on suggestions made to us from one of our readers. Obviously, letters which include diagonal lines (such as K, M, N, Q, V, W, X and Y) will have to be adapted to the horizontal and vertical set up of the display segments. Experience has shown, however, that the eye and the brain soon become accustomed to this.

Now for a short program that will allow a six letter word to appear on permanent display. A good example would be the word 'Junior' as indicated on the prototype of the Junior Computer in the front cover photograph of the May 1980 issue of Elektor and Book 1. The program, JUNIOR, is listed in table 2.

Here the modified SHOW routine will be called SHOWDS and the look-up table that holds the information relating to the display of any particular character is called TXT (text table). The Y index register acts as the display counter and text index. The value contained in the Y register increases from 00 to 05 as an index for the particular character to be displayed. As soon as the value in the Y register becomes 06,

Table 1.

0	40	E	06	o	23
1	79	e	04	P	4C
2	24	F	0E	q	18
3	30	G	42	r	2F
4	19	g (9)	10	S	52
5	12	H	09	S ₁ (5)	12
6	02	h	0B	t	07
7	78	i	7A	u	63
8	00	i	6F	V	41
9	10	j	72	W	01
A	08	K	0A	X	36
a	20	L	47	Y	11
b	03	l	4F	Z	64
C	46	M	48	-	3F
c	27	n	2B	-	37
d	21	0 (0)	40	sp	7F

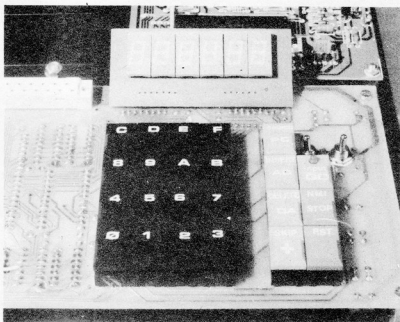

after the instruction INY, it is reset to 00 (jump to DISMPX to begin another round). During the subroutine SHOWDS the Y register contains a delay value which determines the length of time that each display is actually lit. For this reason the previous value contained in the Y register (display counter/text index) must be saved in the address location TEMPY (0004) before the jump to the SHOWDS subroutine takes place.

The function of the X index register, on the other hand, is the same as it was for the SHOW routine: it acts as a display digit switch by way of port B. In other words, the information contained in the

X register (0B, 0A, 0C, 0E, 10 and 12 consecutively) is passed to port B data register to turn each of the displays on in turn.

Text on the run . . .

A stationary text is all very well, but it does tend to get a little monotonous after a while. A much more interesting possibility would be to update the

displayed text every few moments. In this manner whole sentences could be displayed instead of just single words. This can be accomplished with the aid of the program JUNTXT shown in table 3. The effect is very similar to that of an electronic news display. It is an expanded version of the earlier program JUNIOR (table 2). Page 03 is used to store the actual text which can, therefore, be up to 256 characters in length

Table 2.

JUNIOR	0200	A9 7F	LDA # 7F	PA0 . . . PA6 are outputs
	0202	8D 81 1A	STA-PADD	start from Di1
DISMPX	0205	A2 08	LDX # 08	therefore display counter Y = 00
	0207	A0 00	LDY # 00	store display counter
ONEDIS	0209	84 04	STYZ-TEMPY	display first/next character
	020B	20 17 02	JSR-SHOWDS	retrieve state of display counter
	020E	A4 04	LDYZ-TEMPY	increment display counter
	0210	C8	INY	have all 6 displays been accessed?
	0211	C0 06	CPY # 06	if yes, start again
	0213	F0 F0	BEQ DISMPX	if not, next display
	0215	D0 F2	BNE ONEDIS	fetch seven segment code
SHOWDS	0217	B9 30 02	LDA-TXT, Y	place segment code on port A
	021A	8D 80 1A	STA-PAD	turn on display digit
	021D	8E 82 1A	STX-PBD	
	0220	A0 7F	LDY # 7F	
DELAY	0222	88	DEY	
	0223	10 FD	BPL DELAY	delay a short while
	0225	8C 80 1A	STY-PAD	Y = FF (blanking) to port A
	0228	A0 06	LDY # 06	turn off display
	022A	8C 82 1A	STY-PBD	
	022D	E8	INX	prepare next display digit
	022E	E8	INX	
	022F	60	RTS	
TXT	0230	61	"J"	look-up table
	0231	63	"u"	Y = text index
	0232	2B	"n"	(Y = 00 . . . 05)
	0233	6F	"i"	
	0234	23	"o"	
	0235	2F	"r"	

Table 3.

JUNTXT	0200	A9 7F	LDA # 7F	PA0 . . . PA6 are outputs
	0202	8D 81 1A	STA-PADD	contents NUM (0000) to accumulator
	0205	A5 00	LDAZ-NUM	C = 1
	0207	38	SEC	
	0208	E9 05	SBC # 05	NUMCOR = NUM minus 05
	020A	85 02	STAZ-NUMCOR	
BEGIN	020C	A9 00	LDA = 00	first display text
	020E	85 01	STAZ-NUMVAR	
DSTIME	0210	A9 6F	LDA # 6F	establish text display time
	0212	85 03	STAZ-DISCNT	start from DI1
DISMPX	0214	A2 08	LDX = 08	display counter (Y) = 00
	0216	A0 00	LDY = 00	store display counter
ONEDIS	0218	84 04	STYZ-TEMPY	Y to accumulator
	021A	98	TYA	C = 0
	021B	18	CLC	A ← Y + contents NUMVAR (0001)
	021C	65 01	ADCZ-NUMVAR	accumulator to Y
	021E	A8	TAY	display first/next character
	021F	20 39 02	JSR-SHOWDS	retrieve state of display counter
	0222	A4 04	LDYZ-TEMPY	increment display counter
	0224	C8	INY	have all 6 display been accessed?
	0225	C0 06	CPY = 06	if yes, move on to time check
	0227	F0 02	BEQ TMECHK	if not, next display
	0229	D0 ED	BNE ONEDIS	time up?
TMECHK	022B	C6 03	DECZ-DISCNT	if not, repeat present text
	022D	D0 E5	BNE DISMPX	if yes, update text
	022F	E6 01	INCZ-NUMVAR	
	0231	A5 02	LDAZ-NUMCOR	end of text?
	0233	C5 01	CMpz-NUMVAR	if not, show new text
	0235	B0 D9	BCS DSTIME	if yes, start again
	0237	90 D3	BCC BEGIN	
SHOWDS	0239	B9 00 03	LDA-TXT, Y	
	023C	8D 80 1A	STA-PAD	
	023F	8E 82 1A	STX-PBD	
	0242	A0 7F	LDY # 7F	
DELAY	0244	88	DEY	
	0245	10 FD	BPL DELAY	see 'JUNIOR' program
	0247	8C 80 1A	STY-PAD	TXT = 0300 (table 4)
	024A	A0 06	LDY = 06	text index = Y + contents NUMVAR
	024C	8C 82 1A	STY-PBD	
	024F	EB	INX	
	0250	E8	INX	
	0251	60	RTS	

— enough for the average length paragraph!

Again, this program uses the subroutine SHOWDIS, only this time the text table (TXT) is located at address 0300 and although the Y register is still used as a display counter it is no longer used as a text index directly. Instead, the particular section of the text to be displayed is calculated by adding the instantaneous value in the Y register to the contents of address location NUMVAR (0001).

The value contained in NUMVAR will be constant for the period of time a certain text is on display (the actual duration can be adjusted by modifying the contents of location 0211). As soon as that period of time is over the contents of NUMVAR are incremented by one: the entire text shifts one location to the left and the right hand display shows a new character. When the contents of NUMVAR are greater than the contents of location NUMCOR, we will have arrived back at the beginning, as this means that the entire

Table 4.

	0	1	2	3	4	5	6	7	8	9	A	B	C	D	E	F
0300	7F	7F	7F	7F	7F	07	06	2F	23	01	7F	20	7F	02	7F	
0310	01	6F	07	08	7F	07	08	06	7F	61	63	2B	6F	23	2F	7F
0320	46	23	48	0C	63	07	06	2F	7F	3F	7F	03	63	11	7F	03
0330	23	23	0A	7F	24	xx	xx	xx	xx	xx	xx	xx	xx	xx	xx	xx

0000 (NUM) = 34

text will have been displayed. This is because the contents of NUMCOR are 05 less than those of location NUM. The latter (location 0000) is where the user must store the low order byte of the last memory location of the text table. In other words, if the last character of the text message is stored in location 0332, the value 32 is stored in location 0000 (NUM).

Table 4 provides a sample text which can be displayed on the Junior Computer with the aid of the program JUNTXT as given in table 3. The text contains a message for Junior Computer Book 1 owners. A text should always be preceded by at least six blank spaces (7F), so that the beginning and end of the message are clearly separated from each other.

SOUND OF THE SEA

It is a well known fact that the sound of the roaring surf of the oceans is the most satisfying sound in our environment. Those who have experienced the magic of this sound in an otherwise calm surroundings will immediately agree. It is quite a fantastic feeling to sit on the beach, close the eyes and listen to the sound of the sea. The body and nerves which have been subjected to tremendous stress of the day to day life get relaxation from this sound and derive renewed force and energy. Unfortunately most of us can enjoy this pacifying experience once in a while, during holidays. For those who are deprived of this

luxury, we present here a small circuit which can generate the 'Sound of the Sea'. The circuit can be built from just a few components and imitates the sound of the sea in an excellent manner. This can also be used as background for a session of viewing your slides of a holiday on the beach.

The Circuit

As it is already indicated, the circuit must produce the sound of the sea. This is done by the part A of the circuit block diagram shown in figure 1. In order to imitate the rising and falling of the roaring surf, it must

have a control for the sound. This control is provided by the blocks B and C. Block B is an astable multivibrator which produces a rectangular pulse train, with a non symmetrical duty cycle. From the pulse train, block C generates a saw tooth waveform with a rapid rise and slow fall. Both these signals are fed to the input of an amplifier block D in such a way that the signal from A is amplified by block D with amplification proportional to the signal coming out of block C. The rising and falling of this sound is created by this sawtooth waveform.

Let us now see the practical

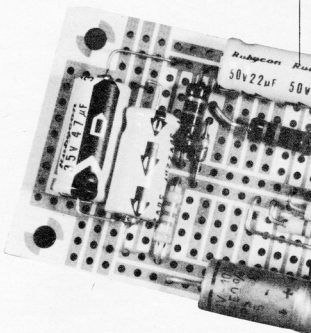

Figure 1 :

Block A produces the noise signal, blocks B & C produce the control signals and block D combines them to produce the sound of the sea.

Figure 2 :

Because of this unusual connection, the transistor behaves as a noise source. The unwanted feature of the intrinsic noise of the transistor is made use of, for producing the sound of the sea.

1

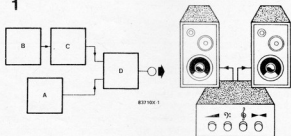

2

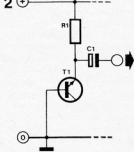

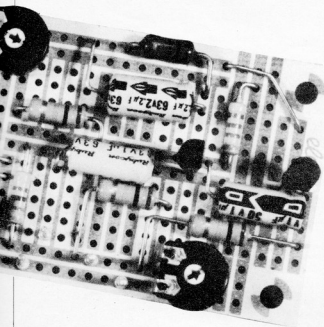

circuit. Figure 2 shows the noise source. This is an unusual connection for a transistor. The NPN transistor T1 is connected in a reverse manner using only the base emitter junction. The collector is left unconnected. A transistor connected in such a manner behaves in a very noisy way. The intrinsic noise of a semiconductor device is a complex phenomena and will not be discussed here. The reverse biased base emitter diode behaves some what like a zener diode. A reverse current flows through this diode and resistance R1. The noise component in this current is connected to the next stage via capacitor C1.

Figure 3 shows the next stage which is an amplifier controlled by an astable multivibrator. T2 is the amplifier of block D. T3 and T4 form the astable multivibrator. The potential divider R2 and P1 give the proper bias voltage to the base of T2 through R3. The setting of potentiometer P1 decides the minimum volume of the sound of the sea.

Figure 3:
The functional blocks of figure 1 can be easily located in this circuit diagram. T1 is block A, T3 and T4 make block B, C4 and (R7 + P2) function as block C and the transistor T2 is the amplifier block D.

Figure 4:
The astable multivibrator produces the rectangular waveform shown as U_{CT3}. This is converted to the sawtooth waveform shown as U_{C4} by C4 and (R7 + P2). This rises rapidly and falls slowly.

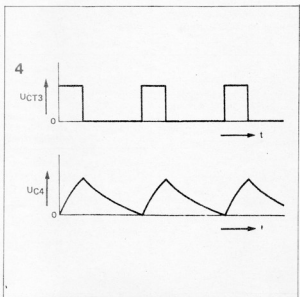
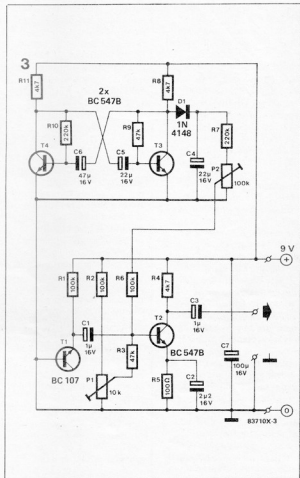

In absence of the signal from the astable multivibrator, the sound would be a continuous noise tone. To convert it into a rising and falling roar of the surf, the control signal is fed to the base through R6. The AMV (astable multi—vibrator) formed by T3 and T4 produces a rectangular wave as shown in figure 4. The frequency of this control signal is about 1/8 Hz. This low frequency is required for the most realistic effects. The C4 (R7+P2) combination produces a sawtooth wave from the rectangular signal. The sawtooth wave is a result of charging and discharging of capacitor C4. During the OFF period of T3, the capacitor C4 charges through R8 and D1. During the ON period of T3, the charging can no more continue, but discharging can take place through R7 and P2. The values are so selected that by the time C4 is discharged, the next charging cycle starts again. As R7 and P2 form a potential divider, the signal fed to base of T2 depends on setting of P2. In technical language, the C4 and (R7+P2) combination is said to be an integrator which integrates the signal at the collector of T3. The sawtooth signal is superimposed on the constant DC level set by P1 at the base of T2 and the

resulting voltage looks like the waveform shown in figure 5 (bottom part). This voltage at the base of T2 controls the amplification factor for the noise signal being amplified by T2. Thus the output of amplifier T2 rises sharply and falls slowly, similar to the real roar of the surf.

The Construction :

The complete circuit can be accommodated on one small SELEX PCB. Component layout is shown in figure 6. As the circuit layout is a bit crowded compared to other simple SELEX circuits, the placement and soldering should be done carefully. The soldering sequence is as usual — jumper wires, resistors, diodes, capacitors, trim pots, transistors and finally the soldering pins or lugs for the external connections. Pay proper attention to the polarity of electrolytic capacitors.

An important point to note about the transistor T1 is that its collector is not connected anywhere. It should not be left floating around on the board but should be cut off near the transistor casing itself. T1 should preferably be BC 107 and may need some trials for selecting a 'good' noisy one. To select T1 by trials, the circuit of figure 2 can be connected to the Tape or Pickup input of the

preamplifier of the Hi-Fi system. If this gives a soft noise output through the speakers, the transistor has good noise properties. After selecting T1 the circuit can be assembled and then the output of T2 should be connected to the Hi-Fi system through the output capacitor C3.

A 9 V miniature battery pack is enough to power the circuit, as the current drawn is between 2-5 to 4.3 mA. However, an ON/OFF switch must be provided. A shielded cable must be used for connecting the circuit to the Hi-Fi system, so that the 50 Hz hum is reduced. The shield wire can be connected to the signal ground.

Adjustments

Two trim pots P1 and P2 are provided for adjustments. The adjustments are interdependent and should be done as follows:

Both the sliding contacts of P1 and P2 should be fully turned towards the earthed terminal initially. Now P1 is slowly rotated till a soft noise is heard. P2 is then adjusted to get the periodic rising and falling of the sound. P1 can be once again adjusted to get the desired volume for the sound of the sea.

Now, close the eyes and relax, imagining that you are already on the beach!

6

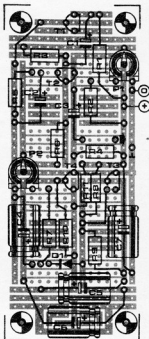

Figure 5:

Uc4 is the voltage output from capacitor C4 and UBT2 is the effective voltage at the base of T2 produced by superimposing the two input signals.

The sawtooth is superimposed on the constant DC level set by potentiometer P1. The amplification provided by T2 is proportional to this signal.

Figure 6:

Component layout of the circuit.

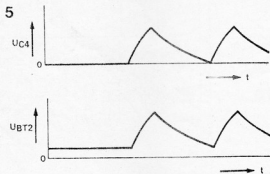

Part List

- R1, R2, R6 = 100 K Ω
- R3, R9 = 47 K Ω
- R4, R8, R11 = 4.7 K Ω
- R7, R10 = 220 K Ω
- P1 = 10 K Ω
- P2 = 100 K Ω
- C1, C3 = 1 μ F/16 V
- C2 = 2.2 μ F/16 V
- C4, C5 = 22 μ F/16 V
- C6 = 47 μ F/16 V
- C7 = 100 μ F/16 V
- D1 = 1N 4148
- T1 = BC 107 or BC 547 B
- T2, T3, T4 = BC 547 B

Other Parts:

- 1 Standard SELEX PCB
- Soldering lugs.
- Battery connector
- 9 V miniature battery pack
- Hi-Fi Amplifier system
- or an Amplispeaker of high capacity.

TOUCH KEYS

Touch keys, sensor switches, touch switches, TAPs Touch Activated Programmer), these are many names for the touch keys. The principle of operation is the same for all. Elektor magazine had developed and published the first touch switch project almost fifteen years ago. Since then there have been many variations and developments and the touch keys have replaced the mechanical keys switches in many sophisticated products. Just touch with a finger and without any "click-clack" the switching operation takes place quickly, safely and quietly.

Principle

The sensing surface of the key consists of two conductive surfaces separated by an insulator. The insulator must have an infinitely high resistance or it can even be an airgap. If these two surfaces are now touched simultaneously with the fingertip, the resistance between them drops below 500K. The exact value depends on various factors like the skin resistance of the individual, the size of the touched area, pressure exerted and even the humidity of the skin. To understand the working principle, you can carry out a small experiment as follows: Connect two coins to a multimeter with the help of crocodile clips. Set

the multimeter in Megaohms range. Keep the two coins near to each other with a small airgap between them. Now touch both of them together with the fingertip. The meter now reads a value less than approximately 500K. The value falls down further if the pressure is increased or if the fingertip is moistened. The principle is thus very clear: the skin has a finite resistance and this resistance appears across the two sensor surfaces of the touch key when it is touched with a finger. When the key is not touched, the resistance between the two sensor surfaces is very high. This means that a current can flow between the two surfaces when touched. The two possibilities are shown in figures 2 and 3. Figure 2 shows a two stage sensor. When the key is touched, a current flows into stage A, this activates the output stage C and the relay is energised. But the relay remains energised only as long as the key is touched.

Figure 3 shows a three stage sensor. When the key is touched, a current flows into stage A, this triggers a flip flop stage B and the flip flop activates output stage C. As the flipflop is latched, the stage C remains activated and relay remains energised even after the finger is removed from the key. To de energise

the relay the key must be touched again, so that the flipflop resets and stage C is deactivated again releasing the relay.

Practical Design

A practical circuit is shown in figure 4. The functional blocks A, B and C can be easily recognised in the diagram.

The first part of the circuit, consisting of transistors T1, T2 and T3 and the resistors capacitor and sensor corresponds to block A. If the sensor is touched, a current flows to the base of transistor T1. Transistors T2 and T3 amplify this current and due to the collector currents of all three transistors passing through R6 and R5 a sufficiently large voltage drop is developed across R6. This brings down the voltage at U1 to almost zero level. Transistors T1, T2 and T3 are all connected in such a manner that they give maximum possible amplification. Information about this type of connection (known as Darlington Connection) has already been given in SELEX.

The middle portion of the circuit enclosed with a dotted line in the diagram corresponds to block B which is the flipflop. For proper understanding of the functioning it is assumed that T5 is conducting and T4 is open.

Now when the sensor is touched, U1 drops from 9V to 0V. This is transferred to the base of T5 via D3 (at point U5). The transistor T5 stops conducting and drives T4 into conduction. This condition is retained even after the finger is removed from the sensor.

Next time the sensor is touched, the jump in voltage at U1 from 9V to 0V is connected to the base of T4 via D2 and now T4 stops conducting and drives T5 into conduction again.

Figure 5 shows all the voltage at various points U1 to U6 in the circuit. Voltage at U6 is used to activate the last stage C which drives the relay. Stage C consists of transistor T6. Voltage at U6 which is connected to the base of T6 via R12 switches the transistor ON and OFF depending on whether it is 0V or 9V. When U6 = 0V, a current flows through R13 and R12 which develops a positive voltage at the base of T6 and T6 goes into conduction. When U6 = 9V no current can flow through R13 and R12 and T6 is cut off.

The relay contacts can be used to switch on any device connected through it.

1

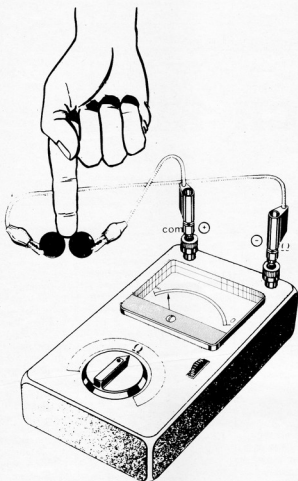

2

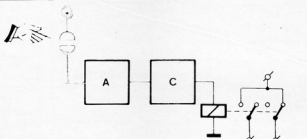

3

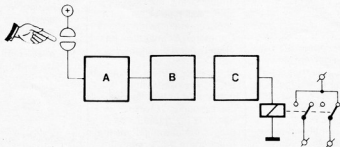

Construction

The complete circuit of figure 4 can be assembled on a double size SELEX PCB (80 x 100 mm). Component layout of the circuit is shown in figure 6. The layout shows two connections in dotted lines between points A—B and C—D, and a connection in solid line between A—D. Connections A—B and C—D are to be used if the complete circuit of figure 4 is assembled. Connection A—D will be used if only the blocks A and C are constructed without using the flipflop circuit of block B. The flip flop will not be required if the switch has to close only for the period when the touch key is touched with a finger. figure 7 shows an assembled PCB as per the layout of figure 6. A 9V miniature battery pack is used as the power supply. The current consumption of the circuit is less than 3 mA when relay is not energised. Any 9V battery eliminator can also be used as the power supply, but this needs a change in the value of C1. It should be increased to 10 μ F. The relay contact can be

Figure 1:
Two coins and a multimeter can demonstrate the principle behind the touch keys.

Figure 2:
Block diagram of the simpler version of the touch key. The relay remains energised only as long as the touch key is touched with a finger.

Figure 3:
Touch key block diagram with a flip flop stage added for latching the relay. The flipflop and the switch toggles every time the key is touched.

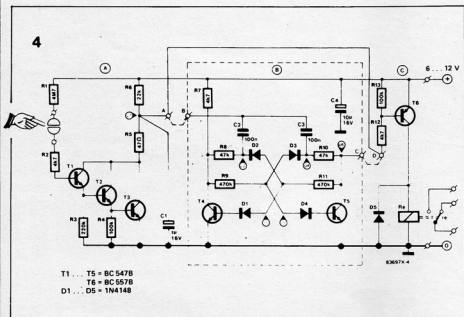
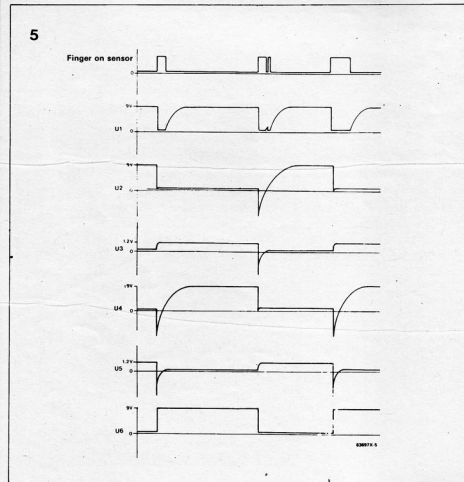

Figure 4:
The complete circuit of the touch key with both possibilities. Circuit of figure 2 is realised by direct connection between A—D and the circuit of figure 3 is realised by connecting links A—B and C—D and assembling the complete flip flop circuit between them.

Figure 5:
The voltage waveforms at various points marked on the circuit of figure 4.



connected in parallel with the existing ON/OFF switch of the device that is to be controlled by the touch key; for example a Hi—Fi amplifier system.

The scheme of this connection is shown in figure 8. The connection will be similar for any device. Only precaution to be taken is that the rating of the relay contacts must be suitable for the application. The touch key is universally applicable, if it is properly mounted in a suitable casing and the relay contacts are made available over sockets as shown in figure 9.

Key Tip

Construction of key tip can be done according to ones own creativity. The important feature to be remembered is that the two conductive surfaces must be separated by an insulator or air gap. The gap should be so small that it can be easily bridged by the tip of a finger. Two ideas are illustrated in figures 10 and 11. One uses a banana socket with a small lug covered with insulating sleeve inserted from behind.

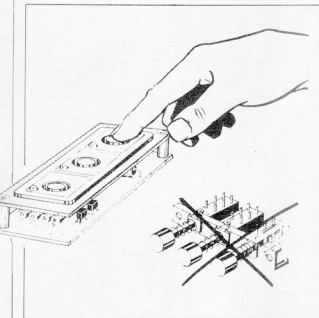

This type of touch key is very easy to install, as the banana socket comes ready with threading and matching nut. Only thing you have to do is drill a hole on the panel and mount the touch key.

Another type of touch key construction shown in figure 11 uses decorative nails, drawing pins and washers of suitable diameter.

This type of construction is very difficult because it requires accurate drilling and soldering. The washer and the nail have to be perfectly concentric and an insulating material must be provided between them if the head of the nail is larger than the internal diameter of the washer. The mounting surface also must be of an insulating material as both the parts are directly mounted on it. Two pins must be accurately soldered onto the washer as shown in figure 11. After inserting these through the panel they can be fixed with adhesive on the back side of the panel. In case the touch key is also assembled directly on the PCB, these pins can be directly soldered on to the PCB instead of fixing with adhesive.

Part List

R1, R2 = 4.7 M Ω
 R3 = 220 K Ω
 R4, R13 = 100 K Ω
 R5 = 47 Ω
 R6 = 22 K Ω
 R7, R12 = 4.7 K Ω
 R8, R10 = 47 K Ω
 R9, R11 = 470 K Ω
 C1 = 1 μ F/16V or 10 μ F/16V
 C2, C3 = 100nF
 C4 = 10 μ F/16V
 D1...D5 = 1N4148
 T1...T5 = BC547B
 T6 = BC557B
 Other parts:
 1 SELEX PCB (80 x 100 mm)
 1 9V Miniature Battery Pack
 Re = Suitable Relay

Figure 6:
 Component layout for the touch key circuit using a double size SELEX PCB (80 x 100 mm). The flip flop circuit is shown on the left half of the PCB. If one does not want the flip flop stage, the remaining circuit can be assembled on the smaller SELEX PCB (40 x 100 mm)

Figure 7:
 Even after mounting the relay there is still a lot of space left on the PCB.

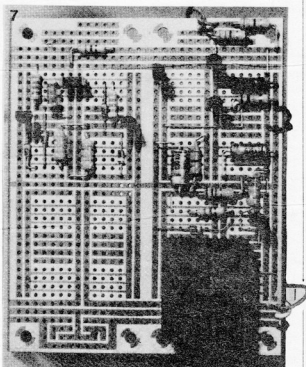
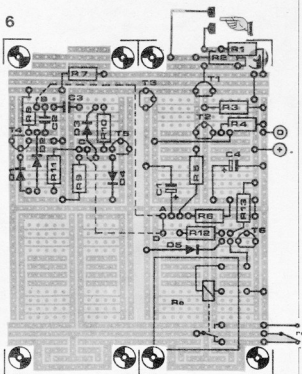

8

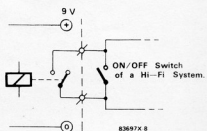

Figure 8:
Touch key connected across the ON/OFF switch of a Hi-Fi amplifier system.

Figure 9:
The touch key becomes universal, if mounted inside a separate case and relay contacts connected to a socket.

Figure 10:
Touch key constructed using a banana socket and a metal lug with insulating sleeve inserted from behind.

Figure 11:
Touch key using decorative nail/pin and a washer. This requires lot of skill in construction as the drilling and soldering must be very accurate.

9

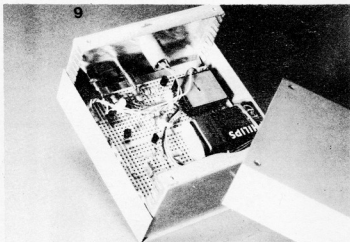

10

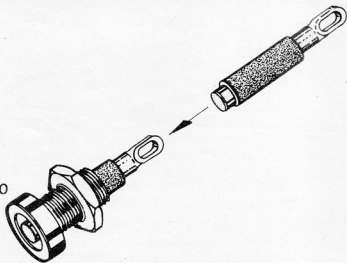

11

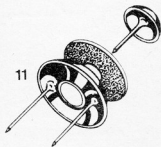

SCOPE/METER

This system which is IBMPC supported is designed to make controlled checks and calibrations of oscilloscopes with bandwidths upto 1GHZ.

- (a) Sensitivities are as low as 40mV to 200V/div. with outputs of \pm DC and square wave of 10HZ, 100HZ, 1 KHZ and 10KHZ.
- (b) Automated or manual operation.
- (c) Fully programmable for automated testing.

The Automated meter calibration system — Lets you calibrate an extensive range of voltmeters, ammeters, ohmmeters and multimeters.



More information:

M/S THE EASTERN ELECTRIC AND ENGINEERING COMPANY PRIVATE LIMITED, Rtd Off. Gyan Ghar, Plot 434A, 14th Road, Khar, Bombay 400 052 Tel: 537210

LCR METER

Ando Electric Co. Japan, offers the AG-4311 digital LCR meter. This unit is designed to make measurements as close as possible to actual user conditions for L, C&R components, semiconductors, complex components, electronic materials etc.

Measurement can be made at 31 spot frequencies from 100 Hz to 100 KHz and atleast signal levels between 1 mV to 5 V.R. L.C.D.Q.G. ESR, B, IZI-O and deviation (absolute or percentage) of component value are measurable. The instrument incorporates an automatic offset "Zero" adjustment function and a high resolution mode to measure minute fluctuations in parameters.



Other features include remote control or use of AG-4311 as part of an automated measuring system through the use of the optional GP-IB plug-in interface and use of an external measurement frequency. A test fixture and test leads help to give quick positive measurement capability. An external d.c. bias can also be applied through the instrument to the component under test.

For further details contact:
MURUGAPPA ELECTRONICS LTD
Agency Divn
Parry House III floor
43 Moore Street
Madras 600 001.

COMPONENT MARKING

No special tools are required for these Machines.

Specifications:

Component Sizes:

Body length: 250" - 2.75"
Body dia : 0.80" - 1.0"

Maximum Imprint:

Depending on type with Rubberplates
2.1/4" x 1" circum.

Cycle rate:

Upto 3200 cycles/hr

Weight:

115 lb (52.3 Kg)



For further information please write to:

M/S KELLY CORPORATION
1413 Dalamal Tower
Nariman Point
Bombay—400 021.

POWER FACTOR METER

Riken Instrumentation, Chandigarh, have developed a wide range of Power Factor Meters which are claimed to be compact, handy and light weight while they are simple in operation. These meters available in MINOR, MAJOR, CLIPON and PANEL types. The instruments conform to IS : 1248-68 and are type tested



For further details write to :
RIKEN INSTRUMENTATION
181/32 Industrial Area Phase I
Chandigarh - 160 002.

SLIDE SWITCH

"IEC" have now introduced new Slide Switch with a rating of 2 Amperes, 250V AC/DC. This Slide Switch is available in single pole, on-off sequence with insulation resistance of 100 M ohms and can withstand high voltages upto 2KV. The switch has a bakelite body with brass terminals and red ABS operating knob. The terminals can be provided with screw contacts or solder contacts. The switch is expected to have a mechanical life of more than 20000 cycles and electrical life over 10000 cycles.



For further information, write to:
INDIAN ENGINEERING COMPANY
Post Box 16651 Worli Naka
Bombay - 400 018.

CABLE TIE

One piece Power Cord Cable Tie provides positive holding of mains cord wire. Available in natural or black colour for cable bundle diameter upto 51 mm. Maintain holding strength over a temperature extreme of -20°C to +95°C



For further details please contact:

SURESH ELECTRICS & ELECTRONICS
Post Box No. 9141
Calcutta-700 016.

MECO DPMs

MECO has just introduced 3 new series of light weight Digital Panel Meters featuring slim profiles with large display. These models are numbered GM-135A/B 3 1/2 digit LED type), GM-035 A/B 3 1/2 digit LCD type) and GM 0-45 A/B 4 1/2 digit LCD type).

These 3 new series feature automatic polarity switching, automatic zero function; over range indication and built-in hold function. The LED Modules operates on 0-5V power supply while the LCD Module operates on 0-9V power supply. Decimal point selection, high input impedance (more than 100 M ohms) are additional features.

Specifications common to all models include bias current 1 pA typical and 10pA maximum; measurement precision of 0.1% \pm 2 digit for 3 1/2 digit and 0.05% \pm 3 digit for 4 1/2 digit instruments; typical temperature coefficient of 25 ppm/C for reference voltage, operating and storage temperature ranges 0-50C and minus 10C to 60C respectively and sampling speed of 2.5 times per second.



For further information, write to:
MECO INSTRUMENTS PVT. LTD.
Bharat Industrial Estate, T.J. Road, Sewree,
Bombay 400 015.

IGE - CNC

I.G.E. (India) Ltd. introduces Computer Numerical Controls in technical collaboration with General Electric, USA. GE has pioneered the introduction of Numerical Controls and CNCs.

IGE will manufacture GE's Mark Century 1050 HLX 2 axis lathe control and Mark Century One for less complex machine tool applications, including turning, milling and machining centres.

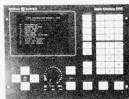

For further details please write to:

I.G.E. (INDIA) LIMITED
Nirmal Niranam Point
Bombay - 400 021.

DIP REED RELAY

PLA series DIP reed relays are now available with 1C/0 and 2C/0 contacts as well, besides 1N/0 and 2N/0 contacts.

Suitable for mounting on a standard Dual-In-Line IC sockets, PLA series DIP reed relays are available with various coil voltages with contacts capable of switching 10W/VA at 0.5 amps, and 100V Max. Salient features also include high speed switching and excellent input to output isolation characteristics.

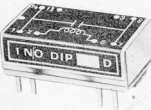

For further information write to:
M/S SAI ELECTRONICS
(A DIVN. OF STARCH & ALLIED INDUSTRIES)

Thakor Estate,
Kurla Kirof Road,
Vidyanagar (West)
Bombay-400 086

Phones: 5131219/5136601

UNINTERRUPTIBLE POWER SUPPLY

'PROFILE' has introduced an UPS Systems which is designed to provide pure power with or without mains, with a reported efficiency of more than 80%.



For further information, please write to:

TARGET MARKETING
DBS Executive Centre
Raheja Chambers
Nariman Point
Bombay-400 021.

KEYBOARD SWITCH

M/s. Darshana Industries has introduced an indigenous low Profile Tactile Keyboard Switch. It is a 12mm x 12mm. Four terminal S.P.S.T. N/O Switch rated at 50m.A 12V. DC., and has a 0.3mm movement. It features a detachable A.B.S. keytop with an acrylic cover. Legends may be Hot stamped, Engraved or stuck on to the A.B.S. top and the acrylic cover snap fitted on top. The switch is available with Silver/gold plated contact terminals.



For further information contact:
M/s. Darshana Industries
63, Industrial Estate, Hadapsar,
Pune - 411 013.

DASA SYSTEM

A data acquisition and signal analysis system (DASA) developed by Gould Inc., USA, is now available through Larsen & Toubro Limited (L&T) is

designed to record, display and analyse all kinds of test results. It has application in such wide testing areas as shock and vibration, stress and strain, ballistics, acoustics engine analysis, crash testing, high voltage power life failures, data stream quality and accuracy, biophysical research and many other types of tests and analysis based on multiple analog signal inputs.

Data acquisition is accomplished by the Gould DASA system with a unique, instrument quality, multi-channel signal digitiser. This front end sub-system accepts upto eight analog signals (± 50 mV to ± 500 V) expandable for upto 112 channels and samples them simultaneously at predetermined rates from 500 Hz to 1/3 MHz.

The use of common time base, clock accuracy of 0.01% and individual channel 8 bit A/D converters ensure that the digital data acquired is synchronous and that there is no time skew between them.



For further details, please contact:

LARSEN & TOUBRO LIMITED
(Instrument Division)
Venkataramana Centre,
8th floor,
563 Anna Salai, Post Box 6093
Teynampet
Madras 600 018

MAKE-YOUR-OWN TV KIT

Taurus Electronics has introduced 14" B & W MAKE-YOUR-OWN TV Kit Model 14220. It is a low priced SKD Kit with cabinet, Picture Tube, all accessories packed in a carton. The kit is pre-aligned with built in connectors. The unit has a highly sensitive VHF Tuner with Channel Coverage 2-12 and gain at 60 db. It has a unique quick heat type picture system. Only BEL make picture tubes are given in the kits. The Peak Audio output is 2 W with an earphone jack for private listening. The TV when assembled works on Ac 220-V,

50 HZ, consumes 10 W power. The TV also works on 12 V DC adaptor. A VCR socket is provided for VCR viewing. The indoor antenna with the kit dispenses the necessity for installing an external antenna in a HPT zone. This kit is also guaranteed.



For further details, contact:
HARESH G. NATHANI,
TAURUS ELECTRONICS,
13, Bussa Udyog Bhavan,
Lower Ground Floor,
T.J. Road, Sewree (W)
near Sewree Bus Terminal,
Bombay - 400 015

MINIATURE SWITCH

SWITCHCRAFT now offer a miniature toggle switch type T-202, D.P.D.T. rated for 2A-250V A.C. These switches can be used for electrical & electronic applications, in telecommunication, electronic data processing etc. The insulating body is made of melamine phenolic to give excellent insulation with dielectric strength. Contact are made of copper, silver plated and terminals are solder lug type. The switches are tested for electrical life at full capacity load for 25,000 operations. The overall dimensions of the switch behind the panel are 13x12.7x14.8 mm. The mounting is on 6 mm dia threaded bush.



For more information contact:
SWITCHCRAFT
24 Panjaj
Vakola Bridge, Santacruz (E)
Bombay-400 055.

New Elektor kits assembling service and unmodified kits repairing facility available. Please write for details to: RACHANA RADIOS, Laxmiganj Guna-473001 (M.P.)

Wanted Knowhow for uninterrupted power supply and 'SMPS' outright purchase or royalty. Write in confidence MARATHEY TARALIKA, 216, Bhalchandra Road, Bombay - 400 019

For Printed circuit boards, Capacitors, Snapping clamp, Any type of press part, Art work, Layout, designing also undertaken, Contact: Shiv enterprises P. Bhagat Marg, Tukaram nagar, Ayre Road, Dombivli (East) 421 201

KITS -Radio remote control Call bell Rs. 150/- Radio remote control music light Rs. 150/- Ask project list with 60 paise stamps Super Electronics, Shivaji Nagar Barsi - 413411

CORRECTIONS

Precision power supply

February 1987p. 2.49

C1, C2 is 1000 μ /25 V and R 22 is 0.22 /3W as shown in the circuit diagram, above values are shown wrongly in the list.

COMPUTERSCOPE-2

February 1987 p. 2.51

Hard copy of the screen image may be made in one of 3 ways:

1. Write the screen contents into a disk and print it later
2. Use a printer with an RS232 interface.
3. Use the Electron interface on the BBC to free the printer port.

Figure 10 of the article is wrong in several areas and should be replaced by new Fig. 10 shown here.

True-RMS meter

January 1987 p. 1.30

The correct signal assignment for the contacts on Sec is: Sec contact a = Dp 2; Sec contact b = Dp 1; Sec contact c = Dp 3.

High power AF amplifier

July 1986 p. 7-18

The suggested heat-sink should be the Fischer Type SK93, not the SK39 as stated in the parts list.

ACE COMPONENTS	5.64
ADVANCE VIDEO LAB	5.58
ANANT ENTERPRISES	5.70
APEX ELECTRONICS	5.64
APPOINTMENTS	5.03 5.68
BMP MARKETING	5.66
CHAMPION ELECTRONICS	5.65
COMTECH	5.70
CREATIVE DATA SYSTEMS	5.76
CYCLO	5.12
DEVICE	5.69
DYNATRON	5.12 5.63 5.66
ECONOMY ENGINEERING	5.63
ELECTRONICA	5.16
ENGINEERING SYSTEMS	5.06
IEAP	5.66
INSTRUMENTS CONTROL DEVICES	5.66
KLAS	5.64
LEADER ELECTRONICS	5.16
LOGIC PROBE	5.61
MAYAN INDUSTRIAL	5.70
MECO	5.07
MX ELECTRONICS	5.10 5.11
NARMADA VALLEY	5.64
NCS ELECTRONICS	5.16
PHILIPS	5.13
PRECIOUS	5.08 5.09 5.15
SAI	5.59 5.61 5.63
SAINI	5.14
SIEMENS	5.38 5.39
SMJ ELECTRONICS	5.02
TESTICA	5.14
TEXONIC INSTRUMENTS	5.14
TRIMURTI ELECTRONICS	5.58
UNLIMITED ELECTRONICS	5.58
VASAVI ELECTRONICS	5.06
VISHA ELECTRONICS	5.75
YABASU	5.12

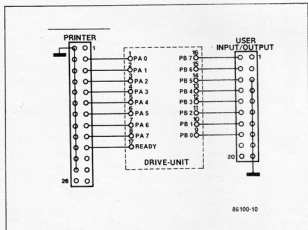

LEARN PROCESS CONTROL

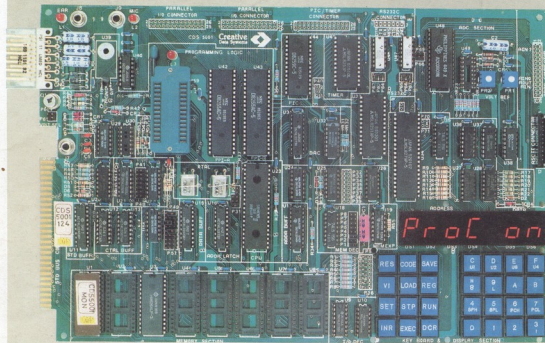

ON IMPACT-1

Impact-1 is a unique combination of Hardware and Software designed for the first time in India for learning Process Control Applications. It is an 8085A based system with on-board ADC/DAC, Timer/Counter, Interrupt Controller, RS 232C Serial Port, Centronics Parallel Port, ASCII Keyboard Interface, Cassette Interface, 48 Parallel I/O lines, EPROM Programmer for 2716 to 27256 with optional Fast-Intelligent Mode, Hex Keypad with 6 digit LED display, STD Bus on card edge and six 28 pin sockets to take memory upto 64K total. Powerful FIRMWARE is given in a 16K EPROM and is supported by comprehensive Documentation. In short, Impact-1 has everything that is required for training in process control applications and that is why it greets you with the message 'Pro Con' at power up!

Want to know more about Impact-1?

Write to us today for the colour brochure of Impact-1 and other 8085 based systems.



**Creative
Data Systems**

14, Hanuman Terrace, Tara Temple Lane,
Lamington Road, Bombay 400 007

Tel: 362421, 353029

Tlx: 011-71801 DYNA IN

Gram: ELMADVICE