

46
February
1987

elektor **INDIA**

Rs. 7.50

electronics

THE FUTURE BELONGS TO THE PHOTON

Processing digital signals
Precision power supply

Sunil Singh

UNIVERSAL CONTROL
FOR STEPPER MOTORS



Electronics Technology

The future belongs to the photon	2.28
Digital signal processing	2.40
Software for the BBC computer	2.42
Flexicell to beat battery weight	2.66

Projects

Indoor unit for satellite TV reception	2.21
Universal control for stepper motors	2.31
Precision power supply	2.44
Computerscope 2	2.51

Information

Editorial	2.05
News ● News ● News ●	2.17
Meet	2.65
New products	2.70
Licences & letter of intent	2.80
Corrections	2.82

Guide-lines

Switchboard	2.77
Classified ads	2.82
Index of advertisers	2.82

Selex-20

Linear scale ohmmeter	2.58
The Cackling Generator	2.61
Power	2.63
Electronic Switch	2.64

Second Stage

YABASU
range of
PCB
Drafting Aids
For precision & quality
at realistic prices

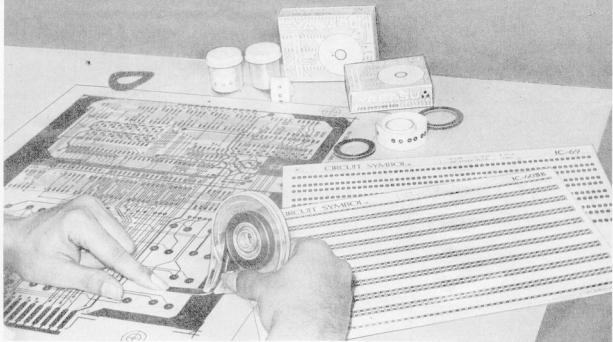

Yabasu PCB Drafting Aids are made to meet international standards keeping in mind that the excellence of PCB artwork is determined by the quality and precision of PCB drafting aids used.

Precious offers a wide range of PCB drafting aids which covers: Red, Blue & Black tapes, Donuts IC Patterns, Connector Patterns, transfer lettering etc.

Distributors

Circuit Aids

No. 451, 64th Cross, V Block, Rajaji Nagar, Bangalore-560 010

J.M. Enterprises

382, Lajpatrai Market, Delhi-110 006

Kaysons Radios

363, Lajpatrai Market, Delhi-110 006

Dimech Enterprises

C/4, Ajanta Flats, Navrangpura, Ahmedabad-380 013

Integrated Electronics Instruments

8-2-174, Red Cross Road, Secunderabad-500 003

NEW

First time in India

YABASU TAPE DISPENSER

- Tape end is instantly located
- Tape is protected against dust and moisture from hands
- Tape aligning & positioning is simpler

Sole Distributors

precious[®]
Electronics Corporation

52-C, Proctor Road, Bombay 400 007,
Tel. 367459/369478, Telex: (011) 76661 ELEK IN

VASAVI OSCILLOSCOPES

SYMBOLISE FIVE STARS

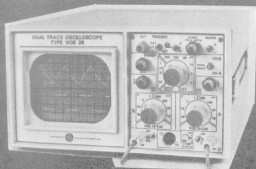
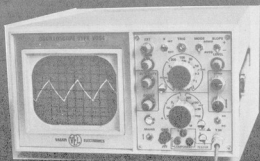

- ★ **SENSITIVITY**
- ★ **SPEED**
- ★ **SUPERIOR COMPONENT
TESTER**
- ★ **SERVICIABILITY**
- ★ **SIMPLICITY.**

for details write to:

VASAVI ELECTRONICS

630, Alkarim Trade Centre
Ranigunj (opposite to Bus Stand)
SECUNDERABAD-500 003.

ph: 70995
gms: VELSCOPE
Telex: 0155-6834

INDIA'S FIRST

Now,
Capture
Store
Display
and
Analyse

signals with

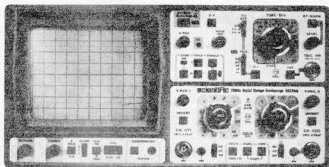

HM 205

DIGITAL STORAGE OSCILLOSCOPE FROM scientific

Scientific now extends the best features of its well-known and time-proven HM series to the Digital technic with the introduction of HM 205, bridging the gap with Analog and Digital Storage operation. Features includes: 2 Channels-20 MHz-2mV, Separate Memories for each channel, Single and Refresh modes, Battery back-up for memory, Highest TB Speed 20 nS, TV Sync. Separator, Addition and Subtraction of channels, Component-Tester, weighing only 8.5 Kg.

OTHER MODELS: ■ 60 MHz, -D.T. 1mV, Max.T.B. Speed 5nS ■ 20 MHz -D.T. 1mV, sweep delay. ■ 20 MHz, -D.T. 2mV, Max.T.B. Speed 20nS ■ 20 MHz, -D.T. 5mV, Max.T.B. Speed 40nS ■ 10 MHz, -S.T. Comp. Tester.

ANALOG AND
DIGITAL STORAGE
OSCILLOSCOPE.

Manufactured by:

SCIENTIFIC MES-TECHNIK PVT. LTD.,

B-14, Industrial Estate, Pologround,
INDORE-452 003

Phone: 31777-78 Cable: SCOPE Telex: 0735-267

Designed to lead. Built to last.

'UL
APPROVED'

PCB



BRAINSTORM FROM STOVEC

Stovec Screens India Ltd. in collaboration with Prestwick Circuits of Scotland, bring you state-of-the-art professional grade Printed Circuit Boards.

Our manufacturing programme encompasses Double-sided Plated through-hole Boards, Multi-layer Boards, Fine Line Boards, Boards for Computers, Telecommunications, Defence and Medical systems.

Quality and reliability are key words in the Stovec lexicon — modes of expression which are given form and meticulously displayed in all phases of the manufacturing programme.

We invite you to join the growing list of our satisfied customers.

For details contact :

STOVEC SCREENS INDIA LTD.

(Circuits Division)

Plot No. B-24, G.I.D.C.

Electronics Industrial Estate,

Sector 25

Gandhinagar 382 025.

Tel. (02712)22061 Telex : 121-326 STVC IN

Cable : "CIRCUITS"

or

A.T.E. PRIVATE LTD.

36 SDF II, S.E.E.P.Z.

Andheri East, Bombay-400 096.

Tel. : (022) 6349032, (022) 6300195

Telex : 11-71513 DIP IN.

IC SOCKETS

HIGHLY RELIABLE

CONSISTENT SUPPLY

AT AFFORDABLE PRICES !

Socket all your IC's with
CHAMPION IC Sockets and MULTIPLY* your PROFITS ! !

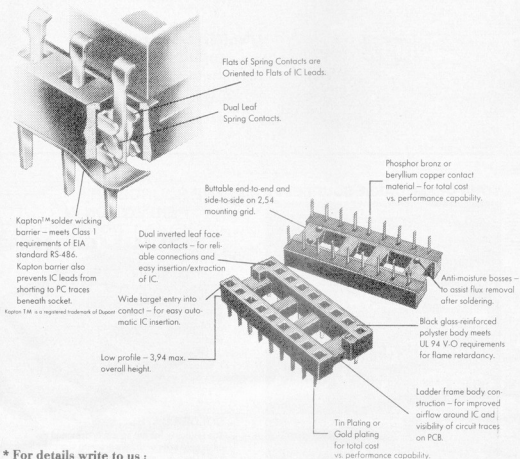

* For details write to us :

Champion Electronics Pvt. Ltd.

In Joint Venture with
CAMBION ©
 MIDLAND ROSS CORP U.S.A.

Champion Electronics Pvt. Ltd.
 S-17, MIDC, Bhosari, Pune 411 026, INDIA
 Phone : (0212) 83791, Cable : CHAMPION
 Telex : 0145-333 MCCI IN, 0145-505 MCCI IN

ORIENT/CE-186

INDOOR UNIT FOR SATELLITE TV RECEPTION — 3

by J & R v. Terborgh

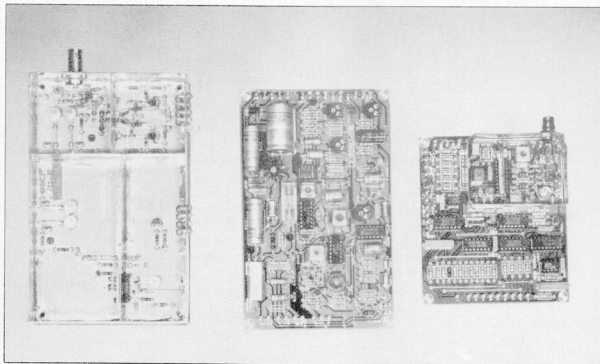

This is the final, optional board in the IDU. As promised in the preceding instalments of the series, it comprises the AFC, scan and remodulator facilities, as well as the LNB theft alarm.

The circuit board described in this article is not, strictly speaking, indispensable for a fully operative indoor unit. But then, the optional add-on circuits are relatively simple to build on a single PCB and may provide you with a number of quite useful extensions.

Circuit description

The circuit diagram of the optional extension board is shown in Fig. 18. The various functions it offers are best discussed by starting from the three possible positions of the front panel mode switch, S_{4a-b} .

1. TUNE. S_{4a-b} is set to position 1, as shown in the circuit diagram. Oscillator IC_5 is disabled by the low level at its

RESET input, pin 4. Electronic switch ES_2 is closed, while ES_1 is opened, so that the DC-coupled video signal, CVBS-1 (see Part 2) is routed to TV modulator IC_{15} . The operation of this versatile RF chip will be reverted to.

The RF board tuning voltage, V_{TUNE} , is taken from the output of summing opamp A_2 , which is driven with the tuning control voltage (terminal T, controls P₁-P₂), and the output voltage of AFC amplifier A_1 .

If AFC switch S_1 is opened (AFC off), ES_1 and ES_2 are off and on, respectively, which means that the voltage at the + input of A_1 is a fixed level, determined with P₁. V_{TUNE} will, therefore, track the voltage at point T, just as if there were no

amplifier of any type in function.

Switching on S_1 , however, causes B_{OC} , rather than the voltage at the wiper of P₁, to be fed to the + input of A_1 . This creates a feedback loop in the tuning voltage circuit. It will be recalled that B_{OC} is the smoothed direct voltage component of the baseband video signal. Tracing its origin will reveal that B_{OC} is the proportional equivalent of the PLL-generated tuning voltage across varactor D_1 , i.e. it can provide information about the instantaneous centre frequency of the PLL subcarrier (see Part 1).

Assuming the AFC function to be switched on, and assuming that the selected oscillator, LO₁ or LO_H, starts to deviate from its

set frequency—which may well happen owing to thermal effects—the PLL will consequently alter the voltage across D_1 —and hence B_{OC} —to match its VCO frequency with that of the incoming carrier at about 610 MHz. The AFC circuit next responds to the assumed fluctuation of B_{OC} by correcting V_{TUNE} such that the oscillator remains at the set frequency, i.e. B_{OC} also remains constant!

The practical limitations of the proposed AFC circuit mainly concern the response speed of the loop, and the AFC hold range. The AFC circuit should be insensitive to the demodulated video component, which, of course, is also the PLL action to an FM input signal. This function is taken care of by C_{SE} (see

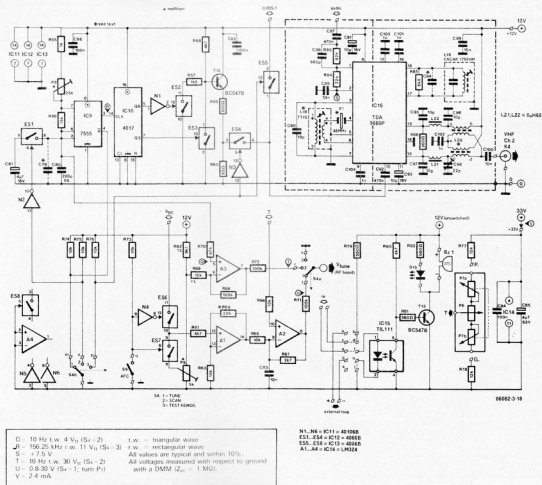

Fig. 19. Circuit diagram of the optional extension board in the IDU.

Part 2), as well as C_{83} . Feedback resistor R_{64} defines the AFC hold range, i.e. the span of V_{line} that ensures a constant Bc voltage. The stated value of this resistor fixes the amplification of A_1 at about 3 $[(R_{64} + R_{63})/R_{63}]$, which will ensure sufficient AFC action in most practical cases.

2. SCAN: S_{1a-b} is set to position 2. ES_1 is closed, and IC_9 oscillates at about 10 Hz. The triangular wave at pins 2 & 6 is amplified to about $30 V_{PP}$ by means of A_3 , which consequently causes the relevant oscillator, LO_L or LO_H , to produce a swept output frequency over its entire mixer injection band. The purpose of the SCAN facility is to facilitate the initial dish positioning procedure. As soon as the dish "sees" the satellite, there will be a marked change on the TV or monitor

screen from stable noise to a rather unsteady flicker, caused by the receiver sweeping across the incoming transponder signals. Also, the S-meter will show some deflection and hence can be used to find the initial aerial position.

3. TEST REMODULATOR: S_{1a-b} is set to position 3. ES_1 is opened, causing IC_9 to oscillate at 156.25 kHz, or 10 times the TV line frequency. Counter IC_{10} supplies two sequential $7 \mu s$ pulses; one for use as a line blanking pulse (Q_1), and one for a white vertical bar (Q_2). These pulses are combined by means of ES_3 and ES_2 to form what can hardly be referred to as a composite video signal, yet is entirely satisfactory for the present purpose. Resistors R_{57} and R_{58} have been dimensioned for a blanking/white ratio of about

1:3. ES_4 is closed, while ES_5 is opened, so that the video test signal is passed to TV modulator IC_{16} .

The remodulator test facility enables ready tuning of the TV set to the modulator output frequency, thereby slightly alleviating the possible difficulty in setting up a satellite reception system for the first time.

LNB theft alarm (IC_{15} ; T_{13}).

The relevant circuit section is

so simple as to obviate the need for a detailed description. With three jumpers installed as shown by the dashed lines, LED D_{15} and buzzer BZ_1 will warn of attempts to steal the costly LNB. The jumper block and the potential-free relay contacts should enable a straightforward connection of the LNB theft alarm to many types of existing alarm system. Table 3 shows some of the possible alarm configurations plus associated jumper positions.

Table 3.

Alarm configuration	jumpers/wires
LED and buzzer only re to external alarm; IDU alarm disabled	c-d-e-f h-l a-c-e-g-d-f h-l
external 20 mA series loop (OR function)	a-b-g-e-c-f h-l
external alarm drives IDU alarm	a-b-d-f-g-f h-l

Parts list

(Note: parts are coded to BS1852; see Infocard 500)

Resistors ($\pm 5\%$):

$R_{155} = 1K\Omega$
 $R_{156} = 15K$
 $R_{157} = 1KB$
 $R_{158}, R_{159}, R_{160} = 4K7$
 $R_{159} = 820R$
 $R_{160} = 82R$
 $R_{162} = 9K1F$
 $R_{163}, R_{164}, R_{165}, R_{171}, \dots, R_{174}$ incl. = $10K$
 $R_{164}, R_{165} = 22K$
 $R_{167} = 2K7$
 $R_{168}, R_{171}, R_{172} = 100K$
 $R_{169} = 12KF$
 $R_{170} = 47K$
 $R_{177}, R_{178} = 12K$
 $R_{179}, R_{181}, R_{182} = 560R$
 $R_{181} = 82K$
 $R_{181} = 6KB$
 $R_{184} = 300RF$
 $P_1 = 25K$ multiturn preset
 $P_2 = 5K\Omega$ multiturn preset

Capacitors:

C_{19} = see text
 $C_{60} = 220p$ 5% styroflex
 $C_{61}, C_{67}, C_{69} = 10\mu$; 16 V tantalum
 $C_{62}, C_{64}, C_{68} = 100n$
 $C_{63}, C_{65}, C_{69}, C_{103} = 10n$ ceramic
 $C_{65} = 4\mu$; 63 V axial electrolytic
 $C_{67}, C_{102} = 470n$
 $C_{68} = 560p$ ceramic
 $C_{60} = 18p$ ceramic NP0
 C_{64} = see text
 $C_{65}, C_{66}, C_{67} = 10p$ ceramic
 $C_{68} = 22p$ foil trimmer (green)
 C_{101}, \dots, C_{104} incl. = $1n$ ceramic

Inductors:

$L_{18} = 7T15$ assembly (Neosid)*
 $L_{19} = KACAK1769HM$ (Tokoi)
 L_{20} = small VHF balun core (appr. $7 \times 5 \times 4$ mm)*
 $L_{21}, L_{22} = 0.68\mu H$ axial choke
* Home-made inductor; see text.

Semiconductors:

$D_{15} = LED$ red
 $IC_8 = 7555$ (do not use a 555)
 $IC_{10} = 4017B$
 $IC_{11} = 40106B$
 $IC_{12}, IC_{13} = 4066B$
 $IC_{14} = LM324$
 $IC_{15} = TIL111$ or TIL311
 $IC_{16} = TDA5660P$ (Siemens)*
 $T_{12}, T_{13} = BC547B$

Miscellaneous:

$B_{21} = 12$ V self-oscillating buzzer
 $\phi 12$ mm
 $K_4 = BNC$, phono or Belling-Lee socket (VHF output).
 $S_1 = 2$ -pole, 3-way rotary switch.
 $S_2 =$ miniature SPST switch.
 $X_1 = 48$ MHz crystal; HC18 case; series resonant 30 pF AT cut.
PCB Type 86082-3 (see Readers Services).
0.1 inch pitch jumper block;
2 rows of 5 pins; jumpers as required.
37 off soldering pins.

* Available from Universal Semiconductor Devices Ltd; Telephone: (01 348) 9420 9425; or from ElectroValue; Telephone (0784) 33603 or (061 432) 4945.

19

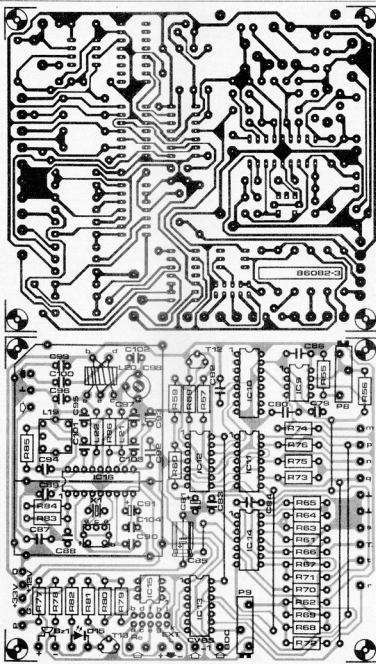

Fig. 19. Track layout and component mounting plan for the IDU extension board.

Remodulator (IC16).

The Type TDA5660 from Siemens is an all-in-one TV modulator chip which can be configured for a wide variety of TV standards. In this design, it provides a double-sideband, AM vision, FM sound, TV signal at 48 MHz, which is roughly channel 2 (48.25 MHz, Band I). Operation on channel 3 or 4 is also possible by simply using an appropriate crystal in the X₁ position. The circuit may also

be modified to output a UHF TV signal (470-790 MHz), but this is rather more complicated than exchanging the crystal, and is, therefore, only recommended for experienced RF constructors. The matter will be reverted to in the section on construction.

The audio input signal to the TV modulator chip is passed through a pre-emphasis network, R_{63} - C_{69} ($\tau \approx 50 \mu s$). The modulator chip provides wide-

band FM modulation at the audio sub-carrier frequency of 6.0 MHz, as set with L_{19} . The VHF output signal is available at symmetrical output pins 13 and 15. A double pi-filter, C_{93} - L_{22} - C_{94} and C_{97} - L_{21} - C_{98} , precedes 300R-to-75R balun L_{20} , form which the TV signal is taken by C_{100} . Trimmer C_{68} is used to set the modulator output filter for optimum balance. The dashed lines around the remodulator circuit denote metal screens

which serve the preclude stray radiation.

Construction

If you have made it so far in building the IDU, you are not likely to encounter serious difficulties in getting the present extension board up and running.

Fig. 19 shows how PC board Type 86082-3 is to be completed. Only three points require special attention, namely making L_{18} and L_{20} , and fitting the extension board on top of the vision-sound-PSU board described in Part 2 of this series. In order to avoid unnecessarily repeating the suggestions for making one's own inductors, it is recommended to re-read the passage on preparing L_{15} ; this can be found in *Elektron India*, December 1986.

With reference to Fig. 20 and Table 4, oscillator coil L_{18} is made as follows (note that the white ABS former as part of the Type 7T1S inductor assembly is divided into two equally long sections by means of a small rim):

1. Starting from f', and observing the indicated winding direction, close-wind 11 turns in upward direction onto the lower section of the former body; doing so will neatly fill this section. Connect to b (not to e!).
2. Starting from e', and once more observing the correct winding direction, close-wind 4 turns upward onto the upper section of the former; the first turn should rest against the rim. Connect to a.
3. Check for any short-circuits between the windings, and verify correct continuity at the pins.
4. If you have a GDO, check whether the inductor can be tuned to about 50 MHz with a 18pF capacitor temporarily fitted across f-b.
5. Mount the former plus screening can onto the PCB. Adjust the yellow-tipped core until its top is level with the hole in the screening can.

As to L_{20} , the construction of this balun (balanced-to-unbalanced transformer) is evident from the six-step instruction shown in Fig. 21. Almost any type of small, two-hole ferrite bead rated for at least 100 MHz can be used in this circuit. The inductor is wound with bifilar

20

L18 Neosid 7T1S
viewed from underneath



Fig. 20. Pin assignment of oscillator tank inductor L_{18} .

Table 4. Home-wound inductors

Inductor	SWG wire	turns	remarks
L_{18} f'-b	30 enam.	11	Closewound on Neosid dia. 4 mm former Type 7T1S; see Fig. 20.
e'-a	30 enam.	4	
L_{20}	30 enam. bifilar	2×3	RF transformer; see Fig. 21.
L_{UH}^*	24 silv.	3	Space windings to obtain overall length of 5 mm. Internal dia = 3 mm.
$L_x; L_y^*$	24 enam.	5	Space windings to obtain overall length of 8 mm. Internal dia = 3 mm.

* Only required for UHF-band operation of remodulator.

21

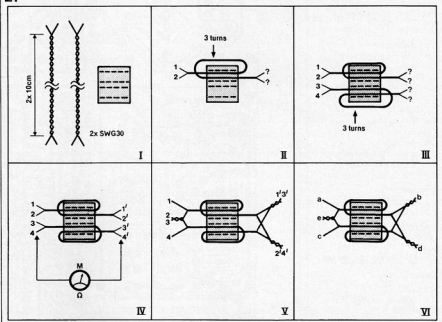

Fig. 21. Suggested construction of balun L_{20} .

wire, which is simply made by twisting two lengths of enamelled copper wire. After winding two times three turns through the bead holes, the string ends are split in order to identify the four individual wires by means of a resistance meter or a continuity tester (step IV). At this stage, it is a good idea to check the wires for internal short circuits caused by the insulating enamel coating being damaged as the windings are tightened around the ferrite bead.

After making the balun and fitting it onto the board, it is time to check whether this is correctly populated. There should be six wire links in all, and the

jumpers in the LNB alarm circuit should be fitted as required. Positions C_{23} and C_{24} are vacant as yet. Make sure that all ceramic capacitors in the remodulator section are mounted with the shortest possible lead length. The crystal case must not be grounded. The position of the 12 mm high metal screen around the remodulator circuit, and the lengthwise fitted screen across IC_{18} , is governed by 9 soldering pins. A single strip of 12 mm wide thin brass sheet or tin plate is readily cut and bent to size. Remember to drill two small (ϕ 3 mm) holes in the screen to enable feeding through the shielded wire to

the audio input, and, if required, the ϕ 3 mm coax cable from the RF output to K₁ on the enclosure rear panel.

The completed extension board is mounted on top of the rear side of the vision-sound-PSU board, i.e. as close as possible to the enclosure rear panel. Remodulator output socket K₂ can be fitted at a suitable location in the rear panel, whilst being connected direct to the relevant pin on the PC board, i.e. without a length of coax cable. Note, however, that this mounting method requires making a suitably sized hole in the previously mentioned screen, allowing for the passing of the socket.

The lowest possible mounting height of the present board above the vision-sound-PSU board is determined mainly by the height of the fuseholder on the latter PCB. Sufficient stability of the "sandwich" construction is ensured by using two conventional 15-20 mm long PCB spacers in the two rear positions.

It goes without saying that the overall height of the two-board unit should enable the IDU to be closed properly. Also, the vision-sound-PSU board should be fully operative and correctly aligned, since many of its adjustment controls are no longer accessible with the extension board fitted on top.

The wiring of the boards should be fairly straightforward, requiring no further remarks other than that the audio, BDC and V_{LINE} connections should be made in conventional shielded microphone cable, while the CVBS-1 connection is made in $\frac{1}{4}$ 3 mm coax. In all cases, ground the cable shield at the lower board only.

Finally, the external loop connection can be made with whatever type of socket or terminal strip is thought most convenient; a 3- or 5-way DIN socket is satisfactory.

Setting up

Before detailing a suggested setting up procedure for the present board, it must be made expressly clear that attempting to use the completed extension PCB along with as yet un-operative RF and vision-sound-PSU boards needlessly complicates getting the IDU to function correctly. Therefore always build up the receiver as detailed in Part 2, and familiarize yourself with the various adjustment points and their typical response, before adding the present board.

1. Set S_4 to **TUNE**, and switch off the AFC (S_5). Turn P_7 (coarse tuning) to check whether V_{LINE} varies from about 1.30 V. Tune to a satellite programme and check the presence of composite video at pin 10 of IC16.

Do the same for the audio at pin 1. Measure BDC, note the value, and adjust P_9 for an identical voltage at its wiper. Switch on the AFC and check its hold range by turning P_1 : reception

should remain unaltered over a certain portion of the tuning control travel, then suddenly be lost.

2. Set S_4 to **SCAN**, and switch off the AFC. Use a scope to check measuring points (1) and (2). V_{LINE} should be an undistorted triangular wave, i.e. it should have clearly defined points of inflection, and no clipped tops or appreciable offset. If necessary, R_{B2} and R_{B3} may be re-dimensioned to achieve the correct wave-form and amplitude degree respectively.

Set P_8 to the centre of its travel and observe the monitor screen to see the effect of the SCAN mode when a satellite is received. You may want to experiment a little with the value of C_{S1} to obtain the best noticeable effect on the screen. Try to remember what it looks like!

3. Set S_4 to **TEST REMOD**, and connect a TV set to K_4 . Tune the TV to channel 2. Adjust the core in L_{18} until the test signal—a white vertical bar two thirds to the left of the screen—can be seen with good definition. Adjust P_8 for optimum synchronization, or use a frequency meter to check measuring point (3) for the presence of the stated rectangular wave (see Fig. 18). Fine-tune the TV set to the test signal, and switch the IDU on and off a few times to verify whether the 48 MHz oscillator starts properly; correct the adjustment of L_{18} , if necessary. Set S_4 to **TUNE** and observe the transponder signal on the TV. It may be necessary to re-do the setting of P_1 and L_{18} , as well as the TV tuning, for optimum picture quality.

Turn up the volume control on the TV and peak L_{19} for best sound reproduction. A suitable ceramic capacitor (10-100p) may be fitted in the C_{S2} position, in case L_{19} can not be tuned low enough.

Finally, tune the TV set to a lower UHF band harmonic of the remodulator, and adjust C_{S3} for minimum signal strength. Unfortunately, the presence of harmonics can not be ruled out altogether, given the relatively low frequency of operation of IC16. Depending on the degree of crystal activity, it may be worth while to fit a damping resistor (1K0-10K) across pins f and b of L_{19} .

Run a quick check on the operation of the LNB theft alarm by disconnecting the download cable at K_1 . Please note that the alarm circuit is fed from the **unswitched +12 V supply**. Therefore the +Bz1 terminal on the PCB should be wired to the buzzer as well as the appropriate connection of S_7 (see Part 2).

Finally, if the setting of P_8 fails to give a satisfactory compromise between the operation of the SCAN function and that of the internal test pattern generator, try fitting a number of small capacitors in the C_{7-9} position.

Remodulator on UHF

The circuit diagram of Fig. 22 shows how to modify the on-board, TDA5660-based, TV modulator for operation in the UHF TV band (470-790 MHz). As this modification is not supported by the PCB layout, altering the circuit is recommended for experienced RF construc-

tors only.

Present P is used to set the desired output frequency, which must be well removed from the PLL VCO frequency to avoid carrier interference. Therefore do not tune IC16 to the generally used modulator channel 36.

The small ceramic NPO capacitors can be fitted in a three-dimensional construction, along with oscillator inductor L_{UHF} which can be spaced or compressed slightly to set the initial output frequency. The 1p5 capacitors are, of course, fitted direct across the relevant IC pins at the PCB track side.

The modulator output filter must also be altered as shown to allow for the higher frequency. Use a suitably rated bead for L₂₃, and wind two turns through each hole, rather than three as in the VHF circuit. The data for L_{UHF}, L_X and L_Y can be found in Table 4.

Aerial positioning unit

The circuit diagram of Fig. 23a and the photograph of Fig. 23b show a simple, yet indispensable accessory unit for the IDU. It is a hand-held remote meter circuit which is connected to the IDU over a length of 6- or 7-way cable, enabling the user to monitor the S-meter indication while lining up the aerial for optimum reception.

It should be noted that the circuit diagram and practical realization are but suggestions; other configurations, as well as more sophisticated controls are perfectly feasible, and constructors should have little difficulty in tailoring the aerial

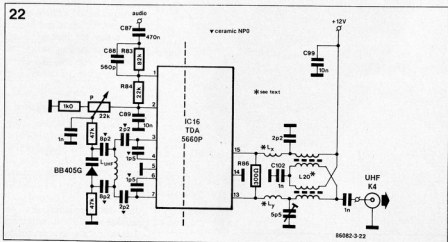
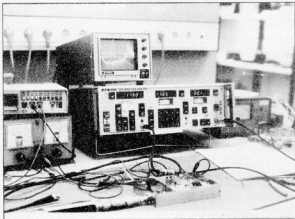

Fig. 22. Modified circuit for the remodulator, if this is to operate in the UHF band.



Test set-up to examine the performance of the BFG65 Prestige in the IDU. Display indications, left to right: frequency (MHz); associated gain (dB); noise figure (dB). Courtesy of SSB Electronics, Iserlohn, Federal Germany.

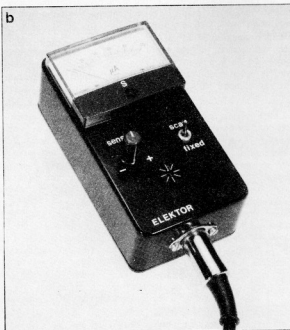
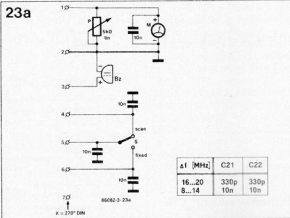

Fig. 23. Circuit diagram (23a) and practical outlook (23b) of the aerial positioning unit.

positioning unit to their specific requirement.

With reference to Fig. 23a, the meter should be a more sensitive type than that incorporated in the IDU. Either a switch, mounted onto the IDU rear panel, or a socket contact, is used to break the S meter driver output to the front-panel mounted meter, and route the signal to the aerial positioning unit. A buzzer is fitted to enable the person remaining at the IDU to notify the other person at the aerial that the IDU is switched from SCAN to TUNE following the slightest sign of reception on the TV or monitor screen.

In practice, the aerial positioning unit may be used as follows (note that a detailed aerial positioning method will be discussed in next month's final instalment of this series):

1. Set the IDU to SCAN, LO₁ or LO₂ depending on the satellite to be received; connect the positioning unit cable, and, if possible, install a helper at the IDU.

2. Take the positioning unit to the aerial site (on the roof, in the garden, or wherever reception is thought feasible).

3. Set the unit to maximum meter sensitivity and line up the dish until some deflection is seen. Hopefully, the person inside has noted the SCAN effect on the screen, and, via the buzzer, notified you that the meter indication will be lost for an instant as he tunes to some transponder.

If no help is available, leave the dish roughly positioned and go inside to switch from SCAN to TUNE yourself. Reception of the satellite may still be weak at this stage, but you have at least managed to find a stable signal.

4. Go outside again and line up the aerial for highest meter deflection, turning down the sensitivity any time the meter reaches its fsd indication.

Threshold extension

The following is a necessarily brief examination of a number of experiments with the PLL demodulator, IC₂, on the RF board. As these experiments are not supported by the PCB layout, their being carried out is only recommended for experienced RF constructors. Also, since the objective of the proposed modifications is to further lower the PLL noise

threshold so as to improve upon reception with relatively low C/n ratios (8-10 dB), there is no point in altering the PLL circuit if your specific outdoor unit ensures a C/n output of more than about 12 dB.

When the C/n ratio at the input of the PLL demodulator approaches the noise threshold, the received picture is more or less impaired owing to noise spikes occurring primarily in the saturated colour areas. This effect is mainly due to insufficient open loop gain of the PLL at the chroma subcarrier, 4.433 MHz (PAL system).

Incorporating a chrominance filter in the secondary PLL loop may improve reception to some extent, but it should be noted that the effect depends on the transponder deviation and bandwidth. For instance, the signal from Teleclub Switzerland could be slightly improved by peaking the chroma filter whilst observing the few remaining sparklies in the ochre rectangle at the lower right of the test chart. Correct tuning of the series filter will enable the sharp white-to-black transitions in the chart to appear with a clearly improved definition. The practical circuit of the chroma filter extension is shown in Fig. 24a.

It will be recalled that C₂₀ and C₂₁ define the secondary loop response and hence the operation of the PLL at a specific transponder deviation. It is important to realize that, at present, there is no single standard for the peak-to-peak deviation of transponders, not even if these are part of one and the same satellite. Research carried out by the EBU and the CCIR has provided evidence for the proposition that, given a specific C/n ratio, S/N rises with increasing deviation. It is, therefore, arguable that future satellites will hold transponders with larger output bandwidth; after all, a number of the present generation of TV satellites were originally designed to operate in data communication networks.

It may be interesting to experiment with the values of C₂₀ and C₂₁ while observing the signal from a relatively weak transponder. The range of values that can be fitted in the stated capacitor positions is quite large — see the small inset table in Fig. 24a. Fig. 24b shows how

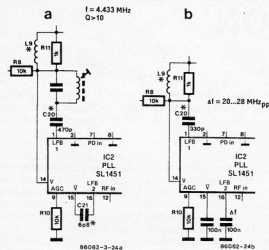

Fig. 24. Experiments in attaining a possibly low noise threshold for various levels of transponder deviation.

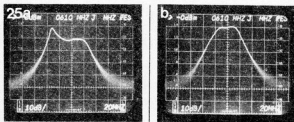
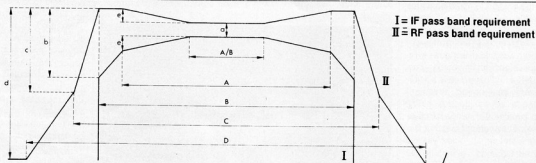

Fig. 25. Pass band curve of an incorrectly aligned (25a) and a correctly aligned (25b) IF chain on the IDU RF board.

25c



The figure is symmetrical relative to centre frequency

A (MHz)	B (MHz)	C (MHz)	D (MHz)	a (dB)	b (dB)	c (dB)	d (dB)	e (dB)
28.8	36.0	45.25	60.0	0.6	2.5	(10.0)*	(25)*	0.3

* There is no requirement for out-of-channel filtering in the transmit equipment. However, it is recommended that out-of-channel filtering be provided in the receive equipment.

86082-3-25c

Fig. 25c. Theoretical requirements as to bandwidth of RF and IF sections in satellite TV receiving equipment (Courtesy of EBU, Brussels).

the secondary loop differential amplifier is converted into a single-sided type by decoupling the LFB₂ input and the V output with 100n ceramic capacitors. This modification is called for when receiving satellite signals with a peak-to-peak deviation of the order of 25 MHz. It should be noted that such a high deviation value does not necessarily mean a higher bandwidth; in next month's article we will examine the exact relationship between these terms.

Finally, interested constructors are advised that Plessey have recently introduced the Type SL1455 quadrature FM TV demodulator, which is stated to achieve a noise threshold of about 7.5 dB, i.e. it is some 1 dB better than the SL1451 configured for optimum operation given a specific deviation.

RF board measurements

The IF amplifier chain on the RF board was studied with respect to its frequency vs amplitude characteristic. Use was made of a 0-1800 MHz spectrum analyzer plus associated sweep unit.

Fig. 25a shows the curve of a wrongly adjusted IF chain; one of the four bandfilter trimmers has obviously been set at too low a frequency, causing a marked peak outside the requisite pass band.

While adjusting the bandfilters

to obtain a satisfactory filter response, it was found possible to locate the pass band anywhere in the 450-650 MHz band, while the bandwidth was never less than about 35 MHz. Therefore, constructors not in possession of an RF sweep generator or other sophisticated equipment to measure the IF bandwidth need not worry too much about the overall pass-band of the RF board. As long as all trimmers can be tuned for stable noise output, the initial alignment is satisfactory.

Fig. 25b shows the band pass curve obtained after very carefully peaking the trimmers for optimum reception of the test chart broadcast by Teleclub Switzerland on ECS-1. The curve thus obtained may be compared to the theoretically required one shown in Fig. 25c. The latter is used by the EBU to specify the minimum requirement for Eutelsat-1 receiving stations.

Next time

Next month's concluding article in this series will tackle a wide variety of questions raised in connection with satellite TV reception. So, should any aspect of the present subject matter still puzzle you, see whether it is among the subjects qualified for closer examination in Part 4.

RKG/Bu

THE FUTURE BELONGS TO THE PHOTON

Electronics has been the main engine of innovation since the invention of the transistor 40 years ago. Most of tomorrow's interesting technologies will work by manipulating light, not electricity.

The electronics revolution is young. The electron was identified less than a century ago and the microchip, on which today's information-technology industry utterly depends, has been around for fewer than 20 years. The successes crammed into these two hectic decades have created the impression that electronics is a technology capable of limitless improvement.

It is not. Electronics will give way to a superior technology based not on electricity but on light. Physicists did not realize until early in this century that light came in the separate packets they now call photons. But science has made startling progress in manipulation photons. A photonics revolution is already in the making.

The first shot of the electronics revolution was the transistor. Photonics' first shot was the invention, in 1960, of the laser. Until then, those trying to do tricks with light had to make do with a jumble of disorderly wavelengths. Lasers create a source of light with a uniform wavelength and with each wave moving in step with its companions. This is a tool of immense power. Lasers can—or so President Reagan hopes—destroy ballistic missiles thousands of miles away. They can cut metal in factories and repair blood vessels in human eyes. Hospitals use laser beams guided through optical fibres to shatter people's kidney stones. A French inventor has replaced the strings of a harp with laser beams. Like transistors, lasers have shrunk: they can now be generated by a chip the size of a grain of sugar. This is paving the way for a wholesale switch from electrons to photons.

Why is the switch worth making? Because photons travel faster than electrons; because

they have no mass; because (unlike electrons, which interfere with each other) photons can be made to pass through each other unperturbed; because light behaves both as a particle and as an electromagnetic wave—which means that optical devices could be based on much the same operating principles as those already used in electronics.

Moreover, electronics is discovering its limits. One is the speed at which electrons travel through semiconductor materials. So long as electrons remain the information carriers of computers, this sets an absolute limit on the speed—and hence power—of computing. Electronics has not reached that limit yet, but it is drawing close enough to worry engineers.

The customary way to make computers cheaper and faster is to squeeze electronic components closer together. The number that can be fitted on a single chip has grown from

about a dozen 20 years ago to 2m today. But miniaturization, too, is bumping against limits. Engineers are running out of ways to etch into chips ever-smaller paths along which electrons can run. And when components get too close, the chips are plagued by "cross talk"—the leakage of charges from one component to another.

If computers are to work faster still, a new approach is needed. The best bet is "parallel processing"—the notion that computers ought to be able to perform a lot of operations simultaneously, instead of channeling all their calculations through one bottlenecked central processing unit. Here, too, the case for a photonic solution is compelling. Sending several electric currents through one chip at the same time risks cross-talk and disaster. Not so with beams of light: a chip could process several at once without their interfering with each other.

Still sceptical? Consider how rapidly light has nudged electronics out of two pillars of information technology: telecommunications and the storage of information.

In communications, telephone companies are tearing out their copper cables as quickly as they can afford to and replacing them with hair-thin optical fibres made of glass. Light is a better messenger than electricity. It wastes less heat and is immune to electromagnetic interference. Better still is light's enormous bandwidth. Because it spans so many frequencies, light can squeeze in far more information than electricity can. The quality of the optical fibres themselves has improved dramatically. In early (circa 1970s) fibres, light ran in a disorganized zig-zag through a relatively large core within the fibre. The resulting collisions with the fibre's cladding absorbed much of the light, requiring frequent repeaters to refresh the signals. In 1977, experimental fibres transmitted up to 140 megabits of data a second, and needed a repeater every six miles or so. Today, one experimental fibre network installed in Britain carries telephone traffic at 1200 megabits a second, with 30 miles between repeaters. The first transatlantic fibres will be carrying data and telephone conversations between Europe and America in 1988. Yet the technology is on the threshold of another luminous leap.

This will not come from changes in the fibre itself, but from the devices used to send and receive the optical signals. The first step is to combine in a single device all the paraphernalia that optical fibres require—lasers to send signals, detectors for receiving them, and a rag-bag of lenses, mirrors and electronic controls.

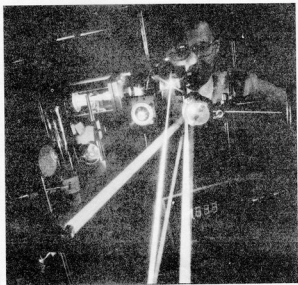

Laser majesty

The second step is to transmit light beams "coherently"—i.e. in tightly-defined wavelengths—into a receiver that can be tuned to select the required wavelengths and sort out the separate streams of data. In principle, coherent transmission enables a single fibre to carry 10m telephone conversations or 10 000 digital television channels at once.

The optical assault on data storage—that other pillar of information technology—has been as impressive. Music lovers were in the van with their compact discs. The music is turned into digital signals, burned on the disc as a series of minute pits and then decoded for playback by a low-power laser.

Audio discs like these are only the first big success of a technology restlessly seeking new applications and markets. Optical discs are beginning to replace magnetic ones as a way to store computer archives. Because they are tough, the discs can be stored inside specially-constructed jukeboxes. One 4.7-inch disc can store about 550m bytes of data—the equivalent of 1500 floppy discs or about 250 000 printed pages. Which means a jukebox can store the archives of an entire government department.

Optical discs suffer from one drawback: erasing them or writing new information on them is difficult. This has impeded their marriage with computers, but has also prompted an imaginative hunt for applications in which data must be stored permanently without alteration.

Discs sold under a standard format known as compact-disc read-only memory (CD-ROM) are enabling data-base companies to sell archival information to subscribers cheaply by post instead of expensively by telephone. Grolier, an American publisher, has put its Academic American Encyclopaedia (30 000 articles, 10 000 pages) on one-tenth of one disc, which it sells for less than \$200. A new generation of discs called WORMs (write-once-read-many-times) is half-way there. These are sold blank, so the end user can store whatever data he likes on them, although the information, once stored, is there to stay. But the technology

for a fully-erasable disc will probably be perfected by the end of the decade. Two ideas for making them are already showing particular promise.

One is based on a magneto-optical process. The disc's recording layer is an alloy of terbium, iron and cobalt. To store information, a laser heats up a tiny spot on this layer, creating a vertical magnetic field. The information is read by another laser: whenever it encounters a magnetised spot, the light's plane of polarization is rotated. The information can be erased by reheating the spot.

The other approach is chemical. Here, a laser is used to switch the structure of a tellurium alloy back and forth between amorphous and crystalline phases, which reflect light differently.

Impressive as they are, the progress made by optical discs and fibres do not amount to a revolution. Photonics will not come fully of age until it equals, and then surpasses, the central triumph of the electronics revolution: the computer.

At the heart of the computer sits the transistor. A transistor, remember, is a switch, a device that can flip backwards and forwards between two states. Computers are chains of switches. They treat sequences of ones and offs to denote numbers (in which case ones and offs are read as the ones and zeros of binary counting) or to denote "true or false" (in which case chains of switches can be used as the building blocks of algebraic logic). The challenge for photonics is to invent a device that does for light what the transistor does for electrons.

Into the heart of the computer

It has virtually happened. At AT&T's Bell Laboratories and Britain's Heriot-Watt University in Edinburgh, small and primitive circuits of the kind that could one day grow into computers are already running on light. The switches they use—known variously as bistable optical devices (BODs) or transphosors—are essentially optical transistors. Light emerges from them as a strong beam (on) or a weak one (off). Put a bunch of transphosors together, shine laser beams through them, and



A handful of light

you have the basic ingredients of an optical computer.

To understand how a transphosor works, think of it as two partially-reflecting mirrors facing each other. If a beam of light is shone through them some of it gets trapped, bouncing backwards and forwards between the mirrored surfaces (see diagram on next page). As these waves cross each other they can either interfere with and weaken the beam or align with it and reinforce it. This phenomenon is the basis of a simple instrument—used to measure wavelengths—invented by two French scientists, Charles Fabry and Alfred Perot, in 1896.

The Fabry-Perot interferometer emits a strong beam or a weak beam depending on whether the waves are being reinforced inside the cavity. On its own, however, it is not a switch: a useful switch needs to be obviously on or obviously off. Common sense says that a gradual change in the intensity of the beam shining in will produce a gradual change in the beam getting out, not the abrupt change that is needed. In ordinary circumstances, common sense would be right. In the case of the transphosor, it is not.

To make the Fabry-Perot interferometer into a switch, physicists hit on the idea of marrying it with a phenomenon known as optical bistability, first observed at Bell Laboratories in 1976. The secret is in the cavity between the mirrors.

If this were filled with an ordinary medium—air, say, or most solids—the intensity of the beam passing out of the mirror would, indeed, change in proportion to changes in the intensity of the beam shining in. Transphosors, however, use a family of materials (such as indium antimonide and zinc selenide) that are "non linear". If a laser beam shines into these materials, a slight change in its intensity can trigger the wave-reinforcement and make the beam coming out of the transphosor suddenly brighter—and make it stay that way until the trigger is released.

Bell Laboratories and Heriot-Watt have made different sorts of transphosors, but they both work. Heriot-Watt's are entirely optical: the laser beams are shone into bistable plates made of zinc selenide. Bell is trying a hybrid approach. Its devices, made of gallium arsenide, use electro-optical interference within the cavity to trigger the reinforcement effect. In an optical computer, these devices would be the "chips", and the "wires" would consist of laser beams.

To make a computer, it is not enough to be able to turn just one switch on or off. Computers are complex arrays of switches, each of which feeds signals into the next. So optical switches must be "cascadable"—the beams of light emerging from one transphosor must be able to flip the next, and so on. They must also be able to receive and send several signals at the

Let there be light: how a transphosor works

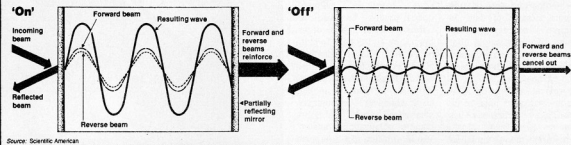

87009 - 1

same time (properties known respectively as "fan-in" and "fan-out").

These obstacles are tumbling fast. Last year, for example, the team at Heriot-Watt University showed that its zinc-selenide transphosors could be kept near their threshold by a holding laser, then switched by turning on a small extra beam. Earlier this year, the team announced that it had placed several transphosors in a cycling loop.

Optical switches should, in theory, be able to operate 1000 times faster than electronic ones. But do not throw your electronic computer away just yet. For the present, transphosors are primitive. They still have to be pumped by too much light, and they are still bulky, separate devices—they have not yet been squeezed together on chips in the way electronics switches have. Even so, optical switching works.

Hybrid vigour

Laboratories everywhere are rushing to bring optical and electronic switches together. One motive is to make even better use of optical fibres. Existing optical networks do not work at the speed of light, because the messages the fibres carry are shuttled between machines such as telephones and computers that run—for now—on electricity, not light. So at each end of even the niftiest optical fibre sits a cumbersome device whose job is to transform optical pulses into electronic ones and vice versa.

To speed this procedure, engineers are creating optoelectronic chips. To do so, they have had to conquer a disadvantage of the photon—its inability to carry an electrical charge. Picking signals off the end of an optical fibre demands some way to sort out waves of light and send them to different destinations. Electrons can be shunted by the application of an electric field; chargeless photons are impervious to such methods.

The answer has been to channel the light through "waveguides" etched into chips made of materials with unusual optical properties. These materials change their ability to conduct light when an electric field is applied to them. Using lithium niobate, engineers have been able to make a wide range of optoelectronic modulators, switches and other devices.

But there is another reason for wanting to bring the photon and the electron together: parallel processing. Britain's Plessey has developed a BOD in which the bistability comes from inserting a photochromic ma-

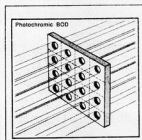

87009 - 2

terial—one whose chemical form changes when exposed to different wavelengths of light—into the cavity. Plessey believes the device could be used for parallel processing. The idea is to squeeze an array of BODs on a single two-dimensional plate. Each then becomes an independent switching centre that can be addressed simultaneously by an incoming laser beam (see diagram below).

This approach comes into its own in applications such as image-processing, in which the value of thousands of picture elements (pixels) must be individually calculated to build up a whole picture. Plessey aims to get around this data-processing bottleneck by using light to process all the pixels at once. The optical switches are not yet as fast as electronic ones, but that hardly matters when they work simultaneously. Plessey reckons that with its photochromic BOD, a device the size of a finger-nail could process 4m pixels in one ten-thousandth of a second.

Photonics has come a long way in the quarter century since the arrival of the laser. But entirely new ideas for manipulating and exploiting light are still popping up. These range from the mundane (mechanical and biological sensors based on optical fibres) to the frankly quixotic (travelling to the stars by giving spacecraft sails that catch photons). Physicists have begun to use laser beams to trap individual atoms so they can be observed in detail. Engineers envisage massive computer memories with data encoded within the light-waves

of a hologram.

Why this sudden flowering? In the 1970s, physics made a wealth of discoveries about the ways in which light interacted with matter. These discoveries are now finding applications.

The properties of non-linear materials—which made the transphosor possible—are one example, but there are others. In some circumstances, light travelling through a material sets up internal sound waves that contour themselves like a deformable mirror, sending the light backwards out of the substance on the path along which it entered. In 1972, Dr Boris Zeldovich and colleagues at the PN Lebedev Physical Institute in Moscow used this property to make something called a phase-conjugate mirror.

This is no ordinary mirror: it can take an image that has been distorted and then straighten out the jumbled-up waves to reconstitute the original image. Like so many technologies, the mirror was treated as a laboratory curiosity at first. It is now being pressed into service by astronomers to take the twinkle out of stars, and by star-wars generals to shoot laser beams through the turbulent atmosphere. The mirrors can also be used to project three-dimensional images through optical fibres and to etch tiny components on microchips. One way or another, light looks like the wave of the future.

Reproduced with permission from *The Economist*

UNIVERSAL CONTROL FOR STEPPER MOTORS

With good quality stepper motors widely available at reasonable cost, this flexible, computer-driven, control board will make it rather hard to hold on to the belief that stepper motors are the exclusive realm of industrial electronics. If you are suspicious about "universal", just glance at the specifications Table below; if you are into industrial electronics, well . . .

Stepper motors come in an astounding variety of types and sizes, and they are frequently spotted items in electronic surplus stores and on hobby venues. Sheer curiosity has prompted many a home constructor to purchase one at a fraction of its original price. However the number of wires coming from the device, and the fact that it is often found far more difficult to get going than a simple servo motor, more often than not causes the perplexed owner to carefully put his price possession in the junkbox, together with other "possibly useful" materials.

In *Stepping Motors*, *Elektron India*, May 1985, the general methods were examined for the driving of stepper motors. Also that article provides a useful discussion of stepper motor terminology, used further on in this article.

The main specifications of the proposed control board are summarized in the shaded Table on this page. The board is readily tailored to suit the user's requirement, but it should be made quite clear at the onset that each of the following sections is to be read closely to be able to decide on the most favourable circuit configuration for a specific application. A detailed discussion of each of the technical features is, therefore, indispensable to a good understanding of the operation of this fully user-configurable interface board between computer and, for instance, robot limbs, a pantograph, or a plotter.

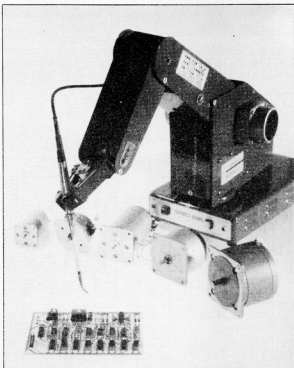

Stepper motors: some problems

The following is a necessarily brief discussion of the main difficulties to be overcome when using stepper motors.

Limited speed range: the stator windings constitute an inductive load, which limits the commutation speed of the coil current. Also, the revolving, permanent magnet rotor causes an inductive voltage which further worsens the commutation. These effects limit the maximum attainable step rate (also: *pull-out rate*), but can be overcome by utilising current drive control.

Resonance: the undamped character of a stepper motor operating at a relatively low step rate causes its movement to be rather halting. The upper oscilloscope trace in Fig. 1 shows the considerable *overshoot* after each step. Should the step frequency equal that of the underdamped oscillations, resonance inevitably occurs, causing a powerful, jerky movement of the spindle. Mechanical damping devices have been developed to ensure a smoother spindle movement, but these permanent loads typically cause the already low efficiency of the stepper motor to fall below the acceptable level.

The lower oscilloscope trace shown in Fig. 1 provides evidence for the proposition that *micro-step* operation can provide a marked improvement in linear spindle movement,

Technical specification

Drive capacity for motor types:	one 4-phase bipolar type; two 2-phase bipolar type; one 8-phase unipolar type; two 4-phase unipolar type.
Max. output current:	L293E fitted: 1 A/phase. L298 fitted: 2 A/phase. Software-controlled polarity and 32-step current flow definition.
Driver type:	Switch-mode current sources.
Digital I/O:	8-bit data input and 2-bit handshaking to Centronics standard.
Supply:	10...35 V with L293E fitted. 10...45 V with L298 fitted. Regulation not required.

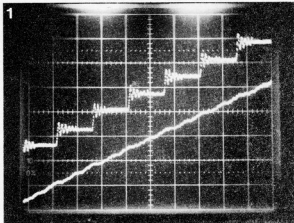

Fig. 1. Comparison between normal (upper curve) and micro-step (lower curve) operation of a stepper motor below its resonance frequency. Overshoot is largely ruled out by the latter mode.

thus enabling the direct transfer of motor power via a set of gears.

Low efficiency: an energized stepper motor dissipates an amount of energy in the resistive load formed by its stator windings. When the spindle is held stationary, this resistance is the sole current limiting factor; also the *stall torque* is often needlessly high. Current drive systems may enhance the dynamic characteristic of the stepper motor to some degree, but linearly controlled current sources, unfortunately, exhibit a very low efficiency.

The present design is based on the use of high efficiency, switch-mode current sources, thereby going round the prob-

lems associated with the previously mentioned systems. Also, the proposed current driver has the advantage of being uncritical of its input supply voltage; extensive regulation and smoothing circuits are, therefore, not required—an important fact in view of the possibly high currents involved in operating the stepper motor. As the current through the windings is fully programmable, the user can arrange for the overall dissipation of the stalled motor to be significantly reduced.

Limited resolution: stepper motors are classified according to the number of steps per spindle revolution. Using the micro-step mode, this specification becomes less important, and a specific type of motor can, therefore, be tailored far better to the task it is to perform.

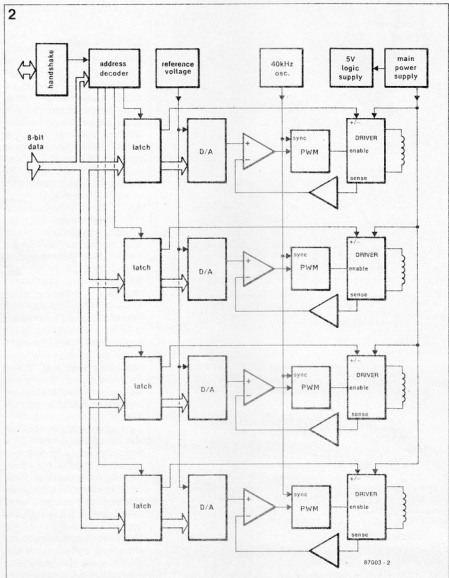

Fig. 2. Block diagram of the stepper motor control board.

Block diagram

After these preliminary considerations, it is time to have a look at the block diagram of the stepper motor control board—see Fig. 2. This design is in essence a quad bipolar power driver. Each driver consists of a bridge circuit and can supply both negative and positive output current from a single supply. Starting at the input side, it is seen that each driver comprises a latch and a D/A converter to enable programming the level and the polarity of the current fed to each individual stator in the stepper motor.

The switch-mode current sources are essentially voltage-controlled pulsewidth modulators (PWMs), driven with the difference between the object amount of stator current and the actually measured current. These two values are obtained from the D/A converter and a DC current sense amplifier, respectively. The four driving PWMs are synchronized via a common 40 kHz oscillator signal, which ensures a favourable switching frequency—the switch losses are still acceptable, and the signal is inaudible—as well as the absence of beat signals.

At the top of the block diagram, there are some more circuit functions common to the four drivers. An address decoder uses the two MS (most significant) bits to discriminate be-

N1...N6 = IC5 = 4069; 74HCT04
 A1...A4 = IC15 = LM324
 A5...A8 = IC16 = LM324
 MMV1, MMV2 = IC17 = NE556
 MMV3, MMV4 = IC18 = NE556
 IC6 = 4556; 74HCT39
 IC7...IC10 = 40174; 74HCT174

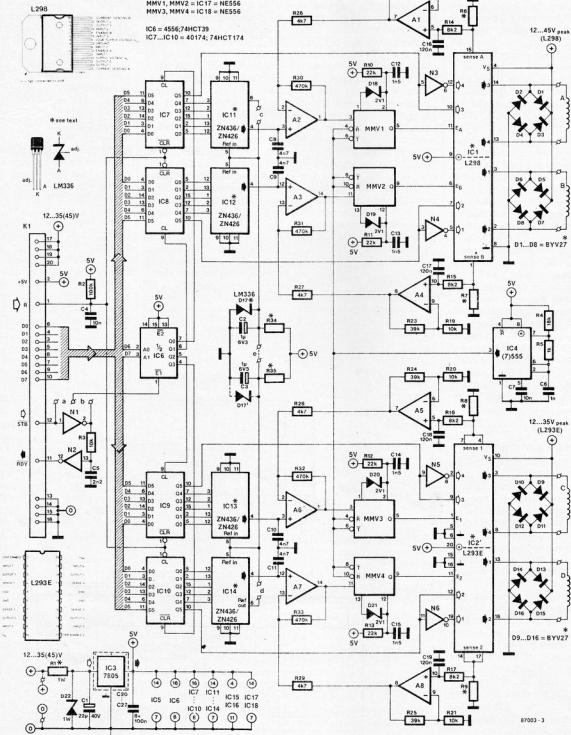

87003-3

tween the control data sent to each of the four driver circuits. Provision has been made to use handshaking with the computer for optimum reliability of the of data transfer to the board. A reference voltage source makes it possible to use D/A converters without an internal reference circuit. Finally, a 5 V supply powers all logic circuits on the board.

Depending on the application you have in mind for the stepper motor control board, this need not incorporate all of the previously introduced circuits. For instance, the relatively expensive D/A converters may be omitted if you do not envisage using the micro-step facility, but would still want to be able to program semi-step operation.

The proposed board makes it possible to drive a four-stator system, even with two separate two-stator motors. It is possible to operate one motor in the micro-step mode, while the other one is controlled in the standard way, i.e. by means of a "stripped down" driver circuit. The user is offered a choice of two possible types of driver IC, which can be fitted as required by the expected output current. As you can see, our use of the word "universal" in the title of the present article is fully justified.

Circuit description

It is not very difficult to spot the various functional blocks in the circuit diagram, Fig. 3. As to the aforementioned common circuits on the board, IC₁ is the 5 V regulator, IC₂ the 40 kHz oscillator, IC₃ the one-of-four driver decoder, and zener diodes D₁₇ and D₁₈ may be used to provide DACs IC₁₁-IC₁₄ with a highly stable 2.5 V reference.

On receipt of a computer-generated STB or STB (strobe) pulse, IC₄ decodes D₆ and D₇ in the sent dataword and enables the corresponding sextuple latch, IC₅...IC₁₀, to clock the 6-bit value which determines the output current level supplied by the driver (D₈...D₉) as well as the polarity (D₅). Therefore, only five bits of the six or eight-bit DACs are used to translate the latch output into a voltage between 0 and 2.5 V in 32 increments (2⁵). Each of the DAC output voltages is used to drive the inverting (+) input of opamps A₂, A₃, A₆ and A₇. How

these in turn are capable of determining the stator output current is detailed in the next section.

Returning to the handshake circuit composed of IC₄, N₁ and N₂, it is seen that both positive and negative-going strobe pulses can be used by fitting the appropriate wire jumper, a (STB) or b (STB). Note, however, that in many Z80-based systems STB is an input signal, and RDY (ready) is an output signal, i.e. the signals are reversed as compared with the Centronics standard. Jumper a is to be fitted when driving the stepper motor board with either a Z80 PIO, or a 6522 VIA, while jumper b accommodates the use of a Centronics port. More information on the handshake circuit can be found in Table 4, while Z80 PIO users may consult *MSX extensions* - 4, elsewhere in this issue.

PWMs and current drive

In order to make clear the operation of the switch-mode cur-

rent driver circuits in this design, it is necessary to study Fig. 4. From a functional point of view, the Types L298 and L293E from SGS Ates are largely identical; these devices merely differ in respect of the maximum available output current. The L298 is twice as powerful as the L293E and is, therefore, housed in a Multiwatt[®] -J5 SIL enclosure, rather than a 20-pin DIL package as is the L293E. Each IC holds two independently controllable bridge circuits plus associated logic drivers. Since these ICs are to be driven with logic voltages only, there would seem to be no way of controlling the bridge currents with a linear regulating system. However in each driver the emitters of the lower bridge transistors are brought out to pins, enabling the connection of an external current sense resistor which provides a voltage drop proportional to the stator current. Fig. 5 further illustrates this principle, which forms the basis of the negative feedback controlled switch-mode current driver.

Any duty cycle of the current drive system starts with IC₁ generating a 1 μs negative reset pulse for all four monostable multivibrators MMV₁...MMV₄. Taking MMV₁ and the upper section of IC₁ as an example, the reset pulse causes C₁₂ to be discharged to the zener voltage of D₁₈. Simultaneously, MMV₁ is triggered, and provides an output period determined with network R₁₉-C₁₂ as well as the DC level applied to the control voltage input, pin 3. This level is internally compared with the voltage across C₁₂ and hence determines the length of the output period. Since the comparator internal to the Type 556 MMV is incapable of linear operation with input control voltages below 1.5 V, D₁₈ leaves sufficient residual charge in C₁₂ for the MMV to produce sufficiently short output periods. From this it is seen that the MMVs in the circuit essentially function as voltage-controlled pulswidth modulators, enabling the power output stages contained in IC₁ and IC₂ for the duration of their output periods.

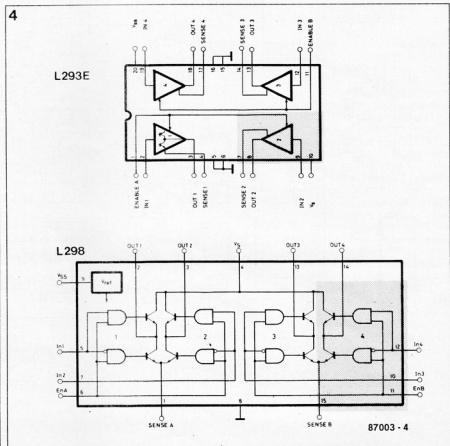

Fig. 4. Internal organization of the SGS stepper motor drivers L293E and L298.

Therefore, current sense resistor R_s carries the stator current and hence produces a proportional voltage drop, which is averaged in network C_{16} - R_{14} and raised in amplifier A_1 .

Opamp A_2 compares the measured current (- input) with the object current (+ input), and corrects its output voltage to MMV₁ until these two values equal. Simple as this may seem at a first glance, there is, however, a snag in the measuring of the stator current. As long as the bridge is enabled, stator current I_s flows through R_{sense} , and its voltage drop is simply $I_s R_{sense}$ volts—see Fig. 5, line a.

The disabling of the bridge immediately breaks the current through R_{sense} , but not that through the stator winding, whose inductance causes it to supply a lagging current, which is driven into the supply via free-wheeling diodes—see Fig. 5, dashed line b. In essence, the self-inductance of the stator winding has a smoothing effect upon the stator current. Therefore, the average value of $U_{R_{sense}}$ is not a direct measure for the stator current, since it does not comprise the free-wheeling current.

With most types of stepper motors, the period L/R of the stator winding is long as compared to that supplied by the PWM drivers ($T=1/40\text{ kHz}=25\text{ }\mu\text{s}$). In practice, the variation in free-wheeling current in between driver pulses hardly causes any ripple, and the error incurred by only measuring the current through the sense resistor is, therefore, caused by the duty factor variation. In general, a relatively small duty factor variation suffices to give a considerable stator current span. As soon as the duty factor rises above some 50%, and the free-wheeling period starts to overlap the bridge on-time, I_s rises relatively quickly. The required duty cycle giving maximum stator current is a function of the ohmic resistance of the stator winding and the supply voltage level. The higher that voltage, or the lower that resistance, the stronger the tendency to large variations in I_s around a 50% duty factor.

The foregoing considerations can not but lead to the conclusion that the output signal of A_1 need not be exactly proportional to the stator current.

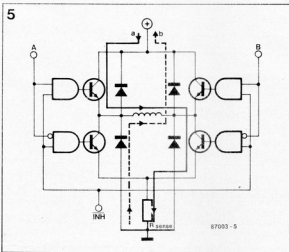
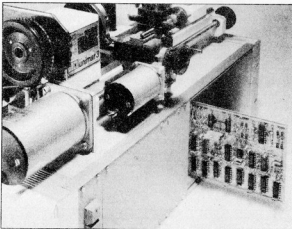

Fig. 5. Current flow during the bridge-on period (a) and during the bridge-off period (b, free-wheeling operation).



Fortunately, the overall linearity is still acceptable, and occasional deviations can be compensated by suitable software.

Returning to the circuit diagram, Fig. 3, the remainder of the circuit functions are quite conventional designs.

Timer IC₁ provides the negative-going 40 kHz synchronization signal for the R and T inputs of the MMVs. In the absence of a common sync signal, the input supply would be corrupted by a good many inductive voltage peaks, which would readily lead to the MMVs being triggered in error and the entire circuit operation being upset in consequence.

Network R_1 - D_{22} prevents 5 V regulator IC₃ from being damaged by too high an input voltage. As the maximum input voltage for IC₃ is 35 V, the use of the Type L298 stepper motor driver ($V_{s(max)}=45\text{ V}_{peak}$) necessitates

fitting the voltage limiting network. But even with the L293E fitted in the circuit, it is still a good idea to use R_1 and D_{22} , as they also afford protection against inductive voltage peaks on the unregulated supply rail. The use of the 2.5 V reference diodes D_{17} and D_{17}' is not obligatory, and their use will be reverted to in the section on construction.

The logic sections of the circuit are composed of CMOS ICs only. This means that the logic drive to the board must be capable of supplying CMOS-compatible signals. Should you want to drive the board with TTL signals from a Centronics logic, the stated CMOS ICs must be replaced by the suggested HCMOS versions.

Construction

Before embarking on the construction of the present board,

Parts list

Resistors ($\pm 5\%$):

- $R_1 = 1\text{ }\Omega$
- $R_2 = 100\text{K}$
- R_3, R_4, \dots, R_{21} incl. = 10K
- $R_4 = 18\text{K}$
- $R_5 = 1\text{K}\Omega$
- R_6, \dots, R_9 incl. = 10^3
- R_{10}, \dots, R_{13} incl. = 22K
- R_{14}, \dots, R_{17} incl. = 8K2
- R_{22}, \dots, R_{25} incl. = 39K
- R_{26}, \dots, R_{29} incl. = 4K7
- R_{30}, \dots, R_{33} incl. = 470K
- $R_{34}, R_{35} = 10^3$

Capacitors:

- $C_1 = 22\mu\text{F}, 40\text{ V}$
- $C_2, C_3 = 1\mu\text{F}, 6\text{V3 tantalum}$
- $C_4, C_7 = 10\text{n}$
- $C_5 = 2\text{n}2$
- $C_6 = 1\text{n}0$
- C_8, \dots, C_{15} incl. = 4n7
- C_{12}, \dots, C_{15} incl. = 1n5
- C_{16}, \dots, C_{19} incl. = 120n
- C_{20}, \dots, C_{27} incl. = 100n

Semiconductors:

- $D_1, \dots, D_{16} = \text{BYV27 (1N4001 also usable with L293E)}$
- D_{17} or $D_{17}' = \text{LM336 } \Phi$
- $D_{18}, \dots, D_{21} = 2\text{V1; } 0.4\text{ W zener diode}$
- $D_{22} = 1\text{ }\Omega$
- $IC_1 = \text{L298 * or } IC_1' = \text{L293E (SGS Ates)}$
- $IC_2 = \text{L298 * or } IC_2' = \text{L293E (SGS Ates)}$
- $IC_3 = 7805$
- $IC_4 = 555 \text{ or } 7555$
- $IC_5 = 40698 \text{ or } 74\text{HCT04}$
- $IC_6 = 45566 \text{ or } 74\text{HCT139}$
- IC_7, \dots, IC_{13} incl. = 401748 or 74\text{HCT174}
- IC_{11}, \dots, IC_{14} incl. = ZN436 or ZN426 Φ
- $IC_{15}, IC_{16} = \text{LM324}$
- $IC_{17}, IC_{18} = 556 \text{ or } 7556$

Miscellaneous:

- $K_1 = 20\text{-way angled plug for PCB edge mounting}$
- $K_2 = 64\text{-way aBc DIN busconnector (if required)}$
- Heatsink for IC_1, IC_2 as required
- PCB Type 87003 (see Readers Services)

Notes

- ¹ See Table 1
- ² See Table 2
- ³ See Table 3
- * Available from Universal Semiconductor Devices • 17 Granville Court • Granville Road • Horney • London N4 4EP. Telephone: (01 348) 9420/9425 • Telex: 25157 usdco g.

Table 1.	Input supply [V]									
	<25		25-30		30-35		35-40		>40	
Output driver(s)	R ₁	D ₂₂	R ₁	D ₂₂	R ₁	D ₂₂	R ₁	D ₂₂	R ₁	D ₂₂
1 × L298	1		220R	—	330R	15 V	330R	15 V	330R	22 V
2 × L298			100R	—	180R	15 V	220R*	22 V	330R*	22 V
1 × L293E			100R	—	180R	15 V	2			
2 × L293E			47R*	—	47R*	—				
L298 & L293E			100R*	—	100R*	—				

1 R₁ = wire link; do not fit D₂₂.
 2 With only one L293E fitted, supply must not exceed 36 V.
 — Do not fit.
 * 4 W type, else 1 W.

Table 2.

stator current	R _{mean} at V _s =		P _r
	<22 V	>22 V	
0.1 A	5R6	6R8	1/4 W
0.2 A	2R7	3R3	1/4 W
0.5 A	1R0	1R2	1/2 W
1.0 A	R47	R33	1 W
1.5 A	R33	R39	1 W
2.0 A	R27	R33	1 W

the type and the number of stepper motors must be considered in order to be able to decide on the most favourable as well as the most economical realization of the circuit.

To begin with, there are the L293E and the L298 to choose between. The latter should be used with currents in excess of 1 A per phase. Two L298s can be bolted onto a common heat-sink, together with regulator IC₃. As all conductive surfaces of these ICs are at ground potential, there is no need for insulating washers and the like. Relatively low output currents can be handled by the more

economic Type L293E, which can be fitted in the IC₁' and IC₂' positions on the PCB. In most cases, the copper surface soldered to pins 5, 6, 15 and 16 of these chips provides sufficient cooling, while IC₃ is best fitted with an insulated, standard U-shaped vane radiator. Should you decide to use a L298 for two stator windings, and a L293E for the other two, do not forget to limit the input voltage in accordance with the maximum specification of the latter. Depending on the type of output driver fitted, dimension R₁ as per Table 1.

As already stated, the stepper

motor current is fully programmable, but in order to attain optimum resolution in the micro-step mode, the maximum value of I_s must be defined by means of selecting appropriate resistors in the R₄ and R₅ as well as in the R₂₂...R₂₅ positions—consult Table 2. As I_{s(max)} is also related to the self-inductance of the windings, it is advisable to actually measure the current consumption of the motor.

The +5 V supply rail is made available at a separate pin of the I/O connector. When feeding the stepper control board from an external 5 V supply, omit R₁,

D₂₂ and IC₃, then fit a wire link in the holes provided for the two outer pins of the regulator. As to the D/A converters, there are a number of types to choose from. In principle, the Type ZN436E gives satisfactory performance for most applications. Note, however, that it comes without an internal reference, so that D₁₇ (D₁₇') must be fitted, and R₃ must be a 1K2 type, while R₅ must be omitted—consult Table 3. Jumpers c and d are not used, and jumper e is fitted to pass the reference voltage to the REF IN pins of IC₁₃ and IC₁₄. The Type ZN426-x (the suffix indicates the

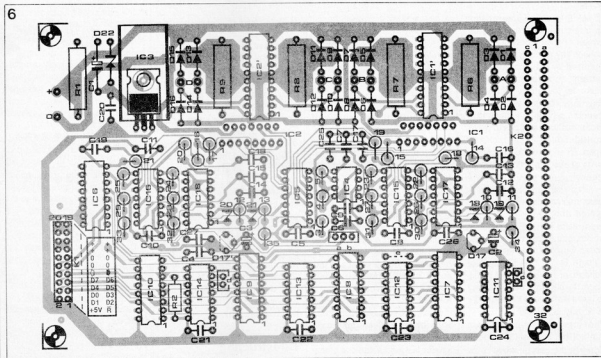

Fig. 6. Track layout and component mounting plan for the motor control board.

Table 3.

D/A converter		jumper					
IC ₁₁	IC ₁₄	c	d	e	R ₃₄	R ₃₅	D ₁₇
ZN436	ZN436	—	—	x	1K2	—	LM336
ZN426	—	x	—	x	390R	—	—
—	ZN426	—	x	x	—	390R	—
ZN426	ZN426	x	x	—	390R	390R	—

— Don't care
 — Do not fit.
 x must be fitted.

number of bits: 6, 7, or 8) is also usable but is expected to be somewhat more expensive, as it holds an internal reference circuit, which can be used by fitting jumper c or d, depending on the position of the DAC on the board, and using a 390R resistor in the R₃ or R₅ position, whichever is appropriate. Should you want to do without the micro-step facility altogether, mount two 10K resistors as shown in Fig. 7. Completing the stepper motor control board is very straightforward indeed when using ready-made, through-plated PCB Type 87003 (see Fig. 6) available from our Readers Services. When using the L293E driver chip, solder it straight onto the board to effect sufficient cooling by the large copper surfaces at the track side of the PCB.

Connections

In general, the connection of bipolar stepper motors is fairly simple. A two-phase motor requires to be driven with one half of the control board cir-

cuitry. The actual connection of the stator windings is largely uncritical. Reversing the polarity of one stator winding, or interchanging both windings simply causes the motor to run in reverse. A bipolar four-phase motor requires to be driven with the whole of the control board. When using such a motor, observe the correct phase relationship between the stator windings, else the spindle will merely oscillate between two positions, rather than revolve.

Basically, unipolar motors can be connected in three ways, as shown in Fig. 8. The first method, shown in Fig. 8a, requires passing less than normal current through the series connected windings to preclude overheating and/or saturation effects in the stator. Also, the increased stator inductance causes a considerably lower pull-in rate.

The second method involves creating a centre-tapped winding—see Fig. 8b. In principle, this arrangement always results in one half of the winding being short-circuited to the positive

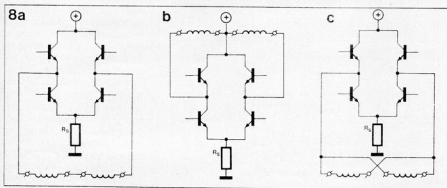
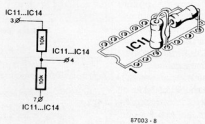

Fig. 8. Basic methods for the connection of unipolar motors.



87003 - B

Fig. 7. Where micro-step operation is not required, each of the DACs in the circuit may be replaced by this resistor combination.

supply rail. As compared with the above method, there is the advantage of the lower overall inductance, but the short-circuited half-winding gives rise to an increased motor dissipation, owing to the inevitably high induced current, which is only advantageous in that it ensures good damping characteristics and hence a relatively smooth spindle movement.

The last alternative is shown in Fig. 8c. This method of connecting a unipolar motor is based upon the use of the individual windings as if these were of the bipolar type. In case the two windings of a stator are not connected internal to the motor, anti-parallel connection is preferable. A normal, parallel connection immediately results in the magnetic fields counteracting, causing the spindle to remain stalled.

Provision has been made on the PCB to fit a 64-way, a & c row busconnector, K₂. Its connections are left vacant to enable users to configure the bus wiring as required. At the other side of the board is K₁, a 20-way angled plug which is used for

the Centronics signals. Depending on the set-up of the computer system in which the present board is to be incorporated, wires may have to be run from K₂ to K₁, or K₂ may be used for mechanical support only. Those users intending to make a stand-alone peripheral device of the stepper motor control may want to cut off the PCB section provided for K₂ altogether.

The power supply

As already stated, the present board is rather uncritical of its input supply voltage. Extensive regulation and smoothing of the 12...35 (45) V input rail is not recommended in view of the overall system efficiency. When designing the power supply in question, merely observe that the ripple voltage does not exceed 10 to 15% of the output voltage.

It must be reiterated that the maximum permissible peak input voltage for the board depends on the type of bridge driver IC fitted; for the L298, V_{in} = 45 V_{peak}; for the L293E, V_{in} = 36 V_{peak}. In practice, it is recommended to keep the input voltage a few volts below these values to allow for the induced peaks caused by the free-wheeling current.

A second factor to be considered in the establishing of the supply voltage is the ohmic resistance of the stator windings in the stepper motor. As a rule of thumb, the supply voltage for the board must be at least two times the typical operating voltage of the motor operated with voltage drive. In principle, therefore, most commonly available 5 V stepper

motors should work all right with a board supply of 10-12 V, but a higher supply is preferable for improved current drive characteristics and hence a higher pull-in rate.

The total current consumption of the system goes mainly on account of the stepper motor(s). Due account should be taken of the fact that the total current drain may amount to 8 A when using the board to drive 4 off 2 A stator windings. Obviously, the mains supply should be designed to reliably cater for possibly high current peaks, and the same goes for the supply wiring. Also observe the 2 times 4 contacts on K₁, reserved for the connection of the input supply; keep the total current drain in mind and, if necessary, use soldering pins to avoid overloading the relatively thin connecting posts in K₁.

Driving stepper motors

As the stepper motor control board is essentially only a peripheral device, the computer—or more precisely the software—determines the movements of the stepper motor spindle.

The key to the driving of the motor(s) is the 8-bit control word sent to the board via the computer's parallel output port. Fig. 9 shows the bit assignment for that control word. The two MS bits—D₆ and D₇—are used to address one of four stator driver circuits. Bit D₅ provides the polarization control, while D₄-D₀ determine the stator current in 32 (2⁵) increments. Note that some Centronics output ports are open-collector types, requiring the data input lines and the STB line to be pulled high to +5 V with 470R-1K0 resistors.

Quite essential to the operation of the stepper motor is the stator current timing sequence. Fig. 10a shows the timing for full step operation, in which the stator current is arranged to reverse with every step. Semi-step operation is illustrated in Fig. 10b; during the reversal of the stator current, this is held at nought. This basic method is further exploited in the quarter-step mode shown in Fig. 10c, while extrapolation of this principle leads to the stator current being reversed linear with time,

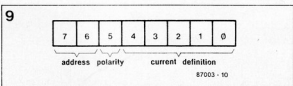

Fig. 9. Bit-functions in the control word sent to the board.

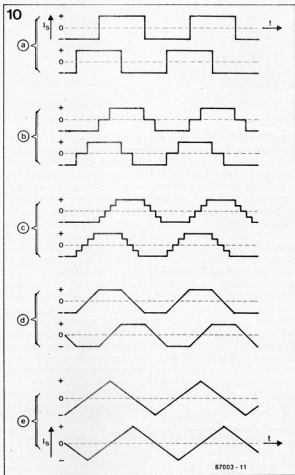

Fig. 10. From simple to complex: timing diagrams relevant to various methods of controlling a stepper motor.

Table 4. Handshake configurations

port type	computer to board	board to computer	wire link or jumper	note(s)
Centronics	STB	ACK/BUSY	b	(1), (2)
280 PIO (output mode)	READY	STROBE	a	—
6522 VIA; 6821 PIA	DATA READY; CA2/CB2	DATA TAKEN; CA1/CB2	b	(3)

(1) Pull-up resistors may be required on board; see text.

(2) Use of ACK or BUSY is system dependent.

(3) Depending on the PCR register contents:

■ pulse mode: DATA TAKEN line not required

■ handshake mode: DATA TAKEN forces interrupt; service routine outputs next byte after required delay.

as shown in Fig. 10d. In practice, however, the linear commutation is slightly problematic, since the sub-steps at the current cross-over point are inevitably larger than those during the start and the end of the commutation cycle. Moreover, the available torque will vary considerably during the sub-steps, as the total stator current is not constant.

During the current reversal, a permanent load fitted to the spindle will cause the rotor to deviate more from the object position than during moments of maximum current, resulting in irregularity of the sub-step size. This effect is generally found to be rather more manifest with dual-stator motors than with four-stator types. Up to and including quarter-step operation, dual-stator motors have an adequate performance, but four-stator types are clearly to be preferred for all applications mentioned so far. The reason for this is the more constant average stator current of the latter motors. In conclusion, dual-stator motors are best operated with a constant total stator current, as shown in Fig. 10e.

The commutation characteristic required for equal step size is mainly determined by the specific type of motor to hand, and some trial-and-error programming may be required to attain optimum performance.

Sending bits to the board

The simplest method of driving the stepper motor is probably the writing of a array which holds all data for a full commutation cycle. Such a cycle essentially involves once reversing the current, and reversing it again to return to the original polarity. In a four-stator motor, this corresponds to 8 full steps. A programmed pointer is used to send the datawords to the board, and can be read, incremented or decremented to control the direction of the spindle rotation. To get the motor to run as required, the pointer is programmed to address the individual array entries in a closed loop.

Table 5a is a data dump of an array to control a four-stator motor according to the timing diagram of Fig. 10d. Note especially the toggling of the

Hexadecimal data for one commutation cycle. Table 5a is for a four-stator motor operating as per Fig. 10d, Table 5b for a two-stator type operating as per Fig. 10e.

Table 5a.

M	data			M	data			
00	1F	1D	80	3F	3D			
02	1B	19	82	3B	39			
04	17	15	84	37	35			
06	13	11	86	33	31			
08	0F	0D	88	2F	2D			
0A	0B	09	8A	2B	29			
0C	07	05	8C	27	25			
0E	03	01	8E	23	21			
10	21	23	90	01	03			
12	25	27	92	05	07			
14	29	2B	94	09	0B			
16	2D	2F	96	0D	0F			
18	31	33	98	11	13			
1A	35	37	9A	15	17			
1C	39	3B	9C	19	1B			
1E	3D	3F	9E	1D	1F			
20	5F	50	A0	7F	7D			
22	5B	59	A2	7B	79			
24	57	55	A4	77	75			
26	53	51	A6	73	71			
28	4F	4D	A8	6F	6D			
2A	4B	49	AA	6B	69			
2C	47	45	AC	67	65			
2E	43	41	AE	63	61			
30	61	63	80	41	43			
32	65	67	B2	45	47			
34	69	6B	B4	49	4B			
36	6D	6F	B6	4D	4F			
38	71	73	B8	51	53			
3A	75	77	BA	55	57			
3C	79	7B	BC	59	5B			
3E	7D	7F	BE	5D	5F			
40	9F	9D	C0	BF	BD			
42	9B	99	C2	BB	B9			
44	97	95	C4	B7	B5			
46	93	91	C6	B3	B1			
48	8F	8D	C8	AF	AD			
4A	8B	89	CA	AB	A9			
4C	87	85	CC	A7	A5			
4E	83	81	CE	A3	A1			
50	A1	A3	D0	81	83			
52	A5	A7	D2	85	87			
54	A9	AB	D4	89	8B			
56	AD	AF	D6	8D	8F			
58	B1	B3	D8	91	93			
5A	B5	B7	DA	95	97			
5C	B9	BB	DC	99	9B			
5E	BD	BF	DE	9D	9F			
60	DF	DD	ED	FF	FD			
62	DB	DB	E2	FB	F9			
64	D7	D5	E4	F7	F5			
66	D3	D1	E6	F3	F1			
68	CF	CD	E8	EF	ED			
6A	C8	C5	EA	EB	E9			
6C	C7	C9	EC	E7	E5			
6E	C3	C1	EE	E3	E1			
70	E1	E3	FE	C1	C3			
72	E5	E7	F2	C5	C7			
74	E9	EB	F4	C9	CB			
76	ED	EF	F6	CD	CF			
78	F1	F3	F8	D1	D3			
7A	F5	F7	FA	D5	D7			
7C	F9	FB	FC	D9	DB			
7E	FD	FF	FE	DD	DF			

Table 5b.

address	data				
M	stator 1	stator 2	M	stator 1	stator 2
00	1F	40	80	3F	60
02	1E	41	82	3E	61
04	1D	42	84	3D	62
06	1C	43	86	3C	63
08	1B	44	88	3B	64
0A	1A	45	8A	3A	65
0C	19	46	8C	39	66
0E	18	47	8E	38	67
10	17	48	90	37	68
12	16	49	92	36	69
14	15	4A	94	35	6A
16	14	4B	96	34	6B
18	13	4C	98	33	6C
1A	12	4D	9A	32	6D
1C	11	4E	9C	31	6E
1E	10	4F	9E	30	6F
20	0F	50	A0	2F	70
22	0E	51	A2	2E	71
24	0D	52	A4	2D	72
26	0C	53	A6	2C	73
28	0B	54	A8	2B	74
2A	0A	55	AA	2A	75
2C	09	56	AC	29	76
2E	08	57	AE	28	77
30	07	58	B0	27	78
32	06	59	B2	26	79
34	05	5A	B4	25	7A
36	04	5B	B6	24	7B
38	03	5C	B8	23	7C
3A	02	5D	BA	22	7D
3C	01	5E	BC	21	7E
3E	00	5F	BE	20	7F
40	20	5F	00	00	7F
42	21	5E	C2	01	7E
44	22	5D	C4	02	7D
46	23	5C	C6	03	7C
48	24	5B	C8	04	7B
4A	25	5A	CA	05	7A
4C	26	59	CC	06	79
4E	27	58	CE	07	78
50	28	57	00	08	77
52	29	56	D2	09	76
54	2A	55	D4	0A	75
56	2B	54	D6	0B	74
58	2C	53	D8	0C	73
5A	2D	52	DA	0D	72
5C	2E	51	DC	0E	71
5E	2F	50	DE	0F	70
60	30	4F	E0	10	6F
62	31	4E	E2	11	6E
64	32	4D	E4	12	6D
66	33	4C	E6	13	6C
68	34	4B	E8	14	6B
6A	35	4A	EA	15	6A
6C	36	49	EC	16	69
6E	37	48	EE	17	68
70	38	47	F0	18	67
72	39	46	F2	19	66
74	3A	45	F4	1A	65
76	3B	44	F6	1B	64
78	3C	43	FB	1C	63
7A	3D	42	FA	1D	62
7C	3E	41	FC	1E	61
7E	3F	40	FF	1F	60

stator address bits and the current polarity bit. Table 5b is a similar dump intended as a guide in controlling a dual-stator motor according to the timing diagram of Fig. 10e. For both applications it is advisable to provide for an interrupt-based synchronization facility, as offered by, for instance, the Type 6522 V/A.

Unfortunately, the fairly large number of sub-steps often makes it impossible for the motor to attain its maximum speed. In this context, there is no doubt about the advantage of machine language subroutines over BASIC programs. Should the need arise to have the motor run at a relatively high speed, it is possible to program for more than one step at a time. At high switching frequencies, the stator inductance limits the current to such an extent, that accurate current drive, and hence micro-stepping, is unattainable anyhow. However this is of little consequence, since the motor will nonetheless run smoothly with the step rate well in excess of the resonance frequency. Micro-stepping is, therefore, primarily of use either for relatively low motor speeds, or for accurate spindle positioning.

When skipping array entries to realize sufficient motor speed, care should be taken to finish with the last byte of the relevant stator phase. Large steps should, therefore, always comprise sub-steps which are powers of two (2, 4, 8, 16 or 32 steps at a time). TW

DIGITAL SIGNAL PROCESSING

Compact disc players have been with us for some time. Digital television receivers are becoming commonplace. These, and other apparatus, have an important aspect in common: digital signal processing. But what is really involved in this?

Digital circuits only respond to discrete values of input voltage and produce discrete values of output voltage. Usually, these circuits operate between two discrete voltage levels, i.e., high and low (logic) levels. It is therefore clear that before such a circuit can operate the analogue signals have to be converted into digital (= binary) signals.

Some fundamentals

Fig. 1 shows the basic set-up of a digital processing circuit. The incoming analogue signals at X are digitized, in an analogue-to-digital (A-D) converter, processed in a (digital) signal processor, and then reconverted into analogue signals in a D-A circuit.

The A-D converter produces a stream of binary values by quantization. In this method, the incoming waveform is divided into a finite number of subranges each of which is represented by an assigned binary value within the subrange. In a compact disc player, a 16-bit A-D converter is perfectly adequate, while in video circuits 8-bit converters are satisfactory.

Since the signal processor operates by computation, it can handle only a finite number of pulses in unit time. It is the task of the A-D converter to ensure that the input capacity of the processor is not exceeded, and this in turn determines the sampling rate.

Sampling is a technique in which only some portions of the (analogue) input are used to produce the set of binary values to represent the information contained in the whole signal. To ensure that the output values represent the input signal without significant loss of information, Nyquist's Sampling Theorem states that the rate of

sampling of a periodic quantity must be at least twice the frequency of the input signal.

A-D converters in CD players therefore produce about 45 000 sixteen-bit values for each second of music. The signal processor in these players need therefore be only moderately fast, as they have some 22 μ s between consecutive computations. A video signal processor must be much faster as this has to carry out more than 10 million computations per second.

Requirements and applications

The set-up of Fig. 1 can perform all the functions of an analogue circuit, and more. It is far superior to a complex combination of resistances and opamps in summing, subtracting, multiplying, and raising to a power.

For example, the volume setting in an analogue circuit involves the signal being attenuated by resistance(s), being distorted in transistors, being subjected to hum from the main transformer, and finally being output by a scratchy volume control wiper. In a digital circuit, it is merely

divided by a variable divider or multiplied by a variable factor.

Filtering in a digital circuit is also simplicity itself: the basic operations of multiplication and addition enable virtually any kind of filter to be realized. Of course, the filter designer must be thoroughly familiar with filter theory, and Fourier and Laplace transforms. Apart from that, the filter can be adjusted, altered, and varied with the aid of software.

For instance, in a digital television receiver, the tuner is connected to the various output stages by digital circuits. These circuits filter (compute) from the video signal the sound and chrominance subcarriers, extract the quadrature components from these and demodulate them; cut off any noise pulses; eliminate any conversion errors and picture interference (within limits); arrange the volume of sound, stereo balance, tone, colour saturation, brightness, and optimum contrast. These circuits are currently contained in special VLSI chips.

As yet, there is no (pre-) amplifier for CD players with direct digital input. But progress is rapid...

Signal processors

As already mentioned, virtually all requirements are met by the basic operations of multiplication and addition. Also, it was shown that the signal processor does not have all that much time left for each computation. Signal processors have, therefore, microprocessors with typical instruction codes; they are relatively small but, none the less, quite fast.

Sequences such as:

"fetch value 1; fetch value 2; multiply values 1 and 2; add value 1 to the result; load the accumulator at the position of value 1 and increase the address counter"

as a rule have only one operational code. Moreover, while an instruction is being processed, the next instruction and the next two values are retracted from the memory (pipelining). This means that such an instruction takes three clock pulses from start to finish. With a 10 MHz clock, a 16-bit multiplication and addition lasts only 300 ns.

Even faster are signal processors that use the Harvard instead of the von Neumann architecture. In the latter, data and instructions are stored in a common memory, whereas in the former separate memories are used (see Fig. 2). In Harvard-type processors, instructions and data (in some even two sets of 16-bit data) are fetched from the memory simultaneously. This means that two to three times as many operations can be carried out per second as compared with a von Neumann device.

The software for the required function is first computed and loaded into a normal computer, with which the run of the processing cycle is simulated before the PROM of the signal processor is loaded.

To conclude, and specially for

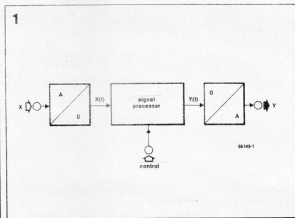

Fig. 1. Basic set-up of a digital signal processing unit.

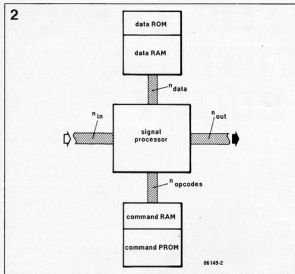

Fig. 2. Modern signal processors use the Harvard structure in which the memories for data and commands are separated.

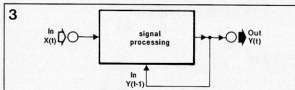

Fig. 3. Basic recursive filter. Output signal $y(t)$ is stored in an intermediate memory and used as input signal $y(t-1)$ for the next computing cycle.

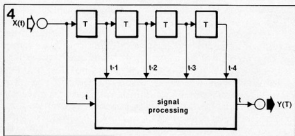

Fig. 4. Basic non-recursive filter. Output signal $y(t)$ is built up from a succession of inputs: $x(t) \dots y(t-n)$. Secondary memories are required for each of the inputs.

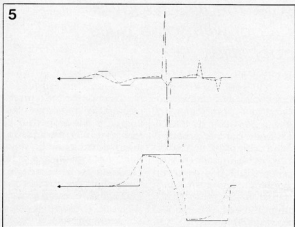

Table 1

```

Start
Clear
Cls
B = 0.5
V% = 205
Define 1
Dim X1%(64)
Dim Y1%(64)
Dim Z1%(64)
For I% = 1 To 64
  X1%(I%) = I% * 10 - 5
Next I%
Polyline 64, X1%(I), Y1%(I) Offset
0, V%
Do
  Mouse X%, Y%, T%
  If T% = 1
    If T1% = 1
      X% = Int(X%/10) + 1
      Y% = Int(Y%/10) * 10 + 5
      Y1%(X%) = Y% - V%
      Polyline 64, X1%(I), Y1%(I)
      Offset 0, V%
    Else
      Cls
    Endif
  Endif
  T1% = T%
  Exit If T% = 2
Loop
Filter:
Print At(1, 1);
(1. . 9)"; Ord
For I = 1 To 64
  Z1%(I) = Y1%(I)
Next I
For I% = 1 To Ord
  For I% = 1 To 64
    Z1%(I%) = B * Z1%(I%) +
    (1 - B) * Z1%(I% - 1)
  Next I%
Next I
Cls
Define 2, 1, 0, 1
Polyline 64, X1%(I), Z1%(I) Offset
0, V%
Define 1, 1, 0, 1
Polyline 64, X1%(I), Y1%(I) Offset
0, V%
Do
  Mouse X, Y, T
  Exit If T = 2
Loop
Alert 1, "Change filter?", 2,
  "New filter, end", 2
If Z = 1
  Goto Start
Endif
If Z = 2
  Goto Filter
Endif
End

```

those readers who want to design a digital filter and are not too familiar with Fourier or filter theory, a sample design for a personal computer.

Basically, there are two types of filter: recursive and non-recursive. Figure 3 shows an example of the simplest type of recursive filter, where the output signal is available for further use a computation cycle T later. This type of filter can be used for high- or low-pass purposes. Non-recursive filters are formed by inserting the input signal(s) into two or more successive filter sections as shown in Fig. 4. Each section must, of course, have a secondary memory. This type of filter is suitable for use as a transverse or comb filter.

A low-pass filter is easily computed from the following mathematical relation

$$y(t) = ax(t) + by(t-1)$$

where $y(t)$ is the output signal resulting from an input signal x at time t ;

$y(t-1)$ is the output signal one computing cycle before $y(t)$;

$$\begin{aligned}
 b &= 1 - a; \\
 0 &< a < 1; \\
 0 &< b < 1.
 \end{aligned}$$

The following example program was written in GFA-BASIC for the Atari-ST. If the GFA interpreter is not available, the Run Only Version can be copied (free of charge) at any Atari dealer. It can, however, be modified for use with other types of computer relatively easily, particularly if Pascal is used.

Table 1. Example program in BASIC for an RC low-pass filter of the n^{th} order and its graphical representation. (Fig. 5).

SOFTWARE FOR THE BBC COMPUTER-2: THE BBC BUGGY

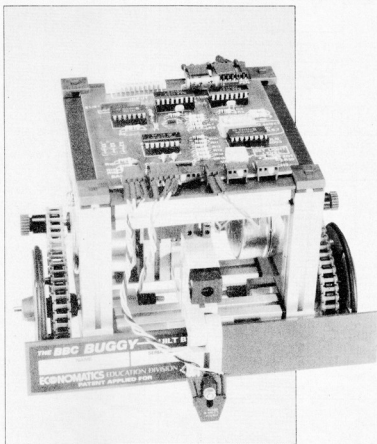

This article deals with a remarkable combination of versatile hardware and ingeniously written, learn-as-you-program, software. The BBC Buggy is a computer-controlled little robot with some quite astounding capabilities.

Although this series of articles is primarily intended to discuss commercially available software packages for the BBC micro, it was deemed worthwhile to introduce the BBC Buggy and its associated control programs to the many owners of a BBC home micro.

Available from Economatix' Education Division, the Buggy is in essence a small vehicle, composed of Fischer-Technik parts, and controlled over a length of flat ribbon cable connected to the standard peripheral port on the BBC machine.

The principle of a steerable

turtle, known from interactive programming languages such as LOGO, has been put into practice in the case of the Buggy, as it is a tangible vehicle rather than any kind of graphics figure moving about on the screen and programmed to make drawings by means of a set

of user-definable commands. In principle, the Buggy is therefore but a tool in learning about structured programming. However the fact that it is a precisely engineered vehicle offers possibilities not commonly available with simulation-based (joystick & screen) systems.

The Buggy hardware

It would be beyond the scope of this article to give a detailed description of the Buggy's construction; the accompanying photographs should give readers a good impression of what the vehicle looks like.

Two powerful stepper motors, controlled via a top-mounted interface board, ensure a high degree of positional accuracy at a remarkably low programming effort. The Buggy can carry a pencil to leave a trace as it completes its task route; the chain-driven wheels and the rear-mounted ball bearing enable the Buggy to revolve around its own axis, leaving only a dot from the electro-magnet operated pencil as the wheels revolve in opposite direction.

Provision has been made for the incorporation of a large number of optional hardware add-ons, such as a grab arm, a bar-code reader (BCR), and a front-mounted light-dependent resistor (LDR), which can be used to track down light sources. The fully equipped Buggy is an agile, semi-intelligent creature that can find and remember its own way through almost any "landscape"; no matter how many purposely created obstructions it encounters while seeking its way to the finish.

The grab arm is a stunning example of the combined power of the Buggy hardware and software; the control program, through a digitizer, monitors the current consumption of the grab arm motors, and thus prevents lifted objects from being crushed. Actually, the Buggy was tested by having it lift, carry, and put down an egg without making a mess of it.

The optional BCR enables the Buggy to travel over a track consisting of one metre or so of bars which may represent, for instance, the notes of a piece of (computer) music; the BCR system is comparable to

that used for the digital reading of price data printed on many shopping items. However, since the Buggy travels at a highly accurate speed, no synchronization bars are required in the coded pattern. A few try-outs showed quite conclusively that the Buggy can be relied on to supply 100% faultless BCR data to the computer. It is also possible to have the Buggy read its route directions from pieces of BCR strip located at a few places in the landscape.

The Buggy software

Whatever the performance of the Buggy's hardware, the vehicle would be but a clumsy toy without the supporting software. Economatics, in our view, deserves credit for the production of software that is, in a word, unbeatable even by experienced machine language programmers. The BBC BASIC interpreter is exploited to the full, and the same goes for the graphics features of the machine. The Buggy command set comprises 10 simple to program instructions, while the user is free to add his own for specific purposes. PENEDIT can be loaded from disk to support the use of the software-controlled pencil; again, the degree of accuracy achieved with the Buggy's propulsion system is astounding: with some skill in programming, writing one's name on a sheet of paper is feasible.

The programs supplied by Economatics are user-friendly and readily extendable for specific purposes. Most instructions relating to the Buggy's movements can be defined in the necessary number of incremental steps; e.g. 128_{hex} FORWARD, TURN 3F_{hex} LEFT, SPEED=7C_{hex}, etc. Economatics supply a copiously detailed instruction manual with the Buggy; a large number of highly instructional programming examples are

given, as well as a step-by-step construction method for the fully-fledged version of the project.

Applications

As already noted, the main interest for the BBC Buggy lies in the educational field; the fact that a tangible vehicle can be seen to move about with apparent intelligence is highly stimulating to further exploration of programming methods. The Buggy therefore comes in when screen-based turtles fail to arouse further interest in writing structured programs leading up to sophisticated applications in the field of robotics and its associated science, cybernetics.

The so-called *Buggy Park* is an outstanding example of the resourcefulness of Economatics in devising a bench-mark for other remote-controlled vehicles.

In essence, the park is a rectangular space bordered by a "wall"; the instruction manual gives full details of the suggested construction, as well as of the way the exact size of the park is entered in the relevant control program.

SUNSEEK can be run to show the Buggy's ability to track down a small light source located anywhere in the park. Neither the displacing of the bulb, nor the raising of obstructions during the performance will keep the Buggy from finding and remembering its

way to the light. On arrival there, a triumphant cry is produced.

Sceptical onlookers can be invited to a game of MAN VS BUGGY, which effectively demonstrates the skill of the latter in finding a particular location within an area, relying on limited sensors (LDR, touch-sensitive bumpers) only.

Conclusions

The BBC Buggy is a most instructive extension of the BBC computer. Its hardware and software operate in a purposeful manner, ensuring both optimum processing of instructions and ease of extension by the user.

The BBC Buggy comes as a Fischer-Technik Kit, together with the associated software and instruction manual, and requires no special tools for assembling.

More information on the BBC Buggy and its hardware and software options are available from

Economatics Education Division

*4 Orgrave Road
Handsworth*

Sheffield S13 9JQ.

Buggy: £129.98; PEN Kit
£19.85; Grab Arm £79.00.

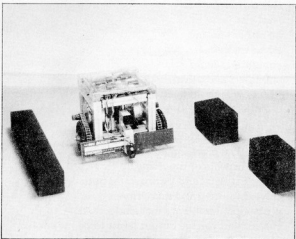

Good control
with high power

precision power supply

Any item of test equipment is useful but only one is absolutely necessary and that is some form of power supply. These normally provide a voltage output of up to 25 or 30 volts at about 1 amp which is fine for most purposes. However, this current level can be rather limiting when testing computers, audio amplifiers and other high power equipment. It is essential too that some form of protection such as current limiting is included in the circuit design. The precision power supply here is capable of providing up to 3 amps at 35 V and incorporates both current limiting and short circuit protection. Meters are included to enable current and voltage output levels to be monitored.

If any circuit is to be accurately and safely tested a good power supply must be used. It is not sufficient for it to be just a stabilised supply, it must also include some form of protection against faults arising in the circuit under test. This usually takes the form of current limiting and output short circuit protection.

In order for it to fulfil its function correctly, a power supply should have the following facilities.

- The ability to deliver fairly high current levels at voltages of 24 V or more.
- It must be completely stable at all output conditions.
- The output must have some form of short circuit protection.
- Current limiting control up to the maximum current output.
- An output voltage control that is fully variable from 0 to maximum.
- Accurate indication of both current and voltage output levels.
- Sense inputs to allow compensation for voltage drops when long supply cables are necessary.

Although the last two points are not strictly necessary, their inclusion makes the power supply more versatile and easier to use.

The precision power supply here follows the standards set by commercial equipment and includes all of the above features. It has a variable output voltage range of 0 to 35 V and continuously variable current limiting up to 3 amps. The performance is on a par with fairly expensive commercial power supplies but approaches the stabilisation problems with a rather novel circuit design.

The principles

The vast majority of power supplies use either 'series' or 'pass' regulation. This means that the stabilising power transistors are connected (effectively) in series or in parallel to the load. In common with most designs the circuit here utilises series pass regulation. The originality in the circuit design is the method used for stabilisation.

The block diagram in figure 1a illustrates the principle of a conventional series regulator. The active element of the cir-

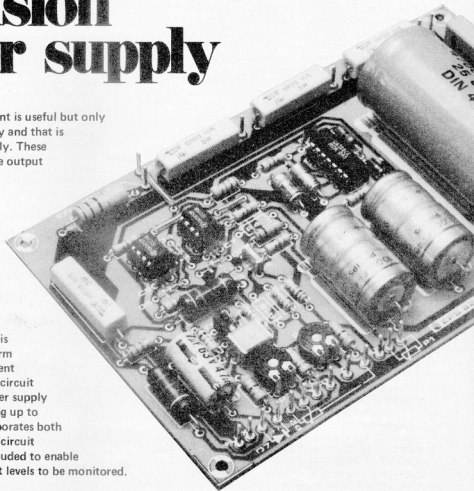

cuit is opamp A and its output is the source of the load current, that is, in series with the load R_L . The non-inverting input of the opamp is held at a reference voltage, U_{ref} . The inverting input of the opamp is at a voltage level that is a proportion of the input voltage — derived by potentiometer P. Under these conditions the output of the opamp will become stable at the point where the voltage difference between the two inputs is zero. That is, the opamp will maintain a condition where the reference voltage and that at the wiper of potentiometer P are equal. It will be obvious that the output voltage will therefore be dependant on the position of P. With the potentiometer in mid position the output will be double the reference voltage. The disadvantages of this system are that the stability factor is dependant on the setting of potentiometer P, the output can never be lower than the reference voltage and the operation of P will not be linear. Two of these points may not be so significant in some cases but an output minimum that is restricted to the reference voltage will be embarrassing to say the least!

The block diagram of figure 1b provides another solution. In this case, the opamp is used as a unity gain amplifier and P becomes a voltage divider connected across the reference voltage. The output of the opamp will now be proportional to the voltage level at the wiper of P.

In this configuration the output range will be between 0 and the reference voltage. This sounds better but it is still far from ideal. The opamp will now require a negative voltage supply rail, an added disadvantage.

The reference voltage must be at least as high as the maximum required output, not an ideal situation! Finally, the stability factor is still a question of potentiometer P.

Figure 1c goes a long way towards removing the problems by replacing the reference voltage, as far as the opamp is concerned, with a reference current. The output voltage is now determined by the current passing through P. The advantage is that the circuit is no longer dependant on the reference voltage level.

We now arrive at figure 1d which, in principle, is very similar to 1c. The ref-

erence current in this case is derived from the output voltage via a series resistor R. The idea is not entirely new but the method used here is a little unorthodox.

As previously mentioned, a current source is achieved by placing a resistor in series with a reference voltage derived from the output. However, for this to happen in practice, the value of potentiometer P has to be much lower than R. The opamp still tries to balance out the difference between the voltage levels at its inputs but now the output voltage will be equal to the level on its non-inverting input.

The series resistor is effectively placed between the two inputs of the opamp. However, due to the high impedance of the inputs, theoretically at least, no current can enter the opamp. In effect then, the current derived from the reference source follows the path shown as a dotted line in the block diagram. Since $U_1 = U_2$ (the opamp ensures this) the current level remains constant, totally independent of P and the load.

The current level is equal to $\frac{U_{ref}}{R}$. The

opamp will balance out the voltage across P and, in doing so, the reference current is compensated for any change in load. The result of all this is that the circuit conforms to what we are looking for, a constant reference current (even at 0 V) using a reference voltage source and a resistor.

The precision power supply

The major difference between the block diagram of the precision power supply in figure 2 and that of figure 1d is the fact that two opamps and a series pass power transistor are included. The current source (U_{ref} and R) and the potentiometer P1 are very similar.

The second opamp A2 is responsible for output current limiting. The voltage across the emitter resistor R_s of transistor T is proportional to the output load current. A proportion of the reference voltage is derived by the setting of P2 and this is compared to the voltage across R_s by opamp A2. When the voltage across R_s becomes higher than that set by P2, the opamp reduces the base drive current to T until the difference is reduced to zero. The LED at the output of A2 functions as a current limiter.

The circuit diagram

So much for the theory, now for its practical application. The circuit of the power supply, shown in figure 3, has two independent power supplies (if that makes sense!). The power for the output stage is provided by transformer Tr2 which, of necessity, will be rather a hefty beast. Transformer Tr1 provides power for the reference source and the opamps.

The reference source is derived with the aid of the inevitable 723 (the worlds longest living chip?). The components

1

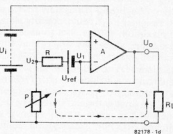
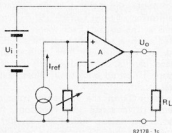
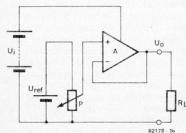
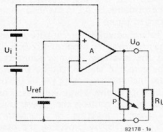

Figure 1. The drawings here, in conjunction with the text, illustrate the advantages of why the use of a constant current reference source is preferable to a reference voltage.

around this IC were chosen to provide a reference voltage of 7.15 V. This appears at the junction of R1/R5, R15/R16 and R9. For ease of understanding it should be noted that R4/R5 represents R and IC2 corresponds to A1 in the theoretical diagram of figure 2.

The reference voltage eventually arrives at the non-inverting input of IC2 (pin 3) while the inverting input is connected to the zero rail via R8. Diodes D2 and D3 are included to protect the inputs of the opamp against surge voltages. The output of IC2 controls the power output stage, consisting of transistors T3, T4 and T5, by providing the base drive current for transistor T2.

A word about transistors T3...T5. These are connected in parallel and their outputs are combined via emitter resistors to provide the power supply output via R21. The use of three 2N 3055's in this configuration provide an economical power stage that can handle up to 3 amps comfortably.

The voltage across R21 is compared in IC3 with a voltage level determined by the setting of P2. This latter is derived from the reference source via R15/R16. The output of IC3, like that of IC2, is fed (via D5) to the base of T2. When the output current is higher than that set by P2, the output current is reduced by IC3 until the two levels are matched. Transistor T1 and its surrounding components cause the LED D7 to light when current limitation is in effect.

Two meters are included to allow direct monitoring of both voltage and current levels at the output. Each meter is provided with a series potentiometer, P3 and P4, to allow for fine calibration. These can be replaced with fixed resistors if desired once their values have been found.

Capacitor C3 in the reference voltage circuit (IC1) serves two functions. It reduces any noise produced by the internal zener of the 723 and it also provides a 'slow start' for the reference voltage supply. This means that when the power supply is first switched on, the opamps are giving time to 'settle down' before being asked to do any work, a sort of early coffee break! If this slow start was not designed in it could possibly allow the maximum voltage level to appear at the output, albeit very briefly, but still potentially damaging.

The diodes D1 to D8 in various parts of the circuit are included to guard against the possibility of accidental connection of an external voltage to the output terminals of the power supply when it is switched off. For instance, this could quite easily occur when working with a circuit that has a built in battery back-up.

Components R7 and C6 increase the reaction time of the circuit when changing output voltage levels while capacitors C7 and C8 eliminate the possibility of oscillation in the opamps. For stable operation of the circuit a minimum

2

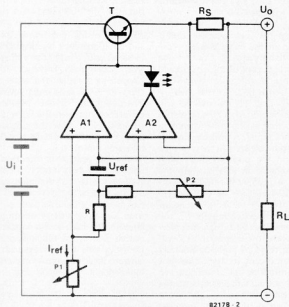
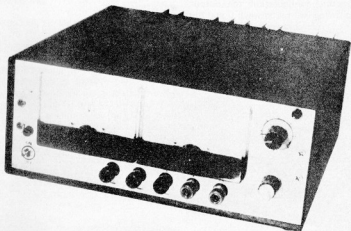

Figure 2. The basic block diagram of the precision power supply. Opamp A1 provides the voltage regulation while A2 takes care of the current limiting.



4

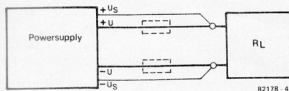

Figure 4. The two sense inputs are used in the manner illustrated here to enable the circuit to compensate for voltage drop caused by the use of long cables.

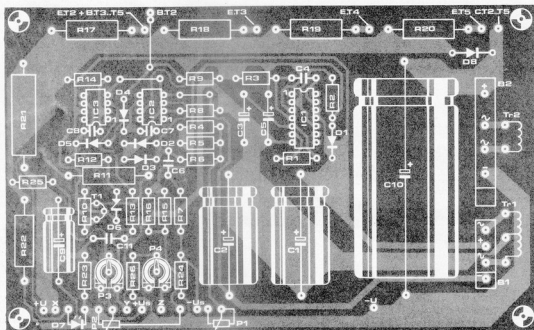
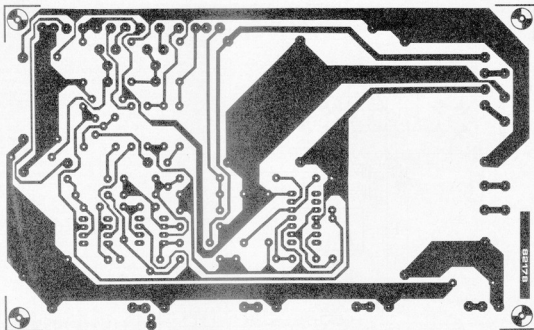

Figure 5. The track pattern and component layout for the printed circuit board used for the precision power supply.

Parts list

Resistors:

R1,R3,R6,R8,R12,R13,R14 = 4k7
 R2 = 22 Ω
 R4,R16 = see text
 R5 = 10 k
 R7,R10 = 1 k
 R9 = 2k2
 R11 = 470 Ω /1 W
 R15 = 15 k
 R17 = 10 Ω /1 W
 R18,R19,R20 = 0,22 Ω /3 W
 R22 = 4k7/1 W
 R23,R24 = 47 Ω
 R25 = 5k6
 R26 = 270 k
 P1 = 50 k potentiometer
 P2 = 1 k potentiometer
 P3 = 2k5 preset
 P4 = 250 k preset

Capacitors:

C1,C2 = 100 μ /25 V
 C3 = 100 μ /10 V
 C4 = 100 p
 C5 = 10 μ /25 V
 C6 = 1 n
 C7 = 100 p
 C8 = 56 p
 C9 = 47 μ /63 V
 C10 = 4700 μ /63 V
 C11 = 820 n
 C12 = 100 n

Semiconductors:

B1 = bridge rectifier B40C1000
 B2 = bridge rectifier B80C5000/3300
 D1,D8 = 1N4001
 D2...D5 = 1N4148
 D6 = 3V3 400 mW zener
 D7 = LED red
 T1 = BC 559C
 T2 = BD 241
 T3,T4,T5 = 2N3055
 IC1 = 723
 IC2,IC3 = 741

Miscellaneous:

S1 = double pole mains switch
 M1,M2 = 100 μ A meter
 Tr1 = 2 x 12 V/400 mA mains transformer
 Tr2 = 33 V/4 A mains transformer
 F = 1 A fuse

output load resistance is necessary. This is taken care of by R22.

It will be noted that there appear to be more output terminals than the usual power supply needs. The two extra outputs, +U_s and -U_s, are in fact inputs. These so-called 'sense' inputs are used to allow for voltage drop compensation when working with long connecting cables between the power supply and its load. Figure 4 illustrates how the inputs are used. Two extra wires are connected as shown between the load and the sense inputs. The result of this is that the supply voltage level is now effectively measured at the load and not at the output terminals of the power supply. This enables the circuit to compensate for any voltage drop resulting from the resistance in the main supply cables. It should be noted that if the total resistance of the two main supply cables is 1 Ω , at the current level of 1 A the voltage drop will be 1 V. In normal use,

6

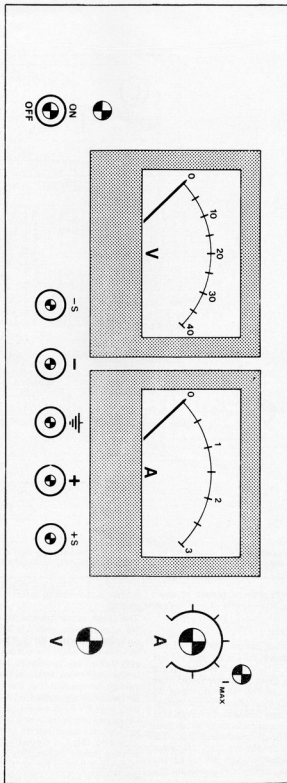
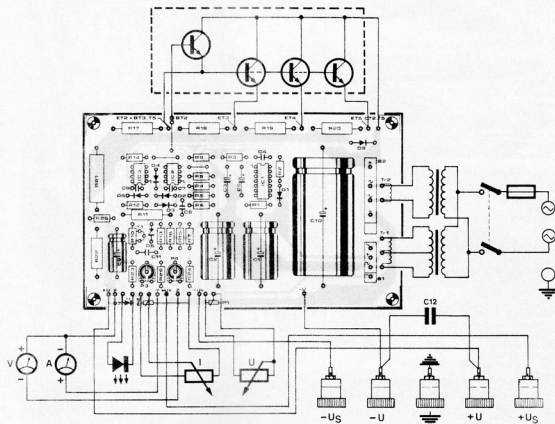

Figure 7. The design of the front panel. The illustration is at a reduced scale, the actual size is 11 cm by 30 cm.



82178-6

Figure 6. The practical wiring diagram for the power supply. Obviously care must be taken with connections, especially with respect to the transformers and power transistors. Errors in this area will not become visible until the smoke clears!

shorting links can be placed between +U and +Us, and -U and -Us.

Construction

The maximum output current of the circuits as shown here is 3 A at 35 V but in principle different current ratings are possible. It must be remembered that any change in this direction must be accompanied by a change in the ratings of both C9 and C10. The limiting factor is the maximum collector/emitter voltage capability of transistors T2...T5. This is 60 V for the 2N 3055. The other deciding factor will of course be the current rating of the transformer for the power output stage. The maximum output of the power supply is a factor $\frac{1}{\sqrt{2}}$ of the current supplied by the trans-

former is required to achieve an output of 3 A.

The three power transistors in parallel are used because each 2N 3055 cannot dissipate more than 50 W. The consideration is that when the output voltage is at 0 V the maximum dissipation required is the maximum level of the rectified voltage multiplied by the maximum current. For an output of 1 A at 35 V only one 2N 3055 would be sufficient. One more power transistor can be added without any modification to the circuit providing that the correct value for the emitter resistor is calculated. A 2°C/W heatsink is needed for each power transistor or a 1°C/W for each pair. Capacitor C12 is mounted directly onto the output terminals as shown in figure 6. Do not mount the resistors R4 and R16 initially as their value will depend on the maximum output voltage and cur-

rent. For this reason it will not be possible to mount the printed circuit board into the case until test and calibration is completed. Set P1 to maximum, switch on and connect a multimeter to the output of the circuit. By trial and error find the actual value of R4 which gives the maximum required output voltage. This can be done by connecting different resistors in parallel to R5. When the correct value has been found it can be soldered in place on the board. Repeat the exercise with P2 and R16 (in parallel with R15) until the maximum current level is found. The remaining calibration is that of the meters by adjustment of P3 and P4. It is possible to build the power supply using only one meter. In this case a 2 pole 2 way switch connected to points x, y and z is required to switch between volts and amps. ■

COMPUTER-SCOPE-2

by R v Linden



After the last detailed look at the layout and circuit of the drive unit, this second part deals with the construction, calibration, and necessary software.

The printed-circuit board (No. 86083-Fig. 5) needs to be completed with perhaps more care and attention than usual for two reasons. Firstly, the clock in the RAM and the A-D-converter operates at a fairly high frequency, so that neat soldering is a must. Secondly, the attenuator section should be constructed and screened neatly, since this determines to a large degree the overall accuracy of the circuit.

Fig. 5 shows the component layout of the PCB: since the board is double-sided with through-plated holes (see

also p. 83 of last month's issue), it is advisable to check all such holes with a multimeter before any work is done; if the through-plating of a hole is not sound, it is a difficult job to locate this after the board has been completed. Readers not familiar with this type of board should note that soldering needs only to be carried out at the underside of the board.

It is best to begin with the mounting of the IC sockets. After these have been soldered in place, mount the resistors, capacitors, preset potentiometers, and trimmers. Take care

with the trimmers, because these often have no value printed on them. Finally, fit the 16 MHz crystal. The completed board is shown in the photograph in Fig. 6.

Next, a screen should be made for the attenuator section. This is cut from 0.5 mm thick tin foil, about 15 mm wide and 400 mm long. This strip is folded as shown in the photograph in Fig. 7 to fit around the attenuator section. The foil is soldered in a few places to pins that have been inserted in appropriate islands on the board. Once the attenuator has

Fig. 5. Printed-circuit board for the drive unit

5

Parts list (drive unit)

- Resistors:
 $R_1, R_2 = 330 \Omega$
 $R_3, R_4, R_{10}, R_{11}, R_{12}, R_{13} = 1 \text{ k}$
 $R_4, R_5, R_{10}, R_{11}, R_{12}, R_{13} = 100 \Omega$
 $R_7, R_8, R_9, R_{12}, R_{13}, R_{14}, R_{15} = 1 \text{ M}$
 $R_{11} = 470 \text{ k}$
 $R_{12} = 330 \text{ k}$
 $R_{13} = 2\text{k}7$
 $R_{14} = 247 \text{ k}$
 $R_{15}, R_{16} = 1\text{M}8$
 $R_{17}, R_{18}, R_{19}, R_{20}, R_{21}, R_{22}, R_{23}, R_{24}, R_{25}, R_{26} = 10 \text{ k}$
 $R_{28} = 100 \text{ k}$
 $R_{29} = 825 \text{ k}$
 $R_{30} = 154 \text{ k}$
 $R_{31}, R_{32} = 250 \text{ k}$
 $R_{33} = 820 \Omega$
 $R_{34} = 2\text{k}2$
 $R_{35}, R_{36} = 470 \Omega$
 $P_1 = 22 \text{ k}$ preset
 $P_2 = 1 \text{ k}$ preset

- Capacitors:
 $C_1, C_2, C_3 = 100 \text{ p}$
 $C_4 = 33 \text{ p}$
 $C_5 = 56 \text{ p}$
 $C_6 = 100 \text{ n}$
 $C_7 = 27 \text{ n}$
 $C_8, C_{12}, C_{13}, C_{14} = 27 \text{ p}$
 $C_9, C_{15} = 10 \text{ p}$
 $C_{10} = 470 \text{ p}$
 $C_{11} = 47 \text{ p}$
 $C_{12} = 10 \text{ p}$
 $C_{14}, C_{16}, C_{17} = 180 \text{ p}$

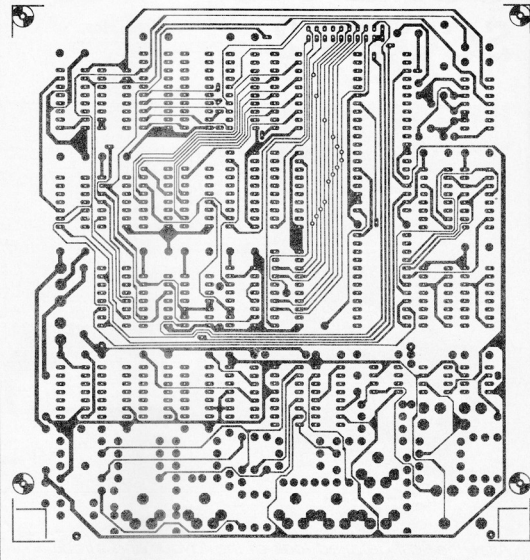

been preset, the top of this section should also be closed with a suitable lid of tin foil. The screen ensures that the input circuit is rendered insensitive to noise.

The board can then be fitted in a suitable enclosure as shown in the photograph at the head of this article.

Apart from this board, the enclosure will also house a simple mains supply. This supply, which delivers $\pm 5 \text{ V}$, is constructed on the PCB shown in Fig. 9; its circuit is given in Fig. 8.

The front of the enclosure should be fitted with two BNC sockets: one for the measuring input and the other for the external trigger input. The rear panel should be provided with an exit for the ribbon cable to the computer and an inlet for the mains cable.

6

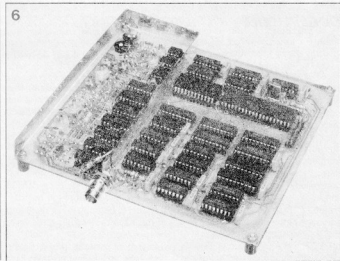
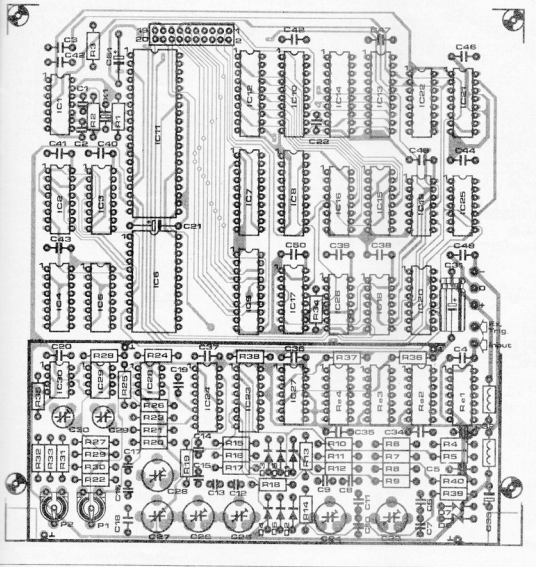

Fig. 6. The completed prototype board for the drive unit.



C17 = 18 p
 C18 = 2n7
 C21 = 10 μ ; 16 V
 C23, C24, C26 = 47 p
 trimmer
 C25, C27, C28 = 22 p
 trimmer
 C29, C30 = 5p5 trimmer
 C31 = 100 μ ; 16 V
 C32, C33 = 22 μ ; 25 V
 tantalum
 C34...C36 = 100 n

Semiconductors:

D1...D6 = 1N4148
 D7, D8 = 3V9/400 mW
 zener diode
 IC1 = 74HCU04
 IC2...IC5 = 74HCT390
 IC6 = 74150
 IC7...IC9 = 74HCT374
 IC10, IC11 = 74HCT244
 IC12 = UVC 3101
 IC13, IC14 = IMS 1420-55
 IC15, IC16 = 74HCT85
 IC17, IC20 = 74HCT153
 IC18, IC19 = 74HCT74
 IC21, IC22 = 74HCT161
 IC23, IC24 = 4052
 IC25 = 74HCT111
 IC26 = 74HCT100
 IC27 = 7406
 IC28, IC29 = LF 356
 IC30 = 3130

LS types may be substituted for all HCT types.

Miscellaneous:

X1 = crystal 16 MHz
 L1, L2 = 100 μ H chokes
 Re1, Re2, Re3;
 Res = miniature relay for PCB mounting; 1 make contact; operating voltage 5 V
 20-way ribbon cable as required
 2 \times 10-way ribbon cable socket for PCB mounting with mating plug
Enclosure: Retex RE3 (231 \times 77 \times 181 mm)
 (Available from Imhof-Bedco; Ashley Works; Ashley Road; Uxbridge; Middx UB8 2SD; telephone (0895) 37123)
 PCB 86083

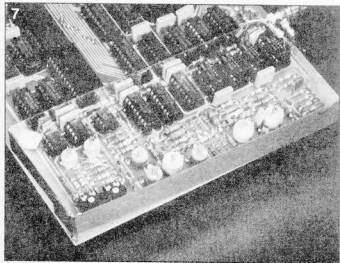

Connecting the computer

The drive unit is connected to most computers via a suitable adapter to enable the data communication between the two units to be controlled. An exception is the BBC Micro, because the program for this computer makes use of the printer port and the user port. The latter serves as the B port and the former as the A port: the READY signal from the drive unit is fed to the ACK input. The connection diagram for this set-up is given in Fig. 10.

The C64 and Electron computers are connected to the drive unit via a PIA (peripheral interface adapter) Type 6821. The connections to this are shown in Fig. 11. It is conveniently

Fig. 7. This shows how the screen should be fitted around the attenuator section.

Fig. 8. Circuit diagram of a simple dual power supply.

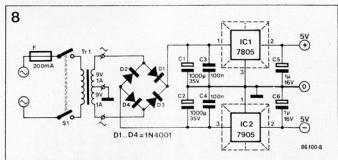
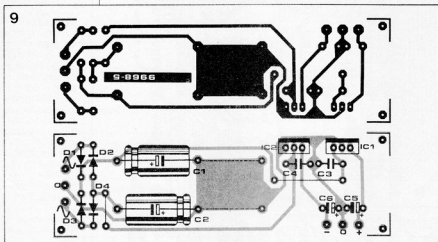

Fig. 9. Printed-circuit board for the power supply.



Parts list
(power supply)

Capacitors:
C₁, C₂ = 470 μ F 16 V
C₃, C₄ = 100 n
C₅, C₆ = 1 μ F 25 V

Semiconductors:
D₁, D₂, D₃, D₄ = 1N4001
IC₁ = 7805
IC₂ = 7905

Miscellaneous:
Tr₁ = mains transformer:
2 \times 9 V; 1 A
S₁ = DPDT mains switch
F = fuse, 200 mA
complete with holder
PCB 9960-5

Fig. 10. This shows how the BBC Micro is connected to the drive unit via the user I/O and printer connectors.

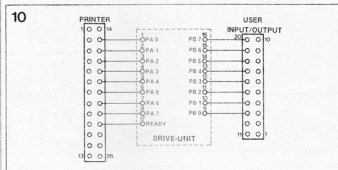
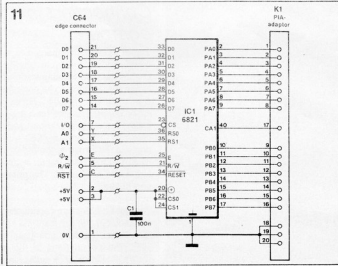

Fig. 11. Connection diagram of the PIA with which the C64 and Electron are coupled to the drive unit.



constructed on the small PC board shown in Fig. 12. The board can be inserted direct into the C64; when it is to be used with the Electron, the connector part may be cut off. The Electron is connected to the PIA as shown in Fig. 13: in this case, an address decoding signal has to be generated with the aid of two additional gates as shown. The PIA is at address FCB0. Finally, the Electron is connected to the drive unit with the aid of a free connector and a length of ribbon cable. Note that the cable between the drive unit and the PIA should be kept as short as is practicable.

Connection between the drive unit and MSX computers needs a somewhat more extensive I/O board, which is planned to be published in a future issue.

Setting up

In the setting up of the drive unit, an oscilloscope is needed. First, connect the drive unit to the computer as detailed above, and switch on both units.

Next, if either the BBC or the Electron is used, write the test program given in Table 1 or 2 respectively into the computer; if the C64 or an MSX unit is used, a couple of POKES is all that is required.

Connect the input of the drive unit to ground, and adjust P₁ until the direct voltage at the output of opamp A₂ (pin 6) is 0.00 V.

Next, inject a 1 kHz square-wave signal into the drive unit, and set the input sensitivity (lines V₀-V₁) to 0000. Adjust trimmers C₂₉ and C₃₀ to obtain a true square-wave signal at the output (pin 6) of A₃.

Set the input sensitivity (lines V₀-V₁) to 0001 and adjust C₂₃ to regain a proper square wave at pin 6 of A₃. Repeat this procedure with sensitivities of 0010, 0100, and 1000 (when C₂₄, C₂₅ and C₂₆, and C₂₇ and C₂₈ respectively are adjusted).

At all times, adapt the level of the square-wave input but take care to avoid overloading the circuit (the level at pin 6 of A₃ should not exceed 5 V_{pp}).

Redo all the adjustments mentioned to make sure that all settings are correct.

With the aid of a voltage divider (made from 1% resistors: e.g. 22 Ω and 2k7, or 82 Ω and 10k) derive a voltage of 40.0 mV from the power supply, and apply this to the junction R₂₃-R₂₄.

Set the signal on lines OF₀-OF₆ to

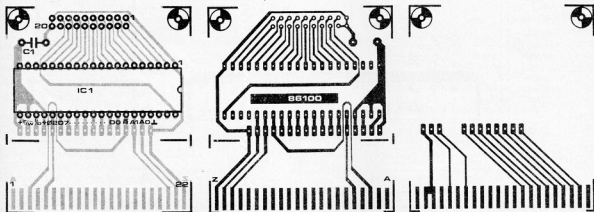

1000000 and the INH signal to logic 1. Adjust P₁ to obtain a direct voltage of exactly 2.0 V at the output (pin 6) of A₁.

Software

First, the PIA (if used) is initialized. Make the RESET line low, which results in all the PIA registers to be set to nought. The adapter occupies four addresses: I/O to I/O+3 incl. (see Fig. 14). Two of the locations have consecutive registers, and these are selected by making bit b₂ in the associated control register 1 (data register) or 0 (data direction register).

Select DDRA as shown above and write FF in this register: all A ports are then set as outputs. Then write 06 in CRA which results in input CA₁ reacting to a leading edge, as well as data register DRA being selected. It is then possible to write into this register, for instance, 18 which pulls the PA₁ line high.

The B ports are arranged as outputs by making control register B logic low, and writing FF in DDRB. They are set as inputs by making bit b₂ in CRB 0, and writing a 0 into I/O+2 and a 4 into I/O+3.

Arrange the A and B ports as outputs; disable the interrupt; and set the interrupt flag (bit 7 of data register A) to a leading edge at CA₁. A timing diagram of all important control signals is given in Fig. 15: this gives a good idea how communication between drive unit and computer takes place.

All PA lines are made 0, after which the data for setting the interface can be written into the latches via the PB

Table 1.

```

10 MODE0
20 dra = $FE61:ddra = $FE63:cra = $FE6C:drb = $FE60:ddrb = $FE62:ier = $FE6E:ifr = $FE6D
30 ?dra = $FF: ?dra = $10: ?ier = 0: ?cra = 1
40 oFF = 0:ING = 0: NIV = 0: TH = 0: TB = 8: AM = 10: TRIG = 0
50 ?ddrb = $FF
60 ?drb = oFF + 64 + 128 * ING: ?dra = $14
70 ?drb = NIV + 64 + 128 * TH: ?dra = $12
80 ?drb = TB + 16 * AM: ?dra = $11
90 ?ddrb = 0: ?dra = 0: ?dra = $40: ?dra = $10
100 HOLD = TIME + (TB + 1) * 10: REPEATUNTIL TIME > HOLD
110 IFTRIG = 0 THEN ?dra = $30
120 IFTRIG = 1 THEN ?dra = $38
130 IFTRIG * 2 THEN 140 ELSE IF INKEY = 99 THEN ?dra = $90 ELSE 130
140 REPEATUNTIL ?ifr < > 0
150 ?dra = 0: ?dra = $20: ?dra = 0
160 FOR I = 0 TO 255: PLOT 69, 2 * I, 4 * ?drb: ?dra = $40: ?dra = 0: NEXT
170 ?dra = $20
180 FOR I = 256 TO 511: PLOT 69, 2 * I, 4 * ?drb: ?dra = $60: ?dra = $20: NEXT
190 ?dra = $10
200 END
  
```

Table 2.

```

10 MODE0
20 dra = $FCB0: ddra = dra: cra = $FCB1: drb = $FCB2: ddrb = drb: crb = $FCB3
30 ?cra = 0: ?ddra = $FF: ?cra = 6: ?dra = $10
40 oFF = 0: ING = 0: NIV = 0: TH = 0: TB = 8: AM = 10: TRIG = 0
50 ?crb = 0: ?ddrb = $FF: ?crb = 4
60 ?drb = oFF + 64 + 128 * ING: ?dra = $14
70 ?drb = NIV + 64 + 128 * TH: ?dra = $12
80 ?drb = TB + 16 * AM: ?dra = $11
90 ?crb = 0: ?ddrb = 0: ?crb = 4: ?dra = 0: ?dra = $40: ?dra = $10
100 HOLD = TIME + (TB + 1) * 10: REPEATUNTIL TIME > HOLD
110 IFTRIG = 0 THEN ?dra = $30
120 IFTRIG = 1 THEN ?dra = $38
130 IFTRIG * 2 THEN 140 ELSE IF INKEY = 99 THEN ?dra = $90 ELSE 130
140 REPEATUNTIL ?cra > 127
150 P = ?dra: ?dra = 0: ?dra = $20: ?dra = 0
160 FOR I = 0 TO 255: PLOT 69, 2 * I, 4 * ?drb: ?dra = $40: ?dra = 0: NEXT
170 ?dra = $20
180 FOR I = 256 TO 511: PLOT 69, 2 * I, 4 * ?drb: ?dra = $60: ?dra = $20: NEXT
190 ?dra = $10
200 END
  
```

Fig. 12. The printed-circuit board for the PIA.

Parts list (PIA)

C₁ = 100 n
IC₁ = 6821
PCB 86100

For Electron:
one 74LS04
one 74LS133

Table 1. Test program for the BBC Micro.

Table 2. Test program for the Acorn Electron.

Fig. 13. This shows how the Electron is coupled to the PIA. The two ICs for the additional address decoding are not provided for on the PIA board.

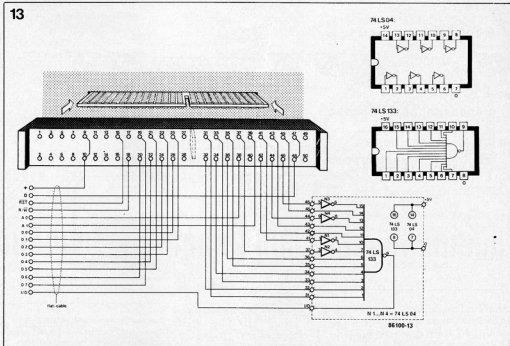

Fig. 14. The registers of the PIA.

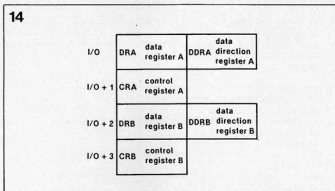

Fig. 15. This timing diagram shows exactly how communication between the drive unit and computer should take place.

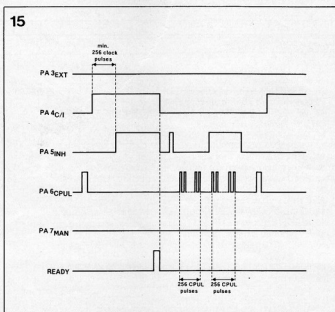
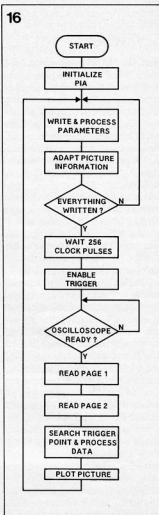

Fig. 16. Flow diagram of the program that produces the picture on the screen; effects the control via the key board; carries out the necessary computations; and communicates with the PIA.



ports. These data relate to the time base; the off-set; the trigger level; leading- or trailing-edge triggering; selection of input sensitivity; and selection of AC or DC inputs. Note that PA₆ to PA₇ incl. are used here as clock signals. See also under *Control signals* in Part 1. Tables 3-8 show the correlation between data and selected settings.

The PB ports are then set as inputs; PA₄ is made logic 0; and PA₅ is briefly made logic 1. This results in the off-set data in the D-A converter being read.

Next, make the PA₄ line high, which creates a waiting period of at least 256 times the selected time base. This ensures that the first memory page no longer contains old data.

Make the PA₅ line (INH) logic high, which results in the digitized input signal being compared with the set trigger level. As soon as these levels are equal, the highest data bit in the RAMs is made 1 (which makes it possible later to determine exactly where triggering took place); the RAM counter is reset; writing is discontinued; and the circuit pulls the READY line (CA₁) high to indicate to the computer that the two RAM pages are full. The computer then makes lines PA₄ and PA₅ logic low, which results in the READY line being pulled low. The computer can then read the RAMs.

First, however, the PA₅ line is briefly made 1 to reset the RAM counter to nought, so that the first memory location can be read immediately. After this, CPUL pulses on PA₅ enable the data of successive addresses to be read at each leading CPUL edge.

After the first memory page (256 bytes) has been read, make PA₅ (INH) high; this serves as the eighth address bit for the memory.

Subsequently, the second page of 256 bits is read in a similar manner. All data can be stored or processed immediately, depending upon the available memory.

Finally, new data may be written (with the PB lines arranged as inputs). A pulse on the PA₆ will cause the off-set data in the D-A converter to be clocked. Making the PA₄ line high will cause the PIA to start again with writing into the first memory page. After an interval of not less than 256 time-base clock pulses, the trigger may be enabled again.

As stated in Part 1, complete programs for the Acorn Electron, the BBC Micro, the Commodore C64, and MSX machines are supplied with printed-circuit board 86083.

To enable owners of other makes of computer to compile their own program, a flow diagram of the program

Table 3.

TB3	TB2	TB1	TB0	
0	0	0	0	1µs/div.
0	0	0	1	2µs/div.
0	0	1	0	5µs/div.
0	0	1	1	10µs/div.
0	1	0	0	20µs/div.
0	1	0	1	50µs/div.
0	1	1	0	0,1ms/div.
0	1	1	1	0,2ms/div.
1	0	0	0	0,5ms/div.
1	0	0	1	1ms/div.
1	0	1	0	2ms/div.
1	0	1	1	5ms/div.
1	1	0	0	10ms/div.
1	1	0	1	20ms/div.
1	1	1	0	50ms/div.
1	1	1	1	0,1s/div.

Table 4.

V0	V1	V2	V3	V _{in} max
0	0	0	0	10mV/div.
0	0	0	1	20mV/div.
0	0	1	0	50mV/div.
0	0	1	1	100mV/div.
0	1	0	0	200mV/div.
0	1	0	1	500mV/div.
0	1	1	0	1V/div.
0	1	1	1	2V/div.
1	0	0	0	5V/div.
1	0	0	1	
1	0	1	0	
1	0	1	1	
1	1	0	0	
1	1	0	1	
1	1	1	0	
1	1	1	1	

Table 3. Correlation between time bases and data on TB₀-TB₃ lines.

Table 4. Correlation between sensitivity settings, maximum input voltage, and data on V₀-V₃ lines.

Table 5. Correlation between trigger levels and data on T₀-T₆ lines.

Table 6. Correlation between off-set voltages and data on OF₀-OF₆ lines.

Table 7. Correlation between type of input and data on AC/DC line.

Table 8. Correlation between type of triggering and data on +/- line.

Table 5.

T6	T5	T4	T3	T2	T1	T0	
1	1	1	1	1	1	1	max.
1	0	0	0	0	0	0	zero level
0	0	0	0	0	0	0	min.

Table 6.

OF6	OF5	OF4	OF3	OF2	OF1	OF0	
1	1	1	1	1	1	1	max.
1	0	0	0	0	0	0	zero level
0	0	0	0	0	0	0	min.

Table 7.

AC/DC	input
1	DC
0	AC

Table 8.

+/-	triggering
1	leading edge
2	trailing edge

is given in Fig. 16. The quality of the screen image will depend largely on the resolution of the computer.

First of all, the location on the first memory page where the trigger bit (D₇) went high must be determined. The next location is the first for a complete picture, from which the whole page may be read. The second page can be started at the first location, since all data there are in correct sequence.

Linear Scale Ohmmeter

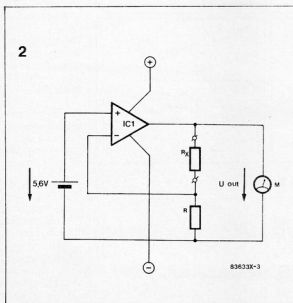
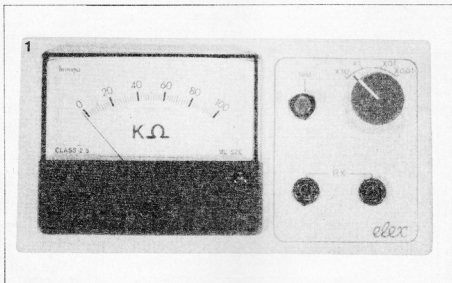

Figure 1 :
The prototype of Linear Scale Ohmmeter, equipped with a 100uA moving coil meter. The circuit can also be constructed as an add on attachment to a standard multimeter.

Figure 2
Simplified schematic diagram of the linear Scale Ohmmeter circuit. The battery shown here is replaced in the actual circuit by a zener diode for stable 5.6V reference.

Why should anyone construct an ohmmeter, when every multimeter has several resistance ranges? True, the multimeter has many ranges for resistance measurement, but the higher end of the resistance scale reads the values very poorly. Due to the nonlinear scale, the values at the higher end are very closely spaced while the values at the lower end are widely spread.

In case of the linear scale ohmmeter, the divisions are equispaced over the entire scale. This advantage is due to the small I.C. OpAmp used in the measuring circuit.

The Circuit

A simplified schematic diagram of the linear scale ohmmeter is shown in figure 2. The actual circuit is shown in figure 3, which looks much more complex than it really is. First, let us concentrate on the circuit shown in figure 2. The main component of the circuit is the Op Amp IC1. IC1 contains a multistage differential amplifier circuit. A differential amplifier amplifies the voltage difference between its two inputs. The voltage on the non-inverting input (+) increases the output voltage, whereas a voltage on the inverting input (-) reduces the output voltage. The gain of such amplifiers is a few hundred thousands. Gain of one hundred thousand means that a difference of 10 microvolts at the inputs gives rise to 1 Volt at the output.

A voltage divider made of R_x and R is connected across the output and the voltage at the interconnection of R_x and R is fed back to the amplifier at its inverting input. This is known as negative feedback. This has an effect on the circuit which makes the voltage on the inverting input practically equal to that on the non-inverting input. To understand exactly what happens, let us

consider a hypothetical experiment. Assume that the voltage on the non-inverting input rises from 5.6 to 6.6 V, i.e. 1 V. The output voltage will try to increase by 100000 V. The voltage on the inverting input will also simultaneously try to rise depending on the ratio of R_x and R . This in turn will try to bring down the output voltage. The result of this will be that the voltage on the inverting input will also rise to almost the same voltage which is on the non-inverting input.

In case of the linear scale ohmmeter circuit, the input voltage on the non-inverting input remains constant at 5.6 V. The voltage across R is thus fixed at 5.6 V as we have already seen in the above experiment. This means that the output voltage at the output of the amplifier depends entirely on the value of R_x . The relation between these values can be calculated as follows:

Voltage on $R = 5.6V$

Voltage on R_x and $R = U_{out}$

$$U_{out} = \frac{R + R_x}{R} \times 5.6V$$

$$= 5.6V \left(\frac{5.6V}{R} \right) \times R_x$$

Which clearly shows that U_{out} is directly proportional to R_x if the constant value of 5.6V is taken care of during calibration with $R = 0\Omega$! To take care of this, the meter is placed on the non-inverting input in the actual circuit, so that the voltage of 5.6V does not play any part in the measurement. The zener diode produces the stable input voltage current for $D1$ is supplied by $R5$.

The output voltage is measured through the combination $R6 - P1 - M1$. Diode $D2$ protects the meter $M1$ from very high voltages, which can occur when the ohmmeter is connected without a test resistance.

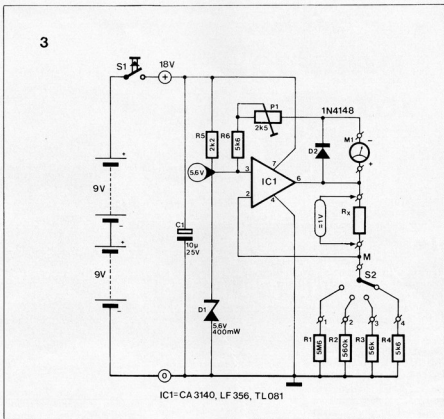

Switch Setting of S2	Full Scale Deflection Resistance Value	Measuring Current
1	1M Ω	1 μ A
2	100K Ω	10 μ A
3	10K Ω	0.1 mA
4	1 K Ω	1 mA

The $R6 - P1 - M1$ combination can be replaced by a multimeter in the 1V or 2.5V range.

The measuring range of the ohmmeter is selected through switch S2. Resistances $R1$ to $R4$ substitute the resistor R from our simplified circuit of figure 1. The four ranges are described in table 1.

The Power Supply for the linear scale ohmmeter is formed by two 9V batteries. The current consumption is around 10 mV and the battery life is very long.

You must have already noticed by now that the circuit functions on the basis of a constant current source. As the voltage on R (or $R1/R2/R3/R4$) always remains constant at 5.6V, the current through $R = R_x$ combination also remains constant. Thus the voltage across R_x is always given by the following relation

$$V_{R_x} = \frac{5.6V}{R} \times R_x$$

As the value of $\left(\frac{5.6V}{R}\right)$ is constant, V_{R_x} is always proportional to R_x .

Figure 3 : The practical circuit of the Linear Scale Ohmmeter. The main component here is the Op Amp IC1, supplied by two 9V batteries

Construction

As usual, the mechanical work involved in construction is much more compared to the job of soldering the electronic components together on the PCB. The mechanical work can be simplified by using a plastic enclosure, which is easier to handle than metal enclosures. Suitable holes must be drilled in the lid for sockets, switches S1, S2 and the meter M1. A large cutout of 50 mm diameter must be carefully made for the meter body.

5

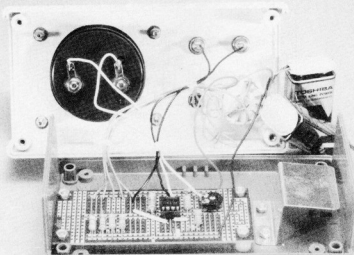

A standard Selex PCB can accommodate all the circuit component. Layout and wiring is quite simple and is shown in figure 4. Pin details of IC1 and diodes D1, D2 must be properly observed.

Three different Op Amps have been specified in the component list for IC1. These are all pin compatible. The commonly used Op Amp 741 will not work in this circuit. The resistances used must be of very close tolerances, typically 2.5% or less, for R1 to R4. This ensures that the scale is uniformly divided. The construction details are shown in figure 5. The Selex PCB is fixed on the bottom of the enclosure and the batteries are clamped using an aluminium clamp.

After wiring and assembly, the potentiometer P1 is adjusted such that the meter shows full scale deflection for a 1K Ω resistance in Range 4 (0 to 1K). The test

resistance of 1K used here must be as accurate as possible.

Table 1 shows the setting of switch S2 and the range covered by the setting. Also indicated is the current through the test resistance for each range. The scale of our prototype is suitable for range 2 (0-100K). For other ranges, the reading must be multiplied by 10 (Range 1), 0.1 (Range 3) 0.01 (Range 4).

Figure 4 :

Layout and wiring diagram, using a standard SELEX PCB. Polarity of diodes and electrolytic capacitor must be properly observed while soldering.

Figure 5:

Inside construction of the Linear Scale Ohmmeter. Use coloured wires to distinguish between different connections.

4

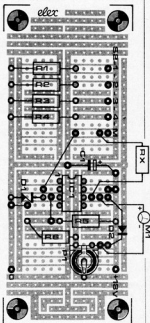

Component List

- R1 = 5.6M Ω , 2.5%
- R2 = 560K Ω , 2.5%
- R3 = 56K Ω , 2.5%
- R4 = 5.6K Ω , 2.5%
- R5 = 2.2K Ω
- R6 = 5.6K Ω
- P1 = 2.5K Ω Trimpot
- C1 = 10 μ F/25V (Electrolytic)
- D1 = 5.6V Zener/400mW
- D2 = 1N4148
- IC1 = 3140/TIL 081/LF 356
- S1 = Push button Switch
- S2 = Four Position Rotary Switch
- M1 = 100 μ A moving coil meter.

Other Parts

- 1 Calibration resistance 1K Ω , 2.5%
- 1 Selex PCB
- 1 8 pin IC Socket
- 2 Banana Sockets
- 2 9V Batteries
- 2 Battery connectors
- Suitable enclosure, wires etc.

The Cackling Generator



If one listens to the cackle of a hen, laying of eggs looks like big work! This interesting sound can be generated by a simple circuit. The circuit described here can also be combined with kitchen timers. Egg timers or can be used as a stand alone noise generator to produce interesting results. It can also become a cause of puzzled faces

and hearty laughs, especially when it is beautifully packed as shown in the photograph given above.

The Circuit

The circuit is shown in figure 1, and mainly consists of three oscillators and one amplifier.

Each of the oscillators is constructed with two

inverting buffers and a few resistors and capacitors. All six inverting buffers are part of one IC (4049).

The first oscillator (using N1 & N2) provides a rectangular signal. The signal is not quite rectangular, due to the presence of C1. The actual waveform is shown in figure 2a. This signal has two jobs to do — it determines the length of the cackling cycle and it also determines the gap between two cackling cycles.

The second oscillator (using N3 & N4) provides the envelopes for the four different cackling sounds which are spread over the full cackling cycle. The length of each envelope is different, as can be seen in figure 2 b.

The third oscillator (N5 & N6) generates the audio frequency noise signal which is enveloped by the second oscillator to produce the bursts of cackling noises.

Functional description

The audio frequency noise signal generated by the third oscillator can be adjusted by the potentiometer P1 to set the desired sound level.

To achieve a near natural cackling quality, four short and then a long cackling noise with rising sound level must be generated. This is achieved by the connection of first two oscillator via a RC network consisting of R4, R8, R10, C3, C4 and D2, D3, D4.

The sound of cackle can be modified by changing C7 by trial and error, to suit your own test!

The voltage on R4 can be greater or less than that on R10, and to take care of this, fact, a combination of D2, D3, C3, C4 is used to function as a bipolar capacitor.

When voltage on R4 is more positive than that on R10, D2 blocks and C3 is

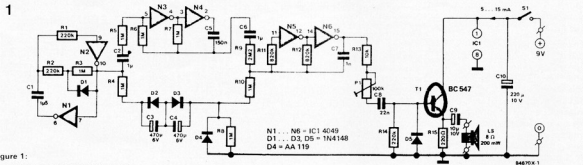

2

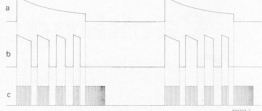

charged. When R10 has more positive voltage than that on R4, D3 blocks and C4 is charged. D4 prevents the voltage on R8 from becoming negative.

The audio signal finally arrives at T1 where it is amplified and fed to the loudspeaker. Observe the shape of the transistor T1 in the circuit diagram.

Construction

This circuit has many components to be accommodated and requires a double size SELEX PCB.

The layout is shown in figure 4. The electrolytic capacitors require the maximum PCB space. While soldering their polarity must be correctly observed. The current consumption is between 5 to 15 mA, and a small 9V battery pack is adequate to supply this current.

If one wants to combine this circuit with a kitchen timer, the relay contacts of the timer circuit can be suitably connected into this circuit so that the cackling noise starts when the set time has lapsed.

If you want to pack this circuit nicely in shape of a hen as shown in the photograph (5), it should be assembled on two small SELEX PCBs and interconnections should be made with wires. The loudspeakers and battery can be fitted as shown in the photograph. Potentiometer P1 can be fitted in front as shown, so that sound level can be conveniently adjusted.

Component List

R1, R2, R14 = 220K(1)
 R3 R8, R10 = 1M(1)
 R9 = 2.2M(1)
 R11, R12 = 820K(1)
 R13 = 10K(1)
 R15 = 220(1)
 P1 = 100K(1) Trimpot or Potentiometer with spindle
 C1 = 1.5µF (Metallised Polyester)
 C2, C6 = 1µF (Metallised Polyester)
 C3, C4 = 470µF/6V
 C5 = 150 nF
 C7 = 1 nF
 C8 = 22 nF
 C9 = 10µF/10V
 C10 = 220µF/10V

D1, D3, D5 = 1N4148
 D4 = AA119
 T1 = BC547B
 IC1 = 4049

Other Parts

S1 = ON/OFF Switch
 1 loudspeaker 8(1)/200 mW
 1 large or 2 Small SELEX PCBs
 9V miniature battery.

Figure 2 :

The waveforms generated by oscillators 1, 2 and 3 shown at a, b and c.

Figure 3 :

Components mounted on a double size SELEX PCB. The electrolytic capacitors take lot of PCB space.

Figure 4 :

Schematic layout. While assembling the circuit, ensure to have correct polarity for electrolytic capacitors, diodes and the IC.

Figure 5 :

A suggested packaging for the cackling generator.

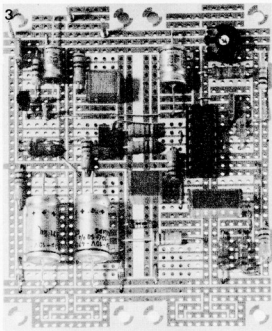

4

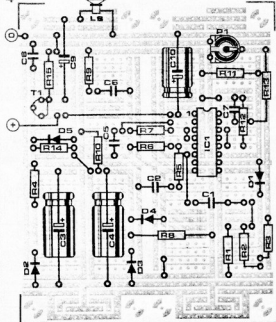

Electrical Power characterises the use or supply of electricity. In the abbreviated form it is represented by the letter P and the units for measuring electrical power are Watts (W). The higher the power of a drilling machine, the higher is the torque generated by it. The higher the Wattage of a bulb, the brighter is its glow. A water heater with 3000 W rating gives more heat than a 1000 W heater. The higher the power of a stereo amplifier, the louder is the music!

However, all the previous examples are not identical. In case of the drilling machine, it draws the specified power from mains supply when it is drilling a hole in a hard material. The power consumption is much less when it is in the free running state. This is not true in case of the bulb or the water heater, because they draw the specified power from mains as soon as they are switched on. Also the example of the amplifier is still different. The power drawn by the

POWER

amplifier can be controlled externally by the setting of the volume control knob, between a minimum and maximum amount. The specified power of the amplifier generally refers to the maximum power. The useful power is much less than the power drawn from mains. When the amplifier draws 30 W from the mains, it does not supply 30 W to the loudspeakers. Even the bulb with 100 W rating does not convert all the 100 W of power into light, most of it is lost as heat and only a part of it is given as light.

There can be two meanings to the power specification of any electrical appliance. It can be the actual power drawn by the appliance from mains or it can be the maximum power the appliance is capable of drawing from the mains supply. Another distinction

must be clearly made when talking about electrical power. The power can be the power taken up by the appliance or it can be the power given out. In case of a 100 W bulb we know that it takes up 100 W from mains. However, only a few watts are given out as light and the remaining power is converted into heat. So, if we are specifying the power that is given out – we cannot claim the bulb to be a 100 W bulb! This is also true in case of the stereo amplifier, we must distinguish between the power drawn by the amplifier and the power given out to the loudspeakers. It generally takes up twice as much as it gives out. Thus an amplifier which is capable of drawing 30 W from mains will not deliver more than about 15 W to the

loudspeakers.

Power is never lost, it is converted from one form to other, when we talk of power loss, what we really mean is that some part of the power is not put to any use – it is converted to a useless form of energy, as in case of the bulb where most of the power is converted into heat. However, if for any reason, we were using a 100 W bulb to heat something, then we would say that most of the 100 W of power is converted to useful heat and some part is lost as light! It all depends on which form of energy the appliance is expected to deliver.

The stereo amplifier draws electrical power at 50 Hz from the mains. It gives out electrical power at the audio frequencies to the loudspeaker. The loudspeaker in turn takes up the electrical power from amplifier and converts a part of it into sound energy, some of it being converted to heat inside the voice coil of the loudspeaker. Though it is not lost, it is useless.

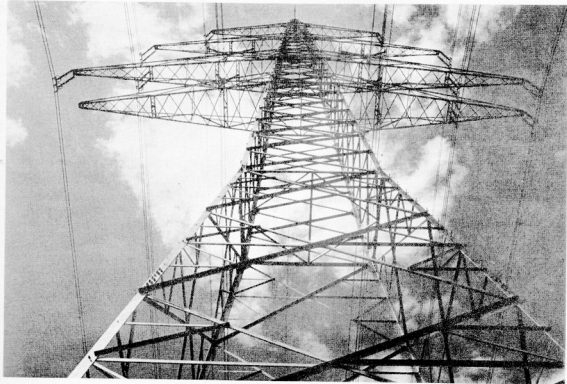

Electronic Switch

Described here is the construction of a simple electronic switch which is electrically isolated from the mains. Electrically isolated means that there is no electrically conductive connection between the switch and the mains supply lines. Also the mains voltage has no effect on the switching mechanism

In most of the cases, a switch in the electrical circuit is directly placed in the power line. This is the simplest way to connect and disconnect an appliance from the mains supply.

However, the disadvantage of such type of switching is that the full supply voltage is always present on one terminal of the switch. This may not always be acceptable, especially in case of switching to be activated by sensitive circuits like computers. In such cases one can also use a driver transistor and a relay, but the relay contacts can create problems when they get worn out. Even during normal operation, the closing and opening of relay contacts can produce electrical disturbances which may in turn affect the actuating circuits of the computer.

The better way is to use an electronic switch similar to the one described here. Even though the practical circuit of an electronic switch used for controlling mains loads from a computer is not as simple as this, the principle remains same. What is described here is a simple battery operated version. The circuit still ensures full electrical isolation from mains voltage.

The Circuit

The circuit of the electronic

switch is shown in figure 1. The heart of the circuit is the "Opto-Coupler" which is nothing but a combination of a small Lamp bulb and an LDR. The Lamp L_a and the LDR are enclosed in a light proof enclosure and properly sealed. The light proof enclosure can be constructed from black card paper or a small piece of black plastic tube.

The construction can be different, as long as the LDR is illuminated only by the Lamp L_a and no other external light source. The LDR is a Light Dependent Resistor, which changes its resistance value depending on the amount of light falling on it. The Lamp and LDR should be placed inside the tube in such a way that there is about 1 or 2 cm. distance between the lamp and the light sensitive surface of the LDR.

The function of the circuit is very simple. When switch S1 is closed, the lamp L_a glows. Due to the light falling on the LDR, its resistance falls to a very low value (approximately 100 to 500Ω!). This low resistance connection between the mains line and trigger pin of the Triac, through the R2, R3, C1 combination now triggers the triac during every half cycle of mains voltage. The load is thus placed directly on the mains line through the triac.

When switch S1 is open, the lamp does not glow, the resistance of LDR rises upto a few megaohms and there is no path for the trigger current to flow. The triac is off and there is no connection between the mains line and the load. R3, C1 form the protective

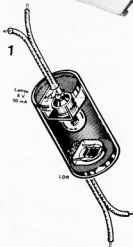
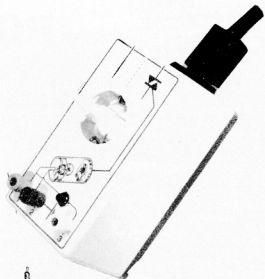

Photograph :

The safety becomes perfect through the use of a plastic enclosure and properly installed mains socket / plug pairs. Three different possibilities of control are achieved through the three banana sockets and switch S1.

Figure 1:

The circuit of the Electronic Switch. The terminals A1 and A2 of the triac should not be interchanged. A2 must be on the load side.

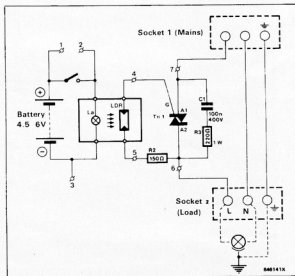

2

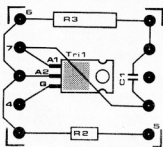

circuit, whereas R2 serves as a current limiting resistance.

Construction

As always, all the rules for construction of a circuit which connects to the mains, must be observed strictly. The circuit can be constructed on a piece of Lug Strip, as shown in figure 2. It can be installed inside a suitable plastic enclosure Standard plug/socket combinations can be used for mains inlet and outlet. Three banana sockets can be installed on the plastic case and connected to points 1, 2 and 3 shown in the circuit diagram of figure 1.

This gives us three alternatives for switching on the load.

1. Directly by switching S1 on.
2. Through an external switch or relay contact connected across sockets 1 and 2
3. By applying an external voltage of 4.5 to 6V across sockets 2 and 3.

Triac TIC 206M, or equivalent, can handle loads upto 200W. Triac TIC 226M, or equivalent, can handle loads upto 300 W.

An important point to remember here is that the lamp takes a little time to extinguish when disconnected from battery, and this will introduce a short delay between turning off switch S1 and switching off the load from the mains.

This circuit will not be suitable for applications which require emergency disconnection of load from the mains.

Figure 2:

The triac, the resistors R2, R3 and capacitor C1 are all mounted on a small piece of Lug strip.

Figure 3:

The pin connections of triac. If you are using any other equivalent triacs, carefully note the pin connections for that triac, which may be different from those shown here.

3

TIC 206 M
TIC 226 M



Parts List

- R1 (LDR) = Any suitable LDR with high resistance in the range of few Megaohms.
 R2 = 150Ω
 R3 = 220Ω / 1 W
 C1 = 100 nF / 400V (for resistive loads)
 C2 = 100 nF / 600V (for inductive loads)
 TR1 = TIC 206M / TIC 226M or equivalent
 La = 6V / 50mA Lamp with holder
 S1 = ON / OFF toggle switch.

Other Parts

- 4.5 or 6V Battery
 Banana Sockets & Pins,
 Black Card paper tube
 or plastic tube,
 Lug Strip
 Suitable Plastic Enclosure, etc.

Meet ...



BHAVI SAKLECHA
 18, Palm Grove Road,
 Austin Town,
 Bangalore - 560 047

An Electronic Engineering student at MSRIT Bangalore, has developed a Robot. The cost of this project, which consists of the control unit and mechanical unit is approx Rs. 3000/- The low cost of the project apart, this is quite an achievement for a Student.

The photograph below show the robot performing its operation.

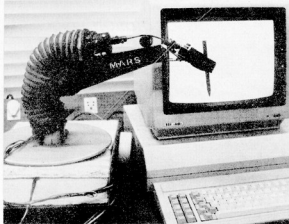

The Control Unit.

- a) 16-Bit microprocessor (INTEL 8086)
- b) Present on card memory of 16K (EPROM) and 8K (RAM)
- c) Provides communication between MARS and user with appropriate displays on monitor.
- d) Easily expandable to control large number of MARS systems simultaneously.
- e) Speed control by simple command from user.
- f) Uses a +12, -12 and +5 volt for motor and control card
- g) User has three modes of operation to choose.
 - 1) TEST mode
 - 2) MANUAL mode
 - 3) TEACH mode

The Mechanical Unit

An omnidirectional ground transporting robot on four wheels are powered by a pair of stepper motors. Each of these motors are capable of independent motion thus very easily MARS can turn about any point.

The ARM unit is capable of handling loads of upto 500gm held at the gripper. High degree of accuracy and low mechanical power input is achieved by the use of gears. ARM unit has 90 degree freedom of movement up and down making it capable of lifting objects from the floor level.

The BASE unit has 360 degree freedom of movement. The very cost effective design of gripper achieves a high degree of compliance to suit any application. Driven by high speed DC motors this gripper makes 'hold' and 'release' action almost instantaneous.

FLEXICELLS TO BEAT BATTERY WEIGHT

by Dr Alan Hooper, Materials Developments Division, Harwell

Engineers designing electrical and electronics equipment, from electric traction vehicles to portable radios for domestic or military use, have always been frustrated by the weight and size of batteries that have to be carried. Now under development at Britain's largest laboratories, in collaboration with other scientists in the UK and in Denmark, all-solid-state rechargeable lithium batteries bring pollution-free driving a great deal nearer and may trigger many new and exciting ideas for battery-powered equipment.

Battery-powered electric vehicles (EVs) are already in use in many countries. One example, in the UK, is the humble milkdelivery wagon, or 'milk float'. It is successful because to do its job it needs to work over only a short range and a low speed is acceptable in built-up areas, where it has the added advantage over the internal combustion engine of not causing pollution. It is efficient and convenient for continual stop-start operation and a commercial fleet of such vehicles is easy to maintain.

On the other hand, its restricted performance causes considerable frustration to motorists who meet it on the open road, for it cannot travel at the speed of the rest of the traffic. Across the Atlantic, the golf-cart would hardly be welcomed on the freeway. So the view of the general public is that electric vehicles have a poor performance but are acceptable for specialist duties.

It is the source of power, the battery, which lies at the heart of the problem. To put it simply, traction batteries are too heavy and too large for the amount of energy they store or the power they can provide: a large fraction of the energy stored in a typical traction battery is needed just to propel the battery itself.

Aqueous electrolytes

For practical purposes, the present choice of batteries for EV traction is between two systems, each employing an aqueous electrolyte, which is either leadacid or nickeliron. This situation has remained essentially unchanged since the beginning of the 20th century despite many attempts, especially over the last 25 years, to develop new systems. Over that period, stimulation by the appearance of potential rivals has led to significant improvements in the

performance of existing systems and of vehicles with good short-range, traffic-compatible capabilities. Most of the vehicles now available are urban delivery vans but one of the latest is a version of the popular Peugeot 205 car, powered by a nickeliron battery. There are certain practical drawbacks specific to individual systems, but the main, general problem is still that of limited range. EVs are still, in general, economically uncompetitive with their internal combustion engine counterparts.

The performance offered by the enormous energy density of petroleum, with more than 10 000 Wh/kg (watt hours per kilogram) compared with 20-40 Wh/kg for leadacid traction batteries and a highrate recharge capability (two minutes at the pump in contrast to a battery charge of several hours), will never be matched by that of any battery system, in spite of an on-board energy con-

version efficiency that is five times better. However, if a battery were available with high energy density (100 to 200 Wh/kg) it would significantly affect the practical value of EVs in a wide variety of applications from wheelchairs and bicycles to commuter cars, taxis and delivery vehicles.

Not only would longer ranges and greater load-carrying capabilities be realised, but the improvements in gravimetric energy density would open up considerable scope for innovative engineering in vehicle design, using lighter and cheaper materials. It is this, rather than cheaper batteries, which would lead to a cost-competitive electric vehicle.

Portable electronics

Similar problems are to be found in other technologically important areas. The vast demand for portable electronics equipment in

the computing and communications fields bring with it a need for small, lightweight, rechargeable power sources. Both the business executive and the infantryman in the field would benefit from a lighter load to carry. It is not only important to achieve lower absolute weights and smaller volumes, to avoid the hand-held cellular radio-telephone or 'wrist-watch' device having a suitcase-size battery, but to be able to provide batteries that are suitably shaped, too. For example, a flat-screen television ideally requires a flat battery pack.

There are also growing markets in the telecommunications and other industries for standby power sources. Here, too, there is a trend towards smaller electronics packages and correspondingly small power sources.

NiCd batteries have been used traditionally in these markets and, more recently, NiH₂ batteries too, for space applications such as power sources for satellites where cycle life and reliability are also of prime importance; but the low energy densities so far achieved have restricted the electrical load capabilities of missions. Space stations and deep space probes will require power sources with higher energy densities.

Much better energy densities are theoretically available from alkali-metal couples, but materials problems have restricted their use mainly to primary battery systems and to secondary batteries operating at high temperature. Of the latter, the sodiumsulphur battery is the best developed. It uses an Na⁺ ion conducting solid, sodium-beta-alumina, as a solid electrolyte and has to be operated at 350°C. Predicted energy densities are more than 100 Wh/kg; more prototype traction batteries have been made and vehicle demonstrations carried out in

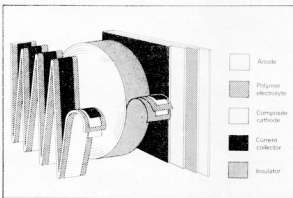

Three ways of constructing all-solid-state cells with large surface contact areas.

several countries. However, sodiumsulphur batteries are still not commercially available, even after some 17 years' research and development by large teams of scientists around the world. Remaining problems include the reproducibility of manufacture and reliability in use of beta-alumina ceramic tubes, and the thermal control and safety of large batteries. High temperature systems of this kind will, even if successful, be useful only where large batteries are needed.

A small, room-temperature, rechargeable lithium battery with a liquid organic electrolyte has recently become commercially available in Canada. Its cathode material (MoS₂) leads to a low open-circuit voltage and moderate energy density. A useful life of more than

100 charge/discharge cycles is quoted but little information is yet available from field trials. Applications under consideration include photographic flashguns and electric wheelchairs.

Radical departure

Rechargeable all-solid-state lithium batteries now being developed at Harwell constitute what is perhaps the most radical new departure in battery technology for decades. They also promise very exciting commercial prospects. Based on thick-film polymer technology, with no liquid components, they offer very high energy density, mechanical flexibility and variable geometry as well as being robust and safe.

This work has evolved from



Solid-state cell components: (a) lithium metal anode, (b) polymer-electrolyte membrane and (c) composite cathode on nickel-foil backing.

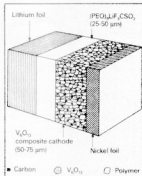

Basic arrangement of the elements of an all-solid-state cell.

The notation PEO stands for poly(ethylene oxide).

a programme begun here in 1978 to investigate materials for advanced alkali-metal rechargeable batteries. It was shared between Harwell, universities in the UK and research and development establishments in Denmark. The Anglo-Danish Battery Programme as it became known was jointly sponsored at Harwell by the UK Department of Trade and Industry (DTI) and the European Community.

The aim of the programme was to examine the properties and behaviour of several promising solid electrolytes and electrode materials described in the literature, to obtain a sound idea of their properties, to define the problems to do with their use in batteries and to assess their compatibility with other materials in cells. Such work would enable us to find out reliably which materials might be technologically useful for electric vehicle batteries in the future. It was hoped to obtain a fairly hard-headed assessment of whether alkali metal batteries could be developed that would achieve their potential energy density advantages and to identify which materials could best be chosen for future cell development studies. A working temperature range of 100°C to 200°C was considered acceptable for a first generation EV battery.

All-solid-state

Because of persisting difficulties with organic liquid electrolyte batteries, all-solid-state cells were seen as the only practical way forward for operation at ambient and moderate temperatures. The cells developed in the programme have lithium anodes and a so-called intercalation or insertion compound as reversible cathodes. Examples are V₂O₅ and TiS₂. Although the early stages of the programme studied

in depth the very interesting crystalline inorganic lithium-ion-conducting electrolytes Li_3N and $\text{LiI}(\text{Al}_2\text{O}_3)_2$, the choice of this type of cell was made more realistic by the discovery of polymer-based solid electrolytes by Michel Armand and fellow workers in France. Certain polar organic materials such as poly(ethylene oxide) will dissolve alkali metal salts and manifest rapid alkali-conductivity.

The absolute conductivities of such polymer-based materials are not in general as high as those of crystalline solid electrolytes, but they may be made into thin, pinhole-free plastic sheets with good enough conductance for use in cells and batteries. Equally important is that the plasticity of the polymers overcomes the other big problem of solid-state battery systems, namely how to maintain good contact between faces.

Harwell staff have concentrated over the last four years on developing the technology for making the polymer-electrolyte plastic battery,* and have built and tested cells. Techniques for continuous production of the electrolyte and cathode components in the form of thin films have been developed and their dimensions can be scaled-up when required. The thickness of a complete cell is only one or two hundredths of an inch (one-quarter to one-half of a millimetre) and there are prospects of making even thinner cells. There are close similarities between the structure and fabrication technology of the battery and many products outside the traditional battery industry.

* This technology should not be confused with the so-called plastic batteries also under development, which use electronically conducting polymers such as doped polyacetylene as electrode materials, with organic liquid electrolytes. They offer only moderate energy densities.

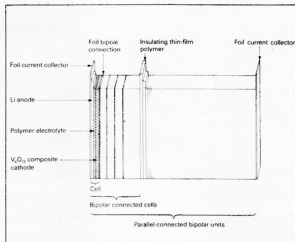

Basic assembly units of series-connected bipolar cells and parallel-connected units to form a traction battery module.

including printed and packaging materials and photographic film. It has been shown that in laboratory-scale cells, operating at around 120°C , there is a high utilization of the active cell materials at discharge rates of a few hours and with lives of over 100 deep discharge cycles. Larger cells, of up to 500 cm^2 area, and series-connected multi-cell stacks have also been successfully made and tested. From these results we predict usable-energy densities for solid-state traction batteries that would make them one-fifth of the weight and one-third of the size of lead acid batteries now in service.

Temperature range

At present the cells, which are poly(ethylene oxide)-based, operate most effectively at 100°C or just above, so they are quite suitable in that respect for vehicle traction service and for use in satellites. Earliest specialist applications may also be found where the environment is hostile with temperatures of up to 150°C , a region where most conventional batteries fail. They may include down-hole instrumentation in the oil industry and certain standby power sources. Furthermore, lower-temperature performance can be achieved with

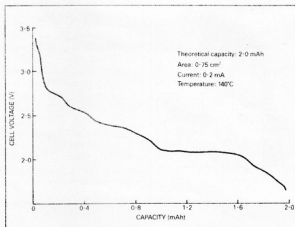

Typical discharge curve of an $\text{Li}/\text{V}_2\text{O}_5$ cell

existing materials and cells when the power requirements are low, as for many micro-electronics jobs.

One attractive possibility in this field is the integration of the battery with the circuit it powers: the thin-film planar technology is compatible with conventional printed circuit board and hybrid electronic circuitry. For example, the technology lends itself to the development of a self-powered intelligent credit card incorporating a micro-processor.

But for many other prospective uses, operation at room temperature and below is required, at high power levels. This will mean developing new cell materials, especially new polymer electrolytes. Work is now going on in many countries and a research and development programme here is being sponsored by an industrial group or 'club' of battery users, manufacturers and materials specialists. Supported by the DTI, our Solid-State Battery Working Party aims to provide the basic technology to make all-solid-state lithium batteries, based on polymeric electrolytes, for as many applications as possible. Studies will concentrate at first on developing better electrolytes but expand as membership of the group grows.

Success in this area will open up many new uses in the military, industrial and domestic sectors. It might well lead to 'cordless' vacuum cleaners, lawnmowers and power tools, and to new flashlights, toys and electronics and communications equipment. The idea of batteries based on an all-solid-state polymer electrolyte, perhaps using various materials and construction technologies for different applications, holds out one of the most versatile and exciting prospects for battery development this century.

Always a move ahead

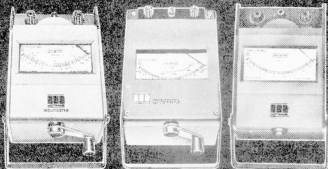

Even in Insulation Resistance Measurement

You have heard about our tradition of quality, of course. But have you ever wondered why we deserve it?

Take our Insutesters®. They have made their reputation for being stable, reliable and accurate. What could the reason be?

Is it because we've used solid state circuitry, with an indicator that is both shock and vibration proof, instead of clumsy clutch mechanism of conventional testers? Or is it our hand driven generator which is smooth, stable, silent, and long lasting—alternatively battery operated? Could it be because of our taut band suspension movement that

eliminates friction error totally? Or the guard terminal that protects your measurements from surface leakages?

What of the extended range: from 100 V/ 20 Mohms to 1000 V/2000 Mohms?

Did you even know that our Insutesters® are housed in attractive, light weight cases which are injection-moulded in high impact plastic, so that they are easily portable and well able to take the rough with the smooth? But if you still insist on metal casing, we provide that too.

Your measurement time being of our concern, we've even updated the response to just 3 seconds!

Yet if you are the kind who is more impressed by actions rather than words, try our Insutesters®. It's not too hard to tell the difference.



For further details write to:
THE MOTWANE
MANUFACTURING COMPANY
PVT. LTD., at Gyan Baug, Nask
Road, 422 101 Tel.: 61297/
61084. Telex: 752-247 MMPL IN Grams: MOT-
WANE or Gyan Ghar, Plot 434 A, 14th Road,
Khar, Bombay-400 052. Grams: MOTESTEM.

_____ Cut here and mail _____

(Please send literature and quotation on your Insutesters)

Name _____

Designation _____

Company _____

Address _____

Telephone _____ Telex _____

SELL AD5, MWAC 12 84

STRIP CONNECTORS

IEC Strip Connectors are available in wide range, from 5 Amps to 30 Amps in 12 ways, moulded in Bakelite & PVC. The metal parts are made of brass and screws of M.S. duly plated to prevent corrosion. The strip connectors are tested to withstand High Voltage for 2 K.V.



For further information, please contact:-

ASIA ELECTRIC COMPANY
Katara Mansion
132A, Dr. A.B. Road, Worli Naka,
Bombay 400 018.

BETA TESTER

This Transistor Beta Tester measures static gain (Beta) upto 300, at collector currents upto 10 Amps and base currents upto 1 Amp, at VCE of 4 Volts, as per international specifications. The currents are pulsed at 2% duty cycle at 50 Hz, avoiding excessive heating and power dissipation, in Transistor under test.

The instrument is useful for bulk users of transistors.



For more details, please contact:
SPECTRON SALES & SERVICE
PVT. LTD.
63, Bharatkunj No. 2
ERANDVANE
PUNE 411 038.

KEY LOCK SWITCH

ELCOM has recently introduced a Key Lock Switch Type KLS-5. This reliable Key

Lock Switch provides added safety to electrical and electronic equipments and prevents unauthorised use.

Panel Projection: 6 mm.
Body: Bright Chrome Plated
Action: 3 Pos. SPDT.
Contact Resistance: 20 Milliohm
Rating: 125 VAC/5A, 250 VAC/3A



For further information:

ELCOM
103, Jaygopal Industrial
Estate 8, Parulekar Marg,
Dadar, Bombay 400 028.

CABLE TIES & TIE MOUNTS

Microsign Products offer a wide line of versatile one piece construction self locking Nylon cable ties of Miniature-Intermediate-Standard section in releasable & Non-releasable type which can secure cables-wires-tubings-houses from 2mm to 75mm in diameter. Miniature cable ties make neat work of intricate wiring. Tie mounts available with screw provision-Adhesive backed-snap in too.



For further information contact:

MICROSIGN PRODUCTS
Mehta Terrace
Satyanarayan Road
Bhavnagar 364 002.

MINIATURE RELAYS

PLA introduces Series 101 Miniature relay in a slim style design with overall dimensions 26(L) x 12.5(W) x 24.5(H) mm Available with 1 changeover contact rated for 6 amps. at 240V Ac/28V DC. It is ideal for high density PCB applications in the field of communication and Industrial Control Systems as well as house-hold electrical appliances.

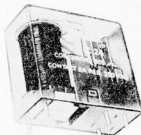

M/S SAI ELECTRONICS
Thakor Estate Kurla Koro Road
Viyavihar (West)
Bombay - 400 086
Phone: 5131219/5136601

PIEZO BUZZER

ION Electronics, have introduced Model 2IPB35 solid state buzzer which emits a pulsating audio signal of 3 kilohertz at the rate of approximately 4 'beeps' per second.

This piezo buzzer measures 40mm in diameter and is provided with 120 mm long wires to connect the supply. They find application in practically all electronic systems and d.c. electrical panels. Typical examples are alarm clocks, telephone sets, gas, detectors, medical instruments, intercoms, timers etc.



For further information, please contact:

ION ELECTRICALS
307, Owners Industrial Estate
505, Gabrial Road, Mahim
Bombay-400 016
Phone: 468157

Flat Cables

Excel have come out with 'Henry Flat Cables'. Satisfying UL and CSA standards, these cables are generally available in 6 to 12 ways either in soft Copper alloy, with silver or gold plating and rated at 300V, 5A. Capable of operation in a temperature range of -45°C to 100°C, the cables can be used as jumpers for interconnections in electronics instruments, communication equipments, business machines and computers.



For details contact:

M/s. EXCEL ELECTRICALS.
C-4 Raj Mahal Apartment,
Caves Road, Jogeshwari (E),
Bombay-400 060.

TEMPERATURE DATA LOGGER

SCR's Temp. Data Logger is a microprocessor based system which accurately records the temperature (of 100 channels) at desired time intervals. The number of channels and the time interval can be programmed by means of a Key board/thumbwheel. The print out gives the time (real or elapsed), channel number and the corresponding temperature reading. This logger is available in different temperature ranges from -50°C to 1800°C with a digital linearised read out and print out having an accuracy of + 0.3%.



For further details, write to:

SCR ELEKTRONIKS,
Opp. Fatima High School
Kirof Road,
Vidyavihar (W),
Bombay-400 086.

NEW PRODUCTS • NEW PRODUCTS • NEW

DIGITAL MULTIMETER

MECO has just introduced the model MIC-6E Digital Multimeter which features a single knob operation for all functions.

It measures AC & DC currents from 200 μ A to 10 A with a min resolution of 0.1 mA, AC voltage upto 750 V and DC voltage upto 1000V, Resistance from 200 ohms to 20 megohms, diode checks and continuity tests.

It has an accuracy of 0.5% + 1 digit for DC Amps-Volt & Resistance measurements and 1% + 3 digit for AC Volt/Amp measurements. It can also measure temperature.



It is over load protected on all ranges except the 10A range. It has facilities for low battery indication and overload indications. It operates on a 9V cell with battery life in excess of 800 hours.

For further information,
MECO INSTRUMENTS
PVT LTD
Bharat Industrial Estate,
1, J. Road, Sewree,
Bombay 400 015.
Phones: 413-7423,
413-2435, 413-0747.

PROXIMITY SWITCHES

IEC offers a new line of inductive Proximity switches which are basically contactless limit switches. In all, they feature

applications like high speed counting. These sensors feature solid state circuitry with no moving parts, and their encapsulated construction makes them resistant to oils, acids, coolants, vibrations, etc.

Sensors are available in both AC and DC versions with sensing ranges from 5 to 20 mm. The AC version can be used to count upto 5 parts/sec while, the DC version can be used for upto 200 parts/sec.



For further information:
INDIAN ENGINEERING
COMPANY

Katara Mansion,
P.B. NO. 16551, Worli Naka,
Bombay 400 018.

CAR BURGLAR ALARM

"ADVANCE" has introduced a car Burglar Alarm. This solid state unit, is compact and hence can be fitted in any remote corner. It protects the doors, dicky bonnet & glove compartment, and also warns if the vehicle is started. It is designed for vehicle with 12V Dc electrical systems.



For Further Details contact
ADVANCE INDUSTRIES
11, Tinwala Bldg
Tribhuvan Road
Near Dreamland Cinema
Bombay 400 004.

POWER PUSH BUTTON SWITCH

Rajkumar engineers offer a new power push button switch incorporating the latest advances in switching technology.

The switch is rated at 5 amperes continuous load and has double pole single throw switching configuration.

The switch incorporates bimetal sandwiched contacts & for fail safe operations it has built in barriers for preventing electrical cross over.

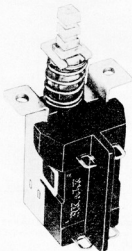

For further information:

Rajkumar Engineers
106, Bajsons Ind. Estate
Chakala Road,
Andheri (East)
Bombay 400 099, India.

DIGITAL FREQUENCY COUNTER VDC18

VDC18 is the smallest size ever made in India. Features include BATTERY OPERATION cum mains operation through adaptor, 7digit 0.5 inch LED display, 30 MHz frequency range, light weight, resolution



selection etc.etc. VDC18 incorporate latest L.S.I. circuitry. Model VDC19 has frequency range upto 500 MHz and PERIOD, FREQUENCY modes.

For details contact:

VASAVI ELECTRONICS
(Marketing Division)
630 Alkaram Trade Centre,
Raniganj
Secunderabad 500 003
Phone: 70995

PLASTIC INSTRUMENT BOX FOR BACK MOUNTING

"Comtech T-77" is an elegantly designed plastic moulded instrument box suitable for back mounted instruments such as Timers, & various other control instruments, having overall dimensions of 110 mm. l x 77mm W x 100 mm. B. It consists of a moulded box, a cover, & a MS plate for back mounting. The box has an inside space of 73 mm. x 71 mm. for various components. A six way terminal strip fixed at the top & bottom, in front of the box provides an easy access for the terminals. The cover can accommodate a PCB of 77 mm x 72 mm. from inside & has a 1.2 mm deep recess in front to take an Aluminium plate of 65 mm x 66 mm for control indications. The box offered in Black & Grey colour with either Glossy or Matt finish, is most suitable for small instruments to be mounted side by side from the back, like e.g., counters, controllers & timers etc.

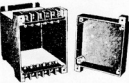

For further details contact
COMPONENT TECHNIQUE
8, Orion Apartment
29-A Lallubhai Park Road,
Andheri (West)
Bombay - 400 058



The Centre for Electronics Design and Technology (CEDT), is dedicated to training engineers as designers of electronic and electromechanical products.

CEDT offers a M.Tech. programme in Electronics Design and Technology which is a unique combination of courses in functional, industrial, mechanical, thermal, reliability, EMC and electrochemical aspects of electronic products. The courses are all highly design and laboratory oriented and give the students an intensive experience in all the processes involved in designing and developing a complete electronic product. Project management and documentation are an

essential part of the course which requires each student to develop one product to its production prototype level.

CEDT was set up in 1974, at the Indian Institute of Science, with active support from the Department of Electronics, Government of Switzerland and the University Grants Commission. The main areas of specialisation at the Centre are Instrumentation, Industrial Microprocessor Systems, Electromechanics, Power Electronics and Industrial Design. The Centre has established extensive facilities that enable the students to effectively translate a concept into a working model of the product. A number of pro-

ducts developed by the students have been produced and marketed.

The M.Tech. programme at CEDT will be of particular interest to aspiring product designers, potential entrepreneurs and sponsoring industries who wish to get a ready-to-production product along with a trained designer.

For details contact:
The Chairman,
Centre for Electronics
Design And Technology,
Indian Institute Of Science,
Bangalore - 560 012.

Don't miss the BUS

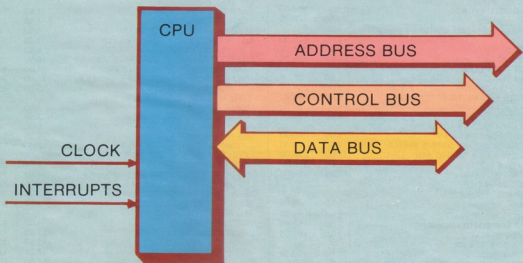

More and more industries are catching the Microprocessor BUS. From Mixers and Toys to highly sophisticated CNC Machines and Industrial Robots, a wide range of products can take advantage of the Microprocessor Technology.

If you too are switching over to Microprocessors, come to Dynalog Micro-Systems. We have the widest range of Microprocessor Development Systems and standard building block type circuit boards which can go into your products/systems as OEM parts. Write or call today and find out more about these products and their applications.

DMS

Dynalog Micro-Systems

14, Hanuman Terrace, Tara Temple Lane,
Lamington Road, Bombay 400 007

Tel: 362421, 353029

Telex: 011-71801 DYNA IN

Gram: ELMADEVICE