

40/41

Aug/Sept
1986

elektor

INDIA

Rs. 15.00

electronics

**Telecommunication
By Optical-Fibre**



Circuits Special 1986 - Over 100 Practical Designs

VASAVI's VLCR7 SAVES YOU FROM AGONY OF BRIDGES.



Measurement of **INDUCTANCE, CAPACITANCE, RESISTANCE** are greatly simplified by VLCR 7. No balancing, no adjustments. VLCR 7 gives you directly the digital reading of value and its loss factor simultaneously. VLCR 7 is the only instrument in India covering the widest ranges of 0.1 pf/uH/m ohm to 0.0001 ohm to 20,000 uf/200H/20 M ohm.

VASAVI OSCILLOSCOPES



Component tester in our oscilloscopes is altogether different from other's. In addition to all Oscilloscope functions component tester provision can test all components passive and active. In circuit and out of circuit. **ONLY OUR SCOPESCAN** recognise NPN/PNP. Distinguish HIGH/LOW Gain, Distinguish AUDIO, R.F., SWITCHING transistors.

DIGITAL FREQUENCY COUNTER VDC 18



Smallest size ever made in INDIA

Battery cum mains operated wide frequency range 30MHz
(our model VDC 18 has Basic sensitivity of 10mv
Bright LED display 7 digit

MULTI FUNCTION OSCILLATOR



- Pure Sine wave output.
- Amplitude settable with ease down to millivolts. X 1, X 1/10 and X 1/100 attenuated outputs available.
- No amplitude bounce when frequency varied.

VASAVI ELECTRONICS

(Marketing division)
630, Alkaram Trade Centre, Ranigunj
SECUNDERABAD-500 003.

ph: 70995
gms: VELSCOPE

Publisher: C R Chandarana

Editor: Srinidhe Iyer
Editorial Assistance: Ashok Dongre
General Manager: J. Dhruv
Advertising: B M Mehta
Production: C N Mahegar

Address:
ELEKTOR ELECTRONICS PVT LTD
52 C Preeto Road
Bombay 400007, India

Overseas editions

Glenopt Publishers Limited
Strand East, House, Bath Place
High Street, Barnet
London EN5 1ED
Editor: Ian Seymour

Elektaur BV
Peter Treckpoelstraal 2-4
6191 VK Beek - The Netherlands
Editor: P E L Kersemekers

Elektaur s.a.r.l.
Ronie Nelsonsle; La Senu, B.P 53
59270 Bellouf - France
Editors: D R S Meyer;
G C P Raedersdorf

Elektaur Verlag GmbH
Susterfeld-Strasse 25
100 Aachen - West Germany
Editor: E J A Krempelsauer

Elektaur EPE
Karaiskaki 74
16673 Voula - Athens - Greece
Editor: E Xenithous

Elektaur JCE
Via Rosellini 12
20124 Milano - Italy
Editor: D Fumagalli

Ferreira & Bento Lda
R D Estefina, 321º
1000 Lisboa - Portugal
Editor: Jorge Goncalves

Ingelek S.A.
Av Alfonso XIII, 141
Madrid 16 - Spain
Editor: A M Ferrer

International co-ordinating
& technical manager:
K S M Walraven

The Circuit is for domestic use only. The submission of designs or articles to Elektor India implies permission to the publishers to alter and translate the text and design and to use the contents in other Elektor publications and activities. The publishers cannot guarantee to return any material submitted to them. All drawings, photographs, printed circuit boards and articles published in Elektor India are copyright and may not be reproduced or translated in whole or part without prior written permission of the publishers. Russian products may appear in respect of circuits, devices, components etc. described in this magazine.

The publishers do not accept responsibility for failing to identify such patents or other protection.

Distributors:

Blaze Publishers & Distributors Pvt. Ltd.

Printed At
Tingto Offset
Bombay 400 013



Copyright © 1986 Elektaur B.V.
The Netherlands

- 21 News and Views
- 115 New Products
- 133 Switchboard
- 127 Appointments
- 127 Readers Services
- 138 Classified ads
- 138 Index of advertisers

ELECTRONICS TECHNOLOGY

- 40 Optical fibre network for office
- 52 Micro-electronics and Pharmaceuticals

PROJECTS

- Audio, music & sound generation**
- 100 audio-controlled mains switch
 - 9b digital volume control
 - 93 disco sound limiter
 - 42 four-tone siren
 - 64 guitar fuzz and
 - 24 high dynamic range mixer
 - 113 loudspeaker protection
 - 60 metal percussion generator
 - 102 microphone-signal processor
 - 103 mmu stereo amplifier
 - 80 noise gate
 - 55 quartz-controlled tuning fork
 - 91 speech processor with background suppression
 - 66 subwoofer filter
 - 38 telephone-bell simulator
 - 50 true class-B amplifier
 - 86 tuning AF power stages
 - 84 two-tone chime
 - 81 VIF bleeder

Cars & motor cycles

- 67 car buglar alarm
- 56 car fuse monitor
- 42 car lights monitor
- 76 car radio alarm
- 79 car radio alarm
- 97 courtesy light delay
- 32 halogen lamp protector
- 98 LED revolution counter
- 36 motor-cycle gear indicator

computers & microprocessors

- 68 8-bit ADC
- 85 8 bit DAC
- 110 40-track adaptor
- 46 270B alternatives
- 111 CPU gear-box
- 58 filtered connector
- 82 improved sound for the BBC micro
- 89 joystick adaptor
- 110 listen-in key for datarecorders
- 78 Mandelbrot graphics
- 45 PLA for Electron
- 94 sideways RAM for BBC and Electron Plus One

design ideas

- 65 analogue & digital
- 104 current drive for stepper motors
- 112 DC-operated 50 Hz timebase
- 70 electronic rotary switch
- 63 fest voltage controlled pulse generator
- 74 HCMOS VCO
- 114 mains zero crossing detector
- 90 programmable odour generator
- 47 smart LED selector
- 107 stepper motor control
- 26 symmetrical cascade oscillator
- 86 tuning AF power stages
- 64 two gate bistable
- 71 up / down clock generator
- 28 up / down counter control
- 31 voltage to-current converter

generators & oscillators

- 114 calibration generator
- 112 DC-operated 50 Hz timebase
- 63 laser voltage-controlled pulse generator

contents

- 74 HCMOS VCO
- 30 programmable odour generator
- 26 symmetrical cascade oscillator
- 71 up / down clock generator

hobby & games

- 73 alternating flasher
- 49 colour wheel
- 86 electronic toss-up
- 112 musical greeting cards
- 25 servo robot driver
- 44 SMD die
- 107 stepper motor control

homes & garden

- 61 call counter
- 80 deceptive lock
- 51 dessicator
- 92 electronic bell pull
- 37 industrial clock controller
- 108 jumbo dimmer
- 50 light sensitive switch
- 95 long-interval timer
- 65 mains based remote controller
- 30 remote control for light switches 1
- 30 remote control for light switches 2
- 58 random lights controller
- 35 rodent's deterrent
- 77 solid state dark room light
- 109 staircase light controller
- 75 super dimmer
- 38 telephone bell simulator
- 36 thermostat controlled soil heating
- 48 toilet ventilator control
- 84 two tone chime
- 68 versatile timer
- 39 watchdog

power supplies, battery chargers & ancillaries

- 57 battery guard
- 72 current indicator
- 56 direct-current monitor
- 67 electronic fuse
- 74 low drop voltage regulator
- 100 mains zero-crossing detector
- 100 NiCd battery charger
- 33 on-chip DC converter
- 83 simple NiCd charger
- 85 supply protection
- 90 switch-mode power supply
- 102 visible power on delay
- 101 voltage inverter

RF & Video

- 114 calibration generator
- 46 line bar generator
- 27 low noise aerial booster
- 72 narrow-band IF filter
- 84 RGB-to monochrome converter
- 43 S meter
- 62 SCART switch
- 59 synchronization separator
- 106 tunable active aerial for SW
- 32 tunable FM booster

test & measurement

- 54 heat beat monitor
- 46 line bar generator
- 103 pocket frequency meter
- 34 rms to-DC convertor
- 2 9 servo motor tester
- 43 S meter

SELEX-15

- I Measuring techniques
- III Loudspeakers
- VI Magnetic flux photograms
- VIII How does a transformer work?

Assembling P.C.B.s?

For instant bonding



use **FEVICOL-CYN**

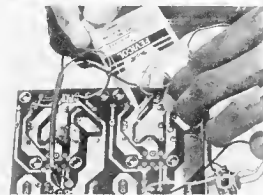

- Fixing large components on Printed Circuit Boards.
 - 1) To prevent breakage of soldered ends due to loads on the components.
 - 2) Prior to use of Wave soldering equipment.
- Fixing jumper wires to avoid hanging wires which could get pulled off.
- Fixing name/number identification tags.
- Repairing cracked P.C.B.s.



FEVICOL-CYN

bonds in 5-10 seconds.
It has high electrical insulating properties.

Stick with the best



FEVICOL

India's largest selling brand
of synthetic adhesives

For further details, contact

Parekh Marketing Pvt. Ltd.

Mafatal House, Backbay Reclamation, Bombay 400 020
Phone 632 31 48, Telex 011 5349 PDI IN, Gram FEVIFIX

* Both  and  and FEVICOL brand are the registered trademarks of Pidilite Ind Pvt Ltd

8088 XT MAIN BOARD
 BK EPROM EXPANDABLE
 TO 40K EPROM
 256K RAM ON BOARD
 8 EXPANSION SLOTS
 8088CPU WITH OPTIONAL 8087
 CO PROCESSOR

Looking for reliable consistent supplies to meet your marketing and production needs? Check us out! Our quality is consistently high, prices are competitive, and deliveries are quick and prompt. We'd like to tell you more about ourselves, so why not contact us today? Big and small orders are welcome!

COMPUTER PARTS,
 COMPONENTS AND C.K.D.
 AND S.K.D. TO MEET YOUR NEED

FLOPPY
 DISK DRIVE CARD
 CONTROL FOUR DS/DD
 DISK DRIVES
 EASY TO INSTALL

COLOR
 GRAPHICS CARD
 USED FOR COLOR
 MONOCHROME
 R G B AND BW MONITOR
 WITH VIDEO RCA AND
 R G B OUTPUT



Our Product Range:

- PCB Connectors (2.5mm min size, 2.54mm, 3.96mm)
- Terminals For Connector Use (M & F)
- Flat Cable (2-64 pins)
- D-Sub Connectors and Hoods (9, 15, 25, 37 pins)
- 57 Series Connectors (M & F)
- IDC Socket/Plug Connectors (16, 20, 26, 34, 40, 50 pins)
- IDC Card Edge Connectors (20, 26, 34, 40, 50 pins)
- 57 Multichannel IDC Connectors (M & F)
- 25 Pin Multichannel IDC Connectors (M & F)
- Cable Assemblies

For fully detailed information send your inquiry today!



立偉電子私營有限公司
Device Electronics Pte. Ltd.

Town Office 101 Kitchener Road #02-04 Jettan Linear Plaza Singapore 0620 Tel: 2986455 (6 Lines)
 Fax: 2988627 Telex: DEVICE RS 33250 Cable: DE-VTRONIC
 Factory 805B MacPherson Road #04-12 Cosmac Industrial Complex
 Singapore 1336 Tel: 2856455 (6 Lines)

1

mini stereo amplifier

This mini amplifier is based on the Thomson Type TEA2025. In this 16-pin DIL device hides a stereo amplifier that with a supply voltage of 9 V will provide 1 watt output per channel into a 4-ohm loudspeaker. At full output, the input sensitivity is about 25 mV_{PP}. If this is too sensitive, a resistor R may be connected between pin 6 and C₇ and between pin 11 and C₂. The sensitivity then becomes $(25 + \frac{1}{2}R)$ mV, provided $R > 1 \text{ k}\Omega$. Furthermore, the supply voltage may lie between 3 V and 12 V.

The operation of the IC cannot be discussed here, but for those interested its internal circuit diagram is reproduced in Fig. 1. One useful feature of the TEA2025 is that it has a soft-start circuit on board, thus obviating annoying pops in the loudspeaker at switch-on.

Construction of the amplifier is fairly simple, but has its peculiarities. First, there is the earth, which in this case should not be of wire, but rather consist of a metal earth plane (if you design your own PCB, this would be of copper). If at all possible, pins 4 and 5 as well as pins 12 and 13, should be connected to a (copper) area of not less than 5 cm². The two areas should be connected in a suitable manner, and in such a way that a heat sink is formed under the IC as shown in Fig. 2. This ensures both good heat conduction and a

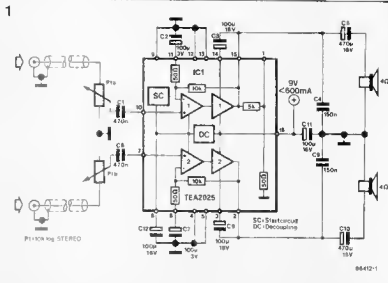

good earth. Moreover, all other connections should, of course, be kept as short as possible. This is particularly important in the case of the supply lines, which should be decoupled by C₁₁ as close as possible to the IC. The negative terminal of this capacitor should be soldered direct onto the earth plane; the positive terminal is soldered in the normal manner to pin 16. Finally, the distortion for a power output of about 0.25 W is roughly 0.3 per cent.

2

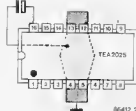

2

high dynamic range mixer

A mixer is expected to have low-noise and high dynamic performance. Most standard mixers use inverting operational amplifiers. Unfortunately, the noise figure of many opamps is poor, and opamps with a good noise figure are normally not suitable for operating with large signals.

The noise factor of standard circuits is often made even poorer because the source and amplifier are not properly matched.

The characteristics of a mixer can be greatly improved, therefore, by the use of buffers at the input stages, and

the constructing of operational amplifiers from good-quality transistors. This has been done in the accompanying circuit. The input is buffered by T₁ and T₂. The input impedance of T₁ can be ignored, so that the source merely needs to be matched with P₁.

The opamp is formed by transistors T₃ to T₆ incl. Good-quality RF transistors have been used in differential amplifier T₃-T₄-T₅. These transistors have a better noise figure at a greater bandwidth than AF types.

The proposed circuit has a frequency range (−3 dB points) of 10 Hz

to 80 kHz; third harmonic distortion of not more than 0.05 per cent at 10 kHz and an output voltage of 9 V_{PP}; and a signal-to-noise ratio of 100 dB.

The signal-to-noise ratio applies to an output signal of 9 V_{PP} with open-circuit input, and a bandwidth of 20 kHz. The maximum value of the output signal is about 12 V_{PP}, measured across a load impedance of 560 ohms. If the mixer is terminated by a higher impedance, the output voltage will be greater.

A further advantage of the circuit is that the popular valve sound may be

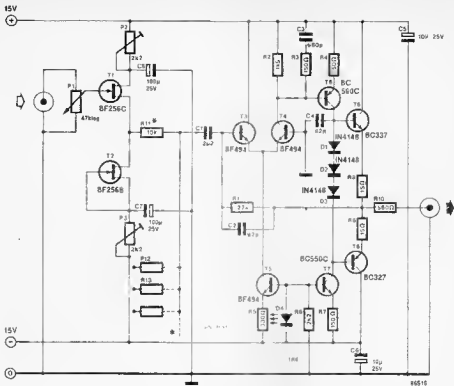

realized in a simple manner. To thus end it is necessary that T_1 and T_2 commence limiting at a slightly lower level, i.e. $1/2 V_{DP}$ input, than the composite opamp. The supply voltage of T_1 and T_2 must then be between $\pm 6V$ and $\pm 9V$. Since T_2 is connected as a current source, the exact

supply voltage can be set with the $2k2$ preset at the wanted clipping level.

If desired, the output off-set may be zeroed by inserting a 50 kilo-ohm preset in the base circuit of T_1 . This base should also be decoupled by a $1\mu F$, $63V$ capacitor.

The current consumption of the opamp is about $35mA$ and that of the buffer stages not more than $10mA$. If, therefore, ten buffer stages are used, the power supply should be capable of providing $150mA$ at $\pm 15V$ (B)

servo-robot driver | 3 |

Over the past few years, robotics and cybernetics have become new fields of interest for many an owner of a personal micro, equipped with the necessary add-on boards to effect peripheral control. However easy it may seem to write robot control programs and to build the associated computer hardware, the construction of accurately operating mechanical parts (or, if you like, limbs) often poses unsurmountable problems, since a miniature set of gears, ball bearings, spindles and cog-wheels are in no way readily made items for those skilled in programming and soldering.

Despite their limitations as to precision of movement, servo-motors

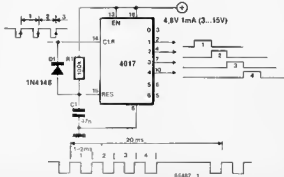



used in model aircraft or boat construction may offer an interesting alternative to more complicated mechanical constructions; applications such as robot arms and sorting machines can be made quite easily with the use of cleverly mounted servo-motors. An example is shown in the photograph; a simple robot which is able to walk a few steps before falling to the ground. Four computer-controlled servos have been fitted on the joints.

The servo control circuit for this staggering little creature is driven with a single computer output signal. A number of wait loops need to be programmed to supply active low ($\bar{0}$) pulses lasting about 0.5 ms, while the interval length between the first and second pulse determines the position of servo 1, while servo 2 is positioned by means of the interval between the second and third pulse, and so on. The repeat rate of the control process should be about 50 Hz

(20 ms); see the inset timing diagram. The synchronization interval is generated with D:R1-C1, which reset the Type 4017 counter when no negative pulse has been received for about 3 ms. The control inputs of the servo-motors may be connected direct to the counter outputs

4 symmetrical cascode oscillator

by R Shankar

Free running as well as crystal controlled clock generators in many digital designs are most frequently based upon the use of one or more inverter gates. However easy it may seem to use these devices for the construction of reliable oscillators, the resultant frequency stability is generally not such as might be expected from a look at the relevant quartz crystal data, and this is mainly on account of the rather poorly defined capacitive and/or inductive loading of the crystal at resonance. Stability, however, may be improved by a factor 3 to 5 by using cascode type inverters in a symmetrical configuration, as can be seen in the accompanying circuit diagram. Two sets of two n- and p-channel MOSFETs, contained in the Type 4007UB IC, have been connected to form a highly stable oscillator circuit capable of operation at frequencies up to 10 MHz, as determined by quartz crystal X_1 , which should be a series resonant type.

As the output impedance of the proposed cascode oscillator is relatively high, buffer stage T_1 has been added to minimize drift with low impedance loads such as (LS)TTL circuits. Furthermore, MOSFET T_1 ensures well-defined logic high and low levels to interface with (HC)MOS and (LS)TTL.

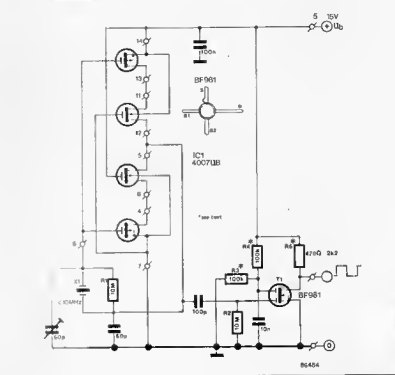

The values of R_4 and R_3 depend on the supply voltage level (U_0), while the voltage at gate 2 should be between 4 and 6 V to achieve a 5 V out-

put level swing. In case the oscillator is to operate from a 5 V supply, gate 2 of T_1 must be connected direct to $+U_0$. (B)

low noise aerial booster

5

After having read the design essentials relevant to wideband amplifiers, RF filtering, intermodulation/cross-modulation characteristics, etc., as given in the articles listed at the end of this article, there would seem to be little need for us to dwell on functional and electrical aspects of the present ultra low-noise, wideband preamplifier incorporating the wonderful Type BFG65 transistor, which, although already introduced in [3], deserves to be put in the RF limelight as it offers an exceptionally low noise figure at more than satisfactory strong signal response, thanks to the relatively high collector current ($F_{dB} = 0.8 \text{ dB}$ at 5 mA, for instance).

Since the important points to observe in RF construction have been covered in [1] and [2], the large earth plane on the component side of the ready-made PCB Type 86504 need not cause any wonder; all parts are soldered direct onto the relevant copper fields; the holes merely serve to aid in locating the parts correctly. The hole for T_1 should be drilled to dia 5 mm for the transistor to be seated and soldered with the shortest possible lead length.

Additional holes have been provided to enable the input and output coax cables to be secured by means of

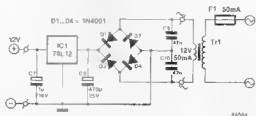
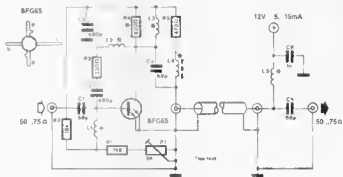

Parts list

Resistors

- $R_1 = 1k\Omega$
- $R_2 = 18k\Omega$
- $R_3 = 330\Omega$
- $R_4 = 820\Omega$
- $R_5 = 470\Omega$
- $P_1 = 5k$ preset

Capacitors

- $C_1, C_4, C_5 = 68pF$
- $C_2, C_3 = 680pF$
- $C_6 = 1nF$
- $C_7 = 1\mu F, 16V$, electrolytic
- $C_8 = 470\mu F, 25V$, electrolytic
- $C_9, C_{10} = 47nF$

Semiconductors

- $D_1, D_4 = 1N4001$
- $IC_1 = 78L12$
- $T_1 = BFG65$ (Philips 'Mullard')

Miscellaneous

- $L_1, L_2 =$ see text
- $T_1 = 12V, 50mA$
- $F_1 = 50mA$, fast
- PCB Type 86405
- 4 soldering pins.

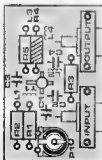
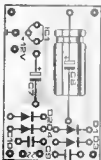

screw-on clamps, although soldering screen and core should also be possible.

It is seen that the ready-made PCB consists of an RF and a supply section, which may have to be separated by cutting if it is desirable to fit the units at different locations, as is the case with a masthead mounted amplifier and the supply located at the nearest mains outlet, e.g. on the attic. On the other hand, if it is more convenient to cut the downlead cable immediately as it appears indoors, amplifier and supply may be left to form one unit for insertion in the coax cable. As in that case the amplifier may be fed direct rather than via the coax cable core, L₄, L₅, C₃ and C₄ are rendered unnecessary and may be removed; the free lead of R₅ should then be

connected to the +12 V terminal on the supply section of the board. The optimum collector current for T₁ is adjusted by means of P₁, which should be set for a value between 5 and 7 mA if the amplifier is to handle relatively weak signals, such as may be received in fringe areas. The indicated collector current corresponds to 2.3 to 3 V voltage drop across R₄; higher values (10 to 15 mA; 4.6 to 6.1 V respectively) should be set when receiving two or more strong (local) transmissions in the 80...800 MHz band.

If masthead-mounted, the amplifier should be fitted in a waterproof enclosure, carefully treated with silicone spray to preclude corrosion of the solder contacts. Finally, the coils are wound as

follows, using dia 0.3 mm (30 SWG) enamelled copper wire:

- L₁: 8 turns, closewound, internal dia 3 mm.
- L₂: 4 turns, closewound, internal dia 3 mm.
- L₃: 5 turns on R₄.
- L₄, L₅: 4 turns through 3 mm ferrite bead.

Literature references

- (1) VHF filters
(E.I. April 1986, p. 4 28)
- (2) VHF amplifier
(E.I. May 1986, p. 5 32)
- (3) Wide band amplifier for satellite TV receivers
(E.I. May 1986, p. 5 48)

6 UP/DOWN counter control

by R v Linden

The up/down binary- or BCD-mode counter is a regularly spotted item in digital circuits of various levels of complexity. The up/down counter simply does what its name indicates; it counts up or down, depending on the logic level applied at the relevant control input, and activates the corresponding output bit pattern at every pulse transition detected at the chip's clock input.

This circuit simplifies the control of up/down counters in that it allows the user to press one button to increment the counter output state, while another decrements it. Each of the changeover type buttons is connected to a two-gate debouncer/bistable (N₁-N₂ and N₃-N₄), which supplies a low pulse at its output when the relevant button is pressed. N₅, which serves as an OR gate, receives the debouncer pulses and, together with N₆, provides the output clock pulse to the up/down counter.

Bistable N₇-N₈ keeps track of the selected count mode, and provides the relevant logic level to the up/down counter input. It should be noted that the logic level designation of the up/down input to the counter chip may differ from type to type; it may therefore be necessary to interchange the UP and DOWN keys.

The use of counter chips changing output state on the negative clock transition is to be preferred for use with the suggested circuit, since bistable N₇-N₈ toggles coincidentally with the positive clock pulse tran-

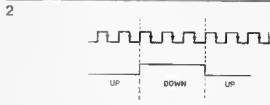
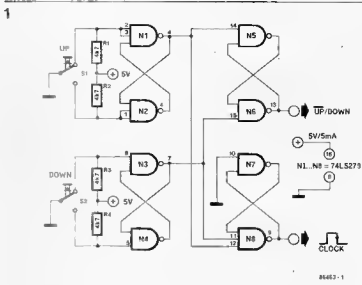

sition (see Fig. 2). However a minor disadvantage of the use of negative-edge clocked up/down counters lies in the fact that the circuit acts upon release rather than depression of the UP and DOWN buttons. Finally, the use of the Type 74LS279 is

in no way compulsory; a combination of other types of TTL IC incorporating the necessary NAND gates should work equally well, but note the three-input NAND gate N₇.

K'W

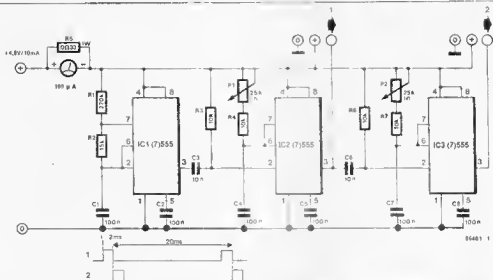

This circuit is of interest to two categories of readers; first, model aircraft/boat/train enthusiasts objecting to having to leave their radio control transmitter switched on for extended periods in order that a servo-motor and associated mechanical parts can be made to function as desired; secondly, constructors of computer-controlled robots incorporating servo-motors. The latter field of interest is a typical combination of mechanics and electronics plus software, and it is sometimes urgently required to be able to keep them apart as the specific parts of the robot have been prepared for testing, which, arguably, should be possible to do without having to write special programs to this end on the computer.

The proposed servo-motor test unit is, as can be seen from the circuit diagram, a downright simple design based on the use of Type 555 or 7555 timer chips connected in a cascade arrangement which can be expanded further to drive more than two servos at a time, if desired; it is readily seen that the second and third stages of the circuit are identical.

The first timer, IC₁, serves as an astable multivibrator whose output pulse period time is determined with $T = 0.693(R_1 + R_2)C_1$. The indicated values for the relevant timing parts therefore provide a pulse period time of about 20 ms at pin 3 of IC₁. The rising edge of this square wave

triggers monostable IC₂, whose output pulse width may be set with P₁; the given series connection of P₁ and R₄ ensures a large enough pulse width range for most types of servo-motor, which typically require activation pulse widths of the order of 1...2 ms.

The second servo control stage is identical to the set-up around IC₂, and up to eight triggered 555 stages, each with its own pulse width control, may be cascaded in this way. It is suggested to fit each of the servo control potentiometers with a simple scale in order to have a relative indication regarding the motor's lateral or angular position.

The ammeter in series with the

positive supply line offers an indication about the total current consumption of the servos, and it is thus readily detected when one or more have got stuck in their movement. The test circuit itself does not contribute much to the total current consumption indicated on the meter, some 3 mA is required for each Type 555 timer in the row, while the use of low power Type 7555 equivalents should reduce this figure even further. It is, therefore, perfectly feasible to make the tester into a portable, battery-operated unit, powered by four penlight type NiCd batteries.

(W)



8

remote control for light switches — 1

We all sometimes wish that some of the switches around the home were just a little easier to locate and operate, notably so in the dark and with less frequently used light switches, such as those for the cellar or garage light. For the physically handicapped, some switch locations present a real hindrance to their mobility in the home; for them, it would be very convenient to be able to operate the switch from a distance. The proposed wireless control system differs from, say, an IR-based set-up in that it requires no line-of-sight path between transmitter and relevant receiver, while the practicable operating range is of the order of a few metres.

The circuit diagram of the control transmitter shows an oscillator composed of T_1 , T_2 and T_3 , the latter transistor merely functioning as a switching device. The oscillator frequency is set at about 30 kHz by means of C_5 , C_6 and L_1 ; the latter consists of about 200 turns of 36 SWG (\varnothing 0.3 mm) enamelled copper wire on a paxolin former to suit the diameter of 10 to 20 cm long ferrite rod, which may be salvaged from a discarded MW/LW pocket radio. The tap on the coil is made at 20 turns from the earth connection.

In order to compensate for the relatively low radiation efficiency of the

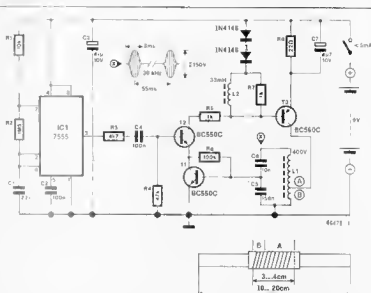

proposed transmitter aerial, the peak pulse voltage across C_4 amounts to some 150 V_{pp} when the oscillator is turned on for 8 ms by T_2 , which is driven with an 18 Hz signal from IC1. The pulsed mode operation of the oscillator ensures a relatively low mean power consumption of the battery-operated transmitter when a receiver unit is to be activated. Testing the transmitter is readily

done with a scope; observe the pulsed 30 kHz carrier, which should look as indicated by the inset signal waveform drawing; the pulse-on time of 8 ms is determined by C_4 - R_7 , and their values had better not be changed, since they are the optimum compromise between transmitter current consumption and output power. (B)

9

remote control for light switches — 2

Just like the associated hand-held transmitter (see previous article), the receiver is simple to construct.

As can be seen from the circuit diagram, parallel tuned circuit L_1 - C_1 receives the transmitter signal, which is first buffered by means of a dual gate MOSFET — T_1 — in order to prevent excessive loading of the tuned circuit. Further amplification is performed by T_2 , before rectifier circuit D_1 - C_2 can provide a pulsating voltage to T_3 , which drives PLL detector IC1, with a sawtooth-like signal. The lock output — pin 8 — of IC1, controls Re , via relay driver circuit T_4 - T_5 .

As to a few details concerning the receiver circuit, the PLL chip signals

the lock condition by pulling pin 8 low: C_{14} is charged and functions as a buffer device in case the PLL input voltage disappears because of the fact that the transmitter coil is no longer held steady for optimum reception (directive effect of the ferrite rod). At the receiver input, R_1 should be mounted direct at the relevant MOSFET gate so as to prevent possible oscillation tendency of T_1 . Like the transmitter coil, L_1 is wound on a 4 cm long paxolin former, which can be slid over the ferrite rod to find the position that gives optimum reception. Use 210 turns of 36 SWG (\varnothing 0.2 mm) enamelled copper wire; the coil length should be about 3 cm.

L_1 and L_2 should be separated from each other with a metal screen to preclude stray coupling.

The receiver is readily tested and adjusted by placing an operative transmitter at a distance of about 4 metres. The optimum position of the coil on the ferrite rod can now be found by connecting a scope to the drain of T_1 and sliding L_1 for maximum received signal. In the absence of an oscilloscope, the signal at the PLL input (pin 3) may be connected to a loudspeaker to position L_1 for maximum voice coil movement at 18 Hz. After it has been positioned correctly, L_1 may be glued into place on the rod.

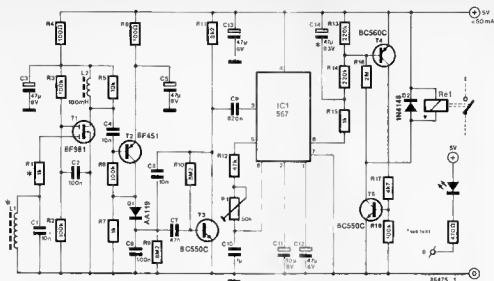

Adjusting the PLL is done with P_4 , which should be turned carefully across its travel to establish the points at which the PLL fails to lock on the incoming signal (Re_1 is deactivated and the lock indication LED, if fitted,

goes out). Now set P_1 to the position in between the no-lock points. Carefully manoeuvre the transmitter to a place where reception is worse, i.e. where Re_1 is observed to go off. Careful adjustment of P_1 and further

trial and error will enable the user to establish the preset position that corresponds to optimum receiver sensitivity and reliability under less than favourable circumstances. (B)

voltage-to-current converter | 10 |

The converter proposed here (also called voltage-controlled current source) is based on just one opamp, and provides to, or draws from, ground a current that is dependent on its input voltage. The unit can convert negative as well as positive voltages into negative currents (from ground) and positive currents (into ground) respectively.

When a Type 741 or CA3140 is used in the A_1 position, $R_v = 1k$, and $R = 10k$, $U_m = \pm 10V$ max.; $I_{out} = \pm 20mA$ max.; and $g_m = -1mS$. It is, of course, possible to change any or all of these values as required by using a different opamp and altering the values of the resistors. The maximum output current is always dependent on the opamp used. To make such changes, the following formulas may prove useful.

$$U^+ = U^- = -(U_m - U_{out})/2 + U_{out}$$

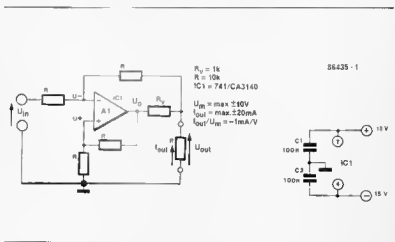

$$U_0 = 2[(U_m - U_{out})/2 + U_{out}] = U_m + U_{out}$$

$$I_{fv} = U_m/R_v$$

$$I_{out} = I_{fv} + I_R = U_m/R_v + (U_m - U_{out})/2R$$

If $R \gg R_v$ (the usual case),

$$I_{out} = U_m/R_v.$$

(S)

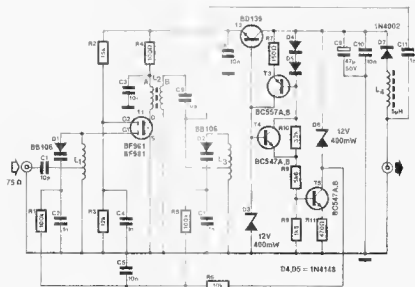

This FM band (88-108 MHz) preamplifier has been designed to come round the problems associated with wideband as well as narrowband aerial boosters. Most commercially available boosters are wideband types with relatively poor selectivity and adjacent station rejection, while the (more expensive) narrowband types are rather impracticable when it comes to receiving stations well removed from the (fixed) frequency of peak amplification.

This proposed design is the best of both worlds, since it features good selectivity and strong signal handling, as well as a relatively low noise figure and sufficient amplification over the entire FM band. Tuning the preamplifier is done in the living room, by means of a simple potentiometer mounted in an enclosure which is conveniently located next to the FM tuner as part of the hi-fi set. The unit can also be made to function as a 2 metres amateur band (144-146 MHz) preamplifier by modifying the tuned circuits to suit the higher frequency.

The circuit diagram of the tuneable

booster—Fig. 1—shows that two remote tuned circuits, along with a MOSFET tetrode have been incorporated to minimize the chances of running into cross- and/or inter-modulation caused by strong local signals. Vancap diodes D_1 and D_2 form the variable capacitance to coils L_1 and L_2 respectively. The tuned circuits are set to the desired frequency by means of the voltage applied to the vancap diodes (3 to 24 V. reverse bias). The RF gain offered by T_1 should be of the order of 25 dB, while the noise figure is expected to be about 2 dB.

The amplifier supply/tuning voltage and superimposed RF output signal are connected to the coax cable core which is run to the power supply/tuning unit, shown in Fig. 2. Tuning control potentiometer P_1 constitutes the feedback loop to the voltage regulator composed of T_2 , T_3 and T_4 . Turning P_1 thus varies the voltage to the mast-mounted booster from 15 to 36 volts. Regulator T_2 - T_3 - T_4 (Fig. 1) provides MOSFET T_1 with a fixed voltage of 11.4 V, irrespective of the DC level on the coax core. Subtrac-

tion of 12 V from the 15-36 V input voltage is by means of zener D_5 and current source T_5 . RF output voltage and DC supply are coupled to the download cable through C_{11} and L_4 respectively. C_{11} and L_4 (Fig. 2) have the same function in the PSU. D_{13} prevents the PSU output voltage from rising above 37 V in case of any breakdown in the supply unit, while D_7 protects the booster from accepting a reverse voltage in case coax core and screen are accidentally reversed. T_6 limits the supply short circuit current to a safe 80 mA.

The following are important points to observe in constructing the mast-head amplifier and associated indoor control unit:

1. Use a copper-clad board of maximum earth plane surface
2. Mount a metal screen across the MOSFET case to suppress any tendency to parasitic oscillation.
3. Keep the source lead as short as possible; solder it direct to the copper surface
4. Keep the leads of G_2 decoupling capacitor C_2 as short as possible; a

ceramic disc capacitor is ideal for this purpose.

5. Keep all coil connections as short as possible to avoid amplifier tuning over the wrong frequency range.

6. Fit T_3 with a small heatsink.

7. Mount a screen between amplifier and DC supply section.

After the construction of RF head and PSU has been completed, the latter is tested by verifying the presence of the variable (15.6 to 36.6 V) supply and tuning voltage on the coax cable core. The voltage across R_{14} should be lower than 0.4 V with the amplifier connected at the far end of the cable. Turning P_1 should cause the voltage at the collector of T_3 to vary between 3 and 24 V.

The voltage at the emitter of T_2 should be constant at 11.4 V with respect to ground, irrespective of the tuning voltage set with P_1 . Drain resistor R_4 should drop between 0.7 and 2 V. Set P_1 to the centre of its travel.

Optimum RF performance of the booster can be achieved by carefully stretching or compressing L_3 for maximum amplification at about 95 MHz; tune the receiver to a weak transmission at this frequency and align for maximum S meter deflection or optimum audibility of the signal above the noise level. Do the same for signals at either extreme end of the band and set P_1 accord-

2

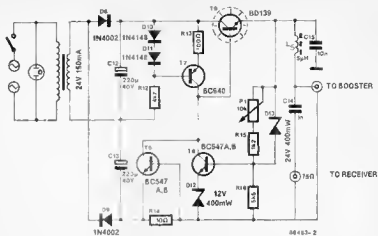

ingly. Ensure that the tuning potentiometer can be set to give optimum amplification for every frequency in the 88 to 108 MHz band and mark the tuning scale on the indoor unit in steps of 1 MHz. In case it is not possible to obtain equal amplification across the band, L_3 may be adapted carefully by increasing or decreasing the number of turns. The tap, however, should remain at 3 turns from ground. Those constructors striving for utmost perfection may fit a 40 pF trimmer capacitor instead of C_{13} in order that the amplifier may be tuned

for optimum (i.e. lowest) noise figure, which is **not** the same as tuning for optimum amplification.

Finally, the coil data for the tuneable booster are as follows:

$L_1 = 9$ turns 22 SWG (0.7 mm dia) enamelled wire, close wound, coil diameter 7 mm. Tap at 1 turn from ground

$L_2 =$ the same, tap at 3 turns from earth.

$L_{2a}, L_{2b} = 6$ and 3 turns respectively, 26 SWG (0.5 mm dia) enamelled copper wire on dia 10 mm ferrite ring Type T37-12. (B)

one-chip DC converter

This DC step-up circuit may prove useful for the incorporation in equipment that requires the presence of a supply voltage in excess of the normal circuit supply rail of, for instance, +5 V. Ideal therefore for generating the necessary +8...12 V voltage to feed RS232 transmitter devices, or the +25 V programming voltage for EPROMs, the Type L497 DC converter requires very few additional passive parts to produce any of the output voltages listed in the table below.

As to the components in support of the converter chip, note L_1 , which is a small coil, readily made by winding about 85 turns of 34 SWG (ϕ 0.2 mm) enamelled copper wire on a small (11x7 mm) pot core having an A_l rating of 160, eg the Siemens Type 6531-L160-A48. The total inductance

of L_1 should be of the order of 100 μ H. Resistor R must be dimensioned as indicated in the table for any of the no-load output voltages. Note that the voltage across R_1 is fixed at 1.2 V, and that the value of R may therefore be computed from

$$R_1 = (V_{out} - 1.2) / I_2 < k\Omega$$

Finally, the output current may, of course, be boosted by means of a medium power transistor in a suitable configuration at the V_o output. HS

V_o	I_2	$m(A)$	$R \nabla$
5	10	125	8.8
5	15	80	13.8
5	20	60	18.8
5	25	50	23.8

∇ Specifies no load output voltage

∇ Theoretical value

select nearest E12 or E24 value

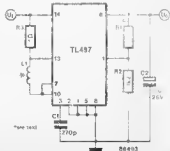

13

rms-to-DC converter

For some obscure reason, establishing the root-mean-square (rms) value of an alternating voltage seems to be among the least familiar procedures for many an electronics hobbyist; measuring the alternating voltage may be easy, but deciding on the relevant unit expressing quantity — rms, mean, or peak-to-peak value — is quite another matter.

Since the rms value of an alternating voltage is the most frequently used of the above mentioned three, some convenient means of obtaining that value without calculations may be of interest in practical measuring techniques.

The rms value of an alternating voltage U across a resistor R equals the direct voltage causing the same dissipation level in R .

Example: a 50% duty factor, 1V_{pp} rectangular voltage across a resistor R . Find the rms level of this voltage. The mean dissipation in R , caused by this periodic signal equals

$$\frac{1}{2} (U_{pp})^2 / R = 1 / (2R) \quad [W]$$

The direct voltage causing the same dissipation has a level of

$$\frac{1}{2} I^2 R = 1 / (2R) \quad [W]$$

This is also the conversion factor for obtaining the rms value from the peak-to-peak value, since

$$U_{rms} = \frac{1}{2} U_{pp} \approx \frac{1}{2} I^2 R \approx 0.71 U_{pp} [V]$$

therefore $U_{pp} \approx 1.41 U_{rms}$ in this example.

1

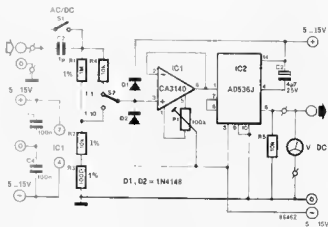

Although moving coil meters measure the mean value of the rectified (pulsating) input voltage, they are calibrated in terms of rms voltages. Therefore, the calibration is only valid for sinusoidal voltages.

The proposed rms-to-DC converter is a relatively simple circuit as it incorporates a dedicated chip, the Type AD536 by Analog Devices. Alternating voltages applied to input terminal 1 are proportionally converted into a direct output current, which causes a direct output voltage across an internal 25 kohms precision resistor; a buffer opamp then the

direct voltage equivalent (i.e. rms value) of the input alternating voltage. IC₁ functions as an input buffer in view of the relatively low input impedance of the rms converter chip. The maximum permissible peak-to-peak value of the input voltage to the Type AD536 equals the symmetrical supply voltage level; D₁ and D₂ have been added to protect IC₁ against accepting input voltage levels in excess of the ± supply voltage. S₂ functions as a x1/x10 input attenuation selector to enable high voltage measurements; the function of S₁ is to block any DC components in the

2

Parts list

Resistors

- R₁: 1M, 1%
- R₂: 10k, 1%
- R₃: 100Ω, 1%
- R₄, R₅: 10k
- R₆: 100k preset

Capacitors

- C₁: 4.7μ 25 V electrolytic
- C₂: 1μ, MKT
- C₃: C₄: 100n

Semiconductors

- D₁, D₂: 1N4148
- IC₁: CA3140
- IC₂: AD536J

Miscellaneous

- S₁: miniature switch
- S₂: toggle switch
- PCB Type: 86462

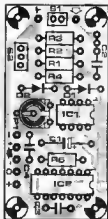

input signal to the converter. It is useful to realize that the rms value of a composite (AC+DC) signal is calculated from

$$U_{rms} = \sqrt{U_{DC}^2 + U_{AC}^2}$$

Pre-set P1 should be turned to obtain 0 V with respect to ground at ter-

munal 6 of IC₂ with no input signal applied and S₂ set to the x1 position. The converter achieves an accuracy of 1% for input voltage levels lower than 100 mV and input frequencies up to about 6 kHz. For signals up to 1 V, the bandwidth is expected to be

of the order of 40 kHz, while 100 kHz may be attained with input voltages above the 1 V level. Current consumption of the circuit is about 5 mA. (TW)

rodents deterrent | 14 |

There are a number of well-founded arguments against the use of poison to get rid of mice, rats and other rodents in and around the home. From an ecological point of view, the undesirable side effects are mainly the disturbance of the natural food chain of animals we do not wish any harm whatsoever; most poisonous substances devised to exterminate mice are, unfortunately, quite difficult to break down compounds, which may, in the end, become manifest as dangerous to our own health.

The ecologically accepted method of getting rid of a population of mice is, therefore, based on the controlled introduction of such predators as cats and owls, causing a high degree of stress on part of the mice, which are then quite quick to leave the relevant premises or area.

Another method of bringing about a high degree of stress is to produce a high-pitch, frequency-swept signal just above the audible range for human beings. The signal is swept rather than of constant frequency in order to prevent mice from becoming immune to the sound.

The proposed rodents deterrent is based upon the Type 555 timer chip, which is configured to produce a 20 to 40 kHz output signal, swept at a 50 Hz rate. The latter frequency is obtained from the mains by means of C₄ and R₃, which pass the modulating signal to input pin 5. The output of the swept oscillator is connected direct to a high-efficiency piezo-ceramic horn tweeter, which

ensures a sufficiently high sound pressure level to keep rodents out of reasonably sized areas, such as attics and garages.

The completed rodents deterrent circuit, along with the tweeter, may be mounted in a simple ABS enclosure, but care should be taken to observe the directivity of the loudspeaker when fitting the unit in its final position. (TW)

Parts list

Resistors

R1 = 1 k
R2, R3 = 15 k

Capacitors

C1 = 1 n
C2 = 1µ; 16 V electrolytic
C3 = 10 n
C4 = 220 n
C5 = 100µ; 16 V electrolytic

Semiconductors

D1 D4 = 1N4001
IC1 = 555

Miscellaneous

Tr1 = 6 V, 200 mA
TD1 = piezo horn tweeter.
F1 = 50 mA, fuse, slow
Fuseholder, PCB type, for F1
PCB Type 86190
ABS enclosure for wall mounting

1

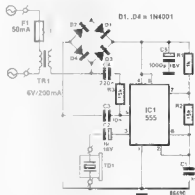

2

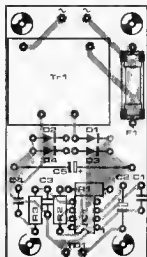

15 thermostat-controlled soil heating

Many people with a keen interest in growing plants insist on the fact that many of the more exotic species, such as certain species of orchid and fungi, will only thrive in warm soil and relatively high humidity.

Whether or not this is a correct assumption, this circuit offers the possibility to keep the soil temperature in a miniature hot-house at a constant, adjustable level.

The heating element is made of several loops of plastic covered steel wire, such as used in gardening. The wire used in the prototype had a diameter of 1 mm and a resistivity of about 0.2 Ω per metre.

The circuit diagram of the soil heater shows that the heating element is temperature controlled by means of a triac, driven by a Type TDA1024 electronic thermostat which gets the necessary information as to the soil temperature from R_s , an NTC type sensor.

The circuit is fed from the transformer secondary by means of rectifier D_1 and series resistor R_1 . Regulation at 6.5 V is internal to the IC, and C_1 smooths this voltage. R_2 and R_4 provide the IC with a mains synchronizing signal, while C_2 causes a controlled phase shift in order that the relatively low operating voltage can still ensure the correct zero-crossing synchronization.

The temperature sensor circuit is composed of R_s , R_3 , and P_1 . The sensor proper, R_s , must be placed into the soil at a suitable position,

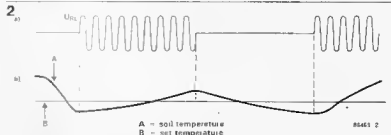
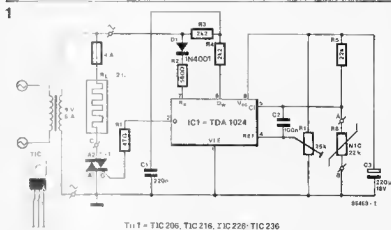

electrically well isolated, of course. The optimum soil temperature, which should be established by trial and error, is adjustable with preset P_1 ; Fig 2 shows the correlation between soil temperature, heating element voltage, and preset temperature.

If necessary, a more powerful

heating element may be dug into the soil, but the ratings of the fuse, T_1 , and T_2 should then be changed accordingly. The transformer secondary voltage, however, should remain at 9 V. With the components as indicated in the circuit diagram, the heating energy is about 40 watts

(Sv)

16 motor-cycle gear indicator

This circuit provides motor-cycle riders with a gear indication to the foot-operated lever at one side of the engine block. The proposed indication unit will be appreciated by those riders in the habit of forgetting which gear they have selected when attempting to drive off at traffic lights or crossroads and finding that the engine stalls because it had been switched to second gear.

The circuit as shown is based on the use of two gear-lever operated,

plunger or roller type microswitches, along with the neutral gear indication lamp, which is a standard item on most types of modern motor-cycle. Bistables N_1 , N_2 and N_3 , N_4 serve as debouncer circuits for microswitches S_1 (lever down) and S_2 (lever up). If either one switch is actuated, N_4 or N_5 will cause bistable N_2 , N_3 to be set or reset; counter ICs counts up ($U/D = 1$) or down ($U/D = 0$) as a result of actuating S_2 or S_1 respectively. On release of the relevant

microswitch, AND simulator D_1 , D_2 , R_5 supplies ICs with a clock pulse, incrementing or decrementing the gear readout composed of ICs and the indication-panel mounted 7-segment LED display. Input pin 5 of gate N_6 may be wired to point A, B, or C to suit 4-, 6-, or 5-gear types of motor-cycle respectively. N_6 inhibits OR gate N_5 from supplying further clock pulses if S_2 is operated when driving in top gear. N_6 and N_7 have the same function

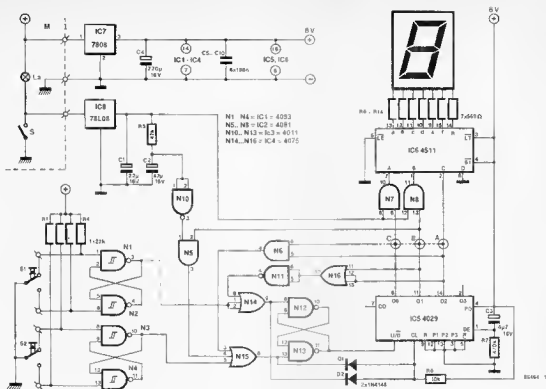

for the bottom gear, preventing the counter from decrementing the display reading at gearing up from neutral to 1.

If the neutral switch — S — is closed, IC₈ supplies the A and B inputs of IC₅ with logic low levels; the level at the C input need not be forced low, since the neutral gear is in between

first and second, both of which positions cause the most significant bit — C — to be low anyway

Parts R₅-C₂-N₁₀-N₅ have been included to prevent an erroneous display reading at gearing down from 2 to neutral and up again; for two seconds, N₅ is disabled from clocking IC₅, so that the lever-up pulse is

not detected.

At power on, R₁ and C₃ preset counter IC₅ to state 1.

In conclusion, it goes without saying that S₁ and S₂ should be good quality microswitches, sealed against moisture and dirt. (R)

industrial-clock controller

17

Nowadays, most clocks and watches are quartz controlled and, therefore, accurate to within a few seconds a year. Older type electric clocks, particularly those used in large groups in warehouses, department stores, factories, railway stations, and so on, were centrally controlled and synchronized. This synchronization was effected by pulses derived from the mains and sent to each clock via a separate cable network. Many people have such a clock as a curiosity, but have not the means of driving it. The circuit described here will help...

With reference to the diagram, pulse shaper T₁ triggers monostable IC₂ at the mains frequency of 50 Hz.



Counter IC₅ is reset automatically after every 3000 pulses by IC₄ and T₂.

At the same time, bistable IC₃ toggles and causes the bridge circuit composed of T₂...T₁ to reverse the motor polarity every 60 seconds.

Depending on the type of clock you have, the transformer secondary voltage may have to be selected to supply about 0.7 times the normal operating voltage of the clock motor. Furthermore, the bridge circuit as shown should not be made to operate at voltages in excess of 30 V, while the maximum current is about 250 mA.

There is only one adjustment point in the circuit, namely P₁, which should be set to achieve maximum suppression of mains borne noise; if this can not be checked, the preset may

be turned to its centre position. Should the clock be slow, P_1 may be adjusted to give a slightly lower

resistance, but care should be taken to avoid setting a monostable time longer than 20 ms, as in that case

only half the number of 50 Hz periods can reach the counter. (Sg)

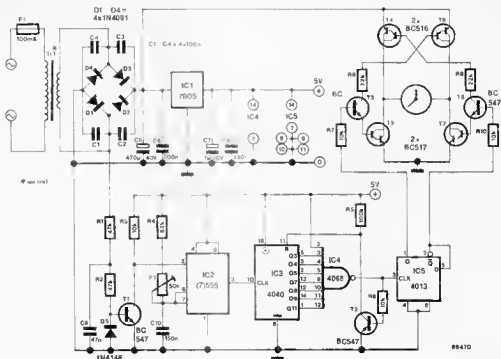

18

telephone-bell simulator

Alan G Hobbs

This circuit is intended for use in a small private telephone installation. The ringing tone sequence is 400 ms on, 200 ms off, 400 ms on, 2 s off.

In the accompanying diagram, N_1 and N_2 form an oscillator that operates at a frequency of 5 Hz, which gives a period of 200 ms. The oscillator signal is fed to two decade scalars, which are connected in such a manner (by N_1 and N_2) that the input signal is divided by 15.

The second input of N_4 may be used to switch the divider on and off by logic levels. If this facility is not used, the two inputs of N_4 should be interconnected.

Resistors R_1 to R_8 incl. form an OR gate that controls a relay via T_1 and T_2 which are connected in a darlington circuit.

Outputs 5 to 9 of IC_2 go high sequentially so that the relay is energized for 400 ms (when 5 and 6 are high), then off for 200 ms (output 7 is not connected), and then energized again for 400 ms (when 8 and 9 are high). After that, the relay is off for 10 periods = 2 s, and then the cycle repeats itself.

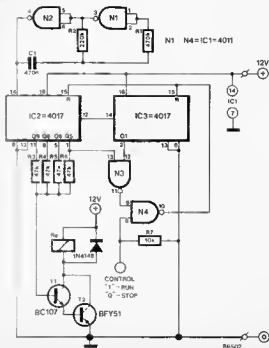

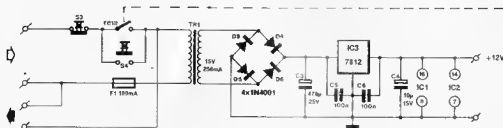
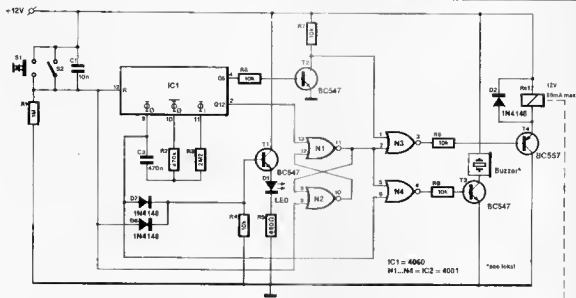

This timer automatically switches off equipment left operating unattended for more than about thirty minutes.

The circuit operation is readily understood by following its power-on and time-out functions. Almost immediately after S_1 has been depressed, relay contact $rela$ closes to power T_1 and the equipment connected to the mains outlet. This thus happens because the initial presence of the +12 V supply voltage in the circuit causes counter-oscillator IC1 and set/reset (S/R) bistable N_1 - N_2 to be reset by means of a short, logic high pulse at the junction of R_1 and C_1 . The outputs of N_1 and N_2 go high and low respectively and T_2 can energize Rel . So far for the power-on automatic hold function of contact $rela$.

After being reset, IC1 starts counting down its on-chip generated clock pulses which have a frequency of about 2 Hz. LED D_1 flashes at this rate to indicate the countdown condition. Note that S_2 has been pro-

vided to reset, i.e. disable the timer permanently, in which case D_1 lights steadily. The LED, therefore, has a threefold indicator function in the present circuit: timer on (flashing), timer and equipment off (off) and timer off while the equipment is on (steady light).

As long as counter output Q_{12} remains at logic low level, the voltage at the collector of Q_2 inverter T_3 can not cause the relay coil current to be interrupted by T_4 . If, however, some 34 minutes ($T(Q_{12}) = \frac{1}{2} \times 2^{12} = 2048$ s) have lapsed since IC and N_1 - N_2 were reset, Q_{12} goes high, causing the two-gate bistable to toggle; the output of N_1 goes low, but Rel remains energized by T_4 , since the other input of NOR gate N_1 is still high, i.e. counter output Q_5 has not been set as yet. The selfoscillating buzzer starts sounding at a 2 Hz rate however, since T_1 is driven by NOR gate N_4 which receives two logic low levels at its inputs. The user is thus notified that the has another

15 seconds or so left to depress S_1 for another 34-minute interval. If no such action is taken to reset the timer, before Q_5 goes high, N_2 disables the relay driver transistor, and contact $rela$ consequently cuts the mains voltage to T_1 and the connected equipment.

The foregoing outline of the circuit operation makes clear that depressing S_1 or switching on S_2 is the only way to keep the buzzer from sounding and the mains relay from switching off both equipment and timer circuit. If desired, push-to-break switch S_2 may be operated to break the mains supply within the half hour interval, and without the annoying sound of the buzzer.

Finally, the indicated timing intervals may be changed to suit individual requirements by using other counter outputs and/or another clock frequency for IC1 (adapt the values of R_2 - C_2).

AS

takes place of this role. This circuit also acts as a regenerative repeater for all the signals transferred along the ring so that a good signal strength is always guaranteed, regardless of the number of stations along the ring or the distances between them. A Philips-designed optical relay, shown in Fig.2, is fitted behind each socket to ensure that the ring is not interrupted when a plug is pulled out or a device is switched off.

Time-division multiplex

Time-division multiplex is used to employ the bandwidth of the optical-fibre ring as effectively as possible and to permit the simultaneous transfer of a large number of 'packets' of information coming from various stations along the ring. The continuous stream of bits passing along the ring is divided into frames with a length of 125 μ s, each containing 320 bytes of 8 bits. A number of bytes in each frame are reserved for messages for the internal organization of the network. One or more of the remaining bytes, a 'time slot', can be allocated for the transfer of an information packet; it is necessary a second time slot can be used at the corresponding position in the next frame, and so on until the complete packet has been transferred. An extreme example is the use of the network for telephone communication; in this case a user determines how long a (narrow) time slot will be occupied. A large number of parallel information streams of varying width, which can be regarded as so many parallel communication channels, travel in this way. The narrowest channel, of 1 byte per frame, has a capacity of 64 Kbit/s, corresponding to the capacity required for a digital PCM telephone line.

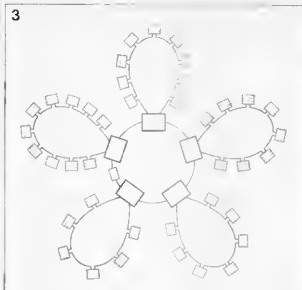

Figure 3 Meander structure in the PHILAN ring. To limit the effects on the users of a fault anywhere in the ring, the ring is subdivided into a number of 'loops' or 'meanders' which are linked via the central control unit. If there is a fault the meander containing the fault is removed from the ring and the remainder continues to operate. Besides taking corrective action in the event of failure, the central control unit synchronizes the signals in the ring and controls the time multiplexing. The time multiplexing subdivides the total transfer capacity of the ring (20 48 Mbit/s) into parallel channels of different capacity as required.

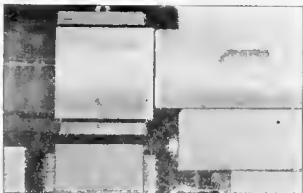

Figure 2 The optical relay socket. There is a relay in it which completes the connection between the device connected to it in such a way that the connection is obtained with the device and with only two

System protection

In a ring network such as PHILAN, measures must be taken to prevent a failure at any point in the ring from pulling the entire net-

work out of action. In the PHILAN ring, this can be done at two levels, a single malfunctioning terminal can be short-circuited or — in the event of a more extensive failure — part of the ring can be short-circuited (cf. Fig.3). In both cases a signal is transmitted to the central unit and an attempt will be made to remedy the failure automatically. Intended information transfer to an inoperative address will also automatically be blocked to prevent unnecessary reservation of transfer capacity. In this way, the network always remains available to as many of the user stations as possible. Another protective measure for use with this transfer of 'packets' of information has been incorporated: feedback to the sender when part of a message is distorted on receipt. This part of the message is then sent again, which means that the sender can be always sure his information has been properly received without having to check it himself.

The demonstration network

A number of widely differing machines have been incorporated in the network that has been constructed for research and demonstration. In addition to the telephone and intercom facilities usually found in offices, a word processor and an electronic 'archive system' (MEGADOC) have been connected, as well as computers of various sizes and types with their terminals. The network can also be used for slow-scan TV, in which a limited number of TV pictures are transmitted per minute for surveillance purposes.

work out of action. In the PHILAN ring, this can be done at two levels, a single malfunctioning terminal can be short-circuited or — in the event of a more extensive failure — part of the ring can be short-circuited (cf. Fig.3). In

20

four-tone siren

This interesting little circuit is particularly aimed at modellers. Based on just one IC, it is easy to make and it is inexpensive. Moreover, it operates from a 3 V battery, and consumes only 150 μ A in the quiescent state, and 28 mA in operation.

The four different tones are selected by two switches, S_1 and S_2 . The table correlates the switch positions and the produced sound. (St)

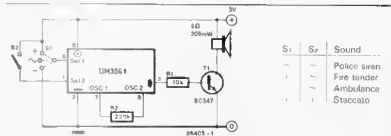

21

car lights monitor

M van Oosten

1

L1 = 11 turns

L2 = 11 turns

L3 = 20 turns

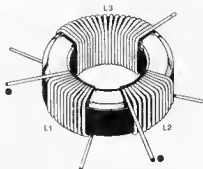
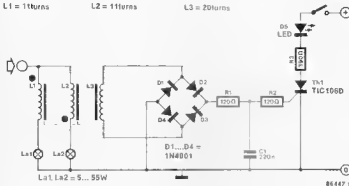

Many traffic accidents are caused by failing car lights. Often, the driver is not aware of such a malfunction, because the warning lights provided on the dashboard do not, strictly speaking, monitor the relevant lights, but rather the switch position since they are almost invariably connected in parallel with the relevant car lights. The proposed circuit is intended to indicate the failure of one light in a pair, sidelights; headlights (up to 55 W); rear lights; brake lights; or fog lights. The two lamps must have the same rating.

Counter-wound coils, L_1 and L_2 , carry the same current when both lamps are working correctly, so that the magnetic fields created by these currents cancel one another. When one of the lamps fails, the magnetic field caused by the current through the

other induces a voltage in L_3 . This pulse causes the TIC106D to switch on, and this in turn makes D_3 light. If both lamps fail simultaneously (the probability of which is, however, minute), the circuit does, of course, not function.

Because in practice the two lamps do not come on or go out simultaneously, R_1 , C_1 , R_2 provide a delay to enable the magnetic field to stabilize. Note however, that C_1 must be matched to the particular lamps being monitored: increasing its value makes the circuit less sensitive (longer delay).

The coil is easily made from an old (or new) core of a choke or dimmer switch. First, wind two times 11 turns SWG22 enamelled copper wire around the core as shown in the drawing. Inductor L_3 consists of

2

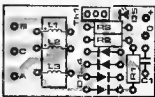

twenty turns SWG40 enamelled copper wire (this coil does not carry a large current). Note that the black spots in the drawing are the same as those in the circuit diagram. If the circuit does not work, it almost certainly means that the connections of either L_1 or L_2 have to be interchanged. To monitor all the lights of car, the cir-

cut will have to be built as many times as there are pairs of lamps. The indicator diodes are best fitted in the dashboard. It is, however, possible to use only one LED for a number of circuits: when this lights, it is then, of course, necessary to walk around the car to see which lamp has failed. Once the LED lights, it remains on

until either the thyristor or the ignition has been switched off.

S meter **22**

Since many amateur receivers are fitted with an S meter that functions far from logarithmically the proposed circuit should be a welcome extension of such receivers.

Although ICs such as the CA3089 or the CA3189 are not in common use any more, they serve a useful purpose in the meter circuit, because, apart from a symmetric limiter, a coincidence detector, and an AFC amplifier, they contain a very good logarithmic amplifier detector.

As is seen, the circuit is fairly simple, but remember that these ICs operate up to about 30 MHz, so that the wiring of the meter, and also its connections in the receiver, should be kept as short as possible.

Note further that

- the input of the CA3189 must be terminated by 50 Ω ;
- the connection to the input of the

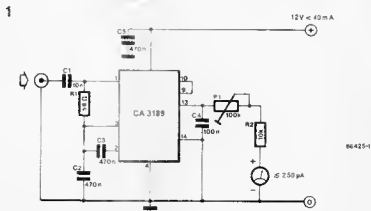

CA3189 should be in screened cable;

- if it is not possible to obtain the input signal from a low-impedance

source, a source follower should be used between it and the meter circuit.

(B)

2

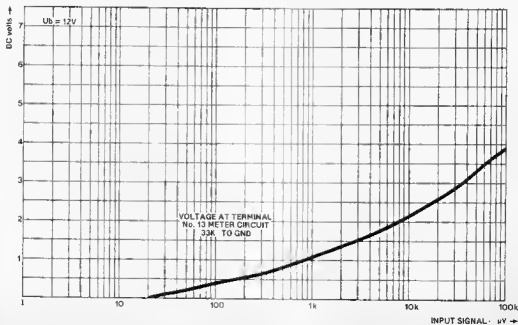

"Alea iacta est" (the die is cast, freely) someone said quite a few years ago, and promptly engaged in sundry military actions that are generally reported as having been decisive for global history. Whatever the relative importance of this notorious person's decision at that time, he is not likely to have employed a SMD die as described here, since he used the verbal form *cast* rather than a clausal construction (in Latin, of course) to indicate the presence of clock pulses from a Schmitt-trigger gate oscillator, at the relevant input of a Type 4029 binary counter which is preset to state 9 by means of jam (preset) inputs J₁...J₃ while its Q₈...Q₂ outputs may represent 1 of 6 pseudo-random states 9...15 after removing one's fingers from the touch-sensitive contacts between oscillator and counter clock input.

Counter output states 9...15 were chosen rather than 1...6 with the corresponding preset 1, in order that the CO (carry out) could be connected to PE (preset enable) via inverter N₂. This arrangement causes the binary value at the Q₈...Q₂ outputs to vary between 1 and 6, since Q₃ is left unused. CO goes low any time the counter reaches output state 16, which can not be represented by means of the four binary outputs to the IC ($2^4=16$). Consequently, the counter loads the preset value 1 (9), since PE goes high.

LEDs D₁...D₇ are arranged in the form as usual on the "six" face of a die, and the random number is, of course, displayed as an imitation of the spot(s) seen on the cube faces.

As to the construction of the SMD die, the tiny parts are fitted onto ready-made, through plated PCB Type 86454 which comes together with the Type 86452 (sideway RAM for BBC and Electron, also a SMD project in this issue).

It is noted that the 9V battery is clipped direct onto the circuit board to make a compact unit with the LEDs facing up. The "cast" contacts are four lengths of stripped wire at the LED side of the PCB, mounted at all four sides. Placing your fingers onto either two of these wires facing one another causes all seven LEDs to light, while on release a pseudo-random value is displayed. (St)

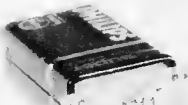
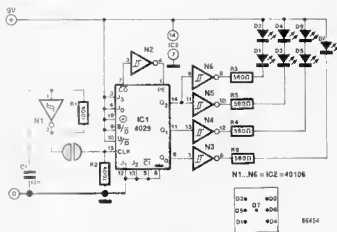

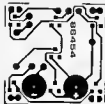

Parts list (all parts SMD)

Resistors

R₁, R₂ = 100 Ω
R₃, R₄, R₅ = 560 Ω

Capacitor

C₁ = 12 n

Semiconductors

D₁, D₂: LED Type COV231 or LSS21000
(Siemens)
IC₁: 4029
IC₂: 40106

Miscellaneous

battery clips for PCB mounting
PCB Type 06454

9 V battery PP3

PIA for Electron 24

R v Linden

Despite its neat design and relatively low cost, the Acorn Electron computer suffers from an unfortunate lack of I/O support, which is remarkable, considering the fact that it is a relatively simple matter to add, say, two I/O ports to enable the computer to drive a printer, plotter, modem, or other peripherals by means of the proposed PIA (peripheral interface adapter).

The circuit diagram of the PIA-based extension shows that address decoding over the full 64 Kbytes is by means of two 8-bit magnitude comparators Type 74LS688. Address selection is manual with switches S₁...S₁₄, which provide a logic low level when closed; observe this when writing out the ones and zeros to arrive at the desired address in the I/O map. The PIA chip is enabled when the preset address matches that on the computer's address bus; writing simple I/O drivers is therefore mainly a matter of assigning the relevant address block to control words and PIA I/O data.

T₁ has been included to enable the PIA circuit to generate and forward interrupt-request pulses by means of the wired-OR arrangement for this control line.

In case it is desirable to switch heavier loads than is normally permissible with the PIA outputs, it is suggested to employ power drivers/inverters such as those in the ULN2000 series.

(St)

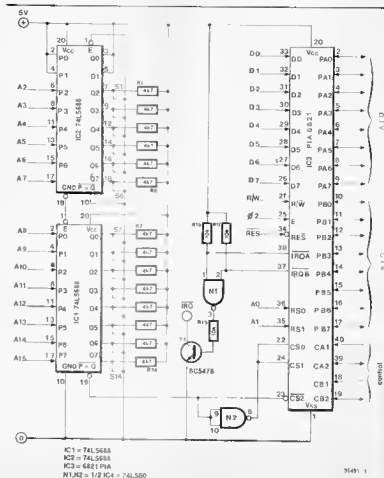

9491 1

25 line bar generator

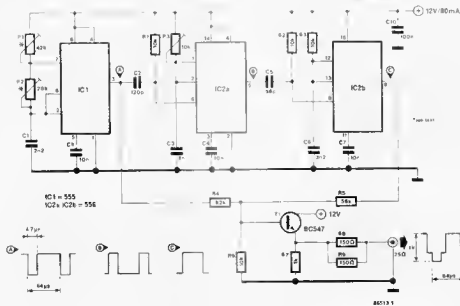

The video signal transmitted by most TV broadcast stations is rather complex. For most tests and experiments, however, a fairly simple signal will suffice. The circuit presented here provides a small, inexpensive source of line synchronizing pulses and line bar.

The first of the three timers in the diagram provides 4.7 μ s sync pulses. It is arranged as an astable multivibrator with a period of 64 μ s. The rising (here: negative-going) edge of the sync pulse triggers a second timer. The width of the output pulse of this timer determines the position

of the line bar. The line bar proper is provided by the third timer. To obtain a usable video signal, the sync and bar signals must be added, which takes place in R_4 - R_5 - R_6 . The resistor network is followed by a buffer that ensures an output impedance of 75 ohms. The unit can, therefore, be connected direct to a standard video input. The sync and bar signals occupy 40 per cent and 60 per cent of the composite signal respectively. Calibration is carried out by connecting the unit to a monitor or, via a modulator, to a normal TV receiver. Presets P_1 , P_2 , and P_3 are set to the

centre of their travel. Turn P_1 to obtain a still picture. If the sync pulse is too wide, it will be visible at the left-hand side of the picture. The pulse may be narrowed with the aid of P_2 , after which P_1 may need a small re-adjustment.

Where an oscilloscope is available, P_2 can initially be set to obtain 4.7 μ s pulses at the output (pin 3) of IC₁. Then, the total period is set to 64 μ s with the aid of P_1 .

The line bar is centred with P_3 ; as its width is fixed, this completes the calibration.

26 2708 alternatives

Thanks to the development of an ever expanding range of capacious EPROMs in the 27xxx and 25xxx series, the Type 2708 has become completely obsolete. Not only is this forerunner in EPROM technology relatively hard to program, it is also expensive in view of its modest 1 Kbyte holding capacity. Moreover, it is a more and more difficult to obtain item.

It stands to reason that replacement of the 2708 with either the 2716 (2 Kbytes) or the 2732 (4 Kbytes) is most readily accomplished if the differences in pin functions are first taken into consideration.

The pinning overview and associated table go to show quite conclusively that the replacement is no daunting task, since the former positive and

negative supply pins to the 2708, 19 and 21 respectively, may be hard wired as suggested for either the 2716 or 2732.

It should be noted that pin 18 (CE for the 2716 as well as the 2732) is tied to ground, while pin 20 (OE) is driven by the computer CS signal. This new arrangement is of no consequence for neither EPROM nor computer, since OE may function as CE if it is

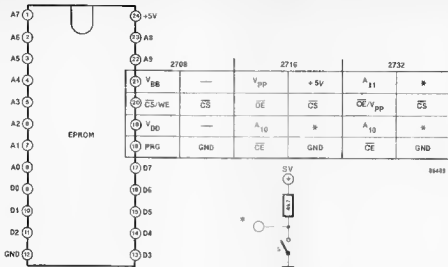

realized that the EPROM can not be switched to its low power standby state anymore. However, this minor drawback merely causes an increase in current consumption, whilst at the same time offering a faster EPROM access time, as only the three-state bus drivers are enabled internally,

rather than the entire chip logic. As the Type 2716 and 2732 EPROMs offer double and four times the capacity of a 2708, respectively, a manual address block selection may be added to the circuit: this set-up, composed of a switch and resistor (to be constructed double for the 2732)

is marked with an asterisk in the accompanying diagram. Wire A₁₀ (and A₁₁, if applicable) to ground if you intend to stick to the 1 Kbyte EPROM contents, located in the first 1024 bytes block. (Sv)

smart LED selector

27

by
R Kambach

In this tiny circuit, for use in, for instance, a two-lights model railway signal, one of two LEDs may be selected with either a single pole switch or a series transistor, as shown in the circuit diagrams. Note that the LEDs are fed via a common current limiter resistor, while a switch is connected in series with one of the LEDs.

Why do not both light simultaneously when the switch is closed? Because, apart from their colours, the two LEDs also differ as regards their forward voltage drop; when connected in parallel, therefore, the LED having the lower voltage drop should be fitted with the series switch; this arrangement causes the high voltage drop LED to light when the switch is open and to go out when the switch is closed, at which moment the other LED takes over.

Two of the accompanying four small circuits show the use of a series switching transistor rather than a real switch, but the difference hardly requires further detailing, since apply-

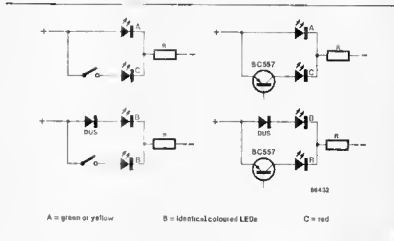

ing sufficient drive to the base is in fact the same as closing the switch. Two LEDs of identical colour may also be used as shown, and the additional series diode is seen to create the necessary voltage drop difference to distinguish between the LEDs, which, of course, have roughly

the same on/off voltage characteristic.

Finally, the value of R is established from the supply voltage level and the typical operating current of the LEDs, which is usually of the order of 20 mA for maximum allowable brightness. KD

spectively, if the second bell is to be kept from sounding for about 50 seconds after S1 has been operated twice.

The power supply for the circuit may be of conventional design, incorporating the ubiquitous 78xx type of regulator. Current consumption of

the circuit is mainly dependent on the type of relay, but 50 to 180 mA would appear to be a typical value. (R)

Colour wheel

29

R Shankar

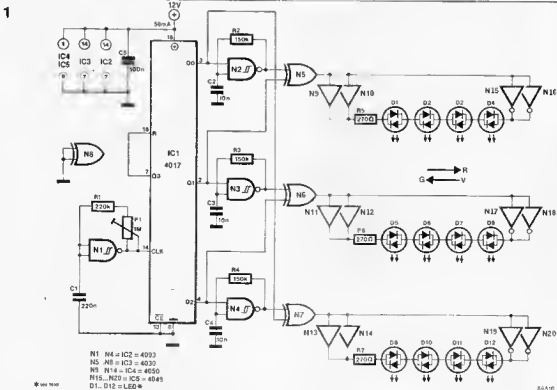

Coloured light effects enjoy a high popularity as ornaments, eye-characters, etc., and the present circuit proves how an apparently rotating colour effect may be obtained with a mere handful of commonly available components.

The colour wheel is composed of twelve bicolour LEDs, arranged in a circular form. First, a set of four red LEDs lights, followed by a green set, and, finally, amber. The colours are arranged to move in a clockwise direction, and at a speed that gives viewers the illusion that the motion is smooth and continuous.

The bicolour LEDs consist of antiparallel connected green and red diodes in a single transparent case. When both light simultaneously, their composite colour, i.e. amber, is emitted.

Which group of LEDs lights depends on the duty factor of the drive signal

from gates N₅, N₆ and N₇. Gate N₁ is a clock oscillator whose frequency is controlled by P₁. IC₁ has been connected to function as decade ring counter, which sequentially enables oscillators N₂, N₃ and N₄ by a logic high level at counter outputs Q₀, Q₁ and Q₂ respectively.

If, for instance, N₂ is enabled, it oscillates at about 500 Hz with an output duty factor of 50%, causing both the green and red LEDs contained in D₁...D₄ to light. At the same time, D₅...D₈ and D₉...D₁₂ light as red and green, respectively, since the associated driver gates N₆ and N₇ provide a steady high and low level, again, respectively. The special configuration of the LEDs, as shown just below the circuit diagram, causes the impression that the LEDs move round and round in ever changing colours

(JB)

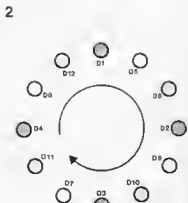

30

true class B amplifier

The quiescent current in this amplifier is always nought, so there is no need for zero setting or for a circuit to prevent thermal run-away. Complexity is further reduced by the use of a single supply voltage.

Voltage divider R_1 - R_2 - R_3 fixes the voltage level at the base of T_1 at just above half that of the supply voltage. Since a current source, consisting of T_1 , R_7 , D_1 , and D_2 , has been included in the collector circuit of T_1 , this stage provides a very high voltage amplification. The return line of the current source is connected to the output, so that the voltage necessary to stabilize the source does not limit the dynamic push-pull characteristic. The current source has, therefore, a high-impedance character.

The complementary power amplifiers, T_2 and T_3 , are darlington transistors, which, of course, enable the collector current in the driver stage to be kept relatively low.

The feedback to the emitter of T_1 via R_5 and R_6 determines the overall voltage gain, here 20 dB, and irons out any non-linear components.

Class B operation is normally obtained by direct interconnection of the bases of the power transistors. In practice, this gave an overall distortion of not more than 0.16 per cent (at a drive power of 0.25 W at 1 kHz). The

simple addition of diodes D_1 and D_2 improved the distortion to not more than 0.1 per cent. Note that these diodes do not alter the operation, because the darlington transistors have a relatively high base-emitter potential.

With a supply voltage of 12 V, the amplifier delivers some 2 W into

4 ohms (input sensitivity 200 mV), or rather more than 1 W into 8 ohms. A higher supply voltage will increase the output power (to a maximum of 10 W into 4 ohms at 24 V), but the power transistors then need cooling

(TW)

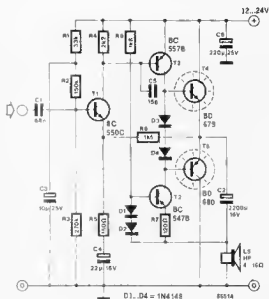

31

light-sensitive switch

by H Huynen

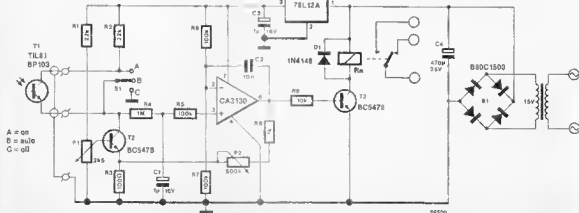

MICROELECTRONICS AND PHARMACEUTICALS

by Charles Lewis

Public confidence in the pharmaceutical industry is such that both doctor and patient usually accept without question the quality and therapeutic reliability of medicinal products.

However, constant and stringent precautions and checks are necessary at all stages of manufacture to ensure the quality and safety of such products. Since pharmaceuticals apply directly to human beings, this is of prime importance and the manufacturers' responsibilities are that much more onerous. Close attention to quality

and safety, of course, is in the interests of the manufacturers themselves, since they have their own hard earned reputations to safeguard by ensuring that their products are exactly what they are claimed to be. Consequently there is a ceaseless search for new and improved ways of achieving these objectives.

The advent of micro-electronics has proved of the greatest importance, not least to the producers of manufacturing machinery. British makers of such equipment have been quick to seize the

opportunities presented in this new and rapidly advancing field, with the result that the pharmaceutical industry is one of the most technically advanced—ensuring a constant flow of precision made, high quality products.

Perhaps one of the most outstanding examples of harnessing modern technologies to the improvement of quality and reliability is the Copley[®] computerized multi-parameter measuring, analysing and data acquisition system known as DATAPHARM. It is a computerized, multi-parameter control system for the formulation, in-process and quality control of tablets and other dosage forms.

Process performance chart

It may be used to assess any or all of the parameters of weight variation, friability, thickness, diameter, and hardness. The results are presented as a simple integrated print-out in the form of a process performance chart and a bar chart/histogram plot. From this the user is able to determine instantly whether the batch being tested has passed or failed. At the same time, correlations can be drawn between the various parameters and an assessment made of any prevailing unwanted trends. DATAPHARM consists of a central computer supplied with the appropriate software and printer. The computer utilizes the measured inputs from the

various test instruments, such as a disintegration tester and a hardness tester. It integrates them into a statistical analysis program. The user-friendly system displays simple operating instructions on the visual display unit, and commands are entered by single key operation. Product specification files can be built up and maintained, together with separate batch production files. The system, being modular, is highly flexible, so that test instruments and associated programs can be added or deleted to suit individual requirements.

The theory behind the equipment is that a multi-parameter control system not only tells the user whether a particular batch of products has passed or failed the chosen parameters, but allows those parameters to be interrelated. The parameters associated with tablet production are in many cases correlative. For example, high hardness values may increase disintegration times and decrease dissolution values. On the other hand, if hardness is too low, friability and the percentage defective could well be too high.

Disintegration and dissolution

A range of values could therefore be chosen so that relatively high hardness would produce adequate disintegration and dissolution values, while maintaining low friability and percentage defective values. Similarly, high proportions of values relating



Figure 1 The Manesty Rotapress Mk 4 is a high speed press capable of producing 600 000 tablets

to weight variation could increase hardness and/or decrease dissolution values.

By exploiting the obvious correlations between hardness, disintegration, dissolution, friability, percentage defective, and weight variations, the parameters can be adjusted to produce the best dosage form.

In operation, a new product file is created or, if one already exists, is recalled. The parameters to be tested—weight variation, hardness, disintegration, dissolution, and so on—are chosen to suit the test program. A representative sample of the product is then divided into an appropriate number of parameter batches and the test proceeds, sequentially, to build up a full case file.

Electronics are also being increasingly incorporated into pharmaceutical checkweighing machines. One example is the Best⁽²⁾ rotary unit for checkweighing cylindrical containers such as miniature aerosol cans. This is done with the cans in a vertical position and to very high accuracies.

The machine satisfies the need for both accuracy and speed. It can handle more than 100 containers a minute with a zone of decision of ± 75 mg.

Starwheel control

It incorporates its own feed scroll and starwheel to eliminate the need for prior pitching of the product. Cans fed at random along a conveyor are picked up by the scroll and fed into the first starwheel, which controls the flow and pitch for checkweighing. After this has taken place, a second starwheel collects the containers from the weighplate and feeds them back on the same conveyor, eliminating the need to side transfer. Incorporated into the

machine is a microprocessor system employing pushbutton set-up facilities for full data acquisition. Between each weighing, the machine is automatically zeroed, and the console incorporates a digital display for instant weight information.

The mean weight control causes the target weight of the checkweigher and associated control limits to adjust automatically, following a trend of increasing or decreasing weight of the packs being passed over the weigh-cell.

A running mean weight is calculated over a block of weights. The size of each block is adjustable at the keyboard and the block size can be set at any number between two and 64.

Audible alarm

The four control limits (two upper and two lower) move with the moving target weight. Should a pack be rejected, its weight is not included in the calculation of the target weight.

Two fixed upper and lower limits, representing the limit to which the target weight is permitted to move, are set at the keyboard and this eliminates the possibility of the control system becoming unstable. An audible alarm sounds if this should occur.

Manesty⁽²⁾, which makes tablet manufacturing equipment, has developed what is termed a total system installation option. This includes tablet presses and coating machines, powder filling systems, capsule filling machines, and blister packing and cartoning machines.

An example of the company's commitment to constant development is the new Rotapress Mk 4 high speed rotary tablet press for large batch production. It is capable of outputs of up to 600 000 tablets an hour. The double-sided press

has a single pre-compression station on each side. Both are strain gauged and linked to monitors in the main control panel, allowing for the precise monitoring and control of the pre-compression force.

Motorized adjuster

Mean tablet weight control is through a motorized adjuster which automatically compensates for any change that may occur. The compaction force and the force on individual tablets are also monitored, and the operator warned if a change exceeds the pre-determined upper or lower values.

Also available is a programmable tablet sampling device, which provides a relatively simple method of sampling individual tablets from an individual station of tooling. It also allows tablets to be sampled sequentially for monitoring purposes. A group sample, with one tablet from every station of tooling, can be taken to represent output

at any one time.

Another useful feature is the detachable control panel, which can be remotely sited, and this is particularly beneficial when tabletting toxic or dangerous products. All power and sensor connections between the panel and the machine are housed in non-toxic flexible conduits.

The obvious next step is the application of the latest video capabilities to inspection processes, and already some British companies are well advanced in this direction. But since pharmaceuticals apply directly to human beings, each step has to be thoroughly and meticulously evaluated and tested before final integration into the overall production system (LPS).

1. Copley Instruments (Nottingham) Ltd, Private Road No 7, Colwick Industrial Estate, Nottingham, England, NG4 2ER
2. Best Inspection Ltd, 3 Fleming Road, Newbury, Berkshire, England, RG13 2DE
3. Manesty Machines Ltd, Speke, Liverpool, England, L24 9LQ

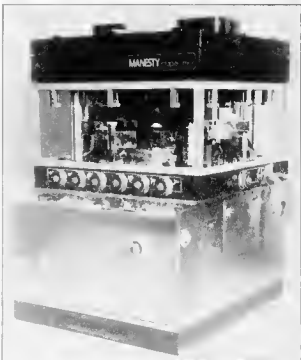
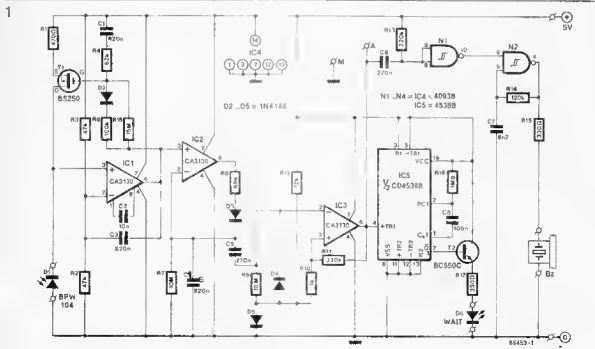

Figure 2. The Best rotary checkweigher



The proposed circuit is based on the fact that the degree of translucence of parts of a mammal's body depends, among others, on the flow of blood. Because the blood supply pulsates at the frequency of the heartbeat, this may be monitored in a simple way without the need for an electrical connection between the mammal and the measuring equipment.

In the proposed circuit, the flow of blood through a finger is monitored. To obviate errors caused by the position of the finger, the receiver diode is included in a loop.

The positive input (terminal 3) of IC1 is held at about 2.5 V. The gain of the device is determined by the ratio R_3/R_4 . Network R_5-D_2 ensures that the circuit stabilizes rapidly. The amplified signal is rectified by IC2. Time constants R_6-C_4 and R_7-C_4 are chosen such that the potential at pin 2 of IC2 has a sawtooth shape. The CA3130 in the IC3 position functions as a trigger. The output signal may, for instance, be applied to the input port of a computer.

If a computer is not available or deemed necessary, the beat is made audible by a piezo-electric buzzer operated by gates N1 and N2.

Circuit IC5 provides a WAIT indication that shows when the circuit

2

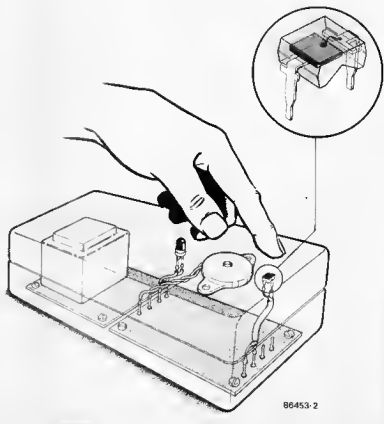

has stabilized and is ready for use. The programme is compiled as follows: wait for a trailing edge, then count until the next trailing edge appears. The count is converted into a number per minute, and this is displayed on the monitor screen. However, the heart beat is not constant, which is quite clear from listening to the buzzer or observing the monitor screen. It is, therefore, advisable to calculate an average over, say, sixty seconds. It is then possible to display the instantaneous value, the average value over 60 seconds, and the trend (rise or fall)

Once the programme is known to work satisfactorily, it becomes interesting to display the actual signal on the screen. If the computer used has an analogue-to-digital converter, the output signal of IC₁ may be used for the display

Fig. 2 shows a possible construction of the heart beat monitor in an ABS enclosure; the measurement may simply be taken by gently pressing one's finger onto the photodiode. (B)

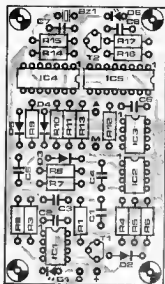
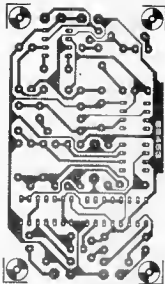

quartz-controlled tuning fork | 34 |

Musical instruments are tuned with the aid of a signal source that generates a signal at a frequency of 440 kHz. An electronic tuning fork is superior to its mechanical counterpart as far as dimensions, weight, and stability with temperature are concerned. The stability is obtained by controlling the signal source by a quartz oscillator. The output of the

oscillator is frequency-divided and then amplified. The output may be made audible by, for instance, a small loudspeaker.

In the accompanying diagram, N₁, N₂, and the quartz crystal form the oscillator. The precise frequency, measured at the Q terminal of FF₂ with a calibrated frequency meter, is set with C₁. Divider Type 4059 is eas-

ily programmed to a different divisor. A duty factor of 50 per cent is ensured by FF₂.

The transducer is shunted by a 100 nanofarad capacitor, because most transducers have a much better high- than low-frequency response, which causes very shrill sounds.

(B)

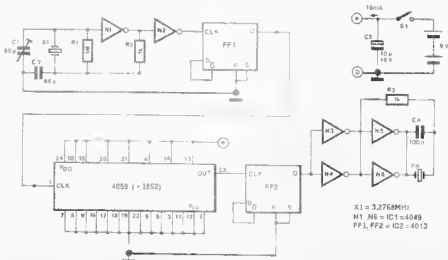

86478-1

This protective circuit is readily incorporated in battery-powered equipment which is typically intended to operate for less than about a minute; possible applications that come to mind include IR remote control units, calculators, etc. Forgetting to switch off such devices irrevocably causes the built-in batteries to be exhausted after a while, however "low" the standby current.

The proposed battery guard automatically switches off the supply current to the circuit, either after about one minute has lapsed after power-on, or when the battery voltage has fallen below the acceptable level for normal operation.

Series regulator FET T_1 can pass a maximum current of 150 mA in the circuit as shown, and it is advisable to use a more powerful type than the BS250 in case more than about 100 mA is expected to be consumed by the equipment connected to the output terminals. The Type BS250 FET drops about 0.5 V at a drain current of 100 mA, and 0.8 V at 150 mA, whence the foregoing consideration. As T_1 is a p-channel FET, it conducts and powers the equipment when the output of Schmitt trigger NAND gate N_3 is low, i.e. when both gate inputs are high. This is so at power-up, since C_2 is still discharged and the inputs of N_4 are kept at logic low level via R_5 . Consequently T_1 is enabled and causes C_2 to be charged via R_2 . After about one minute (R-C time), the voltage across R_2 is low enough for N_3 to recognize a logic low level at pin 1, thereby turning off T_1 . N_2 provides a hold function of this state, since otherwise N_3 might oscillate owing to the slowly varying voltage across R_2 .

At power-on, the output of N_2 is pulsed high by means of R-C network R_1 - R_3 - C_1 , whereby any residual charge in C_2 is cleared; the circuit may, therefore, be switched on with S-S, immediately after automatic power down.

Battery voltage monitoring is accomplished by D_1 , R_4 , R_5 and N_4 . The latter's trigger threshold level is, as with all Schmitt trigger gates, in direct proportion to the supply voltage level to the IC. As long as the supply (i.e. battery) voltage is sufficiently high, N_4 will recognize a logic low level at junction R_4 - R_5 - N_4 . However, if the battery voltage falls, D_1 keeps the input voltage to N_4 at a

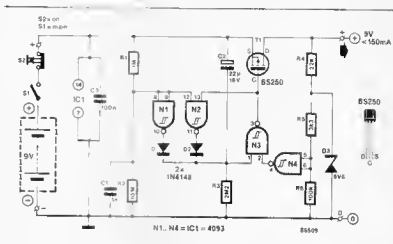

Parts list

Resistors

- R_1 - 1 M
- R_2 - 10 M
- R_3 - 2M Ω
- R_4 - 22 k
- R_5 - 3k Ω
- R_6 - 100 k

Capacitors

- C_1 - 1 n
- C_2 - 22 μ 16 V; tantalum*
- C_3 - 100 n

Semiconductors

- D_1 - D_2 - 1N4148
- D_3 - zener diode 5V8, 400 mW
- IC - 4093*
- T_1 - BS250

Miscellaneous

- S_1 - single pole miniature switch
- S_2 - push to break button
- PCB Type BS6405

* See text

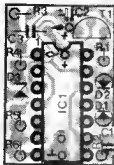

fixed level, causing the gate to supply a logic low level to N_3 , which consequently turns off the series regulator FET.

It should be noted that the exact values of R_1 , C_1 , R_2 and R_3 may have to be adapted to suit operation with certain makes of the Type 4093. Also note that the interval time of one minute may be changed to individual requirements by suitable redimensioning of timing elements R_3 - C_2 .

Adjustment of the battery guard is carried out by temporarily exchanging R_4 and R_5 with a 100 k preset to determine the correct resistor values

for a given switch-off level. Current consumption of the proposed circuit is mainly determined by the zener diode, which has been biased to pass only 1 mA. After automatic power-down, the guard circuit draws a (negligible) current of less than 1 μ A.

38

filtered connector

Computers and computer-driven peripherals are notorious sources of RF interference, and receiver jamming may occur at frequencies well above 100 MHz, even though the computer is said to run at a mere 16 MHz or so. The cause of this problem lies in the very fast pulse rise time of the switching and timing signals internal and/or external to the computer system and its peripherals, which are often located well away from one another (printer, modem, mass storage).

Much of the interference originating from long peripheral wiring systems may be suppressed quite effectively by inserting simple low-pass filters in the signal lines for data and handshaking. The proposed L-C filters are composed of small (3 mm) ferrite beads with 10 turns of 0.2 mm (36 SWG) enamelled copper wire, plus a ceramic 1nF capacitor; the coil inductance is about 80 μ H, which gives a cut-off frequency of about 60 kHz (120 Kbaud).

The filters are mounted on a small piece of veroboard which may be cut and filed to fit into a standard D-connector housing. Other cut-off frequencies may be defined by mod-

ifying the small coils; inductance is proportional to the square of the number of turns, while constructors boasting of good (near) eyesight and lots of patience may endeavour to use thin (0.05 mm) copper wire to run through the beads. However, the L-C ratio as given should not be modified.

In conclusion, it should be noted that a filtered connector dimensioned for, say, 10 kHz, should not be connected to a high frequency (20 MHz) computer output, since the excessively high capacitive load may cause damage to the line driver IC (JB)

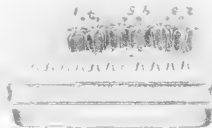
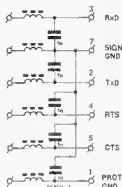

39

random lights controller

Unfortunately, we are all well aware that the annual holiday season is an anxious time for many people, since they worry about leaving the home unattended and therefore liable to be visited by burglars and/or hooligans. Right now is, therefore, an ideal time to construct this circuit before you leave your home and all of your highly-valued property.

It goes without saying that simulating one's presence in the home may be accomplished by having some electronic or mechanical timer device switch on a number of lights when it grows dark, merely keeping them on until a fixed time interval has lapsed. The potential housebreaker, however, may soon detect the regular pattern that occurs every evening, encouraging him to embark on his nefarious activities, since he realizes

he is dealing with a harmless timer rather than persons in the home.

This circuit, while also being a timer, offers a better simulation of human activity, since it automatically arranges for a number of lights to be switched on and off in an apparently random manner, which gives the burglar the impression that there are people at home. In actual fact, the lights pattern is pseudo-random, but 16 possible configurations are bound to ensure sufficient diversity to keep your mind at ease and that of the attentive burglar quite puzzled for at least a few weeks.

And now for the operational principles of this easy-to-build circuit. The evening's specific lights configuration is determined by the four-bit logic code supplied by counter IC₂ at the moment it becomes dark.

Since this never happens at precisely the same time every evening, IC₂ may be considered as a four-bit (1 of 16) random code-generator. Whenever the LDR fails to detect the presence of daylight, the output of N₂ goes high, and D₁ charges C₁. Meanwhile, N₁ constantly applies 100 Hz pulses to the input of counter IC₁. When the voltage across C₁ and R₂ has risen to a level, sufficiently high to be recognized as a logic one by the clock input of quad latch IC₃, the four-bit counter code is latched and transferred to the Q₀. Q₃ outputs of IC₃. In addition, N₃ simultaneously enables IC₁ to start counting and dividing its on-chip generated clock signal.

The latch (IC₃) and counter (IC₂) outputs are combined in AND gates N₄...N₈. The oscillator parts to IC₄

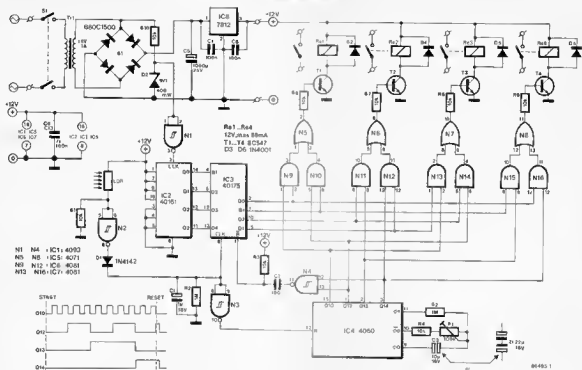

R₁-P₁-R₂-C₂ (the latter is a bipolar type which may be substituted by two series-connected electrolytic capacitors) have been dimensioned such that output Q₁₀ produces 15-minute long, 50% duty factor pulses; this interval may be set accurately by means of P₁. Since IC₃ is a binary (2ⁿ) divider, outputs Q₁₁, Q₁₂ and Q₁₃ provide pulse period times of 60, 120 and 240 minutes respectively. Whether or not these pulses

can appear at the outputs of N₉...N₁₆ depends on the current logic level of each of the associated latch outputs Q₉...Q₁₃. The AND gate outputs have been paired in four OR gates N₉...N₁₂; therefore N₉ and N₁₁ may supply either 15, 60, or 75-minute intervals, while N₁₀ and N₁₂ cater for relay-on times of either 60, 120, or 180 minutes; longer times (e.g. 360 minutes) are not feasible since N₄ resets IC₃, five hours (Q₁ AND Q₁₄ =

60 + 240 = 300 min.) after it fell dark at the LDR mounting position.

It is seen that R₁ and R₂ are therefore best used for those lights that can be expected to go on and off for relatively short periods during the evening, while R₃ and R₄ are energized for longer times at later hours that same night.

Finally, the inset timing diagram illustrates the pulse sequence relevant to the four relay outputs.

A.R

synchronization separator | 40 |

Obtaining TV synchronization pulses from a composite video signal generally presents few problems, as can be concluded from the relative simplicity of sync separator circuits in colour as well as monochrome TV sets. However, if TV sync pulses are to be used for further processing in digital circuits, the commonly encountered sync separator fails to meet the requirements for output pulse definition and "cleanness". Thus, the separation level needs to be accurately defined in order to prevent blanking rather than synchronization pulses to appear at

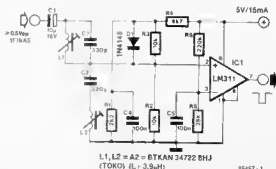

L1, L2 = A2 = BTKAN 34722 BHJ (TOKO) (L = 3.9µH)

86467-1

the circuit output; the former may be wide enough to make a digital circuit go completely haywire! Further sources for possible interference are mainly separation jitter and crosstalk caused by the colour and/or sound carrier; the former is not always suppressed during synchronization intervals, while the latter is, of course, continuously present in the demodulated input signal, which fact necessitates additional filtering at the sound carrier frequency. The foregoing considerations have

led to a circuit which effectively removes the colour carrier from the demodulator output signal, before separating sync from video. A combination of series (L_1-C_3) and parallel (L_2-C_2) tuned circuits is peaked at the colour carrier frequency (4.43 MHz), while D_1 serves as a clamping device for a direct output voltage of about 0.7 V. The inverting (-) input of opamp Type LM311 is arranged to be at 0.75 V with respect to ground in order that signals causing the non-inverting (+) input to be at a voltage lower than 0.75 V can

make the opamp toggle, providing a negative (active-low) output signal, composed of the TV sync signals. Note that the circuit output signals can be made positive (active-high) by interchanging the opamp inputs. As to coils L_1 and L_2 , these may be replaced with fixed value (3.9 μ H) chokes, provided both C_2 and C_3 are consequently replaced with a 270 pF capacitor and a 60 pF trimmer in parallel. If necessary, similar filters may be added to remove the sound carrier. (D)

41 metal percussion generator

The objective of this circuit is to obtain a synthesizer-controlled equivalent sound as produced by such metal indefinite pitch percussion instruments as cymbals, gong, and anvil. Fig. 1 shows that the generator comprises four independently tuneable VCOs which supply rectangular output signals to a combination of XOR gates.

One of four identical KOV (keyboard output voltage) driven VCOs is shown in Fig. 2. The use of fast opamp types ensures linear VCO operation well up to 4 kHz, while FET T_1 improves upon the linearity of the voltage-frequency curve relevant to the combination of integrator and comparator. With the VCO constructed four times over and connected as shown in Fig. 1, drive controls $P_1 \dots P_4$ allow the user to set the output sound as desired.

The outputs of buffer opamps $A_1 \dots A_4$ (IC₁, Type TL084) should measure 0 V offset with the KOV rail grounded. If this can not be attained, the IC will have to be exchanged with a more stable type.

Linearity of each of the VCO circuits is set with the preset at the drain of the FET, P_5 and T_1 respectively in Fig. 2. Use a scope to check whether the rectangular VCO output signal has a 50% duty factor; if not, adjust the relevant preset.

As the four VCOs lack a linear to exponential KOV converter at their inputs, it is not possible to use the present circuit with a keyboard of the 1 V per octave type. However, many keyboards provide an exponential KOV signal whose frequency doubles with every octave and which are, therefore, suitable for use with this generator. (KD)

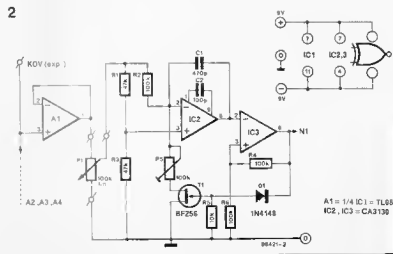
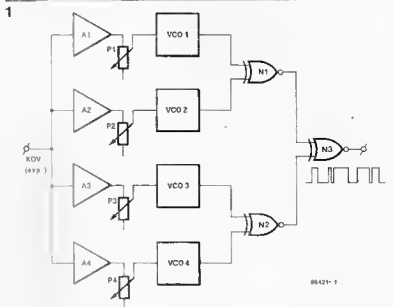

call counter | 42

1

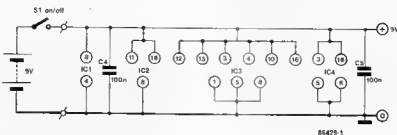
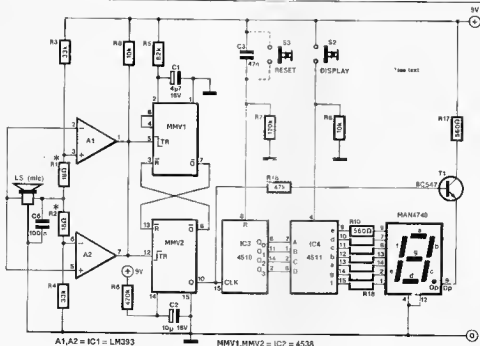

A telephone has the unfortunate disadvantage that you have to be near it to be able to make use of its communication possibilities. If you have a telephone answering unit, you know at least who has called and how many callers there were. If you cannot, or do not want to, hire or buy such a unit, the present low-budget one may be of interest. Low-budget involves the limitation, however, that the incoming calls are merely counted who has called, or what the message was, can only be guessed. Moreover, to avoid problems with British Telecom (or whoever your PTT authority is), the unit is acoustically coupled to the telephone. Such a design must, of course, have excellent pulse suppression, since extraneous sounds must not be interpreted as an incoming call. Finally, the counter's current consumption

2

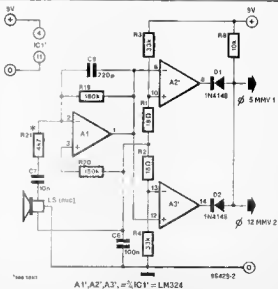

should be (very) low to enable its operation from a battery.

A small, inexpensive loudspeaker is used as the detector, the output of which is applied to window comparator A₁-A₂. In the absence of a signal from the detector, the output at interconnected pins 1 and 7 is logic high. When the loudspeaker picks up a sound from the telephone, the output consists of negative-going pulses. Monostable MMV₁ is triggered by the leading edge of the first pulse, and suppresses the pulse. Only after a time lapse of 0.4 s does MMV₁ enable a second monostable, MMV₂. If the sound is still being detected by the loudspeaker, MMV₁ is then also triggered. This arrangement ensures that noise pulses of less than 0.4 s duration are effectively suppressed. Since MMV₂ is retrig-

gerable, and its mono time is about 5 seconds, the intermittent ringing of the telephone is converted into a single pulse.

The decimal point of the display is switched on via R₁₅ and T₁ indicating that the circuit is in a triggered state. The remainder of the circuit is straightforward: a decimal counter, IC₃, with switch-on reset (R₇ and C₃), and a BCD 7-segment decoder, IC₄. In the quiescent state, the display is not energized in order to keep the current consumption low. Pressing S₂ will indicate how many telephone calls there were. The circuit is reset by briefly switching it off, and then on again, but could be arranged by a simple switch across C₃. Current consumption in the quiescent state amounts to about 0.6 mA, so that a reasonably long life may be ex-

pected from the PP3 battery. If the input sensitivity is poor, it may be improved by lowering the value of R₁ and R₂ to 10 Ω. If this is still not sufficient, a simple input amplifier as shown in Fig. 2 should be added. The LM393 is then replaced by an LM324, which has four suitable opamps. One of these is then used as input amplifier, and two of the remaining three as the window comparator. Diodes D₁ and D₂ are necessary in this case, because the outputs of the LM324, in contrast to those of the LM393, are not open-collector. The value of R₂₁ is established by trial and error to find optimum input sensitivity. Adding the input amplifier has the small disadvantage of increasing the current consumption to around 1 mA.

(TW)

43 SCART switch

This circuit is not really a technical novelty, but it has its practical uses. If, for instance, it is desired to connect a video recorder AND a computer per-

manently to the SCART socket at the back of a modern television set, it will be found that that is impossible. All that can be done is to connect

either the video recorder or the computer. But the proposed SCART switch offers a solution to this problem.

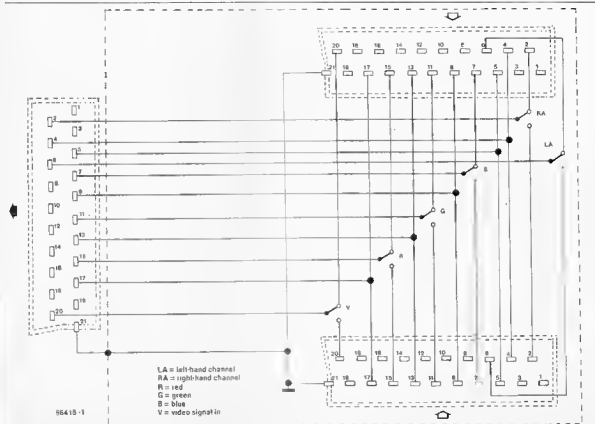

The switch is constructed from a small (110 x 60 x 30 mm) metal case, a six-pole change-over switch, two SCART sockets, one SCART plug, and a length of screened coaxial cable. Suitable holes should be provided in the case to receive the two sockets, a cable outlet, and the switch. The various components are connected together as shown in the accompanying diagram. The SCART plug is connected at the free end of the cable, which should not be longer than 1 metre. The connections to the sockets and plug are also identified in the table.

The completed switch should find a home beside, under, or on top of the TV set: the SCART plug is inserted into the SCART socket at the back of the set. The two SCART sockets on the case are then used to receive the computer and video recorder respectively. From then on, it is a simple matter of switching between recorder and computer! (5V)

SCART connector

Pin	Function	Level
1	Audio output (right hand) or channel 2	0.5 V for output impedances $\geq 1 \text{ k}\Omega$
2	Audio output (right-hand) or channel 2	0.5 V for input impedances $\leq 10 \text{ k}\Omega$
3	Audio output (left hand) or channel 1 or mono	0.5 V for output impedances $\leq 1 \text{ k}\Omega$
4	Audio earth	
5	Blue earth	
6	Audio input (left hand) or channel 1 or mono	0.5 V for input impedances $\geq 10 \text{ k}\Omega$
7	Blue component	Difference between peak value and blanking signal level 0.7 V, load impedance 75 Ω ; superimposed direct voltage - 0.2 V
8	Switching voltage 0 TV reception 1 operation of associated units	0 0.2 V 1 - 9.5 12 V
9	Green earth	
10	Not used	
11	Green component	Identical to 7
12	Not used	
13	Red earth	
14	Not used	
15	Red component	Identical to 7
16	Blanking signal 1 blanking	0 0.04 V 1 - 1.3 V Load resistance 75 Ω
17	Video earth	
18	Blanking signal earth	
19	Video output	Difference between peak white level and sync signal = 1 V; Output resistance = 75 Ω ; Superimposed direct voltage = 0.2 V; Synchronization signal only = 0.3 V _{pp} ; Identical to 19
20	Video input	
21	Housing screen and/or earth	Connected to chassis

fast voltage-controlled pulse generator

44

Certain measuring and process control applications require pulse generator sections which are to operate over a large frequency range and must, therefore, produce a signal with very low pulse width. It is for this reason that the proposed circuit uses high-speed complementary MOS (HCMOS) type gates; the prototype typically produced an output pulse width of 20 ns over the frequency range of several hundred hertz to 25 MHz.

The combination IC1-T1 is a voltage-controlled current source which discharges C. The fast charging of this capacitor is effected through the voltage at the output of Schmitt trigger N1-N2-D1. The lower frequency limit of the proposed circuit mainly depends on the offset voltage of opamp IC1. In order to enable setting the lower frequency limit, T1 must be arranged so as not to draw

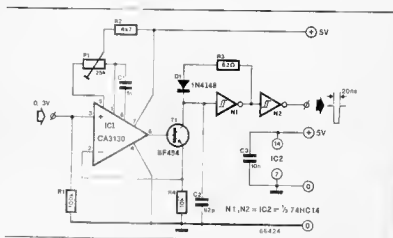

any current at an input voltage of 0V; to this end, offset preset P1 should be correctly adjusted. Finally, the output pulse width may be widened by increasing the capacitance of C2;

this will not alter the attainable sweep range

Literature: E. Abbel, *Electronic Design* 18 (1984), pp 270-271. JB

45

guitar fuzz unit

The fuzzbox, fuzzer, tube screamer, or whatever other name there may exist for the controlled guitar sound distortion unit, is a well-known item in the electrophonic field, which is of common interest to both musicians and electronics enthusiasts.

The majority of fuzz units are simply opamp configurations with some form of maximum input level control, which determines the degree of overdrive by the guitar input signal, and, consequently, the amount of audible distortion, generally referred to as the object "sound" the player has in mind as his very own musical visiting card.

This is probably one of the few fuzz units to feature controllable symmetrical clipping facilities, which means that the limit for distortion-free amplification may be separately defined for both the negative and positive portions of the input sine wave(s), the peaks of which may be clipped by means of shunt transistors T_1 and T_2 respectively, each with its own clipping level control potentiometer (P_1 ; P_2). The transistors, when driven, pass the signal from input opamp IC₁ to the positive supply or to the ground rail, before buffer IC₂ can pass the "fuzzy" guitar sound to the connected amplifier.

Preset P_3 determines the minimum gain of the fuzz unit; the desired level may be set with P_4 turned to its minimum resistance position. Next, P_4 is adjusted to suit the maximum input level that can be expected from the guitar. P_3 and P_4 may then be alternately adjusted to hit the correct compromise between these two signal levels.

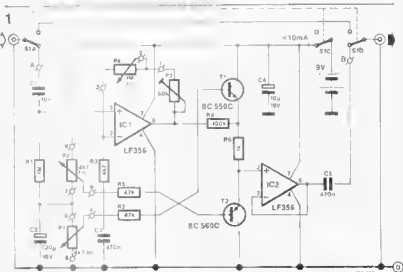

2

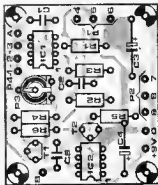
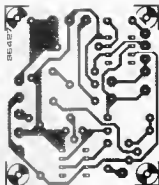

Finally, note the three-pole changeover switch which allows easy bypassing of the fuzzer while

simultaneously switching it off to preserve battery power.

JB

46

two-gate bistable

Probably unequalled as to its simplicity given the digital function, this circuit may serve as a single-button on/off control for incorporation in a wide variety of electronic designs. The operation of the proposed bistable is best understood if it assumed that the input of Schmitt-trigger inverter N_1 is at logic high level; the output of N_2 will therefore be high as well. It is seen that the ca-

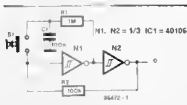

pacitor is discharged because of the low output level of N_2 . Therefore,

depression of the button pulls the input of N_1 to logic low level, causing the bistable to toggle; the capacitor is charged via the 1 M resistor, and the circuit will change state again at the next switch action. The indicated resistor values have been found to offer optimum stability of the bistable, while the use of Schmitt-trigger CMOS inverters is essential to the correct operation.

HS

mains-based remote controller

47

R Bakx

This combination of transmitter and receiver is based upon the use of the mains network in the home for remote control of mains-operated domestic appliances.

Figure 1 shows the transmitter, which merely superimposes a 36 kHz signal on the 50 Hz mains voltage if S_1 is operated. It is noted that IC₁ is fed direct off the mains voltage by means of a rectifier circuit composed of D_1 , D_2 , zener diodes D_3 , D_4 , and smoothing capacitor C_1 ; the proposed configuration is to supply +20 V with respect to the mains neutral (0) line. The 36 kHz output signal of the opamp is fed to the mains by means of coupling capacitor C_2 . R_1 is a bleeder resistor to discharge C_1 and C_2 after the circuit has been unplugged from the mains outlet.

The receiver, shown in Fig 2, is fed with an inexpensive door bell transformer, although any other type supplying 6 to 8 V AC at about 300 mA should do just as well.

Apart from being used to power T_1 , the mains voltage with the 36 kHz carrier is filtered by parallel tuned circuit L_1 - C_5 to detect the presence of the superimposed 36 kHz carrier, which is passed to amplifier IC₂ via R_7 . Subsequent rectification by D_7 enables the relay driver circuit composed of T_1 and T_2 to energize Re_1 . Preset P_1 is adjusted to find the right

1

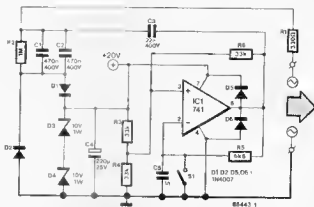

compromise between receiver sensitivity and noise immunity. R_1 should be dimensioned to suit the relay coil current.

As to the construction of the receiver and transmitter, it should be made quite clear that the presence of the mains voltage necessitates the use of sound and safe con-ABS enclosures to prevent accidental contact with the live wires. Do not take any risk in this respect, neither while experimenting with the circuits as shown nor while setting up and testing.

The transmitter, then, is readily fitted in a salvaged mains adaptor case

with a small hole drilled into it for S_1 . The receiver ABS enclosure is likely to be of larger size if a mains socket is incorporated for easy connection to the appliance to be controlled. The contact rating of Re_1 should be duly observed in case heavy loads, such as a coffee machine (4 A), are to be switched.

(W)

2

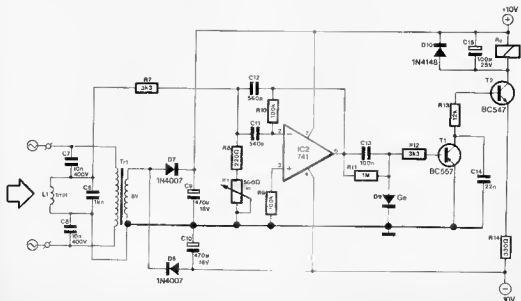

48 subwoofer filter

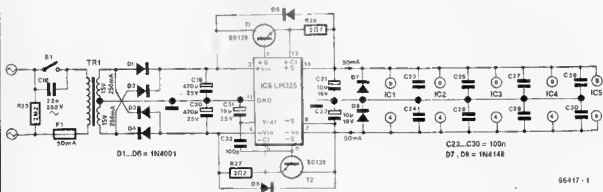
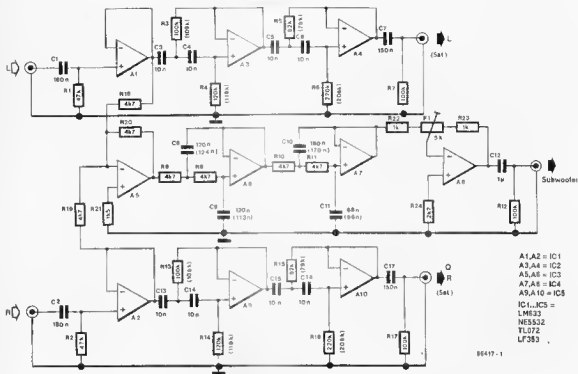

The filter described here is intended primarily for experimenting with a (central) subwoofer (see *Active Subwoofer March 1986*, p 5-18). As the human ear cannot sense direction in a standing wave, directional sensitivity is generally poor at low frequencies, so that it would seem superfluous to use a stereo set-up below about 200 Hz. Therefore, the low frequencies can be concentrated on one good bass enclosure, which, of course, keeps the cost of the overall system down. The satellite loudspeakers, (see *May 1986*,

p. 5-46) will then have to cope with the higher frequencies only. The requisite cross-over network described here is based on 24 dB/octave Bessel filters. The cross-over frequency lies around 200 Hz. With reference to the circuit diagram, A₁ and A₂ buffer the left-hand and right-hand signals respectively. The high-pass filters for the two channels are formed by A₁-A₃ and A₂-A₁₀ respectively. At the same time, the two channels are combined in A₅, and the resulting signal is passed through

low-pass filter A₇-A₈. The amplification of A₅ can be varied with P₁, so that the level of the low-frequency signal can be matched to that of the high-frequency signals. Note that the component values given in parentheses are the calculated values, which perfectionists may try to approach. The power supply is a symmetrical design with short-circuit protection, which also prevents annoying "plops" at on and off switching. If a different cross-over frequency is required, refer to *Active Cross-over Network* in the *October 1984*

(p. 10-22 issue of *Elektron India*)
In the design stages, stability problems were encountered when opamps with JFET inputs (TL074;

LF353, for instance) were used, whereas types with bipolar inputs, such as the NE5534 and the LM833, worked perfectly. The reason for the

instability in the JFET types is not known.

(Sv)

car burglar alarm

49

L. Nunnink

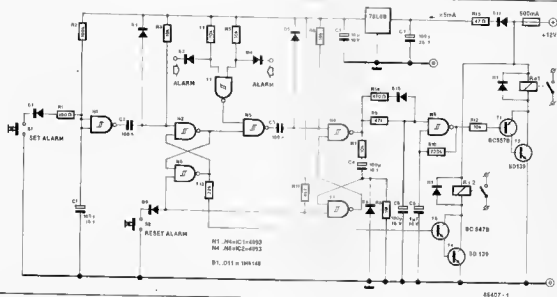

This versatile and yet easy to build circuit may be used as an effective deterrent against criminals attempting to steal what you are bound to consider a highly valued and indispensable piece of property: your car. Extremely simple to control, the circuit leaves the car owner 15 seconds to get out of the vehicle after he has set the alarm. Upon return, he deactivates it again by pressing a hidden reset switch within 7 seconds after having opened the car door(s). Criminals who (hopefully) have not been able to locate the reset switch within the 7 second delay will regale themselves and their accomplices, if any, with a 100 seconds long, intermittent car horn concert which, ideally, should stop them from pursuing their nefarious activities and, in short, scare them off. Also, the lawful owner of the vehicle is alerted by the horn sound that something is amiss, requiring appropriate action. The present circuit offers the possibility to connect several types of alarm activating devices, such as a vibration and/or ultrasonic detector, a window breakage sensor, etc., provided these supply an active low output level when an alarm condition exists. However, it is also possible to

use the courtesy light switches for this purpose, since these usually connect to the car body when a door is opened. To understand the operation of the alarm, refer to the circuit diagram and assume that the circuit is in the non-activated mode. On leaving the car, the user presses the 'set alarm' button, which leaves him some 15 seconds to actually get out and lock the door(s); the 15 second interval is determined by network R3-C1; the N5-N3 bistable will toggle after this delay and activate the alarm proper (watch function). Note that this condition may be signalled by a suitable LED driver circuit instead of RE2 as shown in the circuit. Only when on of the alarm inputs goes low (i.e. active) will monostable N5-N7 toggle and start a 100 second interval, as determined by network R4-C4. However, the horn will not sound immediately, since network R5-C5 provides a 7 second delay to reset (deactivate) the alarm before oscillator gate N6 intermittently switches the horn relay transistors T1 and T2. Note that the horn will stop sounding after 100 seconds, but the alarm will remain in its activated state, i.e. any alarm condition signalled by the sensor devices or the door contacts

will set it off anew and cause another round of horn sounding. As already stated, T3, T4, and R15 may be connected to the N5-N3 bistable to provide a LED indication of the activated state of the alarm. Instead of the LED, a relay may be connected to break the ignition coil primary connection. It should be noted, however, that this relay can not be used in cars with electronic ignition; in this case, another means for disabling the car ignition system should be arranged with the alarm in its activated state. The relays employed in this circuit are standard types as available from motorists' shops. The contacts of RE1 are simply connected in parallel with the existing horn relay contacts. Finally, note that it is of utmost importance to mount the entire circuit and the relay wiring in an out of the way position; the reset switch may be a coded or key operated type and must be fitted well hidden. Current consumption of the circuit in the non-alarm condition is so low as to hardly load the car battery. A voltage regulator section has been added to prevent the alarm from being triggered in error when the car is started. Sv

50

8-bit ADC

Before any analogue voltage can be measured and subsequently processed by a computer, a converter device with the necessary precision is required to provide the computer with the digital n -bit equivalent of the voltage as applied to the DAC circuit. Obviously, the higher n , the more steps involved in the conversion process, but also the higher the accuracy that can be obtained.

This 8-bit ADC circuit works with very few parts; yet it is versatile, fast, and sufficiently accurate for most purposes. The maximum input voltage to the circuit is arranged at 5V, as determined by the resistor network connected to the A_{in} terminal of the Type ZN427 ADC chip. Given this upper limit for V_m , the conversion accuracy equals $5V/(2^8-1) = 19.6mV/step$. Other input voltage levels may be accommodated by appropriate re-dimensioning of the input voltage divider.

Since the proposed ADC chip features an analogue-to-digital conversion time of only $10\mu s$ (typical value), alternating voltages may be measured (digitalized) and processed under machine language control; just as with the above DAC circuit, BASIC is usually not very suitable for this purpose, and its use is restricted to applications where timing requirements are less stringent. It will be understood that fast and therefore smooth computer response to, say, joystick movement is only feasible if the ADC reading subroutine is written in machine code.

A low SOC (start of conversion) pulse at the WR input of the chip triggers the internal voltage conversion pro-

cess and the BUSY output is activated (i.e. pulled low); this, in turn, enables Schmitt trigger gate N to generate the ADC clock frequency of about 900kHz. On completion of the clock-controlled conversion, BUSY goes high, and the CPU may read the 8-bit value contained in the ADC latch by activating the read line. Note that the SOC and read signals must be decoded with suitable circuitry as required by the type of computer or CPU. Provision has been made in the ADC circuit to select either the BUSY or BUSY signal in order to flag the conversion condition to the host

computer CPU.

Calibration of the present circuit is straightforward, since this merely involves setting two presets. First, a simple test loop may be written in machine language; next, adjust P1 (offset) for a computer reading of 0 with no input voltage applied to the circuit; P2 is set to give a reading of 255 (FF_{hex}) with the maximum input voltage at V_m , i.e. 5V. Finally, test the ADC linearity by applying 2.5V from a sufficiently accurate source; the computer should read 128 (80_{hex}).

HS

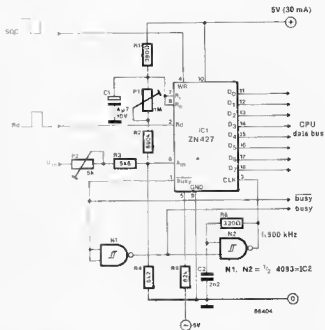

51

versatile timer

This simple-looking circuit enables the arbitrary programming of seven outputs in a series of not more than 2048 (2^{11}) steps. The step length may be set as required. The time base is derived from the mains voltage. Transistor T1 produces a square wave from the mains voltage applied to its base. This square-wave voltage is div-

ided by 10 in IC1, so that the frequency of the signal at the clock input of IC2 is 5Hz. Circuit IC2 serves as address counter for the Type 2716 EPROM. This means that IC2, after a reset, counts upwards from 0 and runs over the successive addresses of the EPROM. Circuit IC2 has twelve outputs which

would enable the use of a Type 2732 (4096 steps), but, on practical and financial grounds, a Type 2716 is used here since 2048 steps are normally quite sufficient.

The outputs of the EPROM are buffered by a Darlington array, IC3, so that seven switch outputs are available with a sink capacity of

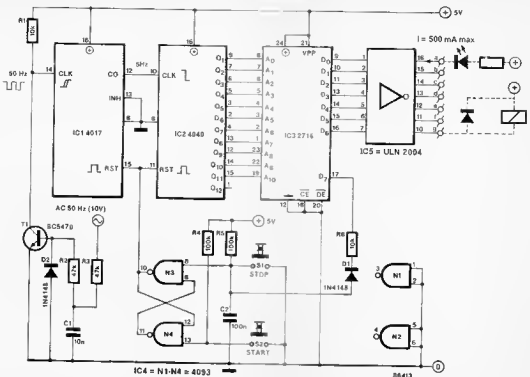

500 mA at a maximum voltage of 50 V. The eighth output contains the stop-bit that provides the facility of stopping the programme if this is shorter than 2048 steps.

The start-stop circuit is based on bistable N₃-N₄. When the supply is switched on, IC₂ ensures that the bistable resets from the stop state. This means that both divider IC₁ and counter IC₂ are in position "zero". The first address in the EPROM must, therefore, have a neutral content, because it is addressed in the stop state and thus appears at the output.

The bistable is set, and both resets cleared, when the start button is pressed. Circuit IC₁ then commences to divide, and IC₂ starts to count. With the present time base, the programmed content of successive addresses will appear at the output of the buffers at 0.2 s intervals. Counting continues until a stop-bit appears at pin D₇ of the EPROM, or stop button S₁ is pressed. If required, a HOLD function may be obtained by connecting a switch across capacitor C₁, which enables the time base to be switched off.

Switching on a specific output... merely requires the corresponding bit position in the EPROM to be left unprogrammed (logic high); programming a 0 disables the relevant output. The stop-bit operates with negative logic: a 0 therefore causes a stop.

Finally, the time base may be adapted for the setting of the required step frequency and accuracy. (Sv)

analogue & digital

52

Leafing through some electronics magazines published over the past few years, it is surprising how fast and vigorous digital techniques have come to the fore. Even audio, until recently virtually untouched, is now becoming digitalized at a rapid pace. What are the consequences of these changes to us engineers, technicians, and hobbyists alike?

As long as a circuit is totally analogue or totally digital, all is well. But as soon as these two techniques

become mixed strange things sometimes happen. Well-known examples are analogue-to-digital converters that will not give a stable reading the last few digits do not match and it appears as if there is a certain regularity in the deviations. Another example is an otherwise good amplifier that generates whistles in perfect rhythm with the digital clock oscillator. And so on...

Often, these flaws can be traced to faulty earth connections, i.e. the zero

supply line, or common ground. Because of that, here are a few tips that may prevent these annoying defects.

- Avoid earth loops.
- Keep the analogue and the digital earths separated
- Interconnect the analogue and digital earths at one point only, for instance, at the analogue-to-digital converter, but NOT at the power supply.
- If there are more earths, connect

these to the same common point.
 ■ At high frequencies, the impedances of earth lines are not negligible: short, thick wires should, therefore, be used.

An example that gives good results is shown in the accompanying drawing. All sensitive parts of the circuits have been isolated from those parts that carry (large) earth currents. Most converters have, therefore, two earth terminals, or an earth terminal and a differential input (which is the same thing).

In audio amplifiers most of us do not dream of wiring the power supply to the output amplifier via the preamplifier. In mixed analogue-digital circuits, such considerations are not so self-evident, although the principle is the same.

Note that in the accompanying drawing the system needs several electrically isolated power supplies; that is unfortunately the price often to be paid for new techniques. (W)

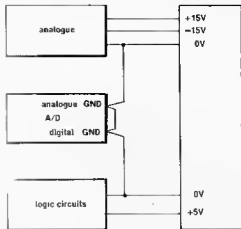

86436 · 1

53

electronic rotary switch

Sooner or later, most types of frequently used multi-way rotary switches develop contact resistance instability or other malfunctions, either caused by internal oxidation or wear and tear of the rotary mechanism. Broadly speaking, the same goes for multi-contact relays. It is, therefore, hardly surprising to encounter the electronic, free-of-wear equivalents of the above devices: *n*-way electronic switches and solid-state relays are at present available in a wide variety of contact arrangements.

The circuit diagram shows the electronic counterpart of a 16-way rotary switch whose pole is connected to earth. Two push buttons have been provided to enable the switch to be "turned" clockwise (up) or anticlockwise (down).

Debouncing bistables N_1 - N_2 and N_7 - N_8 supply a stable low logic level to monostables N_1 - N_2 and N_7 - N_8 respectively in order that these can output approximately $3.5 \mu s$ long pulses to the relevant input of up/down counter IC. The rising edges of the up/down pulse(s) cause this IC to generate the corresponding binary code at its $Q_A \dots Q_D$ outputs, which are connected direct to the $D_1 \dots D_4$ inputs of latching 4-to-16 decoder IC₂ which, in turn, activates

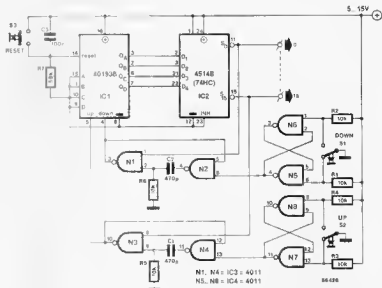

$N_1, N_4; IC_2 = 4011$
 $N_5, N_8; IC_4 = 4011$

86436

the next lower or higher output $S_1 \dots S_{15}$ if the relevant control button was activated. Provision has been made to "stop" the switch if this reaches its first or sixteenth position, which conditions cause the down or up monostable respectively to be disabled. Other switch configurations may be defined by using the

correct active-low outputs to block gates N_2 and N_4 when the desired stop positions are reached.

Finally, push button S_2 resets the counter IC and consequently causes IC₂ to activate its S_6 output, which is also the default switch position at power-on.

GD

Measuring Techniques

Chapter 1

The measured values of any parameters in a circuit are the most important for an Electronics Engineer or Hobbyist. They give the most reliable information about what is going on inside a working circuit. Even in case of a circuit which has stopped functioning, the measured values are of great importance because they tell us what is wrong with the circuit.

To understand more about the measuring techniques used in Electronics, we are starting a new series on "Measuring Techniques", from this issue of *Elektronik*. This and the subsequent articles in this series will explain how the measurements are carried out and with what instruments.

The expectation that a measuring device should work as accurately as possible is obvious. However the measuring instruments used by Electronics Engineers and Hobbyists show different types of tolerance ranges. An average multimeter has a tolerance value of a few percent. This leads to an expectation that the measured values would deviate by just a few percent from those mentioned in the circuit diagrams, or from the theoretically calculated values. Especially the beginner is very much surprised to see the measured values deviate considerably from the theoretical values, and to see that the circuit still functions correctly.

The reason for these deviations is mainly the tolerance on the components used in the

circuit. Resistors can have tolerances up to $\pm 10\%$. Condensators can have even greater tolerances. The current gain of a transistor can vary by 100% or more, and semiconductor threshold voltages can deviate from the expected value by 10 to 15% depending on the current and temperature.

Measuring instruments available in the market can be divided into two groups: Measuring instruments (or meters) with a fixed range for mounting permanently on the panels of various equipments, and measuring instruments with multiple ranges (like multimeters).

Meters with a fixed range

These type of meters have built in shunts or compensating resistors and their scales are calibrated with a fixed range. The important technical specification about these meters is printed in a corner of the scale provided with symbols.

Most frequently encountered symbols are











illustrated and explained in Table 1. The last entry "Class" indicates the accuracy of the meter. The figure shown indicates the maximum deviation from the actual value as a percentage of the full scale reading. For example, a 10-V moving coil meter of class 2.5 will give a maximum reading error of $\pm 2.5\%$ of the full scale value. That works out to an accuracy of ± 0.25 V. This deviation can occur at any measured value. A reading of 1 V on the scale means that the actual voltage is anywhere between 0.75 to 1.25 Volts. Thus the accuracy as a percentage of the actual reading at this point is $\pm 25\%$. To stretch the example a little further we can see that if we are trying to measure a voltage of the order of 0.25 Volts with such a meter, the deviation would be $\pm 100\%$.

High class laboratory grade meters generally have accuracies of the order of $\pm 0.1\%$ to $\pm 0.5\%$, but they are very expensive. On the other hand inexpensive meters can have accuracies

of the order of $\pm 1\%$ to $\pm 5\%$.

Most of the commonly used meters are of the 'Moving Coil' type. 'Moving Iron' type meters are occasionally used, as they are suitable for both AC/DC, however their sensitivity is less.

Table 1:

	Moving Coil Type
	Moving Iron Type
	Direct Current (DC)
	Alternating Current (AC)
	AC/DC
	Rated position - Vertical
	Rated position Horizontal
	Rated position Angular (for example 60°)
	Zero Adjust
	Test Voltage 500 V
	Test Voltage 2 KV
05	Class (for example 0.5)

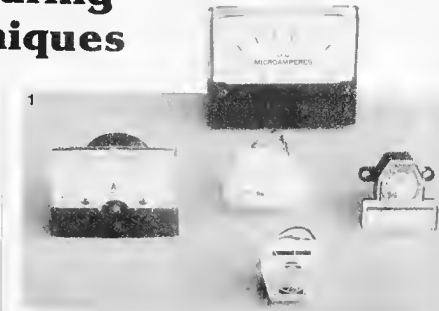

Meters with multiple ranges (Multimeters):

Multimeters contain a moving coil meter, but they also have a number of shunts and compensating resistors which can be switched. A rectifier and a battery is also included in the housing of the multimeter. By switching the ranges or by replugging the measuring leads into different sockets, one can use the multimeter as a Voltmeter, Ammeter or an Ohmmeter. The rectifier allows for measurement of AC voltages and the battery is required for measurement of resistances. The dial of a multimeter is marked with various scales for all the different ranges, however it is marked only with abbreviations due to lack of space on the dial. These abbreviations are explained in Table 2.

Operation of multimeters is quite simple but to avoid damaging the meter or getting incorrect readings, it is always essential that the instructions given in the operating manual should be followed.

Table 2

Legend	Description	Remark
VDC	DC Voltage	Reads values in V DC
mA	DC Current	Reads value in mA DC (Milliampere)
A	DC Current	Reads values in A DC (Ampere)
μ		b
Ω	Resistance	Reads values in Ω (Ohms)
K Ω	Resistance	Reads values in K Ω (Kilo Ohms)
VAC	AC Voltage	Reads values in V AC

Position of meter

Any meter must be used only in its rated position - i.e. Vertical, Horizontal or Angular. In any other

position the measurements may give incorrect readings. This will happen even if the meter is set to zero with the zero adjust screw before starting the measurements. The spring is so delicate that even the imbalance caused by the incorrect positioning of the meter gives rise to measuring errors.

Polarity

When measuring the DC Voltages or Currents, the polarity must always be observed. The black lead is always used for minus and the red lead is always used for plus pole. On a multimeter, the minus pole is marked as 'COM' meaning the COMMON lead. This is so because DC voltages are mostly measured with reference to the common ground line.

In case the polarity is unknown, the safest way to confirm the polarity is to switch the multimeter in the highest voltage (or current) range and touch the leads to the test points only momentarily. If the needle deflects in the reverse direction, remove the lead from the test point quickly, the leads must be interchanged to get the correct polarity.

Even in case the polarity is known but the voltage or current value is unknown it should be first measured on the highest range so as to get a rough idea about the order of magnitude. Then a suitable range should be selected to read the actual value. Generally the range for reading should be so selected as to get the needle in the upper one third of the scale. The measuring accuracy has lesser effect in the upper portion of the scale. Another important point to note is that the range switch should never be changed during measurement.

Direct Current

In some cases, the polarity of the DC current being measured is doubtful. A

2

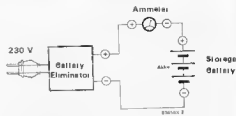

3

Multimeter in Resistance Range

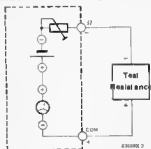

simple example is shown in figure 2. A storage battery is being charged by a battery eliminator.

In this case the plus pole of the eliminator is connected to the plus pole of the storage battery and it may seem doubtful whether the plus pole of the meter should be connected to the plus pole of the battery eliminator or the storage battery.

In such cases, the plus pole of the meter should be connected in the direction of the plus pole of the voltage source in the circuit. In the above example the battery eliminator is the voltage source and hence we must connect the plus pole of the meter to the plus pole of the battery eliminator.

Resistance Measurements

Before carrying out resistance measurements, it may be necessary to do the zero adjustment. For this, the test leads are shorted and the setting knob is turned so as to get the needle to read 0 Ω . This zero setting for resistance is

necessary for every range, and must be done when a new range is selected. If it becomes difficult to do the 0 Ω adjustment even with the knob in extreme position, it means that the battery voltage is very low. The battery must be replaced with a new one.

During the resistance measurements, the polarity of the test leads gets inverted in case of almost all multimeters. This is due to the resistance measuring circuit of the multimeter, which has the internal battery as the voltage source. The meter measures the current drawn by the test resistance from the internal battery. As the multimeter itself is acting as the voltage source in this case, the polarity of the test leads naturally gets reversed. The basic circuit of a multimeter for resistance measurement is shown in figure 3.

The polarity reversal of test leads has no effect on resistance measurement but it must be observed correctly while testing semiconductor devices. The 'COM' terminal acts as the plus pole in this case.

Loudspeakers

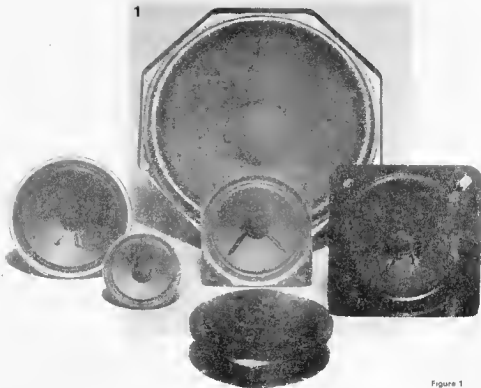

Figure 1
Different sizes of Electrodynamic
Loudspeakers

No audio system can work without Loudspeakers. You will find at least one in every radio set and many of them in a stereo system. How does this funnel shaped structure of paper and metal convert electrical oscillations into sound?

A loudspeaker is a sound transformer. Most loudspeakers are electrodynamic. The electrical current supplied by the amplifier to the loudspeaker flows through a coil. The magnetic field set up by this current interacts with the magnetic field of the permanent magnet inside

the loudspeaker and sets the coil in motion. This is due to the fact that the current is oscillating at the rate of several cycles per second. The coil is connected to the membrane in such a way that the coil sets the membrane also in motion. The sizes and shapes of these loudspeakers can be quite different, as shown in figure 1. Figure 2 shows the basic construction of a dynamic loudspeaker. The construction is quite simple as can be seen from the illustration. The most important part of the

loudspeaker is the permanent magnet. The magnet is circular in shape and like every other magnet, has a north and a south pole.

Loudspeakers with other shapes of magnets are also available but they are very rare.

The so-called pole plates are mounted on both sides of the magnet to improve the flux distribution of the magnetic field. The upper pole plate has a circular opening where as the lower pole plate has cylindrical core. There is a very small airgap between the core

and the walls. The smaller the air gap, the stronger is the magnetic field in the air gap. Figure 3 shows the schematic representation of the path of the lines of magnetic field. The north and the pole plates are drawn in section so as to make the inside view as clear as possible.

A moving coil wound on a paper tube is placed in the airgap and rigidly attached to the conical membrane. The membrane is funnel shaped and made of thin paper or plastic. The upper edge of the membrane is fixed to the metallic frame of

2

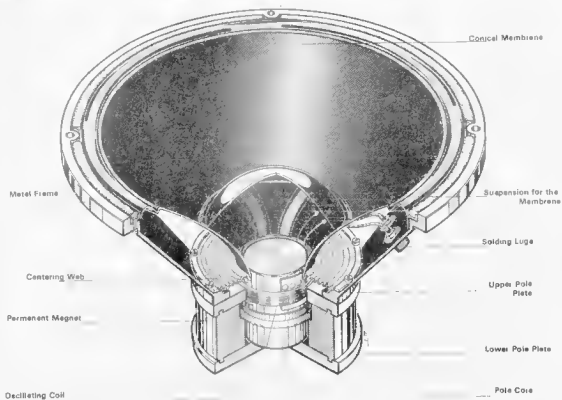

the loudspeaker through a rubber or special fabric suspension. This prevents the horizontal movement of the core and provides the necessary elasticity for vertical movement. The lower end of the core is held in place concentrically by a web, which ensures that the oscillating coil never touches the magnet core or the pole plates. The web also keeps the membrane in a stable position when no signal is fed to the loudspeaker. The alignment of the coil is very important, because the airgap available is just about a few tenths of a millimeter wide.

The terminals of the oscillating coil are brought out to two soldering lugs. The amplifier output is connected to these two lugs. Whenever a voltage is applied across these two lugs, the membrane is set into motion by the current flowing through the

3

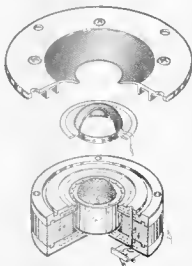

Figure 2
A sectional view of the inside structure of the loudspeaker, showing the details of parts used in the loudspeaker.

Figure 3
At the center of the loud speaker is a permanent magnet, the most important part of the loud speaker.



coil. If the current is AC, then a sound is produced depending on the frequency of the AC current. If the current is DC, then the membrane moves forward or backward only once depending on the direction of DC current and produces just a click. If you can get hold of an old loudspeaker which is still working, this experiment can be easily carried out using a 1.5V battery coil. It can be observed that the membrane moves forward or backward depending on how the cell is connected to the terminals. The movement increases with increase in the supplied

current. The amplifier must be capable of supplying sufficient current to produce the movement of the membrane.

The movement of the coil in the airgap can be explained as follows:

An electrical conductor carrying a current produces a magnetic field around itself. In case of the loud speaker coil the signal current flowing through it is responsible for producing a magnetic field. This field interacts with the field of the permanent magnet. As the opposite poles of two magnets attract each other and similar poles repel each

other, the coil is also repelled or attracted by the permanent magnet depending on the polarity of the magnetic field produced by the coil.

An oscillating current through the coil produces an oscillating magnetic field and sets the coil in oscillating motion. Along with the coil, the membrane is also set in oscillating motion. However, the suspension of the membrane at the top restricts the motion of the cone and limits the deflection. The strength of current flowing through the coil decides the deflection of

cone and thus the amplitude of the sound produced. The frequency of oscillations of the cone is decided by the frequency of the signal current, and this also decides the frequency of the sound produced. The movement of the membrane is transmitted to the surrounding air and thus the output signal coming from the amplifier is finally converted into sound waves by the loudspeaker.

Most of the loudspeaker boxes used in stereo systems contain many individual loudspeakers of different shapes and sizes. The reason for this is that any single loudspeaker can not reproduce all the frequencies equally well. The loudspeakers with large diameters and large, heavy membranes can reproduce low frequencies much better. A light membrane of small size is much more mobile and can move rapidly with high frequency sounds.

In addition to the loudspeaker principle described above, there are a few other types also available, such as the Electrostatic loudspeaker, Strip loudspeakers and Piezo loudspeakers. The most well known and most frequently used type however is the Electrodynamic loudspeaker.

Figure 4

Speaker Boxes are mostly equipped with three to five loudspeakers.

The Digilex-PCB is now available!

Price:
Rs. 85.00 + Maharashtra Sales Tax.
Delivery charges extra: Rs. 6.00

Send full amount by DD/MO/PO.

Available from:

precious[®]

ELECTRONICS CORPORATION
Journal Division

11, Shamrao Vithal Marg (Kln Lane)
Off Lamington Road, Bombay-400 007

Magnetic Flux Photograms

Magnetic force does not need a conductor like the Electric force needs in form of cables and wires. Magnetic force can act independently through space, without a visible connection. However, we can make the lines of magnetic force visible using an interesting technique.

One or more magnets are kept on a flat surface and a paper is placed on top. Now some iron filings are scattered on the paper. These iron filings align themselves with the magnetic lines of force of the magnets lying below the paper, thus making the magnetic lines of force visible. While scattering the filings on paper they should be rubbed between the fingers like a pinch of salt, so that they fall uniformly on the paper.

All you need to do this simple experiment is a few magnets, a paper and some iron filings. If you are

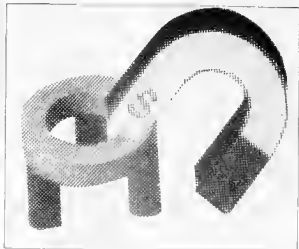

planning to buy the iron filings from a shop, you will be very much disappointed as these are not available in shops!

You will have to get them either from a small workshop, or file a bolt from the junk box into iron filings yourself, and collect the filings with a magnet.

The patterns generated by the iron filings can be very fascinating as can be seen from the magnetic flux photograms reproduced here. These are nothing but the images of the magnetic flux lines captured photographically using iron filings. All we have to do is replace the ordinary paper

from the previous experiment by a photosensitive paper and expose it using an enlarger or an ordinary white light bulb and then develop the paper and fix the image. Obviously, this has to be done in a darkroom. The shadows of the iron filings can be seen in the photogram as white spots, and the remaining area which gets exposed to the light, becomes totally black after developing the paper. If an enlarger is not available, a 25 W bulb or a table lamp can be used for exposing the paper. However, if the enlarger is not used, the result will not be very sharp.

Amateur photographers will need no more instructions, and can go ahead on their own without reading further. But for those who are new to this subject and would like to try their hand at photography on this occasion, here are few guide-lines.

A light sensitive photographic paper must be always stored in dark until you want to expose it. However this paper is not sensitive to red light. The working table for this experiment can therefore be illuminated with a red light using a dark room bulb. You can temporarily convert a room in your house into a dark room using black curtains. Even your bathroom can be used for this purpose. An ordinary 25 W white bulb or a table lamp can be used for exposing the photographic paper. For best results, a high intensity (known as hard) paper must be used.

Keep the magnets on the table and place the photographic paper over them with its emulsion side up. (The emulsion side is shiny.) Now scatter the iron filings on the paper and expose the paper with the white light for about 2 to 4 seconds from a

distance of about 1 meter.

Trays can be carried out on small strips of paper to get the correct exposure time so that a good black background is produced for the photogram.

After exposing the paper the iron filings are collected on another piece of ordinary paper and preserved for the next exposure. The exposed photographic paper is now developed and fixed.

For developing and fixing, three trays will be required containing the solutions. First tray has the developer.

Second tray has water mixed with a few drops of Acetic acid and the third tray has the fixer solution in it. Developer, Fixer and Acetic acid will be available in any Photo goods shop.

The first bath makes the black and white pictures visible after developing in it for about 1 to 2 minutes. The paper is

transferred to the second tray after the picture becomes visible. The dilute solution of Acetic acid (or vinegar) can be used instead of acetic acid. This stops the developing process and rinses off the residues of the developer.

In the third tray we have the fixer solution, made as per instructions on the packet of the fixing salt powder. This bath makes the paper insensitive to light within 2 to 3 minutes. The picture now becomes stable. Leave it in this bath, upside down, for about 10 minutes and then rinse it under running water for another 15 minutes.

The paper can now be kept on a news paper to dry, with the picture side up.

In all three baths, photographic paper must be continuously moved side wise, using three clean plastic clamps. These will also be

available in a photo goods shop. Under no circumstances the solution from second and third tray should go into the first tray. The developer becomes neutralized if it comes in contact with acetic acid or the fixer solution.

When carrying out the tests on strips of photographic paper if the paper does not develop to dark black, increase the exposure time. If it becomes too dark and even white areas start becoming grey or black, reduce the exposure time. You will be able to decide on the correct exposure time after a few trials.

If you follow the instructions on the bottle of developer and the packet of fixing salt powder correctly, there is no reason why the experiments should not produce good photograms.

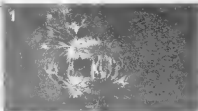

Figure 1
The magnetic field of a horse-shoe magnet

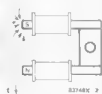
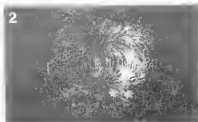

Figure 2
Electromagnet used in an ordinary doorbell produces almost same result as the horse-shoe magnet

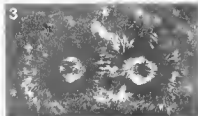

Figure 3
The field between two magnets taken out from an old TV Set. These magnets are used on the picture tube neck.

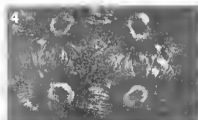

Figure 4
Field lines between four magnets. The lines connect the magnets together. In addition to these we can see even the lines joining the North-south poles of each individual magnet.

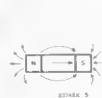

Figure 5
Lines from North-South poles of a vertically placed horseshoe magnet. Lines leave the poles like rays.

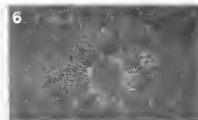

Figure 6
An iron ring joined to North poles of three rod type magnets. The lines move out in all directions. (Actually they bend downwards to the south poles.)



Figure 7
The magnetic field lines produced by a coil carrying about 3 amperes of DC current. In spite of such high current, the lines are very weak. This is because the number of turns in the coil are less.

How does a transformer work ?

How does a transformer work ?

"A transformer increases or decreases the AC voltage given to it"

"I know that, we give the mains voltage at one end of the transformer and a lower voltage comes out at the other end of the transformer"

"The one end where we give the voltage is the input and the other end is the output. In technical language it is called primary and secondary. The input terminals are the primary terminals and the output terminals are the secondary terminals."

"But I don't still understand how the current comes from the primary to the secondary? I have checked the connections of a bell transformer using a multimeter. There is no continuity between the primary and the secondary side."

"That is right. The transformer is intentionally so designed that there is no connection between the primary and secondary. We don't want the 230 V mains voltage to be connected to the bell head."

"But how will the current flow to the bell without a connection?"

"This is done by magnetism! The input terminals lead to the primary winding and the output terminals come out from the secondary winding. When a current flows through a winding, which is nothing but a coil, it produces a magnetic field."

"Quite clear, that means a transformer is just an electromagnet!"

"No, not just that, because the transformer winding is connected to an AC Voltage, and an AC current continuously changes direction."

"That means the magnetism in the transformer also continuously changes its direction."

"Yes, the magnetic field is also an alternating field."

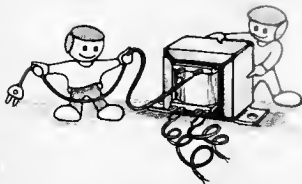

"But what makes a current come out of the secondary side?"

"The alternating field produced by the current flowing in the primary coil also passes through the secondary coil and the secondary coil transforms this magnetic field again into a voltage across itself."

"Oh, I see, then this is the reason why we call it a transformer!"

"And as the magnetic field needs no wires for conduction, there is no electrical connection between the primary and the secondary."

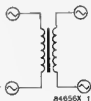

"What is this thick black line between the two coils of the transformer symbol?"

"It represents the Iron Core of the transformer."

"Is this same as the block of plates in the transformer?"

"Yes, these plates are the iron laminations built into a bundle. The magnetism travels, better through iron than through air. Very little magnetic energy is lost when passing through iron."

"And that is why we get a lower voltage at the secondary, is it?"

"No, it has nothing to do with the loss of magnetic energy. The value of the voltage at the secondary is decided by the ratio of the number of turns in the primary and secondary windings."

"I still don't understand how the voltage can be increased by the transformer."

"That is obtained by winding the secondary coil to have more number of turns compared to the primary. This however, reduces the current output at the secondary."

"And why is it so?"

"Because the total energy remains same at the input and output, so a higher voltage must be accompanied by a lower current and a lower voltage with higher current."

"Just like the gears of a car! In the first gear, one can drive at a lower speed but with greater force."

"Yes, that is very interesting comparison."

"Tell me, is there also a reverse gear in electronics?"

1

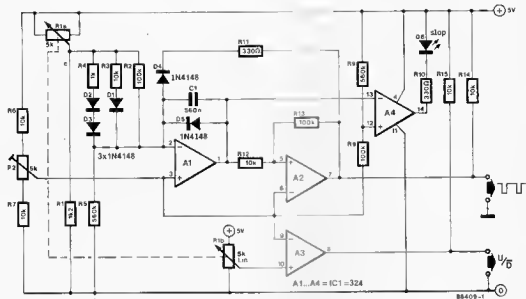

Various designs of clock generators have appeared in previous Summer Circuits issues of *Elektor Electronics*, and this tradition is kept up with the present design which, unlike the other circuits, outputs an up/down indication as well as a rectangular signal over a wide frequency range; 0 Hz to several kHz. The output signal and the U/D indication are both controlled by a single potentiometer. If this is set to the centre of its travel, nothing happens; turning the potentiometer in the clockwise direction causes the U/D output to be at logic high level, and the frequency of the output signal rises with turning P1 further in this direction. The same goes for turning it anti-clockwise, U/D being at low logic level.

The basic operation of the circuit is as follows. Operational amplifiers A1 and A2 together constitute a sawtooth/square wave generator. The falling edge of the sawtooth voltage has a fixed duration of about 200 μ s, as defined by the current through D4. The rising edge time, however, depends on the voltage at the wiper of P1. The wiper of P2 is arranged to be at a slightly higher voltage than that at the wiper of P1, when this is set to the centre of its travel. The STOP LED will light in this

condition. If P1 is turned in either direction, the voltage across R1 rises and causes a low current to flow through R1. This current, and therefore the output frequency, is proportional to the position of the wiper of P1, but this only goes for a limited frequency range. If the voltage across R1 exceeds about 0.6 V, D1 conducts and connects R1 in parallel to R2. D2 and D3 do the same for R4 at about 1.2 V; this method causes the oscillator frequency to be an exponential function of the voltage, set with P1; the arrangement ensures a considerable output frequency range for the oscillator A1-A2. Together with one or more universal counter modules the proposed

clock generator may offer a neat replacement of the well-known BCD coded thumbwheel switches; the potentiometer-set value is present at the Q1...Q4 outputs of IC2, as well as visible on the seven-segment display. The U/D and clock output of the present generator are connected to the relevant points on the modules, as explained in the above mentioned article, but remember to observe the different supply voltages of clock generator and counter module; keep all points marked +5V at that voltage, except the supply pin of the LM324 and R10 and R15, which are connected to the counter module +12 V supply. Current consumption of the present up/down clock generator is modest at about 10mA.

PT

2



55

narrow-band IF filter

Since good crystal filters are expensive, there is a constant search for (less expensive) alternatives. One of these is the ceramic filter, now widely used as IF filter in short-wave receivers. The somewhat poorer temperature characteristics of ceramic filters (as compared with those of crystal filters) are normally not of much consequence.

Numerous experiments have finally led to the circuit of Fig. 1, which uses five 455 kHz ceramic filters. As computer crystals can be obtained cheaply nowadays, it would also be possible to construct a similar filter with a number of such crystals.

The result of our experiments is a

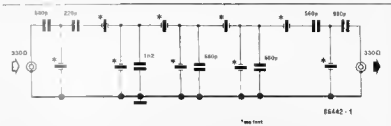

3 dB filter bandwidth of about 800 Hz; the attenuation outside the pass-band is of the order of 60 dB.

A possible application is its use in a receiver with variable bandwidth for SSB, AM, and FM operation.

Another application is as input filter

in a receiver whose dynamic frequency range is inadequate (but the IF should then not be 455 kHz).

Finally, note that correct matching of both the input and output impedance (330 ohms) is imperative.

(B)

56

current indicator

G Schumann

1

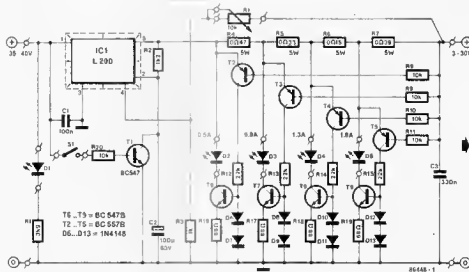

Who has not sometimes wished that the power supply he was using had a voltmeter AND an ammeter? Unfortunately the high cost of such units prohibits their use in many situations. The proposed circuit, which does not include the input section of the power supply, can be built from standard components, except for the low-value 5-watt resistors.

We shall not dwell on the well-known Type L200 voltage regulator, but shall confine ourselves to the current indicator section.

Fig. 1 shows that the circuit contains five LEDs: one (D₁) to show whether the supply is switched on, and the other four to indicate the current consumption in steps of 0.5 A; 0.8 A; 1.3 A; and 1.8 A. As may be deduced from these figures, the unit is capable of providing up to 2 A at an output voltage anywhere between 3 V and 30 V. The colour of the LEDs is immaterial, although it would be useful if the final one would be red to show that maximum current is being drawn.

2

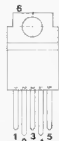

- 1 = input
- 2 = limiting circuit
- 3 = ground
- 4 = reference voltage
- 5 = output
- 6 = ground

Parts list

Resistors

- R₁ = 3k Ω
- R₂ = 1k Ω
- R₃ = 1 k
- R₄ = 0.47 Ω , 5 W
- R₅ = 0.33 Ω , 5 W
- R₆ = 0.15 Ω , 5 W
- R₇ = 0.39 Ω , 5 W
- R₈, R₉, R₁₆, R₁₇, R₂₀ = 10 k
- R₁₂, R₁₃, R₁₄, R₁₅ = 22 k
- R₁₈, R₁₉, R₂₁, R₂₂ = 68 Ω
- P₁ = 10 k linear potentiometer

Capacitors*

- C₁ = 100 n
- C₂ = 100 μ F, 63 V
- C₃ = 330 n

Semiconductors*

- D₁, D₂, D₃, D₄ = LED
- D₅ to D₁₃ incl = 1N4148
- T₁ = BC547
- T₂ to T₅ incl = BC557B
- T₆ to T₈ incl = BC547B
- IC₁ = L200

Miscellaneous

- S₁ = SPST switch

3

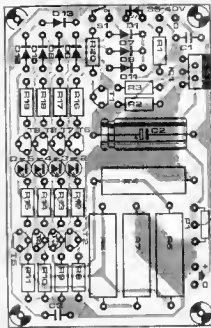
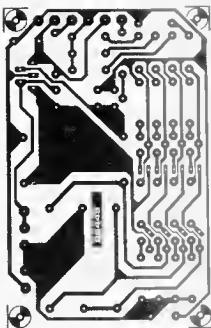

The non-standard resistors, R₄ to R₇ incl., "measure" the actual current consumption. Between point A and the positive output terminal there exists a potential difference. When this p.d. reaches a value of 0.6 V, T₁ and consequently T₆ switch on and thus causes D₂ to light. In the same way, when the p.d. between points B, C, and D respectively, and the positive output terminal reaches about 0.6 V, transistor pairs T₂-T₇; T₄-T₈; and T₅-T₈ switch on, and the associated LED will light.

Resistor R₂ and capacitor C₂ provide a soft start facility at switch-on. Transistor T₁ provides an emergency switch-off facility, which in practice has proved very useful. The input section (not shown) should consist of a mains transformer with 24 V; 2.8 A secondary; a bridge rectifier (e.g. B80C2200/3300), and a 4700 μ F; 40 V smoothing capacitor. The L200 regulator should be mounted on a suitable heat sink. This device has internal short-circuit and overload protection; its pin assign-

ment is given in Fig. 2.

(R)

alternating flasher

57

R Kambach

The proposed circuit is intended for use by modellers at railway crossings, work in progress, advertising boards, and many others. It can be built quite quickly from but a handful of components.

In the accompanying diagram, A₄ determines the flashing frequency, which may be altered by changing the values of R₂ and, particularly, R₃. The latter may be replaced by a suitable preset if the frequency needs to be varied often.

Inverters A₂ and A₃ function as fixed delay elements, while A₄ inverts the drive to D₂. The alternately flashing LEDs may, of course, be of any colour suited to the application.

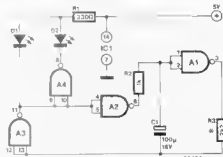

A1...A4 = IC1 = 7400

* See text

58 low-drop voltage regulator

Integrated 3-pin voltage regulators are not suitable for use where the input and output voltages are nearly equal. In fact, with most such regulators, the input voltage is typically 3 V higher than the output potential. To cater for situations where the two voltages are nearly equal, it is necessary to use discrete components. The series transistor is then connected in a common emitter circuit, so that the output voltage is lower than the input voltage only by the saturation voltage of the transistor. However, it is then difficult to provide short circuit protection as is the case in integrated regulators. But, where there is a will, there is a way. In Fig 1, the series transistor obtains its base current from T_2 , which together with T_1 forms a differential amplifier. This arrangement ensures that the junction of voltage divider R_4 - R_5 has the same potential as the cathode of zener D_2 . The crux of the circuit is that T_1 has a certain current amplification, but T_2 can only provide it with as much base current as R_2 allows. The potential difference across R_2 has a maximum value of the zener voltage minus the base-emitter voltage, U_{BE} , of T_2 , which in practice is about 4 V. The maximum current through R_2 is, therefore, about 11 mA, so that, assuming that T_1 has a current amplification of 50, the maximum output current is 0.55 A. If a higher current is drawn, the output voltage will drop. If it drops below the zener voltage of D_2 , the p.d. across R_4 will drop also. The result is that the output current will behave as shown by the fold-back

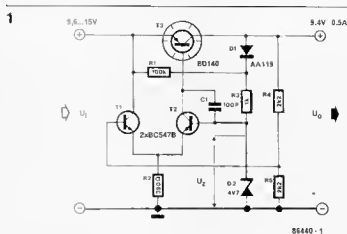

characteristic in Fig. 2. It is clear, therefore, that the series transistor is protected against high (short-circuit) currents.

Diode D_1 and resistor R_1 provide a soft start, because the voltage across the diode, which is connected to the output of the regulator, is nought at switch-on. Since the circuit, because of the high gain, has a tendency to oscillate, capacitor C_1 is included to improve the stability. The output voltage level, U_0 , can be freely selected, within the limits of the series transistor, by D_2 , R_4 , and R_5 , and is determined from

$$U_0 = U_Z(R_5 + R_4)/R_5$$

Resistor R_5 must be matched with the actual current amplification of the transistor used. The maximum dissipation of a well cooled BD140 is of the order of 5 W. If a noise-free output is required, an additional 10 μ F

$$U_0 = \frac{R_4 + R_5}{R_5} U_Z$$



electrolytic capacitor should be connected in parallel with D_2 . The circuit will then have a real soft start. There will be no output for about 0.2 s after switch-on (R)

59 HCMOS VCO

Crafty designers are forever trying to use ICs for applications they were never intended for. In this circuit a member of the newish HCMOS family is used as a voltage-controlled oscillator (VCO). This is achieved by using the characteristic of the HCMOS family of operating from a 2 to 6 volt supply. However, at 6 V these ICs are faster than at 2 V. In the present circuit, a "supply voltage" variable between 1.5 and

5 V is used as the input signal of the oscillator, which consists of three cascaded NAND gates. The VCO operates as follows: a logic 1 at pin 2 causes a logic 0 at pin 3; this becomes a 1 at pin 6, and a 0 at pin 8. Pin 8 is, however, connected to pin 2, which, therefore, is no longer 1 but becomes 0. This 0, because of the delay times of the gates, appears a little later at pin 2 as a logic 1. And so on, the oscillator works! Gate N_4

functions as a buffer for the oscillator output. Since the peak output voltage cannot be greater than the supply voltage, i.e. the input voltage to the oscillator, its level must be adapted to those at the remainder of the circuit, which normally will be 5 V. This is ensured by inverter N_5 , which is powered by a genuine 5 V supply. Because of feedback resistor R_1 , the inverter is arranged as a linear amplifier. It is

1

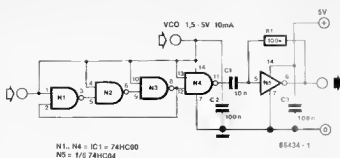

therefore, sufficiently sensitive to amplify positive signals between 2 and 5 V adequately. The characteristic in Fig. 2 shows that the VCO is reasonably linear. Other

output frequencies are not possible with the circuit of Fig. 1, unless the number of gates in the oscillator proper is varied by an even number of identical gates, which

2

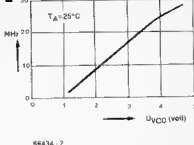

increases the total delay times, so that the frequency is lowered. It is also possible to add dividers to the output circuit. (W)

super dimmer

60

1

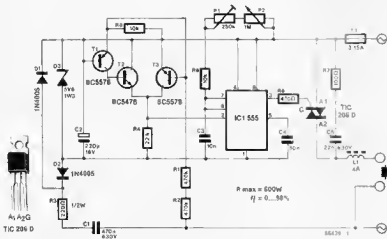

2

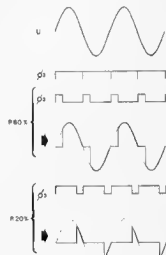

Most dimmers use a silicon-controlled rectifier (triac or thyristor) which is triggered at a fixed phase angle and then conducts until the next zero crossing of the mains voltage. This method is simple, but at the same time it gives problems in controlling small or inductive loads (hysteresis; flickering). The cause of these problems lies in the fact that owing to the small load the current supplied to the bases is insufficient to allow conduction to continue. This means that a region of the control characteristic is not used. The effect is even worse when the load is inductive.

The proposed circuit offers a solution by providing the SCR continuously with gate current, so that even loads of 1 watt can be controlled. To keep the circuit as small and simple as possible, it makes use of the well-known timer buffer Type 555. The output of the 555, which is normally active high, is made active low with the aid of a negative supply voltage. The supply is provided by network C_1 - R_3 , rectifier D_1 - D_2 , and stabilizer D_3 - C_2 . Transistors T_1 to T_3 provide a start pulse at the trigger input of the 555 during the zero crossings of the mains. For a period determined by the setting of P_1 and P_2 , the

output of the timer is high, and there is, therefore, virtually no potential difference between pins 3 and 8, i.e. the SCR is turned off. When the set period has lapsed, pin 3 goes low and the SCR is triggered. For the remainder of the half period, a gate current flows which keeps the SCR in conduction. The minimum position at which, for instance, a light bulb just should not light, is set with P_1 . Filter R_7 - C_5 - L_1 provides the requisite decoupling of the SCR. Finally, note that the maximum power that can be controlled is of the order of 600 watts. (Sv)

61 car radio alarm

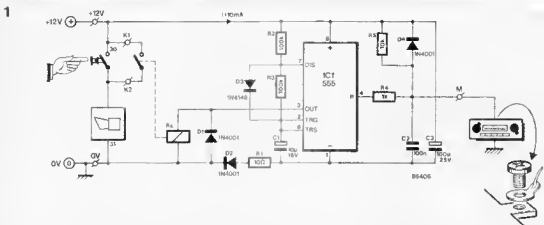

It is an unfortunate as well as a generally acknowledged fact that the car radio (plus cassette recorder) ranks among the most desirable and often surprisingly easy to steal objects on many a burglar's "shopping list". This circuit may help to prematurely end the criminal practice by sounding the horn if it is attempted to remove the radio set, cutting or unplugging an additional ground wire, which has been hidden in the cable for connection to the battery and loudspeaker(s), causes the alarm to be set off, since the connection to the car chassis (ground) is interrupted.

The circuit for the car radio alarm is

composed of a single timer, the well-known Type 555, surrounded by a few additional odds and ends to make an astable multivibrator, whose on-time is determined with C1. Horn relay Re should have a coil resistance to enable the timer chip to energize it direct by means of the voltage at output pin 3.

It is seen that the multivibrator is in the reset state as long as point M is connected to earth, i.e. when the set is in the place where it should be. Removing the car radio inevitably causes the voltage at M to rise to nearly 12 V, ending the reset state of IC, which responds with activating Re, i.e. the car horn, since this is

energized via the relay contacts in parallel with the horn switch in the steering wheel.

Note that Re is a PCB-mount type, e.g. the Siemens Type V23127-A0002-A101; where this is not available, any other type of small changeover relay having a 12 V coil may be wired to the circuit, provided the 555 is capable of handling the coil current;

Parts list

Resistors:

- R1 - 10 Ω
- R2 R3 - 100 k
- R4 - 1 k
- R5 - 10 k

Capacitors:

- C1 - 10 μ , 16 V electrolytic
- C2 - 100 n, MKT
- C3 - 100 μ , 25 V electrolytic

Semiconductors

- D1, D2, D4 - 1N4001
- D3 - 1N4148
- IC1 - 555

Miscellaneous

- Re1 - 12 V coil, single changeover*
- PCB 86406

* see text

2

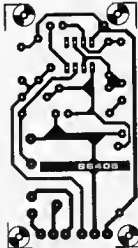
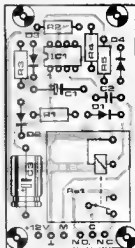

many motorists' and car repair shops can, no doubt, supply you with a suitable relay for the alarm circuit. The sense wire to point M should be hidden in the multi-wire cable to the

radio set, while the circuit itself must be fitted in an out of the way position, somewhere behind the dashboard. In order that not even an attempt is made to break into your car, it is, as

will be readily understood, prudent to stick adhesives to the car side windows, warning of the presence of the radio alarm. (Sv)

solid-state dark-room light | 62 |

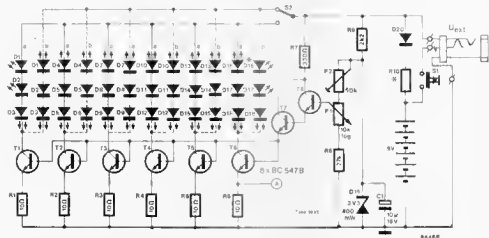

D1a - D18a LED red CQV 51H, CQX 54, CQW 24 2
D1b - D18b LED yellow CQV 53H, CQX 74

Light-emitting diodes are perfectly suitable for dark-room light, because they (a) obviate the need of filters; (b) emit cold light; (c) have a life that is not shortened by continuous on-off switching; and (d) do not radiate infra-rays. The types used must, of course, have a high light output; fortunately, there are nowadays LEDs with a luminous intensity of hundreds of millicandela.

The sensitivity of photographic paper lies between wavelengths 300 nm and about 550 nm, whereas the wavelength of the light emitted by green LEDs is about 565 nm; that by amber types around 585 nm; and that by red LEDs about 640 nm. From this, it is clear that all three types of LED may be used with impunity. None the less, in practice, it is best not to use green ones. Because of the special composition and high sensitivity of colour negative paper, only yellow LEDs with reduced light output should be used when processing this paper. The proposed light, therefore, has provision for reducing the emitted light. Note that since colour reversal paper is sensitive to all colours, it can only be processed in total darkness. When working with

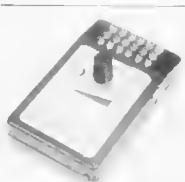

orthochromatic paper, only red LEDs should be used.

With reference to the diagram, each group of three LEDs is fed from a current source, T₁ to T₃ respectively. The current level, and consequently the light output of the LEDs, is determined by the setting of P₁. Zener diode D_z provides the reference voltage for the current sources, ensuring that the light output of the lighting unit remains virtually constant over the life of the PP3 battery. Maximum light output is set with the aid of P₂. To this end, both P₁ and P₂

are first set to maximum resistance, after this, P₂ is adjusted until a potential of 0.2 V is measured at point A. The maximum current through the LEDs is then about 20 mA. As the photograph shows, the unit has been constructed so that S₁ is easily operated. Since this switch is a press-to-make type, the light will switch off as soon as it is put aside, thus preserving the battery. It is possible to have the light on continuously by connecting an external battery to U_{ext}. In that case, R₁₀ must be matched to this source according to

$$R_{10} = (U_{ext} - 9) / I_0 \text{ [k}\Omega\text{]}$$

but only if NiCd batteries are used. If standard cells are used, D_z and R₁₀ must be omitted.

If a variety of photographic paper is processed, it may be useful to be able to switch between red and amber LEDs. For that purpose, each of the eighteen original yellow LEDs is duplicated by a red LED, shown in dashed lines. Switch S₂ may be used to select the relevant bank of LEDs (red or yellow) as required for the specific application. (R)

The computer-based implementation of certain iterative types of calculation may offer highly attractive graphics screen representations, as we got to know when keying in a program to crunch a few numbers in the Mandelbrot series, and found that doing so with the support of the computer's graphics facilities took us through a regular graphics adventure.

On further investigation, it was found that the degree of complexity of the resultant graphics image is in direct proportion with the number of iterative steps the control program is arranged to perform. However, since the necessary calculations to obtain a Mandelbrot series become the more complex, and therefore time consuming, as the computer crunches through its approximations and evaluations, it should not strike the programmer as odd that obtaining a nicely detailed graphics image may take as long as 12 to 24 hours, even with the fastest types of personal or semi-professional types of computer, such as the BBC equipped with a second processor.

The Mandelbrot series of numbers is basically obtained with the use of complex numbers, in a calculation that converges rather than diverges the intermediary results according to the equation $Z=Z^2+C$, where C is the complex number constant having a real part between -2 and 1 , while the imaginary part ranges between $-1.5i$ and $1.5i$; Z is the result of the preceding calculation.

Stepping through a section of the series is possible by assigning start values and/or differently dimensioned step rates to either the real or the imaginary part of C . It goes without saying that calculation time and image resolution increase with the number of iterations used for obtaining results in accordance with the set requirements; the calculations may be stopped when the result is larger than 2 . The colour assigned to any pixel on the screen depends on the number of iterative steps required to satisfy the Mandelbrot equation; if this is not the case, the iteration loop is consequently aborted.

The program shown in Listing 1 has been written for the Electron or BBC computer, and arranges for 15 iterative steps; the screendump of Figure 1 shows the result. Figure 2 illustrates how a section of the

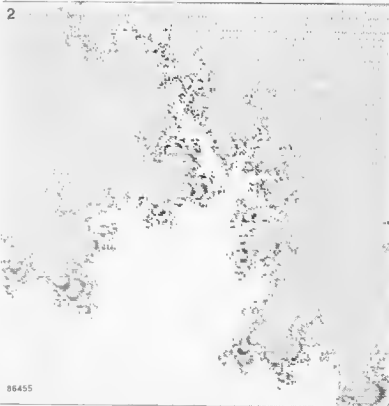
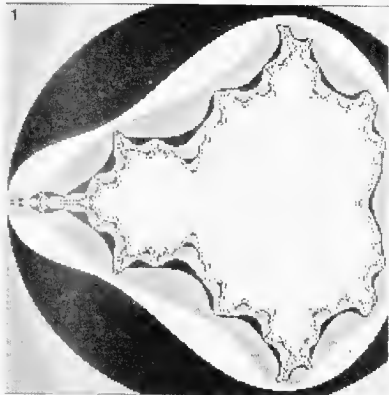

86455

Listing 1.

```

>L
10 REM MANDELBROT
20 NODE 1
30 REM MAXIMUM X AND Y PICTURE COORDINATES
40 MAXX=280 REM MAXX/70#
50 VDU23 1,0:9,0,0 REM CURSOR OFF
60 VDU19,2,2,0,0,0 REM GREEN FOR YELLOW
70 REM DEFINE DISPLAY WINDOW AT CENTRE OF SCREEN
80 VDU24,640-MAXX/2,512-MAXX/2;640+MAXX/2,512+MAXX/2.
90 VDU25,640-MAXX/2,512-MAXX/2.
100 REM DEFINE TEXT DISPLAY AT BOTTOM OF SCREEN
110 VDU26,0,31,99,26
120 REM DEFINE ANGLE AT BOTTOM LEFT. ANGLE=AngleR*AngleI:
130 AngleR=-2 AngleI=-1.25
140 REM LENGTH OF SIDE IN COMPLEX SURFACE
150 Side=2.5
160 REM DISTANCE BETWEEN TWO POINTS IN COMPLEX SURFACE
170 Distance=Side/MAXX
180 T=TIME
190 REM CALCULATION
200 FOR YX=0 TO MAXX STEP 4
210   FOR XX=0 TO MAXX STEP 4
220     REM C=CR+CI
230     CR=XX*Distance+AngleR C1=YS*Distance+AngleI
240     REM Z=ZR+ZI. Start value for Z equals C
250     ZR=CR ZI=C1
260     Iteration%=0
270     REM Z=Z^2+C where Z^2=ZR^2-ZI^2+(2*ZR*ZI)
280     REPEAT
290       A=ZR^2-B=ZI^2 Length=SGR(A+B): ZI=2*ZR*ZI-C ZR=A+B+C
300       Iteration%=Iteration%+1
310       UNTIL Length>0R Iteration%>15
320       GOTO 8, Iteration%MOD4
330       PLOTSG.XX,YX
340     NEXT
350   CLS
360   PRINT 'TIME'-(TIME-T)/100 ' S'
370 NEXT

```

graphics image is enlarged by means of relevant redefinition of the equation variables, as outlined above. Obviously, the suggested program allows a good deal of further patching and experimenting to arrive at even more attractively styled graphics designs, but it should be pointed out that producing Fig 2 took our BBC no less than... 2 days!

(S)

car radio alarm | 64 |

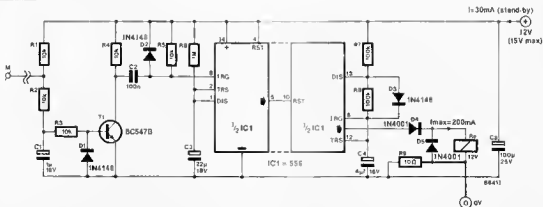

The purpose of this one-chip circuit is to give an audible alarm in case a thief attempts to steal the car radio, which is generally considered an item of prime importance to the motorist's well-being during any trip with his vehicle.

Since removing the car radio necessarily involves cutting or unplugging the supply cables, the present circuit detects disconnection of an extra earth lead, which has been fitted to the rear side of the car radio (metal) housing. In the circuit diagram, this point is marked as M. If M is at earth

potential, T1 is off (high collector voltage); if the earth connection is cut or unplugged, the voltage at M rises to a positive level, T1 conducts, and a negative-going pulse triggers timer IC1, which has been arranged to provide a 30-second timing interval as defined with R6-C3. The second timer contained in IC1 functions as a 0.5 Hz (R1-R4) oscillator section with an output duty factor of 50% (D3). Note that the Type 555 dual timer chip directly energizes a 12 V, low-power relay, whose contacts are connected in parallel with the horn

switch in the car's steering wheel. If it is attempted to steal the car radio, the alarm intermittently sounds the horn for 30 seconds. It is, of course, imperative that constructors of this car radio alarm locate the additional earth connection on the radio set in such a way as to necessitate disconnection at an early stage of attempted theft, otherwise the alarm would come on too late, enabling the thief to get off at his leisure.

Sv

65

deceptive lock

This circuit offers a means to fool all but the cleverest burglar, but, although it is a clever design, it has been kept simple, as a glance at the diagram will show. On the surface it looks like a simple operating panel with ten push buttons. However, anyone trying to open it illegally is in for a surprise! It is not just a matter of keying in the correct code, it is also necessary to keep one of the keys depressed for about 10 to 15 seconds. The circuit is based on a single Type CD4093, which contains four NAND gates with Schmitt trigger inputs. Gates N_1 and N_2 form a bistable that contains the status of the lock.

Assuming that the circuit has been off for some time, switching it on causes network R_1 - C_2 to set the bistable to the "lock" position, that is, the output of N_2 is logic low. Capacitor C_2 is discharged, and the only way the circuit can toggle is by recharging this capacitor. This is done by pressing key S_4 long enough for the trigger threshold of N_1 to be reached. When that happens, the bistable is set to the "open"

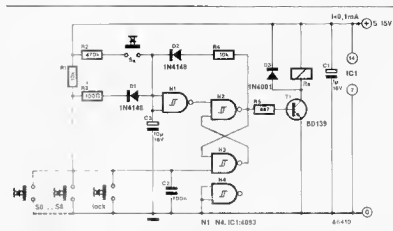

position, that is, the output of N_2 is logic high. Capacitor C_2 remains charged via R_1 - D_2 , even after S_4 has been released. In other words, the bistable remains in the "open" position. The lock is closed again when one of the other keys is pressed, or, if required, by means of a special lock key. This causes C_2 to discharge rapidly via

D_1 - R_3 , which returns the circuit to the "lock" condition. When the lock is "open", relay R_2 will also be open in the present circuit. It is, however, possible to have the relay energized in this condition by connecting the remaining free gate in the 4093 in series with R_3 as an inverter. (Sv)

66

noise gate

from an idea by A. Buhmeier

Noise on an audio signal becomes more troublesome as the signal itself becomes smaller. When a mixer is connected to a number of signal sources, it becomes particularly disturbing when one or more of these sources produce only noise. In these situations, a noise gate is a real help. Such a gate continuously monitors the level of the audio signal and switches it off, after a predetermined period, if the level drops below a preset value.

The circuit consists of two parts: a control section and a regulator section. The control section, based on opamps A_1 to A_4 incl., derives a voltage from the audio signal that is used to drive the regulator.

The regulator is a voltage-controlled amplifier, for which one of the two operational transconductance amplifiers contained in a Type LM13600 or LM13700 is used. For a stereo system, one control section

and two regulator sections are required. For a double mono version, two control sections and two regulators are needed. One LM13600 or LM13700 will thus suffice for all these requirements.

Opamps A_1 and A_2 form a full-wave rectifying circuit. Opamp A_3 compares the peak value of the signal with the direct voltage set by P_2 . If the peak value is larger, capacitor C_2 is charged via T_1 ; the attack time is set by P_3 . The time lapse after which the audio signal is switched off is determined with P_1 . The control of the voltage-controlled amplifier (VCA) and the LED indicating whether there is a signal present is effected by A_4 . Diode D_1 ensures that the amplification of the VCA is really zero when the output of A_4 is low (i.e. less than -15 V).

The input of the regulator section has an impedance of about 10 k Ω and is designed for audio signals of 1 V_{rms}.

However, even for a 12 dB higher input signal, the distortion is still not greater than 1 per cent. Where higher input voltages are the norm, the value of R_1 should be altered accordingly. Where lower inputs are the norm, a preamplifier should be used.

It is, therefore, seen that the noise gate should preferably be connected between the preamplifier and power amplifier.

The output level is set with R_5 , while P_1 enables the circuit to be adjusted for minimum switching noises. To this end, the drive input is switched on and off by S_1 , while the audio input remains open-circuit.

It is best to use a 3.5 mm chassis socket with break contact for the drive input: the break contact then replaces S_1 . As soon as the jack is inserted into the socket, the connection between the audio input and the regulator is broken.

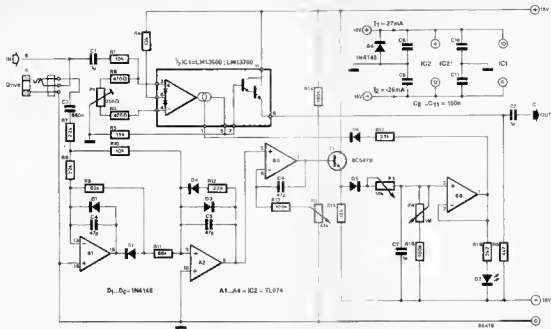

This type of drive input affords a number of special effects, such as the switching in of, say, an echo unit at the command (sufficiently high

signal level) of a given instrument (e.g. a snare drum). The command instrument is plugged into the drive input for this purpose, while the regu-

lator is connected into the effects unit.

VIP-bleeper | 67 |

Here is a circuit that enables you to leave a boring meeting at any time you like. When you have had quite enough of the exasperating, seemingly endless discussions and would-be interesting speeches about trivial subjects, just fumble in your breast pocket to take out a pen or a notebook, stealthily press a relief button to activate the timer function of your VIP bleeper, and pretend to be very attentive and busy so as to be more surprised when, after 20 seconds, you are called up by a loud bleep from your very personal tracer system. Now reset the VIP bleeper by pressing the switch once more, pretend to be quite disturbed, gather your papers, and leave the meeting after having informed the chairman that your presence is urgently requested elsewhere.

The VIP bleeper functions with only very few components, and will be operative for a whole year if powered from a 9V alkaline battery; a normal 9V battery enables use for about 230 days, so it is not even necessary to fit

an on/off switch. Gates N_1 and N_2 have been arranged in a bistable setup which toggles after S_1 is pressed; as long as the circuit is not activated, the output of N_2 will be at logic high level. Some 20 seconds after depression of S_1 , N_2 will enable to low-frequency oscillator gate N_4 to

activate the bleep generator proper, N_5 . The resulting intermittent bleep from the piezo element resembles the ringing sound of a cheap, hand-held telephone set. The bleep volume may be set with S_2 , depending on the feigned urgency and relative importance of the VIP GD

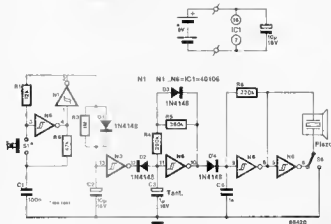

68 improved sound for the BBC micro

Despite the many laudable qualities of the BBC microcomputer as to speed and ease of peripheral interfacing, many users are slightly disappointed with the sound quality of the standard version as manufactured by the Acorn company. An investigation into this matter has revealed that Acorn have disregarded the optional connection of an external audio amplifier to the computer; this is the more surprising since special holes have been provided to this purpose on the main PCB. The result of this omission manifests itself in a very poor sound quality, caused by the small loudspeaker in the cabinet, the high noise level of the improperly driven audio amplifier chip, and the rather coarse volume setting. However, a minor modification to the BBC computer is sufficient to boost its sound production by means of an external, more powerful audio amplifier which may be connected to a sound output socket on the computer. Proceed as follows:

1. Open up the computer, remove the keyboard and the main PCB.
2. Locate the PCB holes for plug 16, to the left of IC₁, the Type LM386 audio amplifier chip.
3. Use desoldering braid to open up the holes for plug 16, if these are filled with solder.
4. Cut off the centre pin of a three-pin, 0.1 inch pitch single row PCB header, and solder it in the holes provided for plug 16.

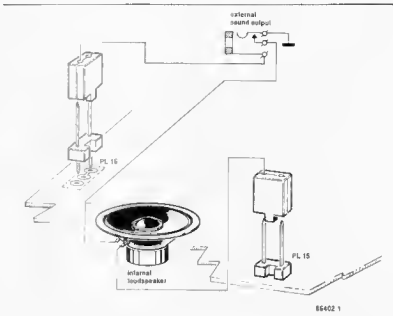

5. Mount a 3.5 mm jack-type audio socket with a break contact at the rear side of the computer, and wire P15, P15, and the internal loudspeaker as shown in Fig. 1.
 6. Reassemble the computer and test the new audio output by connecting an external amplifier set to the jack socket. Insertion of the jack plug should silence the internal loudspeaker.
- Now that we are on the subject of the BBC computer, it is just as well to

give a few hints concerning reduction of the total power consumption of the computer. The Type 6522 VIA chips may be replaced with their new CMOS equivalents 65C22 to reduce the total current consumption by some 240mA. The 6850 chip may also be replaced with a 6350, but this is a riskier matter since the former chip is soldered direct onto the PCB.

HS

69 halogen lamp protector

Halogen lamps are, unfortunately, rather prone to burn out when they are switched on, and this is mainly owing to the high current consumption of these devices during the initial stage of heating up to the normal operating temperature of the filament in haloid gas. A typical value for the cold resistance of a 6 V · 4 W halogen lamp is about 0.3 ohm, demanding a turn-on current of 20 A. In view of the relatively low internal resistance of car and motor-cycle batteries, such a current surge is not at all to be

dismissed as purely theoretical, and it is easily seen that the ensuing rapid heating inside the lamp is a prime cause for the thin filament to melt at the sudden temperature effect. What is required, therefore, is a series regulator system to limit the current during the heat-up phase; in other words, a soft turn-on facility. The circuit diagram shows that C₁ is charged to the battery voltage by means of R₁ and R₂, causing FET T₁ to become slowly conductive after S₁ has been closed. The Type BUZ10(A) power FET is used in view of its low

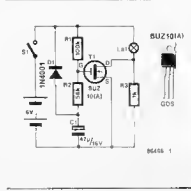

drain-source resistance in the fully conductive state; a typical value for $R_{ds(on)}$ is 0.19 ohm, which ensures a low voltage drop across the FET, and, therefore, a sufficiently high operating voltage for the halogen lamp. Parts D₁ and R₁ discharge C,

after opening S₁, so that the power on delay functions correctly any time the lamp is turned on. Lamp voltages other than 6 V require R₂ to be modified according to $R_2 = 200,000/(V_{lar} - 3)$ [Ω]. In case the BUZ10(A) proves hard to

obtain, other types of n-channel power MOSFET may be used in the circuit. The minimum requirements are: drain-source voltage $V_{ds} = 50$ V, drain current $I_d = 19$ A, and drain-source on resistance $R_{ds(on)} = 0.2$ Ω.

AR

simple NiCd charger | 70 |

Dry batteries have one major disadvantage: they go flat. Rechargeable types, such as NiCd cells, also suffer from this drawback, but they can at least be recharged. Sometimes even a fifteen minute charge is sufficient to give enough life to, say, an electronic flash battery.

A NiCd charger is, in essence, nothing but a sophisticated current source. The present design contains four such sources with a common control switch, but each with a separate LED that lights as soon as a battery is connected to it.

In position 1, the sources each provide a current of about 90 mA; in positions 2 and 3 values of between 100 and 300 mA as required. Note, however, that with charging currents above about 200 mA the transistors must be fitted on suitable heat sinks. On stability considerations, it is advisable to mount diodes D₁ to D₄ incl. in good thermal contact with the relevant transistors.

Terminals +B and -B enable the circuit to operate from a 12 V DC source, such as a car battery, in situations where a mains supply is not available.

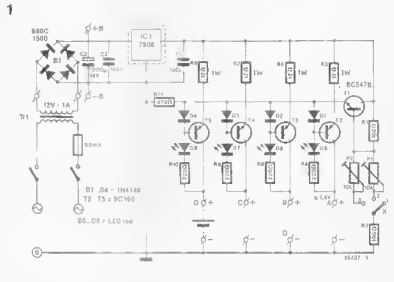

Modern NiCd cells can be given a fast charge without any problems. The present unit can charge Type AA (=HP7=R6) cells in about 8 hours (position 1=90 mA), Type C (=HP11=R14) cells in 10-14 hours (position 3=180 mA); and Type D

(=HP2=R20) in 20 hours (position 3=200 mA).

(D)

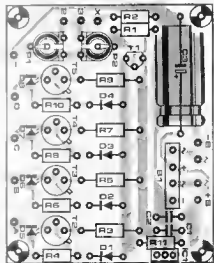
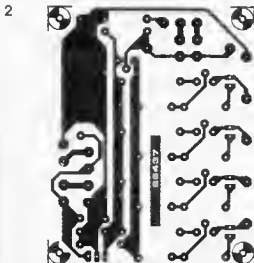

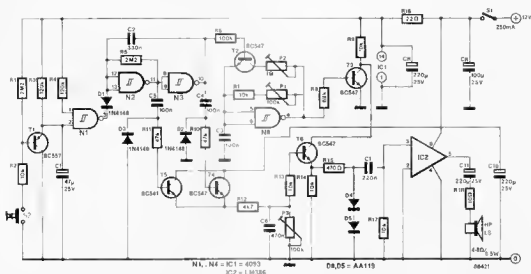

This electronic chime is easily built from commonly available, inexpensive parts.

Depression of the door bell button, S_1 , causes inverter T_1 to pass a logic low level to NAND gate N_1 , which responds with a logic high level at its output, enabling the oscillator composed of N_3 and N_4 to toggle at about 1 Hz. Since buffer capacitor C_1 remains charged for some time after S_1 has been released, the oscillator

will continue to provide 1 Hz pulses to C_1 and C_2 , as well as to a second oscillator section, composed of N_4 and associated parts via R_6 .

A logic high level at pin 10 of inverter N_2 enables T_2 to connect P_1 in parallel with frequency determining parts R_7 - P_1 , which arrange the frequency of N_3 to toggle at a few hertz. The two superimposed frequencies may be adjusted to individual taste with P_1 and P_2 .

In addition to controlling the tone frequencies of the chime, the 1 Hz pulses also determine the envelope shape of the resultant chime sound by means of T_3 - T_5 and associated parts. Preset P_2 is used to define the desired decay characteristic, while emitter follower T_5 functions as a very simple voltage-controlled amplifier, driving one-chip AF output amplifier Type LM386.

KD

RGB-to-monochrome video combiner

This circuit offers impeccable monochrome images when driven by the digital RGB and sync signals of a high-resolution graphics card such as the one featured in *Elektronika* issues from December 1985 to April 1986.

Transistor T_2 in the video combiner/buffer ensures a short circuit proof, 75Ω impedance monochrome and composite video signal with an rms value of about 1V, as usual for connection to a monitor. The combination of a PNP and an NPN transistor, T_1 and T_2 respectively, for amplification and combination of video and sync typically exhibits a good response to the fast rise and fall times

of these signals, and thus enables sufficient picture definition in the case of, for instance, text presentation at 80 characters per line, or high-resolution graphics applications.

The input circuit arrangement with T_1 and the mixer resistors is a D/A converter in its most rudimentary form: the R, G, B, and I signals are applied to resistors at values that correspond to the luminance percentage of each basic colour, to the effect that any colour shade is represented as one of 16 shades of grey on the monochrome monitor. Where this is desirable, the intensity bit resistor may be replaced with a 2k5 preset;

this enables setting the intensity ratio. In case the present combiner is used with a video interface that merely supplies a video and sync signal, or merely RGB signals, the unused inputs may simply be left open.

The sync signals are combined with the video signal at the base of T_2 ; depending on the system setup, the sync input may have to be slightly modified. Where an inverted CSYNC (composite sync) signal is available, as in the case of the Elektor graphics card, all parts relevant to the sync inputs may be dispensed with, except for D_1 . Resistors R_5 and R_6 determine the black level of the composite

video signal, to which the sync component is added by D_1 , which is capable of lowering the base voltage of T_3 to a value, lower than the black level. Diode D_2 allows separate, inverted sync signals to be applied to the combiner, and T_3 , R_{10} , R_{12} and R_{11} may be added for video systems that output a positive-going, separate sync.

The combiner may also be used with the video-interface incorporated in the IBM PC if this computer is equipped with a monochrome video board, the sync mixer only requires D_2 , R_{11} , R_{12} , and T_3 . The IBM colour board requires the addition of R_{10} , whereas D_2 may be left out. Figure 2 shows how the video combiner is typically connected to the IBM colour board. Note the use of the 'reserved' line (7) for the +5V supply voltage of the combiner circuit.

CD

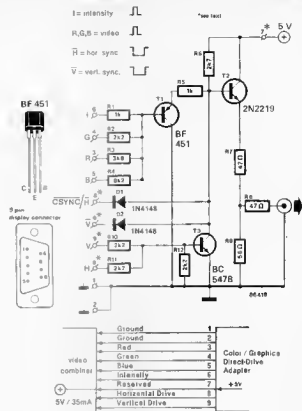

supply protection

73

The use of external mains voltage adaptors for cassette recorders, portable radios, home computers, pocket calculators, and so on, is common practice since the typical enclosure sizes of this type of electronic equipment either does not allow the incorporation of a mains supply, or the device has been primarily intended for battery operation.

Unfortunately, the degree of idiosyncrasy among manufacturers of adaptors is rather high; a standard for adaptor output voltage and output polarity is definitely hard to find. It may, therefore, be quite risky to power, say, the home computer from an adaptor which is not tailored to this (expensive) piece of electronic equipment.

Here is a simple circuit to prevent a lot of trouble; its extremely low cost fully justifies incorporation in any equipment operated from an external DC supply. The supply protection consists of a mere four parts and a

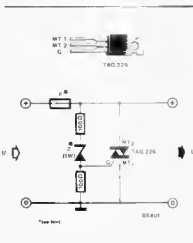

fuse, which may already be incorporated in the equipment. The zener diode is selected to have a zener voltage of about one volt higher than the equipment supply voltage. In case the input voltage to the cir-

cuit has the wrong polarity, the zener diode conducts and causes the triac to fire, since its gate is driven positive with respect to MT2; the current flow through the triac is sufficiently high to look like a short-circuit to the fuse, which duly melts and breaks the supply voltage, before damage is inflicted upon equipment parts.

Operation of the circuit in an over-voltage condition is even simpler, since in that case the zener also supplies the gate of the triac with a firing voltage.

Obviously, if everything is in perfect order, the protection circuit is as if non-existent to the equipment it is part of, because it introduces no additional voltage drop. Finally, the only modification to the circuit for use in positive-earth equipment involves insertion of the fuse in the negative supply line.

HS

74

electronic toss-up

The electronic version of the well-known coin to toss up prior to commencing a football match—or any other sports event where this a generally established formality on part of the referee—consists of a row of seven LEDs, the centre one being green, the others red. After having reset the circuit, the odds are exactly equal for either one red LED located next to the green one to light when the toss-up key is pressed, we have, therefore, a left/right decision circuit operating on the basis of pure arbitrariness.

As to the operation of the circuit, button S_1 may be pressed at any time to preset counter IC₁, which responds with outputting the binary code for 0 at its Q_0 , Q_1 and Q_2 outputs, causing BCD-to-decimal decoder IC₂ to light the corresponding LED, i.e. the green one—D₄—at the centre of the row. The preset code for the initial state of the circuit is determined with preset inputs P_0 , P_1 being tied to ground, causing IC₁ to load 0000 as the binary start-up value when S_1 is pressed.

Depression of button S_2 causes the bistable composed of N_1 and N_2 to toggle, providing a single pulse transition at the clock input of IC₁. Depending on the logic level at the UP/DOWN input of IC₁, the one-of-eight decoder will light either D₅ (right) or D₃ (left), since counting up from 0000 gives the next higher binary code 0001, while counting down gives 1111. The latter value causes IC₂ to light D₃ at the Q-output, since the most significant bit input—D₃—has been tied to ground. The arbitrariness of the toss-up circuit is ensured by the speed at which oscillator N_1 - N_2 applies pulses to the

counter UP/DOWN input. The odds are 1 to 1, theoretically, while the circuit can not be bribed...

Seven of the eight active-high outputs of IC₂ have been wired direct to the corresponding LED while Q₀ serves to inhibit the counter via the CARRY IN terminal it is readily seen that counter inhibiting occurs automatically when IC₁ counts up from output state 3, or down from state 5; both conditions cause Q₀ and

therefore CARRY IN, to go high, disabling further counting until the reset button is pressed.

Finally, repeatedly depressing S_2 without resetting the circuit will cause any other, random, LED in the row to light, and this facility may be put to good use in any other, random decision based game or serious application you have in mind.

GN

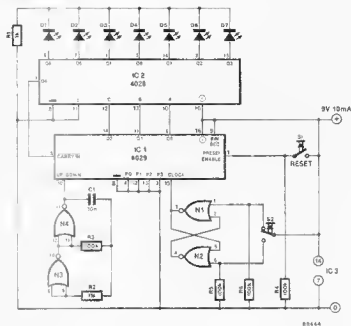

D1...03,05 D7 = LED 5mm red
D4 = LED 5mm green
N1...N4 = IC 3 = 4001

75

tuning AF power stages

Simple, economically priced audio output stages, such as, for instance, those using the hybrid ICs in the STK series, may be improved in a simple manner as regards distortion, noise, and offset voltage. To this end, the output amplifier is included in the feedback loop of an op-amp Fig. 1 shows the set-up for inverting output

amplifiers, and Fig 2 that for non-inverting ones (the normal situation). In the calculations to arrive at the new gain of the output amplifier, determined by R_1 and R_2 , it is assumed that the LF356 provides an undistorted signal of 5 V_{rms}; note also that this type of op-amp must work into a load of not less than

5 kilo-ohms to prevent distortion. For an output power of 50 W into 4 ohms, the output stage must provide a voltage, $U = PR = 14.2$ V_{rms}. If the amplification of the stage is 3, the op-amp should deliver 4.73 V. For the set-up in Fig. 1, the value of R_2 is then $R_2 = 3R_1$, while for that in Fig. 2, $R_2 = 2R_1$. Note that in both versions only

the value of R_1 should be altered. The total amplification may be calculated from the ratio of R_A and R_B as follows: $A = (R_A + R_B)/R_B$. Furthermore, because of the load impedance of the op-amp, $R_1 > 10\text{ k}$ (Fig. 1); $R_2 > 10\text{ k}$ (Fig. 2); $R_A > 10\ \Omega$; and $R_C > 10\ \Omega$ (Fig. 1 and 2).

To compensate for the off-set voltage of the output amplifier, the input capacitor should be replaced by a wire link. The capacitor in series with R_1 in Fig. 2 should also be short-circuited. The lower frequency limit of the complete circuit is then determined by $C_B = 1/2\pi f_{lm}R_A$. The off-set voltage is then smaller than 3 mV, provided both R_A and R_C are equal to, or greater than, 100 k Ω . Where greater accuracy is required, P1 can be used to set the off-set to exactly 0 V.

To ensure that there is no direct voltage at the new input of the amplifier, capacitor C_C should have a value of $C_C = 1/f_{lm}R_C$.

Since the amplification of the output stage has been reduced to 3, its feedback factor has gone up, and the distortion has gone down. The additional feedback of the LF356 reduces the distortion even further. An overall reduction in the distortion from 1 per cent to 0.1 per cent is fairly typical.

The altered feedback unfortunately results in a change in stability. If there is a tendency to oscillate, the first thing to do is to bring the upper frequency limit back to its previous value with the aid of $C_V = 1/2\pi f_{lm}R_A$. If the tendency persists, capacitors C_X must be used: their value lies between 100 pF and 1 nF. Our prototype (using STK ICs) worked satisfactorily without either C_X or C_V . (W)

1

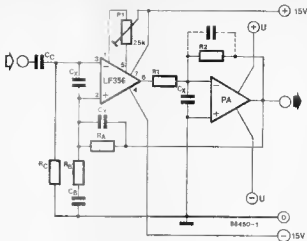

2

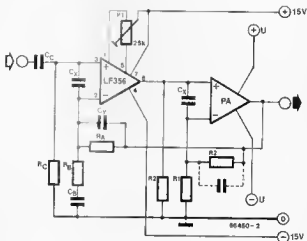

electronic fuse

76

It is perfectly understandable why many a constructor is in a cold sweat when faced with the decision whether or not power may be applied to his circuit board or experimental set-up at a more or less advanced stage of completion. Even after the closest inspection of the relevant circuit, sheer experience has taught many of us to be wary of calmly curling smoke signals from quite unexpected PCB locations, along with a sudden and violent action on part of the ammeter in the supply line, often followed by rapid

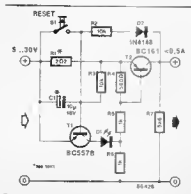

overheating of the power supply series regulator and blowing of a fuse, all of which typically take place before the mains switch can be reached to prevent further damage from being inflicted upon power supply and/or expensive parts in the circuit under test. Murphy strikes again!

Some of the above-mentioned plight may be alleviated by this circuit, which functions as a resettable, non-destructible fuse replacement for series connection in the positive supply line to DC operated circuits

consuming up to about 500 mA at an operating voltage between 5 and 30 V.

The circuit diagram shows series resistor R_1 , which drops a voltage in proportion to the current it passes to the load at the circuit output. Whenever this voltage exceeds about 0.5 V, series-connected transistor T_1 is turned off and LED D_1 lights to indicate the overload condition.

S_1 is pressed to restore the supply current to the circuit under test, but only after the cause of the "fuse" action has been investigated and corrected.

Whenever the current consumption of the circuit under test is lower than about 500 mA (determined by R_1), T_1 remains off. However, when the load at the circuit output consumes more than 500 mA, T_1 is arranged to act as a relatively low resistance between

the base and emitter of T_1 , which is consequently turned off, interrupting the current flow to the load, just like a fast acting fuse. Resistors $R_3 \dots R_8$ have been provided to maintain the necessary base current for T_1 once the circuit has disabled the load, since that condition implies the absence of a sufficiently high voltage across R_1 . Therefore, it is seen that pressing S_1 is the only way of restoring the current flow to the circuit under test.

The circuit as shown is readily modified to suit a wide range of selectable output currents by replacing R_1 with a 12-way, single pole switch and a set of 12 suitable series resistors, each calculated from $R = 0.4I_{max}$ for operating voltages below about 20 V. The indicated transistor types, however, do not allow a current consumption in excess of 500 mA, while the voltage drop

caused by the circuit is of the order of 1 V.

In case the proposed electronic fuse is to monitor the current consumption of digital circuits, notably those incorporating ICs from the well-known TTL families, the fuse action LED may light after power has been applied, despite the fact that the relevant digital circuit is known to function all right. The explanation of this phenomenon lies in the relatively high peak power consumption of these chips, which draw the more current as their switch rate increases. In order to render it impossible for the electronic fuse to react to such current peaks, smoothing capacitor C_1 may be added, its value should be 10 to 100 μ F, determined on a trial-and-error basis.

TW

77

8-bit DAC

This simple circuit enables computer users to generate analogue voltages under software control, which, no doubt, offers interesting possibilities for intelligent control of, for example, volume adjustment of audio equipment, light dimmer circuits, etc. It is also possible to write machine language algorithms for the generation of several different, complex periodic output voltages, in short, to construct a computer-controlled function generator using a minimum amount of hardware.

The circuit is based on the Type ZN426 digital-to-analogue converter (DAC), which is an 8-bit resolution (255-step), high conversion speed (1 μ s) device for direct microprocessor interfacing. The circuit may be connected to an 8-bit output port which provides TTL or CMOS compatible digital levels; most computers currently on the market have such a port, or the manufacturer has made provision to add one or more of these in the form of an expansion. The conversion time of the DAC chip allows the use of machine code for high frequency output voltages; BASIC is usually too slow for this purpose. The DAC output voltage is buffered with an BIFET opamp, which can be adjusted for a step response of 15mV/step, which means that the maximum output voltage of the present circuit is 3.825V, since 8 bits

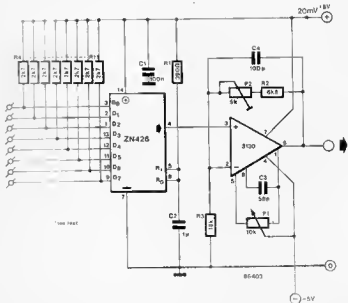

represent 255 steps (2^8-1).

Adjustment of the circuit is straightforward: connect a DVM to the output and adjust P_1 for an indication of 0.00V with nought (0) written to the DAC; next, write 255 (FF_{hex}) and adjust P_2 for the maximum voltage indication of 3.825V.

The circuit is also very suitable as a D-to-A converter driven by 8-bit I/O port (EE, December 1985) as part of

the universal I/O bus. It should be noted, however, that writing FF_{hex} to this port gives an analogue output voltage of 0V, since the ULN2003 buffer IC in the 8-bit output port is an inverting device; moreover, the eight data lines to the DAC chip should be fitted with pull-up resistors as shown in the circuit diagram.

HS

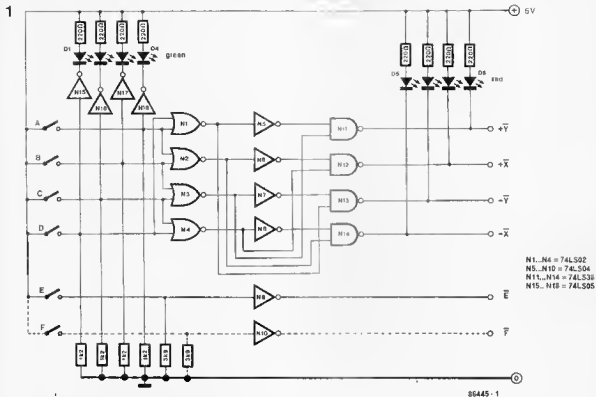

Some popular computer games require the joystick to be turned 45° in order to get the correct cursor movement on the screen. Obviously, this presents problems in case the joystick is desk mounted or of the type that is ergonomically styled and hand-held.

The electronic solution to this inconvenience starts from a redefinition of the joystick axes, as shown in Fig. 2. Direction *A* is defined as in between the positive *X* and *Y* axes; direction *D* as in between the negative *X* and positive *Y* axes. Directions *C* and *B* are opposite to *A* and *B* respectively. Table 1 summarizes the old and new direction assignments and associated activated outputs.

The circuit diagram of the adaptor circuit — Fig. 2 — shows that the output levels to the computer are active low rather than high as in the unmodified joystick connection; this necessitates the use of inverter gates between adaptor and computer input. A Type 74LS04 hex inverter may be used to this end, and the trigger (fire) function(s) can also be inverted at the same time, since this IC contains six inverters.

Table 1

Direction	Contact
A	+X and -Y
B	-X and Y
C	+X and Y
D	-X and -Y

Direction	Contact
A and B	+X
B and C	-Y
C and D	+X
D and A	-Y

Table 2

CBM64	MSX
(1) -Y	(1) +Y
(2) Y	(2) Y
(3) X	(3) X
(4) -X	(4) -X
(5)	(5) +5V
(6) trigger	(6) trigger 1
(7) +5V	(7) trigger 2
(8) ground	(8) output
(9)	(9) ground

The double trigger function enables the turned joystick to be connected to MSX types of computer as well. Table 2 lists the relevant connections for both the C64 and the MSX computer type.

The adaptor input and output signals may be visualized with red and green LEDs, clearly indicating the electronic signal turn over 45°. When the joystick is moved into direction *A*, for instance, input LED +*Y* lights, as well as output LEDs +*Y* and +*X*. Current consumption of the adaptor circuit is about 75 mA.



2



79

switch mode power supply

One of the major problems in the design of switch mode power supplies is that most available (and suitable) ICs only offer the absolutely necessary facilities and not, for instance, thermal or short-circuit protection.

Linear Technology offers a solution to these problems with their LT1070 range of switching ICs. These devices are as easy to use as the familiar 3-pin regulator ICs. All steps have been taken to make the design of a simple, yet efficient, switch mode supply as easy as possible. The peak output current is 5 to 9 A, and a current-limiting circuit is provided.

The diagram shows a switch mode DC-to-DC converter, whose output voltage may lie between 12 and 48 V, provided the input voltage is greater than 3 V. The input voltage of the circuit as shown must always be lower than the output voltage. It is, however, possible to modify the circuit to obtain an output voltage that is lower than the input voltage. One of the modifications is replacing L_1 by a suitable transformer.

The output current is dependent on the value of the input voltage. For an input voltage of 3 V, the output power is 10 watts maximum. Our prototype, operating from 3 V, delivered about 50 mA at 48 V, while at an input voltage of 24 V the output current was over 1 A.

In the construction, account must be

1

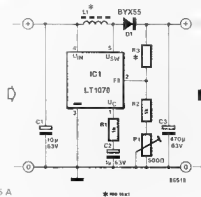

L_1 200 300 μ H 5 A

* see text

2

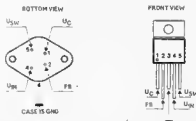

taken of high peak currents: all connections should, therefore, be short, and the input and output lines should be SWG20 (0.8 mm \varnothing) or thicker. This also applies to the earth connections.

It should also be noted that spikes are present on the output voltage. If

necessary, these may be eliminated by an LC filter, the inductance of which has the same value as L_1 , and the capacitance is between 10 and 100 μ F. The quality of the capacitor is of importance because of the required low series resistance for RF signals. (B)

80

programmable odour generator

The proposition that television "brings the world into your living room" has gathered strength with the latest addition to the colour vision-stereo sound-three dimensional TV line of development in "tube technology": the programme-controlled odour generator, which is expected to herald a new era of real life to television, since broadcasters will no doubt avail themselves of the opportunity to delight us viewers with the appropriate smell to go with a certain action in the relevant film or documentary.

1



2

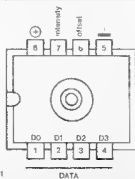

CD4711

DATA

96511 2

Odorant Elektronik GmbH of Cologne, Germany have recently introduced their Type CD4711 4-bit programmable, bio-electronics based odour generator, suitable for digitally controlled TV sets. Journalists were regaled on a number of sample odours from the new chip at a rushed press conference, during which a spokesman of Odorant claimed that the Type CD4711 is capable of producing 1 of 15 odours as selected by the bit pattern on the four CMOS- and TTL compatible data inputs (see Fig. 3), while an 8-bit version with odour intensity modulation will shortly be announced.

3

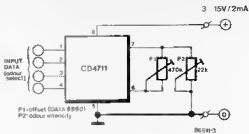

speech processor with background suppression | 81 |

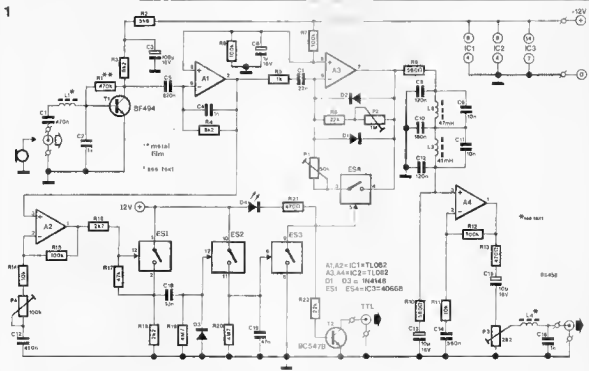

A speech processor is commonly used in public-address installations and in utility transmitters. It augments the average value of the speech signal, so that in spite of a high level of background noise or, in the case of a radio transmission, a lot of interference, speech recognition remains possible. In many cases it is, however, undesirable that this background noise or interference is enhanced together with the wanted signal. A possible remedy, as out-

lined here, is to provide an adjustable threshold at which the speech processor becomes active. With reference to the diagram, the signal from the microphone is amplified in T_1 (a low-noise amplifier) and in A_1 . Limiting (or clipping) of the signal takes place in A_2 . The signal (taken from the output of A_1) is also amplified in A_3 . When the output of this opamp reaches a certain level, electronic switch ES_1 is actuated. Consequently, the mono-

stable formed by ES_2 changes state, and thus closes ES_3 , whereupon ES_4 is opened, which in its turn increases the amplification of A_3 . When ES_4 is closed, the amplification of A_3 is determined by the ratio P_1/R_3 ; when the switch is open, by the ratio $(P_2 + R_4)/R_3$. The mono-time, determined by the time-constant $R_{20} \cdot C_{18}$, has been chosen such that speech is not clipped. The low-pass filter between A_3 and A_4 ensures that frequencies

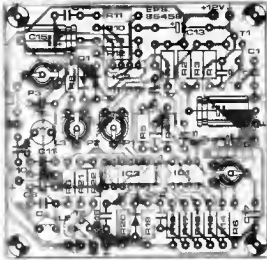
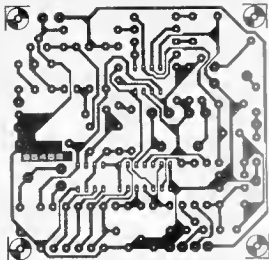

above 3 kHz are severely attenuated. The required output level is set by P_3 .

Calibration is somewhat unorthodox: a signal source with a continuous output of speech by trained speakers is used. The microphone is positioned in front of the loudspeaker at normal speaking distance and the sound level adjusted to roughly the level of the user. Next, connect a pair of headphones to the output of the pro-

cessor and make sure that only the output of these phones can be heard. Adjust P_4 for maximum resistance, and then set the clipping level with P_2 (which is a matter of personal taste). At maximum clipping level, intelligibility of the speech will remain good in the presence of interference, but it will have a somewhat harsh, metallic character. Then, adjust P_1 for maximum resistance, and P_5 till all background noise disappears. Fi-

nally, set the ratio signal: background noise with P_1 ; this is best done by making a recording of the user's speech via the microphone and the processor. When the processor is active, i.e. clips, D_4 lights.

L_1 to L_6 incl. are 6 turns 36 SWG CuL through 3 mm ferrite beads. (B)

82

electronic bell-pull

The simplest circuit in this issue of *Elektor Electronics* consists of a single transistor and resistor, which, when put together as shown, constitute the electronic equivalent of an old-fashioned, stylish bell-pull used in conjunction with a chime or bell circuit of any relative complexity offering whirling melodies, buzzing or ringing sounds, or chime imitations to prompt the homeowner to open the front door.

The bell-pull is made from a TO39-style NPN transistor which is taped or isolated by means of a length of heat shrink sleeving, after the emitter and collector leads have been fitted with wires for the electrical connection to the bell circuit. A small, conductive plate is secured onto the isolated transistor head, and the base lead is joined to this plate over a series resistor which is dimensioned according to $R = U_b / I_b$ [k Ω]. The completed assembly may also

1

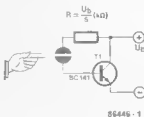

2

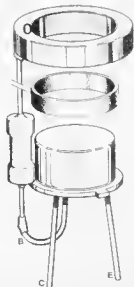

be cast into epoxy resin to make a nice compact unit that can handle the treatment of even the roughest caller at the door!

KW

disco sound limiter 83

by R Schrott

1

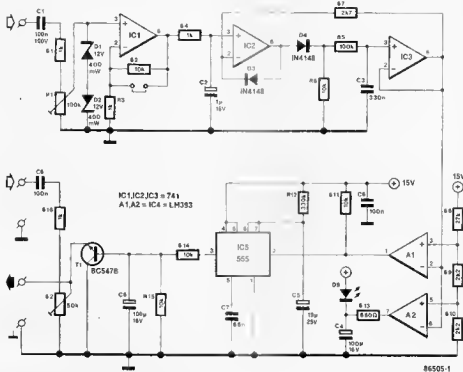

The environmental nuisance value of discos is in direct proportion to their sound level. The circuit proposed here cannot be disabled by the disc jockey, since it is built into the output amplifiers used in the disco. Its operation is amazingly effective: if the preset sound level is exceeded, the input of the amplifier is short-circuited for a few seconds. Any disc jockey whom that has happened to a couple of times soon gives up trying to break the sound barrier.

The power amplifier output is connected to the metering input of the present circuit (C_7). This signal is applied to low-pass filter R_4-C_2 via P_1 (which sets the maximum volume) and buffer IC₁. In case of line inputs, this opamp can be given a gain of 20 dB by the omission of the wire link across R_2 .

The signal from the low-pass filter is rectified (half wave) by IC₂ and IC₃. The resulting direct voltage is applied to A₁ and A₂ which compare it with two reference voltages derived

2

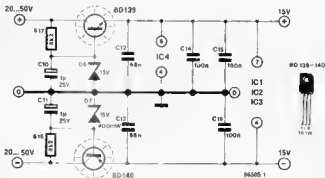

from potential divider R_8-R_{10} . When the first threshold is exceeded, D_3 lights to warn that maximum sound level has almost been reached. When the sound level then increases by 6 dB, A₁ also toggles, which triggers monostable IC₃. The input signal to the power amplifier (via C_5 , R_{14} , and P_2) is then short-circuited to ground via T_1 . Resistors

R_{14} and R_{15} , and capacitor C_5 , obviate any "plops" from the loudspeakers. Power for the present circuit may be derived from the output amplifier. The normally quite high supply voltage there is reduced to ± 15 V by two complementary power transistors. Current consumption of the circuit is about 40 mA

84

sideway RAM for BBC and Electron Plus One

As already reported on numerous occasions in this magazine, the BBC micro ranges among the most widely used types of personal computer currently available. To newcomers in the computer field, the amount of commercially available ROM-supplied software is truly staggering, and there seem to be programs to suit almost any requirement and budget.

However, the number of ROMs that may be located in the BBC computer is limited to four in the basic version and sixteen when it is equipped with a sideway ROM expansion card. Users in possession of a good many ROMs and EPROMs are, therefore, often forced to exchange these before a program can be run; a method that is both cumbersome and possibly bad for the ICs and their sockets.

A way of getting round this problem is to install RAM rather than ROM or EPROM chips on the sideway board, so that software may be readily moved about between ROMs, direct access memory, disk and RAM, since many of the originally ROM-based programs may also be run from RAM, it has appeared.

Since it was thought convenient to plug 16 Kbytes of static RAM into any one vacant ROM socket, the circuit was constructed in all-SMD technology on a ready-made PCB of very small size.

The circuit diagram shows two 8 Kbyte, low-power static RAMs Type 6264FP-15 as a replacement for a 16 Kbyte EPROM Type 27128; a single inverter selects the relevant 8 Kbyte block when the (formerly) ROM socket is addressed.

Working with SMD parts to achieve a truly miniature ROM replacement should be based on the necessary skills in soldering and handling these new parts, and the construction of the proposed extension therefore requires to be done as follows.

It should be noted that the through-plated PCB for this project comes together with the SMD die, described elsewhere in this issue.

Fit 28 short (1 cm) pins at the sides of the PCB to enable it to be received in an IC socket—see the accompanying photograph.

The SMD RAMs are mounted piggy-back onto the PCB, with the exception of pin 28 of the top mounted

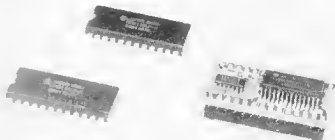
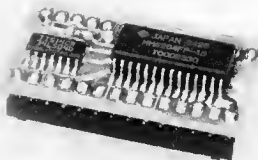
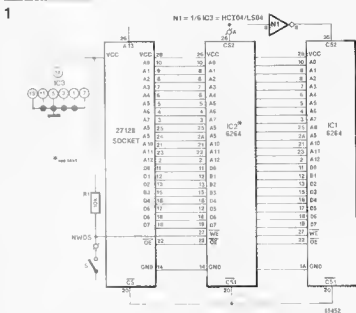

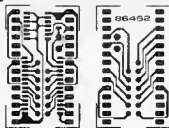

Parts list

R1: 100 k
 IC1, IC2: 6264FP 15
 IC3: 74HC04
 PCB: 86425

Miniature switch for write protection if required

RAM; this terminal should be wired to socket pin 28. The SMD parts 74HC04 (IC3) and R1 may now be fitted to conclude the PCB construction. Once the unit has been plugged into a ROM socket, a short wire is run from pin 8 of IC17 on the BBC main

board to the NWDS input on the SMD board.

Finally, although not mentioned so far, the Electron Plus One computer may also benefit from the proposed sideways RAM circuit which, as will be readily understood, need not

necessarily be constructed with SMD parts; a veroboard and normal sized components, along with a bit of wiring, will also do in many cases, although it may be hard to surpass the elegance of the plug-in unit.

HS

long interval timer

85

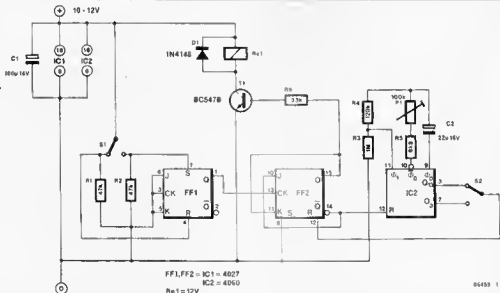

This low-cost timer circuit can offer switching intervals up to about 24 hours and may, therefore, be useful for a variety of domestic as well as electronic applications.

Depression of S₁ causes Re₁ to be energized and the timer to be started; the position of P₁ determines the duration of the timing interval — the given value for C₂ allows a maximum of 12 hours. Doubling the capacitance of C₂ lengthens the timing interval accordingly; the timer may thus be employed to control a NiCd battery charger. Depressing S₁

at any time during the interval causes the timer to be reset and Re₁ to be deactivated.

The function of FF₁ is that of a debouncer circuit for S₁ which, when actuated, causes FF₁ to apply a logic high pulse to the clock input of FF₂, which toggles IC₂ starts counting, since its reset condition is ended. At the same time, T₁ is driven with a positive logic level, and Re₁ is energized. After the timing interval has lapsed, i.e. when counter output Q₁₃ goes high, FF₁ is reset and Re₁ deactivated in consequence.

Setting the exact duration of the timing interval is readily accomplished by temporarily using counter output Q₃ rather than Q₁₃ to reset FF₁; with the component values as indicated, the interval should be adjustable between 3 and 45 seconds. Divide the desired relay-on time by 1024 and set P₁ accordingly; connect the FF₂ R input to Q₁₃ again, depress S₁ and have Re₁ power the relevant equipment for as long as set.

(St)

from an idea
by R Conell

86

digital volume control

This digital potentiometer circuit is a hybrid analogue and digital design offering push-button controlled programmable attenuation as well as high to low impedance conversion by means of a single active device. Digital noise is eliminated as effectively as possible through galvanic isolation of digital and analogue parts in the input attenuator.

At the heart of the digital control section is a Type 2716 EPROM, which can be programmed either as shown in Table 1 or to individual requirements, as will be detailed below. At power-on, debouncer bistables N_1 - N_2 and N_3 - N_4 force logic low levels onto EPROM address lines A_5 and A_6 respectively, selecting a programmed address range that supplies the digitally coded, initial volume setting. R-C network R_{10} - C_2 causes gates N_7 and N_8 to generate a clock pulse for IC_2 , which latches the 8-bit word from IC_1 , passes this

information to driver IC_3 , and thus determines which relay(s) is/are energized, thereby fixing the attenuation before the AF signal is applied to opamp IC_4 . Depression of S_1 (up) or S_2 (down) causes the corresponding address line A_5 or A_6 to go low, selecting a certain address range in the EPROM. The exact address location is determined by the value last latched into IC_2 after either key has been released. It is readily seen that the five available databits at the Q_1 ... Q_5 outputs of IC_2 allow 32 (2^5) simulated potentiometer settings.

The digital control section has been designed to offer an auto-repeat function when either one of the step control keys is kept depressed: oscillator gate N_6 then provides a clock pulse train to N_7 - N_8 , and so causes successive addresses in IC_1 to be scanned automatically, until either the lowest or highest possible volume setting is reached, at which

moment the circuit forces itself to a hold state, which can also be selected at any time by simultaneously depressing the up and down key.

S_3 enables the user to select a further address block, programmed with another set of volume steps; the circuit as shown, along with the data from Table 1 arranges for 3 dB steps. The analogue section of the circuit is basically a four-section, relay-controlled attenuator composed of resistor networks to achieve a signal attenuation in 3 dB increments, as defined with the relevant bit pattern at the Q_1 ... Q_5 outputs of IC_2 . Re_4 (Q_5), if deactivated, enables IC_3 to amplify its input signal by 3 dB. The inset resistor and preset combination may be used take over the function of C_{10} , since the latter should be a high stability foil type, which may be a rather difficult to obtain part. Both circuit alternatives function as click

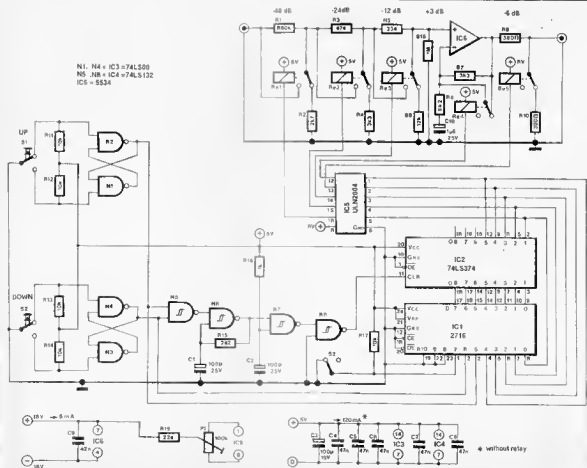

suppressors when stepping through the available range of volume settings. The preset, if used, should be set for zero offset voltage at pin 6 of the opamp; replace C₂ with a wire link.

It is suggested to use miniature DIL relay types in the Rel...Res positions, while all resistors in the attenuator are preferably close tolerance (1%), high stability types. Also observe that the supply voltages to analogue and digital section are kept well apart and decoupled so as to preclude introducing switching pulses and digital interference in the sensitive attenuator sections as well as the opamp output stage.

Finally, Table 1 offers a suggestion for programming the EPROM with data to achieve circuit operation as set out above. (Sv)

Table 1

0000	00	01	02	03	04	05	06	07	08	09	0A	0B	0C	0D	0E	0F
0010	10	11	12	13	14	15	16	17	18	19	1A	1B	1C	1D	1E	1F
0020	00	00	01	02	03	04	05	06	07	08	09	0A	0B	0C	0D	0E
0030	0F	10	11	12	13	14	15	16	17	18	19	1A	1B	1C	1D	1E
0040	01	02	03	04	05	06	07	08	09	0A	0B	0C	0D	0E	0F	10
0050	11	12	13	14	15	16	17	18	19	1A	1B	1C	1D	1E	1F	1F
0060	0E	0E	0E	0E	0E	0E	0E	0E	0E	0E	0E	0E	0E	0E	0E	0E
0070	0E	0E	0E	0E	0E	0E	0E	0E	0E	0E	0E	0E	0E	0E	0E	0E
0080	00	01	02	03	04	05	06	07	08	09	0A	0B	0C	0D	0E	0F
0090	10	11	12	13	14	15	16	17	18	19	1A	1B	1C	1D	1E	1F
00A0	00	00	00	01	02	03	04	05	06	07	08	09	0A	0B	0C	0D
00B0	0E	0F	10	11	12	13	14	15	16	17	18	19	1A	1B	1C	1D
00C0	02	03	04	05	06	07	08	09	0A	0B	0C	0D	0E	0F	10	11
00D0	12	13	14	15	16	17	18	19	1A	1B	1C	1D	1E	1F	1F	1F
00E0	0E	0E	0E	0E	0E	0E	0E	0E	0E	0E	0E	0E	0E	0E	0E	0E
00F0	0E	0E	0E	0E	0E	0E	0E	0E	0E	0E	0E	0E	0E	0E	0E	0E

courtesy light delay 87

Ever been groping about for the safety belt, ignition slot, choke control or a map while in utter darkness and happy to have closed the car door(s) because of the cold, or foul weather? Wouldn't it be convenient to have the courtesy light on for a few more instants in order to get the vehicle started and ready to move off? Figure 1 shows a courtesy light delay circuit for easy incorporation in almost any type of car. The courtesy light is switched by power MOSFET T₂, which is a Type BUZ72A ensuring a low voltage drop (0.2 V typ.) across drain and source and therefore the lowest possible power loss. The door contact, connected to terminals B and C, is normally a push to break type. T₁ is therefore off and C₁ discharged when the door is closed, MOSFET T₂ does not conduct, so that the courtesy light remains quenched. Opening the door, however, causes T₁ to charge C₁ and the courtesy bulb will therefore light in a gradual manner. Although closing the door turns T₁ off again, C₁ continues to supply gate drive to T₂ for a few more seconds; the courtesy light will be dimmed slowly. The suggested MOSFET type should not switch more than about 10 W, which is the usual power rating for the courtesy light.

Figure 2 shows how the circuit may be modified to enable the courtesy light to go out immediately after the ignition key is turned. The terminal numbers refer to the wiring code

1

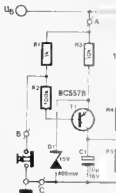

2

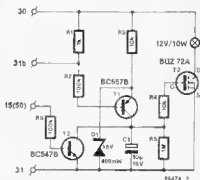

convention as relevant to most types of European car:

15 = +V_{bat} - ignition on.

30 = +V_{bat} - unswitched.

31 = ground

31b = door contact (connects to ground).

50 = +V_{bat} - starter motor on.

Figure 3 clearly shows the circuit connections in accordance with the foregoing convention.

In case the suggested MOSFET Type BUZ72A (Siemens) is a difficult to obtain item, any equivalent n-channel power MOSFET to the following specifications will also do adequately: V_{ds} ≥ 100 V; I_d ≥ 9 A; P_d ≥ 40 W; R_{ds(on)} ≤ 0.25 Ω.

3

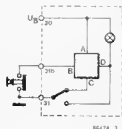

Source: Siemens Components XX (1985) No. 6.

A close look at the dashboards of a number of cars may reveal the use of three basic types of rev counter: first, the still most commonly found needle and round scale, analogue combination; second, a set of digital displays (often LCDs); and third, a pseudo-analogue meter in the form of multi-coloured LED bar looking much the same as a LED-based VU meter on modern recording equipment

The circuit presented here belongs to the third category. However, contrary to the straight LED bar indication, this design features a round scale with a coloured LED needle imitation, just as the good old mechanical rev counter

The circuit is based on the Telefunken Type U1096B analogue input LED driver which can light one of 30 LEDs on the rpm scale, whose lower and upper indication limits may be set to individual requirements; e.g. the 30 LEDs may merely indicate a limited rpm range

1

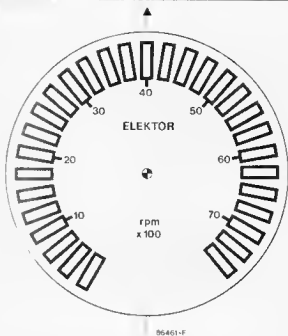

2

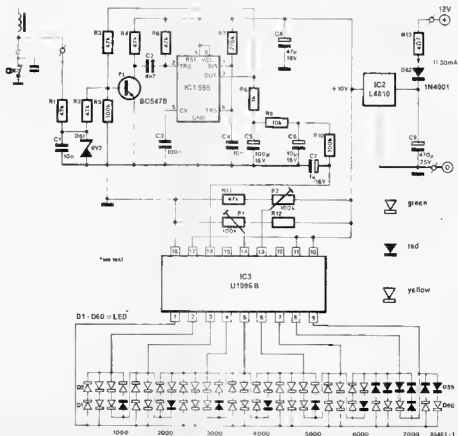

to attain a higher resolution.

The circuit diagram shows IC₁ to receive the contact breaker pulses and to reshape them for conversion to an analogue voltage in an R-C filter, which passes the signal to the input of the LED driver.

The detailed operation of the circuit is as follows. Zener diode D₁ and parallel capacitor C₁ safeguard the base of inverter transistor T₁ against receiving high voltage pulses induced in the ignition coil secondary winding. The Type NE555 timer has been configured to function as a monostable with an output pulse period time of 3 ms, during which time R₁ causes T₁ to conduct so as to prevent erroneous triggering of the monostable. The analogue voltage, proportional to the engine rpm rate, is established by means of smoothing network R₂-C₂, R₃-C₃ and R₄-C₄. The indication range for the LEDs may be set with P₁ and P₂, the presets for the lower and upper limit, corresponding to LEDs D₁-D₂ and D₂₉-D₃₀ respectively. Note the relative simplicity of the LED array connection to IC₁; only nine IC output lines suffice to drive any one of 30 pairs of LEDs, whose colour may be chosen to individual taste, while it is also possible to use series-connected LEDs to achieve a brightly as well as functionally ln rpm scale.

The circuit diagram shows two rows of LEDs; the upper one is the normal rpm indication scale, for which the following coloured subdivision may be used: 0 to 5000 rpm are green LEDs; from 5000 to 6000 rpm yellow

or orange types; 6000 rpm and up are bright red types. This range and subdivision may, of course, be adapted for the specific type of engine.

The lower row of LEDs may be used to indicate a number of fixed rpm rates on the scale, for instance at 1000 rpm intervals.

The PCB track layout and component overlay with this design should enable anyone to readily construct the LED scale revolution counter, but note that the LEDs are mounted at the PCB track side to get the correct indication in clockwise direction with increasing the rpm rate. Also note the use of the low voltage-drop regulator IC₂ which supplies IC₁ and IC₃ with a stable, noise-free 10 V rail.

Parts list

Resistors		Semiconductors
R ₁	R ₂ , R ₃ , R ₁₁ 47 k	IC ₁ : 555
R ₅	R ₆ 100 k	IC ₂ : L4810
R ₇	270 k	IC ₃ : UJ968
R ₈	1 k	(Telefunken)
R ₉	10 k	D ₁ : D20 LED
R ₁₂	220 k	(see text)
R ₁₃	4.7 Ω	D ₂₁ : zener diode 8V2
P ₁ , P ₂	100 k preset	400 mW
Capacitors		D ₂₂ : 1N4001
C ₁ , C ₄	10 n	T ₁ : BC547B
C ₂	4n7	Miscellaneous
C ₃	100 n	PCB Type 96461
C ₅	100 μ, 16 V	
C ₆	10 μ, 16 V	
C ₇	1 μ, 16 V	
C ₈	47 μ, 16 V	
C ₉	470 μ, 25 V	

AS

3

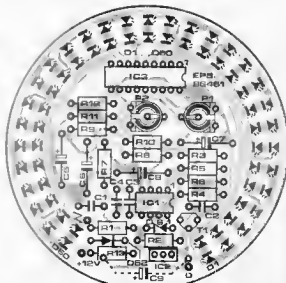

89 audio-controlled mains switch

It is often useful for audio or video equipment to be switched off automatically after there has been no input signal for a while.

The function of the on-off switch in such equipment is then taken over by switch S_2 in the accompanying diagram. It remains, however, possible to switch off manually by means of S_1 . Automatic switch-off occurs after there has been no input signal for about 2 minutes; this delay makes it possible for a new record or cassette to be placed in the relevant machine.

The audio input to the proposed circuit may be taken from the output of the relevant TV set, amplifier, or whatever. The input earth is held at +6 V with respect to the circuit earth by potential divider R_1 - R_2 - R_3 - R_4 . The two 74ls function as comparators: the output of IC₁ goes high when the input signal is greater than +50 mV, whereas the output of IC₂ goes high when the input signal becomes more negative than -50 mV. Resistors R_5 , R_6 , and R_7 form an OR gate that

drives transistor T_1 . If the output of either IC₁ or IC₂ is logic 1, T_1 conducts.

The 555 operates as a retriggerable monostable, whose period is determined by R_{10} and C_1 . The device is triggered when its pin 2 is earthed by the closing of S_2 . Its output, pin 3, then remains high for 1 to 2 minutes, depending on the leakage current of the 555. The monostable resets itself as soon as the potential across C_1 exceeds a certain value. As long as there is an input signal to the circuit, T_1 conducts and C_1 remains uncharged. As soon as the audio signal ceases, T_1 switches off, and C_1 charges until the potential across it is

sufficient to reset the 555. The monostable may also be reset by closing S_1 , which connects pin 6 of the 555 to +12 V.

When IC₂ is reset, C_1 is discharged via its pin 7. Resistor R_{11} serves as protection, because without it T_1 could short-circuit the supply lines. When the output of IC₃ goes high, T_2 conducts, the relay is energized, and the relay contacts switch on the mains voltage as appropriate. To counter the induced potential when the relay contacts close, which could damage T_2 , diode D_1 has been connected in parallel with the relay coil.

(S/V)

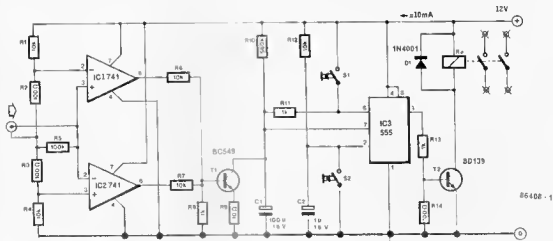
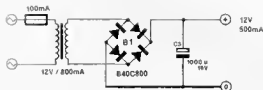

90 NiCd battery chargers

Quite arguably, Nickel Cadmium (NiCd) batteries are frequently used as replacements for disposable types of battery; this is possible because they can be inserted readily in the existing battery compartment and supply the same voltage as dispos-

able batteries. The fact that one need not go out to purchase (relatively expensive) batteries puts the rechargeable cells in an advantageous position.

However, one drawback of the use of rechargeable batteries is the need

to remove them from the equipment any time their charge is exhausted. It would, therefore, be convenient to leave them where they are, i.e. in the battery compartment, as they receive the charge current.

Two circuits are suggested for the in-

corporation in existing battery-operated equipment. Figure 1 shows the absolute minimum in the form of a simple current source. The reference voltage is obtained from the forward drop across LED D₁ (about 1.5 V for a red LED). R₁ fixes the current through the LED, and the voltage at the base of T₁ is therefore about 1.5 V lower than the positive supply rail. The voltage across R₂ is about 0.85 V, and this value may be used to determine the charge current for the battery, since $I_B = 0.85R_1$, independent of the circuit supply voltage.

The value of R₁ is thus readily calculated if it is known that most NiCd batteries are preferably charged with a current of one tenth their capacity in amperes per hour (Ah). A number of the more popular battery types and associated values for R₁ have been listed in Table 1. A noteworthy aspect of the circuit is the fact that LED D₁ will go out in the absence of a battery, since the voltage across R₁ inevitably drops; the LED current which used to flow through R₂ will now pass through R₁ and the base-emitter junction of T₁. The elaborated version of the NiCd charger, shown in Fig. 2, includes a diode to protect the circuit from being damaged by input voltages

1 * see text

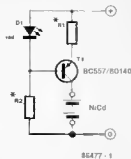

having the wrong polarity. R₁, R₂ and T₁ have been incorporated to disable the charger in the absence of a sufficiently high input voltage; Table 2 lists the relevant values for R₂ and R₁, given the number of 1.2 V cells contained in the NiCd battery. Almost any type of silicon PNP transistor in the BC series should work satisfactorily in the T₁ position if the charge current does not exceed about 100 mA. Higher input voltages and/or charge currents are, however, better handled by a medium-power transistor from the BD series. The input voltage to the charger

2

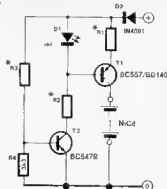

need not be elaborately regulated or smoothed; in fact, any type of inexpensive adapter providing the necessary direct output voltage and current may be used. Depending on the number of cells contained in the NiCd battery, the charge current may also be obtained from the 1.2 V car battery. The circuits as shown are readily fitted on a small piece of veroboard to suit incorporation in the relevant equipment; the input voltage to the charger is conveniently connected to a small plug or socket fitted onto the cabinet. (H)

Table 1.

battery type	size	capacity [mAh]	charge current [mA]	R ₁ [Ω]
9 V block	-	110	11	82
body R1	N	180	18	47
micro RO3	AAA	180	18	47
penlight R6	AA	500	50	15
(mignon)				
baby R14	C	1200	120	6.8
		1800	180	4.7
mono R20	D	4000	400	2.2

Table 2

number of cells	V _{in} (min.)	R ₂ [Ω]	R ₁ [Ω]
2	5	270	22
3	6	330	27
4	7.5	470	39
5	9	560	47
6	10	680	56
7	12	820	68

voltage inverter

91

Here is a circuit that produces a negative voltage from a positive one, for instance, from +5 V to -10 V. The output voltage, U₀, is determined from

$$U_0 = -1.2(R_1/R_2 + 1) [V]$$

As in other, similar circuits, the maximum output current depends on the ratio between input and output voltage and is calculated from

$$I_{(max)} = 500/(R_1/R_2 + 1) [mA]$$

The choke is readily made with a 17.5 mm pot core on which 85 turns of 0.2 mm² enamelled copper wire are close-wound.

The maximum input voltage to the IC is 15 V. Efficiency is of the order of 50 per cent. (ST)

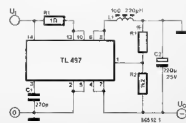

* see text

In broadcasting systems, intercoms, and mobile radio telephones it is necessary to amplify the microphone signal over a restricted range only. This may be achieved with the aid of a compressor or a clipper. The former provides low distortion, but its design is rather complex, whereas a clipper is of simple construction, but suffers from appreciable harmonic and intermodulation distortion. Of these two, intermodulation distortion is far and away the most troublesome, in fact, the acceptability of a clipper in an audio signal processor would not be far greater if clipping would not cause such severe intermodulation distortion.

In the accompanying diagram, intermodulation distortion is reduced by signal-control of the cross-over point. The principle of operation is shown in Fig. 1. The amplifier has a very high impedance input (value of R_1). When the signal level is so low that the diodes do not conduct, the cross-over point is determined by R_1 : C . As soon as the diodes conduct, the input impedance of the amplifier is reduced, which causes the cross-over point to shift upwards. The lower amplification of the frequencies is then smaller, and this enhances intelligibility. In fact, intelligibility of a signal processed in this manner is much better than a conventionally clipped signal.

The diagram in Fig 2 shows the detailed realization of the principle. Transistor T_1 is a microphone low-noise microphone preamplifier. The clipping circuit is based on A_1 : the limiting level is set by P_1 . The values of certain components depend on the application: guide lines are given in the table

For input signals above about 100 mV, the microphone preamplifier may be omitted. The input signal is then applied to the junction C_4 - C_5 via a re-

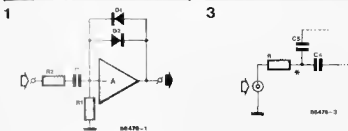

2

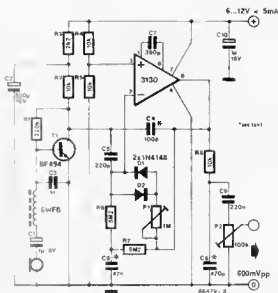

Application	C_4	C_5	C_6
Hi fi		47 nF	470 pF
Communications or intercom	100 220 pF	0.47 nF	4.7 nF

sistor (R in Fig 3). The value of R and the microphone used is about 10 kilo-ohms. (B)

by R Jacobs

While in the process of repairing or testing electronic equipment, it is often desired to have more time available for hooking up an oscillo-

scope probe or test lead to the part in question, after power has been applied.

This circuit gives you plenty of time

to reach any component in the circuit, since the equipment is only switched on after a fixed interval following depression of the start button.

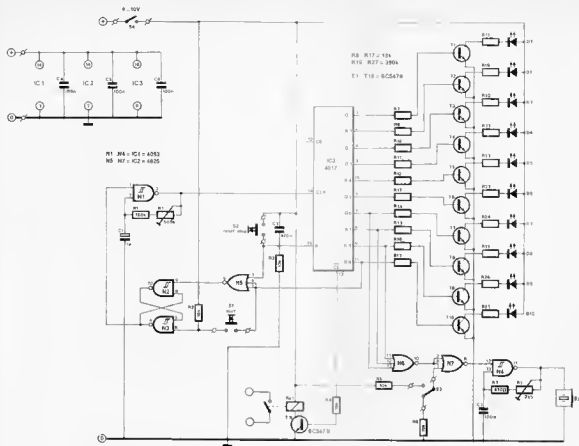

The basic operation of the circuit is as follows. Activating start switch S_1 sets the bistable composed of N_2 and N_3 , causing N_2 to provide clock pulses to decade counter IC_3 . The driver transistors at the outputs of this IC will light the LEDs one after another, indicating the countdown function of the circuit. Re_1 is energized the moment the last LED in the row lights; IC_3 is disabled via its CE

input, and the N_2 - N_3 bistable is reset, all at the same time. The equipment, powered over the relay contacts, is turned on, and the user may take the desired reading. The power-on interval may be restarted or interrupted during countdown by depressing S_2 , which resets the bistable and counter. During the final three stages of the countdown, a warning buzzer is ar-

ranged to sound by means of N_4 ; this function may be disabled by means of S_3 .

Re_1 should not consume more than 100 mA of coil current, while its contact(s) should be rated to suit the load to be switched (R)

pocket frequency meter

94

by R Shankar

This easy to construct circuit meets the demand for a simple, yet versatile battery operated frequency meter which can interpret signals with a minimum rms voltage of 10 mV and a maximum frequency of 100 kHz. The quiescent current consumption of the meter circuit is only 4 mA, which ensures a long life for the 9 V battery. Also of interest is the fact that the circuit continues to work normally with

battery voltages down to about 5 V. The meter input is protected up to 250 V AC. From the circuit diagram it is seen that the input signal is applied to the gate of T_1 via R_1 and C_1 . C_1 is an additional speed-up capacitor to improve the response at higher frequencies, while anti-parallel connected diodes D_1 and D_2 protect the FET gate from high voltage surges

T_1 functions as a buffer, preceding Schmitt trigger A_1 , which has been dimensioned for a relatively low hysteresis of about 18 mV to prevent the overall sensitivity being too strongly degraded. The output of A_1 is fed direct to divide-by-two counter IC_{1a} , which is followed by three cascaded divide-by-ten IC sections. S_2 selects the divisor and hence the relevant frequency range. Whatever range is

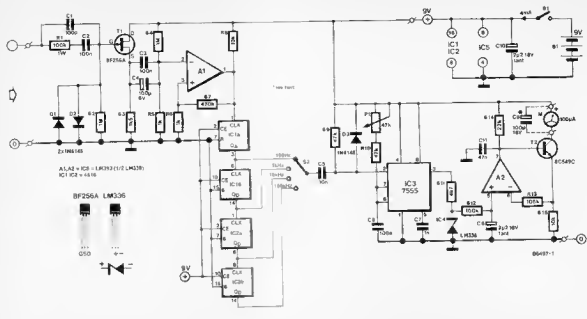

selected, a frequency of 50 Hz at the pole of S_2 corresponds to a full scale reading on moving coil meter M. The signal at the pole of S_2 is used to trigger the monostable built around the Type 7555 low-power precision timer. The correct operation of this circuit section can only be achieved if the time period of the monostable is less than half that of the full scale frequency, i.e. $\frac{1}{2}(1/50)s = 10ms$. Therefore, a monostable time of 8ms is used in the proposed configuration.

The output signal from IC₃ has a

duty factor which is proportional to the input signal frequency. The pulses from IC₃ are levelled at 2.5 V_{PP} by IC₄, before being integrated by R₁ and C₅ to produce a direct voltage which is proportional to the input frequency. The circuit around A₂ and T₂ is a simple voltage-to-current converter with the 100 µA moving coil meter connected in the collector supply line to T₂. C₅ may be added to stabilize the read-out at the lower end of the scale. Though a Type LM339 opamp has been used, the less expensive Type

LM339 also works all right, provided the inputs of the unused opamps contained in this chip are tied to the positive supply rail to minimize their power consumption. The frequency meter is so sensitive that merely touching the input terminal with a finger causes the meter to read the mains frequency. This is, incidentally, a convenient method of calibration, since P₁ may be set to give a reading in accordance with the local mains frequency, which is usually stable within 1%.

CD

95 current drive for stepper motors

Stepper motors have either unipolar or bipolar stators. In unipolar models, each stator winding has a centre tap, which enables the magnetic field to be inverted by switching from one to the other half of the winding. Bipolar types have a single stator winding, so that the direction of the current through it must be changed to attain inversion of the magnetic field. From this, it is clear that, given that the two motors are of similar size, the bipolar type will provide a larger couple than the unipolar model. There is, however, a price to be paid for this larger couple: the drive of a bipolar motor is more complex than that of a unipolar type.

The drive for bipolar motors may, in

principle, be obtained by means of a

- full bridge circuit, i.e. four transistors per stator winding;
- half bridge circuit and dual power supply, i.e. two transistors per stator winding;
- half bridge circuit with large output capacitor.

The last method is totally unsuitable for low stepping frequencies or stand-still. Of the other two, the half bridge is to be preferred in most cases, in spite of the requirement for a dual power supply. In this context, it should be noted that the supply need not be regulated, since constancy of current is guaranteed by a zener diode and emitter resistor, even with variable input voltage. The

value of the smoothing capacitors in the power supply is determined by the total stator current, and is a minimum of 2000 µF/A.

Values of R₁ and R₂ are given for various values of stator current in the table below.

R ₁ & R ₂	I _s
33 Ω; 5 W	100 mA
18 Ω; 1 W	200 mA
6Ω; 2 W	500 mA
3Ω; 4 W	1 A

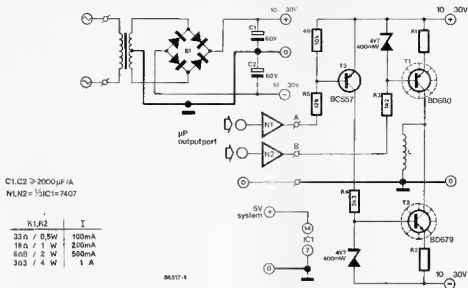

2

Current drive ensures a higher pull-in rate, i.e. permissible starting frequency, because commutation is quicker with an inductive stator winding.

The higher the supply voltage, the more effective the drive, but also, unfortunately, the dissipation in T1 and T3. In practice, a 2×12 V or 2×18 V mains transformer has proved very satisfactory. Note that freewheeling diodes have been included in the darlington circuit to give a good measure of protection against high induced voltages caused by switching.

The prototype was used in the first instance for the control of four-phase stepper motors via an eight-bit output port of a microprocessor system. The interface used to obtain TTL levels was a Type 7407 which has 30V open-collector outputs. The control instructions may be generated as shown in the table.

If the stepper motor is required to be used on its own, this may be done with the aid of commercially available control ICs such as the SAA1027 or the TEA1012. The latter is dealt with in Circuit No. 97 in this issue and may be connected as shown in Fig. 2. (TW)

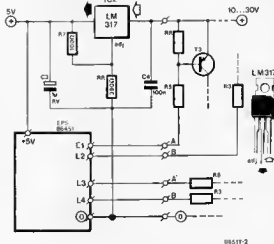

Phase	1	2	3	4					
Bit	7	6	5	4	3 2 1 0				
Output byte	1	0	1	0	1	0	1	0	initial position
Auxiliary byte	0	0	0	0	0	1	1	XOR with output byte	
New O/P byte	1	0	1	0	1	0	0	made one step	
Rotate aux. byte	0	0	0	0	1	1	0	0 preset for next step twice*	

*Direction of turning determines rotational direction of motor.

96 | tuneable active aerial for SW

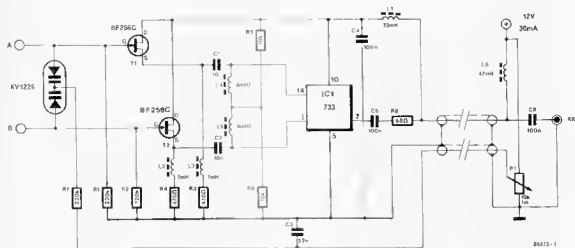

Many of the modern, synthesertuned, general coverage SW receivers incorporate the latest types of high dynamic range RF prestages and mixer devices, while the good old tuneable preselector stage seems to have been eradicated in all but the most expensive and sophisticated types of multi-mode receiver. It would seem as if manufacturers associate a simple tuning control with an attack on user friendliness of the receiver, while a well-designed, tracked or individually controllable input attenuator would have been a better solution to the problems caused by the worldwide escalation of SW transmitter output levels.

A likewise argued plea for reestablishing the tuning control could be entered for the active aerial which, while not able to offer the performance of a long wire or multi-band beam aerial, is none the less generally recognized as a satisfactory means for receiving broadcast programmes in the SW bands up to about 15 MHz.

As generally known, an active aerial is composed of an aerial proper and associated amplifier. As to the latter, the circuit diagram shows that the design has a varactor-tuned, symmetrical input using two FETs Type BF256C which are fed over the coax cable to the receiver Opamp IC1, functions as a fast symmetrical to asymmetrical converter capable of

Table 1.

F _{min} [MHz]	L1 [μH]	turns n	l [m]
150	2200	32	1
		51	0.5
350	390	13	1
		20	0.5
1000	47	4	t
		6	0.5
2000	12	2	1
		3	0.5
4000	3.9	1	0.5

operation up to about 30 MHz. Note that the varicap diode set is tuned over a separate cable; twin-lead 75 Ω coax cable is, of course, ideal for the present purpose. The indicated varicap set ensures a tuning ratio of about 1:2 to 1:3.

When constructing the aerial to this design, it should be noted that neither the circumference of the loop aerial nor the total length of the dipole must be in excess of one tenth of the relevant wavelength in order to ensure the correct directivity characteristics, especially in the case of the loop aerial; the dipole will typically fail to match the amplifier input impedance and thus cause

2

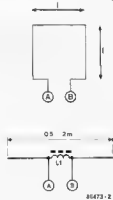

problems in getting the device tuned properly

Table 1 summarizes the aerial construction data, given a number of possible operating frequencies. The aerial should be mounted in such a position as to receive a minimum amount of man-made, short range interference; the amplifier's symmetrical input should ensure sufficient aerial directivity to find a dip for the interfering source.

The loop aerial is uncritical as to the height above ground, but not so the dipole, which is bound to act as a vertical rather than horizontal aerial when mounted at less than a quarter wavelength above ground. (B)

stepper motor control

97

The control of stepper motors is not simple, particularly when no specially designed control circuit is used. The Type TEA1012 is an integrated stepper motor controller that can cope with most if not all situations. In addition to controlling the phases for whole and half steps, it also sets the current with the aid of these phases.

The TEA1012 was specially designed for the control of unipolar stepper motors, in which the current passes through the stator windings in one direction. Because the windings

behave inductively, the current through them will become too large when the stepping speed is low. The reason for this is that in that situation only the ohmic resistance, which is fairly small, determines the value of the current. To limit the current, a limiting circuit is connected in series with the windings. In the diagram, the current through L_1 and L_2 is restricted to $0.3/R_s$, and that through L_3 and L_4 to $0.3/R_s$. This enables the current through the stator windings to be adapted to any type of motor. The table shows in what sequence

the various phases are driven with full and half step control, as well as for clockwise and anticlockwise control. The stepper motor is arrested in the position it occupies with the STOP input. CL is the clock input, for each pulse, the motor turns one step forwards or one step backwards. Because inputs CL, STOP, CCW/CW, and F/H all are TTL compatible, it is not difficult to connect these controls to a computer. Resistors R_1 to R_4 incl. and the associated switches, enable the circuit to be manually provided with control

1

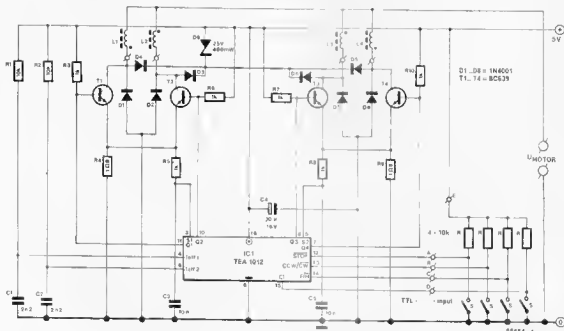

Parts list

Resistors

- $R_1, R_2 = 10 \text{ k}$
- $R_3, R_4, R_5, R_7, R_8, R_{12} = 1 \text{ k}$
- $R_6, R_9 = 150$

Capacitors

- $C_1, C_2 = 2 \times 2$
- $C_3, C_4 = 10 \text{ n}$
- $C_5 = 10 \mu \text{ F}$

Semiconductors

- T₁, T₂, T₃, T₄ = BC639
- D₁ to D₄ incl = 1N4001
- D₅ = zener 25 V, 400 mW
- IC₁ = TEA1012

2

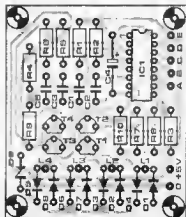
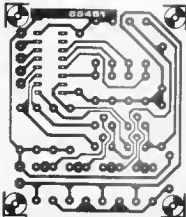

data. The maximum stepping speed depends on the type of motor and on switch-off time-constants T_{off1} and T_{off2} .

Letters CW and CCW signify clockwise and anticlockwise respectively, while input F/H enables choosing whole (F) or half (H) steps. A double resolution is, therefore, possible.

The supply voltage of the IC may be between 4.5 V and 15 V. The outputs of the TEA1012 are open collector, so that the operating voltage of the stepper motor may be made independent of the supply voltage to the IC.

(S)

Table

CL	inputs			outputs			
	F H	CCW/CW	STOP	Q1	Q2	Q3	Q4
	half	clockwise	run				
1	0	0	1	0	0	0	1
2	0	0	1	0	1	0	1
3	0	0	1	0	1	0	0
4	0	0	1	0	1	1	0
5	0	0	1	0	0	1	0
6	0	0	1	1	0	1	0
7	0	0	1	1	0	0	0
8	0	0	1	1	0	0	1
	counter						
	half	clockwise	run				
1	0	1	1	1	0	0	1
2	0	1	1	1	0	0	0
3	0	1	1	1	0	1	0
4	0	1	1	0	0	1	0
5	0	1	1	0	1	1	0
6	0	1	1	0	1	0	0
7	0	1	1	0	1	0	1
8	0	1	1	0	0	0	1
	full						
	clockwise	run					
1	1	0	1	1	0	0	1
2	1	0	1	1	0	1	0
3	1	0	1	0	1	1	0
4	1	0	1	0	1	0	1
	counter						
	full	clockwise	run				
1	1	1	1	0	1	0	1
2	1	1	1	0	1	1	0
3	1	1	1	1	0	1	0
4	1	1	1	1	0	0	1

98

jumbo dimmer

The name *jumbo dimmer* points to its association with the *jumbo Display* (see August/September 1985), but it can, of course, also be used with other appliances such as lamps, pumps, ventilators: in short for all applications where a direct voltage is to be controlled by pulse duration modulation.

With reference to the diagram, A1 is a rectangular-wave generator: a useful by-product of this stage is the (quasi) triangular voltage at its inverting input. This signal is applied to the non-inverting input of comparator A2. The reference voltage for this stage is derived from preset P1. The output of the comparator is a rectangular voltage with a frequency of around 200 Hz and a pulse duration that is variable between nought and 100 per cent. The onset point of the pulses is determined by the setting of P1. The actual control function is provided by transistor T1, which switches the relatively large display

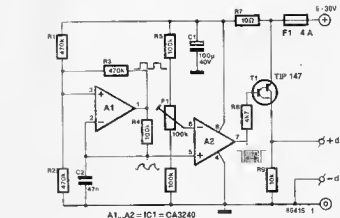

current of up to 5 A. The supply voltage must lie between 5 V and 30 V; note that the efficiency

of the circuit is directly proportional to the supply voltage.

(S)

staircase light controller

99

This circuit has been designed to function as an automatic switch-off facility on the lines of the well-known hotel switch circuit, i.e. the combination of two switches and a single light. While not exactly a replacement of any of the two changeover switches at the top and the bottom of the stairs, the proposed controller may be fitted into one of the relevant junction boxes in which a live mains line is available.

The circuit diagram shows that the controller is fed direct off the mains. C_3 and R_2 create a suitable series impedance which charges C_4 to 6.8 V by means of rectifier D_5 and zener diode D_7 . Set-reset bistable T_3 - T_4 keeps track of the position of S_2 , which determines which of the two tracs is to be driven so as to turn the light on. Any time S_2 is operated, timer IC_1 is started by means of C_1 - R_1 , C_2 - R_3 , N_1 , N_2 and N_3 ; the out-

put of the latter goes high in this condition, resetting IC_1 , and causing it to pull all of its counter outputs low. Note that the reset condition can also be forced by depressing S_1 .

FET T_5 is turned off at reset, and 50 Hz clock pulses are applied to the Φ_1 (clock input) terminal of IC_1 . Any one of the five timer outputs Q_0 - Q_4 may be wired to the inputs of gate N_4 to select the desired on-time for the light; longer intervals may be realized by adding a further counter.

When the selected light-on interval has lapsed, T_5 conducts and disables IC_1 , from receiving clock pulses; the counter state is thus frozen until a reset pulse is applied at terminal 12. Finally, T_1 and T_2 provide DC control of the relevant trac, while AND gate simulators D_1 - D_3 and D_2 - D_4 - R_4 ensure the correct selection of Tr_1 or Tr_2 to power the bulb.

The circuit is readily constructed on

a piece of veroboard and fitted into an ABS mains wiring junction box, as a replacement of one of the switches in the hotel circuit.

As many points in the circuit are at mains potential, due precautions should be taken in the construction and wiring of the controller. Note that S_1 should be rated at 240 V AC, in view of the necessary isolation with respect to the mains voltage.

Tr_1 and Tr_2 require no heatsinks if the bulb is rated at 100 W or less, while the maximum power rating for the tracs is about 400 W.

(Sv)

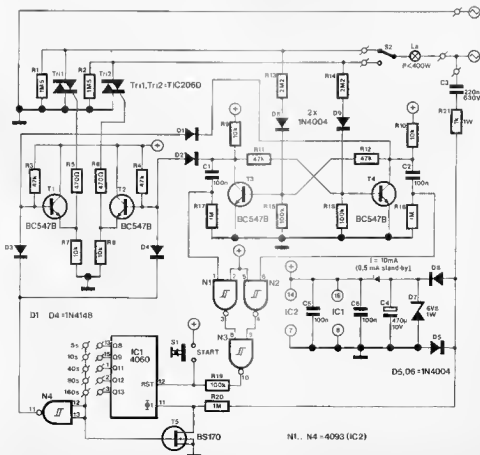

96448

100

listen-in key for data recorders

The pros and cons of using data (cassette) recorders for mass memory storage in a computer system are likely to be so well-known that any further discussion as to the relative cost efficiency of the cassette tape would seem to be superfluous.

There is, however, one distinct disadvantage to the data recorder that is relatively easy to get rid of, viz the trouble many users experience in positioning the tape to the leader note of the desired program or file to load into the computer. Many data recorders, while offering the highest possible save and load speed, fail to produce the sound on tape when the computer audio cable is plugged into the earphone socket, forcing the user to plug and unplug this cable in a desperate search for the program.

The solution to this sorry plight consists of a simple combination of resistor and push to make button, which are to be built into the cassette recorder. The circuit diagram shows the method of connecting these

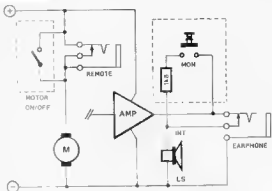

66458 1

parts; pressing the button with the earphone plug inserted in the socket will enable the user to listen to the recorded data as the tape is played. The value of the resistor may have to be adapted to suit the specific output power of the data recorder, given the optimum playback level for the computer.

Now that you have opened the recorder for the outlined modifi-

cation, it is just as well to mount a second button enabling tapes to be rewinded and played while the remote control plug rests inserted in the associated socket; this simple modification may also be of appreciable interest for the improved efficiency in locating files on tape.

AS

101

40-track adaptor

Over the past few years, the cost of 5¼ inch floppy disk drives has gone down to the extent that modern, 80-track, double-sided drives now cost less than a simple, 40-track, single-sided type some three years ago. It is, therefore, not surprising to see many computer owners upgrade their systems with a set of 80-track, slim-line drives to boost the mass storage capacity of their micro.

However, 40-track stored programs are not readily retrievable in the new system, because the distance between tracks in the 40-track drive is twice that in the 80-track model.

This circuit offers a solution to the problem, in that it doubles the step distance for the R/W head in the 80-track disk drive, so as to make it "look like" a 40-track type to the computer which should, of course, be programmed with a 40-track disk operating system (DOS).

It is seen from the circuit diagram

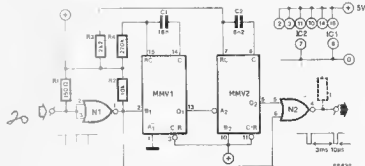

N1, N2 = IC2 = 74LS23
MMV1, MMV2 = IC1 = 74LS221

66426

that Gate N₂ receives the FDC controller STEP pulse, which is used in the circuit as a timing reference for the automatic generation of another STEP pulse to follow the first after 3 ms.

It should be noted that, when incor-

porating the circuit in an 80-track drive, the track-to-track access time in the 40-track mode is double that as given in the drive specifications, which refer to 80-track use.

HS

While many computer enthusiasts are keen on getting their system to run at the highest possible clock speed, there are often quite awkward constraints posed by relatively slow, bus-connected support chips, and the ensuing frustration after failing to get reliable system operation at, say, double the 'old' clock speed may readily lead to abandoning the speed-up project altogether, for lack of precise information regarding the necessary clock-based synchronization between CPU and peripheral chip(s).

A noteworthy example of this happening in practice is the go at incorporation of the Type 9367 CRT controller in a 6502-based computer system running at 2 MHz; the specific application concerns the high-resolution graphics card published in *Elektronika*.

This circuit ensures a correctly timed, synchronized slow-down of the system clock speed, when appropriate for CPU access to a memory-mapped (E150E15F) device. Following the reception of a high level on the relevant I/O line, the proposed circuit arranges for the clock signal frequency to be divided by two, while a low I/O causes division by four.

It is important to point out why the commonly used method of using $\Phi 2$ to enable the address decoder chip is to no avail when it comes to synchronous and glitch-free clock speed switching under software control; the following paragraphs therefore aim at offering an insight into the basic operation of the gear-box circuit and its incorporation in a 6502-plus-graphics card system.

Figure 1 shows the hardware to the gear-box. A logic level at the I/O input is passed to the D (data) input of bistable FF₁, as well as to the R (reset) input of FF₂. FF₁ toggles and activates its Q output; this causes the 4 MHz clock signal, divided by two in FF₂, to be output as 2 MHz towards the CPU Φ_{in} terminal. Division by four (1 MHz clock output) should take place in a synchronous timing arrangement as soon as I/O goes low; just prior to this pulse transition, Φ_{in} has already gone low, so that the level change at the FF₂ reset input is of no consequence to the CPU operation at that time, however the bistable can not change state anymore. Thus, FF₁ will have to

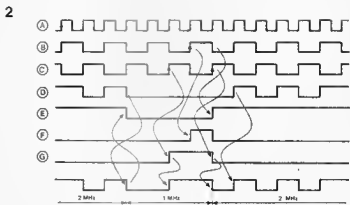
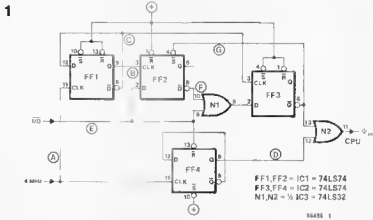

supply the output clock signal; the D input follows the I/O signal transitions, since Q of FF₂ was forced to go low in consequence of S (set) being activated. The first leading edge coming from the FF₁ Q output will cause Q of FF₂ to go logic high, ending the set condition of FF₂. Given an input clock frequency of 4 MHz, the outlined timing sequence results in Q of FF₂ going high after 250 ns, followed by a low level at Q of FF₂ after another 250 ns. The timing diagram shown in Fig. 2 clarifies this, admittedly rather complicated, timing arrangement in the gear-box circuit. It is noted that a complete 1 MHz period has lapsed, provided FF₁ is properly synchronized during the CPU initialisation cycle. Theoretical research into this matter, however, has shown that this is not always the case; the result is an asymmetrical output clock period with a logic low and high level duration of 250 and 500 ns respectively. The remedy for this undesirable effect is simple, since it merely involves inter-

changing the clock signal connections to FF₂ and FF₁.

It is seen that $\Phi 2$ -based I/O decoding is less desirable, since it involves too long a delay; what remains is to indicate the method of obtaining I/O from the graphics card system (EE, November 1985, p. 71).

XX5X is dismissed for now obvious reasons, but $P=Q$ at pin 19 of IC₁ can be used for our purpose, while the possible objections to the resultant, rather coarse address decoding are readily rendered devoid of relevance by the incorporation of a single 3-to-8 decoder Type 74LS138, mounted piggy-back onto IC₂ and connected direct to pins 1...5, 16 and 8. The remaining pins of the additional IC are either cut off or bent to preclude wrong contacts from being made in the circuit. However leave pins 6 and 10 in function, since the former should be tied permanently to +5V (small wire to pin 16), while the latter can now be used to supply the correct I/O pulse for the CPU gear-box. (D)

103

musical greeting cards

The designer of this circuit will readily admit that it is literally not much to make a song or dance about, since what is shown as the circuit diagram speaks (sings) for itself.

Available in about 30 different song versions, the Type UM3166-xx is a

fully autonomous melody generator chip which operates at extremely low battery voltages (1.3...3 V), while capable of directly driving a small piezo-buzzer from antiphase output terminals 2 and 4. If you wish, you may connect an AF amplifier to

either of these pins in order that more listeners may be captured by the melody selected from the accompanying table. The melody may be played continuously by connecting terminal 3 to 7 rather than 1. (S)

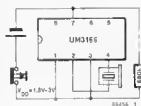

Table

TYPE	MELODY	TYPE	MELODY
UM3166 1	JINGLE BELLS · SANTA CLAUS IS COMING TO TOWN · WE WISH YOU A MERRY X MAS	UM3166 16	TOMORROW
UM3166 2	JINGLE BELLS	UM3166 17	WE WISH YOU A MERRY X MAS · SILENT NIGHT
UM3166 3	SILENT NIGHT	UM3166 18	WEDDING MARCH (WAGNER) FOR ELISE
UM3166 4	JINGLE BELLS · RUOOLPH, THE REO NOSEO REINOER + JOY TO THE WORLD	UM3166 20	WHEN THE SAINTS GO MARCHING IN CONGRATULATION + HAPPY BIRTHDAY
UM3166 5	HOME SWEET HOME	UM3166 22	JINGLE BELLS (NEW VERSION)
UM3166 6	LET ME CALL YOU SWEET HEART	UM3166 23	IF YOU LOVE ME
UM3166 7	CONGRATULATIONS	UM3166 24	TWINKLE TWINKLE LITTLE STAR
UM3166 8	HAPPY BIRTHDAY TO YOU	UM3166 25	MARCH OF TOY SOLDIER
UM3166 9	WEDDING MARCH (MENOELSSOHN)	UM3166 26	ROCKABYE BABY
UM3166-10	I WILL FOLLOW HIM	UM3166 27	CHORAL SYMPHONY (BEETHOVEN SYMPHONY NO 9)
UM3166 11	LOVE ME TENDER, LOVE ME TRUE	UM3166 28	HAPPY BIRTHDAY TO YOU (NEW VERSION)
UM3166 12	SUCH A WONDERFUL DAY	UM3166 29	BLUE BELLS OF SCOTLAND
UM3166 13	EASTER PARADE	UM3166 31	LULLABY (SCHUBERT)
UM3166 14	GRAOUATION MARCH		
UM3166 15	ALOHA OE		

104

DC operated 50 Hz timebase

Many clocks, both of the digital and the analogue type, make use of a 50 Hz timebase signal which is usually derived from the mains. In order that these clocks may also work in places where there is no mains supply available, as in cars, on boats, or, say, on a camping site, this one-chip circuit provides an accurate 50 Hz square wave output signal,

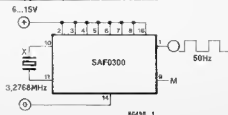

while being fed off any DC supply voltage between 6 and 15 V (battery, solar cell array, etc.). Current consumption of the circuit is only 3 mA (max.).

The Type SAF0300 by ITT Semiconductors merely requires a crystal to perform the above task, while also offering the possibility to adjust the exact output frequency by means of seven active low bits as listed in the pin assignment table.

If a 64 Hz output frequency is desired rather than 50 Hz, the crystal may be replaced with a 4.194812 MHz type.

pin	function		
1	Output 1 (50 Hz)	9	Test pin M ($F_x/4$)
2	Adjustment pin 122 ppm	10	Crystal connection
3	Adjustment pin 61 ppm	11	Crystal connection
4	Adjustment pin 30.5 ppm	12	Bridge output
5	Adjustment pin 15 ppm	13	Bridge output
6	Adjustment pin 7.6 ppm	14	Ground, 0
7	Adjustment pin 3.8 ppm	15	leave vacant!
8	Adjustment pin 1.9 ppm	16	Supply voltage

Finally, the 50 (64) Hz output pulse has a voltage swing of nearly the IC

supply voltage, and a duty factor of 0.5.

HS

loudspeaker protection

105

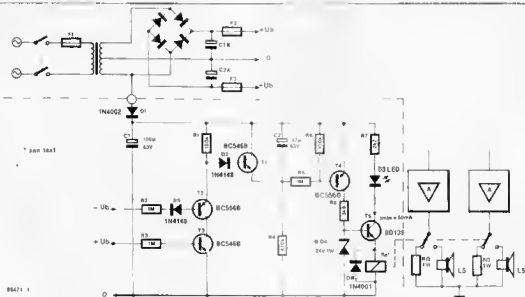

This is an all-transistor design for incorporation in AF amplifiers that produce nasty clicks in the loudspeakers when turned on or off, jeopardizing the voice coils by passing a large current surge.

Assuming that AF amplifier and protection circuit are off, C_1 and C_2 are empty of charge and Re is deactivated. At power-on, D_1 rapidly charges C_1 . Provided both the negative and the positive supply voltage are present and at the correct level, T_1 and T_2 conduct, while T_3 is off, enabling C_2 to be slowly charged via R_1 . If the voltage across C_2 is sufficiently high for T_4 to conduct, T_5 will draw base current and energize Re , which connects the loudspeakers to the amplifier outputs. Zener diode D_4 fixes the voltage across the coil of

Re , so that differently rated relays may also be used in the circuit, provided D_4 is changed accordingly. However the relay coil current should not exceed about 50 mA, while the changeover contacts should be rated in accordance with the amplifier output power and impedance; for a $2 \times 100 W$ at 8Ω type, for instance, the relay contacts should be rated at least 8 A. Should either one or both supply voltages ($-U_b$; $+U_b$) disappear for some reason or other (amplifier malfunction, short-circuited smoothing capacitor, etc.), the relevant transistor T_2 or T_3 will be disabled, causing T_1 to receive base current via R_1 ; C_2 will be discharged forthwith and Re is deactivated in consequence since T_4 and T_5 are turned off. The amplifier

channels can now produce clicks they like; the output is safely applied to two resistors matching the output impedance.

The protection circuit is fed off the voltage across C_1 , which is purposely rated at only $100 \mu F$ to enable Re to be deactivated almost immediately after the amplifier has been switched off. Power-off clicks, if produced, will therefore end up in the dummy resistors rather than the expensive loudspeaker voice coils.

The protection unit is most readily fitted on a piece of veroboard, while Re should be mounted close to the loudspeaker output terminals to keep contact losses as low as possible.

AS

106

mains zero-crossing detector

Both safe and remarkably simple to construct, this circuit detects the zero crossing moments of the mains voltage, in order to provide other circuitry with timing information about the correct instant for switching mains-connected loads, in other words, when the least possible switching dissipation is involved, and, therefore, least interference is induced on the mains lines.

The proposed circuit operates direct off the mains, while comprising no more than two opto-couplers and two resistors. It is seen that photodiodes D_1 and D_2 are connected in anti-parallel while being fed with the mains voltage via a resistor, which limits the current through the relevant diode to about 2 mA as it conducts (i.e. lights) during the negative or the positive half wave (D_2 or D_1 respectively) of the mains sine-wave; in either case, the circuit output voltage is low, since the associated phototransistor conducts and draws current from $+U_b$ via R .

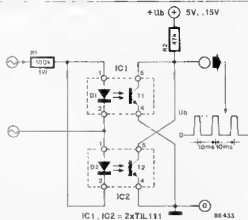

However, at the moment of zero crossing, neither one of the diodes conducts, and the voltage at the circuit output rises to near $+U_b$ level, whence the 100 Hz pulse train. The value of R_2 may be adapted to suit the level of $+U_b$ and the manufacturer-specified typical collector

current through the phototransistor. For the Type TIL111, the current should not exceed about 50 mA. The type of optocoupler used in the circuit should not be very critical, but the value of R_2 had best be left at the indicated 100 k so as not to run into excessive diode dissipation. *CN*

107

calibration generator

A calibration generator is of particular use with many older generation receivers, which have no, or a poor, frequency read-out. However, the RF section of these receivers is invariably far superior to that of most modern models, and consequently there are still many of these 'oldies' in use.

The circuit in the accompanying diagram provides calibration signals at multiples of 100 kHz and 1 MHz, all of which are available simultaneously, so that no switching is necessary.

The output signal of the crystal oscillator, T_1 is divided by 10 in IC₁. Astable N_1 operates at a frequency of around 22 Hz, which is low enough to allow zero beat tuning even in SSB operation. The 100 kHz harmonics sound (on AM) like a sort of woodpecker.

Astable N_2 operates at about 1.5 kHz and is gated with the 22 Hz signal. Consequently, the 1 MHz signal appears for 22 ms as a carrier wave,

which is modulated with the 1.5 kHz signal during the next 22 ms. This signal is also easily tuned for zero beat.

The circuit is usable up to 30 MHz when CMOS devices are used, and up to around 300 MHz with HCMOS ICs. *(B)*

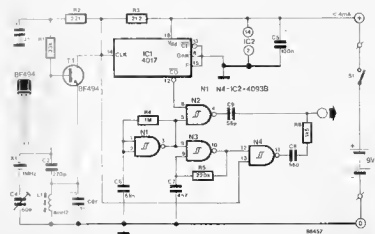

KWIK KLIP

Kwik Klips provide a new convenience in initial assembly of wires, wire bundles are secured in moments with a fingertip twist. Kwik Klips are made from non-corrosive and non-conductive nylon. These clips remain rigid even when subjected to severe temperature extremes from -35°C to +135°C. Available in black colour they are resistant to solvents, alkalies, dilute mineral acids and most organic acids.



For further information, contact
SURESH ELECTRICS & ELECTRONICS
Post Box No 9141
Calcutta-700 016

CABLE MARKERS

Novoflex Cab lok Cable Tie and Cable Marker combination provides a permanent identification for buried Cables, Carrier Cables or any other Cable Conduit Pipes or Tubing. Novoflex Cable Markers are heat stamped with number Zero through nine and alphabet A through Z, ., /, . Each character is on a separate marker and desired legends can be made up. Available for Cable diameters upto 106 mm. These markers can be used at the ends as well as at any intermittent positions.



For further details please contact
NOVOFLEX CABLE CARE SYSTEMS
Post Box No 9159
Calcutta-700 016
Telephone No 290482, 295939
29 3991

PUSH BUTTON SWITCHES

Unique has introduced a new range of Push Button Switches. These switches are compact in size with Silver plated Phosphor Bronze Contacts, Stainless



Steel Springs, Extension-rib with mechanised interlock and option for PCB Mounting. Direct wiring. Rated at 1A 25V. These switches are available in 3 Poles/4 Poles, 2 way in a set of single button to 12 buttons.

Typical applications include intercoms, panel boards and scientific instruments.

For further information contact
M/S UNIQUE ELECTRIC COMPANY
Unit No B 1-2, BK Chhabra Compound
Bulstrode Lane, Vakola Bridge
Santacruz (East)
Bombay 400 055

HOBBY KIT

EICKIT-511 is for the electronics hobbyist. It includes a loudspeaker, a solderless breadboard, terminals and a mains operated regulated power supply with full protection against accidental short-circuits and overload. A hobby circuits manual, connecting components required for making the projects mentioned therein are included with the kit. No soldering is required and the components can be used and over again.



For further details, contact
ELECTRONIC INSTRUMENTATION & CONTROL
24, Visveswarayya Industrial Area II
Mahadevapura
Bangalore 560 048

THYRISTOR CONVERTORS

Static Power Systems Pvt Ltd have introduced solid state thyristor converters for DC Motors where infinitely variable speed control is required.

These drives have full wave half control or full wave full control, depending on the



specific application. The circuit has been divided into various modules (With separate fault indicators and test points) thus facilitating maintenance and servicing. They are also available for group drives with multiloop feedback and with acceleration/deceleration control.

Used extensively in power control systems, oven and furnace temperature control. These converters are available upto 150KW rating.

For further details please write to

M. S. STATIC POWER SYSTEMS PVT LTD
D-148, Bonanza Ind Estate
Ashok Chakravathy Road
Kandivali (E)
Bombay-400 001

ROTARY SWITCH WITH ADJUSTABLE STOP TRS-12

'Comtech' TRS-12 is a Rotary switch which is offered in 3 models, First 1 pole 12 positions, Second 2 pole 6 positions and Third 4 pole 3 positions. A stop ring is provided with each switch to enable the user to adjust the switch-stop position to meet his requirements. Each model is available with printed circuit and solder terminals having tin-lead plating to impart quick solderability.

The body is made up of glass filled Nylon and the contacts are made from brass and phosphor bronze. The switch at present is offered with nonshorting contacts (Break before make), having a rating of 350 mA at 110 V AC/DC, and with contact resistance of 20 milliohms max.

PRODUCTS NEW



The switch is having a minimum mechanical life of 20,000 detent operations. The shaft accepts any knob suitable for 1/4" diameter.

For further details contact
COMTECH TECHNIQUE 8, Orion Apartment
29 A Lalubhai Park Road
Andheri (West)
Bombay-400 058

CONNECTOR STRIP

RL Components have developed new type of connectors suitable for direct mounting on PCB/Instruments and transformers. These are available in 2/3/6/8 ways in ratings of 5, 10, 15 A at 130L, 130LS types. Some of the important features of these connectors include built-in terminal marketing arrangement, SHROUDDING for protection against accidental touch, semi dimensions, clamping action for outward connections, flame-retardant and high impact properties.



For more details, please contact
M/S RL COMPONENTS
Yaksh Nagar
A-21, Kothrud
Pune-411 029

ALL THAT STANDS BETWEEN DARKNESS AND HER IS YOUR SIGNATURE.

To
K S Gupta
The General Secretary,
Lok Kalyan Samiti,
Sucheta Bhawan
11-A, Vishnu Digambar Marg
New Delhi - 110002

For Rs. 100 per operation, I would like to sponsor

- 1 cataract operation yearly
- 2 cataract operations yearly — payable yearly/half yearly
- 4 cataract operations yearly — payable yearly/half yearly/quarterly
- 6 cataract operations yearly — payable yearly/half yearly/tri-monthly

I am enclosing herewith a crossed cheque/demand draft in favour of Lok Kalyan Samiti for Rs. _____

Please send me details with photographs of the person/s I am sponsoring

Name _____
Address _____
Profession _____
Date _____ Tel _____

Income Tax Exemption under Section 80G of the Income Tax Act



IMAGINE A WORLD OF LENGTHENING SHADOWS. OF VISIONS FADING INTO OBLIVION. A WORLD STEADILY GROWING DARKER. CATARACT, A DISEASE THAT CLOUDS THE LENS OF THE EYE OBSTRUCTS THE PASSAGE OF LIGHT, MILLIONS IN OUR COUNTRY, ABOVE THE AGE OF SIXTY ARE ENGULFED IN THIS FOG. WE, AT LOK KALYAN SAMITI ARE ASKING YOU TO HELP WE TAKE CARE OF OVER 35,000 EYES EVERY YEAR. WE HAVE ORGANIZED 77 EYE CLINICS IN 16 STATES AND OPERATED 1,000 CATARACT PATIENTS TO DATE. YOU CAN HELP FINANCE A CATARACT OPERATION IT COSTS 100 RS PER EYE. WITH THE FINANCIAL SUPPORT YOU CAN HELP FINANCE A CATARACT OPERATION IT COSTS 100 RS PER EYE. WITH THE FINANCIAL SUPPORT YOU CAN HELP FINANCE A CATARACT OPERATION IT COSTS 100 RS PER EYE. WITH THE FINANCIAL SUPPORT YOU CAN HELP FINANCE A CATARACT OPERATION IT COSTS 100 RS PER EYE.



Lok Kalyan Samiti

Founder: Late Sri. Sushro Khandelwal

A voluntary, non-political, non-profit health and welfare organization

SET YOUR SIGHTS ON THE NEARLY BLIND. GIVE.

Created in the interest of public service by Lotus India Limited, New Delhi

elektor INDIA Kits



LCD Thermometer Issue No. 26 EPS No. 82156

Simple! Easy to assemble. Based on IC 7106. This thermometer is very accurate with a temperature range - 50°C to + 150°C. Ideal for house or laboratory.

Complete kit (with cabinet)
Rs 575.00

Capacitance Meter Issue No. 11 EPS No. 811012 - 1/2

To measure those elusive torads, this project features:

- Read out on a 3 1/2 digit LCD
- A measuring range from 0.1 pF to 20 mfd
- high accuracy

It is a complete instrument at a hobbyists price. Complete kit (with out cabinet) Rs 750.00

Digilex Digital Trainer

Teach yourself digital electronics in a simple, unique manner. Broaden your horizons and improve your fundamental understanding of the changing world of electronics around you. This trainer gives you an opportunity to learn electronics at a very reasonable cost.

Complete trainer at Rs 325.00

Junior Computer Kit

This kit enables you to have a practical orientation of the concepts explained in the Junior Computer Book 1. Get actual 'hands-on' experience. Learn the basics of hardware and software in an innovative step-by-step manner.

And that too at an amazingly low price!

Complete kit (without cabinet)
Rs. 1500.00

Elektor Binder — This reddish binder collects your loose copies of Elektor into one handy volume. A

simple system enables you to add each copy as it arrives and to remove a single copy without disturbing the others.

Price Rs. 25.00 plus Rs. 5 for Packing & Postage

Kits currently available

Issue No.	EPS No.	Title	Price.
33	85110	Telephone Exchange	Rs 1200.00
36	9827	Magnetiser	Rs 65.00
37	80054	Talk Funny	Rs 210.00
39	86013	Single Trace CRT Converter	Rs 190.00
39	9967	VHF/VHF Modulator	Rs 105.00
28/29	85447	Fault finding probe for UPS	Rs. 60.00
28/29	8543	Hi-fi headphone amplifier	Rs. 75.00
28/29	85476	Brokelight Monitor	Rs. 25.00
28/29	85448	Electronic Dog	Rs. 180.00

Special offer - 10% off

on Video Amplifier, Stereo Balance Indicator, After Burner, Elektor terminal Bell, Electronic Pocket Pin Ball game, 7400 siren, hfe tester. Offer valid for Aug/Sept. 86 only.

Buying one of our kits will save you the frustration of tracking down those elusive components that hold up your projects. General information:

Ordering information:

1. All payments in Advance by M/R P/O or D/D only
2. Items will be sent by RPP only
3. Price includes Packing & Postage
4. For orders out of Maharashtra's state. Please add 10% as a 'Incidental Charges'. Send payment to:

precious[®]
ELECTRONICS CORPORATION

Journal Division 11 Kln Lane, Off, Lamington Road, Bombay - 400 007.

THE SIMPLE ANSWER FOR ELECTRONIC COMPONENTS

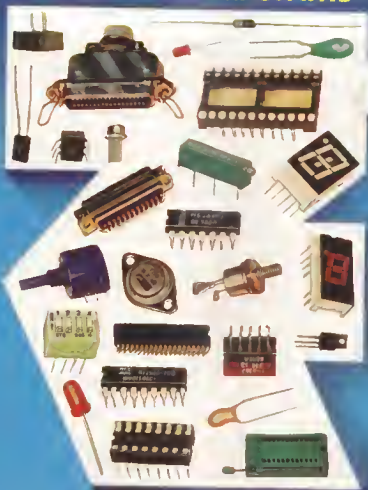

EACH NEW DAWN BRINGS THE
POSSIBILITY OF A NEW PROGRESS.

- ICs: TTL, CMOS, MOS, LSI, LINEAR, MICROPROCESSOR, MICRO COMPUTER etc.
- IC SOCKETS: MOLEX & SMK MAKE INCLUDING MOLEX PINS & TEXTOL 'O' INSERTION SOCKETS.
- TRIMPOTS MULTI TURN AS WELL AS SINGLE TURN OF BOURNS, VRN & BAKEMAN MAKE
- DISPLAYS: 3", 5" & 1" IN COMMON CATHOD & COMMON ANODE INCLUDING 3½ DIGIT LCD.

TANTALUM CAPACITORS OF ALL VALUES
ZENER DIODES, SILICON DIODES,
TRANSISTORS, PHOTO TRANSISTORS,
PHOTODIODES, LED'S CRYSTALS

INDENTOR FOR ALL TYPES OF
ELECTRONIC COMPONENTS,
INSTRUMENTS, GREEN PHOSPHOR
AS WELL AS RGB
MONITORS ETC.

Our Principles:

M/s. ZIEX TRADING PTE LTD
SINGAPORE/HONGKONG



Zodiac

**ELECTRONICS
CORPORATION**

BHUSHPANT NIWAS
3 CHUNAM LANE
3RD FLOOR, OFF LAMINGTON ROAD
GRANT-ROAD, BOMBAY-400 007

PHONES: OFFICE : 369192 5137225, 5135845

EXTRA AUDIO QUALITY



COSMIC
WE ARE SOUND

STEREO

ALTS. FREQUENCIES