

133

June  
1986

elektor

INDIA

Rs. 7.50

# electronics

Portable mixer

Sirens

Flashing colours

Magnetic-field  
sensors

Versatile stereo amplifier

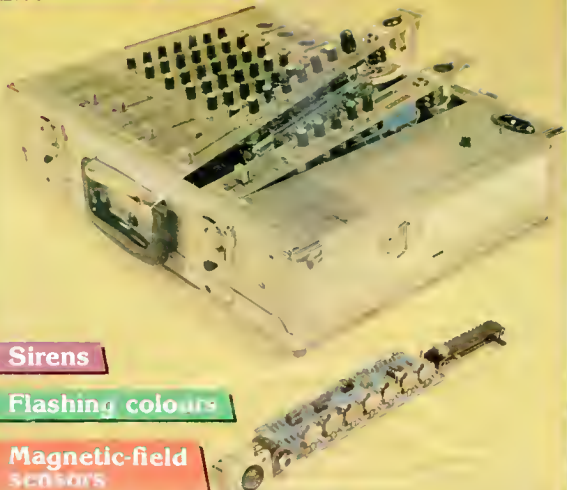

Publisher: C R Chandrana

Editor: Surendra Iyer  
Editorial Assistance: Ashok Dongre  
General Manager: J Dhes  
Advertising: B M Mehta  
Production: C N Mahasari

Address  
ELEKTOR ELECTRONICS PVT LTD  
52 C Princes Road  
Bombay - 400007, India

#### Overseas editions

Glenstep Publishers Limited  
Sandlert House Bath Place  
High Street Barnet  
London EN5 1 ED  
Editor: Len Seymour

Elektaur B.V.  
Pasei Treckpoelstraat 2 4  
6191 VK Beek - the Netherlands  
Editor: P E L Kersmakers

Elektaur sari  
Route Nationale, Le Saux; B P 53  
59270 Belleul - France  
Editors: D R S Meyer,  
G C P Raedersdorf

Elektaur Verlag GmbH  
Susterfeld Straße 25  
100 Aachen - West Germany  
Editor: E J A Kempelsaus

Elektaur EPE  
Karaçakki 14  
16673 Voula - Athens - Greece  
Editor: E Xanthoulis

Elektaur JCE  
Via Rosellina 12  
20124 Milano - Italy  
Editor: D Fumagalli

Ferreira & Bento Lda.  
R D Estefânia, 32-1º  
1000 Lisboa - Portugal  
Editor: Jorge Gonçalves

Ingelek S.A  
Av Alfonso XIII, 141  
Madrid 16 - Spain  
Editor: A M Ferris

International co-ordinating  
& technical manager  
K. S. M Walraven

The Circuits are for domestic use only. The submission of designs or articles to Elektor India implies permission to the publishers to alter and translate the text and design, and to use the contents in other Elektor publications and journals. The publishers cannot guarantee to return any material submitted to them. All drawings, photographs, printed circuit boards and articles published in Elektor India are copyright and may not be reproduced or translated in whole or part without prior written permission of the publishers.

Patent protection may arise in respect of circuits, devices, components etc. described in this magazine.

The publishers do not accept responsibility for failing to identify such patents or other protection.

Distributors  
Blaze Publishers & Distributors Pvt. Ltd

Printed At  
Trippr Offset  
Bombay 400 013



Copyright © 1986 Elektaur B.V.  
The Netherlands



## electronics technology

Loudspeaker impedance correction	6.28
Computers and health care	6.31
Electronics and temperature control	6.33
Magnetic-field sensors	6.38
Early detection of electronic failures	6.42
A million frames hold the new Domesday	6.43
Pioneering nuclear power for peaceful purposes	6.44
Design ideas: LC displays	6.46

## projects

Portable mixer - 1	6.16
Flashing colours	6.26
Simple auto slide changer	6.35
Sirens	6.40
Versatile stereo amplifier	6.49

## information

New products	6.63
Readers services	6.71

## guide lines

Switchboard	6.69
Appointments	6.73
Classified ads	6.74
Index of advertisers	6.74

## selex-13

Digi-Course II (chapter 7)	6.54
The Oscilloscope	6.56
TV Antenna signal distributor	6.60
Tips for selex PCB	6.61

# VASAVI OSCILLOSCOPES

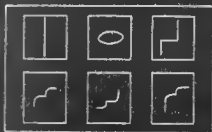
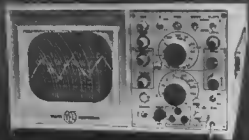

Component tester in our oscilloscopes is altogether different from other's. In addition to all Oscilloscope functions component tester provision can test all components passive and active, in circuit and out of circuit. **ONLY OUR SCOPES CAN recognise NPN/PNP. Distinguish HIGH/LOW Gain, Distinguish AUDIO, R.F., SWITCHING transistors.**

## MULTI FUNCTION OSCILLATOR



- \* Pure Sine wave output.
- \* Amplitude settable with ease down to millivolts. X 1, X 1/10 and X 1/100 attenuated outputs available.
- \* No amplitude bounce when frequency varied.



# VASAVI ELECTRONICS

630, Alkarim Trade Centre Ranigunj  
SECUNDERABAD-500 003. ph: 70995

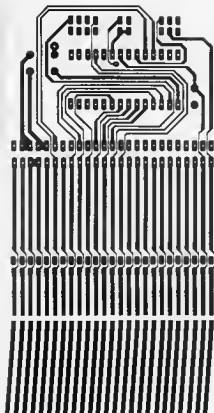

**AT LAST**

**THE PRECISION  
AND QUALITY**

**you were looking for  
at realistic prices**

**YABASU**

**PCB Drafting Aids now made in India.**

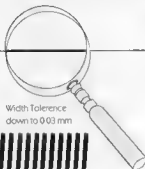

Width Tolerance  
down to 0.03 mm

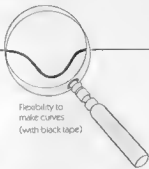

Flexibility to  
make curves  
(with black tape)

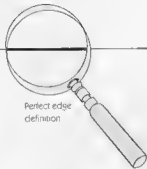

Perfect edge  
definition

- Tapes in black, red & blue. All widths in inch or metric measure available ex-stock.
- IC Patterns and Donuts to be introduced soon.

Write to

**precious<sup>®</sup>**  
**ELECTRONICS CORPORATION**

52-C, Chhotani Building, Proctor Road, Grant Road (E), Bombay-400 007.

**Dealers wanted all over India**

Whatever your multimetering needs...



**Motwane has its measure.**

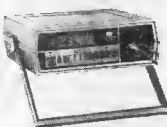

Have you ever thought of how dependant we are on electricity and what an indispensable instrument the Multi-meter is today? There is not an Industry, Communication and Utility service, Defence force, or even a general technician that does not use one.

Much has been made of the merits of Digital Multimeters over that of Analog ones, but in truth both enjoy basic inherent advantages. Its simply a matter of the right application. You must give your measurements the instrument they deserve.

The prime benefits of Digital Multimeters lie in their:  
 1. Unambiguous readings—no kit operation  
 2. Speed  
 3. Infallible accuracy  
 4. Systems capability  
 5. Minimum circuit load  
 6. And bonus features such as True RMS, Conductance measurements and Diode testing—like the Motwane DM 450—the 4½ digital that stands tall with the

best in the world, and our DM 351—the 3½, digital whose features other companies are still designing.

Yet there is no denying the finesse of Analog meters when you need:  
 1. The trend in variations to be easily perceivable—invaluable in peaking and nulling.  
 2. Wide dynamic resistance ranges not limited by the number of display digits.  
 3. Excellent immunity to voltage transients.  
 4. Quick go-no-go checks.  
 5. A totally panelmatic instrument—like the Motwane EX Mark III—the grand old man of Multimeters—experienced and confident, and the EX Mark I—the handheld bred with an eye on cost effectiveness and field operation.

We are the only company in India and one of the few in the world, to offer you the best of both worlds—Digital and Analog. Motwane is the certain guarantee of Quality these exclusive, at a price that's not — by any measure.



For further details write to:  
**THE MOTWANE MANUFACTURING COMPANY PVT. LTD.,**  
 at Gyan Baug, Nasik  
 Road 422/101  
 Tel. 86297/86084 Telex 752-247 MMPL IN  
 Grams: MOTWANE or Gyan Ghar, Plot 434 A,  
 14th Road, Khar, Bombay-400 052. Grams:  
 : MOTESTEM

Cut here and mail

Please send literature and quotation on your Multimeters

Name \_\_\_\_\_  
 Designation \_\_\_\_\_  
 Company \_\_\_\_\_  
 Address \_\_\_\_\_  
 Telephone \_\_\_\_\_ Telex \_\_\_\_\_

SEL. ADS/MWC 12 84

# Device offers



**ELECTRONIC  
EDUCATIONAL  
& TESTING  
DEVICES**

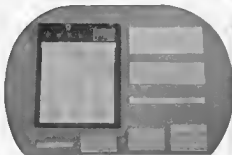

Solderless Bread Board



1 DL-400 Logic Trainer

1 DL-800 Digital Lab

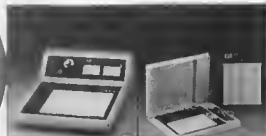

1 DL-600 Analog Lab

DT-01 Digital Trainer

**We stock:**

**elektor**  
Magazines

IC IZUMIYA IC INC.  
P.C.B. Drafting Aids

**TELEDYNE**  
RELAYS

**RCA**  
Semiconductors

**KONTAKT  
CHEMIE**  
Cleaners

**RAYTHEON**  
Semiconductors

**FAIRCHILD**  
Semiconductors

  
TEXAS INSTRUMENTS  
Semiconductors

**VRN** Trimming  
Potentiometers

Ribbon Cable  
Connector Panels

**SSS**  
Semiconductors

RS 232  
Connector Panels

## SPECIAL EX STOCK OFFER

				E-Prom	
D-RAM	Regulators	SCR/Triacs	TTL/CMOS	2716	27128
4116 41256	7805 - 24	4 amp - 40 amp	74 LS00 - 629	2732	27256
4164 42128	7905 - 24	400 V - 600 V	4001 - 40257	2764	

Bulk importers and users in India may Kindly forward their specific enquiries



# Device Electronics Pte. Ltd.

101 Kitchener Road \*02-04, Singapore Electrical, Electronics and Hardware Centre,  
Singapore 0820. Telex: DEVICE RS 33250

FOR ENQUIRIES **CALL: 298 6455** (4 lines)

# Today BESTAVISION are in the news...

## TOMORROW, THEY'LL BE MAKING HEADLINES

Improved standards of living, coupled with Doordarshan's vastly expanded transmission facilities have already generated a substantial increase in the demand for TV's.

With growing emphasis on modernisation in management and industry, the demand for computers is also going up at a rapid pace.

In view of the above factors, the 7th Five Year Plan envisages a spectacular 500% growth for the Electronics Industry. And the government is extending massive support to make this growth possible.

Bestavision Electronics Ltd. are all set to cash in on the favourable opportunities offered by the electronics boom, by setting up a plant in Noida, for manufacturing both computers and TV's.

Today, this Company are already well known for the vast range of televisions marketed by them. And now, people are talking about their new line of products for computers, VCR's, VCR's, Computers, Computer peripherals, microprocessor-based systems and various other electronic items — in

**technical tie-up with the world renowned IAP International of U.S.A.**

With the vast experience of their dynamic Managing Director, Mr. A.C. Bajaj, and the technological expertise of their highly qualified team, the professionally managed Bestavision are heading far for a lead in the field of electronics.

With all this in their favour, would it be surprising if BESTAVISION hit the headlines soon?

#### HIGHLIGHTS

- Existing profit-making Company.
- Professional management by persons having intensive experience and expertise in electronics.
- Technical tie-up with IAP International of U.S.A., the renowned world leaders in the field of electronics.
- 80CC, 80L tax and wealth tax benefits.
- Extensive product range for the home, office and industry.
- No gestation period — assured dividend and excellent future prospects.

\*Applied for

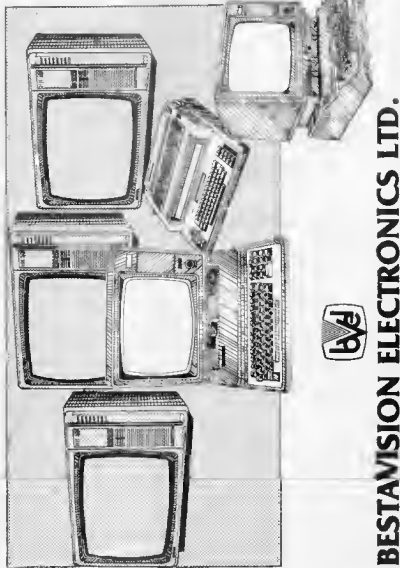

## BESTAVISION ELECTRONICS LTD.

A-20 Defence Colony, New Delhi-110024

PRESSMAN

### WATCH FOR THE PUBLIC ISSUE

**CMOS Technology RCA 1802 Microprocessor Based Micro Computer and Control Systems. for DEFENSE APPLICATIONS, FIELD DATA LOGGING, Electroplating Process Control and other Industrial Applications.**

**savla pc 1**



Extremely low power requirements of CMOS chip makes it most suitable for field applications and stand alone units.

- CMOS 8-bit Microprocessor RCA 1802 with 16 bit Multi function registers matrix of 16 x 16 This extremely reliable and breakdown free Microprocessor has been built into the space shuttle satellites and other military devices.
- 1802 calls a sub-routine in 2.5 micro seconds (as against 8.5 microseconds of Z-80)
- Rapidly switchable program counter (faster than a Jump in Z-80)
- On 1802 one can generate powerful Pseudo Codes with the available page addressing.
- A complete and systematic Microprocessor with true built-in Direct Memory access.

Contact:

**precious** ELECTRONICS CORPORATION

52, C. Proctor road, Grant Road (E) Bombay - 400 007, Ph. 367459, 369478

Manufactured by

**SAVLA ELECTRONICS PVT. LTD.**

Ahmedabad 380 006

Phone 462866

**Artwork & Layout for Printed Circuit Boards**

Gala No - 10 Jaydeep Pkcs. 134/5

Old Bombay - Pure Road, Phone 400 605

ADVANCE INFORMATION FOR

RESEARCHERS, CONSULTANTS, OLS & OTHERS

Printed Circuit Board designing is our business. Layouts & Artwork in 2x on polyester film, Legend printing, Solder masking Artwork & Photography facilities. Lead time is 7 days for Bombay area and 14 days for generation orders, from the day we accept your order. Urgent orders will be treated separately. Please ensure that the circuit diagram is complete and legible. Circuit diagrams, Artwork Layouts etc being proprietary items will be treated as confidential. Clients outside Bombay will be serviced by post, whereas their Artwork can be preserved with us. Layout, circuit diagram and photographic material will be supplied to them. Artwork can be collected from us at any future date. PCB Designing rates are: Minimum charge being Rs 700/- Double sided / PTH Rs 30/Sq In (Rs 45/Sq. Cm) Single sided Rs. 15/Sq In (Rs 25/Sq. Cm) Legend printing artwork Re. / Poler. Solder masking artwork Re. / Poler. Photomask charges 25 Paise/Sq. Cm / Film The rates quoted are for the actual area of the PCB. We can supply phenolic, glass epoxy and plated through boards. Packing, Forwarding and Postage will be at extra cost.

SELF EMPLOYMENT & HOBBY CORNER.  
WIDE RANGING OF PROJECTS.  
FROM S.S. INDUSTRIES

DEAR HOBBYIST,

We propose to set up a DEALER NETWORK for hobby kits, & provide after sales Technical Service, to achieve this we are inclined to appoint Dealers from the hobbyist community, schools, colleges in cities all over INDIA. Existing Dealers are also invited to participate in our NETWORK.

We have identified more than 200 Projects in kit form, complete with hardware, pcb, electronic parts, component layout, acrylic boxes specially designed for the kits with assembling details. REMOTE CONTROL, REMOTE BELL, CLAP SWITCHES, DIMERS, VOLTAGE STABILISERS, AMPLIFIERS, WATER LEVEL CONTROLLER, TIMERS and many more are included in our PROJECT LINE.

For further details of Dealership appointments, Project list, and Technical assistance regarding circuit problems, can be solved on receipt of a self addressed stamped envelope with a Money Order of Rs 5/- in favour of S.S. INDUSTRIES.

All Dealership enquiries should accompany details of projects handled in the past and your experience with the same. We propose to conduct a small test for all prospective Dealers as per their age, qualification and interest. The winners of this test will be awarded Dealership with attractive terms.

**FREE GIFT AWAITS THE EARLY BIRD**

You can convert your circuits into kit form as we have the facility for generation of Layouts & Artwork for PCBs.

S.S. INDUSTRIES  
SHOP NO. 10, JAYDEEP APARTMENTS,  
134/5, OLD BOMBAY PURE ROAD,  
KALME, THANE 400605



# PORTABLE MIXER — 1



*This mixer is not designed for the occasional party, where one slide control per channel will suffice. Rather, it is intended for the serious electrophonics enthusiast. And quite naturally, therefore, it has all the facilities such users have come to expect.*

Professional mixers are expected to meet a long list of special requirements: balanced and unbalanced inputs and outputs; independent control of each channel for driving special effects equipment and monitors; automatic setting of input sensitivity to match the signal level; multiple tone controls per channel; and many more. No wonder that such mixers are, to put it mildly, pretty expensive. It is, however, possible, to

build one of comparable quality at much lower cost, as described in the following pages.

## *Modular construction*

The mixer is constructed from four modules. A fifth module provides

the power for the entire mixer. The mono input unit is almost certainly the most often used module. Its input sensitivity is adjustable between 0 dB and +60 dB. This enables all sorts of mono signal sources, from microphone to keyboard, to be connected to this module. The unit is provided with a three-way tone control; a peak indicator for possible overloads; a monitor; a multi-track or PFL (pre-fade listening) control; and

a panorama control. Balanced inputs are standard, but any of these can be made unbalanced by connecting one of its terminals to earth.

The stereo input unit is intended for use with a wide variety of signal sources. Its input can be switched between MD (variable-reluctance pick-up), AUX (high-level stereo), and LINE (mono). The latter position is for use in the event the mono module is not available. The balance control functions as panorama control when the input is switched to LINE.

The headphone-monitor module contains a stereo headphone amplifier via which each module may be monitored. Unlike the other modules, this unit is provided with a parametric equalizer instead of a three-way tone control. This is a very useful facility, because it enables any tendency to acoustic feedback between the microphone and monitor loudspeaker to be suppressed effectively. The main controls and output terminals of the special effects channel are also fitted on this module.

The most important unit is the output module. Apart from the main tone control and other refinements, it has a stereo LED VU (volume unit) meter. The output is available as a balanced or as an unbalanced signal.

## Power supply

Since any equipment is only as good as its power supply, all the supply lines in the present mixer are stabilized twice: once in the power unit and once in the relevant module. Apart from its mains transformer and on/off switch, the power supply unit shown in Fig. 2 is contained on a separate printed-circuit board. It is suitable for the supply of up to eighteen modules.

Regulators IC<sub>1</sub> and IC<sub>2</sub> hold the supply voltage, preset with the aid of R<sub>1</sub>-R<sub>4</sub>, at  $\pm 18$  V. Transistors T<sub>1</sub> and T<sub>2</sub> and associated RC networks ensure a sufficiently slow rise of the supply voltage to prevent loudspeaker clicks when the mains is switched on. Resistor R<sub>5</sub> is a voltage-dependent resistor that suppresses noise present on the mains.

Switch S<sub>1</sub> enables the mains earth to be isolated from the case earth, which may be necessary in certain theatres. If S<sub>2</sub> is open, and something goes wrong, neon lamp La<sub>1</sub> breaks down, and the mains fuse blows. The values of resistors R<sub>1</sub> and R<sub>4</sub> can be ascertained precisely for any individual power unit by replacing them by two 5k preset poten-

1

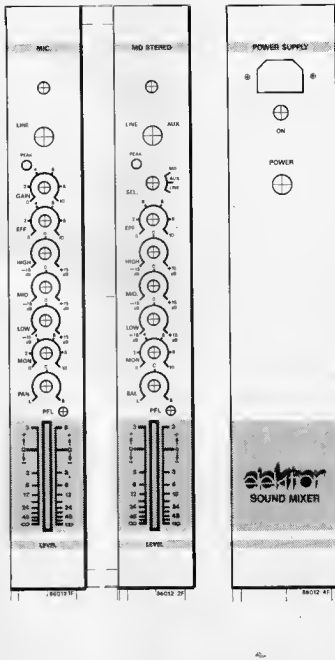

tiometers. Adjust these presets until the output of the relevant regulator is 18.1 V. Switch off, remove the presets, and carefully measure their values with an ohmmeter. Fixed resistors with values so found should then be soldered in the R<sub>1</sub> and R<sub>4</sub> positions (this may, of course, entail making up a parallel combination to obtain the correct value). Check that the output voltages of the regulators are still  $\pm 18$  V.

## MIC-LINE module

Although the number of presets may give the impression of complexity, the circuit in Fig. 3 shows that this would be misleading. Operational amplifiers A<sub>1</sub>, A<sub>2</sub>, and A<sub>3</sub> form an instrument amplifier that provides, properly balanced inputs.

The sensitivity of the microphone input is about 20 dB higher than that of the line input.

Fig. 1 The front panels of (a) the MIC-LINE module; (b) the stereo module, and (c) the power unit

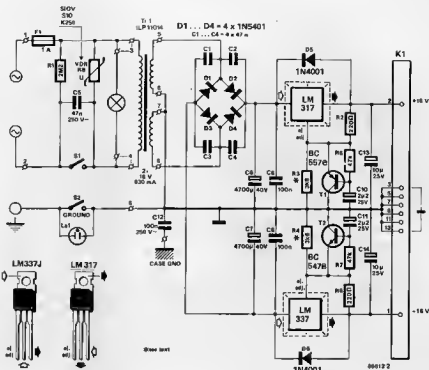

Fig. 2. Circuit diagram of the power unit.

To keep the overall noise level down,  $A_1$  and  $A_2$  are low noise types, while  $R_1$  to  $R_{10}$  incl. are high-stability (1%) metal film resistors.

Gain control  $P_1$ , which enables setting the gain between 20 dB and 60 dB, must be a high-quality type, because it is located in a noise- and scratch-sensitive position.

The peak indicator is formed by transistors  $T_1$  and  $T_2$ . The threshold of operation is fixed at 9  $V_{DD}$  or 3  $V_{EMS}$  by voltage divider  $R_1$ - $R_2$ . These levels correspond to a microphone input of 3 mV<sub>rms</sub> at maximum amplification. Reservoir capacitor  $C_2$  ensures that short-duration overloads are also clearly indicated.

Coupling capacitor  $C_4$  prevents any DC reaching the potentiometers and connects the amplified input to the three-way active ( $A_1$ ) tone control. Effects control  $P_2$ , of course, precedes the tone control stage.

Potentiometer  $P_3$  sets the wanted monitor output level.

Stereo slide potentiometer  $P_7$  is the fade control.

Since a signal to drive a multi-track recorder is also required, slide control  $P_7$ —the fader—is a stereo type to prevent any feedback between

the stereo channel and the multi-track outputs. An alternative to this arrangement is to provide each channel with a PFL (pre-fade listening) facility;  $C_{10}$ - $R_{10}$  can then be omitted,  $P_7$  can be a single track control, and  $S_1$  and  $R_{12}$  are fitted externally.

### Stereo input module

The stereo input module—see Fig. 7—has no balanced input; instead, it is provided with an equalizing pre-amplifier, formed by  $A_1$  and  $A_2$  ( $A_1'$  and  $A_2'$ ), for use with variable-reluctance pick-ups.

Input selection is effected by  $S_1$ ; position 1 is for variable-reluctance pick-ups; position 2 for high level inputs, such as from tape recorders; and position 3 for mono signals.

Position 3 is for use when the MIC LINE module is not available, or, for instance, when more equipment is to be connected than was originally foreseen. Note, however, that only line signal sources can be connected: not microphones. The (unbalanced) signal is then taken from

the right-hand AUX input, and amplified in  $A_2$  and  $A_2'$  by a factor 3. Stereo potentiometer  $P_1$  provides a monophone effects signal, but is arranged such that its input and output resistance are equal, whatever the position of the wipers.

The active tone control is followed by the controls for the monitor output ( $P_3$ ), the channel output ( $P_4$ ), and the balance ( $P_7$ ). With  $S_1$  in position 3 (LINE), the balance control functions as panorama control.

The pre-fade listening facility is constructed with (external) components  $R_8$ ,  $R_{10}$ , and  $S_2$ .

A multi-track output is not necessary in this module, because the unit is normally fed from a multi-track tape machine.

If the MD input is not required, the operation of  $A_1$  ( $A_1'$ ) can be made linear by omitting  $C_6$  and  $C_5$  ( $C_6'$  and  $C_5'$ ), and replacing  $R_4$  and  $R_5$  ( $R_4'$  and  $R_5'$ ) by  $R_x$  ( $R_x'$ ). The value of the new resistor may be calculated from

$$R_x = R_5 (\alpha - 1) \quad [9]$$

where  $\alpha$  is the amplification of the amplifier. If the amplification is large,  $R_x \approx R_5$ .

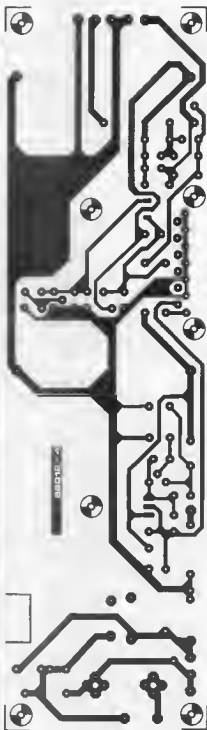
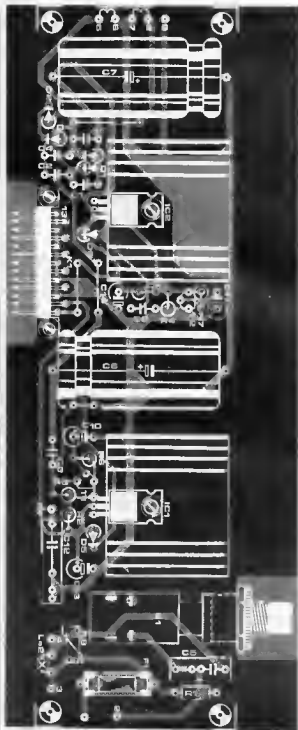

## Parts list

## Resistors:

$R_1 = 2M\Omega$   
 $R_2 = 220\Omega$   
 $R_3 = 3k6^*$   
 $R_4 = 2k^*$   
 $R_5 = 120k$   
 $R_6, R_7 = 47k$   
 $R_8 =$  voltage-dependent resistor Siemens Type S10V S10k250 (may be available from ElectroValue - telephone 0784 33603 or 061 432 4545)

## Capacitors:

$C_1, C_4 = 47n$   
 $C_5 = 47n, 250VAC$   
 $C_6, C_7 = 4700\mu, 40V$   
 $C_8, C_9 = 100n$   
 $C_{10}, C_{11} = 2, 2, 25V$   
 $C_{12} = 100n, 250VAC$   
 $C_{13}, C_{14} = 10\mu, 25V$

## Semiconductors:

$D_1, D_2 = 1N5401$   
 $D_3, D_4 = 1N4001$   
 $T_1 = BC557B$   
 $T_2 = BC547B$   
 $IC_1 = LM317T$   
 $IC_2 = LM337T$

## Miscellaneous:

$S_1 =$  SPST mains switch suitable for PCB mounting  
 $S_2 =$  SPST switch  
 $F_1 =$  miniature fuse: 1 A, delayed action; complete with PCB type carrier  
 $L_{A1} =$  neon bulb without bias resistor  
 $L_{A2} =$  neon bulb with bias resistor  
 $T_1 =$  toroidal mains transformer,  $2 \times 18V$ ; 0.83 A secondary (e.g. ILP Type 11014)  
 $K_1 =$  13-pole PCB connector to DIN41617  
 Heat sinks for  $IC_1$  and  $IC_2$   
 Front panel fail 86012-4F\*\*  
 PCB Type 86012-4\*\*

\* see text

\*\* available through our Readers Services (see p. 82)

Fig. 3 The printed-circuit board for the power unit.

Fig 4 Circuit diagram of the MIC-LINE module

Parts list

Resistors:

- $R_1 = 100 \text{ k}^*$
- $R_2, R_3 = 1 \text{ k}^*$
- $R_4, R_6, R_8, R_9, R_{12}; R_{17} = 10 \text{ k}^*$
- $R_5 = 100 \text{ Q}^*$
- $R_7 = 6\text{k}\Omega^*$
- $R_{10}, R_{11} = 2\text{k}\Omega^*$
- $R_{14} = 47 \text{ k}$
- $R_{15}, R_{16} = 6\text{k}\Omega$
- $R_{17} = 1\text{k}\Omega$
- $R_{18}, R_{25}, R_{27}, R_{31}, R_{32} = 22 \text{ k}$
- $R_{19}, R_{20}, R_{21}, R_{22} = 10 \text{ k}$
- $R_{23}, R_{11}; R_{24}, R_{26} = 3\text{k}\Omega$
- $R_{24}, R_{27} = 100 \text{ k}$
- $R_{12} = 1 \text{ M}$

- $P_1 = 25 \text{ k linear potentiometer}^+$
- $P_2, P_4 = 25 \text{ k logarithmic potentiometer}^+$
- $P_3 = 100 \text{ k linear potentiometer}^+$
- $P_5 = 10 \text{ k log stereo slide potentiometer } 58 \text{ mm long}$

- $^* 1\% \text{ metal film type}^+$
- $^+ \text{ with } 4 \text{ mm} \text{ spandic for PCB mounting}$

Capacitors:

- (polycarbonate or polystyrene unless otherwise indicated)
- $C_2, C_3 = 15 \text{ p}$
- $C_1 = 2\mu\text{F}; 16 \text{ V}; \text{ electrolytic}$
- $C_4, C_{11} = 10 \mu\text{F}; 40 \text{ V}; \text{ bipolar electrolytic}$
- $C_6 = 47 \text{ n}$
- $C_8 = 5\text{nF}$
- $C_7 = 22 \text{ n}$
- $C_9, C_{10} = 4\text{nF}$
- $C_{10} = 10 \text{ p}$
- $C_{12} = 470 \text{ n}$
- $C_{18} = 220 \text{ n}$
- $C_{14}, C_{15} = 100 \text{ n}$
- $C_{16}, C_{17} = 100 \text{ p}$
- $C_{18}, C_{19} = 10 \mu\text{F}; 16 \text{ V}; \text{ electrolytic}$
- $C_{20} = 100 \text{ n}$

Semiconductors:

- $D_1, D_2 = 1\text{N}4148$
- $D_3 = \text{LED}, \text{ red}$
- $T_1, T_2 = \text{BC}568\text{B}$
- $IC_1 = \text{NES}532 \text{ or LMS}33$
- $IC_2 = \text{LF}356 \text{ or TL}071$
- $IC_3 = \text{TL}072$
- $IC_4 = \text{XR}4195 \text{ (see fig 6)}$

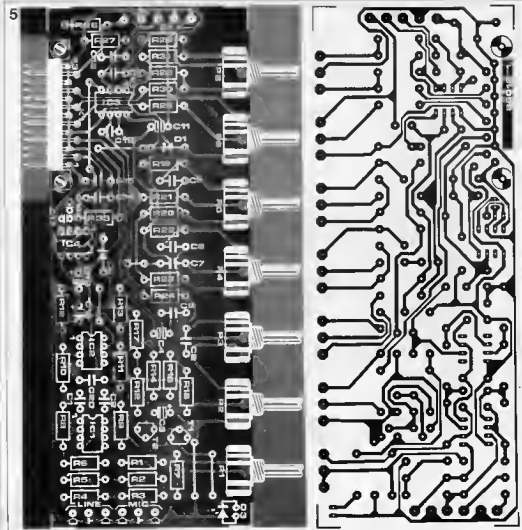
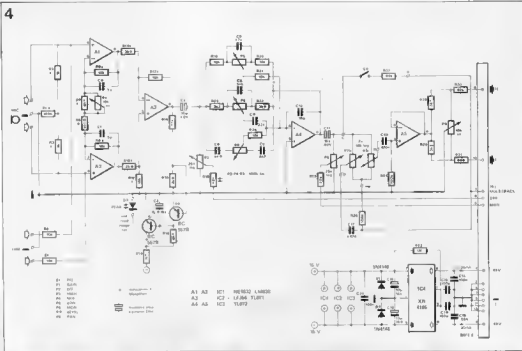

Fig 5. The printed-circuit board for the MIC-LINE module

Capacitor  $C_1$  ( $C_1'$ ) may be adapted to match the output impedance of the tape machine used.

## Construction

Before buying any new components, it is wise to determine how many modules are required.

Prepare the printed-circuit boards shown in Fig. 5, Fig. 8, and Fig. 9; note that the board in Fig. 8 consists of two parts, which must be separated before any components are fitted.

The dimensions of the front panels are given in Fig. 10: 10a is that for the MIC-LINE module; 10b that for the stereo module; and 10c that for the power supply. The overall length will, of course, depend on the cases used. The prototype was built in one aluminum case with compartments for the various modules. The construction of this will be described in next month's issue.

In the mean time, the completed modules may be tested by connecting their outputs to the TUNER or

4

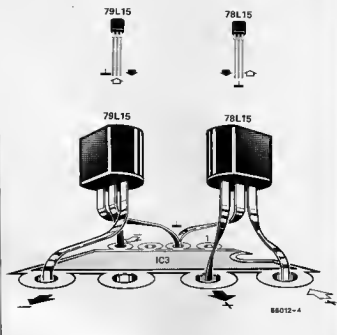

Miscellaneous

S<sub>1</sub> - mini SPST switch  
 3.5 mm insulated stereo chassis socket (6.3 mm dia. mounting hole)  
 XLR Cannon type 3-pin chassis socket  
 13-pole PCB-type connector to DIN41517  
 Knobs for potentiometers as required  
 Front panel for 88012-1F\*  
 PCB Type 88012-1\*

\* available through our Readers Services (see p. 82)

Fig 6 Where a Type XR4195 voltage regulator is not available, it may be replaced by a 78L15 and a 79L15 connected as shown here

5

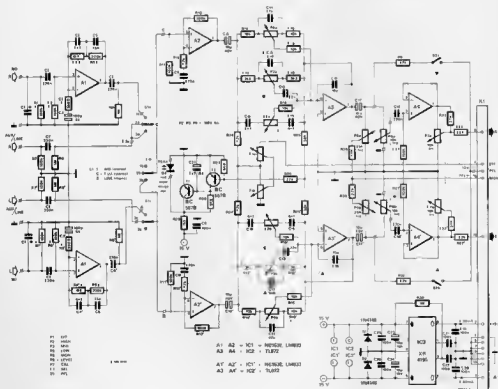

Fig 7 Circuit diagram of the stereo module

*Fig 8 The printed circuit board for the stereo module consists of two parts, which must be cut apart before any components are fitted*

**Parts list**

**Resistors**

- $R_1, R_1', R_2, R_2' = 100 \text{ k}^*$
- $R_3, R_3', R_{10}, R_{10}', R_{11}, R_{11}'$
- $R_{12}, R_{12}', R_{13}, R_{13}' = 100 \text{ k}$
- $R_4, R_4' = 390 \Omega^*$
- $R_5, R_5' = 18 \text{ k}^*$
- $R_6, R_6' = 200 \text{ k}^*$
- $R_7, R_7', R_8, R_8' = 1 \text{ M}$
- $R_9, R_9', R_{14}, R_{14}', R_{15}, R_{15}'$
- $R_{16}, R_{16}', R_{17}, R_{17}', R_{18}, R_{18}'$
- $R_{19}, R_{19}' = 22 \text{ k}$
- $R_{20}, R_{20}' = 47 \text{ k}$
- $R_{21}, R_{21}', R_{22}, R_{22}', R_{23}, R_{23}'$
- $R_{24}, R_{24}', R_{25}, R_{25}' = 10 \text{ k}$
- $R_{26}, R_{26}', R_{27}, R_{27}' = 3\text{ k}3$
- $R_{28}, R_{28}' = 56 \text{ k}$
- $R_{29}, R_{29}' = 6\text{ k}8$
- $R_{30}, R_{30}' = 1\text{ k}5$
- $R_{31}, R_{31}' = 1 \text{ M}$

- $P_1 = 25 \text{ k}$  linear stereo potentiometer\*
- $P_2 = P_4 = 100 \text{ k}$  linear stereo potentiometer\*
- $P_3 = 25 \text{ k}$  logarithmic stereo potentiometer\*
- $P_5 = 10 \text{ k}$  logarithmic stereo slide potentiometer 58 mm long
- $P_7 = 10 \text{ k}$  linear stereo potentiometer

\* 1% metal film type  
\* with 4 mm spindle for PCB mounting

**Capacitors.**

[polycarbonate or polystyrene unless otherwise indicated]

- $C_1, C_1' = 100 \text{ n}$  (see text)
- $C_2, C_2', C_3, C_3', C_4, C_4', C_5, C_5'$
- $C_{10}, C_{10}' = 220 \text{ n}$
- $C_{11}, C_{11}' = 100 \mu\text{F } 3 \text{ V}$  bipolar electrolytic
- $C_6, C_6' = 4\text{ n}7$
- $C_7, C_7' = 15 \text{ n}$
- $C_8, C_8', C_9, C_9', C_{12}, C_{12}'$
- $C_{13}, C_{13}' = 100 \text{ n}$
- $C_{14}, C_{14}' = 470 \text{ n}$
- $C_{15}, C_{15}', C_{16}$
- $C_{17}, C_{17}' = 10 \mu\text{F } 40 \text{ V}$  bipolar electrolytic
- $C_{18}, C_{18}' = 47 \text{ n}$
- $C_{19}, C_{19}' = 56 \text{ n}$
- $C_{20}, C_{20}' = 22 \text{ n}$
- $C_{21}, C_{21}', C_{22}, C_{22}', C_{23}, C_{23}'$
- $C_{24}, C_{24}' = 10 \text{ p}$
- $C_{25}, C_{25}' = 100 \text{ p}$
- $C_{26}, C_{26}' = 10 \mu\text{F } 16 \text{ V}$  electrolytic
- $C_{27} = 2\mu\text{F } 16 \text{ V}$  electrolytic

8a

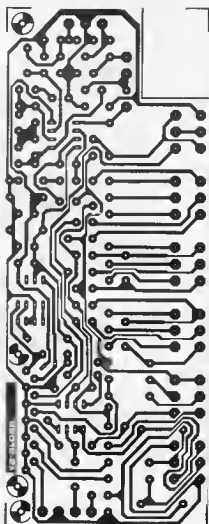
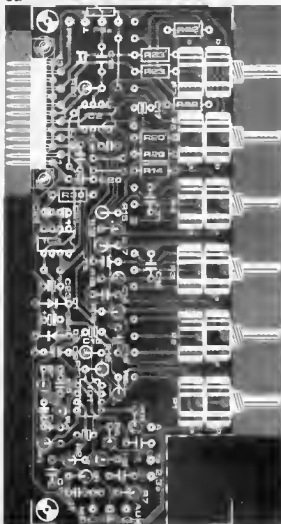

8b

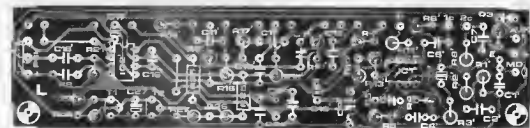
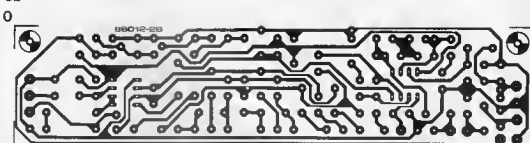

9

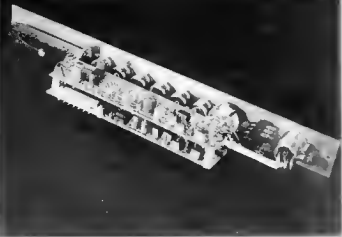

AUX input of a stereo power amplifier, and injecting a suitable signal into the various module inputs. The correct operation of all potentiometer controls can then be checked.

Part 2 of the *Portable Mixer* will appear in the next month's issue.

*Fig 9 This illustrates how the boards can be screwed together*

#### Semiconductors.

$D_1, D_2 = 1N4148$   
 $D_3 = \text{LED, red}$   
 $T_1, T_2 = \text{BC557B}$   
 $IC_1, IC_1' = \text{NE5532 or LM833}$   
 $IC_2, IC_2' = \text{TL072}$   
 $IC_3 = \text{XR4195 (see fig 6)}$

#### Miscellaneous:

$S_1 = 3 \text{ pole 3-position rotary switch}$   
 $S_2 = \text{DPST mini switch}$   
 3.5 mm insulated stereo chassis socket (6.3 mm dia. mounting hole)  
 XLR Cannon type 3-pin chassis socket  
 13-pole PCB-type connector to DIN41617  
 Knobs for potentiometers as required  
 Front panel for 86012-2F\*  
 PCB Type 86012-2\*

\* available through our Readers Services (see p. 82)

10

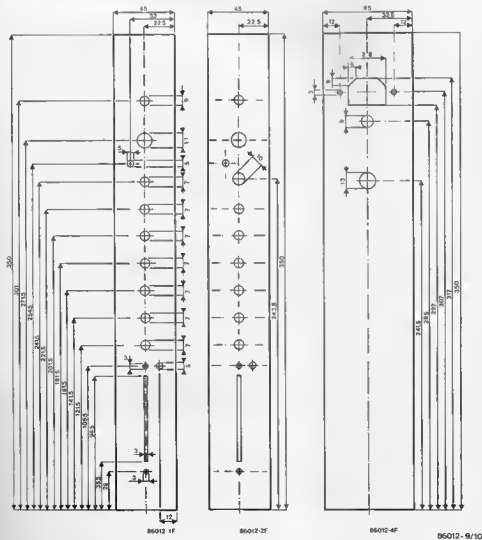

*Fig 10. Drilling plans for the front panels: (a) the MIC-LINE module, (b) the stereo module, and (c) the power unit.*



Many high-resolution graphics images may be considerably embellished by highlighting and enlivening effects such as controlled colour flashing and inversion, since the degree of screen animation seems to be proportional to the interest viewers take in watching the image.

# FLASHING COLOURS

The proposed circuit has been designed for insertion between the digital RGB(I) outputs of the Elektor high-resolution colour system and a RGB(I) monitor; see *Elektor India*, issues from October 1985 onward. The colour inversion and flashing effects are entirely under software control (BASIC); they are easily brought about by writing appropriate data to a specific memory location, as will be explained further on in this article. Since the proposed design of the flash/invert extension is fairly universal, other graphics colour systems may also incorporate it,

provided the necessary control signals are available

## Colour inversion

One of the fundamental operations in Boolean algebra is referred to as the **exclusive-OR (EXOR)** bit manipulation method, which is a means for controlling the digital polarity (inverted/non-inverted) of an operand  $A$  when this is applied to either one input of an EXOR type logic gate, the other input being driven by a logic

level (0 or 1)  $PROG$ . Depending on the logic level assigned to  $PROG$ , operand  $A$  will appear either in the non-inverted form ( $B=A$ ;  $PROG=0$ ), or the inverted form ( $B=\bar{A}$ ;  $PROG=1$ ) at the EXOR gate output; see the diagram opposite this text illustrating the logic function of this programmable inverter gate.

In the present add-on circuit, gates  $N1$  to  $N21$  receive the RGB(I) signals and a common control  $COLOR$  which is obtained by latching the  $D_1$  databit from the host processor bus during a memory write operation to I/O map location  $XX67$  — see Fig. 1.

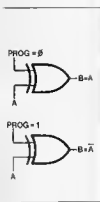

Fig. 1. A few SSI gates, a dual counter, a latch, and two diodes constitute a programmable flash/invert add-on circuit for the high-resolution graphics card. All signals at the left of the figure come from the existing main and colour extension board. Application of HC(T) type ICs is preferred for ICs and ICs, although standard LS equivalent types will also do.

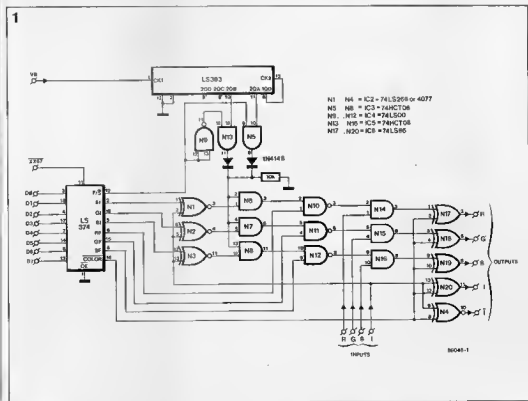

Table 1.

		byte at XX67 <sub>hex</sub>								
bit		D <sub>7</sub>	D <sub>6</sub>	D <sub>5</sub>	D <sub>4</sub>	D <sub>3</sub>	D <sub>2</sub>	D <sub>1</sub>	D <sub>0</sub>	
function	F/S	BF	GF	RF	COL	BI	GI	RI	I	effect
0	X	X	X	X	X	X	X	X	X	slow flash
1	X	X	X	X	X	X	X	X	X	fast flash
X	0	0	0	0	X	X	X	X	X	no flash
1	0	0	1	X	X	X	0	0	0	pale red; fast flash
X	0	0	1	X	X	X	0	1	0	bright red; no flash
X	0	0	1	X	X	X	1	0	0	pale red, no flash
0	0	0	1	X	X	X	1	1	0	bright red; slow flash
X	X	X	X	0	X	X	X	X	X	RGBI not inverted, I inverted
X	X	X	X	1	X	X	X	X	X	RGBI inverted, I not inverted
1	1	1	1	X	0	0	1	—	—	fast flash of pale blue, pale green, and bright red

0 = bit at logic low level.

1 = bit at logic high level.

X = bit level irrelevant to listed effect.

— = bit is low or high as required for corresponding colour

Thus, by setting and resetting this bit at the indicated memory location, the user is in control of simultaneous colour inversion of all picture elements. Since there happened to be an EXNOR gate left over in IC<sub>2</sub>, this was put to good use as an additional I<sup>-</sup> output along with I<sup>+</sup>.

## Flashing colours

The colour flash circuitry is a bit more complicated than the combination of gates to effect colour inversion since, as opposed to the overall effect of the latter, the flash circuit section operates specific to any of the colours red, green, or blue. To start with, some slow, periodic switching signal is required to determine the flash rate. The present design enables software selection of two flash rates, fast or slow, as selected by the logic level of D<sub>7</sub> written to XX67. In order to ensure the necessary fixed phase relationship between picture scan and flash pulse, the vertical blanking pulse (VB) is applied to the CKI input of a dual 4-bit counter Type 74LS393. The outputs 2QA and 2QB of the second counter section in this IC have been selected to supply two flash frequency rates to selection gate network N<sub>5</sub>-N<sub>11</sub>-N<sub>9</sub> and the two diodes in OR configuration. Fast or slow flashing is now under control of the F/S signal; in other words, D<sub>7</sub> at XX67. Note that proper operation of the diode OR simulator may only be achieved with the use of HC(T) types for IC<sub>3</sub> and IC<sub>4</sub>, which must feature good high and low level definition to compensate for the inevitable voltage drop across the silicon diodes. However, where these new types are not yet available, the use of 74LS equivalent types may be

resorted to.

The function of the other logic gates in the circuit is best elucidated by starting at the output side of the proposed design, establishing, for instance, the order in which the red (R) signal is processed. When pin 2 of N<sub>11</sub> is permanently at high logic level, the red bit is simply passed by this gate; if, however, the logic level at this pin is arranged to toggle along with the flash signal, the red output bit will also flash, whether or not inverted by N<sub>11</sub>. Gate N<sub>9</sub> functions as a programmable switch to pass or block the flash signal to N<sub>11</sub>; if the user sets RF (red flash, D<sub>4</sub> at XX67), red flashes. It will be readily understood that the other colour bits may also flash if their F bit has been set with an appropriate instruction.

## Colour selection

To select between flashing the eight bright or the eight pale colour shades, the I (intensity) bit is applied to gates N<sub>1</sub>, N<sub>2</sub>, and N<sub>3</sub>, together with three intensity select bits RI, GI, and BI. If we take red once more as an example, it will be seen that AND gate N<sub>6</sub> will only pass the flash signal if its pin 1 is at logic high level, that is to say, only if the user-programmed level of the RI bit is the same as that of the I bit. Thus, the user may have bright red flash by setting RI (i.e. logic high); whereas pale red flashes with RI low, since the I bit is also low in this condition.

## Hardware and software

The flash/invert circuit had best be put together on a small piece of veroboard, and construction should

present no problems to those who have already been successful in putting the Elektor graphics system together. The databus connections to the octal latch are made with eight short lengths of wire to points 8...13 on the colour extension card; the XX67 signal is available at pin 9 of IC<sub>2</sub> also on this card (see *Elektor India*, March 1986 issue). As for the VB signal, this may be taken from pin 16 of the GDP chip, wired to an unused pin on the 64-way DIN connector (for example pin 2c), and put onto the bus for use in the flash/invert circuit. Finally, do not forget to fit every IC with a decoupling capacitor and avoid long wire runs, which may result in picture degradation due to cross-talk effects.

Since the video interpreter for the high-resolution graphics system does not support programming the present add-on board, the user must rely on his BASIC interpreter to transfer the necessary codes. Table 1 summarizes the bit functions and gives examples of how a specific effect may be obtained by setting or resetting bits at XX67. Note that the user must first calculate the decimal equivalent of this output address for his configuration in case the BASIC interpreter does not allow the use of hexadecimal address notation in a POKE instruction.

In conclusion of this article, some examples of POKES to effect interesting effects on the screen: POKE XX67,8 inverts all colours; POKE XX67,16 causes the pale red pixels to flash slowly, and POKE XX67,144 flashes the bright red ones at double speed; POKE XX67,212 gives a fast flash of bright blue and pale red.

PL/DM

*Table 1 Every bit in the byte written (POKEd) to XX67<sub>hex</sub> specifies a function in the flash/invert extension; the examples listed in this table serve to illustrate some of the possible programming configurations with their resultant effects on the RGBI monitor.*

# LOUDSPEAKER IMPEDANCE CORRECTION



*A loudspeaker presents a complex load to the output amplifier and the cross-over network. This load can be measured and any deviation from the nominal impedance corrected. In this manner a multi-way loudspeaker system with a passive cross-over network can be made to function optimally.*

A loudspeaker looks a simple enough device: a frame, a coil, a magnet, and a cone of paper or of man-made fibre. Put it in a box and you have a

sound reproducer. If only it were as simple as that... *Designing a closed loudspeaker box* (Elektor India, March 1986) explained the fundamentals of calculat-

ing the dimensions of a closed box on the basis of the characteristics of the drive unit used. That thus dealt with the acoustics of the system. The present

article takes a closer look at the electrical aspects. Before reading any further, note that if the cross-over network is of the active

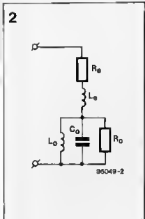
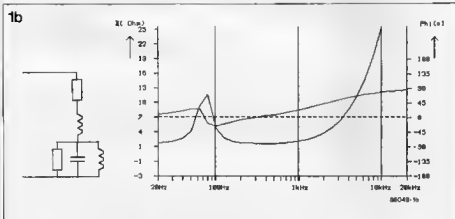
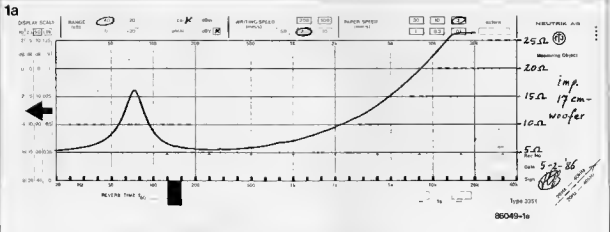

type, the loudspeaker impedance is of no particular importance. With a passive filter, however, it is a prime factor.

## Dynamic Impedance

A drive unit may be represented by an electrical circuit containing resistance, capacitance, and inductance. Its impedance may, therefore, be inductive, capacitive, or resistive, depending on the frequency of operation. Moreover, the impedance is affected, to some extent, by the type and dimensions of the enclosure in which the drive unit is housed. Figure 1 shows the dynamic impedance of a 17 cm bass unit measured

over the frequency range of 20 Hz to 20 kHz. This curve is characterized by the peak around 75 Hz and the slowly rising impedance with frequency. The peak is caused by the resonance frequency of the equivalent circuit, while the rising with frequency results from the self inductance of the voice coil. As the crossover network has been designed for operation into a constant-value ohmic load, the performance of the system will be adversely affected by this varying impedance.

## Equivalent circuit

A (simplified) equivalent circuit of a typical drive unit is shown in Fig. 2. The

voice coil has a resistance,  $R_e$ , which determines the minimum impedance of the drive unit. From the curve in Fig. 1 it is clear that for the drive unit used here  $R_e=5.5$  ohms. The inductance of the voice coil is represented by  $L_e$ . The parallel circuit  $L_e-C_0-R_0$  causes exactly the same peak as the drive unit proper. Note that it is in series with the series combination of  $R_e$  and  $L_e$ .

## Impedance calculations

A dynamic impedance characteristic, such as that in Fig. 1, can be determined with the simple set-up of Fig. 3. If the resistance  $R$  is large compared with the nominal loud-

speaker impedance curve of a typical loudspeaker unit in (a) was measured under controlled conditions. Subsequently, an equivalent circuit was calculated and built; the impedance curve of this is shown in (b). The resemblance between the two characteristics is striking.

Fig. 2 The equivalent electrical circuit of a loudspeaker looks anything but a resistance.

3

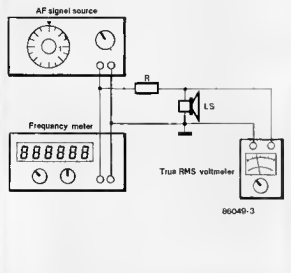

speaker impedance, the AF signal source functions as a perfect current source. If, for instance,  $R=3k\Omega$ , and the output of the signal source is set at 3.3 V r.m.s., the current through the loudspeaker coil is 1 mA. Each millivolt drop across the loudspeaker, therefore, represents 1 ohm. It is clear that the true RMS voltmeter should be a sensitive type. The impedance presented by the loudspeaker can now be measured over a range of frequencies, and the curve plotted from the values measured. If, of course, essential that the drive unit is housed in its normal enclosure to ensure that the true impedances are measured.

The voice coil resistance,  $R_e$ , may be measured with an accurate ohmmeter, or with the set-up of Fig. 3. The latter is not too accurate, but it will do. In this case, the minimum impedance over the frequency range is ascertained.

Next, ascertain the impedance,  $Z_0$ , at the resonant frequency,  $f_0$ . The true impedance,  $Z$ , is

$$Z = Z_0 - R_e \quad (1)$$

Subsequently, calculate the impedance,  $Z_1$ , at the  $-3$  dB points from

$$Z_1 = R_e + Z\sqrt{2} \quad (2)$$

Measure at which frequencies above and below  $f_0$ ,  $f_a$  and  $f_b$  respectively, the impedance has the value  $Z_1$ . The bandwidth, BW, of the resonance peak is calculated from

$$BW = f_a - f_b \quad (3)$$

Values of the equivalent circuit components can now be calculated from the following.

$$L_0 = BWZ/2\pi f_0 \quad (4)$$

$$C_0 = 1/2\pi BWZ \quad (5)$$

$$R_0 = Z \quad (6)$$

For bass speakers, measure at which frequency,  $f_s$ , the impedance is equal to  $2R_e$ . Then,

$$L_0 = \sqrt{3R_e/2\pi f_s} \quad (7)$$

For middle and high frequency speakers, measure at which frequency,  $f_s$ , the impedance is equal to  $\sqrt{2}R_e$ . Then,

$$L_0 = R_e/2\pi f_s \quad (8)$$

Fig 3 Typical set-up for measuring loudspeaker impedance over a range of frequencies.

Fig 4 An RC network across the loudspeaker compensates for the rise in impedance with frequency

Fig 5 The resonance peak of a loudspeaker may be negated with a suitable LCR network across the unit

4

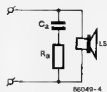

5

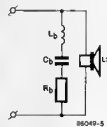

$$R_0 = R_e + R_e^2/R_0 \quad (13)$$

These correcting networks ensure that the passive cross-over filter is terminated into a constant-impedance.

HB

## Correcting the dynamic impedance

To ensure optimum performance from the passive network and loudspeaker, the impedance presented to the filter by the loudspeaker should remain constant over the frequency range of the system. This is readily effected by an RC combination across the drive unit as shown in Fig. 4, where

$$R_0 = R_e \quad (9)$$

$$C_0 = L_e/R_e^2 \quad (10)$$

Note that the minimum impedance of the loudspeaker remains equal to  $R_e$ .

Correcting the resonance peak is normally not necessary, because it usually lies well outside the pass band of the cross-over network. None the less, where it is felt necessary, it can be done with the aid of the circuit in Fig. 5. Here,

$$L_0 = L_e R_0 \quad (11)$$

$$C_0 = C_0 R_0 R_b \quad (12)$$

# COMPUTERS AND HEALTH CARE

by Helena Buswell

When a 38 year old Scottish housewife made an appointment to visit her doctor at the local health centre, she was unaware of the role that computers were about to play in her life.

Mrs Ann Robertson (not her real name) had stomach pains, and, like most people, was nervous when she tried to describe her condition.

Dr Michael Ryan had before him a summary listing his patient's details produced by the health centre's own computer ready for Mrs Robertson's visit. He could see at a glance her age, number of children, occupation, height, weight, blood pressure, previous and current health problems, and other demographic data relevant to her general health.

Almost all of the 56 million population is registered with one of about 50 000 general practitioners (GPs), contracted to work within the National Health Service (NHS). Each GP has a list of several thousand people, and for each and every one he has case notes — most going back to that person's birth. At health centres like Howden, near Livingston in central Scotland, these details have been transferred to new computer systems, which produce a summary sheet ready for each patient's consultation.

## Further tests

In Mrs Robertson's case, Dr Ryan decided to send her to the area hospital — Bangour General Hospital — for further tests. Her appointment there had already been computer generated, and, when she

arrived, more details were entered into the computer system by the receptionist. As Mrs Robertson had been a patient at the hospital some years before, the computer automatically alerted the hospital staff, and her earlier case notes were produced. Bangour uses the de Dombal system for diagnosing abdominal conditions. Developed by Tim de Dombal, a consultant surgeon at Leeds General Hospital, this computer-based diagnostic system assesses the chances of different causes of acute abdominal pain with a very high degree of accuracy. The system is now used in many British hospitals, and, with fewer unnecessary exploratory operations of the abdomen, more patients are sent home from casualty wards and both lives and money are saved.

The system is also used in submarines of both the US Navy and the Royal Navy. Dr Ryan says: "In these sort of conditions, with long periods at sea, acute abdominal complaints are the most critical to diagnose correctly. After all, apart from heart attacks, they are the most likely to kill you."

A comparable system in

use at Glasgow has a dyspepsia program that obtains data on symptoms by directly interviewing the patient. Where direct computer interviewing is also used, the patient is often more relaxed and forthcoming, talking directly to a machine, rather than to another person. The de Dombal interview has already been translated into Swedish and Dutch, and is being tested in other clinics here and overseas.

## Possible appendicitis

Mrs Robertson, however, was asked a series of structured questions by the hospital doctor, and her answers keyed into the computer. The computer's diagnosis showed a 90 per cent chance of appendicitis, with lesser chances of constipation or gynaecological abnormalities.

Admitted to hospital, Mrs Robertson's subsequent operation and stay were logged from start to finish on the hospital's computer. Her files, both at the health centre and Bangour, were updated. Howden Health Centre is one of 50 to have recently installed computer systems

in Scotland with the help of the Scottish Home and Health Department. The GPs buy their own British built Apricot computers, but the software and its development and maintenance are provided free by an NHS computer team. Dr Ryan, who is chairman of the project's steering committee, says: "We expect many more practices to install computers in the near future." Some of the practices already using computers are in Scotland's most isolated communities — the outlying islands. As well as holding patient records, the computers are used for repeat prescriptions, and for monitoring continuous conditions like hypertension, diabetes, and thyroid problems. Under the overall direction of the Department of Health & Social Security, health care in England is provided by regional health authorities, which in turn are divided into administrative districts. The logistics of running such an enormous enterprise are formidable, and it is this, as much as anything, that has encouraged the introduction of computers at all levels.

## Management information

The NHS is introducing new management information systems in the next two to three years, and their success will rely heavily on the use of computers. However, computers are not new to the health service. Some were installed nearly 20 years ago, and with this wealth of experience, the NHS is now marketing a range of software in other countries. Milton Keynes General Hospital is typical of those



A VDU and keyboard gives hospital staff instant information.

opened in recent years. The new town of Milton Keynes has a population of 145 000 — expected to reach 220 000 by the year 2000. The hospital was planned in three phases. Phase one began in 1978 as a community (mainly geriatric) hospital. Phase two, with 400 beds, was opened in 1984, when the computer system was installed. The last phase is scheduled for 1990, giving space for more beds and a mental health unit. The computer system is based on three interlinked minicomputers — in the event of breakdown or maintenance the system can run on one — and 100 terminals around the hospital, half of which have a printer attached. Terminals are also on-line at outlying clinics. And under a pilot scheme, one GP in an outlying district is on-line to a clinic terminal.

A computer system is used for patient identification; record management; patient location and logging; bed, clinic, and waiting list management; and management information. Each ward has a terminal, as do the casualty, pathology, and radiology departments. A busy hospital has much in common with a large hotel in the comings and goings, catering, cleaning, general maintenance, and payment of wages. Patients have to be booked in and out in the same way as hotel guests. Surprising as it may seem, bed management is a permanent problem. At Milton Keynes, tight computer control is kept on the occupancy of beds, where and when beds are available for waiting list patients (there are always beds kept for emergencies), patient movement from ward to ward, and so on. A computer check is maintained 24 hours a day so that all authorized personnel can see at a glance which beds are occupied, and who the patients are. Before computerization, it could take

hours for an accurate bed check to be made.

## Wider health context

Although computerized bed management has been developed to facilitate the smooth running of hospitals, the accumulated data can provide vital information in a wider health context. At Milton Keynes, a potential minor epidemic was averted after a patient, who had entered hospital for routine treatment and a two week stay, was discovered to have active tuberculosis. From computer data, all his contacts from several wards — staff, patients (most of whom had already been discharged), and even visitors — were located in less than 24 hours. A special clinic was set up for screening and immunization the same day. Payroll systems were among the first computer applications introduced by British health authorities. The West Midland Regional Health Authority uses OMR (Optical Mark Reading) forms and readers to process a complicated payroll for 102 000 people working in a widespread area. As a further complication, about 52 per cent are monthly salaried, with the rest being paid weekly. "People fail to realize that every sort of trade and profession — from surgeon to carpenter — is employed by the NHS," says computer operations manager Peter Owen. "We have one of the most complex payroll structures in the country. At least once a month some 200 000 OMR documents are being processed." The East Anglia Regional Health Authority covers Cambridgeshire, Norfolk, and Suffolk, and has a population of two million. The eight major hospitals, and many of the smaller ones, have computer systems dealing with ad-

ministration, in-patients and out-patients, radiology, and pathology. Pathology statistics help to analyse the incidence of medical conditions, providing valuable leads to links between such parameters as occupations, social conditions, and the occurrence of illness. As with all regional authorities, East Anglia writes its own software. A recently developed catering program at Peterborough General Hospital has simplified patient menu orders, and has drastically cut costs. Around the area's health community centres, all child health immunization programmes are also computerized. International Computers Ltd (ICL) has emerged as one of the leading suppliers of computer equipment to the NHS. Formed in 1968, ICL operates in over 70 countries and employs 21 000 people worldwide. It has collaborative agreements with Fujitsu of Japan; PERQ Systems of the United States of America, and Mitel of Canada, and also has a joint research institute in Munich with Bull of France and Siemens of West Germany.

## Patient administration

ICL has recently formed the ICL Health Systems Business Unit. It includes the 100 strong team that has been working on the ICI Patient Administration System already ordered by about ten health authorities. The company also runs seminars for NHS personnel and ICL user groups. An idea of the scale of ICL's health computer systems, and of the phenomenal growth of NHS computerization, is evident in just a short selection of recent installations. An ICL supplies information system being installed for the Grampian Health Board in Scotland

will handle 6500 stock items, ranging from staff uniforms and cleaning material to surgical needles and sutures. The Brighton Health Authority is installing two new networks for district information, replacing and upgrading older hardware. Brighton will also be one of the first districts to install an obstetrics software package developed at St Mary's Hospital in London, where the Princess of Wales had her children. Obstetrics computer systems have helped reduce perinatal death rates. Tender letting control systems have been installed by seven health authorities to help with the administration of the tendering process, including the monitoring of successful contractors.

## Real-time systems

A new real-time patient administration system is being used by the West Glamorgan and Gwynedd health authorities. Supplies information systems have been installed by all the districts under the southwest London Regional Health Authority, and by six districts of the Oxford Health Authority. Apart from systems based on orthodox computer hardware, British scientists have developed advanced computer based technology for the specialized diagnosis and treatment of a range of illnesses. The National Hospital for Nervous Diseases in London, for example, is to have a prototype expert system called BRAINS designed to give powerful aid in the analysis of brain scans. The main goals of a team from University College, London, Leicester Polytechnic, and the hospital were to give the radiologist a tool for fast and efficient study of the scan image, and to reduce unnecessary scans. The team decided to

make use of the statistical methods that had grown up in epidemiology in the last 25 years.

A statistical database of 900 scans has been entered into the system by Mr du Boulay, the team's

radiologist. The database took five years to collect, covers 22 different forms of cerebral disease, and can be extended.

The system allows less experienced radiologists to access sample scans of

diseases and compare them with the scan of the patient being examined. To get advice from the system, the radiologist is required to describe the position and appearance of damaged tissue, and

indicate the presence or absence of other signs. Based on this information, the system gives a shortlist of disease probabilities, and indicates which symptom leads to its prediction.

LPS

# ELECTRONICS AND TEMPERATURE CONTROL

by Vic Wyman

Temperature control is often the key to efficient and economic industrial production. In many process plants, for example, the temperature may need to be held within narrow bounds if the process is to be a success. And the close control of the temperature of production processes and of factory environments can often lap a large chunk from a company's annual energy bill.

A growing number of control equipment suppliers recognize that simply knowing a temperature is of little use. What is needed is the ability to monitor how temperature is changing and adjust it accordingly. These demands are being increasingly satisfied as electronics expands the options of equipment designers and allows low cost solutions to past problems

## Microprocessor based

A good example of the great flexibility available with the latest temperature controllers is the microprocessor based digital unit from Control & Readout<sup>1</sup>, designated the 451. The general purpose 451 is aimed particularly at machine makers and users in the food, plastics, oven and furnace industries, and accepts a range of inputs. But as well as being a

proportional, integral or derivative (PID), three term or on/off control unit with a range of common features, the 451 is easily reconfigured to change the basic functions. The measurement range, control algorithm and limit mode, as well as PID terms, output cycle time and limit setting, can be changed as often as wanted.

Because of this, any 451 can serve as the spare for other units, cutting the number of controllers held in stock and minimizing the cash tied up in spares. The 451 can take inputs from K, J and S sensors over the respective temperature ranges 60 to 1200 °C, 60 to 600 °C, and 60 to 1600 °C, as well as from Pt100 sensors over -200 to + 400 °C and 4 to 20 mA, 10 to 50 mV or zero to 20 mA, 0 to 50 mV signals. The controller works on supplies of 115/230 V at 50/60 Hz.

## Hidden button

For commissioning, an internal security switch is actuated and a hidden button on the front panel operated together with the normal controls. This allows the 451 to be matched to the process needs.

Any reconfiguration requires the entry of a special code after the actuation of an internal security switch. As an example of how input and output control functions can be altered, the unit could be changed from

thermocouple input with on/off control to a resistance thermometer sensing instrument with PID control. A non-volatile memory retains the configuration for more than ten years, even without power.

For slow and controlled heating of large structures, the 451 has a soft start or controlled ramp function, with a digitally set rate of 0.1 to 50 °C/minute.

An automatic manual option also allows such processes as mixing to be started manually and then switched to automatic control. The device has 5 A relay or logic outputs.

## Self-tuning adjustment

Another digital indicating temperature controller is the 810 unit, which, the manufacturer, Eurotherm<sup>2</sup>, claims, has carved out a niche for itself in industry only a short while after its introduction. The device won an award from the Design Council in 1984. To expand the market further, the company has introduced a self-tuning control adjustment aimed mainly at the plastics extrusion and continuous furnace markets. The new feature is intended to cut out long, involved manual adjustment.

The 810 is a three term, microprocessor based instrument with a high degree of control accuracy and easy front panel adjustment of all 15 main parameters. It features a new, self-tuning algorithm

for such equipment as extruder barrel and die zones, where there is a maximum rate of temperature change under full power of about one unit/second, requiring only 300 bytes of code space. The three easily set operating modes provide self-tuning on start-up as long as the measured value is well below the desired set-point, and self-tuning at set-point if the loop is over-damped or under-damped. In the third mode, self-tuning can be initiated manually during operation.

There is a high or deviation alarm and three set-point and alarm ranges from zero to 500 °C, zero to 1000 °C and zero to 1500 °C. The operator can override all the parameters available from the 810's scroll push-buttons.

## Set-point changed with time

The flexibility of the latest control equipment is illustrated by the possible uses claimed by Gulton<sup>3</sup> for its West 2050 programmable controller. The PID, microprocessor based unit is said to be suitable for the heat treatment of metals, kiln control, environmental chambers and cabinets, food and chemical processing, resin manufacture, textile dyeing and autoclaves, as well as other uses where set-point must be



changed with time. The 2050, from the Gulton group's control and instrumentation division, is based on the established West Opus 70 temperature and process controller. It has the same mechanical construction and is in a metal case with splash-proof and dust-proof membrane front panels. The programmer controls a modulated value through a set-point profile which can change with time through up to four stages, each with a ramp and a dwell segment adjustable up to 99 hours 59 minutes. Rate or time programming can also be adopted for the ramps. The 2050 can handle thermocouple, resistance thermometer, direct current linear, and voltage and current inputs. Output forms include relay, logic for solid state relay, direct current linear, voltage and current, thyristor pulse, and valve motor drive.

### Integral lock-out

The manufacturer claims a 0.25% accuracy and the PID control has an integral lock-out. Typically, control parameters can be retained without power for five years, according to Gulton.

The 2050's optional extras include an RS422 serial interface, a digital (event) output, a remote programme start, and guaranteed soak times. Preliminary trials of FGH Controls' furnace temperature controller, known as the thermal head ratio system, suggest typical fuel cost savings of 15 per cent. Aimed at such sectors as the aluminium industry, with medium sized and large furnaces, the system is claimed to improve the efficiency of heat treatment and to be simply controlled by non-specialist workers.

Present control methods for furnace temperatures typically involve regulating the furnace atmosphere and letting the load warm to this tem-

perature, or controlling the load at a chosen temperature and probably suffering from high atmosphere temperatures and high load skin temperatures.

### Thermocouples

To eliminate the need for this wasteful system, FGH has come up with a two instrument and two thermocouple design. The thermocouples monitor load and atmosphere temperatures. One instrument compares the load temperature with a load set-point and generates a further set-point, which is led to the second instrument. The second set-point is compared with measured atmosphere temperature which it maintains. To avoid dangerously high atmosphere temperatures, the user can include a further set-point in the atmosphere controller instrument, operating as an upper clamp. A range of control components can be coupled to the system. FGH can also supply suitable thermocouples, and up to three can be used to sense load temperature. In this case, an additional control unit selects the highest temperature and switches this through to the ratio system.

A similar set of three thermocouples can be used for atmosphere temperature sensing.

### Factory heating

Temperature control can also be applied profitably to the heating system of a factory or other plant. A recent addition to the energy management equipment made by Gent<sup>50</sup> is the microprocessor based 6202 temperature controller. This unit, which is easy to program with a 25 button keyboard, can be used as a stand alone energy management device or can form part of a more comprehensive control system. It is suitable for both existing and new heating installations. The 6202 can control up to eight zones, three boilers, a main system pump, a hot water circuit and alarms, with up to 14 digital outputs. The unit accepts signals from up to 24 dedicated analogue inputs. Gent sees as a particular advantage the ability of the 6202 to control energy use in any of three ways. The first, a pulsed power mode, links a zone direct to a boiler and pump operation. By monitoring outside and zone temperatures, the unit calculates

the input power each zone needs to maintain the desired space temperature. By monitoring the system flow temperature, the controller also determines the period the zone valve needs to be pulsed open.

### Three way valve

The modulating valve mode calls for each zone to be controlled by a three way valve and zone circuit pump, with a corresponding zone flow temperature sensor. The valve is modulated in line with the outside and space temperatures.

The third mode, designated on/off, is for a wide range of energy consuming plant such as oil and gas fired air heaters, electric heaters, lighting, and pumps. Independent zone operation allows time and temperature or time-only control.

The 6202 can also be programmed with 99 consecutive shut-downs up to six days in advance, and there is a back-up battery to retain programs for up to 72 hours. The user can also select parameters to be coupled to alarm outputs, and an RS232/422 interface can be used to connect the unit to remote computer equipment. LPS



The 6202 energy management unit from Gent can produce major cost savings when applied to factory temperature control.

1. Control & Readout Ltd, Woods Way, Goring-by-Sea, Worthing, West Sussex, BN12 4TH
2. Eurotherm Ltd, Faraday Close, Worthing, West Sussex, BN13 3PL
3. Gulton Ltd, West Division, The Hyde, Brighton, East Sussex, BN2 4JJ
4. FGH Controls Ltd, Burymead Road, Hitchin, Hertfordshire, SG5 1RT
5. Gent Ltd, Temple Road, Leicester, LE5 4JF

# simple auto slide changer

W. Fröse

Automatic slide changers are extremely useful when a recorded commentary is used to accompany a programme of slides. Most auto slide changers make use of a control signal. This may be a high frequency low level signal, recorded on the same track as the commentary, which is unobtrusive but which may be extracted for control purposes by a filter. Alternatively, an audio tone may be recorded on a parallel track.

The slide changer described here uses neither of these methods but senses the drop in signal level of the commentary when the commentator stops speaking for more than one second.

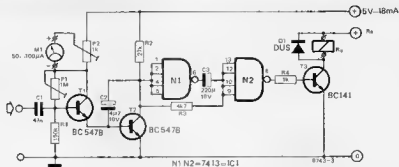

Figure 1 shows the simple circuit of the auto slide changer. In the absence of an audio signal at the input T1 and T2 are cut off. When a signal exceeding a predetermined level (set by P1) appears at the input then T1 will conduct on the positive peaks of the signal. The output from the emitter of T2 is integrated by C2 and T2.

The collector voltage of T2 will be below the negative-going threshold of Schmitt trigger N1, so the output of N1 will be high. The input of N2 also floats high, its output is low and T3 is turned off, so the relay is not energised.

If the input signal to T1 drops below the threshold, then T1 turns off. If the

input voltage to T1 remains low then after a delay of about one second T2 will also turn off taking the input of N1 high. The output of N1 will go low and pull down the input of N2 via C3. The output of N2 will go high, turning on T3 and energising the relay. The relay contacts are connected to the remote change jack of the slide projector, so the slide will change.

C3 will charge via R3 until the positive-going threshold of N2 is exceeded, when the output of N2 will go low ready for the sequence to repeat, and the relay will drop out. Diode D1 protects T1 against the back e.m.f. generated by the relay coil.

P1 provides a preset bias on the base of T1 and thus determines the threshold voltage at which T1 starts to conduct. By suitable adjustment of P1 it is possible to have background music underlying the commentary at a low level. P1 is adjusted so that T1 is not turned on with background music only present, but will turn on during the much louder speech passages.

Figure 2 shows a typical setup for preparing a slide commentary. Recorded music and speech are mixed together and recorded onto tape. The slide changer is placed at the output of the mixer to check that the slide change does take place during pauses.

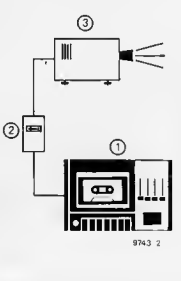
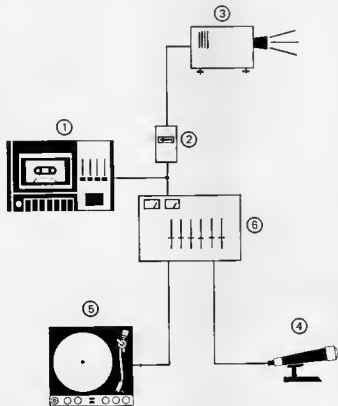

Figure 1. Circuit of the auto slide changer.

Figure 2. Showing the setup for recording a commentary of speech and music to accompany a slide programme. When the output of the mixer drops below the preset level the slide will change.

Figure 3. For playback the slide changer is connected to the line output of the tape deck.

Notes: 1: Tape deck. 2: Auto slide changer. 3: Slide projector. 4: Microphone. 5: Record deck. 6: Audio mixer.

During the slide show the slide changer is connected to the line output of the cassette recorder (figure 3), or some other point in the system where the signal level fed to it is unaffected by volume or tone controls, since once the changer has been set up the signal level must not be altered.

To set up the slide changer during recording potentiometers P1 and P2 should first be set to their mid-position. P1 is then adjusted until the slide change will occur when a pause of about one second occurs in the commentary. P2 calibrates meter M1 to provide an indication of the threshold level. P2 should be adjusted so that M1 reads about a quarter scale when P1 is correctly set.

Figure 4. Printed circuit board and component layout for the auto slide changer (EPS 9743).

If the record and replay levels of the tape deck are correctly matched then no adjustment will be required when playing back the commentary. If, however, the playback level is different from the record level then it may be necessary to adjust P1 to set the correct threshold level for playback.

A p.c. board and component layout for the slide changer are shown in figure 4.

The unit requires a supply of 5 V at 18 mA (excluding the relay) which can easily be supplied by a simple zener stabiliser. A separate supply pin is provided for the relay, so that if a 5 V - 6 V type is not available some other voltage can be used, possibly derived from the unregulated input to the power supply.

4

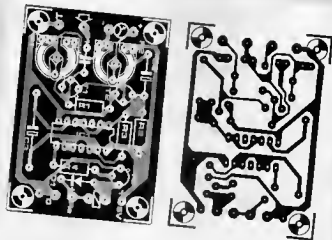

#### Parts List

##### Resistors:

R1 = 150 k  
R2 = 27 k  
R3 = 4k7  
R4 = 1 k  
P1 = 1 M preset  
P2 = 1 k preset

##### Capacitors:

C1 = 47 n  
C2 = 4μ7/10 V  
C3 = 220 μ/10 V

##### Semiconductors:

T1, T2 = BC547B or BC107B  
(or equivalent)  
T3 = BC141 or BC142  
D1 = DUS  
IC1 = 7413

##### Miscellaneous:

Relay 5 V - 6 V coil 68 Ω or greater, see text, normally open contact rated to suit current taken by projector remote change

# MAGNETIC-FIELD SENSORS



*Announced as being more sensitive than Hall-effect elements, magnetoresistive sensors (MRS) have recently been introduced by leading manufacturers of electronic components. This introductory article examines their fundamental characteristics and possible applications.*

The physical operation of magnetic sensitive resistors is based on the Gauss-effect, which may be summarized as follows. A magnetic field with lines of force perpendicular to a current carrying conductor forces charge carriers to travel along the surface of that conductor; the magnetic field 'pushes' the current into a thin layer, which results in a diminished cross-sectional area for the current to pass along, or, in other words, an increased resistivity of the conductive material. Figure 1 illustrates this effect which has been known for quite some time, but has re-

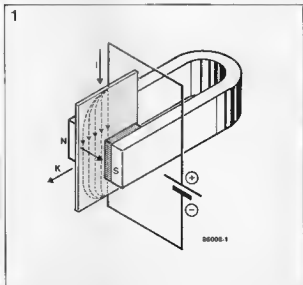

*Fig 1 The magnet pushes the electric current out of the area with maximum magnetic field strength*

*Fig 2 A sufficiently high total resistance can only be obtained by means of a long conductor path.*

*Fig 3 Gold stripes have been applied to the resistor track, which make it look like a barber's pole*

*Fig 4 The four resistive elements in a Wheatstone bridge configuration*

2

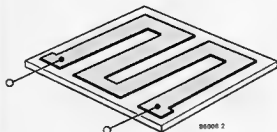

3

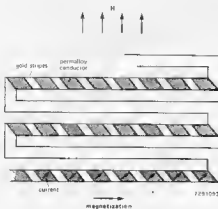

4

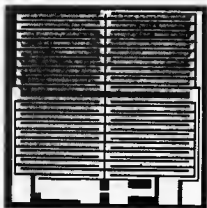

mained disregarded by the electronics industry until quite recently, when suitable alloys were developed to put the effect to practical use. The increase in resistivity caused by the Gauss-effect is minimal with pure metal conductors, with the exception of bismuth (Bi), which is a so-called diamagnetic metal with poor conductivity. However, certain alloys have been developed which are more sensitive to the presence of a magnetic field.

Siemens, for instance, use a semiconductor with antimony (Sb) based alloys, such as indiumantimonid-nickelantimonid ( $\text{InSb-NiSb}$ ). This material has semiconductor properties and may be glued onto a permeron, ferrite, ceramic or plastic substrate. The magnetic sensitive resistor is usually realized in the form of a meander path as shown in the sketch of Fig 2; this is done to achieve a maximum-length current track within the encapsulation.

While Siemens manufacture single, flat type resistive elements, Philips have developed complete Wheatstone bridges in a standard transistor case. These devices are made from a thin permalloy layer on a silicon substrate. Permalloy is a 20% iron, 80% nickel ferromagnetic alloy without semiconductor properties. The resistivity of a polycrystalline alloy such as permalloy varies in direct proportion to the angle between magnetic field lines and the direction of the current in the conductor. In order to obtain a maximum operational linearity for these devices, Philips have come up with a special arrangement for the permalloy track: a regular pattern of gold stripes is applied onto the conductive track, at an angle of  $45^\circ$  with respect to the current flow direction. For reasons made clear by Fig. 3, this layout is referred to as a 'barber's pole'. Since gold has a

much higher conductivity than permalloy, the gold stripes effect a net current turn of  $45^\circ$  with respect to the conductor axis; this causes the current to travel zigzag through the flat, conductive track. A complete sensor device of this type contains two resistive elements that feature an increase in resistance with an increase in magnetic field strength, and another two elements with precisely the inverse property: their resistance decreases in a stronger magnetic field. These four resistors have been connected in a Wheatstone bridge setup, with the same resistor types arranged diagonally, as illustrated by Fig. 4. The diagonal configuration offers a high element sensitivity while minimizing bridge unbalancing by changes in ambient temperature.

One of the most important advantages of magnetic sensitive resistors is the ease of device sensitivity definition by means of the manufacturing process. The new Philips magnetic sensitive Wheatstone bridge devices come in a TO92 style case with four leads: two for the bridge supply voltage and two for the bridge output voltage. Applications are found in any electronic field involving magnetic force detection or measurement. A revolution counter, for instance, may be constructed by mounting a MRS device between a permanent magnet and a cogwheel, driven by the engine; every passing cog will unbalance the Wheatstone bridge and cause an output voltage which may be applied to equipment for further signal processing. Similarly, these devices may be used to determine the angular position of a spindle. If placed close to a current carrying conductor, a magnetic sensor may even perform the function of current transformer.

VK

# SIRENS

Sound effects are always popular. One of the most popular effects for 'livening up' disco-shows, films, etc., is the (police) siren. The crime series on TV have taught practically everybody the difference between the European two-tone siren and the banshee wail of the American version. The circuit described here can produce either sound.

The basic principle of the siren is shown in the block diagram (figure 1). The first section is an oscillator (Astable MultiVibrator, or AMV). For the European siren, the square-wave output from this oscillator is fed direct to the control input of a Voltage Controlled Oscillator (VCO). This causes the VCO to switch to and fro between two frequencies.

For the American siren, the output from the AMV is first passed through an integrating low-pass filter. The output from this stage is something mid-way between a sine wave and a triangular wave. When the VCO is driven by this signal, the result is a close approximation to the noise made by the American cops.

The complete circuit is shown in figure 2. Transistors T1 and T2 are the active elements in the AMV. With S1 in position 'E' (for European) the time-

determining elements are P1, R2, R3 and C2. P1 sets the 'switching frequency'. The time-determining elements for the American siren are P2, R3 and C2. P2 sets the 'wailing speed'. Any number of additional preset potentiometers can be added if further siren effects are required.

The main components of the integrator are P3, R10, C5 and T3. P3 sets the amplitude of the output signal from this stage, so it is used to set the difference between the highest and lowest frequency of the American siren.

Transistors T4...T7 are the active elements in the VCO. The voltage at the control input (base of T6) determines the output frequency. For the American siren, the control voltage is the output from the integrator. Since this voltage swings up and down in the rhythm of the AMV, the output from the VCO will swing up and down in the same rhythm.

The centre frequency of this wailing siren is set with P6.

For the European siren, the square-wave output from the AMV is fed direct to the VCO, causing the latter to produce two frequencies alternately. P5 sets the lower of the two, and P4 sets the difference between them - so it can be used to set the higher frequency.

The adjustment procedures for the two sirens are quite simple.

For the European siren, first set the desired switching frequency with P1. Then set the lower frequency with P5; finally, set the upper frequency with P4. The American siren is slightly more difficult to adjust. First set the 'wail speed' with P2. Then adjust P5 and P6 to get the desired effect. Note that P3 will need readjustment if the setting of P2 is altered.

If more than one American siren is to be preset, an extra switch will be required between C3 and P3, so that it becomes possible to switch in several different presets for P3.

Alternatively, normal potentiometers can be used with a calibrated scale. An almost infinite number of different sirens can then be 'dialed in'. ■

Figure 1. Block diagram of the siren.

Figure 2. Circuit diagram of the complete unit. The three switches can be coupled for ease of switching between the American and European type of siren.

Figure 3. Printed circuit board and component layout.

#### Resistors:

R1, R16, R17 = 2k2  
 R2, R3, R5, R20 = 100 k  
 R4, R7, R10 = 10 k  
 R6, R8, R9, R11, R12, R13, R14 = 1 k  
 R15 = 3k3  
 R18 = 22 k  
 R19 = 12 k  
 P1, P2 = 470 k (preset)  
 P3 = 100 k (preset)  
 P4 = 22 k (preset)  
 P5, P6 = 4k7 (preset)

#### Capacitors:

C1 = 22  $\mu$ /6 V  
 C2 = 1 $\mu$ 5/63 V  
 C3, C6 = 47  $\mu$ /16 V  
 C4 = 470  $\mu$ /6 V  
 C5, C8 = 4 $\mu$ 7/16 V  
 C7 = 680 n

#### Semiconductors:

T1, T3, T8 = TUN  
 T2 = TUP  
 T4 ... T7 = BC547B, BC107B or equ.  
 D1 ... D4 = 1N4148  
 Z1 = 4.7 V/250 mW zener

#### Sundry:

S1 ... S3 = 3-pole, 2-way (see text)

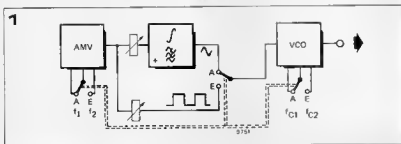

1

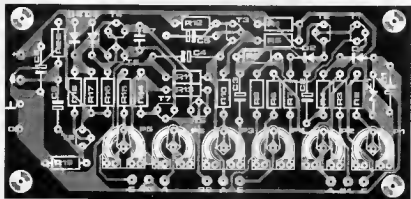
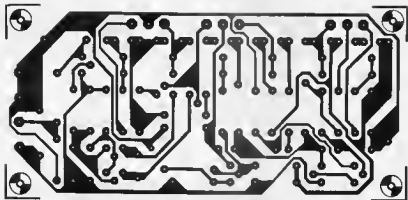

2

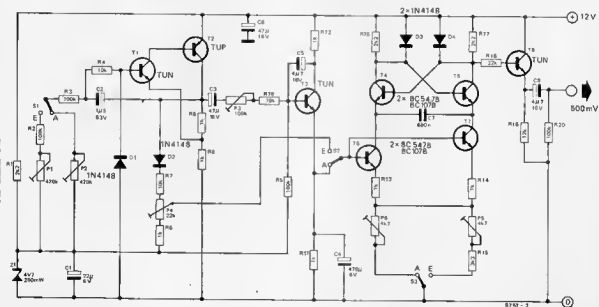



# EARLY DETECTION OF ELECTRONIC FAILURES

by H.A. Cole, CEng, MIERE

The graphical relationship between the failure rate and operating time of virtually any man-made product follows a curve which, because of its shape, is known as a "bath tub". Such a curve has three distinctive regions, the first of which represents an unexpectedly high failure rate within the first year of operation.

The central flat region, extending from about one to ten years, represents normal operating performance where the failure rate is as predicted. The third region represents the so called "wear out" phase where an increasingly high failure rate is to be expected as the product enters its end of useful life period.

Failures that occur in the first year of operation fall into three categories:

- \* Failure to function on the very first occasion (dead on arrival).
- \* Failure almost immediately after first use (infant mortality).
- \* Failure early in the first year of use (early life failures).

Those in the first category should, ideally, never be experienced by the end user since they ought to have been discovered by the retailer and rectified before the product was delivered. Such faults are usually simple to rectify. The second category failures are almost always experienced by the end user, usually within a few hours, days or weeks, depending on the length of continuous operation and working environment experienced by the product. It is this type of fault that causes the greatest annoyance to users and the most damage to the

reputation of retailers and manufacturers.

## *Reputation under threat*

Failures that fall into the third category, although less of a shock to users, are nevertheless likely to result in feelings of disappointment and resentment at being let down. Such failures also represent an additional cost to the manufacturer in honouring product guarantee agreements.

All premature failures are bad for the reputation of a manufacturer since customers who feel they have been let down tend to have long memories of brand names and are only too pleased to pass on their unpleasant experiences to other potential customers. It is, therefore, in the interests of everyone for the manufacturer to do everything reasonable to weed out products that are likely to fail prematurely.

One of the simplest ways of weeding out a potentially faulty electronic product is to operate the finished version or its sub-assemblies at an elevated temperature for a given period of time. Doing this speeds up the early failure rate, shortens the time period of the start of the bath tub curve and quickly identifies those products or components that would otherwise have failed within the first year of normal operation. The technique of doing this sort of test is known as "burn-in", the purpose of which is to ensure that the finished product begins its normal operating life at the start of the flat central

region of the bath tub curve. A particularly attractive feature about burn-in is that it reduces the needs for a large inventory of expensive test equipment as well as time consuming test procedures on virtually every component.

## *Early failures*

In practice, the magnitude of the elevated temperature is limited by the design rating of the individual parts and components of the product. Semiconductor devices such as integrated circuits are usually burnt-in separate from other components at a temperature of 125 °C for periods of up to nearly 170 hours.

Experience has shown that over 80 per cent of all likely early failures in semiconductor devices show up during the first 24 hours of burn-in at 125 °C, and also that for every 10 °C rise in operating temperature the burn-in time could be halved. Fully assembled printed-circuit boards are limited to temperatures of about 70 °C. They consequently require longer burn-in times to achieve the same results that would have been achieved had the burn-in temperature been much higher. Even lower burn-in temperatures are permissible on fully assembled products.

The simplest and least expensive method of burn-in is undertaken under static operating conditions where the component or product under test is placed in a temperature-controlled oven and subjected to the required burn-in temperature. Unfortunately,

not all faults manifest their presence under such passive operating conditions. A more reliable form of testing is by dynamic burn-in, where the components are continually subjected to the sort of electrical stresses and power handling excursions likely to be experienced under normal operating conditions. Dynamic burn-in may be extended to include monitoring of the performance of individual components under test. Clearly dynamic burn-in systems call for a larger quantity of ancillary test equipment and a more sophisticated monitoring programme than is the case for static burn-in.

## *Trans-global deal*

An excellent example of modern dynamic burn-in equipment is that manufactured and marketed by Sharetree, one of Britain's leading manufacturers of stress testing equipment for the semiconductor industry. This company has recently concluded negotiations with Trio Tech International in Singapore for the joint manufacture of an advanced range of computer-controlled burn-in systems. Under the agreement, Sharetree will supply electronic sub-assemblies which will be built into completed systems by Trio Tech's manufacturing plant. Design work has been completed and the first kit was shipped to Singapore in July 1985. In the Sharetree burn-in system the device under

test (DUT) is loaded into one of many sockets connected to a double-sided printed-circuit board (PCB). The DUT board is then placed inside the oven and automatically connected to a back plane connector, to which various test function instructions are applied. These include power supply, clock pulse data and external monitoring facilities, and are controlled by three plug-in circuit cards.

The program card is used alone when static burn-in is the sole requirement. The card routes power and static sources to the appropriate connecting pins of the DUT and controls the temperature of the oven as set by the user. The clock card includes all the functions of the program card but includes too the application of clock pulses, temperature cycling and load variations.

The monitor card is used when the user wishes to compare the dynamic performance of the DUT with that of a reference device, known to be of faultless performance, that is mounted on the program card. Any discrepancy between the two devices is readily identified and recorded by an associated microprocessor data logging facility.

The Sharetree system provides the user with a range of options that should meet the majority of varying requirements. At one extreme there is a parallel bus system that allows maximum packing density of DUTs per board, up to 225 16-pin integrated circuits. At the other extreme a fully flexible facility allows the programming of various device

types on a single card at the expense of packing density. An important advantage of the fully flexible system is that the DUT boards can be made to accept a variety of device types simply by changing the program card. For example, a device board fitted with an array of 16-pin dual-in-line sockets can be made to accept 8-pin, 14-pin or 16-pin devices. A fully flexible type of DUT board has a maximum packing density of 120 16 pin devices.

(LPS)

Sharetree Ltd,  
70 Westward Road,  
Stroud,  
Gloucestershire GL5 4JA.



The so called bath tub curve that relates operating time and failure rate

## A MILLION FRAMES HOLD THE NEW DOMESDAY

by Amanda Wood

Armchair exploration of every square kilometre of Britain, by directing the display on a video screen, will be possible from November 1986, when the BBC's electronic Domesday project is completed. The information input is based on work begun in November 1984 by 14 000 schools and local organizations, as well as national bodies. Their combined data are in the process of being transferred to two optical video discs resembling long-playing records, which will display more than a million picture and text colour frames—depending on method of classifying screen displays. The discs will be played on a laser disc player working in

tandem with a microcomputer and screen. BBC Enterprises plans to sell the discs to schools, business houses, libraries, universities, tourist authorities, and anyone who wants to see what Britain looks like 900 years after the first detailed record of 1086. The original Domesday Book was a survey of England ordered by King William I, in which information on the population and land ownership and use was recorded. The purpose was to give England's first Norman ruler a record of the extent of Crown lands and to provide a framework for taxation. It provided a picture of life at the time which is unique in Europe.

The original Domesday described every village and field in abbreviated Latin but was largely unread—even by William the Conqueror, who died before its full transcription. The user can start with an aerial satellite picture of the United Kingdom and then, by stages, select from some 23 000 four-by-three kilometre map sections. The user can then go on to text and photographs of structures and daily life in the area, and can even screen ground plans of famous buildings or monuments such as Stonehenge. This can be done simply by pointing a cursor and pressing a hand-held mouse which takes one beyond the subject on the

screen, either direct to the next stage or to a printed menu of options. The user can type in a place name, a subject of interest on a postcode and get a map of the area covered, which can then be researched in greater detail. The project began with volunteer groups being allocated the 23 000 four-by-three kilometre blocks from the Ordnance Survey. For each block they provided 20 pages of descriptive text about local life, with colour photographs and basic survey facts for every square kilometre, including amenities and land cover—grassland, woodland, housing, or industry. Complementing this Com-

munity Disc, which has been edited from more than 9 000 floppy discs sent by schools and other voluntary organizations to the BBC Domesday project headquarters in London is the National Disc. This provides material from more formal academic and official sources in the form of essays and published articles with illustrations, as well as specialized maps and photographs chosen from a national competition. This material is also reached through the mouse, or by typing in a subject on the microcomputer keyboard. Much of the national disc material has been submitted in computer tape form, but Community Disc material required more work in transferring it to a mainframe computer before incorporation in the optical video disc. Data is retrieved for screen display by a laser playing over the disc and responding to instructions from the microcomputer. The viewer simply has to point the cursor at a

place on a map to get a menu of options—photographs, daily life descriptions, land cover and amenities, with additional references to subjects handled in depth on the National Disc. Launched in October 1984, the £2.5 million Domesday project had an original target of 10 000 schools, but this had to be revised upwards to 13 000 because of the response, with contributions also coming from local groups such as women's institutes and cultural organizations. "The range of the children's interest was quite impressive," said Mike Tibbetts, assistant director of the project. "I was surprised by the depth of detail they came up with, such as the colloquial terms used by people in a fishing village for example. The photographs have also been impressive." It is the biggest videodisc venture undertaken anywhere since the new technology became available. Domesday has already at-

tracted inquiries from international broadcasting and academic organizations. Sections are already displayed on a pilot basis at the Domesday headquarters in Ealing where a team is processing the software. The project is funded jointly by the Department of Trade, Philips Electronics, which makes the videodisc player, and BBC Enterprises. Acorn Computers has provided the interfacing to link the microcomputer to the Philips player. Logica Communications and Electronic Systems Ltd produced the software for retrieval and display. For schoolchildren, the survey was their first chance to use microcomputers in an important national project. Combined with the authoritative National Disc, their input forms a picture of Britain that will interest educationists, the business community, and tourists. Domesday is expected to be the pilot of a series of BBC-backed interactive

video titles. The value of British pioneer work in the field was recognized in January when it was announced that Esprit—the European Strategic Programme for Research and Development in Information Technology—would be funding work on a new interactive videodisc-based public information system. The project partners are BBC Enterprises, Nederlandse Philips Bedrijven, Logica UK, and the Société Européenne de Propulsion (Division Traitement d'Images). The aim is to devise a voice and picture storage retrieval system for use by the public without the technical, psychological, and cost barriers imposed by conventional computer based systems.

(LPS)

*Domesday Project  
BBC TV  
Bilton House  
54-58 Uxbridge Road  
London W5 2ST*

## PIONEERING NUCLEAR POWER FOR PEACEFUL PURPOSES

by James Varley, Editor *Nuclear Engineering International*

When it comes to civil nuclear technology, Britain can claim membership of a very exclusive club indeed. It is one of only four or five countries that have successfully brought to fruition a completely home grown technology for generating electricity from the atom. It can also lay claim to being the first country to build and put into commercial operation a nuclear powered central generating station. This was Calder Hall, which has been supplying electricity since 17 October 1956

In the British design of reactor, which is used in all the country's commercial nuclear power stations circulating gas (carbon dioxide) is used to carry heat from the nuclear core to the boilers. As in a conventional coal or oil fired power station, the boilers produce the steam to drive turbines, which in turn drive alternators and produce electricity. In 1983, some 17 per cent of Britain's electricity came from reactors of this type which are known as gas-cooled reactors. Most of the remaining electricity

was generated from coal.

### *On the rise*

In 1978 the nuclear figure was around 12 per cent—so the contribution from gas-cooled reactors has been steadily increasing in recent years. It is also destined to keep rising in the near future: three large advanced gas-cooled stations, each of 1200 MW, are in the process of being brought up to full power, although, it must be admitted, behind their original timetables. In addition, a further two

advanced gas-cooled stations of the same large size are under construction. Primarily as a result of lessons learned from the earlier units, these two massive and complex nuclear construction projects are exactly on schedule. Currently about half completed, they should be in operation in three years' time. This will bring Britain's commercial nuclear generating capacity to about 12 000 MW. About one-third of this will come from the older Magnox units, the early design of gas-cooled reactor. The remainder will

come from reactors of the later AGR (advanced gas-cooled) design. In this continuing pursuit of gas-cooled nuclear technology, the United Kingdom has followed an independent path. Although countries such as Italy, Spain, France, and Japan built one or two gas-cooled reactors in the early stages of their civil nuclear programmes, water-cooled reactors, principally the pressurized water reactor (PWR), which originated in the United States of America as a submarine propulsion unit, have proved more popular with the world's electricity producers.

## Water instead of gas?

Water-cooled reactors have, in fact, achieved almost complete domination of the world market in the event, despite high hopes of the early days. Britain has only exported two complete nuclear power stations, the Latina Tokai Magnox units, to Italy and Japan respectively. Both of these date back to the late 1950s.

Indeed, even Britain itself is now in the process of taking a hard look at the PWR. The country's next proposed nuclear plant, which has been the subject of a public inquiry, the results of which will not be known until the middle of this year, is a PWR known as Sizewell B. If this project succeeds, it would spell the end of gas-cooled reactor construction.

Some people might argue that this would be a great pity in view of the massive investments made in modern plant and production techniques for the latest AGRs. These new techniques include the use by Northern Engineering Industries (NEI) Nuclear Systems of a unique computerized robotic welding system in the manufacture

of boilers. But with the country's many years of experience of manufacturing to the stringent standards demanded for nuclear power stations, British companies rightly argue that they are well equipped to make a substantial contribution to nuclear power plants of any kind—gas-cooled or otherwise.

## If Sizewell is approved

The £1000 million Sizewell B PWR would give them a chance to prove this. Although it would use the technology of the United States company

Westinghouse, over 90 per cent of the work would go to British firms. Letters of intent, subject to the project going ahead, have already been received by a boilermaking firm, Babcock Power (which has recently carried out a major investment programme at its works in Scotland) and NEI Nuclear Systems.

These letters are for the steam generators (which is nuclear jargon for boilers) and the pressurizer. These are some of the very demanding large components needed for the primary circuit, the giant piece of very high integrity plumbing which circulates water through the core and the steam generators.

British engineers, particularly within the National Nuclear Corporation, as well as in the Central Electricity Generating Board, (the large utility that would own and operate Sizewell B), have already made a substantial contribution to the detailed design of the station, which is widely accepted as being one of the world's most advanced PWRs.

The high level of indigenous participation and local manufacture is rare in a country's first

large PWR project. But British companies, in addition to their gas-cooled reactor expertise, can already point to a fair amount of experience in the provision of components for PWRs overseas. There is also the considerable experience gained in developing and building the small PWRs for Britain's submarine fleet. These are supplied by Rolls-Royce in conjunction with Vickers, Foster Wheeler, and Babcock.

## Nuclear exports

Among the most prominent of British companies in overseas nuclear projects has been GEC, which joined Westinghouse to build South Korea's first nuclear station. The British designed and built major parts of the nuclear section of the plant and all the "unconventional" side (turbines, alternators, etc). As well as sending turbo-machinery to other South Korean nuclear stations, GEC has supplied turbine generators to plants in Canada, Sweden, India, and the United States. NEI Parsons is another prominent exporter of turbo-machinery for nuclear plant, having supplied South Korea as well as many Canadian nuclear reactors, all of the Candu type. The latter units have some of the world's best performance records, and NEI Parsons is currently working with Atomic Energy of Canada (the Candu vendor) on a possible Turkish plant. As well as turbine generators, British firms have supplied a large range of smaller components to nuclear power stations around the world. These have included valves, pumps, pipework, insulation and pressure vessels, and the customers over the years have covered the whole gamut of reactor types.

## Reprocessing of fuel

One of the most consistently successful export businesses for the United Kingdom nuclear industry has involved the uranium fuel on which nuclear power stations run. British Nuclear Fuels Ltd (BNFL), employing around 15 000 people, is one of the world's largest nuclear fuel companies and provides extensive services for export markets, including mainland Europe, Japan, and North America.

Among its activities are fuel manufacture (including the highly sophisticated technology of uranium enrichment) for all types of reactor and recycling or reprocessing of used fuel. BNFL is currently involved in a £3000 million refurbishment programme which should ensure it remains in the forefront of the high technology nuclear fuel business.

Another area where Britain's nuclear industry is likely to play an increasingly important role is in the development of the fast breeder reactor, an advanced type that effectively breeds its own fuel. Although it is unlikely to have any commercial application before early next century, recently signed agreements will ensure that the United Kingdom plays a key role in the large European demonstration fast reactor plants that will need to be built in preparation for commercialization. All this means British industry will continue to take a pioneering role in the development of peaceful uses for nuclear technology, as it has in the past.

(LPS)

# LCD TYPE LM16251

by Paul Lenz

E0-FF 32 special characters, such as Greek letters and lower case letters with descenders.

Apart from the 192 characters, the unit processes other instructions as well, for instance: erasure of displayed characters;

positioning of the cursors; on and off switching of the cursors; shifting of characters on the display; and others. The characters

A series of liquid displays—LCDs—available from Sharp Electronics offers models which can display up to 4 lines each with from 6 to 80 characters. Some versions have an integral character generator, in a few cases complemented by a controller. This article will concentrate on the Type LM16251, which has an integral character generator and controller, and needs only two supply voltages. The LM16251 has a viewing area of two lines, each of which can accommodate up to sixteen characters. Characters are normally displayed on the upper line, and the lower line is then used for a cursor. The display is soldered onto a PC8 containing the back-up electronics, which is CMOS and TTL compatible. Typical current consumption is of the order of 7 mA. There is ample diode protection and the whole unit is easily connected to a four- or eight-bit microprocessor system. Dimensions are: PC8 84x44 mm; LCD housing 70.5x34.2 mm; viewing area 56.7x11.5 mm; character with cursor 5.55x2.95 mm.

## Facilities

A total of 192 characters is available from the character generator as shown in Table 1. These comprise:

- 00-07 8 characters to be defined by the user;
- 20-7F 96 ASCII characters;
- A0-DF 64 Japanese characters (kana);

		0	2	3	4	5	6	7	A	B	C	D	E	F
	#1 abi 4bit	0000	0010	0011	0100	0101	0110	0111	1010	1011	1100	1101	1110	1111
0	XXXX0000	CO RAM (1)		0	1	2	3	4	5	6	7	8	9	0
1	XXXX0001	(31)	!	"	#	\$	%	&	'	(	)	*	+	,
2	XXXX0010	(3)	"	2	B	R	b	r	Γ	ι	ψ	χ	β	θ
3	XXXX0011	(4)	#	3	C	S	c	s	┘	ω	τ	ε	ς	∞
4	XXXX0100	(5)	\$	4	D	T	d	t	、	ι	τ	μ	ω	Ω
5	XXXX0101	(6)	%	5	E	U	e	u	•	ο	α	1	σ	ϖ
6	XXXX0110	(7)	&	6	F	V	f	v	ο	α	2	ρ	ζ	Σ
7	XXXX0111	(8)	'	7	G	W	w	α	φ	α	3	q	π	
8	XXXX1000	(3)	(	8	H	X	h	x	ι	φ	ο	ν	ξ	
9	XXXX1001	(37)	)	9	I	Y	i	y	ι	φ	ο	ν	υ	
A	XXXX1010	(3)	*	:	J	Z	j	z	ε	ο	ν	κ	ι	φ
B	XXXX1011	(4)	+	;	K	L	k	l	ο	α	ο	π	°	φ
C	XXXX1100	(5)	,	<	L	¥	l	ι	φ	ο	ν	φ	φ	φ
D	XXXX1101	(8)	—	=	M	I	m	ι	φ	ο	ν	φ	φ	÷
E	XXXX1110	(7)	„	>	N	^	n	φ	ο	α	ο	π	φ	
F	XXXX1111	(8)	/	?	O	_	o	φ	ο	α	ο	π	φ	■

#1 High-order

#2 Low-order

86040-T2

**Table 1. Correlation between input codes and character patterns** Note that CG-RAM is a memory in which user-defined patterns can be stored

**Table 2 Instructions and corresponding actions**

**Fig 1. Circuit diagram of a possible set-up.**

always appear in the cursor position, irrespective of whether the cursor has been switched on or not. Collective data and addresses of cursor positions may also be displayed. Moreover, it is possible to determine from the busy flag whether the unit has executed the previous command and is ready for the next instruction. The addresses in Table 2 apply only to an unshifted display. With each shift (S=1 or SC=1), the addresses are also displaced, so that position upper left can no longer be selected with address 00. It is, therefore, advisable initially to work without shifting the display (S=0 and SC=0) and leaving the cursor switched on (C=1). Writing data as well as programming the character generator also shifts the cursor (but not the addresses), so that these must be relocated by appropriate commands after the stated operations have been completed.

With BF=1 (busy flag), the device is executing a command; when BF=0, it is awaiting the next instruction. If an attempt is made to write data or instructions when BF=1, overheating of both ICs may result.

## Circuit example

A possible circuit is shown in Fig. 1, which uses a Z80A; the memories and other peripherals have

**Table 2**

ID=0	shift to the left
=1	shift to the right
S=0	display is static
=1	display is shifted
D=0	display is switched off
=1	display is switched on
C=0	cursor is switched off
=1	cursor is switched on
B=0	static characters
=1	flashing characters
SC=0	cursor is shifted
=1	display is shifted
RL=0	shift to the left
=1	shift to the right
DL=0	4 bits
=1	8 bits
N=0	upper row
=1	both rows
Digits:	from 000 (figure 0) to 111 (figure 7)
Lines:	from 000 (upper) to 111 (lower)
Addresses:	left right not visible
upper	00 to 0F 10 to 27
lower	40 to 4F 50 to 57

been omitted for simplicity's sake. The Z80A is suggested, because this can readily be synchronized with the relatively slow display via its WAIT input.

Address decoder Type 4028 is connected to IORQ only, and not to WR or RD, to facilitate writing as well as reading of the LCD with the least possible number of components. In case outputs Q<sub>2</sub>-Q<sub>4</sub> of the 4028 are used for the control of further IO functions, it is necessary to select a number of addresses for the write and read functions. A bistable Type 4013 (or

4042) is actuated via Q<sub>1</sub> of the 4028, and determines the value of D<sub>8</sub> before passing this on to input RS of the LM16251.

The signal at Q<sub>6</sub> of the 4028 is used to switch on monostable Type 4528. The internal delays in the decoder and the monostable amount to some 140 ns. Network R<sub>1</sub>C<sub>1</sub> stretches the pulse at the Q output of the 4528 to about 700 ns. These times ensure that a machine-language programme can load the display so fast that the thirty-two characters appear simultaneously (at least as far as the human eye is concerned).

The inverted pulse at the Q output of the 4528 is led to the Z80A to ensure that the data and the WR controlled level at the RW input of the LCD remain stable for a sufficiently long time. This momentary stopping of the microprocessor does not affect the operation of the dynamic RAM.

The clock (Φ) output of the Z80A is converted by C<sub>1</sub>-D<sub>1</sub>-D<sub>2</sub>-C<sub>2</sub> to a negative voltage, which is set to

about -2 V by P<sub>1</sub>. The precise value can only be set during actual operation.

The circuit operates well with a clock frequency up to 4 MHz. If the slower 4514 is used as address decoder, the clock frequency should not exceed 2 MHz.

## Some practical hints

When the LCD is switched on, the upper line should become dark, whereas the lower one should remain bright. If this does not happen, V<sub>0</sub> must be made more negative until it does.

Next, the first instruction may be given to the LCD. At all times the busy flag should be consulted (read the address and link it via an AND gate to 8). The very first action should be to initialize the LCD by switching RS to 0 and leading DL=1, N=1, i.e. 38<sub>hex</sub>, to the display. The upper row should now also light. From now on the sequence of commands is arbitrary. For instance, to switch the cursor on, feed 01 into the LCD (which quenches the display), then D=1, C=1, and B=Q, i.e. 0E<sub>hex</sub>. Since the cursor should function as on a monitor screen, also feed 06<sub>hex</sub> into the LCD, as well as ID=1 and S=0. The LCD is now ready for the first characters. Switch RS to 1 and feed in succession 31<sub>hex</sub>, 32<sub>hex</sub>, and 33<sub>hex</sub> into the LCD, when figures 1, 2, and 3 should be displayed. If not, V<sub>0</sub> is not negative enough.

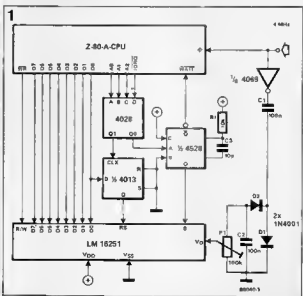

# DESIGN IDEAS

This is the moment to set  $V_0$  correctly with the aid of the small preset at the back of the LCD board. The setting will depend to some extent on the angle at which the display will be viewed.

The cursor can then be set at the centre of the lower row, i.e. at address 48, by writing  $C8_{hex}$  after RS has been made 0. Next, the user-defined character can be placed here by setting RS to 1 and writing  $03_{hex}$  into the display. Line 1 of this character is

programmed by setting RS to 0 and writing  $01_{hex}$ +character  $011$ +line  $001=59_{hex}$  into the display. The line should then consist of three dots. Then set RS to 1 and write  $00010101=15_{hex}$  into the display.

To shift the three digits and the other character to the right, set RS to 0, SC to 1, RL to 1, and write  $1C_{hex}$  into the display. That the addresses have also shifted to the right can be seen by setting the cursor to address 00, i.e. writing  $80_{hex}$  into the display: the cursor will then appear underneath figure 1. The characters are returned to their original position by writing the instruction *home*, i.e.  $02_{hex}$ . ■

Table 4

x = arbitrary

Instruction	RS	R/W	Data								Action		
			D7	D6	D5	D4	D3	D2	D1	D0			
Quench display	0	0	0	0	0	0	0	0	0	0	1	Collective data store, but not the character generator, is erased; cursor is set in home position, address 00 is at upper left	
Cursor home	0	0	0	0	0	0	0	0	0	1	x	Cursor is set in home position; if the display was shifted, it is relocated; address 00 is at upper left; stored data remain unchanged	
Manner in which characters should be displayed	0	0	0	0	0	0	0	1	ID	S		Determines into which direction the cursor will be shifted (ID) after a character has appeared, and whether simultaneously the entire display should be shifted one position (S)	
Display & cursor on/off	0	0	0	0	0	0	1	D	C	B		Display is switched on or off (ID); cursor (line under character) is switched on or off (C); cause the character at the cursor position to flash (B)	
Shift cursor or display	0	0	0	0	0	1	SC	RL	x	x		Cursor or entire display is shifted without any change to the memory contents	
Function	0	0	0	0	1	DL	N	x	x	x		Indicates the width of the databus and whether only the upper row or both rows will be used	
Character generator address	0	0	0	1	digits			lines				Sets the address of the memory of the character generator; the subsequent data produce the relevant character pattern	
Data memory address	0	0	1	address									Sets the address of the data memory; the subsequent data produce the relevant ASCII characters
Busy flag; read address	0	1	BF	address									Reads BF to determine whether the display is ready for the next instruction; also reads the cursor position
Write data	1	0	data									Writes data into the data memory or into the character generator	
Read data	1	1	data									Reads data from the data memory or from the character generator	

Table 3

1 to 8	bidirectional three-state data bus, D7 to D0
9 (EI)	enable (active high). Note that it is important that when RS and R/W have attained their level, at least 140 ns must lapse before this pin goes high, and the data must remain stable on the data bus at least until the trailing edge of the enable pulse
10 (R/W)	0 = write, 1 = read
11 (RS)	register select enables the display to differentiate between data and instructions. This pin should be controlled by a bistable: 0 = instruction; 1 = data
12 (V <sub>e</sub> )	a vital supply for the LM16251. Its value is about -2 V with very low current consumption. Its correct value can only be set empirically, and depends on the required contrast and viewing angle
13 (V <sub>DD</sub> )	DC supply voltage (CMOS): +5 V
14 (V <sub>SS</sub> )	ground (CMQS)

Table 3. Pin connections

Table 4. Summary of instructions

## Control amplifier

Transistors T1 and T2 form a voltage amplifier with a high input impedance and a low output impedance. When the slider of preset potentiometer P1 is set to give the full value of 1 k, the input sensitivity in combination with the 3-watt amplifier is about 150 mV for the 12-volt version working into a 4- $\Omega$  load, or 200 mV for the 17-volt version working into an 8- $\Omega$  load. If a higher input sensitivity is required, P1 can be set to a value lower than 1 k. If switching to different values of input sensitivity is needed, fixed resistors can be used in place of P1, with values determined according to the formula:

$$R_x = \frac{500 \times V_{in}}{300 \times V_{in}} \text{ (ohms)}$$

where  $V_{in}$  is the RMS input voltage in mV. The formula holds good for input voltages from 5 mV to 250 mV. T3 is used in a standard Baxandall tone control circuit. The 1 n capacitor between the collector and earth is to prevent oscillation.

# AUSTEREO

*Here is an interesting project for the audio enthusiast, who likes to play around with the circuit rather than just assemble a given project. The 'Austereo' has been split up into modules which can be combined to build a stereo amplifier of your own choice, or you can use any of the modules in a design of your own!*

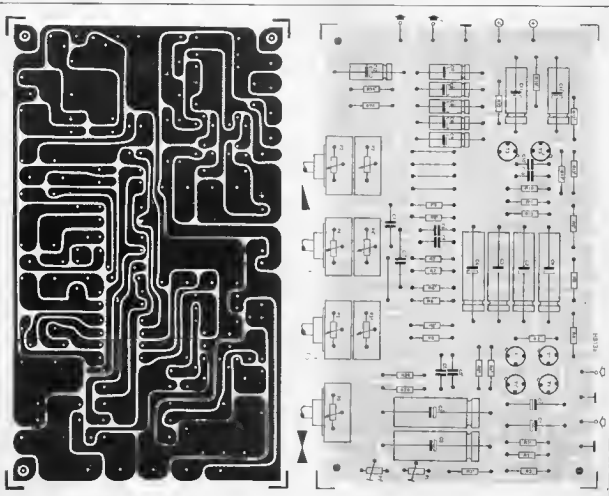



## Resistors:

R1 = 2M7  
 R2 = 4M7  
 R3, R4, R5, R12 = 1 k  
 R6, R9, R13 = 4k7  
 R7 = 39 k  
 R8 = 5k6  
 R10 = 47 k  
 R11 = 220 k  
 R14 = 100 k

## Capacitors:

C1 = 1  $\mu$ , 6 V tantalum  
 C2 = 470  $\mu$ , 6 V electrolytic  
 C3 = 100  $\mu$ , 16 V  
 C4 = 100  $\mu$ , 25 V  
 C5, C6 = 2n2  
 C7 = 39 n  
 C8, C9, C12 = 25  $\mu$ , 16 V  
 C10 = 1 n  
 C11 = 50  $\mu$ , 6 V

## Sundries

P1 = preset potentiometer  
 1 k lin.  
 P2 = potentiometer  
 4k7 log stereo  
 P3, P4 = potentiometer  
 100 k lin. stereo  
 P5 = potentiometer 10 k lin  
 Semiconductors  
 T1, T3 = 8C 148 B  
 T2 = 8C 158 B

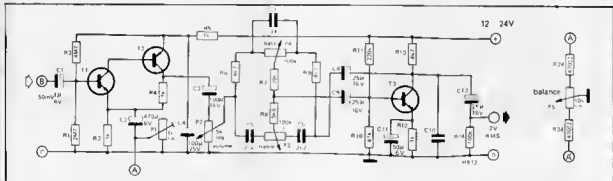

## Disc preamplifier

The disc preamplifier, of which only one channel is shown in the circuit, incorporates equalisation to correct the output of a magnetic cartridge according to the RIAA playback curve, and also amplifies the signal to a level sufficient to drive the control amplifier. It consists of a two-stage voltage amplifier, T4 and T5, with the RIAA feedback network R18, R19, C15 and C16 connected from the collector of T5 to the emitter of T4. DC feedback and biasing of T4 is provided by R15. The disc preamplifier board should preferably be mounted inside the turntable box as otherwise the capacitance of the screened lead between the cartridge and the disc preamplifier can form a resonant circuit with the self-inductance of the cartridge. If this resonance lies within the audio spectrum it may cause a peak in the frequency response. Of course some

cartridge manufacturers quote a recommended load capacitance and if this is so their recommendations should be adhered to. Another good reason for mounting the disc preamplifier inside the turntable is to keep it away from the

hum fields of the amplifier's mains transformer. Turntable motors usually have much less stray field than the average mains transformer! It can be seen that the layout for the two channels is symmetrical.

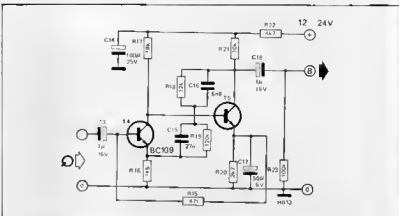

## Resistors:

R15 = 47 k  
 R16 = 1k5  
 R17 = 18 k  
 R18 = 12 k  
 R19 = 120 k  
 R20 = 2k7  
 R21 = 10 k  
 R22 = 4k7  
 R23 = 100 k

## Capacitors:

C13, C18 = 1  $\mu$  16 V  
 C14 = 100  $\mu$ /25 V  
 C15 = 27 n  
 C16 = 5n8  
 C17 = 47 ... 50  $\mu$ /6 V

## Semiconductors:

T4 = 8C 109 C  
 T5 = 8C 148 B

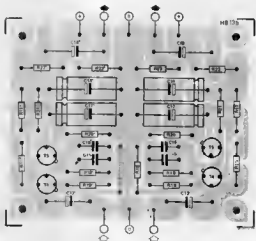

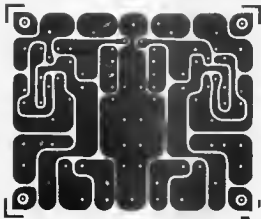

### 3-Watt output

Transistors T1 and T2 form a direct-coupled voltage amplifier. Resistor R6 and diodes D1/D2 determine the quiescent current of the quasi-complementary driver stage T3/T4 and the output stage T5/T6. The values of resistors R7 and R8 are chosen so that the output transistors are either just biased on or just cut off depending on the gain of the transistor used. C3, C5, C6 and R3 help to maintain stability. The input sensitivity of the amplifier is about 400 mV for 12-volt operation with a 4- $\Omega$  load,

and 600 mV for 17-volt operation with an 8  $\Omega$  load. The gain may be increased by reducing R4 but this is not recommended as instability may occur and distortion is increased.

The following layout precautions should be noted when assembling the completed board onto a chassis:

	12 V	17 V
R12	680 $\Omega$	1 k
C4	4700 $\mu$	2200 $\mu$
LS	4 $\Omega$	8 $\Omega$

1. Loudspeaker common must be connected directly to the power supply common and should be kept well away from the boards.
2. Separate leads must be run from the supply to the supply points on each board.
3. Outputs of any board should be kept well away from inputs of other boards (except of course where the output of a stage is connected to the input of the succeeding stage)
4. Care should be taken to avoid earth loops. Each section of the amplifier should have only one connection to supply common.

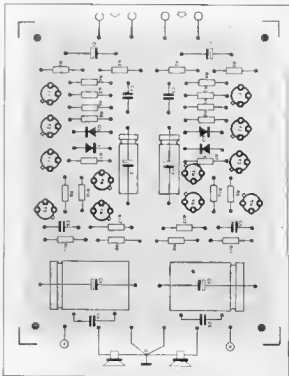
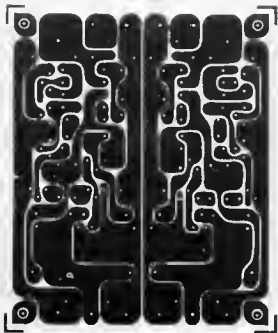

## Resistors:

R1, R2 = 100 k  
 R3, R5 = 4k7  
 R4 = 470  $\Omega$   
 R6 = 33  $\Omega$   
 R7, R8 = 56  $\Omega$   
 R9, R10 = 0,2  $\Omega$   
 R11 = 1 k  
 R12 = see table

## Capacitors:

C1 = 2,2  $\mu$ , 16 V  
 C2 = 100  $\mu$ , 16 V  
 C3 = 10 n  
 C4 = see table  
 C5, C6 = 47 n

## Semiconductors:

T1, T3 = 8C 148 B  
 T2, T4 = 8C 158 B  
 T5, T6 = 2N1613  
 D1, D2 = 1N 4001  
 heatsinks for TO-5

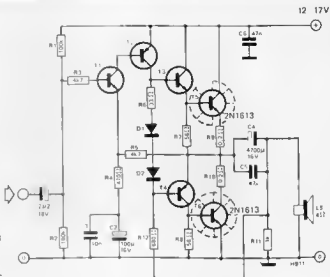

## Power supply for 3 watt output

Transistors T1 and T2 form a Darlington pair acting as a compound emitter-follower with a reference voltage provided by Z1. Z1 is chosen as a 13 or 18 volt zener for a 12 or 17 volt supply respectively. Since T2 dissipates only a small amount of power a heatsink is not required.

## Resistor:

R1 = see table

## Capacitors:

C1 = 2200  $\mu$ , 25 V  
 C2 = 100  $\mu$ , 25 V

## Trafo:

Tr = 2 A sec., see table

## Sundries:

B = B40C2200  
 Z1 = zenerdiode, 250 mW, see table  
 N = neon  
 S = on/off switch

## Semiconductors:

T1 = 2N3055  
 T2 = see tabl.

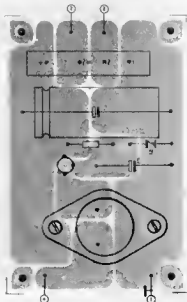
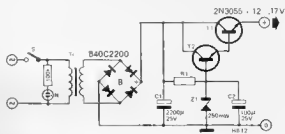

	12 V	17 V
R1	270 $\Omega$	680 $\Omega$
Z1	13 V	18 V
T2	BC 148 B	BC 147
Tr	12 V~	18 V~

## 15-30 Watt output

The 'austereo' 3-watt amplifier is used as a drive amplifier for the 2N3055 output transistors, and very few changes in the circuit or the component values are needed. Capacitor C7 is introduced to compensate for the phase shift due to the output transistors. The value of R1 is reduced to 56 k, and additional decoupling, in the form of a 47-k resistor and a 10- $\mu$  capacitor, is inserted between the high-potential end of R1 and supply positive. The output impedance is very low, as T5/T7 and T6/T8 form power darlings. The 'austereo' control amplifier is well capable of supplying the 1-V RMS input voltage needed.

Because of the low input sensitivity, the amplifier has good stability and its sensitivity to hum is low. Substantial negative feedback via R4 and R5 ensures low distortion.

Maximum permissible supply voltage is 42 V. The power supply circuit is developed from the stabilised power supply unit for the 'austereo' amplifier, with circuit modifications and also changes of component ratings to suit the higher working voltages.

In addition to the heat sinks shown in the amplifier and power supply circuits, the three 2N3055 transistors should be cooled by mounting them on the amplifier or power supply boxes (as applicable) using mica insulating washers. The power supply table is worked out for stereo. Power for the control amplifier is drawn from a 2N1613 with its base potential held at half the main supply voltage.

### Parts list for 15-30 W amplifier

Resistors:  
 R1 = 56 k  
 R1a = 47 k  
 R2 = 100 k  
 R3, R5 = 4k7  
 R6, R9, R10 = 33  $\Omega$   
 R7, R8, R11 = 1 k  
 R12 = 1k2  
 R13, R14 = 0.22  $\Omega$ , 5 W

Capacitors:  
 C1 = 2.2  $\mu$ , 35 V  
 C2 = 100  $\mu$ , 35 V  
 C3 = 10 n  
 C4 = see table  
 C5, C6 = 47 n  
 C7 = 100 p  
 C8 = 10  $\mu$ , 35 V

### Power output (w) with:

	8 $\Omega$	4 $\Omega$	2 $\Omega$ (R13, R14 = 0.1 $\Omega$ )		
power	30	9.5	19	35	25
supply voltage (V)	36	15	30	55	25
	42	20	40	70	35
	2200	4700	10,000		
	C4 capacity ( $\mu$ F)				

Semiconductors:  
 T1, T3 = BC107  
 T2, T4 = BC177  
 T5, T6 = 2N1813  
 T7, T8 = 2N3055  
 D1, D2 = DUS  
 5 heatsinks for TOS

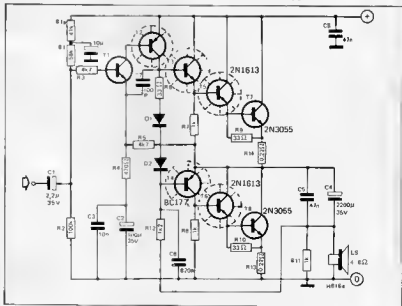

## Power supply for 15-30 watt output

### Parts list for 15-30 W power supply

Resistors:  
 R1 = see table  
 R2 = 1k8  
 R3 = 100  $\Omega$   
 R4, R5 = 10 k  
 R6 = 100 k

Capacitors:  
 C1 = see table  
 C2 = 47  $\mu$ , 60 V  
 C3 = 47  $\mu$ , 25 V  
 C4 = 47 n

Transformer:  
 see table

Sundries:  
 B = Bridge rectifier, see table  
 Z = Zener diode, see table  
 N = Neon lamp  
 S = On/off switch  
 Heat sink for TOS

Output power	Transformer secondary		B 840C...	C1 x 100 $\mu$ F	Z	R1 $\Omega$ 1 watt
	V	A				
9.5 · 19 · 35	30	1.2 · 4	1000 · 2200 · 5000	22 · 47 · 100 50 V	ZD 33	680
15 · 30 · 55	36	1.2 · 2.4 · 4.8	2200 · 3200 · 5000	22 · 47 · 100 60 V	ZD 39	820
20 · 40 · 70	42	1.2 · 2.5 · 5	2200 · 3200 · 5000	22 · 47 · 100 70 V	ZD 43	1 k

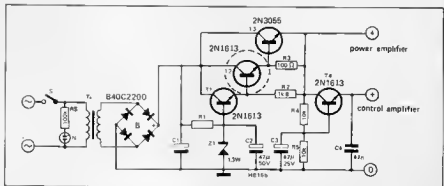

# Digi-Course II

## Chapter 7

In this chapter of Digi Course, we introduce another important concept of the logic circuits — the time dependant operation. In case of such circuits which will be described in this chapter, the logic state of the circuits depends not only on the input levels, but also on the moment of time of viewing.

For experimenting with time dependant circuit we shall need some passive components:

- 3 Resistors 3 K  $\Omega$  / 1/2 Watt.
- 3 Electrolytic Capacitors 47  $\mu$ F/16V
- 1 Electrolytic Capacitor 4.7  $\mu$ F/16V

A connecting link will have to be soldered to each lead of these components so that they can be used directly on our Digilux PCB

The circuit shown in figure 1 is a simple 'Monoflop'

1

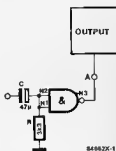

The solid black bar in the capacitor symbol is the negative terminal of the capacitor. Connect this terminal to zero level (ground line) so that the capacitor is fully discharged. The capacitor voltage is 0 V and the output indicator LED lights up because of the NAND gate inverter. Now if the "1" or +5V level is given at the negative terminal of the capacitor the LED is turned off for some time and then it lights again on its own.

With a high input to the capacitor, the voltage at the input of the NAND inverter also jumps to "1", thus turning off the LED. As the capacitor slowly charges, the current flow through 3 K resistor decays and along with that the voltage at the input of the NAND inverter also decays to "0". Once this stage is reached, the output of the NAND inverter again becomes "1" and the LED glows. The time taken by the capacitor to charge is decided by the values of R and C, which also decide the time for which the LED remains turned off.

The circuit in figure 1 can be further modified as shown in figure 2

2

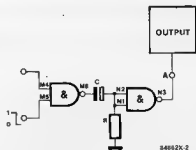

With this modification the circuit becomes a controlled Monoflop. With M4 at "0" level the circuit can be disabled and with M4 at "1" the circuit is enabled and becomes operative. Terminal M5 is the trigger input. Many standard ICs have an input similar to the terminal M4 which is called the Enable Input.

The Monoflop just described is also known as a Monostable Multivibrator. The Flipflop described in previous chapters is known as a bistable multivibrator.

Now let us see the effect of connecting two Monoflops in series as shown in figure 3

3

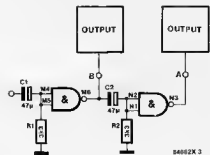

When capacitor is switched from "0" to "1" first the LED B is turned off, then after a period decided by the values of R1 and C1, it glows again. At this exact moment of time the second Monoflop gets a transition from "0" to "1" at the input of capacitor C2 which turns off LED A for an equal amount of time, then it glows again.

Similar to the "0" to "1" transition available at M6 when B started glowing again, we also have a "0" to "1" transition available at N3 when A starts glowing again. This transition can be further used to trigger the first Monoflop again. Connect the circuit as shown in figure 4 and observe what happens!

4

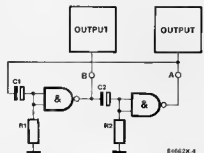

This circuit will switch both the Monoflops alternately and the LEDs will glow and extinguish alternately. This is an oscillator — called Astable Multivibrator. The period of oscillations will be decided by the individual values of R1, C1 and R2, C2.

To study the effect of R and C values, change the capacitor C1 from 47  $\mu$ F to 4.7  $\mu$ F. Now the periods of LEDs A and B glowing and extinguishing become unequal. The exact effect is illustrated in the pulse diagram of figure 6. The diagrams on the left correspond to circuit values in figure 3 and the diagrams on right correspond to circuit values in figure 5.

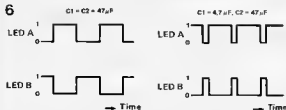
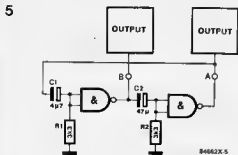

In engineering language this is called a symmetric and asymmetric duty cycle. A simple explanation of the three terms we have encountered so far in multivibrators is as follows: A Monostable Multivibrator is one which has only one stable state, if we force it to change the state, it returns to its stable state after a fixed period of time. Other names for this circuit are Monoflop or Monoshot.

A Bistable Multivibrator has two stable states, if we force it to change its present state it goes to the other stable state and remains in that state till forced again to change state. Another name for this circuit is FlipFlop.

An Astable Multivibrator has two states, but it can never remain in one state permanently. It keeps on changing the states periodically. There is no other name for this circuit.

We can as well add one more Monoflop to our Astable Multivibrator to obtain the circuit shown in figure 7.

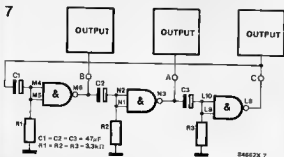

This circuit gives a running light effect, as the three LEDs turn ON and OFF serially. If this circuit does not start up on its own, it must be externally triggered. Any number of extra Monoflops can be added to this circuit provided that the total number is odd.

In Digital Technology, there are many more oscillator circuits. To summarize those will be outside the scope of this series. An important point worth mentioning here is about the high frequency oscillators. Such circuits are used for generating the clock frequencies for computers and other applications, and to obtain a stable frequency quartz crystals are used.

The simple oscillator circuit of figure 4 can be combined with one of the counter or shift - register circuits described earlier. One such arrangement is shown in figure 8.

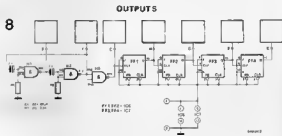

Like the Flipflops studied in previous chapters, Monoflops are also available commercially as integrated circuits. One such IC is the 74123 which contains two Monoflops. The Monoflops are retriggerable, that is, they can be triggered again during the ON period. The time period is calculated as follows:

$$t = 0.32 \times C \times (R + 700)$$

for R = 5 to 25 K $\Omega$  and C = 10 pF

In case of electrolytic capacitors, a diode 1N4148 must be used as shown in figure 9, and the period is shortened to

$$t = 0.28 \times C \times (R + 700)$$

The Monoflops trigger on rising edge at B if A is on "0" and on falling edge at A if B is on "1".

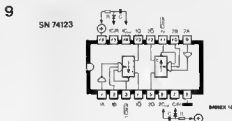

The instrument mostly found in the centre of a laboratory work bench is an oscilloscope. The electronics expert finds it the most important measuring instrument. Meaning of the Greek word 'Oscilloscope' translated into simple English would be something like this. "An apparatus for making the oscillations visible". It records the waveforms and displays them on the screen so that they can be visualised as a time versus voltage graph.

Figure 2 shows an oscilloscope with a rectangular waveform being displayed on the screen. Most important data of the oscillations like the voltage values (in vertical direction) and period (in horizontal direction) can be measured directly from the screen. From the screen we can further observe that the edges of the waveform are not quite sharp as would be expected in an ideal rectangular waveform.



## The Oscilloscope



### The Structure :

The main part of the the oscilloscope is obviously the screen - which is the front face of the picture tube or the Cathode Ray Tube (CRT). The shape of the CRT can be seen in figure 4. The front face is coated with a Phosphorous layer on the inside, and this forms the screen where waveforms are displayed. The CRT has a vacuum inside it.

An "Electron Gun" is situated in the neck portion of the CRT, which "shoots" Electrons onto the front screen. When the beam of electrons hits the Phosphorous material on the screen it creates a glowing dot on the screen due to the energy being carried by the electron beam.

Figure 1 :  
Invaluable dream of the Electronics Hobbyist. A sophisticated oscilloscope with all accessories.

Figure 2 :  
Rectangular voltage waveform with not so-sharp edges.

Two deflecting plate pairs are used to deflect the electron beam in the desired direction. By applying a voltage to the deflecting plates, the deflection is achieved towards the plate which is more positive. As the deflecting force acts both in horizontal and vertical direction, the resulting force can take the beam and the glowing dot to any position on the screen.

The vertical pair of plates deflects the beam horizontally and the horizontal pair of plates deflects the beam vertically. The vertical pair is called X-plates or horizontal

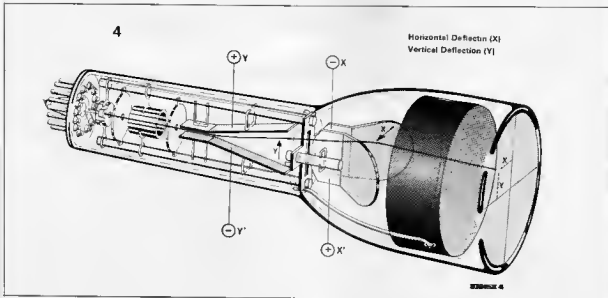
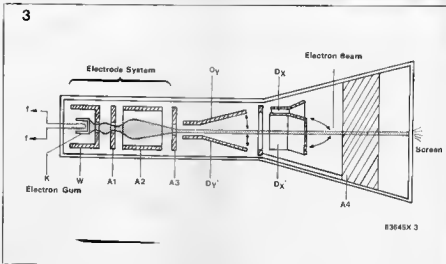

deflection plates and the horizontal pair is called Y-plates or vertical deflection plates

The X-plates are normally fed with a saw-tooth voltage. (figure 5) This voltage deflects the beam periodically from left to right and back on the screen, generating a steady horizontal glowing line on the screen. The return is very quick and the beam is blanked during the return, so that we see only the left to right trace on the screen. The waveform to be measured is applied to the

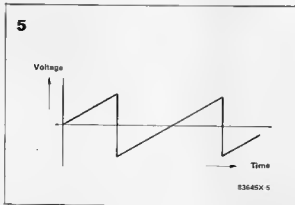

Figure 3 :

The phosphorous layer on the screen emits light when electron beam hits it.

Figure 4

Both the deflecting voltages can direct the electron beam to any desired point on the screen. The beam bends towards the plate which is more positive.

Figure 5 :

The saw-tooth voltage which deflects the beam from left to right on the screen and then back



6

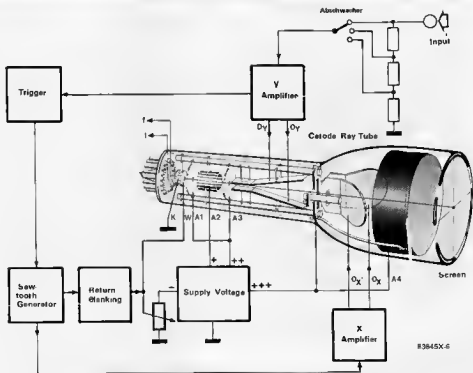

Y-plates. This superimposes the vertical movement on the beam, which is directly proportion to the voltage on the Y-plates. Thus what we see on the screen is a graph which shows the time on X-axis and voltage on Y-axis, giving the true picture of the waveform being measured. The scanned image remains visible on the screen only for a fraction of a second. However the sawtooth on X-plates makes it repeat continuously, and the glowing image is refreshed on every cycle of the sawtooth wave. In order that the image formed in each cycle of the sawtooth perfectly coincides with the image formed in the previous cycle, a special device is used to trigger the sawtooth exactly on the same point in the waveform being displayed. This gives a steady image on the screen. To simplify what happens during the trigger operation we can visualise that the

trigger circuit makes the glowing dot to wait on the left edge of the screen till the input waveform reaches a particular voltage level which is set as the trigger level. When it reaches that level, the saw-tooth sweeps one cycle across the screen. In addition to the triggering device, it is also essential to have a control over the period of the saw-tooth, so that the time scale on the X-axis is under our control. If the frequency of sawtooth is very high, the screen shows only a small portion of the input waveform. If the frequency of the sawtooth is very low, the screen will contain many cycles of the input waveform.

### The Function :

A block schematic diagram of the oscilloscope circuit is shown in figure 6. It clearly shows all the functional blocks we discussed so far. The cathode K is heated by

the heater coil (H) to such an extent that it starts emitting electrons. This process can be compared with boiling water which emits water molecules from the surface in form of steam. As soon as the electrons leave the cathode plate end enter the vacuum they are attracted and accelerated and focused by the anodes A<sub>1</sub>, A<sub>2</sub> and A<sub>3</sub>. As the anodes are circular and open in the center, they do not absorb the electrons but allow them to pass through at an accelerated speed in form of a bunch in the direction of the screen. This bunch of electrons moving at an accelerated speed forms a sharp beam which finally hits the phosphorous layer on the screen.

There is also a cylindrical electrode in between the cathode and anodes which has an adjustable negative voltage on it. This voltage decides the amount of electrons that will finally

reach the screen, by deflecting back the remaining electrons towards the cathode again. This voltage is called the Wehnelt Voltage or Z-Voltage, and regulates the flow of electrons. It also carries out another important task. When the beam jumps back from right to left, a strong negative pulse is given to the Z-electrode (Wehnelt Cylinder) so that the return of the beam is not seen on the screen.

Figure 6  
The block schematic diagram of the oscilloscope circuit

As the electron beam travels at a high speed, both the X and Y deflection voltages must be sufficiently high to be able to deflect the beam. To raise the voltage level for the deflection plates, two amplifiers called X-Amplifier and Y-Amplifier are used. The X-Amplifier is fed from the saw-tooth generator and the Y-Amplifier is fed from the input signal. The Y-Amplifier is very sensitive and can process very low input voltages. If the input voltages are quite a high level, it is attenuated with voltage dividers before feeding it to the Y-Amplifier.

There is one more anode on the CRT on the wall of the tube which is supplied with a very high positive voltage between 2 to 15 KV. This further accelerates the electron beam, and gives them a very high energy which is converted into light when the beam hits the phosphorous layer on the screen. After delivering the energy to the screen, the slowed down electrons are absorbed by the high voltage anode, and complete the circuit.

## Front Panel Controls

Every oscilloscope will have a different type of front panel layout, and the nature of controls available will depend on the type of oscilloscope and the level of sophistication. Controls on a simple single channel oscilloscope are described here with the help of a typical front panel shown in figure 7. Some oscilloscopes are equipped with two input channels and can display two waveforms simultaneously on the screen for mutual comparison. Typically the input and output waveforms of an electronic circuit can be studied in relation to each other with the help of this function. Such oscilloscopes have two independent Y-Amplifiers

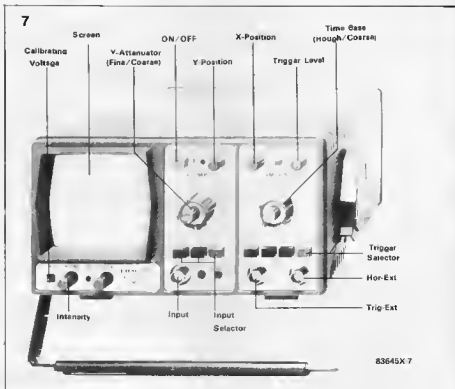

and the trace generated by the same saw-tooth for both the channels

An intensity control appears below the screen. This controls the brightness of the display by controlling the Wehnelt Voltage. Focus control is also provided to adjust the sharpness of beam.

With the switches above the input connector, the method of operation of the oscilloscope can be selected:

- DC : for direct display of the true input voltage
- AC : for display only the AC component of the input voltage
- CT : for component test function available in some oscilloscopes
- GD : Ground for indicating the zero line

The rotary switch marked Y-Attenuator controls the attenuation of the signal going to the Y-Amplifier. It is calibrated in V/cm or mV/cm. The figures show

how many Volts or mill Volts are represented by 1 cm in the vertical direction on the screen. This measurement is enabled by the centimeter grid shown on the screen.

The Y-Position knob allows you to move the image up or down on the screen.

The right side of the front panel has the horizontal portion controls. The saw-tooth generator or the time base control is achieved through a rotary switch calibrated in ms/cm or us/cm. Which decides the slope and period of the saw-tooth wave given to the X amplifier. The setting of this switch tells you how much time is represented by one centimeter in the horizontal direction on the screen. Located under this rotary switch are the trigger selection switches. The models of triggering can be selected through these switches. The triggering can be either through the external trigger, by a TV video signal, or by a rising or falling edge. When the

"AT/Norm" knob is pressed, the trigger level can be controlled through the "Level" knob. The "Hor. Ext" switch disconnects the X-Amplifier from the saw-tooth generator and connects it to the external horizontal input socket.

The X-Position control allows you to move the image left or right. The "CAL" terminal provides a 1 KHz rectangular wave with a 200 mV level for calibration of the display.

Unfortunately the sophisticated oscilloscopes are very expensive and generally beyond the reach of a hobbyist.

Figure 7  
Front panel controls of a single channel oscilloscope

# TV Antenna Signal Distributor

Here is a simple circuit which will allow you to use only one antenna between two TV sets

No, it's not as simple as connecting two TV sets in parallel to the antenna. Such a connection will reduce the load impedance seen by the antenna to half the value of impedance of each TV set as shown in figure 1. This will introduce a mismatch.

To get over this problem of impedance mismatch, all you need is three resistances and a capacitor

Figures 2 and 3 show how this circuit is to be constructed.

The Circuit diagram is shown in figure 2, and the actual prototype constructed using half of the Selex PCB (size 1) is shown in figure 3. The shield wire sheathings are connected firmly using three copper or bronze strips. These strips are bent with help of a 6 mm drill bit or a stud and a bench vice the jaws of the vice are opened about 8 to 10 mm wide and the strip is placed over it. The central portion of the strip is bent into U shape by keeping the broad side of the drill bit or the stud over it end hitting from the top, so that the strip is driven into the gap between the jaws of the vice. Both ends of this bent strip are now bent back with a hammer.

Soldering of components on the Selex PCB is quite simple and can be done as shown in the layout given in

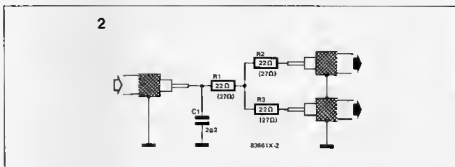
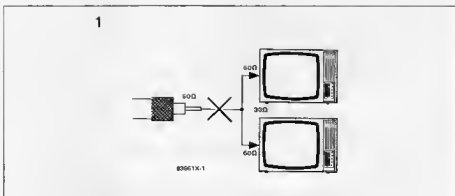

the figure 4. R1, C1 and the antenna cable are soldered together.

The functioning of the circuit is as follows:

The 22 Ω resistance in series with the connecting cable of the TV sets increases the 60 Ω impedance to about 80 Ω. Further when these two are connected in parallel, the impedance seen at the junction of R1, R2, R3 is 40

Ω. Thus when added to the 22 Ω resistance R1, the antenna sees an impedance of approximately 60 Ω again. Matching with the impedance of the antenna cable.

C1 compensates for the inductance. Because impedance of a resistance increases at very high frequencies due to the effective inductance. As the impedance of a capacitor decreases at high frequencies, it compensates for the increase in impedance of resistors

Figure 1 :  
Two parallel connected TV sets give effectively half the impedance and create a mismatch with the antenna.

Figure 2 :  
Three resistances and one capacitor matches the effective impedance. However, a part of the antenna signal is dissipated as heat in the resistors

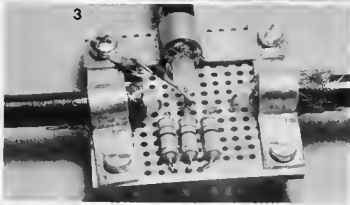

The disadvantage of this simple circuit is that some of the antenna signal is dissipated as heat by the resistors. But this should not create a problem in areas where signal is quite strong. During construction, be careful and keep all connections as short as possible, and make them well conducting. A small plastic box can be used as housing.

For antenna systems with 75  $\Omega$  cables, change the 22  $\Omega$  resistances to 27  $\Omega$ . C1 can remain 2.2 pF.

**Component List :**

- R1, R2, R3 = 22  $\Omega$  or 27  $\Omega$
- C1 = 2.2 pF (Ceramic)
- 3 Copper Strips, Screws etc.
- 1 Selex PCB (Size 1) cut into half
- 1 Lug Strip

**Figure 3.**  
The actual construction of the circuit, using brass clamps

**Figure 4.**  
R1 and C1 are directly soldered with the antenna cable.

4

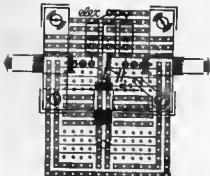

# Tips for Selex PCB

There's almost nothing that can't be simplified further. It is also true for the Selex PCB. An easy way to assemble a Selex project on a Selex PCB is to paste a copy of the given component layout directly on the PCB and then insert the components directly in position. If you wish to remove the layout after the soldering is done, fix it only with a cello tape. There is no effect on the working of the circuit even if you

permanently paste the layout in place and don't remove it after soldering.

The Selex PCB is so versatile that it can also be used to make your own layouts for different circuits. In such case whenever it becomes necessary to cut the tracks, you can use a 3 mm drill bit and turn it back and forth in the hole from the track side. This will remove copper around the hole and open the track.

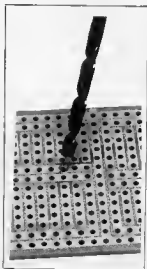
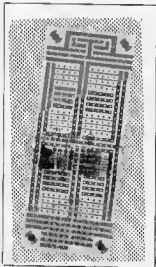

# NEW PRODUCTS

## Mini printer for portable/compact equipment

Epson OEM Division's new M-180 series miniature shuttle printers combine high print quality and speed with low power consumption. The new range includes the M-180, 181, 182, and 183 printers. The basic 24-column M-180 provides a print speed of 1.5 lines per second (LPS) and 144 dots per line (DPL). The M-181 will give 30 columns, 1.3 LPS and 180 DPL; the M-182 36 columns, 1.1 LPS and 218 DPL; the M-183 42 columns, 0.9 LPS and 252 DPL. The paper width is the same for all types at 57.5 mm, and power consumption is low at 200 mA (typ) from a 5V supply, which makes battery operation feasible. The printers can operate in text and graphics mode; a compact control board, the BA-180 and

single-chip dedicated controller, the LA-180, are available to simplify interfacing to the range. Ideal for use in hand-held terminals, cash registers, calculators and portable data logging systems, the printers measure 91mm x 46.9mm x 15.8mm.

Epson (UK) Limited  
Dorland House  
388 High Road  
Wembley  
Middlesex HA9 6UH.  
Telephone: 01 902 8892  
(3430.3 F)

## Top class letter quality printer

Star Micronics have recently introduced a new dot matrix printer, the NB-15. Fitted with a 24-pin head, it is capable of producing draft copy at 300 cps and letter quality print-outs at 100 cps. In addition to the standard ASCII set with international alternatives in both draft and letter quality, up to two additional font modules may be in use at any one time, giving a remarkable degree of flexibility. Standard features of the



new LB-15 include both tractor and automatic single sheet feed, easily accessible DIP switches and comprehensive front panel controls, full 18M character set including standard block graphic characters, 16 Kbyte buffer, and easily interchangeable interfaces. Priced at around £950, the LB-15 is claimed to be significantly better equipped than competitive products, since it offers a true letter quality print-out as compared with the current near letter quality offered in most cases.

Star Micronics UK Limited  
Croven House  
40 Uxbridge Road  
Ealing  
London W5 2BS.  
Telephone: 01 840 1800  
Telex: 948501 (3430.4 F)

EPROM. A 6522 VIA provides 16 I/O lines, two 16-bit interval timers and a serial shift register. A further eight inputs and outputs are provided for keyboard or system interlacing. A 6551 ACIA provides an asynchronous serial port allowing all standard baud rates to be used. Also on the board are a real-time clock chip and a 16-character LCD display which allows user interaction and system status monitoring. The card comes with a powerful monitor program and a full documentation package; the price of the unit is £199.95 + VAT. J.P. Designs  
37 Oyster Row  
Cambridge CB5 8LL  
Telephone: (0223) 322234  
(3430.6 F)

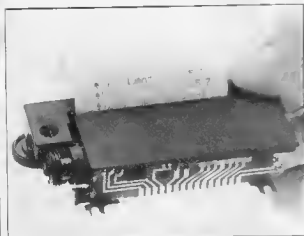

## Single-board controller

New from J.P. Designs is the Gemini 2 hand held controller, ideally suited for real time applications such as lathe control, robotics, etc. where user interaction may be required. At the heart of the system is a Type 6502 microprocessor operating at 1 MHz, with up to 8 Kbytes of static RAM (2K provided),

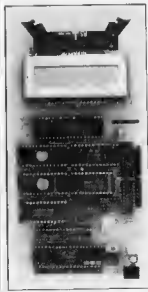

# NEW PRODUCTS

## THERMOSTATS

PATEL'S offer a range of Thermostats which provide low cost adjustable temperature controls. The stem is comprised in two parts inside is made of low expanding ALLOY STEEL ROD and the outer shell consists of a high expanding ALLOY TUBING this differential expansion principle enables advantages such as

- Withstands large temperature changes without damage
- resistance to vibration
- simple and full adjustability over range
- high sensitivity
- inherent temperature anticipation
- wide operating range
- direct response to radiant heat
- high switching

The capacity of the Thermostats is 15 Amps at 240 volts, 50 cycles A.C They can be fixed in any position

For further information contact -  
PATEL'S ANALOG & DIGITAL MEASUREMENT CO PVT LTD.  
A/6, Functorm Electronics Estate, Bhosri Industrial Area, Poona - 411 026  
MAHARASHTRA STATE (INDIA)

## EXHAUST FAN

M/S. HIND ELECTRIC & ELECTRONICS introduces a Tube Axial Exhaust fan for equipment cooling purpose. The features include light weight, heavy duty, low power consumption, 230V 50HZ operation single phase

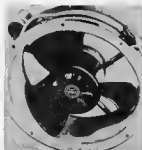

This unit has air flow of 71 cubic feet per minute at free air delivery it can be mounted on either side depending on air direction required. This product is basically designed for the requirement of Electrical and Electronic Equipment Control panels etc.

For further details please write to

M/S. HIND ELECTRIC & ELECTRONICS  
Shed No. 2, 1 D A, Cheriapah  
Hyderabad 500 051  
Phone No. 850 287

## CABLE TIES & TIE MOUNTS

Microsign Products offer a wide line of versatile one piece construction self locking Nylon cable ties of Miniature-Intermediate-Standard section in releasable & Non-releasable type which can secure cables-wires-tubings-housings from 2mm to 75mm in diameter. Miniature cable ties make neat work of intricate wiring. The mounts available with screw provision-Adhesive backed snap in too

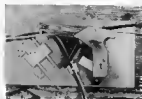

For further information contact

MICROSIGN PRODUCTS  
Mehta Tarare  
Satyanarayan Road  
Bhavnagar 364 002

## FLOWMETERS

Panamatrics has introduced a flared gas flowmeter which transmits simultaneously three 4-20 mA outputs flow velocity V, molecular weight Mw and



mass flow rate M. These outputs help flare operators find leaks fast, avoid wasting steam, protect vapour recovery compressor turbines against overheating when vapour molecular weights fall too low and in general improve material balances and conserve energy and money.

For more informations contact  
CHEMTROLS ENGINEERING PRIVATE LIMITED  
910 Tulsim Chambers  
212 Nariman Point  
Bombay 400 021

## DIGITAL IC TESTER

RC Digital IC Tester 4024D is a microprocessor based instrument designed to perform automatic functional testing of TTL, RTL, HTL, DTL, CMOS and MOS IC's

Pre-programmed software for about 300 most commonly used IC's is stored in memory with provision to update the programme for another 100 IC's

Among important functional features are, automatic identification of an IC number, automatic identification of power pins of IC, audio alarm for fault indication etc. Optional features include logic level testing over recommended supply voltage range, convenient print out and provision for testing IC under wide temperature range. It operates on 230 V, 50 Hz AC with low power consumption.



Contact -

RC INFORMATION TECHNOLOGY SYSTEMS PVT LTD.  
1413, Dalalmei Tower  
Nariman Point  
Bombay-400 021

## ABL CAPACITORS

ABL manufacture a wide range of Polyester, Metallised Polyester and Polypropylene Capacitors to suit various small signal circuit applications

These Capacitors are manufactured with Plant and Machinery from Japan in association with Hitachi.

The Capacitors are available in 2.5mm, 5mm, 10mm pitches. The Automatic Winding machines, Testing Equipments

etc, ensure that the capacitors are of uniform quality

The following range is currently available

Plain Polyester 001 uf to 0.6B

Plain Polyester Capacitance range 001 uf to 0.6B uf

Voltage 100 V to 630 V

Tolerance + 5% & + 10%

Metallised Poly Capacitors

Capacitance Range Capacitance 0.1 uf to 3.5 uf

Voltage Range 100 V D.C. to 630 V D.C.

Tolerance + 5% & + 10%



For further details please contact.

ABL CAPACITORS (INDIA) LIMITED  
78, East Avenue Road,  
Punjab Bagh,  
New Delhi 110 026  
Telephone - 502068

## LINE FREQUENCY METER

Delta Control Engg. Corpn has introduced 3 digit Line Frequency Meter MFC-3 having resolution and accuracy of 0.1 Hz. It has 0.001% accurate crystal controlled time base, frequency range of 40.0 Hz to 65.0 Hz and 5-Second Sampling interval to give steady and better averaged readings. Enclosure used is rugged ABS moulded 1/2 DIN size box, requiring a panel cut-out of 92 mm x 46 mm. It uses high professional grade components mounted on glass-epoxy PCB give reliability.

Contact -

M/S DELTA CONTROL ENGINEERING CORPORATION,  
C-224, Shreyas Industrial Estate,  
Western Express Highway,  
Goregaon (East), Bombay - 400 063.

**SINGLE PHASING PREVENTOR**  
EEC have developed a Single Phasing Preventor which protects motors against danger of single phase, high & low voltage, phase unbalancing, phase reversing etc. The unit is totally solid state and can be used with any HP motor. It is housed in dust & damp proof sheet steel modular enclosure. An Auto/Oil/Manual switch and an indicating light is provided.



For further details please write to  
**ELECTRICAL EQUIPMENT CORPORATION**  
13/63, Punjabi Bagh  
NEW DELHI 110 026

**FLEXIBLE RELEASE CORD**

IEC is now marketing a Flexible Cord/Cable Release System which is specially useful for a panel builder who is often confronted with mis-matching between the Relay actuator and the Push button.

The standard Cable release systems are made for a few well-known types of Relays, addition of a suitable Clamp can make it useful for any type of Relay.

This unit withstands more than 1,00,000 mechanical operations and is alleviated with superior insulation to prevent thermal and electrical abuses.

For further information, contact  
**INDIAN ENGINEERING COMPANY**  
Post Box 16551, Worli Naka,  
Bombay 400 018

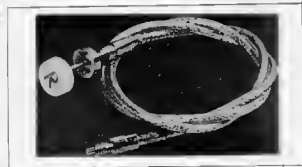

**COATING FOR PCBs**

CRC Acryform, is made in India under agreement with CRC chemicals, Europe. It is a fast drying single component conformal coating for application on printed circuit assemblies. It is easy to apply, has a shelf life of 2 years, and is easy to remove if rework becomes necessary. CRC Acryform is dry to touch (air drying) in 20 minutes. CRC Acryform is transparent, so coated components are easily identified. Single components may be replaced by soldering or desoldering directly through the coating. The cured film can be removed using chlorinated solvents such as methylene chloride or trichloroethane.



**DANMET CHEMICALS PVT. LTD.**  
Electric Mansion, 6th Floor,  
Appasaheb Marathe Marg  
Prabhadevi  
Bombay 400 025

**CUTTER - STRIPPER**

CYCL-O Has Developed a new cutter-cum-stripper for Electrical cables up to 5 mm in diameter. The stripper strips off wire up to 25 mm/1 inch in Length.



For Further details contact  
**CYCL-O COMPUTERS**  
625 'Panchratna'  
Opera House  
Bombay 400 004

**NEW PRODUCTS**

**CURRENT SOURCE**

Kethley has introduced a new Programmable current source model 224 with the following Specifications.

- + 5NA to 101MA dc Output
- 10<sup>12</sup> output resistance.
- 5 Programmable Current ranges
- Auto Increment/decrament
- Hi-LO Limit for Auto increment/decrament.
- +1V to + 105V Programmable V-Limit



Contact Address —  
**MICRONIC DEVICES**  
403, Gagan Deep  
12, Rajendra Place  
New Delhi 110 008  
Phone 589771

**TACHOGENERATOR**

Advan-Oerlikon have added a new Techogenerator, Model DTG-IT-143-0 to their range of power control equipment. This version gives minimum deviation from the linearity. Minimum ripple in the output voltage, close tolerance regulation and better performance at lower speeds. It is tailor made to suit operation conditions in various industrial applications. It is Designed for speed indication and feedback control of DC variable speed drives.

The equipment can be flange and/or foot mounted. Special temperature compensation for output voltage can be provided.



upto 90°C. Also voltage to speed ratio can be adjusted as per customers requirements. For more details, quota ref No P19/7/84 and write to, Advan—Oerlikon Limited Post Box No. 1545 Bombay 400 001.

**ROTARY SWITCH WITH ADJUSTABLE STOP TRS-12**

'Contact' TRS-12 is a Rotary switch which is offered in 3 models, First 1 pole 12 positions, Second 2 pole 6 positions and Third 4 pole 3 positions. A stop ring is provided with each switch to enable the user to adjust the 'switch-stop' position to meet his requirements. Each model is available with printed circuit and solder terminals having tin-glow plating to impart quick solderability.

The body is made up of glass filled Nylon and the contacts are made from brass and phosphor bronze. The switch at present is offered with nonshorting contacts (Break before make), having a rating of 350 mA at 110 V Ac/Dc, and with contact resistance of 20 milliohms max. The switch is having a minimum mechanical life of 20,000 detent operations. The shaft accepts any knob suitable for 1/4" diameter.



For further details contact,  
**COMPONENT TECHNIQUE**  
8, Orion Apartment  
29-A Lallubhai Park Road  
Andheri (West)  
Bombay-400 058

## CONDITIONS OF ACCEPTANCE OF CLASSIFIED ADVERTISEMENTS

1) Advertisements are accepted subject to the conditions appearing on our current rate card and on the express understanding that the Advertiser warrants that the advertisement does not contravene any trade act in force in the country.

2) The Publishers reserve the right to refuse or withdraw any advertisement.

3) Although every care is taken, the Publishers shall not be liable for clerical or printer's errors or their consequences.

4) The Advertiser's full name and address must accompany each advertisement submitted.

The prepaid rate for classified advertisement is Rs. 2.00 per word (minimum 24 words). Semi Display panels of 3 cms by 1 column. Rs. 150.00 per panel. All cheques, money orders, etc. to be made payable to Elektor Electronics Pvt. Ltd. Advertisements, together with remittance, should be sent to The Classified Advertisement Manager. For outstation cheques please add Rs. 2.50

Wanted well experienced Electronics Engineers with experience in design and development of Electronics Testing and Industrial Instrumentation on regular/consultation basis. Kindly contact Post Box 4324, New Delhi 110019

Walkie Talkie Transmitter Circuits available. Sample circuits Rs. 15/- Write to R N D Electronics, 12-11-133, Ravhavan-dranagai, Secunderabad 500 361

HURRY! One Chip Radio ICs: ZN 415 E Rs. 62.00, ZN 416 E Rs. 78.00 (All inclusive). Send 50% with order (M O or D D) to INTELLIGENT ELECTRONICS, 65, SBI Colony Gopalnagar, Nagpur 440022

## CORRECTIONS

### Phase-corrected cross-over filter

(January 1986, p.1-30)

The introductory paragraph to formula (6) should read, "where both the low- and high-pass output are attenuated by 6 dB (the so-called half power points).

### Telephone exchange

(January 1986, p.1-54)

Capacitors C<sub>21</sub> and C<sub>22</sub> are shown the wrong way around on the PCB lay-out in Fig. 3, the circuit diagram in Fig. 2 is correct.

### MSX Extensions - 2

(March 1986, p.3-30)

The text in the third column should read "to MSX signal CS12, CS2 or CS1 in that order, . . .

ACE COMPONENT .....	6.66
APEX .....	6.12
APPOINTMENT .....	6.72
ATRON ELECTRONIC .....	6.66
BESTAVISION .....	
ELECTRONICS LTD .....	6.13
COMPONENT TECHNIQUE .....	6.10
COSMIC .....	6.76
CYCLO .....	6.06
DEVICE .....	6.11
DYNALOG MICRO SYSTEM .....	6.15
DYNATRON .....	6.65
ELECTRO SYSTEM .....	6.14
ELCIAR .....	6.10
IEAP .....	6.12
K. RUSTOM & CO. ....	6.08
LABELLA LABORATORY .....	6.04
LEADER .....	6.04
MODI ELECTRONICS .....	6.70
MOTWANE .....	6.09
MOVOFLEX .....	6.10
OSWAL ELECTRONICS .....	6.02
PECTRON .....	6.70
PIONEER .....	6.67
PLA .....	6.12
PRECIOUS BOOKS .....	6.66
RAJASTHAN .....	6.02
R.C. TECHNOLOGY .....	6.67
SAINI ELECTRONICS .....	6.67
SAVALA PC .....	6.14
SUCHA ASSOCIATES .....	6.68
SUPPER PRODUCTS .....	6.06
S.S. INDUSTRIES .....	6.14
TESTICA .....	6.68
TEXONIC .....	6.08
UNLIMITED .....	6.08
VALIANT ELECTRO MARKETERS .....	6.06
VASAVI .....	6.05
VISHA .....	6.75
YABASU .....	6.07



# EXTRA AUDIOLOGY



RECORDERS CASSETTE DECKS SPEAKERS

CD PLAYERS HEADPHONES

**COSMIC**  
WE ARE SOUND