

132

May  
1986

elektor **INDIA**

Rs. 7.50

# electronics

**Active  
subwoofer**

**Talk funny**

**Electronic maze**

**Real time clock**



**Junior computer**



*Stuart Lloyd*

*Satellite loudspeakers are not a separate category of sound reproducing equipment; any loudspeaker whose best performance should be improved could be classified as a satellite. So-called bookcase loudspeakers are invariably satellites, because their modest dimensions prohibit proper reproduction of frequencies below about 100 Hz.*

*The article follows on the Active subwoofer and deals with the satellite loudspeakers that complement the subwoofer to give complete coverage of the audio spectrum.*

## projects

Subwoofer .....	5-18
Talk funny .....	5-26
Electronic maze .....	5-29
VHF amplifier .....	5-32
Real time clock .....	5-36
Junior Computer .....	5-42
Satellite loudspeakers .....	5-46

## information

News and views .....	5-16
New products .....	5-59

## guide lines

Switchboard .....	5-67
Classified ads .....	5-74
Index of advertisers .....	5-74

## selex '12

Digi-Course II (chapter 6) .....	5-51
Mini Amplifier .....	5-52
Z-Diode tester .....	5-55

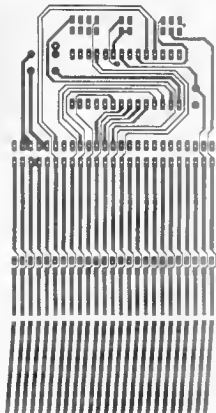

**AT LAST**

**THE PRECISION  
AND QUALITY**

**you were looking for  
at realistic prices**

**YABASU**

**PCB Drafting Aids now made in India.**



Width tolerance  
down to 0.03 mm

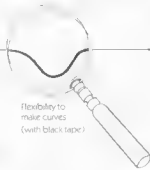

Flexibility to  
make curves  
(with black tape)

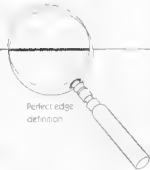

Perfect edge  
definition

- Tapes in black, red & blue. All widths in inch or metric measure available ex-stock.
- IC Patterns and Donuts to be introduced soon.

Write to

**precious<sup>®</sup>**  
ELECTRONICS CORPORATION

59-C, Chhotani Building, Proctor Road, Grant Road (E), Bombay-400 307

**Dealers wanted all over India**

**Publisher:** C R Chandarana  
**Editor:** Surendra Iyer  
**Editorial Assistance:** Ashok Dongre  
**Advtg & Admin:** J Dhas  
**Production:** C N Mithagari

**Address**  
ELEKTOR ELECTRONICS PVT LTD  
52 C Proctor Road,  
Bombay 400007 India

**Overseas editions**

Gintop Publishers Limited  
Stendrast House Bath Place  
High Street Bathnet  
London EN6 1 ED  
**Editor:** Len Seymour

**Elektuur BV**  
Peter Treckpoetsstraat 2 4  
5191 VK Beek — the Netherlands  
**Editor:** P E L Keisemakers

**Elektor srl**  
Route Nationale, Le Sabou, B P 53  
59270 Bailled France  
**Editors:** D R S Meyer  
G C P Raedersdorf

**Elektor Verlag GmbH**  
Susterfeld Straße 25  
100 Aachen — West Germany  
**Editor:** E J A Kneipelsauer

**Elektor EPE**  
Karasko 14  
10673 Voula — Athens — Greece  
**Editor:** E Xanthoulis

**Elektor JCE**  
Via Rosellini 12  
20124 Milano — Italy  
**Editor:** D Fumagalli  
Ferraris & Bento Lda  
R.D. Estefânia, 32-1º  
1000 Lisboa — Portugal  
**Editor:** Jorge Gonçalves

**Ingelek S A**  
Av Alfonso XIII, 141  
Madrid 16 — Spain  
**Editor:** A M Ferrer

**International co-ordinating  
& technical manager:**  
K S M Walraven

The contents are for domestic use only. The submission of designs, all articles to Elektor India implies permission to the publishers to alter and translate the text and design and to use the contents in other Elektor publications and journals. The publishers cannot guarantee to return any material submitted to them. All drawings, photographs, printed circuit boards and articles published in Elektor India are copyright and may not be reproduced or imitated in whole or part without prior written permission of the publishers.

Patent protection may exist in respect of circuits, devices, components etc. described in this magazine.

The publishers do not accept responsibility for being to identify such patent or other protection.

**Distributors:**  
Batec Publishers & Distributors Pvt Ltd

Printed At  
Tripathi Offset  
Bombay 400 013



Copyright © 1986 Elektuur B V  
The Netherlands



## Video in decline?

Now the semiconductor markets are beginning to show signs of a slow revival, it seems to be the turn of video revenues (and therefore profits) to start declining. The reason for this is that some forty per cent of households in the industrialized world already have a VCR (video cassette recorder).

To retain their share of the consequently declining market, the 20-odd Japanese (and some other Asian) manufacturers have become engaged in a price war that is hotting up.

What they are all hoping for is a miraculous expansion of the market, or a new market. But that is pie in the sky, because market observers believe that such an expansion or new market will only occur if a technically new, yet lasting and exciting, equipment is introduced. Moreover, such equipment must be relatively inexpensive, easy to operate, and offer a high degree of standardization.

The only equipment that seems to meet most of these requirements is Sony's new 8 mm video system. But since this is not compatible with the 100-odd million half-inch VCRs already in use, it has a long, hard slog ahead of it.

In the mean time, the video market is likely to go on declining at an increasing rate. As guarded estimates suggest that nearly a fifth of Japanese electronics sales consists of VCRs and their components, some sectors of the Japanese industry are in for a leaner time than they have experienced for years. The question is: what are they going to do about it?

# Afcoset Components Finder

A complete  
REFERENCE GUIDE  
for your file.

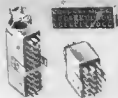

## PLUGS & SOCKETS 4, 6, 8, 12, 18 & 33 PIN

- Spark proof 100% sure sprung contacts
- Burn-proof bakelite moulding
- 5 Amps 1000 volts per contact
- Top quality thick silver plating
- Unbreakable and dust proof
- Numbered inside & outside
- Compact easy to fix & insert
- Wrong insertion impossible
- Retainers + cable clamp prevent disconnection

- Two devices insulated from each other
- Both case & leads insulated from double sided PCBs
- Good mechanical support
- Heat proof Nylon

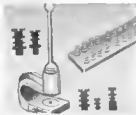

## SOLDER TERMINALS & SWAGERS (Turret terminal posts/Fluxtable Taps)

- Rigid mounting
- High current capacity
- Fast assembly
- Connect double sided PCB
- Protect from soldering heat
- Multiple and feed through connection
- Also mount components and lases
- SWAGERS (Hand Riveting machines)
- Firm riveting upto 10 cms from board edge
- Speed up assembly



## INSULATING BUSHES, WASHERS & CLIPS

- For insulation of fixing screws on heatinks or chassis
- Also for insulation of heatsink or PCB from cabinet
- Hold LEDs, transistors diodes & cables to the PCB

## LOW POWER TRANSISTOR COOLERS

- Cool Transistors & ICs
- Mount directly on device or PCB
- Tight fitting
- Maximum cooling power
- Excellent thermal contact



## NEW PRINTED CIRCUIT EDGE CONNECTORS

- Reliable contact (Spring quality phosphor bronze bright tin or gold plated)
- Smooth insertion/withdrawal (Specially profiled contact surface)
- No scratches on PCB plating (rounded, polished & burr free contact edges)
- No mistake in wiring (contacts both numbered and lettered)

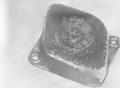

## TRANSISTOR COVERS

- Insulate the case of Power Transistors
- Protect Transistors from damage dust & moisture
- Protect personnel from SHOCK

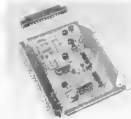

## NEW BANANA SOCKETS

- Spark resisting brass contacts
- Excellent conductivity & solderability due to silver plating
- Easy fitting into 5 mm standard drilled holes



## HEATSINKS

- Designed to maximize heat transfer
- Made from the most heat conductive alloy
- Superb finish (No pores/scratches) for better device contact
- Perfect fitting—No tolerances
- Conveniently cut & drilled—Ex stock

## HEATSINK COMPOUND

- (Thermally conductive)
- Helps to cool devices
- Fills minute gaps between device & heatsink
- Excellent heat conduction
- Thermally stable



## IC & TRANSISTOR PAKS

- Speed up assembly by easing insertion of delicate Transistor and IC leads in PCB
- No sleeving of every lead

## AFCO INDUSTRIAL & CHEMICAL LTD.

Kanjurmarg (East) Bombay 400 078  
Phone 582164 582978  
Telex 011-71478 • Grams 'TUTELA'

## DEALERS - BRANCHES (PHONES)

BOMBAY National (31 6713) Cresta (45 7230), BANGALORE Amar (220547) Afco (225657), DELHI Synthetic (511436), Afco (513537), PUNE Universal (445729), BARODA Jayman (56-811) SECUNDERABAD Shilpa (73792), Tirunelveli (551379), MADRAS Tayonic (844405), CALCUTTA Pioneer (452091), TRIVANDRUM Bhavanash (51719), JAIPUR PM Electro (77492)

# We have a chip.



Are you a designer? Do you enjoy playing around with microprocessors? Here's a great chance to enjoy yourself and make some money.

Design an application based on SCL 6502 in one of the fields listed below\*, or any other. We'll give you the microprocessor and peripheral interface devices plus the hardware/software manuals.

## It might get you a thousand chips!

**DESIGN AN APPLICATION. THE BEST TEN WILL WIN Rs. 1000 EACH**

#### \*Consumer

cash registers, washing machine control, music control, message display system, ticketing machines, toys, any other home application.

#### Refrigeration/Air-conditioning

temperature switches, thermostat control, etc.

#### Automobile

light control, dashboards, etc.

#### Instrumentation

temperature monitoring, moisture measurement, etc.

#### Advanced dedicated instruments/ industrial applications

weighing bridges, batch counting, process monitoring, pH metres, remote monitoring, etc.

#### Telecommunication

modem controllers, intercoms, etc.

#### Computational applications

slave processor, I/O controller, etc.

#### Any other application

**The SCL 6502 Microprocessor. Makes it all possible.**

For details contact:  
Marketing Division



**Semiconductor  
Complex Ltd.**

(A Govt. of India Enterprise)  
Registered Office: Phase VIII, S.A.S. Nagar 160059 (Punjab)  
Tel: 87443 (Gram) CHALSI Telex: 0395-270 LSI IN

Please write to us by 30.4.86 about the area in which you are working. The final design should reach us by 30.6.86.

# Hilversum Cores

- all the efficiency and reliability your SMPS needs

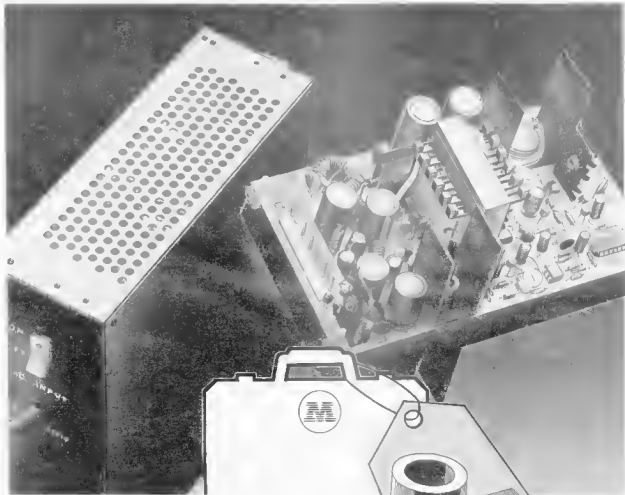

**Murugappa Electronics Ltd**  
offers you high quality soft ferrite cores,  
manufactured by Hilversum Electronics  
- a name to reckon with

The selection of appropriate cores plays a crucial role in transformer choke design - and Hilversum offers the solution.

**Features like never before:**

- High grade imported raw material
- Sintered in controlled nitrogen atmosphere
- Low loss factor
- Wide range of permeabilities
- Choice of specific AL Values.

**Areas of Application:**

- Power & Pulse transformer
- Inverters & DC converters
- Filter Chokes & SMPS
- CTV's
- Computers & Terminals
- Transducers - and the areas of application are endless

**Our engineers' application assistance helps enhance your products' performance.**



**MURUGAPPA**  
**ELECTRONICS LTD.**  
World Standards in India

Manufactured by:

**HE** HILVERSUM ELECTRONICS

Prop. Gundy Tubing of India Ltd. Madras

Marketed by: MURUGAPPA ELECTRONICS LIMITED PARRY HOUSE 3rd Floor, 43 Moore Street, Madras 600 001 INDIA Tel Nos 25505, 29251 Ext 261 Telex 41-301 TMS IN/41-7429 AMEX IN

Branches • Bangalore - Tel Nos 601278/603742 • Bombay - Tel No 318000 Telex 11-2237 PARY IN  
• Calcutta - Tel Nos 449932, 33 Telex 21-786B AJAX IN • New Delhi - Tel No 6434274 • Secunderabad  
Tel No 70151 Telex 1556-205 PARY IN • Allehabad - Tel No 55134

# ADVANI-OERLIKON BRINGS YOU ADOR PC-4896

India's first cost-effective programmable logic controller.



Trust Advani-Oerlikon research to design and develop India's first cost-effective programmable logic controller. Based on a microcomputer chip, ADOR PC-4896 can accept as many as 96 I/Os. Thus making it ideal for use in continuous process plants where several functions are involved: logic control, sequencing, timing, counting, etc. ADOR PC-4896 has an edge over conventional relay panels. Simple to

programme and easy to operate, it obviates the need for trained personnel, programmers and software specialists

while eliminating cumbersome relay/contacter hard-wired systems which have to be planned and designed much in advance of a project.

ADOR PC-4896 incorporates the latest microprocessor-based design leading to low power consumption. Modular in construction and compact in size, it offers the same flexibility of computers — without the high cost.

#### APPLICATIONS

##### Cement Plants

- Control of rhythmised drive in sequence for crushing section
- Control and interlock of raw mill, kiln section, coal grinding, coal/gypsum handling

##### Steel Plants

- Cold rolling mills
- Blast furnace firing sequence control

##### Petrochemical Plants

- Start/stop sequence of huge crude handling systems
- Pipeline controls

##### Thermal Power Plants

- Logic circuit causing main unit shutdown
- Boilers and turbines start up and shutdown process

##### Paper & Pulp Industries

- Automatic mixing and dispensing of ingredients
- Material Handling
- Control of powerless conveyor systems

#### ADOR PC-4896.

The logic behind continuous process controls.

For enquiries, quote Key No. AD-531 and write to P.O. No. 1546, Bombay 400 303.



#### ADVANI-OERLIKON LIMITED

Bangalore 50, Baroda 11, Bhubaneswar 5, Bombay 10, Calcutta 10, Coimbatore 10, Hyderabad 10, Jamshedpur 10, Lucknow 10, Madras 10, Pondicherry 10, Raipur 10, Ranchi 10, Thiruvananthapuram 10, Visakhapatnam 10.

Circle AD-531



*The subwoofer described in this article can be used to extend any existing loudspeaker system. It has been designed to obtain a frequency response within  $\pm 1$  dB over the frequency range 30-100 Hz with an enclosure volume of only 85 litres.*

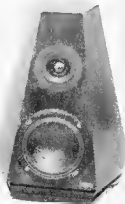
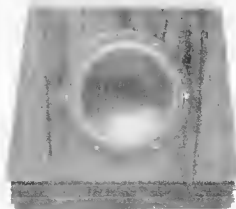
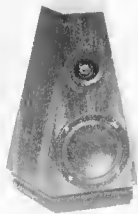

# ACTIVE SUBWOOFER

The faithful reproduction of very low audio frequencies in normal living rooms poses a number of problems. The first is that the lowest frequency  $f$ , that can be reproduced depends

on the length,  $l$ , of the room:

$$f = c/2l \text{ [Hz]}$$

where  $c$  is the velocity of sound waves in metres per second at normal atmospheric pressure and at 20 °C.

In a 6-metre long room, therefore, the lowest frequency that can be reproduced without distortion is about 28 Hz. In practice, other problems, such as the vibrating of doors, windows, cupboards, glassware, and so on, become evident long before this frequency has been reached.

A more important problem concerns the dimensions of the enclosure. For a reasonably faithful reproduction at 30 Hz and full volume, the enclosure should normally have a volume of not less than 100 litres, and preferably about 200 litres. Two

such large boxes required for a stereo installation are often unacceptable in a normal living room.

Fortunately, there is an alternative which offers much the same bass performance and has a much more modest space requirement. It uses only one enclosure for the low frequencies, even in stereo operation. For the middle and high frequencies, one loudspeaker system per channel remains required.

The alternative solution is made possible by the human ear having virtually no sense of direction at frequencies below about 200 Hz. This means that if frequencies below, say, 100 Hz, are reproduced by one central subwoofer, and the remainder of the audio spectrum by so-called satellite loudspeakers, there is no discernible impairment of the stereo effect. Note that the satellite speakers can be kept small

## Technical characteristics

System	active closed box
Net volume	85 litres
Crossover network	electronic 24 dB octave, Bessel filter
Frequency range*	30-100 Hz (see Fig. 1a)
Recommended amplifier output	50-100 W
Maximum sound pressure	> 100 dB (50-100 Hz)
Sensitivity	87.5 dB (1 watt at 1 metre)

\*The system has been provided with a presettable output power limiter.

because they are required to reproduce frequencies above 100 Hz only. The design and construction of these satellite loudspeakers will be described in this issue

Table 1 shows some types of loudspeaker system and their most important characteristics. It is clear that the closed box generally offers the best performance, were it not for its

inability to reproduce very low audio frequencies when its volume is modest to small. The bass reflex and transmission-line types are superior in this respect, but these suffer from an inferior frequency response characteristic and a much worse step response. The horn and transmission-line types are, furthermore, rather difficult to build.

This leaves, in practical terms, the active closed box. The properties of

this type depend to a large extent on its specific design, which can be approached from different directions. The questions that immediately crop up are: "how low should the  $-3$  dB point be?", and "what are the acceptable dimensions of the enclosure?" The lower the frequency at the  $-3$  dB point for a certain volume, or the smaller the dimensions for a given  $-3$  dB point, the more electronic correction will be necessary.

Table 1. Some prominent types of loudspeaker system and their most important properties.

Fig. 1a Frequency response characteristic of the Dynaudio 30W54 drive unit in an 80-litre closed box without any filtering

Fig. 1b Frequency response characteristic of the Dynaudio 30W54 drive unit in an 80-litre closed box with electronic crossover network and correction filter

Type of system	Dimensions	Sensitivity	Step response	Characteristic	Lower $-3$ dB point
Horn	very large	very high	reasonable	very regular	fairly high
Bass reflex	large	high	reasonable	irregular	low
Transmission line	large	low	poor	irregular	low
Closed box	large	fair	good	tapering	high
Active closed box	small	reasonable*	good*	smooth*	low*

\* Depends to a large extent on the system set-up.

1a

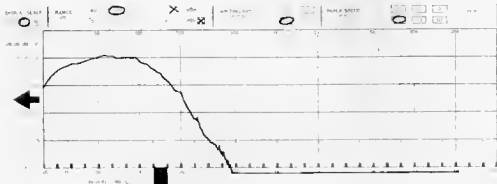

1b

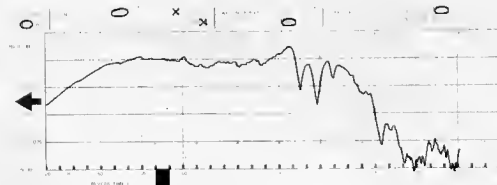

But this correcting cannot be taken too far, otherwise the sensitivity as well as the step response will suffer; also, distortion will increase and power handling will be reduced.

The present system was designed to give a reasonable performance without any electronic help first, and then some electronic circuits were added to extend the frequency range downwards.

The frequency response of the subwoofer in an 80 l enclosure is given in fig 1: 1b clearly shows the effect of the added filters, particularly the lowering of the -3 dB point from about 50 Hz to 30 Hz.

## Set-up

The system is arranged as shown schematically in Fig 2, and is seen to consist of the loudspeaker in its enclosure, an output amplifier, and an electronic circuit. The output amplifier will not be discussed here, because any good type may be used, as long as it is capable of delivering at least 50 W into 8 ohms. The enclosure is simple to build as described under *Construction*. The loudspeaker used in the prototype was a Dynaudio (Denmark) type 30W54—see Fig. 3. This is a robust 300 mm drive unit on a light metal frame with high peak power handling capability, good step response, and a suitable frequency response (see Fig. 1a).

The electronic circuit consists of two parts: the filters and the output

2

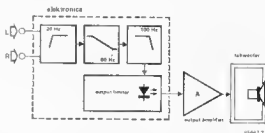

limiter. There are three filters a steep-skirted anti-rumble type with its change-over point at 20 Hz; a correction filter for the very low audio frequencies from 50 Hz downwards; and a crossover filter with change-over point at 100 Hz and a slope of 24 dB/octave. The combination of these filters results in the frequency response shown in Fig. 1b.

The output limiter is, strictly speaking, not essential but very useful, particularly where full volume is used habitually. It has been added to allow for the decreasing power handling capability of the drive unit below 50 Hz. The coming into operation of the limiter is indicated by the lighting of an LED.

## Subwoofer and satellite speakers

In principle, the subwoofer can be

used as an addition to any loudspeaker system that has unsatisfactory performance at low frequencies. If, however, a new loudspeaker system is planned, the design of the satellite speakers should take account of the subwoofer. These units need reproduce frequencies above 100 Hz only, so that the volume of their enclosures can be kept to about 10 litres

The various units should be interconnected as shown in Fig. 4. The simplest and least expensive way is shown in Fig. 4a: the subwoofer system, including the output amplifier and filters is simply connected to the loudspeaker terminals of the existing amplifier. Capacitors C form a 6 dB filter to protect the satellite speakers high low frequency output power. The necessary level matching between the subwoofer and the satellite speakers may be effected with a preset on the filter PCB.

Where the pre-amplifier an output amplifier are separate units, interconnections may be made as illustrated in Fig. 4b. In this way, each loudspeaker has its own output amplifier, so that filtering can take place between the pre-amplifier and the output amplifiers. The set-up in Fig. 4b is preferable to that in Fig. 4a. The question may be asked why the satellite speakers are filtered at only 6 dB/octave from 100 Hz, whereas the subwoofer has a skirt roll-off of 24 dB/octave. The answer is that the satellite speakers (in a closed box) have an inherent fall-off of about 12 dB/octave. Together with the additional filtering, this works out at 18 dB/octave, which is ample in this combination.

The value of capacitor C is determined from

$$C = 10^4 / 2\pi Zf \quad [\mu F]$$

where Z is either the impedance of the satellite speaker (Fig 4a), or the

of the  
woofer  
Any  
100 W  
satellite  
enclosure  
is better

the 30W54  
unit

3



a

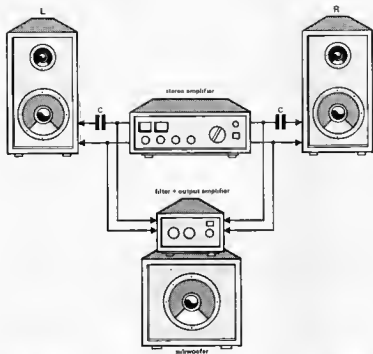

b

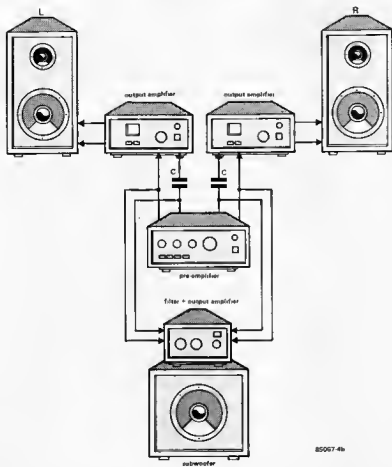

85067-4b

Fig 4 Two different arrangements for using the subwoofer system with a pair of satellite loudspeakers. The set-up in 4b is preferred

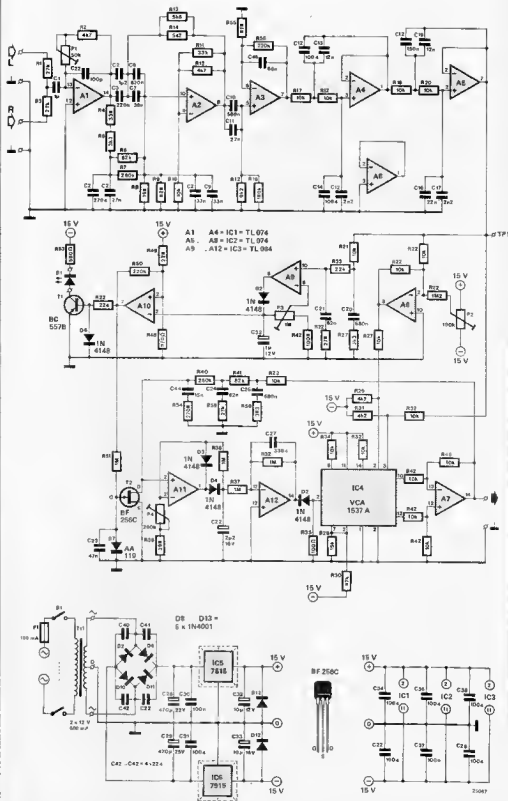

Fig 5 The cut diagram of the three filters and output power limiter. Diode D<sub>1</sub> should be mounted so that it can be seen from the outside since it serves as overload indicator.

input impedance of the relevant output amplifier (Fig. 4b) in ohms, and  $f_c$  is the roll-off frequency in hertz.

If, therefore, in Fig. 4a the satellite speaker impedance is 8 ohms, and the roll-off frequency is 100 Hz, the series capacitor should have a value of 300  $\mu$ F. It is recommended to shunt such large bipolar electrolytic capacitors by a foil capacitor of 1  $\mu$ F, which improves the properties of the filter.

Since the input impedance of the output amplifiers in Fig. 4b is considerably higher than the loudspeaker impedance, the value of the filter capacitor is much smaller. For instance, an input impedance of, say, 20 k gives a value of  $C=80$  nF (use 68 nF or 0.01  $\mu$ F).

## Electronic circuits

The circuit diagram of the three filters and the active output limiter is given in Fig. 5.

After the two input signals have been summed in amplifier  $A_1$ , they are applied to a complex rumble filter formed by  $A_2$ . This elliptical or Cauer (high-pass) filter provides an attenuation of 0 dB at 25 Hz, -3 dB at 20 Hz, and 40 dB at 10 Hz. Note that some resistors and capacitors are connected in parallel to obviate the need for non-standard 1 per cent components.

The rumble filter is followed by the correction filter, which, covering a range of only 3-6 dB, is a fairly simple circuit. It is formed by  $A_3$  and the frequency-determining components are  $R_{50}$  and  $C_{46}$ .

The third filter is the actual crossover network and is constructed around  $A_4$  and  $A_5$ . It is a fourth-order Bessel type which provides an even phase shift and very good step response.

The remainder of the circuit is the active output power limiter. The filtered signal at pin 7 of  $A_5$  is applied to a metering circuit formed by  $A_6$  and  $A_{10}$ . Network  $R_{17}-R_{12}-R_{12}-R_{27}-C_{28}-C_{21}$  ensures that the input to  $A_6$  is large at low frequencies (against which the system needs protection) and small at high frequencies. The rectified signal is compared in  $A_{10}$  with a reference voltage. If the signal becomes too large, the comparator toggles,  $T_1$  is switched on, and  $D_1$  lights. At the same time,  $T_2$  is switched off and the control loop of attenuator IC<sub>1</sub> is actuated.

The voltage-controlled attenuator (VCA) was described in *Design Ideas* in the February 1986 issue of *Elektronika*. Opamps  $A_6$  and  $A_7$  provide buffering of the input and output of the VCA respectively.

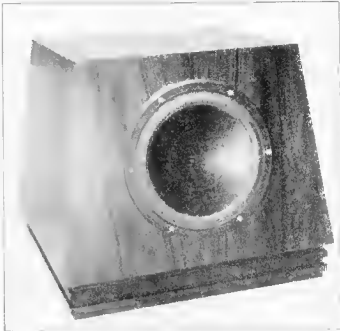

The buffered signal at pin 14 of  $A_7$  is passed via low-pass filter  $R_{40}-R_{41}-R_{42}-R_{54}-R_{59}-R_{58}-C_{24}-C_{26}-C_{44}$  to active rectifier  $A_{11}$ . This low-pass filter serves to adapt the control characteristics to the frequency-dependent power curve of the loudspeaker. Note that the signal is passed to  $A_{11}$  only when  $T_2$  is switched off. The output of the rectifier is applied to the control input of the VCA via integrator  $A_{12}$ . As long as the signal level at pin 6 of  $A_{10}$  remains below that of the reference voltage at pin 5,  $T_2$  remains on. The control loop of the attenuator is then inactive and the VCA merely passes all signals applied to it. This arrangement ensures effective limiting of the output signal. The power supply is a fairly standard circuit. Diodes  $D_{12}$  and  $D_{13}$  prevent a temporary reversal of the supply voltages on switch-off the ICs cannot then accidentally be put into an undefined state.

## Construction (electronic circuits)

It is best to complete the electronic part first on the PCB shown in Fig. 6. Most of this work is pretty straightforward, except for the heat sink of regulators ICs and ICs. This should be made from a 25x100 mm strip of 1 mm thick tin or tinned copper. Bend this lengthwise into an L of 70x30 mm. Drill two holes in a suitable position in the short leg to receive the ICs. Place the heat sink

onto the PCB along the indicated flat line and solder it in place with the aid of two pins mounted as shown. The regulators are then fitted to the heat sink, the 7815 without, and the 7915 with, insulating washers.

If the arrangement of Fig. 4b is used, the values of resistors  $R_1$  and  $R_2$  should be as shown in the parts list. With the set-up of Fig. 4a, their value should be increased to about 560 k. Some trial and error may be necessary to find the correct value that gives a satisfactory control range of  $P_1$ .

The (mono) output amplifier required should, as already stated, be rated at not less than 50 W for satisfactory performance. Together with the filter PCB and mains transformer, it can then be fitted in a suitable case.

Connections between the filter board and output amplifier should be made in screened audio cable. The amplifier and subwoofer drive unit may be interconnected by any twin cable with a cross-sectional core diameter of 2.5 mm<sup>2</sup> for lengths up to 7 metres.

## Construction (enclosure)

The enclosure is, simply, a rectangular box that must be really solid and have a net volume of about 85 litres. A suitable construction is shown in Fig. 7 but it should be noted that the dimensions stated may be varied by  $\pm 30$  per cent, as long as the net volume remains about 85

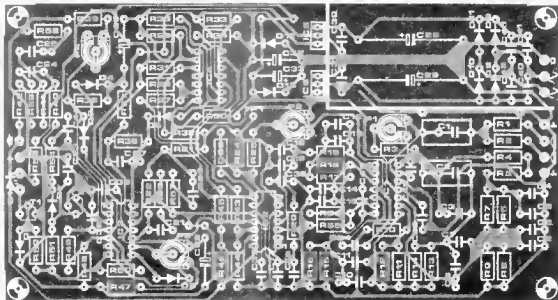

#### Parts list

##### Resistors

R1, R2, R23, R24 = 27 k  
 R3, R12, R29, R31 = 4k7  
 R4, R11 = 33 k  
 R5, R37, R38 = 3k3  
 R6, R7, R22, R41 = 82 k  
 R7, R40 = 500 k  
 R8, R28 = 15 k  
 R10, R17 R21, R24, R25,  
 R27, R32 R34,  
 R42 R46 = 10 k  
 R13, R14 = 5k6  
 R15 8k2  
 R16 180 k  
 R26 = 1M5  
 R30, R36 = 47 k  
 R35 100  $\Omega$   
 R36 R38 R61 = 1 M  
 R25 = 89 k  
 R47 100 k

R48 = 470  $\Omega$

R49, R52 = 22 k

R53 = 560  $\Omega$

R54 = 270 k

R56 = 220 k

P1 = 50 k preset

P2 = 100 k preset

P3 = 1 M preset

P4 = 250 k preset

##### Capacitors:

C1 = 1  $\mu$  metal foil  
 plastic or polystyrene  
 C2 = 1 $\mu$ 5 metal foil  
 plastic or polystyrene  
 C3 = 220 n  
 C4 = 270 n  
 C5 = 27 n  
 C6 = 820 n  
 C7 = 33 n

C8, C9 = 33 n

C10 = 560 n

C11, C12, C24 = 82 n

C12, C14, C26, C31

C34 C38 = 100 n

C13 = 18 n

C15 = 6k8

C16 = 56 n

C17 5n6

C18 150 n

C19 = 12 n

C20, C25 = 880 n

C22 1  $\mu$ 16 V

C23 = 47 n

C25 = 2 $\mu$ 2, 16 V

C27 330n

C28, C29 470  $\mu$ 25 V

C32, C33 = 10  $\mu$ 16 V

C40 C42 22 n

C44 15 n

C45 = 100 p

C46 = 68 n

##### Semiconductors

D1 = LED, red  
 D2 D6 = 1N4148  
 D7 = AA119  
 D8 D13 = 1N4001  
 T1 = BC557B  
 T2 = BF256C  
 IC1, IC2 TL074  
 IC3 = TL084  
 IC4 = 1537A (Aphex)  
 IC5 7815  
 IC6 7915

##### Miscellaneous

F1 = fuse 100 mA,  
 delayed action  
 T11 mains transformer,

secondary 2 x 15 V at  
 500 mA

S1 = mains on/off  
 switch

Enclosure as per Fig 7

Damping material

Drive unit Dynaudio  
 30W54

2 varnoents of 110 mm  
 dia

Terminals as required

Loudspeaker grille cloth  
 as required

Rubber feet: 4 or 6 as  
 required

Wood glue as required  
 Wood screws and nails  
 as required

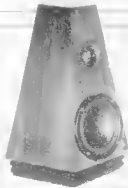

litres. The holes for the two acoustic resistors (variovents) in the back of the enclosure should, however, always have a diameter of 110 mm. These units attenuate the resonance peak of the drive unit and contribute, therefore, in a real sense to the performance of this relatively small enclosure.

The material should preferably be 23 mm plywood. All edges should be provided with 45 x 45 mm reinforcing battens. Moreover, a 45 x 45 mm cross-piece at the centre of the box

will further prevent any panel resonance.

It is best to start with gluing the battens to the panels, followed by the gluing together of the four side panels. Provided the holes for the drive unit and the variovents have been sawn, the front and back panels can then be glued into place. One of these may be screwed, instead of glued, into place, but suitable tape should then be used to seal the gap. This tape should also be used around the frame of the

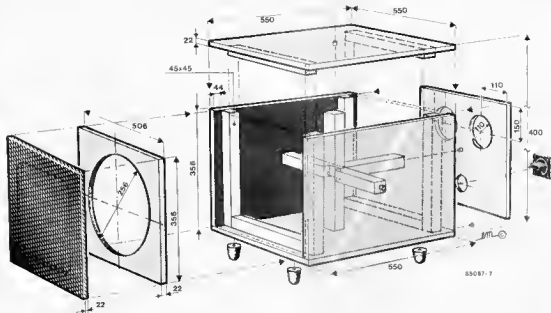

drive unit to ensure an airtight construction.

Panel resonance can further be prevented by gluing strips of rubber-backed floor covering at the inside of all but the front panels and then covering these panels with 30 mm thick rock-wool.

The photograph on the previous page shows an enclosure of around 85 litres of which the dimensions vary from those shown in Fig. 7.

50 Hz). Adjust  $P_2$  so that  $D_1$  just lights.

• When the input signal is increased, the VCA should limit the output voltage, and this is achieved by adjusting  $P_4$  so that the multimeter reading remains 12 V r.m.s. for any further increase of the input level.

• Preset  $P_1$  is used to adjust the sound pressure of the subwoofer relative to the satellite loudspeakers.

woofer, this is best determined by trial and error, because it is impossible to give strict guide lines for every type of living room it is, of course, wise to place it initially somewhere between the satellite speakers. It is, however, recommended to place it, if at all possible, about 110 cm (4 ft) in front of the satellite speakers. In any case, do not place it direct against a wall or in a corner.

*Fig. 7 shows the use of acoustic "castles" of the enclosure. The dimensions may vary but care should be taken that the net volume remains about 85 litres. The diameter of the PVC joints must be 110 mm.*

## Setting the limiter

To set the limiter, a digital multimeter and a 50 Hz test generator are required. Fig. 8 shows how such a simple test generator may be built.

- Set all potentiometers to the centre of their travel.
- Connect inputs L and R to earth.
- Connect the multimeter (set to a DC mV range) to the output and adjust  $P_2$  for a reading of exactly 0 V.
- Disconnect the L and R inputs from earth and apply a 50 Hz signal to one of them.
- Connect the output to the (mono) power amplifier but do not yet connect the drive unit.
- Turn  $P_3$  fully clockwise (i.e. towards  $C_{21}$ ).
- Set the multimeter to the 20 V or 50 V AC range and connect it to the output of the amplifier.
- Increase the input signal gradually until the meter reads 12 V r.m.s. (i.e. the maximum allowable voltage across the drive unit at

## Some practical points

It is advisable not to place the enclosure direct onto the floor, but to provide it with four or six rubber feet. This acoustic decoupling prevents any tendency to boom.

As regards the location of the sub-

8

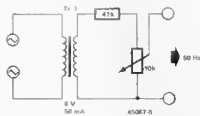

*Fig. 8 If an audio tone generator is not available, this simple to build 50 Hz generator will do nicely.*



# talk funny?

## ring modulator, chopper and frequency modulator

Deliberate electronic distortion of speech and music signals can give fascinating results. Professional musicians use extremely expensive equipment to obtain their very own weird and wonderful 'sound'. For electronics enthusiasts, it is much more fun to get the same sort of results from very simple circuits. Which is what this article is about: getting effective effects using a single IC, the 2206.

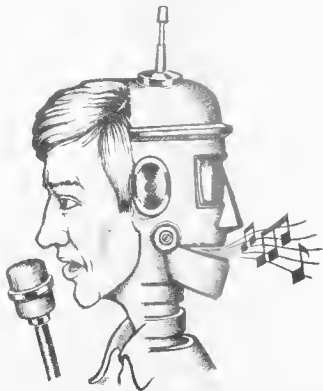

One of the best known and most impressive distorters for audio signals is the ring modulator. Normally speaking, a ring modulator circuit has two inputs: one for the audio signal (speech, for instance) and one for a 'carrier'. The weirdest effects are obtained when the carrier frequency is within or just above the audio range; using different carrier shapes (sinewave, squarewave or triangular waveform) can produce different effects.

The circuit can be drastically simplified by using a 2206. This IC contains a suitable generator for the 'carrier', and a multiplier circuit that is ideally suited for use as a ring modulator. The internal block diagram is shown in figure 1.

The oscillator (VCO) is already connected internally to the multiplier. This means that, basically, applying an audio signal to the other multiplier input (pin 1) will produce a 'ring-modulated' output at pin 2. Simplicity itself!

Obviously, a few other components are needed in a practical circuit. Not many, though, as shown in figure 2. A single capacitor, C4 (C<sub>EXT</sub> in figure 1), determines the frequency range of the VCO. With the value given, the 1M potentiometer (P1; R<sub>EXT</sub> in figure 1) can be used to set any frequency between approximately 10 Hz and 10 kHz. The wave-shape is selected by means of S1: switch closed for sinewave, switch opened for triangle.

The audio input signal is fed to the modulation input via C1. A voltage divider circuit (R1, P2, R2) sets two DC bias levels: the voltage across C2 provides the basic internal DC reference, and P2 is used to adjust the operating point of the multiplier. This adjustment is important: it determines the 'carrier level' (the output from the oscillator).

### Table

Technical data for the complete circuit (figure 3).

#### Functions

Ring modulator

Chopper

Frequency modulator

#### Frequency range of VCO:

Low range 1 Hz ... 300 Hz

High range 100 Hz ... 20 kHz

#### Frequency modulation:

- 30% frequency swing for 1V top-to-top modulation signal.

#### Impedances

Input 30 k

Output 2 k

#### Signal levels:

Input, nominal 1 V<sub>eff</sub> (350 mV RMS)

maximum 8 V<sub>eff</sub> (2.8 V RMS)

Output, maximum 10 V<sub>eff</sub> (3.5 V RMS)

#### Supply

12 V, stabilised, 30 mA max

1

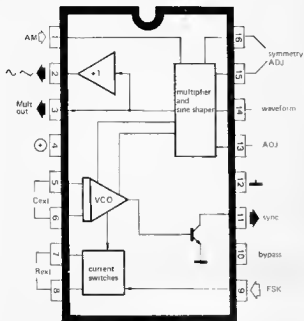

Figure 1. Internal block diagram of the 2206. This IC is a complete function generator, containing a VCO and a multiplier. The latter is ideally suited for use as a ring modulator.

present in the final audio output. The easiest way is to short the audio input and then adjust P2 for zero audio output. Only then is the circuit operating as a true ring modulator. If P2 is incorrectly set, the oscillator frequency will appear at the output, amplitude modulated by the input (speech) signal. This can give interesting effects, but it isn't really the intention!

A stabilised supply must be used, otherwise the DC settings may drift. This would mean regular re-adjustment of P2 — which is rather a nuisance.

### Chopping and frequency modulation

The circuit can be extended, as shown in figure 3. Only a few additional components are needed to really use the IC to the full. Apart from adding the 'chopper' and 'frequency modulator' features, a useful linear frequency scale for the oscillator control is obtained as an additional bonus.

The basic ring modulator circuit is virtually identical to the circuit given in figure 2. The main difference is that the multiplier bias adjustment is improved: P3 is used for initial coarse adjustment, with P2 in the mid position; then P2 is used to tune out the last traces of the carrier.

The chopper circuit makes use of a squarewave output available at pin 11. To be more precise, this is the collector of an internal switching transistor (see figure 1). With S5 in position 'chopper', this point is connected to the signal output. When the transistor is turned on, the output is shorted; since the transistor is turned on and off periodically by the internal oscillator, the chopper frequency is determined by the setting of P5 (the VCO frequency control). Switch S2 can be used to select the audio signal before or after the ring modulator; note, however, that in the latter case the 'carrier' frequency for the ring modulator and the chopper

2

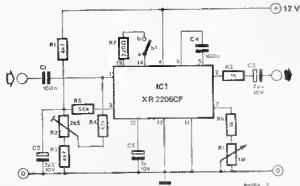

Figure 2. A simple circuit, using the 2206 as a ring modulator

3

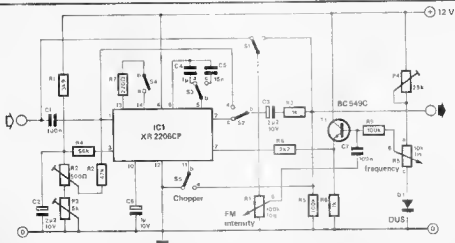
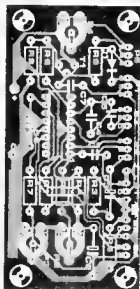
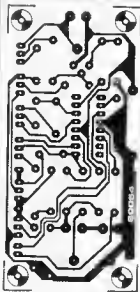

Figure 3. The simple circuit given in figure 2 can be extended as shown here. The 2206 is now used to the full: the input signal can be ring modulated and/or frequency modulated and/or chopped.



#### Parts list

##### Resistors:

R1 = 3k9  
 R2 = 47 k  
 R3, R8 = 1 k  
 R4 = 56 k  
 R5 = 100 k  
 R6 = 2k2  
 R7 = 220 Ω  
 R9 = 100 k  
 P1 = 100 k log  
 P2 = 470 Ω (500 Ω) preset  
 P3 = 4k7 (5 k) preset  
 P4 = 47 k (50 k) preset  
 P5 = 10 k lin

##### Capacitors

C1, C7 = 100 n  
 C2, C3 = 2μ2/10 V  
 C4 = 1 μ (nor elec)  
 C5 = 15 n  
 C6 = 1 μ/10 V

#### Semiconductors

IC1 = XR2206CP  
 T1 = BC 109C, BC 549C,  
 or equ  
 D1 = DUS  
 Switcher:  
 S1, S2, S3, S5 = single pole  
 changeover  
 S4 = single-pole, make

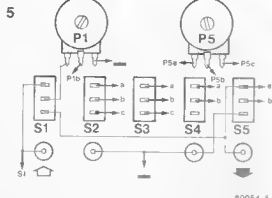

80054 5

Figure 5 Wiring diagram for the front panel controls. The small arrows indicate connections to the corresponding points on the board

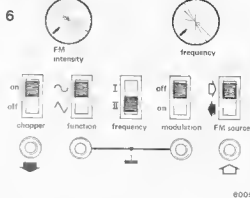

80054 6

Figure 6 A suggested front panel layout

frequency are identical — they are both derived from the same VCO.

The main reason for modifying the frequency control circuit for the VCO is to obtain a linear voltage control point. The frequency of the VCO varies linearly with the voltage at the base of T1; this voltage is determined by the setting of P5, but a frequency modulation signal can be superimposed via C7. P1 sets the modulation level; S1 is used to select either the audio input signal or the output signal.

The frequency control range is set by P4. The procedure is as follows: Turn P5 right up (lowest frequency) and set P4 to maximum resistance. C5 is switched into circuit via S3 and P2 is offset so that the oscillator signal appears at the output. P4 is now slowly turned down until the oscillator stops, and then turned back until it starts again reliably. This is the optimum setting. Once again, it depends on the supply voltage — so the latter must be stabilised.

7

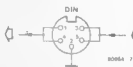

Figure 7. A combined in-end output can be wired as shown here

A simple supply using a 78L12, say, is adequate.

A basic printed circuit board layout for the circuit itself is given in figure 4, and the two sides of the front panel with the controls are shown in figures 5 and 6. Finally, a suggestion for a combined in- and output connection is shown in figure 7. All of these drawings are included as suggestions only, the final design may be modified according to personal taste.

#### How funny does it sound?

Sound effects are always difficult to describe — you've got to hear them. The

ring modulator 'sound' is perhaps the best known: all kinds of additional frequencies are added to the original signal, without any harmonic relationship. If really sharp dissonances are what you want, the 2206 ring modulator is just the trick!

The effect can be 'improved' by switching from sinewave to triangle if you're not careful, you end up with a completely scrambled signal. On the other hand, using a low-frequency sinewave produces a more 'pleasant' sound — the ring modulator adds an interesting rhythmic effect to the original.

The chopper facility can be useful on its own, producing a kind of 'robot' or 'computer' sound. When used in combination with the ring modulator, the most weird results can be obtained. In the same way, combining frequency modulation with the ring modulator can be interesting: low modulation levels produce a kind of vibrato effect, and high modulation levels — well. Try it! 

# electronic maze

The problem in most mazes is simply to find the way out, with no account being taken of the number of false steps made. Part of the novelty of this electronic labyrinth is that it counts the number of incorrect steps made. The maximum number of errors permitted can be preset to 10, 20, 40 or even 80. If the hapless victim has failed to find his way out of the maze before reaching the preset limit, an audio tone sounds to indicate that he has lost. The number of steps taken to escape from the labyrinth is indicated on a digital display so that successful contenders can compare their scores, the one with the lowest score obviously winning.

The maze itself consists of a matrix of drawing pins or furniture tacks on the playing board. All pins that be along the correct path are linked and connected to positive supply, whilst other pins are grounded. The path through the maze is traced using a probe wired to the input of the error counter. So long as the correct path is followed the counter input will remain high, but whenever a false step is taken the counter input will receive a low-going pulse and will advance.

## Complete circuit

The major part of the maze circuit consists of a two decade counter, which is shown in figure 1. The probe, which can be a 'banana' plug or may be made from an old ballpoint pen, is connected to the input of Schmitt trigger N2. So long as the probe input is high or floating (not grounded) the input of N2 will remain high. If the probe is grounded the input of N2 will be pulled low. The output of N1 will then go low, clocking the counter IC4. The filter network R4/C2 connected at the input of N2 helps suppress noise generated by 'contact bounce' between the probe and the drawing pins. This bounce could cause the counter to advance several counts for only one wrong step.

When the counter reaches a predetermined number, selected by S1, the appropriate output of the second decade counter (IC3) will go high. The oscillator constructed around N4 will then produce an audio tone to indicate that the contestant has lost. This tone is amplified to loudspeaker level by T1

Whether they are formed by garden hedges or walls, galleries of mirrors or simply lines on paper, mazes have always proven a popular pastime for all ages. The 'electronic maze' described in this article provides an extra 'twist' to the problem of finding the correct path through the maze.

D. Neubert

and T2. The volume can be adjusted by changing the value of resistor R3. The counter is reset to zero at the start of the game by a pushbutton switch, S2.

Two 7447 BCD-to-seven-segment decoders (IC1 and IC2) drive the seven-segment displays which indicate the number of errors made.

## Multiple exits

A maze with only a single path would quickly lose its entertainment value. This can be avoided by providing multiple exits from the maze. To achieve this, several paths are provided to exit points around the periphery of the maze. However, these are not permanently wired to positive supply, but each path is linked to positive supply only when it is in use, and all other paths are grounded. Light-emitting diodes mounted around the edge of the playing board indicate which exit is being aimed for.

The switching circuit used to select the paths of a four-exit maze is shown in figure 2. When exit D1 is selected, for example, then output D1 of the switching circuit is high. All points in the path leading to exit D1 only are linked to output D1. Provision is also made for connecting points that are common to two paths. For example, output A is high when output D1 is high and when output D4 is high (see table 1). Any points common to both these paths should be linked to output A. Output B performs a similar function for outputs D2 and D3. It is important that any points common to two paths should be linked to A or B and not back to any of the D outputs, as this would mean that one of the outputs would be trying to pull these points low while the other was trying to pull them high.

Provision is not made for connecting points that are common to three or more paths. Such points should be avoided when drawing the maze, but if any such points are unavoidable they should be treated as 'dead' points and left floating.

## Constructing the maze

The construction of a 14 x 14 point maze is illustrated in figure 3. To con-

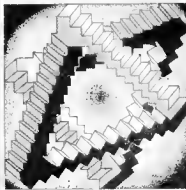

1

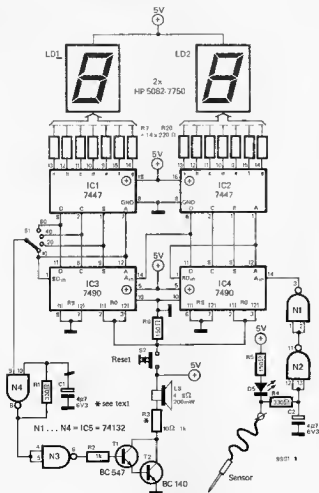

Figure 1. Circuit of the counter and audible warning oscillator, which forms the major part of the maze electronics.

Figure 2. This gating circuit provides four different exits from the maze by taking the required path high and all other paths low.

Figure 3. A typical layout for a 14 x 14 maze, with the four exits at the corners.

Figure 4. Main power supply for the maze circuit.

Table 1. This table illustrates the four possible combinations of S3 and S4, and the state of the outputs that define which path through the maze is active.

2

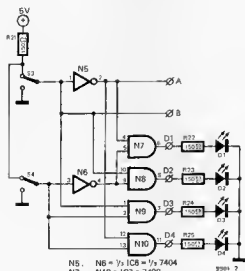

N5, N6 =  $\frac{1}{2}$  IC8 =  $\frac{1}{2}$  7404  
N7 ... N10 = IC7 = 7408

struct the maze a sheet of squared (e.g. graph) paper is glued to a playing board made of suitable material such as strong card (Bristol board) or thin plywood. Drawing pins or furniture tacks are then pushed through the paper and the baseboard to form a matrix. It is important that the spacing between the heads of the tacks should be such that it is not possible to move the probe from one to the next without breaking contact.

On the underside of the board all tacks which form part of a path through the maze should be linked together and connected to the appropriate points (D1 to

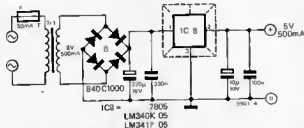
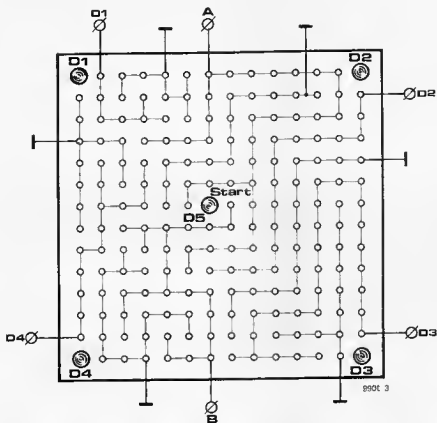

D4, A or B). Points not forming part of any path are permanent blind alleys and should be connected to ground.

#### How to play the game

A maze usually is nothing more than a complicated pattern of lines drawn on paper, and there is normally only one correct way through the maze with a large number of blind alleys leading off from the main path.

However, if 'walls' are drawn for this electronic maze it becomes a fairly

simple task to find the proper way out. The game becomes much more interesting (or frustrating) if no lines are drawn, so that the path must be found in true 'hit or miss' fashion by the player. LED D5 indicates each false step, and the player must remember each step taken - otherwise the 'wrong step counter' will quickly reach the maximum permitted setting!

An alternative possibility is to construct a truly complicated maze, including lengthy and involved blind alleys, and draw in the walls alongside the rows and columns of the matrix. In this case the

Table 1.

S3	S4	D1	D2	D3	D4	A	B
0	0	1	0	0	0	1	0
1	0	0	1	0	0	0	1
1	1	0	0	1	0	0	1
0	1	0	0	0	1	1	0

'wrong step indicator' D5 and displays LD1 and LD2 should obviously not be visible to the player, as he would then be aware that he was wandering off the correct path.

#### Power supply

A suitable power supply circuit for the maze is given in figure 4. Care should be taken to ensure the electrical safety of the circuit, especially if it is to be used by children. All mains wiring should be extremely well insulated from the low-voltage circuits.

# RF CIRCUIT DESIGN

Third in the series, this article discusses aspects of good VHF preamplifier design, before proposing a practical circuit that enables reception of FM broadcast signals hitherto lost in noise.

## VHF PREAMPLIFIER

Fig 1 Represents a typical daytime FM-band spectrum (a survey of signal strengths within a certain frequency band) may look very much as sketched in Fig 1a; there are a number of very strong transmissions, as well as relatively weak and also neatly invisible (ie inaudible) ones, sometimes quite close to one another. This spectrum

Some of the important aspects in aerial amplifier design have already been covered in *Elektron* India April 1986 issue, along with the prerequisites for successful VHF filter realization. While the points discussed in that article remain fully valid, the present article aims to look at the most important technical characteristic of any VHF preamplifier stage: its noise figure.

While many of today's FM tuners have very sophisticated tuning control systems and excellent stereo demodulation, the design of up-to-date RF amplification and first mixer sections often deplorably lags behind. Since it is certainly not advisable to embark upon a complete reshuffle of the proprietary RF parts in the receiver front end, an add-on preamplifier stage of good design may prove helpful in updating the receiver performance to a considerable degree. Moreover, as the above mentioned article already pointed out, a VHF aerial booster should not be mounted in the receiver, but at the other end of the download coax cable at the one and only place where it is effective; direct at the aerial connections (masthead mounting).

### Noise

There are a number of basic considerations to go with design and construction of an RF preamplifier stage, if this is to operate in the very high frequency (VHF) range, generally referred to as 50...300 MHz. A section of this band is of special interest for this article, namely the FM broadcast band which extends from 88 to 108 MHz, while being quite crowded with local stations in most built-up areas, only few stations may be received in rural districts. This is due to the straight line propagation characteristics of the RF waves at these frequencies, which makes it impossible to receive over-the-

horizon stations, except during special weather conditions.

A typical daytime FM-band spectrum (a survey of signal strengths within a certain frequency band) may look very much as sketched in Fig 1a; there are a number of very strong transmissions, as well as relatively weak and also neatly invisible (ie inaudible) ones, sometimes quite close to one another. This spectrum

is purely hypothetical, however, since it is a representation of relative signal strengths at the aerial connections, i.e. without noise caused by any active electronic device. Obviously, the spectrum analyser itself would feature a certain amount of self-generated noise, but this has been disregarded for the sake of clarity. The low noise level  $N$  in Fig 1a is, however, present at any

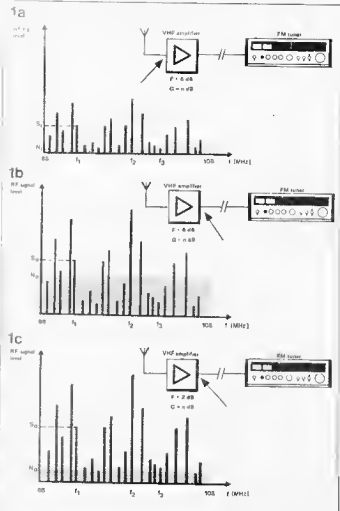

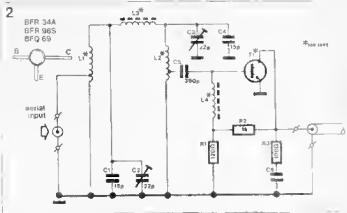

VHF aerial, since this picks up a certain amount of atmospheric noise; the nature of this effect would lead us into theoretical physics, which is beyond the scope of this article. Spectrum analysis of the preamplifier output signal (Fig. 1b) reveals that while all signals have been amplified, a certain amount of additional noise is introduced by the aerial booster, to the effect that some signals have got lost underneath the noise threshold  $N_0$  and are, therefore, inaudible in the receiver. Since the amplifier noise output is not caused by amplification of the atmospheric noise level  $N$ , (compare the signal levels of  $S$  in Fig. 1a and 1b), level  $N_0$  must needs be generated by the amplifier itself; clearly, this is an undesirable effect. If we consider the effective signal strengths of, for instance, the transmission at  $f_1$  in Fig. 1a as opposed to Fig. 1b, the total noise factor of the amplifier stage may be defined as the overall ratio of the output signal/noise ratio to the input signal/noise ratio, or

$$F = (S_0/N_0)/(S/N) \quad (1)$$

the noise figure may be calculated from  $F$  using

$$F_{dB} = 10 \log_{10} F \quad (2)$$

Clearly,  $S_0/N_0$  for  $f_1$  is worse (lower) than the original  $S/N$  and this arises from the extra amount of noise generated by the amplifier. Were this device ideal, then

$$S_0/N_0 = S/N \text{ or } F = 1, \text{ or } F_{dB} = 0 \text{ dB} \quad (3)$$

Unfortunately, no electronic device has been developed as yet for use in the ideal preamplifier, nor will it ever be developed, due to some basic laws of physics. However, modern SHF transistors are now readily available with noise figures as low as 1.5 dB at 1000 MHz, while Gallium Arsenide (Ga-As) FETs have been de-

signed to achieve 2.8 dB at 12 GHz; however, the cost and circuit design complexity of these devices puts them well beyond the reach of the average home constructor.

The importance of a low preamplifier noise figure is evident after a comparison of Figures 1b and 1c; while its signal gain (amplification factor) is still  $n$  dB the amplifier of Fig. 1c has a noise figure improved by 4 dB, which enables reception of signals that were inaudible with the  $F=6$  dB amplifier of Fig. 1b. We may, therefore, establish the general rule that reception is improved with a lower preamplifier noise figure. Thus, designing for low noise should be a high priority issue.

So far, only the active device in the preamplifier has been held responsible for the noise addition, but it should be pointed out that this device can only attain its minimum noise contribution when supported by passive components that ensure thermal stability and low signal insertion loss at the amplifier input. It will stand to reason that any mismatch at the booster input will adversely affect (i.e. increase) the transistor noise figure as given in the manufacturer's data sheets.

No preamplifier stage, however low its noise figure, will be capable of reception improvement if the signals at the target frequency have been considerably attenuated before being applied to the first active device, either by downlead cable losses or a severe mismatch at the booster input. As the above mentioned article pointed out, however, the preamplifier input necessarily consists of a low-loss filter, which serves the dual function of an out-of-band signal attenuator and signal source to transistor input impedance transformer (source matching). It should be fairly obvious by now that the actual gain of the booster is far less important than its noise figure, if the former is some 10 dB higher than the downlead cable attenuation, adequate

results are usually obtained; a gain of 15...20 dB is common for a single-transistor preamplifier stage.

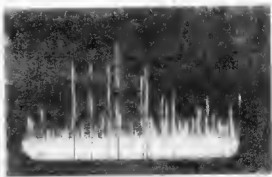

## Practical circuit

The circuit diagram of the present VHF preamplifier is shown in Fig. 2. The RF signal at the input is passed to the base of  $T_1$  by a capacitance-tuned, inductive top-coupled, low insertion loss and source matching bandpass input filter with a -2 dB bandwidth of 20 MHz (85...

108 MHz). This is quite a mouthful for a basically simple filter that performs the functions outlined above. Note the taps on  $L_1$  and  $L_2$  to obtain impedance matching of the cable and the transistor respectively. Any of the listed transistor types may be used in the circuit, but the Type BFQ65 is preferable because of its extremely low noise figure. Since this transistor has been introduced only quite recently, however, it may prove difficult to get hold of.

The amplifier is fed by the receiver power supply over the downlead coax cable, the parts to the right of the dotted line are, therefore, mounted in the FM tuner. Decoupling parts  $L_5$  and  $C_7$  ensure that no RF signal is lost in the power supply. The amplifier bias setting is effected with  $P_1$ ; depending on the transistor in use, this preset may be adjusted to find the right compromise between

1.5  
dB  
10V  
AMP  
RES  
10.0  
11.0



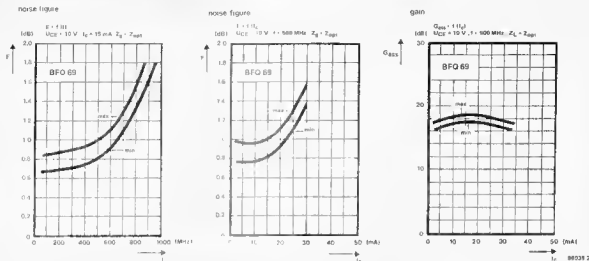

Fig 3 Curves showing the characteristics of the new BFO69 transistor. Note that the curves in Figures 3b and 3c refer to a test frequency of 500 MHz and not to the design frequency of the present pre-amplifier (Siemens)

Fig 4 This RF design is also fitted on the universal prototyping board 85000 available through the Readers Services

optimum noise figure (low current) or maximum amplification with acceptable intermodulation response (high current). For further details on the bias setting of RF preamplifier transistors, refer to *Elektronics (UK)*, February 1980 issue. Fig. 3 shows three curves relevant to

the novel BFO69, a collector current of 15 mA appears to be suitable for a minimum noise figure of about 1 dB, which will bring the total noise figure of the present design in the 1...2 dB range with a Type BFO69 fitted and the filter tuned to optimum input matching. However the Types

BFR34A and BFR96S will also ensure a noise figure that is usually far better than the average FM tuner specification in this respect.

The coils and chokes for the present design are wound as follows:

$L_1$  = 4 turns 20SWG ( $\pm 1$  mm) enamelled wire, close wound on dia 6 mm, tap at 1.5 turns from earth.

$L_2$  = identical to  $L_1$ , but tap at 2.5 turns from earth.

$L_3$  = 11 turns 20SWG enamelled wire on toroid core Type T50-12 (Amidon).

$L_4$ ;  $L_5$  = 4.5 turns 30SWG ( $\pm 0.3$  mm) enamelled wire through 3x3 mm ferrite bead.

For more information on inductor calculations and specifications, refer to last month's issue of *Elektronics*.

## Construction and alignment

The present amplifier is fitted on the universal RF board 85000 as shown in Fig 4; not shown are the bias setting parts, since these are mounted in the receiver. After completion, the unit may be tested by tuning the receiver to a weak transmission at about 95 MHz and adjusting  $C_1$  and  $C_2$  for optimum reception. The collector current setting should be fairly un-critical, its precise effect on the amplifier performance can only be judged when a very stable and yet sufficiently weak transmission is being received and the input filter has already been correctly tuned. Finally, the preamplifier may be fitted in a suitable water-resistant case for masthead mounting, equipped with suitable coaxial sockets, and fixed to the aerial mast.

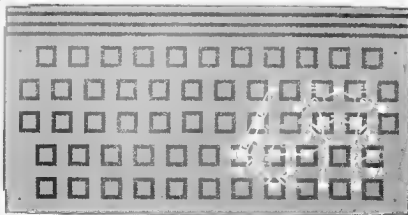
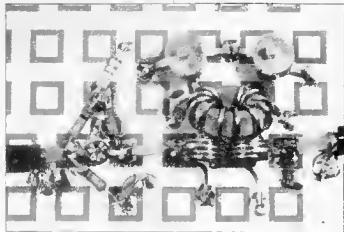

PCB track patterns for  
Subwoofer & Satellite loudspeaker

Satellite loudspeakers

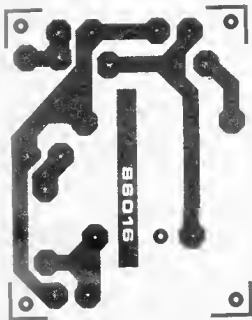

Subwoofer

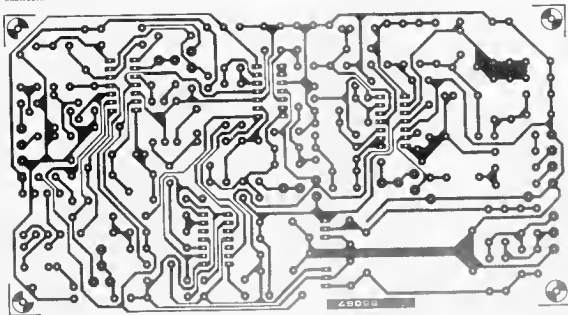

# REAL-TIME CLOCK

*A good many highly interesting computer applications will no doubt have been cancelled for lack of a programmable time keeping device. This article, however, offers a truly up-to-date RTC extension board to program dates with data!*

With the presentation of the universal I/O bus in the June 1985 issue of *Elektronika* the peripheral handling capabilities of the popular C64 computer, as well as other personal micros, have been considerably enhanced, since the I/O bus board allows a number of extension boards to be inserted in a neat and versatile arrangement.

The present design enables the user to program real-time software drivers without the need for critical and cumbersome machine language wait loops. Time and data can now be read from and written to I/O addresses, in the very same manner as customary with peripheral control ports; the time updating process is autonomously controlled by a dedicated low-power chip: the Type ICM7170 manufactured by Intersil.

In order to be useful for many owners of personal micros currently on the market, the present add-on RTC board has been designed to operate in both 6502- and Z80-based systems equipped with Elektor's

universal I/O bus. However, there is one important restriction for use with the Z80 processor: since the I/O bus was originally intended for the 65XX series of microprocessors as used in Commodore machines, no bus line is left over for the Z80 NMI or INT input; this means that the alarm and periodic interrupt facilities offered by the RTC chip can not be put to use in conjunction with the Zilog CPU. None the less, the time and calendar features of the ICM7170 will also be fully functional with the Z80.

## Inside the RTC chip

Since the real-time clock controller (RTC) Type ICM7170 is an all-CMOS device with extremely low power consumption, it may conveniently be operated from a back-up battery to keep the internal oscillator and counter sections working when the

computer supply voltage is off, or when a mains failure occurs. The main features of the RTC chip in the proposed circuit may be summarized as follows:

- full compatibility with 8-bit microprocessor types that have either a fully decoded or multiplexed address bus;
- time registers supply binary coded data to simplify software;
- faultless RTC register-to-CPU data transfer thanks to intermediary buffer section;
- calendar with automatic leap year correction;
- chip switches automatically to back-up supply;
- chip access time less than 300 ns;
- software selection of one of four crystal frequencies;
- data buffering after any read of 10 millisecond register (1/100th part of a second);
- programmable alarm with memory function;
- CPU interrupt requests generated by alarm section or by one of six selectable periodic signals;
- 2  $\mu$ A typical standby current at 3V and oscillator frequency of 32 kHz

Fig. 1 Internal organization of the Type ICM7170 chip, an all CMOS and microprocessor compatible real-time clock (RTC) controller

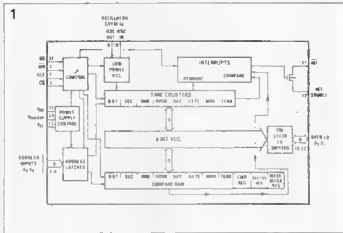

The internal organization of the ICM7170 RTC controller is shown in Fig 1. The chip has a low-power Pierce-type CMOS oscillator which only requires two external capacitors and a quartz crystal to obtain an accurate frequency standard for the present RTC extension board. One of the capacitors is an adjustable type for precise alignment of the crystal frequency, which is divided down to 4 kHz by a programmable prescaler section. By virtue of this prescaler, four crystal frequencies may be used with the on-chip oscil-

Table 1

COMMAND REGISTER ADDRESS (10001b, 11h) WRITE-ONLY							
D7	D6	D5	D4	D3	D2	D1	D0
n/a	n/a	Test	Int	Run	12/24	Freq	Freq

Table 2

D1	D0	CRYSTAL FREQUENCY	D2	24/12 HOUR FORMAT	D3	RUN/STOP	D4	INTERRUPT ENABLE	D5	TEST BIT
0	0	32.768kHz	0	12 hour mode	0	Stop	0	Interrupt disabled	0	Normal Mode
0	1	1.048576MHz	1	24 hour mode	1	Run	1	interrupt enable	1	Test Mode
1	0	2.097152MHz								
1	1	4.194304MHz								

Table 3

ADDRESS						FUNCTION	DATA						VALUE		
A4	A3	A2	A1	A0	HEX		D7	D6	D5	D4	D3	D2		D1	D0
0	0	0	0	0	00	Counter 1/100 seconds	-	-	-	-	-	-	-	-	0-99
0	0	0	0	1	01	Counter hours	-	-	-	-	-	-	-	-	0-23
						12 Hour Mode	-	-	-	-	-	-	-	-	1-12
0	0	0	1	0	02	Counter minutes	-	-	-	-	-	-	-	-	0-59
0	0	0	1	1	03	Counter seconds	-	-	-	-	-	-	-	-	0-59
0	0	1	0	0	04	Counter month	-	-	-	-	-	-	-	-	1-12
0	0	1	0	1	05	Counter date	-	-	-	-	-	-	-	-	1-31
0	0	1	1	0	06	Counter year	-	-	-	-	-	-	-	-	0-99
0	0	1	1	1	07	Counter day of week	-	-	-	-	-	-	-	-	0-6
0	1	0	0	0	08	RAM 1/100 seconds	M	-	-	-	-	-	-	-	0-99
0	1	0	0	1	09	RAM hours	-	M	-	-	-	-	-	-	0-23
						12 hour Mode	-	-	M	-	-	-	-	-	1-12
0	1	0	1	0	0A	RAM minutes	M	-	-	-	-	-	-	-	0-59
0	1	0	1	1	0B	RAM seconds	M	-	-	-	-	-	-	-	0-59
0	1	1	0	0	0C	RAM month	M	-	-	-	-	-	-	-	1-12
0	1	1	0	1	0D	RAM date	M	-	-	-	-	-	-	-	1-31
0	1	1	1	0	0E	RAM year	M	-	-	-	-	-	-	-	0-99
0	1	1	1	1	0F	RAM-day of week	M	-	-	-	-	-	-	-	0-6
1	0	0	0	0	10	Interrupt Status and Mask Register	+	-	-	-	-	-	-	-	
1	0	0	0	1	11	Command register	-	-	-	-	-	-	-	-	

## Notes

+ = not present in interrupt-mask register, MSB in interrupt-status register.

- = not used.

\* = AM/PM in 12-hour indication mode; (AM = 0, PM = 1).

M = alarm time is compared with corresponding counter time when this bit is programmed low (0).

Note that addresses 10010 up to and including 11111 (i.e. 12hex...1Fhex) are not used by the RTC chip.

Table 4.

INTERRUPT MASK REGISTER ADDRESS (10000b, 10h) WRITE-ONLY							
D7	D6	D5	D4	D3	D2	D1	D0
n/a	Day	Hour	Min	Sec	1/10 sec	1/100 sec	Alarm

INTERRUPT STATUS REGISTER ADDRESS (10000b, 10h) READ-ONLY							
D7	D6	D5	D4	D3	D2	D1	D0
Int	Day	Hour	Min	Sec	1/10 sec	1/100 sec	Alarm

lator: 4.194304 MHz, 2.097152 MHz, 1.048576 MHz, or 32.768 kHz. As can be seen from Tables 1 and 2, two bits, D<sub>6</sub> and D<sub>1</sub> in the RTC command register at address 11<sub>hex</sub> (10001<sub>b</sub>) select the appropriate prescale divisor for the crystal in use. Databit D<sub>2</sub> allows selection between 12- or 24-hour mode operation.

The 4 kHz signal is next divided down to 100 Hz for use as a central clock input to the ripple counter stages. The time and calendar data are available from eight sequentially arranged and programmable counter sections: 10 milliseconds, seconds, minutes, hours, day of the week, date, month, and year. The in-

formation is binary coded and basically consists of eight bits per section, as can be seen from Table 3. However, since a maximum indication of 31 is sufficient for the date counter, 59 for the seconds counter, and so on, eight bits are never required (2<sup>8</sup> = 256); the unused ones are kept logic low (0) during a read, while they are not observed ('don't care') in the case of a write operation. Also inside the chip is a 51-bit RAM memory area to hold the alarm time and date as programmed by the user; these registers are loaded in exactly the same way as the updated counter sections. When set to the alarm mode, the RTC chip will gen-

erate an interrupt request signal when the current (updated) time matches the preprogrammed alarm time, i.e. the updated counter sections are constantly compared on a byte-by-byte basis to their RAM counterparts after every counter step. If a certain counter section is to be ignored in this continuous comparison, the user may set the M (mask) bit in the relevant RAM byte, which will prevent an interrupt from being generated if the updated counter contents match those of the corresponding alarm register.

The RTC chip interrupt request output may be programmed to supply any one of the following periodic

Table 1. RTC command register organization

Table 2. Programming functions of bits D<sub>6</sub>, D<sub>5</sub> in the command register at address 11<sub>hex</sub>

Table 3. Address organization for the RTC counter sections and their RAM counterparts

Table 4. Organization of the internal RTC interrupt mask and interrupt status registers at address 10<sub>hex</sub>

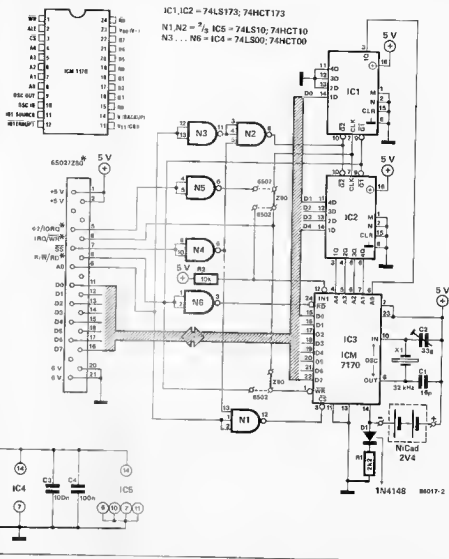

Fig 2 By virtue of the high number of functional sections contained in ICs, the final circuit of the RTC extension board is fairly simple. Note that it is not possible to use the RTC chip interrupt facilities in Z80-based systems, since this would require an additional bus line.

digital signals: 100 Hz, 10 Hz, 1 pulse/second, 1 pulse/minute, 1 pulse/hour, or 1 pulse/day. Provision has been made for both simultaneous and independent interrupt operation of the alarm and periodic signal circuitry.

Both the alarm and periodic interrupts are under the control of the interrupt-mask register (IMR) and interrupt-status register (ISR), the bit assignments of which are shown in Table 4. Selection of the desired interrupt signal is effected by setting the relevant bit in the IMR. By reading ISR, the CPU is informed about the nature of the interrupt request; ISR is automatically cleared by the falling edge of the CPU read pulse.

Whatever the source of the interrupt request signal, it may or may not be passed to the 6502 IRQ line depending on the logic level of the interrupt

enable bit in the RTC command register (see Table 1). This bit controls an on-chip output FET which has its drain connected to the INT terminal (pin 12) and its source to the INTERRUPT-SOURCE terminal (pin 11). This arrangement allows the INT output to be used in an existing WIRED-OR interrupt request bus configuration, together with other devices that may supply interrupts to the CPU. If an interrupt is generated by the RTC chip, the INT output will be at near interrupt-source potential, since the FET is switched on internally; this may occur both in the standby and in the power-down (battery back-up) mode.

If, as in the proposed circuit, the RTC supply voltage is connected to the  $V_{dd}$  and  $V_{ss}$  terminals, and the interrupt-source connection also to  $V_{ss}$ , the INT output can only be active (ie logic low with respect to

$V_{ss}$ ) in the presence of a sufficiently high chip supply voltage; that is, when the computer has been switched on (RTC fully operational). In case the user wishes to pass interrupts in the power-down mode only, pin 11 should be connected to the negative terminal of the battery at the  $V_{back-up}$  pin. This arrangement may be useful to activate a computer wake-up circuit after a predetermined time has elapsed since system power-down.

When the voltage between the  $V_{back-up}$  and  $V_{ss}$  terminals drops below 1 V, the RTC chip switches to the power-down mode with only the internal clock and interrupt sections active; all other functions are disabled to ensure minimum power consumption from the back-up battery. Chip terminals  $A_0$ ,  $A_1$ ,  $D_0$ ,  $D_1$ ,  $D_2$ ,  $D_3$ ,  $D_4$ ,  $D_5$ ,  $D_6$ ,  $D_7$ ,  $D_8$ ,  $D_9$ ,  $D_{10}$ ,  $D_{11}$ ,  $D_{12}$ ,  $D_{13}$ ,  $D_{14}$ ,  $D_{15}$ ,  $D_{16}$ ,  $D_{17}$ ,  $D_{18}$ ,  $D_{19}$ ,  $D_{20}$ ,  $D_{21}$ ,  $D_{22}$ ,  $D_{23}$ ,  $D_{24}$ ,  $D_{25}$ ,  $D_{26}$ ,  $D_{27}$ ,  $D_{28}$ ,  $D_{29}$ ,  $D_{30}$ ,  $D_{31}$ ,  $D_{32}$ ,  $D_{33}$ ,  $D_{34}$ ,  $D_{35}$ ,  $D_{36}$ ,  $D_{37}$ ,  $D_{38}$ ,  $D_{39}$ ,  $D_{40}$ ,  $D_{41}$ ,  $D_{42}$ ,  $D_{43}$ ,  $D_{44}$ ,  $D_{45}$ ,  $D_{46}$ ,  $D_{47}$ ,  $D_{48}$ ,  $D_{49}$ ,  $D_{50}$ ,  $D_{51}$ ,  $D_{52}$ ,  $D_{53}$ ,  $D_{54}$ ,  $D_{55}$ ,  $D_{56}$ ,  $D_{57}$ ,  $D_{58}$ ,  $D_{59}$ ,  $D_{60}$ ,  $D_{61}$ ,  $D_{62}$ ,  $D_{63}$ ,  $D_{64}$ ,  $D_{65}$ ,  $D_{66}$ ,  $D_{67}$ ,  $D_{68}$ ,  $D_{69}$ ,  $D_{70}$ ,  $D_{71}$ ,  $D_{72}$ ,  $D_{73}$ ,  $D_{74}$ ,  $D_{75}$ ,  $D_{76}$ ,  $D_{77}$ ,  $D_{78}$ ,  $D_{79}$ ,  $D_{80}$ ,  $D_{81}$ ,  $D_{82}$ ,  $D_{83}$ ,  $D_{84}$ ,  $D_{85}$ ,  $D_{86}$ ,  $D_{87}$ ,  $D_{88}$ ,  $D_{89}$ ,  $D_{90}$ ,  $D_{91}$ ,  $D_{92}$ ,  $D_{93}$ ,  $D_{94}$ ,  $D_{95}$ ,  $D_{96}$ ,  $D_{97}$ ,  $D_{98}$ ,  $D_{99}$ ,  $D_{100}$ ,  $D_{101}$ ,  $D_{102}$ ,  $D_{103}$ ,  $D_{104}$ ,  $D_{105}$ ,  $D_{106}$ ,  $D_{107}$ ,  $D_{108}$ ,  $D_{109}$ ,  $D_{110}$ ,  $D_{111}$ ,  $D_{112}$ ,  $D_{113}$ ,  $D_{114}$ ,  $D_{115}$ ,  $D_{116}$ ,  $D_{117}$ ,  $D_{118}$ ,  $D_{119}$ ,  $D_{120}$ ,  $D_{121}$ ,  $D_{122}$ ,  $D_{123}$ ,  $D_{124}$ ,  $D_{125}$ ,  $D_{126}$ ,  $D_{127}$ ,  $D_{128}$ ,  $D_{129}$ ,  $D_{130}$ ,  $D_{131}$ ,  $D_{132}$ ,  $D_{133}$ ,  $D_{134}$ ,  $D_{135}$ ,  $D_{136}$ ,  $D_{137}$ ,  $D_{138}$ ,  $D_{139}$ ,  $D_{140}$ ,  $D_{141}$ ,  $D_{142}$ ,  $D_{143}$ ,  $D_{144}$ ,  $D_{145}$ ,  $D_{146}$ ,  $D_{147}$ ,  $D_{148}$ ,  $D_{149}$ ,  $D_{150}$ ,  $D_{151}$ ,  $D_{152}$ ,  $D_{153}$ ,  $D_{154}$ ,  $D_{155}$ ,  $D_{156}$ ,  $D_{157}$ ,  $D_{158}$ ,  $D_{159}$ ,  $D_{160}$ ,  $D_{161}$ ,  $D_{162}$ ,  $D_{163}$ ,  $D_{164}$ ,  $D_{165}$ ,  $D_{166}$ ,  $D_{167}$ ,  $D_{168}$ ,  $D_{169}$ ,  $D_{170}$ ,  $D_{171}$ ,  $D_{172}$ ,  $D_{173}$ ,  $D_{174}$ ,  $D_{175}$ ,  $D_{176}$ ,  $D_{177}$ ,  $D_{178}$ ,  $D_{179}$ ,  $D_{180}$ ,  $D_{181}$ ,  $D_{182}$ ,  $D_{183}$ ,  $D_{184}$ ,  $D_{185}$ ,  $D_{186}$ ,  $D_{187}$ ,  $D_{188}$ ,  $D_{189}$ ,  $D_{190}$ ,  $D_{191}$ ,  $D_{192}$ ,  $D_{193}$ ,  $D_{194}$ ,  $D_{195}$ ,  $D_{196}$ ,  $D_{197}$ ,  $D_{198}$ ,  $D_{199}$ ,  $D_{200}$ ,  $D_{201}$ ,  $D_{202}$ ,  $D_{203}$ ,  $D_{204}$ ,  $D_{205}$ ,  $D_{206}$ ,  $D_{207}$ ,  $D_{208}$ ,  $D_{209}$ ,  $D_{210}$ ,  $D_{211}$ ,  $D_{212}$ ,  $D_{213}$ ,  $D_{214}$ ,  $D_{215}$ ,  $D_{216}$ ,  $D_{217}$ ,  $D_{218}$ ,  $D_{219}$ ,  $D_{220}$ ,  $D_{221}$ ,  $D_{222}$ ,  $D_{223}$ ,  $D_{224}$ ,  $D_{225}$ ,  $D_{226}$ ,  $D_{227}$ ,  $D_{228}$ ,  $D_{229}$ ,  $D_{230}$ ,  $D_{231}$ ,  $D_{232}$ ,  $D_{233}$ ,  $D_{234}$ ,  $D_{235}$ ,  $D_{236}$ ,  $D_{237}$ ,  $D_{238}$ ,  $D_{239}$ ,  $D_{240}$ ,  $D_{241}$ ,  $D_{242}$ ,  $D_{243}$ ,  $D_{244}$ ,  $D_{245}$ ,  $D_{246}$ ,  $D_{247}$ ,  $D_{248}$ ,  $D_{249}$ ,  $D_{250}$ ,  $D_{251}$ ,  $D_{252}$ ,  $D_{253}$ ,  $D_{254}$ ,  $D_{255}$ ,  $D_{256}$ ,  $D_{257}$ ,  $D_{258}$ ,  $D_{259}$ ,  $D_{260}$ ,  $D_{261}$ ,  $D_{262}$ ,  $D_{263}$ ,  $D_{264}$ ,  $D_{265}$ ,  $D_{266}$ ,  $D_{267}$ ,  $D_{268}$ ,  $D_{269}$ ,  $D_{270}$ ,  $D_{271}$ ,  $D_{272}$ ,  $D_{273}$ ,  $D_{274}$ ,  $D_{275}$ ,  $D_{276}$ ,  $D_{277}$ ,  $D_{278}$ ,  $D_{279}$ ,  $D_{280}$ ,  $D_{281}$ ,  $D_{282}$ ,  $D_{283}$ ,  $D_{284}$ ,  $D_{285}$ ,  $D_{286}$ ,  $D_{287}$ ,  $D_{288}$ ,  $D_{289}$ ,  $D_{290}$ ,  $D_{291}$ ,  $D_{292}$ ,  $D_{293}$ ,  $D_{294}$ ,  $D_{295}$ ,  $D_{296}$ ,  $D_{297}$ ,  $D_{298}$ ,  $D_{299}$ ,  $D_{300}$ ,  $D_{301}$ ,  $D_{302}$ ,  $D_{303}$ ,  $D_{304}$ ,  $D_{305}$ ,  $D_{306}$ ,  $D_{307}$ ,  $D_{308}$ ,  $D_{309}$ ,  $D_{310}$ ,  $D_{311}$ ,  $D_{312}$ ,  $D_{313}$ ,  $D_{314}$ ,  $D_{315}$ ,  $D_{316}$ ,  $D_{317}$ ,  $D_{318}$ ,  $D_{319}$ ,  $D_{320}$ ,  $D_{321}$ ,  $D_{322}$ ,  $D_{323}$ ,  $D_{324}$ ,  $D_{325}$ ,  $D_{326}$ ,  $D_{327}$ ,  $D_{328}$ ,  $D_{329}$ ,  $D_{330}$ ,  $D_{331}$ ,  $D_{332}$ ,  $D_{333}$ ,  $D_{334}$ ,  $D_{335}$ ,  $D_{336}$ ,  $D_{337}$ ,  $D_{338}$ ,  $D_{339}$ ,  $D_{340}$ ,  $D_{341}$ ,  $D_{342}$ ,  $D_{343}$ ,  $D_{344}$ ,  $D_{345}$ ,  $D_{346}$ ,  $D_{347}$ ,  $D_{348}$ ,  $D_{349}$ ,  $D_{350}$ ,  $D_{351}$ ,  $D_{352}$ ,  $D_{353}$ ,  $D_{354}$ ,  $D_{355}$ ,  $D_{356}$ ,  $D_{357}$ ,  $D_{358}$ ,  $D_{359}$ ,  $D_{360}$ ,  $D_{361}$ ,  $D_{362}$ ,  $D_{363}$ ,  $D_{364}$ ,  $D_{365}$ ,  $D_{366}$ ,  $D_{367}$ ,  $D_{368}$ ,  $D_{369}$ ,  $D_{370}$ ,  $D_{371}$ ,  $D_{372}$ ,  $D_{373}$ ,  $D_{374}$ ,  $D_{375}$ ,  $D_{376}$ ,  $D_{377}$ ,  $D_{378}$ ,  $D_{379}$ ,  $D_{380}$ ,  $D_{381}$ ,  $D_{382}$ ,  $D_{383}$ ,  $D_{384}$ ,  $D_{385}$ ,  $D_{386}$ ,  $D_{387}$ ,  $D_{388}$ ,  $D_{389}$ ,  $D_{390}$ ,  $D_{391}$ ,  $D_{392}$ ,  $D_{393}$ ,  $D_{394}$ ,  $D_{395}$ ,  $D_{396}$ ,  $D_{397}$ ,  $D_{398}$ ,  $D_{399}$ ,  $D_{400}$ ,  $D_{401}$ ,  $D_{402}$ ,  $D_{403}$ ,  $D_{404}$ ,  $D_{405}$ ,  $D_{406}$ ,  $D_{407}$ ,  $D_{408}$ ,  $D_{409}$ ,  $D_{410}$ ,  $D_{411}$ ,  $D_{412}$ ,  $D_{413}$ ,  $D_{414}$ ,  $D_{415}$ ,  $D_{416}$ ,  $D_{417}$ ,  $D_{418}$ ,  $D_{419}$ ,  $D_{420}$ ,  $D_{421}$ ,  $D_{422}$ ,  $D_{423}$ ,  $D_{424}$ ,  $D_{425}$ ,  $D_{426}$ ,  $D_{427}$ ,  $D_{428}$ ,  $D_{429}$ ,  $D_{430}$ ,  $D_{431}$ ,  $D_{432}$ ,  $D_{433}$ ,  $D_{434}$ ,  $D_{435}$ ,  $D_{436}$ ,  $D_{437}$ ,  $D_{438}$ ,  $D_{439}$ ,  $D_{440}$ ,  $D_{441}$ ,  $D_{442}$ ,  $D_{443}$ ,  $D_{444}$ ,  $D_{445}$ ,  $D_{446}$ ,  $D_{447}$ ,  $D_{448}$ ,  $D_{449}$ ,  $D_{450}$ ,  $D_{451}$ ,  $D_{452}$ ,  $D_{453}$ ,  $D_{454}$ ,  $D_{455}$ ,  $D_{456}$ ,  $D_{457}$ ,  $D_{458}$ ,  $D_{459}$ ,  $D_{460}$ ,  $D_{461}$ ,  $D_{462}$ ,  $D_{463}$ ,  $D_{464}$ ,  $D_{465}$ ,  $D_{466}$ ,  $D_{467}$ ,  $D_{468}$ ,  $D_{469}$ ,  $D_{470}$ ,  $D_{471}$ ,  $D_{472}$ ,  $D_{473}$ ,  $D_{474}$ ,  $D_{475}$ ,  $D_{476}$ ,  $D_{477}$ ,  $D_{478}$ ,  $D_{479}$ ,  $D_{480}$ ,  $D_{481}$ ,  $D_{482}$ ,  $D_{483}$ ,  $D_{484}$ ,  $D_{485}$ ,  $D_{486}$ ,  $D_{487}$ ,  $D_{488}$ ,  $D_{489}$ ,  $D_{490}$ ,  $D_{491}$ ,  $D_{492}$ ,  $D_{493}$ ,  $D_{494}$ ,  $D_{495}$ ,  $D_{496}$ ,  $D_{497}$ ,  $D_{498}$ ,  $D_{499}$ ,  $D_{500}$ ,  $D_{501}$ ,  $D_{502}$ ,  $D_{503}$ ,  $D_{504}$ ,  $D_{505}$ ,  $D_{506}$ ,  $D_{507}$ ,  $D_{508}$ ,  $D_{509}$ ,  $D_{510}$ ,  $D_{511}$ ,  $D_{512}$ ,  $D_{513}$ ,  $D_{514}$ ,  $D_{515}$ ,  $D_{516}$ ,  $D_{517}$ ,  $D_{518}$ ,  $D_{519}$ ,  $D_{520}$ ,  $D_{521}$ ,  $D_{522}$ ,  $D_{523}$ ,  $D_{524}$ ,  $D_{525}$ ,  $D_{526}$ ,  $D_{527}$ ,  $D_{528}$ ,  $D_{529}$ ,  $D_{530}$ ,  $D_{531}$ ,  $D_{532}$ ,  $D_{533}$ ,  $D_{534}$ ,  $D_{535}$ ,  $D_{536}$ ,  $D_{537}$ ,  $D_{538}$ ,  $D_{539}$ ,  $D_{540}$ ,  $D_{541}$ ,  $D_{542}$ ,  $D_{543}$ ,  $D_{544}$ ,  $D_{545}$ ,  $D_{546}$ ,  $D_{547}$ ,  $D_{548}$ ,  $D_{549}$ ,  $D_{550}$ ,  $D_{551}$ ,  $D_{552}$ ,  $D_{553}$ ,  $D_{554}$ ,  $D_{555}$ ,  $D_{556}$ ,  $D_{557}$ ,  $D_{558}$ ,  $D_{559}$ ,  $D_{560}$ ,  $D_{561}$ ,  $D_{562}$ ,  $D_{563}$ ,  $D_{564}$ ,  $D_{565}$ ,  $D_{566}$ ,  $D_{567}$ ,  $D_{568}$ ,  $D_{569}$ ,  $D_{570}$ ,  $D_{571}$ ,  $D_{572}$ ,  $D_{573}$ ,  $D_{574}$ ,  $D_{575}$ ,  $D_{576}$ ,  $D_{577}$ ,  $D_{578}$ ,  $D_{579}$ ,  $D_{580}$ ,  $D_{581}$ ,  $D_{582}$ ,  $D_{583}$ ,  $D_{584}$ ,  $D_{585}$ ,  $D_{586}$ ,  $D_{587}$ ,  $D_{588}$ ,  $D_{589}$ ,  $D_{590}$ ,  $D_{591}$ ,  $D_{592}$ ,  $D_{593}$ ,  $D_{594}$ ,  $D_{595}$ ,  $D_{596}$ ,  $D_{597}$ ,  $D_{598}$ ,  $D_{599}$ ,  $D_{600}$ ,  $D_{601}$ ,  $D_{602}$ ,  $D_{603}$ ,  $D_{604}$ ,  $D_{605}$ ,  $D_{606}$ ,  $D_{607}$ ,  $D_{608}$ ,  $D_{609}$ ,  $D_{610}$ ,  $D_{611}$ ,  $D_{612}$ ,  $D_{613}$ ,  $D_{614}$ ,  $D_{615}$ ,  $D_{616}$ ,  $D_{617}$ ,  $D_{618}$ ,  $D_{619}$ ,  $D_{620}$ ,  $D_{621}$ ,  $D_{622}$ ,  $D_{623}$ ,  $D_{624}$ ,  $D_{625}$ ,  $D_{626}$ ,  $D_{627}$ ,  $D_{628}$ ,  $D_{629}$ ,  $D_{630}$ ,  $D_{631}$ ,  $D_{632}$ ,  $D_{633}$ ,  $D_{634}$ ,  $D_{635}$ ,  $D_{636}$ ,  $D_{637}$ ,  $D_{638}$ ,  $D_{639}$ ,  $D_{640}$ ,  $D_{641}$ ,  $D_{642}$ ,  $D_{643}$ ,  $D_{644}$ ,  $D_{645}$ ,  $D_{646}$ ,  $D_{647}$ ,  $D_{648}$ ,  $D_{649}$ ,  $D_{650}$ ,  $D_{651}$ ,  $D_{652}$ ,  $D_{653}$ ,  $D_{654}$ ,  $D_{655}$ ,  $D_{656}$ ,  $D_{657}$ ,  $D_{658}$ ,  $D_{659}$ ,  $D_{660}$ ,  $D_{661}$ ,  $D_{662}$ ,  $D_{663}$ ,  $D_{664}$ ,  $D_{665}$ ,  $D_{666}$ ,  $D_{667}$ ,  $D_{668}$ ,  $D_{669}$ ,  $D_{670}$ ,  $D_{671}$ ,  $D_{672}$ ,  $D_{673}$ ,  $D_{674}$ ,  $D_{675}$ ,  $D_{676}$ ,  $D_{677}$ ,  $D_{678}$ ,  $D_{679}$ ,  $D_{680}$ ,  $D_{681}$ ,  $D_{682}$ ,  $D_{683}$ ,  $D_{684}$ ,  $D_{685}$ ,  $D_{686}$ ,  $D_{687}$ ,  $D_{688}$ ,  $D_{689}$ ,  $D_{690}$ ,  $D_{691}$ ,  $D_{692}$ ,  $D_{693}$ ,  $D_{694}$ ,  $D_{695}$ ,  $D_{696}$ ,  $D_{697}$ ,  $D_{698}$ ,  $D_{699}$ ,  $D_{700}$ ,  $D_{701}$ ,  $D_{702}$ ,  $D_{703}$ ,  $D_{704}$ ,  $D_{705}$ ,  $D_{706}$ ,  $D_{707}$ ,  $D_{708}$ ,  $D_{709}$ ,  $D_{710}$ ,  $D_{711}$ ,  $D_{712}$ ,  $D_{713}$ ,  $D_{714}$ ,  $D_{715}$ ,  $D_{716}$ ,  $D_{717}$ ,  $D_{718}$ ,  $D_{719}$ ,  $D_{720}$ ,  $D_{721}$ ,  $D_{722}$ ,  $D_{723}$ ,  $D_{724}$ ,  $D_{725}$ ,  $D_{726}$ ,  $D_{727}$ ,  $D_{728}$ ,  $D_{729}$ ,  $D_{730}$ ,  $D_{731}$ ,  $D_{732}$ ,  $D_{733}$ ,  $D_{734}$ ,  $D_{735}$ ,  $D_{736}$ ,  $D_{737}$ ,  $D_{738}$ ,  $D_{739}$ ,  $D_{740}$ ,  $D_{741}$ ,  $D_{742}$ ,  $D_{743}$ ,  $D_{744}$ ,  $D_{745}$ ,  $D_{746}$ ,  $D_{747}$ ,  $D_{748}$ ,  $D_{749}$ ,  $D_{750}$ ,  $D_{751}$ ,  $D_{752}$ ,  $D_{753}$ ,  $D_{754}$ ,  $D_{755}$ ,  $D_{756}$ ,  $D_{757}$ ,  $D_{758}$ ,  $D_{759}$ ,  $D_{760}$ ,  $D_{761}$ ,  $D_{762}$ ,  $D_{763}$ ,  $D_{764}$ ,  $D_{765}$ ,  $D_{766}$ ,  $D_{767}$ ,  $D_{768}$ ,  $D_{769}$ ,  $D_{770}$ ,  $D_{771}$ ,  $D_{772}$ ,  $D_{773}$ ,  $D_{774}$ ,  $D_{775}$ ,  $D_{776}$ ,  $D_{777}$ ,  $D_{778}$ ,  $D_{779}$ ,  $D_{780}$ ,  $D_{781}$ ,  $D_{782}$ ,  $D_{783}$ ,  $D_{784}$ ,  $D_{785}$ ,  $D_{786}$ ,  $D_{787}$ ,  $D_{788}$ ,  $D_{789}$ ,  $D_{790}$ ,  $D_{791}$ ,  $D_{792}$ ,  $D_{793}$ ,  $D_{794}$ ,  $D_{795}$ ,  $D_{796}$ ,  $D_{797}$ ,  $D_{798}$ ,  $D_{799}$ ,  $D_{800}$ ,  $D_{801}$ ,  $D_{802}$ ,  $D_{803}$ ,  $D_{804}$ ,  $D_{805}$ ,  $D_{806}$ ,  $D_{807}$ ,  $D_{808}$ ,  $D_{809}$ ,  $D_{810}$ ,  $D_{811}$ ,  $D_{812}$ ,  $D_{813}$ ,  $D_{814}$ ,  $D_{815}$ ,  $D_{816}$ ,  $D_{817}$ ,  $D_{818}$ ,  $D_{819}$ ,  $D_{820}$ ,  $D_{821}$ ,  $D_{822}$ ,  $D_{823}$ ,  $D_{824}$ ,  $D_{825}$ ,  $D_{826}$ ,  $D_{827}$ ,  $D_{828}$ ,  $D_{829}$ ,  $D_{830}$ ,  $D_{831}$ ,  $D_{832}$ ,  $D_{833}$ ,  $D_{834}$ ,  $D_{835}$ ,  $D_{836}$ ,  $D_{837}$ ,  $D_{838}$ ,  $D_{839}$ ,  $D_{840}$ ,  $D_{841}$ ,  $D_{842}$ ,  $D_{843}$ ,  $D_{844}$ ,  $D_{845}$ ,  $D_{846}$ ,  $D_{847}$ ,  $D_{848}$ ,  $D_{849}$ ,  $D_{850}$ ,  $D_{851}$ ,  $D_{852}$ ,  $D_{853}$ ,  $D_{854}$ ,  $D_{855}$ ,  $D_{856}$ ,  $D_{857}$ ,  $D_{858}$ ,  $D_{859}$ ,  $D_{860}$ ,  $D_{861}$ ,  $D_{862}$ ,  $D_{863}$ ,  $D_{864}$ ,  $D_{865}$ ,  $D_{866}$ ,  $D_{867}$ ,  $D_{868}$ ,  $D_{869}$ ,  $D_{870}$ ,  $D_{871}$ ,  $D_{872}$ ,  $D_{873}$ ,  $D_{874}$ ,  $D_{875}$ ,  $D_{876}$ ,  $D_{877}$ ,  $D_{878}$ ,  $D_{879}$ ,  $D_{880}$ ,  $D_{881}$ ,  $D_{882}$ ,  $D_{883}$ ,  $D_{884}$ ,  $D_{885}$ ,  $D_{886}$ ,  $D_{887}$ ,  $D_{888}$ ,  $D_{889}$ ,  $D_{890}$ ,  $D_{891}$ ,  $D_{892}$ ,  $D_{893}$ ,  $D_{894}$ ,  $D_{895}$ ,  $D_{896}$ ,  $D_{897}$ ,  $D_{898}$ ,  $D_{899}$ ,  $D_{900}$ ,  $D_{901}$ ,  $D_{902}$ ,  $D_{903}$ ,  $D_{904}$ ,  $D_{905}$ ,  $D_{906}$ ,  $D_{907}$ ,  $D_{908}$ ,  $D_{909}$ ,  $D_{910}$ ,  $D_{911}$ ,  $D_{912}$ ,  $D_{913}$ ,  $D_{914}$ ,  $D_{915}$ ,  $D_{916}$ ,  $D_{917}$ ,  $D_{918}$ ,  $D_{919}$ ,  $D_{920}$ ,  $D_{921}$ ,  $D_{922}$ ,  $D_{923}$ ,  $D_{924}$ ,  $D_{925}$ ,  $D_{926}$ ,  $D_{927}$ ,  $D_{928}$ ,  $D_{929}$ ,  $D_{930}$ ,  $D_{931}$ ,  $D_{932}$ ,  $D_{933}$ ,  $D_{934}$ ,  $D_{935}$ ,  $D_{936}$ ,  $D_{937}$ ,  $D_{938}$ ,  $D_{939}$ ,  $D_{940}$ ,  $D_{941}$ ,  $D_{942}$ ,  $D_{943}$ ,  $D_{944}$ ,  $D_{945}$ ,  $D_{946}$ ,  $D_{947}$ ,  $D_{948}$ ,  $D_{949}$ ,  $D_{950}$ ,  $D_{951}$ ,  $D_{952}$ ,  $D_{953}$ ,  $D_{954}$ ,  $D_{955}$ ,  $D_{956}$ ,  $D_{957}$ ,  $D_{958}$ ,  $D_{959}$ ,  $D_{960}$ ,  $D_{961}$ ,  $D_{962}$ ,  $D_{963}$ ,  $D_{964}$ ,  $D_{965}$ ,  $D_{966}$ ,  $D_{967}$ ,  $D_{968}$ ,  $D_{969}$ ,  $D_{970}$ ,  $D_{971}$ ,  $D_{972}$ ,  $D_{973}$ ,  $D_{974}$ ,  $D_{975}$ ,  $D_{976}$ ,  $D_{977}$ ,  $D_{978}$ ,  $D_{979}$ ,  $D_{980}$ ,  $D_{981}$ ,  $D_{982}$ ,  $D_{983}$ ,  $D_{984}$ ,  $D_{985}$ ,  $D_{986}$ ,  $D_{987}$ ,  $D_{988}$ ,  $D_{989}$ ,  $D_{990}$ ,  $D_{991}$ ,  $D_{992}$ ,  $D_{993}$ ,  $D_{994}$ ,  $D_{995}$ ,  $D_{996}$ ,  $D_{997}$ ,  $D_{998}$ ,  $D_{999}$ ,  $D_{1000}$ .

single 50 k $\Omega$  resistor. In case a battery back-up supply voltage can be dispensed with,  $V_{DD}$  may be connected to  $V_{BACKUP}$ .

## Practical circuit

The proposed circuit of the real-time clock extension board for the universal I/O bus is shown in Fig. 2. Note that very few components are required to make a functional unit with the ICM7170 RTC chip in a 6502- or Z80-based system. To select between these two types of microprocessor, the user need merely fit the appropriate wire links; connection to the I/O bus is through a standard 21-way PCB connector.

The ready-made PCB for this project is fitted with the necessary parts as shown in the mounting plan of Fig. 3. Note that the battery is an integral part of the completed RTC board; it may be charged from the computer +5V supply by means of  $D_1$  and  $R_1$ . Since it was considered a waste of available I/O address space to reserve 17 memory locations or I/O channels for the RTC registers,  $IC_1$  and  $IC_2$  latch the RTC register number which must be supplied as a databyte with a POKE or OUT instruction to an address within the slot that has a  $\emptyset$  for address line  $A_8$ ; the contents of the RTC chip registers are next read from or written to an address within the same slot with  $A_8$

high (1). Since every slot offers four I/O addresses (see the article on the universal bus, *Elektor Electronics*, June 1985), both the latch and the RTC chip appear two times within the slot occupied by the present extension board. Finally, Z80 programmers are referred to the first article in the series on MSX extensions in the February 1986 issue of *Elektor India* to find details on modification of the universal I/O bus as required for this CPU.

## Setting up

As can be seen from Table 1, the real-time clock may be stopped and started by programming bit  $D_1$  in the command register; this bit controls the 100 Hz clock input to the counter sections. To stop the clock in order to synchronize it with an available time standard,  $D_1$  must be set low (0). The desired start time for the RTC is next loaded into the time registers, the correct data is also supplied, and the RTC may be started at the desired time by setting  $D_1$  again (1). To enable the CPU to read glitch-free and therefore absolutely stable time data from the RTC chip, time register data are passed through a buffer section before being transferred to the CPU databus during a read cycle. However, this buffer is only loaded when the 10 ms register is read, and programmers are advised to start any

time reading from the RTC chip with a read of this latching register to ensure that time data are stable and accurate.

The command register comprises a TEST bit ( $D_5$ ) to apply the internal 100 Hz signal to the seconds counter; this will cause the clock to run a hundred times faster than normal, which may be useful for test purposes. It will be evident that the accuracy of the present RTC board depends solely on crystal stability and correct frequency setting of the oscillator. Outlined below is a preferred alignment method using a period counter such as the one featured in *Elektor India* February 1985. To prevent the RTC INT output from actually generating an interrupt pulse in the computer during the alignment session, temporarily disconnect the wire at pin 12 of  $IC_4$ .

First, write all zeros to the IMR. Next, load the command register with decimal values 24 or 28 (18 or 1C hexadecimal respectively) to run the clock in either the 12- or 24-hour mode with interrupts enabled. Now set  $D_5$  in the IMR to generate periodic interrupts with a frequency of 1 Hz. Adjust capacitor  $C_3$  for an indication of exactly 1.000 second on the period counter which should be connected to the RTC chip INT output (pin 12). For this measurement, the period counter should be set to trigger on the falling edge of the digital input signal. Reset ISR by

Fig. 3. Component mounting plan for the RTC extension. Note the on-board NiCd battery and the wire links to accommodate either the 6502 or the Z80 processor in the host computer

3

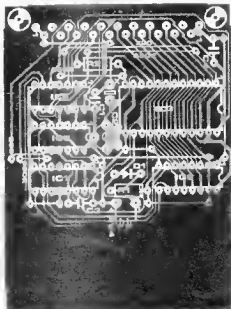
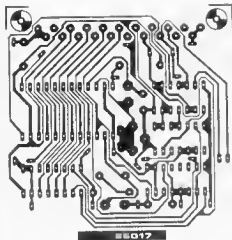

### Parts list

#### Resistors

$R_1 = 2k$   
 $R_2 = 10k$

#### Capacitors

$C_1 = 10p$   
 $C_2 = 10\ 33p$  trimmer  
 $C_3, C_4 = 100n$

#### Semiconductors:

$D_1 = 1N4148$   
 $IC_1, IC_2 = 74HC17/LS173$   
 $IC_3 = ICM7170$  (Intersil)  
 $IC_4 = 74HC17/LS100$   
 $IC_5 = 74HC17/LS10$

#### Miscellaneous

$X_1 = 32\ 768$  kHz quartz crystal (subminiature type)  
21 way DIN41517 connector, angled connections  
NiCd battery 2.4V or two 1.2V cells connected in series  
PCB 86017

```

5 CLS:PRINT"**** MSX REAL-TIME CLOCK ****"
7 OUT 113,17:OUT 112,4:REM STOP CLOCK
9 REM GO GET TIME&DATE INFO
10 N=0:US="SYNCHRO":60SUB 1000
20 CLS: PRINT "SET "I:US:"DATE =":A(N+5):"-":A(N+4):"-":A(N+6)
30 PRINT "SET "I:US:"TIME =":A(N+1):":A(N+2):":A(N+3):":A(N+4)
40 PRINT "IF CORRECT PRESS [Y]":INPUT QS:IF QS="Y" OR QS="y" THEN 60
50 GOTO 7
55 REM GO LOAD RTC
60 N=0:60SUB 2000
70 CLS:PRINT"HI" ANY KEY TO START CLOCK"
75 IF INKEY$="" THEN GOTO 75
80 CLS
84 REM READY TO START CLOCK
85 OUT 113,17:OUT 112,12
90 OUT 113,0:A=INP 12:REM 10MS LATCH
100 OUT 112,3:S=INP 12
110 OUT 113,2:M=INP 12
120 OUT 113,1:H=INP 12
130 LOCATED,0:PRINT"TIME=":H":":M":":S
140 IF INKEY$="" THEN GOTO 90
150 END:REM OPTION HERE FOR RETURN
1000 REM GET TIME AND DATE
1010 INPUT"YEAR =":Y:A(N+6)
1020 INPUT"MONTH =":M:A(N+4)
1030 INPUT"DATE =":D:A(N+5)
1040 INPUT"DAY OF THE WEEK =":W:A(N+7)
1050 INPUT"HOURS =":H:A(N+1)
1060 INPUT"MINUTES =":MIN:A(N+2)
1070 INPUT"SECONDS =":S:A(N+3)
1080 INPUT"10 MILLI-SECONDS =":MS:A(N)
1090 RETURN
2000 REM LOAD RTC REGISTERS
2005 FOR N=N TO N+7
2010 OUT 113,N:REM POINT LATCH
2020 OUT 112,A(N):REM LOAD RTC
2030 NEXT N
2040 RETURN

```

*Listing 1 The essentials of MSX real-time clock programming. Although the present RTC hardware does not support interrupts with the Z80, provision has been made to set the RTC alarm function. For this purpose, the subroutines at lines 1000 and 2000 may be called with N=8 and US="ALARM". Note that the register latch is at OUT 113, the RTC proper at INP/OUT 112.*

reading it; this will also deactivate the INT output (logic 1). The outlined method should be programmed as an instruction loop to obtain maximum clock accuracy.

Where a period counter is not readily available, use may be made of another time reference signal with known accuracy, such as the BBC time signals on radio and TV. Obviously, this method costs more time and requires a good deal of patience before the target accuracy is reached.

## RTC programming

Hardware needs software support and vice versa. To complete this article, two sample programs are offered to guide in further programming explorations, which will, no doubt, lead to more complex and sophisticated time-keeping software once the basics of RTC control have been mastered.

Programmers should be well aware of the essential difference in I/O mapping between the Commodore type of computer and Z80-based micros, such as the MSX series. Generally speaking, the former use memory locations for I/O byte transfer, the latter have 256 I/O channels available which are under control of IN and OUT instructions, whereas the 65XX-based computers work with PEEKs and POKES for this purpose. However, the basic method of RTC control remains the same for both computer types: first the internal RTC register is specified with an appropriate instruction, then data may be read from or written to that register by addressing the RTC proper.

MSX users may key in the program of Listing 1 which displays a digital clock in the top left-hand corner of the screen. Obviously, the screen formatting and graphics features of this computer type allow the user to 'brush up' this little program to his

heart's content. Note that line 100 reads the 10 ms register before the actual time reading is performed in a loop. Experienced programmers may have a go at writing a routine that prints time and date on every printer sheet prior to a listing or any other draft copy. Note that, once the clock has been synchronized, time display is simply effected with GOTO 90. However, some provision will have to be made to exit the time display loop and resume the main program.

The sample program listed for the Commodore 64 and 128 model computers is somewhat lengthier than the MSX version, and, therefore, offers more programming functions; among these are selection of video polarity and word-based input of days and months — see Listing 2.

H/S/G/S

```

10 REM * COMDDDDRE 64 REAL-TIME CLCK CTRL *
20 DIM A$(12),B$(7)
30 RESTORE
40 FOR O=1 TO 12:READ A$(O):NEXT O
50 DATA "JANUARY","FEBRUARY","MARCH","APRIL","MAY","JUNE","JULY","AUGUST"
60 DATA "SEPTEMBER","OCTOBER","NOVEMBER","DECEMBER"
70 FOR O=1 TO 7: READ B$(O): NEXT O
80 DATA "MONDAY","TUESDAY","WEDNESDAY","THURSDAY","FRIDAY","SATURDAY","SUNDAY"
90 PRINT CHR$(147):PRINT:PRINT"--COMDDDDRE 64 REAL-TIME CLOCK CTRL--"
100 PRINT:PRINT:PRINT:
110 INPUT "CLOCK SETTING (Y/N)";V$
120 IF V$="N" THEN 365
130 PRINTCHR$(147)
140 REM CLCK SETTING
150 INPUT " ENTER HOURS ";H:PRINT:PRINT
160 INPUT " ENTER MINUTES ";M:PRINT:PRINT
170 INPUT " ENTER SECONDS ";S:PRINT:PRINT
180 INPUT " ENTER MONTH ";MS:PRINT:PRINT
190 FOR O=1 TO 12: IF MS=A$(O) THEN R=O
200 NEXT O
210 INPUT " ENTER DATE ";D:PRINT:PRINT
220 INPUT " ENTER YEAR ";Y:PRINT:PRINT
230 F1=INT(F/100):F2=INT(F1/10):F3=F1-10*F2:Y=F-F1+100
240 INPUT " ENTER DAY OF THE WEEK ";W$:PRINT:PRINT
250 FOR O=1 TO 7:IF W$=B$(O) THEN E=O
260 NEXT O
270 INPUT " PRINT MODE (NDRMAL/REVERSE) ";P$: IF P$="R" THEN C=128
280 POKE 56832,17:POKE 56833,4:REM 24 HOURS-MODE SELECT
290 POKE 56832,1:POKE 56833,H:REM SET HOUR
300 POKE 56832,2:POKE 56833,M:REM SET MINUTES
310 POKE 56832,3:POKE 56833,S:REM SET SECONDS
320 POKE 56832,4:POKE 56833,R:REM SET MONTH
330 POKE 56832,5:POKE 56833,O:REM SET DATE
340 POKE 56832,6:POKE 56833,Y:REM SET YEAR
350 POKE 56832,7:POKE 56833,E:REM SET DAY OF THE WEEK
360 POKE 56832,17:POKE 56833,12:REM ACTIVATE CLOCK
365 PRINT CHR$(147)
370 POKE 56832,0:REM PUT TIME IN LATCH
380 POKE 56832,1:H=PEEK(56833):REM READ HOUR
390 POKE 56832,2:M=PEEK(56833):REM READ MINUTES
400 POKE 56832,3:S=PEEK(56833):REM READ SECONDS
410 DH=INT(H/10):UH=H-DH*10+C:DH=DH+C:REM PRINT HELP HOURS
420 DM=INT(M/10):UM=M-DM*10+C:DM=DM+C:REM PRINT HELP MINUTES
430 DS=INT(S/10):US=S-DS*10+C:DS=DS+C:REM PRINT HELP SECONDS
440 POKE 56832,4:R=PEEK(56833):REM READ MONTH
450 POKE 56832,5:D=PEEK(56833):REM READ DATE
460 OD=INT(D/10):UD=D-OD*10:REM PRINT HELP DATE
470 POKE 56832,8:Y=PEEK(56833):REM READ YEAR
480 DY=INT(Y/10):UY=Y-DY*10:REM PRINT HELP YEAR
490 POKE 56832,7:E=PEEK(56833):REM READ DAY OF THE WEEK
500 KL=54272:REM PRINT TIME WITH COLOUR HELP
510 PDKE1051,DH+48:PDKE1051+KL,14
520 PDKE1052,UH+48:PDKE1052+KL,14
530 PDKE1053,58+C:POKE1053+KL,14
540 PDKE1054,DM+48:PDKE1054+KL,14
550 PDKE1055,UM+48:PDKE1055+KL,14
560 PDKE1056,58+C:POKE1056+KL,14
570 PDKE1057,DS+48:POKE1057+KL,14
580 PDKE1058,US+48:POKE1058+KL,14
590 PRINT:PRINT TAB(27);8*(E)
600 PDKE1171,DD+48:PDKE1171+KL,14
610 PDKE1172,UD+48:POKE1172+KL,14
620 PRINTTAB(30);A$(R)
630 PRINT " ":REM CURSOR 3 LINES UP
640 PDKE1211,48:PDKE1211+KL,14
650 PDKE1212,57:POKE1212+KL,14
660 PDKE1213,DY+48:PDKE1213+KL,14
670 PDKE1214,UY+48:POKE1214+KL,14
680 GOTO 370

```

*Listing 2 Commodore 64 and 128 users may enter this BASIC program, intended as a guide to further experiments with the real-time clock board as described in this article*  
*Note the PEEK and POKE instructions to access the RTC registers at locations 56832 (RTC) and 56833 (latch)*



# junior computer

*The cost and complexity of home computers is a serious deterrent to the newcomer to computer operating and programming. We know of many readers who would like to 'build their own' but who lack the necessary technical knowledge. The Junior Computer has been designed (for just this reason) as an attempt to 'open the door' to those readers who need a push in the right direction.*

*It should be emphasized that, although simple to construct, the Junior Computer is not a 'toy' but a fully workable computer system with the capability for future expansion. It has been designed for use by amateurs or experts.*

*The purpose of this article is to give a general description of the operation of the Junior Computer. It has been decided to publish a more detailed description in book form.*

*The arrival of 'The Junior Computer' Books 1 and 2 on the market will be announced shortly. This, however, is a preview intended to give the reader an idea of what the computer entails.*

There are many readers who would like to know more about home computers but who may not be technically minded or who consider them too complicated to understand. These two reasons, coupled with cost, tend to prevent many people from 'taking the plunge'. To help overcome these problems we have designed the Junior Computer (JC). Do not be misled by the term 'Junior'—this computer provides the first step to understanding large and powerful systems. When fully expanded the Junior Computer can work with higher level languages. It uses a simplified method of operation and has the advantage of various expansion

possibilities.

The heart of the JC occupies no more than a single printed circuit board which should dispel any fears produced by large and complicated systems. The intention of this article is to encourage readers to take the initial steps towards constructing and operating their own personal computer. Extensive and precise details will not be dealt with here but will be published in depth in book form—the Junior Computer Books 1 and 2. We can however whet the appetite and set the ball rolling. Specific data concerning the computer are given in Table 1, this is intended for readers who are already familiar with computers.

## Block diagram

The fundamental features of the Junior Computer are shown in the simplified block diagram of figure 1. The heart of any computer system is the CPU, or central processing unit. In this particular case it is a 6502 microprocessor, a 40 pin chip that you can hold in the palm of your hand—but shouldn't! Its purpose is to control communications between the various units inside the computer in accordance with the instructions of the program. A clock generator (oscillator) serves as a 'pacemaker' for the processor.

A certain amount of memory is required by the microprocessor to store programs and data. In the JC it consists of two sections. The first one for storing permanent data and the monitor program. The monitor program contains a number of routines which perform such chores as program loading, debugging and general housekeeping. The second section of memory is used for storing temporary data and program instructions.

The block marked I/O (input/output) maintains contact between the computer and the outside world including the keyboard and display. In the circuit the I/O appears as the PIA, or peripheral interface adapter. It takes care of the data transfer in two directions and can (temporarily) store data. The operator communicates with the computer via the keyboard and display.

Computers are not as 'intelligent' as some television programmes would have us believe. In fact, they merely carry out (programmed) instructions in a certain (programmable) order. There are three sets of parallel interconnections (called buses) which carry the various data and control signals. First of all there is the data bus to consider. It is made up of a number of lines along which data travels from block to block. The processor must also be able to indicate the memory location where data is to be stored or removed. This is performed by the second bus, the address bus. Last, but by no means least, is the control bus which ensures that the CPU is able to control the internal status, for instance the nature and direction of data transfer and the progress of successive program sections.

This then very briefly covers the various blocks, their functions and their interconnections. We can now move on to look at the circuit in greater detail.

## Circuit diagram

The circuit diagram of the entire Junior Computer (except for the power supply) is shown in figure 2. Now that the block diagram has been examined, each section should be easily recognisable. The 6502 microprocessor is IC1. Below it is clock generator formed by N1, R1, D1, C1 and the 1 MHz crystal. The system uses a two-phase clock, shown in the circuit diagram as signals  $\phi 1$  and  $\phi 2$ . The memory is constituted by IC2, IC4, IC5 and part of IC3. The monitor program is stored in IC2, which is an EPROM (Erasable Programmable Read-Only Memory). This is the basic program in the computer (not to be confused with BASIC - a high level computer language). The RAMs (Random Access Memory) IC4 and IC5 serve as user memory and together have a capacity of 1024 bytes.

In the PIA, IC3, there are another 128 bytes of RAM. The PIA constitutes a data buffer which controls all the data transfer passing in either direction between the computer and ports A and B. The port lines are fed out to a 31 pin connector. IC3 also contains a programmable interval timer.

The displays (Dp1 ... Dp6) and keys (S1 ... S23) are at the bottom of the circuit diagram. Of these keys, sixteen are for the purpose of entering data and addresses in hexadecimal form and the remaining seven have various control functions. Data to the displays and from the keyboard is transferred across seven lines from port A. The information on the displays is controlled by the software in the monitor program, which also ensures that key function signals are recognized. IC7 multiplexes the displays and periodically checks the state of the rows of keys to see which one, if any, is being depressed. With the aid of switch S24 the display may be switched off.

The display may be used in two different ways. Usually, the four left hand displays will indicate an address and the two right hand ones will indicate the data in the address location concerned. As a second possibility, the two left hand displays can show the hexadecimal code of an instruction while the others display the address of the data corresponding to this instruction. This makes program entry much easier.

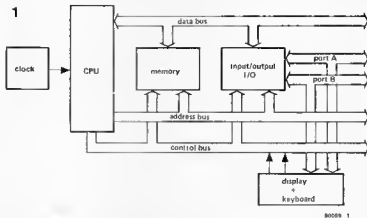

Figure 1. Block diagram of the Junior Computer.

The address decoder, IC6, provides chip select signals for each of the various memory blocks. These appear as K7, K6 and K5 for the EPROM, PIA and the RAMs respectively. The other five selection signals are available externally for memory expansion. The RAMs also require a R/W (read/write) signal. This is made available via gate N6 and is generated by a combination of

the R/W signal in the 6502 and the  $\phi 2$  clock pulse ( $\phi 2$  data bus enable). Another control signal is the reset signal RES, which places the microprocessor and the PIA in the correct initial condition for the monitor program. A reset is generated when key RST (S1) is pressed and half of a 556 timer (IC8) is used to suppress any contact bounce this key might produce.

1

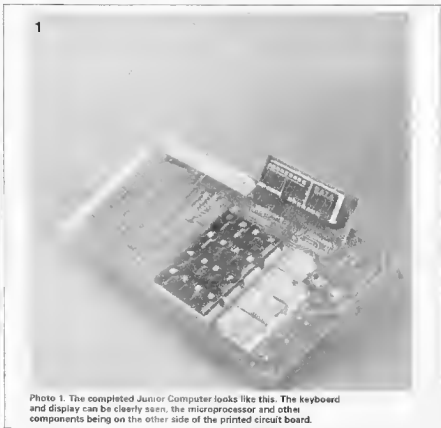

Photo 1. The completed Junior Computer looks like this. The keyboard and display can be clearly seen, the microprocessor and other components being on the other side of the printed circuit board.

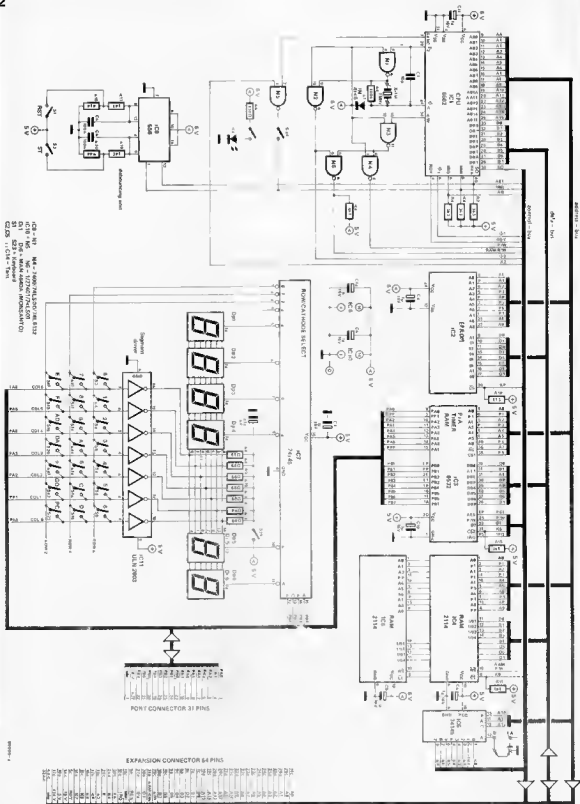

Figure 2. The circuit diagram of the Junior Computer.

Tabla 1

General information on the Junior Computer

- single board computer
- programmable in machine language (hexadecimal)
- microprocessor type 6502
- 1 MHz crystal
- 1024 bytes of monitor in EPROM
- PIA type 6532 with two I/O ports, 128 bytes of RAM and a programmable interval timer
- six digit seven segment display
- hexadecimal keyboard with 23 keys: 16 'alpha' keys and 7 double function control keys

Control keys (normal mode)

- + : Increment address on display by one
- DA : enter data
- AD : enter address
- PC : call up contents of current program counter position
- GO : start program from address on display
- ST : interrupt program by way of NMI
- RST : call up monitor
- STEP: step by step run through program

Control keys

(editor mode via ST)

- insert : insert program step before address shown on display
- input : insert program step after address shown on display
- skip : jump to next op-code
- search : search for a certain label
- delete : delete row of characters on display

Possibilities

- debugging : all internal registers may be shown on display
- hex editor : label identification with hexadecimal figures JMP, JSR, branch instructions operate with label
- hex assembler : conversion of label numbers into displacement values for real address
- branch : calculate address offset for jump instructions

Applications

- can be used as a basis for many expansions
- can be used as a 6502 CPU card
- educational computer for beginners

- can be expanded with:
  - elaktarminal
  - cassatta interface
  - video interface
  - matrix printer
  - assembler
  - disassembler
  - editor

3

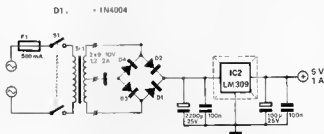

There are two ways in which a program being run can be interrupted by means of the NMI (non-maskable interrupt). The first one is provided by the STOP key S2 (which uses the other half of IC8 for contact bounce suppression) and the second is provided by the STEP switch S24 when this is in the 'ON' position. When the output of N5 then changes from high to low, the IRO (interrupt request) connection causes the program being run to be interrupted, for instance by programming the interval timer in IC3. Also present on the control bus are the two clock signals  $\phi 1$  and  $\phi 2$  which control the PIA and the RAM R/W signals. These determine the direction of data transfer. Finally, lines RDY, SO and EX provide possibilities for future expansion.

All the address, data and control signals are fed to a 64 pin expansion connector which, as its name suggests, is meant for the purpose of expanding the system further at a later stage. Figure 3 shows the power supply for the Junior Computer. This produces +5V for all the ICs and the displays.

A few remarks

Before work is begun on the construction of the Junior Computer, two more aspects have yet to be considered. The entire system is built up on three printed circuit boards of which one is double sided with plated through holes. It is advisable to check all the through connections with an ohmmeter to make sure that both sides of the circuit are well connected. This will avoid problems, for after soldering it is very difficult to trace any breaks.

How to build the Junior Computer

Construction of the Junior Computer is not difficult by any standards. If it is assembled carefully (paying particular attention to solder connections) and the instructions are followed to the letter, very little can go wrong. The three sections of the JC are each constructed on a separate printed circuit board: the main board (including keyboard) the display board and the power supply. Detailed instructions for construction will be given in Book 1.

The 6502 (CPU) is available from M/s Semiconductor Complex Ltd See page No. 5.11

# SATELLITE LOUDSPEAKERS

*This article deals with the satellite loudspeakers that complement the subwoofer featured elsewhere in this issue, to give complete coverage of the audio spectrum. These satellite are, however, also perfectly suitable for independent use.*

Satellite loudspeakers are not a separate category of sound reproducing equipment; any loudspeaker whose bass performance should be improved could be classified as a satellite. So-called bookcase speakers are invariably satellites, because their modest dimensions prohibit proper reproduction of frequencies below about 100 Hz.

If you are planning a new loudspeaker system, you could do worse than to opt for a subwoofer-satellites system. It is then, of course, best right from the start to design the satellites for optimum performance with the subwoofer and vice versa. It is on this basis that the present article has come about: the results are very satisfactory, indeed.

Even those who are not terribly interested in the subwoofer will find

that the bass performance of the satellite speakers ( $-3$  dB point at 65 Hz) is perfectly adequate for their requirements.

Although the design of a loudspeaker enclosure is never an easy task, the one proposed here presents the constructor with relatively few difficulties. This is, of course, largely due to there being no need of paying much attention to the bass reproduction. A response down to 100 Hz would be perfectly adequate; true, an octave further down would be very nice, but is, in this case, not necessary.

This immediately removes the problem of choosing the right shape and size of enclosure and deciding how many "ways" the system should have. The enclosure decided on is a normal closed box while it was felt that a two-way system would be perfectly

acceptable, provided that the chosen drive units would allow this. The latter aspect also requires less arithmetic and fewer measurements than, e.g., a three-way system.

These considerations have resulted in a very satisfactory practical realization, both as regards the enclosure and the number of drive units. As a bonus, the bass performance measured is considerable better than that aimed at. In short, the proposed design is compact, easy to build, not expensive, and, even without a subwoofer, gives an excellent overall performance.

## *The drive units*

As said, the design is based on two drive units. Since the majority of

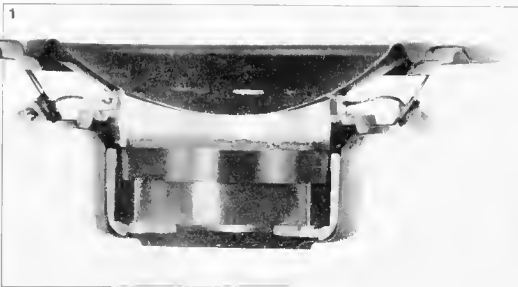

*Fig 1 The Dynaudio Type 17W75 was used as the bass and middle frequency drive unit in the prototype system. Noteworthy aspects of this unit are the centre magnet and the PHA (phase homogenous area) propylene cone.*



*Fig. 2 The tweeter is a Dynaudio Type D-28 AF, which was specially designed for use with 6 dB/octave cross-over filters*

middle-frequency units are not really satisfactory above about 2000 to 2500 Hz, which causes problems in the choice of tweeter. Dynaudio units were used for the prototypes. These units did not only meet the requirements for the present design better than most; they also offer the advantage of an excellent match with the subwoofer (which also uses a Dynaudio drive unit). The units are the Type 17W75, a 170 mm bass and middle-frequency unit, and the Type D-28 AF tweeter.

The 17W75, shown in Fig. 1, is a drive unit with a relatively large voice coil (75 mm) in hexacoil technique, which, in conjunction with the unusual shape of the one-piece cone, gives an ideal transfer of the acceleration force from the coil to the PHA (phase homogeneous area) cone. Another advantage of the big voice coil is the short rise time (fast transient response) of 50  $\mu$ s. Very low distortion and excellent phase characteristics are a result of the total concave shape of the cone.

The D-28 AF, shown in Fig. 2, is a 28 mm soft dome tweeter. The voice coil is coupled with the aid of ferro fluid. The unit has a noteworthy fast transient response (short rise time) of 12  $\mu$ s. It offers the great advantage of having been designed specifically for use with 6 dB/octave filters: not many dome tweeters have!

### Cross-over filter

Cross-over filters (or networks) are,

unfortunately, necessary, because there is not a drive unit that can reproduce the entire audio range satisfactorily. As long as these filters are not too steep-skirted, they do not cause too much harm, but with increasing skirt steepness the flaws they introduce become more and more serious. Steep-skirted filters have particularly bad transient response characteristics.

The design of a cross-over network should therefore be based on 6 dB/octave slopes, provided the drive units used allow this. This is so in the present design as can be seen from the diagram in Fig. 3. Strictly speaking, this circuit contains only two true filter components:  $L_1$  and  $C_1$ . The remainder of the components perform the correcting functions that are always necessary for good filter operation. Network R-C<sub>2</sub> serves to counteract the impedance of the 17W75, which increases with rising frequency. This carefully designed network ensures that the overall impedance of the drive unit remains constant above its resonance frequency. Only because of this can the filter perform as required.

Resistive divider R<sub>1</sub>-R<sub>2</sub> serves a twofold function. In the first place, it ensures level matching of the tweeter, whose efficiency is somewhat higher than that of the 17W75. Then, the value of R<sub>2</sub> may be varied between zero ohms and 2.2 ohms without the necessity of changing the value of C. A value of 0 ohms corresponds to a 0.5 dB correction for the tweeter, while 2.2 ohms gives

a -1.5 dB correction. Moreover, R<sub>2</sub> smoothes out a small unevenness in the tweeter characteristic: its value must, therefore, not be changed under any circumstances.

The characteristic in Fig. 4 represents the output voltage of the filter, measured across the two drive units. Note that the cross-over point only appears to be at -5 dB, it is actually at the customary -3 dB. The characteristic of the 17W75 has a slight peak at the cross-over frequency, and this has been corrected by a slightly earlier action of the filter. Acoustically, everything is, therefore, as it should be.

Construction of the filter should not give any difficulties if the PCB (Type 86016) shown in Fig. 5 is used. However, that L<sub>1</sub> should be fastened with glue or a brass/nylon bolt. a

*Fig. 3 The 6 dB/octave cross-over network is typified by its simplicity*

3

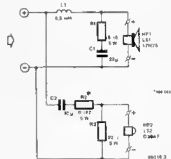

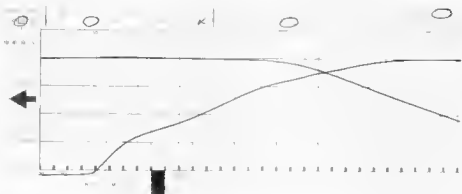

86016-4

Fig 4 Computer  
simulated curves of the  
output voltage of  
the drive unit  
measured  
in the drive  
unit connected

Fig 5 The  
circuit-board  
layout for the  
network  
(Type 86016  
— available  
through our  
Readers'  
Services)

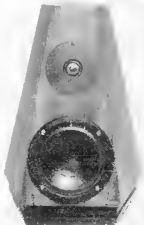

steel fastening would affect the value of the inductor. Also, observe correct polarity when the drive units are connected to the board. The PCB may be conveniently mounted—on spacers—on the bottom lid or against the back panel of the enclosure.

### The enclosure

According to the manufacturer's data, the 17W75 is best housed in a 10 to 15 litre closed box, which has been provided with a so-called varnovent (acoustic resistance).

Although theoretical considerations point to a somewhat larger volume, in practice the manufacturer's recommendations proved to be correct. In a damped closed box of exactly 10 litres volume, the bass performance of the 17W75 was surprisingly good. The difference between a box with, and one without, a varnovent is slight. The varnovent only serves to attenuate the resonance peak, and this results in a somewhat more rigid performance at low frequencies.

Although some photographs accompanying this article show a beautifully styled pentagonal, pyramid-shaped prototype enclosure (courtesy Dynaudio), the proposed enclosure has been kept rather simpler. Note, however, that the pentagonal enclosure is available from Dynaudio as a kit: it is acoustically excellent, but quite difficult to build. Our own proposal, shown in Fig. 6, offers similar advantages as the Dynaudio design: no parallel side panels; leaning backwards, upward tapering front panel; but does not demand the craft of a furniture maker.

The material is 18 mm fine-chip board; plywood may, of course, also be used, but is rather more expensive. The front, back and side panels have exactly the same dimensions. If these are sawn very carefully, all four can be glued together in one go. The bottom and top lid must be sawn very carefully to ensure a good, tight fit onto the leaning vertical panels. The top lid may be glued in place, but the bottom panel is best fitted with screws and sealing tape so that access is possible at a later stage, if required. Next, the holes for the drive units, the varnovent, and the connector terminals should be cut. The varnovent should be glued into

5

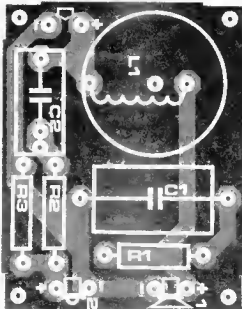

#### Parts list

L1 - 0.5 mH air cored inductor, wire diameter 1 mm  
C1 - 22  $\mu$  bipolar electrolytic or polyester  
C2 - 10  $\mu$  polyester  
R1 - 5  $\Omega$ ; 5 W  
R2 - 0.47  $\Omega$ ; 5 W  
R3 - 22  $\Omega$ ; 5 W  
Dynaudio Type 17W75 drive unit  
Dynaudio Type D-28 AF drive unit  
chip board or plywood, 18 mm thick as required (see Fig. 6)  
about 0.25 m<sup>2</sup> rubber backed floor covering  
about 0.25 m<sup>2</sup> rock wool (varnovent); 110 mm, (Dynaudio)  
connector terminals as required  
wood glue, screws, and nails as required

#### Technical characteristics

System	passive, two way
Enclosure	closed box
Net volume	about 10 litres
Cross over filter	6 dB/octave, cross-over point at about 2500 Hz
Frequency range	-3 dB points at 50 Hz and 20 kHz
Amplifier rating	30-100 watts
Sensitivity	89 dB

6a

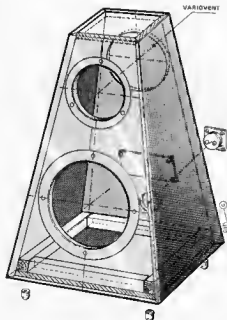

place, while the drive units should be screwed on. Afterwards, the gap between the rim of the drive units and the front panel should be sealed with suitable tape.

The best place to fit the cross-over filter is at the back panel between the variovent and the connector terminals.

Panel resonance is further prevented by gluing strips of rubber-backed floor covering at the inside of all panels and then covering these with 30 mm thick rock-wool. If this material is amply cut, the strips will be push-fit, obviating the need for gluing them into place.

The finish of the exterior of the enclosure is left to your own taste and preference.

#### Performance

It is, of course, easy (and tempting) for a designer to sing his own praises, so the performance of the system can be gauged from the measured impedance and frequency response characteristics illustrated in Figures 7 and 8 respectively. The smooth impedance curve should not present any problems to a good output amplifier. The frequency response curve was measured with  $R_L = 0.47$  ohms. When this is increased to 2.2 ohms, the characteristic shifts down by about 2 dB above 2 kHz. Response at low frequencies was ascertained by close-proximity (20 mm) measure-

6b

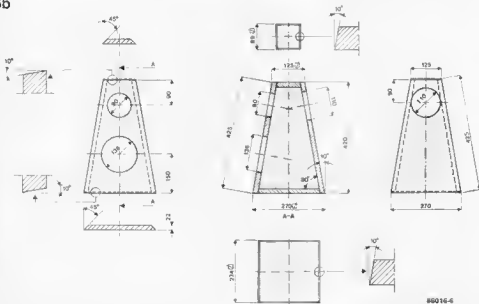

Fig 6 Construction details of the proposed enclosure. The material may be 18 mm plywood or good quality chip board.



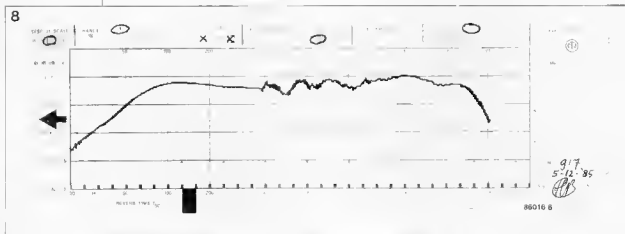
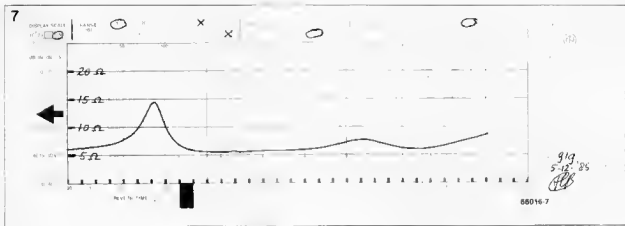

Fig 7 Characteristic impedance curve of the completed satellite system

Fig 8 Frequency response curve of the completed satellite system



ments. The acoustics of the test room has such an effect that measurements at greater distances give no meaningful information as to the behaviour of the system at low frequencies. For measurements at middle and high frequencies, the test microphone was placed at a distance of about 2 metres at roughly the height of the acoustic centre of the enclosure

We have seen so far how divider and counter circuit can be constructed using cascaded D flip-flops.

In this chapter, we shall see another practical application of the cascaded flip-flops; the 'Shift Register'.

# Digi-Course II

## Chapter 6

1

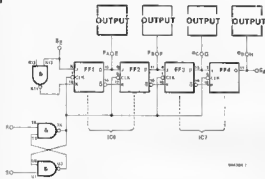

Figure 1 shows a cascade of four flip-flops connected in such a way that the outputs Q and  $\bar{Q}$  of each flip-flop are connected to the inputs J and K of the next flip-flop. The clock inputs of all four flip-flops are connected together. A 'NAND' gate inverter is inserted at the input of the first flip-flop so that the possibility of having  $J/K = 1/1$  or  $0/0$  is eliminated. The state of input SE is thus taken as a single input to the cascade and travels to the next flip-flop on occurrence of a clock pulse at the clock input. If we set the input SE = "1" at the first clock pulse and then reset it to "0" before the second clock pulse, we can observe that this "1" will travel to the next flip-flop on every subsequent clock pulse. On the fifth clock pulse the "1" gets out of the last flip-flop and as the output of the last flip-flop is floating, it is lost from the cascade.

The clock pulses are generated by alternately connecting the R and S inputs to the ground line. The NAND gate flip-flop consisting of gates T and U switches states on each transition and the clock is "debounced".

As the circuit described in Figure 1 is used to shift the data at the input forward to the next flip-flop on every clock pulse, it is called a 'Shift Register'. For proper functioning of the circuit, all unused inputs of IC 6 and IC 7 must be connected to "1".

Figure 2 shows how we can prevent the "1" from getting lost on the fifth pulse.

2

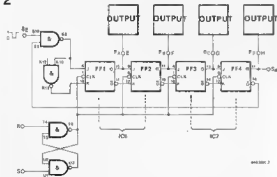

Here the  $\bar{Q}$  output of the last flip-flop is connected back to the input of the first flip-flop, through the OR gate obtained by using a NAND gate. A NAND gate functions as an OR gate with inverted inputs. In the circuit of figure 2, SE must always be held at "1" and taken to "0" only at the first clock pulse, so that a "1" is entered into the Shift Register. At the fifth pulse when QD switches from "1" to "0", OD switches from "0" to "1" and this "0" being shifted out of the FF 4 appears at the input Sg of the NAND gate S. This in turn appears as a "1" at the output pin S8 and enters flip-flop FF 1 on the fifth clock pulse. This "1" again travels through the cascade for next four clock pulses, and appears at the QA output of FF 1 on the 9th clock pulse. This operation continues as long as we provide the clock pulses. This modified circuit is called the Ring Counter.

As the flip-flops can assume any state when power is switched on for the first time, we must initially Reset all the flip-flops to "0" before starting the clock pulses, otherwise the initial condition of the flip-flops will keep on rotating through the Ring Counter.

The circuit of figure 2 has only four flip-flops, and can count only four clock pulses. If we want to construct a Decimal Ring Counter we need 10 flip-flops. This will have its feedback line which activates after every 10 pulses. Another Decimal Ring Counter can be operated from this feedback pulse used as a clock pulse. Practically, such circuit are not constructed using individual flip-flop ICs. Fully integrated Shift Register or Ring Counter ICs are available for these applications.

Shift registers are often used in Computer Technology, and rather than entering 1 bit, a series of bits is entered. For example, a bit sequence of 1001 can be entered into a Shift Register using clear and preset inputs and shifted out bit by bit. This will represent a serial transmission of the binary number 1001 (Decimal 9).

If the sequence 1001 is entered bit by bit into a shift register on 4 clock pulses, we have the combination 1001 at the outputs QA, QB, QC and QD at the end of the fourth clock pulse, thus representing a serial input of the binary number 1001 into the 4 bit Shift Register, which gives a parallel output 1001 at the end of the 4th clock pulse. In the first case when we set the 4 flip-flop outputs to 1001 before giving the clock pulses, it can be described as parallel input/serial output operation. In the second case, where we had all flip-flops set to zero, and entered the sequence 1001 bit by bit at every clock pulse, it can be described as serial input/parallel output operation.

Data transmission between two devices can either be serial or parallel. Serial transmission requires only two lines, one data line and one ground line. Parallel transmission requires one line for each bit and an additional ground line. For 8 bit data transmission in parallel mode, we would thus require a 9 core cable. However, as the parallel transmission can take place in one shot, it takes much less time than in case of serial transmission. An 8 bit data to be transmitted serially will require minimum 8 clock pulses, whereas if it is transmitted parallelly it will take only one clock pulse (almost 8 times faster).

## 3 74LS194

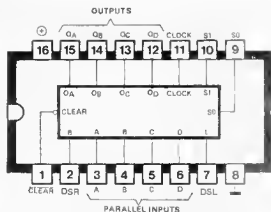

04025-3

You can try the serial and parallel data transmission using two Digilex Boards. The internal block diagram of a 4 bit Shift Register IC 74 LS194 is shown in Figure 3

This particular IC can operate as Shift Left or Shift Right Register. The direction of Shift is decided by the combination at the inputs S0 and S1. A 01 combination gives Shift Left and a 10 combination gives a Shift Right operation. A 11 combination allows parallel entry of data. The Clock input is blocked by the 00 combination. CLEAR input is used to reset all the outputs to '0'.

Pins DSR and DSL are used as the data input pins during Shift Right and Shift Left operations.

# Mini Amplifier

A small amplifier circuit is described here for the readers who are always looking for a practical project. The description 'Mini' does not apply to the performance of the amplifier, it applies to the size, and number of components required.

A full fledged amplifier generally consists of two main stages, a pre amplifier to amplify the signal coming from the signal source like a Tuner, Cassette-player or a record player, and the power amplifier which amplifies the signal further and delivers the driving power to the loud speaker.

The circuit presented here takes care of the second function. It raises the signal level coming from the pre amplifier and delivers the driving power to the loudspeaker. It can give a maximum of 10 Watts to a suitable loudspeaker. It is built around a single IC and a few additional passive components.

## The Circuit

The main component of the circuit illustrated in figure 2 is the amplifier IC TDA 2002 (which can also be substituted by another IC

TDA 2002 without affecting the performance).

It is a compact integrated low frequency amplifier suitable for output capacities upto 10 Watts.

Only a few passive components (resistors and capacitors) are necessary to complete the amplifier circuit.

The input signal is given to the IC through capacitor C1. This is amplified by the IC and is available at the output pin 4. The gain of the amplifier is decided by the ratio of resistances R1

1

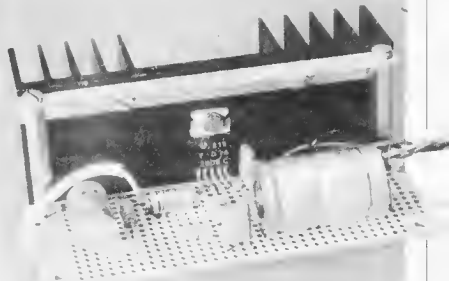

Figure 1  
Fully assembled 'Mini Amplifier'

and R2. This is equal to 100 in the present circuit, with the selected values of R1 and R2 as 220 $\Omega$  and 2.2 $\Omega$  respectively. The bandwidth of the amplifier is decided by the RC combination R4 and C7. With the selected values of 47 $\Omega$  for R4 and 100nF for C7 the bandwidth available is 33KHz. If the input signal is within this range, the amplifier works without any loss of amplification. However, for signals with frequencies above 33KHz, the amplification falls rapidly. The output signal available at pin 4 of the IC is supplied to the loudspeaker through

the capacitor C4. The impedance of the loudspeaker finally decides the output power. If the supply voltage is 18 volts, the output power available from a 21 $\Omega$  loudspeaker is full 10 Watts. A 4 $\Omega$  loudspeaker gives 6 Watts and an 8 $\Omega$  loudspeaker delivers just 1.5 Watts. The RC combination R3, C5 is connected across the loudspeaker to avoid unstable operation of the entire circuit. The no load current drawn by the amplifier is about 50 mA. It draws about 500 mA when delivering 6 Watts power through a 4 $\Omega$

loudspeaker and can go upto 1A when delivering 10 Watts through a 2 $\Omega$  loudspeaker. The input signal being a 1 KHz sine wave and the supply voltage at 18 V. If the power amplifier is used in a car radio or cassette player the power supply can be directly taken from the car battery. Though the maximum specified supply voltage is 18 Volts, the amplifier can be operated from lower voltages. A battery eliminator circuit is also presented here in figure 3 for those who want to operate the amplifier

from mains supply. It is a simple battery eliminator circuit with a 12V/1.5A transformer, a bridge rectifier consisting of 4 diodes of the type 1N4002 and an electrolytic filter capacitor of 1000  $\mu$ F/25 V. This gives a no load voltage of about 16V. The supply voltage to the IC should not be more than 18V in any case. Though the IC can tolerate upto 28V without any damage, the performance of the amplifier is affected beyond 18V and the volume drops to zero.

## Construction

The component layout of the circuit on a size 1 SELEX PCB is shown in figure 4. The layout is very simple and everything except the loudspeaker and the battery eliminator fits on the PCB.

The assembly should be carried out in the usual sequence - jumper wires, resistors, capacitors and then finally the semiconductors. The fully assembled PCB is shown in photograph 1, which clearly shows the construction details. It also shows how the heatsink is fitted to the PCB and the IC cooling fin. The cooling fin of the IC is internally connected to pin 3 which is externally connected to the ground line. No mica washers are therefore necessary between the IC and the heat sink. Care should be taken while mounting the heatsink that the mounting screws on the PCB do not short the heat sink with any other tracks, because the heat sink is connected to the ground line through pin 3 of the IC. There should be a gap of about 2 to 3 mm between heat sink and the PCB.

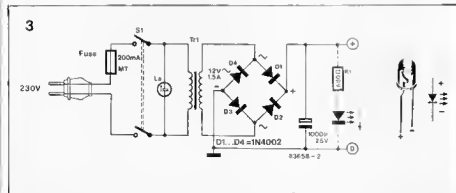
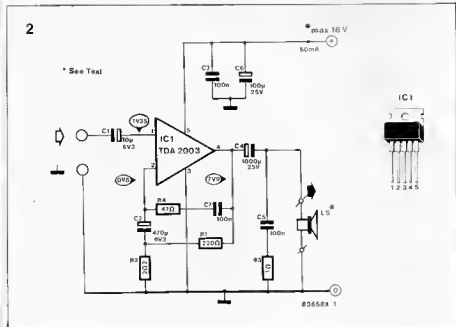
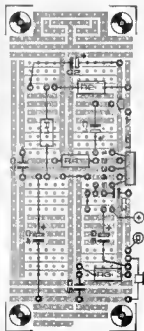

Figure 2 Complete Circuit diagram of the Mini Amplifier.

Figure 3 Simple battery eliminator circuit for use with the Mini-Amplifier

4



The battery eliminator circuit must be constructed separately as it has no space on the main PCB. The output of the battery eliminator must be connected through a cable to the amplifier PCB at the terminals marked + and 0.

## Testing

When the assembly is complete, the first test can be carried out. The input is connected to the ground line, and a suitable loudspeaker is connected at the output. A multimeter is inserted in the supply line to measure the no load current. The measuring range is set to 100 mA. As

5

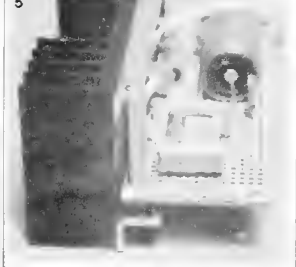

soon as the supply is switched on, the meter should read about 50 mA, and the loudspeaker must not make any sound (Because the input is connected to the ground line.) If one or both of these indications are not there, immediately switch the power off. Check the PCB for faulty connections or short circuits if any.

If the first test is passed, then remove the multimeter from the supply line and connect the output of the eliminator directly to the amplifier PCB. Now you can check all the DC voltages marketed in the circuit diagram of figure 2. If these are all as per the specified values, you are ready to operate your amplifier. The short circuit between the input and ground can now be removed and the input can be connected to the output of a preamplifier.

If an 18V supply is used and the loudspeaker has an impedance of 2Ω then the preamplifier output required to drive the amplifier at full load is about 45 mV. A 50 mA signal is required if the loudspeaker has an impedance of 4Ω or 8Ω. If you expect the preamplifier to deliver a higher output signal, then a potentiometer must be used in the input circuit as shown in figure 6. The connection between the preamplifier and the power amplifier must be through a shielded cable, with the shield connected to the ground and the core connected to the signal. This precaution reduces the hum pick ups by the amplifier.

It is generally very difficult to obtain 2Ω loudspeakers and a simple solution to this problem is to use two 4Ω loudspeakers in parallel.

6

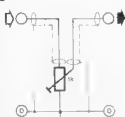

Figure 4  
Component layout on SELEX PCB, which accommodate everything except the loudspeaker and battery eliminator.

Figure 5  
2 to 3 mm edge available between the heat sink and the PCB.

Figure 6  
Volume control to be provided in case of connection to high output pre amplifiers.

### Component List :

- R1 - 220Ω
  - R2 - 2.2kΩ
  - R3 - 1Ω
  - R4 - 47kΩ
  - C1 - 10μF/6.3V
  - C2 - 470μF/6.3V
  - C3 - 470μF
  - C4 - 100nF/25V
  - C5 - 100nF
  - C6 - 100μF/25V
  - C7 - 100nF
  - IC1 - TDA 2003 / TOA 2002
  - LS - 2Ω 10W Loudspeaker
  - LS - 4Ω 4W Loudspeaker
  - LS - 8Ω 3W Loudspeaker
- Other parts  
1 SELEX PCB Size 1  
1 Suitable heatsink  
Aluminum angle and spacers for mounting heatsink

## The Digilex-PCB is now available!

Price:  
Rs. 85.00 + Maharashtra Sales Tax.  
Delivery charges extra: Rs. 6.00

Send full amount by DD/MO/PO.

Available from:

**precious**<sup>®</sup>

ELECTRONICS CORPORATION  
Journal Division

11, Shamrao Vitthal Marg (Kln Lane)  
Off Lamington Road, Bombay-400 007.

# Z-Diode Tester

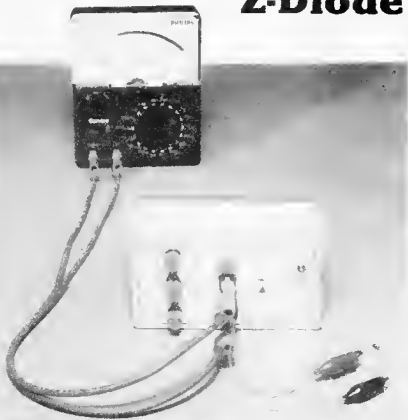

For example, "4 V 7" or "5 V 6" means a Z-Voltage of 4.7 V or 5.6 V. However, there are some Z-Diodes which have code numbers only and no Z-Voltage markings. In case of these diodes, one must either consult the manufacturers data book or use the Z-Diode Tester to find out more about the diode.

Sometimes when using components removed from old circuit boards, one may come across a diode with illegible markings. In such a case, firstly we want to find out if it is a Z-Diode at all, and if it is, then we must find out the Z-Voltage.

How well a Z-Diode functions depends upon its V-I characteristics. The V-I characteristics of an ideal Z-Diode and a practical Z-Diode are shown in figure 2a and 2b. In case of an ideal Z-Diode, the diode is non-conducting till the voltage reaches the Z-Voltage value. As soon as the Z-Voltage is reached,

current flows through the diode and the diode behaves like a short circuit. The voltage remains clamped at the Z-Voltage value and remains independent of the amount of current flowing through the diode. The characteristic curve goes up vertically towards infinity.

If we operate such a diode with a series resistance as shown in figure 3, the voltage across the diode remains clamped at the Z-Voltage and only current changes with change in UB. This property is very useful in designing stabilised power supplies.

A practical Z-Diode does not function as effectively as an ideal Z-Diode. The characteristic curve of a practical Z-Diode is shown in figure 2b.

Right at the beginning, let us make it clear why we have called it a Z-Diode Tester and not a Zener Diode Tester as you might be expecting. A little bit of hair splitting is necessary to understand this. To be very precise,

Zener Diodes are available only for the voltages between 2.7 and 5V. Only these are the genuine Zener Diodes, based on the effect invented by Mrs. Zener! The so-called Zener Diodes available for higher voltages are really 'Avalanche-

Diodes' which are based on the Avalanche effect. Zener Diodes for voltages less than 2.7 V are also not true Zener diodes but they are just the combinations of two or three ordinary silicon diodes in series packaged in a single glass body.

Precisely for this reason, we have not used the name Zener Diode Tester. The name Z-Diode is used to cover all the three types of diodes.

The Z-Diode tester described here can be used for all types of Z-diodes, as well as for ordinary diodes. The tester can be used to test a Z-diode and find out if it can function, how well it can function and how high is the Z-Voltage.

Normally the Z-voltage is marked on the body itself

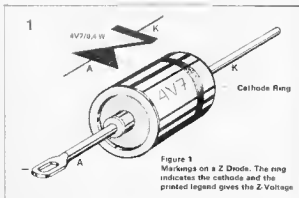
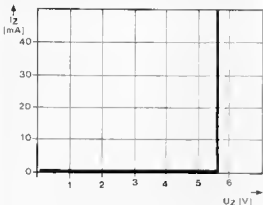

Figure 1  
Markings on a Z-Diode. The ring indicates the cathode and the printed legend gives the Z-Voltage

2a



2b

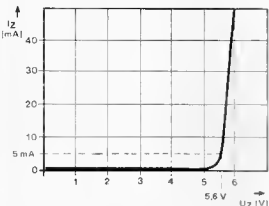
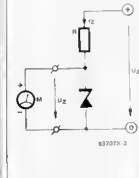

Figure 2a : Characteristic curve of an ideal Z-Diode. Voltage across diode remains constant independent of current until it breaks down at the Z-Voltage.

Figure 2b: Characteristic curve of a practical Z-Diode. The voltage slightly increases with current.

Figure 3: Principle of operation of the Z-Diode Tester.

3



The curve does not rise vertically upwards, but does so at an angle. Due to this slightly slanted curve, the voltage across the Z-Diode does not remain fully independent of the diode current. How well the Z-Diode functions can be seen from how steeply the curve rises. The Z-Diode tester described here has a facility to measure the Z-Voltage at seven different currents flowing through the Z-Diode.

## The Circuit

The principle of our Z-Diode Tester is similar to the circuit shown in figure 3. A DC voltage, a series resistance and a Z diode. When the voltage is more than the Z-Voltage, a current flows through the circuit. Value of the current is decided by the series resistance and the Z-Voltage of the diode.

With a 9 V DC supply, a resistance of 1K and a Z-Voltage of 4.7V, the voltage across the resistor is 4.3V and current flowing through the circuit is 4.3 mA.

Now if we replace the Z-Diode by another one with a Z-Voltage of 6.8V, then the voltage across the resistance is only 2.2V and the current through the circuit is only 2.2 mA.

From the above observations, we can draw a conclusion that just a series resistance is not enough if we want to test different Z-diodes at the same current. We need a constant current source for this preferably one with different current settings available.

Figure 4 shows the practical circuit of the Z-Diode Tester with a constant current source and three switches to set the constant current value. Transistors T1 and T2 together function as a constant current source. These are connected in such a way that the collector current of T1 always remains constant and depends on the resistance

across the Base-Emitter of transistor T2; which can be varied in seven steps by setting the switches S1, S2 and S3 in different combinations.

To understand the functioning of the circuit, assume that switch S1 is closed. With the power supply connected across (A) and (B) various currents will flow in the circuit.

The collector current of T1 also flows through the Z-Diode and through the resistance R1. However, as the resistance R1 is directly connected between the base and emitter of transistor T2, voltage across R1 cannot exceed 0.6V which is the Base-Emitter voltage of T2. When voltage across R1 tries to cross 0.6V, T2 goes into conduction and its collector current flowing through R4 increases. With increased current through R4, the voltage on the base of T1 reduces. A drop in base voltage of T1 means a drop in its collector current, which is nothing but the Z-Diode current. These two actions balance each other in such a way that voltage across R1 is not allowed to rise beyond 0.6V and in effect the collector current which is also the Z-Diode current remains constant.

By changing the switch settings in various combinations, we can obtain seven different values of the diode current for our tester. The three switches give three independent settings, then combinations of two switches closed simultaneously and one combination where all three are closed simultaneously. When more than one switches are closed simultaneously it results into a parallel combination of resistances. Table 1 gives all the seven combinations, and the values of currents produced by them with a 24 V power supply.

Table 1

Switches closed	$I_Z$ bei $U_B = 24 V$ in mA
S1	2,22
S2	5
S3	21,3
S1 + S2	7,2
S1 + S3	23,5
S2 + S3	26
S1 + S2 + S3	28,4

With the power supply voltage of 24 V, Z-Diodes for voltages upto 21 volts can be tested. It is easier to obtain a supply voltage of 18 V rather than 24V, by connecting two 9V battery packs in series. With an 18 V supply, Z-Diodes for voltages upto 15V can be tested. The currents shown in table 1 will be slightly reduced with an 18V supply. Even otherwise, the currents will deviate by +10% due to tolerances in resistance values and transistor characteristics. Practical application of the Z-Diode Tester is not affected by this deviation. If need for testing Z-Diodes for voltages above 15V is expected, a 24V supply must be made available. One such circuit for a 24V battery eliminator is given in figure 5.

## Construction

The circuit of the Z-Diode Tester is so simple to construct, it can be easily assembled on a size 1 SELEX PCB including two 9V battery packs.

The component layout is shown in figure 6. It occupies just half the area on the PCB, and if you are good at soldering, probably nothing can go wrong!

Details of the prototype mounted in a plastic cabinet are shown in the photograph which appears at the end of this description. The front panel layout can be seen in the photograph at the beginning of this article.

Figure 4

The practical design of the Z-Diode Tester. A constant current source is incorporated.

Figure 5

This simple battery eliminator circuit can be used to provide a 24V supply voltage to the Z-Diode Tester.

4

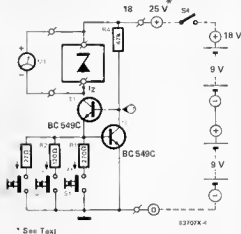

5

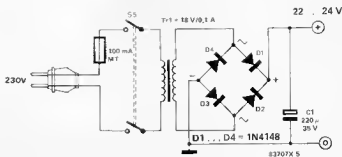

The switch appearing in the top right hand corner is the ON/OFF switch which connects or disconnects the power supply. Two small wires with crocodile clips are provided for connecting the Z-Diode under test, red for the cathode and black for the anode of the Z-Diode. The symbol of the Z-Diode is also painted on the front panel between the two connecting wires. Two banana sockets are provided for connecting the multimeter leads, the colours chosen are again red for plus and black for minus. On the left hand side of the panel, there are three push button switches S1, S2 and S3.

Once the assembly is complete, the functioning of the Z-Diode Tester can be checked as follows:

- 1) Check the supply voltage.
- 2) Connect the two crocodile clips together and check the voltage on the base of transistor T1 to be 1.2V and that on the base of transistor T2 to be about 0.6V. At least one of the three push buttons must be pressed during this measurement.
- 3) Connect the two crocodile clips to the leads of a multimeter and keep the multimeter in the 50 mA measuring

range. Press the push buttons as per combinations shown in table 1 and check the current flowing through the collector of transistor T1. The measured current should agree with the values given in table 1 with a maximum deviation of +10% for a 24V power supply. If an 18V power supply is given using two 9V battery packs, the current values may be a little less than those indicated in table 1.

If all the above tests are passed - your Z-Diode Tester is in perfect working order.



## Testing with the Tester.

If you have used two 9V battery packs as the power supply of your Z-Diode Tester, it will be suitable for testing Z-Diodes from 1.5 to 15V and the normal silicon diodes like 1N4148, 1N4001 etc. (With a supply voltage of 24V, you can test Z-Diodes upto 21 V.)

For testing, the Z-Diode is connected with the two crocodile clips and the multimeter is connected through the banana plugs. The measuring range to be set on the multimeter is 20V D.C. Switch S2 is now pressed and you can directly read the Z-Voltage on the multimeter. Switch S2 is used because it gives approximately 5 mA current through the Z-Diode, and the rated Z-Voltage is generally specified at 5 mA operating current. This is true for almost all 0.4W Z-Diodes. In case of 1 W Z-Diodes, keep all three switches pressed to give the maximum test current of about 28 mA when measuring the Z-Voltage.

The find out how well the Z-Diode functions, measure the Z-Voltage at every switch combination of table 1. The variation in Z-Voltage with increase in current will tell you how steeply the characteristic curve rises. A 5.6V/0.4W Z-Diode may give a variation of about 0.2V in the Z-Voltage over the current range of 5mA to 28mA. The smaller this variation, the better is the Z-Diode.

If during the test, the multimeter shows a Z-Voltage comparable to the supply voltage itself, this can mean the following:

1. The Z-Voltage is beyond the measuring range of our tester.
2. The Z-Diode is open.
3. This is not a Z-Diode but it may be just an ordinary germanium or silicon diode.

Now if the diode polarity is reversed and switch S2 is closed, the voltage measured by the multimeter should be about 0.6 to 0.7V for Germanium and 0.2 to 0.4V for silicon diodes. If this voltage is less than 0.2 volts it means that the diode is short circuited.

In case of a good Z-Diode which showed the Z-Voltage equal to the supply voltage, it should show a voltage of about 0.7 when its polarity is reversed.

A good diode (other than a Z-Diode) will always show the Z-Voltage to be almost equal to the supply voltage when connected in the blocking direction.

### Component List

- R1 - 270 $\Omega$
- R2 - 120 $\Omega$
- R3 - 27k $\Omega$
- R4 - 47k $\Omega$
- T1 - BC 549 C
- T2 - BC 548 C
- S1 - S3 - S P S T Push button Switches
- S4 - ON/OFF Toggle Switch

**Other parts**  
2 wires with crocodile clips  
2 wires with banana plugs at both ends

- 1 SELEX PCB Size 1
- 2 9V miniature batteries
- 2 Connecting clips for batteries
- 1 Plastic casing and suitable assembly material

### Components for Battery Eliminator

- Tr 1 - Mains transformer 18V/0.1A
- S1 - 100mA slow blow fuse
- S5 - DPST Mains Switch
- D1 - D4 - 1N4148
- C1 - 220 $\mu$ F/35V

### Other parts for Battery Eliminator

- 1 Mains cord
- 1 Fuse holder
- 1 Suitable enclosure and other assembly material.

Figure 6  
The component layout of the Z-Diode Tester on a SELEX PCB Size 1

6

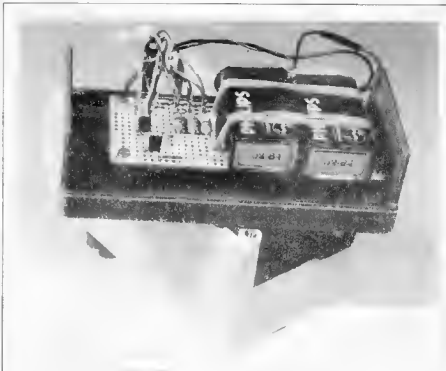
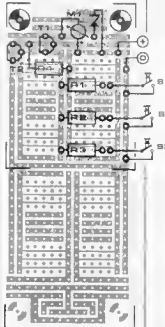

## INSULATION TESTER

Economy's Digital Insulation Tester has 3 fundamental features

- 1) It measures insulation properties on two tanges viz 20 mega ohms and 2000 mega ohms
- 2) It measures resistance in 5 ranges from 200 ohms with 0.1 ohms resolution, and 2K ohms 20 K ohms, 200 K ohms and 2 M ohms
- 3) The instrument is well protected and also measures the line voltage if the probes are connected to the supply, up to 1000 Volts AC

Besides, it features Sunlight visible LED display, High Sensitivity, High stability, Portability, Single glass epoxy PCB interlocking switches



For further details contact  
**ECONOMY ELECTRONICS**  
15 Sweet Home Plot No 442  
2nd Floor, Pnambat Lane,  
off Tutta Pipe Road, Mehra,  
Bombay 400 016

## VOLT METER

Century Instruments manufacture Micro Volt Meters for precise measurement of D C Voltages in various testing & measuring Labs. With 3 1/2 digit LED display it has 5 ranges of voltage with a resolution of 1 microvolt. The equipment is equipped with zero adjustment pot for the 2 lower ranges. Made with MOS/LSI technology this drift free instrument guarantees greater reliability and long term usage.



For further information please write to  
**CENTURY INSTRUMENTS**  
PVT LTD  
SCO 289, 1st Block, Sector 35 D  
CHANDIGARH - 160 036

## REFLECTOMETER

Dr Bruno Lange of West Germany have come out with a new Laboratory Reflectometer to measure gloss levels on all material surfaces to international standards and specifications

Depending on the Measuring head used the Reflectometer can individually or simultaneously measure gloss at the angles of 20°, 60° or 85°. This unit also has a statistics facility to automatically calculate mean, standard deviation and coefficient of variability. These results are displayed digitally with a print out facility on a built in metallic paper matrix printer. An RS 232 interface is included.



For further details please contact  
**TOSHNIWAL BROS (HYD) I**  
PVT LTD  
268, Kilpauk Garden Road,  
Madras 600 010

## FREQUENCY METER

This Digital Line Frequency Meter measures line frequencies from 45 Hz to 55 Hz. The minimum resolution is 0.01 Hz with an accuracy of 0.01%. Self check facility is also provided. It is sensitive from 10V AC to 250V AC

Applications are in power generating stations, Load dispatching stations, Textile Industries, Fertiliser industries and Diesel Generator sets



For further details contact  
**M s ARUN ELECTRONICS**  
PRIVATE LIMITED  
B 125 126 Ansa Industrial  
Estate  
Sakti Vihar Road, Sakri Naka,  
Bombay 400 072  
Phones 583354 581524

# PRODUCTS



## INSTRUMENT TROLLEY

Elma Industries offers TROLLEY that is suitable for all types of Electronics Measuring Instruments. The stands are made of square pipe highly chrome plated. The shelves are made of 18 gauge M S Steel and finished in oven baked enamel paint. The Total height of the trolley is 32" from floor. Top shelf size 17 1/2" Long X 11" Wide. Middle shelf size 22" Long X 11" wide. Distance between the top end middle shell is 15". Distance between the middle & bottom shell is 7" below the drawer. They also undertake special orders.

For further information, Please Contact  
**ELMA INDUSTRIES**  
A 15, Aaram Society, Vakola,  
Sector 1, East,  
Bombay 400 055  
Telephone 612 93 15

## PLASTIC MOULDED DOUBLE DIN STD INSTRUMENT CASE

'COMTECH' T 192 is a double DIN standard instrument case having over all dimensions of 192 mm x 96 mm x 150 mm. The case is offered in three different styles: 1) Panel Flush Mounting 2) Table Top Model 3) Carry case

The description of Panel Flush Mounting is given in March

issue of *Elektron India*. This issue we are describing Table Top style of the same

## TABLE TOP MODEL

The same instrument case can be used as table top model having white plastic Bezal & black frame, & instrument test kit to impart suitable inclination. The Metal Chassis is offered as an accessory. The Case has two grooves on vertical & horizontal side to serve as PCB guide

For further details please contact  
**COMPONENT TECHNIQUE**  
8, Orton Apartment  
29-A Lalubhai Park Road,  
Andheri (West)  
Bombay 400 058

## DIGITAL BOARD TESTING COURSE

TEKINS USA offers a course on audio-cassettes for digital board testing. This provides professionals associated with the manufacture of commercial and military systems a thorough understanding of automatic digital testing. This course teaches essential digital board programming skills. The complete course consists of three units namely

- Unit 1 on TESTING CONCEPTS
- Unit 2 on TESTER HARDWARE
- Unit 3 on TESTER SOFTWARE

Each unit includes 6 Cassettes, a student workbook, lesson books and examinations

For further details contact  
**M S BAKUBHAI AMBALAL**  
Division of Ambalal Sarabhai  
Enterprises Ltd  
Kasturba Hind Building  
Currambhoy Road, Bellard Estate  
Bombay 400 038

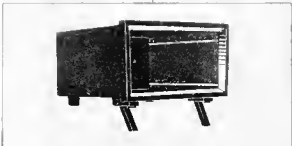

# NEW PRODUCTS

## CABLE MARKERS

**MICROSIGN** Chevron cut T - universal cable markers feature interlocking of multiple legends to keep them aligned. Manufactured from special soft PVC, they are available in white or yellow PVC Background with Black hot stamping with standard markings 0 to 9 A to Z+ Special markings and background as per international resistot 5 colour code system can also be available in the form of continuous (detachable) form. These are suitable for 3mm to 5.5 mm diameters of wires.



For further information  
**MICROSIGN PRODUCTS**  
Mehta Terrace, Saiyentayan  
Road,  
**BHAVNAGAR 364 001**

## AC DRIVE SYSTEM

**Advance-Oerlikon** have developed a solid state AC drive system named "ADCR AMPVERT" for variable speed control of AC squirrel cage induction motors. The system enables bidirectional speed control with regenerative braking using the principle of current source inverter. It maintains a constant voltage frequency ratio ensuring constant torque operation in the overall range. Its important feature is that during reversal or deceleration in either direction it prevents



wastage of mechanical energy. This is done by feeding the energy back into the mains supply.

Modular in construction, the system comprises power components, control switchgear and PCB rack fitted in standard cubicles. It incorporates safety guards like electronic overcurrent trip, under voltage trip, overvoltage trip, etc. It is designed to suit 3 phase 415V 50Hz AC supply line.

For more details, quote ref No P3 2-84 and write to  
**Advance-Oerlikon Limited**  
Post Box No. 1546  
**Bombay 400 001**

## THICK FILM KIT

**Electro-Science Laboratories, Inc., U.S.A.** have announced a new prototype Resin Products kit which makes it easier and more economical to print and evaluate the materials and processes for fabricating hybrid thick film prototype and experimental circuits.

The kit contains a complete system of eleven functional compositions of high quality ESL polymeric resin conductor, resistor, dielectric, and solder pastes. Comprehensive instructions are provided to guide the user in building a large number of experimental and prototype circuits on rigid or flexible printed circuit board. An optional digital LED multimeter is also available.



include High speed of response, no overshoot or hunting, no waveform distortion, no effect of Load power factor or supply frequency, Line & Load regulation of +0.5%, solid state plug in control card for easy maintenance.

## CAR BURGLAR ALARM

**ADVANCE** has introduced a car Burglar Alarm. This solid state unit is compact and hence can be fitted in any remote corner. It protects the doors, dicky bonnet & glove compartment, and also warns if the vehicle is started. It is designed for vehicle with 12V Dc electrical systems.



For Further Details contact  
**ADVANCE INDUSTRIES**  
11 Tinswala Bldg  
Tribhuvan Road  
Near Deamland Cinema  
**Bombay 400 004**

For more information please contact

**ELTECK'S CORPORATION**  
C-314 Industrial Estate Peenya,  
**BANGALORE 550 058**

Telex: 0845 8328 KSC IN  
ATTN "ELTECK'S"

Phones 384002 353940

## PCB TERMINALS

**ELCOM** offers a new PCB mounted screw terminal block. It is available as a standard 3 pin module, which is stackable in multiples of 3 without disturbing the 5 mm Pitch. The pin diameter is 1 mm and the maximum wire size that can be used with the block is 2.5 square mm. Current rating is 10 A at 380 V (RMS).

Maximum operating temperature is 100°C.



For further information

**ELCOM**  
103, Jaygopal Industrial  
Estate, B Parulekar Marg,  
Dadar, Bombay 400 028

## VOLTAGE REGULATOR

**INSTANT** Servo Controlled Line Voltage Regulators Series 1100 are useful in stabilizing mains voltage. Features



## BETA TESTER

This Transistor Beta Tester measures static gain (Beta) upto 300 at collector currents upto 10 Amps and base currents upto 1 Amp, at VCE of 4 Volts, as per international specifications. The currents are pulsed at 2% duty cycle at 50 Hz, avoiding excessive heating and power dissipation, in Transistor under test. The instrument is useful for bulk users of transistors.



For more details, please contact  
**SPECTRON SALES & SERVICE**  
PVT LTD  
63, Bhairalkun No 2  
ERANDVANE  
**PUNE 411 038**

Unable to  
join classes?

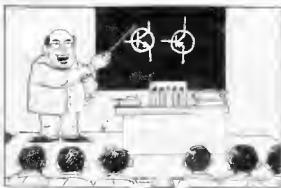

Unable to  
understand complicated books?



# Now you can Learn Electronics Through Exciting Experiments

*Q: Can a beginner  
hope to become  
an expert in  
electronics?*

*A: Certainly!*

*Q: How?*

*A: By experimenting!*

*Q: What else does  
he require?*

*A: An excellent  
introduction  
and some  
confidence!*

*Q: Who will show  
the way?*

*A: Dynatron!*



*The Electronics Fever Is On!*

*So hurry up, write to:*

**Dynatron Electronics**

3, Chunam Lane, Bombay 400 007.

# An Industrial TWO-in-ONE

## Digital Relative Humidity & Dry Bulb Temperature Indicator

Direct digital readout of %RH

HUMTHERM-847C is a handy precision instrument especially designed for application in industries where Relative Humidity and Dry Bulb Temperature have to be measured with utmost accuracy and convenience

A high degree of accuracy is achieved by the use of LSI technology. The solid state sensor is excellent in performance even at elevated ambient temperatures because of its high stability and quick response. There is no need for heating elements to remove moisture nor to change probes during measurements.



HUMTHERM-847C

### FEATURE HIGHLIGHTS

- Compact and light weight
- Automatic temperature compensation
- LSI based circuitry
- State-of-the-art RH sensor
- Low power consumption

### SPECIFICATIONS

Measurement Range Accuracy Resolution

Display Dimensions (at 100° Power)



HUMTHERM-849M

HUMTHERM-849M can be panel indicator and also used in conjunction with 3 wire RH & Temperature Transmitter HUMTHERM-848T for remote indication. Details on request.

Temperature 0°C to 50°C ± 0.5% ± 1°C

HUMTHERM-847C 3-digit 0.5" LCD 180 x 66 x 85 9V DC (Battery 216)

Humidity 90% to 99% ± 2% RH at 25°C 0.1% RH

HUMTHERM-849M 3-digit 0.5" LED 96 x 96 x 105 130V 50Hz AC Panel



Engineered for Reliability

Instrument Research Associates Pvt. Ltd. P. 13/10, 20th, 7th Fl., Market Road, Bangalore-560 015. Phone: 804693, 804694, 804695, 804696, 804697, 804698, 804699.

## Impact Extruded Capacitor Housings from KLAS

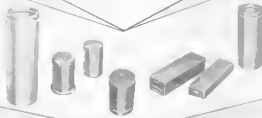

- Automated mass production ensures low unit cost and quick delivery
- Special rectangular & oval cans with grooves and other projections
- 99.5% pure Aluminum. Close tolerances can be maintained
- Wide range of sizes 5 to 90 mm dia upto 250 mm length



**Klas Engineering Private Ltd.**

31 1st Block East Jayanagar Bangalore-560 011  
Phone 804693 Grams KLASANG Telex 0845-756 KLAS IN

BAG/CL/LE 8A

## Two latest, indispensable aids for the industry—FULLY ELECTRONIC



DIGITAL CLAMP TESTER

and



DIGITAL MULTI METER

- Large LCD for easy reading

**MECO INSTRUMENTS PRIVATE LTD.**

Gharal Industrial Estate T J Road Seewee Bombay-400 015  
Phones 413-7423 413-2436 413-0747 Telex 011-71001 MECO IN

MECO for Precision, Accuracy & Reliability

YOUR DEPENDABLE SOURCE...

TEXONIC  
INSTRUMENTS

<b>ERE ELECTRONICS</b> SPECIALIST SUPPLIER OF BENCH CALIBRATED ELECTRONIC TEST EQUIPMENT	<b>MELETRON</b> Specialist Supplier of Electronic Test Equipment	<b>SEMELTRON</b> Specialist Supplier of Electronic Test Equipment
<b>MANUFACTURING</b> INDUSTRIES LTD. Specialist Supplier of Electronic Test Equipment	<b>PROTECTION</b> Specialist Supplier of Electronic Test Equipment	<b>COMPOUND</b> Specialist Supplier of Electronic Test Equipment
<b>PRESBYTER</b> Specialist Supplier of Electronic Test Equipment	<b>ELITE</b> Specialist Supplier of Electronic Test Equipment	<b>EP</b> Specialist Supplier of Electronic Test Equipment
<b>ELITE</b> Specialist Supplier of Electronic Test Equipment	<b>LITTON</b> Specialist Supplier of Electronic Test Equipment	<b>ALCANTARA</b> Specialist Supplier of Electronic Test Equipment

**TEXONIC**  
H I N Z

2, MANERBAGH LANE,  
2/F, BANGALORE  
MANUFACTURING  
INDUSTRIES LTD.

Our Most Important Component - SERVICE

**pla** LCD DMM  
DM 14B1



**Rs. 1025/-**

**BE PROUD  
INDIAN,  
SUPPORT  
INDIAN  
TECHNOLOGY.**

Contact:

**PLA ELECTRO APPLIANCES PVT. LTD.**  
THAKOR ESTATE, KUFLA KIROL ROAD,  
VIDYAVIHAR (W), BOMBAY 400 086  
PHONES: ☐ 5132668 ☐ 5132667

\* Duties & Taxes Extra

## BOOKS ON DATA - HARDWARE - SOFTWARE

A WIDE RANGE OF  
COMPREHENSIVE LITERATURE



### • NATIONAL SEMICONDUCTORS

INTERFACE BICULAR BI-BIPOLAR MEMORY  
PROGRAMMABLE LOGIC DATA BOOK  
SERIES 80 B L C STRAPLEX DEVELOPMENT SYSTEM  
DATA BOOK 50/-

### • THE RELIABILITY HANDBOOK

An introduction to Military/Aerospace Semiconductor  
reliability concerns, screening techniques and  
standardization programs 1/- 00

### • INTERSL

Advanced low power analog and digital semiconductor  
components and data acquisition are described in this  
data book 900/-00

### • COBOL A STRUCTURED APPROACH

This book is intended for beginner programmers who  
have no experience with computers 75/-00

### • CMOS DATA BOOK

Contains information on standard 5S/MSI CMOS  
products 850/-00

### • THE TRANSISTOR SUBSTITUTION MANUAL

This book is compiled to help you identify the  
transistors of 8 major manufacturers with different type  
numbers but identical performance in Japan 75/-00

### • THE TRANSISTOR MANUAL

(New Transistor Manual) and lists the transistors  
registered with C.I.A. Japan 75/-00

### • MOTOROLA SEMICONDUCTOR MASTER SELECTION GUIDE AND CATALOG

Presents the full line of Motorola Products with  
tables highlighting the preferred devices for various  
applications 00/-00

### • TTL DATA BOOK

A complete reference source for all Fairchild  
Semiconductor 5S/MSI TTL products 900/-00

### • THE APPLE II CIRCUIT DESCRIPTION

This book is a detailed circuit description of the Apple II  
computer 75/-00

### • MOTOROLA SCHOTTKY TTL DATA

Complete specification of Advanced low power  
Schottky TTL (family ALS) and Fast Schottky TTL family  
provided in data sheet form 900/-00

Send full advance by M.O./D.D. only

Available at

**precious**<sup>®</sup>

**ELECTRONICS CORPORATION**  
Journal Division  
11, Kln Lane (Shamrao Vithal Marg)  
Bombay-400 007

## CONDITIONS OF ACCEPTANCE OF CLASSIFIED ADVERTISEMENTS

1) Advertisements are accepted subject to the conditions appearing on our current rate card and on the express understanding that the Advertiser warrants that the advertisement does not contravene any trade act in force in the country.

2) The Publishers reserve the right to refuse or withdraw any advertisement.

3) Although every care is taken, the Publishers shall not be liable for clerical or printer's errors or their consequences.

4) The Advertiser's full name and address must accompany each advertisement submitted.

The prepaid rate for classified advertisement is Rs. 2.00 per word (minimum 24 words). Semi Display panels of 3 cms by 1 column. Rs. 150.00 per panel. All cheques, money orders, etc. to be made payable to Elektor Electronics Pvt. Ltd. Advertisements, together with remittance, should be sent to The Classified Advertisement Manager. For outstation cheques please add Rs. 2.50

Immediate possession at Bhandup on lease 1000 S ft with power, water, phone Ideal for light Electronic Industry Reply Box No. 0586, Elektor India, 52, C Proctor Road, Grant Road (E) Bombay-400 007

8085 Microprocessor Trainer built in EPROM programmer, power supply, 2K CMOS/RAM with dry cell back up expandable to 8 K, 12 K user EPROM installed Rs 2975/- All inclusive EPROM Eraser Rs 500/- Contact NEW AGE ELECTRONICS, Third Floor Laxmi Mahal, Near Vandana Cinema, Agra Road, Thane 400 607

Unassembled/Assembled kits  
1) MW Transmitter 150 meter range for Rs 90/- 2) 12 Melodies horn for vehicles Rs 80/- Kits price list Re 1/- (50% Advance for VPEI PERFECT ELECTRONICS 453, Ganpati Ab, Wai 412 803 (Satara)

Now Available Electronics projects book-1, Price Rs 5 M s Renuka Electronics 18, Ranganathan Street, Nehru nagar, Chromepet, Madras - 600 044 (All India Universal Electronics Club FREE membership Enrolment form Re 1 )

## CORRECTIONS

## MSX

Extensions - 3  
(April 1986)

The caption to Fig. 5 should have read: "For slot signal functions see Infocard 121"

Note that further information on the connector is given in Infocard 122 in this issue (p 81)

RF Circuit  
Design - 2  
(April 1986)

The value of  $f$  in Fig. 4b should read 65.0 MHz, not 65.0 Hz

Active subwoofer  
in this issue

Owing to a printers error, figures 1a and 1b have been interchanged

The end of paragraph 2 on should read (use 68 nF or 0.1  $\mu$ F)

ACTRON	5.12
ADVANI OERLIKON	5.15
AFCO I & C LTD	5.09
APEX	5.66
APLAB	5.06
COMPONENT TECHNIQUE	5.10
CTR	5.07
DEVICE	5.65
DYNALOG MICRO SYSTEMS	5.76
DYNATRON	5.61
ECONOMY ENGINEERING	5.12
ELECTRON SYSTEM	5.14
IEAP	5.66
INSTRUMENT CONTROL	5.10
INSTRUMENT RESEARCH	5.62
ION ELECTRICALS	5.08
JUNIOR COMPUTER	5.69
KAYCEE ELECTRONICS	5.70
KEJRIWAL	5.10
KLAS ENGINEERING	5.62
LEADER ELECTRONICS	5.14
MECO INSTRUMENTS	5.62
MODI ELECTRONICS	5.06
MOTWANE	5.63
MURGAPPA ELECTRONICS	5.13
OSWAL ELECTRONICS	5.02
PIONEER ELECTRONICS	5.08
PLA	5.73
PRECIOUS KITS	5.71
RAJASTHAN ELECTRONICS	5.02
SAINI ELECTRONICS	5.70
SEMICONDUCTOR COMPLEX	5.11
S.S. INDUSTRIES	5.14
SUCHA ASSOCIATE	5.64
TESTICA	5.64
TEXONIC	5.73
UNLIMITED	5.64
VALIANTELECTRO	5.08
VASAVI	5.12
VISHA	5.75
YABASU	5.04
ZODIAC	5.66

# ELECTRONICS HOBBYISTS

*How long will you continue to play with simple projects and obsolete technologies?*

*Electronics Hobbyists all over the world are experimenting with Microprocessors and their most exciting applications. Now Dynalog makes it possible even for you to get into the exciting world of Microprocessors.*

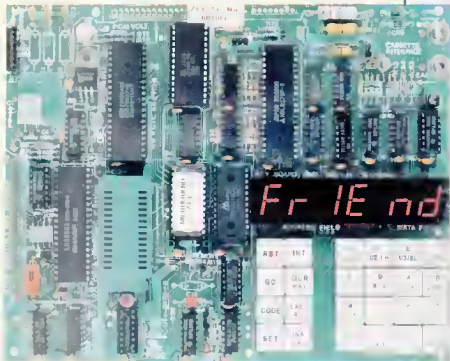

*Dynalog has specially designed two **LOW COST** Microprocessor Trainers based on the popular chips 8085A and Z80A. Advanced Hobbyists, Students and Beginners can use them initially for learning and then for experimenting with Microprocessor Applications.*

Write today for more details.

**DMS**

**Dynalog Micro-Systems**

14, Hanuman Terrace, Tara Temple Lane,  
Lamington Road, Bombay 400 007

Tel: 362421, 353029 Telex: 011-75614 SEVK IN Gram: ELMADEVICE

Branches and representatives at: Pune, Bangalore, New Delhi, Hyderabad and Chandigarh

ADDMark