

131

April  
1986

elektor **INDIA**

Rs. 7.50

# electronics

**8 mm video**  
System of the future?

**Intercom**

**Photonics**

**VHF filters**

**MSX extensions (3)**

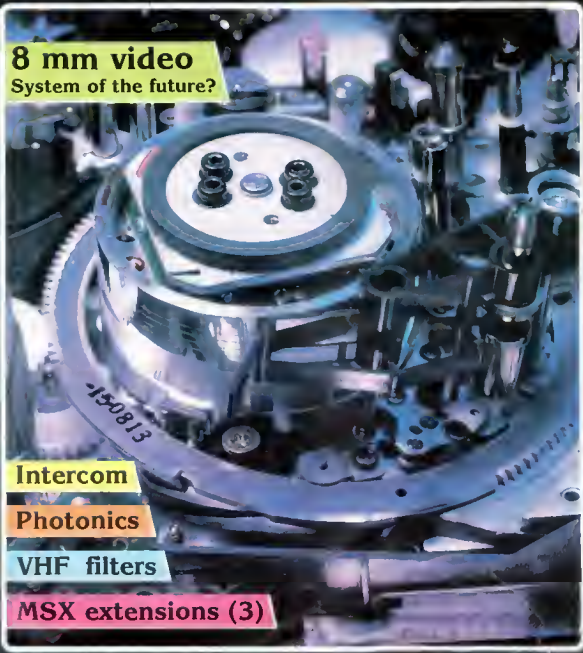

April 1986

Publisher: C R Chandarana

Editor: Surendra Iyer

Editorial Assistance: Ashok Dongre

Advtg &amp; Admn: J Dhea

Production: C N Mithagari

Address  
ELEKTOR ELECTRONICS PVT LTD  
52, C Proctor Road  
Bombay 400007 India

## Overseas editions

Glentop Publishers Limited  
Sunderland House, Beth Place  
High Street, Reinet  
London EN5 1 ED  
Editor: Len Seymour

Elektor B.V.  
Peter Treckpoelstraat 2-4  
6181 VK Beek - the Netherlands  
Editor: P E L Kersemakers

Elektor sari  
Route Nationale, Le Seau; B P 53  
59270 Basilleul - France

Editors: D R S Meyer,  
G C P Readersdorf

Elektor Verlag GmbH  
Susterfeld-Strasse 25  
100 Aschen - West Germany  
Editor: E J A Krempelsaer

Elektor EPE  
Karnatak 14  
18673 Voula - Athens - Greece  
Editor: E Xanthoulis

Elektor JCE  
Via Rossini 12  
20124 Milano - Italy  
Editor: D Fumagalli  
Ferreira & Bento Lde  
R D Estefana, 32-1º  
1000 Lisboa - Portugal  
Editor: Jorge Goncalves

Ingelek S A  
Av Alfonso XIII, 141  
Madrid 16 - Spain  
Editor: A M Ferrer

International co-ordinating  
& technical managers.  
K S M Walraven

The Circuits are for domestic use only. The submission of designs, or articles to Elektor India implies permission to the publishers to alter and translate the text into English, and to use the contents in other Elektor publications and activities. The publishers cannot guarantee to return any material submitted to them. All drawings, photographs, printed circuit boards and articles published in Elektor India are copyright and may not be reproduced or translated in whole or part without prior written permission of the publishers. Patent protection may exist in respect of circuits, devices, components etc. described in this magazine.

The publishers do not accept responsibility for failing to identify such patent or other protection.

Distributors  
Baze Publications & Distributors Pvt Ltd

Printed At  
Tripath Offset  
Bombay - 400 013

Copyright © 1986 Elektor B V  
The Netherlands

elektor  
electronics

## electronics technology

8 mm video ..... 4-18  
will this become the video system of the future ?

Photonics ..... 4-24  
a brief look at how information is conveyed by photons with particular reference to optical fibre cable

Inductors in practice ..... 4-39  
an attempt at simplifying the design and construction of inductors

Light work for submarine cable ..... 4-42  
(these cables are entering a new era with the application of photonics)

## projects

RF circuit design ..... 4-28  
this second of a short series of articles looks at VHF filters

MSX extensions ..... 4-33  
the third article in the present series deals with an add-on bus board

Graphics card 7 ..... 4-45  
the concluding article describes the software

Intercom ..... 4-48  
a domestic intercom using only a handful of components

Magnetiser ..... 4-50  
a device which will produce an alternating magnetic field of the type suitable for medical use

## information

News and views ..... 4-16

New products ..... 4-64

Readers Services ..... 4-71

## guide lines

Switchboard ..... 4-69

Classified ads ..... 4-74

Index of advertisers ..... 4-74

## selex 11

Digi-course II (chapter 5) ..... 4-52

Capacitors ..... 4-54

Different types of capacitors ..... 4-55

Capacitors in series/parallel connections ..... 4-57

The filter capacitor ..... 4-57

Darlington pair ..... 4-59

Unable to  
join classes?

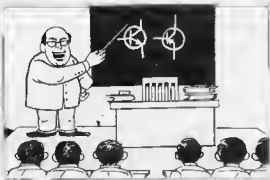

Unable to  
understand complicated books?



## Now you can **Learn Electronics** Through Exciting Experiments

*Q: Can a beginner  
hope to become  
an expert in  
electronics?*

*A: Certainly!*

*Q: How?*

*A: By experimenting!*

*Q: What else does  
he require?*

*A: An excellent  
introduction  
and some  
confidence!*

*Q: Who will show  
the way?*

*A: Dynatron!*

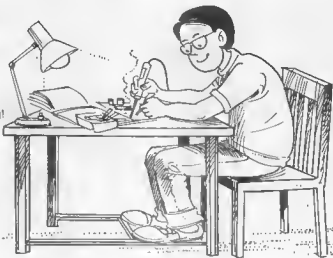

*The Electronics Fever Is On!*

*So hurry up, write to:*

**Dynatron Electronics**

3, Chunam Lane, Bombay 400 007

# The Challenger

Scientific's New HM 605 60 MHz Oscilloscope provides a real challenge to other oscilloscopes in this range with its outstanding features and performance. See for yourself how HM 605 scores over the leading brand.

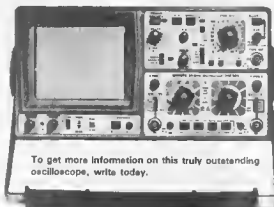

| Features            | Leading Brand           | HM 605                  | User's benefit   |
|---------------------|-------------------------|-------------------------|--|
| 1. Bandwidth        | Y - 50 MHz<br>X - 1 MHz | Y - 60 MHz<br>X - 5 MHz | At the cost of 50 MHz HM 605 offers higher BW  |
| 2. Horizontal Sweep | 10 nS/Div               | 5 nS/Div                | Better signal resolution and accuracy in RT measurements   |
| 3. Trigger BW       | 50 MHz                  | 100 MHz                 | Jitter free triggering upto 100 MHz  |
| 4. Accel Voltage    | 10 KV                   | 14 KV                   | Helps in viewing fast events at low rep. rates.  |
| 5. Z - Mod          | No                      | Yes                     | For 3rd Axis Display   |
| 6. Analog Y Output  | No                      | Yes                     | For further signal processing  |
| 7. Single Sweep     | No                      | Yes                     | For viewing non repetitive transients  |
| 8. Component Tester | No                      | Yes                     | For quick testing of components in circuit or otherwise  |
| 9. Sweep Delay      | Yes (Alt. TB)           | Yes                     | Alt. TB useful in low specialised applications HM 605 uses new simple technique for majority of applications |

**scientific** HM 605 OSCILLOSCOPE



**Challenging the Leader!**

Manufactured by **SCIENTIFIC MES-TECHNIK PVT. LTD** B 14 Industrial Estate, Indore 452 003 Phone 31777/8, Cable SCOPE.

**POPULAR**

**TESTICA T-3**



ONLY

Rs170/-

THE ONLY MULTIMETER WITH PROMPT SERVICE AFTER SALES

**ACCURATE! ROBUST! ECONOMICAL!**

AVAILABLE AT ALL COMPONENT SHOPS

MANUFACTURERS :  
**ELECTRICAL INSTRUMENT LABORATORIES,**

339/68, RAJESH BUILDING, LAMINGTON ROAD, BOMBAY-400 007. PHONE-36 07 49.

**YOUR DEPENDABLE SOURCE ...**

**TEXONIC INSTRUMENTS**

|   |  |   |
|---|--|---|
| <p><b>ETYLEAS OMBRESOENCE LAB.</b></p> <p>PERSONAL CARE PRODUCTS<br/>CARD STOCK, BUILT &amp; PAINT, COPIERS, ETC. CO.</p> | <p><b>Elco</b></p> <p>PERSONAL CARE PRODUCTS</p>   | <p><b>Gilard Electronics</b></p> <p>GE</p> <p>POWER AIDS MARKET - 1<br/>*RADIUM ALUMINUM PANEL<br/>*RADIUM P.C.</p> |
| <p><b>Electronics</b></p> <p>FOR SPECIALTY STORES, PARTS, REPAIRS, SERVICE</p>  | <p><b>ENGINEERING ENTERPRISES</b></p> <p>PHOTO COPIERS, COPY PRINTERS &amp; TYPING COPIERS</p> | <p><b>REPRODUCERS LTD.</b></p> <p>PHOTO SERIAL MANIPULATION, SERIALS, PHOTOGRAPHY</p>                               |
| <p><b>Elco Electronics</b></p> <p>PERSONAL CARE PRODUCTS</p>  | <p><b>SOLDRON</b></p> <p>DIY KIT PARTS, WIREING KIT &amp; ELECTRICAL TOOLS</p>                 | <p><b>INTERNATIONAL ELECTRICS</b></p> <p>ALL TYPES OF ELECTRICAL TOOLS</p>  |
| <p><b>PASSIVE DEVICES</b></p> <p>PERSONAL CARE PRODUCTS, REPAIRS, SERVICE, PARTS, WIREING KIT &amp; ELECTRICAL TOOLS</p>  | <p><b>P B VOIRA</b></p> <p>DIY KIT PARTS, WIREING KIT &amp; ELECTRICAL TOOLS</p>               | <p><b>TOPI</b></p> <p>PERSONAL CARE PRODUCTS, REPAIRS, SERVICE, PARTS, WIREING KIT &amp; ELECTRICAL TOOLS</p>       |

**TEXONIC INSTRUMENTS**

V. ANANDARAM SWAMI  
INDIAN POST  
MADRAS-600 002  
PIN: 6000044441/2

G. MANOCHANDRAN SANKAR  
E.P.P. ROAD CROSS  
MADRAS-600 002  
PIN: 6000044442

Our Most Important Component - SERVICE

# Learn Electronics Now !!!

## This Is The Age Of Electronics

### The Worlds Fastest Growing Industry



**elektor KITS**  
Provide a practical way to your Hobby ... Career ... Future

#### DESCRIPTION

| ISSUE NO. | EPS NO.  | TITLE                         | PRICE  |
|-----------|----------|-------------------------------|--------|
| E 4/5     | 83597    | PORTABLE EGG TIMER            | 55-00  |
| E 4/5     | 83508    | VOLTAGE MONITOR               | 49 00  |
| E 4/5     | 83503    | FLASHING RUNNING LIGHT        | 130 00 |
| E /6      | 80543    | THE STAMP                     | 57-00  |
| E /7      | 83098    | BATTERY ELIMINATOR            | 90-00  |
| E /8      | 78003    | POWER FLASHER                 | 85-00  |
| E /9      | 831 13   | VIDEO AMPLIFIER               | 115-00 |
| E /13     | 9765     | SIGNAL INJECTOR               | 30 00  |
| E/16/17   | 84457    | MUSICAL DOOR BELL             | 105-00 |
| E/16/17   | 84471    | SUPER SIMPLE BELL EXTENSION   | 18-00  |
| E/16/17   | 84476    | STEREO BALANCE INDICATOR      | 18 00  |
| E/16/17   | 3231     | AFTER BURNER                  | 60-00  |
| E/16/17   | 84484    | ELECTRICAL BELL               | 100-00 |
| E/16/17   | 84485    | ADJUSTABLE OHM METER          | 30 00  |
| E/16/17   | 84487    | IN CIRCUIT FUSE INDICATOR     | 30 00  |
| E 4/5     | 83501    | ELECTRONIC POCKET PIN BALL    | 125 00 |
| E/16/17   | 84426    | ALARM TIMER                   | 75 00  |
| E/ 4/5    | 83580    | HEAT TESTER                   | 60-00  |
| E 7       | 83088    | ELECTRONICS VOLTAGE REGULATOR | 140-00 |
| E 11      | 84009    | DIGITAL TACHOMETER            | 55-00  |
| E 15      | 9448     | + 5V 500 MA                   | 50-00  |
| E 15      | 9468     | + 15V 250 MA                  | 75-00  |
| E 15      | 9218     | + 15V 1 A                     | 70 00  |
| E 15      | 77059    | 0-10V 300 MA                  | 90 00  |
| E 18      | 9967/1/2 | TELEPHONE AMPLIFIER           | 125-00 |
| E 18      | 84073    | LAMP SAVER 1                  | 55-00  |
| E 18      | 84083    | LAMP SAVER 2                  | 45-00  |
| E 21      | 1487     | LIGHT DIMMER                  | 40 00  |
| E 21      | 91 19    | 7400 SIREN                    | 35-00  |
| E 21      | 9506     | 7W AMPLIFIER                  | 50-00  |



#### Important Information:

1. The price includes packing and postage
2. All despatches will be by Regd. Post
3. Please send full amount by D/D or M.O. No Cheques or V.P.P.
4. Allow four weeks for despatches
5. The kits contain the PCB and

components that go on to the PCB  
 6. All these projects are from elektor india. Circuits/Data are not provided in the kits as the magazines contain this information. All issues are available at the cover price

**precious<sup>®</sup>**  
ELECTRONICS CORPORATION

11, Shamrao Vithal Marg (Kin Lane) Off Lamington Road, Bombay-400 007.

# 8 mm VIDEO



*Since its introduction to the public in 1984, the 8 mm video system has been seen, tested, and liked by thousands. Already there are voices saying that this will become the video system of the future.*

Ever since the development of the first commercial video cassette recorder—VCR—manufacturers have been trying to reduce the width of the video tape without sacrificing picture and sound quality. In the early days, video studios used 2 inch wide tape and, to

achieve the required bandwidth of up to 5 MHz, a recording speed of 120 ft/s. Current domestic VCRs use half-inch wide tape and a recording/playback speed of 24 cm/s (15/16 i.p.s.). The three existing domestic video systems,

VHS, Betamax, and V2000, suffer from the great disadvantage of being totally incompatible with one another. Moreover, the video cassettes of all three systems are too large to construct a manageable camcorder (camera and recorder in a single housing) around them.

These disadvantages have always been considered serious enough by the various manufacturers to cause them to invest heavily in the development of a new system. Most development was centered around 8 mm wide tape, which would, incidentally, also compete

Fig 1. General view of the 8mm video cassette. A number of holes at the lower end provide information to the recorder as to type of tape, tape thickness, and tape length

Fig 2. Composition of the signals as recorded onto the tape. Note that here the NTSC standard is used, for the PAL system, the frequencies are slightly different

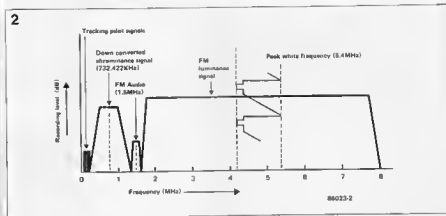
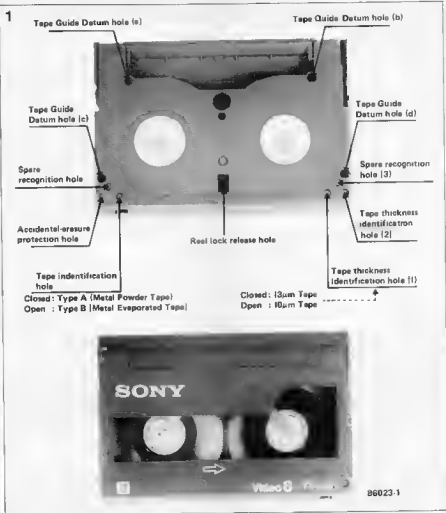

with 8 mm film. Fortunately, the manufacturers of the 1980s are more sensible than those of the 1950s and 1960s, and therefore put their heads together about the new system to try and avoid the mistakes of the past. The first 8 mm video conference in 1982 was

attended by no fewer than 122 manufacturers from all over the world. Progress was so rapid that within just over a year a proposal was made to the IEC (International Electrotechnical Commission) for a standardized 8 mm video format. This format has been accepted in

principle, although some "peripheral" points have yet to be agreed. There is, of course, some reluctance on the part of certain producers, particularly those manufacturing VHS hardware and video cassettes to go hard on the new system. However, just over a year ago, Sony

surprised all and sundry with a complete 8 mm video system. The Sony designers are to be congratulated on succeeding in bringing out a perfectly working new system in such a short time. It is, of course, too early to say how the consumer market will take to the new

Fig 3 Signal layout on the tape. At the two sides, space has been reserved for the stationary heads, the use of which is, however, restricted to special applications.

Fig 4. Photograph of a typical rotary head drum, which has a diameter of only 40 mm

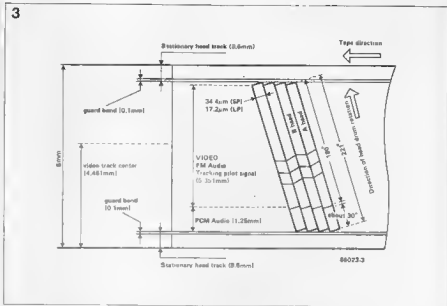

system, particularly bearing in mind its inconsistency as regards current video systems and the video disk. If the new system fails, it will not be because of its technology: this is already near perfect and is even now still being improved.

## The new video format

The 8 mm video system

uses a tape cassette that is about the same size as current audio cassettes. This cassette has a number of features which can be seen in Fig 1. Various holes at the lower end give information as to tape length, type of tape, and tape thickness to the recorder. Noteworthy also is the protective "bridge" at the front of the cassette. This consists of two parts so that the tape is protected at its front and back, which is a vast improve-

ment over the current VHS and Betamax cassettes. Furthermore, the cassette has been simplified as compared with current types. For instance, it no longer has tape guides. Another novelty is the type numbering, there are different cassettes for PAL/SECAM and NTSC (as with current VCRs). This is necessary because in the PAL and SECAM systems a field frequency of 50 Hz (25 Hz frame frequency) is used, whereas the NTSC

system uses a 60 Hz field frequency. This means that there is a difference in the length of tape used per minute between the PAL/SECAM and NTSC systems. And since the recorder is given information by the cassette as to the playing time, the correct type must be known. For instance, in a Type P5-90 cassette, the P indicates metal powder tape (an E would indicate metal evaporated tape); the 5 indicates a 50 Hz



Table 1.

### Technical characteristics

|                                   |                              |
|-----------------------------------|------------------------------|
| Tape width                        | 8 mm                         |
| Dimensions of cassette            | 96 × 62.5 × 15 mm            |
| Diameter of head drum             | 40 mm                        |
| Tape speed                        | 20.05 and 10.05 mm/s         |
| Rotary speed of head w.r.t. tape  | 3.1 m/s                      |
| Video track width                 | 34.4 or 17.2 µm              |
| Effective video signal width      | 5.351 mm                     |
| Number of heads                   | 3 (2 for video; 1 for erase) |
| Recording angle                   | 10° azimuth                  |
| Luminance signal                  | Frequency modulated          |
| FM carrier                        |                              |
| peak white frequency              | 5.4 MHz                      |
| sync pulse                        | 4.2 MHz                      |
| down-converted chrominance signal | 732.422 kHz                  |
| FM audio channel:                 |                              |
| frequency range                   | 30 to 15 000 Hz              |
| S + N/N ratio                     | about 90 dB                  |
| PCM audio channel                 |                              |
| frequency range                   | 20 to 15 000 Hz              |
| S + N/N ratio                     | about 88 dB                  |



5

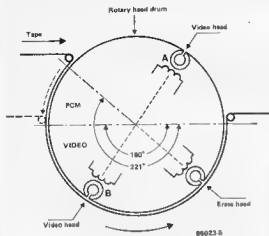

field frequency (a 6 would indicate 60 Hz field frequency); and the 90 gives the playing time in minutes.

It should be noted that there is, as yet, no agreement as to the SECAM video system (no video recorders are produced in France, the home of the SECAM system). Current thinking is along the lines of a SECAM-to-PAL transcoder for use in SECAM countries (France and Eastern Europe). It may

also be that the new MAC system now being studied by a number of European administrations will eventually offer a solution to this problem.

One of the most noteworthy points of the new system is that the video, audio, and tracking signals are recorded onto the tape together: Fig. 2 shows how. Note that this is an NTSC layout, but the PAL system is virtually identical. Of interest here is the FM-modulated

6

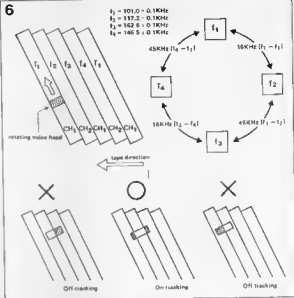

audio signal, which is a great improvement over current video systems. Since the pilot signals are recorded at the same time as the video signals, separate synchronization signals are no longer necessary.

Where the various signals are located on the tape is shown in Fig. 3. It is seen that the combined video and audio signal takes, as would be expected, the larger part of the tape. Guard bands are pro-

*Fig. 5. Strictly speaking, the tape needs to travel an angle of only 180° along the drum for the recording of the composite video signal. The additional 41° are needed for the recording of the PCM*

*Fig. 6. Auxiliary frequencies superimposed on the tracks enable exact alignment of head and track. If these are not aligned properly, a difference frequency is generated, on the basis of which the degree and direction of the required correction are determined*



Fig 7 Block schematic of the digital audio section. Although the system is only 8-bit based, a number of clever circuits ensure very good sound quality

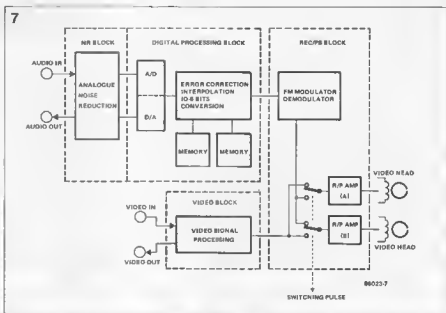

vided at both sides of the tape, but these are not yet used. Also provided is a PCM (pulse code modulated) audio track, which is intended for stereo PCM signals.

Fig 3 also shows a feature that has not been mentioned before, namely that the track width is dependent on the selected tape speed. This width is 34.4  $\mu\text{m}$  for single play (SP) and 17.2  $\mu\text{m}$  for long play (LP). The playing time for LP is, therefore, twice as long as that for SP. The remarkable

thing is that the picture quality at LP is not significantly degraded as compared with that at SP.

### The rotary head drum

Fig 4 shows that the drum contains only two video heads and one erase head. The advantage of a rotating over a fixed erase head (as found in current systems) is that recordings can be linked together

without the occurrence of visible loops in the picture. This is because the part of the track that is erased is immediately re-recorded. The tape does not, as in current systems, travel an angle of 180° along the drum, but one of 221° — see Fig 5. The additional 41° are intended for the PCM audio.

The video tracking uses an automatic track finding system (ATF), which has been derived from the V2000 system. Its operation

depends on a number of frequencies superimposed on the video tracks. The general operation of this system is shown in Fig. 6. If the video head is not aligned with its track, the difference frequency is detected by the head. On the basis of that frequency, it is determined in which direction the head must be moved to bring it into alignment with its track.

The 8 mm system can also be provided with dynamic track following (DTF),

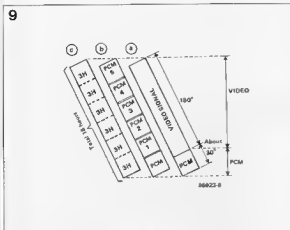
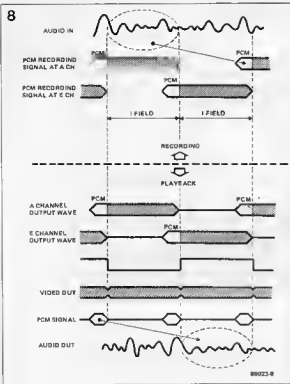

**Fig 8** Since the PCM signal is recorded at the end of the video frame, the audio data must be collected and stored during a frame period and then recorded all at once. During playback all data words are stretched over a frame period with the aid of a delay line

**Fig 9** It is possible to use the entire tape width for PCM audio, when a total of six stereo channels can be accommodated

another Philips development. In this, use is made of small pieces of piezoceramic material, onto which the video head is mounted. By applying a voltage to this material, the head can be moved up or down to a small extent, so that it can be perfectly aligned with the video tracks. At the moment, DIF is not yet provided in the Sony equipment.

## Audio

The audio signal is re-

corded by the same heads, and at the same time, as the video signal. This guarantees high quality sound, which is, however, monaural. The audio frequency band lies between 30 and 45 000 Hz, and the signal+noise-noise ratio is a respectable 90 dB.

## The Sony PCM system

Apart from the standardized FM signal, Sony has provided the possibility of adding PCM audio onto the tape as already discussed with Fig. 3. Sony has opted for an 8-bit system, probably in view of the available tape space. Note that the compact disk (CD) system uses 16 bits. However, non-linear quantization results in a dynamic range that is equivalent to a 13-bit system.

Apart from non-linear quantization, a compressor circuit is used to compress 10 bits to 8 bits. The sampling frequency in the PAL version is 31.25 kHz, so that the frequency range extends to about 15 kHz. There are also pre- and de-emphasis circuits for high frequencies, just as in the FM audio recording section. See Fig. 7. The number of data words to be recorded for each frame amounts to  $1250 (625 \text{ (lines)} / 2 \times 2 \text{ (channels)} \times 2)$ . The final factor of 2 derives from the error correction system, which adds for each recorded data word one word with the correction code (cross interleave code).

The PCM signal is always recorded at the end of a video frame. This means that all PCM data are collected and stored during a frame period and then recorded all at once. During playback, the reverse happens: a delay line then stretches the data words over a frame period. In practice, the sound is of much better quality than would be expected of an 8-bit

system. See also Fig. 8. Apart from the separate PCM part of the tape, it is possible (but, so far, in the Sony system only) to use the entire tape width for PCM as shown in Fig. 9. This enables the recording of six stereo signals, a vast quantity of audio information. Indeed, which gives 18 hours playing time on one tape.

## What of the future?

The technology on which the 8 mm video system is based leaves little, if anything, to be desired. The system appears to meet all the requirements the ever more critical user will demand from this type of equipment. And, don't forget that however good the Sony system already is, there is room for improvements and extensions without the loss of compatibility.

Much will depend, however, on the buying pattern in the consumer market, as well as on the marketing of the system (the lack of good marketing is almost certainly one of the main causes of the relative failure of the V2000 system and of the total failure of the video disk). Because of the worldwide standardization and consequent compatibility, it is to be hoped that the new system be accepted soon and readily to the great benefit of the consumer.

HB

# PHOTONICS

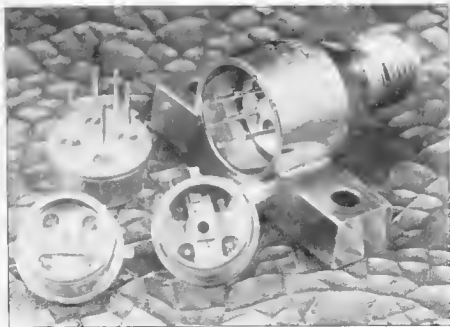

*Photonics is the technology of using photons to convey information in a controlled manner. A photon is an elementary particle of light in the frequency range from  $3 \times 10^8$  MHz to  $6 \times 10^{10}$  MHz (corresponding to wavelengths from 1000 nm —upper limit of infra-red region— to 5 nm —lower limit of ultraviolet region. Photonics must not be confused with opto-electronics—in which photons and electrons interact— or with electro-optics, which is a study of the relation between the refractive indexes of certain dielectrics and the electric fields in which they are situated.*

Photons may not replace electrons in data processing and storage this century, but there are reliable indications that they will be used increasingly in data communications via optical-fibre cables. And, of course, they are already in use in the remote control of countless hi-fi and television sets; they are also indispensable in the Strategic Defence Initiative (Star Wars). There is also the photonic

computer now being developed at Heriot-Watt University, Edinburgh, and at the Bell Laboratories in Princeton, New Jersey. These computers use transphasors, the optical equivalent of transistors. Their main attraction is that they can work thousands of times faster than electronic ones because, although electrons, under ideal conditions, move almost as fast as light, they are slow-

ed down to a per cent or two of that speed in silicon. However, we will not be able to give a description of the photonic computer until that has been unveiled in some twelve to eighteen months' time. Instead, in this article we will concentrate on optical-fibre cable. The basic principles of transmission in an optical-fibre cable were established by Hockam and

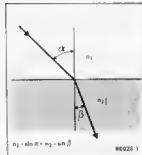

Fig 1 Illustrating Snell's Law

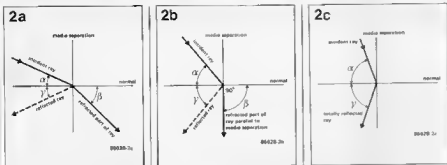
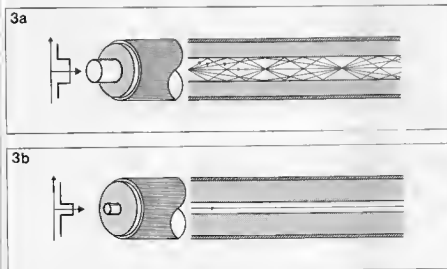

Fig 2 Depending on the angle of incidence of the light ray the transmission path is called low- or high-order mode the greater the angle, the lower the mode

Fig 3a Multi-mode fibre

Fig 3b Mono-mode (or single-mode) fibre



Kao, working at the Standard Telecommunication Laboratories at Harlow, Essex, in 1966.

### Some fundamentals

Although light is a form of energy, it may also be considered as a wave motion. A ray of light is the direction along which the light energy, i.e., photons, travels. A beam of light is a collection of rays. According to the principle of reversibility of light, if a light ray is reversed, it always travels along its original path. Light waves can be reflected or refracted. In reflection, some or virtually all of the light is thrown back into the original medium when the light strikes a surface of separation of two media. Highly polished metals reflect most of the light incident on them, whereas, for instance, plate glass

reflects only about five per cent. Refraction is the change of direction that a ray of light undergoes when it enters another transparent medium. In reflection, the incident ray, the normal, and the reflected ray lie in the same plane. Also, the angle of incidence with the normal is equal to the angle of reflection with the normal. In refraction, the incident ray, the normal, and the refracted ray all lie in the same plane (see Fig 1). Snell, a Dutch scientist, found in 1620 that the ratio  $\sin \alpha : \sin \beta$  is a constant, where  $\alpha$  is the angle of incidence and  $\beta$  is the angle of refraction. Snell's Law, as it is known, is usually expressed as

$$\sin \alpha / \sin \beta = n_1/n_2 = \mu \quad (1)$$

where  $n_1$  and  $n_2$  are the refractive indexes of the two media, and  $\mu$  is a constant. Light is refracted because it has different velocities in

different media. The Wave Theory of Light shows that the refractive index  $n_2$  for two given media 1 and 2 is given by

$$n_2 = c_1/c_2 \quad (2)$$

where  $c_1$  and  $c_2$  are the velocities of light in medium 1 and 2 respectively. If medium 1 is a vacuum, the value is the absolute refractive index. The value for any other two media is the relative refractive index. The absolute refractive index,  $n$ , of a medium is then

$$n = c/v \quad (3)$$

where  $c$  is the velocity of light in a vacuum, and  $v$  is the velocity of light in the medium. As the absolute index of air is 1.000 29, in practice, the velocity of light in air can replace that in a vacuum. There are, of course, situations where there is a partial reflection and a

partial refraction of the light. For instance, in Fig. 2a, the angle of incidence is so small that a large part of the incoming light is refracted. In optical fibre, this would mean that a large part of the light would be lost in the cladding of the cable.

Fig. 2b shows the critical angle of incidence: the refracted light here is at an angle of  $90^\circ$  with the normal. At the critical angle, the refracted light may cause interference. It is, therefore, essential that the angle of incidence is greater than the critical angle — see Fig 2c — when total reflection takes place. The condition for total reflection is that the ray of light travels from an optically dense medium with a relatively large refractive index to a less dense one with a smaller refractive index. Rays of light that fall upon the media separation at an angle smaller than the critical one called high-order modes they take

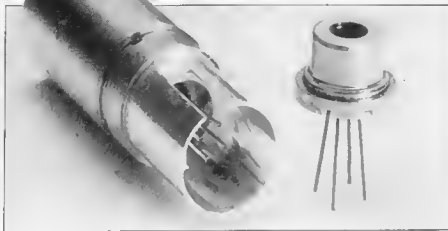

relatively longer to reach the end of the cable. Rays of light that travel almost parallel to the optical axis, i.e., at an angle greater than the critical, are called low-order modes. Low-order modes travel faster because they are reflected less often than high-order modes. Low-order modes are far less prone to losses than high-order ones. The sine of the angle of incidence of the ray of light is called the numerical aperture, this is the prime factor where two optical waveguides are to be linked. The numerical aperture is also an indication of the difference between the refractive indexes of the core and the cladding the smaller it is, the wider the bandwidth of the optical signal.

## Optical-fibre cable

In multi-mode fibre (see Fig. 3a), the ray paths of the different modes are of different lengths and have, therefore, different transmission times. Because the modes are divided by a pulse, this is subject to progressive spreading as it travels along the fibre, causing it to interfere with adjacent pulses. In mono-mode (also called single-mode) fibre (see Fig. 3b), the core diameter is comparable with the wavelength of the light, so that there can be only one electromagnetic

propagation mode and spreading of the pulse (called multi-path dispersion) is eliminated. Its small core size makes mono-mode fibre more difficult to use, but it can be made with an attenuation of less than 0.4 dB/km at a wavelength of 1.3  $\mu\text{m}$  (as against 2 to 10 dB/km for multimode fibres). A typical bandwidth of mono-mode fibre is 10 GHz.

A typical design of optical-fibre cable is detailed in *Light work for submarine cables* elsewhere in this issue. The fast rate of incremental improvements in optical fibre technology, which is due mainly to AT&T's Bell Laboratories, British Telecom, and Japan's NTT (Nippon Telegraph & Telephone), have made multimode fibres already obsolescent as far as long distance cables are concerned. (Multi-mode fibre cables

need repeaters every few miles, whereas with mono-mode fibres distances between repeaters are of the order of 50 to 100 miles). The three organizations are already researching new core materials which, they hope, will eventually enable repeaterless trans-oceanic cables. Currently, the central core of optical-fibre cables is made of doped silica sheathed in pure silica. New core materials now being studied include oxide-based and halide-based fibres. These could be from 2 to 1000 times more transparent than silica. They would also disperse less light than silica, which would result in cables with much greater capacities than present ones.

## Data transfer

Optical-fibre networks need, of course, other than the cable a sender,

receiver, coupler, and repeaters (see Fig. 4). There are two main types of optical sender, the infra-red diode and the laser diode (laser=light amplification by stimulated emission of radiation). Both enable light energy at wavelengths from 0.8 to 1.5  $\mu\text{m}$  to be injected into the fibres. The most commonly used type is the infra-red diode, however, because it is relatively cheap, reliable, has a long life ( $10^4$  to  $10^7$  hours), and is easy to use. Furthermore, they have only little drift with temperature, and their current can be modulated readily. For wavelengths from 0.7 to 0.9  $\mu\text{m}$  silicon diodes are used, but in the range 1.1 to 1.5  $\mu\text{m}$  AlGaAs (aluminium-gallium-arsenide) types are necessary, as the energy transfer of silicon diodes at those frequencies drops sharply. Infra-red diodes have the disadvantages that their bandwidth is limited and that they cannot emit parallel beams of light. The latter means that the light emitted must first be passed through an optical system where it is converted into a parallel beam.

Laser diodes do not need such an optical network and also have a higher output (up to 650 mW). Pulsed lasers may deliver up to 100 W bursts. Furthermore, the attainable bandwidth is much wider than possible with infra-red diodes. Because the

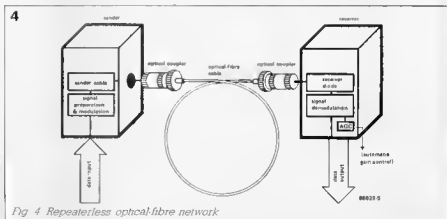
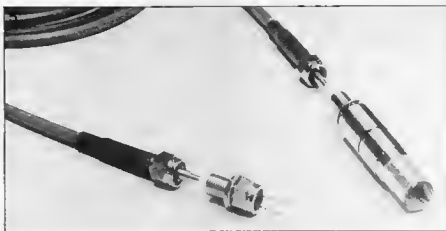

Fig 4 Repeaterless optical-fibre network

light rays in a laser beam are to all intents and purposes parallel, a larger part of the available energy is injected into the fibre. Unfortunately, lasers also have some drawbacks: they are difficult to manufacture; they are, therefore, expensive; their life at 40° hours is much shorter than that of IR diodes; and they drift with changes in temperature. The latter means that the relatively high current through them (in pulsed types a few amperes as compared with about 150 mA in IR diodes) must be regulated. As laser diodes take 4 to 8 ns before they emit infra-red light (at the onset they start emitting visible light), their quiescent current must also be regulated to make controlled operation possible.

Summarizing, laser diodes require auxiliary electronic circuits, whereas IR diodes require additional optical networks (lenses). For the receiver there are also two possible devices: p-i-n diodes and avalanche diodes. A p-i-n diode is a photodiode that contains a region of almost intrinsic (i-type) semiconductor between the p-type and n-type regions.

P-i-n diodes combine fast reaction times (shorter than 1 ns which makes them very suitable for operation with laser-type senders) with small supply voltages, simple electronic circuitry, and relatively low prices. Unfortunately, they



are very noisy, and this is the more troublesome since their low output must be amplified by a so-called trans-impedance amplifier: this device also acts as a current-to-voltage converter.

Avalanche photodiodes provide a substantial gain (40 to 60 dB) and are also very sensitive. Furthermore, they are far less noisy than p-i-n diodes. They are, however, more expensive, have a small demodulation bandwidth, and are only suitable for use with digital signals. Moreover, they require a very high supply voltage of 100 to 1000 volts, which, incidentally, shortens their life as compared with p-i-n diodes.

A description of a typical repeater is given in *Light work for submarine cables*.

A range of couplers is commercially available, and some typical examples of these are

seen in the photographs. These are used where the connection is not permanent. For permanent connections, the two cables are spliced under the microscope with the aid of a small electric welding tool. If the splicing is carried out properly, the joint attenuation will be less than 0.15 dB.

T-junctions are also possible, a typical optical coupler for this purpose is shown in Fig. 6. This device is, incidentally, also suitable for use as a duplexer.

Another interesting possibility is wavelength multiplexing as illustrated in Fig. 7, which can greatly increase the capacity of the fibre cable. The light from the sender diode is parallelized and then projected via a lens onto a reflection filter that is inclined with respect to the axis of the lens. This filter reflects the light rays into a direction that

depends on the wavelength. The lens converts the change of direction into a positional shift so that the reflected rays of all wavelengths converge, after which the compound ray is injected into the transmission fibre.

Fig. 5. Optical-fibre cable with couplers

Fig. 6. Optical T-junction illustrating the duplexing concept

Fig. 7. Construction and mode of operation of the optical multiplexer

6

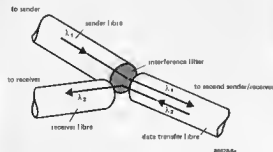

7

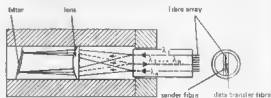

*Do you get annoyed from time to time (or more often) by your favourite FM radio programme being interrupted when a strong out-of-band signal blocks the receiver? If so, read this article and find out how to design and construct a filter that may ban this irritation for ever.*

## VHF FILTERS

by A Bradshaw  
&  
J Barendrecht

*Elektor Electronics* has presented its readers with comprehensive articles on theory and practice of VHF aerial amplification before, see, for instance, the February 1980 (UK) issue of this magazine. The conclusions reached in those articles may be summarized as follows:

1. A well-designed aerial amplifier can only compensate for cable loss if it is mounted in the immediate vicinity of the aerial (masthead mounting).
2. To be of any beneficial use at all, this booster must have appreciably lower self-generated noise than the receiver.
3. The first active device in the receiver RF signal chain determines

to a large extent the total receiver system noise figure and thus its sensitivity for weak signals.

4. A good directional aerial is the best booster because it generates no noise, is absolutely intermodulation-free and functions as a selective device at the same time.

As evidenced by the article on the wideband aerial booster with Type BFT66 transistor, low noise, good intermodulation ratio and high signal gain are generally appreciated characteristics of active devices in VHF aerial amplifiers. However, it was also pointed out that only one of these characteristics may be favoured over the others given a certain transistor working point; the

three are never optimum for one bias setting.

It is for this reason that many wide-band amplifier designs use two identical, cascaded *high fr* type transistors; the first (aerial side) set for low noise, the second (receiver side) for high overall gain. It will be fairly obvious that intermodulation characteristics of such a design are far from ideal, simply for lack of suitable DC setting and appropriate filtering. To increase bandwidth and reduce the intermodulation products, these transistors are usually direct-coupled, and every effort has been made to keep booster gain as high and constant as possible over a frequency range as large as 50...800 MHz.

It will stand to reason that this type of amplifier can not be used for reception of weak FM band signals, because the odds are that a far stronger RF signal present outside the receiver tuning range will wreak havoc with the booster transistors. Even if the aerial features some attenuation for this out of band signal, booster input voltages may be as high as 100 mV with a powerful transmitter in close proximity. Even a very selective and intermodulation-free receiver can not do anything towards improvement of reception in this case, simply because it sees a mess of interference and intermodulation products at its input.

To keep strong out-of-band signals away from the base of the VHF pre-amplifier stage, some filtering device is called for. Conflicting design considerations contend for the upper hand, however, and a basic knowledge of filter operation and construction is required to find

*Photograph 1*  
*Practical realization of the VHF roofing filter LPF section. Though its characteristics are not ideal, it provides a good starting point for more advanced filter construction. Note the two capacitors at the input, their total capacitance should be about 44 pF.*

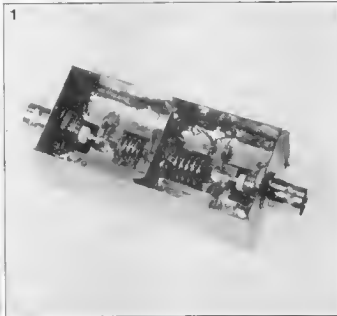



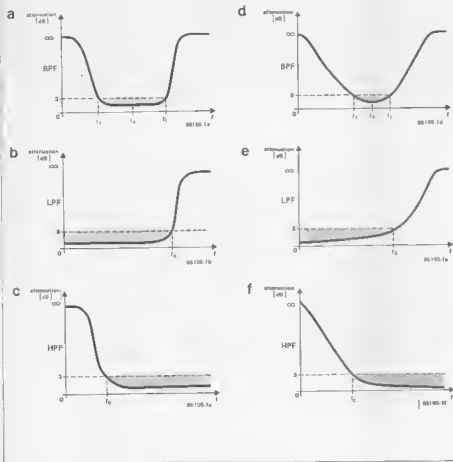

Fig. 1. Typical curves showing that a band-pass filter (BPF) profile is obtained from adding constituent low pass (LPF) and high pass (HPF) sections

the right compromise for a given situation.

## VHF filters; a crash course

For a basic understanding of filter operation, it is useful to think of it as a sieve; depending on the diameter of its holes, it will pass the desired liquid and block large particles, however many. In electronics, such a sieving device is generally referred to as a **band-pass filter**, it has a high attenuation for all signals outside its pass band.

A typical frequency vs attenuation curve of a bandpass filter (BPF) is shown in Fig. 1a. The shaded area is referred to as the filter **3dB bandwidth**. Note that Fig. 1d also shows a BPF curve, but this time with lower skirt steepness than that of Fig. 1a, and a reduced 3dB bandwidth. From this comparison of filter curves it should be evident that the term **filter selectivity** is not related direct to

3dB bandwidth.

Although the band-pass filter type is a suitable starting point for introducing filter theory, it must be mentioned here that it is basically a combination of two constituents: a low-pass filter (LPF) and a high-pass filter (HPF), the curves of which are shown in Figures 1b and 1c respectively. Note that skirt steepness of both LPF and HPF may be less, as shown in corresponding Figures 1e and 1f. It will be evident that the BPF curves of Figures 1a and 1d may be obtained by adding Fig. 1b to 1c and Fig. 1e to 1f respectively.

To define the 3 dB bandwidth of the BPFs, it will be seen that

$$\text{BPF } f_1 = \text{HPF } f_c \text{ and} \quad (1)$$

$$\text{BPF } f_2 = \text{LPF } f_c \quad (2)$$

where  $f_c$  is the **cut-off frequency** of LPF or HPF, or the frequency at which the filter output,  $U_o$ , falls to

$$U_o = 0.708 U_i = \frac{1}{\sqrt{2}} \sqrt{2} U_i = 3 \text{ dB attenuation} \quad (3)$$

Thus, the 3 dB bandwidth of a BPF

may be calculated from

$$BW_{3dB} = f_2 - f_1 < \text{Hz} > \quad (4)$$

The curves shown in Fig. 1 are theoretical and therefore idealized; depending on component tolerance and construction method of the filter, it may feature far less smooth characteristics, as will be seen later. Neither need band-pass curves always be symmetrical like those of Fig. 1; depending on skirt steepness of constituting LPF and HPF, the low and high side **roll-off characteristic** of a BPF may have quite different profiles.

To come to a conclusion about suitable electronic components for use in filters, the low-pass setup shown in Fig. 2a may be examined; it is also known as a 'pi type' (note its visual similarity to  $\pi$ ).

Assuming that the circuit is at resonance, that  $R_0 = Z_1 = Z_0 = R_0 = Z$  and that Q (quality factor) is fairly high, then the basic design equations for this filter are as follows:

$$Z = \sqrt{\frac{L}{C}} \quad (5)$$

Photograph 2  
Roll-off characteristic of the VHF roofing filter LPF section (2a) and response of the same when swept over several hundred Megahertz (2b)  
Note that low attenuation corresponds to a high point in the curve, as opposed to the curves in Figures 1 and 2

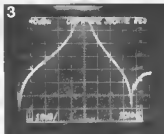
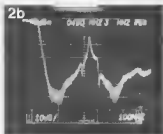
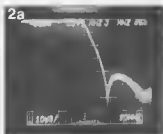

Photograph 3  
Band-pass profile of the VHF roofing filter, sweep centre frequency at 97 MHz

Fig 2 Starting from the basic pi-LPF (Fig 2a) *m*-derived sections may be added (Fig 2b) to obtain a low pass profile as shown in Fig 2c.

$$L = \frac{R}{\pi f_c} \quad (6)$$

$$C = \frac{1}{\pi R f_c} \quad (7)$$

$$f_c = \frac{1}{2\pi \sqrt{LC}} \quad (8)$$

where

*R* = filter termination resistance < $\Omega$ >

*L* = inductance in filter <*H*>

*C* = capacitance in filter <*F*>

*f<sub>c</sub>* = 3 dB cut-off frequency <*Hz*>

*Z* = filter impedance < $\Omega$ >

For VHF applications, these equations are adapted as follows to calculate with nH (nano Henry,  $10^{-9}$  H), MHz (mega Hertz,  $10^6$  Hz), and pF (pico Farad,  $10^{-12}$  F):

$$Z \approx \sqrt{\frac{1000L}{C}} <\Omega> \quad (9)$$

$$L = 159.2R/f_c <nH> \quad (10)$$

$$C = 318\,000/Rf_c <pF> \quad (11)$$

Example: if a filter of this type were to be constructed for *f<sub>c</sub>* = 100 MHz, and *Z* = 50  $\Omega$ , the following component values are found: *C* = 63.6 pF, *L* = 79.6 nH

To improve the filter skirt steepness, several of these sections may be cascaded provided they have been designed for the same termination impedance. However, so-called *m*-derived sections at both LPF input and output may be a more efficient way to get the desired curve shape; see Fig 2b for the basic arrangement. With *L* and *C* calculated from (9), (10), and (11), the component values for these additional sections are computed from

$$L_1 = mL \quad (12)$$

$$C_1 = \frac{1-m^2}{4m} C \quad (13)$$

$$C_2 = mC \quad (14)$$

To understand how *m* is determined, refer to Fig. 2c which shows the frequency vs attenuation curve of the filter proposed in Fig. 2b. To be noted are the 'humps' which appear above *f<sub>c</sub>*; at *f<sub>∞</sub>*, the filter attenuation seems to be infinite, and this is repeated at regular intervals as *f* increases. The points of infinite attenuation are called poles and, generally speaking, the more filter sections, the more poles will appear; this also goes for high-pass sections, and, consequently, for band-pass filters which will feature poles at either side of the curve. The value of *m* is calculated from

$$m = \sqrt{1/f_c^2/f_{\infty}^2} \quad (15)$$

where *f<sub>∞</sub>* is the frequency of the first pole. Most designers, however, use the value 0.6 for *m*, which gives us

$$L_1 = 0.6L \quad (16)$$

$$C_1 = 0.27C \quad (17)$$

$$C_2 = 0.6C \quad (18)$$

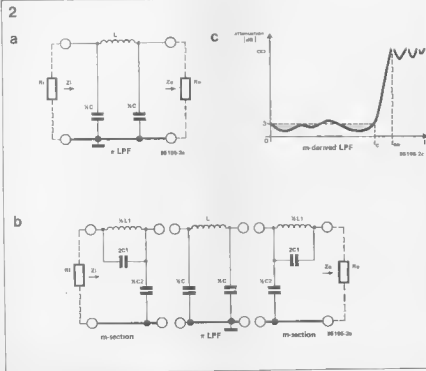

for the three-stage LPF of Fig 2b. There are several types of *m*-derived sections, and some of them are shown in Fig. 3. To go into the design calculations for the components in these sections would be beyond the scope of this article, and interested readers are referred to the numerous handbooks on this subject.

## VHF roofing filter

A practical example will no doubt be quite helpful at this stage; if only to get an idea of the practical problems involved in filter design and construction.

Figure 4 shows the circuit diagrams of precisely calculated filters with *m*-derived sections shown in Fig. 3. If the proposed LPF and HPF are cascaded, a band-pass filter may be obtained with suitable characteristics for selective VHF reception (85...110 MHz). Note the component values in LPF and HPF; they are, of course, theoretical. The term roofing filter is used to refer to the protec-

tive (i.e. selective) character of this device, which is intended to keep strong out-of-band signals away from the first active device in the aural booster, for reasons outlined above. Prototypes were made of these sections, and the LPF is shown in Photograph 1. Note the RP-tight construction in a brass enclosure and the short capacitor lead lengths to avoid stray inductance. The frequency curves of this LPF were examined with an RF sweep generator; Photograph 2a shows the roll-off characteristic and the first pole at about 130 MHz. Skirt steepness looks quite acceptable, and so does the pass-band attenuation; so far, so good. Sweeping the filter over a larger frequency range, however, reveals a quite unexpected peak in the UHF area; at 490 MHz, filter attenuation is only 13 dB, or about 5 times. As this frequency lies within TV band 4, there may still be trouble with a local transmitter despite the fact that the filter 'looks good' when swept over its target frequency range.

The rather disappointing results of these measurements, however, are still useful because we should be on our guard when looking at beautifully symmetrical curves of filters with low pass-band insertion loss, high Q factor, and near-perfect input and output matching, there are bound to be ugly peaks at frequencies well removed from the filter design frequency.

To finish this paragraph, Photograph 3 shows the impeccable band-pass curve of the roofing filter consisting of cascaded LPF and HPF to the designs of Fig. 4. Note the near-symmetrical profile and 3 dB bandwidth of about 25 MHz. Finally, it must be mentioned that the undesirable out-of-band peaks are mainly caused by the rather unpredictable, complex impedance of the filter for frequencies outside its pass-band range. Furthermore, the choice of capacitors plays an important role, so constructors who have read the following paragraphs may use the information given to produce a better version of this filter.



Photograph 4 A look at some filter components, upper row BNC type socket and plug, BNC plug for 10 mm diameter coax cable, home made N to BNC adapter Middle row split stator (butterfly) trimmer, ceramic tubular trimmer's chassis and PCB mount types, VHF coil Lower row leadless capacitors (chip types)

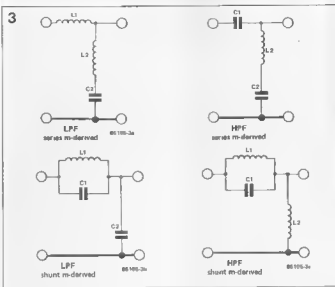

Fig 3 These are some of the simpler configurations for m-derived sections

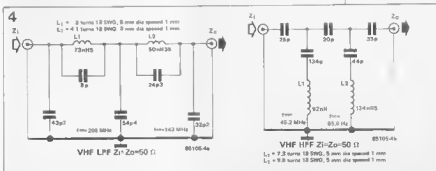

Fig 4 Circuit diagrams and coil winding data for LPF and HPF which, when cascaded, form a VHF roofing filter. Note that the filters use m-derived sections shown in Fig 3

## Filter matching

Filter design theory generally assumes ideal impedance matching at input and output. However, effects like out-of-band peaking can hardly be calculated because there are too many unknown variables involved. For a strong out-of-band signal, a four-element VHF Yagi type aural has a very unpredictable impedance, and so has the filter input.

Photograph 5  
This is a 5-stage  
helical filter for  
use in the 400 to  
500 MHz fre-  
quency range  
Coils are  
inductive-  
coupled and  
tuned with brass  
precision screws  
Note the low-  
impedance tap  
at input and out-  
put coil

The only known and stable impedance in the receiver RF chain is provided by the coaxial cable (50 or 75  $\Omega$ ).

The undesired signal, then, will find the filter input as highly unmatched, and a large part of the signal will be reflected into the cable, only to be reflected again by the aerial. The delaying effect of the coax cable added to the unavoidable phase shift and reflection cause a so-called **standing wave**. It will stand to reason that the filter input must be as **reflection-free** as possible for the desired frequency band, simply because a large part of the RF signal would else be lost to the active device. Furthermore, **filter insertion loss** must also be as low as possible, but, as we have seen, good band-pass profiles require many filter sections and thus many components to pass the signal, and neither of these has ideal (low-loss) characteristics. A total filter insertion loss of 0.5 to 1 dB is already a good figure, but it should be kept in mind that any insertion loss adversely affects the optimum noise figure of the active device coupled to the filter output.

## Filter construction

To conclude this article, some useful suggestions will be given for the choice of filter components and mechanical construction, because it ought to be clear by now that good filter calculation may be useless if the practical realization is not up to the 'VHF standard'. As these are mostly unwritten laws, it is very instructive to have a look at some of the established VHF construction methods in, for instance, a discarded VHF/UHF TV tuner.

**Coils:** Use 20 SWG or thicker silvered copper wire (CuAg) for the self-supporting, air-cored coils, and make sure that coils in separate filter sections can not 'see' each other to avoid unwanted stray coupling. In case the coils are PCB mounted, coupling can be avoided by positioning them at an angle of 90°. There are, however, also filter types that are based on inductive or capacitive coupling of coils to achieve a suitable bandwidth, e.g. helix type narrow band slot-coupled filters, in which case the above rule does not apply.

**Capacitors** To arrive at the calculated cut-off frequency, the capacitors must be close tolerance types (1 or 2%) with good high frequency characteristics (NPO or silver mica). Keep leads as short as possible to avoid introducing stray in-

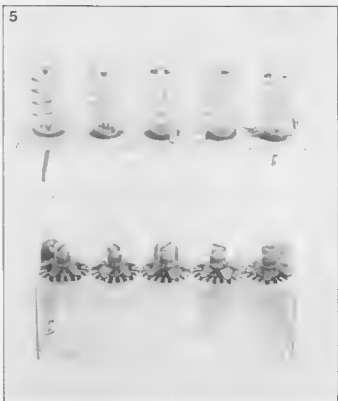

ductance in the circuit; where available, ceramic chip capacitors are the ultimate solution. Trimmers, if used, are preferably tubular glass or ceramic types with extremely low end capacity (1 pF or less); older types of TV tuner still contain them in abundance, but they are not easy to get out intact.

**Connectors.** Use standard 50  $\Omega$  plugs and sockets such as those in the UHF series (PL259-SO239), BNC or N types are even better, however, and much to be preferred. Do not ask for trouble by using the cheap coax connections as used with modern TV sets and FM tuners.

**Housing** The filter should be fitted in a stable metal housing (decast box) to prevent strong signals from bypassing. If at all possible, fit the amplifier in a separate housing and connect it to the filter output with a short length of low-loss coax cable fitted with BNC or N plugs; this also goes for the aerial-to-filter connection. Photograph 4 shows some preferred parts for VHF filter construction, and, finally, Photograph 5 shows a UHF type band-pass filter for professional use.

## Next time

A further instalment in this series will concentrate upon an up-to-date VHF

preamplifier stage constructed on the universal HF board. JB:JB

### Literature

*Radio Communication Handbook* vol. 1, publ. the Radio Society of Great Britain (RSCB)

*The Radio Amateur's Handbook*, publ. the American Radio Relay League (ARRL)

*Elektor Electronics*, February 1980 issue (UK)

*Reference data for Radio Engineers* 4th edition, pp 164-182, publ. IIT UKW Berichte 3-75, P. Lenx DL3WR: 'Rauschen in Empfangsanlagen'

This third part in the series presents an MSX busboard to overcome the limitations of that single slot on the computer; up to eight cartridges may be inserted and selected with keys or under software control.

# MSX

## EXTENSIONS - 3

### eight-slot bus board

Any MSX user in possession of several cartridges must at some time have wished to be relieved of the cumbersome cartridge-exchange procedure: power off — remove cartridge — insert cartridge — power on — test. Moreover, frequent cartridge exchanging may cause bad slot contacts after a while. Note that not all cartridges have an insert/remove protection fitted, so that it is sensible to always switch off computer power before exchanging any cartridges; it is better to be on the safe side!

The present eight-slot MSX busboard offers an interesting solution to these problems, because cartridges are now constantly available to the user; he need only issue a slot (i.e. cartridge) select instruction in MSX BASIC or press a single key to have the desired game or utility ready for use.

#### Block schematic

A functional diagram of the MSX busboard is shown in Fig. 1. All MSX computer signals have been buffered for safe use with the cartridges; this is customary practice with computer expansion projects to avoid overloading the available computer output signals.

One of eight slots is selected by the

DECODE SELECT section; the active slot (cartridge) is indicated by a lighted LED. Slot selection is effected either manually or by software; depending on the data transfer direction set by the DATA SELECTOR, either three databus bits (software) or three bits from the manual slot selection circuit ENCODE SELECT are passed to the DECODE SELECT section which decodes the three bit combination into a relevant slot select signal.

The DATA SELECTOR is set to databus transfer by a signal from the I/O SELECT DECODER section which compares the eight-bit address LSB (least significant byte) during CPU output with a switch-set output channel code; when the two bytes match, i.e. the computer selects the desired output channel, the DATA SELECTOR transfers the three-bit slot selection code supplied with the output instruction to the DECODE SELECT section, and the desired slot is selected. Similarly, the manual slot selection code may be passed to DECODE SELECT whenever the I/O SELECT DECODER is inactive.

#### Practical circuit

Circuit diagram Fig. 2 shows how a

number of integrated circuits realize the above mentioned functions. Databus Buffer IC<sub>1</sub> is an octal bidirectional device enabled with MSX signal SLTSL (slot select), while direction of data transfer is determined by the logic level of RD (read); this was so arranged because using WR (write) for this purpose more readily leads to bus contention problems due to critical signal timing.

Output pin 19 of 8-bit magnitude comparator IC<sub>2</sub> will only go low when two conditions are met: the address set with switch block S<sub>0</sub> matches the CPU-generated address LSB and IORQ is active (i.e. logic low), which indicates that the eight bits are a valid output channel currently addressed by the CPU. The SEL input of multiplexer IC<sub>3</sub> is consequently low and this device will pass D<sub>0</sub>-D<sub>7</sub> from the databus to the A-B-C inputs of IC<sub>7</sub>. The multiplexer may conveniently be compared to a four-pole two-position switch where the position of the switch is determined by the logic level applied to the SEL input. If SEL is at low level, data transfer nA → nY is effected (software slot selection), else nB → nY (manual slot selection). Thus, latching 3-to-8 decoder IC<sub>7</sub> may receive its slot selection code from two sources, and it activates the output corresponding to the binary

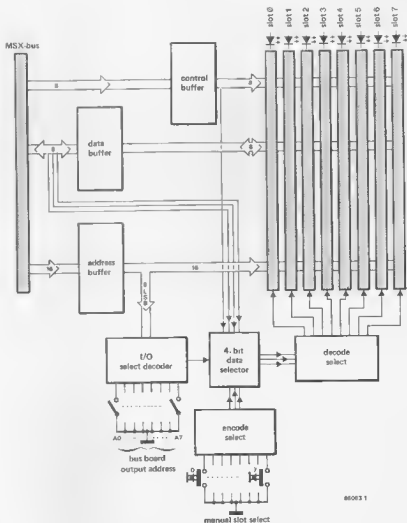

Fig 1 Block schematic presentation of the MSX bus board. Any one of eight slots may be selected either by software or manually with a set of switches

code applied to the A-B-C inputs on the low-to-high transition of the logic level at the GL (latch enable) input. In this way, one of eight MSX slots plus relevant LED may be activated. The latching function of IC<sub>2</sub> is essential to operation of the present circuit; the device holds the last applied binary code and activates the corresponding output until a further low-to-high level transition at its GL input signals the presence of a new slot select command. In the case of software slot selection, WR supplies the latching pulse, whereas for manual selection combination of gates N<sub>1</sub>-N<sub>2</sub> simulates a correctly timed WR signal.

Manual slot selection is effected by IC<sub>3</sub> and associated keys S<sub>1</sub> to S<sub>8</sub>; if the user wants to enable a specific cartridge by hand, he may simply press the appropriate key to override any previous slot selection command. When one of the keys S<sub>1</sub> to S<sub>8</sub> is pressed, priority encoder IC<sub>3</sub> supplies the three-bit binary code relevant to the number of the key, and output GS (group select) goes low. This pulse, together with E<sub>0</sub>, triggers the WR simulator. Key S<sub>0</sub> selects slot 0, which is also the default slot after power-up; thus, any cartridge present in slot 0 will be automatically selected when the computer is switched on. Should any keys be

pressed simultaneously, then the one with the lowest number has highest priority.

In case the power supply inside the computer is not able to handle the current consumption of the cartridges on the bus board, the supply voltage connections may be removed to connect an external power supply to the relevant pins (+5V, +12V, -12V). However, **check and double-check** that external power is applied to the **correct** pin, i.e. the one that connects to the cartridge bus lines. If this precaution is not observed, irreparable damage may be inflicted on vital (i.e. costly) computer parts. Unfortunately, one

Fig. 2 Circuit diagram of the MSX eight-slot bus board. Note the application of 74HC(T) IC types which ensure extremely low power consumption

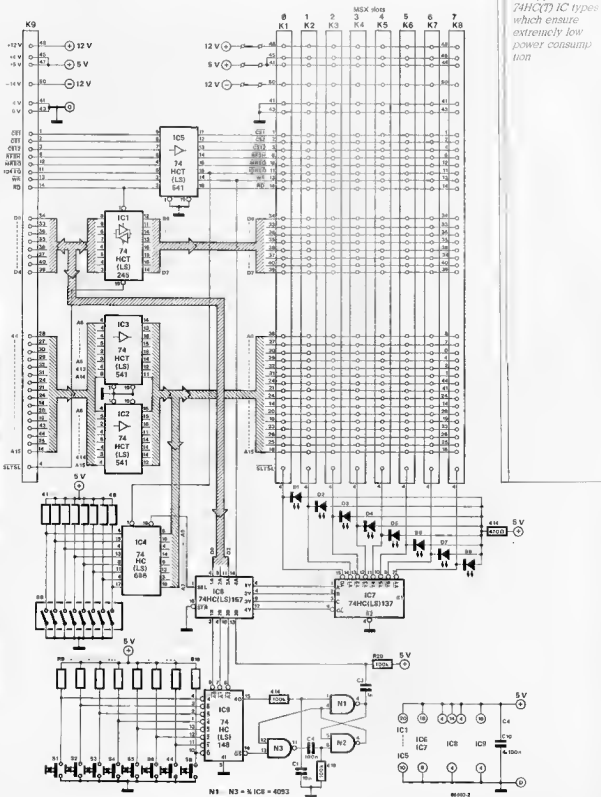

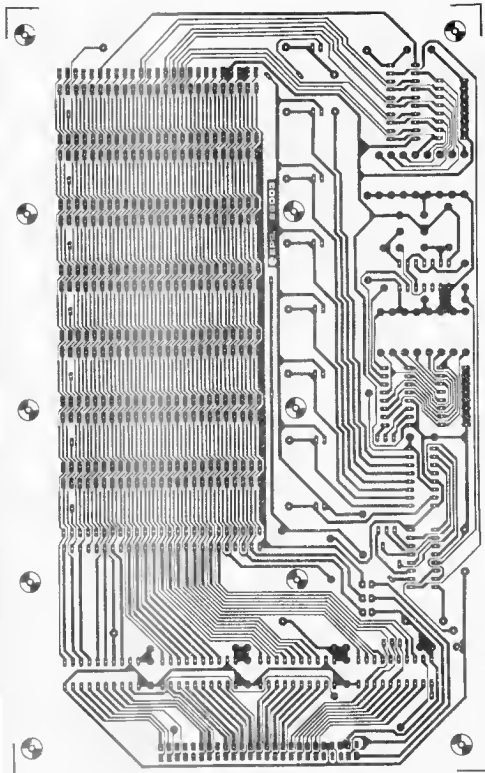



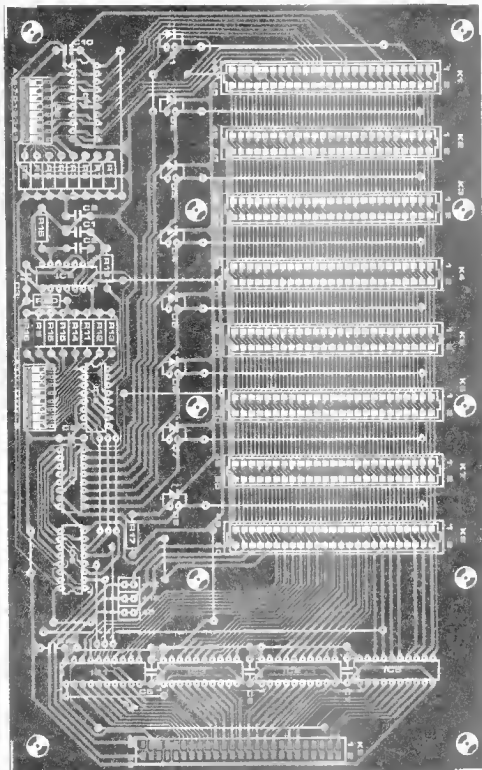

#### Parts list

##### Resistors

- R<sub>1</sub> - R<sub>10</sub> 10k  
 R<sub>11</sub> - R<sub>12</sub> 470Ω  
 R<sub>13</sub> - R<sub>14</sub> 100k

##### Capacitors

- C<sub>1</sub> - C<sub>10</sub> 10n  
 C<sub>11</sub> - C<sub>12</sub> C<sub>13</sub> 100n  
 C<sub>14</sub> 1n

Diodes unless for  
 (see text)

- IC<sub>1</sub> 74HC(T) LS245  
 IC<sub>2</sub> 1C<sub>1</sub>, IC<sub>3</sub> 74HC(T)  
 LS541  
 IC<sub>4</sub> 74HC(T) LS688  
 IC<sub>5</sub> 74HC(T) LS157  
 IC<sub>6</sub> 74HC(T) LS137  
 IC<sub>7</sub> 4093  
 IC<sub>8</sub> 74HC(T) LS148  
 D<sub>1</sub> - D<sub>4</sub> LED 3mm

##### Miscellaneous

- S<sub>1</sub> - S<sub>4</sub> - see text  
 S<sub>5</sub> 8 way SPST DIL  
 switch block  
 K<sub>1</sub> - K<sub>4</sub> 50 way slot  
 connector 0.1 inch  
 pitch  
 K<sub>5</sub> 50 way (2 rows of  
 25 pins) PCB mount  
 plug  
 6 off soldering pins  
 PCB 86003

mistake may have detrimental consequences, and it is therefore strongly suggested to mark the relevant soldering pin.

## Construction

The ready-made PCB for the MSX bus board is shown in Fig 3; its dimensions are mainly determined by the eight slot connectors  $K_1 \dots K_8$  and the necessary space for the cartridges.

Construction is best started with fitting the wire links, followed by the IC sockets and the six soldering pins for external supply connection. For the time being, these pins may be jumpered with wires.

The component mounting plan shows a block of eight DIP switches for output address selector  $S_1 \dots S_8$  and slot selection keys  $S_1 \dots S_8$ . The latter, however, may be replaced by eight small push-to-make keys, connected to the bus board via a length of flat ribbon cable and a DIP header. In this case, a normal 16-way IC socket is fitted on the board instead of the DIP switches. The constructor is free to make a nice looking slot-select keypad with a LED to go with every key.

A noteworthy aspect of the present design is the application of high-speed CMOS ICs (HC or HCT types) which results in very low power consumption and a high degree of immunity to digital noise. More information on these novel devices may be found in *Elektor India* October 1983 issue. However, where 74HC(T) types are not yet available, the well-known 74LS

equivalents may also be used in this circuit.

## Computer connection

Last month's article in this series on MSX add-on units (introduced a cartridge extension board which basically consisted of an adapter plug and an EPROM section (see *Elektor India* March 1986 issue).

The present bus board may be connected to this 50-way plug with a length of 50-way flat ribbon cable equipped with suitable press-on type sockets — see Fig. 4.

With the bus board completed and no cartridges inserted as yet, connect the extensions as indicated and verify that the computer still functions as normal. The LED with slot 0 should light at this stage. Set a slot selection output channel on the bus board with switch block  $S_1$  for instance  $3F_{hex}$ . This is done as follows: first, establish the binary code of the channel, in this case  $3F_{hex} = 00111111 (A_7 \dots A_0)$ .

Next, set this code with the eight switches, but note that 'switch = on' corresponds to 'bit = low (0)', and also remark the order of the switches as arranged on the board. Output channel  $3F_{hex}$  corresponds to this combination of  $S_1$  (left to right): on-on-off-off-off-off-off-off ( $A_0 \cdot A_1 \cdot A_2 \cdot A_3 \cdot A_4 \cdot A_5 \cdot A_6 \cdot A_7$ ).

Set this combination and see if the LED with slot 4 ( $K_4$ ) lights when instruction OUT &H3F,4 is issued in MSX BASIC. If this works, test the manual slot selection by pressing

some of the keys to see whether the desired slot is selected as indicated by the corresponding LED.

Switch off power and insert cartridges, but remember to plug them in with the front (label) side towards the computer connector  $K_1$ ; it is sensible to mark slot pins 1 with a spot of white paint to avoid inserting cartridges the wrong way about. Fig 5 once more shows the MSX slot pin designation with signal functions. The universal I/O bus may also be connected to the present bus board (see *Elektor Electronics*, January 1986 issue). With this amount of computer expansion available, it would be fair to say that MSX interfacing is truly up-to-date and ready for almost any task that has to do with peripheral control.

GD:BL

Fig. 5 Recapitulation of MSX slot signal functions

Fig 4 Connecting the bus board to the cartridge extension board with a length of flat ribbon cable effectively enables MSX users to install a total of eight cartridges

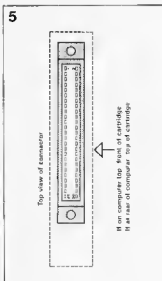
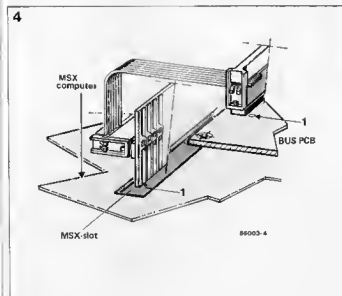

# INDUCTORS IN PRACTICE

*In spite of their apparent simplicity, inductors none the less often pose problems, because invariably they cannot be obtained ready-made, i.e. they have to be designed and wound by the constructor. This article aims at removing some of the obscurities surrounding this subject and showing that making an inductor is not such a daunting task as some think.*

An inductor is an electronic component that possesses appreciable inductance. Self-inductance is the property of a circuit to oppose any changes in current flowing through the circuit; this manifests itself by the production of a voltage that tends to oppose the change of current. This voltage is called the back-e.m.f. Mutual inductance is the phenomenon whereby voltage is induced in one circuit by changing the current in another. The unit of both self- and mutual inductance is the same: the henry, but their respective symbols are  $L$  and  $M$  (or  $L_{12}$ ). An inductor has an inductance of 1 henry if the back-e.m.f. in it is 1 volt, when the current through it is changing at the rate of 1 ampere per second. Inductors invariably consist of many turns of wire wound adjacent to one another on the same support, called the former, but in high-frequency applications they are often self-supporting (i.e., air-cored). The former may also be of ferromagnetic material to

increase the inductance many hundreds of times. Unfortunately, so-called eddy currents are induced in the ferromagnetic material, and these increase the DC resistance in a practical inductor. Powdered-iron cores are, therefore, used at high frequencies because their high resistivity makes eddy-current losses negligible. Such ferrite materials are not as useful as iron at low frequencies, however, because magnetic saturation restricts the maximum power level of the inductor. Inductors have a frequency-dependent resistance (called reactance) to AC currents, and an ohmic resistance, which is primarily due to the wire from which the inductors have been wound. The reactance,  $X_L$ , is equal to  $\omega L$ , where  $\omega = 2\pi f$ , in which  $f$  is the frequency of operation, and  $L$  is the inductance in henries. The ratio of the reactance to the ohmic resistance, i.e.  $\omega L/R$  is called the  $Q$  (quality) factor of the inductor. The combination of reactance and resistance is called

the impedance,  $Z$ .

An inductor is generally called a choke if its main purpose is to present a high reactance to AC currents. At high frequencies it is often sufficient to run the supply or bias lines in a circuit through small ferrite beads to effectively prevent these lines picking up (and radiating) RF signals.

Where spurious coupling with other circuit elements is to be avoided, the diameter of the choke should be kept small as a practical way of narrowing the magnetic field around it. Pol cores are another means of obviating radiation and spurious coupling. Nowadays, designers have a wide choice of cores and formers for all types of application. It should be noted that a wide range of standard RF chokes is available from most good electronics suppliers. These components are usually wound on a ferrite core and are encapsulated to prevent stray fields around them. The  $Q$ -factor of these chokes is often good

enough to allow their use in tuned circuits. However, if they are to be used in filters, they should have a resistance of not more than 0.8 ohm per milli-henry, and they must be ferrite-encapsulated. Non-encapsulated types must be separated by at least one diameter, or an earthed screen placed between them.

## *Inductors in tuned circuits*

Inductors for use in tuned circuits, such as oscillators and filters, should normally be specially wound for the purpose to ensure correct inductance, resistance,  $Q$ -factor, and dimensions. Losses in inductors are mainly due to the resistance of the wire used for winding the inductor, and the so-called *skin-effect*. Since RF currents travel mainly along the surface of a wire, this is often silvered to keep IPR losses low. Where large wire diameters are necessary to achieve a certain inductance, it is possible to

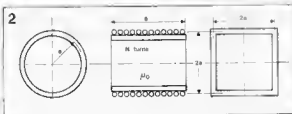
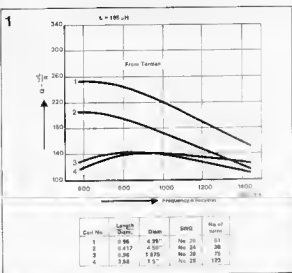

use hollowcopper tube to wind the inductor, since this may considerably lower its total costs and weight; from an RF point of view, it makes no difference whether the wire is hollow or solid, because of the skin-effect. However, it should also be noted that a solid wire has considerably lower resistance than a hollow wire of identical diameter. Since an increase in resistance inevitably causes a lower Q factor (see formula (10)), the hollow tube is generally only used for relatively low frequency applications, where considerable currents flow, e.g. in the case of short-wave power amplifier tank coils, or antenna tuning units. As already discussed, designing for a known Q factor is accomplished by careful consideration of a number of factors that relate to practical inductor winding data. To illustrate the relative importance of these factors, Fig. 1 shows a number of Q factor curves obtained with different winding data to obtain a given inductance. From these and

*Fig. 1 These curves show that the Q factor of an inductor strongly depends on its winding data*

*Fig. 2 These coil data provide the necessary information for the inductance calculations*

*Fig. 3 Correlation between number of turns and inductance for a number of wire and former diameters*

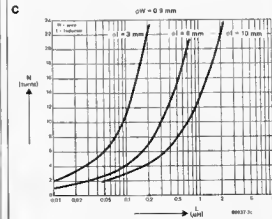
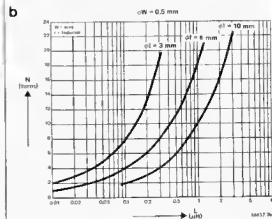
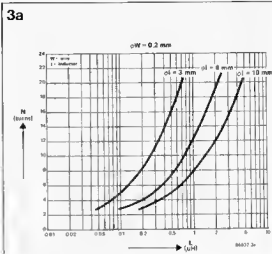

Listing 1. This program, written in MBASIC, will come up with the number of turns for a circular or square inductor, given the target inductance, wire and coil diameter

#### Listing 1

```

10 PRINT "INDUCTOR DESIGN"
20 INPUT "WIRE DIAMETER (INCHES):"; D
30 INPUT "TARGET INDUCTANCE (HENRIES):"; L
40 INPUT "COIL DIAMETER (INCHES):"; CD
50 INPUT "COIL LENGTH (INCHES):"; CL
60 INPUT "PERMEABILITY (RELATIVE):"; MU
70 INPUT "WIRE TYPE (1=ENAMELED, 2=ALUMINUM):"; WT
80 INPUT "WIRE COLOR (1=RED, 2=GREEN, 3=BLUE, 4=BLACK):"; WC
90 INPUT "WIRE GAUGE (AWG):"; WG
100 INPUT "WIRE WEIGHT (POUNDS):"; WW
110 INPUT "WIRE LENGTH (FEET):"; WL
120 INPUT "WIRE AREA (SQ INCHES):"; WA
130 INPUT "WIRE PERMITTIVITY (RELATIVE):"; WEP
140 INPUT "WIRE RESISTIVITY (OHM INCHES):"; WR
150 INPUT "WIRE TEMPERATURE (DEGREES F):"; WTMP
160 INPUT "WIRE TENSILE STRENGTH (POUNDS):"; WTS
170 INPUT "WIRE YIELD STRENGTH (POUNDS):"; WYS
180 INPUT "WIRE ELONGATION (%):"; WE
190 INPUT "WIRE MODULUS OF ELASTICITY (POUNDS/SQ INCH):"; WME
200 INPUT "WIRE THERMAL EXPANSION COEFFICIENT (PER DEGREE F):"; WTEC
210 INPUT "WIRE THERMAL CONDUCTIVITY (BT/INCH DEGREE F):"; WTK
220 INPUT "WIRE THERMAL CAPACITY (BT/INCH DEGREE F):"; WTC
230 INPUT "WIRE THERMAL RESISTANCE (DEGREES F/WT):"; WTR
240 INPUT "WIRE THERMAL STABILITY (PERCENT):"; WTSB
250 INPUT "WIRE THERMAL SHOCK RESISTANCE (PERCENT):"; WTRB
260 INPUT "WIRE THERMAL STRESS (POUNDS/SQ INCH):"; WTSB
270 INPUT "WIRE THERMAL STRAIN (%):"; WTSB
280 INPUT "WIRE THERMAL STRESS RATE (POUNDS/SQ INCH/DEGREE F):"; WTSBR
290 INPUT "WIRE THERMAL STRAIN RATE (%/DEGREE F):"; WTSBR
300 INPUT "WIRE THERMAL STRESS RATE (POUNDS/SQ INCH/DEGREE F):"; WTSBR
310 INPUT "WIRE THERMAL STRAIN RATE (%/DEGREE F):"; WTSBR
320 INPUT "WIRE THERMAL STRESS RATE (POUNDS/SQ INCH/DEGREE F):"; WTSBR
330 INPUT "WIRE THERMAL STRAIN RATE (%/DEGREE F):"; WTSBR
340 INPUT "WIRE THERMAL STRESS RATE (POUNDS/SQ INCH/DEGREE F):"; WTSBR
350 INPUT "WIRE THERMAL STRAIN RATE (%/DEGREE F):"; WTSBR
360 INPUT "WIRE THERMAL STRESS RATE (POUNDS/SQ INCH/DEGREE F):"; WTSBR
370 INPUT "WIRE THERMAL STRAIN RATE (%/DEGREE F):"; WTSBR
380 INPUT "WIRE THERMAL STRESS RATE (POUNDS/SQ INCH/DEGREE F):"; WTSBR
390 INPUT "WIRE THERMAL STRAIN RATE (%/DEGREE F):"; WTSBR
400 INPUT "WIRE THERMAL STRESS RATE (POUNDS/SQ INCH/DEGREE F):"; WTSBR
410 INPUT "WIRE THERMAL STRAIN RATE (%/DEGREE F):"; WTSBR
420 INPUT "WIRE THERMAL STRESS RATE (POUNDS/SQ INCH/DEGREE F):"; WTSBR
430 INPUT "WIRE THERMAL STRAIN RATE (%/DEGREE F):"; WTSBR
440 INPUT "WIRE THERMAL STRESS RATE (POUNDS/SQ INCH/DEGREE F):"; WTSBR
450 INPUT "WIRE THERMAL STRAIN RATE (%/DEGREE F):"; WTSBR
460 INPUT "WIRE THERMAL STRESS RATE (POUNDS/SQ INCH/DEGREE F):"; WTSBR
470 INPUT "WIRE THERMAL STRAIN RATE (%/DEGREE F):"; WTSBR
480 INPUT "WIRE THERMAL STRESS RATE (POUNDS/SQ INCH/DEGREE F):"; WTSBR
490 INPUT "WIRE THERMAL STRAIN RATE (%/DEGREE F):"; WTSBR
500 INPUT "WIRE THERMAL STRESS RATE (POUNDS/SQ INCH/DEGREE F):"; WTSBR
510 INPUT "WIRE THERMAL STRAIN RATE (%/DEGREE F):"; WTSBR
520 INPUT "WIRE THERMAL STRESS RATE (POUNDS/SQ INCH/DEGREE F):"; WTSBR
530 INPUT "WIRE THERMAL STRAIN RATE (%/DEGREE F):"; WTSBR
540 INPUT "WIRE THERMAL STRESS RATE (POUNDS/SQ INCH/DEGREE F):"; WTSBR
550 INPUT "WIRE THERMAL STRAIN RATE (%/DEGREE F):"; WTSBR
560 INPUT "WIRE THERMAL STRESS RATE (POUNDS/SQ INCH/DEGREE F):"; WTSBR
570 INPUT "WIRE THERMAL STRAIN RATE (%/DEGREE F):"; WTSBR
580 INPUT "WIRE THERMAL STRESS RATE (POUNDS/SQ INCH/DEGREE F):"; WTSBR
590 INPUT "WIRE THERMAL STRAIN RATE (%/DEGREE F):"; WTSBR
600 INPUT "WIRE THERMAL STRESS RATE (POUNDS/SQ INCH/DEGREE F):"; WTSBR
610 INPUT "WIRE THERMAL STRAIN RATE (%/DEGREE F):"; WTSBR
620 INPUT "WIRE THERMAL STRESS RATE (POUNDS/SQ INCH/DEGREE F):"; WTSBR
630 INPUT "WIRE THERMAL STRAIN RATE (%/DEGREE F):"; WTSBR
640 INPUT "WIRE THERMAL STRESS RATE (POUNDS/SQ INCH/DEGREE F):"; WTSBR
650 INPUT "WIRE THERMAL STRAIN RATE (%/DEGREE F):"; WTSBR
660 INPUT "WIRE THERMAL STRESS RATE (POUNDS/SQ INCH/DEGREE F):"; WTSBR
670 INPUT "WIRE THERMAL STRAIN RATE (%/DEGREE F):"; WTSBR
680 INPUT "WIRE THERMAL STRESS RATE (POUNDS/SQ INCH/DEGREE F):"; WTSBR
690 INPUT "WIRE THERMAL STRAIN RATE (%/DEGREE F):"; WTSBR
700 INPUT "WIRE THERMAL STRESS RATE (POUNDS/SQ INCH/DEGREE F):"; WTSBR
710 INPUT "WIRE THERMAL STRAIN RATE (%/DEGREE F):"; WTSBR
720 INPUT "WIRE THERMAL STRESS RATE (POUNDS/SQ INCH/DEGREE F):"; WTSBR
730 INPUT "WIRE THERMAL STRAIN RATE (%/DEGREE F):"; WTSBR
740 INPUT "WIRE THERMAL STRESS RATE (POUNDS/SQ INCH/DEGREE F):"; WTSBR
750 INPUT "WIRE THERMAL STRAIN RATE (%/DEGREE F):"; WTSBR
760 INPUT "WIRE THERMAL STRESS RATE (POUNDS/SQ INCH/DEGREE F):"; WTSBR
770 INPUT "WIRE THERMAL STRAIN RATE (%/DEGREE F):"; WTSBR
780 INPUT "WIRE THERMAL STRESS RATE (POUNDS/SQ INCH/DEGREE F):"; WTSBR
790 INPUT "WIRE THERMAL STRAIN RATE (%/DEGREE F):"; WTSBR
800 INPUT "WIRE THERMAL STRESS RATE (POUNDS/SQ INCH/DEGREE F):"; WTSBR
810 INPUT "WIRE THERMAL STRAIN RATE (%/DEGREE F):"; WTSBR
820 INPUT "WIRE THERMAL STRESS RATE (POUNDS/SQ INCH/DEGREE F):"; WTSBR
830 INPUT "WIRE THERMAL STRAIN RATE (%/DEGREE F):"; WTSBR
840 INPUT "WIRE THERMAL STRESS RATE (POUNDS/SQ INCH/DEGREE F):"; WTSBR
850 INPUT "WIRE THERMAL STRAIN RATE (%/DEGREE F):"; WTSBR
860 INPUT "WIRE THERMAL STRESS RATE (POUNDS/SQ INCH/DEGREE F):"; WTSBR
870 INPUT "WIRE THERMAL STRAIN RATE (%/DEGREE F):"; WTSBR
880 INPUT "WIRE THERMAL STRESS RATE (POUNDS/SQ INCH/DEGREE F):"; WTSBR
890 INPUT "WIRE THERMAL STRAIN RATE (%/DEGREE F):"; WTSBR
900 INPUT "WIRE THERMAL STRESS RATE (POUNDS/SQ INCH/DEGREE F):"; WTSBR
910 INPUT "WIRE THERMAL STRAIN RATE (%/DEGREE F):"; WTSBR
920 INPUT "WIRE THERMAL STRESS RATE (POUNDS/SQ INCH/DEGREE F):"; WTSBR
930 INPUT "WIRE THERMAL STRAIN RATE (%/DEGREE F):"; WTSBR
940 INPUT "WIRE THERMAL STRESS RATE (POUNDS/SQ INCH/DEGREE F):"; WTSBR
950 INPUT "WIRE THERMAL STRAIN RATE (%/DEGREE F):"; WTSBR
960 INPUT "WIRE THERMAL STRESS RATE (POUNDS/SQ INCH/DEGREE F):"; WTSBR
970 INPUT "WIRE THERMAL STRAIN RATE (%/DEGREE F):"; WTSBR
980 INPUT "WIRE THERMAL STRESS RATE (POUNDS/SQ INCH/DEGREE F):"; WTSBR
990 INPUT "WIRE THERMAL STRAIN RATE (%/DEGREE F):"; WTSBR
1000 INPUT "WIRE THERMAL STRESS RATE (POUNDS/SQ INCH/DEGREE F):"; WTSBR

```



other experimental data, the following rules of thumb have emerged to obtain a high Q factor:

- 1 The ratio of the inductor length to diameter should be between 0.5 and 2.
- 2 The ratio of inductor to wire diameter must be greater than about 5.
- 3 For long coils, the spacing between turns should be 0.7 times the wire diameter. Short coils are best close-wound, or, where this is less desirable, with a turn-spacing not wider than 0.3 times the wire diameter may be used. (Literature reference 1).
- 4 Silvered wire is preferable for winding inductors for operation at frequencies above 300 MHz. (strip lines, Lecher lines, UHF filters).

## Inductance calculation

There are a number of formulas for the calculation of inductance, and these usually start from the physical characteristics shown in Fig. 2. Note, how

ever, that any inductance calculation is only a mathematical approximation, which gets closer to the actual inductance when it becomes more complex. To obtain very close approximations, the following formulas may be used (refer to Fig. 2):

$$L = \mu n^2 a (\log_e(1 + \pi ab)) + \frac{1}{2} (2.3 + 1.6b/a + 0.44(b/a)^2) <H> \quad (2)$$

for circular coils, and

$$L = \mu n^2 a (4/\pi \log_e(1 + \pi ab)) + \frac{1}{2} (3.64 + 2b/a + 0.51(b/a)^2) <H> \quad (3)$$

for square coils, where  $a$  and  $b$  are the inductor sizes in metres as indicated in Fig. 2,  $L$  is in henries, and  $\mu$  is the absolute permeability standard, defined as  $4\pi \times 10^{-7}$  <H/m>.

The three charts shown in Fig. 3 give inductor winding data for a number of popular wire and former diameters, but the computer program of listing 1 allows a great many more possibilities for fast calculation of inductor winding data, both for

circular and square inductors. The latter are perhaps less known among designers, but square inductors may be used as window mounted, multi-turn rhombic aerials for directive reception of medium- and long-wave signals.

The computer program listed has been written in MBASIC, and may require a patch here and there to suit the specific screen and cursor commands at some computers. For spaced inductors, the program uses an iterative approximation routine, which supplies a start value (guess) to the main calculations and adapts the variables to step towards maximum accuracy. Obviously, the better the guess, the faster the program will come up with the result, since in that case less calculation time is required. It stands to reason that n-step iteration is practically not feasible with only a pencil and a cheap calculator, since far too much time would be wasted before a useful result is obtained. Therefore, the number crunching facilities offered

by the computer are welcomed by many designers of air-cored inductors.

J.B.L.



Literature references.  
 1) Proceedings of the IEE, Vol. 70 no 12, December 1982: Wheeler, H. A. Inductance formulas for circular and square coils.  
 2) Radio Engineers Handbook, by F. E. Terman, McGraw-Hill.

# Light work for submarine cables

by Kenneth Fitchew, British Telecom Research Laboratories, Martlesham Heath, Ipswich

*Submarine cables have entered a new era with the application of optical technology, making them compatible with digital networks ashore. During 1985 the world's first international optical-fibre submarine cable was laid between the UK and Belgium, bringing a new economy to this means of international communication.*

It is well over 100 years since the first submarine telecommunications cables were laid. The Atlantic Ocean was spanned successfully in 1866, an event that opened the first age of submarine cables, the telegraph cables. They were simply insulated conductors; on long routes they caused a great deal of attenuation and distortion of signals at even very low frequencies, so they could be used only for low-speed telegraph signals. And their gutta-percha insulation was often attacked by teredo worms.

The development of the thermionic valve provided a means of amplifying signals at intervals along a cable; this allowed higher frequencies to be transmitted over long distances, and meant that a number of speech channels could be carried on one cable. In 1943 British Telecom (then the British Post Office) laid the world's first experimental submarine telephone

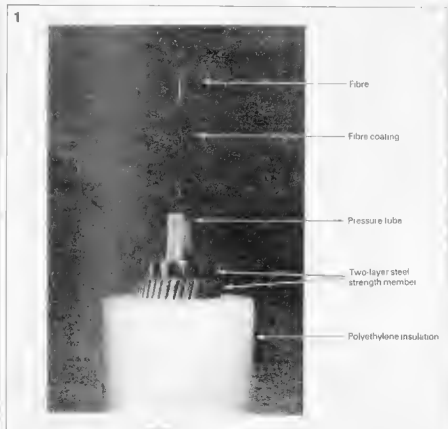

Sample of deep-water optical cable made by STC

repeater in a cable between the Isle of Man and mainland Britain, and in 1956 a repeatered telephone cable carrying 36 circuits was successfully laid across the Atlantic Ocean, firmly establishing the arrival of the age of the coaxial cable. This type of system has been developed over the years and systems with capacities of up to 5520 circuits using frequencies up to 45 MHz have been supplied by Standard Telephones and Cables (STC). Coaxial cables are providing excellent service around the world and new ones are still being ordered.

Developments in technology have now reached a point where we are on the threshold of the third age, that of the optical-fibre cable. Optical systems offer several advantages. First, they should be cheaper, mainly because they use fewer repeaters; in the first

generation of optical systems the repeater spacing is about 40 km, seven times greater than that of the latest coaxial systems. Second, more traffic-carrying circuits are available, because several fibre pairs can be included in one cable and the development of systems using higher data transmission rates is quite feasible. Third, optical cables are better suited to digital operation, and so are more compatible with the worldwide move to digital communications. The world's first reported trial of an experimental optical submarine cable was carried out in Loch Fyne, Scotland, by British Telecom and STC in 1980. This has been followed by trials from all those other countries with an interest in making submarine systems, namely Japan, USA and France. The world's first international optical-fibre submarine cable has been provided

between the UK and Belgium by STC. The cable, code-named *UK-Belgium 5*, will eventually carry 11 520 circuits linking the UK to Belgium, the Netherlands and West Germany. The system contains six fibres, three operating in each direction and each carrying data at an information rate of 280 Mbit/s. The system length is 113 km, with three repeaters.

## Optical fibres

The basic principles of optical-fibre transmission were established by Hackham and Koa, working at Standard Telecommunications Laboratories in the UK in 1966. For most submarine applications the high data-rates and long spans make it essential to use monomode fibre rather than the more well known multimode fibre.

transmits light in only one transmission path (see diagram on page 3) so eliminating multipath dispersion, but its small core size makes it more difficult to use. Monomode fibre can now be made with an attenuation of less than 0.4 dB/km at a wavelength of 1.3  $\mu\text{m}$ ; the manufacturing process needs to be well controlled to ensure not just low loss, but good concentricity at the core and adequate strength.

## Design

The design requirements for optical submarine cable are severe because of the physical environment. The cable must be capable of withstanding pressures of 70 MPa in areas as deep as 7.3 km, and tensile loads of several tonnes when being picked up during repair work. Owing to the movement of a cables ship on the sea the tensile force on the cable during recovery is a static load with a cyclic variation; this means the cable has to withstand fatigue.

In most optical submarine cables the fibres are protected within a tube which provides a pressure-resistant structure. It also carries longitudinal steel wires to provide the necessary tensile strength. However, a cable with a single layer of stranded steel wires as a strength member has a rather low modulus of elasticity, so under tension it stretches partly through extension of the steel and partly through the strand untwisting. But the silica fibres are far less elastic than steel, so they may break.

Three possible ways round this problem are to make fibre that is very strong and can withstand the stress, to include 'slack' fibre in the cable, or to design a strong cable which can cope with high tensile loads without undue strain. The third ap-

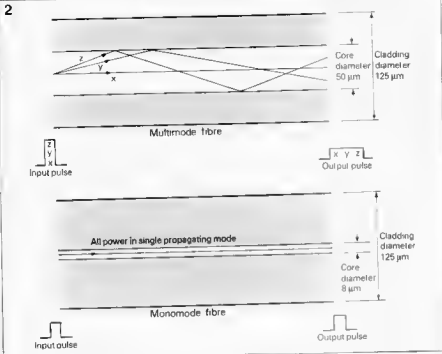

In multimode step-index fibre (a) the different propagation modes may be represented as ray paths ( $x, y, z$ ) which are of different lengths and therefore have different transmission times (delays). Because a pulse divides between the modes it is subject to progressive spreading as it travels along the fibre, causing it to interfere with adjacent pulses. In monomode fibre (b) the core diameter is comparable with the wavelength of the light, so there can be only electromagnetic propagation mode and spreading of the pulse is eliminated.

proach is used in cable made in the UK. Its strength member consists of two layers of steel wires wound with opposite lays so that there is no untwisting under tension. With shallow-water cables a main danger is from fishing trawls. One way to protect them is to surround the cable with steel armour wires; they provide resistance to abrasion and add to the strength. Coaxial cables have been protected in this way for many years, using one or two layers of armour wires wound with a relatively long pitch. However, tests here have shown that a much more resistant cable can be made by winding the outer layer of armour wires with a very short pitch; this type of cable, known as 'rock' armour, has been used in the North Sea in areas known to be especially hazardous.

## Burial

A second way of protecting the cable is to bury it in the sea-bed. Where possible the preferred method is immediate burial by means of a plough towed behind the cableship. For *UK-Belgium 5* the cable was buried for most of the route using a new plough being built in the UK. In British Telecom conjunction with the

Danish Posts and Telegraphs Department. It differs from most existing ploughs for submarine telecommunications cables in that the plough blade has been designed to disturb the sea-bed as little as necessary, to give immediate, good cover with the added advantage of reducing the towing force needed. In areas of the *UK-Belgium 5* route where burial is not possible, rock armour cable was used.

## Repeaters

The repeater housings contain optical regenerators, one for each fibre, with equipment for power feed and remote fault location. An optical regenerator has four main parts: a receiver comprising a photodiode and an amplifier; an electrical decision circuit; a retiming unit, and a transmitter which includes a semiconductor laser. The regenerator examines every element, or 'bit' of received digital signal and generates it anew for onward transmission. Most of the regenerator consists of high-speed electronic circuits; the circuit functions are far more complex than those of repeaters for coaxial systems which often use simple, three-transistor amplifiers. So it has been

necessary to progress from using separate transistors to employing integrated circuits (ICs). The requirements for the ICs are very demanding. First, they must handle data at rates in excess of 300 Mbit/s, which means using emitter-coupled logic (ECL) circuits. ECL is suitable for high-speed operation because the saturation states of the transistors are controlled to avoid conditions requiring significant recovery times. Furthermore, the circuits allow signals to be passed between electronic gates using balanced arrangements that avoid the parasitic inductance encountered when local earth is used as the return path. Second, the ICs must be very reliable: the target failure rate for a complete transoceanic system is a maximum of three failures in 25 years, and that includes all type of component. For ICs themselves, the target is better than one failure in 25 years from 15 000 devices.

In the UK, the problem of IC designs has been approached by building on previous experience of semiconductors. For many years British Telecom Research Department has manufactured high-reliability silicon transistors for use in coaxial submarine systems. The last generation of these was the Type 40 transistor sup-

plied by BT for use in the 45 MHz repeaters manufactured by STC. The same fundamental technology has been used to construct ICs for use in optical repeaters, building on the proven reliability of the Type 40. Processing technology for this includes the use of a special gold-titanium metallization process which is inherently very reliable; other processing techniques are substantially the same as for the Type 40, though certain additional steps are necessary in making a complete IC. In this way a series of ICs known as ECL40 has been developed for use in *UK-Belgium 5*. The silicon-diffused transistors and resistors of the ICs are in the form of an uncommitted array, whereby various circuit configurations can be obtained simply by using different metallization patterns to connect the transistors and resistors. Because metallization is the last step in processing the silicon wafer, this approach means that to provide a new circuit to do a particular job only a new metallization pattern has to be made instead of new designs of diffusions as well as metallizations, which have to be made for fully custom-designed ICs. After metallization the individual silicon chips are mounted in ceramic chip carriers and are rigorously tested to ensure reliability.

Other key components used in optical regenerators include the lasers and photodiodes, and Surface Acoustic Wave (SAW) filters, used in the retiming circuits to filter the clock frequency signals from the data stream. Lasers and photodiodes used in most optical systems at 1.3  $\mu\text{m}$  are based on the compound III-V semiconductor InGaAsP, but germanium avalanche photodiodes are proposed for receivers by some manufacturers. The task of producing suitable lasers from

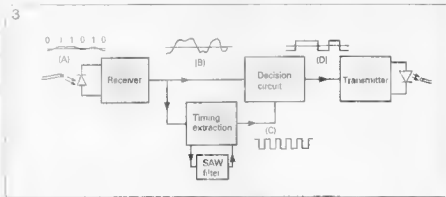

In an optical regenerator the pulse train (A) is converted to an electrical signal in the receiver and amplified (B). A timing extraction circuit filters out a clock signal (C) using a SAW filter. The clock controls the decision circuit to ensure that signal (B) is sampled at the correct instants. A regenerated waveform (D) drives the laser, to transmit the optical signal onwards.



InGoAsP has proved far from easy, but suitable devices are now available and undergoing life tests.

## Other planned cables

In addition to UK-Belgium 5, other contracts for optical submarine cables are in hand. The *AT-8* cable is due to be laid in 1988, linking the USA with the UK and France, using a submerged branching unit on the edge of the European continental shelf. The firm ATT of the USA is to provide the main transatlantic link from the USA to the branching unit, STC and the French company Submarcom are providing the links from the UK and France to the branching unit. A cable spanning the Pacific Ocean is planned on a similar time-scale, to be made by the USA and Japan; other systems, both long and short, are under

discussion. Short systems at up to 150 km offer interesting possibilities, for developments in optical technology means that spans of this length can now be contemplated without having to use intermediate repeaters, giving a useful saving in cost. Such systems will offer an attractive option on routes which are too long for satisfactory performance from microwave radio links.

## Cable or satellite

Arguments of the relative merits of satellites and cables are very complex. Each case must be treated on its own merits bearing in mind technical, economic and political factors. Nevertheless, there are a few broad principles that may help in understanding some of the factors influencing decisions about

which to use. First, satellite and cable links both continue to get cheaper as each new generation offers lower cost per circuit. Second, a signal crosses the Atlantic ocean by cable in about 30 ms, whereas with satellites now in use the delay is about 260 ms because of the high orbit required for geostationary operation. This means that cable circuits have advantages for certain applications of speech and data. Third, cable tends to be cheaper on short routes because cost is roughly proportional to length. For satellite circuits, the cost is independent of length, making satellites progressively more competitive on longer routes. Fourth, cable is essentially a point-to-point carrier and is especially appropriate for routes with a reasonable concentration of traffic. Satellites may be more appropriate where tight traffic originates over

a wide area. Fifth, submarine cables have a design life of 25 years, as opposed to between seven and ten years for satellites. Cable therefore becomes more attractive for a longer-term view of financial planning. Last, many telecommunications administrations like to use a mix of circuits of different types for diversity and security. It now seems certain that the introduction of optical technology to submarine cables will increase the demand for cable circuits and there is good reason to believe that circuit costs will continue to fall as the technology is developed.

LPS

# HIGH-RESOLUTION COLOUR GRAPHICS CARD — 7

*After the general programming information given in part 5 of this series (see *Elektron Electronics* — January 1986), the present article enables any user to get the video interpreter up and running on his computer system.*

## Hexadecimal patching

Owing to lack of space, the video interpreter developed for the high-resolution card (see *Elektron India* February 1986) can not be presented in the form of a source

listing to assist users who wish to make their own modifications to it. None the less, the hexadecimal dump provided with this article, together with the information below, will be sufficient help to adapt the interpreter for any individual purpose. Here are the main points to observe for patching the program:

- The address of the initialization routine is B000, that of CHROUT is B003, while that of the (optional) character reception subroutine is B006. When CHROUT is called, the character to be transmitted must be present in the CPU accumulator.
- The graphics card selection addresses are E152, .E15F





# INTERCOM



A domestic intercom doesn't require a complicated circuit. The unit described here uses only a handful of components, even though an automatic gain control has been incorporated in the circuit.

This intercom was designed to meet two requirements: low cost and high performance.

To keep the cost down, the output stage is nothing more than a two-transistor class-A stage that can deliver 100 mW. To maintain good intelligibility in spite of this low power output stage, an automatic gain control is incorporated. This ensures that the output stage will nearly always be fully driven. To keep the cost of this gain control down, an OTA is used as the preamplifier - its gain is a function of a DC bias current. Small 150  $\Omega$  loudspeakers are used both as microphone and as loudspeaker

## The circuit

Switch S1 is the master 'press-to-talk'

button. When this switch is depressed, the loudspeaker in the main station (the upper loudspeaker in the diagram) is connected to the input of the amplifier. When the button is released, the other loudspeaker is connected.

Resistors R2, R4 and capacitor C1 produce a smoothed DC bias voltage for the OTA. R5 and C4 are included in the input circuit to reduce clicks during switch-over from 'talk' to 'listen'; they also reduce the effect of interference pulses picked up by the (long) leads from the substation.

The output signal from the OTA is fed to the 'power' output stage T2 and T3. This stage only gives a voltage gain of a factor 2, its primary function is current gain, to drive the loudspeaker. S1 is

wired in such way that the output is fed to the loudspeaker that is not being used as microphone at that moment. Understandably . . .

The automatic gain control is derived from T1 with its associated components. This transistor is connected as a current source. The maximum current it can supply to the bias input of the OTA (pin 5) is

$$\frac{0.6 \text{ V}}{470 \Omega} = 1.2 \text{ mA.}$$

This corresponds to a maximum gain of the OTA of 2500 x. When the output voltage rises above a certain level, current starts to flow through D3. This raises the base voltage of T1 towards the supply level, thereby reducing the current through T1. This in turn reduces the gain of the OTA. This automatic gain control action is 'tamed' by including C5.

## Installation

In most cases, the wiring to the sub-

### Parts list

#### Resistors:

R1 = 47 k  
R2 = 22 k  
R3, R4, R6 = 10 k  
R5, R10 = 1k2  
R7 = 10 M  
R8 = 470  $\Omega$   
R9 = 33  $\Omega$   
R11 = 1 M  
R12, R13 = 2M2  
R14, R15 = 1 k

#### Capacitors:

C1, C3 = 100  $\mu$ /16 V  
C2, C5 = 10  $\mu$ /16 V  
C4 = 100 n  
C6 = 2 $\mu$ /16 V  
C7 = 100  $\mu$ /25 V

#### Semiconductors:

IC1 = CA3080  
T1 = BC857B, BC117B, 2N1211  
T2 = BC517 (darlington)  
T3 = BC160, BC161, 2N3653  
D1 . . . D3 = DUS, 1N4148

#### Sundries:

Cooling fan for T3  
2 loudspeakers, 150  $\Omega$ /1 Watt  
Switch or pushbutton, 2P2T

#### power supply

Trafo 12 . . . 15 volt, 100 mA  
Fuse 100 mA slow blow (and fuse holder)  
Bridge rectifier B40C400  
1000  $\mu$ , 25 V etco



station can be normal two-core cable. However, if the distance is too great or if the leads run close to mains wiring it may be necessary to use single-core screened cable.

Since the output stage is running in class-A, the current consumption is too high for battery operation. It would be possible to use batteries if an on/off switch is included in the main station, but this would mean that the substation cannot initiate the conversation. For

1

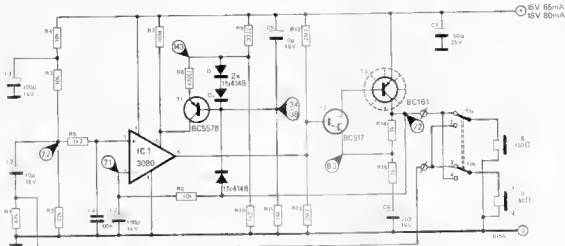

2

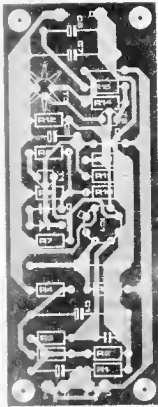
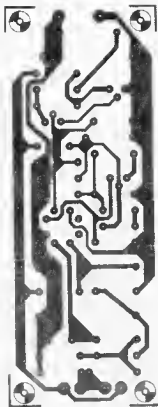

battery operation, the supply voltage can be reduced to 9 V, although this will reduce the output level.

A better solution is to use a mains-driven supply. A transformer with a 12...15 V secondary which can supply 100 mA is sufficient. Connect this to a bridge rectifier followed by a 1000  $\mu$  25 V smoothing electrolytic.

The gain of the intercom will vary between a maximum of 5000 x and a minimum of 150 x, depending on the

Figure 1. The circuit of the intercom. T1 is the main component in the automatic gain control circuit.

Figure 2. The printed circuit board and component layout for the intercom. Switch S1 and the two loudspeakers are connected to points 1...4, as shown in the circuit diagram.

Photo. A finished unit. Note the way the cooling fan is mounted on T3. A common mistake is to mount it 'upside down', but this makes it much less effective.

automatic gain control. The maximum is set by R8, increasing the value of this resistor will reduce the maximum gain. Do not decrease the value, as this can damage the IC. The minimum is set by the value of R7; this should not be altered.

S1 can be either a switch or a push-button, according to taste. In either case, it should be a break-before-make type.

# MAGNETISER

During the second 'Bioclimatological Colloquium' which took place in September 1976 in Munich, a report was presented of a series of experiments carried out initially by Professor Dr. R. Mecke of the University of Freiburg and continued by several researchers of the University of Tübingen (Dr. W. Ehrmann, Dr. W. Ludwig et al.). 920 patients who complained of psychosomatic ailments were treated with a device which is the model for the 'magnetiser' described in this article. Of these 920 patients, 220 received a placebo, i.e. the device was a dummy. The complaints of the patients included insomnia and chronic headaches; since 1975 patients suffering from such ailments as migraine, neuralgia, extra-articular rheuma, damaged joints, neck and back pains, skin allergies, bronchial asthma, travel sickness and fear of heights have also been treated. It is significant that during the above experiment, the patients required approx. 50% less medication than normal. The overall results of the experiment (shown in table 1) are quite remarkable, particularly when one bears in mind that they are far better than the results obtained by the use of pharmaceuticals.

The figures given are all from a report released by W. Ehrmann, W. Ludwig, and their colleagues at Tübingen University. Our thanks go to Dr. Ludwig for his co-operation in the preparation of this article.

The device which is described in the remainder of the article, is of the same type as that used in the above experiment. It should be stressed that, although Flektor cannot offer any guarantees as to the efficacy of this treatment, the device is by no means to be considered in the same light as copper bracelets and old potatoes, but rather is a scientifically based approach which merits serious medical consideration.

## The effect of magnetic fields

The penetration of an alternating electromagnetic field is determined by its frequency. As long as the frequency is in the ELF (Extremely Low Frequency) range, the electric field can be ignored. The alternating magnetic field

Recent medical experiments have lent weight to the idea that magnetic fields are of therapeutic value in the treatment of psychosomatic complaints and rheumatic ailments.

The following article, which is preceded by details of a controlled experiment into the efficacy of this method of treatment, describes a device which will produce an alternating magnetic field of the type suitable for medical use.

on the other hand, will induce eddy currents throughout the entire organism, thereby causing shifts in the charge of the cell membranes. This stimulates the nervous system, removing any blockages which may exist.

For example, it was noticed that at frequencies below 8 Hz, a widening of the blood-vessels occurred, whilst at frequencies above 12 Hz the blood-vessels became narrower.

Experiments have also shown that the sensitivity of an individual to magnetic fields can be quite frequency-dependent. It is at a maximum at the frequency which coincides with the alpha-rhythm of that person's EEG. This is readily explicable in the light of the fact that externally induced pulses will obviously have the greatest effect upon pulses with which they are synchronous.

Steeper pulses which have a large number of harmonics produce better results than sinusoidal fields of similar amplitude. However the rise time need not be shorter than the response time of the tissue.

The therapeutic ELF-frequencies lie between approx. 0.5 Hz and 20 Hz, and can be subdivided into 4 treatment-specific groups.

- 1 . . . 3 Hz, counteract infections,
- 4 . . . 6 Hz, have a soothing effect, and counteract muscular spasm;
- 8 . . . 11 Hz, act as an analgesic, as a tonic, and exert a stabilising influence;
- 13 . . . 20 Hz, for patients who suffer from over-tiredness, these frequencies have the same effect as 8 . . . 11 Hz have upon 'normal' patients.

The last group of frequencies is only used when lower frequencies have had no result. The 4 . . . 6 Hz range should not be used whilst the patient is engaged in activities which require increased concentration (e.g. operating machinery, driving etc.).

Treatment with magnetic fields is not known to produce any side-effects, although persistent use may result in a lessening of its efficacy. It is therefore recommended that, for the time being, a treatment session should not last longer than 15 minutes. Patients with a heart pacemaker should not be treated with the lowest frequency range unless it is known for certain that it will not react to the magnetic field.

For normal use, i.e. when not applied to a localised area of pain, the magnetiser can be carried in a jacket pocket or waist pouch. If used when lying down, it can be placed under the neck or beneath a cushion or pillow.

## The circuit

Figure 1 shows the circuit diagram of the magnetiser. The circuit contains two stable multivibrators, one of which (N1/N2) oscillates at approx. 1.15 Hz, the other (N3/N4) at either 4.4 Hz, 9.7 Hz or 14.2 Hz, as selected by S1 . . . S3 respectively. Some further

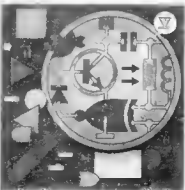

**Table 1**

| No | Number of patients/<br>devices | Frequency,<br>[Hz] | Field strength<br>(max.) | symptoms                                 | Success<br>No. | rate<br>% |
|----|--------------------------------|--------------------|--------------------------|--|----------------|-----------|
| 1  | 430 <sup>1</sup>               | 9-10               | ca 100 A/m               | psychosomatic<br>complaints              | 375            | 87%       |
| 2. | 70 <sup>2</sup>                | 4-12               | ca 200 A/m               | psychosomatic<br>complaints and<br>pains | 63             | 90%       |
| 3  | 200 <sup>1</sup>               | 1-15               | ca. 200 A/m              | rheumatic pains                          | 194            | 97%       |
| 4  | 160 <sup>2</sup>               | 10                 | -                        | psychosomatic<br>complaints              | 33             | 21%       |
| 5  | 60 <sup>2</sup>                | 4-12               | -                        | rheumatic<br>pains                       | 12             | 20%       |

1 = properly functioning device  
2 = dummy device

frequencies are obtained by closing more than one of the switches.

S1 + S2 = approx. 3.0 Hz;

S1 + S3 = approx. 3.4 Hz;

S2 + S3 = approx. 5.8 Hz;

S1 + S2 + S3 = approx. 2.5 Hz.

Transistor T1 is turned on and off in time with the chosen frequency. The pulsed collector current magnetises the core of coil L1, which consists of 600 turns of 0.2 mm diameter enamelled copper wire (38 SWG). In the Elektor lab a normal 'steel' bolt 40 mm long and 6 mm in diameter was used as the core. The coil may be scramble wound, i.e. the turns need not be wound in layers. The resultant field strength is comparable with that obtained from commercially available devices.

To prevent possible risks arising from a defect in the second AMV, it is recommended that in devices intended for use by patients with a heart pacemaker, components R1, R2, R5, R1 C) and C5 are not soldered onto the p.c.b., and that the free input of N1 be connected to the positive supply rail.

**Figure 1.** Circuit diagram of the magnetiser. The device requires only a small number of inexpensive components and is therefore cheap to build.

**Figure 2.** Copper side and component layout of the printed circuit board for the magnetiser (EPC9827).

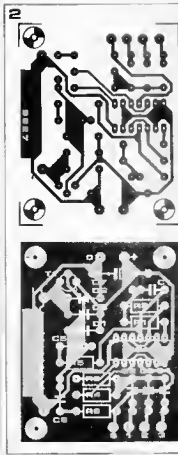

**Parts list.**

**Resistors:**  
R1, R4 = 4M7  
R2 = 2M2  
R3 = 10 M  
R5, R6 = 4k7

**Semiconductors:**  
IC1 = 4011  
T1 = BC557B, BC177B  
D1, D2, D3 = 1N4148

**Capacitors:**  
C1 = 180 n  
C2 = 22 n  
C3 = 10 n  
C4 = 6n8  
C5, C6 = 15 n  
C7 = 47 μ/10 V

**Miscellaneous:**  
S1, S2, S3 = SPST switch  
L1 = see text

**Bibliography:**

G. Altmann, (1969). Die physiologische Wirkung elektrischer Felder auf Organismen Arch. Met. Geoph. Biokl. 17: 169-290.

S.M. Bawin, L.K. Kaczmarek, W.R. Adey (1975) Effects of Modulated VHF Fields on the Central Nervous system, ANN New York Acad. Sc., USA, 247: 74-81.

D.E. Belscher, J.D. Grasser, R.E. Mitchell, (1973). Exposure of Man to Magnetic Fields Alternating at Extremely Low Frequency. NAMRL-1180.

Dokumenta Geigy (1968): 109-123

W. Ehrmann, H. v. Leitner, W. Ludwig,

M.A. Persinger, W. Sadtke, R. Thomas

(1976): Therapie mit ELF-Magnet-

feldern. Z. Phys. Med., 5: 161-170.

W. Ehrmann, H. v. Leitner, W. Ludwig,

M.A. Persinger, W. Sadtke, R. Thomas

(1976): Entwicklung eines elektro-

medizinischen Taschengeraets.

Acta Medicotechnica, 24: 282-285.

N. Geyer, G. Fischer, H. Riedl,

H. Strampfer, (1976): The effect of an

Artificial Electroclimate on Physiological

Values. Arch. Met. Geoph. Biokl.

Ser. B, 24: 111-112.

E.S. Maxey, (1975). Critical Aspects of

Human versus Terrestrial Electro-

magnetic Symbiosis, UNSC/URSI-

IEEE Meeting, Boulder, Colorado, USA

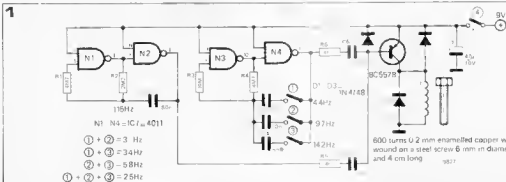

# Digi-Course II

## Chapter 5

We described the divider circuits based on Flipflops in the last chapter of Digi Course-II. We have seen that by feeding a series of pulses at the input of a Flipflop, we get only half the number of pulses at the outputs of the Flipflop. The input pulses toggle the Flipflop ON and OFF for every pulse, alternately. By cascading many such Flipflops together, it is possible to obtain a division by 4, 8, 16 . . . . .

1

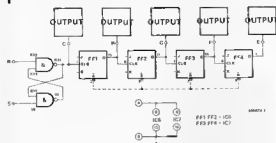

It can be easily observed that the output indicator LEDs light up in form of a binary number. That is, if we designate a glowing LED as "1" and an extinguished LED as "0", we get the group of 4 LEDs to represent a series of binary numbers. These binary numbers are shown in table 1

Table 1

| Input Pulses (Qscms) | Outputs E F G H (Binary) |
|----------------------|--------------------------|
| 0                    | 0000                     |
| 1                    | 0001                     |
| 2                    | 0010                     |
| 3                    | 0011                     |
| 4                    | 0100                     |
| 5                    | 0101                     |
| 6                    | 0110                     |
| 7                    | 0111                     |
| 8                    | 1000                     |
| 9                    | 1001                     |
| 10                   | 1010                     |
| 11                   | 1011                     |
| 12                   | 1100                     |
| 13                   | 1101                     |
| 14                   | 1110                     |
| 15                   | 1111                     |
| 16                   | 0000                     |

As can be seen from the sequence of binary numbers and the corresponding number of pulses, the group of 4 LEDs functions as a pulse counter. This pulse counter can count from 0 to 16, and is suitable for hexa decimal system. With the 16th pulse, the counter resets to 0000 and starts counting again.

Our observation about the cascaded dividers also applies to the counter, each additional Flipflop increases the counting capability by a factor of 2. Thus a counter with 5 Flipflops cascaded together would count from 0 to 32. It will reset on the 32nd pulse. A counter with 6 Flipflops will count from 0 to 64 and so on.

An adaptation of the hexadecimal counter to the decimal system is already known to us and it is given here again in figure 2. This counter resets to 0000 on the tenth pulse

2

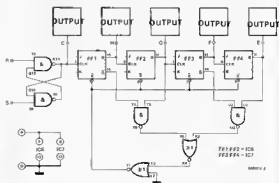

The decoder part using gates T, U, X and Y reacts to the binary combination 1010. We can reorganise the decode also to react to another binary combinations like 1100, which, then will reset on the 12th pulse and will function as a Duodecimal counter

3

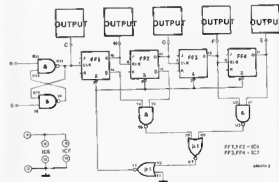



This type of decoder circuits are very important to the Computer Technology. The Central Processing Unit, (CPU) which is the brain of the computer works with various peripheral devices like the Keyboard, CRT Screen, Printer etc.

The CPU can select the desired peripheral by sending a binary code to the decoder circuit, which decodes the binary code and turns ON the Interface to that particular peripheral device.

Even in the Digital Technology, decoders have an important place. The most commonly encountered decoders digital circuits are the BCD-to-Decimal decoders and BCD to 7-Segment decoders. The standard ICs available for these functions are 7442 and 7447. Figure 4 shows the pin connections of 7442.

4

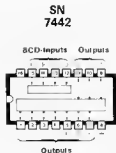

This IC can convert the output values available at the outputs E,F,G,H of our decimal counter to the corresponding decimal number. The particular pin corresponding to that decimal number is made "0" by the decoder, whereas all other 9 pins remain "1".

This decoder is not suitable for driving a seven segment digital display, which is the most commonly used display device in digital technology.

The seven segment LED display consists of seven tiny bar shaped LEDs arranged to make the figure of 8. The decoder IC 7447 has seven outputs which are connected directly to these seven segments (in practice, current limiting resistors are also used, one for each segment).

5

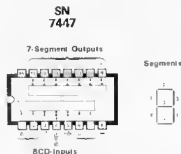

6

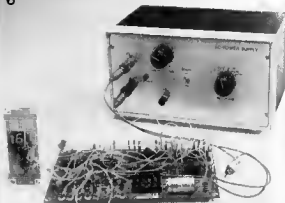

Let us go back to our decimal counter again. The 4 gates used in the decoder specifically react only to the 1010 combination. It will also be enough to decode only the 1st and 3rd binary position to check if it is "1". Decimal ten is the first number which gives a "1" at the 1st and 3rd binary position simultaneously. If this condition is used to reset the counter, the remaining decimal numbers which also give rise to this condition, will never be encountered as the counter will always reset on the tenth pulse. This simplified decoding arrangement is shown in figure 7.

7

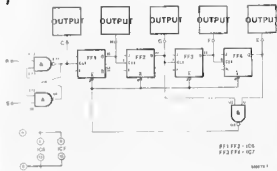

The simplified decoder is called an "incomplete Decoder" compared to the Complete Decoder shown in figure 2. However, even when using the incomplete decoder, the first combination that resets the counter is 1010, and remaining combinations like 1011, 1110 and 1111 are never allowed to reach.

Another important point to note is the spurious triggering that many take place and affect the functioning of the circuit. To take care of this problem, connect all unused inputs to "1" (Pins 4/9, 12/16, 2 and 7).

# CAPACITORS

"Guess what I have got today, it looks like a candy, has two legs, has a low resistance in the beginning when measured with a multimeter but shows open circuit after some time I have taken it out from my old pocket radio"

"Well, candy reminds me of Condensers! Show me what you have brought!"

"O K , I'll show you what it is"

"Oh! it is really a Condenser"

"What kind of resistance is this?"

"No, it is not a resistance, it is a Condenser, or a Capacitor"

"But my multimeter showed a low resistance in the beginning and then it went on increasing to infinity"

"I will explain it later first let us see what the Condenser does"

"If it sort of a resistor that slowly opens up to a high value?"

As a matter of fact, Condensers have nothing to do with resistance. Condensers, more commonly called Capacitors, store electrical charge. When current is allowed to flow into a Capacitor, it accumulates the charge flowing into it. The Capacitor is said to be charged. When we provide a conducting path to this charge, it can flow out of the Capacitor once again.

"Then why these Capacitors are not called Accumulators?"

"Capacitors and Accumulators do have similar function, but Accumulators are slower than Capacitors in charging and they can store much more charge compared to the Capacitors. Capacitors are quickly charged and discharged."

"Which is the circuit symbol used for Capacitors?"

"The Capacitor symbol consists of two parallel bars, which represent the two Capacitor plates."



"What are these plates? I don't see any plates in this Capacitor!"

"The symbol of plates has come because of the old Condensers which really consisted of two large metallic plates insulated from each other and placed parallel to each other."

"These two simple plates can store electrical charge?"

"Yes, however, they must be quite large and must be separated by a very small distance. Such plates are not used any more. The plates are now replaced by thin aluminium foils, separated by a thin insulating plastic

film. To increase the total area of the foil, this sandwich of foils is rolled up to make the Capacitor, the two wires coming out from the capacitor are internally connected to these two aluminium foils."

"Wait a minute, you just said that these two foils are totally insulated from each other?"

"That is right!"

"Then how did the multimeter show a low resistance in the beginning?"

"Yes, that happens only for a brief period, during which the charging current flows into the capacitor. After that, the multimeter slowly goes towards infinite resistance. The battery inside the multimeter provides the charging current to the capacitor through the test terminals. When a multimeter measures resistance, what it really does is, it measures current flowing through that resistance and knowing the voltage available at the test terminals, the reading is directly calibrated in Ohms. When the charging current flows through the capacitor, an equivalent resistance value is shown by the multimeter. As soon as the capacitor is fully charged, the current stops and the multimeter shows infinite resistance."

"This is exactly similar to the Accumulator. But what voltages do these capacitors have?"

"I don't understand what you are saying, what voltages can the Capacitors have?"

"Like 1.2 Volts of the Nickel-Cadmium Accumulator batteries!"

"Oh, if that is what you mean, the capacitors have no such voltages. The uncharged Capacitor has no voltage on it, and as the charge builds up, the voltage goes on increasing."

"You mean the voltage on the Capacitor is an indication of the filling level of the Capacitor?"

"Yes, and one must always consider the storage capacity of a particular Capacitor. In case of large Capacitors, the voltage increases slowly than in case of small capacitors."

"Like in a bucket the water level rises quickly than in a bath tub."

"Quite right! But to be more precise a capacitor can be compared to a tube in the cycle tyre. The pumping of air is initially quite easy, because the tube is empty, and becomes more difficult as the pressure inside the tube builds up. The pressure inside the tube can be compared to the voltage on the Capacitor and the air can be compared to the charge in the Capacitor."

"Can a Capacitor also burst like the tube if we try to force more charge onto it and raise the voltage beyond its limits?"

"Even this is true in capacitors, they can rupture or even burst with a loud noise if a high voltage is applied beyond its specified value."

"Well, then we can even design a voltage operated bomb using capacitors!"

# Different Types Of CAPACITORS

The basic principle behind all capacitors is same, there are two metallic surfaces parallel to each other, insulated from each other and each connected to a terminal. However there are many different types of materials and methods of construction being used in the manufacture of capacitors.

The insulating material between two metal surfaces is known as dielectric materials. A plastic film is generally used as dielectric material.

Figure 1 shows one method of making a tubular

capacitor. Two long strips of metal foil and dielectric foil are placed alternately and rolled up to make a tubular capacitor. Two wires are connected to the two metallic foils and brought out as the two terminals of the capacitor.

Figure 2 shows the construction of a plastic film capacitor, which is made up of a number of aluminium and plastic foils stacked one above the other. These two methods are very efficient, because they practically double the metallic surface area available from each foil. Each foil has surfaces

of the other foil parallel to on both the sides.

Many manufacturers have also developed techniques for depositing aluminium layer on plastic film which is then used to roll up and make the capacitors. Ceramic and Mica are seldom used as film capacitors. Both these materials are used in capacitors for high frequency applications like Radio and TV.

Electrolytic capacitors are made by using a paper strip soaked in an electrolyte as the insulating material.

After manufacturing these capacitors are subjected to a voltage which makes the electrolyte react with the metal foil and produce a very thin oxide film, on the positive side.

Electrolytic capacitors have very high capacitance, even upto several thousands of  $\mu\text{F}$ . The highest capacitance manufactured uptill now is 1F (1,000,000  $\mu\text{F}$ ). The polarity is very important in case of electrolytic capacitors, because reversal of polarity results in destroying the oxide layer.

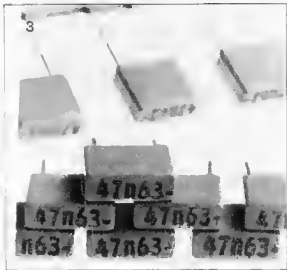
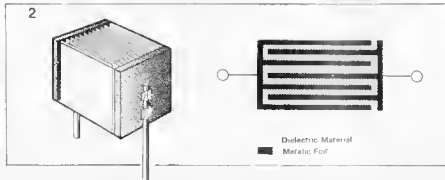
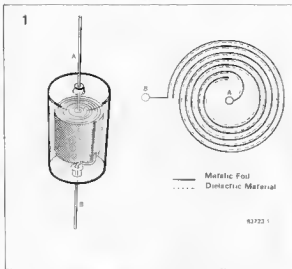

Figure 1  
A tubular capacitor, the aluminium and plastic foils are alternately arranged.

Figure 2  
Metal and plastic foils used in a plastic film capacitor.

Figure 3  
Film capacitors sheathed with a plastic sleeve. They are so small that there is not enough space for writing the full data 47 nF 63V which has been shortened to just 47 n63.



Figure 4  
Laquered ceramic capacitors



Figure 5  
Typical texture of the large electrolytic capacitors in the aluminum can

The dielectric strength is generally low in these film capacitors. This results in comparatively low voltage ratings for the electrolytics. Tantalum capacitors is a modern development in electrolytic capacitors. The size is very small in case of these type of capacitors.

Variable capacitors used in tuning circuit of large Radio sets use air as the dielectric insulating medium and have truly solid metal plates which are grouped alternately. They are evenly spaced and one of the groups can be rotated around a common axis so that the two groups of plates can be interposed more or less with each other to increase or decrease the capacitance. Miniature types of variable capacitors are made from thin metal foils and plastic film dielectric. These metal foils are grouped alternately together and one group is rotated around a common axis to change the effective interposed area. This, in

turn, varies the capacitance. Commonly used variable capacitors have very low values, generally around 100 pF (1 pF = 1 Pico Farad =  $10^{-12}$  Farad). Most common application for these variable capacitors (Gang Condensers) is in the tuning circuits of radio receivers.

One of the recent developments in variable capacitors is the capacitance diodes. These are specially designed semiconductor devices which are used in reverse biased condition and possess a variable capacitance that depends on the applied voltage.

Figure 5  
The 'Gang Condenser' with aluminum plates alternately grouped to increase the total area. The position of the plates connected to the shaft decide the effective capacitance.

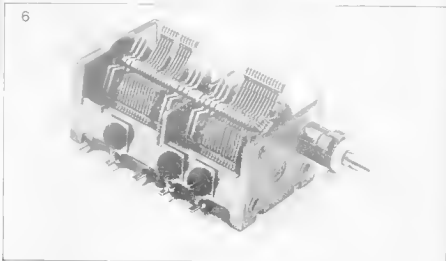

# CAPACITORS

## in series/parallel connection

We have already studied the series and parallel connections of two resistors. Two capacitors can also be connected in series or parallel combination. However, the result is totally different. Figure 1 shows a parallel combination of two capacitors. The values of individual capacitors and  $C_g$  is the effective value of the combination.

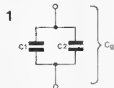

Figure 1  
Parallel connection of capacitors, which increases the capacity.

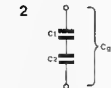

Figure 2  
Series connection of capacitors, which decreases the effective capacity but increases the allowable voltage across the combination.

The effective surface available is increased by the parallel connection and as the total capacity is proportional to the area of the plates, the effective capacity is obtained by adding the two individual values.

$$C_g = C_1 + C_2$$

This relation is quite useful in practice to obtain non standard values by just

adding up standard values through parallel connections. For example, a 20 nF capacitor will not be available as a standard value and to obtain 20 nF we can connect two 10 nF capacitors in parallel. The formula for parallel combination of capacitors is similar to the formula for a series combination of resistors.

$$R_g = R_1 \cdot R_2$$

The converse is also true. The formula for a series combination of capacitors is same as that for the parallel combination of resistors.

$$\frac{1}{R_g} = \frac{1}{R_1} + \frac{1}{R_2}$$

$$\text{or } R_g = \frac{R_1 \times R_2}{R_1 + R_2}$$

Similar formula for capacitors in series is

$$\frac{1}{C_g} = \frac{1}{C_1} + \frac{1}{C_2}$$

or  $C_g = \frac{C_1 \cdot C_2}{C_1 + C_2}$

Thus a series connection of capacitors gives an effective value which is less than both individual values of the capacitors. This type of combination is useful in obtaining nonstandard values as well as for increasing the voltage rating. In case of AC voltages series combination of capacitors can also be used as voltage divider.

# THE FILTER CAPACITOR

The filter capacitor used in battery eliminators is a simple form of stabilising circuit. It is just a single passive device which does quite an effective job. It stabilises the pulsating D.C.

voltage coming out of the rectifier bridge by its charging and discharging characteristics.

Figure 1 shows the circuit of a simple battery eliminator. The mains A.C.

input is stepped down by the transformer  $T_r$ . The bridge rectifier made of four diodes D1 to D4 converts the output voltage of the transformer to a pulsating D.C. voltage.

The transformer output voltage wave form is shown in figure 2 a. During the positive half cycle of this voltage diodes D2 and D3 are forward biased and they start conducting. During the negative half cycle, diodes D1 and D4 are forward biased and start conducting. It can be easily seen that during both the half cycles, the voltage available at the output of the bridge (across the capacitor C) is always plus on the top and minus on the bottom terminal. This output voltage is shown in figure 2 b.

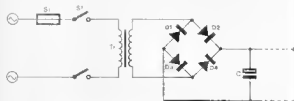

Figure 1  
A commonly used circuit of battery eliminator. The mains supply voltage is stepped down, rectified and filtered by the capacitor C.

Even though the output of the rectifier bridge is unidirectional, it does not have a steady value. This shortcoming is corrected by the capacitor *c*, the so called 'Filter Capacitor'. When the voltage shown in figure 2 b is applied across capacitor *c*, (an Electrolytic capacitor) it accumulates

the charge during the rising portion of the wave. When the voltage from bridge rectifier output starts falling, the capacitor supplies some of its accumulated charge and does not allow the effective voltage to fall rapidly.

The voltage does fall, but very slowly. By the time the

voltage has fallen by a small magnitude, the output voltage from the bridge again starts rising and the capacitor again charges upto the peak value.

This cycle continues and produces a voltage at the output which is shown in figure 2c. The process of charging and discharging of

the capacitor *C* is shown in figure 3. The minor fluctuation that still remains in the output voltage is called residual hum. The value of capacitance generally used is upto several thousand  $\mu\text{F}$ .

The filter capacitor used here not only stabilises the output voltage, but it also serves another important function. Electronic circuits operating from this voltage may not always draw a steady current. The current requirement frequently varies over a wide range. Sometimes the circuit may draw a high current for a short period. This high current also requires extra charge to be supplied during that period, and this charge is also supplied by the electrolytic capacitor. The voltage thus remains considerably steady even during peak loads.

The function of the filter capacitor can also be explained in simpler terms. The capacitor can be considered as a short circuit for A.C. and an open circuit for D.C. If we consider the pulsating D.C. voltage in figure 2b as a combination of a stable D.C. and an A.C. voltage superimposed on that, the filter capacitor acts as a short circuit for the A.C. part and an open circuit for the D.C. part. The A.C. part is thus prevented from going over to the output, and can be said to be effectively 'Filtered' out by the capacitor.

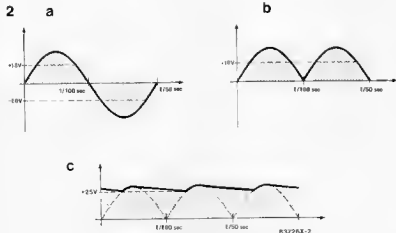

**Figure 2**  
The rectifier bridge gives a unidirectional voltage at its output. The variations in the voltage level are bridged by the filter capacitor which takes up charge during the rising part of the voltage and gives out charge during the falling part of the voltage.

**Figure 3**  
During the rising part of the voltage the capacitor is charged, during the falling part of the voltage, the capacitor gets discharged.

**Figure 4**  
The unidirectional pulsating voltage can be considered as made up of a steady D.C. voltage and an A.C. voltage superimposed on it.

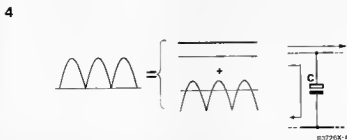
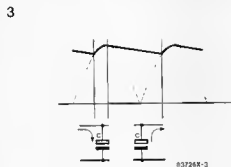

# THE DARLINGTON PAIR

Figure 1 shows a circuit which is known as the Darlington Pair - it is just simple connection of two transistors, but the result it gives is quite astonishing: it almost multiplies the gain of one transistor by that of the other.

A Darlington Pair of transistors having individual current gains ( $\beta$ ) of 200 each will give an amplification almost as high as 40000!

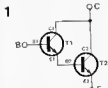

The principle of operation is simple. Transistor T1 amplifies its base current at B1 by a factor  $\beta$ , which is the current gain of transistor T1. The amplified output current is available at E1.

which is same as the base current of transistor T2. Transistor T2 also amplifies its base current at B2 by a factor of  $\beta$ , which is also the current gain of T2. Thus the total amplification available is  $\beta^2$ . Assuming a typical current gain  $\beta = 200$  for both T1 and T2, we have the effective current gain of the Darlington Pair as  $200 \times 200 = 40000$ .

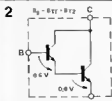

In this process, the effective base to emitter voltages of the two transistors are added up and we need a driving voltage which is double the individual threshold voltage of each transistor (approximately 0.6

volts each). In practice, we need not connect the circuit as shown in figure 1. The Darlington Pair is available as a single package with three terminals. It looks like a single transistor, but has a threshold voltage of 1.2 to 1.4 Volts and gives a very high current gain. Some of the standard Darlington Transistors available are listed in table 1, along with the important specifications.

In case of Power Darlingtons, feedback resistances are incorporated from base to emitter of each transistor to ensure a stable operation. This reduces the effective current gain of the pair to a value which less than the theoretically expected current gain multiplication. A parallel diode is also incorporated across collector and emitter to protect the transistor when it is used to drive loads like relays.

Darlington transistor packages with three or more transistors connected in the Darlington configuration are also available. The base to emitter voltage increases by 0.6 to 0.7 volts with each additional transistor.

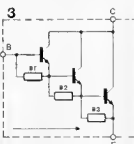

Threshold Voltage 1.8 to 2.1 V

Table 1

| Type  | Polarity | Maximum Collector Emitter Voltage | Maximum Collector Current | Maximum Power Dissipation | Collector to Base Leakage Current | Current Gain |
|-------|----------|-----------------------------------|---------------------------|---------------------------|-----------------------------------|--------------|
| BC516 | PNP      | 30 V                              | 400 mA                    | 625 mW                    | < 100 nA                          | > 30 000     |
| BC517 | NPN      | 30 V                              | 400 mA                    | 625 mW                    | < 100 nA                          | > 30 000     |
| BD675 | NPN      | 45 V                              | 4 A                       | 40 W                      | < 200 nA                          | > 750        |
| BD676 | PNP      | 45 V                              | 4 A                       | 40 W                      | < 200 nA                          | > 750        |
| BD677 | NPN      | 60 V                              | 4 A                       | 40 W                      | < 200 nA                          | > 750        |
| BD678 | PNP      | 60 V                              | 4 A                       | 40 W                      | < 200 nA                          | > 750        |
| BD679 | NPN      | 80 V                              | 4 A                       | 40 W                      | < 200 nA                          | > 750        |
| BD680 | PNP      | 80 V                              | 4 A                       | 40 W                      | < 200 nA                          | > 750        |



## internal circuits

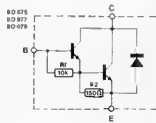
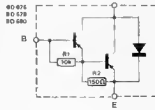
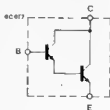
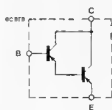

# check list for electronic fault finding

## or 'where and how to look for what that doesn't'

### Before soldering in components

- Check that the components agree with the parts list (value and power of resistors, value and voltage rating of capacitors, etc . . .). If in any doubt, double-check the polarized components (diodes, capacitors, rectifiers, etc . . .).
- If there is a significant time lapse between last reading an article and building the circuit, take the trouble to re-read the article, the information is often given in very condensed form. Try to get the most important points out of the description of the operation of the circuit, even if you do not understand exactly what is supposed to happen.
- If there is any doubt that some components may not be exact equivalents, check that they are compatible.
- Only use good quality IC sockets.
- Check the continuity of the tracks on the printed circuit board (and through-plated holes with double-sided boards) with a resistance meter or continuity tester.
- Make sure that all drilling, filing and other 'heavy' work is done before mounting any components.
- If possible keep any heat sinks well isolated from other components.
- Make a wiring diagram if the layout involves lots of wires spread out in all directions.
- Check that the connectors used are compatible and that they are mounted the right way round.
- Do not reuse wire unless it is of good quality. Cut off the ends and strip it anew.

### After mounting the components

- Inspect all solder joints by eye or using a magnifying glass and check them with a continuity tester. Make sure there are no dry joints and no tracks short circuited by poor soldering.
- Ensure that the positions of all the components agree with the mounting diagram.
- Check that any links needed are present and that they are in the right position to give the desired configuration.
- Check all ICs in their sockets (see that there are no pins bent under any ICs, no neighbouring ICs are interchanged, etc . . .).

- Check that all polarized components (diodes, capacitors, etc . . .) are fitted correctly.
- Check the wiring (watch for out-cuts of component leads); at the same time ensure that there are no short circuits between potentiometers, switches, etc . . . and their immediate surroundings (other components or the case). Do the same with mounting hardware such as spacers, nuts and bolts, etc . . .
- Ensure that the supply transformer is located as closely as possible to the circuits (this could have a significant influence in the case of critical signal levels).
- Check that the connections to earth are there and that they are of good quality.
- Check that any pins, plugs or other connectors used are making good contact.
- Make sure the circuit is working correctly before spending any time putting it into a case.

### And if it breaks down . . .

- Recheck everything suggested so far.
- Reread the article carefully and clarify anything about which you are doubtful.
- Check the supply voltage or voltages carefully and make sure that they reach the appropriate components especially the pins of the ICs (test at the pins of ICs and not the soldered joints!).
- Check the currents (generally they are stated on the circuit diagram or in the text). Don't be too quick to suspect the ICs of overheating.
- If possible check the operation of the circuit in separate stages. As a general rule, follow the course of the signal.
- Check the contents of any PROMs or EPROMs fitted.
- While checking voltages, currents, frequencies or testing the circuit with an oscilloscope, work systematically and take notes.
- It is always a good idea to do any fault finding as a combined operation with a friend, two heads are better . . .
- Be wary of 'red herrings' when fault tracing. Do the simple checks first.
- Finally, remember our constant companion Murphy is looking over your shoulder. If that part of the circuit cannot possibly be wrong and you haven't checked it - that's where to start looking.
- . . . And don't forget to switch the power on and check the fuses!



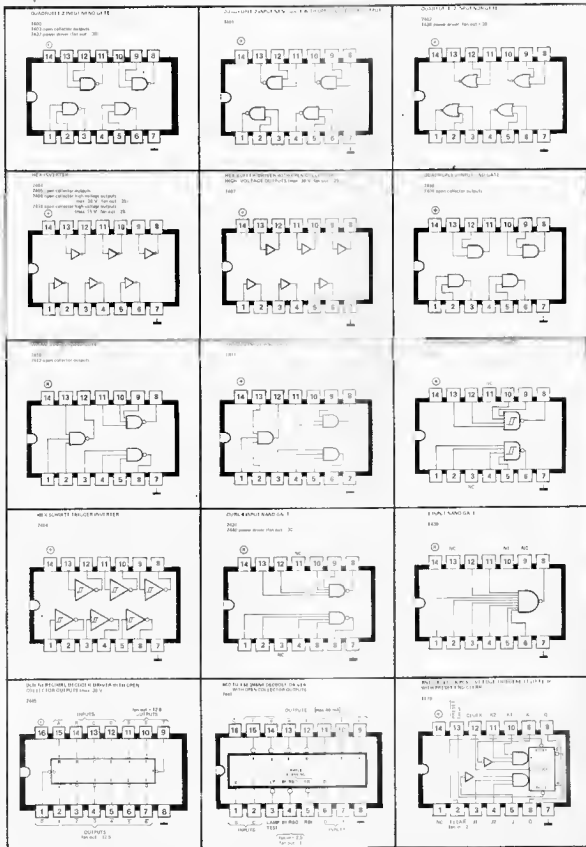

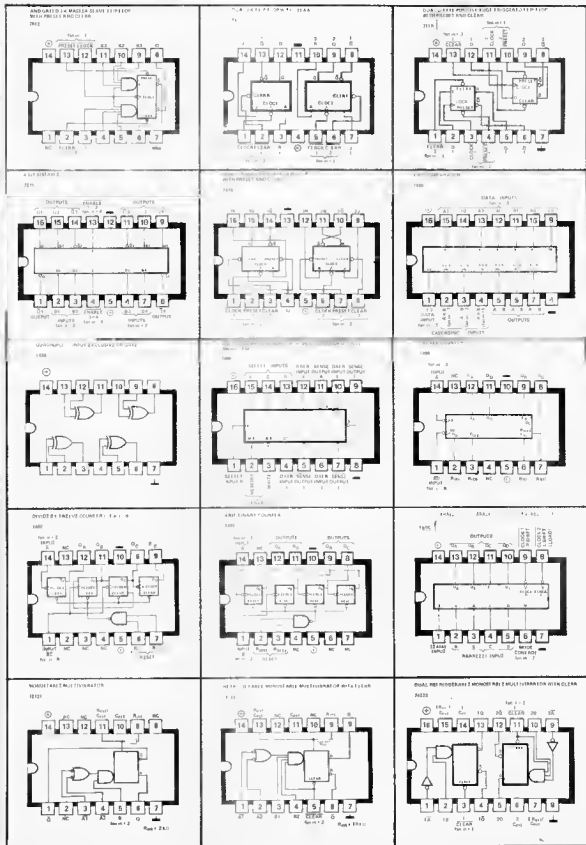

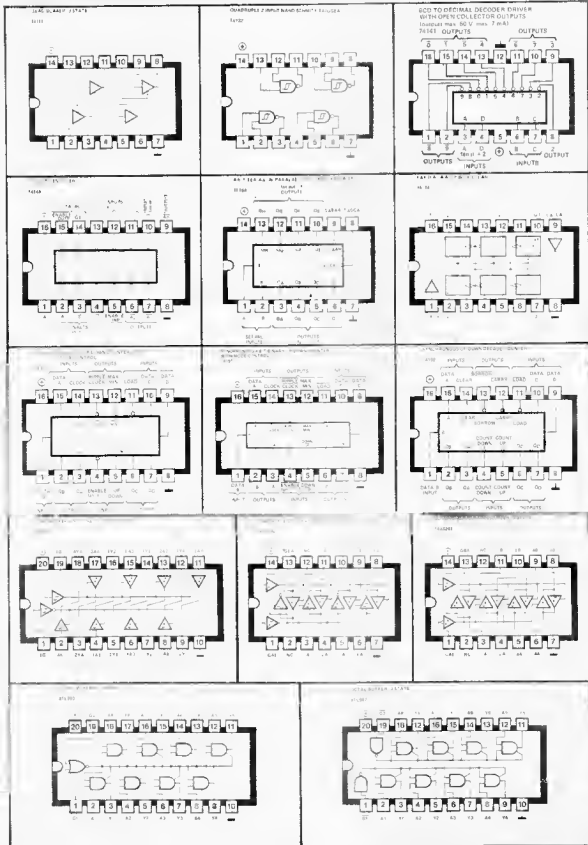

# NEW PRODUCTS

## 240-Watt switched power supply

New in their ERX series of single-output L-chassis switching power supplies, Kepco Inc. and TDK jointly introduce a 240 Watt unit, available in 5, 12, 15, and 24 Volt models. These are dual-FET forward converters, operating at a frequency of 100 kHz with an efficiency of 80%, achieved through the use of a recently developed TDK ferrite called H7C4. As with the other members of the series, the noise density of the new ERX unit is low enough to comply with the VDE 0871/6.78 requirements from 450 kHz to 30 MHz.

Important features of all ERX models are rectangular current limiting (for driving non-linear loads); +10%, -20% voltage adjustment; over-voltage protection; a holding time of 30 ms typical, 20 ms minimum to enable orderly shutdown at power failure; remote error voltage sensing, and selectable 115/230 VAC input. Cost of the new switcher is \$179.00, single unit price.

*Kepco Inc.*  
131-38 Sanford Avenue  
Flushing, NY 11352 USA  
Telephone  
010 1 212 461-7000  
TWX 710-582-2631 (3417:1 F)

## Soldering iron tips

The 3S-TIP is a range of long-lasting soldering iron



tips specially made as replacement in Weller TCP and ECP temperature controlled irons. The range has recently further been improved by an additional treatment of the areas welded by the solder. Various tip designs are available as shown in the photograph.

*Cabonic Limited*  
32 Ludlow Road  
Guilford  
Surrey GU2 5NW  
Telephone: (0483) 505260  
Telex: 28604 (3382.18 F)

with green baize under-trim and non-slip feet.

*R A Kent Engineers*  
243 Carr Lane  
Tarlton, Preston  
Lancashire PR4 6YB  
Telephone: (077 473) 4998  
(3417:9)

## Driver ICs feature Bimos II technology

Sprague has introduced the UCN5800A and UCN5801A latched drivers, high voltage, high current integrated circuits which, fabricated using bipolar/MOS technology, provide a very low power latch with maximum interface flexibility.

Type dependent, the devices contain four or eight CMOS data latches, a bipolar Darlington driver stage for each latch, and CMOS, PMOS, and NMOS compatible inputs for latch control circuitry. Both units have open-collector output and integral diodes for inductive load transient suppression. The output transistors are capable of sinking 500 mA and will sustain at least 50 V in the Off state. Applications include use with relays, solenoids, stepping motors, LED and incandescent displays, and other high-power loads.

*Sprague Electric UK Ltd*  
Sailbrook Road  
Salfords  
Surrey RH1 5DZ (3417:5)

## Kits for making Morse-code keys

A low-cost kit, available from R A Kent Engineers, contains all the necessary components for making Morse-code keys. Developed for radio amateurs, the key can be assembled in less than one hour.

Made of solid brass, the key is pivoted on ball race bearings and has solid-silver contacts to ensure accurate and reliable performance. It has fine-pitch threaded screws with instrument knurled heads to allow for precise adjustments to be made. The kit is supplied complete with detailed assembly instructions, and the manufacturers can also supply a French-polished hardwood base.

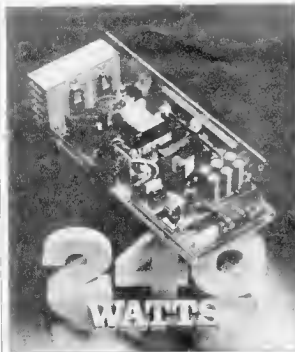

## HCMOS TTL compatible oscillators

A complete range of HCMOS quartz crystal clock oscillators is now available from M-Tron through UK stockist and distributor MCP Electronics. Frequencies between 3.0 and 25 MHz are available. The waveform rise and fall time under ten TTL loads exceeds TTL requirements.

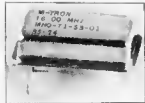

Standard versions have a frequency tolerance of  $\pm 50$  ppm and a stability of 100 ppm over the temperature range 0 to 70 °C.

MCP Electronics Limited  
26-32 Rosemont Road  
Alperton  
Middlesex HA0 4QY  
Telephone: (01) 902 6146  
(3382.15-F)

## 10-bit CMOS multiplying DAC

The MP7633 from Micro Power Systems has been

designed as a pin-for-pin compatible replacement for the industry standard MP7533 and offers the additional advantages of lower output capacitance and very high linearity and accuracy. The low output capacitance results in higher speed, faster settling, and easier interfacing with output amplifiers. The linearity and accuracy are of the order expected of a 12-bit device.

Micro Power Systems (UK) Limited  
Orion House  
49 High Street  
Addlestone  
Surrey KT15 1TU  
Telephone (0932) 57315  
Telex 8812984 (3382 14 F)

## Miniature DIL DPMs

A new range of miniature LCD DPMs (digital panel meter) has been introduced by Lascar Electronics. All types utilise surface mount techniques to vastly reduce the overall size. The DIL format is claimed to make the meters particularly easy to use by low or high volume users.

Each meter is also supplied with a 'snap-in' bezel for fast fitting. Standard features include auto-zero, auto-polarity, 200 mV f.s.d, programmable decimal points and 'low battery' indication, together with a range of useful engineer-

ing symbols incorporated on the LCD. Three different versions are available with

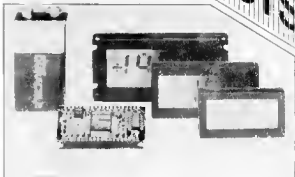

character heights of 15mm, 12.5mm, and 10mm, the latter type (DPM400) being the world's smallest off-the-shelf DPM. With a one-off price of £16.95 it is also probably the cheapest.

Lascar Electronics Ltd  
Module House,  
Whiteparish  
Salisbury, Wilt, SP5 2SJ  
Telephone (07948) 567  
Telex: 477876 (3417-8 F)

wide selection of measurements including contact resistance on switches and relays, internal resistance of batteries, and junction capacitance. In semiconductors the model 5700 features auto-ranging and a measurement mode which automatically selects the optimum range in measuring unknown component values. Two 3½ digit LED displays, each with a maximum reading of 1999, are provided for measurement indication.

Advance House of Instruments  
Raynham Road  
Bishop's Stortford,  
Herts CM23 5PF  
Telephone: (0279) 55155  
Telex 81510 (3417.3 F)

## Digital LCR meter

New from Advance House of Instruments is the SOAR Model 5700 digital LCR meter which provides a

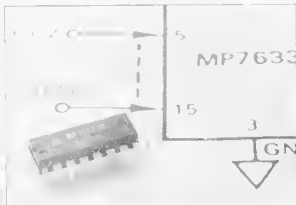

# ELECTRONICS HOBBYISTS

*How long will you continue to play with simple projects and obsolete technologies?*

Electronics Hobbyists all over the world are experimenting with Microprocessors and their most exciting applications. Now Dynalog makes it possible even for you to get into the exciting world of Microprocessors.

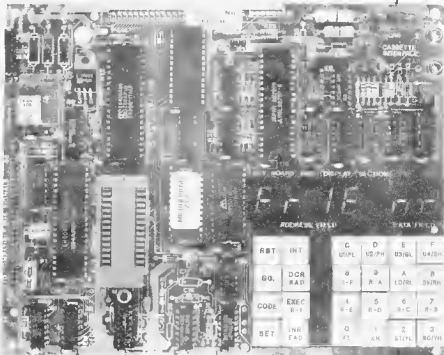

Dynalog has specially designed two **LOW COST** Microprocessor Trainers based on the popular chips 8085A and Z80A. Advanced Hobbyists, Students and Beginners can use them initially for learning and then for experimenting with Microprocessor Applications.

Write today for more details:



## Dynalog Micro-Systems

14, Hanuman Terrace, Tara Temple Lane,  
Lamington Road, Bombay 400 007

Tel: 362421, 353029 Telex: 011-75614 SEVK IN Gram: ELMADEVICE

Branches and representatives at: Pune, Bangalore, New Delhi, Hyderabad and Chandigarh

ADDMark

## CONDITIONS OF ACCEPTANCE OF CLASSIFIED ADVERTISEMENTS

1) Advertisements are accepted subject to the conditions appearing on our current rate card and on the express understanding that the Advertiser warrants that the advertisement does not contravene any trade act in force in the country.

2) The Publishers reserve the right to refuse or withdraw any advertisement.

3) Although every care is taken, the Publishers shall not be liable for clerical or printer's errors or their consequences.

4) The Advertiser's full name and address must accompany each advertisement submitted.

The prepaid rate for classified advertisement is Rs. 2.00 per word (minimum 24 words). Semi Display panels of 3 cms by 1 column, Rs. 150.00 per panel. All cheques, money orders, etc. to be made payable to Elektor Electronics Pvt. Ltd. Advertisements, together with remittance, should be sent to The Classified Advertisement Manager. For outstation cheques please add Rs. 2.50

Now Available: Electronics projects book-1 Price Rs 5. - M/s Renuka Electronics, 18, Ranganathan Street, Nehru Nagar, Chromagar, Madras - 600 044 (All India Universal Electronics Club FREE Membership - Enrolment form Ra 1/-)

WANTED Electronic Engineers with 2 to 3 years good working experience in development of digital equipment. Attractive remuneration depending on merits. Apply with full particulars to OMEGA ELECTRONICS, 36 Hathi Babu Ka Bagh Jaipur 302 006

Unassembled/Assembled kits

1) MW Transmitter 150 meter range for Rs 90/- 2) 12 Melodies horn for vehicles Rs 80/- Kits price list Re 1/-, (50% Advance for VPP) PERFECT ELECTRONICS 453, Gangathi Ali, War - 412 803 (Satara)

|                          |      |
|--------------------------|------|
| ACE COMPONENTS           | 4 04 |
| AFCO 1 & C. LTD          | 4 06 |
| APEX                     | 4 08 |
| APLAB                    | 4 04 |
| ATRON ELECTRONIC         | 4 67 |
| COMPONENT TECHNIQUE      | 4 12 |
| COSMIC                   | 4 76 |
| DEVICE ELECTRONICS       | 4-11 |
| DYNATRON                 | 4 05 |
| ELCIAR                   | 4 08 |
| ELCOT                    | 4 73 |
| ELTEK BOOKS N KITS       | 4 67 |
| IEAP                     | 4 14 |
| KAYCEE                   | 4 66 |
| KLAS ENGINEERING         | 4 14 |
| LEADER ELECTRONICS       | 4 12 |
| LEONICS                  | 4 66 |
| MECO INSTRUMENTS         | 4 04 |
| MOTWANE                  | 4 07 |
| OSWAL ELECTRONIC CO      | 4 02 |
| PIONEER ELECTRONICS      | 4 14 |
| PLA                      | 4 70 |
| PRECIOUS KITS            | 4 13 |
| RAJASTHAN ELECTRONICS CC | 4 02 |
| SAINI ELECTRONICS        | 4 08 |
| SCIENTIFIC               | 4 10 |
| SUCHA ASSOCIATES         | 4 12 |
| TESTICA                  | 4 10 |
| TEXONIC                  | 4 10 |
| UNLIMITED ELECTRONICS    | 4 72 |
| VASAVI                   | 4 67 |
| VISHA                    | 4 75 |
| YABASU                   | 4 09 |
| ZODIAC                   | 4 72 |

**Components**

are normally available with the following companies:

**VISHA ELECTRONICS**

17, Kalpana Building,  
349, Lamington Road  
Bombay - 400 007 Phone: 362650

**DYNALOG MICRO SYSTEMS**

14, Hanuman Terrace,  
Tara Temple Lane,  
Lamington Road  
Bombay - 400 007, Phone: 353029, 362421

**ELECTROKITS**

20, Narasingapuram Street  
(First Floor) Mount Road  
Madras - 600 002

**INTEGRATED ELECTRONICS  
INSTRUMENTS**

8-2/174 Red Cross Road  
Secunderabad 500 003 Phone: 72040

**SILIKON ELECTRONICS**

315, Lamington Road, Shop No. 4  
Kalpana Mansion, Opp. Police Station  
Grant Road, Bombay - 400 007  
Ph: 350644

# Watts News?



After 30 years of communicating our finest efforts to you—we still have more news for you.

Cosmic is now breaking every sound barrier in maintaining its sophisticated electronic image by touching perfection in the manufacturing of its Tape decks/recorders, Stereo Systems, Amplifiers, Turntables, Head-Phones.

A single dominant factor has encouraged us to keep expanding and that is consumer satisfaction.

Stay tuned to us.

## COSMIC

**We are Sound!**