

129

February
1986

elektor **INDIA**

Rs. 7.50

electronics



Car electronics

Infra-red light switch

Solid-state ignition

MSX extensions

Public-address amplifier

Publisher: C.R. Chandarana

Editor: Surendra Iyer

Editorial Assistance: Ashok Dongre

Advtg & Admn: J. Dhas

Production: C.N. Mithagari

Address:

ELEKTOR ELECTRONICS PVT. LTD.

52, C. Proctor Road,

Bombay - 400007, India

Overseas editions:

Glenpost Publishers Limited
Standfast House, Bath Place

High Street Barnet

London : EN5 1ED

Editor: Len Seymour

Elektor B.V.

Peter Treckpoelstraat 2-4

6191 VK Beek - the Netherlands

Editor: P E L Kersemakers

Elektor sarl

Route Nationale, Le Seau, B.P. 53

59270 Bailleul - France

Editors: D R S Mever, G C P Raedersdorf

Elektor Verlag GmbH

5133 Gangelst - Postfach 1150

West Germany

Editor: E J A Krempelsauer

Elektor EPE

Karaiskaki 14

16673 Voula - Athens - Greece

Editor: E Xanthopoulos

Elektor JCE

Via Rosellini 12

20124 Milano - Italy

Editor: D Fumagalli

Ferreira B Bento Lda.

R. D. Estefânia, 32.1^o

1000 Lisboa - Portugal

Editor: Jorge Goncalves

Ingelek S.A.

Av. Alfonso XIII, 141

Madrid 16 - Spain

Editor: A M Ferrer

International co-ordinating

& technical manager: K S M Walraven

The Circuits are for domestic use only. The submission of designs, of articles to Elektor India implies permission to the publishers to alter and translate the text and design, and to use the contents in other Elektor publications and activities. The publishers cannot guarantee to return any material submitted to them. All drawings, photographs, printed circuit boards and articles published in Elektor India are copyright and may not be reproduced or imitated in whole or part without prior written permission of the publishers.

Patent protection may exist in respect of circuits, devices, components etc. described in this magazine.

The publishers do not accept responsibility for failing to identify such patent or other protection.

Distributors:

Blaze Publishers & Distributors Pvt. Ltd.

Printed At:

Trupti Offset

Bombay - 400 013

Copyright © 1986 Elektor B.V

The Netherlands



electronics technology

- design ideas** 2-16
voltage-controlled attenuators
- car electronics** 2-26
an overview of the state of the art and feature developments
- protecting data from prying eyes** 2-41
computer data in Britain must now be protecting by law.
- educational software for the handicapped** 2-42
the work of Special Education Research Centres
- CAD in practice at Renault** 2-44
artistic flair and talent not jeopardized by computers

projects

- solid-state ignition** 2-18
ensures smooth starting of cold and/or damp engines.
- infra-red light switch** 2-23
to control your lighting needs by body heat
- graphics card** 2-32
the software
- mobile audio power amplifier** 2-38
a good quality PA amplifier for operation from vehicle batteries
- MSX extensions** 2-46
the first in a series of add-on units for this versatile type of computer

information

- news and views** 2-13
- new products** 2-61
- guide lines**
- switchboard** 2-69
- appointments** 2-70
- classified ads** 2-74
- index of advertisers** 2-74

selex-9

- digi-course II (chapter 3)** 2-53
- wet-finger-test** 2-55
- experiments with a transistor** 2-56
- transistor tester** 2-58

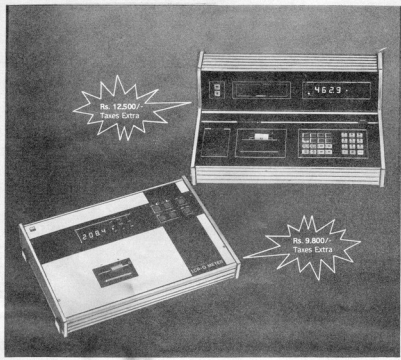

Rs. 12,500/-
Taxes Extra

Rs. 9,800/-
Taxes Extra

An era of new generation in automated test equipment.

Select Cream of Electronic Components. No Trouble with Experiments in Lab! No Trouble with Instruments You Make! Use APLAB 4910 LCR-Q Meter

- Direct Digital read-out within no time.
- Automatic discrimination of inductance & capacitance.
- 100Hz or 1KHz selectable test frequency.
- 0.25% basic accuracy.
- Bias voltage for electrolytic capacitors.

You have a choice for component sorter which selects the components within the set limits.

Apilab

APPLIED ELECTRONICS LTD.
Apilab House, A-5/6 Wagle Industrial Estate
Thane 400604, India. Phone 59 18 61/2/3, 507318
Telex: 011 71979 APEL IN, Cable: Apilabthana.

WE KEEP LARGEST STOCK AT THE MOST CHEAPEST PRICE

EPROM ● 2716 ● 2732 ● 2532 ● 2764	REGULATOR IC ● 7805 ● 7809 ● 7812 ● 7815	CERAMIC FILTER SFE 5, 5 MB SFE 10, 7 MB
TTL/CMOS 74 LS00-373 4001-40106	SCR/TRIAC 6A-40A 400V-600V	OP-AMP ● 324 ● 339 ● 741 ● 158 ● 258 ● 358
TBA-SERIES ● 800 ● 810 ● 820 ● 920	TDA-SERIES ● 1154 ● 1170 ● 1190 ● 2593	TRANSISTORS ● 2N ● BC ● BD ● BF-SERIES

MANY MORE SALEABLE ITEMS

CONTACT
ROCHOR ELECTRONICS ENTERPRISE PTE LTD
 10, Jalan Besar 101-05 Sim Lim Tower Singapore 0820
 Tel: 2950729, 2928364, Telex: RS 26483 ROTRON,
 Cable: ROTRONIC

RK&LK NEW RANGE OF T.V. COMPONENTS

VCR SOCKETS (COAXIAL) 	ANTENNA SOCKETS 300 TO 75 OHM ADAPTOR
 TUNER PLUG	<div style="border: 2px solid black; padding: 10px; width: fit-content; margin: 0 auto;"> YOUR LINK TO QUALITY </div>
 DPDT	
 PCB CONNECTORS MULTIWAYS & MULTI PITCHES	 POIPO SWITCH

SYMBOL OF SUPREMACY

RAJKUMAR ENGINEERS
 108, Bajajons Industrial Estate, 40, Chakala Road
 Andheri (East) Bombay - 400 099, ph: 6049518
 Cable: "ROCKRTEST" Andheri, Bombay - 400 099

0100 0100
0101 1001
0100 1110
0100 0001
0100 1100
0100 1111
0100 0111

**Bit
by
Bit**

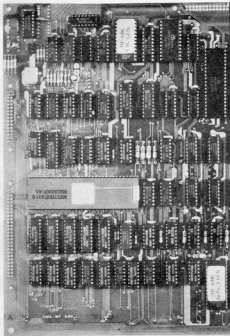
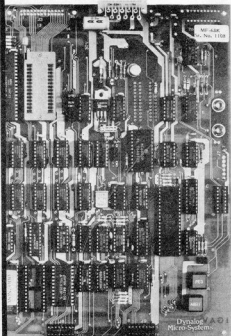

Dynalog has grown...

Starting as a manufacturer of 8 bit microprocessor trainer kits in 1982, Dynalog has now grown to be the only manufacturer in the world to offer sophisticated microprocessor training and development systems based on almost all the popular and latest microprocessors.

The Dynalog range covers microprocessor training and development systems based on 8085, Z80, 8086, 8088, 6802, 6502, and the latest 16/32 bit CPU 68000. Many other advanced products like Single Board Computers based on Z80, Universal EPROM programmers, IBM PC/XT compatible Motherboard and Add-on cards, STD Bus compatible cards, VT 52 compatible CRT Terminals, Graphica 1185 Colour Graphic Terminals and Data Loggers are also available from Dynalog

For more information, write or call:

DMS

Dynalog Micro-Systems

14, Hanuman Terrace, Tara Temple Lane,
Lamington Road, Bombay 400 007

Tel: 362421, 353029 Telex: 011-75614 SEVK IN Gram: ELMADEVICE

Branches and representatives at: Pune, Bangalore, New Delhi, Hyderabad and Chandigarh

LEADER

DEFLECTION COMPONENTS & TUNER

- EHT TRANSFORMERS (ALL MAKES)
- DEFLECTION YOKE
- LINE-DRIVER TRANSFORMER
- LINEARITY COIL
- TUNER
- V.I.F. BOARD
- BOOSTER
- MAIN TRANSFORMER FOR TV

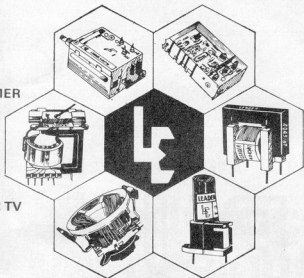

FOR DETAILS CONTACT

SOLE-DISTRIBUTOR

Oswal Electronic Co

339 LAJPAT RAI MARKET DELHI-110 005 PHONE 2911772

MANUFACTURED BY:

LEADER ELECTRONICS

NEW!



EPROM ERASER

A range of Erasable Programmable Read Only Memories (EPROMs) like 2708, 2716, etc. require Ultra Violet Light for erasing them. New Professional Electronic Products offer a compact UV Light Source UVLS-8 which can erase Eight EPROMs at a time. A 0-60 minute timer is provided on the unit to automatically shut-off the lamp.

For further details write to:

PROFESSIONAL ELECTRONIC PRODUCTS

Delhi Road, Post Box No. 316, MEERUT CITY-250 002



ALPHA NUMERIC PRINTERS (DATA LOGGER)

FEATURES

- Based on Single Chip Microcomputer
- Universal Input Standards
- Data in ASCII Format
- Software Commands enhance Performance
- Panel Mountable as well as bench useable
- Impact or Thermal Printer Mechanism
- Optional Graphic Facility in Thermal printers.

SPECIFICATIONS

- Data Input : 8 bit parallel (TTL Level) Full serial input RS232C
- Data Code : ASCII 96 Characters
- Print/Position : 20 positions/line
- Rate Speed : 1.8 lines/Sec.
- Power Supply : 230V AC \pm 10%
- Commands : Software based, CR, LF, MF, etc.

Applications

Print out of μ P based systems
Cash Register, Electronic Scales
Data Acquisition Systems,
Micro-Computers, Medical Electronics

For details contact:



ARUN ELECTRONICS PVT. LTD.

B-125/126 Ansa Industrial Estate,

Saki Vihar Road, Saki Naka, Borivay 400 072

Phone: 563354/561524 Gm: ARUNTEL Telex: 115667 EXIM IN

MREC Forges Ahead with PREH of West Germany

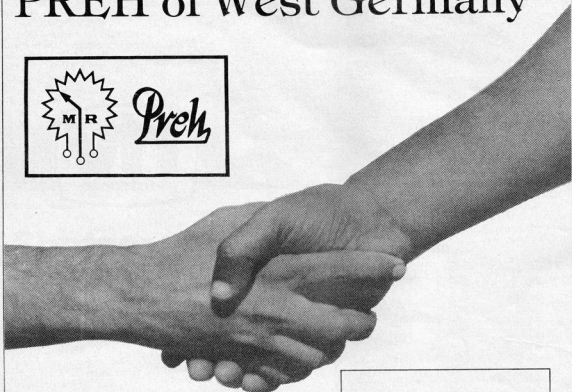

MREC have finalised a technical agreement with the world famous *Preh* of West Germany to assemble and manufacture **Control Units** for colour TVs in India.

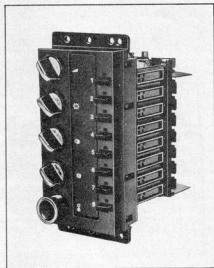

M.R.ELECTRONIC COMPONENTS LTD.

Factory : Developed Plots 8 & 11 Industrial Estate, Guindy Madras 600 032
Ph. 432214, 432215, 432768

Regd. Office : T.N.K. House 48 Anna Salai Madras 600 002 Ph. 840699

Telegram : 'VOLUME'

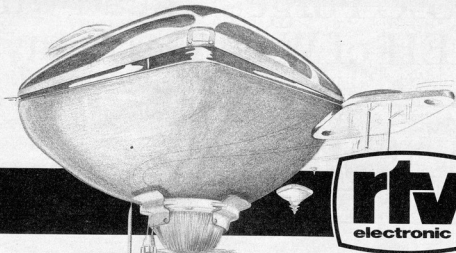

Interested? Contact:

RTV ELECTRONIC
GmbH & Co.
P.O.B. 2217
D-56332 Wermelskirchen
Federal Republic of Germany
Phone: (02193) 37-0
FAX: (02193) 3062
Telex: 8513393 rtv d

Bangalore:
VETRIL Electronics (P) Ltd.
SB-111, Industrial Estate
Peenja,
Bangalore-560 058
Phone: 384415
Cable: VETRILCO
Tx: 0845-8328

Bombay:
Messrs. Bakubhai Ambalal
Division: Electronics
Kaiser-I-Hind B'ldg
3rd Floor
Currimbhoy Road
Bombay-400 038
Cable: EXTENSION
Phone: 260419, 268756
Tlx: 0115379 ASE IN

Special Offer Price (CIF sea) in \$

We are the leading supplier of electronic components to the TV-industry. Available ex-stock in West Germany the following as well as many other components:

Qty.	Component	Price (CIF Air) in \$
150 K	TBA 120 S	0,26
200 K	TBA 810 AS	0,26
200 K	TDA 1044	0,80
150 K	TV 20	0,48
200 K	BU 205	0,58
100 K	BU 208	0,62
1000 K	IN 4148 _{per 100}	0,88

200 K	100 + 100 mfd	0,36
	350 V	
150 K	100 + 100 mfd	0,86
	450 V	
150 K	200 + 400 mfd	0,86
	200 V	
	B & W Picture Tube	
100 K	20 inch	20,40
50 K	24 inch	24,80

Our selling line also includes: Flyback transformers sawfilter and UHF, VHF tuners, we are also exclusive distributor for the STOCKO-CONNECTOR SYSTEMS, EUROPEAN CTV Chassis and operating units with and without remote control.

DESIGN IDEAS

Voltage-controlled attenuator

Although Apex's Type 1537A voltage-controlled attenuator has been on the market for some time, it appears that the device is not generally known. A pity, because it offers very low distortion, high stability, low noise, and a wide dynamic range. Its attenuation can be controlled precisely from 0 dB down to -100 dB.

Moreover, the 1537A is designed for a high slew rate, resulting in low transient intermodulation and a wide bandwidth, so that it can be used over the frequency range DC to 50 MHz.

The very good performance characteristics of the 1537A make it suitable for use in a wide range of audio applications, such as voltage-controlled filters, synthesizers, compressors, and others, as well as in, for instance, tone burst generators, robotics, servo-controlled machines, and many other general electronic applications. In general, voltage-controlled attenuators, which normally use log-antilog multiplier circuits, exhibit high non-linear dis-

1

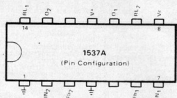

85138-1

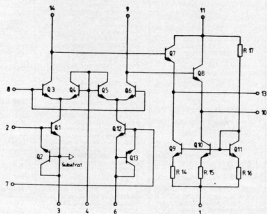

Characteristics

Frequency range:	0...50 MHz
Total harmonic distortion:	0.04%
Intermodulation (ISMPTE):	0.03%
Signal/noise ratio (peak, CCIR 468):	90 dB
Modulation noise:	6.5 dB
Slew rate:	10 V/ μ s
Input impedance:	0 Ω (current driven)
Maximum attenuation:	\geq 96 dB
Offset voltage: (20 Hz...50 kHz)	\leq 5 mV
Current consumption:	33 mA at 25 °C

Note: $U_a = +15$ V; T (ambient) = 25 °C; 0 dBm = 0.775 V.

Fig. 1. Pin configuration and internal circuit layout of the 1537A.

Fig. 2. A simple practical circuit is obtained by combining the 1537A with two additional opamps.

Fig. 3. This rather more elaborate circuit than that in Fig. 2 has an additional input buffer.

2

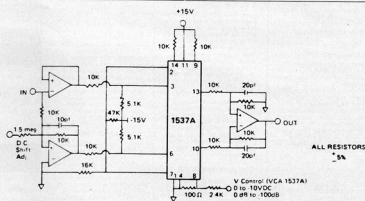

3

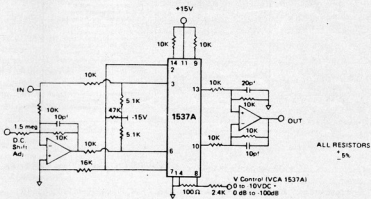

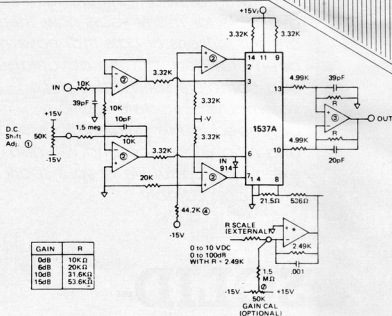

Fig. 4. A typical full implementation circuit of the 1537A.

Fig. 5a. Voltage-controlled resistor.

Fig. 5b. Voltage-controlled high-pass filter.

Fig. 5c. Voltage-controlled band-stop filter.

Fig. 5d. Suggested automatic gain control circuit.

ortion and high noise. The 1537A uses new proprietary techniques that result in much lower levels of these characteristics. Moreover, since it is a true class A device, its crossover distortion is much lower than that of most other voltage-controlled attenuators. The 1537A is housed in a 14-pin dual-in-line package. The pin configuration and internal circuit are shown in Fig. 1. Current sources Q_1 and Q_2 , driven by the input signal, control amplifiers Q_3 and Q_4 . The gain of these amplifiers is controlled via their base voltage (since that voltage controls the transconductance of the transistors). The output is buffered by transistors Q_5 and Q_6 . Some practical circuits using the 1537A are shown in Figures 2, 3, and 4. The circuit in Fig. 2 is the simplest, requiring only two additional opamps. It is suitable for source impedances up to about 150 Ω . Where the source impedance is higher, but does not exceed 2 k Ω , the circuit of Fig. 3 should be used. This is comparable to that of Fig. 2, but has an additional input buffer. For optimum utilization of

the 1537A, the circuit shown in Fig. 4 is suggested. This uses even more additional opamps, and these should be of the low-noise type, such as the TL027, LF353, or NE553A. Some typical applications of the 1537A are shown in Fig. 5. The voltage-controlled resistance in Fig. 5a has a value, $R' = R/(1-\alpha)$, where α is the attenuation of the 1537A. The high-pass filter of Fig. 5b has a cut-off frequency

$$f_c = (1-\alpha)2\pi RC$$

where f is in hertz, and α is the attenuation of the device.

The circuit in Fig. 5c is a band-stop filter, whose centre frequency of the attenuation band f is

$$f_c = 1/2\pi\sqrt{R_1R_2C_1C_2} \quad (\text{Hz})$$

Finally, Fig. 5d shows a suggested automatic gain control (AGC) circuit.

Literature:

1537A voltage-controlled attenuator
Aphex Systems Limited
7801 Melrose Avenue
Los Angeles
California 90046
Telephone: (213) 655-1411
Telex: 910-321-5762

5a

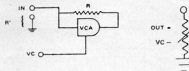

5b

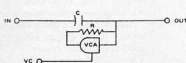

5c

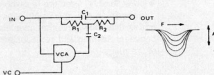

5d

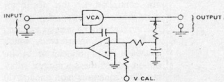

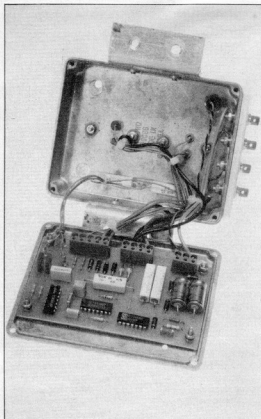

Although transistor ignition has been available for many years now, there are still millions of cars that have not been provided with the advantages of a complete solid-state ignition system. The solid-state ignition described in this article will give long and reliable service and will also extend the useful life of your spark plugs appreciably.

SOLID-STATE IGNITION

by
Hans Steeman

A full solid-state ignition system has many advantages over conventional systems. It will, for instance:

- enable the engine to be started readily, whether this is cold, wet, or hot — provided your battery is in good condition, of course;
- ensure that even a cold or damp engine continues to run once it has been started;
- ensure that the spark energy is constant and independent of the engine speed;
- considerably reduce carbon deposit on the spark-plug electrodes, thus allowing longer intervals between cleaning and replacement of the plugs.

A comparison

Fig. 1 shows a conventional coil ignition system as used in most petrol engines. The contact breaker points are controlled by the distributor cam: when they open, the current flowing through the primary winding of the coil is interrupted, which causes a high potential to be induced across the secondary winding. This voltage is high enough (10 to 15 kV) to ignite the compressed charge of air and petrol vapour in the

engine cylinder via the spark-plug. The distributor ensures that the high tension is applied to only one cylinder at a time. The distributor is driven by the engine at half engine speed.

In the solid-state ignition system the function of the contact breaker points is transferred to a transistor switch: the points merely serve to trigger the transistor. Because of the consequent appreciable reduction

in current flowing across the points, these become virtually free of wear. The timing diagrams in Fig. 2 show the differences between the ignition pulses generated in the two systems. When the points in the coil ignition system are closed, no current flows through the primary of the coil. Note the overshoot and ringing occurring at the secondary immediately after the points have closed. These phenomena are caused by stray

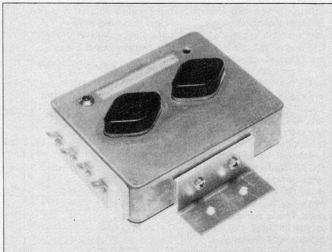

1a

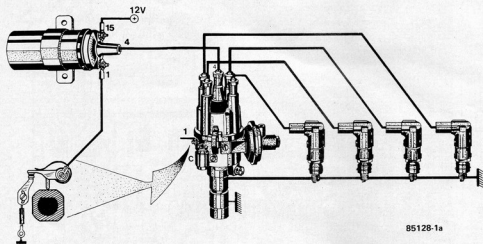

1b

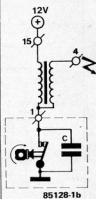
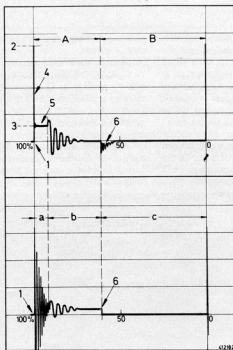

Fig. 1. Conventional coil-ignition system for petrol engines.

Fig. 2. Timing diagrams of coil ignition (left) and solid-state ignition (right).

2



- 1 points open
- 2 ignition voltage
- 3 firing voltage
- 4 peak secondary voltage
- 5 firing voltage level
- 6 points close

- A points open period
- B points closed period
- a spark duration
- b points open period
- c points closed period

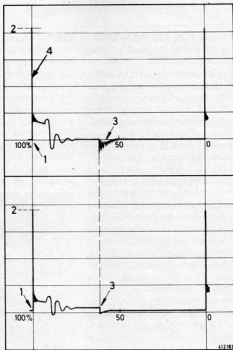

- 1 ignition period starts; transistor switched off
- 2 sparking voltage; zener voltage
- 3 transistor switches on
- 4 peak secondary voltage

85128-2

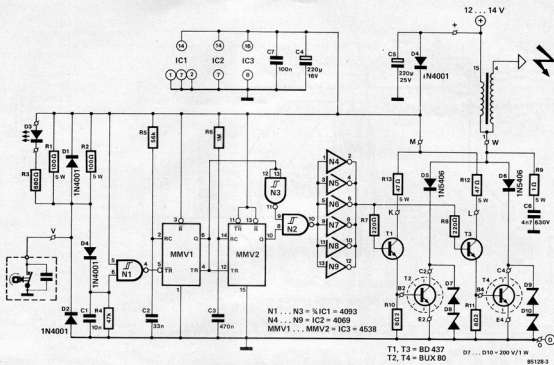

Fig. 3. The circuit diagram of the solid-state ignition system.

capacitance and inductance which, since the coil is not replaced, also occur in the solid-state system.

When the points are open, i.e., at the moment the high tension is induced, the two systems behave in an unlike manner. A voltage similar to the peak secondary voltage just before the spark-plug fires — 4 in both diagrams — exists across the primary winding and dies out only after ignition has taken place.

Once the required level of high tension is reached, the coil in the sparking plug becomes conductive, and a spark jumps across the gap. Therefore, during the actual ignition, the full secondary voltage exists across the plug electrodes. At the primary side in the solid-state system, there is no longer the characteristic overshoot and ringing of the coil system. The energy in the secondary winding declines until it is no longer sufficient to sustain the spark, and this then dies out.

Circuit description

The voltage pulses provided by the contact breaker are reshaped by Schmitt trigger N1 — see Fig. 3 — and then applied to monostable MMV1. This stage has been arranged such that it provides pulses of about 1.8 ms at its Q output (pin 6).

This corresponds exactly to the required spark duration.

In a four-stroke, four-cylinder petrol engine, each cylinder is ignited at every second engine revolution. Since the four cylinders must each fire at regular intervals, two sparks are required for each engine revolution. This means that at an engine speed of 6000 rev/min the interval between two sparks is 5 ms. As the spark duration is 1.8 ms, the coil has 3.2 ms to restore its energy. This

period is, of course, longer at lower engine speeds.

Monostable MMV1 is triggered at its TR input (pin 4) every time it provides a pulse at its Q output. This pulse is applied via NAND Schmitt triggers N3 and N2 to parallel-connected inverters N4 to N9 that drive the power output stages.

For safety, the output stages T1-T2 and T3-T4, have been duplicated and then connected in parallel. Diodes D5 and D6 and zeners D7 to D10 pro-

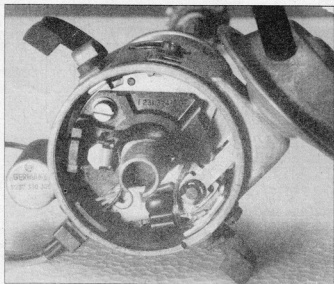

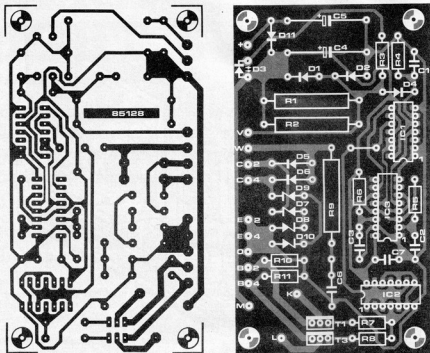

Fig. 4. The printed-circuit board for the solid-state ignition system.

Parts list

Resistors:

- R₁, R₂ = 100 Ω, 5 W
 R₃ = 680 Ω
 R₄ = 47 k
 R₅ = 56 k
 R₆ = 1 M
 R₇, R₈ = 220 Ω
 R₉ = 1 Ω, 5 W
 R₁₀, R₁₁ = 8.2 Ω
 R₁₂, R₁₃ = 47 Ω, 5 W

Capacitors:

- C₁ = 10 n
 C₂ = 33 n
 C₃ = 470 n
 C₄ = 220 μ, 16 V
 C₅ = 220 μ, 25 V
 C₆ = 4.7 n, 630 V
 C₇ = 100 n

Semiconductors:

- D₁, D₂, D₄, D₁₁ = 1N4001
 D₃ = LED; red
 D₅, D₆ = 1N5406
 D₇ to D₁₀ = zener diode 200 V, 1 W
 T₁, T₃ = BD437
 T₂, T₄ = BUX80
 IC₁ = 4093
 IC₂ = 4069
 IC₃ = 4538

Miscellaneous:

- Heat sinks for two TO-3 transistors; not required if a die-cast aluminium box is used
 Insulating plates — preferably Teflon — for mounting the power transistors
 2.5 mm² stranded wire as required
 4 car-type male terminals and mating receptacles for fitting with M3 size self-tapping screws
 four insulating bushes for use with M3 size screws
 metal — preferably die-cast — case 120 × 95 × 30 mm; if a die-cast case cannot be obtained, use thick aluminium sheet
 PCB 85128

text the power stages from negative pulses and over-voltages.

Monostable MMV₂ is triggered by the output pulses of MMV₁ and generates for each of these a pulse of about 0.5 s at its Q output (pin 10). The duration of this pulse is determined by the time constant R₆-C₃. The pulse ensures that gate N₂ remains open to accept control pulses. When the engine stops, the contact breaker no longer provides control pulses, and the gate closes after

0.5 s. This ensures that the ignition coil cannot burn out when the engine is not running. In that condition, parallel-connected resistors R₁ and R₂ allow a current of about 250 mA to prevent the contact breaker points from corroding.

Construction

When the printed-circuit board — see Fig. 4 — which is available

through our Readers' services, is used, no construction problems are envisaged.

Collector resistors R₁₂ and R₁₃ get quite hot and must, therefore, be glued onto the inside of the lid of the metal case.

The remainder of the construction should broadly follow the lines suggested in Fig. 5. If you cannot get a cast enclosure, fit the power transistors on suitable heat sinks. Do not skimp on the heat conducting paste! Before the ignition is fitted into the vehicle, it should be checked with an ohmmeter to make absolutely certain that it is free of short-circuits.

As shown in Fig. 5, one of the sides of the enclosure should be provided with four insulated car-type male terminals onto which the interconnecting cables are push-fitted by means of mating receptacles. These male and female connectors are available from most motorists' shops. It is advisable to fit the receptacles with insulating sleeves.

The case should be fitted under the bonnet in a position where it is reasonably well protected from water ingress.

It should normally not be necessary to alter the ignition timing. This timing can be checked roughly with the aid of diode D₁, which should light when the points are closed. However, if in any doubt, the timing

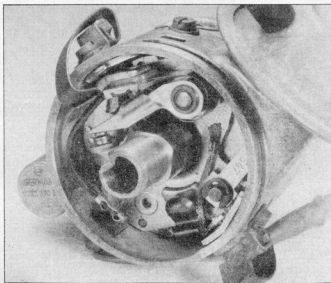

5

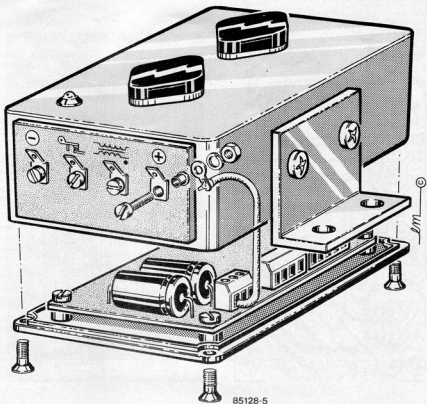
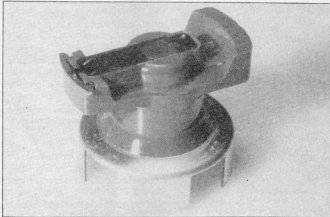
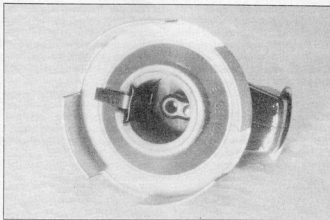

Fig. 5. Artist's impression of how the solid-state ignition system may be constructed and housed.



should be checked properly with a stroboscope with the engine turning over at constant speed.

In some cars, a resistor is connected in series with the ignition coil. This resistor, which is shorted out when the engine is started, must not be removed. Apart from the connection to terminal 1 of the coil, i.e., that to the contact breaker, all wiring in the car remains as before. If the car is fitted with a revolution counter, this should remain connected to terminal 1 of the ignition coil. **M**

FINALLY A WARNING. WHEN THE ENGINE IS RUNNING DO NOT UNDER ANY CIRCUMSTANCES TOUCH THE TERMINALS OR COMPONENTS OF THE IGNITION SYSTEM, BECAUSE THE HIGH TENSION PRESENT AT VARIOUS PLACES MAY BE FATAL.

INFRA-RED LIGHT SWITCH

Anyone who has ever tried to switch the light on when entering a dark room with both hands full will appreciate this light switch. It operates automatically upon being triggered by your body heat.

The idea behind this infra-red controlled light switch is quite simple. The body heat — which occupies the electromagnetic spectrum between light and radio waves, i.e. 0.74 to 300 μm — is picked up by a sensitive Fresnel lens. This lens, which has at its focus a double differential pyroelectric sensor, IR_v, is largely unaffected by other electrical radiation. The area served by the light

switch is divided into a number of zones as illustrated in Fig. 1. When someone moves from one zone into another, there is a change of temperature, which is collected by the lens as a variation in electromagnetic energy. The sensor reacts to this change by generating a small electric signal. That signal is processed and used to operate the light switch. Instead of a Fresnel lens, it is also

possible to use a simple home-made lens. More about this under *Construction*.

The circuit is suitable for operating lamps rated at up to 150 W. Depending on the setting of the presets, the light(s) will stay on for periods varying from 5 seconds to 7 minutes. If the light is required to stay on, the normal switch should be used, or an additional on-off switch provided in parallel with D₂. The latter switch should be rated at 240 V. The last solution is, in any case, to be adopted if the infra-red switch replaces the original light switch in the wall-mounted box.

An additional facility is the automatic brightness control which prevents sensor signals being processed as long as there is sufficient daylight in the room.

Circuit description

The signal provided by the sensor is so small that it must first be amplified. This is done in A₁ and A₂, which together provide a gain of 47 dB. The input amplifier is preceded by an RC filter, which removes any low frequency components. Moreover, A₁ and A₂ function as an active band-pass filter with a bandwidth of 1.5 MHz to 15 MHz.

Opamp A₁ is arranged as a comparator. The reference voltage is applied to the non-inverting input, pin 10, via divider R₁-R₄. As soon as the potential at the inverting input becomes smaller than the reference voltage, for instance, when the sensor has been triggered, the opamp toggles, its output — pin 8 — goes high, and capacitor C₂ charges quickly. Comparator A₂ then toggles, which causes T₁ to switch on. Capacitor C₁ discharges slowly through P₁ and R₁₀, and when the potential at the in-

by
Peter Theunissen

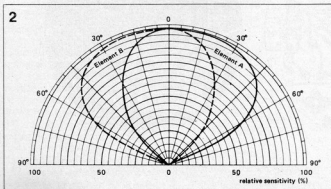
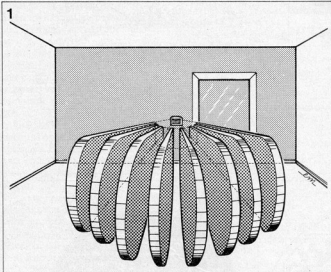
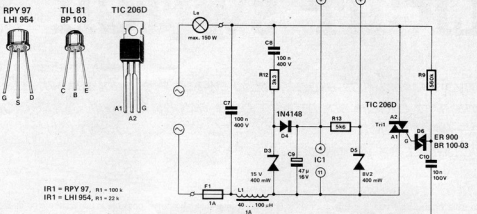

Fig. 1. This illustrates the division of a space into zones by a Fresnel or a home-made lens.

Fig. 2. Typical field-of-view diagram in the x-x plane of dual-element sensor Type RPY97.



Parts list

Resistors:

- $R_1 = 100 \text{ k}$
 $R_2 = 68 \text{ k}$
 $R_3, R_4, R_{11} = 100 \text{ k}$
 $R_5 = 27 \text{ k}$
 $R_6, R_7 = 10 \text{ k}$
 $R_8, R_9 = 2\text{M}$
 $R_{10} = 560 \text{ k}$
 $R_{12} = 3\text{k}$
 $R_{13} = 5\text{k}$

- $P_1 = 10 \text{ M}$ preset for vertical mounting on PCB
 $P_2 = 250 \text{ k}$ preset for vertical mounting on PCB

Capacitors:

- $C_1 = 10 \mu\text{F}, 10 \text{ V}$; tantalum
 $C_2, C_4, C_5 = 10 \text{ V}$; tantalum
 $C_3, C_8 = 4\text{nF}$; ceramic
 $C_7, C_8 = 100 \text{ nF}, 400 \text{ V}$; 15 mm matrix
 $C_6 = 47 \mu\text{F}, 16 \text{ V}$
 $C_{10} = 10 \mu\text{F}, 100 \text{ V}$

Semiconductors:

- $D_1, D_2, D_4 = 1\text{N}4148$
 $D_3 = \text{zener}, 15 \text{ V}, 400 \text{ mW}$
 $D_5 = \text{zener}, 8\text{V}2, 400 \text{ mW}$
 $D_6 = \text{ER}900 \text{ or BR}100\text{-}3$
 $T_1 = \text{TL}081 \text{ or BP}103$
 $T_2 = \text{BC}546$
 $\text{Tri}_1 = \text{TIC}206\text{D}$
 $\text{IC}_1 = \text{LM}324$

Miscellaneous:

- $L_1 = \text{choke}, 40 \text{ to } 100 \mu\text{H}, 1 \text{ A}$
 $\text{IR}_1 = \text{RPY}97^*$
 Fresnel lens Type MSFL24*
 Infra-red translucent window material; $100 \times 100 \text{ mm}^*$
 $F_1 = \text{miniature fuse}, 1 \text{ A}$
 Fuse carrier for PCB mounting
 Two-way spring-loaded terminal strip for PCB mounting
 PCB 86006; 63 mm dia.

*Available from Chartland Electronics Limited
 P O Box 83
 Cobham
 Surrey
 Telephone: (037 284) 2553
 Telex: 263578 (chking) g

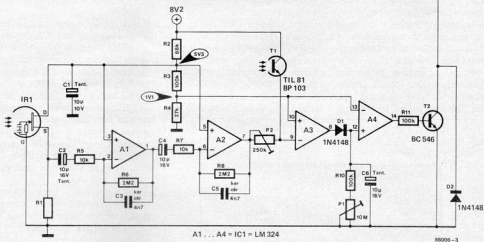

Fig. 3. Circuit diagram of the infra-red light switch.

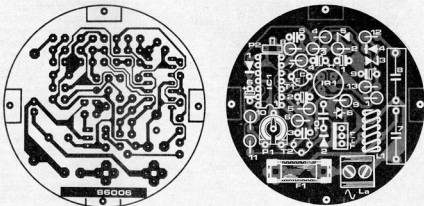

Fig. 4. The printed-circuit board for the infra-red light switch is available through our READERS SERVICES.



86006-5

verting input of A_4 rises above the level of the reference voltage, the comparator toggles again, and T_2 is switched off.

The length of time the light remains switched on depends on the time-constant $P_2R_{10}C_4$.

When T_2 is switched off, one terminal of C_{10} is open-circuited, and nothing will happen, because the triac gets insufficient gate current. As soon as T_2 is on, however, C_{10} is connected to earth and begins to charge. After a short while, the voltage across it is sufficient to switch on diac D_5 . Capacitor C_{10} then discharges via the diac and the gate of Tri_1 , which causes the triac to conduct. The potential across Tri_1 is, therefore, shaped as shown in Fig. 6, and is reminiscent of that produced by a dimmer switch. The resemblance does not end there, because, just as in the case of dimmer control, the lamp never gets the full mains voltage. This is in any case necessary to ensure that the circuit gets sufficient power.

If the room in which the switch is installed is open to daylight, it would, of course, be nonsense to have the light switched on every time someone moved across the field of the sensor during the day. This is, therefore, prevented by the automatic brightness switch. This consists of phototransistor T_1 and potentiometer P_2 with which the sensitivity of the circuit is set. When a certain amount of light falls onto T_1 it conducts, which results in a larger potential at the inverting input of A_4 than at the non-inverting input. The comparator output then remains low, which prevents T_2 from conducting, so that the triac cannot fire. Note that a higher resistance of P_2 corresponds to a higher sensitivity of the circuit and that, therefore, even a small amount of incident light may prevent the triac from switching on. If the brightness control is not required, merely omit T_1 and replace P_2 by a wire link.

The remainder of the circuit forms a simple power supply that is stabilised by zener diodes D_3 and D_4 .

Choke L_1 and capacitor C_7 prevent switching pulses generated by the triac from reaching the mains supply.

Construction

The circuit is best constructed on the PCB shown in Fig. 4, since this has been designed for fitting into a round electrical junction box. It may be necessary to file the edges of the board to make it fit snugly into the box. Be careful, however, not to take too much off, particularly around C_7 and C_8 .

The sensor may be fitted well away from the circuit, in which case a simple cable is needed to connect the two. Alternatively, it may be fitted onto the PCB, in which case the entire unit should, of course, be installed in a suitable position as suggested in Fig. 1.

The sensor or the entire unit, whichever construction is chosen, is best placed at a height of about 2 m (6 ft 6 in) at a downward angle of about 14° from the vertical in such a position that the door opening is fully covered. It should not be placed in direct sunlight, nor above heating appliances. Note that the unit is not really suitable for use in the open.

As stated earlier, the sensor may be fitted behind a proper Fresnel lens or a home-made one as shown in Fig. 5. A Fresnel lens is composed of a number of smaller lenses so arranged that they give a very short focal length. Such lenses are used in headlights, camera viewfinders, and spotlights, to name but a few. If you opt for a home-made lens, this is best constructed from some flexible cardboard into which a number of longitudinal slits are cut as shown in Fig. 5. These apertures should then be covered with clingfilm or similar foil. The reason for this is that the sensor should be open to infra-red light, but not to draughts or similar air currents. As the lens is bent into a semicircle, the open sides should also be made airtight.

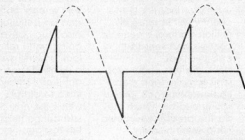

86006-M

Finally

When planning the installation, bear in mind that the sensitivity of the sensor is greatest for movements in parallel with it, and least for movements towards it. The sensitivity is greatly enhanced when a Fresnel lens is used. Further information on this, as well as on the sensor, may be found in the July 1985 issue of *Elektron India*.

WARNING Remember to switch off the mains when working on the PCB and when wiring the switch into the domestic light system. Remember that touching the mains can be fatal!

Fig. 5. Suggested construction of a cardboard lens.

Fig. 6. Wave shape of the potential across the triac.

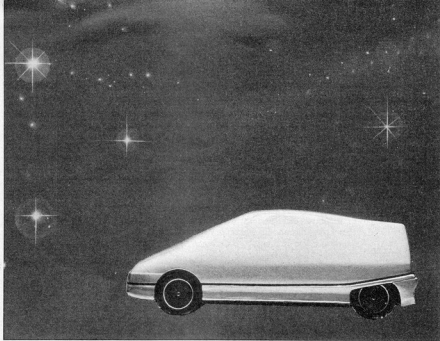

car electronics now and in the future

After we reported some five years ago that the motor industry was rather slow in adopting microelectronics, there has been a drastic reversal of this negative attitude. Indeed, most manufacturers, of cars as well as components, now reckon that without microelectronics the future of the industry would be pretty bleak. This is because they cannot see their way of meeting the requirements of the future by pure mechanical changes. These requirements involve reliability, efficiency, fuel consumption, performance, and comfort, among others. It is, therefore, not surprising that vast sums have been invested in research and development, particularly in the field of microprocessors. In the early years it was found that electronic

equipment just was not capable of operating reliably under the bonnet. It could, for instance, not cope with temperatures varying from -40°C to $+150^{\circ}\text{C}$; vibrations up to 200 g; salt spray; dust; sand; oil; and petrol. But all this is history now, and it is true to say that properly engineered electronic units are at least as reliable as mechanical car parts — and they are just as robust. It has been estimated that the motor industry in this country will fit some £200 million worth of electronic controls and sensors in cars this year. None the less, some problems remain. Even electronic systems can fail spontaneously. When they do, the breakdown should not present a safety hazard. Preferably, the car should be able to con-

tinue in spite of such failures. Because of this sort of consideration, it is becoming more and more important that the more complex electronic units are provided with an auto-diagnostic facility. The most important areas of research and development are concerned with electronic petrol injection and ignition systems; electronic diesel fuel injection; and electronic catalysers. It is interesting to note that these are all concerned with energy consumption and air pollution. There is also much development going on to refine the anti-lock braking system (ABS), a safety device so important that it surely should be fitted to all new cars within the next five years. Last but not least, there is the research into electronic gravity sensors for the control of airbags and

safety belts. A pictorial summary of these and many other aspects is given in Fig.1.

Fuel injection system with lambda probe

An interesting development by Bosch, particularly for small cars, is the Mono Jetronic injection system. In this, the required petrol-air mixture is determined from the position of the throttle valve, and the engine speed. This simple, but economical, method of engine control is optimized by an electronic circuit. Deviations from the correct mixture are detected and quickly corrected. The error signal is provided by the lambda probe. This system has been in use for some time

1

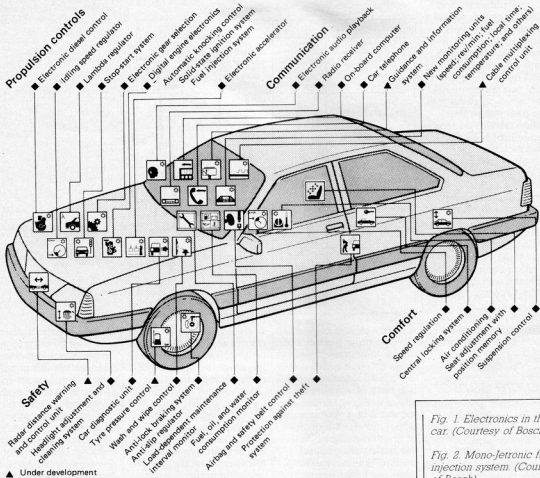
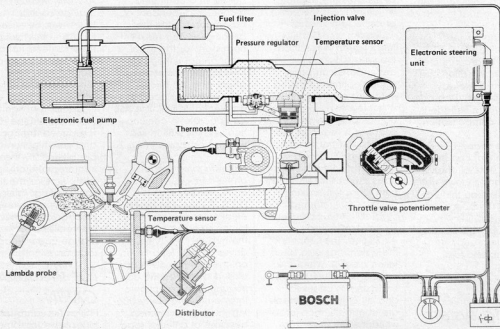

Fig. 1. Electronics in the car. (Courtesy of Bosch)

Fig. 2. Mono-jetronic fuel injection system. (Courtesy of Bosch)

2



now and has proved itself to be both accurate and reliable. Bosch has recently introduced a heated lambda probe, which, it is claimed, has a very long life, and provides enhanced accuracy at low exhaust gas temperatures; earlier switch-on of the system after the engine has been started; and improved reliability in difficult installations.

Note that a catalytic converter can only work efficiently if the air-fuel mixture is finely tuned: it must be close to what is known as the stoichiometric ratio, i.e., 14.7 parts air to one part fuel. It is clear that the converter works at an optimum in conjunction with an electronic fuel injection system: some 90 per cent of the three main pollutants present in the exhaust gases can then be converted.

Battery temperature sensor

Alternators and generators in cars are generally provided with a temperature compensation control, which ensures that the charging rate is higher when the battery is cold than when it is warm. This control will, however, only work satisfactorily if its temperature is equal to that of the battery.

A temperature sensor is, therefore, fitted to the battery case, and connected to the compensation control unit via a two-way cable. In this way, the optimum charging voltage is set by the compensation regulator.

Trials have shown that this type of control can improve the state of charge in winter and in town traffic by more than thirty per cent. With the battery maintained in this way, the engine will, therefore, fire much more readily — even at sub-zero temperatures.

Anti-lock braking system

The anti-lock braking

3

	Cold probe	Heated probe	Heated probe (lean burn engine)
Air-fuel ratio	14.7	14.7	>14.7
Operating temperature	350-850 °C	200-850 °C	150-800 °C
Application	Petrol engines	Petrol engines	Lean-burn petrol engines Diesel and LPG engines
Fuel	Lead-free	Lead-free	Max. 0.4 g Pb/l
Life expectancy	80 000 km	>160 000 km	80 000 km

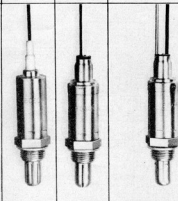

system, ABS, was originally developed for aircraft, but is now, in modified form, fitted to a number of standard production cars. The principle of its operation is shown in Fig. 4. Sensors attached to the hub of each wheel monitor the number of wheel revolutions. When the brakes are applied and the wheels tend to lock, electronic circuits controlled by the sensors operate an hydraulic brake pressure solenoid, which reduces the brake pressure to a level at which the wheel shows no tendency to lock. Since the system works independently on each wheel, optimum braking — for the circumstances — is achieved. As the wheels do not lock, the danger of skidding is reduced substantially. Many millions of hours of driving cars equipped with this system have shown that under all conditions the braking distance is shortened appreciably compared with that of cars not so equipped. The security of the system has also been taken care of. When the engine is started, the entire system is checked, and all of its components are constantly monitored while the engine is running. If an error is

detected, the ABS is disabled, and the normal braking system takes over: the driver is given an indication of this.

Anti-slip regulator

The Anti-slip regulator — ASR — prevents the driven wheels from running on in slippery conditions when the engine moment is reduced in a controlled manner, independent of how much throttle the driver gives. This makes it necessary for the usual mechanical linkage between the accelerator pedal and the throttle valve to be replaced by an electronic link. The ASR can operate in conjunction with the ABS in two versions as shown in Fig. 6.

ASR with throttle and brake control

In this version — see Fig. 5a — the combined electronics are controlled by the signals provided by the hub sensors. If the driven wheels tend to run on, the throttle valves are closed a little by the control unit of the electronic throttle link, thereby reducing the engine moment. If, because of different road track conditions, only one

Fig. 3. Comparison between cold and heated lambda probes. (Courtesy of Bosch)

wheel tends to run on, this is braked by the ABS in addition to the throttle reduction. This sort of combination is, in a practical sense, an electronically controlled limited-slip differential. The ABS hydraulics may have to be extended with an hydraulic memory, but this is not necessary if the ABS is factory fitted integrally with the normal braking system.

ASR with throttle and ignition control

In this version — see Fig. 5b — the hydraulics of the ABS need not be modified, and do not affect the ASR. Only the ABS electronics are extended with the ASR parts. To reduce the reaction time when the engine moment is reduced, the ignition and fuel injection settings are altered by the electronic accelerator at the same time as the throttle valve setting. This system does, however, need a mechanical limited-slip differential for safe performance under treacherous road conditions.

For the future: CARIN

Philips Research Laboratories have for some time been working on an elec-

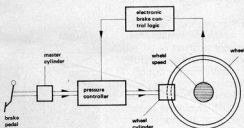
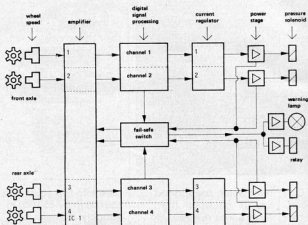

tronic co-pilot for cars, which can plan the route, guides the driver to this destination, knows the position of the car and can specify it at any moment, and can also provide a number of details about the environment or the destination of the journey. This co-pilot has been given the name CARIN: CAR Information and Navigation.

In later phases of the project, CARIN will be integrated with dashboard functions. Spoken warnings can then be given if the car needs to be filled with petrol or oil, if the temperature goes too high, or if there are battery problems. The system could also be linked to traffic warnings over the car radio. This might be done by means of the Radio Data System (RDS) which is now the subject of standardization discussions on the European level, while RDS test broadcasts are already taking place in this country as well as, for example, in France, Germany, and Sweden. The coupling of CARIN to RDS, for example, would make it possible to plan alternative routes to avoid traffic queues, road works or icy patches, and to modify the guidance pro-

vided accordingly. The digital RDS signals are accessible to the on-board computer and do not interrupt or interfere with the normal radio programme. Traffic research in this country has shown that drivers could plan their routes approximately twenty per cent more efficiently on average if they did not merely guide

themselves by familiar landmarks. Fuel costs and driving time are included in the calculation. With CARIN one could always reach one's destination in the most efficient manner possible.

Basic configuration
The basic configuration of CARIN is shown in Fig. 7. Parts of the system are:

Fig. 4. Anti-lock braking system.

Fig. 5a. ABS/ASR controlling brakes and throttle valve. (Courtesy of Bosch)

Fig. 5b. ABS/ASR controlling brakes, throttle valve, and ignition. (Courtesy of Bosch)

5a

- ① ABS & ASR electronics
- ② ABS & ASR hydraulics
- ③ Electronic accelerator
- ④ Wheel speed sensor

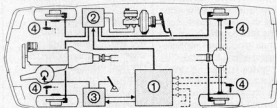

5b

- ① ABS & ASR electronics
- ② ABS hydraulics
- ③ Electronic accelerator
- ④ Wheel speed sensor
- ⑤ Limited-slip differential
- ⑥ Electronic ignition and fuel injection

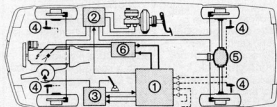

- A modified compact disc unit for the car which could not only play audio discs, but also read road information stored on compact discs, for example a complete road map of the UK, of a town, etc.

- A navigation system which determines the current position of the car.
- An on-board computer which carries out all processing.

- Sensors which provide data about the functioning of the car to the computer, for example the temperature of the cooling water, the amount of petrol available etc.
- A car radio to receive traffic information or warnings.

- Communication and control equipment consisting of a speech module with which, via a speech-synthesis chip, information could be given to the user, a screen for visual information — for example a road map — and a keyboard with which the driver can feed information or instructions to the computer. Here is a brief review of a number of these system components.

Large reliable storage capacity

A Compact Disc (CD) was originally intended to store 1 hour of music. This means that for 3600 seconds analogue signals are sampled 44.1 thousand times a second (that is the standard frequency) in two channels (stereo) and recorded on the disc at 16 bits per sample. The disc therefore has a capacity of:

$$3600 \times 2 \times 44.1 \times 1000 \times 16 \text{ bits} \\ = 5 \times 10^9 \text{ bits (5 Gbit).}$$

This makes available a gigantic ROM (Read Only Memory) which is very rapidly accessible at any point and on which, for example, a complete road map of the UK plus all sorts of travel information could be stored.

This idea of an electronic digital road atlas is being



elaborated further. The CD system had to be modified for its CD-ROM function by extending its error correction capacity, so that less than 1 bit error in 10^{18} bits might reasonably be expected for chance errors on an undamaged disc. That is a factor of a million better than computer tape. In other words, even a scratched or contaminated disc is more reliable than a computer tape.

The inclusion of an additional fault-correcting algorithm does cost some storage capacity, because extra information must be stored to remedy errors. This is something like sending an important message twice to make quite certain that it reaches its destination. By cunning selection of the error-correcting algorithm only 6×10^8 bits are lost instead of half the storage capacity, so that 4.4×10^8 bits remain available. However, if the playing time of the CD-ROM is increased to 66 minutes, as is intended, it will hold 4.8×10^9 bits which corresponds to 6×10^8 bytes.

Economic coding

The digital cartographer is confronted with the task of economically transferring to the CD a normal map with a scale of eg. 1:15 000 and containing about 30 colours.

An accepted method of scanning a map point by point makes use of a grid of horizontal and vertical

lines which are spaced say, 0.1 mm apart. The map is thus divided into tiny squares of $0.1 \times 0.1 = 0.01 \text{ mm}^2$, each of a specific colour. In this way an area of land 12x14 km (approximately the area of Oxford) on a scale of 1:15 000 would require 75 million picture elements. These would have to be indicated in colour. Since 5 bits represent $2^5 = 32$ colours, 75 million $\times 5 = 375$ million bits are required. That is almost 8 per cent of the capacity of the CD-ROM. In addition, this method would not make it clear to the computer where the roads were located on the map.

For this reason another solution has been sought. The method chosen is one of representing the roads — which is what it is really all about — with the help of angle points and node points. A dead-straight road without side streets has only two of these points, one at each end. A bending road is approximated by straight sections with angle points at intervals. An intersection is a node point. Thirty-two bits are needed for each point, i.e. 16 for the x co-ordinate and 16 for the y co-ordinate.

The area of land and inland water that can be handled with such a coding can be calculated as follows. Sixteen bits give $2^{16} = 65 000$ possibilities (approx.). If mainland Britain be div-

ided into two squares of 650 000 m by 650 000 m (roughly 400 miles by 400 miles), any position within each square, accurate to within 10 metres, can then be represented by 2×16 bits (two times 65 000 possibilities).

An absolutely straight road, as stated, can be indicated by only 2 points. A ring road, such as the M25 around London, needs about 4000 points, however, to be described properly. The average road in British towns can be described by 12 points, each of which requires 32 bits. The total is thus $12 \times 32 = 384$ bits on average per road. To this must be added an address of 32 bits to indicate where the additional information associated with these points (eg., the street name) is located on the disc. Since names (High Street, Station Road) are preferable to degrees of latitude and longitude, the relationship between the street names and co-ordinates must be recorded, and that takes memory capacity.

The average street requires, as seen above, $384 + 32 = 416$ bits. If a town contains, say, 3000 streets, $3000 \times 416 = 1.25$ million bits are needed. Adding a similar number of bits for the coding of the street names gives a total of 2.5 million bits or about 0.05 per cent of the CD-ROM capacity. That is a great deal more economical than the 8 per cent ob-

Fig. 6. CARIN in action. The keyboard will in future be replaced by a touch screen. (Philips Press Photograph)

Fig. 7. Constituent parts of the CARIN system. (Courtesy of Philips)

Fig. 8. How CARIN works on the road. (Courtesy of Philips)



tained with the first method. These considerations, of course, only indicate the order of magnitude. If more information is to be stored, or greater accuracy attained, more storage space is required.

Defining position

The CARIN system must be able to define the position of the car at any moment, for which various different technical methods are possible. An obvious answer in the short term is an electronic compass. With the help of such a compass, the direction of motion of the vehicle relative to the earth's magnetic field can be established.

With this information, and knowing the distance which the car travels from the odometer, the on-board computer can determine the position of the car. It is also able to correct errors caused by such things as passing cars or bridges made of reinforced concrete. The mass of iron causes an additional magnetic field which is registered by the car compass. The on-board computer corrects these errors by regularly comparing the information with the digital road map. If the calculated position is away from the road which the car should be following according to the map, an automatic correction is made (Fig. 8). Other solutions are being in-



vestigated for the short term to avoid the problem of disruption of the earth's magnetic field by iron objects.

Satellite navigation

In the longer term, satellite navigation will be possible, e.g., with the help of the American NAVSTAR Global Positioning System (GPS) which will be completed at the end of 1988 with 18 satellites in space. The civilian part of this system will make it possible to define a position at any moment of the day and at any point on the earth with an accuracy of about 40 metres. The satellites are located about 20 000 kilometres high in 6 different orbits which are distributed regularly around the earth. The orbiting period is 12 hours. Therefore, at any moment 4 satellites will be able to be received at any point on the earth. That is sufficient to determine longitude, latitude, height, and time (with the accuracy of an atomic clock). At present, 5 test satellites have already been brought into orbit and it is expected that at the end of 1987 there will be 12, sufficient for latitude, longitude, and determination of the time.

Contact with the driver

In the design of the CARIN system much attention has been paid to ergonomics, which includes ease of use and traffic safety.

-  direction according to digital road map
-  measured direction
-  correction

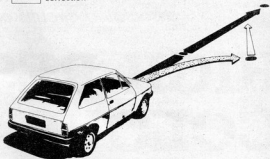

Thus, it is preferable in traffic that the computer gives its advice and information by means of the spoken word. The speech synthesis chip provides the means of doing this. Another precaution is that the screen can only be consulted when the car is standing still. It will then be possible to look at the map, for example, or ask for tourist information. It has already been indicated that the system can accept normal names for destinations, such as The Regency, Sea Road, Brighton, so that it is not necessary to struggle to specify the destination in degrees, minutes, and seconds. At the same time, the system tries to discover what the user wants with the help of simple questions.

For example, the following situation might occur: the user wants to travel from Gloucester to the Manor Hotel in Cheltenham. He gets into his car and inserts the CD-ROM which includes Gloucester and Cheltenham into his CD player. After starting up the system the following appears on the screen:
 WELCOME TO CARIN
 SELECT THE DESIRED FUNCTION:
 1. ROUTE INDICATION
 2. TOURIST INFORMATION
 3. OTHER FUNCTIONS
 The driver then keys in "1". The system replies:
 PLEASE INDICATE YOUR STARTING POINT: (The driver types in the street name and the closest intersec-

tion point).
 PLEASE INDICATE YOUR DESTINATION:
 TOWN? (The driver types in "Cheltenham").
 STREET OR DESTINATION? (The driver types in "Manor Hotel")
 The computer then selects the best route and stores it in its memory. If the driver desires he can now remove the CD-ROM from the player and put in a music disc.
 After the car has started, CARIN will guide the driver to his destination using the speech module. In the future the keyboard will be replaced by a touch screen. It will then be possible to indicate where one wants to go on a map, or find and indicate a street name alphabetically, after which the on-board computer does the rest.
 CARIN is no dream of the future but a technical reality to which Philips is giving detailed form. **M**

After last month's article on the construction of the graphics card, this fifth part in the series deals with the software, necessary for efficient operation of GDP and associated circuits on the board.

HIGH-RESOLUTION COLOUR GRAPHICS CARD - 5

by P Lavigne & D Meyer

The graphics control program, further on referred to as 'video interpreter', consists of a little less than 4Kbytes of 6502 machine code located in host computer memory. To understand the use of the available video commands, it is useful to have datacards 116, 117 and 118 to hand for reference. The colour extension as promised in the preceding article in this series will be featured in next month's issue. For now, the present video interpreter already supports all commands for use with the colour extension, so no software patching is required once this extension is put together.

Video and/or graphics terminal

The video interpreter allows the graphics card to function either as text or graphics terminal, or both at the same time. In the case of text mode, the screen is organized as 32 lines and 80 columns, whereas the graphics mode divides the screen in 512 x 256 or 512 x 512 pixels with 16 selectable colours. In the case of a text/graphics combination, a formerly connected separate terminal (VDU card, Elekterminal) is no longer needed.

Switching between text and graphics mode involves no hardware whatsoever; the video interpreter takes over this task with a set of dedicated subroutines. Furthermore, the interpreter is easily linked to the BASIC already available for the 6502-based host computer.

For ease of understanding, it is convenient to conceive of the present video interpreter as a printer; it

receives codes, either to be understood as alphanumeric characters or as graphic commands, and subsequently executes the necessary operations to make the relevant character or combination of lines and points visible on the screen. For this purpose, the interpreter issues the necessary commands to GDP and some auxiliary registers on the graphics card. The essential difference, however, be-

tween the interpreter and a printer is the fact that the former uses the host's microprocessor for instruction execution, whereas the latter relies on its internal processor for this purpose.

After initialization, the interpreter always switches to text mode, because only this mode allows entering and reading system data before a graphics program, if any, can be started at all.

Fig. 23. Inserting the graphics card and its 6502-based video interpreter in an input/output distributing system is not very complicated. It may be worthwhile to keep the existing alphanumeric VDU card in function, and to use the graphics card for graphics purposes only. To implement this, a single address in the host computer software will require modification; that is to say the address within the I/O distributor that gives access to the CHROUT routine in the present video interpreter.

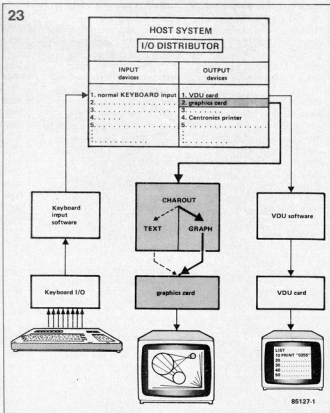

In the text mode, then, a screen is normally filled from the top left-hand corner (home position) onwards, just as with standard video or printer terminals. All standard cursor controls such as CR (carriage return), LF (line feed), and BS (back space) are available and take full account of the current character size. Thus, when a double character size has been set, the LF, for instance, will also have 'double size'.

Screen organization in the graphics mode starts at the bottom left-hand corner (origin, X=Y=0). Contrary to the text mode, terms like pen destination, pixel, and segment are used rather than rows and columns. The graphics mode has two possible types of access: instantaneous and provisional. Instantaneous access implies leaving the text mode for good, whereas provisional access allows interpretation and execution of all possible graphics commands until a closing CR sign is encountered which will put the system back into the text mode.

As stated before, the dominant mode is text. This will be obvious, considering that the text mode is automatically selected after a graphics program is interrupted with the BREAK key. When BASIC generates the message BREAK IN LINE X, the video interpreter must be signalled to switch to text mode. As will be

come evident from the discussion of the graphics mode commands further on in this article, the letter A in the work BREAK has been chosen for this purpose.

Host I/O distribution

Although text and graphics mode use quite different commands and screen layouts, it is certainly possible to have both interact to create, for instance, an inverse overlay text anywhere on a nice background design.

As the graphics card is also suitable for use as an alphanumeric terminal, the video interpreter has an input routine for reception of characters entered via the host keyboard. This leads to the following functional distinctions to be made for the video interpreter:

- visual representation of ASCII codes on screens with 32 lines and 80 columns;
- reception of keyboard-generated ASCII codes and relevant movement of a blinking cursor (blink rate is programmable);
- dot by dot control of the graphics screen, as defined by specific instructions.

The first two tasks typically belong to the text mode, the third to the graphics mode. The tasks may be mixed freely, as they function quite independently of one another.

Basically speaking, the interpreter will look like a super printing routine called CHROUT (character output). It receives all ASCII codes directed to the graphics card and fully autonomously puts alphanumeric characters in the relevant screen locations (text mode), or executes the given graphics command (Fig.23).

A character read routine, CHRNP (character input), has been provided for in the video interpreter, in case the graphics card is used as a terminal with the host computer. This would only require modification of input and output vectors in the host computer to make it communicate with the graphics card through the video interpreter. To implement this configuration, it would be ideal to program an I/O distributor routine containing all relevant system I/O addresses in their order of priority — Fig. 24.

The interpreter itself would require a patch to suit the host computer BREAK routine, but this is not strictly necessary and will be reverted to later.

A further important interpreter routine involves the initialization procedure for graphics card software and hardware. It will hardly be surprising to learn that this routine is called INITAL (initialize all).

In its present state, the interpreter occupies less than 4 Kbytes of host memory, which makes it possible to put the program in a Type 2732 EPROM for this purpose. However, the interpreter requires an additional 40 or so bytes for use as scratch and parameter storage area. Therefore, it would seem wiser to locate the interpreter in RAM area, in order to have some free space available right above it for scratch use. Example: the 4K interpreter RAM area C000 . . . CFFF would leave, say, CF80 . . . CFFF free for scratch purposes. If, however, the interpreter is run from EPROM at these addresses, some other RAM area would have to be reserved for scratch use, for instance DF80 . . . DFFF. Fig. 25 shows a possible memory map of the host computer system.

Fig. 24. The graphics card and its video interpreter may also function as an autonomous graphics and/or alphanumeric terminal. In that case, the interpreter will have a threefold function. Two addresses in the host computer software will require modification: one in the output distributor (printer routine), the other in the input distributor (reception of keyboard characters).

24

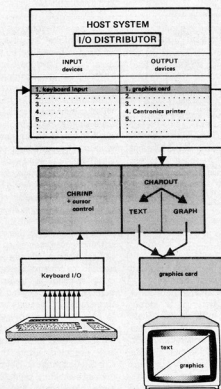

Text mode commands

At this stage, it is useful to have *Elektron* infocard 118 to hand to study the text mode commands as listed.

Fig. 25. Data transport in a system using an alphanumeric terminal (in this case the VDU card plus associated software), along with the graphics card and its interpreter. The graphics commands, as printed (1 and 1') by a BASIC program, are sent to the distributor by the BASIC interpreter (2 and 2'), and then simultaneously to the VDU software (3) and graphics software (3'). Depending on the configuration of the input distributor, characters as supplied by the keyboard (6) are directed to either the VDU or the graphics software (CHRINP in fig. 24).

The video interpreter text commands always consist of a single character (no parameters required) and have ASCII values lower than 20hex (32 decimal). They are usually referred to in hexadecimal notation, so 0D is carriage return, 08 is cursor left (backspace, BS). The corresponding BASIC notation, however, uses the decimal values, so CHR\$(13) and CHR\$(8) respectively, preceded by the PRINT statement. Commands CHR\$(8) .. CHR\$(13) and CHR\$(26) .. CHR\$(29) are standard video control characters and require no further comment, except that they take full account of the current character size.

CHR\$(17) and **CHR\$(18)** switch the graphics card to the text and graphics mode, respectively.

CHR\$(20) resets character size to minimal. Starting from an 8x5 matrix, characters may either be enlarged vertically or horizontally with graphics command S. Text command code CHR\$(20), or 14hex, will effect immediate return to minimal character size, irrespective of current size.

CHR\$(4) forces all ASCII codes in between this command and the CR code to be executed as being graphic instructions. The CR will restore operation in the text mode. Code CHR\$(4) is particularly useful for mixing drawings or background colours with text overlays, or for changing character size within a listing or a menu.

Suppose, for instance, that the text mode is set and that a program menu is to be put onto the screen. The characters are to be double sized and in red. Underneath the menu must appear the prompt 'enter your choice, please' in blue, normal sized characters. Programming character size can only be effected in the graphics mode, so that the current text mode will have to be temporarily left to insert relevant graphics commands, preceded by CHR\$(4):

```
10 REM colour red (=6)
20 REM double sized characters
30 REM normal height
40 PRINT CHR$(4)"C6,S2,1"
50 REM final CR will
60 REM restore text mode
70 PRINT "MENU..."
.
```

```
90 REM end of menu
100 REM colour blue (=3)
110 REM normal sized characters
120 PRINT CHR$(4)"C3,S1,1"
130 REM final CR will
140 REM restore text mode
```

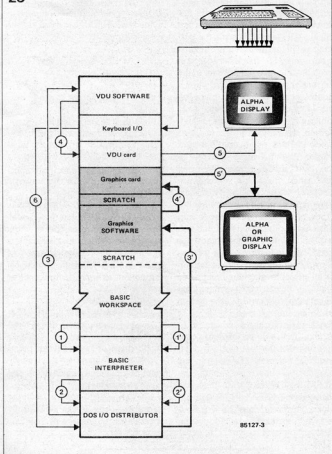

150 PRINT "enter your choice, please"

Alternatively, lines 120 and 150 could be written as:

```
120 PRINT CHR$(4)"C3"
150 PRINT CHR$(20)" enter your choice, please"
```

Note that use of CHR\$(17) and CHR\$(18) for this purpose is far less elegant than CHR\$(4), which instruction results in a more compact program.

CHR\$(1) transfers video buffer contents to GDP for execution at high speed.

CHR\$(2) opens or closes the video buffer area (toggle function). These two commands require some further explanation. In a monochrome system, one screen equals 16 Kbytes of GDP memory; 48 Kbytes are required with 8 colours (RGB); 64 Kbytes with 16 colours (RGBI). Remember that these memory areas are located on the graphics board, not in the host computer. Transfer of graphics card memory to host com-

puter memory would be convenient if a copy of the current screen were to be stored on disc or tape. However, reading a copy of the screen contents into host computer memory would require it to have a 64 Kbyte RAM area available for this purpose, which would seem a bit large, even for a simple 16 colour image. Obviously, it would be far more efficient to copy the sequence of GDP instructions generating such an image, rather than the image itself as it is present in GDP memory. Even more space could be saved if all insignificant ASCII codes, such as LFs and spaces, are not written into this command buffer. With this method of copying, more than some 16 Kbytes of host memory will hardly ever be needed for storage of even the most complex image in the form of a relevant graphics command sequence. Once the sequence has been stored in host memory, it is available for inspection, modification, or for saving it onto disc, to be reloaded later and executed using the PRINT CHR\$(1) instruction. Note also that from an aesthetic point of view, it is more pleasing to see a graphic image develop according to its

architectural logic rather than to see it completed by a scanning line from top to bottom of the screen. Moreover, the GDP has an execution speed which fully justifies the command sequence approach.

Fig. 26 shows that it is useful to reserve a dedicated RAM area in the host computer for video buffer purposes. Note that the buffered and disc-stored instruction sequence may also be loaded into another 6502-based computer equipped with the present graphics card.

CHR\$(2). By now it is time to explain how the GDP instruction sequences must be stored in the video buffer. Theoretically, this buffer may have infinite length, but a 4...5 Kbyte area would appear sufficient for most purposes.

Fig. 26a shows that a buffer that has not been opened, and then closed at the end with a CHR\$(2) instruction, is as if non-existent and can not be read by the video interpreter. This effectively protects the area from being written into inadvertently. Once opened with a CHR\$(2) command, the buffer will receive *all and only* the video interpreter commands meant to control the GDP, and exactly in the order in which they are issued, be it in the text mode or in the graphics mode. This process of copying will stop once a further CHR\$(2) command is encountered, which will effectively lock the buffer area — Fig. 26b. The buffer contents are now available for use, as outlined above.

CHR\$(1). This command enables execution of the GDP instructions contained in the video buffer by the video interpreter — Fig. 26c. After receiving a PRINT CHR\$(2) command, the interpreter searches for the buffer start address, reads the sequence of instructions and executes them one by one with dedicated subroutines, until the end-marker is encountered. Execution runs at a considerable speed, as all intermediate (BASIC) *x,y* coordinates calculation time is no longer required. Thus, a first test-run of a BASIC graphics program may show a relatively slowly developing graphic image. However, with the buffer opened before this run, it would afterwards contain only the necessary video interpreter instructions for very fast execution by a PRINT CHR\$(1) command.

Graphics mode commands

Like commands for the text mode,

26a

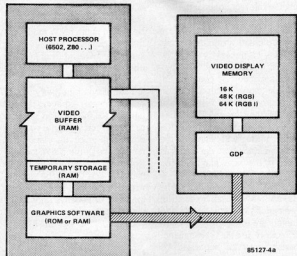

b

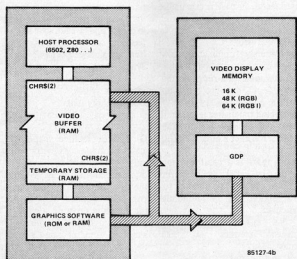

c

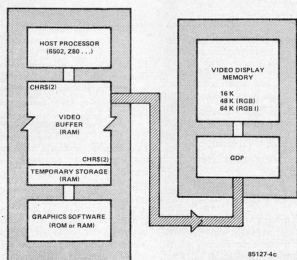

Fig. 26. In Fig. 26a the video interpreter controls the graphics card, but GDP instructions are not saved. Fig. 26b makes clear that every GDP instruction is copied into the host's video buffer, especially opened for this purpose with a CHR\$(2) instruction. Fig. 26c schematically shows how a 'packet of GDP instructions' is taken out of the video buffer for transfer to the graphics card. This process runs under video interpreter control and is started off with a PRINT CHR\$(1) command in BASIC.

those for use with graphics consist of a single byte (ASCII code A...Z) to specify the relevant command. However, certain instructions require one, two, or even three parameters to follow it. To create a ring or a circle, for instance, it is necessary to specify the radius, thickness, and sector(s), all neatly separated by commas.

In the text mode, reception of an ASCII value 42hex will result in a B printed on the screen. This same value, however, received in the graphics mode will change the background colour into the colour as specified by the parameter following the B command.

Syntax rules for the graphics commands are as follows: spaces in between or before commands and parameters are ignored by the interpreter, except for the P command. Parameters must be separated by commas; but there should be no comma between a command and its first parameter. In case a command follows a parameter, a comma should be inserted. The command string is always closed with a CR.

Certain (recursive) commands allow a series of parameters to follow them without the need for a repeat of the relevant command code; refer, for example, to commands D, J, or X.

If an expected parameter is missing, the interpreter assigns default value 0 to it. Thus, B/CR or B equals B0/CR or B0.

Whenever there is a parameter too many, or any other syntax error exists, the wrong instruction is entirely ignored and consequently not executed.

Note that the interpreter only recognizes integers, so 15.6 becomes 156.

Certain instructions must be followed by CR, in absence of which they will not function properly. This is notably so in the case of the P command.

After these general remarks, the particulars of every graphics command will be examined. Refer also to infocard 118.

A : return to text mode. Whenever a graphics program is interrupted, the BASIC interpreter will print BREAK IN LINE... on the screen, of which message letter A is used as the command to return to text mode.

Syntax: A CR
A ,next text mode command

B : set background colour. The only parameter expected after this command is the code number of the background colour to be set. After its initialization, the interpreter defaults to a black background.

Syntax: B n (CR)

B n ,next graphics mode command

Note that the B command must never be issued in the RMW mode, as then the background is not erased. Yet, issuing it may result in quite pleasing effects.

C : set or combine pen colour. The only parameter expected is the code number for the desired pen colour, its initial colour being white. This command may be used without restrictions in the RMW mode.

Note that the parameter for commands B and C may be positive (in which case the former colour is ignored), or negative (in which case the new colour is combined with the current colour by an AND logic operation).

D : draw from current position to x,y destination. At least two positive parameters are expected to define the absolute destination for the pen to draw a line to, starting at its current position. X,Y coordinates are given from absolute origin (X=Y=0).

Syntax: D x,y (CR)
D x,y ,next command

Recursive syntax:

D x,y,x,y...x,y (CR)
D x,y,x,y...x,y ,next command

G : draw geometrical shape. The letter G stands for geometry and provides access to two fixed geometrical shapes as selected by the first parameter. The sign of this parameter defines whether or not the shape is open or solid. The x,y parameters define the size of the shape in terms of x and y units on their respective axes, starting from the current pen position. When x and/or y are negative, the shape will be drawn behind and/or below the current pen position.

Syntax: G ± n,x,y (CR)
G ± n,x,y ,next command

H : home pen to current origin (see I), irrespective of its current position, and without drawing. No parameters are expected.

Syntax: H (CR)
H ,next command

I : set current location as new absolute origin. No parameters are expected.

Syntax: I (CR)
I ,next command

J : this command is the relative counterpart of the D command. At least two parameters are expected to define the relative x,y destination of the drawing pen. The relative coordinates are defined with respect to

current pen position, and either one of them may be negative to indicate that the pen destination is behind and/or below its current position. Syntax: see command D.

L : set line type n. One parameter is expected to specify the type of line the GDP is to use for drawing. Note that the type of line not only affects outlines, but also plain surfaces like circles, squares, or rectangles and triangles, which may produce highly interesting effects. Syntax: see command C.

M : move to absolute location x,y without drawing. Coordinates x and y must be positive.

Syntax: M x,y (CR)
M x,y ,next command
often: M,,1 = M 0,0,1
to home pen to absolute screen origin

N : plot dot x,y. Two parameters are expected to define absolute pen destination x,y and one for colour c of the plotted point.

Syntax: N c,x,y (CR)
N c,x,y ,next command
Recursive syntax: see command D.

O : draw a circle, ring, or section of it with current absolute origin as centre. Depending on the type of circle or ring, the pen need not always return to the centre at the end of the drawing.

Syntax: O s,r,t (CR)
O s,r,t ,next command
where s is the code for the drawn part or sector of the circle, r is the radius, and t the thickness of the ring.

When r equals t, a disc is obtained (quickest drawing); when r > t, a ring is drawn with thickness t; appearances are deceptive in this case, as this shape requires less lines to be drawn, and yet is slower to finish.

P : print alphanumeric characters without leaving the graphics mode. This command functions like its text mode counterpart CHR\$(4). All codes following command P are printed as alphanumeric characters, starting from the current pen position.

Syntax: P characters (CR)
Example:
10 E = 12
20 PRINT "M 128,15,1"
30 PRINT "P example number ";E
The text "example number 12" is printed from location X=128, Y=15 onwards without leaving the graphics mode. Note that P is the only graphics command in which spaces are significant.

Q : set the print direction. One parameter is expected to select horizontal or vertical printing direction for characters following the above command P.
Syntax: see command B.

R : move to relative *x,y* position from current pen position, without drawing. This command is the **relative** counterpart of command M. Thus, *x* and *y* may be negative.
Syntax: see command M.

S : set character size. Two expected parameters *x* and *y* define the alphanumeric character size horizontally (*x*) and vertically (*y*). The parameters are independently specified to enable printing very wide, yet short characters, or, alternatively, very tall, yet narrow ones on the same screen. Parameter values must be in the range of 0...15, and S1.1 resets normal size.
Syntax: see command M.

T : set character type. One parameter is expected to select normal or italicized characters, irrespective of current printing direction.
Syntax: see command B.

U : select pen/eraser activity up/down. Two parameters are expected with this command: the first selects either pen or eraser, the second determines whether the pen or eraser is active (on the paper) or inactive (off the paper). This command allows drawings to be generated by means of recursive algorithms which alternately lift the pen and put it down.
Syntax: U pu (CR)

U pu, (next command)
Note that the interpreter is always in the 'pen down' mode after its initialization. Thus, it is not necessary to issue command U1 at the start of every graphics program if it is remembered to run the INITAL routine first.

V : get pixel status. Two parameters are expected to specify the coordinates of a pixel whose status is to be read from the screen memory.
Syntax: see command N.

The four colour bits of a specified pixel become the lower nibble (bits 0...3) of a buffer called PIXBUF. Access of PIXBUF will be reverted to later.

W : set read-modify-write (RMW) mode. One parameter is expected to select/deselect RMW operation, as explained in the first part of this series of articles.
Syntax: see command B.

X : draw coordinate axis. Three parameters are expected to specify direction *a*, increments *s*, and marking intervals *i*.

Syntax: X a,s,i (CR)
X a,s,i, (next command)

Recursive syntax:
X a,s,i,...,a,s,i (CR)
X a,s,i,...,a,s,i, (next command)

Z : select page. One parameter is expected to select a screen page. Depending on the set vertical resolution, two or four pages of screen memory are available. The Z command enables the user to smoothly thumb through the screen memory pages to look for certain data or drawings.

Syntax: Z p (CR)
Z p, (next command)
where *p* has a value between 0 (page 1) and 3 (page 4).

Parameters and variables

The above summary of available text and graphics commands shows their conciseness and suitability to be effectively used in any BASIC program, as they can be printed as a so-called string of characters. This implies that all parameters may be thought of as variables and that their signs (plus or minus) remain significant. In extreme cases, one variable could be assigned to a whole sequence of graphics commands to create recursive algorithms and, consequently, compact programs like the ones shown below.

The first program draws one of the figures as shown on page 45 in the January 1986 issue of *Elektor India*. The second program does the tubular figure as shown on the front cover of the November 1985 issue.

```
10 DISK:IO BEEP: DISK:IO ,84
20 PRINTCHR(2)CHR(10)CHR(120),10,"
30 FOR=40000:1:PRINT"1",200,"A",NEXT
40 FOR=204800:1:PRINT"011",1,"A",NEXT
50 PRINT"b-1,"
60 FOR=100000:1:PRINT"1",1,"NEXT
70 FOR=102000:PRINT"0",1,"A",NEXT:PRINTCHR(2)
80 FOR=17000:PRINTCHR(0):NEXT:DISK:IO ,84

10 DISK:IO BEEP: DISK:IO ,84:PRINTCHR(10)CHR(67),84
20 FOR=40000:10000:NEXT:DISK:IO ,10:END
30 T=4.20E17(2):R=INT(250*(1-ABS(COS(T)))
40 PRINT:LINE INPUT"Y":Y=INT(Y)
50 GOTO:1:PRINT"Y",T,"C",C,250,48,84:RETURN
```

Graphics card and Junior Computer

As an expansion of the DOS-equipped Junior, the graphics card and its video interpreter may be

used as a dedicated graphics terminal, together with the VDU card for alphanumeric I/O (Fig. 23). However, it is also possible to use the graphics card in the text mode, thus obviating the VDU card and software altogether.

It is possible to use the CHRNP routine, but this is not obligatory (note that Junior's DOS supports several output devices, but only one input device, i.e. usually the keyboard). In the source listing of the video interpreter, the BREAK-test subroutine has been adapted to suit the Junior. What remains to be done is modification of two addresses in the Junior output distributor: the address of the CHROUT routine (video interpreter) is placed in between the addresses of VDU driver and Centronics printer routine.

Attention! The addresses to be placed into the distributor are always one byte lower than the actual routine addresses. Thus, if the video interpreter was assembled to run from B003 onwards, the byte to be placed in location 2313_{hex} or 2315_{hex} is 02, not 03:

```
2313: 02 } "IO ,02" or "IO ,83"
2315: B0 }
or
2315: 02 } "IO ,04" or "IO ,05"
2316: B0 }
```

The character read routine, CHRNP, is placed in locations 2301_{hex} and 2302_{hex} as B005_{hex} (= B006). The address of routine INITAL is B000_{hex}. This routine is accessible with disc command DISK"GO B000", and ought to be run one time before a graphics program is started to clear all preceding variables. Attentive readers will have found out by now that the graphics interpreter is assembled into a 4Kbytes block of 6502 object code starting at B000_{hex}. This memory area lies within the RAM work space of the BASIC interpreter, so a modification of V3.3 disc track 0 is called for. The procedure to effect this has been described in *Elektor India* issue of

October 1983, page 10-45. Referring to table 2 on that page, change the byte in location A21b_{hex} from BF into AF. Write modified track 0 back onto disc. The modification with the I/O distributor is also done on track 0: the corresponding addresses are either (A)313 and (A)314 or (A)315 and (A)316.

The video buffer containing the GDP command sequence extends from 7000_{hex} right up to AFF_{hex} (16 K). This implies that 12 Kbytes are left for the BASIC program, starting from 3A79_{hex}. This will be large enough for most purposes. ■

Its modest dimensions and battery operation make this amplifier eminently suitable for use out of doors: at garden parties, sporting events, boating galas, to name but a few. It might be classed as a good-quality PA (public address) amplifier in view of its better frequency response than usually found in run of the mill PA units.

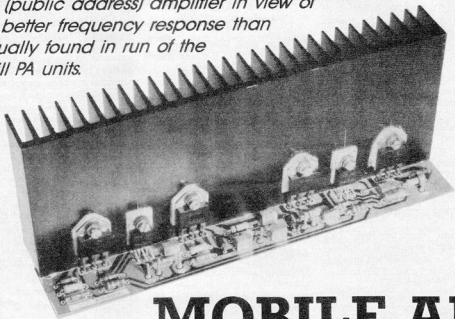

MOBILE AF POWER AMPLIFIER

by
Arno Sevriens

In contrast to hi-fi power amplifiers, which are designed for low distortion, high slew rate, low noise, and good damping factor, public address amplifiers must meet different requirements. Among these are high output power, good reliability, and robustness.

Generally, low supply voltages result in relatively low power outputs. This is, however, not the case in the present amplifier, as shown in Table 1. The figures in this table become even more impressive if the modest dimensions of the amplifier are considered. Note that the supply voltages in the table are either asym-

metrical or symmetrical. The difference between the two will be reverted to later.

Circuit description

Designing a power amplifier used to be a complicated and complex job. Nowadays, however, the complexity is contained entirely in proprietary ICs to which only a few external components need to be added to obtain a first-class amplifier. There used to be a lot of scepticism about these 'black boxes', but over the years they have more than proved themselves, so that any doubt as to their operational qualities is quite misplaced. The only drawback with them is that there is so little to explain about the final circuit.

Figure 1 shows that the proposed design is of the double push-pull type, which is about the only way that a large output power can be obtained from a low supply voltage. This arrangement ensures an available power output double that

of a single push-pull amplifier. If then the output impedance is halved, the output power is doubled again, so that four times as much power becomes available. Note that the power developed by an output amplifier is determined by

$$P = u_{pp}^2 / 8R_L \quad (1)$$

where P is the output power, u_{pp} is the maximum peak-to-peak voltage excursion across the load, and R_L is the load (i.e., loudspeaker) impedance.

A noteworthy aspect of the circuit is that, although the loudspeaker is direct-coupled to the amplifiers, an asymmetrical supply may be used. This is made possible by the virtual earth created by R_1 and R_2 . It is, of course, true that this is high impedance, but this is of no consequence here because the output current does not return via earth. However, since it is permissible — and often preferable, as will be seen later — for a symmetrical supply to be used, the circuit makes provision

Table 1.
Correlation of
input voltage,
output power,
and supply
voltage.

Table 1.

Supply voltage	Supply current	Output power	Corresponding input voltage (rms)
12 V (± 6 V)	1 A	5 W into 4 Ω	85 mV
12 V (± 6 V)	2 A	10 W into 2 Ω	85 mV
24 V (± 12 V)	3 A	40 W into 4 Ω	210 mV
24 V (± 12 V)	6 A	80 W into 2 Ω	210 mV
36 V (± 18 V)	5 A	100 W into 4 Ω	330 mV

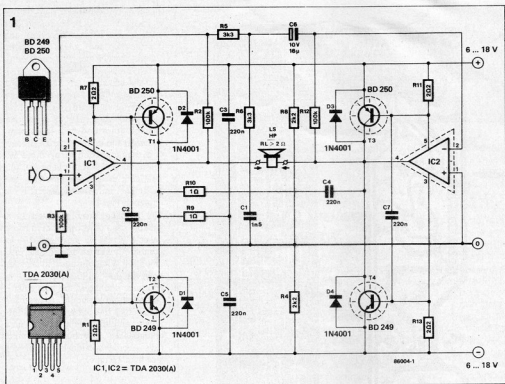

Fig. 1. The circuit diagram of the power amplifier is basically a double push-pull arrangement.

for both. Normally, therefore, an asymmetrical supply of 12 to 36 V is connected to the \ominus and \oplus terminals. Both push-pull amplifiers consist of a Type TDA2030(A) driver and complementary power stages Type BD249-BD250. The TDA2030(A) is a self-contained Class AB amplifier capable of delivering up to 18 W into a 4 Ω loudspeaker. It may, unfortunately, prove difficult in certain areas to get hold of a TDA2030A, in which case the TDA2030 may be used. This delivers a maximum power of about 14 W into 4 Ω . A further difference between the two types is that the (A) version may be used with supply voltages of up to ± 22 V as against ± 18 V for the basic version. Whenever the load current rises above a level which the drivers cannot handle (and this almost entirely depends on the supply voltage), power stages T₁ to T₄ are switched on via resistors R₁, R₇, R₁₁, and R₁₃. Negative feedback provided by R₅-R₆-C₁-C₆ ensures fully stable operation.

Although there is no real protection against short-circuiting of the output, since this is difficult to realize in this type of amplifier, the thermal protection circuit in the driver ICs enable the unit to withstand quite a lot of rough treatment.

Construction

It is advisable to build the amplifier

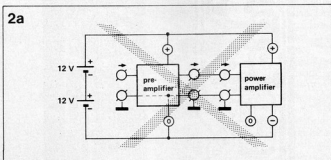

Fig. 2a. Incorrect way of using the same supply for a pre-amplifier and the power amplifier, because the earth return lines in the two units are at a different potential.

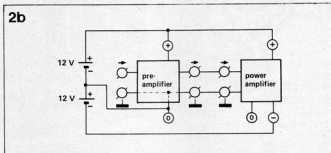

Fig. 2b. A pre-amplifier intended for operation from an asymmetrical supply should be connected as shown here.

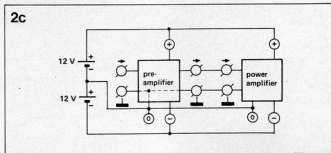

Fig. 2c. If the pre-amplifier is designed for a symmetrical power supply, it should be connected as shown here.

Fig. 3. The printed-circuit board for the power amplifier can conveniently be combined with a 200 mm long heat sink for the power stages.

Parts list

Resistors:

R₁, R₇, R₁₁, R₁₃ = 20Ω
 R₂, R₃, R₁₂ = 100k
 R₄, R₆ = 2kΩ
 R₅, R₈ = 3kΩ
 R₉, R₁₀ = 1 Ω

Capacitors:

C₁ = 1n5
 C₂...C₆, C₇ = 220n
 C₈ = 10μ, 16V

Semiconductors:

T₁, T₃ = BD250
 T₂, T₄ = BD249
 D₁...D₄ = 1N4001
 IC₁, IC₂ = TDA2030(A)
 (see text)

Miscellaneous:

heat sink
 100 × 200 × 25 mm, e.g.
 Fischer SK42 type

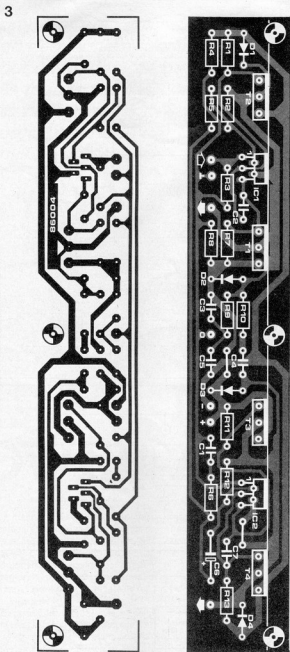

on the printed-circuit board shown in Fig. 3. This has been designed to mate with a 200 mm long heat sink for the ICs and power transistors, which obviates any long connecting wires between these components and the board.

The driver ICs and power transistors should be mounted onto the heat sink with the aid of insulating washers (provided with these components) and ample silicone grease. It is recommended to tap three M3 threaded holes in the flange of the heat sink to facilitate mounting the PCB. The completed assembly is shown in Fig. 4.

The amplifier may be fitted in a suitable case of its own, but in many cases it would be more sensible to combine it with an appropriate pre-amplifier. Whatever housing is used, however, it is important that there is adequate cooling of the heat sink. Screened cable should be used for connecting the pre-amplifier to the power amplifier. Power lines and loudspeaker connections should have a cross-sectional area of not less than 2.5 mm².

Use of a pre-amplifier

As stated earlier, the power amplifier may be powered by an asymmetrical 12 to 36 V supply or a symmetrical ±6 to ±18 V one. The supply may consist of a 12 V car battery, or two or more of such batteries in series, or it may be a simple mains supply. In the latter case, a symmetrical version is obtained by the use of a centre-tapped mains transformer.

If the supply is used to power the pre-amplifier also, care should be taken to ensure that the signal earths in the two amplifiers are at the same potential. If, for instance, the pre-amplifier is intended to be powered by an asymmetrical supply and is then connected to the power amplifier supply, the 0 line in the power amplifier will be shorted to earth as shown in Fig. 2a. The only solution to this problem is to use a symmetrical supply and power the pre-amplifier from one half of this as shown in Fig. 2b. If the pre-amplifier is intended to be powered symmetrically, there are, of course, no problems — see Fig. 2c. ■

SGS application

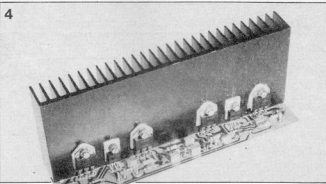

Fig. 4. Completed assembly of PCB and heat sink.

Protecting data from prying eyes

by Alan Burkitt

The banks are closed and you want to check how much money is in your account. You put your plastic card into an automated teller machine and the bad news is printed out. Does anybody else know? Your employer's personnel department has just put all its records on computer, including details of your employment history, your health, your education, and even family information. Once it was kept in a locked cabinet and only one person had the key. Now terminals all over the company, even in other branches, are connected to the same computer. Who can read your personal files?

Your company has installed an up-to-the minute office automation system. Senior staff dial it up every evening and use their own home computers to analyse sales data and work on new product plans. How do they know that rival companies are not dialling the same computer and stealing information?

Espionage or accident

In each case it is impossible to give an accurate answer. Because of its very nature, no one knows how much computer "espionage" goes on. What is certain is that, as companies put more and more of their vital data — and information about their employees and customers — onto computer, the risks are growing. Information thieves can be just as clever as the people running the computer system. But it is not only deliberate

theft of information that computer operators have to guard against. If many different departments use the same system — or if there are links between systems — there is the risk of accidentally straying on private information, rather like hearing something spicy on a crossed telephone line.

It is relatively easy to protect information in old fashioned filing cabinets. A lock on the cabinet and another on the door may be enough. In any case, it is obvious to anyone when someone is rifling through

a drawer. But who knows who is tapped into a computer?

Protection by law

Protection of computer data is no longer optional in Britain, one country where electronic data is now very widely used. It has become a legal obligation, certainly as far as personal information is concerned. A Data Protection Authority, established by the British Government,

is drawing up rules that will apply to everyone using a computer to store or process such information — in theory, even owners of home computers. Fortunately, however, there are means of protecting information. The personal identity number needed to key into a bank machine is helpful, but to be easily memorized such numbers usually have only four digits, so that a determined spy could perhaps discover it by trial and error. In any case, that does not protect the information zipping along the telephone wires from the bank's computer, which can be tapped by anyone with simple equipment. More sophisticated means are needed and here the computer industry has taken lessons from governments that want to protect secrets by using codes. Confidential information is converted into a secret code by an encryption unit using a system known as the Data Encryption Standard or DES. It can then be stored in a computer or transmitted down a telephone line. Either the system is pre-set with an individual code or key, or it is typed in by the operator at the time. Encrypted data bear no resemblance to the original and, because of the vast number of possible keys, only one of the world's leading intelligence agencies would have the ability to decipher it.

Special software

But the system is expensive, or it has been until now. A DES encoder/de-

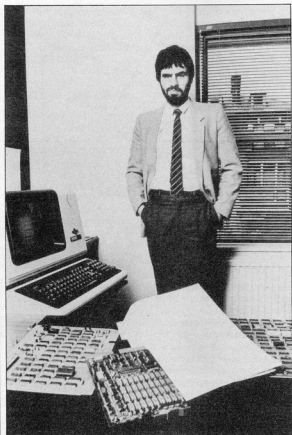

Dr John Yardley, managing director of JPY Associates, which produces the data protection software package Data-Lock.

coder costs about £3000 in the United Kingdom and a separate unit has to be bought for every bank branch and every company computer. However, it is possible to use the computer itself as the encryption system. All that is needed, instead of a "black box", is special software that programs the computer to encode or decode information as it goes into or comes out of the memory.

That means companies can ensure the confidentiality of their information at only a fraction of the cost and, as the DES code is used, the security is every bit as good. Pioneering the software approach is a three year old company, JPY Associates of New Malden, which has invented a system called Data-Lock.

John Yardley, JPY's managing director, said: "So far, our customers have wanted to protect either personal data or commercially sensitive information. We have had a lot of enquiries from people developing office automation systems, where they want Data-Lock written into the software."

Speeding up the process

Compared with the traditional hardware solution, this might work out at under £500 for the cheapest version — a big saving. JPY has started off by producing the software to run on PDP-11 and VAX computers made by the Digital Equipment Company.

A potential drawback of software encryption is that it can be slow: after all, some complex mathematical processes are applied to the data. "We have put everything into our software to make it go fast," said Dr Yardley.

"Data-Lock processes three or four blocks of 512 characters each per second." In other words this whole article could be encrypted in about four seconds — not too long to wait if the information is confidential.

"The encrypted information can be computer programs, databases, or anything. It really does not matter, and we think we can get the system to operate even faster."

Even the engineer main-

taining a computer cannot obtain the data without the key, which is a sequence of eight characters, numbers or letters. "It could be a name or a telephone number, although ideally it should be random," Dr Yardley said.

Limited keys

In one approach, the operator enters the key at the terminal so that data can be coded or decoded. But the key, itself encoded, can be stored in the system and the operator keys in another sequence to operate it. With this method, users can label their keys with familiar names, without compromising security. This system is called Key Manager.

What happens if the operator forgets the sequence, or even dies? "In co-operation with the owner of the computer we can get the key back if it is on a key manager system," Dr Yardley said. "Otherwise it is lost for all time."

Obviously this can create

problems, and JPY is thinking of a way round them. One possibility is to limit the operator to a certain number of possible keys — so that they can be tried in turn.

"It may take a week to come up with the right one," said Dr. Yardley. That of course may not be secure enough for really vital commercial information, but few intending spies have the resources to devote that length of computer time to ordinary material.

And it will mean we can be confident no unauthorized eyes are looking at our bank accounts or other personal details stored on computer.

Educational software for the handicapped

by Jack Cross

Among special devices to allow handicapped children to play and learn with computers are a work station with voice synthesizer for the blind, a helmet projecting an electronic beam for those with difficulties in controlling their limbs, and a controller operated by movements of the eye for the severely disabled. Simpler aids include extra-large switches or levers for children who have difficult-

ies with standard switches; and various computer programs tailored specifically for those with different learning disabilities.

All this hardware and software has been produced by the four Special Education Microelectronics Research Centres (SEMERCs) covering England and Wales. The centres are a task force that collaborates closely with the regional and national offices of Britain's

highly successful Microelectronics Education Programme (MEP), established in 1981 to foster computer awareness among teachers and pupils.

Power and flexibility

MEP's national coordinator for special education is Mary Hope, who is based at the Council for

Educational Technology in London. In 1982 she wrote: "We are just starting to get some idea of how we can help children with learning difficulties; to enable the severely physically handicapped to communicate and express themselves despite their handicaps; to help deaf children overcome their speech and language problems; and to minimize some aspects of the handicap of blindness. The

power and flexibility of the new technology is enormous and must be one of the most exciting areas of development in education."

Well balanced team

The best known SEMERC is probably the one at Newcastle, which covers northern England and is conveniently close to the MEP Directorate's offices. Colin Richards, the centre's manager, calls micro-electronics "a caring technology which opens doors that, without it, would remain firmly shut". He and his team enthusiastically demonstrate the capabilities of some of the many devices held by the SEMERC, emphasizing that each has to be evaluated as a teaching tool.

It is not difficult for the layman to perceive why so many of these are designed to operate without the familiar typewriter keyboard. It is not suitable for the blind or near-blind, or for young people who suffer from a severe motor impairment. In any case, the aim is to assist in general teaching/learning activities, not to impart touch typing skills. So most of the hardware can be controlled by such actions as the flick of an eyelid,

sucking and blowing, using a large simple switch — or whatever method suits each handicapped child.

For the very young, mentally or multiple-handicapped children, there are simple and cheap electronic interfaces that allow them to use a large switch to operate an ordinary toy — from a drum playing fluffy rabbit to a laser gun. This system, developed by the Manchester SEMERC, can be operated by hand, foot, breath pressure, voice or grasp. It can be used to encourage attentiveness or as a reward for performing in response to varied commands from the computer, such as: "Hit the blue switch three times and the rabbit will beat his drum."

Head movements

The "Phonetic Wand" is a kind of plastic helmet which projects an electronic beam to control a moving spot on a visual display screen. Though designed — by Dr John Cole of Chester — for people capable of making well controlled head movements, the wand is a source of motivation even for sufferers from fairly severe cerebral palsy. It comes complete with pro-

grams dealing with literacy, number work, music and painting. The Newcastle SEMERC group is trying to find out what kind of software works best with Twinkle. The device utilizes eye movements which, by way of sensors affixed to the child's forehead, give the user access to the computer.

The staff is particularly excited about the potential of the Adventure Board produced by Britain's Education Development Centre at Walsall. A magnetized playing piece is moved along grooved pathways cut into a solidly built flat surface, actuating a series of 16 switches which produce messages on a screen. The demonstration model portrays a village, with shops, a farm, animals and trees — the kind of small toys found in any home or infant school. A typical "adventure" might read: "I set off from the farm gate. . . I saw a duck and three ducklings. . . I crossed the bridge over the stream" — and so on. The program can be stored, returned to, and, with the appropriate equipment, printed out. Teachers can prepare their own boards and write their own stories about anything from the route to school to a treasure island. Walsall Education Authority, which holds the patent on Adventure Board, hopes to go into commercial production soon.

Overlay keyboard

Teachers particularly prize devices that allow them to present their own material without having to have any programming skills. The overlay or Concept keyboard, now coming into general use, is essentially a flat board, produced in various sizes, inlaid with rows of touch sensitive pads. On this is placed a piece of paper

with up to 256 pre-produced items — they can be words, pictures, diagrams, numbers, textured surfaces or passages in braille. The pupil gains access to this "prompt, cheap, microprocessor" as Mr Richards describes it, by pressing the relevant section of the overlay. There are several devices that use graphics to assist speech training and make it enjoyable. Micro Mike has been developed by the Manchester SEMERC and the NorthWest England Computer Club. Children can draw pictures or control racing vehicles on the screen by making the correct sounds at the right volume. Visi Speech (Jessop Acoustics) displays sounds in shapes, which the speech impaired child is invited to match. C-Speak (Rank Stanley Cox) operates in much the same way, using a radio microphone and a display on an ordinary television set.

Viewscan has been designed to help visually handicapped people read text. He or she moves a miniature scanning camera over the surface of the page; its content is magnified up to 64 times and can appear as dark on a light background, or the reverse, in selected degrees of intensity. Totally blind people can learn to use Opticon, which translates printed words into tactile signals received by the reader through the fingertips.

Voice synthesizer

Britain's Royal National Institution for the Blind has particularly welcomed a work station developed with MEP funding by Dr Tom Vincent of the Open University at Milton Keynes. A keyboard microcomputer turns words into print and then, using a voice synthesizer,



Wendy Kerton operates a Braille keyboard microcomputer which turns her words into print and then into speech.

into speech. It received an award from the BBC radio "In Touch" programme as the year's best invention to help the visually disabled. MEP Touch Screens are a welcome addition. These fit to the front of a computer screen and are a way of bypassing the standard keyboard. Mike Bostock, technology manager for MEP, writes: "For many children this is not a serious inconvenience, but such distraction can become acute for very young children, those with manipulation problems, short concentration spans, or acute learning difficulties." With this system, they simply have to point to the required

object on the screen and the computer responds directly. The SEMERCs hold many thousands of software programs. Some are commercially produced, others were developed by MEP groups and may be copied, without charge in Britain, for educational purposes. Mr Richards and his team in Newcastle are continually evaluating new devices and software in discussion with teachers and other users' groups, and demonstrating their potential classroom use in an area running from the Scottish border southeast to the boundary between Lincolnshire and Cambridgeshire.

Since it is British Government policy to put as many handicapped children as possible into mainstream education (only 2% go to special schools), many of those who attend the SEMERC courses are non-specialist teachers from ordinary primary or secondary schools.

Special Education Micro-electronics Research Centre, Newcastle Polytechnic, Coach Lane Campus, Newcastle upon Tyne, England, NE7 7XA.

Micro-electronics Education Programme's Directorate, Cheviot House, Coach Lane Campus, Newcastle upon Tyne, England, NE7 7XA. Council for Educational Technology, 3 Devonshire Street, London, W1N 2BA.

CAD in practice at Renault

Much has been written on the changes brought about by the introduction of robotics in vehicle production, but little is heard about the tremendous progress which the use of computers and robots has brought to the initial stages of vehicle conception — the design stage. Technological advances in recent years have led to an accelerated vehicle renewal rate. But development time is long. First, the general style and mechanical characteristics of the vehicle must be defined, feasibility studies carried out, production methods determined, production plants modified, tooling manufactured, and so on. The production of a new vehicle is like a giant jigsaw puzzle which relies on the input of many specialist technologies before each piece falls into place.

The robot as sculptor

Once past the heavily-guarded gates of the Renault Technical Centre at Rueil, outside Paris, the visitor to the styling department is in for a surprise. Looking through a

glazed partition protecting a battery of screens and computer keyboards, he would see a life-size car taking shape in plastic — under the expert "hand" of a robot. The articulated robot "arm" automatically obeys the commands of a computer programme. In just two days, the life-size

model will be ready for finishing and painting. This robot sculptor is just one of the aspects of what is known in Renault as CAO (Conception Assistée par Ordinateur) or Computer Aided Design (CAD). The use of computers at the design stage may seem surprising — almost shocking. What happened to the artistic talent, flair, design abilities and knowledge, which no mere machine can provide? But it is not really a contradiction in terms: an electric typewriter enables the author to put his thoughts on paper more quickly — it does not provide him with the plot for his story.

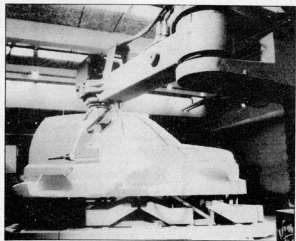

From drawing board to model

The first step in the design

of a new vehicle is taken by the stylist, who produces the initial rough sketches. But a vehicle is a three-dimensional object and nothing can be finalized until a model is prepared — first at 1/15th scale and then, if initial results seem satisfactory, life-size.

For accurate comparison, several models must be made based on different sketches. But to make a model, sketches must first be translated into accurate plans from which the model will be constructed. Before the introduction of CAO, all these stages involved long manual processes. First step for Renault was the introduction of computers able to convert drawings into plans. Progress has been rapid.

The battle of pictures

Touch sensitive screens, sculptor robots, and 3-D interpretation of drawings are just some of the CAO applications at Renault. But now a new field of development promises rich rewards: the synthetic computer picture. "Star Wars" fans will be familiar with these animated images created directly on a screen by a computer programme — the technique also used for certain television programmes.

Formerly, it was not until the life-size model was completed that a realistic 3-D representation of the vehicle was obtained. But the touch sensitive screen image, good as it is, is still

been reduced by half — to between 6 and 8 weeks. While reducing costs (again by half), the process also liberates designers from what was a time-consuming procedure. The Renault computer system used for all these operations is known as Unisurf. Matra Datavision, who developed a three-dimensional logistics system known as Euclid, recently signed a co-operation agreement with Renault, as a result of which the Renault Unisurf and Surfapt systems will be progressively integrated with Euclid.

in co-operation with universities specializing in these techniques. But the synthetic image, like the sculptor robot, is only a tool — fascinating, powerful, and enabling designers to devote their talents entirely to creativity by liberating them from long and repetitive tasks. Just as the fountain pen assisted writers by saving them the time formerly spent sharpening their quills, CAO assists creativity but is not a substitute for it.

*Renault U.K. Limited
Western Avenue, London,
W3 0RZ Telephone:
01 992 3481*

A means of communication

All this may sound like magic: project an image of the vehicle on to the screen, select the desired angle, choose the colour — and there you have it. But one can go further by calling for a close-up of a detail (wheel arch, windscreen, etc.) and this presents many advantages.

The image thus obtained, apart from its aesthetic quality, is rigorously accurate and makes it possible to check volumes and line quickly. It is also an efficient means of communication with other departments concerned, and enables them to begin their work on the project at an early stage. The synthetic image is in full development. Soon it will be possible to project the image, life-size, on to a screen... to modify a curve, a volume, or a detail straight on to the screen... to develop a programme which will animate the image so that it can be seen in motion against a chosen background.

The field of research is vast, but it depends on intensive work in programme development. Renault is tackling the task

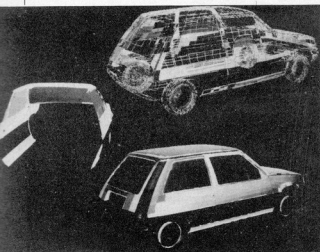

One computer programme can interpret the stylist's drawing in plan form on to a screen and on to a tracing console. This programme not only interprets a drawing — it can also handle volume (small model) or work from a sketch drawn on a graphic console (touch sensitive screen).

Once the plans have been prepared, the life-size model can be constructed by the sculptor robot, again using the programme which controlled the preparation of the original plans.

only a line drawing, and for stylists and decision-makers it is vital to be able to "visualize" the project from every angle as early as possible, before committing themselves to costly model production. The synthetic computer image answers this need.

Twice as fast

Using traditional techniques, it took 12 to 16 weeks to make a model. With CAO and the use of plastics, the time has

The concept of MSX makes it possible to design programs and add-on units that will work with any MSX computer. In a short series of articles we will offer you designs for a number of useful extensions intended to enhance the computer's abilities to control external equipment.

MSX

EXTENSIONS - 1

by Gerrit Dam

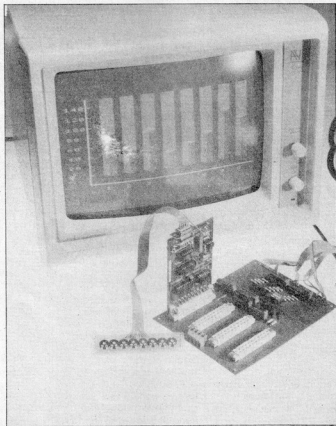

The coming of the MSX series of computers has been a success in so far that incompatibility problems among different computer types have largely been overcome, both in the software and in the hardware field. With standardization finally at a practical level, it is now possible to develop programs and add-on units that will work on any MSX computer, irrespective of its make. The first part in this series of articles will deal with a versatile MSX input/output bus and a digitizer plus 8-bit I/O port to plug into it, thus considerably enhancing the computer's abilities to control external equipment.

Microsoft Extended BASIC (MSX) is now the software base for a whole group of computers with largely identical hardware features. Compared with the well-known Commodore C64, they feature the following improvements:

- a further expanded BASIC with improved string handling capabilities and a larger number of graphic commands;
- built-in printer interface to the Centronics standard;
- cartridge slots to plug in hardware expansions or game/utility packs;
- disc operating system (MS-DOS) standard available.

This article will concentrate on the modifications to the universal I/O bus designed to operate with the C64 computer and as described in the June 1985 issue of *Elektor India*. These modifications are necessary because MSX computers generally use the Z80 microprocessor. The add-on boards for this bus published so far will also require slight modifications; the digitizer A/D and D/A converter is featured in the June 1985, and the 8-bit I/O port in the January 1986 issue of *Elektor India*.

I/O bus modifications

For use with the Z80 processor, the universal I/O bus will require some minor modifications because of the IORQ, RD and WR signals of this CPU, which also uses another selection of I/O channels as compared to the 65XX type.

The IORQ signal will have to be inverted if it is to replace the 65XX $\Phi 2$ clockpulse. For this purpose, IC₁ is replaced by an inverter Type 74LS240. This modification will inevitably invert all signals passing through IC₁, but it is quite useful because the bus RD (read) signal is

inverted as well, and may now be used to enable data transfer onto the bus without contention problems. Because addresses $A_0 \dots A_3$ are also inverted, slot numbers 1...4 will be in the reverse order, as will the four addresses available within each individual slot. Programs for the digitizer and the 8-bit I/O port need no modifications, however, for these boards are selected by SS (Slot Select) only, and do not use any address decoding within their slots.

A further advantage of the Z80 \overline{IORQ} signal is a simplification of the address decoding circuitry. As this

CPU is able to select I/O channels 0...255 by means of \overline{IORQ} and $A_{15} \dots A_1$, components IC₁, R₁...R₄ and S₁ are removed. IC₁ is connected to I/O bus line A_{10} while CPU $A_{14} \dots A_7$ go to I/O bus lines $A_{12} \dots A_{15}$. Connect pin 18 with 19 of the empty IC₁ socket to enable IC₁ with the \overline{IORQ} signal and install jumpers h, d, and g as indicated in Fig. 1.

The Z80 processor uses separate read and write signals (RD and WR) instead of a combination (R/W), so the \overline{IORQ} line had to be sacrificed to make room for the Z80 WR. This im-

plies that the digitizer and the 8-bit I/O port will have to take their WR signal from the former \overline{IORQ} bus connection, but more about this later.

As MSX computers do not use the BUSACK signal, T₁, R₁₃, and R₁₄ may be removed. Fig. 2 shows the modified PCB.

Add-on board modifications

The digitizer and the 8-bit I/O boards will have to be slightly

Fig. 1. Originally designed for use with the Commodore C64, this universal I/O bus is easily modified to work with any type of MSX computer.

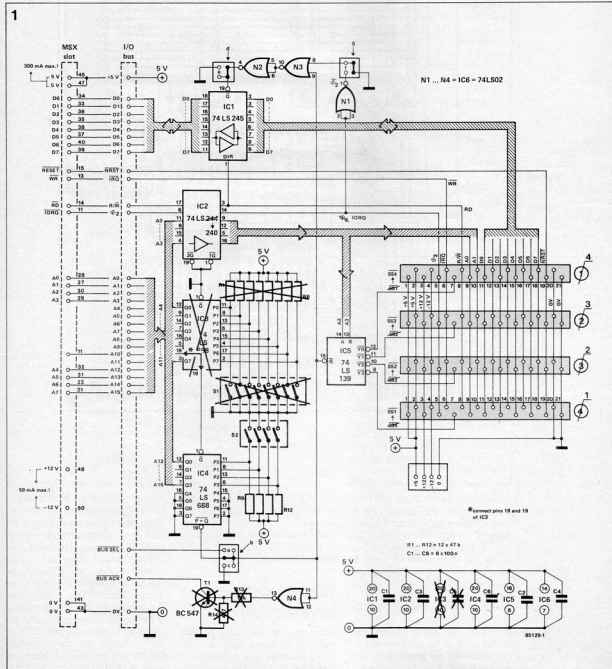

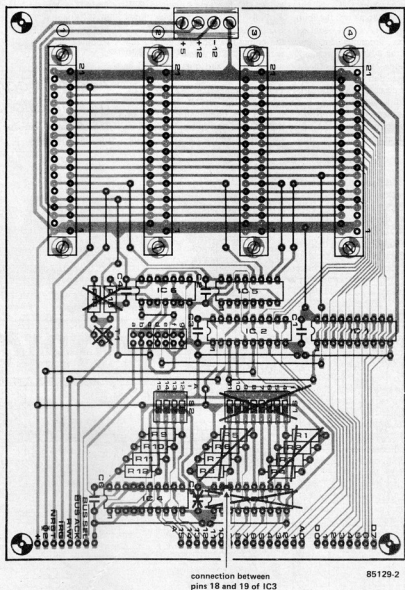

Fig. 2.
Modified PCB
layout for the
I/O bus.
Remember to
connect pin 18
to pin 19 of the
empty ICs
socket.

modified for use with the Z80 WR signal. As for the former, Fig. 3 shows these modifications in heavy lines. IC₁ is now clocked direct by WR. To make this possible, pin 6 of IC₁ is cut off from the IC body. A wire is installed from IC₁: pin 7 to pin 6 of the bus connector — see Fig. 4.

The 8-bit I/O port is modified as follows: disconnect pin 8 of IC₁ by cutting it off. Fig. 6 shows how socket pin 8 of IC₁ is connected to bus pin 8; do not forget to fit the marked wire link on the component

side. Fig. 5 shows the relevant part of the circuit diagram for reference purposes.

This completes the adaptations of the digitizer and the 8-bit I/O port for MSX applications.

Ribbon cable connection

Depending on the make of MSX computer, it either features a so-called cartridge slot, a 50-way I/O connector, or both. Connectors for

the cartridge slot are hard to obtain, however, because they are in fact no more than a projecting piece of the PCB on which the expansion circuit (EPROM, interface) is mounted. Cartridges usually come in a small plastic housing, and a cheap one may be salvaged and carefully taken apart, so that it will still function after the flat ribbon cable is connected to it for signal extension towards the I/O bus. A means for switching off the cartridge (i.e. the contained PROM) will be needed when the wires to the I/O bus are connected

SLOT		SIGNAL DESCRIPTION	
PIN NO.	NAME	I/O	DESCRIPTION
1	CS1	O	ROM 4000 ~ 7FFF select signal (128K)
2	CS2	O	ROM 8000 ~ BFFF select signal (128K)
3	CS12	O	ROM 4000 ~ BFFF select signal (256K)
4	SLTSL	O	Slot selected signal. ← Fixed select signal for each slot.
5		—	Reserved for future use only
6	RFSH	O	Refresh signal
7	WAIT	I	Wait signal to CPU (wired-OR)
8	INT	I	Interrupt request signal
9	M1	O	Fetch cycle signal of CPU
10	BUSDIR	I	This signal controls the direction of external data bus buffer when the cartridge is selected. It is low level when the data is sent by the cartridge.
11	IORQ	O	I/O request signal
12	MERO	O	Memory request signal
13	WR	O	Write signal
14	RD	O	Read signal
15	RESET	O	System reset signal
16		—	Reserved for future use only
17	A9	O	Address bus
18	A15	O	
19	A11	O	
20	A10	O	
21	A7	O	
22	A6	O	
23	A12	O	
24	A8	O	
25	A14	O	
26	A13	O	
27	A1	O	Data bus
28	A0	O	
29	A3	O	
30	A2	O	
31	A5	O	
32	A4	O	
33	D1	I/O	
34	D0	I/O	
35	D3	I/O	
36	D2	I/O	
37	D5	I/O	
38	D4	I/O	
39	D7	I/O	
40	D6	I/O	
41	GND	—	Ground
42	CLOCK	O	CPU clock 3.58 MHz
43	GND	—	Ground
44, 46	SW1, SW2	—	Insert/remove protection, if fitted
45, 47	+5 V	—	+5 V power supply
48	+12 V	—	+12 V power supply
49	SOUND IN	I	Sound input (+5 dbm)
50	-12 V	—	-12 V power supply

Input and output is measured with respect to MSX computer

I/O-TEST - 1

```
10 FOR A=0 TO 255
20 IF INP(A)<>255 GOTO 30 ELSE 40
30 PRINTA,INP(A)
40 NEXT
```

I/O-TEST - 2

```
10 FOR A=0 TO 7
20 OUT112,A
30 PRINTA,INP(112)
40 NEXT
```

in accordance with Table 1. Once the cartridge PCB has been removed (which may require quite an effort depending on the type used), it is necessary to establish the order of the slot connections. The even numbered connections are at the front (label) side of the PCB, the odd ones at the reverse side. With the PCB facing downwards (label side visible), connection 2 is at the utmost right of the front row. The row of odd numbers starts with 1, opposite to 2. To make things absolutely certain: the notch at the rear of the cartridge must now be at the lower left side. The through-plated holes in the cartridge PCB are used to connect the flat ribbon cable to. It may be necessary to first open these holes using desoldering braid. In case there is no through-plated hole available for a connection, the wire end will have to go direct to the appropriate PROM pin. It is useful to use some wires in parallel for the power supply connections, so that 29 of them are required in total. Finally, a feed-through slot is sawed into the plastic box to lead the ribbon cable through.

The above mentioned 50-way I/O connector is definitely much neater for the ribbon cable connection, but special tools are required to successfully fix the (expensive) connector to the cable. Effective disabling of the (E)PROM in the cartridge is not difficult, as it is very likely compatible with the well-known 27XX types. In the case of a 28-pin type, cut the track to pin 20 (CE) and solder a wire from this pin to the pole of a small change-over switch. One of the switch contacts goes to slot connector pin 1 or 3 (+5 V), the other to the track which used to lead to (E)PROM pin 20. In the case of a 24-pin (E)PROM, do the same with pin 18 (CE). To disable the cartridge you may now switch its (E)PROM CE pin to +5 V (Fig. A).

Table 1 shows the pin designations and signal definitions of the 50-way slot connector. Note that pins 44 and 46 are used for optional computer-

Table 1. Pin designations of the available signals on the MSX 50-way slot connector.

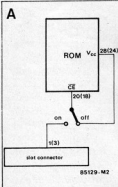

Listing 1. This tiny program checks the connection between MSX computer and the I/O bus, plus the correct function of the modified decoding circuitry.

Listing 2. Suggestion for a test program to verify correct operation of the modified digitizer board.

IOTST8

```
10 OPEN"grp:"FOROUTPUTAS#1
20 ACOL=9:BCOL=8:CCOL=14
30 R1=8:R2=8:U1=4:U2=4
40 SCREEN2,2
50 COLOR15,4,4
60 CLS
70 LINE(32,0)-(32,176)
80 LINE(31,0)-(31,176)
90 LINESTEP(+0,+0)-STEP(+210,+0)
100 LINESTEP(+0,+1)-STEP(-210,+0)
110 FORY=155TO15STEP-20
120 PRESET(0,Y-2)
130 PRINT#1,MID$(STR$(155-Y),1);";";
140 LINE(31,Y)-(36,Y+1)
150 NEXTY
160 GOSUB180
170 Q=0:GOTO160
180 FORA=1TO8
190 OUT0,A-1
200 H(A)=INP(0)/1.6
210 A$(A)=CHR$(A+48)
220 NEXTA
230 FORN=56TO232STEP24
240 Y=160:X=N
250 Q=Q+1:H=H(Q)
260 A$=A$(Q)
270 IFNOT(H<=M(Q)-10RH)>M(Q)+1)THEN320
280 PRESET(X-5,Y+24)
290 PRINT#1,RIGHT$(A$,2);
300 IFF=1ANDM(Q)>=4THENGOSUB350ELSEGOSUB380
310 M(Q)=H
320 NEXTN
330 P=1
340 RETURN
350 LINE(X-1,Y-U1-H)-(X-R1,Y-U1),ACOL,BF
360 LINE(X,Y-U2-H)-(X-1+R2,Y-U1),BCOL,BF
370 GOTO400
380 LINE(X-1,Y-U1-H)-(X-R1,Y),ACOL,BF
390 LINE(X,Y-U2-H)-(X-1+R2,Y),BCOL,BF
400 LINE(X-R1,0)-(X-1+R2,Y-U1-H),3,BF
410 PRESET(X,Y-H)
420 DRAW"cccol;a2m+=r1;,+u1;m=-r2;,+u2;"
430 PRESET(X-1,Y-H-U1-U2)
440 DRAW"cccol;a0m+=r1;,+u1;m=-r2;,+u2;"
450 PAINT(X,Y-U1-H),CCOL
460 PRESET(X,Y)
470 DRAW"cmb;1+=r1;+u+=u1;m+=r1;,+u1;"
480 PAINTSTEP(-4,-1),0
490 PRESET(X,Y),0
500 DRAW"r+=r2;u+=u2;m=-r2;,+u2;"
510 PAINTSTEP(+4,-1),0
520 RETURN
```

Listing 3. Graphic presentation of the input signals to the digitizer is possible after keying in this program written in Microsoft Extended BASIC.

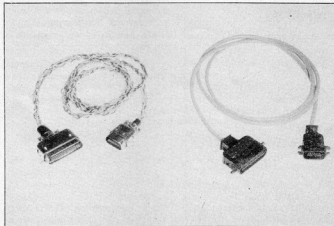

and cartridge protection. The necessary circuitry for this protection, however, may not be incorporated at all, so it is still sensible to switch off the computer before plugging in or removing any cartridges.

Testing

After completion of the wiring job using Table 1 as a guide, an initial test of the I/O bus may be performed. The digitizer and the 8-bit I/O must be removed for this purpose.

The Z80 processor features 256 I/O addresses, and every slot on the I/O bus takes four of them. With all switches on block S₂ closed, the computer will find the slots in the address range 0...15. To check the correct function of the modified address decoding part, two bits of every slot are hard-wired to its SS signal (pin 7), thus creating a byte to be read by the computer at the appropriate address. At slot 1, connector pins 17 and 18 are wired to pin 7. At slot 2, pins 15 and 16, at slot 3 pins 13 and 14 and, finally, pins 11 and 12 go to pin 7 of slot 4. Remember that the slot numbers refer to the new, reversed order, and that the computer may **only read** these addresses when the wires are present.

Once the computer addresses a slot, its SS signal goes low, together with the connected databits. This results in the following decimal values to be read from the slots: slot 1 = 63; slot 2 = 207; slot 3 = 243; and slot 4 = 252.

Listing 1 shows a program to test all I/O locations from 0...255. It will skip any addresses reading 255, i.e. with all bits high. The range from 0...127 is reserved for the I/O bus, as MSX itself uses 128 and onwards. Locations 152 and 162, for instance, contain the VDP (Video Display Processor) and PSG (Programmable Sound Generator) status, respectively. In case the indicated decimal values are not read correctly by the program, some wiring error may have been made, or the jumpers b, d, and g are not yet in their correct positions.

If the first test-run is successful, the modified digitizer board may be plugged in and tested using program Listing 2. Fig. B shows how the digitizer is tested by connecting the wipers of eight preset potentiometers to the appropriate inputs. The potentiometers are connected between the +5 V supply and earth. Program Listing 2 will start the A/D converter eight times to subsequently read the converted values. Turning the presets will verify the correct function of the digitizer

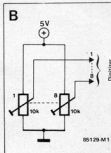
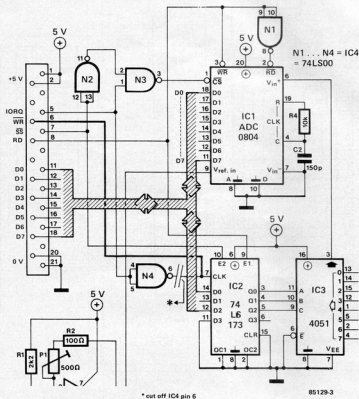

Fig. 3. Modified circuit diagram of the digitizer board. One of the necessary alterations involves the removal of pin 6 from IC4

board. Because Listing 2 uses slot address 112, switches 12, 13, and 14, as indicated on the PCB, will have to be opened.

This program is also useful to test the

8-bit I/O board. All inputs are connected direct to the outputs by eight wires. The program will read back the sent values 0...7 as 255...248 because of the bit-inversion by the

ULN 2803. By changing A in line 20 to NOT A AND 255, the test program will print two neat columns of 0...7.

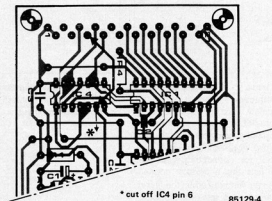

Practical example

The input signals to the digitizer are highly suitable for graphic presentation on the screen, as they are simultaneously visualized. Listing 3 suggests a program to implement this. The value at each input is shown as a vertical bar on the screen. A scale enables the values to be read off. Lines 20 and 30 of the program allow experiments with colours and bar sizes.

The vertical axis is drawn in lines 70 and 80, the horizontal one in lines 90 and 100. The scale is set up in lines 110...150, completing the basic layout of the screen. Line 170 is the central starting point in the program, the remainder of which consists of two subroutines. Lines 180...220 first read the input data of the digitizer before lines 230...340 put

Fig. 4. PCB of the digitizer, including the extra wire link.

Fig. 5. The heavy lines indicate the modifications to the 8-bit I/O board.

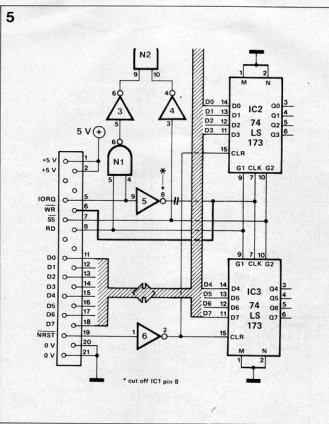

Fig. 6. Modified PCB of the 8-bit I/O port. Just as with the digitizer, an IC pin has to be removed; in this case pin 8 of IC1.

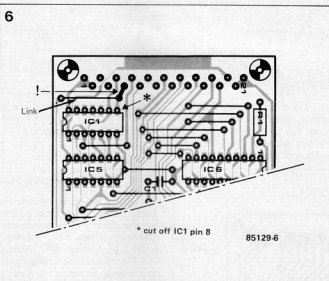
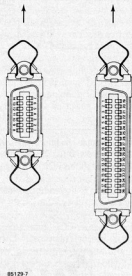
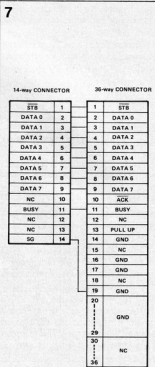

Fig. 7. It pays to make one's own printer cable. Eleven wires in a cable between two connectors do the job.



them on the screen using another subroutine from line 350 onwards, which merely converts the data into coloured bars. To erase any previously higher values, line 400 puts a green part on top of every bar. As a finishing touch, lines 410...510 provide bevelled edges to the bars.

A printer cable

As soon as the computer starts to

grow into a so-called 'system', cables are required to connect peripheral equipment like a disc drive, a modem, or a printer. Considering the cost of a ready-made cable, it is certainly worthwhile to make one yourself for connecting a printer. Fig. 7 lists the necessary connections in the form of a table; the 14-way connector goes into the computer and the 36-way type (known as a Centronics connector) into the printer.

More interesting extensions of MSX computers will be featured in future issues of *Elektor India*. ■

Digi-Course II

Chapter 3

Chapter 2 of our Digi-Course II had described different versions of the set-reset Flipflop. Operation of the D-Flipflop was described in-detail. The gates M and N are wired in such a way that the condition of the C input decides whether or not the input D will be passed on to output Q or blocked. The actual Flipflop part consists of gates T and U.

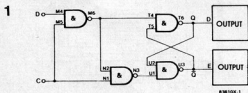

The NOR-version of the D-Flipflop is shown in figure 2. In this circuit, the value present at input D is stored by the Flipflop on the "0" to "1" transition of the signal on the C input.

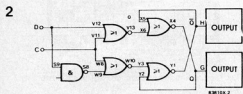

The truth table and the timing diagram for the D-Flipflop is given below for reference.

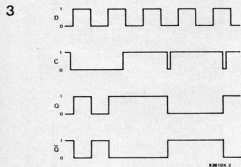

Table 1.

C	D	Q	\bar{Q}
0	0	1	0
0	1	0	1
1	0	0/1	1/0
1	1	0/1	1/0

From the truth table we can see that the Q and \bar{Q} outputs are not the same here, as we had in our original circuit that we started with, in Chapter 1. It is reversed in this case and we interchange Q and \bar{Q} .

In practice, this simple D-Flipflop does not meet all the requirement of an advanced design for functioning as a storage element. In the application of Digital technology, storage elements are required which take up and retain information in a precisely defined time frame. In a D-Type Flipflop the moment of storing the input signal level is precisely defined, but before that moment, the output Q takes on all the values that appear at the input.

Practically this problem is solved by using an additional Flipflop. This additional intermediate Flipflop takes on all the values appearing at the input, but passes on the value to the output Flipflop only when a command to do so is given to it. This combination of Flipflop is called a Master Slave JK Flipflop.

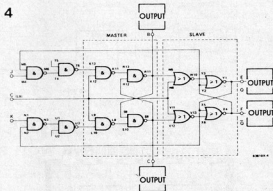

The figure 4, given above shows one such complicated circuit. This circuit requires all the gates so far installed on our Digilex Board. The contents inside the dotted rectangles are actually two independent RS Flipflops, with status control. Two output indicators are used for each Flipflop and the conditions of both Master and Slave Flipflops can be seen simultaneously on these LEDs. A logical "1" on the C input (L9) causes all the values at the inputs J and K to be taken up by the first Flipflop.

The second Flipflop reacts only to the values provided by the first Flipflop at the time when input C goes to "0" from "1". The actual response of this circuit can be studied by observing the conditions of the output indicator LEDs B/C and E/F.

The control signal at C (L9) is also called the 'Clock' signal. As the Flipflop reacts only at the moment when input C goes to "0" from "1", it is said to be edge-triggered, triggered by the negative going edge of the input clock. As the edge defines an exact point of time during the sequence of events, this type of arrangement is practically very useful. In the computer technology, mostly the triggering is done on the positive or negative going edge of control signals. Some computers are so fast in operation, the rise time and fall time of the positive or negative going edge also matter and affects the operation.

A few trials on the circuit will be enough to clarify the actual operation of the JK Flipflop. The circuit functions properly only when the data remains stable during the clock pulse. For proper operation data must be placed on the inputs before the clock pulse is applied, and should remain unchanged during the clock pulse.

The input conditions 0/0 on J/K do not affect the output, the condition 1/1 on J/K reverses the output conditions on Q/Q̄ at every clock pulse.

For a practical application, one need not construct the JK Flipflop using so many discrete gates. A single chip containing two such JK Flipflops is commercially available. The number of the TTL IC is 74L576.

The circuit symbols for a Flipflop are shown in figure 5 and the pin diagram and internal connections are illustrated in figure 6.

5

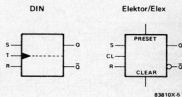

6

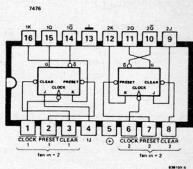

In addition to the known inputs J, K and C of our original Flipflop circuit, this IC has two more inputs, PRESET and CLEAR inputs, as their names indicate, are used to preset or clear the Q output to "1" or "0". The bars on PRESET and CLEAR indicate that the desired effect is achieved when the original on one of these inputs is "0". These ICs can be installed in the sockets (IC 8 and IC7) provided for them on the Digilex board.

Figure 7 shows the Pin diagrams and internal connections of some other TTL Flipflop ICs.

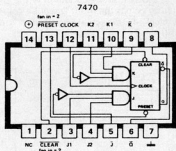

JK Flipflop with three inputs, PRESET and CLEAR.

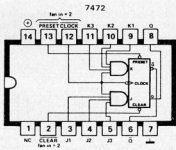

JK Flipflop with three inputs, PRESET and CLEAR.

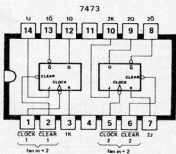

Dual JK Flipflop with only one J/K input and CLEAR.

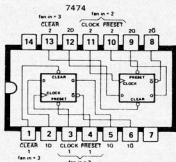

Dual-D Flipflop with D input, PRESET and CLEAR.

Wet-Finger-Test

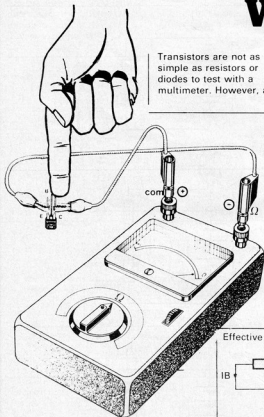

Transistors are not as simple as resistors or diodes to test with a multimeter. However, a

rough check is easily possible with what is called a 'Wet-Finger-Test'. The multimeter is kept in the Ohms range. It is connected to the emitter and collector. The 'COM' (common) terminal, which is generally the positive terminal, is connected to collector of NPN transistors and emitter of PNP transistors. We have seen that a transistor is constructed by creating two diode junctions which are in opposite directions (the Base-Emitter junction and the Base-Collector junction). There can be no current from Collector to emitter or emitter to collector when the base is kept

unconnected. The multimeter shows infinite resistance.

Now if we touch the base and collector terminals with a wet (moist) finger tip, a small current flows through the base which is amplified by the transistor and the amplified current flows through the collector. If the transistor under test is in good condition, this collector current is sufficient to deflect the multimeter needle. The current is supplied by the internal battery of the multimeter. The multimeter reads the resistance value on the scale which is roughly given as

$$R = \frac{V}{I_C}$$

V being the multimeters voltage available at the two leads, and I_C is the collector current that flows through the transistor when we touch the base with a wet-finger.

Effective resistance of the Wet-Finger

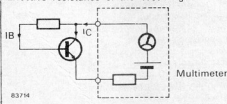

83714

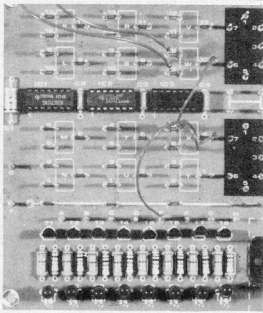

The Digilex-PCB is now available!

The Digilex-PCB is made from best quality Glass-Epoxy laminate and the tracks are bright tin plated, the track side is also soldermasked after plating. Block schematic layout of components and terminals is printed on the component side.

Price:

Rs. 85.00 + Maharashtra Sales Tax.

Delivery charges extra: Rs. 6.00

Send full amount by DD/MO/PO.

Available from:

precious®

ELECTRONICS CORPORATION

Chhotani Building, 52-C, Proctor Road,
Grant Road (East), Bombay 400 007

Experiments with a Transistor

Transistor is the most important component in the history of electronics. It is the most important semiconductor device designed so far. Even the integrated circuits which have taken over the discrete circuits, are nothing but chips with thousands of transistors integrated on them (in many cases, the number is very very large!)

The transistor is basically a current amplifier, and a few simple experiments should illustrate the functioning. The components required for these experiments will be easily available from an electronics shop.

The list of components required is given below.

- 1 4.5 V Battery Pack
- 1 Transistor BC 547 or any other small signal NPN

transistor like BC 107, BC 550 etc.

- 1 Light Emitting Diode (LED)
- 1 Resistance 220Ω (1/8 Watt)
- 1 Potentiometer $100k\Omega$ (Linear)

In the experiments that we are going to conduct, the LED is used to give a rough indication of the level of current flowing through the circuit, because the brightness of the glow depends on the amount of current flowing through the circuit.

First, let us see how brightly the LED glows, when directly connected in series with a battery pack and a 220Ω resistor. The figure 2 illustrates how this is done. As the circuit is complete, current flows through the resistor as

2

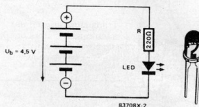

3

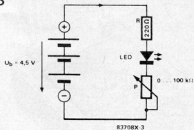

4

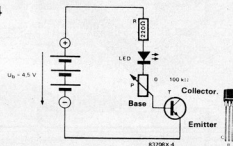

well as LED, if the LED polarity is correct.

If the LED does not glow, change the polarity of the LED. (If it still does not glow, and the battery pack is new, change the LED!)

Now introduce the potentiometer in the circuit as shown in figure 3. As the center and one extreme terminal are connected together, the potentiometer functions like just a variable resistor. The current in the circuit can now be adjusted by changing the potentiometer setting. The greater the resistance, the lesser is the current and lesser is the brightness of glow for the LED. When

Figure 1: Simple solderless connections for the experiments.

Figure 2: Current flowing through the closed circuit makes the LED glow. The 220Ω resistor helps in limiting the current through the LED to a safe value.

Figure 3: With an additional potentiometer, the current flowing through the circuit, is further reduced. The value of the potentiometer is so high that just a little movement of the potentiometer away from the zero resistance end almost extinguishes the LED.

Figure 4: The insertion of transistor has no significant effect as the Base-Emitter is connected in forward direction

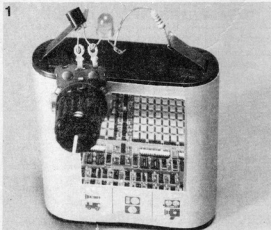

the resistance is gradually decreased, the brightness increases and at the lowest extremum when

potentiometer setting gives a zero resistance, the LED glows as brightly as before.

5

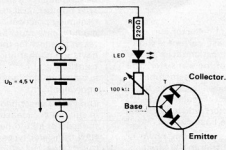

6

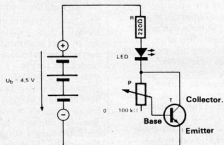

7

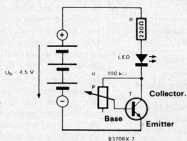
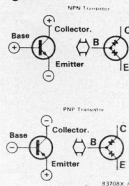

Figure 6:
Collector of the transistor connected to the junction between the LED and the potentiometer. This provides an alternative current path for current flowing out of the LED.

Figure 7:
Illustration of figure 6 redrawn to clarify the current flowing through LED and the collector of transistor. A small current flows through the potentiometer to the Base of the transistor. Base current can be adjusted by varying the potentiometer setting. Collector current is proportionally amplified and LED glow varies accordingly.

Figure 8:
NPN and PNP transistors. Circuit symbols and simplified symbols.

8



Introducing the transistor in the circuit as shown in figure 4, the results are not much different initially. The Base-Emitter junction is connected in such a way that it just behaves like a diode connected in forward direction

To make understanding this a bit easier, figure 5 shows the transistor in a simplified form as a connection of two diodes connected back to back (Remember, this is not a simple physical joint of two diodes but it is an integrated junction inside the structure of the transistor).

If the potentiometer is connected to collector of the transistor instead of the base, the circuit is no longer completed as the two diodes are in reverse direction and now the Base-Collector junction behaves like a diode connected in reverse direction.

Now try the combination shown in figure 6. The collector is connected to the junction of potentiometer and LED, and the center pin of the potentiometer is connected to the base of the transistor. The behaviour of this circuit is now totally different. The variation in the potentiometer setting now prominently affects the glow of the LED. As we had already seen in figure 3 a current can flow through the LED and the Base-Emitter junction of the transistor. (Base current).

This current causes a much greater current to flow through the Base-Collector junction. (Collector Current). Both the Base current and Collector current flow simultaneously through the Emitter to the minus pole of the battery and flows through the LED. The LED glows much brighter

than in case of the circuit in figure 3 and 4, because in the circuit of figure 6, the transistor acts as a current amplifier and the current flowing through the collector is proportionally much greater than that flowing through the base.

We can summarise the observations as follows:

1. A small base current flows through the 202Ω resistor, the LED and the potentiometer. This current enters the base and leaves through the emitter. This current must flow through the Base-Emitter junction. The potentiometer setting can be adjusted to adjust the base current.
2. The current flowing through the Base-Emitter junction decides how much current should flow through the Base-Collector junction. This property is called the current amplification, as the Base-Collector junction carries much greater current than the Base-Emitter junction.

The ratio between the Collector Current and the Base Current is the factor by which the current is amplified. This is called the Gain of the transistor.

$$B = \frac{\text{Collector Current}}{\text{Base Current}}$$

For a small signal transistor like BC 547, the current gain lies between 100 and 500; the heavy duty transistor have a lesser current gain... about 20 to 150.

The simplified representation of a transistor shown in figure 5 shows two diodes connected back to back. This junction can also have exactly reverse polarity. The first one is called an NPN transistor and the one with reversed polarity is called a PNP transistor. The individual symbols and their simplified representations are given in figure 8.

Transistor Tester

Transistors are current amplifiers. This property has been stressed many times so far. We have even seen a very simple way to give a rough check to the transistor by using the 'Wet-Finger-Test'.

For those who are interested in going a step ahead, and do some circuit construction, we have a simple project here.

Figure 2 shows the current paths inside a transistor. The base current flows into the base and leaves through the emitter. The collector current enters the collector and leaves through the emitter. The collector current is much greater than the base current and the ratio of collector current and the

ratio of collector current and base current is the amplification factor or the gain of the transistor. The transistor is sometimes compared to a valve for current through the collector, which is opened by the base current.

This comparison, however, is not true in the strict sense. The value only controls the opening for the flow, whereas in our case, the base current not only opens the valve but also decides the amount of flow. In case of an ordinary valve the flow also depends on the pressure, which is not true in case of the transistor. The collector current is decided only by the base current and not by the supply voltage between collector and emitter.

The current gain of the transistor is expressed as

$$B = \frac{\text{Collector Current}}{\text{Base current}}$$

As this is the most important feature of a transistor, we have described a circuit to measure the current gain. (D.C. current gain, to be more precise.) The current gain is not identical for all transistors, not even for transistors having the

same type number. The value deviates considerably from one transistor to another. A typical value can be generalised for a particular type number, and in designing practical circuits, care must be taken to allow for this deviation so that one transistor can be substituted with another equivalent.

The circuit described here is suitable for measuring the gain of all the normal NPN transistor types. (Alternative circuit for PNP transistors is suggested at the end of this article.)

The basic circuit is given in figure 3, to explain the function of the transistor tester. The transistor under the test is designated by TUT (Transistor Under Test). The constant current of 10 micro amperes, which is the base current. This must produce a current through the collector which is the 'B' times the base current. The collector current IC flows through the resistor R3 and must produce a voltage drop across R3 which will be given by $V = R3 \times IC$.

Now if we can somehow measure this voltage drop, we shall be able to calculate the value of B accurately. To measure this voltage using a meter would be an expensive proposition because the meter cost would be much greater compared to cost would be much greater compared to the total cost of the remaining circuit. So, to keep the expenses low, we shall use an indirect method to measure the current gain of the transistor. A comparator IC, which is quite inexpensive, is used here (IC1). The comparator compares the voltage drop across R3 with the variable voltage given at its another input. When these two voltages are equal, the output of the comparator becomes zero and the LED glows.

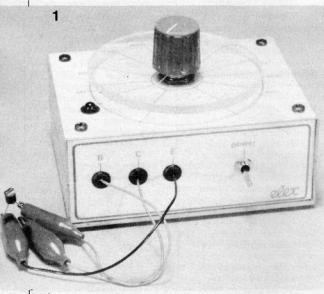
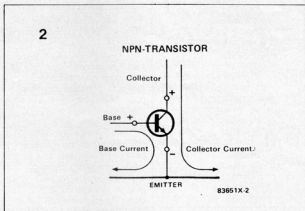

Figure 1 : The operation of the transistor tester is simple. Connect the three leads of the transistor, switch on the power and adjust the potentiometer till the LED just glows. The dial will directly give the B value.

Figure 2 : The collector current is proportional to the base current. Both the currents flow out through the emitter



The Practical Circuit :

A practical circuit is given in figure 4. The constant current source here is made up of R1, R2, D1 and T1.

The zener diode D1 gives a constant voltage across the emitter resistance R1. A constant voltage across R1 means a constant current through the

emitter. As the base current is negligible compared to the collector current, the emitter current is almost same as the collector current and hence the circuit results in a constant collector current for transistor T1. The values have been selected in such a way that this current is 10 micro amperes.

This constant current of 10 microamperes flows through the test sample to be minus pole of the battery. A constant base current of 10 micro amperes causes a collector current which is given by the following relation :

$$I_C = B \times 10 \mu A$$

This current flows through R3 and causes a voltage drop.

$$V = I_C \times R_3 \\ = B \times 10 \mu A \times 1 K \Omega$$

This voltage now appears on one of the inputs of the comparator, IC1. Other input of the comparator is fed with the voltage given by the voltage divider potentiometer P1. The

potentiometer P1 is connected in parallel across the zener diode, thus giving a range of 0 to 4.7 V on the voltage divider output. The potentiometer can be adjusted in such a way that both inputs of the comparator are at same voltage level.

When the inputs to the comparator are equal, its output is zero and the zero voltage at one end of resistor R4 causes a current to flow through LED and R4. This current makes the LED glow brightly.

The comparator IC1 is an operational amplifier and amplifies the voltage difference between its two inputs. The gain of this operational amplifier is several hundred thousand. A small difference in the two input voltages is amplified to a high voltage. Even a small difference in the range of few microvolts will be amplified to such a level that the LED will be extinguished. The LED

3

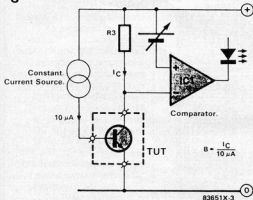

4

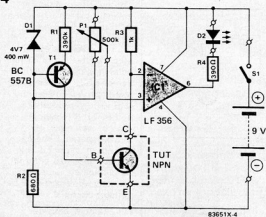
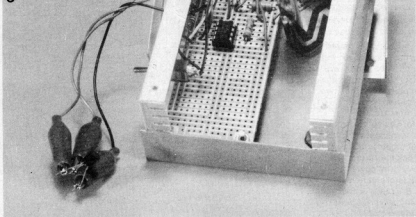

Figure 3:
The basic circuit of the tester. A constant current source gives a constant base current to the Transistor Under Test. The collector current of the TUT produces a proportional voltage drop across R3.

Figure 4:
Complete circuit of the tester for NPN transistors. The LED glows when voltages across R3 and the voltage divider are equal.

Figure 5:
Assembled circuit fitted into a suitable case. A standard 9V battery pack is used as the supply for the tester.

5



practically glows only when the two input voltages are equal. The potentiometer knob can be fitted with a dial and it can be calibrated to read the gain of the transistor directly.

Construction Details :

The entire circuit of the tester is so small that it fits on just half of the SELEX PCB. A list of components and the connection diagram is given for simplifying the task of construction. As usual remember to solder the passive components first and then the semiconductor components. Jumper wires should be insulated and properly soldered. Single strand jumper wires will be preferable as they have no risk of splicing up and touching other component leads or PCB tracks like the stranded wires. The assembled circuit can be fitted inside a standard case similar to the one shown in figures 1 and 5. LED is fitted using an LED holder. A standard knob with dial can be used for the potentiometer. Three wires with three different colours are used for Base, Collector and Emitter connections to the TUT. These wires should be fitted with mini crocodile clips at the other end. The openings through which these wires come out from the case should be marked B, C and E for convenience in connecting the TUT.

The operational amplifier specified is LF 356, but can be substituted with TL 081 or 741 in case of non availability of other two ICs. However, using 741 will hamper the performance of the tester and transistors with B values below 120 will be impossible to test. The heavy duty power transistors generally have the B values in this range. Finally a word about the IC. Insert the IC in its

Component List

- R1 = 390 K Ω
 - R2 = 680 Ω
 - R3 = 1K Ω
 - R4 = 390 Ω
 - P1 = 500 K Ω Linear Potentiometer
 - D1 = 4.7 V zener diode 400 mW
 - D2 = LED
 - T1 = BC 557B
 - IC1 = LF 356
 - S1 = Toggle Switch
- Other parts
- 1 SELEX PCB
 - 1 Battery connector clamp.
 - 1 9 V battery pack.
 - 3 Mini Crocodile Clips.
 - 1 LED holder
 - 1 100 K Ω Linear potentiometer for calibration.
 - 1 Potentiometer knob with dial or pointer.
 - 1 Suitable case and related hardware.

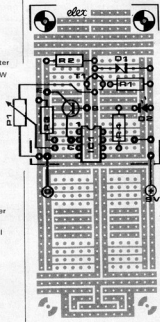

6

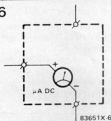

7

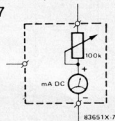

8

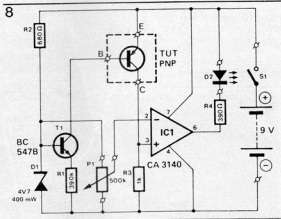

Figure 6:
Measuring the current of the constant current source.

Figure 7:
Connections required during calibration of potentiometer scale.

Figure 8:
Alternative circuit for testing PMP transistors

socket in the correct direction. The IC pins may need a little bending inwards if the IC is brand new, before inserting it into the socket.

Calibration:

Once you have your tester working, the scale of potentiometer P1 can be calibrated. Figures 6 and 7 shows the connections required during calibration. First the multimeter is connected in place of the TUT as shown in figure 6. The actual current is measured using the DC micro-amperes range of the multimeter, to see if it deviates from the desired 10 micro-ampere value. After this the multimeter is connected with a 100 K Ω potentiometer (Linear), as shown in figure 7. With the test circuit different collector currents between 0.25 mA and 4.5 mA are simulated in 0.25 mA and 0.5 mA steps. At every step the position of P1 for balancing the voltage across R3 is marked. The markings will correspond to B values between 25 and 450 if the base current was really 10 microamperes. If the base current measured during the first test was different, the simulated values of collector current should be suitable / changed.

For example, consider a case where the base current is 11 microamperes instead of 10.

The collector current simulated for B value of 25 would be 0.275 mA instead of 0.25 mA.

Alternative Circuit for PNP Transistors.

Figure 8 gives the suggested alternative circuit for testing PNP transistors. The functioning of the tester is similar to the one described for NPN transistors.

Digital Sequential Alarm Annunciator Panel (Ador Sequence-guard Series)

Advani-Oerlikon solid state Digital Sequential Alarm Annunciator Panel has been designed and developed for the first time in the country for use in thermal power plants and other heavy engineering industries where continuous process systems are required to be monitored.

In the standard product, it is not possible for the operator to identify the point that has given the alarm first, and the subsequent sequence. Now, with the use of Advani-Oerlikon Digital Sequential Alarm Annunciator Panel, the operator can numerically identify the sequence of faults indicated digitally with the help of seven-segments LED displays mounted along with every window. The first nine faults are announced in this style.

The Panel is modular in construction.

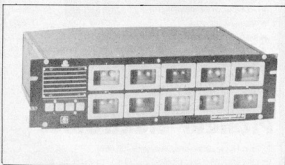

For further details please quote ref. No. P/26/L/SHG and write to: Advani-Oerlikon Limited Post Box No. 1546 Bombay 400 001.

Hand-held Plastic Moulded Instrument Case: T-28

"Comtech - T-28" is a well designed plastic moulded instrument case basically suitable for many Hand-Held Instrument having overall dimension of 28mm W x 85 mm x 163.5mm L. The front Bezel (20.8mm x 51.8mm) is suitable for 3½ digit display. The instrument case can accommodate a pcb of 79mm x 74mm on the four projected lugs provided on the inside of the front cover, by using No. 4 self tapping screws.

The 0.5mm deep recess on the front cover will accept an aluminium table of 111 mm x 71.5 mm for various control indications and a similar recess on the back cover (64mm x 46mm) can be used for manufacturer's details.

The moulded case features a separate battery compartment suitable for 9V flat cell, such that the cell can be replaced without

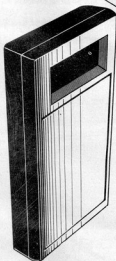

opening the instrument. The two antislip rubbers at the back, preserve the case from scratches. The case offered in-grey and black colour, is suitable for DMM, Temperature Indicators & remote-controllers etc.

For more information write to :

M/s. Component Technique 8, Orion Apartment 29-A, Lalubhai Park Road Andheri (West) Bombay - 400 058

PLA Digital Multimeter Type : DM-14B1

Pla introduced cheapest indigenous DMM type DM-14B1 in their handheld DMMs family. It measures AC/DC volts, DCI and ohms with superb overload

NEW PRODUCTS

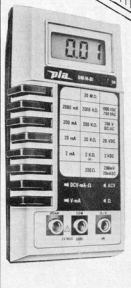

protection on all inputs. Push button switches for easy single hand operation, plug-in LSI/LSD/ICS, single 9V battery lasting 1000 hrs. These all features available at rock bottom prices. Very useful for day to day work, rugged and compact. Please enquire for price, available ex-stock.

For further details contact

PLA Electro Appliances Private Limited Thakor Estate, Kurla Kiro Road, Vidyavihar - (West), Bombay - 400 086.

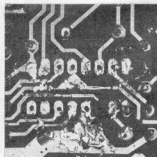

Desoldered
Without
Diamond

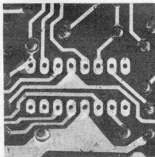

Desoldered
With
Diamond

Diamond Desoldering Pump

- Desolders thoroughly.
- Sturdy construction
- Replaceable Teflon Nozzle
- Largest selling in India
- Widely accepted in U.K., U.S.A., West Germany and Singapore.

Export Enquiries Welcome

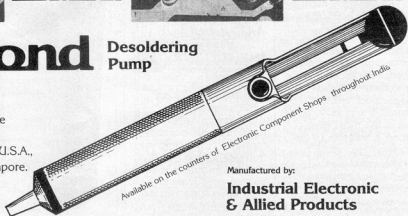

Available on the counters of Electronic Component Shops throughout India

Manufactured by:

Industrial Electronic & Allied Products

1423, Shukrawar Peth,
Off. Bajirao Road,
POONA 411 002, India.
Phone: 446241, Gram: SEFOTAKE.

Distributors:

precious Electronics Corporation

Chhotani Building 52C, Proctor Road Grant Road (E), Bombay-400 007.

DATA BOOKS

Signetics



MOTOROLA

NATIONAL SEMICONDUCTOR

FAIRCHILD

INTERSIL



TEXAS INSTRUMENTS

Zilog

RCA

intel

SIEMENS

SANYO

ANALOG DEVICES



PHILIPS

SPRAGUE



TELEDYNE

GENERAL ELECTRIC

HEWLETT PACKARD

GENERAL INSTRUMENT

PMI

COOK BOOKS, OSBORNE BOOKS, SYBEX BOOKS,
TAB BOOKS, SAMS BOOKS, TOWER BOOKS,
ELEKTOR BOOKS, APPLE COMPUTER BOOKS AND
MICROPROCESSOR COMPUTER BOOKS ETC
PLEASE WRITE FOR DETAILS.

ELTEK BOOKS-N-KITS

6 RITCHIE STREET, MOUNT ROAD

MADRAS-600 002. S. INDIA

GRAM: ELTEK PHONE: 844405 TELEX 41-6734 TEX IN

NEW ARRIVAL

SANYO - "S T K" DATA DIAGRAM BOOKS
UP-TO-DATE

WORLD TRANSISTOR COMPARISON BOOKS

Almost Everything For

Sinclair ZX

SPECTRUM

Computers

- Guaranteed Repairs.
- Latest Software Rs. 50/- for two programmes including cassette and manual, Get our free list.
- Custom written Software.
- Monitor Rs. 2100/-
- 80 Column Dot Matrix printers with interface for QL also.
- All types of Interfaces.
- All types of Peripherals.
- Many Accessories.
- C-10-C-15 blank cassette for data recording.
- Furniture: Simple and Elegant tables specially made for computers.

Contact :

Pioneer Electronics

2, Court House, Dhobitalao, Bombay - 400 002.

Ph: Office: 311634 Res: 475693

Whatever your multimetering needs..

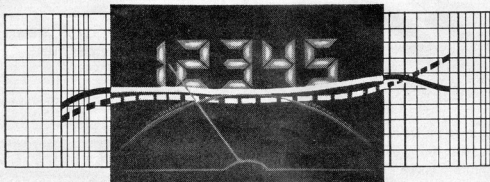

Motwane has its measure.

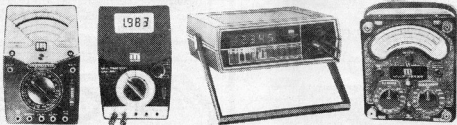

Have you ever thought of how dependant we are on electricity and what an indispensable instrument, the Multimeter is today? There is not an Industry, Communication and Utility service, Defence force, or even a general technician that does not use one.

Much has been made of the merits of Digital Multimeters over that of Analog ones, but in truth both enjoy basic inherent advantages. Its simply a matter of the right application. You must give your measurements the instrument they deserve.

The prime benefits of Digital Multimeters lie in their: *Unambiguous readings—no skill/operation *Speed *Infallible accuracy *Systems capability *Minimum circuit load *and bonus features such as True RMS; Conductance measurements and Diode testing—like the Motwane D.M. 450—the 4½ digital that stands tall with the

best in the world, and our D.M. 351—the 3½ digital whose features other companies are still designing.

Yet there is no denying the finesse of Analog meters when you need: *The trend in variations to be easily perceptible—invaluable in peaking and nulling. *Wide dynamic resistance ranges not limited by the number of display digits. *Excellent immunity to voltage transients. *Quick go-no-go checks. *A totally panclimatic instrument—like the Motwane BX Mark III—the grand old man of Multimeters—experienced and confident; and the BX Mark I—the handheld bred with an eye on cost effectiveness and field operations.

We are the only company in India and one of the few in the world, to offer you the best of both worlds— Digital and Analog. Motwane is the certain guarantee of Quality that's exclusive, at a price that's not—by any measure.



For further details write to:
THE MOTWANE MANUFACTURING COMPANY PVT. LTD.,
 at Gyan Baug, Nasik
 Road 422 101
 Tel.: 86297/86084 Telex: 752-247 MMPL IN
 Grams: MOTWANE or Gyan Ghar, Plot 434 A,
 14th Road, Khar, Bombay-400 052. Grams:
 MOTESTEM.

— Cut here and mail —

Please send literature and quotation on your Multimeters

Name _____
 Designation _____
 Company _____
 Address _____
 Telephone _____ Telex _____

SELL ADS.MMC.12.84

CONDITIONS OF ACCEPTANCE OF CLASSIFIED ADVERTISEMENTS

1) Advertisements are accepted subject to the conditions appearing on our current rate card and on the express understanding that the Advertiser warrants that the advertisement does not contravene any trade act enforce in the country.

2) The Publishers reserve the right to refuse or withdraw any advertisement.

3) Although every care is taken, the Publishers shall not be liable for clerical or printer's errors or their consequences.

4) The Advertiser's full name and address must accompany each advertisement submitted.

The prepaid rate for classified advertisement is Rs. 2.00 per word (minimum 24 words). Semi Display panels of 3 cms by 1 column. Rs. 150.00 per panel. All cheques, money orders, etc. to be made payable to Elektor Electronics Pvt. Ltd. Advertisements, together with remittance, should be sent to The Classified Advertisement Manager. For outstation cheques please add Rs. 2.50

8085 Microprocessor trainer in briefcase Rs. 2970/- Built in EPROM PROGRAMMER power supply. 2K CMOS RAM with dry-cell back up expandable to 8K, 12K, user EPROM. New Age Electronics third floor, Laxmi Mahal, Near Vandana Cinema, Agra Road, Thane-400 802.

Translator for French, German, Italian, Spanish, Portuguese, Japanese and other foreign languages contact: MIHR A. VITHANI 45B, J.S.S. Road, 3rd floor, Block No. 36, Chirabazar, Bombay - 400 002.

Components

are normally available with the following companies:

VISHA ELECTRONICS

17, Kalpana Building,
349, Lamington Road
Bombay - 400 007 Phone: 362650

DYNALOG MICRO SYSTEMS

14, Hanuman Terrace,
Tara Temple Lane,
Lamington Road
Bombay - 400 007. Phone: 353029, 362421

ELECTROKITS

20, Narasingapuram Street
(First Floor) Mount Road
Madras - 600 002

INTEGRATED ELECTRONICS INSTRUMENTS

8-2-174 Red Cross Road
Secunderabad 500 003 Phone: 72040

SILIKON ELECTRONICS

315, Lamington Road, Shop No. 4
Kalpana Mension, Opp. Police Station
Grant Road, Bombay - 400 007
Ph. 350644

AFCO I. & C. LTD.	2.05
APEX	2.68
APLAB	2.04
APPOINTMENT	2.70
ARUN ELECTRONICS	2.10
ATRON ELECTRONICS	2.68
BAKUBHAI AMBALAL	2.12
COMPONENT TECHNIQUE	2.06
COSMIC	2.76
DEVICE ELECTRONICS	2.67
DYNALOG MICRO SYSTEM	2.07
ELETEK BOOKS N KITS	2.62
ELCIAR	2.73
GRAFICA DISPLAY	2.71
IEAP	2.62
KAYCEE	2.72
LEADER	2.10
LEONICS	2.68
LOGICS	2.72
MOTWANE	2.63
M.R. ELECTRONICS	2.11
OMLILA'S	2.71
OSWAL ELECTRONIC CO.	2.02
PADMA	2.66
PECTRON	2.06
PIONEER	2.62
PLA	2.06
PROFESSIONAL ELECTRONIC	2.10
RAJASTHAN ELECTRONIC	2.02
RAJKUMAR	2.04
ROCHER ELECTRONICS	2.04
SAINI ELECTRONICS	2.65
SIEMENS	2.08 2.09
SOLDRON	2.71
SUCHA ASSOCIATES	2.66
TESTICA	2.65
TEXONIC	2.66
UNLIMITED	2.65
VASAVI	2.64
VISHA	2.75
ZAC ELECTRONICS	2.64
ZODIAC	2.64

FOR THE HOBBYIST & ELECTRONIC BUFF WE HAVE GOT IT ALL

SEMICONDUCTORS IN READY STOCK

No.	Price	No.	Price	No.	Price
		U1N 2003	30.00	LM 379	65.00
		LM 301	10.00	LM 380	20.00
741	6.00	LM 307	20.00	LM 381	35.00
741 TO5	14.00	LM 308	15.00	LM 382	30.00
723 DIC	10.00	LM 311	15.00	LM 384	30.00
723 TO5	15.00	LM 317T	18.00	LM 386	15.00
555	5.00	LM 317K	60.00	LM 387	35.00
BEL 700	10.00	LM 318	45.00	LM 389	30.00
CA 3028	30.00	LM 324	8.00	LM 391	50.00
TLO 61	30.00	LM 339	10.00	LM 3900	10.00
TLO 71	35.00	LM 348	20.00	LM 3914	65.00
TLO 72	35.00	LM 356	30.00	LM 3915	65.00
TLO 82	35.00	LM 358	20.00	LM 1818	55.00
TLO 84	35.00	LM 377	45.00	MM 5387	50.00
				MM 5402	50.00
				MM 7317	60.00
				UAA 170	35.00
				UAA 180	45.00

Also we have wide range of TRANSISTORS in 2SA, 2SB, 2SC, BC, BF & 2N series

NEW KITS

TELEPHONE EXCHANGE

Complete kit as described in Elektor - India Jan 1986 issue, kit for Rs. 1300.00 only.

(Kit contain the PCB and components that go on to the PCB)

NOW AVAILABLE

Molody bell in semi assembled module (with speaker) for Rs. 60.00 only.

RESOURCING SUPERIOR QUALITY COMPONENTS FROM TREASURY SUPPLIERS

VISHA
ELECTRONICS

17, Kalpana Building, First Floor
349, Lamington Road
Bombay-400 007

TERMS:

- Goods by return post subject to availability
- Minimum outstation order Rs. 50.00
- Prices are subject to change without any prior notice
Prices will be charged as prevailing on date of despatch of goods.

ORDER:

- Please fill in order form and send it alongwith order by M.O. or D.D. ELECTRONICS
- Cheque payment not accepted.
- Add 15% M.S.T. on total amount.
- Prices quoted do not include packaging and forwarding charges.
- Material will be sent by V.P.P. for the balance amount.
- We do not undertake any responsibility for any losses or damage in transit.
- Send self addressed envelopes with your enquires

Watts News?



After 30 years of communicating our finest efforts to you—we still have more news for you.

Cosmic is now breaking every sound barrier in maintaining its sophisticated electronic image by touching perfection in the manufacturing of its Tape decks/recorders, Stereo Systems, Amplifiers, Turntables, Head-Phones.

A single dominant factor has encouraged us to keep expanding and that is consumer satisfaction. Stay tuned to us.

COSMIC
We are Sound!