

128

January  
1986

elektor

INDIA

Rs. 7.50

# electronics

**Telephone  
exchange**

**surface-mount  
devices**

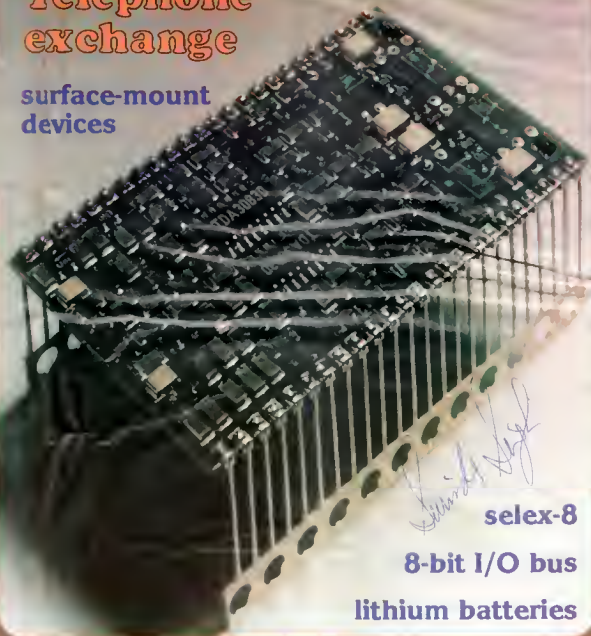

*Handwritten signature*  
**selex-8**

**8-bit I/O bus**

**lithium batteries**

## news & views

Editorial .....	05
Electronics scene .....	16

## electronics technology

Lithium batteries .....	34
Surface-mount technology .....	38
Channel multiplier for flat TV panel .....	45
Microprocessor navigation .....	46
Protecting computers from fraud .....	47

## projects

Jumbo clock .....	18
Zero-modern connector .....	24
Deep-freeze alarm .....	25
8-bit I/O bus .....	26
Phase-corrected cross-over filter .....	30
Graphics card — 4 .....	49
Telephone exchange .....	54
Dissipation limiter .....	60

## information

Year index 1985 .....	41
New products .....	69
Corrections .....	82

## guide lines

Switchboard .....	77
Appointments .....	78
Classified ads .....	82
Index of advertiser .....	82

## selex-8

digi-course II (chapter-2) .....	61
semiconductors .....	63
transistors .....	64
resistance bridges .....	65
resistance decade box .....	66

*This month's cover of a typical surface-mount assembly shows clearly that this has a rather different appearance than conventional printed-circuit boards. Although they differ externally from their current counterparts, surface-mount devices are internally basically the same, except that they are generally of better quality. Although surface-mount technology is undoubtedly the assembly technique of the future, largely replacing printed-circuit boards within the next decade, it is still in its infancy and dynamic development is likely to continue for some years.*

**Publisher:** C.R. Chandarana

**Editor:** Surendra Iyer

**Editorial Assistance:** Ashok Dongre

**Advtg & Admn:** J. Dhas

**Production:** C.N. Mithagari

**Address.**

ELEKTOR ELECTRONICS PVT LTD  
52, C. Proctor Road,  
Bombay - 400007, India

**Overseas editions.**

Glentop Publishers Limited  
Standlast House, Bath Place  
High Street Bariat  
London ENS 1 ED  
**Editor:** Ian Seymour

**Elektor B.V.**

Peter Dieckhoffstraat 24  
6191 VK Beek - the Netherlands  
**Editor:** P. E. L. Kensemakers

**Elektor sari**

Routir Natogale, Le Seau, B.P. 53  
69270 Baillet - France  
**Editors:** D. R. S. Meyer, G. C. P. Raedersdorf

**Elektor Verlag GmbH**

5133 Gangelit - Postfach 1150  
West Germany  
**Editor:** E. J. A. Krepelsauer

**Elektor EPE**

Karassaki 14  
16673 Voula - Athens - Greece  
**Editor:** E. Xanthoulis

**Elektor JCE**

Via Rosellini 12  
20124 Milano - Italy  
**Editor:** D. Fumagalli

**Ferreira & Bento Lda.**

R. D. Estrelária, 32 1.<sup>o</sup>  
1000 Lisboa - Portugal  
**Editor:** Joaze Goncalves

**Ingelek S.A.**

Av. Alfonso XIII, 141  
Madrid 16 - Spain  
**Editor:** A. M. Ferrer

**International co-ordinating**

**& technical manager:** K. S. M. Walraven

The Circuits are for domestic use only. The submission of designs of articles to Elektor India implies permission to the publishers to alter and translate the text and design, and to use the contents in other Elektor publications and activities. The publishers cannot guarantee to return any material submitted to them. All drawings, photographs, printed circuit boards and articles published in Elektor India are copyright and may not be reproduced or imitated in whole or part without prior written permission of the publishers.

Patent protection may exist in respect of circuits, devices, components etc. described in this magazine.

The publishers do not accept responsibility for failing to identify such patent or other protection.

**Distributors:**

Blaze Publishers & Distributors Pvt. Ltd

**Printed At:**

Trupti Offset  
Bombay - 400 013

Copyright © 1986 Elektor B.V.  
The Netherlands

## Communicating electronics

Electronic is the world's No. 1 industry. In India, too, it has emerged as the most important one and is on the verge of dwarfing such giants as steel, chemical, automobile, et. al.

Such is the impact that electronic has made on the society: it has brought about progressive sophistication and automation; progressive reduction in cost without compromise in quality; and progressive increase in speed and accuracy of operation. Indeed, electronics is progressively leading us to become a high level information society.

At the beginning of this century who could have foreseen such a remarkable metamorphosis in scientific technology. And the developments that have taken place in the last decade are a pointer to things to come in the 21st century.

If the progressive and pragmatic policies adopted by our country are any indication, the year 2000 will usher in a century of changes thereby leading us to enjoy convenience and comfort to the full in every aspect of life.

On this cheerful note, elektor, the magazine that communicates electronics, enters the New Year. The elektor group comprises a team of 150 professionally skilled and dedicated people working in Holland as well as in many countries of the world with a common goal—of throwing light on the exciting world of electronics on a continuing basis. The group has made a dynamic success story over last 25 years producing a diverse range of electronic designs for textiles, telecommunication, cars, computers, stereos, ships, and many more.

This tremendous growth stems from: a keen awareness of the need to move with the times; high-reaching ideals; and a strong will towards constant innovation and improvement.

Watchwards these that will carry us to even greater heights in 1986.

# **pla** HAND HELD LCD DMMs SERIES DM14

## **A PROFESSIONAL'S CHOICE**



- EXCELLENT PROTECTIONS
- EASY REPLACEABLE LSI/LCD
- REDUCED PRICES
- EX STOCK
- SERVICE & ALL PARTS AVAILABILITY FOR MANY YEARS

- Why buy smuggled DMMs with many problems?
- Non available components/difficult to replace LSI/LCD.
- Absence of guarantee/after sales services.
- Costly imported components.  
Some are totally nonavailable.
- Repair very difficult an PTH PCB puts DMM out of use in few months.

**CONSIDER COST OF OWNERSHIP OVER SEVERAL YEARS  
RATHER THAN INITIALLY CHEAP PURCHASE PRICE.**

**BEAWARE:— IMPORT POLICY DOES NOT ALLOW RESALE OF IMPORTED DMMs.**



**CONTACT NOW**

**PLA ELECTRD APPLIANCES PVT LTD**

THAKOR ESTATE, KURLA KIROL ROAD, VIDYAVIHAR (W)  
BOMBAY 400 086. PHONES: 5133048/5132667

- INSTECH SALES & SERVICE BOMBAY Ph. 354827 & 382866
- AMITRONICS BANGALORE Ph. -221246
- LITTLE TRADERS, NEW DELHI Ph. 625769
- KINS ELECTRONICS MADRAS Ph. 411601
- TECHNO SCIENTIFIC CO. CALCUTTA Ph. 278742
- FORTIBUS ENGINEERING PVT. LTD. PUNE Ph. 347 06
- PRIME ELECTRONIC PRODUCTS PVT. LTD. HYDERABAD Ph. C/o 38358.



## MEASUREMENTS MADE EASY



Measurement of **INDUCTANCE**, **CAPACITANCE**, **RESISTANCE** are greatly simplified by VLCR 7.

Connect the component to the terminals, VLCR 7 gives you directly the digital reading of value and its loss factor simultaneously.

**FOUR TERMINAL** measurement eliminates inherent errors due to lead resistance. **GUARD TERMINAL** provided eliminates errors due to lead capacitance.

VLCR 7 is the only instrument in India covering the widest ranges of

0.1 pF/ohm/m ohms to 9,000 ohm to 20,000µH/200H/20 M ohm.

### FEATURES:

- Digital, Direct reading
- Widest possible range
- Simultaneous display of TAN DELTA (Loss factor)
- 4 Terminal measurement
- BIAS terminal provision
- GUARD terminal provision
- MODULAR Construction

### DIGITAL FREQUENCY COUNTER VDC 18

## Smallest size ever made in INDIA

Battery cum mains operated

wide frequency range  
30MHz

(our model VDC 18 is  
300MHz)

Basic sensitivity of 10mv  
Bright LED display 7 digit



**Range of our Products:**  
Oscilloscopes • Curve Tracers  
Oscillators • Function Generators

### Digital

LCR Meters • Capacitance Meters  
Multimeters • Milli Ohm Meters  
Micro Voltmeters • Frequency Counters

## VASAVI ELECTRONICS

(Marketing division)

630, Alkaram Trade Centre, Ranigumfi

SECUNDERABAD-500 003.

ph: 70995

gms: VELSCOPE

## PUT AN END To your Hardware/Software Worries

### accord

Offers you

## A Microprocessor System Analyser

- Develop & Diagnose Your Hardware/Software with this Versatile Instrument
- Microprocessor System Analyser finds application in R & D Production, Testing & Field Servicing. Compatible both on 8085 and Z-80

For further information contact

**accord  
electronics**

3 B Mahalaxmi Industrial Estate, Vasat Road (E)  
Dist. Thane - 401 202

**ECONOMY'S**

## ELECTRIC MELTING POTS

For

- Tin, Lead & Glue Melting.
- Wax & Plastic Melting.
- Solder Melting.
- Impregnating.
- Dip Coating.

• Rugged Construction  
• Temperature Controlled.

Economy's Electric Solder melting pots and tanks are elegantly designed. They are made available in wide range of capacities in Round and Rectangular shapes incorporated with INFATROL for temperature regulation. Special optional equipment including stands, valves, ladders and special controls are available to specifications.

### Economy's Other Products:

- Electric Heaters.
- Hot Air Units
- High temperature cables.
- Thermocouples etc.



**Economy  
Engineering Corporation**

18, Bank Street, Southwicks Bldg., 2nd floor, Fort, Bombay 400 023  
Gms: "ECONHEAT" Phons. Office 251165. Factory: 5514396.

**KEONICS**

# MiniCircuits Limited

## HYBRID TECHNOLOGY

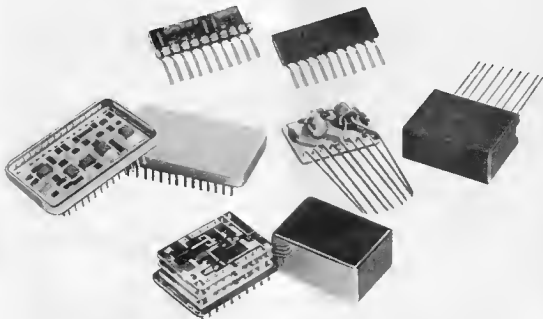

MiniCircuits now pioneers the use of Hybrid Microelectronic circuits in the independent sector, for the first time in India.

By a judicious mix of indigenous and overseas technology tailored to India's requirements, MiniCircuits offers a wide range of Hybrids, both conventional and modern, fabricated in a sophisticated facility at Bangalore.

Backed by a large industrial group, MiniCircuits is all set to revolutionise electronic Micropackaging in many ways.

Application areas include: Radio Amplifiers, Stereo Amplifiers, Telephone handsets, Resistor Arrays, P.A. Systems, Electronic TV Tuners & Circuits, Automotive electronics, Electro-medical equipments, Instrumentation

Amplifiers, Communication equipments, Computers, Defence electronics, Space modules etc.

The task of a pioneer is arduous and MiniCircuits are entirely geared up with the latest machinery and qualified manpower to meet your stringent demands.

**Value Engineer your Modules with ...**

### MiniCircuits Limited

Reghavendra Complex  
418/1, 10th Mn, IV Block,  
Jeyenagar, Bangalore-560 011.  
Tlx. 0845-8429 PAC IN

Talcherkars/MnL-1

# TIME TESTED ELECTRONIC TIMER

A new concept in Electronic Time Delay is introduced. Our up-to-date and innovative technology gives trouble free service and long operational life.

## ADVANTAGES :

1. High repeat accuracy  $\pm 1\%$ .
2. DPDT relay with contact rating of 10A.
3. Two mode of operation-delay on energize/interval.
4. Fifteen voltage ranges from 12 V AC/DC to 240 V AC.
5. Three types of terminations.
6. Available upto 60 hrs. Time range.
7. More than 4000 types to choose.



For further details contact :  
**KOENIG ELECTRONICS & INDUSTRIES (P) LTD.**  
 54, INDUSTRIAL AREA, PHASE-II,  
 CHANDIGARH-160 002.

# IEC SWITCHES

Largest range designed to International Standards of Quality & Reliability.



Toggle-Push Button-Rotary-Micro-Centrifugal-Foot-Rocker-Slide-Limit-Cord-Proximity and other switches.

## Indian Engineering Co.,

Post Box 16551, Worli Naka, Bombay-400 018 (India)  
 Phone: 493-9544 & 493-5565  
 Cable : AMPVOLT Telex : 11-75217 IERG IN

Only  for Switches  
 25 Years 1960 - 1985

## ZAC ELECTRONIC TRADING

Distributors & Stockists of  
**ELECTRONIC COMPONENTS**

WE CAN OFFER:

Memories Computer Microprocessor  
 General I.C.'s  
 other Semiconductor devices  
 Also-  
 Special Developed Custom Chips

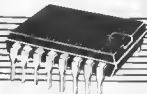

We entertain all enquiries

**ZAC ELECTRONIC TRADING**  
 865, Mountbatten Road # 06-09  
 Katong Shopping Centre, Singapore 1543  
 Telex 52685 ZATEL

CALL US AT: 440 1282 Or 447 2722

Always a move ahead

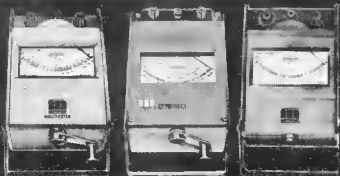

## Even in Insulation Resistance Measurement

You have heard about our tradition of quality, of course. But have you ever wondered why we deserve it?

Take our Insutesters®. They have made their reputation for being stable, reliable and accurate. What could the reason be?

Is it because we've used solid state circuitry, with an indicator that is both shock and vibration proof, instead of clumsy clutch mechanism of conventional testers? Or is it our hand driven generator which is smooth, stable, silent, and long lasting — alternatively battery operated? Could it be because of our taut band suspension movement that

eliminates friction error totally? Or the guard terminal that protects your measurements from surface leakages?

What of the extended range: from 100 V/20 Mohms to 1000 V/2000 Mohms?

Did you even know that our Insutesters® are housed in attractive, light weight cases which are injection-moulded in high impact plastic, so that they are easily portable and well able to take the rough with the smooth? But if you still insist on metal casing, we provide that too.

Your measurement time being of our concern, we've even updated the response to just 3 seconds!

Yet if you are the kind who is more impressed by actions rather than words, try our Insutesters®. It's not too hard to tell the difference.



**MOTWANE**

For further details write to  
THE MOTWANE  
MANUFACTURING COMPANY  
PVT. LTD., at Gyan Baug, Nask  
Road, 422 101 Tel.: 61297/  
81084 Telex 752-247 MMPL IN Grams MOT-  
WANE or Gyan Ghar, Plot 434 A, 14th Road,  
Khar, Bombay-400 052 Grams: MOTESTEM.

Put here and mail

Please send literature and quotation on your Insutesters

Name \_\_\_\_\_

Designation \_\_\_\_\_

Company \_\_\_\_\_

Address \_\_\_\_\_

Telephone \_\_\_\_\_ Telex \_\_\_\_\_

SELL AD5/MWC 12 84





# VU METERS

## FOR EVERY APPLICATION

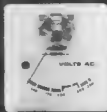

### STOCKISTS

Western Region :  
**Precious Electronics Corporation.**  
 Chhotani Building, 52-C, Proctor Road,  
 Grant Road (East), Bombay - 400 007  
 Phones : 367459, 369478

Southern Region :  
**Precious Electronics Corporation.**  
 9, Athipattan Street, Mount Road,  
 Madras - 600 002, Phone : 842718

Northern Region :  
**Tantla Electronics Co.**  
 422, Lalpat Rai Market,  
 Chandani Chowk, Delhi - 110 006  
 Phones : 238612, 233856

Manufactured by :  
**Padma Electronics Pvt. Ltd., Tamil Nadu**

## COMTECH



### HALF DIN STD. INSTRUMENT CASE FOR DPM. TYPE-T-48



#### Instrument Case With Standard Clamps



- Size 48 x 96 x 105 mm.
- Moulded In Plastic
- Colour Grey & Black
- Front Acrylic: Red, Green & Natural Colour
- Arrangement For 12 Pin Connector Mounting
- Panel Flush Mounting

For more information, contact  
**COMPONENT TECHNIQUE**  
 8, Orion Apartment, 29/A Lallubhai Park Road,  
 Andheri (West) Bombay-400 058 Tel Sales: 4224066

Active 811

### WE OFFER FROM STOCK

- I.C.'s :** TTL, CMOS, MOS, LSI, Microprocessor, Micro computer etc.
- Zener Diodes :** 400 MW & 1 Watt
- LED's :** Red, Green, Yellow in 5mm and 3mm dia
- IC Sockets :** SMK & Memorex make
- Trimpots :** Multiturn Bourn's, VRN & Beckman make
- Single Turn cermets :** EC as well as imported
- Floppy Discs :** B' as well as mini floppy of memorex, & dyson make

Write to



**ZODIAC**  
**ELECTRONICS**  
**CORPORATION**

Pushpant Niwas 3rd Floor, 3, Chunam Lane, Dr. D. Bhadkamkar  
 Marg Bombay-400 007, Phone 5137225, 5135845

# Device offers



**ELECTRONIC  
EDUCATIONAL  
& TESTING  
DEVICES**

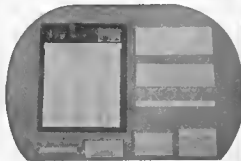

Solderless Bread Board

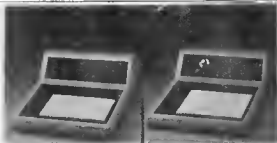

1 DL-400 Logic Trainer

1 DL-800 Digital Lab



1 DL-600 Analog Lab

DT-D1 Digital Trainer

**We stock:**

**elektor**  
Magazines

IC IZUMIYA IC INC.  
P.C.B. Drafting Aids

**TELEDYNE**  
RELAYS

**RCA**  
Semiconductors

**KONTAKT  
CHEMIE**  
Cleaners

**RAYTHEON**  
Semiconductors

**FAIRCHILD**  
Semiconductors

  
TEXAS INSTRUMENTS  
Semiconductors

**VRN** Trimming  
Potentiometers

Ribbon Cable  
Connector Panels

**SSS**  
Semiconductors

RS 232  
Connector Panels

## SPECIAL EX STOCK OFFER

				E-Prom	
D-RAM		Regulators	SCR/Triacs	TTL/CMOS	2716 27128
4116 41256	7805 - 24	4 amp - 40 amp	74 LS00 - 629		2732 27256
4164 42128	7905 - 24	400 V - 600 V	4001 - 40257		2764

Bulk importers and users in India may Kindly forward their specific enquiries



# Device Electronics Pte. Ltd.

101 Kitchener Road \*02-04, Singapore Electrical, Electronics and Hardware Centre,  
Singapore 0820. Telex: DEVICE RS 33250

FOR ENQUIRIES **CALL: 298 6455** (4 lines)

# electronics scene

## Sales Tax Slashed

Television sets used to cost more in Bombay and other parts of Maharashtra compared to the rest of the country. A stiff sales tax imposed by the state government had upset the manufacturers, dealers and buyers as well. The government of Maharashtra, after a persistent demand from all sections, has decided to reduce the sales tax on electronic goods. All manufacturers of electronic goods, components and peripherals and computer companies have welcomed this move.

The sales tax reduction, establishment of three electronic industrial estates, single window clearance and setting up of a high-level Maharashtra Electronics Development Agency will go a long way in achieving the target of Rs. 3,000 crore in electronics goods by 1990 according to the Bombay Chamber of Commerce and Industry.

The All India Radio and Electronics Association, hailing the sales tax cut as a badly needed boost to the industry urged the government to levy a uniform four per cent tax on electronic goods, irrespective of the place of production.

The Maharashtra TV manufacturers' association has expressed the hope that the production of TV sets in the state would increase manifold and assured the government that the concession would be fully passed on to the consumer.

The All India Association of Industries said the sales tax cut would encourage entrepreneurs to set up new units in the state. The government has taken a step in the right direction by this announcement.

TV manufacturers, true to their word seem to have already implemented their decision to pass on the concession to consumers as advertisements have been appearing announcing a reduction in prices.

## Export Zones

The chairman of the Electronics Commission, Dr. M. S. Sanjeevi Rao, has urged the foreign firms to consider relocation of electronic units in India from export processing zones in other countries.

The wage rates in countries like Hong Kong, Korea and Singapore, where foreign subsidiaries have been set up to cater to the export market, have increased considerably compared to the wages prevailing in India. It would be profitable for those foreign firms to locate their units in Indian export processing zones. Dr. Rao said while inaugurating a seminar on 'Export processing zones

as an instrument of export promotion', organised by the Trade Development Authority, recently. Exports from the Santa Cruz Electronics Export Processing Zone crossed Rs. 1,000 million last year and by 1990, the exports would touch Rs. 3,500 millions. Currently, 65 units function in SEEPZ, Bombay.

## Value and output

Electronics will become a forgotten industry unless a demand is created among consumers, according to Mr. S.R. Vijaykar, Secretary to the department of electronics.

Research and Development facilities in electronic units should improve not merely to indigenous the imported equipment but also to understand the suitability and adaptability of foreign goods to Indian conditions. Mr. Vijaykar said while delivering the key-note address at a workshop on "Banking requirements of the Electronics Industry".

The seventh plan target of Rs. 10,000 crores of output set for the electronics industry should be viewed not in terms of value but in terms of output, he opined. To meet the objective of modernisation, accepted by the planners, the electronics industry would have to become internationally compatible both in quality and in price.

Mr. Vijaykar termed the plan allocation of Rs. 4,000 crores to the communication sector as meagre and said at least double the amount was needed to achieve the programme of producing 100,000 micro-computers by 1990.

Dr. C. Rangarajan, Deputy Governor of the Reserve Bank of India, who inaugurated the workshop said the banks should take maximum care in financing electronic products as these faced a high degree of obsolescence. He desired the development of a new financial norm to ensure that both the promoters and financiers shared the risk equally.

Mr. D.N. Ghosh, Chairman of the State Bank of India said the aim of the workshop was to understand the emerging financial needs of the electronics industry particularly in view of the envisaged massive expansion of investment under the new economic policy.

## High-Tech MECCA

The Media Laboratory, a new experiment which began early in 1985 at the Massachusetts Institute of Technology, is backed by more than 40 giant corporations with an investment of 40 million dollars for the building and computers alone with

another four million dollars for operating expenses every year.

Media Lab's mission is to explore what computers could be doing ten or 20 years from now. It has diverse and mind-boggling projects that range from talking computers to electronic newspapers, from computer programmes for kids to computers that make music.

The founders of the lab, Nicholas Negroponte, an MIT professor of media technology and Jerome Wiesner, president emeritus of MIT and science adviser to President Kennedy, have conceived a lab different from others. Here researchers buy off-the-shelf equipment and programme them for new uses in creative fields like broadcasting, publishing, motion pictures, music and theatre.

None of the lab's work is proprietary. The corporate sponsors can visit the lab for five years and learn anything they want of the various projects.

Marvin Minsky of MIT who is called the dean of artificial intelligence, using computers to try to emulate human thought, Seymour Papert, the math and education professor of MIT, who developed the computer language, Logo, used by school children all over the world, Negroponte himself, an architect and pioneer in computer-aided design technology, are among the staffers of the Media Lab.

The Media Lab believes executives will find computers more friendly in offices of the future. Instead of wrestling with keyboard and enigmatic codes the businessmen will be able to run the computers by talking to it, pointing to it or even by glancing at it.

One of the research specialists, Richard A. Bolt wearing special glasses, sits facing as many as 40 television pictures, all running simultaneously on a giant screen. Sensors on the glasses track where his eyes are looking and that information goes by cable to a central computer. If his gaze rests on a single picture, the other 39 recede and that one fills the screen. This exciting project is named Gaze Orchestrated Dynamic Windows project.

The Conversational Desktop is Media Lab's talking computer. It can perform secretarial tasks as making phone calls and reminding the boss of important meetings.

Scientist Bolt has a wrist band with a magnetic sensor that can move an image from one location on a computer screen to another. As Bolt's hand moves through a magnetic field, sensors on the wristband send signals by cable to the computer, relaying where on the

# electronics scene

screen he is pointing His eye, hand and voice systems could possibly enable a businessman to glance at a screen and have it display a report while talking on the phone

Another section of the Media Lab is busy programming a computer to play a synthesiser, following the tempo set by the conductor. When the conductor slows his baton, a sonar sensor following his hands tells the computer to have the synthesiser play more slowly. The synthesiser can react as quickly as a live musician and plays in nearly perfect synchronisation with a violinist and a flutist.

Marvin Minsky wants to study what goes on in the mind when someone writes music or listens to it as he believes that understanding how people think about music will ultimately lead to smarter machines.

Patrick Purcell, an associate professor of computer graphics, is developing a suit that emits infrared signals to be read by four light sensors connected to a computer which then generates a stick figure on its screen, copying every movement. The stick figure could be dressed in any way one likes. NHK, the Japanese counterpart of the BBC, has already picked up this technology and created a computer-animated host for a new show on the 21st century.

## Enter Teletext

A beginning has been made in modernising visual communication medium, with the introduction of teletext service by Dethi Doordershan. The service will give information to viewers on finance, railway, airline timings, weather, major events in India and abroad and so on. This service is available from 9 a.m. to 2 p.m. and from 3 p.m. to 10 p.m. only. Criticisms have been made on the ground that this facility is not available to the black and white TV sets and even in colour TV sets, the viewer has to purchase a special decoder. Moreover, the decoders are now imported and one does not know whether all the aspiring colour TV owners have been able to get the decoders. An additional query is on the choice of second channel for teletexting this service. Why not show it on the first channel itself and even TV authorities have no answer for this. Viewers in other cities have been promised that this facility will be extended to them in a phased manner and one hopes that by that time the teething problems will be overcome.

## Electron Microscope

A research team of Tottori university in western Japan has developed the world's most powerful scanning electron microscope, with a resolution of up to five angstroms. An angstrom is one hundred-millionth of a centimetre.

This microscope will provide a better view of the microcosm of antibodies which lend immunity to the human biological system, the genes and enzymes with their contents like Deoxyribonucleic acid (DNA) and so on. The microscope is capable of magnifying object 800,000 times and researchers can see the rugged surfaces of ultra micro organism in three dimensions.

This instrument, developed in collaboration with Hitachi Ltd., can be used to examine precisely finished microchips, leading to the possibility of even higher integration of Very Large scale integrated circuits.

The high resolution of this new electron microscope has been attained by combining an electric on gun which shoots a very fine electron beam and a method to place samples in a special magnetic lens called high excitation objective lens. The previously most powerful scanning electron microscope, also developed by the Tottori university, provided a resolving power of up to 15 angstroms, thereby yielding magnification by 350,000 times.

## New Entrants

Murugappa Electronics Ltd., a new company has entered the capital market and its project is located at Hebbal industrial area in Mysore district. MEL is setting up a project to manufacture 2,350 million metres of 3.81 mm width high quality audio magnetic tapes. It has also registered for manufacturing 23 million audio tapes, using its own production. The cost of the project is Rs 530 lakhs. The company is expected to go into commercial production by April, 1986 and in the first full year of operation it hopes to market about five million cassettes, increasing to about 12 million at the end of the third year of operation.

Computer Point (India) Ltd. which opened the first retail shop for all computer related items under one roof, has completed one year and is now entering the capital market. The company has retail outlets in Bombay, Bangalore and Madras. It has commenced a computer education service called "Chip club".

A new chain of computer retail shops called "Computer Shack" will soon come up in Bombay and other metropolitan cities, following in the foot steps of Computer Point. According to Mr Ashok Someshwar, director of Computer Shack the initial project cost was around Rs. 60 lakhs. The unit would stock microcomputers in the price range of Rs 5,000 to Rs 2 lakhs. It would also sell packaged and custom-made software, computer media, peripherals, computer books and magazines.

## Snookered — by a robot

The world's first snooker-playing robot is expected to be in action in about a year's time. The robot is the brainchild of scientists from Bristol University and London's Imperial College. They say that the robot will initially have fairly limited skills at the game, but that there are plans to develop it further so that it will be capable of taking on top human players such as Steve Davis. The metal maestro of the green baize table will be programmed to learn the rules of the game and to study the position of the balls so that it can work out the best shots. It will then propel itself around the snooker table on wheels to play. The robot will have TV camera eyes and the sight will be fed into a computer which will operate as the robot's brain. Snooker is particularly well suited to robotic research because the game requires a high level of co-ordination between hand and eye. Scientists have long been trying to build such skills into robots for industrial applications.

## Ham Directory

A Directory of Licenced Amateurs in India, popularly known as the Indian Callbook, updated till August 1985, has now been published. The last edition having been published in 1982, this new edition containing over 2000 entries will be found useful by all amateurs (Hams) and Shortwave Listeners (SWLs).

The cover price is Rs. 10/- post free. If supply is required by registered post, Rs 4/- should be added irrespective of number of copies in the order. The Callbook is available against prepayment only from RADIO, 3 Thiru-Vi-Ka Road, Post Box 725, Madras 600 006, to whom remittances should be sent by Money Order or Bank Draft.

This digital clock makes use of the giant displays published in the August/September 1985 issue of *Elektronika*. It has a face of 720 mm wide by 280 mm high, which makes it readable at distances of up to 100 m. The display alternately shows the time and the ambient temperature.

# JUMBO CLOCK

by A Sevriens

The circuit diagram in Fig. 1 shows that the clock is designed around well-tried ICs. The clocking frequency is derived from the mains:  $T_1$  is provided with part of the secondary voltage of  $T_2$  and converts this into a suitable rectangular signal. Low-pass filter  $R_1, C_2$  and monostable  $IC_{21}$  ensure a noise-free 50 Hz signal. This signal is divided by 6 in  $IC_4$ , then by 5 and 10 in  $IC_5$ , and finally by 10 in  $IC_6$ . The signal at pin 12 of  $IC_4$  is, therefore, 1/60 Hz, which is 1 pulse per minute.

Circuit  $IC_7$  functions as a frequency converter: signals of 8 1/2 Hz, 1 1/2 Hz, and 1/60 Hz are applied to its  $D_4, D_2,$  and  $D_0$  inputs respectively. When  $S_3$  is in the centre — NORM — position, control inputs A, B and C of the IC are logic low, and  $D_0$  is then connected to output W. The clock is then supplied with normal minute pulses and operates normally. The clock may be set by switching  $S_3$  to FAST or SLOW as the case may be.

## Clockwork

The clockwork is formed by the chain consisting of four bit synchronous counters  $IC_{11}$  to  $IC_{15}$ . The Q-outputs of these circuits give the counter position in 11-bit digital code, where  $Q_A$  of  $IC_{11}$  has the lowest value bit. Connections between the outputs and gate  $N_7$  are so arranged that when the counter position reads 1011111111 (decimal 1439), the three ICs are reset to 0. This counter position corresponds to 23 hours 59 minutes. The clock can also manually be set to 00 hours 00 minutes with the aid of reset button  $S_2$ .

## Thermometer

Circuit  $IC_{15}$  is the temperature sensor. Its temperature-dependent current causes a voltage drop across  $R_{11}$ , which, after amplification in  $A_1$ , is supplied to digitizer  $IC_{14}$ . Provided  $P_1$  and  $P_2$  are adjusted correctly, the Q-outputs of  $IC_{14}$  have logic levels corresponding to the temperature. The digitizer is clocked via gate  $N_4$ .

## Decoding

The 11-bit digital information as to time and the 8-bit data on temperature are applied to the A and B outputs of multiplexers  $IC_9 \dots IC_{10}$  respectively. The signals at the A/B input of these three ICs determine

whether the time or temperature information is provided to their outputs. The signals at the A/B inputs are derived from the clock oscillator, and arrange for a regular change-over at three-second intervals.

The output signals of the multiplexers are simply used as addresses for EPROMs  $IC_{13}$  and  $IC_{16}$ . Two EPROMs provide 16-bit data, and, since four digits are used for the clock, these are divided into four groups of four bits. At each address in the EPROMs now exists the relevant BCD code for controlling each of the four clock digits.

## Display

How the outputs of the EPROMs control the individual display boards is shown in Fig. 2. Each of the display boards has a BCD to seven-segment decoder — see Fig. 4. This decoder converts the BCD codes into control voltages for each individual LED element of the display in accordance with Fig. 3. The RBI input of the left-hand display board is connected to the  $D_4$  output of  $IC_{15}$ : if this is logic low, the display cannot light (so that zeros are not shown in this position). The colon required for time indication is switched off by  $T_2$  when temperature is displayed.

The degree symbol is obtained by making the B-inputs of  $IC_{10}$  logic high. This results in segments b, f, and g of the right hand display board being activated via the BCD code, and segment a via  $T_3$  and the Z terminal. Connections to the collectors of  $T_2$  and  $T_3$  must still be made, because they were not provided for in the *jumbo displays* article in the August/September issue.

These displays have a number of advantages:

- they are entirely solid state, which prevents segment failure since the life of LEDs is much longer than, for instance, that of incandescent lamps;
- they do not need intricate reflector constructions;
- if any one LED fails, they remain fully legible by virtue of the special segment construction;
- they are easily arranged in a variety of colours — red, green, blue, yellow, orange;
- they work from 24 V with relative high efficiency, which keeps heat dissipation low.

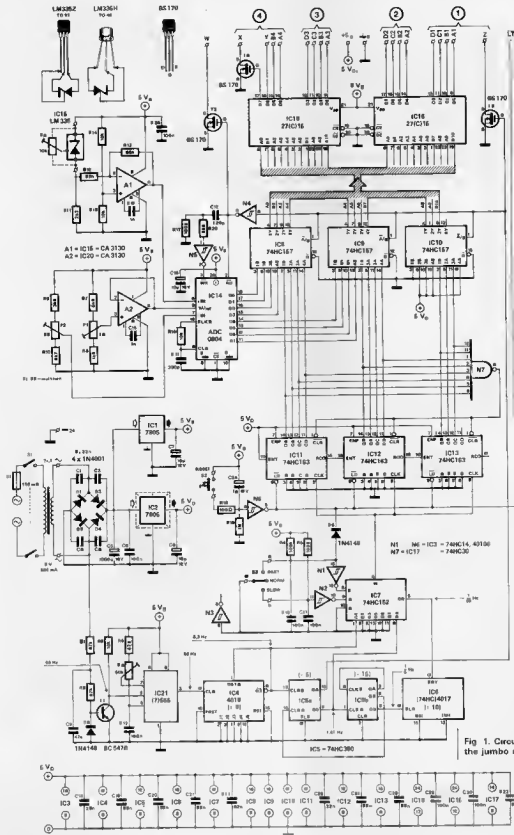

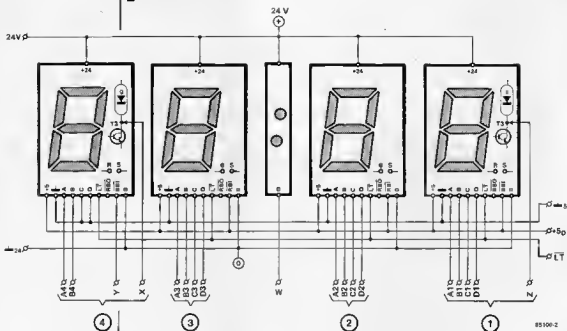

Fig. 2. Connections between the display and control boards.

It may be said that the large number of LEDs required is a disadvantage, but, in our opinion, this is largely negated by the advantages.

The seven-segment display, shown in Figure 4, is based on a type 74LS348 decoder, which has the same features as the well-known type 74LS47/247, but has in addition internal pull-up resistors and inverted output signals, so that external transistors can be used to cope with the large currents drawn by the segments. The inputs and outputs to the decoder, the read-outs, and the

additional functions are correlated in Figure 3.

All input and output controls have been arranged external to the decoder, so that they can be used in the same way as with normal displays. Wire link R5 serves to interconnect the earths of the +5V and +24V supplies.

At the output of the decoder there is a switching stage for each segment that switches the relevant segment on or off. Each segment consists of four parallel groups of eight or nine LEDs in series with

Fig. 3. The BCD-to-seven-segment decoders on the display boards function according to this table

3



number of function	inputs						RBO/BI	outputs						
	LT	RBI	D	C	B	A		a	b	c	d	e	f	g
0	H	H	L	L	L	L	H	H	H	H	H	H	L	L
1	H	X	L	L	L	H	H	L	H	H	L	L	L	L
2	H	X	L	L	H	L	H	H	H	L	H	H	L	H
3	H	X	L	L	H	H	H	H	H	H	L	L	L	H
4	H	X	L	H	L	L	H	L	H	H	L	L	H	H
5	H	X	L	H	L	H	H	H	L	H	L	L	H	H
6	H	X	L	H	H	L	H	H	L	H	H	L	H	H
7	H	X	L	H	H	H	H	H	H	H	L	L	L	L
8	H	X	H	L	L	L	H	H	H	H	H	H	H	H
9	H	X	H	L	L	H	H	H	H	H	L	L	H	H
10	H	X	H	L	H	L	H	L	L	L	H	H	L	H
11	H	X	H	L	H	H	H	L	L	H	H	L	L	H
12	H	X	H	H	L	L	H	L	H	L	L	L	H	H
13	H	X	H	H	L	H	H	H	L	L	H	L	H	H
14	H	X	H	H	H	L	H	L	L	L	H	H	H	H
15	H	X	H	H	H	H	H	L	L	L	L	L	L	L
BI	X	X	X	X	X	X	L	L	L	L	L	L	L	L
RBI	H	L	L	L	L	L	L	L	L	L	L	L	L	L
LT	L	X	X	X	X	X	H	H	H	H	H	H	H	H

X = irrelevant

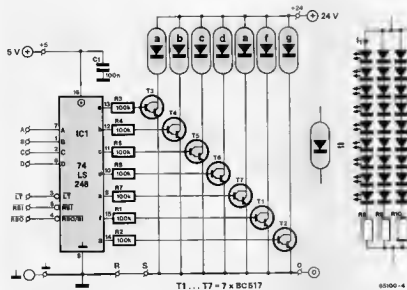

Fig. 4. Circuit diagram of a seven-segment display board.

a current limiting resistor.

The displays can be powered from a non-stabilized 20...24 V supply. The current drawn per segment varies from 60 mA to 100 mA.

Figures 1b and 1c give the diagrams for displays with a "1" and a "1." respectively. Both can be used for a 12-hour clock. The "1" display has provision for a lamp test (LT); open inputs are considered active, i.e., the display lights. This is in contrast to the seven-segment display which treats inputs that are not connected as logic high, that is, inactive.

As mentioned earlier, read-out boards consisting of several figures may be composed by mounting a number of displays side by side on a flat base. The whole may be protected by translucent red perspex; this also acts as a light filter, which improves the legibility considerably.

As you need a large number of LEDs, shop around for these because many dealers are prepared to allow a quantity discount. Uniformity of brightness of these diodes is not so important for this application, because at the distances for which these displays are intended, differences in brightness do not show up.

### Power supplies

Fig. 1 shows that the temperature processing circuits have their separate power supply, +5 A, provided by an additional voltage regulator Type 7805. This arrangement is necessary to prevent the analogue circuits being affected by the digital pulses in the remainder of the unit.

The displays have their own power supply — see Fig. 5, which is not regulated. The secondary voltage of  $T_2$  was chosen at 2 x 18 V

### 5

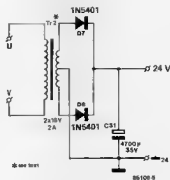

Fig. 5. The power supply that enables the 346 LEDs to glow brightly

for red LEDs and good brightness. If green or yellow LEDs are used, or the displays need not be so bright, a secondary output of 2 x 15 V at 1.5 A will suffice.

### Construction and setting up

The only problem in the construction is likely to be a wandering of concentration, since there are no fewer than some 2500 soldering joints to be made. It is, therefore, all too easy to make a dry joint.

The clock itself needs no adjustments, but the temperature circuits need to be set up as indicated below.

The temperature sensor is not yet fitted at this stage: in its place, connect a variable power supply (+ to the cathode terminal). The output voltage of the supply should be monitored with a digital voltmeter. As the LM355 provides a voltage of 10 mV/K, the voltage should be set to 2.53 V to simulate a temperature of  $-20^{\circ}\text{C}$ .



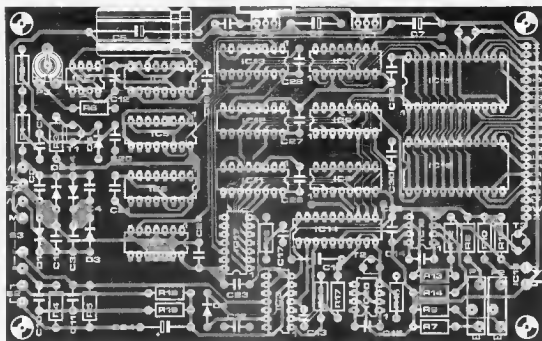
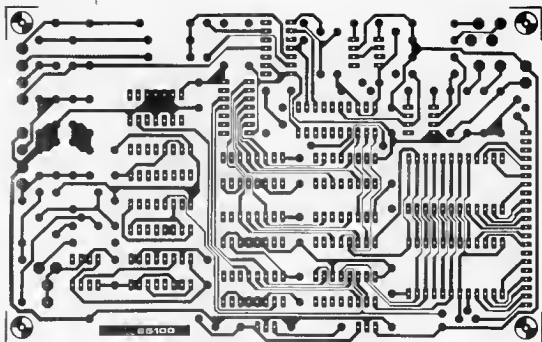

Next, connect the digital voltmeter across pins 6 and 7 of  $IC_{14}$ . Set the voltmeter to its most sensitive range and adjust  $P_2$  so that the meter reads exactly 0.000 V. Then, set the power supply to 3.230 V, and measure and note the voltage now pertaining across pins 6 and 7 of  $IC_{14}$ . Finally, connect the voltmeter between pin 9 of  $IC_{14}$  and earth and adjust  $P_1$  so that the meter reads exactly half the voltage noted before.

Greater accuracy may be obtained by connecting  $P_1$  as shown in dashed lines in Fig. 1, and adjust this preset with the aid of dishes of water at exactly 0 °C and +50 °C. Now, fit  $IC_{10}$  into place.

Finally, connect an analogue voltmeter between +5D and pin 3 of  $IC_{21}$ , and adjust  $P_3$  so that the meter reads about 300 mV. The clock should then operate normally.

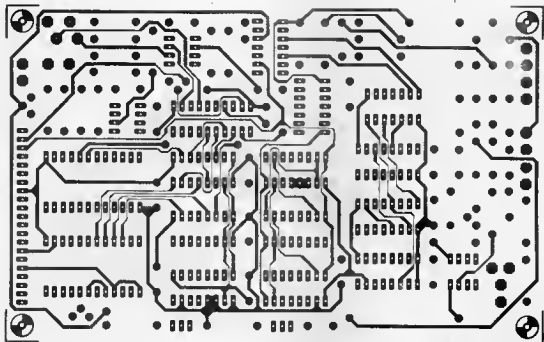

Fig. 6. The (double-sided) printed-circuit board for the control circuits.

#### Parts list (control board)

##### Resistors:

$R_1, R_2 = 47 \text{ k}$   
 $R_3, R_{14} \dots R_{16} = 10 \text{ k}$   
 $R_4, R_9, R_{17} = 100 \text{ k}$   
 $R_6 = 82 \text{ k}$   
 $R_7 = 6\text{ k}8$   
 $R_8 = 1\text{ k}5$   
 $R_9 = 3\text{ k}9$   
 $R_{10} = 4\text{ k}7$   
 $R_{11}, R_{20} = 2\text{ k}2$   
 $R_{12} = 22 \text{ k}$   
 $R_{13} = 68 \text{ k}$   
 $R_{16} = 100 \Omega$   
 $R_{19} = 1 \text{ M}$   
 $P_1, P_2 = 2 \text{ k}$  multiturn preset  
 $P_3 = 50 \text{ k}$  preset  
 $P_4 = 10 \text{ k}$  preset\*

##### Capacitors

$C_1 \dots C_4, C_{19} \dots C_{23}$   
 $C_{25} \dots C_{28} = 22 \text{ n}$   
 $C_5 = 1000 \mu, 16 \text{ V}$   
 $C_6, C_{10}, C_{11}, C_{25}, C_{28}$   
 $C_7 = 100 \text{ n}$   
 $C_7, C_8, C_{16} = 10 \mu, 16 \text{ V}$   
 $C_9 = 47 \text{ n}$   
 $C_{12} = 180 \text{ n}$   
 $C_{13} = 220 \text{ p}$   
 $C_{14}, C_{15} = 1 \text{ n}$   
 $C_{17} = 330 \text{ p}$   
 $C_{24} = 1 \mu, 16 \text{ V}$   
 $C_{31} = 4700 \mu, 35 \text{ V}$

##### Semiconductors:

$D_1 \dots D_4 = 1\text{N}4001$   
 $D_5, D_6 = 1\text{N}4148$   
 $D_7, D_9 = 1\text{N}5401$   
 $T_1 = \text{BC}547\text{B}$   
 $T_2, T_3 = \text{BS}170$  or  $\text{VN}10\text{KE}$   
 or  $\text{VN}1$ ,  $\leq \text{M}$   
 $\text{IC}_1, \text{IC}_2 = 7805$   
 $\text{IC}_3 = 40106$  or  $74\text{HC}14$   
 $\text{IC}_4 = 4018$   
 $\text{IC}_5 = 74\text{HC}390$   
 $\text{IC}_6 = 4017$  or  $74\text{HC}4017$   
 $\text{IC}_7 = 74\text{HC}157$   
 $\text{IC}_{11}, \text{IC}_{13} = 74\text{HC}163$   
 $\text{IC}_{14} = \text{ADC} 0804$   
 $\text{IC}_{15}, \text{IC}_{16} = 2716$  or  $27\text{C}16$   
 $\text{IC}_{17} = 74\text{HC}30$   
 $\text{IC}_{18} = \text{LM}355$   
 $\text{IC}_{19}, \text{IC}_{20} = \text{CA} 3130$   
 $\text{IC}_{21} = 555$  or  $7555$

##### Miscellaneous:

$T_{11} =$  mains transformer with  $9 \text{ V}, 500 \text{ mA}$  secondary  
 $T_{12} =$  mains transformer with  $2 \times 18 \text{ V}, 2 \text{ A}$  or  $2 \times 15 \text{ V}, 1.5 \text{ A}$  secondary\*  
 $E_1 =$  fuse,  $1 \text{ A}$ , delayed action  
 $S_1 =$  double pole mains switch  
 $S_2 =$  single-pole, 1.5 amp to make button switch  
 $S_3 =$  single pole change-over switch with open centre last position  
 heat sink for  $\text{IC}_2$   
 PCB 85100  
 \*see text

#### Parts list (colour display)

$R_1, R_2 = 270 \Omega$   
 18 LEDs, 5 mm, colour to choice  
 PCB 85413-3

#### Parts list (display board)

NOTE: every component is required four fold

##### Resistors:

$R_1, R_7 = 100 \text{ k}$   
 $R_8, R_{9a}, R_{9b}, R_{9c}, R_{10a}, R_{10b}, R_{10c}, R_{10d}$   
 $R_{11a}, R_{11b} = 330 \Omega$   
 $R_{9a}, R_{9b}, R_{9c}, R_{10a}, R_{10b}, R_{10c}, R_{10d} = 270 \Omega$

##### Capacitors:

$C_1 = 100 \text{ n}$

##### Semiconductors:

$T_1 \dots T_3 = \text{BC}517$   
 $\text{IC}_1 = 74\text{LS}248$   
 232 LEDs, 5 mm, colour to choice  
 PCB 85413-1

# zero-modem connector

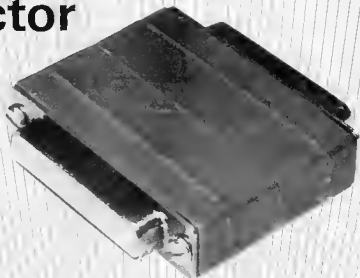

by J Steeman

Fig.1 A number of possible connections between two RS232 connectors.

There is probably no other interface that gives so many problems as the RS232. Quite a few connecting wires are needed to ensure the correct links for all possible applications. The reason for this lies in the number of possible handshakes pertaining to the RS232 protocol. With modern equipment, many of these handshakes are no longer strictly necessary, so that a much simpler connection will suffice. At the same time, many idiosyncrasies of various computer manufacturers can be circumvented. The zero-modem connector proposed is based on the idea of reducing the handshakes. Each equipment provides its own handshake, while the connector looks after the interconnections of the data lines. There is then, of course, no longer any control between the individual units, but there is a correct data link.

Normally, a cable is needed for connecting, for instance, a DTE (data terminal equipment) to a DCE (data circuit terminating equipment); the pins of the connectors terminating the cable are then linked direct, i.e., there are no cross-connections. When two computers are inter-connected (DTE to DTE), some cross-connections are required: a few examples of these are shown in Fig.1. Fig.1d is the cross-connection used in the present zero-modem connector. It is, therefore, possible to interconnect two computers with the cable shown in Fig.1a and the zero-modem connector.

## Construction

Two D-25 shells are needed, of which the top is cut away with a metal saw. The

1a



b



c

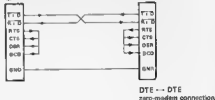

d

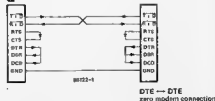

2

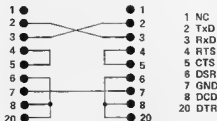

decapitated shells are then glued together at the cut edges as shown in Fig 3. A D-25 female connector is then fitted at one end of the composite shell, and a D-25 connector at the other end. These two connectors should be linked together as shown in Fig 2.

### Finally

This simple unit makes virtually every RS232C connection possible. Note, however, that it does not relate to connections via a secondary channel as indicated in the V23 protocol. Further, it is assumed that the data formats agree with one another.

Fig 2 Internal wiring diagram of the zero-modem connector.

3

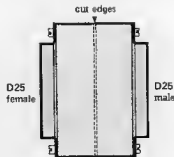

Fig 3 Schematic representation of the composite shell.

The alarm described has been in continual use for over a year at a temperature of around  $-18^{\circ}\text{C}$ , which is, of course, quite normal for a deep-freeze alarm. Its function is to indicate an accidental rise in temperature. There are, of course, indicators provided on the deep-freeze unit, but as these are mains-operated they are of not much use in case of mains failure!

The principle of operation is quite simple: a green LED lights as long as the temperature stays within limits defined by the user, while a red LED shows when the temperature has risen above a critical level.

Since operational amplifier IC<sub>1</sub> is arranged as a differentiator, two possible states ensue: (a) the output voltage is positive as long as the potential at the non-inverting input is higher than that at the inverting input, and (b) the output voltage is negative when the input levels are reversed with respect to those in (a). The voltage at the non-inverting input is derived from potential divider  $R_2$ - $R_3$ - $P_1$ , and is set by the user. The voltage at the inverting input varies with temperature. The sensor is formed by the base-emitter junction of n-p-n transistor  $T_1$ , which can be almost any type. The value of resistors  $R_3$  and  $P_1$  depends on the transistor used. The values stated in the circuit diagram pertain to a 2N1711, a threshold temperature of  $-15^{\circ}\text{C}$ , and a supply voltage of  $\pm 4.5\text{V}$ .

If more than a visual indication is required, the circuit may be used to control an additional audible alarm. When  $D_2$  lights, transistor  $T_2$  is saturated, so that its collector is nearly at earth potential. This transistor can, therefore, operate a small buzzer or

## deep-freeze alarm

siren, or, indeed, anything else convenient to you. The additional alarm must be connected between  $S^+$  and  $S^-$ .

If you are happy with the LED indication, transistor  $T_2$  may be omitted and resistor  $R_5$  replaced by a wire link.

If only periodic checks are to be carried out, the circuit may be supplied from two 4.5...9V dry batteries via a spring-loaded push button switch. Where permanent monitoring is desired, however, it is advisable to use two 6...9V rechargeable NiCd batteries (without a switch). The current drawn by the buzzer or siren should not exceed 500 mA.

C Sadot

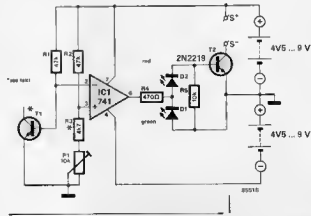

by J Steeman

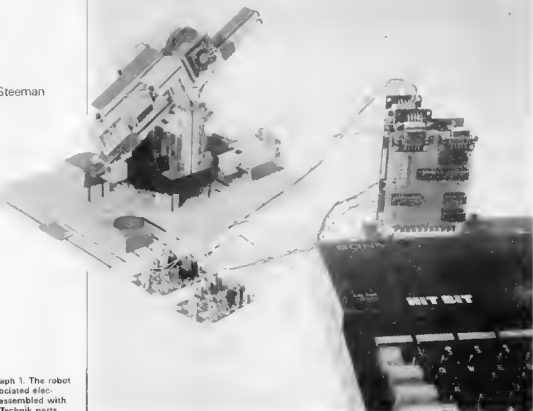

Photograph 1. The robot and associated electronics assembled with Fischer Technik parts.

# 8-bit I/O bus

Robots are now being used in a variety of industrial processes, but they are very unlike their namesakes appearing in science fiction fantasy. Robotics is by now a generally accepted science, and constitutes an interesting meeting point for applied electronics, mechanics, and computer programming. To control a simple robot, a computer will need input and output channels, so there's another reason to build this expansion for the universal I/O bus.

This circuit, together with the analogue computer input featured in the June 1985 issue of *Elektronika* opens the world of control and measurement technology. It enables the measuring and logging of eight analogue and eight digital channels, as well as the control of eight digital outputs. All physical quantities, converted to electric signals by sensors, may be measured by the computer, which checks the results and takes corresponding action, or corrects an occasional system fault via the eight outputs. This procedure is called interactive control.

There is a constant exchange of data between the measured quantities, the computer, and the controlled systems. The software enabling such interactive procedures may be written in BASIC.

## Applications

Have your computer perform a useful task instead of playing games. Have it guard and control all of your domestic appliances like heating, telephone, aquarium, slide projector, etc. You may also build a computer measuring device to check your loudspeakers or the entire hi-fi installation.

These examples, of course, require a certain amount of software to handle the data. The nucleus of such a program is the correct supply of control data to the input and output channels. BASIC programs with PEEKs and POKEs will be quite adequate for the selection of these channels. The eight outputs are thoroughly buffered and may switch up to 50 V at 0.5 A by means of a ULN 2803.

## The circuit

The ULN 2803 provides an ideal interface between TTL levels and relays, electromagnets, stepper motors, etc. with its high-current Darlington transistor arrays, which allow a peak current of 500 mA. All outputs are of the open collector type and diodes for momentary suppression of inductive surges are fitted internally. The maximum voltage is 50 V, so a variety of relays may be used to increase switching currents and voltages (e.g. 240 V).

As can be seen in the circuit — Fig. 1 —, gates  $N_7 \dots N_{14}$  are driven by two bistable ICs which latch the output data. The bit combination at outputs  $Q_8 \dots Q_7$  is retained until:

1. the RESET button is pressed. Bus signal NRST goes low, is inverted by  $N_6$ , and clears any programmed data in  $IC_2$  and  $IC_3$  via their CLR inputs.
2. new output data is loaded by a POKE. This involves bus signals SS, R/W, and  $\Phi 2$ . When the board has been selected by SS and R/W is on write, data from the databus is read into the bistables  $IC_2$  and  $IC_3$  during a  $\Phi 2$  cycle.

3. the mains supply fails, or the computer is switched off.

$IC_2$  is selected by gates  $N_1 \dots N_4$ . A low level at the  $G_1$  and  $G_2$  inputs enables data transfer to the bus. This low level exists for the duration of a  $\Phi 2$  cycle (high level), when the board has been selected by the SS (Slot Select) signal and when R/W is in the read mode (i.e. high). The inputs of driver  $IC_6$  have pull-up resistors and accept TTL levels.

## Construction

If the ready-made PCB, available through our PCB service, is used, the construction of this I/O unit will present no difficulties. Moreover, no adjustments are required. More information on the I/O bus can be found in the June 1985 issue of *Elector India*.

## The robot

There are many applications for interactive control, but undoubtedly the most appealing is robot control, for the very reason that one sees what happens. We already have

1

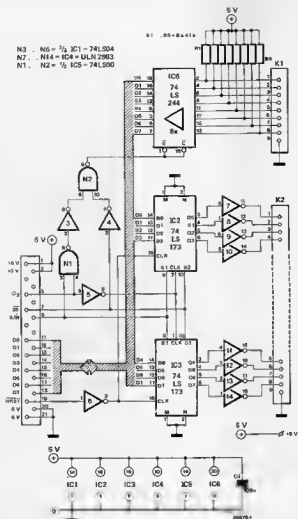

Fig 1. Another circuit for the universal I/O bus. It provides control of eight input and output channels.

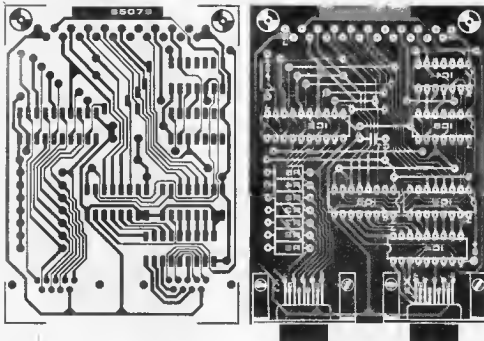

Fig. 2 The board is simply plugged into one of the I/O bus extension connectors.

#### Parts list

##### Resistors

$R_1, R_9 = 47 \text{ k}$

##### Capacitor

$C_1 = 100 \text{ n}$

##### Semiconductors

$IC_1 = 74LS04$   
 $IC_2, IC_3 = 74LS173$   
 $IC_4 = ULN 2803$   
 $IC_5 = 74LS00$   
 $IC_6 = 74LS244$

##### Miscellaneous:

21 way DIN 41617 connector, right-angle model  
 K1, K2 - 9-way D-connector, right-angle model  
 PCB 85079

the controlling elements such as computer, I/O bus, analogue input, and the present circuit. Only the robot is missing. A prototype robot shown in the photograph was built from Fischer Technik parts. Its movements may be limited, but it is eminently suitable for demonstration purposes. These mechanical parts may also be used to build other devices like a lathe, elevator, antenna rotor, sorting machine, pantograph, or a solar cell tracking system.

The robot's arm (Fig. 3) may be moved up

and down through an angle of thirty degrees. At the same time, it can revolve around its own axis, thus creating a cone-shaped working area: Fig. 4.

The robot is able to move small metal objects to and from different locations within its working area, by means of a small electro-magnet at the end of its arm. Two motors move the arm: one takes care of the movement in the vertical plane, while the other revolves the arm around its axis. A set of gears enables the spindle of poten-

### 3

- A=robot arm
- B=potentiometer 1
- C=motor 1
- D=electro-magnet
- E=potentiometer 2
- F= motor 2
- G=metal object
- H=dumping area

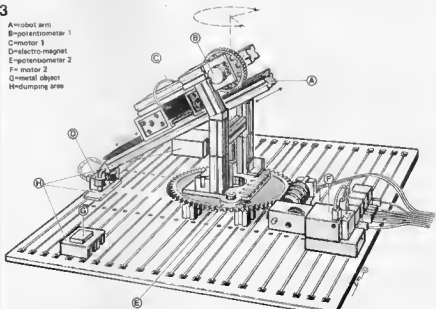

Fig. 3. The most important parts they enable the robot to move a coin from one place to another.

tometer 1 to turn in line with the first motor, while potentiometer 2 is driven direct by the axle of the arm.

Both potentiometers are connected between the +5 volts supply and ground, so that the voltages at their wipers vary between these potentials, according to the position of the arm. These two voltages may be read by the computer via its analogue input, and thus provide information about the position of the arm. A level of 5 volts is translated to the binary value 1111 1111 = 255 by the A/D converter. Thus, 2.5 volts equals decimal 128, 1.75 volts equals decimal 64; etc. These values are subsequently read by the computer with a PEEK command for comparison with the position to which the arm is to be moved.

Motor control is effected by four output channels of the present I/O unit. Outputs 1 and 2 move the arm up and down, whereas outputs 3 and 4 move it in the horizontal plane. As far as their power consumption is concerned, the motors could be connected direct to the outputs, but this would preclude the possibility of reversing their direction of travel. For this purpose, a bridge circuit such as the one published in the August/September 1984 issue of *Elektronika*, page 8-98, will be needed.

The electro-magnet is switched by output bit 8. Table 1 shows the eight output bits and their corresponding functions. Switching the electro-magnet on and off is achieved by addition or subtraction of decimal 128 to or from the decimal value of the lower four bits. The wiring of the robot is evident from Fischer Technik's documentation. Fig. 5 shows the interconnections between robot, computer I/O, and analogue input. Any other connection results, of course, in different bit combinations. For other purposes, more I/O units or analogue inputs may be added onto the bus.

Finally, although the Fischer robot is an interesting demonstration model, clearly showing the workings of simple robotics, it is simply too small, too light, and lacking in precision for any useful applications. And yet, it offers a worthwhile comparison with an industrial robot, because technically it hardly makes any difference whether one moves tiny parts or heavy loads from one place to another.

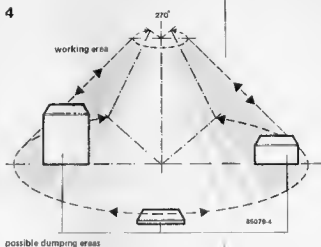

Fig. 4. The robot's working area is restricted. The arm may be moved through an angle of thirty degrees in the vertical plane, and around its own axis.

Fig. 5. Wiring plan for the robot. Different connections result in different bit-combinations.

Table 1. The stored bit-combination determines the movement and actuates the electro-magnet.

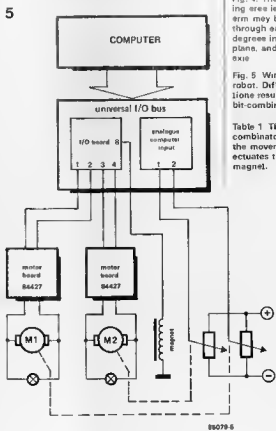

Table 1.

output channels I/O unit

8 7 6 5 4 3 2 1

8a 7 6 5 4 3 2 1 0



POKE XXXX, 0 = 0 0 0 0 0 0 0 0 = magnet off, arm holds

POKE XXXX, 128 = 1 0 0 0 0 0 0 0 = magnet on, arm holds

POKE XXXX, 134 = 1 0 0 0 0 0 1 1 0 = magnet on, arm moving upwards to the left

POKE XXXX, 9 = 0 0 0 0 0 1 0 0 1 = magnet off, arm moving downwards to the right



Zero phase shift between the drive units in an active loudspeaker unit has been the goal of virtually all designers and constructors ever since the first multiple speaker unit was conceived. For a long time, it has been like trying to achieve a *perpetuum mobile*, but now it has become reality!

# phase-corrected cross-over filter

by T Scherer

It is well known that the loudspeaker is the weakest link in an hi-fi chain: it is the final factor that determines how the hi-fi installation sounds. The most serious problem is that presented by the processing of the wide range of frequencies. As long ago as the thirties, designers have tried to solve this problem by sub-dividing the audible frequency range and using a separate drive unit for each of the resulting bands. In the simplest case, this means that a bass speaker (woofer) is used for the low audio frequencies, and a so-called tweeter for the high audio frequencies.

Right up to the 1960s, the network that divides the frequency ranges consisted of a passive filter constructed from chokes and capacitors. When semiconductors became less expensive, designers began to use active filters and to provide each separate drive unit with its own power amplifier that is fitted inside the speaker enclosure. Such active systems are generally better than passive ones, but they are also more expensive. But whether active or passive, filters create problems of their own.

signal at the bass speaker lags that of the input signal by 45°, while that at the tweeter leads that of the input signal by 45°. Because of the phase difference of 90° between the signals at the two speakers, the air pressures produced by them are added geometrically, so that the overall sound is as if caused by a signal that is identical to the original input signal to the filter. Provided, that is, that everything is ideal.

Tolerances in the components, differences in the drive units, and effects of the enclosure prevent such an ideal state being attained. Even tolerances of 10 per cent can alter the situation quite a lot. If, for instance, the capacitance is 10 per cent smaller, and the choke 10 per cent larger, the levels at the two drive units are almost 0.5 dB lower than in the ideal case: -3.444 dB. The phase difference is also larger: 95.5°. The result is that the overall signal is almost 0.9 dB lower than the original signal. This may not seem serious, until the considerations concern higher-order filters that give a Bessel, Butterworth, or Chebishev response. Such filters have a much steeper cut-off profile. Even small component tolerances then cause a reduction of a few dB in the available gain. The phase characteristic in these filters also has a steeper roll-off. Component tolerances may cause such a large phase shift that the gain is reduced by another few dB. Finally, the loudspeaker characteristics themselves should also be taken into account. The (larger) bass unit is inherently somewhat slower in action than the (smaller) tweeter, they have different rise times. The difference between these times manifests itself at the cross-over frequency as an additional phase shift. Odd-order filters have a phase difference of about 90°. In a two-way system with a cross-over frequency of 1 kHz and a difference in rise times of 100 µs (a typical, practical value), there is an additional phase shift of 36°, resulting in a total of 126°. Even if all other parameters of the network are one hundred per cent correct, such a phase shift results in a 2 dB loss. In even-order filters, the situation is somewhat better: here an additional phase shift of 36° causes only 0.5 dB loss.

## Solution

The requirement is, therefore, for a filter that produces no phase shift between the loudspeakers, is not affected by component

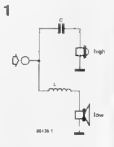

Fig. 1. The simplest form of cross-over network. Its simplicity causes problems, however

## Problems with filters

The simplest two-way dividing filter consists of a choke in series with the bass speaker and a capacitor in series with the tweeter — see Fig. 1. At the cross-over between low and high frequencies, both drive units are fed with the same signal, the level of which is about 3 dB below that of the nominal output at the input to the filter. Moreover, the

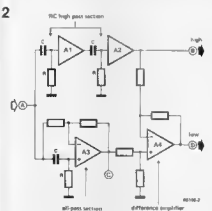

Fig. 2. New techniques of filter design enable the construction of this type of filter that in spite of having only two RC sections provides a 12 dB/octave profile and obviates a number of problems inherent in other types of filter.

tolerances, is easily reproducible, and, in spite of being a unit for home construction, is absolutely linear.

A critically damped second-order filter (i.e., one consisting of two cascaded simple  $RC$  high- or low-pass sections) has the same phase response as an all-pass filter. The filter in Fig. 2 consists of two high-pass sections,  $A_1$  and  $A_2$ . The phase shift,  $\phi$ , is calculated from

$$\phi = \arctan \frac{1}{\omega RC} \quad (1)$$

where  $\omega = 2\pi f$  (and  $f$  is in Hertz);  $R$  is in ohms; and  $C$  is in farads.

The phase shift in all-pass filter  $A_3$  in Fig. 2 is determined by

$$\phi = 2 \arctan \frac{1}{\omega RC} \quad (2)$$

The phase shift vs frequency and gain,  $G$ , ( $= U_o/U_i$ ) vs frequency characteristics at B, C and D in Fig. 2 are given in Fig. 3. They show that the phase shift at B (output of

two high-pass sections) is identical to that at C (output of the all-pass section). The only difference between the signals at B and C is that the gain of the former is frequency dependent

$$U_{o(B)}/U_i = \frac{1}{\sqrt{1+(1/\omega RC)^2}} \quad (3)$$

The amplification of the signal at C is unity, i.e.,

$$U_{o(C)}/U_i = 1 \quad (4)$$

The output at B only contains high audio frequencies, whereas that at C includes all audio frequencies at the same level. If then the signal at B is deducted from that at C, the gain,  $G_D$ , at D, i.e., Eq. (4) - Eq. (3) becomes

$$G_D = U_{o(D)}/U_i = 1 - \frac{1}{\sqrt{1+(1/\omega RC)^2}} \quad (5)$$

Plotting Eq. (5) shows that the output voltage  $U_{o(D)}$  is very small at high frequencies and is equal to  $U_i$  at low frequencies. The signal at D is, therefore, the low-frequency output of

### 3

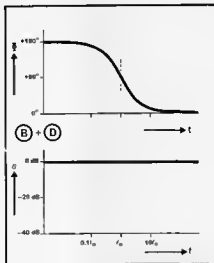
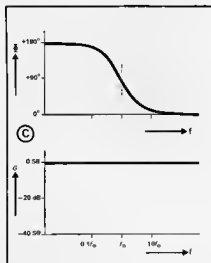
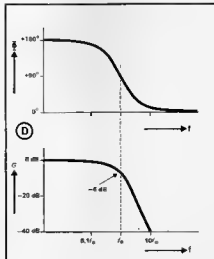
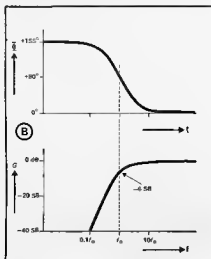

Fig. 3. Box B shows the phase vs frequency and gain vs frequency response at point B in Fig. 2. Boxes C and D show the same for points C and D respectively. Box B + D gives the phase and gain vs frequency response of the acoustically summed B and C outputs of Fig. 2.

the filter. Note, however, that its phase characteristic has the form of that of a high-pass section; that is, the phase of  $U_{(D)}$  leads that of the input signal. This means that there is no phase difference between the high-pass and low-pass branches over the entire frequency range.

The dividing filter of Fig. 2 is a two-way version. It has a 12 dB/octave cut-off profile. Normally, such second-order filters have two RC networks in both the low- and high-pass branches. Problems may arise then if, owing to component tolerances, the time constants in the two branches are not the same. These problems are negligible in the set-up of Fig. 2, because, due to difference amplifier  $A_4$ , the sum of outputs B and D is always the same as input A, irrespective of component tolerances.

The cross-over frequency,  $f_c$ , is defined as that frequency where both the low- and the high-pass output are attenuated by 3 dB. This happens when  $\omega_c RC=1$ , whence

$$f_c = 1/2\pi RC \quad [\text{Hz}] \quad (6)$$

where  $R$  is in ohms and  $C$  in farads

### Practical filter

The foregoing considerations lead to a practical filter, the block schematic of which is given in Fig. 4 and the circuit diagram in Fig. 5. It concerns a three-way version with a 24 dB/octave cut-off profile: its response resembles that of a critically coupled network, i.e., there is no tendency of overshoot. The filter has two low-frequency outputs, which are inverted with respect to one another. This offers a simple push-pull amplifier for the bass drive unit, since this often requires more power than the middle- and high-frequency speakers.

The input signal — Fig. 4 — is applied via a buffer to a four-stage RC high-pass section, and is then available at the high-frequency

output. Two of the RC stages are designated a; the other two, b. This is done to clarify that the phase shift in all-pass section  $AP_a$  is identical to that in the  $HP_a$  sections; the phase shift in  $AP_b$  is the same as that in sections  $HP_b$  — more about this later.

The difference amplifier forms from its two input signals a low-frequency output, whose half power frequency,  $f_c$  — see Eq. (6), is the dividing frequency between the high- and middle frequency branches. This signal is fed to another four-stage RC high-pass section, and is then available as the middle-frequency output. The low-frequency output is obtained in the same way as the middle-frequency output.

### Circuit description

Opamp  $A_1$  is the input amplifier, whose low-impedance output provides the audio signals for the remainder of the circuit. Opamps  $A_2 \dots A_5$  and  $A_9 \dots A_{13}$  are buffers that decouple successive high-pass sections from one another. Opamps  $A_6, A_8, A_{10}, A_{12}$  and  $A_{14}$  are connected as all-pass sections with a leading phase shift characteristic. Opamps  $A_3$  and  $A_{15}$  are arranged as difference amplifiers, while  $A_{16}$  functions as an inverter.

### Construction

There is no ready-made printed-circuit board available for the filter, but it should fit on a vero board, or similar, the size of half a Eurocard, i.e., 80 x 100 mm. Before the construction is started, the two cross-over frequencies should be decided. The relevant component values in Fig. 6 result in cross-over frequencies of 570 Hz and 3800 Hz. That is a frequency ratio of 1:6.7 — about two and a half octaves, which is a convenient value. The frequency ratio should not be allowed to be less than 1:4. The cross-over frequencies,  $f_c$ , are calculated from Eq. (6). The next aspect to be looked at is the impedance of the RC networks. To ensure low thermal noise and minimum delays, all resistors should have values between 10 k and 27 k. As the opamps also contribute to noise (see, for instance *Intuitive IC Opamps* by T M Frederiksen, published by National Semiconductor), the TL 074 should be preferred to the TL 084. Capacitor values are calculated from Eq. (6) once the resistor values have been determined.

Where absolute accuracy is desired, one per cent resistors should be used: these are much cheaper and more easily obtained than close-tolerance capacitors. However, in most cases five per cent resistors are perfectly all right but it is preferable that resistors with the same letter indices, for instance,  $R_{2a}$  and  $R_{2b}$  or  $R_{12a}$  and  $R_{12b}$ , have identical values. It is, therefore, more economical to buy, say, fifty five per cent 18 k resistors than thirty-two 1 per cent ones, and, with the aid of a digital multimeter, sort out equal-value ones: four groups of three and eight sets of two identical resistors are required.

Capacitors can be sorted in a similar way — see Fig. 6. Connect one of the capacitors to

Fig. 4 Block schematic diagram of the proposed three-way filter with a 24 dB/octave profile. The low frequency output is provided at two terminals where the signals are in antiphase. This arrangement makes it possible for a push-pull amplifier to be used for the bass loudspeaker.

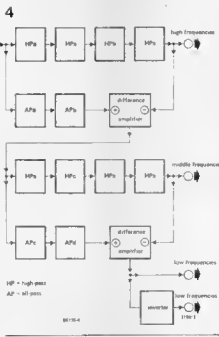

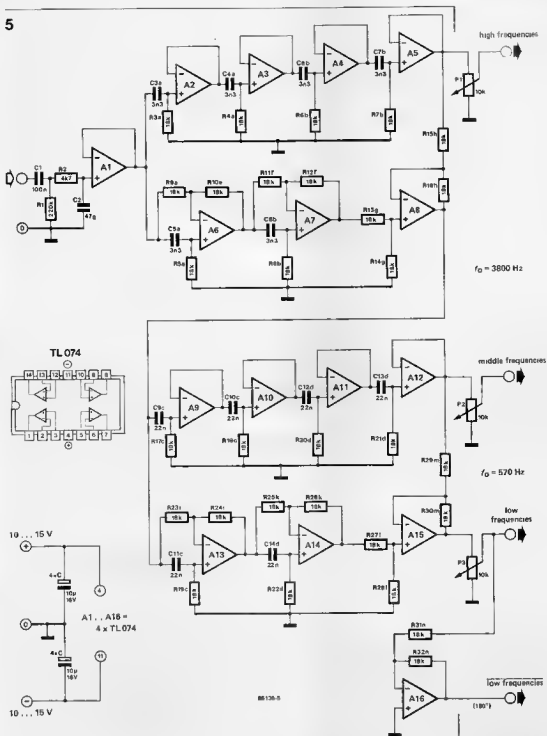

Fig. 5. Circuit diagram of the 24 dB/octave fourth-order filter.

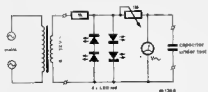

Fig. 6 Test circuit to enable the sorting of capacitors in groups of near-identical values.

the output terminals of this test circuit and adjust the potentiometer for a reading of 1.8 V on its 2.0 V AC range. Without resetting the potentiometer, check all capacitors and group them in identical sets.

The overall result of this grouping should be sets of resistors within 1 per cent, and sets of capacitors within 5 per cent. These tolerances will ensure a cross-over filter with an accuracy that exceeds even that found in expensive, professionally made loudspeaker units.

# lithium batteries

by Ernst Krempelsauer

For more than ten years, lithium cells and batteries have been used in digital watches, pocket calculators, and pacesetters, but now they appear to be on the verge of coming into much wider use in other electronics equipment. Already, they are used for direct mounting onto printed circuit boards, and some ICs have already had them embedded inside their dual in-line packages.

Because of their small size and extremely high energy density, lithium batteries are eminently suitable for use in miniaturized electronic equipment. They operate over a wide range of temperatures (typically  $-20^{\circ}\text{C}$  to  $+50^{\circ}\text{C}$ ), have an exceptionally low rate of self-discharge, and maintain their e.m.f. within tight tolerances with normal loads throughout their life.

Unfortunately, at present lithium batteries are not really suitable as direct replacement for conventional dry batteries: apart from their higher price, they do not stand up well to short circuits, and are also easily mechanically damaged. Under certain circumstances, they have a tendency to catch fire or even explode. None the less, as already stated, there are economically priced, perfectly safe versions for use in a variety of small electronic equipment.

## Types of lithium battery

Lithium, a silver-white metal that tar-

nishes rapidly in air and reacts with water, halogens, nitrogen, and hydrogen, is, with a density of only 0.531, the lightest alkali metal. It is of particular interest as the anode material in a voltaic cell, where it provides a higher e.m.f. (3.020 V) than other materials.

Because of its reaction with water — producing explosive hydrogen — lithium poses problems, since it is not easy to produce an electrolyte that is completely devoid of water. Sometimes acetonitrile,  $\text{CH}_3\text{CN}$ , is used. This is a poisonous liquid, prepared from ethyne and ammonia.

The choice of cathode material also has a decisive effect on the cell. This is the reason for the multiplicity of available lithium-based batteries and the differences in e.m.f. and energy density between the various versions. Basically, there are two main types of lithium battery. One uses a liquid or gaseous cathode, such as sulphur dioxide,  $\text{SO}_2$ , or thionyl chloride,  $\text{SOCl}_2$ ; the second has a solid cathode, typically manganese dioxide,  $\text{MnO}_2$ , and polycarbonmonofluoride, (CF)n. In general, solid cathodes are used in small to medium capacity batteries required to deliver relatively low load currents, while the other type of cathode finds application in larger capacity batteries that provide relatively high load currents.

It is worth noting that the data sheets of all manufacturers given even more stringent warnings against misuse and abuse of batteries with liquid or

gaseous cathodes than those given with lithium cells generally. SAFT, for instance, warns specifically of the danger of explosion and the production of poisonous gases in the use of liquid- or gaseous-cathode batteries.

## Construction and properties

Externally, lithium batteries resemble NiCd batteries rather than conventional dry batteries. Both spiral-wound and pressed electrodes are found, again as in NiCd cells. Spiral-wound electrodes have a larger operating surface and are, therefore, able to provide a higher current than pressed electrodes. On the other hand, cells using pressed electrodes generally have a larger capacity-to-volume ratio. Fig. 1 shows the construction of a typical, sealed, cylindrical cell with solid (CF)n cathode.

Lithium batteries are available in cylindrical, button, or special shape; the latter, for instance, as a nylon-enclosed memory back-up cell for direct mounting onto a printed-circuit board.

It should be noted that there are appreciable differences in the characteristics of the same type of lithium battery produced by different manufacturers, and also between the various types. For instance, the data sheets of a number of manufacturers give low operating temperatures vary-

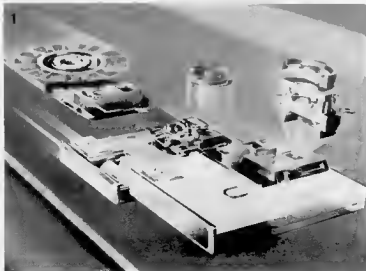

2



Fig. 1 A typical application of lithium batteries: two BR-2/3A cylindrical cells in a Kodak disc camera provide 6 V (also for flash). They have a nominal capacity of 1.2 Ah, which, according to Kodak, is sufficient for at least 2000 exposures and an operating life of 5 years is, therefore, guaranteed.

Fig. 2 The smallest cylindrical lithium cell in the world is Metshusite Electric's (Panasonic) BR21. This has a diameter of only 2.2 mm, a length of 11 mm, an e.m.f. of 3 V, a capacity of 5.4 mAh, and weighs only 0.9 g.

3

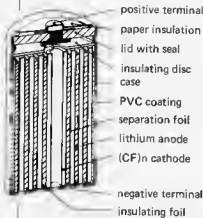

85062.3

4

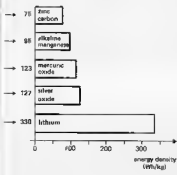

5

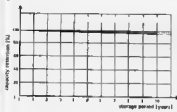

ing between  $-20^{\circ}\text{C}$  and  $-40^{\circ}\text{C}$ ; upper temperatures from  $+50^{\circ}\text{C}$  to  $+175^{\circ}\text{C}$  (sic); and e.m.f. values of 1.5 V; 2.4 V; 3.0 V; and 3.5 V. To put these values in perspective, brief characteristics of some types are given below.

#### Lithium manganese dioxide, $\text{LiMnO}_2$

Solid cathode; e.m.f. 3 V; universal type for relatively small currents; can withstand short-circuits for brief periods; operating temperature range typically  $-20^{\circ}\text{C}$  to  $+50^{\circ}\text{C}$ , maximum  $-40^{\circ}\text{C}$  to  $+85^{\circ}\text{C}$ ; capacity about 5 Ah; intended for use as back up battery for CMOS RAMs

#### Lithium carbon monofluoride, $\text{Li(CF)n}$

Solid cathode; e.m.f. 3 V; universal type for small to medium value currents up to 150 mA; higher current pulses up to 1 A permissible; cannot withstand short-circuits; operating temperature range  $-40^{\circ}\text{C}$  to  $+85^{\circ}\text{C}$ ; capacity up to 5 Ah; intended for use in camera flash equipment, distress-signal transmitters, distress lights, and memory back-up.

#### Lithium copper oxide, $\text{LiCuO}$

Solid cathode; e.m.f. 1.5 V; universal type for load currents up to 1 A; operating temperature range  $-20^{\circ}\text{C}$  to  $+55^{\circ}\text{C}$  (some manufacturers claim up to  $+135^{\circ}\text{C}$ ); capacity up to 20 Ah; intended for use in distress-signal transmitters and equipment operating at high temperatures.

#### Lithium copper oxyphosphate, $\text{LiCu}_2\text{O(PO}_3)_2$

Solid cathode; e.m.f. 2.4 V; derived from  $\text{LiCuO}$  cells; and properties therefore generally similar to those, but temperature range extended to  $-40^{\circ}\text{C}$  to  $+70^{\circ}\text{C}$  (for special appli-

Fig. 3 Sectional view of a lithium carbon monofluoride cell

Fig. 4. Energy density of a number of cells.

Fig. 5. The capacity vs storage period curve shows that lithium batteries even after 10 years storage have more than 90% of their capacity left

Fig. 6 Output voltage vs discharge period curves for various temperatures.

Fig 7a Output voltage vs discharge current curves at various temperatures of a lithium thionyl chloride cell

Fig 7b. Output voltage vs discharge period curves of a lithium thionyl chloride cell.

6

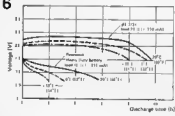

7a

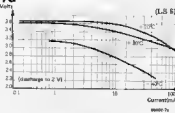

7b

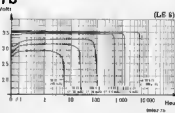

Table 1.

Characteristics of some typical size C (IEC R14) lithium cells compared with conventional alkaline manganese,  $\text{ZnMnO}_2$ , type.

	$\text{ZnMnO}_2$	$\text{LiCuO}$	$\text{LiCu}_2\text{O(PO}_3)_2$	$\text{Li(CF)n}$	$\text{USOCI}_2$
Nominal e.m.f.	1.5 V	1.5 V	2.4 V	3.0 V	3.5 V
Recommended load current	80 mA	40 mA	40 mA	150 mA	ca 100 mA
Maximum constant current	$\geq 1 \text{ A}$	$0.5 \text{ A}^{1)}$	ca $0.3 \text{ A}^{2)}$	$0.3 \text{ A}^{2)}$	$0.5 \text{ A}^{1)}$
Current pulses	$\geq 1 \text{ A}$	$\geq 1 \text{ A}$	$\geq 1 \text{ A}$	$\geq 1 \text{ A}$	$\geq 1 \text{ A}$
Nominal capacity	5.5 Ah	10 Ah	5 Ah	5 Ah	5 Ah
Operating temperature	$20^{\circ}\text{C}$ $+70^{\circ}\text{C}$	$-40^{\circ}\text{C}$ $+60^{\circ}\text{C}$	$0^{\circ}\text{C}$ $+175^{\circ}\text{C}$	$-40^{\circ}\text{C}$ $+80^{\circ}\text{C}$	$-40^{\circ}\text{C}$ $+60^{\circ}\text{C}$
Energy available	8 Wh	15 Wh	12 Wh	15 Wh	18 Wh
Weight	65 g	56 g	55 g	47 g	56 g

<sup>1)</sup> at  $20^{\circ}\text{C}$  for 75% nominal capacity

<sup>2)</sup> at  $150^{\circ}\text{C}$  for 75% nominal capacity.

<sup>3)</sup> Limiting value.

<sup>4)</sup> at  $20^{\circ}\text{C}$  for 50% of nominal capacity



8a

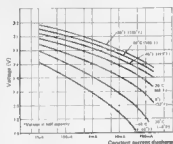

8b

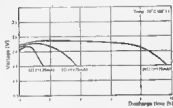

8c

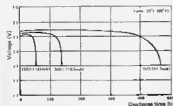

9

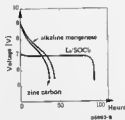

10

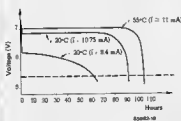

11



Fig. 8. Characteristic curves of a lithium carbon monofluoride cell: (a) output voltage vs constant discharge current; (b) output voltage vs discharge time; (c) output voltage vs discharge time for different loads than in (b).

Fig. 9. Output voltage vs discharge time curves of an alkaline manganese, a carbon zinc and a lithium thionyl chloride 9 V cell. Load 636 ohms, temperature 25 °C.

Fig. 10. Output voltage vs discharge time curves of a 9 V lithium thionyl chloride cell at different operating temperatures.

Fig. 11. Various types of lithium batteries

cations, up to +175 °C); capacity up to 5 Ah.

**Lithium thionyl chloride.  $\text{LiSOCl}_2$**   
Liquid cathode; e.m.f. 3.5 V; universal type for load currents up to 2 A; operating temperature range -40 °C to +75 °C; capacity up to 18 Ah; intended for use in measuring instruments and communications equipment operating under difficult conditions

## Application and use

It appears that not all types of lithium battery are suitable for general use yet. This has not so much to do with the price as with the care that needs to be taken by the user. Although short circuits do not necessarily cause an explosion, account must be taken of the tremendous rise in temperature (to well over 100 °C). Under these conditions, pressure inside the cell will rise, causing the safety valve to open and health damaging gases to escape. Batteries (consisting of more than one cell) are normally protected against short circuits by a fuse or series resistance.

Lithium cells used as back-up for memory ICs should be provided with a protection diode to prevent any tendency to charge and also to avoid large discharge currents. Soldering direct to the battery terminals is not permissible. Many lithium batteries are, however, provided with soldering tags at their terminals, but even these should not be subjected to soldering heat for more than 10 seconds.

The very low rate of self-discharge allows small charge and discharge currents — of the order of a few  $\mu\text{A}$  — so that these batteries may be charged from solar cells.

At the time of writing, it is not known whether these batteries will become

available in higher capacities and for higher load currents.

Many lithium batteries can cope with the momentary short circuit during dip soldering, but normally require hours to recover their e.m.f. If a battery falls into the soldering bath, it may explode: it is, therefore, essential that it is securely fastened to the board or equipment being soldered.

## State of the art

SAFT have produced a replacement for conventional 9-volt PP3 batteries that demonstrates the advantages of lithium batteries in an impressive manner. This new battery consists of two button cells of the  $\text{LiSOCl}_2$  type, and thus provides an e.m.f. of 7 V. Since this voltage remains stable during the operational life, the battery is perfectly suitable as a substitute for a PP3. In contrast to most other lithium batteries, this new type stands up very well to short circuits: its temperature rise during such conditions rises only moderately. From a technical point of view, this battery would have to be recommended for any application requiring a 9-volt source. Unfortunately, at a retail price of well over £10, it is not going to replace too many PP3s just yet.

### Characteristics

Nominal capacity	1.1 Ah
Output voltage	7.0 V
Recommended load current (for 50% of nominal capacity at 20 °C)	50 mA
Weight	30 g
Operating temperature range	-40 °C to +70 °C

### Rechargeable lithium batteries

Although much research has been carried out, a number of patents have

13

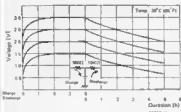

14

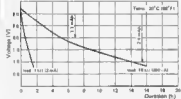

Fig. 12 This is the size of Panasonic's rechargeable lithium carbon battery.

Fig. 13 Charge-discharge curves of Panasonic's rechargeable lithium carbon battery

Fig. 14 Discharge characteristics of Panasonic's rechargeable lithium carbon battery

12



been registered, and several prototypes have been publicized, there is, at present, only one rechargeable lithium battery in production. This is a Panasonic lithium carbon type, first introduced in early 1984. Production models are expected to become available in Europe during 1986. The most important characteristics are shown in the table below and in the accompanying charge and discharge curves. These curves show the truly amazing property of this battery, which enables the output voltage to be freely chosen between 1.5 and 3.0 V dependent upon the charging voltage. As regards the life-span, the makers claim that even after 2000 charge-

discharge cycles the capacity shows no signs of deterioration.

#### Characteristics

Nominal capacity	1 mAh (at 2...3 V)
Nominal voltage	3 V
Recommended load current	1 $\mu$ A to 5 mA
Charging voltage	1.5 to 3.0 V (constant) with current limiting resistance
Life expectancy	At least 2000 charge-discharge cycles
Diameter	10 mm
Thickness	2 mm
Weight	1.9 g





# surface-mount technology



Surface mount technology uses components that are much smaller than conventional ones. These SMDs (surface-mount devices) have no or very short connecting terminals since they are intended to be soldered direct to the copper tracks of a circuit board. It is expected that within five years half of all electronic circuits will use SMDs, while within another five years it will be hard to find current type components.

Most manufacturers engaged in the electronics industry are already firmly committed to surface-mount technology. This has come about not only because of further miniaturization, but also — and perhaps more importantly — because these manufacturers are under pressure to reduce their assembly costs.

## Advantages of SMA (surface-mount assembly)

Currently, the cost of an electronic circuit is determined primarily by the assembly and not by the components. This has come about because component manufacturers have continuously invested heavily in the development of better, smaller, and cheaper components, whereas equipment manufacturers have hardly changed their production methods since PCB assembly was automated. Relatively speaking, therefore, assembly costs have continued to rise, while component costs have become lower. The reduction in the number of layers

of the printed-circuit board, the holes, and the cost of plating, together with the increase of the board density and complexity, is the key factor of surface-mount technology. This in spite of the fact that SMDs are currently still more expensive than conventional components.

SMDs have connecting terminals of 1 mm or less, whereas conventional components require at least 2.5 mm. This means not only a 70 per cent saving on board space (National Semiconductor figure), but also one third of the internal semiconductor leads. These two factors together result in

substantially reduced parasitic parameters, which is of particular importance in high-frequency circuits. Reliability is of prime concern to any engineer. Most component manufacturers have run extensive reliability programmes, which show that the reliability of SMAs is better than that of conventional PCBs.

## Some hidden difficulties

It must be pointed out that there are also unforeseen difficulties with surface-mount assembly, but only in existing system designs. These designs are often poorly partitioned for surface-mount realization, and this is hampering the introduction of surface-mount techniques by original equipment manufacturers (OEMs).

The difficulties originate in the current practice of including a mixture of control and associated higher dissipation interface circuits on PCBs. As these higher power components are not yet available in surface-mount, the designer is left with the choice of either using the unpopular mixed print board with a combination of through-hole and surface-mount devices, or repartitioning the design into surface-mount and through-hole boards. Such repartitioning represents a major design investment, which is difficult to justify for an existing system and, therefore, tends to restrict the use of surface-mount techniques to new systems.

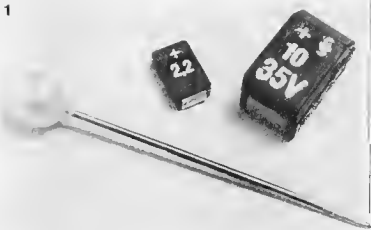

Fig 1 Surface-mount tantalum capacitors from Siemens. Compared with the already small conventional tantalum capacitor, the SMD type is 80 per cent smaller

## Surface-mount devices

The photographs accompanying this article show that SMDs, compared with conventional components, have a rather different appearance: miniature blocks and cylinders, tiny ICs with very short pins, and other unfamiliar exteriors. As far as their interiors are concerned, however, there are no basic differences other than that SMDs are generally of better quality than their conventional counterparts. An important aspect is that SMDs are designed to withstand immersion into molten solder.

Rather than ask which components are already available in surface-mount technology, ask which ones are not yet available, because about eighty per cent of conventional components have a surface-mount counterpart, be they resistors; ceramic, electrolytic, or tantalum capacitors; diodes; transistors; ICs; even inductors and LEDs are already available in surface-mount.

### Passive components

Surface-mount resistors are available in values from 1 ohm to 10 megohms, with tolerances of  $\pm 5\%$ ;  $\pm 10\%$ ; and  $\pm 20\%$ . The construction of such a resistor is shown in Fig. 2a. It consists of a rectangular ceramic carrier onto which a layer of resistive material is deposited that is cut to its exact value by a laser. The whole is glazed for protection.

Ceramic capacitors are available in surface-mount in values from 0.47 pF to 1  $\mu$ F. The value affects the dimensions, of course, and there are, therefore, quite a number of formats. All types have the same working voltage: 50 V (IEC standard). A typical construction is shown in Fig. 2b. Screened electrodes are pressed onto ceramic wafers, after which the wafers are pressed together, protected by foil, and then cut into small blocks. Finally, the two terminations are attached. Electrolytic capacitors — see Fig. 2c — come in values from 0.1  $\mu$ F to 22  $\mu$ F and working voltages from 6.3 V to 63 V. They are constructed from etched aluminium foils, which are separated by paper impregnated with electrolyte. The tubular aluminium case is provided with a polythene sleeve. The bevelled edge identifies the anode (+). These capacitors come in two sizes.

Tantalum capacitors come either as chips or in moulded form; values of the former range from 0.1  $\mu$ F to 100  $\mu$ F, with working voltages of 4 V to 50 V; the latter are available in values from 0.068  $\mu$ F to 100  $\mu$ F, and working voltages of 3 V to 50 V. A typical moulded tantalum capacitor is shown in Fig. 2d. Chip types have body coats of tough epoxy resin.

### Active components

Virtually all current transistors and diodes can be produced in surface-

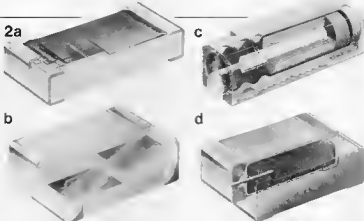

Fig. 2. Construction of respectively a resistor (a); a ceramic capacitor (b); an aluminium electrolytic capacitor (c); a moulded tantalum capacitor (d); all in surface-mount. These components are all designed to withstand a brief immersion into molten solder

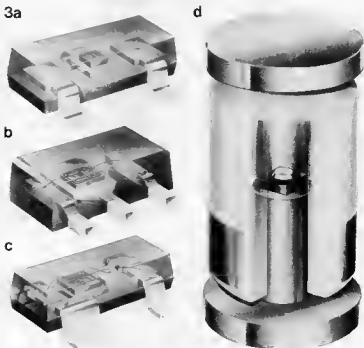

Fig. 3. A number of different case styles of surface-mount semiconductors: SOT-23 (a); SOT-89 (b); SOT-143 (c); and SOD-80 (d).

mount technology without any difficulty: too many to describe in detail. There are general purpose, switching, high-frequency, low-noise, field-effect; and high-voltage transistors. Diodes are available from zener, Schottky, and

switching to variable capacitance types. Various types of case are shown in Fig. 3: (a) SOT-23; (b) SOT-89; (c) SOT-143; and (d) SOD 80.

### Integrated circuits

Many familiar ICs are already available in surface-mount technology: digital as well as analogue; TTL as well as CMOS. Inverters; multivibrators; buffers; decoders; multiplexers; shift registers; voltage comparators and regulators; timers; phase-locked loops; video amplifiers; digital-to-analogue converters; stereo decoders; IF amplifiers; and many more.

As far as cases are concerned, there are two basic styles, the length of which varies with the number of pins. Fig. 4 shows an SMD-IC in a 14-pin



Fig. 4. Already there is ample choice of surface-mount ICs. Shown here is a typical example in a SO-14 package.

SO-14 case.

The quality of SMD ICs is, like that of transistors and diodes, at least as good as that of DIL types, since the same type of crystals are used. The smaller package results in a lower permissible dissipation, however.

Note that Hall-effect SMD ICs are also available.

## Mounting SMDs

For mass production purposes, SMDs are packed in blister tape — see Fig. 5. The tape protects the components and ensures that they are efficiently processed by the automatic mounting equipment. Mounting of SMDs in quantity production is, of course, fully automatic: that was the whole idea behind the new technique. It is beyond the scope of this article to give other than a brief description of this automatic process.

The most commonly encountered process uses droplets of thermal hardening epoxy glue which holds the SMDs temporarily in position. The glue may be applied to the substrate (the circuit board) or to the components. After the glue has been hardened, the components are attached to the board by two stages of wave soldering: one to ensure that all metal surfaces are provided with sufficient solder, and the second to remove any excess of solder. Home constructors, of course, have no access to automatic mounting equipment and wave soldering baths, and they will, therefore, have to mount SMDs with small pincers and a mini soldering iron. None the less, it is advisable to glue the components in place prior to soldering. Glue should be applied with the sharp end of a pin. Soldering should be done very carefully, and the tip temperature should be electronically controlled. A special surface-mounting solder cream is produced by the Indium Corporation of America and is available in the UK from Dage (GB) Limited.

SMDs may also be attached to the board with special conductive epoxy, which is, however, quite expensive. Where this epoxy is used, it should be hardened at 150 °C for not more than 60 minutes. A termination material that will not oxidize, such as gold plating, should preferably be used if the epoxy forms the electrical connection between the component and the board.

## The future

It is clear that surface-mount technology is not a whim that is forgotten tomorrow; it is the assembly technique of the future. It is also still in its infancy, and dynamic development will no doubt continue for some years. At present, the technology is really only suitable for automatic mounting equipment in factories, but, no doubt, equipment for the smaller producer

5



Fig. 5. For mass production, SMDs are delivered in blister tape, i.e. a series of compartments separated by a thin polythene tape. The tape can be fed into automatic mounting equipment. SMDs are, however, also available in different packing

will become available in the foreseeable future. It is to be hoped that in the further development, the one-off producers, the hobbyists, will not be forgotten and then for them, too, there will become available suitable tools for use with SMDs.

Surface-mounting solder cream available from:

Dage (GB) Ltd • Intersem Division  
• Rabans Lane • Aylesbury •  
Bucks HP19 3RG • Telephone (0296) 33200

## Sources.

*Transistors & diodes for surface mounting* (ITT)  
*SMD Technik* (Siemens)  
*Oppervlaktemontage* (Philips)  
*Surface-mount Components* (Sprague)

6

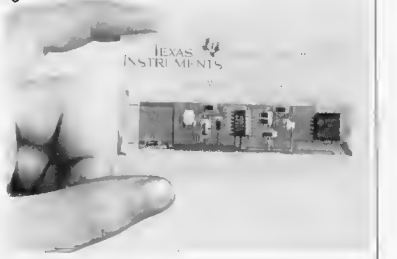

Fig. 6. A surface-mounted board has a different appearance than a conventional PCB. This sample board houses a simple flashing-light circuit.

# year index

# 1985

## audio, video and sound generation

mini-amplifier	8 83
MOSFET power amplifier	8 96
PL 301 loudspeaker	10 26
portable guitar amplifier	2 28
rumble detector	2 39
30 watt $\Rightarrow$ f output stage	2 34
sound-level indicator	8 40
sync separator	8 93
tone burst generator	7 16
video amplifier for B/W television sets	8 98
video buffer/repeater	8 21
video distribution amplifier	8 81
video selector	8 70
audio transfer equalizer	8 49
AXL amplifier	4 23
cleaning video recorders	10 50
discmixer	8 61
electronic dog	8 23
first cuckoo in spring	5 35
heat sink monitor	8 84
hi-fi headphone amplifier	8 78
loudspeaker protection	8 85
melodic sawtooth	8 32
microphone pre-amplifier	3 30
microphone pre-amplifier with mute switch	8 25
7 watt IC audio amplifier	1 53

## computers and microprocessors

8502 tracer	8 85
A/D and D/A conversion	6 16
alphanumeric display	7 52
commodore cassette interface	2 23
computer eye	7 58
current loop for modem	8 71
digitizer	6 36
direct reading digitizer	8 60
electronic pentograph	7 42
EPROM selector	3 46
faultfinding probe $\Rightarrow$ ps	8 47
floppy centring unit	8 82
floppy disc drive	8 67
hexadecimal keyboard	8 88
high resolution colour graphics card (part 1)	10 40
high resolution colour graphics card (part 2)	11 20
high resolution colour graphics card (Part 3)	12 50
on IBM compatible micro	6 34
on IBM compatible micro	7 24
JSR swap	2 38
mains interface	8 75
measuring with the BBC micro	8 44
mouse training with the Junior Computer	8 54
new keyboard for Spectrum	4 38
programmable array logic	6 40
programmable baud rate generator	8 48
programmable keyboard encoder	3 56
programmable rhythm box	3 40
QL RAM extension	8 54
RAM used as EPROM	7 32
RS 232 interface	8 56
RS 232 interface	10 54
serial line driver and receiver	8 21
simple video inverter for the ZX 81	8 51
speech for microcomputers	4 34
sync inverter for QL	8 71
twin keyboard for Apple 11	9 02

two-frequency clock	8 78
universal I/O bus	6 29
X-Y graphic plotter	5 24
shorthand BASIC	1 23

## measuring and test equipment

12 GHz input stage	3 24
19 kHz precision calibrator	4 42
audio sweep generator	12 26
audio tester	3 68
automatic switch off	8 59
crystal tester	8 38
faultfinding probe for Ps	8 47
frequency standard	10 46
GHz prescaler	9 06
hand-held anemometer	11 36
measuring with the BBC micro	8 44
meter amplifier	8 45
metering selector	8 39
microprocessor controlled frequency counter	2 42
noise generator	8 72
opamp tester	8 37
pH meter	4 28
RLC meter	3 50
RTTY calibrator indicator	8 46
simplified word comparator	8 36
the short search	7 50
tone burst generator	7 16
transistor untester	4 48
versatile counter circuit	4 44
microprocessor controlled	
frequency meter (part D)	1 56
simple transistor tester	2 58
sound pressure meter	4 54
L.C.D. thermometer	6 48
luxury transistor tester	11 44
FET millivoltmeter	10 39
multivolt	12 33
Function generator	1 26

## music

blow that synthesizer	9 03
digital oscillators	7 46
fantasia on a MIDI theme	12 34
portable guitar amplifier	2 28
programmable rhythm box	3 40
sound rotator	11 26
swell pedal	8 76
web web box for guitars	8 57
easy music	3 49

## power supplies and batteries

10 A power supply	5 39
12 V NiCd battery charger	8 30
active rectifier without diodes	8 66
battery charging indicator	8 39

# year index

# 1985

battery fitness centre	8 20
DC/DC converter	8 22
direct-voltage doubler	8 82
economical power supply	8 43
heat sink monitor	8 84
lead-acid battery charger	8 73
mains interface	8 75
mains power supply with primary regulation	8 20
mains voltage monitor	8 72
negative supply converter	8 34
power supply sequencing for opamps	8 58
simple zero crossing detector	8 69
variable 3 A power supply	8 84
low voltage stabiliser	2 59
voltage frequency converter	5 38
inverter	12 41

## generators and oscillators

clock oscillators (design ideas)	11 17
digital oscillators	7 46
noise generator	8 72
programmable baud-rate generator	8 72
rectangular pulse generator	8 52
two - frequency oscillator	9 00
the XR 2206 in the function generator	1 20
function generator	1 28
CMOS function generator	2 56

## domestic

automatic sliding door	9 04
burglar deterrent	8 27
CH-boiler control	8 28
flashing light with twilight switch	8 93
four position touch dimmer	8 50
hotel switch	8 50
infra-red light barrier	8 32
infra-red movement detector	7 18
intruder alarm	10 16
LED direction indicator	8 97
mains voltage monitor	8 72
mains wiring locator	8 59
metal-pipe detector	8 28
programmable timer	6 20
set pointer	8 95
siren	8 27
smoke and gas detector	8 75
temperature regulator with zero crossing switch	8 43
temperature sensor	8 29
twin bell-push	8 40
twin dimmer	8 99
water diverter	8 99
water diverter	8 34
time switch	1 32
computer controlled slide feeder	1 42
light dimmer	1 58
long interval timer	5 38
multipurpose time switch	6 52
reading in bed limiter	8 54

## HF

electronic VHF/UHF aerial switch	8 48
light powered radio	5 18
NAVITEX receiver	8 44
RATTY calibration indicator	8 48
RTTY/CW filter	8 38
send-receive ident	8 79
simple field strength indicator	8 88
spot frequency receiver	8 77
VLF converter	8 58
VHF/UHF TV modulator	2 28

## hobby and car

absorption-type metal detector	8 53
automatic car alarm	9 01
bicycle lights and alarm	8 31
digital joystick interface	9 05
garage stop light	9 01
K.I.T scanner	4 20
metal detector	8 35
model aircraft monitor	8 56
model railway monitor panel	8 94
remote model control with a microprocessor	3 32
revolution counter	5 20
service interval timer	7 35
7400 siren	1 58
simple sound effects	11 48

## miscellaneous and design ideas

christmas star	12 15
clock oscillators (design ideas)	11 17
combining digital circuits	8 80
designing a low noise amplifier	8 70
DIY connector	3 39
electronic pentograph	7 42
fast opto-coupler	8 66
fast opto-isolator	8 98
gyroflash	8 88
jumbo displays	8 97
LED direction indicator	8 97
radius	12 58
miniature running lights	8 23
on the air indicator	8 97
overload protection for electric drills	12 40
play ball with Elektrol	12 42
power supply sequencing for opamps	8 58
set pointer	8 95
soler battery	7 55
solid state relay	10 22
stage lighting (part 1)	11 29
stage lighting (part 2)	12 16
stepping motors	5 42
time-lapse unit	8 37
thrifty LED indicator	8 46
time stretcher	8 99
versatile counter circuit	4 44
X-Y graphic plotter	5 24
economical crystal time base	2 59
temperature to voltage converter	6 52

# year index

# 1985

electronic VHF/UHF aerial switch	8 48
light powered radio	5 18
NAVTEX receiver	8 44
RTTY calibration indicator	8 46
send-receive ident	8 79
simple field strength indicator	8 66
spot frequency receiver	8 66
VLF converter	8 58
VHF/UHF TV modulator	2 26

## corrections

1.2 GHz input stage (March 85 p. 3 24)	5 74
anodizing aluminium (Oct. 84 p. 10 46)	2 72
aviary illumination (June 84 p. 6 38)	3 72
daisywheel typewriter printer interface (July 84 p. 7 32)	3 72
digital bandpass filter (Aug./Sept. 84 p. 8 42)	4 70
direct reading digitizer (Aug./Sept. 85)	10 82
elabyrinth (April 84 p. 4 30)	2 72
EPROM copier (June 84 p. 6 48)	3 72
the first cuckoo in spring (May 85 p. 5 35)	6 74
floppy centering unit (Aug./Sept. 85)	10 82
lunny bird (Aug./Sept. 84 p. 8 82)	2 72
a new keyboard for spectrum (April 85 p. 4 38)	7 78
RLC meter (March 85 p. 3 50)	9 38
speech for microcomputer (April 85 p. 4 34)	5 74
Reading in bed limiter (May 85 p. 5 53)	6 74
versatile counter circuit (April 85 p. 4 44)	11 74
VLF converter (Aug./Sept. 85 p. 8 58)	11 74
PL 301 (Oct. 1985)	11 74
Digilex (Oct. 1985)	11 74
musical door bell (Aug./Sept. 84 p. 8 80)	4 70
PARSER (Aug./Sept. 84 p. 8 94)	2 72
capacitance meter (March 84 p. 3 42)	2 72
FM pocket radio (Aug./Sept. 84 p. 8 53)	2 72
veve amplifier (Dec. 84)	2 72
burglar deterrent (Dec. 84)	2 72
ZXB1 cassette pulse cleaner (November 84)	2 72
real time analyser (part 1) (April 84 p. 4 74)	4 74
how to recycle dry batteries (Nov. 84 p. 11 58)	2 72
digital tachometer (Oct. 84 p. 10 35)	2 72
flesh meter (Oct. 84 p. 10 30)	4 70

## informative articles

artificial intelligence	12 22
batteries and the environment	12 39
capacitors and resistors	12 24
clock oscillators	11 17
computers aid survival of rare plants	12 47
computers of the future	2 21
digital graphic equalizer LMC 835	3 60
electric motors, drives, and controls	7 14
electronics and medicine	11 12
gender unification: for and against	4 18
moves towards a cashless society	12 48
output amplifier IC LM 1875	2 62
shining a light on new technology	6 14
stepping motors	5 42

the changing face of communications	5 16
2000 kilowatts under the sea	3 17
newdata in Britain	11 50
voice recognition and speech processing	10 80
wide band amplifier for satellite TV receivers	5 48
give your soldering tip a longer life	1 38
with a pencil point	1 38
toroidal transformers	1 54
electrolytics run dry	2 60
COS/MOS digital ICS	4 49
throwing some light on LEDs	4 50
soldering aluminium	4 37
out put power nomogram	4 37
capacitance coupling	5 50

## selex 1

symbols used in selex articles	5 54
bar code	5 55
dig-course (chapter 1)	5 57
bicycle siren	5 60

## selex - 2

digilex	6 56
dig-course (chapter 2)	6 58
voltage, frequency, current	6 61

## selex - 3

soldering techniques	7 60
dig-course (chapter 3)	7 62
batteries	7 64
transformers	7 65
components	7 67

## selex 4

digcourse (chapter 4)	9 07
radar	9 10
4.5V battery eliminator	8 12
computer tomography	8 14
batteries in series connection	8 17
dry battery charger	8 18
experiments with batteries	9 19
components	9 21
testing batteries with an ammeter	8 22

## selex 5

moving coil meters	10 62
resistors	10 63
current paths	10 83
the ohm's law	10 85
dig course (chapter 5)	10 67

## selex 6

dig course (chapter 6)	11 56
constant current sources	11 58
AC supply	11 61
resistor combination	11 62

## selex 7

dig-course II	12 59
audible continuity tester	12 61
potentiometers	12 63
polarity tester	12 65

# check list for electronic fault finding

## or 'where and how to look for what that doesn't'

### Before soldering in components

- Check that the components agree with the parts list (value and power of resistors, value and voltage rating of capacitors, etc. . . .). If in any doubt, double-check the polarized components (diodes, capacitors, rectifiers, etc. . . .).
- If there is a significant time lapse between last reading an article and building the circuit, take the trouble to re-read the article; the information is often given in very condensed form. Try to get the most important points out of the description of the operation of the circuit, even if you do not understand exactly what is supposed to happen.
- If there is any doubt that some components may not be exact equivalents, check that they are compatible.
- Only use good quality IC sockets.
- Check the continuity of the tracks on the printed circuit board (and through-plated holes with double-sided boards) with a resistance meter or continuity tester.
- Make sure that all drilling, filing and other 'heavy' work is done before mounting any components.
- If possible keep any heat sinks well isolated from other components.
- Make a wiring diagram if the layout involves lots of wires spread out in all directions.
- Check that the connectors used are compatible and that they are mounted the right way round.
- Do not reuse wire unless it is of good quality. Cut off the ends and strip it anew.

### After mounting the components

- Inspect all solder joints by eye or using a magnifying glass and check them with a continuity tester. Make sure there are no dry joints and no tracks short circuited by poor soldering.
- Ensure that the positions of all the components agree with the mounting diagram.
- Check that any links needed are present and that they are in the right position to give the desired configuration.
- Check all ICs in their sockets (see that there are no pins bent under any ICs, no neighbouring ICs are interchanged, etc. . . .).

- Check that all polarized components (diodes, capacitors, etc. . . .) are fitted correctly.
- Check the wiring (watch for off-outs of component leads); at the same time ensure that there are no short circuits between potentiometers, switches, etc. . . ., and their immediate surroundings (other components or the case). Do the same with mounting hardware such as spacers, nuts and bolts, etc. . . .
- Ensure that the supply transformer is located as closely as possible to the circuits (this could have a significant influence in the case of critical signal levels).
- Check that the connections to earth are there and that they are of good quality.
- Check that any pins, plugs or other connectors used are making good contact.
- Make sure the circuit is working correctly before spending any time putting it into a case.

### And if it breaks down . . .

- Recheck everything suggested so far.
- Reread the article carefully and clarify anything about which you are doubtful.
- Check the supply voltage or voltages carefully and make sure that they reach the appropriate components especially the pins of the ICs (test at the pins of ICs and not the soldered joints!).
- Check the currents (generally they are stated on the circuit diagram or in the text). Don't be too quick to suspect the ICs of overheating.
- If possible check the operation of the circuit in separate stages. As a general rule, follow the course of the signal.
- Check the contents of any PROMs or EPROMs fitted.
- While checking voltages, currents, frequencies or testing the circuit with an oscilloscope, work systematically and take notes.
- It is always a good idea to do any fault finding as a combined operation with a friend, two heads are better . . .
- Be wary of 'red herrings' when fault tracing. Do the simple checks first.
- Finally, remember our constant companion Murphy is looking over your shoulder. If that part of the circuit cannot possibly be wrong and you haven't checked it - that's where to start looking.
- . . . And don't forget to switch the power on and check the fuses!

# Channel multiplier for flat TV panel

Scientists of the Philips Research Laboratories in Redhill, Surrey, have achieved a flat cathode-ray tube with a picture diagonal of 12 inches and normal TV resolution. The depth of this tube is less than 3 inches. The first flat, sealed-off monochrome tubes have been made. The problems of gain stability have been overcome and an acceptable operating life can now be obtained. The feasibility of achieving full colour has been demonstrated. For the near future applications are expected to be in professional use only.

## System

The flat cathode-ray tube (see Fig.1) consists of an electron gun, deflection plates, an electron multiplier array, a phosphor screen, and a faceplate that is vacuum sealed in a metal can. Because of the electron multiplier, the electron beam can be of both low current (less than  $1 \mu\text{A}$ ) and low energy (400 eV). The electron beam travels down the back of the tube to a reversing lens where it is turned through  $180^\circ$  into the front section. A central partition carries a series of frame deflection plates which create a field to turn the beam forward on to the multiplier. The current from the gun is amplified several hundred times by the multiplier before the beam is accelerated to the screen. Because of the low primary beam energy and current, the scanning system can be unorthodox. Vertical scan is achieved by progressively ramping the potentials on the frame plates. Electrostatic deflectors near the gun provide the line scan.

## State of the art

Much progress has been made concerning the picture area and resolution. The spacing between the multiplier channel centres has been reduced to 0.55 mm, providing approx. 170 000 channels in the 305 mm diagonal display. The resolution of the screen image and the grey scale capability is appropriate for TV applications. The spot size is limited by the resolution of the tube is limited by the pitch of the channels in the electron multiplier. The main factor which determines the life of the flat display tube is deterioration of multiplier gain. Multiplier tests show that after 7500 hours of continuous operating the gain

falls to 63% of its original value.

Colour is important for many professional applications and several methods have been studied. The presence of the electron multiplier poses problems which are very different from those of a shadowmask tube. Colour selection can be carried out either before or after the multiplier. If the selection process takes place before the multiplier then one channel must be dedicated to each primary of a colour triad. This limits the maximum colour-display resolution to one third of its monochrome resolution. The Philips Research Laboratories are studying methods in which a system of electrodes on the output of the multiplier directs the emerging electrons onto phosphor of the desired colour. The ultimate tube design has one gun, and sequential colour selection is therefore needed. The low deflection voltages and the high picture brightness make the tube particularly suitable for this mode of operation. Two methods are being studied, the dots and rings method and the deflection method.

## Dots-and-rings method

The electron source inside each multiplier channel is a ring which is imaged on to the screen. A system of dynode-like electrodes at the multiplier output can be made to act as a lens of variable focal length, enabling the size of the image to be altered. The

phosphor triads on the screen consist of concentric patterns in the three primary colours, which are aligned with the multiplier channels. The emergent electrons from each channel can be focused into a spot exciting the red phosphor, a ring exciting blue, or a larger ring exciting green.

## Deflection method

With the deflection method, the screen consists of a pattern of phosphor strips in the three colours. A positive voltage applied to a dynode-like extractor electrode is used to draw the electrons from the final multiplier stage. They are then deflected on to the desired colour by pairs of strip electrodes located between adjacent rows of channels. The strip electrodes and the extractor electrode form an asymmetric lens which causes the electrons to be focused on the screen as an elongated spot.

The results of both methods obtained so far are close to the requirements for various professional applications (such as data display) where flat screens are important; the possibilities for domestic applications are being studied. The practical work is carried out in demountable vacuum systems with small-area multipliers (2 by 2 inches). They now need to be developed into a large-area technology.

The results described here refer purely to laboratory research; they in no way imply the manufacturing or marketing of new products.

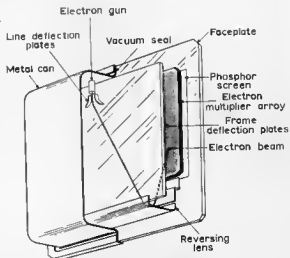



# Microprocessor navigation

by Kevin Desmond

The miniaturization and computerization of electronic navigational aids can only benefit today's motor yachtsman as he voyages through increasingly crowded waters and marinas.

His means of knowing his speed, direction, and the depth have been made simpler, largely thanks to the sophistication of microprocessor controlled alphanumeric displays, which are easy to recall and read and are small enough to fit into a handbag.

Take, for example, the Triton F.15 as developed by Baron Instruments<sup>(1)</sup>. Here is a 15 function yacht instrumentation system, fitted into a console measuring a mere 234x171x50 mm. It is designed with the express purpose of easing the congestion of a whole array of instruments.

The functions are boat speed; velocity made good; total log; resettable log; depth in feet; depth in metres; depth in fathoms; true wind speed; apparent wind speed; true wind angle; apparent wind angle; elapsed time; countdown timer (10 min); real time in hours, minutes and seconds; date (day/month).

## Digital display

These functions may be recalled on a large digital display which makes use of a six digit, 25 mm, liquid crystal system. This is backlit for night illumination and also fitted with an anti-glare window. Another 14 light emitting diode indicators in traffic light red are positioned immediately beneath the display to denote the particular function selected. Below that again are the function switches themselves, placed over touch sensitive membrane devices.

Using the latest generation 8031 microprocessor, Triton F.15 works off a 12 or

24 V supply, consuming only 300 mA at 12 V. When the power is turned off, the clock calibration and alarm settings are retained by an internal nickel cadmium battery, rechargeable off the ship's supply to give up to six months' back-up.

Existing Baron water speed and depth transducers can be used with the Triton F.15 system.

As with the voice advice system used on the Austin Maestro and other cars, so has Seafarer<sup>(2)</sup> made it possible for the yachtsman to be "told" his depth, enabling him to focus his eyes on other tasks in hand. The Echovox talking repeat meter can be used in conjunction with the 110 m Seafarer 5 and the 183 m Seafarer 700 echo sounders.

## Clear voice

Metric and imperial versions are available, offering presentation of soundings both through a numerical digital display and a variable volume, synthesized, clear English voice. Soundings are given in units and decimal parts of a unit in depths of less than 10 m. The voice repetition rate increases in shallowing water and a shallow water alarm signal can be preset to any depth up to 10 m.

Echovox operates from a ship's supply of 12 V dc and measures a mere 158x168x75 mm.

If you do not like voice synthesis, there is the Navsounder, as developed by Stowe Marine Equipment<sup>(3)</sup>. This is a microprocessor controlled digital depth sounder, with alarm settings that can be selected individually at either station — so that the yachtsman does not venture into water that is too deep or risk running aground.

The liquid crystal display gives a digital presentation to a range of 100 m. In this particular unit, the eight-bit microprocessor, with 2 K of fixed random access memory, gives special capacity to selectively process and interpret acoustic signals. Secondary acoustic signals caused by turbulence, debris and fish are rejected and do not appear on the display.

Deep and shallow alarms can be set to the nearest foot, fathom or metre, and allow for keel offset. Audible deep and shallow alarms are distinguished from each other by tone, with dashes for deep, and dots for shallow. When selected, the "anchor watch" function continually monitors depth and warns of abnormal changes.

## Universal sensor

Navsounder operates from a ship's supply of 10 to 12 V and 80 mA, with 60 mA lighting when required. It measures 110x110 mm.

Moving from depth to direction, development of the age old compass has certainly not stood still. This is evident in the Meteor Digitrac electronic compass system produced by Marinex<sup>(4)</sup>.

The detection of the earth's magnetic field with a solid state, electronically damped universal sensor, enables up to five remote compass displays, both analog and digital, to be actuated without any extra circuitry.

Among these displays are an analogue pointer display; an analogue head-up display unit with rotating card or grip pointer options; a digital display unit, and a microprocessor controlled tape repeater with liquid crystal display. The Meteor system can also be used for satellite navigation, automatic direction finding, and autopilot interface.

The all-important universal sensor unit offers automatic compensation for changes in the horizontal field strength, and maintains absolute voltage control outputs. It is also constant over angles of dip of up to 80 degrees. This aids helmsmen of both power and sail boats to maintain an accurate course, even in very rough conditions. By allowing analogue and digital displays to be inter-wired, both helmsman and navigator can see what is happening, on different types of compass.

## Ship to shore

Apart from human-controlled direction, there is automatic control. With the Wheelipilot 4000, developed by Navico<sup>(5)</sup>, the functions of rudder ratio, sea state, and trim are entered via keyboard control. Each and every command is confirmed on the liquid crystal display and by a beep.

There is also an off-course alarm, a port and starboard dodge facility, and a highly efficient gearbox. During the design stage, Navico researchers paid a great deal of attention to waterproofing, so that special seals and double gaskets were incorporated to function even in the wettest and roughest of sea conditions.

Last but not least, the ability to communicate ship to ship and ship to shore must be regarded as a vital aid to navi-



The Triton F.15 is a 15 function yacht instrumentation system.

gation. Navico has also come up with the first totally British designed and built microcomputer controlled VHF radio telephone for yachtsmen.

With its black casing 190 mm wide by 89 mm high, the Navico RT 6100 is also of handbag size. There is a scan of up to ten channels, each easily programmed via a large keypad, with entry confirmed by both an alphanumeric liquid crystal display and a bleep. There are also six private channels, a fist microphone or telephone handset option, and a selective calling system option.

These and other electronic navigational aids under development by

small and enterprising British companies inevitably lead one to either dream of, or dread, the time, in the not too distant future, when computerized, voice synthesis, navigator robots will do all the work, leaving the motor yachtsman the uncluttered leisure of such pastimes as fishing, photography, and even sunbathing. (LPS)

1. Baron Instruments Ltd,  
6 West Wycombe Road, High  
Wycombe, Buckinghamshire,  
England, HP11 2LG.

2. Seafarer Navigational International  
Ltd, Fleets Lane, Poole, Dorset,  
England, BH1 5BW.

3. Stowe Marine Equipment Ltd,  
1 Bowes Hill, Rowlands Castle,  
Hampshire, England, PO9 6BP.

4. Marinex, 11 Balena Close,  
Creekmoor, Poole, Dorset,  
England, BH17 7DB.

5. Navico, 49 Harbour Parade,  
Ramsgate, Kent, England, CT11 8LJ.

## Protecting computers from fraud

by Cheryl F Williams

In the enthusiastic rush to gain the full benefits of computers, few companies seemed to have thought of the disadvantages and, in particular, the problems of computer security.

Computer crime is a new growth industry of the 1980s, with rich pickings being available. Many frauds are never made public and the increasing use of computers in routine commercial work offers increased scope for this type of crime. Even the most sophisticated computer lacks the human attribute of commonsense and so any transaction that conforms to the computer's rules will be processed.

Computer frauds require a knowledge of the system's characteristics and could involve tampering with data, programs or software. The perpetrators vary widely from trainees to senior management, and the sums involved range from tens to millions of pounds.

### Heavy losses

A study of computer crime by an American Bar Association committee says that organizations often did not know who had committed a crime; many did not know when a computer crime had taken place and could not monitor their systems to detect it. In a survey of 283 large corporations and government agencies about 48% reported some form of computer crime in the last year with losses conservatively estimated at between \$145 million and \$730 million.

A recent "Washington Post" series on computer crime suggested that annual losses may be between \$100 million and \$300 million. No one knows with any certainty how many millions are

going missing, and the problem is snowballing.

Open Computer Security<sup>1)</sup> comments: "For every one computer crime that is reported it is estimated that probably a further 20 go completely undiscovered. Such frightening figures indicate two things.

### Coded messages

"First, without the proper safeguards almost every computer is prone to this type of attack and, second, there are more individuals than you would imagine who have the required degree of technical knowledge to carry out armchair robberies. Indeed, computer crime has become so rife and so lucrative that the head of the Scotland Yard specialist section in London recently predicted that, by the end of the decade, all cases of fraud would involve a computer."

Open Computer Security goes to great lengths to ensure that its systems are secure. It says: "Dua to the extremely high levels of encryption and verification which are built into our systems, not even we are able to overcome the security procedures inherent to our finished and installed product. Apart from putting a message into coded form there are special authentication codes built into our security units.

"This means that the host computer will accept instructions only from another computer that has previously been given clearance. Also, if the tamper-proof box is opened the memory is instantly wiped clear and the system goes into alarm. Every message that goes through the system automatically has an authentication

code attached in it which tallies with the contents of the message.

"This means that an instruction to transfer \$1000 cannot be changed to \$1000 000 — either by operator intervention or a fault on the line — without the change being highlighted."

### Automated security

Open Computer Security has designed and manufactured the authentication equipment for CHAPS, the Clearing Houses Automated Payment Scheme in London. CHAPS will replace the physical carrying of large cheques about the City of London by messengers. Approximately \$37 000 million a day is handled between different clearing banks, the clearers and the Bank of England.

CHAPS uses the data encryption standard (DES) as its basic scrambling device and the session key, which is changed daily, is held in a tamper-resistant module designed by Open Computer. The module fits into the authentication unit attached to the tandem gateways in each of the clearing banks.

The key itself is a series of random numbers produced by electronic noise and no one, neither the users nor Open Computer staff need know what it is. CHAPS has a way of identifying each bank's module to prevent substitution. The authentication unit is designed to detect and reject any message that has been interfered with.

Many specialists believe that it is one of the most secure systems in the world and it is becoming a model for other financial institutions. One expert has commented: "CHAPS is more

secure than an armoured car — you are not going to get in there".

## Award winner

Open Computer Security has won the British Computer Society/Computing Applications Award for its Padlock system which was designed to prevent software piracy. Padline 7, a more recent development, is operative at all seven levels of communication as defined by the International Standards Organisation in its OSI model. This allows the unit to be used in virtually all computer networks whether public — such as X25 — or private — such as SNA.

From the most basic physical layer — level 1 — Padline will perform through X25 layers right up to level 7. Here, encryption takes place under the control of the user's actual applications software making this, the manufacturer believes, the most secure method yet devised. This "end to end" level gives total network transparency under all communications protocols. Data encryption is via the accepted DES algorithm.

Special circuitry in Padline allows the generation of truly random keys whilst the RSA public key provides a secure method of transporting the keys over non-secure networks, so that the user can confidently design a complete key management system. The codes used in Padline 7 are housed within one of the machine's microprocessors.

To prevent the possibility of these codes being misused, the entire cabinet is designed as a totally sealed unit. Padline is without vulnerable air vents and, if it is tampered with, the memory is instantly wiped clear and alarms are triggered. Data can be loaded into the unit via its cassette input socket so the user can upgrade Padline on site — perhaps to operate on a different communications level — from a supplied tape.

## Double locked

For security reasons, field upgrades can only be carried out in the presence of both keyholders. Additionally, the tape (which is prepared to order) is programmed to match only the particular Padline for which it was intended.

Racal-Milgo<sup>(2)</sup> has designed the Datacryptor II which operates by rearranging the digital bit pattern of information into an indecipherable stream. This is achieved with the DES algorithm. By using this in a single bit cipher text feedback mode, Datacryptor II achieves a high degree of security with true protocol independency. Both asynchronous and synchronous protocols can be managed by Datacryptor II operating in full or half duplex modes over point-to-point and multidrop networks. The unit will also operate over leased line or dial-up circuits. A point-to-point link merely

involves two Datacryptor II units — one at both central and remote sites. Each unit has a small, hand held, removable memory device known as a key transport module (KTM).

The KTMs are normally double locked inside the Datacryptor II units and without them the system will not operate.

## Master key

The Datacryptor II has randomly generated 64 bit keys. The user does not see these keys or have any influence over their generation. The initial or master key is generated at the central site Datacryptor and is loaded into two KTMs. One KTM is then transported and loaded into the remote site Datacryptor and the other is left at the central site unit.

The central Datacryptor then generates a working key which is down-line loaded to the remote site. This operation is quickly and simply carried out at the central site Datacryptor II front panel. Working keys may then be changed as often as required — at both ends of the link — simply by pushing a button at the central site. The master key is also easily and quickly changed simply by generating a new key for loading into central and remote sites.

Down-line key loading provides an additional degree of security against the persistent line monitor attempting to determine the working key. This dual level of keys therefore ensures a higher level of security for sensitive data networks and avoids costly and time consuming procedures of constant transportation of keys.

All key management and control functions are performed at the central site Datacryptor where key generation and down-line loading are also carried out.

All controls and the KTM are double locked behind a front panel which can only be accessed by the operation of two security key locks.

## Information rejected

Once accessed, the controls consist of three pushbuttons, one to initiate the master key, one to copy this information into the second KTM, and one to generate down-line loaded working keys. The front panel LED indicators display transmission and security status.

Test indicators allow checking of keys and the data link. Datacryptor II is housed in a robust and secure package. Should any unauthorized access to the unit be attempted, the anti-tamper switches will automatically erase the keys, disabling the system, and maintaining the integrity of the data network.

In the event of a power failure, the working key and module security code are protected by a nickel-cadmium battery for a minimum of 1000 hours. As a standard feature, Datacryptor can be securely mounted on a desk top or in a rack. Removal requires the use of two keys. Datacryptor can be enhanced by the expansion module option which provides a module security code. This allows the user to provide each remote site with an individual address so that, unless the correct KTM is received, the key information is rejected.

1. Open Computer Security Ltd, 31-32 High Street, Dorset Place, Brighton, East Sussex, England, BN2 1RP.
2. Racal-Milgo Ltd, Richmond Court, 309 Fleet Road, Fleet, Hampshire, England, GU13 8BU.



The Racal-Milgo Datacryptor II.

After the preliminary and theoretical considerations of the past three months, this fourth article in the series deals with the construction of the main printed-circuit board. The board is Euroformat (100 x 160 mm), double-plated, and has through-plated holes: clearly not a card for home production.

It is not absolutely necessary to have read through the three previous articles, but it does help. It should be noted, however, that the circuit diagram was published in Part 3

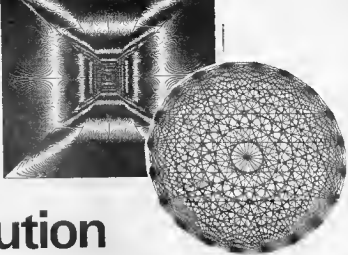

# high-resolution colour graphics card - 4

(December issue), and this, of course, is essential knowledge. The construction of the card is not all that difficult, particularly since there are no adjustments or calibration. None the less, a beginner in this type of work will almost certainly experience difficulties if it comes to fault-finding. A really good soldering iron is required, preferably with a temperature-controlled tip, which should not be heavier than indicated in the photograph. Because of the thinness of some of the tracks, the card may easily be damaged beyond repair if too much heat is applied to it.

The ICs may be mounted in good-quality sockets, but, at least as far as the dynamic RAMs are concerned, it is better not to. If any faults manifest themselves, do not immediately suspect the ICs: experience shows that in the initial stages most faults are not caused by faulty components, but rather by suspect workmanship. If, in spite of all this, it is found that an IC is at fault, just cut off the pins, remove the body, and then unsolder the pins from the holes in the board. If you have a desoldering device available, so much the better.

Although the board is a very reliable component, it often pays to inspect it carefully (and possibly with a magnifying glass) for hairline breaks in the tracks. This can save a lot of tedious work later.

## Fitting the components

First, fit the five wire links. Since these carry a reasonable current, they should be made of relatively heavy insulated copper wire. The GDP (graphics display processor) is best fitted in a really first-class socket. DIL switches  $S_1 \dots S_5$  are soldered direct to the board.

Make sure that the quartz crystal used is housed in a HC18U or HC25U case, and that its frequency is suitable for the GDP used (14 MHz for the 9365 or 9366, and 12 MHz for the 9367). Where available,  $R_1 \dots R_8$ ,  $R_9 \dots R_{15}$ , and  $R_{27} \dots R_{34}$  should be bought

as ready-made networks, which are easier to handle. Capacitors  $C_{10} \dots C_{13}$  are not yet fitted: more about this later. Connector  $K_1$  may also be omitted for the moment, as it is not required until the colour extension is added. Movable wire links A, B, C, D, and I-J are best made with PCB pins and 2.54 mm matrix shorting sockets. Links K, G, K, H, E and F, on the other hand, consist of stout wire or of normal soldering pins — see also Table 2.

Once this done, a first test should be made to verify that the supply voltage is present at the IC sockets or relevant soldering terminal on the board. Note that in the case of  $IC_{17} \dots IC_{24}$  the +5 V line is connected to pin 8, and the return (earth) line to pins 1 and 16.

Next, oscillator  $IC_{25}$  and the address decoding ICs ( $IC_1 \dots IC_3$ ) should be fitted. When the supply is connected, pin 8 of  $IC_{25}$  should produce a clock signal of 12 MHz or 14 MHz, depending on the crystal.

When the decoding address for the graphics card is known, write to it the highest-value byte with the aid of  $S_1 \dots S_5$ . In case of address range E1XX<sub>hex</sub>, the situation shown in Fig. 19 then pertains.

As soon as an address from this range appears on the address bus, output P=Q (pin 19) of  $IC_1$  goes low. Pin 9 of  $IC_2$  must be low at address XX50, while pin 10 should be active at address XX60. As these addresses are present on the bus of the microprocessor for very short times only, it is impossible to detect them with an oscilloscope. It is, therefore, better to construct a small instruction loop to produce the wanted addresses cyclically.

When the address decoding has been tested in this way, buffer  $IC_4$  and registers  $IC_6$ ,  $IC_{11}$ ,  $IC_{12}$ , and  $IC_{13}$  can be fitted. It is, of course, not permissible that these ICs affect the computer that controls the graphics card. Next,  $IC_{29}$ ,  $IC_{30}$  (programmed PROM), and  $IC_{15}$  should be fitted. After this it should be verified whether signals STR, RAS, CAS, CK, LD, and ATX are present at

by P Lavigne & D Meyer



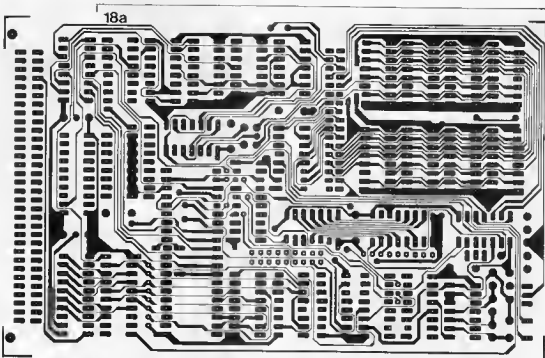

Fig. 18. The double-plated printed circuit board also has through plated holes.

Fig. 22. Wiring diagram for socket K1, which is required for the colour extension card

Table 7 Order of actions and construction check list.

Table 8. Optional wire links.

Table 9 Memory ICs.

Table 9

## YES

2164 15 INTEL  
I2164-20

MSM3664 12 OKI  
MSM3664-15  
IMS3664 201  
MK4364-15 MOSTEK  
IM94564 201

$\mu$ PD4164 3 NEC  
 $\mu$ PD4164 21  
 $\mu$ PD4164 11

HM4864-2 HITACHI  
(HM4864 3)

TMM4164P-2 TOSHIBA  
TMM4164P 3  
(TMM4164P 4)

TMM4164AP-12 TOSHIBA  
TMM4164AP 15  
(TMM4164AP 20)

MB8264-15 FUJITSU  
IMB8264-20

MSK4164ANP-15 MITSUBISHI

## NO

MCM8664 MOTOROLA  
HYB4164 SIEMENS

EP8665 THOMSON  
F4164 FAIRCHILD  
TMS4164 Texas Instruments  
IMS2600 INMDS

Table 7

tick	ICs	actions
	none	carefully check the board optically and electrically
	none	fit permanent wire links, 64 way plug, and IC sockets
	none	fit optional wire links (see Table 8), DIL switches
	none	test the supply voltages
	none	fit all resistors and capacitors, except C <sub>10</sub> - C <sub>18</sub>
	IC <sub>28</sub>	fit crystal X <sub>1</sub> , check operation of clock oscillator
	IC <sub>1</sub> ... IC <sub>3</sub>	address decoding XX50...XX5F and XX64 XX67
	IC <sub>11</sub> ... IC <sub>13</sub>	check signals STR; RAS, CAS; CK, LD; and A7X
	IC <sub>16</sub> , IC <sub>25</sub> , IC <sub>30</sub>	check signals STR; RAS, CAS; CK, LD; and A7X
	IC <sub>4</sub> ... IC <sub>10</sub> , IC <sub>25</sub> , IC <sub>28</sub>	write 00...03, in that order, to address XX66 (IC <sub>11</sub> ) and verify that the signal at A7X changes in accordance with Fig 20
	IC <sub>14</sub> , IC <sub>15</sub>	check signals ALL, BLK; ALLX; BLKX, DAD0 DAD6, SYNC
	IC <sub>17</sub> - IC <sub>24</sub>	fit capacitors C <sub>10</sub> - C <sub>17</sub>
		check signals MIX, SH//; RAS0 RAS7; I
		check the supply voltages and currents
		read XX50, 07, 05, or 00
		XX51 00
		XX53; 03
		write XX64 00
		XX66, 00 01, 02, or 03 for turning the page)
		XX51-01
		XX53 03
		XX50 0C (screen becomes white)
		XX64 01
		XX50 0C (screen goes black)

Table 8

A positive sync pulse (HS + VS - CSYNC)  
B negative sync pulse (HS + VS - CSYNC)  
C 4 pages; 256 lines; sequential scanning  
D: 2 pages; 512 lines; interlaced scanning  
E 512 x 256 (EP9365); 512 x 512 (EP9365, EP9367)  
F 512 x 256 (EP9367)

	EP9365, EP9366	EP9367
G:	yes	no
H:	no	yes
I:	no	yes
J:	yes	no

22 K1

LINE	10	O2	VIDI
EXT	30	O4	REFR
MMVS	50	O8	DIRX
CSYNC	70	O8	LD
QND	80	O10	QND
QND	110	O12	QND
WRX	130	O14	QND
RAS0	150	O16	RAS0
RAS1	170	O18	RAS1
RAS2	190	O20	RAS2
RAS3	210	O22	RAS3
A3	230	O24	A7
A8	250	O26	A4
A2	270	O28	A8
A1	290	O30	A5
CA3	310	O32	BLKX
HCK	330	O34	WR

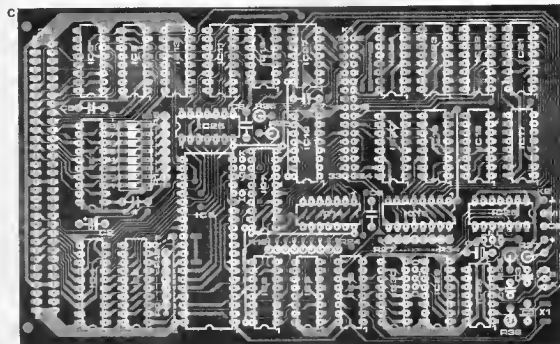
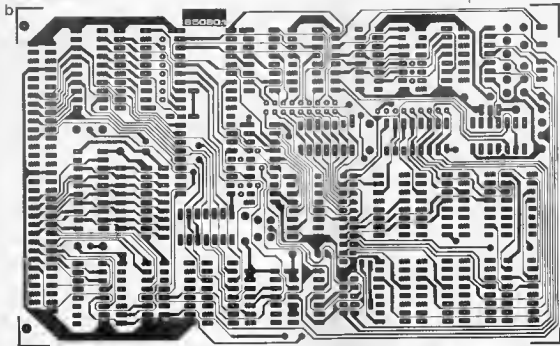

**Parts list**

**Resistors:**

R<sub>1</sub>, R<sub>16</sub>, R<sub>27</sub>, R<sub>37</sub> = 1 k\*  
R<sub>18</sub>, R<sub>26</sub> = 22 Ω

**Capacitors**

C<sub>1</sub> = 33 p  
C<sub>2</sub>, C<sub>18</sub>\* = 10 μ, 16 V tantalum  
C<sub>3</sub> = 10 p  
C<sub>4</sub>, C<sub>8</sub> = 100 n  
C<sub>5</sub> = 1 μ, 16 V tantalum  
C<sub>10</sub>, C<sub>17</sub> = 100 n\*

**Semiconductors**

IC<sub>1</sub> = 74LS688  
IC<sub>2</sub>, IC<sub>3</sub> = 74LS138  
IC<sub>4</sub> = 74LS245  
IC<sub>5</sub> = EF9365, EF9366, EF9367\*  
IC<sub>6</sub>, IC<sub>7</sub> = 74LS374  
IC<sub>8</sub>, IC<sub>9</sub> = 74LS283  
IC<sub>10</sub>, IC<sub>30</sub> = 82S123  
IC<sub>11</sub>, IC<sub>16</sub> = 74LS174  
IC<sub>12</sub> = 74LS74  
IC<sub>13</sub> = 74LS173  
IC<sub>14</sub> = 74LS30  
IC<sub>15</sub> = 74LS166

IC<sub>17</sub>, IC<sub>24</sub> = 4164  
164 K × 1 bit\*  
IC<sub>25</sub>, IC<sub>26</sub> = 74LS32  
IC<sub>27</sub> = 74LS08  
IC<sub>28</sub> = 74LS04  
IC<sub>29</sub> = 74LS191

**Miscellaneous**

X<sub>1</sub> = crystal 14 MHz  
1EF9365, EF9366) or 12 MHz  
(FF9367) in HC18U or HC25U case  
K<sub>1</sub> = test socket; double row, 17 way, matrix

2.54 mm for mating with flat ribbon plug  
K<sub>2</sub> = 4 small soldering pins  
S<sub>1</sub> = 8 - octal DIL switch in 16-way case  
6 standard soldering pins  
three 3-pin test plugs with suitable short-circuit sockets  
PCB 85080 1

\* see text

Fig. 19 Example of setting of DIL switches S<sub>1</sub>...S<sub>8</sub> here set for address decoding at 4E1XX.

19

A15	A14	A13	A12	A11	A10	A9	A8
S1	S2	S3	S4	S5	S6	S7	S8
OFF	OFF	OFF	ON	ON	ON	ON	OFF
1	1	1	0	0	0	0	1
E							1

Fig. 20. Timing diagram of a number of the more important signals. The chronological order of these is also important. Note that the four signals A<sub>7</sub> do not appear simultaneously, since each belongs to a different page. These signals are produced by writing data 0, 1, 2, or 3 to XX66<sub>hex</sub> in register IC<sub>17</sub>.

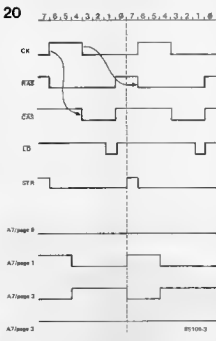

the output of IC<sub>16</sub> and the inputs of the relevant ICs — particularly pin 1 of IC<sub>5</sub> (which has not yet been fitted). The timing diagram of these signals is given in Fig 20 (see also Fig. 16 in the November issue).

The card is now in such a stage that the most important components can be fitted: graphics display processor IC<sub>5</sub> and memories IC<sub>17</sub>...IC<sub>20</sub>, as well as all the other ICs, such as FROM IC<sub>10</sub>.

Before any further progress can be made, a monitor is needed. If this has a separate SYNC (link A) or SYNC (link B) input, carry on. If, however, it needs a composite video signal, it is necessary to first build the mixer stage of Fig. 21.

When the supply is switched on (power-on reset), nothing will initially be visible on the screen, because the image depends, among others, on the decoupling capacitors on the power lines to the dynamic RAMs. These capacitors, C<sub>10</sub>...C<sub>17</sub> are not fitted on the component side of the board, but direct at the supply connections (pins 8 and 16) of the ICs as shown in Photograph 1. It is very important that the leads of these capacitors are properly insulated. Without these capacitors, the +5V line would be badly affected by the current pulses which are so typically produced by the RAMs. There are, therefore, sound reasons for fit-

ting the capacitors at the track side of the board.

When, after the capacitors have been soldered in place, no image at all appears on the screen, this is normal. It may also be that there are some vertical lines visible. All that is not so important; what is, however, is that the screen image **does not change** after the power has been switched on. It is also advisable to check the supply to the control computer before and after the graphics card has been switched on. The current should be of the order of 450 mA, but may vary widely from this figure, depending on the screen image. The only IC that may get slightly warm is the GDP: all the others should stay fairly cool.

When power is switched on, the registers of the GDP may be read; they should show:

XX50: 07, 05, or 0D

XX51: 00

XX53: 03

in hexadecimal, of course.

It is now possible to carry out a simple test:

- enable the write mode of the screen memory by writing 00 to addresses XX66 and XX64.
- Next, write 0C to XX50 in the command register of the GDP.
- If the contents of that register is 03 at XX53, the screen will go white.

The screen is cleared by writing 01 to XX64 and giving the GDP the command 0C at XX50. If everything is in order, the screen should now turn black. Note that the command 0C at XX50 cannot be read, since at this address of the graphics processor writing accesses the command register; and reading, the status register.

If nothing happens on the screen, either the graphics processor has not received any instructions, or the logic levels on the WRIS and DIS lines were not correct for a write operation. In either case, the WRIS line must be logic 0 to enable the memories to be accessed, while DIS must be logic low to light the pixels, and logic 1 to quench them. It may be that the output-register has not received signals HCK and SH/I required for its proper operation. It is also necessary to verify signal STR at IC<sub>1</sub>, signal RAS for collective accessing at pin 14 of IC<sub>10</sub>, and signals RAS for individual accessing at pins 1...7 and 9 of IC<sub>10</sub>. The slightest short-circuit or bad contact at one of the signal lines can disrupt or even disable the whole system.

If something has gone wrong, a systematic search and verification of the various signals will soon show where the fault lies. For instance, if signal CK is not present at pin 1 of IC<sub>5</sub>, the device will not work. The same applies if signals RAS, CAS, or HCK are not present. If one of the signals RAS<sub>0</sub>...RAS<sub>7</sub> is missing, one eighth of the screen does not function; the remainder operates normally. If one of the DAD lines is short-circuited, the card will only function partly: the extent of the malfunction depends on the binary loading of the relevant address line.

The information given here, particularly that in Table 7, will enable anyone with some

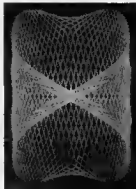

experience in electronic construction to build the card satisfactorily. The colour extension will be dealt with in a forthcoming article. Remember that plug K, will provide the connection between the black-and-white card and the colour extension. The wiring to this connector is shown in Fig. 22. Until the colour extension is there, the plug is useful in providing test signals.

### Choosing the GDP and memory ICs

As the EF9365, EF9366, and EF9367 cost roughly the same, it is best to buy the EF9367. This is the latest model and also the most efficient; moreover, it can be used in interlaced as well as in sequential scanning. In the present graphics card, it permits the following modes of operation:

512 x 256 (sequential scanning), and  
512 x 512 (interlaced scanning)

It also offers the possibility of providing 1024 x 512 pixels, but this is not used in the card, mainly because this mode of operation demands a very high quality monitor, particularly as regards bandwidth and resolution.

The EF9366 is also an excellent device, but it cannot work in interlaced scanning mode and its resolution is, therefore, limited to 512 x 256 pixels in the present card. In most cases, this is, however, perfectly satisfactory. It should be noted in this context that a vertical resolution of 512 pixels in interlaced mode requires a good-quality colour monitor.

Choosing the correct memory ICs is also important. In theory, they should be fast, say, 150 ns access time or better, so that the RMW mode functions properly. Practical experience with the GDP has shown, however, that in many instances access times of 200 ns or even 300 ns do not pose particular problems.

Moreover, these ICs do not get a refresh pulse on A<sub>7</sub> and A<sub>15</sub>, and pin 1 (which is earthed) does not receive a refresh clock pulse. Table 9 shows all suitable types as far as they are known to us (column YES), those in column NO are definitely NOT suitable. The types in brackets in the YES column have an access time that, theoretically, is too long for the RMW mode. Photo 2 shows ICs of the Japanese firm Fujitsu as used in one of our prototypes.

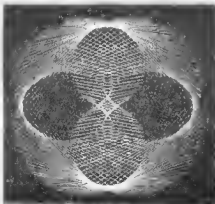

21

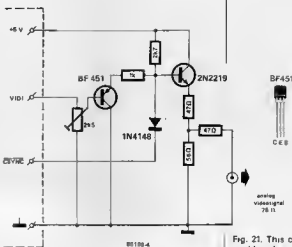
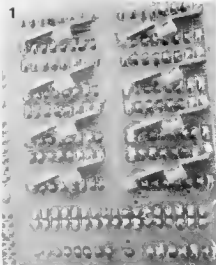
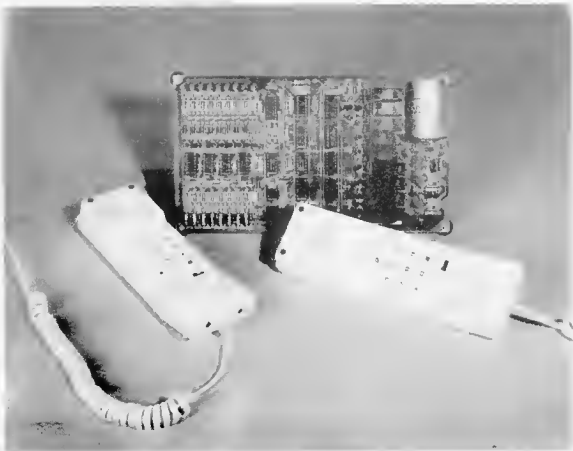

Fig. 21. This circuit enables signals VIDEO and CSYNC to produce a composite video signal (video + sync).







# telephone exchange

by J Steeman

Nowadays, there is a variety of inexpensive, yet sophisticated, telephone sets on the market. Not all of these are permitted to be connected to the British Telecom network, however. None the less, two or more of such sets may be used to form a simple, but effective, internal telephone system for the home, an office, or anywhere where a number of people want to communicate from different locations within the same building.

The proposed system may, of course, also be built around British Telecom approved sets. Note that the system is intended for up to eight sets each of which generates a pulse code when a number is dialled or keyed in.

## Facilities

A telephone exchange does, of course, more than just connecting one set to another. In fact, this is about the only thing it need not do, because the set with which communication is required is already accessed by the pulses generated when the relevant number is dialled or keyed in. What the exchange is required to do is

- to decode and process the pulses generated by the telephone sets;
- to generate a dialling tone;
- to generate and pass on a ringing tone;
- to interconnect sets as soon as the receiver is lifted,
- to prevent a third set listening in;
- to generate and pass on to a third set an engaged tone.

In addition, the system allows communication between two sets to be established in two ways:

- by dialling or keying in the required number and waiting till the other set responds;
- semi-automatic: when the receiver of one

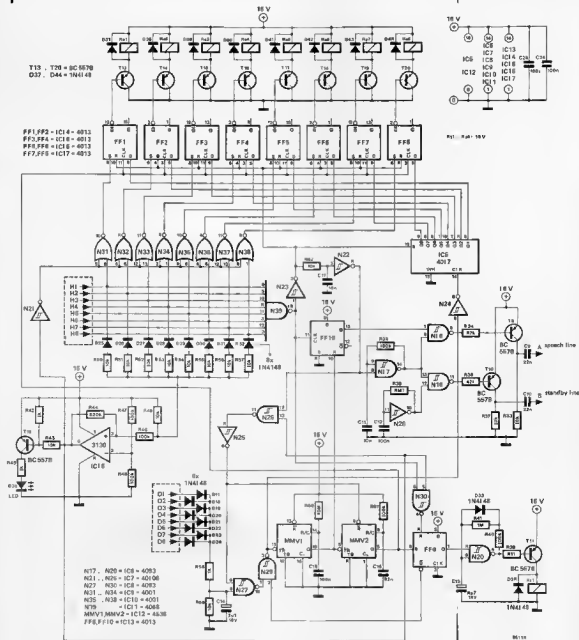

Fig. 1. Circuit diagram of the home telephone exchange

set is off the hook, and the receiver of another set is lifted, the two sets are interconnected, even when no number has been dialled.

The exchange is provided with LEDs that show at all times which of the sets, if any, are engaged. A ninth LED indicates whether the exchange is engaged or not; this only goes out when the communication has been terminated, i.e., when the two relevant receivers have been replaced on their rests. All sets are powered from a common source via the standby and speech lines; the connection between each of the sets and the exchange is, therefore, in many cases possible, via two lines only. The bell voltage is placed on the speech line via a relay.

Calling one set from another is done by simply dialling or keying in the number of the wanted set, i.e. 1...8.

#### Circuit description

Since the telephone sets can only be connected to the exchange — see Fig. 1 — via the interface shown in Fig. 2, it is important to know how many sets the exchange will control before all the parts are bought. If, for example, only three sets are envisaged, the relevant part of the circuit in Fig. 2 needs to be built only three times. If, however, the full capacity of the exchange is used, eight interfaces are required.

As soon as the receiver of a set, say, number

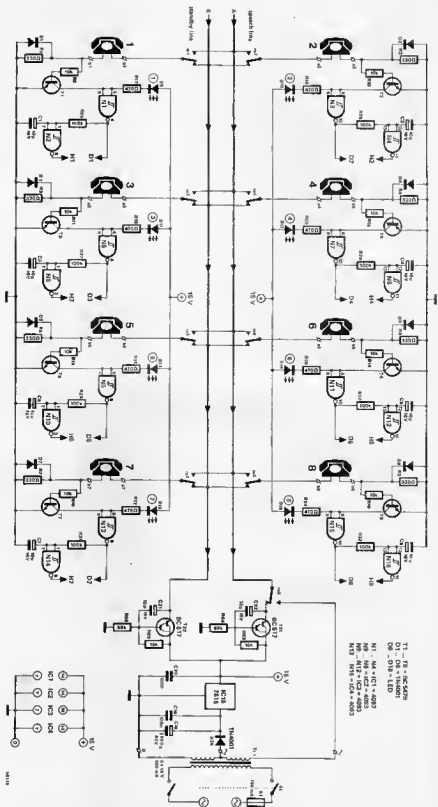
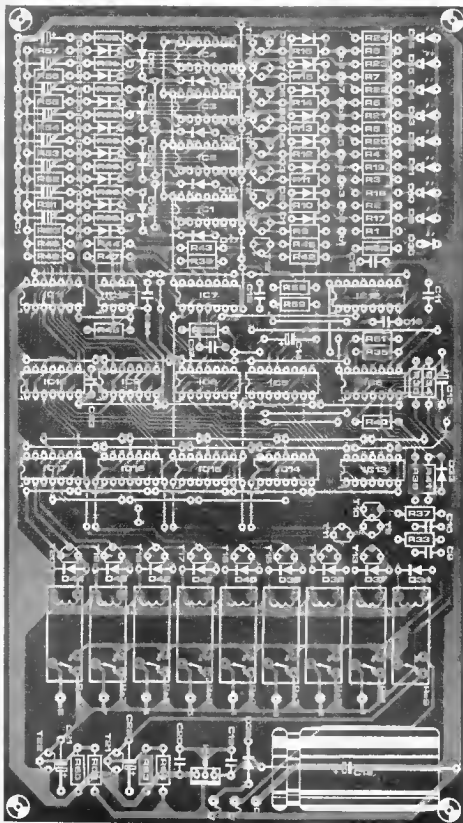

Fig 2 Circuit diagram of the power supply (for up to eight telephone sets) and the interface required for connecting the telephone to the exchange. One interface is required for each and every telephone



## Parts list

## Resistors

R1	R <sub>9</sub> = 330Ω	
R <sub>2</sub>	R <sub>16</sub> R <sub>22</sub>	
R <sub>3</sub> R <sub>4</sub> R <sub>5</sub> R <sub>6</sub> R <sub>7</sub> R <sub>8</sub>	R <sub>10</sub> R <sub>11</sub> R <sub>12</sub> R <sub>13</sub> R <sub>14</sub> R <sub>15</sub>	R <sub>27</sub> R <sub>29</sub>
R <sub>17</sub>	R <sub>18</sub> R <sub>19</sub> R <sub>20</sub> R <sub>21</sub> R <sub>23</sub> R <sub>24</sub> R <sub>25</sub> R <sub>26</sub>	
R <sub>28</sub>	R <sub>30</sub> R <sub>31</sub> R <sub>32</sub> R <sub>33</sub> R <sub>34</sub> R <sub>35</sub> R <sub>36</sub> R <sub>37</sub> R <sub>38</sub> R <sub>39</sub> R <sub>40</sub> R <sub>41</sub> R <sub>42</sub> R <sub>43</sub> R <sub>44</sub> R <sub>45</sub> R <sub>46</sub> R <sub>47</sub> R <sub>48</sub> R <sub>49</sub> R <sub>50</sub>	

## Capacitors

C1	C <sub>2</sub> , C <sub>21</sub> , C <sub>22</sub> = 10 μF 16 V
C <sub>3</sub> , C <sub>10</sub> , C <sub>18</sub>	= 22 n
C <sub>11</sub> , C <sub>17</sub>	= 10 n
C <sub>7</sub> , C <sub>15</sub> , C <sub>19</sub> , C <sub>20</sub> , C <sub>23</sub>	
C <sub>4</sub>	= 100 n
C <sub>13</sub>	= 47.16 V
C <sub>5</sub>	= 2μ2, 16 V
C <sub>8</sub>	= 2200 μ 40 V

## Semiconductors

T1	T <sub>8</sub> = BC547B
T <sub>9</sub>	T <sub>20</sub> = BC557B
T <sub>21</sub> , T <sub>22</sub>	= BC517
D1	D <sub>8</sub> , D <sub>26</sub> = 1N4001
D <sub>9</sub>	D <sub>16</sub> , D <sub>25</sub> = LED
D <sub>17</sub>	D <sub>24</sub>
D <sub>27</sub>	D <sub>28</sub> = 1N4148
IC1	IC <sub>4</sub> , IC <sub>6</sub> , IC <sub>8</sub> = 4093
IC <sub>2</sub>	= 4017
IC <sub>7</sub>	= 40106
IC <sub>3</sub> , IC <sub>10</sub>	= 4001
IC <sub>11</sub>	= 4068
IC <sub>12</sub>	= 4538
IC <sub>13</sub>	IC <sub>17</sub> = 4013
IC <sub>18</sub>	= 3130
IC <sub>19</sub>	= 7815

## Miscellaneous

S1	double pole mains switch
Rel	R <sub>8</sub> = 12 V relay for PCB mounting (e.g. Siemens type V23027 B0002) may be available from Electrovalue (0784) 33603 or (061 432) 4945)
T <sub>1</sub>	mains transformer, 2 × 18 V at 500 mA, or 0.16 36 V at 500 mA, or 0.18 V at 500 mA, or one of 0.36 V at 50 mA
F1	fuse 100 mA
	PCB 85110

Fig 3. Printed circuit board of the telephone exchange. Note that the mains transformer is not fitted on this board. The track side of the PCB is shown on page 45.

1, is taken off the rest, the relevant transistor, here  $T_1$ , is switched on, so that the output of  $N_1$  goes high. After a time determined by the RC network at the input of  $N_2$  this gate toggles and its output goes low.

If now from set 1 a number is dialled, the output of  $N_1$  will toggle in rhythm with the pulses produced by the telephone set. Because of the RC network at its input, gate  $N_2$  will not follow suit: its output remains logic low during the dialling of a number. The low logic level indicates to the exchange that the receiver is off its rest. As soon as the receiver of one of the other sets is also taken off its rest, the output of comparator  $IC_{18}$  goes low, which renders all other sets inoperative. How this is achieved will be reverted to later.

The pulses generated during the dialling of a number trigger monoflops  $MMV_1$  and  $MMV_2$  via one of the lines  $D_1$ ,  $D_8$ , and also serve as clock signal for  $IC_5$ , a counter with ten outputs. The contents of this counter, i.e., the dialled number, is only accepted by bistables  $FF_1 \dots FF_9$  if two conditions are met: (a) only one receiver is off its rest, and (b)  $FF_9$  is not generating a ringing tone. As long as pulses keep arriving at pin 11 of  $MMV_1$ , the Q output of this monostable will remain high. When this pulse train comes to an end, a short pulse is provided at the Q output (pin 6) of  $MMV_2$ . This pulse sets  $FF_9$  (which generates the ringing tone) and clocks bistables  $FF_1 \dots FF_8$ , depending on the output code of  $IC_5$ . The wanted set is then connected to the speech line via its associated relay  $A_i$  at the same time,  $N_{20}$  (an oscillator with a long '1' and a short '0') intermittently connects the bell voltage onto the speech line via contact  $w_9$  (see Fig. 2). The wanted telephone will then ring until its receiver is lifted.

To ensure that a third set cannot listen in, the logic levels at the Q outputs of  $FF_1 \dots FF_8$  are held: this is done by making both the set and reset inputs of these bistables low when the receivers of two telephone sets are off their rests. The set inputs are made low via  $IC_{16}$ : the output of this opamp is low when two telephones are interconnected. The output of Schmitt trigger  $N_{21}$  is then high, and since this output is connected to  $FF_1 \dots FF_8$  via NOR gates  $N_{31} \dots N_{38}$ , the set inputs of the bistables are low. As long as two receivers are off the hook, the output of  $N_{29}$  is logic high. The output (pin 2) of  $N_{23}$ , and consequently the reset input of bistables  $FF_1 \dots FF_8$ , is then low.

An engaged tone, generated by gates  $N_{18}$  and  $N_{26}$  in combination with transistor  $T_{20}$ , and applied to the wait line, indicates that the exchange is busy. This tone generator, as well as the dialling tone generator consisting of  $N_{27}$ ,  $N_{19}$ , and  $T_9$ , is actuated by  $FF_{10}$  as soon as the receiver of any one of the sets is lifted. The dialling tone generator is provided to indicate that the exchange is processing a number: it has no connection with the actual dialling pulses. In fact, as soon as a dialling pulse appears on one of the D lines, the dialling tone generator is switched off immediately by  $FF_{10}$ .

Semi-automatic operation is achieved as

follows. As stated, bistables  $FF_1 \dots FF_8$  are rendered inoperative when two telephone sets are communicating. When only one receiver is off the hook, the output of  $N_{21}$  is low, and the bistables can still be accessed. When in that condition a second receiver is lifted, it takes a second before the bistables are really inoperative, and the two telephones are interconnected. Note that it is not necessary in this case to dial a number.

### Power supply

The +15 V power supply is provided to the exchange via the speech and standby lines. The bell voltage — here chosen at 2 x 18 V — is also applied to the speech line, but in this case via relay  $Re_9$ . Transistors  $T_{17}$  and  $T_{22}$  ensure a high supply impedance to prevent attenuation of the speech signal.

### Construction

As no presetting or alignment is necessary, the exchange may be fitted in a suitable enclosure as soon as the wiring of the PCB shown in Fig 3 has been completed. The telephone sets are connected to terminals  $a_1 \dots a_8$  and  $b_1 \dots b_8$  on the board respectively. Note that British Telecom approved sets need a four-wire connection to the exchange, because their bell circuits need to be connected separately to the standby and speech lines respectively. The bell wires in these sets are coloured red and green, while the other two are blue and white respectively.

### Finally

Because of the RC network between gates  $N_1$  and  $N_2$  (or  $N_{5,7}$  and  $N_{6,8}$ ) in the interface circuit of Fig. 2, the bell rings briefly when the wanted extension picks up the receiver. This could have been eradicated, but it was not thought that the cost of the additional electronics required was justified by this very minor flaw. ■



Telephone exchange

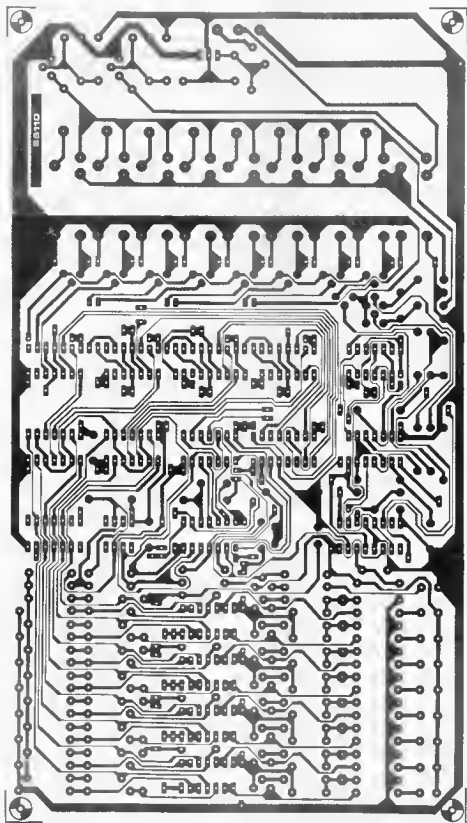

# dissipation limiter

switches  
transformer  
secondary

Z. Paškvan

Figure 1. Switching from half-wave to full-wave rectification is effected by applying a suitable voltage to the base of T2.

Figure 2. This diagram shows the effect on the voltage applied to the rectifier circuit when a base voltage,  $U_B$ , is applied to T2.

Figure 3. To get the full secondary output voltage, a voltage of 1...10 V must be applied to the base of T2. Rectifiers D1, D2, Th1, and Th2 are then connected in a bridge configuration.

Figure 4. When Th1 and Th2 are off, D1 and D2 function as half-wave rectifiers. As the two halves of the transformer secondary are effectively connected in parallel, the pulsating voltage applied to the rectifiers is  $1/2 u_s$ .

In a stabilized power supply the dissipation in the stabilizer may become very high when the difference between input and output voltages is large. This phenomenon occurs particularly in stabilized mains supplies, and can be remedied by lowering the secondary voltage before the stabilizer. The suggested circuit here does this in a neat manner by making it possible to select either the full or half the secondary voltage. And that with only a few components!

The stabilizer in a power supply may get very hot indeed when the output current is high and the output voltage is low, because it alone has to dissipate the difference between the input and output voltages. It should therefore not come as a surprise when the device gives up the ghost. Some supplies are fitted with a switch that enables the lowering of the secondary transformer voltage,  $u_s = u_1 + u_2$ , in such situations, so that the stabilizer need not dissipate so much power.

The proposed circuit shown in figure 1 also makes it possible to lower the secondary transformer voltage but in a rather special way. With a centre-tapped transformer it is possible to halve the output voltage,  $u_o$ , by switching the rectifiers from full-wave to half-wave rectification. The switching is effected without the use of a mechanical switch: all that needs to be done is to give the correct instruction and even that could be automated!

## From full-wave to half-wave and vice versa

The two parts of the secondary winding of the transformer must be in series to give  $u_s = u_1 + u_2$ . All that is necessary to ensure this is to apply a voltage of 1...10 V to the base of T2. Both that transistor and T1 then conduct: silicon-controlled rectifiers (SCRs) Th1 and Th2 are consequently switched on via R1, R1', D4, and D5. The SCRs together with D1 and D2 now form the wanted full-wave rectifier in a simple Graetz circuit as shown in figure 3. Diode D3 ensures that in this configuration the secondary windings are not short-circuited via the centre tap and one of the SCRs.

When it is required to halve  $u_o$ , the base voltage of T2 should be made zero. The SCRs are then off and rectification is carried out by D1 and D2 only: this is half-wave rectification. This situation is shown in figure 4 and illustrated in figure 2. You will see that the peak value of  $u_o$  rises appreciably when a base voltage is applied to T2, and drops to  $u_1 = u_2$  when the base voltage is removed.

No values have been given in this article because these will of necessity depend on the type of supply used. All component ratings, particularly those of D1 and D2, must, of course be chosen to comply with your particular requirements.

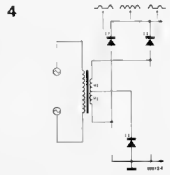
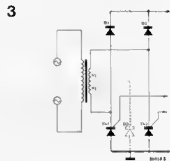
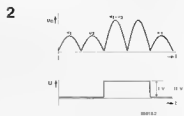
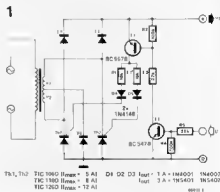

# Digi-Course II

Chapter - 2

In the last chapter of Digi-Course II we have seen how two NAND gates can be connected to make a simple R-S Flipflop

The circuit and its truth table is again reproduced here for reference.

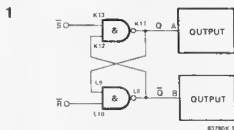

Table 1

S	R	Q	Q̄
0	0	1	1
0	1	1	0
1	0	0	1
1	1	0/1	1/0

As we have already seen, the last line of the truth table is ambiguous. Its relation is not defined in isolation, but the previous history of the outputs is involved in deciding which of the outputs will be 1 and which will be 0. The gate which had a "0" input prior to going on "1" retains a "1" at the output. By placing a "0" on the S input (set input) the Q output LED is turned on. By placing a "0" on the R input (Reset input) the Q output LED is turned off. A practical application of this simple Flipflop circuit is the game of skill called "Old Shatterhand", this game tests how steadily you can move your hand?

Our R-S Flipflop works as an impartial judge of this game. The basic idea is very simple. A metallic ring is passed over a complexly bent wire such that the ring surrounds the wire but does not touch the wire at any place. If the ring touches the bent wire at any moment, that player has to drop out. Whether the ring touches the wire or not, is faithfully recorded by the R-S Flipflop.

The bent wire is connected to the ground terminal on the Digilex board and the ring is connected to the input S (Pin K13). At the beginning of every round, the R input (Pin L10) is momentarily shorted to the ground terminal. This gives "0" input to R, thus resetting the Flipflop, and turning off the Q output LED. Now the player engages the ring around the bent wire at one end and starts moving it towards the other end, without touching the wire with the ring. Even if the ring touches the wire just for a fraction of a second, the Flipflop is immediately set and the Q output LED glows, announcing the player to be an "Old Shatter hand".

The simple Flipflop circuit that we have just used can be said to have stored the information that the particular player has touched the wire with the ring. In short, the Flipflop is a memory device which stores the information last received. The information stored is always in form of zeroes and ones.

For complex memory applications like data storage, data processing, calculations which require large quantities of data to be handled, we require extremely large quantities of storage cells like Flipflops. Each Flipflop contains one bit-which is either zero or one. Integrated Circuits which serve this purpose are commercially available. One such IC is the popular 6116 memory IC, called a Static RAM. This Chip contains more than 16 thousand Flipflops. These Flipflops are internally arranged in such a way that they can be accessed externally using just a few pins (16 thousand pins are not required).

Now let us see another variation of our basic Flipflop. Connect two more NAND gates as shown in figure 3.

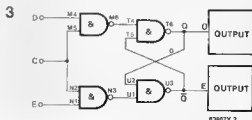

This arrangement is called a controlled or clocked R-S Flipflop. The Flipflop of this circuit can change its state only when a "1" appears on the control or clock input C.

Table 2.

D	E	C	Q	Q̄
0	0	0	0/1	1/0
0	1	0	0/1	1/0
1	0	0	0/1	1/0
1	1	0	0/1	1/0
0	0	1	0/1	1/0
0	1	1	0	1
1	0	1	1	0
1	1	1	1	1

The last condition which was present when C changed to "1" is retained, depending on which input had a "0" at that moment.

The C input thus behaves like a "Store" command input. The input conditions present when this input gets the "Store" command (logical "1" on C) are allowed to set or reset the Flipflop and this condition at the output is retained till a new "Store" command appears at pin C.

One disadvantage that still remains in this circuit can be removed by modifying it as shown in figure 4. Now we have only one input D for Set/Reset and one input for the control command "Store".

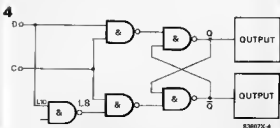



# selex

The restriction of having to use a zero as an input on R and S is now removed. The pin D can accept either zero or one.

Table 3

D	C	Q	$\bar{Q}$
1	1	1	0
0	1	0	1
1	0	Q/t	t/0
0	0	Q/t	t/0

Depending on the last condition when a "1" appeared on C

The functioning of this circuit can be summed up briefly as follows.

"1" appearing on D sets the Q output to "1"  
 "0" appearing on D resets the Q output to "0"  
 provided a "1" was present on C. When a "0" is present on C, input D becomes ineffective.

As we have already seen, truth tables in case of Flipflops have ambiguous entries due to the time dependent nature of Flipflop operation. A better way to understand Flipflop operation is the use of timing diagrams.

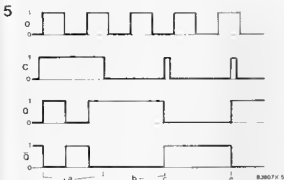

These timing diagrams clearly illustrate the following properties of the Flipflop

1. When C=1 (section a), whatever appears on D also appears on output Q.
2. When C=0 (section b), output retains its last level when C changed from 1 to 0 which means that the condition of output Q which was present at the moment when C changed from 1 to 0, is stored in the Flipflop. This is called the falling edge of the input on C.
3. Now that we have seen that only the following edge of input on C is effective as a "Store" command, we can easily understand the significance of points C and  $\bar{C}$  in the timing diagrams.

How long the level at c remains "1" is not important, what is important is only the moment it falls to "0" whatever state Q has at this moment is then retained.

The circuit of figure 4 can be further simplified as shown in figure 6

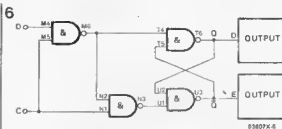

And using the counterpart of the NAND gate, namely the NOR gate, we can construct a Flipflop as shown in figure 7 below

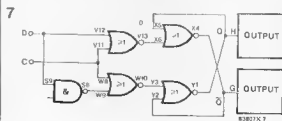

The NOR-Flipflop functions a bit differently from the NAND-Flipflop. Now that you have studied the NAND Flipflop in detail, it will not be difficult for you to prepare the truth table for the NOR-Flipflop as well, alongwith the timing diagrams!

A simplification of the circuit of figure 7 is also possible, and it is given below for reference

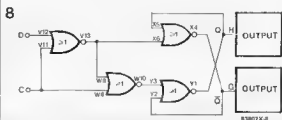

"..... do you know different word for resistors?"

"No "

"Semiconductors!"

"Why do you say that?"

Resistors are not semiconductors!"

"Why not? If something has almost no resistance, we call it a conductor. If something has such a high resistance that it does not allow any flow of current, we call it a non-conductor. So if something has a resistance in between these two we must call it a semi-conductor!"

"No, it is not so. The resistors are not semiconductors. The word semiconductor has a different meaning.

"Semiconductors are materials which sometimes conduct and sometimes don't. When they conduct and how much they conduct depends on various other factors."

"Then these semi conductors must be some sort of switches!

"No, these are not switches either you are somewhere near the truth. We shall see a semiconductor with an example. You have seen a diode this is a semiconductor. It has two leads, and its symbol is like an arrow head and a bar. A current can flow through the diode if it has a direction which coincides with that of the arrow. In the other direction, no current can flow.



For simplicity let us say that when the plus pole of the applied voltage is behind the arrow, a current can flow, however when the plus pole is in front of the arrow, the bar between the plus pole and the arrow head can be imagined as blocking the current flow."

"In that case, we can call the diode as an electrical 'One Way street!'"

"Exactly that is what a diode is!

It acts as a conductor for current trying to flow in the direction of the arrow and it acts as a non-conductor for current trying to flow in the opposite direction.

This is the reason why it is called a semi conductor. We can also compare the diode with a unidirectional valve which opens only in one direction."

"But how do you compare this with a switch?"

"Let us again take the example of a diode

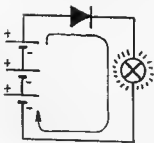

## Semiconductors

This illustration shows a diode connected in series with a lamp and a battery. As we have already seen, the diode will allow the flow of current because the plus pole is behind the arrow head. The current will flow through the lamp and the lamp will glow. This diode is acting as a closed switch between the battery and the lamp.

Let us see now, what happens when the battery polarity is reversed.

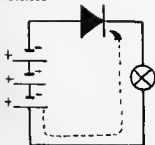

This time the plus pole is in front of the arrowhead and the bar comes between them. The current flow will be blocked by the bar and the lamp will not glow. The diode now behaves as an open switch."

"Then this circuit can be used as a polarity tester?"

"Right! The diode can certainly be used to check the polarity, because it behaves as a closed switch with the correct polarity and as an open switch with the wrong polarity."

"Is that all a diode can do?"

"Of course not! The diode is a very versatile device. Haven't you seen these diodes in a battery eliminator? There they work even four at a time."

"What are these diodes doing in a battery eliminator?"

"Diodes are used to rectify the alternating voltage. We have already seen how alternating voltage behaves, haven't we?"

"Yes, I remember quite clearly. The alternating voltage changes its polarity hundred times every second. Therefore on every terminal of the plug socket there is always a plus pole and a minus pole alternately...."

"... and on the other terminal it is the opposite, i.e. minus pole and plus poles."

"That is quite logical!"

"And for obtaining a direct voltage from an alternating voltage, we put a diode in the circuit. It allows the current to flow when the polarity is correct. It blocks the current flow when the polarity is wrong. As the diode allows only half the cycle of the alternating current to pass through, it is called a half wave rectifier."



# Transistors

"... . What are transistors?"

"Transistors are also semiconductor devices like diodes. We have seen how diodes function like one way valves. Transistors also behave like valves, but with a difference. Transistors are valves for electrical currents which can be regulated. With transistors, we can make currents flow with greater or lesser intensity."

"They are the water taps of electronics"

"Right!"

"But than the current can also be regulated with a potentiometer"

"A potentiometer has to be turned mechanically. It has a rotating spindle and a knob. The transistor has no such mechanical parts, it functions fully electronically. Most of the transistors are quite small and they have three leads coming out at the bottom."

"Three terminals? Then certainly it has some kind of a potentiometer inside?"

"No, transistors and potentiometers have absolutely nothing in common. The transistors have two very intelligently designed diodes inside them, as you can see in the illustration given here."

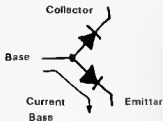

"How can you control current with two diodes?"

"No, it is not at all possible just with two diodes. But it can be done with a transistor. The illustration we just saw is nothing but a simplified view and not a physical combination of two ordinary diodes."

"I don't understand!"

"This is how it happens. When a positive voltage is applied to the base, a current flows through the diode between the Base and the Emitter."

(Illustration)

"Now, if we apply a negative voltage to the Collector current is also allowed to flow through the diode between the Base and Collector"

(Illustration)

"That is right, and with a plus pole connected to the collector..."

"... the upper diode will block the current! What is the use of all this?"

"Just wait. It is certainly true that the upper diode will block. But as I have already said, these are just ordinary diodes. These diodes are designed in such a way, that the upper diode becomes conductive due to the current flowing through the lower diode. To

simplify the matters we can say that the current flowing into the Base terminal, takes along a current from the collector and comes out through the Emitter terminal."

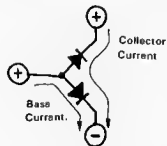

"Unbelievable! Do you mean to say that a current flowing into the Base can make the upper diode conduct a current from Collector to Emitter even with a plus pole connected to the collector?"

"That is exactly what happens inside a transistor. However when there is no Base current, the upper diode can block the current and no current can flow from Collector to Emitter."

"This means that the transistor is working like a remote control switch, which is switched ON and OFF by the current flowing through the Base."

"Yes, it can be used as a switch controlled by the Base current. Incidentally, as the transistor is not just two diodes connected together, it has been given a different symbol."



"Does the transistor work only like a switch? Then what does it do in an amplifier?"

"The Collector current is not only switched ON and OFF by the Base current. It can also be regulated by the base current. As in case of our water tap, the quantity that can flow through is adjustable. The Collector current can be as strong as 500 times the Base current. A Base current of just two microamperes can cause a Collector current of about one milliampere, which is quite a substantial amount in electronic circuits."

"This means that a transistors can also be called an amplifier?"

"Yes, and the ratio of the Collector current and the Base current can be said to be the amplification factor of that transistor"

"Do the Hi-Fi Stereos also function in the same manner?"

"You are right! However, a large number of transistors and many other components are necessary to obtain the Hi-Fi quality Stereo amplification."

"Has nobody ever thought of building an amplifier from water taps? We could call it an Under-water Hi-Fi"

# Resistance Bridges

In electronics, circuits similar to that shown in figure 1, are called bridges. When all the elements of such a circuit are rectifier diodes, we call it a rectifier bridge - which is commonly used in battery eliminators. When all the elements of such a circuit are resistors, we call it a resistance bridge. The circuit of figure 1 is also known as a "Wheatstone Bridge".

Now, let us see the functioning of this bridge circuit. Figure 2 shows a practical bridge circuit, drawn in a simplified manner for better understanding. The two branches made up of  $R_1$ ,  $R_2$ , and  $R_3$ ,  $R_4$  are nothing but voltage dividers. The meter connected between these two branches at the junctions between  $R_1$ ,  $R_2$  and  $R_3$ ,  $R_4$  measures the difference between the two junction points.

In the circuit of figure 2, the left branch  $R_1$ ,  $R_2$  divides the voltage into 2V on  $R_1$  and 3V on  $R_2$ . The right branch divides the 5V supply voltage into 2.5V and 2.5V across  $R_3$  &  $R_4$ .

The difference voltage thus becomes  $3V - 2.5V = 0.5V$  which is measured by the meter and indicated.

If we now reduce  $R_1$  to  $260\Omega$  instead of  $400\Omega$ , the voltage across  $R_2$  will increase by about 0.5V. This will increase the reading on the meter across the junction points by 0.5V. The meter connected directly across  $R_2$  will also show an increase in reading by 0.5V.

A very important fact can be observed here that for a rise of about 17% in the voltage across  $R_2$  there has been a rise of 100% in the difference voltage across the junction points of the bridge, which can also be called as the bridge voltage. The above observation shows how sensitive the bridge voltage is, in relation to any change in the individual branch voltages. Even the slightest change in branch voltages will be reflected as a large deviation in the bridge voltage.

When the ratios of the voltage divider branches on left and right are both exactly identical, the bridge voltage is zero.

This condition of the bridge when the voltage divider ratios of both the branches are identical is known as a balanced bridge - the bridge is said to be a balanced bridge.



A simple application of this bridge circuit is shown in figure 3, which works as a light intensity meter. One of the resistors in the left branch of this bridge is an LDR. The Resistance of an LDR in darkness is very high, whereas its resistance in light falls as the intensity of light increases. Thus the voltage across  $R_1$  becomes dependant upon the intensity of light falling on the LDR. The potentiometer  $P_1$  can be adjusted to compensate for voltage across  $R_1$  so that

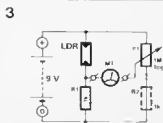
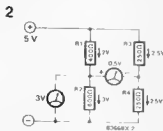
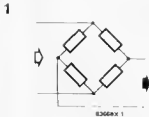

the meter reading becomes zero. If the potentiometer knob is provided with a dial, it can be calibrated to read the light intensity.

This circuit can work even without the resistance R2 (1K $\Omega$ ) shown in dotted lines, but to protect the LDR from excess current when the potentiometer is in the extreme lower position, R2 should be included in the circuit.

The potentiometer position required, to obtain zero reading on the meter when the LDR is in total darkness, can be marked as zero intensity. The light can then be increased in known steps of intensity level and every time the position of potentiometer can be marked with the known value.

This circuit can be easily assembled on a small SELEX board and calibrated using a standard light intensity meter as a reference.

For a resistance bridge, the individual values of the resistances are not important. The operation depends only on the resistance ratios of the individual branches. When the resistance ratios of the left and right branch become equal, the bridge voltage becomes zero, irrespective of the individual values of resistors and supply voltage.

Figure 1 :

Standard configuration of a bridge circuit. The individual elements can be any type of impedances, or even rectifier diodes.

Figure 2 :

The meter connected across the junction points measures the voltage difference between those two points. The sensitivity of this measurement is much more than that of a meter directly connected across one of the voltage divider resistor.

Figure 3 :

A simple light intensity meter. The potentiometer is used to balance the bridge in such a manner that the voltage across the shunt arm of the bridge is zero.

Figure 4 :

The circuit of figure 3 can be assembled on a small SELEX PCB.

## Resistance Decade Box



Even though the resistance decade is not a very sophisticated circuit, it has very great practical utility. The resistance decade box can be used for experiments, testing, bridge balancing, voltage dividing and many other practical applications. The values available being adjustable from 10 $\Omega$  to more than 1M $\Omega$ .

The circuit is shown in figure 2. This is a selectable series connection of total 50 resistors, individual resistors are added in to the series combination by selecting the switch positions. Each switch selects the number of resistors from a group of 10 resistors from a group of 10 resistors of equal value. The total resistance of equal value. The total resistance

comprises of effectively 5 different resistance values selected by the 5 switches, as shown in figure 3. The individual values of resistors used in each group are selected in such a way that each switch represent a decimal place in the final effective combination of the five groups.

The series combination of five groups R1 . . . R5, added up to make the total resistance  $R_g = R_1 + R_2 + R_3 + R_4 + R_5$ , lies between the external sockets A and F of the decade box. It is not essential that sockets A & F must be used as the two ends of the effective resistance from the decade box. Any pair of

2

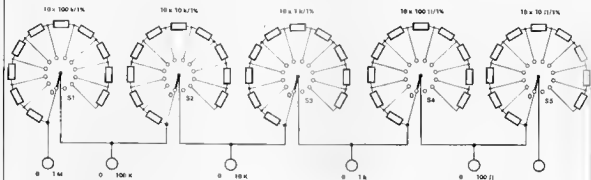

sockets can be used for this purpose, depending on the required resistance value, as shown below :

- R (A-C) = R1 + R2
- R (B-D) = R2+R3
- R (C-F) = R3+R4+R5

As the 5 groups of resistors covered by the 5 switches have 10 resistors of equal values each - the switch position multiplied by the individual resistor value gives the effective values of R1 ..... R5

For example, switch 1 controls a group of 10 resistors of 100KΩ each. Thus the switch 1 set to position 3 will give a value of 300KΩ for R1. Switch 1 set to positions 0 to 10 will give values of 0 to 1MΩ in steps of 100 K Ω each.

The individual values within each group are selected as multiples of 10. Group 1 has 10 resistors of 100KΩ each, group 2 has 10 resistors of 10KΩ each and so on, group 5 has 10 resistors of 10Ω each.

Advantage of this selection of values is that each switch represents one decimal place

Every switch is connected with an external socket, so that any of the 5 groups can be used to make up the required value of resistance. Using all five decimal places may turn out to be ineffective due to the individual tolerance values of resistors. For instance, let us examine the setting of switches in the sequence 51381 (513810Ω). As we have used resistors with 1% tolerance, the error on the 1st switch itself can build up to 5Ω (1% of 500kΩ) thus making the setting of 4th and 5th switches superfluous. In spite of this drawback, the decade box is provided with five switches, so that the full range of values is available to the user

### Construction Details :

The construction of resistance decade box mainly consists of soldering work and mechanical fitting work. The 50 individual resistors must be soldered onto the lugs of the 5 different switches as shown in figure 6. The final fitting into a standard enclosure is simple, as shown in figure 4

1% Metal Film Resistors must be used if a good accuracy is to be achieved. Even 5% Carbon Film Resistors will work equally well if the accuracy aspect is neglected.

### Applications :

This resistance decade box can be used as an adjustable resistor, or as a voltage divider.

When using this as an adjustable resistance, only 3 digits (switches) can be used at a time due to the accuracy consideration we have already seen. The remaining two switches can either be set to zero or

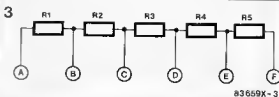

83659X-3

4

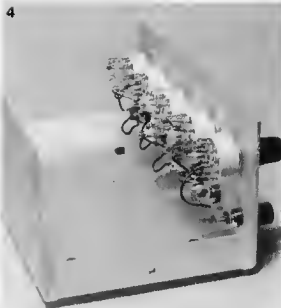

we can use only the sockets relating to the switches of interest.

When using the circuit as a voltage divider, any one of the sockets B, C, D, E can be used as the output socket for the divided voltage and the switches can be set to suitable positions to achieve the desired voltage division.

A more useful application of this circuit is as a decimal voltage divider. For this the switch settings must be in the sequence 9, 9, 9, 9, 10 on the five switches from left to right. The effective distribution of resistors is as shown in figure 5. By connecting a voltage V across sockets A and F we are able to get the following voltage outputs on the sockets

- A = V
- B = V/10
- C = V/100
- D = V/1000
- E = V/10000
- F = 0

This has been achieved by the fact that the resistance between the pairs of sockets are distributed as follows

- R (A-F) = 1 M $\Omega$  = R<sub>g</sub>
- R (B-F) = 100 K $\Omega$  = R<sub>g</sub>/10
- R (C-F) = 10 K $\Omega$  = R<sub>g</sub>/100
- R (D-F) = 1 K $\Omega$  = R<sub>g</sub>/1000
- R (E-F) = 100  $\Omega$  = R<sub>g</sub>/10000

Using this circuit it is possible to obtain very small voltages. For instance, a 4.5V battery connected across sockets A and F will give a voltage of 450 micro volts at socket E.

#### Figure 1 :

A good sturdy sheet metal enclosure gives a professional appearance to the decade box. The front panel graphics has been designed for ease of understanding the operation.

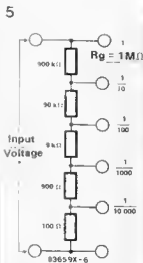

Figure 2 :

The resistance decade contains 50 resistors. They are divided into 5 groups. Each group has one selector switch for selecting the individual digit value of that decimal place.

Figure 3 :

The effective combination of the resistances, R1, R2, ..... R5 are selected by the switch positions. A, B, C, ..... F are the sockets on the front panel.

Figure 4 :

Inside view of the assembled decade box. The switches are mounted on front panel.

Figure 5 :

Use of the resistance decade box as a decimal voltage divider. Voltage divisions available are from 1/10 to 1/10000.

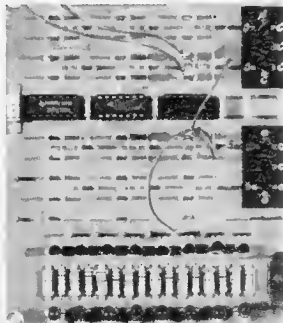
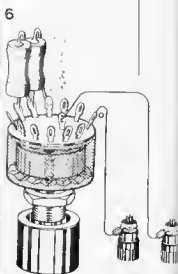

## The Digilex-PCB is now available!

The Digilex-PCB is made from best quality Glass-Epoxy laminate and the tracks are bright tin plated, the track side is also soldermasked after plating. Block schematic layout of components and terminals is printed on the component side.

#### Price:

Rs. 85.00 + Maharashtra Sales Tax.  
Delivery charges extra: Rs. 6.00

Send full amount by DD/MO/PO.

Available from:

**precious**<sup>®</sup>

ELECTRONICS CORPORATION

Chhotani Building, 52-C, Proctor Road,  
Grant Road (East), Bombay 400 007

## SYNCHRONOUS GRETEO MOTOR

The Vishal high starting torque, self and instant start, geared reversible synchronous motor operates on 240/110V (or any other volts), +10V, 50 Hz supply and consumes less than 2.5 or 5 W. The basic motor speed is 375, 500 or 1,000 RPM and, with a suitable gear-train output speed can be made available from 1 sec/rev to 168 hours/rev. The motor can be directly used as a drive for motorised potentiometers, eddy current drives, servo applications, colour photo printers, etc.

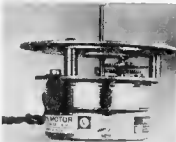

Vishal Electromag Industries  
D-202, Bonanza Indl Estate, Ashok  
Ashok Chakravarti Road  
Kandivli (E), Bombay 400 001

## SOLID-STATE RELAY

ERI's J Series solid-state relays offers the features of logic compatibility (TTL/CMOS), zero turn-on/random turn-on, 2,500 VAC optoisolation, or microsecond switching. It is totally potted to minimise the effects of humidity and vibration. The relay can handle up to 40 A and 480 VRMS. It finds applications in programmable logic controllers, machine tool controls, process control instrumentation, traffic controls, etc.



Electronic Relays (India) Pvt Ltd.,  
34/1A, 1st Main Road, Gandhinagar,  
Bangalore 560 009

# new products

## SOUND WAVE GAUGE

Anushya have developed the Cutt (compensated ultrasonic timer technique) instrument for measuring the travel time and velocities in solids. Based on NGRI's Patent No. 406 DEL/83, the solid-state digital instrument uses a direct pulse for opening an electronic gate from a compensating set of no delay acoustic transducers, and another delayed pulser from a second set of acoustic transducers to close the gate of an electronic timer/counter, displaying the gated interval digitally. The instrument finds applications in studying the sound wave velocities under varying environmental conditions in geology, geophysics, civil and mining engineering, and material sciences.



Anushya Electronics Private Limited  
11-714/C/3, New Bakaram,  
Gandhinagar, Hyderabad 500 380

## CONTACTLESS MAGNETIC PROXIMITY SWITCHES

IEC have brought range of magnetic proximity switches, basically reed switches actuated by a magnet in their proximity. The actuating magnet is either provided separately (NO type) or in the same housing as the switch (NC type). The switches are available in both AC and DC versions and can switch loads of up to 750 mA. They feature applications make us high speed counting where the performance of micro-switches would fall short. Typical applications can be found in lifts, plain paper copiers, counters, etc.



For further information, contact  
Indian Engineering Company  
Post Box No 16551, Wathi Naka,  
Bombay 400 018

## DIGITAL TACHOMETER

Spectrum Services offer the digital tachometer Model AT-100 to measure rotational surface speeds, over a range of 0 to 10,000 RPM, to an accuracy of 1 RPM. A memory circuit facilitates measurement of speed at inaccessible places. The memory is actuated by a touch switch. Storage is indicated by LED. The built-in auto shut-off circuit switches off power after 35 seconds if left unattended. The instrument works on 6V DC off four pencil cells.



Spectrum Services  
P O Box 7623, Malad (West),  
Bombay 400 064

## ELECTRONIC PROJECT KIT

EHC offer the 40-in-1 electronic project kit, an electronic educational aid with fun and games. The kit covers sound, music, disco, test circuits, timer, communication circuits, etc., from basic to advance. A feature of the kit is that it involves no soldering—parts can be used repeatedly—and even a non-electronic person can handle the kit easily. A 50-page instruction manual in colour is provided with the kit, which comes in a plastic cabinet of 30.48 x 20.32 x 5.08 cm with accessories.



For further information write to  
Electronic Hobby Centre  
F-37 Nand Dham Indl Estate,  
Marol, Bombay 400 059



# new products

## DIGITAL PANEL METER

The DIC DI 80 3½-digit panel meter, suitable for OEM production of digital instruments, is housed in a 68 x 28 mm panel cut-out metallic box. It is available in two basic ranges of 200 mV and 1.999 V DC operating at 5 or +5 V for a range of parameters. Also available are DPMs for measuring high DC and AC voltages, ohms and DC/AC current. The DPMs are provided with auto polarity, over-range indication and programmable decimal indication. Other options are also available with facilities such as mains operation, multiplexer of parallel BCD outputs. Hold condition, use of external reference, etc.



For further information contact  
Digital Instruments Corporation  
N B Chamber,  
Opp Canara Bank,  
Sappur Bazaar,  
Ahmedabad 382 345

## SOLDERING IRON

SOLDRON has recently introduced a 50 Watt/230V soldering iron. This new model has features similar to the 25 Watt quick heating light weight soldering iron. Due to its high efficiency, the 50 Watt soldering iron can replace the conventional 65 Watt soldering iron and the resulting saving in electrical consumption is claimed to be about 20%. The iron comes with a 'Cool Grip' polypropylene handle, 5mm spade and 5mm chisel type slip on bits are available.



For further information, write to:  
Bombay Insulated Cables & Wires Co.,  
74, Podar Chambers, S.A. Brelvi Road,  
Bombay 400 001.

## DISPOSABLE DISC WITH HOLDER

Imexu (India) have developed a disposable disc with holder based on technical know-how from the Fibral Organisation of UK. The disc is suitable for applications such as cleaning, surface preparation and conditioning, micro-deburring, polishing and decorative finishing, deburring, and de-tuzzing in a variety of industries—metalworking, electronics, woodworking, aerospace, automotive ceramic, metal and non-metal. The 75-mm dia disc is made from low density, three dimensional impregnated abrasive with controlled cutting action fits the holder without the use of any tool, by positive mechanical locking in a fraction of a second. The holder has a 6-mm dia spindle and, as such, can be mounted on any portable/stationary tool. The holder need not be removed from the tool/machine for changing the disc. The disc is available in four types of construction—plain, spirally wound flap, and puma—end in aluminium oxide and silicon carbide of 80-600 grit. The product comes in kits of 15 discs each with two holders.



For further information write to  
Imexu (India)  
6-A Vaibhav Industrial Estate,  
Saki Vihar Road, Saki Naka,  
Bombay 400 072

## LIGHTED PUSH BUTTONS

Efficient Engineers have developed a new series of lighted push buttons and indicators with rectangular bezel of 48 x 24 mm. Two independent lamp circuits and one or two pole self cleaning and snap acting microswitches in momentary or maintained action are offered. Any legend can be engraved on the front face. These push buttons are suitable for process control instrumentation, supervisory remote control systems, data acquisition, control systems, sequencing logic controls, hierarchy controls and turn key instrumentation.

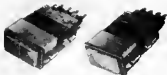

For further information, write to:  
Sai Electronics  
Thakore Estate,  
Kurla Kiroli Road,  
Vidyevihar (West),  
Bombay 400 086

## QUARTZ DIGITAL STOP-WATCH

ION Electricals have developed a quartz digital stop-watch, which features the Lap function (useful in sports events), an accuracy of 0.001% at 25°C, and a resolution of 0.01 second (for readings up to 30 minutes). The full range covers 12 hours. The stop-watch has two modes of operation—Start/Lap/Stop and Start/Stop. The ergonomically designed case fits perfectly in the palm and operation is controlled by two thumbswitches. On the switch being pressed, a Beep sound indicates that the switch has made proper contact. The switches are positioned such that left or right handed operation is equally easy. The stop-watch works on a single penlite cell with a service life of about two years. It measures 6.5 x 1.3 x 3 cm and weighs less than 150 g. A silk-strap is provided for safe handling.



For further information write to  
ION Electricals  
Unique House, 5th Floor.,  
25 S.A. Brelvi Road,  
Bombay 400 001

## 16 PIN IC CLIP

Comtech have introduced their T-16 IC clip for 16 pin DIL packages. It provides easy access to ICs through non-shorting electrical contacts with positive mechanical clamping. Selectively gold plated spring brass contacts are designed for wiping action. The contact-comb with its insulating barriers provides easy positioning and prevents accidental shorting of adjacent leads.

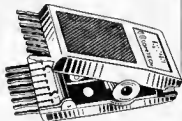

For further information, write to:  
Component Technique  
8, Orion Apartments,  
29/2, Lallubhai Park Road,  
Andheri (West), Bombay 400 058.

## Great little printer

Now available from STC Electronic Services is the Centronics GLP (Great Little Printer) Series dot matrix printer. Completely portable (3 kg), it measures just 333x191x70 mm, features a print speed of 50 c.p.s. (draft printing), near letter quality printing (12 c.p.s.); character pitch of 5, 8.5, 10, and 17 c.p.i.; horizontal tabulation, 48 international characters, high-resolution pin addressable characters. The GLP offers a choice of enlarged, condensed, emphasized, and double-strike print modes, as well as subscript, superscript, and underlining facilities. In addition, two copies besides the original may be obtained.

To interface the printer with a wide range of commonly used PCs simply requires a connecting cable to a Centronics parallel interface or a single unit incorporating the parallel interface plus the RS232.

The GLP's low cost, ease of operation, size and compatibility make it an ideal choice for the personal computer user.

*STC Electronic Service*  
Edinburgh Way  
Harlow  
Essex CM20 2DE  
Telephone: (0273) 26811

(1280 1)

## New rotary step switch

A new range of versatile rotary miniature step switches, manufactured by Henaput of Switzerland, is now available from Stanley Components.

The HS 24 12 range allows users to choose up to 12 switching positions and segments all have a make or break switching option.



Various output pin arrangements are available. Maximum switching voltage is 250 V AC or 150 V DC, and the maximum switching current is 0.5 A AC or DC.

*Stanley Components Limited*  
Business Centre  
Hay Lane  
Braintree  
Essex CM7 6ST  
Telephone: (0376) 40902

(13280 7F)

## $\mu$ P programmable mapping decoder

A new low power ISO-CMOS programmable mapping decoder, the type MV74HCT515, designed for use in high speed memory and peripheral address decoding systems has been announced by Plessey. The device can also be used as a 9 bit pin programmable code detector.

The MV74HCT515 decodes two binary inputs, A<sub>3</sub> and A<sub>1</sub>, to select one of four mutually exclusive, active low outputs (00 to 03), enabled by a pin-programmable 9-input AND gate. E<sub>1</sub> and E<sub>2</sub> inputs E<sub>3</sub> and E<sub>4</sub> are permanently active high while E<sub>5</sub> and E<sub>7</sub> may be programmed active high or active low in any

## new products

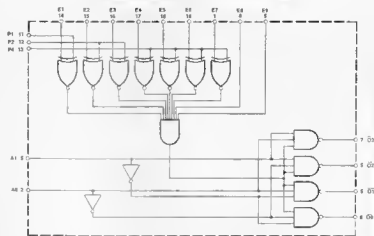

MV74HCT515 logic diagram

combination by hard-wiring inputs P<sub>1</sub>, P<sub>2</sub>, and P<sub>3</sub>.

*Plessey Semiconductors Limited*  
Cherry Manor  
Swindon SN2 2GW  
Telephone: (0753) 36251  
Telex: 449637

(13280 10F)

## Hybrid and stepper motors

Crouzet's new range of hybrid and permanent stepper motors which includes twenty one types plus controllers in the hybrid servo stepper motor range and five types plus controllers in the permanent magnet stepper motor range, offers significant advantages over many existing products.

Also available is an extensive range of multi-function electronic timers providing nineteen different functions, all with heavy-duty relay outputs and single function S range solid-

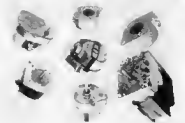

state output timers with adjustable timing intervals from 60 milliseconds to 10 hours. Each S range timer is designed to operate at any voltage between 10 and 264 V.

*Crouzet Limited*  
108 Hawley Lane  
Farnborough  
Hants GU14 8HY  
Telephone: (0252) 513211  
Telex: 858612

(13280 4F)

## Capacitive proximity sensors

Following the recent introduction of inductive proximity sensors and photoelectric devices, Sigma has now added a new range of capacitive proximity sensors to its already extensive switch and sensor range. The new capacitive range contains both DC

and AC models which will sense most materials including liquids.

DC models are tubular with either plain all plastic bodies, or threaded metal-cased bodies. The shielded models offer a sensing range of 15 mm, unshielded ones 20 mm. Outputs are p-n-p or n-p-n, normally open, with a maximum output current of 200 mA.



A similar range of sensors is available for AC input. The shielded and unshielded models have sensing ranges of 15 mm and 20 mm respectively, while a flat disc model offers an extended sensing range of 70 mm. AC sensors have NC or NO output at 5...200 mA.

*Sigma Limited*  
Spring Road  
Letchworth  
Herts SG6 4AJ  
Telephone: (04626) 3841  
Telex: 825535

(13280 11F)

## Single-chip TV control and tuning IC

The new SAA1280 from ITT Semiconductors provides push-button synthesized tuning of up to 16 stations, and analogue volume, brightness, contrast, and saturation controls. The chip features three bandwidth and one VCR switch outputs, four analog outputs, four way multi-standard switching, output for a 1½ digit station display, muting during change of station or band, and tuning voltage generation with rate multiplier.

The device connects to a 28-key pad which it automatically debounces. The keypad and display being interconnected for key pad scanning.

In addition to direct station selection, the SAA1280 also provides sequential station selection, automatically scanning through the stations at 150 millisecond intervals.

YOUR OPENABLE SOURCE...

TEXONIC  
INSTRUMENTS

<b>CC</b> CIRCUIT BOARD REPAIR SERVICE POWER SUPPLY UNIT	<b>MELTRON</b> ELECTRONIC EQUIPMENT	<b>ZHELTRON</b> ELECTRONIC EQUIPMENT
<b>MAHA ELECTRIC INDUSTRIES LTD</b> ELECTRIC INSTRUMENTS ELECTRICAL COMPONENTS ELECTRICAL LABORATORY	<b>PROTECTION</b> ELECTRONIC EQUIPMENT	<b>PROTECTOR</b> ELECTRONIC EQUIPMENT
<b>PARAMOUNT INDUSTRIES</b> ELECTRIC INSTRUMENTS ELECTRICAL COMPONENTS ELECTRICAL LABORATORY	<b>2</b> ELECTRONIC EQUIPMENT	<b>3D</b> ELECTRONIC EQUIPMENT
<b>SHRI RAM INSTITUTE</b> ELECTRIC INSTRUMENTS ELECTRICAL COMPONENTS ELECTRICAL LABORATORY	<b>TRINOSON</b> ELECTRONIC EQUIPMENT	<b>AKROE AF00 LTR</b> ELECTRONIC EQUIPMENT

**TEXONIC**  
INSTRUMENTS

1. AMBARNATHI ROAD, MUMBAI-400 007. TEL. 361 0944/45/46/47

2. MANDESHWAR LANE, S.J.P. ROAD CROSS, MUMBAI-400 026. TEL. 374657/224138

Our Most Important Component — SERVICE

NOT  
JUST ANOTHER  
DATALOGGER...

...IT'S UNIOUE  
AND IT'S FROM APLAB



APLAB 9640 Universal Datalogger/Controller

Automatic control of the process is a unique feature of 9640. This means, your process industry can go on without your continuous supervision. Amazing isn't it? Yes—With 9640, your constant intervention with the controls is no longer required. You just leave it to 9640 which can manage it alone

- Maximum of 96 inputs channels in 19" rack construction.
  - Software linearisation.
  - Wide range of sensors.
  - Built in cold junction compensation
- Alphanumeric printer with real time clock
  - Analogue or Digital Input

**Aplab**

APPLIED ELECTRONICS LTD  
Aplab House A-5/6 Wagle Industrial Estate  
Thane 400 604 India  
Phone: 59 18 61/2/3, 50 73 18.  
Telex 011 71979 APEL IN, Cable: Aplabhana

APLAB/1/85

POPULAR

**TESTICA T-3**



ONLY

Rs170/-

THE ONLY MULTIMETER  
WITH  
PROMPT SERVICE AFTER SALES

**ACCURATE! ROBUST!  
ECONOMICAL!**

AVAILABLE AT ALL COMPONENT SHOPS

MANUFACTURERS:  
**ELECTRICAL INSTRUMENT  
LABORATORIES,**

339/68, RAJESH BUILDING, LAMINGTON ROAD,  
BOMBAY-400 007. PHONE-36 07 49.

# THE AUTO LOGIC MONITOR

## LOGICCLIP LC-16

16 Channel Logic Monitor

- Just clip it on your IC and Logicclip instantly and accurately shows both static and dynamic logic states on a single 16-LED display.
- All 16 leads do not require the usual 16 male supply ground connections or keep your hands occupied.
- Simultaneous monitoring of all 16 pins cuts out guess work, saves time and enhances the job of circuit trouble.
- LC-16 is compatible with all chips on 16-logic ICs: TTL, TTL, TTL, ECL, LLS, CMOS logic 16 pins.

### TECHNICAL DATA

Power Requirement: 100-240V AC, 50/60 Hz  
 Size: 100mm x 100mm x 30mm  
 Weight: 100g  
 Price: Rs. 885/-  
 Lead Time: 10 days  
 Availability: In stock

Try the LC-16 and you will wonder how you ever managed without it!

### Applications

Design, troubleshooting, testing and servicing of logic systems.  
 Design, testing and servicing of digital logic systems.  
 Design, testing and servicing of logic functions in sequential operations.  
 Monitoring of individual IC pins operation at various stages in given IC.  
 To find any malfunction in logic and or more ICs in digital logic by using lead or more IC.  
 Please write us for your ICs.



Now with imported contact clip

Only Rs. 885/-



## PULSECHO SYSTEMS

117, Narml Industrial Estate, Near Sion, Fort Road No. 29, Sion (East), Bombay 400 022 INDIA  
 Telephone 47 10 55 48 20 87  
 Gram PULSECHO Matunga, Bombay 400 019  
 Telex Cir. 011 7546 7 MDIV IN

# DATA BOOKS

<b>Signetics</b>	<b>MOTOROLA</b>	<b>NATIONAL SEMICONDUCTOR</b>
<b>FAIRCHILD</b>	<b>INTERISL</b>	
 <b>TEXAS INSTRUMENTS</b>	<b>SIEMENS</b>	
<b>Zilog</b>	<b>intel</b>	<b>SANYO</b>
<b>ANALOG DEVICES</b>	<b>PHILIPS</b>	<b>SPRAGUE</b>
<b>TELEDYNE</b>	<b>GENERAL ELECTRIC</b>	
<b>HEWLETT PACKARD</b>	<b>GENERAL INSTRUMENT</b>	<b>PMI</b>

COOK BOOKS, OSBORNE BOOKS, SYBEX BOOKS, TAB BOOKS, SAMS BOOKS, TOWER BOOKS, ELEKTOR BOOKS, APPLE COMPUTER BOOKS AND MICROPROCESSOR COMPUTER BOOKS etc  
 PLEASE WRITE FOR DETAILS.

## ELTEK BOOKS-N-KITS

6 RITCHIE STREET, MOUNT ROAD  
 MADRAS 600 002, S. INDIA  
 GRAM: ELTEK PHONE: 844405 TELEX 41-6734 TEX IN

NEW ARRIVAL  
**SANYO - "S T K" DATA DIAGRAM BOOKS UP-TO-DATE**  
**WORLD TRANSISTOR COMPARISON BOOKS**

## THE SIMPLE ANSWER FOR ELECTRONICS COMPONENTS

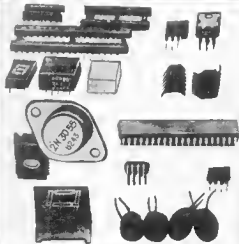

EACH NEW DAWN BRINGS THE POSSIBILITY OF A NEW PROGRESS.

- ICs: TTL, CMOS, MOS, LSI, LINEAR, MICROPROCESSOR, MICRO COMPUTER, etc.
- IC SOCKETS: MOLEX & SAK MAKE INCLUDING MOLEX PINS & TEXTOL & INSERTION SOCKETS.
- TRANSISTORS: MULTITURN AS WELL AS SINGLE TURN OF DOUGLAS, VRN & BAKEMAN MAKE.
- DISPLAYS: 3", 5" & 6" IN COMMON CATHOD & COMMON ANODE INCLUDING 3/16 DIGIT LCD.
- TANTALUM CAPACITORS OF ALL VALUES.
- ZENER DIODES, SILICON DIODES, POWER TRANSISTORS, PHOTO TRANSISTORS, PHOTODIODES, LED'S CRYSTAL, etc.

**INDENTOR FOR ALL TYPES OF ELECTRONIC COMPONENTS, INSTRUMENTS, GREEN PHOSPHOR AS WELL AS RGB MONITORS ETC.**

# LEONICS

FOR SEMICONDUCTOR DEVICES

2/24, LASANWALA CHAWL  
 M.G. ROAD, GHATKOPAR (EAST),  
 BOMBAY-400 077.  
 PHONES: 5137225, 5135845

### CONDITIONS OF ACCEPTANCE OF CLASSIFIED ADVERTISEMENTS

1) Advertisements are accepted subject to the conditions appearing on our current rate card and on the express understanding that the Advertiser warrants that the advertisement does not contravene any trade ect inforce in the country.

2) The Publishers reserve the right to refuse or withdraw any advertisement.

3) Although every care is taken, the Publishers shall not be liable for clerical or printer's errors or their consequences.

4) The Advertiser's full name and address must accompany each advertisement submitted.

The prepaid rate for classified advertisement is Rs. 2.00 per word (minimum 24 words). Semi Display panels of 3 cms by 1 column. Rs. 150.00 per panel. All cheques, money orders, etc. to be made payable to Elektor Electronics Pvt. Ltd. Advertisements, together with remittance, should be sent to The Classified Advertisement Manager. For outstation cheques please add Rs. 2.50

READ all ELECTRONICS BOOKS at 1/3 ed of original price For details contact SRI KRISHNA ASSOCIATES, B/25, Mahesh Co-operative Housing Society Dattapada Road Bombay - 400 066

Available data sheet and application of any electronic components Minimum charges Rs 15/- Write to DATA BANK, Plot No 16, Bldg No 3 Flat No 17, Bhavani Nagar, Marol Maroshi Road, Andheri (East), Bombay - 400 059

Take our practical oriented home study course on "BASIC ELECTRONICS". Golden opportunity to learn from experts. Write to ELECTRONICS CENTRE, 21 Shastri Nagar, Jaipur - 302 016

ACCORD ELECTRONICS .	1-10
AFCO I. & C. LTD . . . . .	1-72
APEX . . . . .	1-76
APLAB . . . . .	1-75
APPOINTMENT . . . . .	1-78
ATRON ELECTRONIC . . . . .	1-80
COMPONENT TECHNIQUE . . . . .	1-14
DEVICE ELECTRONICS . . . . .	1-15
ECONOMY ENGINEERING . . . . .	1-10
ELCIAR . . . . .	1-72
ELTEK BOOKS N KITS . . . . .	1-06
GLOLITE ELECTRICALS . . . . .	1-72
IEAP . . . . .	1-76
INDIAN ENGINEERING . . . . .	1-12
KEJRIWAL . . . . .	1-08
KIRLOSKAR ELECTRODYNE . . . . .	1-04
KOENIG ELECTRONICS . . . . .	1-17
LEADER . . . . .	1-08
LEONICS . . . . .	1-79
LOGICS . . . . .	1-74
MINI CIRCUITS . . . . .	1-11
MODI ELECTRONICS . . . . .	1-80
MOTWANE . . . . .	1-13
ONGC . . . . .	1-81
OSWAL ELECTRONIC CO. . . . .	1-02
PADMA ELECTRONICS . . . . .	1-14
PECTRON . . . . .	1-78
PIONEER . . . . .	1-08
PLA . . . . .	1-09
PULSHECHO . . . . .	1-79
RAJASTHAN ELECTRONIC . . . . .	1-02
ROCHER ELECTRONICS . . . . .	1-73
SAINI ELECTRONICS . . . . .	1-76
SIEMENS . . . . .	1-06
SOLDRON . . . . .	1-74
SUCHA ASSOCIATES . . . . .	1-73
TESTICA . . . . .	1-75
TEXONIC . . . . .	1-75
UNLIMITED . . . . .	1-73
VASAVI . . . . .	1-10
VISHA . . . . .	1-84
ZAC ELECTRONICS . . . . .	1-12
ZODIAC . . . . .	1-14

## corrections

### QL RAM extension

(Aug/Sept 1986 .

P 54)

In the text (penultimate paragraph) it is erroneously stated that in the 54 K extension pin 11 instead of pin 13 of IC<sub>5</sub> must be used as CS. In fact pin 11 must be used in both extensions.

**WE WISH YOU A VERY  
HAPPY NEW YEAR**

**RUSH YOUR ORDER  
TILL STOCKS LAST !!!**

## LED Digital Clock Kit

### Using IC MM 5387

Digit size 0.5 inch. Crystal controlled operation.  
Kit is supplied without cabinet.

**Rs. 235.00**

### With Calendar Function Using IC MM 7317

Digit size 0.5 inch. Crystal controlled operation.  
Kit is supplied without cabinet.

**Rs. 260.00**

(Red colour display with "5" digit height, crystal controlled operation)

### NEW ARRIVAL

**SOLDERLESS** Bread board  
(small size) WBU-301  
ideal for testing  
small electronic projects  
for Rs 90.00 only

### SPECIAL OFFER

**Two Colour LED**  
in 5 mm, Flat  
& 3 mm. Sizes.  
**Rs. 3.00 each**

### DEMANDED KIT

LCD thermometer  
Complete kit  
now  
for Rs 600.00 only

### NOW AVAILABLE

**DIGILEX PCB**  
**Rs. 85.00 Only**

## EX STOCK

10 Bands per channel.  
Frequency response 10Hz to 20KHz.  
(equaliser with all controls of zero)

Ronge  $\pm 13$  dB.  
Maximum output (0.1% distortion) 6 Volts.  
Maximum input 10 Volts.  
Input Impedance 47 K.  
Output Impedance 100 ohms.

**Complete kit with cabinet Rs. 800.00**

**VISHA  
ELECTRONICS**

17, Kelpara Building, First Floor  
349, Lamington Road  
Bombay-400 007 Tele: 362650, 363549

### How to order:

- Send 50% in advance along with order by M.O. or D.D. in favour of VISHA ELECTRONICS.
- Cheque payment not accepted
- Add 15% M.S.T. on total amount
- Prices quoted do not include packaging and forwarding charges
- Material will be sent by V.P.P. for the balance amount
- Send self addressed envelope with your enquiries
- Mention only Pack No. in your order.