

126

November
1985

elektor

INDIA

Rs. 7.50

electronics

incorporating
selex

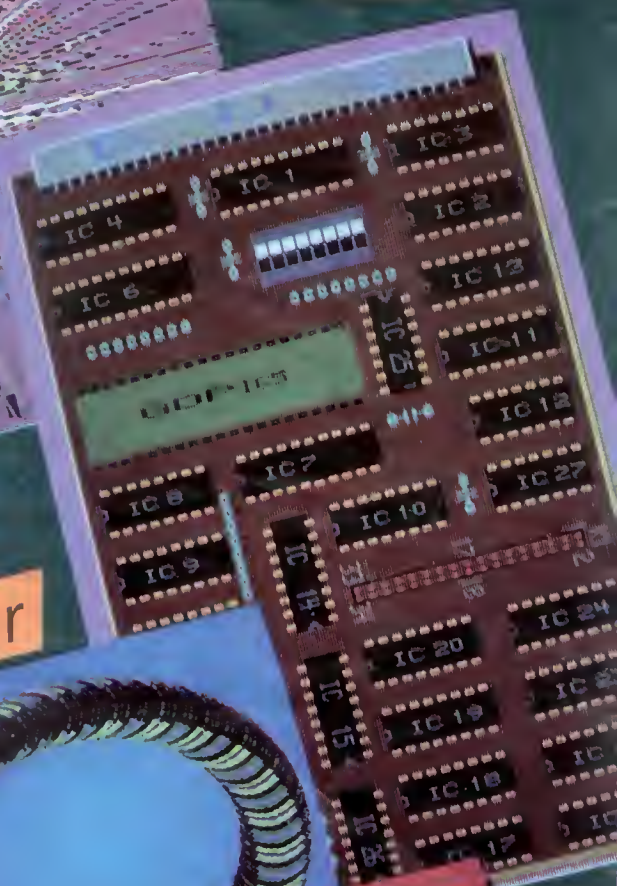
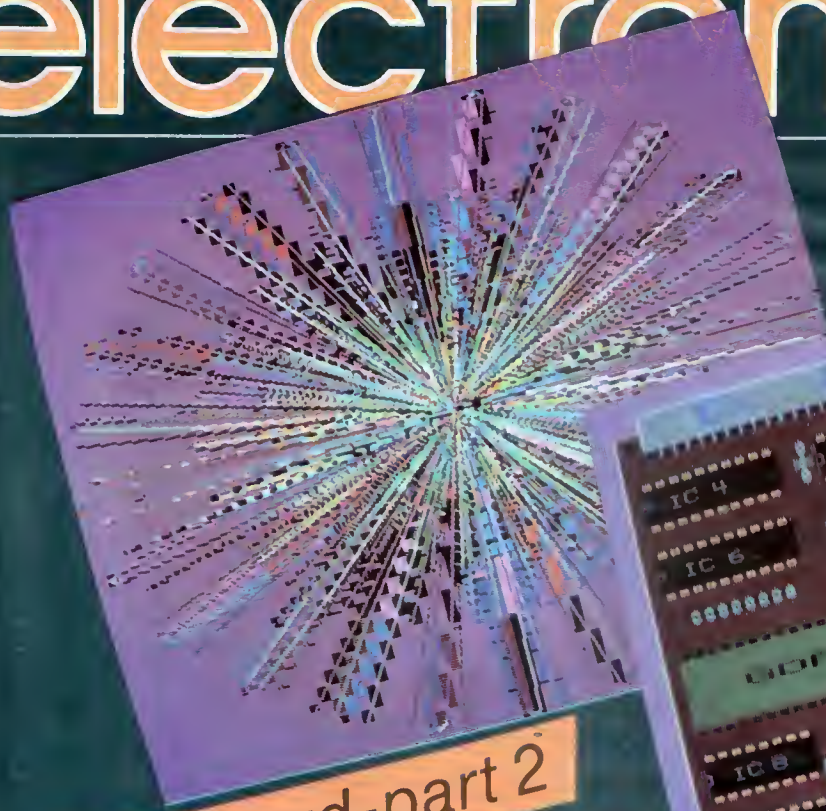

graphics card-part 2

luxury transistor tester

simple sound effects

stage lighting

sound rotator

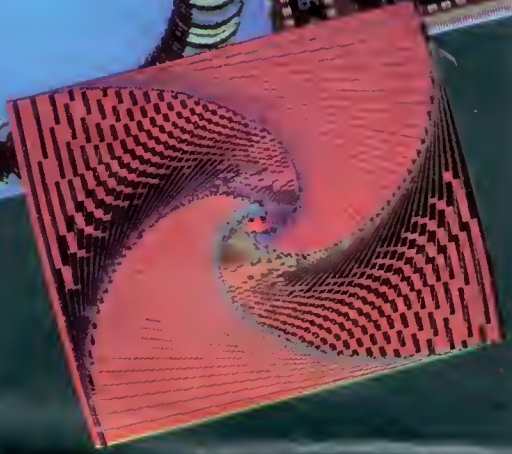

This month's front cover shows the high - definition colour graphics card described in four parts in our October 1985 to January 1986 issues, and some typical examples of the displays obtainable with it.

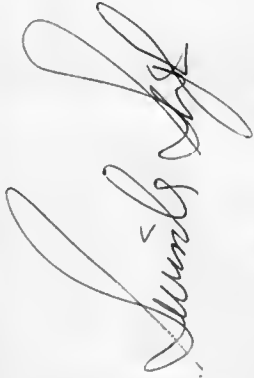

A selection from our next issue :

- sweep generator
- stage lighting - 2
- MIDI interface
- graphics card - 3
- car radio amplifier

news & views

editorial	5
electronics scene	15

electronics technology

electronics & medicine	12
design ideas — clock oscillators	17
viewdata in Britain	50
electronics select	52

projects

high-resolution graphics card — 2	20
<small>Second part of the articles describing a versatile graphics card.</small>	
sound rotator	26
<small>Electronic version of the mechanical Lesley speaker system.</small>	
stage lighting	29
<small>Economical way of obtaining a fully controllable stage lighting system.</small>	
hand-held anemometer	36
<small>Ideal for, among others, wind surfers, glider pilots, amateur meteorologist, and yachtsmen.</small>	
luxury transistor tester	44
simple sound effects	48
<small>using only two ICS a wide range of sounds can be produced varying from an American police siren to the twittering of birds</small>	

information

corrections	74
new products	65

guide lines

switchboard	69
classified ads	74
advertisers index	74

selex-6

digi course (chapter-6)	56
constant current sources	59
AC supply	61
resistor combination	62

PRECISION
DIGITAL MULTIMETER
FROM
LOGICS

Table Model
LD 255 & LD 555
3 1/2 And 4 1/2
Auto Manual Range



Voltage : 0—1000 Vts Ac/Dc
Current : 0—10 A Ac/Dc
Resistance : 0—20 Meg
Accuracy : $0 \pm 5\%$ And $0 \pm 0.05\%$
Optional : Frequency Counter and
Thermometer

Hand Held
LD 155
3 1/2 And 4 1/2 D.M.M.
Auto or Manual Range.



Voltage : 0—1000 Vts Ac/Dc
Current : 0—10 Amps
Resistance : 0—20 Meg.
Capacitance : up to 20 MFD

Please Contact:

LOGICS

107, 6 Main road,
8 Cross Malleswaram
BANGALORE--560 003
Phone 366 526 Grams: COMPULOGIK

COMTECH



INSTRUMENT—CASE TYPE-T-220



Suitable for
PORTABLE—TABLE TOP
TEST INSTRUMENTS

- Digital counters
- DMM
- Multifunction Meters
- Ph meters
- Size—220×230×56 to 92
- Moulded in ABS plastics
- Choice of colours. Beige & light gray
- Inclinable handle

Also available

- Thumbwheel switches
- Display Bezel for 3 1/2 digit
- Instrument clamps

For more information, contact:

COMPONENT TECHNIQUE

8, Orion, L.P. Road, Andheri (W), Bombay-400 058.

Tel: c/o 4224066

Padhye prints



TEXES TRANSFORMERS

**In both design and construction
the reliability of the
Transformer is given
first consideration.**

TEXES FOR TRANSFORMERS

- **Top is Sound Mechanical Construction**
- **Economical and Compact Design**
- **X, Flux and Current Density such as to avoid local loading.**
- **Excellent Performance**
- **Strict Quality Control.**

Manufacturers of Step up & Step down Power Transformers (Single Phase & Three Phase), Ignition and Neon Sign Transformers, Power Supplies and Special Transformers as per Customers Specifications.

Regd. Office,

TEXES TRANSFORMERS

Sabeena
Apna Vatan, Opp. Deonar Bus Depot.
Bombay - 400 088. Phone: 551 3681

PUBLISHER: C.R. CHANDARANA
EDITOR: SURENDRA IYER
EDIT ASSISTANCE: ASHOK DONGRE
ADMINISTRATION: J. DHAS
PRODUCTION: C.N. MITHAGARI

ADVERTISING & SUBSCRIPTIONS

elektor ELECTRONICS PVT LTD.
 Chotani Building
 52 C, Proctor Road Grant Road (E)
 Bombay-400 007.

DISTRIBUTORS:

Blaze Publishers & Distributors Pvt. Ltd.
 Eucharistic Congress Building No 1, S Convent Street,
 Bombay - 400 039

PRINTED AT:
TRUPTI OFFSET

103, Vasan Udyog Bhavan,
 Off Tulsii Pipe Road,
 Lower Parel, BOMBAY-400 013.

Elektor India is published monthly under agreement with Elektuur B.V. Holland, August/September is a double issue.

SUBSCRIPTION

INLAND
 1 Yr Rs. 75/- 2 Yrs Rs. 140/ 3 Yrs Rs. 200/-

FOREIGN

One year Only
 Surface mail Rs. 125/- Air mail Rs. 210/-

The Circuits are for domestic use only. The submission of designs, of articles to Elektor India implies permission to the publishers to alter and translate the text and design, and to use the contents in other Elektor publications and activities. The publishers cannot guarantee to return any material submitted to them. All drawings, photographs, printed circuit boards and articles published in Elektor India are copyright and may not be reproduced or imitated in whole or part without prior written permission of the publishers. Patent protection may exist in respect of circuits, devices, components etc. described in this magazine.

The publishers do not accept responsibility for failing to identify such patent or other protection.

INTERNATIONAL EDITIONS EDITOR K. Walraven

Overseas editions
Elektuur BV
 Peter Treetspoortstraat 2-4
 6321 XK Boven - the Netherlands
Editor: P. E. L. Kerssemakers
Elektor satl
 Route Nationale Le Seau B.P. 53
 5670 Balleul France
Editors: D. R. S. Meyer G. C. P. Raenderdorf
Elektor Verlag GmbH
 5133 Gangeln Postfach 1190
 West Germany
Editor: E. J. A. Kempenhauser
Elektor EPE
 Kazanlika 14
 16073 Voulas Athens Greece
Editor: E. Xanthopoulos
Elektor JCE
 Via Rossellini 12
 20124 Milano Italy
Editor: O. Fumagalli
Ferreira & Bento Lda
 R. O. Esselama 32 1.
 1050 Lisboa Portugal
Editor: Jorge Gonçalves
Inzelek S.A.
 Av. Alfonso XIII, 141
 Madrid 16 Spain
Editor: M. Ferrer

Copyright © 1985 Elektuur B.V. Netherland

Sinclair: any suitors?

Why is it that so many clever and inventive entrepreneurs seem to run into trouble so often? Take Sir Clive Sinclair: entrepreneur and inventor par excellence. But, so far, this year has not been a very good one for him. Starting with a divorce, it then confronted him with a declining home computer market, troubles with the Advertising Standards Authority about the C5 one-man electric car, and a writ claiming more than £1.5 million from Hoover for alleged non-payment of bills.

It all seems rather unfair to a man who has, arguably, contributed more to the computer industry than anyone else since the early 1970s. In fact, it is fairly certain that without him there would never have been so many computer enthusiasts in Britain — or in the rest of the world.

Clive Sinclair started his first company in 1962 while still in his early twenties. Ten years later, Sinclair Radionics launched a pocket calculator which was then almost certainly the smallest, best designed, and cheapest in the world. But fierce and growing competition caused the company to be bailed out some years later by the National Enterprise Board. Within a short time, Clive Sinclair had left the company: was it because he could not — or would not — work within the constraints of an industrial undertaking?

However, this move was the computer world's gain. Within two years, Sinclair had launched the first-ever computer to sell for under £100: the ZX80. Over 100 000 of these were produced. Its successor, the ZX81, was even more successful with sales topping a million worldwide. Even that has been put in the shade by the ZX Spectrum, probably the most successful computer the world will ever see.

But then, a decline set in: neither the hand-held flat-screen TV receiver nor the new QL computer caught on. It seems, however, that the C5 electric car — or rather the £12 million spent on its design? — has done the most damage to Sinclair.

Sinclair has still plenty of ideas, but he needs money to materialize them. There should be sufficient interest from industrial backers for his wafer-scale chips and his compact data-storage device; rather less so for his electric car with a roof.

When, last June, Mr Robert Maxwell proposed a £12 million rescue plan, there were sighs of relief in many quarters of the industry. But, alas, when it was learnt that the stock of computers amounted to no less than £35 million, Mr Maxwell called off the deal.

At the time of writing, no other helping hand has been extended. None the less, there are some glimmers of hope for Sir Clive. The recently merged Dixons/Currys Group have placed a £10 million order for computers and miniature TV sets. At the same time, there are signs that the miniature television receiver may take off at last in earnest — particularly in the USA.

We hope these may prove to be turning points for Sir Clive, but even so, he will need further financial help. We wish him well: he deserves it!

*The Pioneer in
PC Technology*

MICROPACK pioneers many **FIRSTS** in micropackaging Electronic Circuits, such as

- Multilayer Boards (Mass laminated)
- SMOBC/SSC (Solder mask on bare copper/Selective solder coating) PTH Boards for wave soldering
- CNC Drilling (small holes)
- Computer Aided Testing
- Membrane Touch Panels
- Multilevel circuits
- Polymer Thick Film hybrids
- Bonded Heat Sink PCBs
- Solder coated boards to MIL-P-55110 C

- **Multilayers approved by Underwriter's Laboratories (U.L.), U.S.A.**

Contact MICROPACK
and touch tomorrow

mp Micropack

MICROPACK LIMITED

Raghavendra Complex
418/1, 10th Main, IV Block,
Jayanagar, Bangalore-560 011.

Ph. 41232 Grams : 'MICROPACK-Bangalore'
Tlx. : 0845-8429 PAC IN

Talcherkars/ML-6



**Semiconductor
Complex Ltd.**

- * Microprocessor Ics/LSI
- * CMOS/Linear
- * Watch Modules/Displays
- * New range of ICs to be announced.

Contact

**General
Electronics**

307, Arun Chambers, Tardeo, Bombay 400 034
Telephone: 4946422, 4947953, 4946553
Cable: AHUJEEC. Telex: OH-76393 GENE. 001

Market Showroom

General Sales Agency

4, Yamuna Bldg, Tara Temple Lane, Lamington Road,
Bombay 400 007. Tel: 369250, 386178.

Almost Everything For
Sinclair ZX
SPECTRUM
Computers

- Guaranteed Repairs.
- Latest Software Rs. 50/- for two programmes including cassette and manual. Get our free list.
- Custom written Software.
- Monitor Rs. 2100/-
- 80 Column Dot Matrix printers with interface for QL also.
- All types of Interfaces.
- All types of Peripherals.
- Many Accessories.
- C-10-C-15 blank cassette for data recording.
- Furniture: Simple and Elegant tables specially made for computers.

Contact :

Pioneer Electronics

2, Court House, Dhobitalao, Bombay - 400 002.

Ph. Office: 311634 Res: 475693

CLEANLINESS – The Invisible Dimension of Quality –

DISCOVER WITH KIRLOSKAR CLEAN AIR SYSTEMS.

A must for Dustfree, sterile Atmosphere in
Electronics, Aeronautics, Engineering, Medical,
Chemical and Pharmaceuticals.

Clean Bench : Horizontal/Vertical Flow

- Provides class 100 Clean Air in restricted area
- Removes dust particles down to 0.3 micron
- 99.97% efficiency
- Available in size – 610×610 mm, 1220×610 mm, 1830×610 mm
- Table Top Models also available

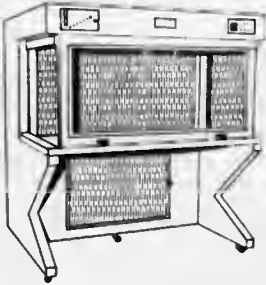

Clean Room :

- Provides upto class 100 Clean Air over large work areas.

Air Curtain :

- Arrests entrance of dust in doorways.
- Available in different sizes

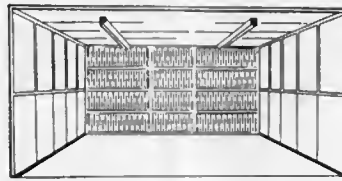

Air Shower :

Fully automatic, electrically operated, direct highly pressurised air through nozzles to remove all dust particles from clothing, footwear and other articles before entry into a clean room.

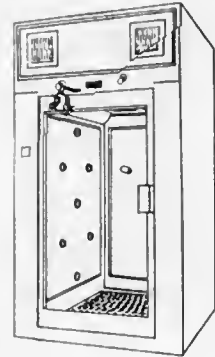

Bio Hazard Unit with U/V Light/Virus burn unit.

- Ideal for safe microbial research
- Available in size – 610×610 mm, 1220×610 mm, 1830×610 mm

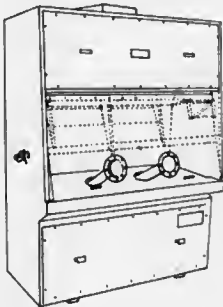

- Chemical Benches are also available in above sizes.

Portable Electronic Cleaner :

For fume clearing and recovery of suspended particles in pharmaceutical industry. Handles 15 to 180 M³/minute air.



- Works with high efficiency at high temperature.
- Can be coupled to air conditioning or airhandling systems
- Low on power consumption.
- Easy to maintain.
- Long life

For details contact

**KIRLOSKAR
ELECTRODYNE
PVT. LTD.**



118, General Block, M.I.D.C.
Bhosari, Pune 411026
Tel : 86121, 86122, 86123,
86124, 84429
Telex : 145-260 KEPL IN
Regional Offices at:
Ahmedabad Tel. 52228
Bangalore Tel. 369556,
Calcutta Tel. 433836,
New Delhi Tel. 312131,
Jaipur Tel. 77734

Kirloskar Electrodyne :
Total Capability In Clean Air Systems

UNLIMITED

Electronic and Computer Components
The Largest Retail Showroom
 ON FIRST FLOOR

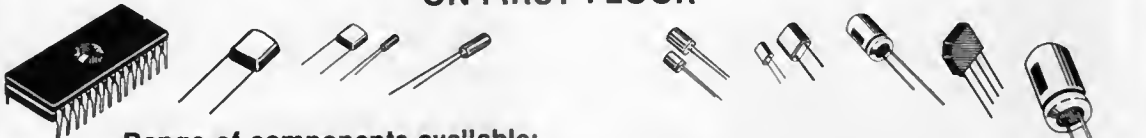

Range of components available:

■ Microprocessor ICs ■ Linear ICs ■ Entertainment ICs ■ CMOS, TTL, LS ICs
 ■ MC, LF, CA, XR, TLO, 8T series ICs ■ CD, CD45, 74, 74S, 74C, 74LS series ICs ■ 78, 78M, 78L,
 78P, 79 and LM series Voltage Regulators ■ All type of Transistors and Semiconductors ■ A wide
 range of Resistors and Capacitors ■ Ten Turn Trimpots, Single Turn Trimpots, Cermet Pots,
 Helipot ■ Flat Cables ■ FRC Connectors, D Type Connectors ■ Textool ZIF Sockets ■ IC
 Sockets ■ A wide range of Switches and Thumbwheel Switches ■ Standard Cabinets and Hardware
 ■ ASCII Keyboards ■ Floppy Discs ■ Spare Parts and software for SPECTRUM. ■ Seven Segment
 LED and LCD Displays ■ Crystals from 1MHz to 32.768MHz ■ Optocouplers.

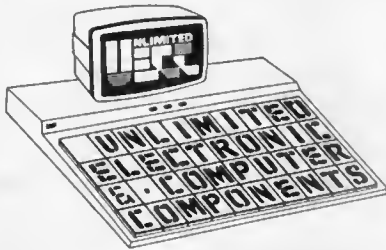
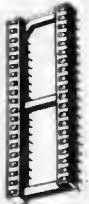

UNLIMITED Electronic & Computer Components

Neelam Manzil, 1st Floor,
 350, Lamington Road,
 Bombay 400 007

Phone: 369370



AE NUMERIC PRINTERS



■ Epson 460 Mechanism ■ 16 Columns
 of numeric print ■ BCD TTL Input ■ Parallel
 and/or mux data input ■ Parallel and mux data
 input can be mixed ■ Microprocessor based
 ■ Compact and panel mountable ■ Drawout
 design for paper roll replenishment ■ Low
 price for its value

Also available alphanumeric printers

For details contact:

ARUN ELECTRONICS PVT. LTD.
 B Ansa Industrial Estate,
 Saki Vihar Road. Bombay-400 072
 Tel. 583354, 587101, 585975
 Gram ARUNEL Telex: 11-72236 AOPL-IN

WE KEEP LARGEST STOCK
 AT
 THE MOST CHEAPEST PRICE

EPROM ● 2716 ● 2732 ● 2532 ● 2764	REGULATOR ● 7805 ● 7809 ● 7812 ● 7815	CERAMIC FILTER SFE 5, 5 MB SFE 10, 7 MB
TTL/CMOS 74 LS00-373 4001-45106	SCR/TRIAC 6A-40A 400V-600V	OP-AMP ● 324 ● 339 ● 741 ● 158 ● 258 ● 358
TBA-SERIES ● 800 ● 810 ● 820 ● 920	TDA-SERIES ● 1154 ● 1170 ● 1190 ● 2593	TRANSISTORS ● 2N ● BL ● BD ● BF-SERIES

MANY MORE SALEABLE ITEMS



CONTACT:

梧槽電子企業

ROCHOR ELECTRONICS ENTERPRISE

500B, BLK 1, ROCHOR ROAD, (ROCHOR CENTRE) SINGAPORE 0718
 TEL 2941094, 2928364 TELEX RS 26483 ROTRON CABLE ROTRONIC



**A MADE IN U.S.A. label
is the only feature
we don't offer**

**"ALISDA
APPROVED"**

The Motwane 4½ Digit Multimeters DM-450 and 451 are as good as the best in the world. Developed in our inhouse R & D laboratory, these DMMs compare in terms of reliability, efficiency, performance, quality of design and manufacture; or simplicity in operation—with the Prime. The Motwane DM-450/451 offer a host of features, the most outstanding of which are:

- True R.M.S. volt and current measurements over a wide frequency range (Model DM-450).
- 10 microvolt resolution on AC and DC
- Imposing accuracy—Basic of 0.03% of reading + 1 digit and low Tempco.
- B.C.D. output for systems capability.
- Full protection against inadvertent overload.
- Sleek, plastic casing for the most effective sealing, longer lasting good looks, making the instruments practically unbreakable.
- Quality that's exclusive, at a price that's not.

These 4½ digit, 5 function, 27 ranges DMMs measure upto 1000V on AC and DC, 2 Amps on AC and DC and 20 Megohm. With careful component selection, sophisticated L.S.I. technology and ultra precision resistors, they guarantee excellent long term stability, quick response time and greatest reliability.

Since instruments of this kind are most often used as a secondary standard, recalibration intervals are longer. These DMMs naturally include automatic polarity and zero, Hi Lo ohms, have only two terminals and are human engineered for the simplest, yet most efficient operation.

Anticipating your future need to build a system around these instruments, also available are the following optional accessories:

- Digital limit comparator for go-no-go checks.
- Digital printer for hard copy
- A simple quick mate jig for speedy Q.C tests.

The DM-450 and 451 perform better because they are built better. We had you in mind when we designed them.



For further details write to:
THE MOTWANE MANUFACTURING
COMPANY PVT. LTD., at Gyan Baug,
Nasik Road 422 101 Tel.: 86297/
86084 Telex: 752- 247 MMPL IN
Grams: MOTWANE or Gyan Ghar, Plot 434 A, 14th
Road, Khar, Bombay-400 052.Grams: MOTESTEM.



—Cut here and mail—

oPlease send literature and quotation

Name _____
Designation _____
Company _____
Address _____
Telephone _____ Telex _____

SELL ADS.MMC.12.84

elektor india november 1985 11.11

Electronic instrumentation is saving lives

The use of electronic devices and instrumentation in medical care has increased dramatically over the past 20 years and new technology is being introduced at an exciting pace. Electronic instrumentation is used to monitor the heart, brain and liver, and to measure pulse rate, blood flow, and metabolism of the human body.

It is used to determine the size, shape, and orientation of an unborn child, and to locate the presence of tumours, damaged tissue, and broken bones.

From the simple blood pressure analyser to the heart pacemaker and whole body scanner, electronic instrumentation has made possible the alleviation of suffering and the prolongation of human life to an extent that would have caused past generations to gasp in astonishment.

Among recent developments has been the pioneering of life-saving surgery by the so called *laser scalpel* developed by

fed into the patient and carefully positioned so that its pin-head tip is aligned opposite the treatment site. The important alignment procedure is assisted by passing visible light through the cable and connecting it to a viewing device known as an endoscope.

When the cable tip is precisely positioned at the delivery site, the visible light is replaced with a short duration burst of near-infrared light derived from a powerful laser. The laser, its power supply, and all the controls are housed in a floor-standing unit that can be used anywhere in the hospital where a three phase electrical supply and mains cooling water are available. Known as Fiberlase-100, the system uses a neodymium doped yttrium aluminium garnet laser (usually described by the abbreviation Nd-YAG), which produces near-infrared light at a wavelength of $1.06 \mu\text{m}$. At this wavelength, the laser light is able to penetrate deep into the tissue and can seal off large, bleeding vessels and



Harwell developed ultrasonic inspection system in use at Moorfields Eye Hospital, London displays ultrasonic images of the eye directly on a television screen and allows them to be recorded on a standard video recorder.

Electronics and medicine

Barr & Stroud. This revolutionary technique was first used in the early 1980s and, in particular, in 1984 at the Oldham and District General Hospital in northwest England, by Naru Hira, senior consultant surgeon. He treated bleeding stomach ulcers and removed tumours all without open surgery and with only a local anaesthetic.

Laser Light

The Barr & Stroud technique relies upon a length of fibre optic cable being

destroy tumour cells. The laser power delivered to the target site is microprocessor controlled and can be delivered in pre-settable 10 W increments over the range 50 to 100 W. The laser pulse duration can be similarly pre-set over the range 0.1 to 9.9 seconds in increments of 0.1 second.

Digital displays are a very important feature of the Fiberlase-100. They can be used to indicate the energy delivered by each laser pulse, the number of pulses delivered, and the accumulated energy dose received at the target site.

Radioactive Tracers

An ancillary facility provided by the system is the ability to deliver carbon dioxide gas at low or high flow rates for clearing blood from the target site. The first application of nuclear radiation in medicine took place in 1898, when Marie Curie and her husband Pierre used gamma radiation from naturally occurring radium on tumours in the human body. Since then, techniques have been developed for producing an enormous range of very useful radioactive isotopes of a type that do not exist in nature.

These so called artificial radio-isotopes are produced mainly from the neutron irradiation of non-radioactive nuclei in a nuclear reactor or, less frequently, from proton irradiation of such nuclei in the target chamber of a particle accelerator such as a cyclotron.

Radio-isotopes are widely used in the medical field as tracers, for example, for determining the uptake of iodine by the thyroid gland, the reaction of metabolism of the body to iron and other minerals, and the formation and utilization of fats. Tracers are also widely used to detect the presence of tumours, to measure blood volume in a limb, and to diagnose heart disease.

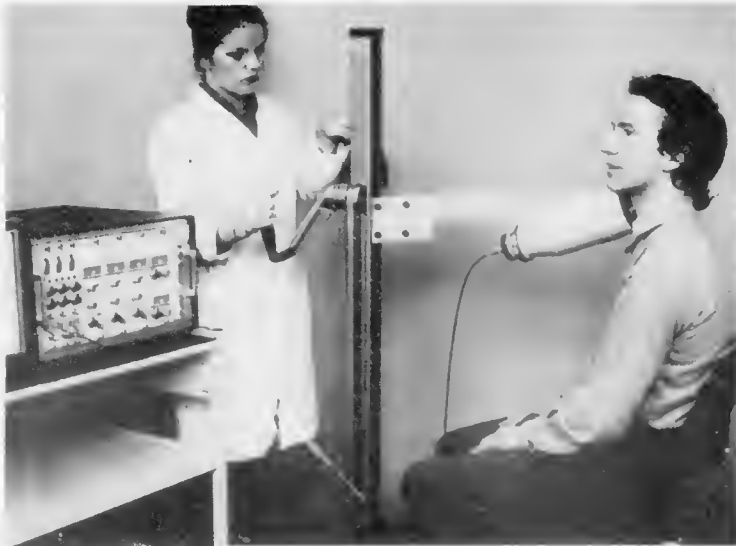

This thyroid counting system from Nuclear Enterprises features a dedicated microprocessor that provides all the facilities required for operating the system.

Picture of Heart

Many of the radio-isotopes used in Britain — and in many other parts of the world — are manufactured in two nuclear reactors and a powerful cyclotron at the Harwell Laboratory in Oxfordshire. These isotopes, in the

main, are marketed by Amersham International, which has two packaging and distribution plants in Britain and exports more than 80 per cent of its products.

The Harwell laboratory has recently perfected a new production technique using its variable energy cyclotron for producing the radioactive isotope gold-195m. This new radio-isotope has a half-life of only 30.5 seconds and is used in a technique known as *single pass nuclear angiography* for investigating the dynamics of the heart.

The technique begins with the injection of a small amount of radioactive gold into the bloodstream and it quickly passes through the vessels of the heart.

A radiation detector made by Scintronix of Livingston in the Lothian Region is positioned outside the body over the heart, and is used to detect the gamma radiation emitted by the radioactive blood cells. It supplies signals to a special camera, which takes up to 60 pictures a second of the emitted radiation. The equipment uses these to build up an image of the heart for display on a conventional television monitor, and to record the data on a video recorder. The image displayed on the monitor can show the heart beating and provides information about its function and operating efficiency.

Repeated Tests

It is the short half-life of gold-195m that makes this particular isotope so valuable. Earlier techniques made use of the technetium-99m radio-isotope, but this has a half-life of six hours.

With a half-life of only 30.5 seconds the injected gold disappears from the body within a few minutes and enables the patient to be subjected to repeated tests at short intervals. The ability to

do this is valuable in monitoring the performance of the heart after exercise or assessing its response to drugs or other stimuli.

The new gold radio-isotope has enabled a major advance to be made in the development of standard diagnostic tests for coronary heart disease and is being assessed at St Bartholomew's Hospital, London, and at the Western Infirmary, Glasgow.

A British company that specializes in the design, development, and manufacture of nucleonic instruments is Nuclear Enterprises of Reading. Founded in 1956, this company supplies instruments to hospitals, teaching establishments, and nuclear installations all over the world.

Ultrasonic Radiation

Representative of the company's nucleonic instrumentation in the medical field is its thyroid counting system. This comprises a scintillation-type radiation detector connected to a microprocessor-controlled electronics assembly. A single channel analyser is set to respond to a narrow band of gamma radiation centred on that emitted by the iodine radio-isotope contained in the patient's thyroid gland. Signals originating in this way are fed to a ratemeter, whose output is connected to a chart recorder displaying the relationship between thyroid uptake and time.

Among many other products applicable to the medical field, Nuclear Enterprises also manufactures the lonex dose/dose-rate meter, which allows precision routine measurements of accumulated gamma-ray dose and dose rate at therapy and patient protection levels.

Ultrasonic radiation is increasingly used in medicine because it is possible to image soft tissue structure, and it is

a safer substitute for X and gamma radiation, particularly in the examination of pregnant women and of those parts of the body where there is insufficient contrast in the irradiated tissue to produce a satisfactory radiograph. A good example of the use of ultrasonics is the new data recording and imaging system developed by the Harwell laboratory for the ultrasonic eye scanner used at the Moorfields Eye Hospital, London.

The system displays ultrasonic images of the eye directly on a standard television monitor and allows them to be recorded on a video cassette recorder. The recording provides the surgeon with a permanent record of the patient's eye condition and allows images to be replayed later during diagnostic discussions.

Campaign against noise

Noise is a hazard that all too often is over-looked by workers and management who could be unaware of its harmful effects until it is too late. That is why Britain's Health and Safety Executive (HSE), the organization that checks safety at work, has launched a major campaign to reduce noise levels at the place of work.

It is estimated that in the United Kingdom alone almost a million people work in noise levels high enough to create a risk to their ears. Some workers may actually suffer permanent damage. Those particularly at risk include shipbuilders, steel workers, men using pneumatic hammers, riveters and, those employed in canning factories.

A circular saw produces about 102 dB and a stockman who looks after pigs can be subjected to squeals of 108 dB. This may not sound much of a difference until it is remembered that 1 dB (decibel) is a logarithmic unit of sound intensity, so that a difference of 6 dB represents a sixfold increase in noise. The HSE campaign hopes to increase awareness of the danger of noise and to encourage quieter machines. Noise in machinery can be dampened by enclosure — for instance, chipboard drills can be quietened by 30 dB in this way — or by special mountings that can reduce noise from vibrating machinery by 13 dB in some cases. The HSE has produced a booklet listing 100 examples of quietening tools and equipment.

Ear Protectors

Another objective is to encourage equipment manufacturers to make quieter machines. This *design against noise* campaign has received support from the Government and is gaining wider backing all the time.

The HSE is also trying to persuade



Conducting a noise level survey in a factory.

workers that when ear protectors are supplied by management they ought to be worn at all times. Noise related hearing impairment is often slow to develop, but, once it does, can be permanent.

Total or partial loss of hearing can result, or the workers may suffer from tinnitus — a constant ringing in the ears. Whatever the risk, all too often workers leave ear protectors off because they are uncomfortable.

In a more general effort to increase noise awareness, the HSE has a mobile exhibition that tours Britain, and it would welcome further legislation to control noise.

Computerized artificial hand

Doctors and biomechanical researchers are producing ingenious devices to replace defective or missing parts of the human body. Prostheses, as they are called, rarely copy the originals absolutely but, with constant advances in associated fields, such as control engineering and electronics, mechanical prostheses are getting better.

At the University of Southampton, Professor Jim Nightingale and his team have been concentrating on one part of the body where an efficient prosthesis could transform the patient's life. For the last 13 years they have been working on an artificial hand. Now, using computer technology and miniature motors, Professor Nightingale believes the team will soon have a model to go into clinical trials.



This sophisticated artificial hand, controlled by sensors and a microcomputer carried by the user, was designed at Southampton University, England.

Numerous problems face existing prosthetic hands. Many are cumbersome with a limited amount of movement. They are generally controlled by muscle stimulation in the stump and, because of poor processing of this signal, hand movements tend to be delayed and only one move can be made at a time. This is quite difficult for the patient when, for example, he

wants to pick up a glass. In addition, the user has consciously to provide muscle stimulation all the time to maintain a grip.

Professor Nightingale has solved many of these problems with the help of a small personal computer that is carried by the patient. He has also designed special sensors to form part of the artificial hand and constantly feed information back to the computer.

More Sensitive Grip

This means that all the patient now has to do is to put the new hand near, say, the glass and, through the normal muscles in this arm, instruct the fingers to close. Three tiny motors in the hand control the thumb, forefinger and other fingers. They all move separately so that the hand closes on the glass with the fingers wrapped into the appropriate positions. From then on the patient can forget that he is using a prosthesis because the computer takes over. Should the glass slip, special slip sensors cause the hand pressure to be increased. The hand weighs only 450 g but can deliver a grip force of 2 kg and, with the sensors embedded in the fingers, should be almost as robust as a normal hand.

The computer that controls it is about the size of a video tape cassette but Professor Nightingale believes his team might soon be able to fit a smaller one into the hand itself. Unfortunately, the battery to power the equipment is still fairly cumbersome. Professor Nightingale's prosthesis is still in the research stage, but the successful use of sensors and feedback with a computer that is not preprogrammed offers real hope for more natural mechanical hands.

More effective monitoring of drug safety

Britain's Committee of Safety of Medicines (CSM), which monitors the effects of drugs on patients, has initiated a trial to improve the reporting by family doctors of adverse drug reactions on patients. The pilot study will involve 300 doctors and will look at the feasibility of using microcomputers of viewdata equipment to make the reports. If the scheme is successful, there is the likelihood that such systems will ultimately be installed in every family doctor's surgery.

The CSM normally learns about adverse drug reactions by what is known as the yellow card system. The doctor is supposed to fill in a yellow form and post it to the CSM if he has observed some side effect.

Many health workers believe this system misses too many cases. If the computerized scheme proves popular, the CSM is confident it will improve



A family doctor takes part in a pilot project in Britain designed to give rapid warning of harmful side effects caused by drugs. The doctor used Prestel viewdata equipment in his surgery to feed the warning into a central data bank.

the quality and quantity of reports.

Doctors involved in the pilot study key in answers to various questions that they call up on the screen. These questions relate to specific reactions to a drug. The keyed-in information is then sent direct to the CSM by telephone link. Every family doctor has his own security code in the system and the central databanks are further protected by more complex codes so that only authorized people can gain access.

The process will speed up the assessment of a drug's safety and effectiveness. It should also permit drugs that have proved dangerous to be withdrawn immediately.

The CSM now hope to be able to tell doctors that a drug has been banned before the decision is made public through the newspapers. However, the CSM has assured doctors that the computer link will not automatically lead to more drugs than at present being taken off the market.

(LPS)

clock oscillators

An oscillator is a circuit that converts direct-current power into alternating-current power, in contrast to a generator, which is a device that converts mechanical energy into electrical energy.

There are, basically, two categories of oscillator that are of interest to the electronics engineer: harmonic and relaxation. The former produce sinusoidal waveforms and contain at least one active element that supplies power constantly to the passive components, whereas relaxation oscillators produce non-sinusoidal waveforms, such as rectangular pulses.

An oscillator is generally an amplifier operating with positive feedback in a manner whereby an output is produced without any input signal. To achieve the desired frequency, every oscillator contains a frequency-determining part, which may be an LC circuit, a phase-shifting RC network, or a quartz crystal.

Clock oscillators are the simplest of crystal oscillator, which may, none the less, have an overall accuracy of 50 p.p.m. These oscillators form the backbone of the vast majority of digital circuits.

The amplification of an amplifier operating with positive feedback is given by

$$A' = \frac{A}{1 - \beta A} \quad (1)$$

where A' is the amplification with feedback; A is the open-loop amplification; and β is the portion (expressed as a vulgar or decimal fraction) of the output that is fed back to the input.

In designing oscillators, it is necessary to control the feedback in a manner whereby $\beta A = 1$ (the Barkhausen criterion) is true at only one frequency: the desired frequency. When this criterion is met, an output signal exists even when the input signal is zero.

The quartz crystal

A quartz crystal is cut from a bar of manufactured quartz. If an alternating electric potential is applied across a certain direction (related to Young's modulus) of the crystal, mechanical vibrations result. If the frequency of the applied potential corresponds to a natural frequency of vibration of the crystal, very powerful vibrations are set up, which, in turn, cause an alternating field across the crystal. The mechanical vibrations suffer little from damping and have a sharp resonance peak.

The equivalent circuit of a quartz crystal is shown in Fig. 1. Note that C_1 ,

design ideas

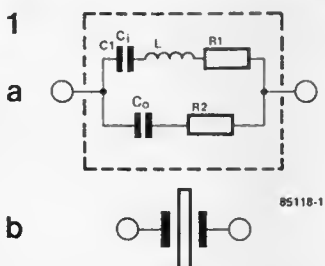

Fig. 1 (a) Equivalent circuit of quartz crystal, and (b) circuit symbol.

L , and R_1 are not true electrical components, but merely serve to illustrate the performance of a crystal vibrating at, or near, its resonance frequency, while C_0 is the electrostatic capacitance of the electrodes, and R_2 is the connection resistance, which normally has such a low value that it can be ignored. Typical values for a 100 kHz crystal are $L = 85$ H; $C_1 = 0.03$ pF; $R_1 = 280 \Omega$; and $C_0 = 3.5$ pF. The series-parallel equivalent circuit shows that there is both a series resonant frequency, f_s (zero impedance), and a parallel resonant frequency, f_p (infinite impedance). The series resonant frequency is

$$f_s = \frac{1}{2\pi\sqrt{LC_1}} \text{ [MHz]} \quad (2)$$

The parallel resonant frequency is

$$f_p = \frac{1}{2\pi\sqrt{LC}} \text{ [MHz]} \quad (3)$$

where

$$C = \frac{C_1 C_0}{C_1 + C_0} \quad (4)$$

From (2) and (3) it is evident that the parallel resonant frequency is always greater than the series resonant frequency, although, since $C_0 \gg C_1$, they are very close.

If the modulus of impedance, $|Z|$, of the crystal is plotted as a function of the frequency, a characteristic curve as shown in Fig. 2 is obtained. When the frequency is increased beyond the

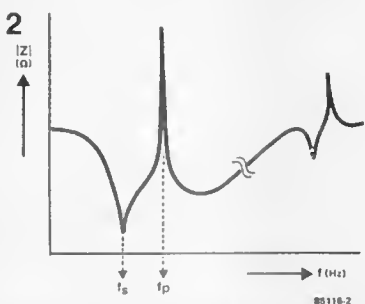

Fig. 2 Modulus (=magnitude) of impedance plotted against frequency.

parallel resonant frequency, the crystal behaves again as a capacitance (as it did below f_s). At about three times the fundamental resonant frequency, there is again a series and a parallel resonance: this is called the third harmonic frequency of the crystal. The physical representation of how a crystal can vibrate at three times its fundamental frequency is given in Fig. 3. The thin

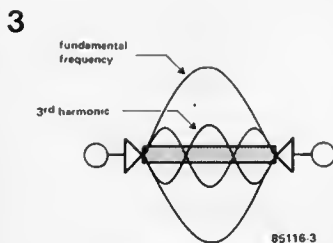

Fig. 3 Physical representation of a vibrating crystal.

quartz disc is deformed longitudinally, but the deflection at the suspension points remains zero, so that only vibrations that are an odd multiple of the fundamental frequency can take place. Modern crystals are available with fundamental frequencies from a few kHz up to about 30 MHz, third harmonics from 20...90 MHz, and fifth harmonics from 60...150 MHz. Note that the mode of vibration is primarily dependent upon the thickness of the plate.

Requirements of a clock oscillator

Clock oscillators must be reliable, easily reproducible, and simple. An example of such an oscillator is shown in Fig. 4. This operates in the parallel

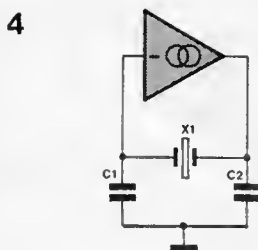

Fig. 4 Circuit of a simple clock oscillator operating in the parallel mode.

mode, which generally means at fundamental frequency. The dynamic capacitance (C_1 in Fig. 1) and capacitors C_1 and C_2 form a capacitive divider, which means that the inverting amplifier needs a high impedance input and output (whence the current source symbol at its output). The output current should not exceed a certain maximum value, otherwise the

design ideas

crystal may become damaged. Also, since some of the energy is converted into heat by R_1 , an excessive current may adversely affect the stability. In general, the power supplied to crystals operating in the 2...30 MHz range should not exceed 10 mW; a safe value is 1...3 mW. Some special crystals for operation below 2 MHz should not be supplied with more than 100 μ W.

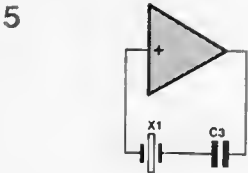

Fig. 5 Circuit of a series-mode oscillator, which is, however, not very reliable in operation.

A series-mode oscillator, Fig. 5, uses a non-inverting amplifier, so that both the input and the output are low impedance. This type of circuit is not very reliable. For instance, when the Q of the crystal is not very high, the oscillator may work as an astable multivibrator (AMV).

The quality factor, Q of a crystal is

$$Q = \frac{2\pi f_s L}{R_1} = \frac{1}{2\pi f_s C_1 R_1} \quad (5)$$

Even fundamental frequency crystals may, in a series-mode circuit, prefer to work on the third harmonic. It is, therefore, advisable that, in general, clock oscillators use parallel-mode circuits.

Overtone oscillators

Oscillators intended for operation on harmonics of the crystal frequency are called overtone oscillators. The series-mode overtone oscillator of Fig. 6

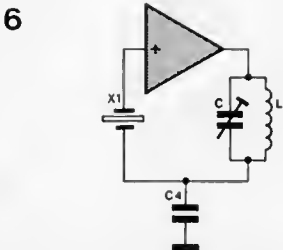

Fig. 6 A series-mode oscillator can be made to operate on the third harmonic by the use of a notch filter tuned to the fundamental frequency.

needs a notch filter, $L-C_4$, tuned to the fundamental crystal frequency, for satisfactory operation. In the parallel-mode overtone oscillator of Fig. 7, however, it is sufficient that either the input or the output of the active

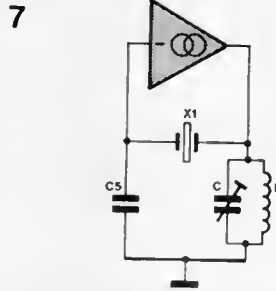

Fig. 7 A parallel-mode oscillator can operate on harmonic frequencies (to which the LC circuit is tuned), but this is rarely done in practical circuits.

element is tuned to, or, rather, to just below, the harmonic, because the modulus of impedance must be capacitive. Although the circuit of Fig. 7 is suitable for operation at up to the fifth harmonic, it is rarely used in practice.

Practical circuits

The most frequently encountered oscillator using NOT gates (inverters) is

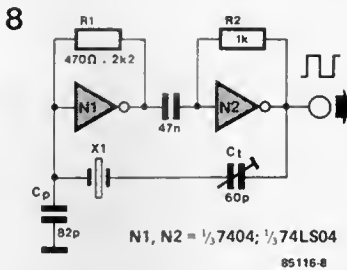

Fig. 8 One of the most common crystal oscillator circuits using TTL gates.

shown in Fig. 8. This series-mode circuit is suitable for operation between 1 and 8 MHz. Fine adjustment of the frequency is provided by trimmer C_1 . If the required frequency accuracy is not great, the trimmer may be omitted. Capacitor C_p prevents operation on a harmonic frequency. The value of R_1 is 2k Ω for operation below 2 MHz. The value of R_2 is calculated from

$$R_2 = 3000 / f_c \quad [\Omega] \quad (6)$$

where f_c is the crystal frequency in MHz.

A better oscillator using inverter gates is given in Fig. 9; it operates in parallel mode. Resistor R serves to limit the current through the crystal. If fine frequency adjustment is not required, C_1 may be omitted and C_p increased to 56 pF. This circuit is suitable for use between 1 and 30 MHz.

Whereas the oscillators in Fig. 8 and 9

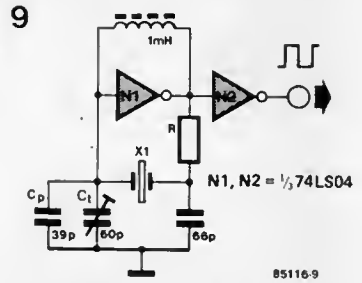

Fig. 9 Although this parallel-mode oscillator using low-power Schottky TTL gates needs fewer components than its series-mode counterpart, it is hardly ever found in practice.

are intended for use with low power Schottky - LS - gates, that in Fig. 10 uses high-speed CMOS devices. Reliable operation is guaranteed up to

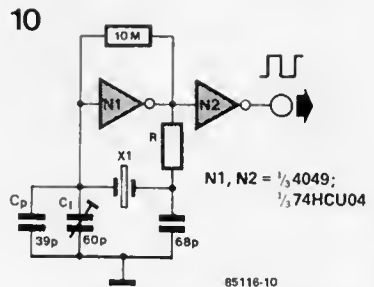

Fig. 10 When unbuffered high-speed CMOS gates are used, the parallel-mode oscillator is second to none.

30 MHz. The value of R is computed from

$$R = 10^4 / f_c - 300 \quad [\Omega] \quad (7)$$

where f_c is the crystal frequency in MHz.

Since the output impedance of the gates is fairly low, it is necessary to connect a resistor in series with the output to prevent damage to, or destruction of, the crystal. It would be better to use a control system, but that is not easy to realize with gates.

If, however, the oscillator uses discrete components, output control may be achieved in a convenient manner — see Fig. 11. The active element in this circuit is a dual-gate MOSFET. The interesting feature of this circuit is that the DC bias is obtained by feedback from the drain to gate G_2 . Diode D_1 in the feedback loop ensures that the potential at G_2 drops as soon as the signal at the drain exceeds 1.5 V_{pp} . This causes a reduction of the current through T_1 , which limits the peak output of the oscillator.

A high drain impedance is obtained by connecting a 10 mH choke, L_1 , in series with R_3 .

Transistor T_2 is not required if the output of the MOSFET is AC coupled to a trigger circuit (LS or HC MOS).

design ideas

The oscillator of Fig. 11 is intended for operation with fundamental frequency crystals in the parallel mode over the frequency range of 0.1...30 MHz. It can, however, easily be modified for operation on harmonics. To this end, R_4 is replaced by an LC circuit tuned to the desired harmonic — see Fig. 12. When this circuit is required to operate at frequencies above about 45 MHz, a BFR91 should be used in the T₂ position, and R_5 should be reduced to about 220 Ω. The value of L_2 is determined by

$$L_2 = 724 / f_c^2 [\mu\text{H}] \quad (8)$$

where f_c is the crystal frequency in MHz.

A Q value of around 30 is sufficient. The oscillator of Fig. 12 is suitable for operation at frequencies up to 100 MHz. The L_2C_x circuit is tuned to the correct frequency, i.e., the third or

fifth harmonic, with the help of a frequency counter. If such a counter is not available, connect the detector of Fig. 13 to the output and turn the trimmer until the meter deflects. Turning the trimmer even further will cause the

oscillator to switch off. The correct position of C_x is about midway between the two points thus found. If this position is far from the centre position, the value of L_2 is incorrect, or the circuit is tuned to the wrong harmonic.

11

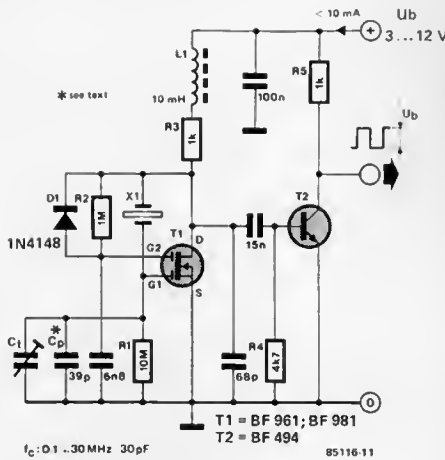

Fig. 11 The best oscillators still use discrete components; this circuit is intended for operation on the fundamental crystal frequency.

12

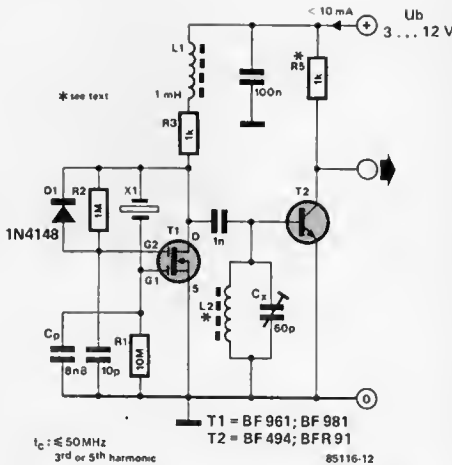

Fig. 12 A few small modifications make the circuit of Fig. 11 suitable for operation on harmonic frequencies.

13

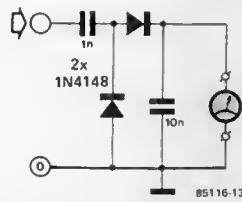

Fig. 13 This detector circuit can be used to tune the L_2C_x circuit in Fig. 12 if a frequency counter is not available.

14

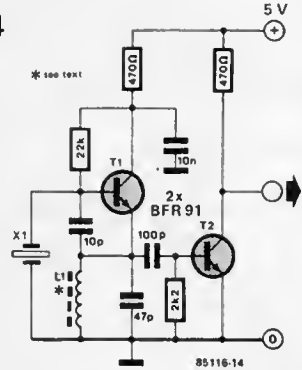

Fig. 14 This oscillator for operation on 3rd harmonic frequencies need not be tuned.

Another type of third-harmonic oscillator is shown in Fig. 14. The resonant frequency of the LC circuit is

$$f_{res} = 0.63f_3 \text{ [MHz]} \quad (9)$$

where f_3 is the frequency of the third harmonic in MHz.

This circuit does not need trimming, because at the fundamental frequency it is inductive and can, therefore, not oscillate. At the third harmonic it is capacitive, however, so that oscillating is possible. The value of L is calculated from

$$L = 1616 / f_3^2 [\mu\text{H}] \quad (10)$$

where f_3 is the frequency of the third harmonic in MHz. ■

high-resolution colour graphics card - 2

the second in a series of articles describing a 512×512 or 512×256 pixel, black & white or colour, graphics card

by P Lavigne & D Meyer

A graphics display processor (GDP) such as the Thomson Types EF9365, EF9366, or EF9367 is designed to generate the video signal and the sync(hronization) signals. To the user, it acts as an intelligent graphics screen controller with a picture scan that can be programmed via an eight-bit microprocessor. Apart from these functions, it also contains circuits for writing to the screen memory: a vector generator and a character generator. These enable writing on the screen at high speed (for instance, a 512 pixel diagonal in less than 700 μ s) so that the host microprocessor is relieved of these basic tasks.

The GDP has virtually no effect on the memory addressable by the microprocessor since it occupies only sixteen addresses: with the addition of external registers such as scroll, colour, and page switching, to no more than twenty addresses. A further advantage is that the host and GDP memories have completely different cycles. This does not cause problems when the microprocessor bus has to communicate direct with the screen memory since a special timing procedure prevents the disruption of the display. The GDP is programmed by 11 internal registers occupying 16 successive addresses. These registers may also be changed by the character or vector generators while a command is being

executed. This means that the user does not have to input a new command or change the contents of any of these registers before the previous instruction has been executed. The GDP's internal structure is illustrated in Fig. 4, while the pin designations for the Types EF9365, EF9366 and EF9367 are shown in Fig. 5. Only the functions and signals of the GDP that are relevant to the present article will be discussed.

Power supply & logic levels

A 5 V power supply is used, all inputs and outputs of which are TTL compatible. A high input level lies between 2.2 V and 5.0 V; a low level between 0 V and 0.8 V. Nominal current consumption is about 80 mA.

Microprocessor bus

The input/output (I/O) buffers on lines $D_0 \dots D_7$ (pins 33...26) are enabled by \bar{E} ; the direction is controlled by R/\bar{W} . Writing is indicated by a low logic level. The \bar{E} signal has the dual tasks of synchronizing and enabling communication via the bus. The address of the register that is to be accessed is applied to lines $A_0 \dots A_3$ (pins 9...12). The \bar{IRQ} signal at pin 13 provides an interrupt request and is programmed by the CTRL1 register.

Figure 4. Internal organization of the graphics display processor.

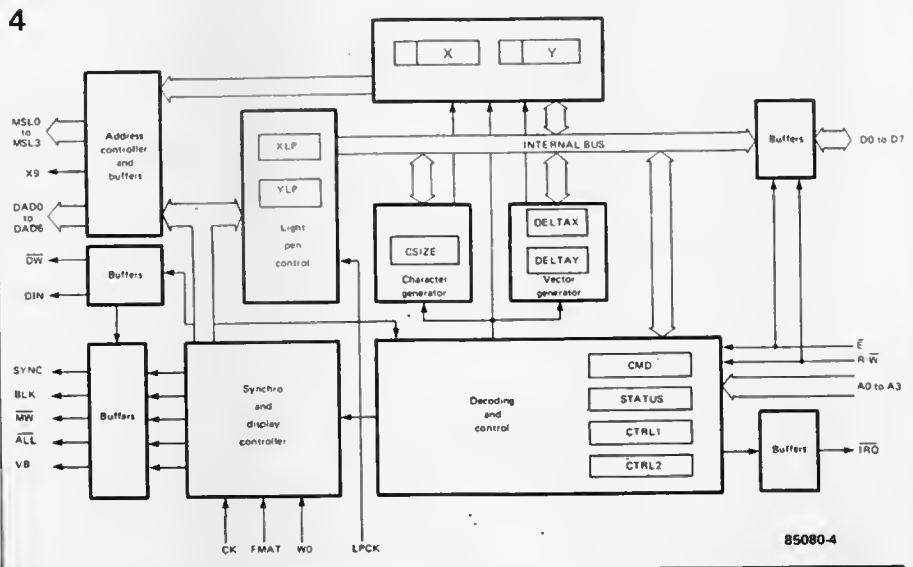

Light pen

If a light pen is used, the **WHITE** on pin 24 forces the video signal to become white. The signal provided by the light pen is applied to the **LPCK** (light pen clock) input on pin 21. The **GDP** then loads the current address into registers **XLP** and **YLP**.

Sync(hronization) signals

The line (horizontal) and field sync pulses (625 lines; 50 Hz) for the video monitor are provided by the **SYNC** signal on pin 34. All signals outside the display window are suppressed by the blanking signal (**BLK**) on pin 25. The vertical blanking (**VB**) signal on pin 16 is high during the field retrace.

Setting the parameters

The format (**FMAT**) input must be connected as shown.

FMAT	vertical resolution	
	256	512
processor		
EF9365	0	1
EF9366	1	—
EF9367	0	1

When the write only (**WO**) signal on pin 23 is high, there is no display and the memories are not refreshed. None the less, the vector and character generators function as normal.

Clock and screen memory addressing

The general clock (**CK**) is input at pin 1; all internal signals are changed at the trailing edge of the clock pulse. It is used for multiplexing video memory addresses **DAD₀...DAD₆**. When **CK** is low, the addresses of the row address strobe (**RAS**) lines are output on **DAD** lines **A₀...A₆**. The frequency of the clock is the same as that of the sync pulses. The display and refresh addresses appear on pins **DAD₀...DAD₆** in two steps; the maximum memory space is 16 K. Memory select lines **MSL₀...MSL₃** provide signals that define a written pixel; they are needed to access a single of the eight bits addressed by **DAD₀...DAD₆**.

A low level on the **ALL** line at pin 22 indicates that the operation in progress concerns all the memory banks (i.e., collective access). This is, of course, different to the bit-by-bit access provided by the **MSL** signals. Collective access is normally used for display, refreshing, or erasing. The data written to the memory consists of a single bit output by the display in (**DIN**) line on pin 15. If this pin is high, it represents a dark pixel on the screen. In a monochrome application, **DIN** could be the direct data input to the memories. For a colour application, however, **DIN** must be combined with the **RGB** inputs. Writing to the screen memory is enabled by the display write (**DW**) signal on pin 14. A low memory free (**MFREE**) signal at pin 19 indicates that the bit addressed by the microprocessor via a special instruction is available at the output of the appropriate memory. This signal, therefore, enables communication with the memory address indicated by registers **X** and **Y** — which can be programmed by the user — without disrupting the display. It always responds to an external request for access to the screen memory. All these signals will be met again later in this article.

Screen memory

If a picture consists of VH pixels, and each pixel can have 2^b states — where V is the number of usable lines; H is the number of bits in a horizontal line; and b is the number of primary colours — the screen memory must contain VHb bits. Note that a pixel may comprise several bits: usually three, sometimes four. If H is large, the frequency of the video signal is greater than the maximum frequency for reading the memories. When, for instance, $H=512$ and the normal line scanning frequency of 15.625 kHz is used, pixels appear at 70 ns intervals. A horizontal line is divided into h bytes of n successive bits that are read simultaneously onto the screen and converted by an autonomous (= dot clock + shift register) circuit into the video signal. The memory is, therefore, accessed h times per line. Each

5

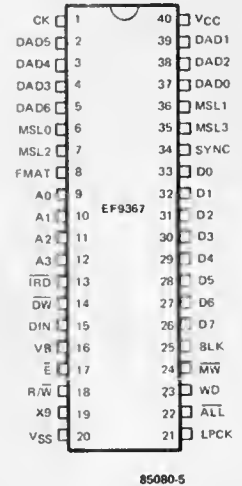
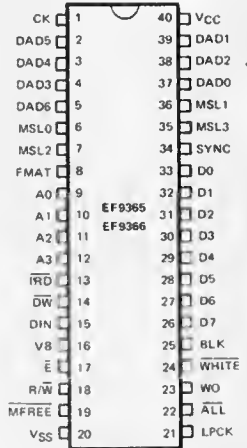

Figure 5. Pin-outs of the Thomson-EFCIS graphics display processors.

6

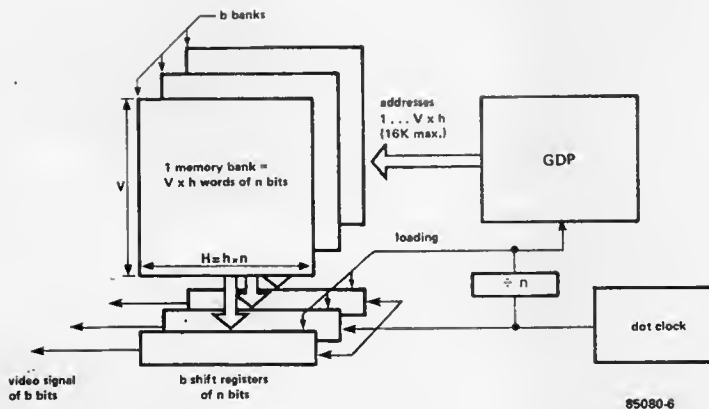

Figure 6. Schematic representation of the screen memory.

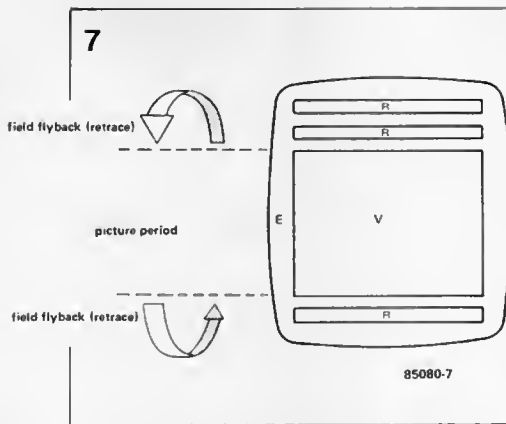

Figure 7. Outside the display window, writing can take place at all times, except during the three refresh cycles shown.

access loads every one of b registers with n bits. The memory then contains Vhb words of n bits as shown in Fig. 6. In the present circuit, the following formats are possible:

- b theoretically unlimited; in practice 0...4 (RGB+I)
- n 8
- H 512
- V 256 or 512

Figure 8. Correlation between the display and write addresses.

8

9366/9367 (512 × 256)

h5	h4	h3	h2	h1	h0	V7	V6	V5	V4	V3	V2	V1	V0
X8	X7	X6	X5	X4	X3	Y7	Y6	Y5	Y4	Y3	Y2	Y1	Y0

9367 (512 × 512)

h5	h4	h3	h2	h1	h0	V7	V6	V5	V4	V3	V2	V1	V0	t
X8	X7	X6	X5	X4	X3	Y8	Y7	Y6	Y5	Y4	Y3	Y2	Y1	Y0

Figure 9. Illustrating the discrimination between collective and pixel-by-pixel access.

9a

9366/9367 (512 × 256)

ALL	CK	MSL				DAD						
		0	1	2	3	0	1	2	3	4	5	6
0	0	X	X	X	1	h5	h4	h3	h2	h1	h0	V0
0	1	X	X	X	1	V7	V6	V5	V4	V3	V2	V1

b

X = don't care

ALL	CK	MSL				DAD						
		0	1	2	3	0	1	2	3	4	5	6
1	0	X0	X1	X2	1	X8	X7	X6	X5	X4	X3	Y0
1	1	X0	X1	X2	1	Y7	Y6	Y5	Y4	Y3	Y2	Y1

c

9367 (512 × 512)

ALL	CK	MSL				DAD						
		0	1	2	3	0	1	2	3	4	5	6
0	0	X0	X1	X2	V1	h5	h4	h3	h2	h1	h0	V0
0	1	X0	X1	X2	Y1	V7	V6	V5	V4	V3	V2	t
1	0	X0	X1	X2	Y2	X8	X7	X6	X5	X4	X3	Y1
1	1	X0	X1	X2	Y2	Y8	Y7	Y6	Y5	Y4	Y3	Y0

Apart from the DAD₀...DAD₆ signals, used to address the h words of n bits, there are also MSL lines to select a pixel of b bits within the addressed word. Since $n=8$, there are three MSL lines: MSL₀...MSL₂. The MSL₃ line, used in the interlaced scanning mode ($V=512$), enables distinction to be made between odd and even numbered frames. It controls the A₇ line of the Type 4164 ICs.

Refresh and display

As stated earlier, the GDP effects three fundamentally different operations on the memory: display D which arranges the contents of the memory before making it visible on the screen; writing W; and refreshing R. Outside the window, where the memory is used only for display and refreshing, writing can take place at all times, except during three refresh cycles as shown in Figure 7. The nature of the operation is indicated by the state of the BLK and ALL signals as shown.

BLK	ALL	
0	0	D
1	1	W
1	0	R

It will be seen later that there are exceptions to these situations.

Relation between DAD & MSL outputs and x, y coordinates

Registers X and Y are twelve-bit read and write registers that contain the coordinates of the next pixel to be written onto the screen memory. They have nothing whatever to do with the video scanning functions but form the write address for the memory. With 2×12 bits, this address covers a space of $4096 \times 4096 (=2^{24})$ pixels. Only the least significant bits (LSBs) are needed because the actually memorized image is of lower definition. None the less, the most significant bits (MSBs) are used, since they enable an image to be generated that is much larger than the actual size of the screen.

The nine least significant bits of coordinates x and y are called X₀...X₈ and Y₀...Y₈ respectively.

The internal counters generating the screen memory addresses are organized into:

- six line address bits ($h=64$ words of n bits): $h_0; h_1; h_2; h_3; h_4; h_5$
- nine field address bits ($V=256$ or $V=512$): $t; V_0; V_1; V_2; V_3; V_4; V_5; V_6; V_7$

where t is the LSB that indicates the parity of the frames if $V=512$; when $V=256$, t does not exist.

The correlation between the display address (bits h, V , and t) and the write address (bits X and Y) is given in Figure 8. The Type EF9365 processor is purposely not included in this figure, although it can

support either interlaced or sequential scanning, because it imposes a field resolution that is equal to the line resolution. The EF9366 provides sequential scanning only ($V=256$). The EF9367 can handle either 512×256 or 512×512 pixels. In the sequential scanning mode, the EF9366 is interchangeable with the EF9367.

Everything dealt with so far has been fairly straightforward, but the procedure for assigning the address bits for display and writing to the processor's output pins (DAD and MSL) is rather more complicated. So as to simplify matters a little, Fig. 9 discriminates between collective and pixel-by-pixel access. The sequential scanning mode, shared by the EF9366 and EF9367, is, as shown in Fig. 9a, a collective access mode since $\overline{ALL}=0$. During the first half of the access cycle, when $CK=0$, and the system is in the display mode, lines $DAD_0 \dots DAD_6$ output horizontal address bits $DAD_0 \dots DAD_5$ as well as least significant field address bit V_0 on DAD_6 . This is important for the operation of the scroll circuit.

During the second half of the access cycle, still in the display mode, the DAD lines provide the remainder of the field address bits. **Note that all through this cycle, the logic levels on the MSL lines are irrelevant because operation is in the collective access mode.**

Pixel-by-pixel access is illustrated in Fig. 9b. The three LSBs of register X appear, therefore, on the MSL lines for selecting one of the eight bits in the word addressed by the DAD lines. Here again, the least significant vertical address bit is found in the first half of the access cycle along with the line address bits. This time, the MSL lines are used to address a single bit in the word addressed by the two bursts of signal issued by the DAD pins. Figure 9c shows the two memory access modes grouped together for an EF9367 in interlaced mode (collective: $\overline{ALL}=0$; pixel-by-pixel: $\overline{ALL}=1$). The manner of dealing without output X_9 of the EF9367 will be discussed later.

In the Type EF9366, the memory is refreshed every two display lines (128 refresh cycles), whereas in the EF9367, this refresh occurs every four lines (256 refresh cycles).

Dynamic random access memory

A knowledge of the basic function of a dynamic random access memory (RAM) is essential for an understanding of the operation of the present circuit and for seeing the importance of rigid timing of all signals. Each of the Type 4164 RAMs contains 2^{16} ($=65536=64\text{ K}$) one-bit memory cells. The contents of each of these cells must be refreshed once every two milliseconds to prevent their corruption. A refresh is effected simply by a read operation.

In principle, sixteen separate address lines are needed to access each of the 65536 cells. Fortunately, the 64 K bits are arranged in a matrix with multiplexed

addressing. This means that the address of the matrix line ('row address') on which the cell to be accessed is situated is specified first and then — on the same address line — the address of the column on which the cell is located. In this way, only eight address lines and two extra pins for enable signals are needed. These latter signals indicate when the addresses applied to the RAM are row addresses and when they are column addresses. They are called \overline{RAS} (row address strobe = line address enable pulse) and \overline{CAS} (column address strobe = column address enable pulse) respectively. The bar above the signals indicates *inverse logic*, i.e., the signals are active when their logic level is low.

Not all 65536 cells need to be accessed individually for a refresh: a collective refresh can be used in which only the 256 matrix lines are addressed. Manufacturers of integrated circuits endeavour to keep the 64 K RAM circuits compatible with their 16 K predecessors, which have only 2^{14} ($128 \times 128 = 16384$) cells, with the result that some 64 K memory chips need a refresh of only 128 instead of 256 lines. The relevant data sheet indicates this by the note "128 refresh cycles/2 ms", while the diagram of the refresh signals shows "A₇: don't care".

The timing of the \overline{RAS} and \overline{CAS} signals, and the corresponding address signals, is important. Timing diagrams are shown in Figures 10 and 11.

During a read or a write operation, the first signal to become active is \overline{RAS} (pin 4 of a Type 4164). The RAM uses the eight logic levels present on pins $A_0 \dots A_7$ at that moment to address the relevant matrix line. A short time later, while \overline{RAS} remains active, \overline{CAS} also becomes active. The IC then sees the levels on address lines $A_0 \dots A_7$ as the column address, but — in terms of the 64 K memory — these are really address lines $A_8 \dots A_{15}$. It is, therefore, necessary that the bits of address lines $A_8 \dots A_{15}$ are applied to pins $A_0 \dots A_7$ after \overline{RAS} but before \overline{CAS} . Note that with dynamic RAMs address signals $A_0 \dots A_7$ need not be present before the \overline{RAS} or \overline{CAS} pulses, because t_{ASR} and t_{ASC} may be 0!

Figure 10. Timing diagram of the read cycle.

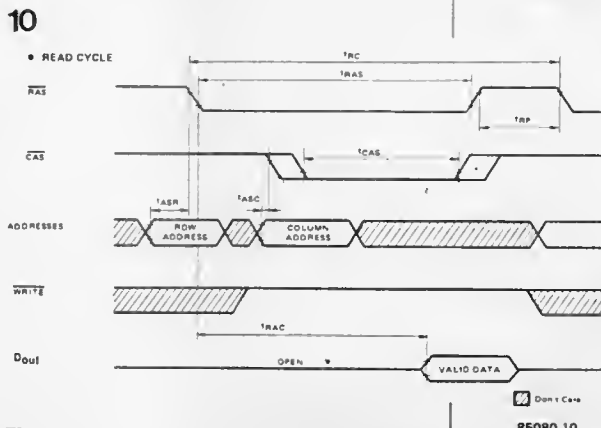

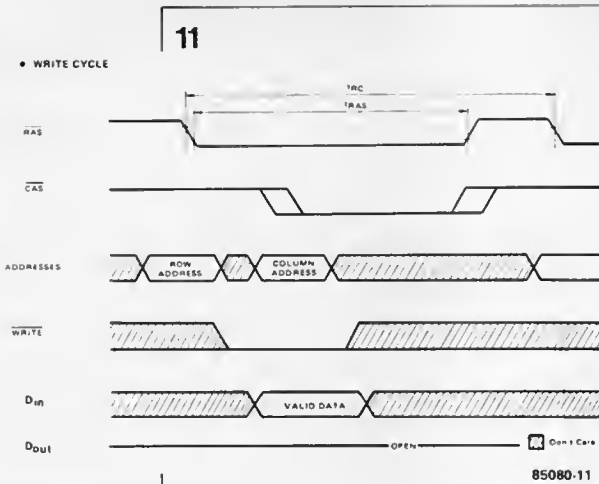

Figure 11. Timing diagram of the write cycle.

If the above were a read operation, the logic level of the addressed bit would appear on the D_{out} pin of the RAM a few nanoseconds after the address signals had been strobed. If the memory were written to, the $WRITE$ line (pin 3 of a Type 4164) would be activated and the correct logic level applied to the D_{in} pin shortly before CAS became active.

For a refresh, the address line must be selected and RAS activated, when not only the timing of the refresh but also that of the RAS signal is important. Before the RAS signal can become active, and remain low during t_{RAS} , it must have been high for at least t_{RP} , i.e., the pre-charge time needed by the IC.

Read-modify-write mode

One unusual mode of operation is the read-modify-write (RMW) mode, in which a given address is read from, and written to, in the same access cycle.

In Part 1 it was shown that, depending on the logic levels, six colours plus black and white can be produced, and further that a bright pixel has a low logic level, while a dark pixel has a high logic level.

Every time an object is moved across a design (base) on the screen, part of that

design is defaced. When the movement ceases, all defaced parts of the base have to be reconstructed. This complex operation is carried out by an eight-input NAND, two AND, and two OR gates as shown in Figure 12.

Writing to the screen is only possible when the $WRITE$ signal has been enabled and the logic level of the data to be written (D_{in}) has been defined. In the RMW mode, this level is defined not only by the wanted result (pixel bright or dark), but also by the previous state of the element. If the pixel was bright before, it will be quenched; if it was dark, it will be bright. When the pixel appears on the screen, it is examined. If the screen is dark, the pixel appears bright, and if it is light, the element is dark. The screen is returned to its previous state by redrawing all relevant pixels at the same position, but with the logic level reversed.

To make an object appear on the screen, the state of the relevant pixels is reversed. To revert to the original state, this operation is carried out a second time. The successive inversions negate one another. This could be considered as an exclusive OR (XOR) function between the pen and the paper: if the paper is white, the pen is black; and where the paper is black, the pen is white.

An RMW cycle starts with accessing the video memory for a read and finishes with a write. Between these actions, the addressed bit is modified.

The eight-input NAND gate returns the addressed bit with its state inverted, while all other bits are forced high. When the read-modify-write-select (RMWS) line is high, it indicates that the RMW mode is active. If the line is low, the level on the D_{in} pin, which is provided by the GDP, is loaded into the screen memory when the data write DW pulse appears. The state of the screen is not taken into account then, since that is only of importance in the RMW mode. When that mode is selected, the combination of RMWS and load (LD) signals prevent the DW signal from reading the bit output by the NAND gate into the memory; otherwise, this bit would be inverted by the NAND gate and returned to the relevant RAM via D_{in} . If a bright pixel is required, the D_{in} line should be low; the corresponding logic level is loaded via D_{in} . If, on the other hand, the element is to be dark, the D_{in} line should be high, with the result that the corresponding bit in the memory is and remains high.

Operation in the RMW mode can be disrupted if the delay inherent in the NAND, AND and OR gates does not corrupt the timing of the RAM. The shorter the t_{RAC} signal, the more time there is for the RMW logic to change the data and input this to D_{in} before the $WRITE$ pulse arrives. t_{RAC} is the time between the start of RAS and the appearance of data on D_{out} , called "access time" on the relevant data sheet. In theory, t_{RAC} should not exceed 150 ns (NEC4164-3; Hitachi 4864-2;

Figure 12. RMW selection in the monochrome mode is carried out by this array of gates.

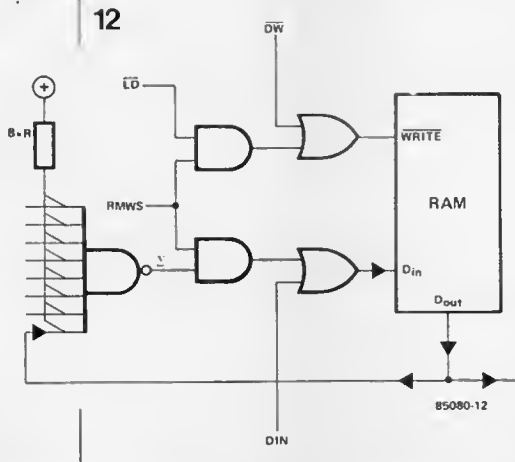

Toshiba 4164-3; OKI 3764-15; MOSTEK 4564-15; and others), but practical experience has shown that the RMW circuit will work quite satisfactorily with access times of up to 300 ns.

If colour is included, the RMW circuit is as illustrated in Figure 13, in which the gates specific to this mode are shown shaded. One of the seven gates is shared with another function, which will be reverted to in due course. The two extra gates increase the efficiency of the whole and do not increase the delay when a data bit travels from the output of a memory to its input.

The circuit remains the same as for monochrome, except that some colour selection signals are added. These consist of red select (RS; green select (GS; blue select (BS); red write select (RWS; green write select (GWS; and blue write select (BWS). Unlike DIN and $\bar{D}W$, which are provided by the GDP, these signals are controlled by the user via the colour register. If one of RS, GS, or BS is high, the addressed pixel will be dark as far as the corresponding colour is concerned, provided the RWS, GWS, or BWS line is low to allow the memory to be accessed. If an RS, GS, or BS signal is low, and the associated RWS, GWS, or BWS signal is also low, the corresponding pixel will have the relevant colour. All possible combinations with and without RMW (in monochrome) are listed in Table 2.

Table 2.

(DW = 0)			pixel
RMWS	$\bar{D}_{out} = \Sigma$	DIN	
0	X	1	dark
0	X	0	bright
1	0	0	bright (was dark)
1	0	1	dark (was dark)
1	1	X	dark (was bright)

Memory capacity & image resolution

If an image has a horizontal resolution (the number of pixels on a line scanned in the display window) of 512, and a vertical resolution (number of lines scanned) of 256, the display window contains a total of 131 072 pixels, so that 16 K of memory is needed per colour. An image with a resolution of 512 x 512 pixels needs 32 K of memory. Note that in the latter case there are, in fact, two interlaced images, each requiring 16 K. Doubling the vertical resolution increases the quality of the image, but also shows up an instability of the interlaced image, which is quite noticeable on static displays like those produced by the present graphics card. It is more visible on some monitors than on others.

Whatever resolution is selected, no more than a quarter to a half of the 64 K

13

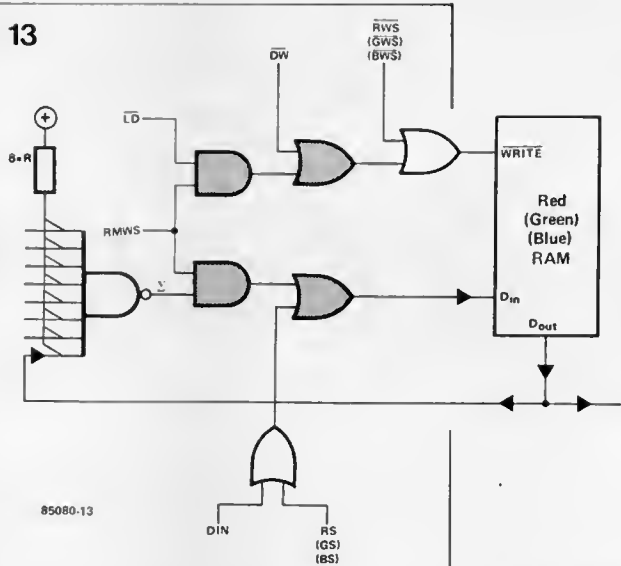
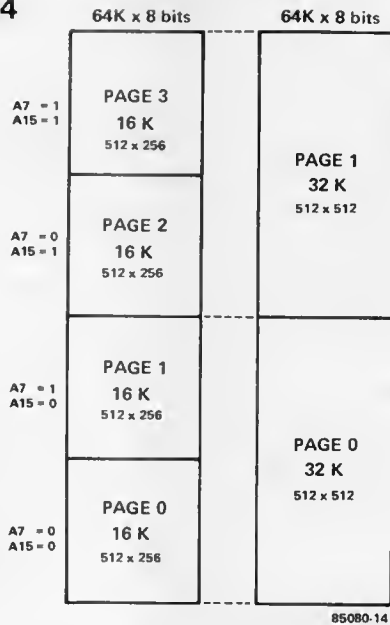

Figure 13. RMW selection in the colour mode is carried out by this combination of gates.

memory is needed. The remainder cannot be used for colour, but it need not go to waste, since it is useful for storing several totally independent images that can quite simply — and immediately — be displayed on the screen. In one case, there are four pages available, numbered 0...3, depending on the logic levels of multiplexed address signals A_7 and A_{15} ; in the other case there are two pages, numbered 0 and 1 as shown in Figure 14.

14



The use of A_7 and A_{15} to switch pages introduces a limitation, namely that the type of RAM used should not require A_7 and A_{15} to be refreshed; this prohibits, for instance, the use of the Siemens HYB4164 on the graphics card.

Part 3 will appear in our December 1985 issue.

sound rotator



by T S Norris &
M M Bhalsod

Audio signals produced by electrophonic instruments, such as electric pianos, organs, and synthesizers, often sound rather artificial and thin, lacking the natural colour of acoustic instruments. Early in electronic organ development, it was realized that a mechanically rotating speaker system (sometimes known as a Lesley speaker system) partially overcame this limitation by providing phase shifts that produce interference, both constructive and destructive, at a number of frequencies in the audio spectrum, which gives vitality and interest to the resulting sound.

When two speakers rotate around one another, there exist constantly varying time delays — and therefore phase shifts — in the paths the sound takes to travel from the loudspeakers to the listener. A similar effect can be produced electronically by the use of a delay line with varying time delay.

A charge-coupled device consists of an array of MOS capacitors that are coupled, so that charges can be moved through the semiconductor substrate in a controlled manner. Although essentially an analogue shift register for use in signal processing, the CCD can perform a wide variety of electronic functions.

The schematic diagram of the sound rotating circuit, which uses a CCD (charge-coupled device) delay line IC, is shown in Fig. 1. The input signal passes along one route to the mixing amplifiers, and along another to the delay line circuit. Filters are required before and after the delay line, because a difference frequency, $f_d = f_s - f_i$, is produced in the delay sampling process, where f_s is the delay line clocking frequency; f_i is any input frequency; and f_d is the difference frequency. Delayed signals u_{del} and \bar{u}_{del} are then mixed with the original input signal to produce output signals $u_{o(L)}$ and $u_{o(R)}$.

A high-frequency oscillator provides a clocking signal, u_{clk} , to pass charge packets along the delay line. The clocking signal is frequency-modulated by signal u_m that is provided by a low-frequency sweep oscillator.

Circuit description

The circuit diagram of the sound rotator is shown in Fig. 2: IC₁ is the sweep oscillator; IC₂ and FF₁ form the clocking oscillator; IC₄ is the delay line; A₁ (IC₅) is the first, and A₂ is the second, low-pass filter; A₃ and A₅ are the mixers; and A₄ is the phase inverter.

The frequency determining components for IC₁ and IC₂ are R₁-C₂ and R₇-C₅ respectively, but the voltage at their pin 5

also influences the output frequency. The frequency of IC₁ can be set between 0.2 and 6 Hz with P₁. The shape of the output at pin 4 is triangular, but this is transformed to near sinusoidal by low-pass network R₃-C₃. The voltage across C₃ is used to frequency-modulate clocking oscillator IC₂.

The output of IC₂ is a rectangular voltage (at pin 3) at a frequency of about 120 kHz. D-type bistable FF₁ halves the frequency and shapes the signal to a square wave (duty factor=1:1).

Delay line IC₄ is fed with both the Q and the \bar{Q} output of FF₁; these signals are, of course, in antiphase.

Opamp A₁ (IC₅) is a low-pass filter that reduces aliasing caused by the input signal being sampled at the 60 kHz clocking frequency. The filter has a cut-off frequency of about 15 kHz with a 12 dB roll-off.

The filtered signal is applied to the input (pin 5) of the delay line via C₉. The input pin is also provided with bias voltage preset by P₂. The output of the delay line is fed to the second low-pass filter, A₂, via SET BALANCE preset P₃ and C₁₄.

Low-pass filter A₂ prevents high-frequency clocking signals from reaching the mixer amplifiers; its characteristics are similar to those of filter A₁.

The original input signal is applied in equal proportions to the non-inverting inputs of mixers A₃ and A₅. The level of the delayed signal fed to A₃ via R₂₂, and to

A_5 via R_{25} and phase inverter A_4 , is adjusted by SET DELAY SIGNAL LEVEL control P_4 .

Construction and testing

The TDA1022 delay line should be treated with care, because it is a MOS IC that has no special protection against static electricity.

When the construction of the circuit has been completed, a 9...15 V supply should be connected and the operating current measured: this should be around 25 mA. Note that once the preset controls have been set at a certain supply voltage, they may have to be reset if the level of the supply voltage is changed.

Check with an oscilloscope that the signal at pin 3 of IC_2 is about 120 kHz. If the measured frequency is very different from this value, change R_7 by trial and error: a smaller value for this component causes a higher frequency, and vice versa. At the same time, check that there is slight frequency modulation on this signal.

Check with an analogue voltmeter — set to the 10 V AC range — connected between pin 4 of IC_1 and earth, that IC_1 oscillates. Also, check with P_1 that the output frequency is adjustable.

Next, inspect the signal at the wiper of P_3 ; bias control P_2 should be adjusted to give a voltage of 5...6 V at this point. The signal here should show some high-frequency clocking residue.

Then, adjust P_3 to minimize the clocking residue on the signal at the output of A_2 .

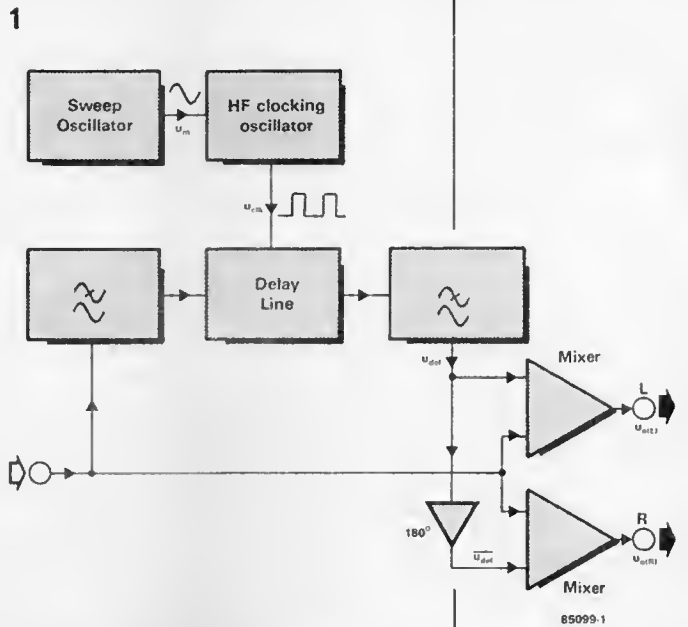

Finally, apply a suitable signal (from a signal generator, organ, or synthesizer) to the input terminals, and adjust P_4 and P_5 to give the desired "sound rotation" effect to the signal at the output terminals.

Figure 1. Schematic representation of the principle of operation of an electronic "Lesley system".

Finally

The sound rotator is suitable for signal levels up to about 1 V r.m.s. and is intended to be installed prior to a power

Figure 2. The circuit of the sound rotator is based on a charge-coupled device <CCD> Type TDA1022.

2

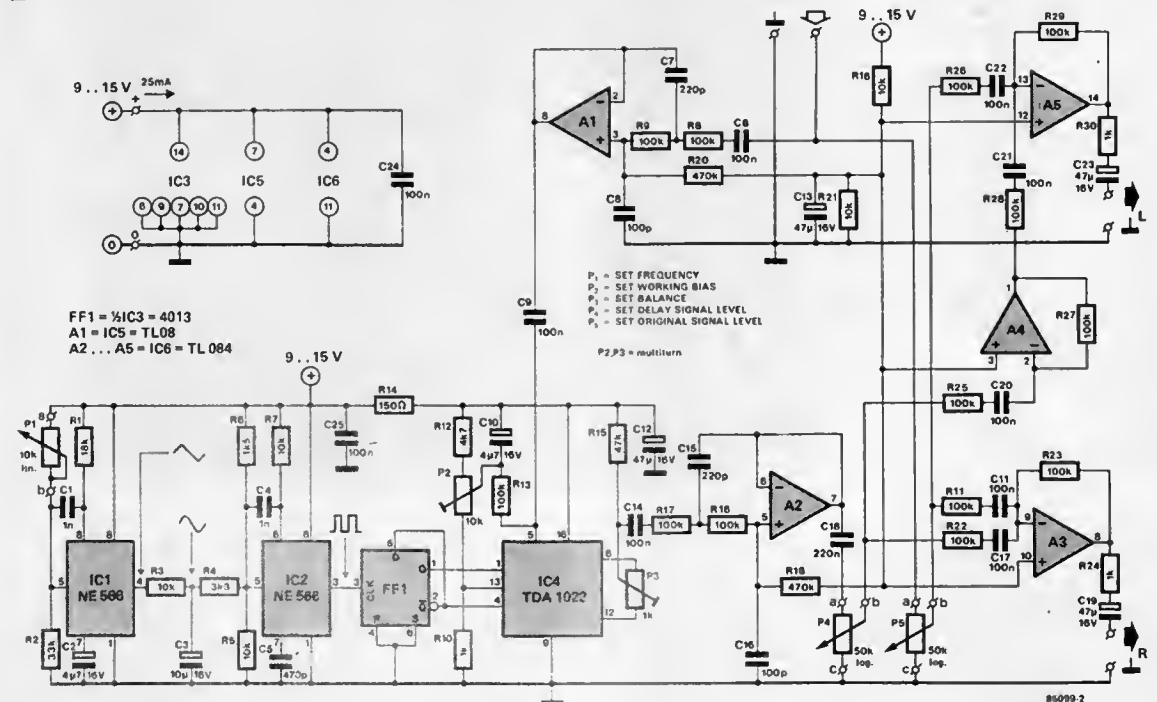
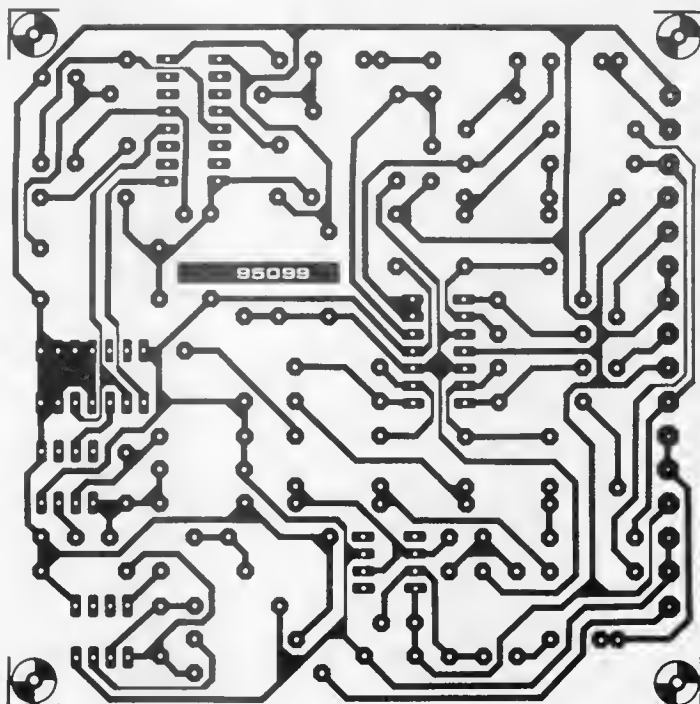

Figure 3. The printed circuit board for the sound rotator.

3



Parts list

Resistors:

- R₁ = 18 k
- R₂ = 33 k
- R₃; R₅; R₇; R₁₆; R₂₁ = 10 k
- R₄ = 3k3
- R₆ = 1k5
- R₈; R₉; R₁₁; R₁₃; R₁₇; R₁₈; R₂₂;
R₂₃; R₂₅... R₂₉ = 100 k
- R₁₀; R₂₄; R₃₀ = 1k
- R₁₂ = 4k7
- R₁₄ = 150 Ω
- R₁₅ = 47 k
- R₁₉; R₂₀ = 470 Ω
- P₁ = 10 k linear potentiometer
- P₂ = 10 k multitrn preset potentiometer
- P₃ = 1 k multitrn preset potentiometer
- P₄; P₅ = 50 k logarithmic potentiometer

Capacitors:

- C₁; C₄ = 1 n
- C₂; C₁₀ = 4μ7; 15 V
- C₃ = 10 μ; 16 V
- C₅ = 470 p
- C₆; C₉; C₁₁; C₁₄; C₁₇;
C₂₀... C₂₂; C₂₄; C₂₅ = 100 n
- C₇; C₁₅ = 220 p
- C₈; C₁₆ = 100 p
- C₁₂; C₁₃; C₁₉; C₂₃ = 47 μ;
16 V
- C₁₈ = 220 n

Semiconductors:

- IC₁; IC₂ = NE 566
- IC₃ = 4013
- IC₄ = TDA 1022 (if this is difficult to obtain locally, it may be had from MB Instruments, 31 Ashvale, Cambridge, from whom other parts are also available)
- IC₅ = TL 081; TL 071; LF 356
- IC₆ = TL 084; TL 074

Miscellaneous:

- IC sockets as required
- knobs for potentiometers as required
- input, output, and battery terminals
- PCB 85099

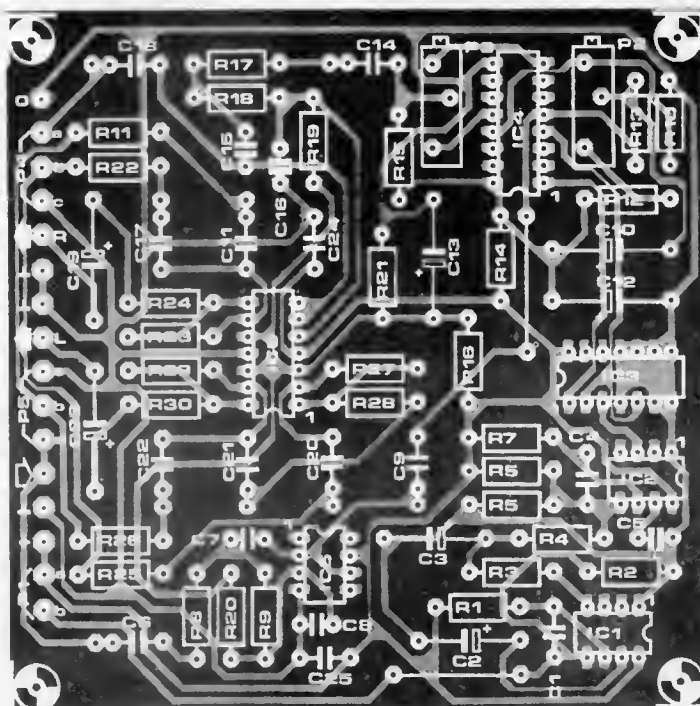

amplifier. A PP3 battery can be used to operate the unit if it is, for instance, to be used in a foot-pedal or similar portable enclosure.

Our tests show that the effect of the sound rotator is most noticeable with solo instrumental music, and least when the unit is used with popular music received

from the radio. In this context, it should be noted that there is not really a "Lesley effect" with monophonic music, but rather a sort of vibrato mixed with phasing. None the less, the sound of small electronic organs, synthesizers, and electric guitars and pianos will benefit from the richness imparted by the sound rotator.

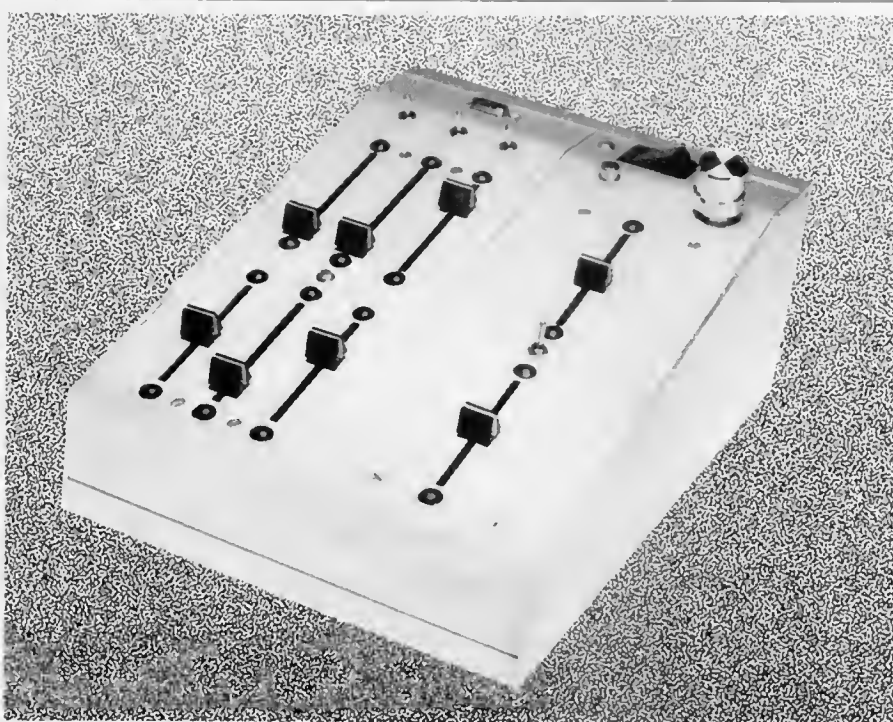

stage lighting — 1

by A Sevriens

At this time of the year, thousands of amateur and school dramatic and music societies and groups are preparing for the coming season. A large number of these societies often wish they had a proper stage lighting installation, which permits the smooth changing and blending of lights and colours, the setting up of complete scenes with preset light intensities, and the smooth transition of light of two or more colours from one scene to the next at a controlled rate. The control panel of this type of installation can be located at a convenient place from where the operator can view the scene. Unfortunately, professional installations of this nature cost anything from a couple of thousand pounds upwards. The installation described in this and the next issue can, however, be built for a fraction of that cost.

The control panel contains two separately preset light channels. Each lamp of the stage lighting system is controlled by two independent potentiometers, I and II in Fig. 1, which are connected into circuit by a main control switch (S_2 in Fig. 1). This enables the brightness of each lamp to be preset at two different levels, as selected by the two main potentiometers. In practice, this makes it possible for a scene to be enacted, while the light levels for the next scene are being set up. These functions are shown schematically in Figure 1. The upper group in this diagram contains the two main controls, I and II, an audio input with associated electronic circuitry, and a change-over switch S_2 , which permits the desired blend to be selected. In position I, the two channels are preset independently

and then mixed. In position I+II, fading of both channels is effected by preset I only. At one end of the travel of this control, channel I is operational, while at the other end, channel II is; at intermediate positions, both channels are operational to a degree which is proportional to the setting. This position of S_2 , therefore, allows smooth transition from one to the other channel.

The centre group of functional blocks in Fig. 1 represents the individual channels for each lamp. The lamps are connected in groups of three. Each lamp channel is provided with two slide potentiometers, which are fed from main controls I and II. The slide potentiometers enable the brightness of each lamp to be preset at two different levels. Each group of three lamp channels is accommodated on one

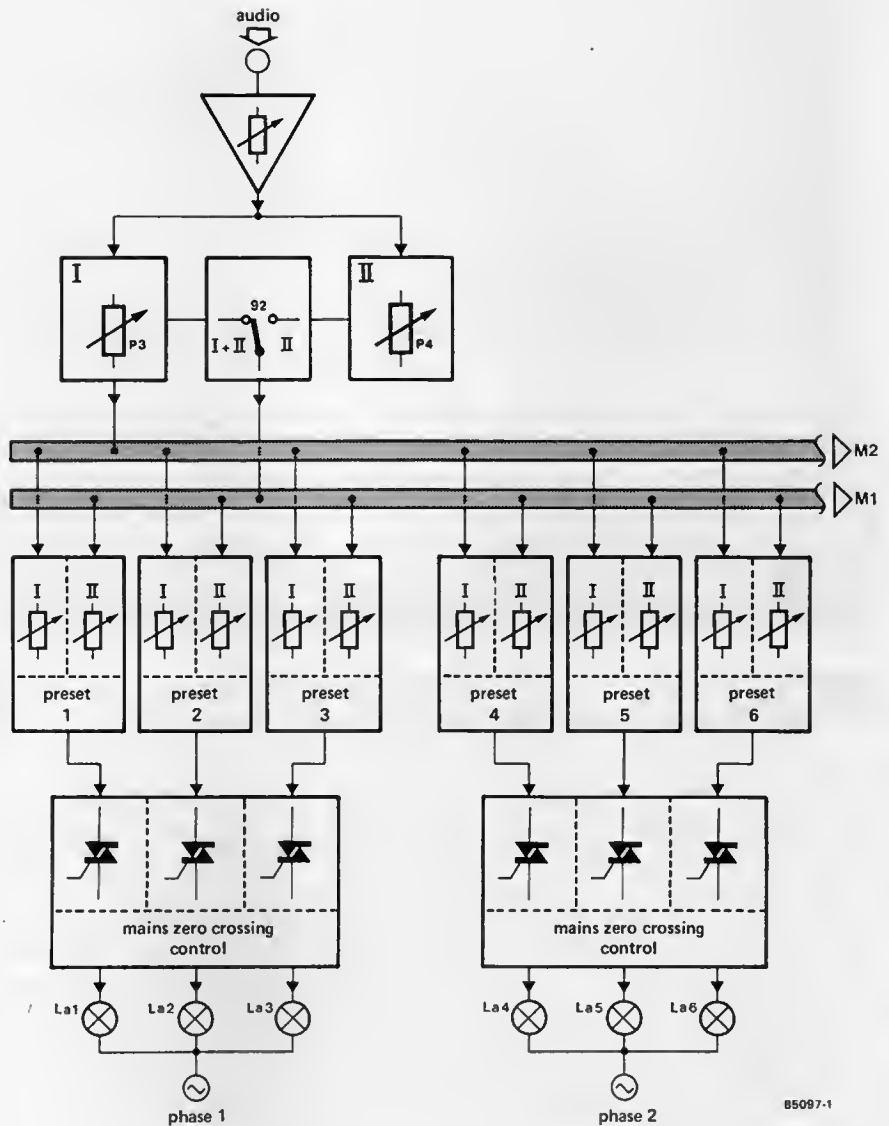

Figure 1. Block schematic diagram of a six-channel stage lighting installation. More channels may be added as shown.

printed-circuit board (PCB). Even in its smallest set up, the stage lighting control can, therefore, accommodate three spotlights.

The bottom group comprises the power stages with triac control. These stages and the wiring of the system will be discussed in Part 2 in our December issue. Suffice it to say at this stage that each group of three triacs and the zero crossing control is accommodated on two PCBs. Zero crossing control ensures minimal noise and interference being fed back to the mains, while the three triacs permit each of the three lamps to be connected to one phase of the mains. This in turn means that lamps of up to 5 kW power rating can be used. This is sufficient even for the Royal Opera House, Covent Garden! The power stages are, of course, controlled via

opto-isolators, ensuring complete isolation from the mains.

Main control

The circuit diagram of the main controls and the required power supply is shown in Figure 2. This circuit, with the exception of the mains transformer, is built on one printed-circuit board.

The power supply provides a symmetrical 15 V supply as well as a 10 V reference voltage (via IC_5). Great care has been taken in the design to prevent noise and other interference being fed back to the mains supply or into the control circuit, so that spurious operation of lamps is effectively obviated.

The system can be audio controlled as

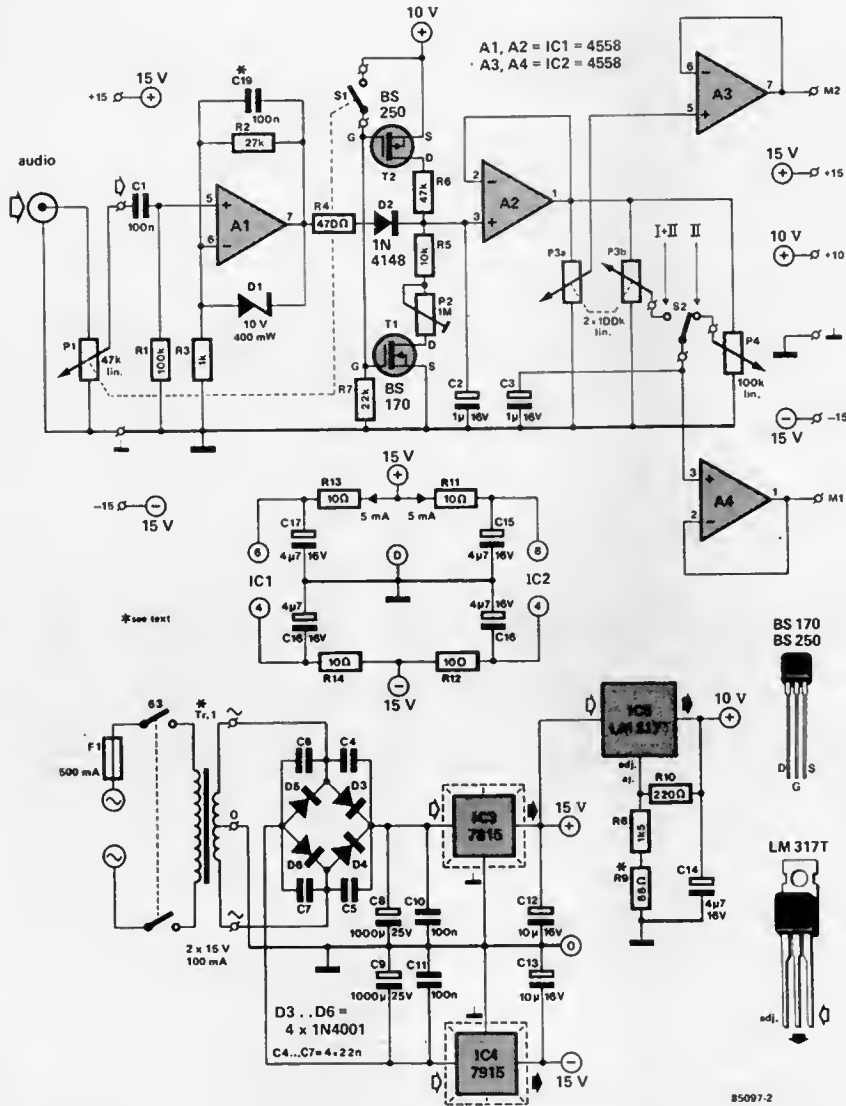

Figure 2. Circuit diagram of the main control board.

well as operated normally. The audio input is amplified and processed in opamp A₁. Potentiometer P₁, which has an internal switch, S₁, can set the input sensitivity to about 100 mV. When P₁ is turned fully anticlockwise, the audio input is short-circuited and S₁ closes. This results in T₁ switching off and T₂ conducting. The inverting input of buffer amplifier A₂ is then no longer fed with the rectified audio signal; instead, the 10 V reference voltage is applied to it, which enables normal (manual) operation. Capacitor C₁₉ limits the base response of the audio circuit; if this limitation is not required, the capacitor may have a lower value or be omitted altogether. Preset P₂ enables setting of the drop-out time. The 10 V reference voltage is provided by

IC₅, which has a good temperature stability. The exact value of the reference voltage is determined by R₉. Should the reference voltage not be exactly 10 V, the value of R₉ should be altered by trial and error until a value of 10 V is obtained. A higher value of R₉ causes a higher value of the reference voltage. Opamp A₂ buffers the reference voltage, which is applied to its inverting input via T₂ and R₆. Its output is applied to the two main controls, P₃ and P₄, which serve channels I and II respectively. Note that P₃ must be a stereo potentiometer, because in the circuit as drawn with S₂ set for normal operation, the buffers are fed separately by P₃ and P₄. Channels I and II can, therefore, be mixed or set independent of one another. With

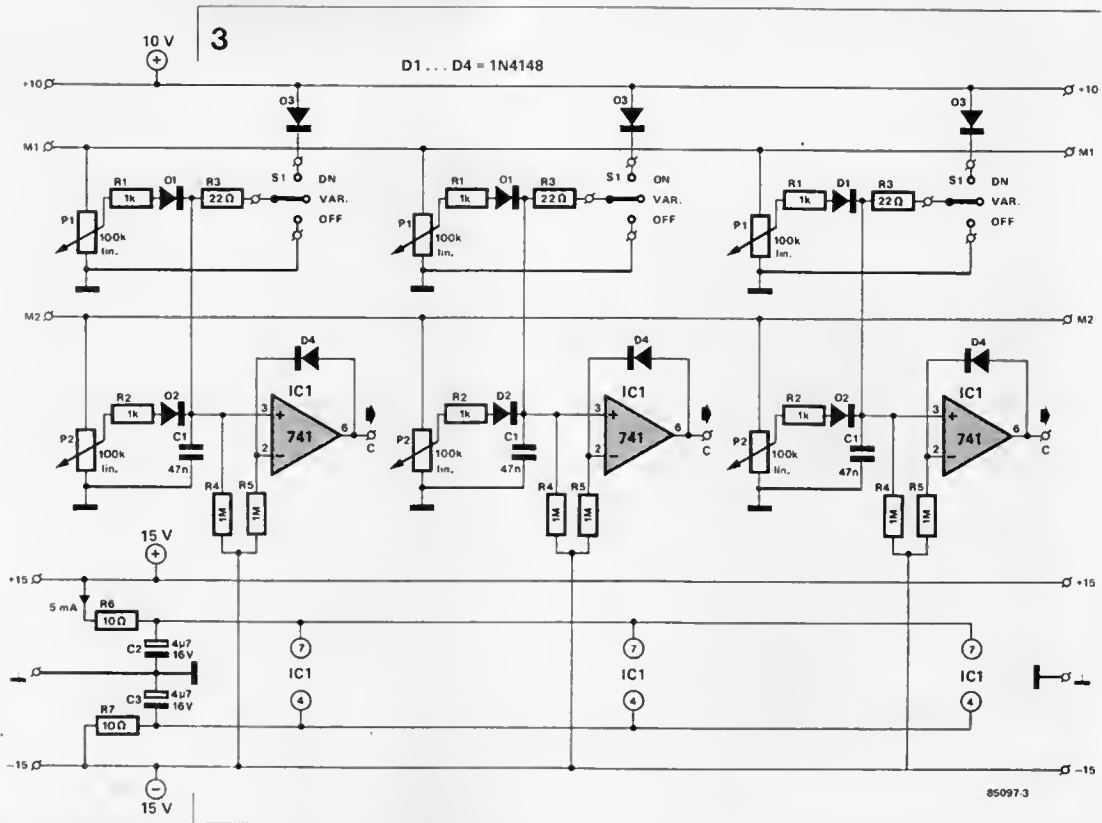

Figure 3. Circuit diagram of a lamp channel.

S_2 in the other position, the control voltages for Channel I (A_3) and Channel II (A_4) are both provided by P_3 . The two halves of this potentiometer are in "opposition", i.e., in one of the extreme positions, Channel I is operational, and in the other, Channel II. The output voltages from A_3 and A_4 are fed to the presets on the lamp channel board(s).

Lamp channels

The circuit in Figure 3 shows that only one opamp is used for the entire lamp

channel. The input voltages at M_1 and M_2 are supplied direct to presets P_1 and P_2 respectively. The voltages at the wipers of these presets are combined and applied to the inverting input of IC_1 via diodes D_1 and D_2 . The diodes prevent interaction between the two presets and ensure that the higher of the two voltages determines the operation of IC_1 . The 0.6 V drop across the diodes is countered by that across D_4 in the feedback loop. With full drive, the output of IC_1 is 10 V. The resulting voltage at terminal C is a measure of the brightness of the lamp connected to this channel.

An additional facility is provided by S_1 , a change-over switch with open centre position. As drawn, the voltages from the presets determine the operation. When S_1 is switched to earth, the lamp goes out, since the voltages from the presets are then virtually shortcircuited by R_3 . With S_1 connected to the cathode of D_3 , the voltage at terminal C remains at 10 V so that the relevant lamp is held at full brightness.

Finally

Some thought should be given at this stage to the front panels. Figures 4 and 5 illustrate one possibility for the main and lamp control unit(s) respectively. Note that the position of the switches and potentiometers is determined by the printed-circuit boards. The sandwich construction results in a compact unit as shown in Figure 6.

Section of aluminium moulding which facilitates the construction of the housing.



4

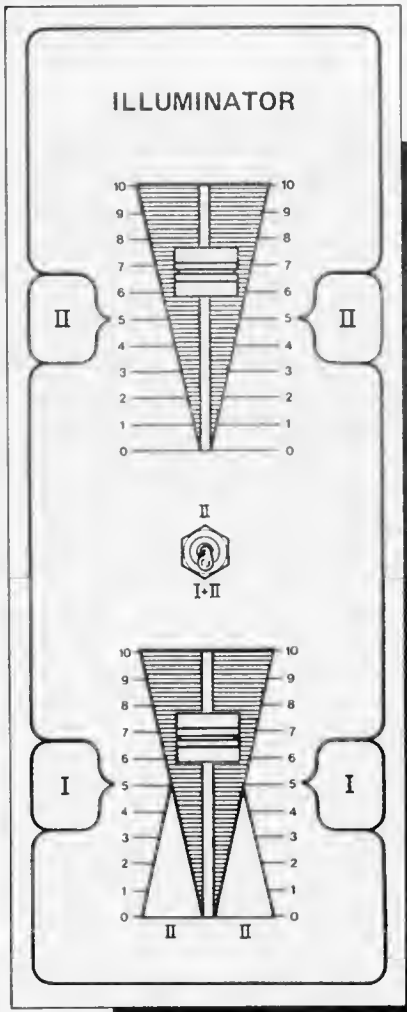

85097-4

5

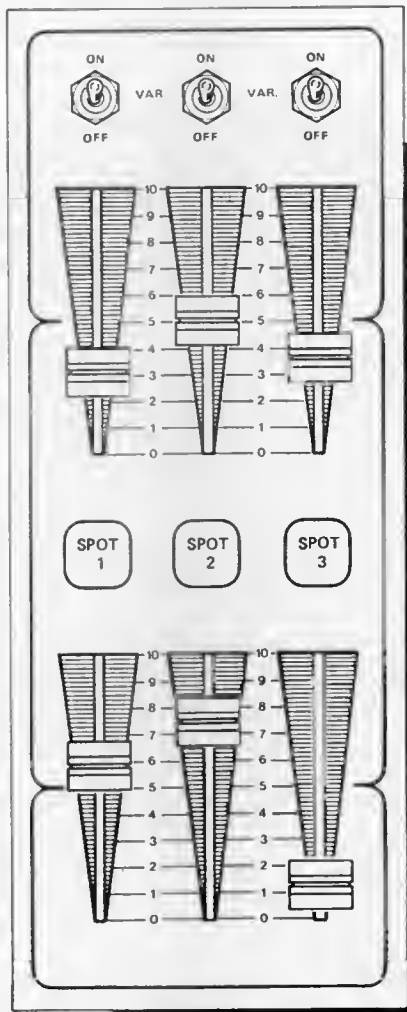

85097-5

Figure 4. One possible layout of the front panel for the main control unit.

Figure 5. One possible layout of the front panel for the lamp channel unit.

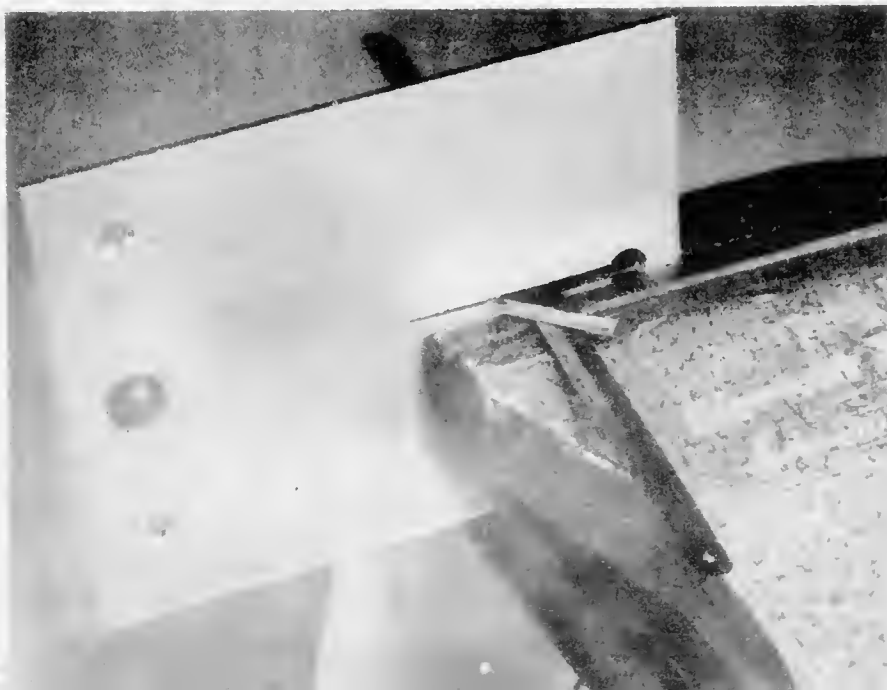

Figure 6. The slide potentiometers are soldered to the track side of the PCB, which makes it necessary for their terminals to be bent as shown by the arrow.

Figure 7. Illustrating how the PCBs are fitted to the front panel.

Parts list (Fig. 8)

Resistors:

- R₁ = 100 k
- R₂ = 27 k
- R₃ = 1 k
- R₄ = 470 Ω
- R₅ = 10 k
- R₆ = 47 k
- R₇ = 22 k
- R₈ = 1k5
- R₉ = 68 Ω*
- R₁₀ = 220
- R_{11...R₁₄} = 10 Ω
- P₁ = 47 k linear potentiometer with switch
- P₂ = 1 M preset potentiometer
- P₃ = 100 k stereo slide potentiometer, linear, for PCB fitting
- P₄ = 100 k mono slide potentiometer, linear, for PCB fitting

Capacitors:

- C₁; C₁₀; C₁₁; C₁₉* = 100 n
- C₂; C₃ = 1 μ; 16 V
- C_{4...C₇} = 22 n
- C₈; C₉ = 1000 μ; 25 V
- C₁₂; C₁₃ = 10 μ; 16 V
- C_{14...C₁₈} = 4μ7; 16 V

Semiconductors:

- D₁ = zener diode, 10 V, 400 mW
- D₂ = 1N4148
- D_{3...D₆} = 1N4001
- T₁ = BS 170
- T₂ = BS 250
- IC₁; IC₂ = 4558; 1458; TL 082
- IC₃ = 7815
- IC₄ = 7915
- IC₅ = LM317T

Miscellaneous:

- S₂ = single pole change-over switch
- S₃ = double pole mains switch
- F₁ = fuse, 500 mA, delayed action
- fuse holder for F₁; single hole mounting
- mains chassis socket
- heat sinks for IC₃ and IC₄
- mains transformer;; secondary 2 × 15 V; 2.5 VA or 4.5 VA
- knobs for slide potentiometers
- PCB 85097-1

*see text

6

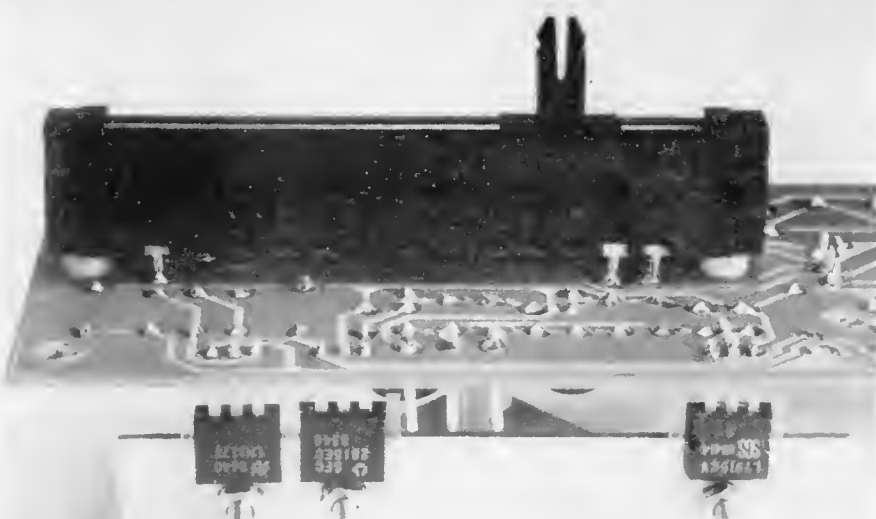

Before the construction is started, it is necessary to be quite clear on the size of the required unit. As stated, in its smallest form, the installation offers three lamp channels, for which one main control and one lamp channel PCB are required. Where nine lamp channels are needed, two more relevant PCBs are required. The power supply shown in Figure 2 can cope easily with this number of boards. The housing of the control panel can be kept fairly flat and light as shown in Figure 7. The power stages, which will be

discussed in detail next month, are housed in a separate enclosure and connected to the control panel by a simple control cable. The wiring in the control panel is not critical, since the boards are interconnected by simple jumpers. It is essential that the potentiometers are of good quality, because "scratchy" ones may result in flickering lamps.

Part 2 will appear in our December 1985 issue.



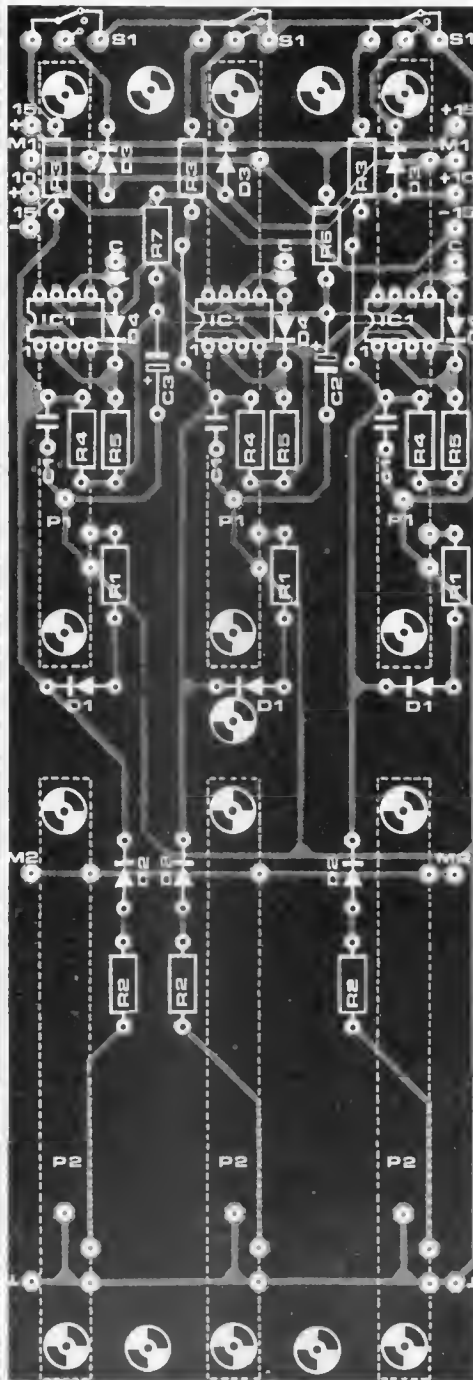
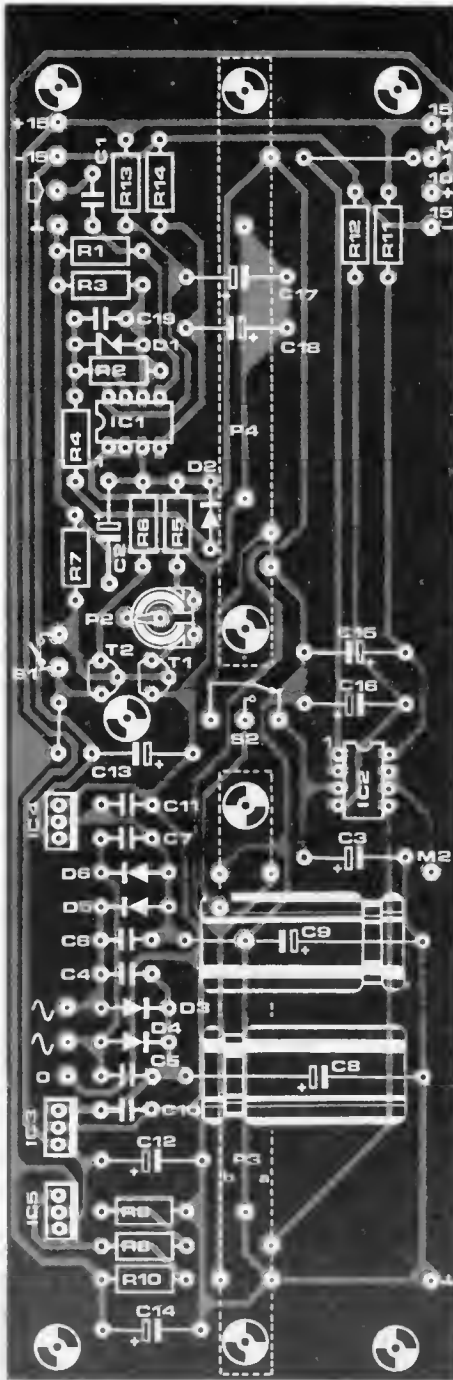

Figure 8. Main control printed-circuit board.

Figure 9. Lamp channel printed-circuit board.

Parts list (Fig. 9)

Resistors:

R₁; R₂ = 1 k
 R₃ = 22 Ω
 R₄; R₅ = 1 M
 R₆; R₇ = 10 Ω
 P₁; P₂ = 100 k mono slide potentiometer, linear, for PCB mounting

Capacitors:

C₁ = 47 n
 C₂; C₃ = 4μF, 16 V

Semiconductors:

D₁...D₄ = 1N4148
 IC₁ = 741; LF 356

Miscellaneous:

S₁ = single pole change-over switch with open centre position
 two knobs for slide potentiometers
 PCB 85097-2

NOTE: all these parts, except the PCB itself, are required three-fold for each board.

Please see page 11.64 for PCB artwork.

Anemometers are in steady demand by yachtsmen, wind surfers, glider pilots, and amateur meteorologists, to name but a few. The digital anemometer presented here can be built for about half the price of commercially available mechanical versions.

An anemometer is a device for measuring the velocity of, among others, air movement, i.e., wind. Its transducer (also called sensor), i.e., the device that converts the wind speed into electrical signals, is usually driven by a small windmill, or a set of cups. The latter is used in the present design — Fig. 8.

The sensor, at the left in Fig. 1, generates sixteen pulses for every rotation of the set of cups. These pulses, taken over a time

hand-held anemometer

by M Huch



Fig. 1 Block schematic of the anemometer.

determined by the control, are added in a counter. At the end of each counting period, the counter reading is applied to an EPROM; the output data of the EPROM are stored in a display driver. For every counter position, the EPROM has a code in two successive bytes, which determines what will be shown on the LCD display. Via switch S_2 , four ranges of the EPROM can be selected over two free address lines, so that the counter reading may be displayed in four different units: metres per second, m/s; knots; kilometres per hour, km/h, and the Beaufort scale. The conversion between these units is, therefore, not carried out direct by the unit, but rather by the programming of the EPROM.

As the anemometer is battery powered, CMOS ICs are used to ensure a low current drain, while the EPROM is only switched on briefly at the end of a counting period to codify the counter reading.

Circuit description

Counters IC_1 and IC_2 in Fig. 2 control the operation of the circuit. A 4.433 MHz (television) crystal can be connected direct to the oscillator input of IC_1 .

AND gates N_1 and N_3 generate the pulses required by the sensor. These pulses have a duty factor of 1:64.

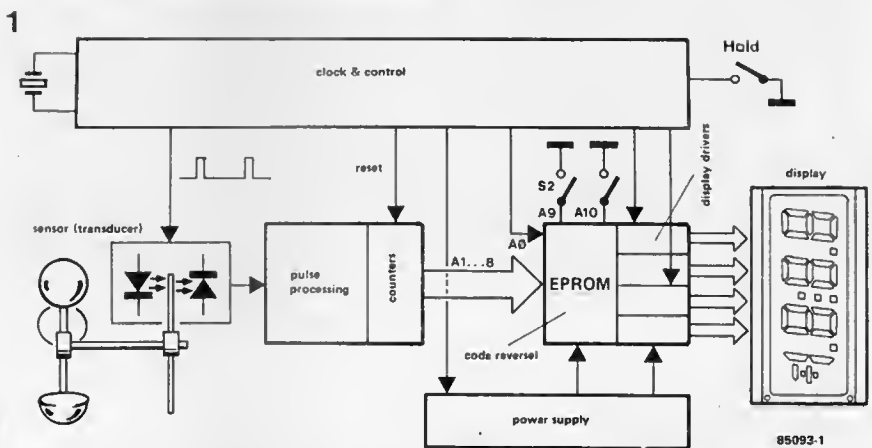

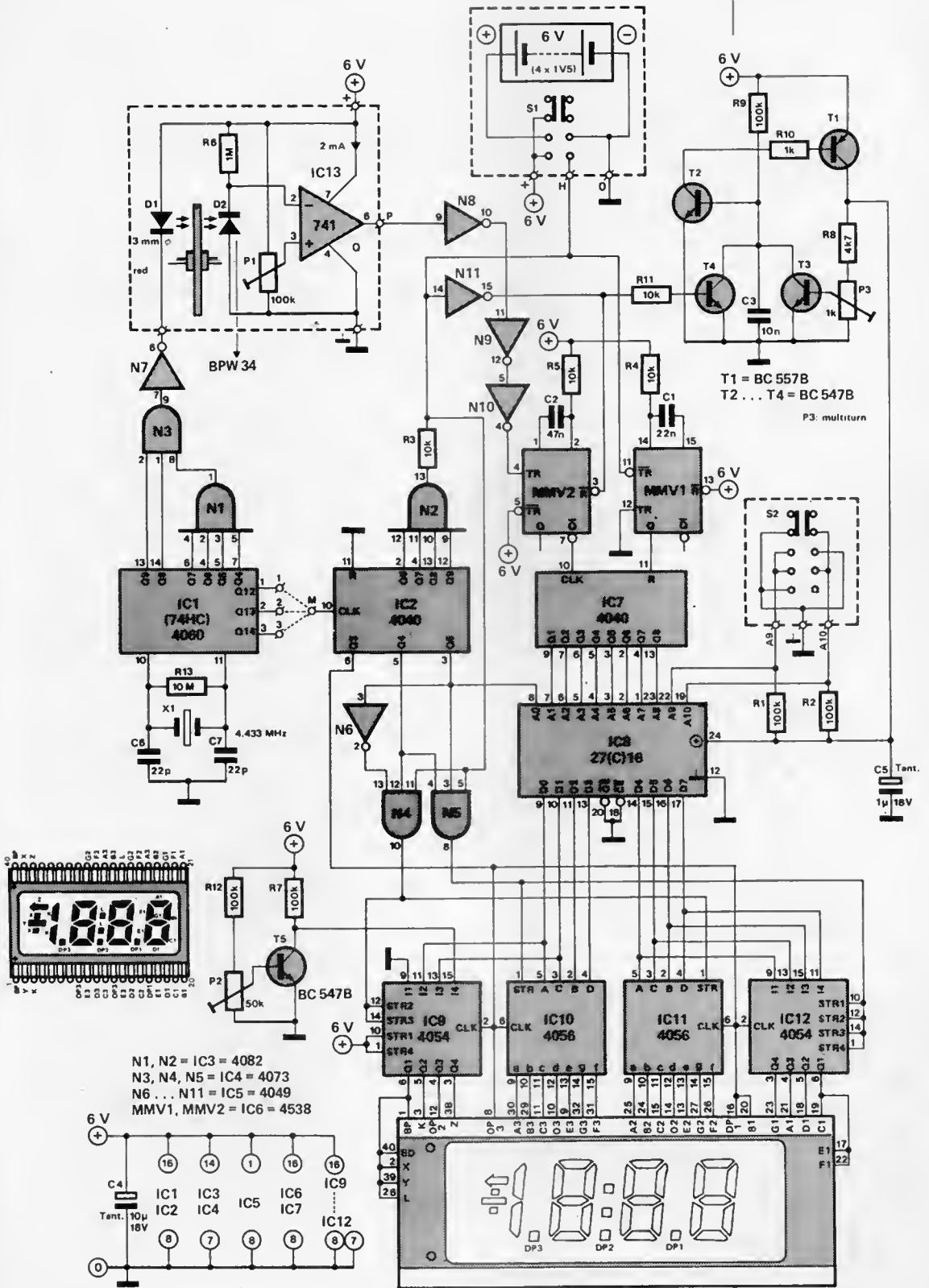

85093-2a

Fig. 2 (a) Circuit diagram of the anemometer.

Fig. 3 Timing diagram of the sensor.

2b

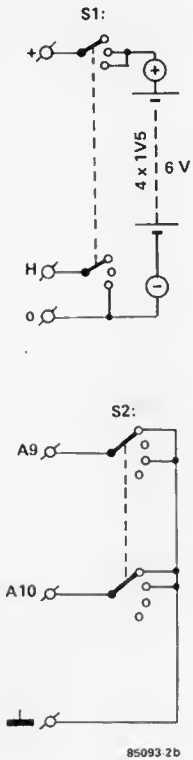
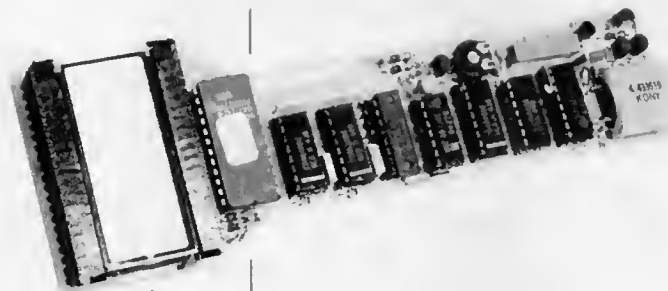
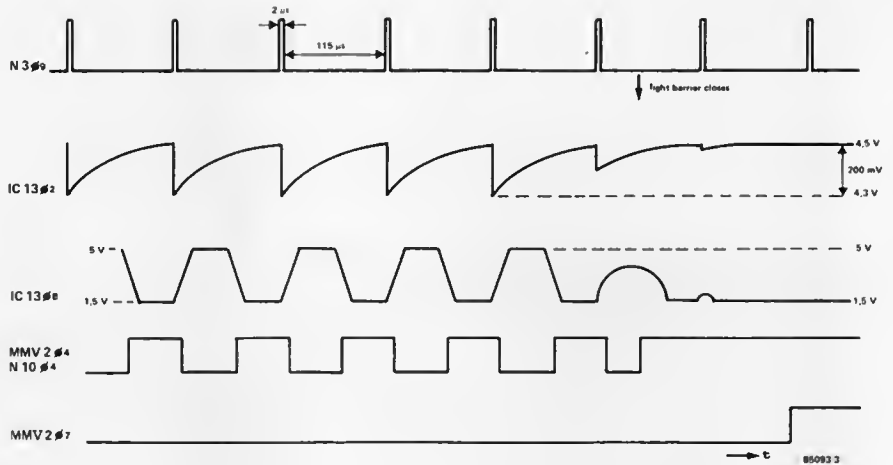

Fig. 2 (b) Diagram for use when rotary instead of slide switches are used in the S₁ and S₂ positions.



3



The LED in the sensor is driven direct by inverter N₇; a limiting resistor is not required. When the light barrier is open, trapezium-shaped pulses as shown in Fig. 3 appear at the output of the sensor. These pulses are reshaped into rectangular form by inverters N₈...N₁₀. The resulting pulses are stretched by monostable MMV₂ in such a way that they become one pulse, whose period is equal to the time the light barrier is open. These pulses (sixteen per revolution) are counted in IC₇.

The measurement period is controlled by counter IC₂; the relevant timing diagram is shown in Fig. 4. The duration of a measurement may be set to ½ s, 1 s, or 2 s with link M. This enables the processing circuits to be matched to the transducer. As long as the output of AND gate N₂ is logic low, the signals provided by the sensor are processed and counted. When the output goes high, counting stops, the

supply to the EPROM is switched on, and pin A₀ of the EPROM is made logic 0. Gate N₄ then generates a pulse which stores the contents of the memory addressed by the counter in the display driver in such a way that bits 0...3 go to IC₉ and bits 4...7 to IC₁₁. Pin A₀ of the EPROM then goes high, and the resulting pulse from N₅ writes bits 0...3 and 4...7 into IC₁₀ and IC₁₂ respectively. The supply to the EPROM is then switched off, the counter is reset by MMV₁, and a new counting period starts.

With switch S₁ closed, new counts are not loaded into the display. The previous information remains, therefore, displayed until the switch is opened. In this way, the EPROM programming can determine which units are to be displayed.

The display

The readings appear on a 3½ digit liquid-crystal display (LCD), which also shows LO BAT when the battery voltage is getting low.

This type of display must be controlled with alternating current, since DC control causes damage by electrolysis. Special drivers are, therefore, used to provide an AC control signal. Every other output pulse of the four-bit latches in IC₉ and IC₁₁ is inverted by the clocking signal at pin 2 before the output is fed to the display. As the clocking signal is also applied to the backplane of the display, the segments that are in phase with the backplane (latch=0) remain invisible, while the elements that are out of phase with the backplane (latch=1) show up black. IC₁₀ and IC₁₂ operate in an identical manner, but are decoded for a 7-segment display.

The two centre digits of the display are binary coded decimal (BCD). The leading], the decimal point after the second digit, and the segments of the last digit can be individually controlled with the

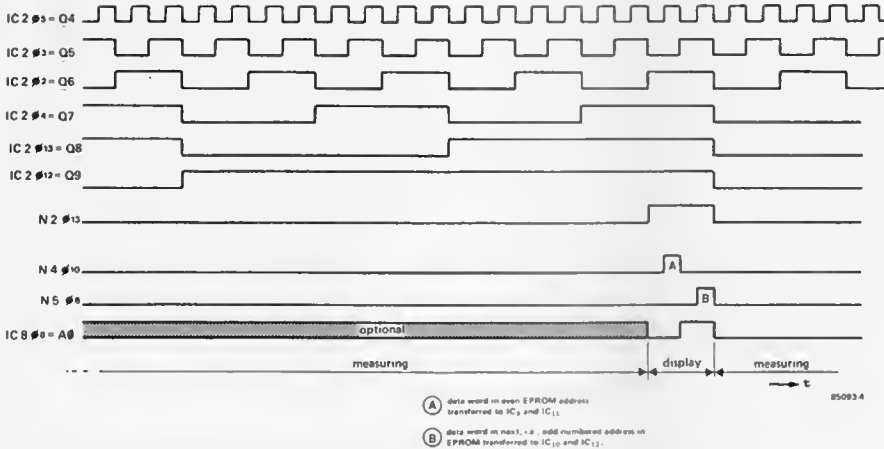

Fig. 4 Timing diagram of the processing circuits.

appropriate bits. This makes it possible for special symbols to be displayed in the last position, e.g., a "b" for Beaufort, and a horizontal stroke for the other units.

The sensor

A thirtytwo-segment disc is rotated across the light barrier by the set of cups that is fitted to the same spindle — see Fig. 5. The thirty-two segments are equally divided into clear and opaque ones. A simple amplifier processes the signals provided by the photodiode. The LED is driven by 2 μs pulses provided by N₃ (pin 9). The duty factor of these pulses is 2:117 as shown in Fig. 3. The pulses provided by the light barrier are received by photodiode D₂. Because of the delay in the diode, the signal at the non-inverting input of comparator IC₁₃ is sawtooth-shaped. The output of the comparator is a square wave (duty factor 1:1). Preset P₁ should be adjusted so that with the light barrier open the signal at pin 6 of IC₁₃ is as clean a square wave as possible.

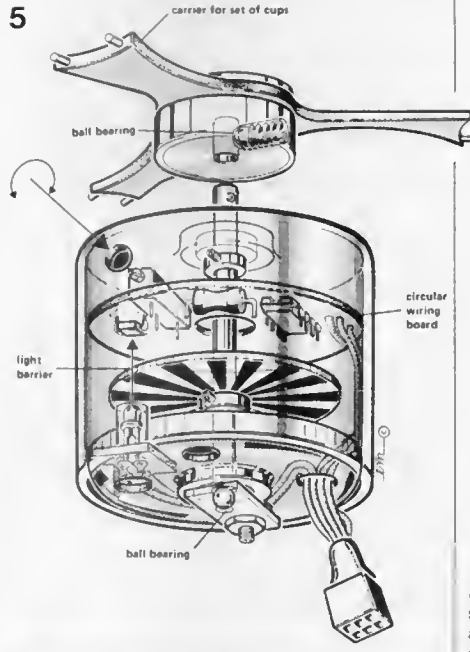

Fig. 5 Suggested construction of the sensor and the carrier for the set of cups (scale=13:20).

Power supply

The unit is intended for operation from four mercuric oxide button cells, whose e.m.f. ranges from 5 V to 7 V. This is no problem for the CMOS ICs, but does mean that a separate, stable 5.5 V supply is needed for the EPROM. This could, of course, be avoided by the use of a — rather more expensive — CMOS EPROM. Transistors T₁ . . . T₄ form a voltage limiter, whose output voltage vs battery voltage characteristic is shown in Fig. 6. The limiting threshold can be set with P₃. If the base of T₄ goes high, the supply to the EPROM is switched off. Transistor T₅ functions as a battery voltage monitor. Preset P₂ is set so that T₅ cuts off as soon as the battery voltage drops below 4.5 V i.e., the level at which the



EPROM begins to work unreliably. When T_5 does not conduct, pin 15 of IC₉ goes high and LO BAT is shown on the display.

Construction

The sensor is most conveniently made from an old cassette recorder motor from which all the innards, except the spindle, have been removed. To make the spindle rotate virtually friction-less, a small ball-bearing is added at the lower end as shown in Fig. 5.

The sensor circuit is built on a circular (vero) board, which must be made to fit exactly in the motor housing. After the board has been wired up, it should be glued firmly in the housing as shown in

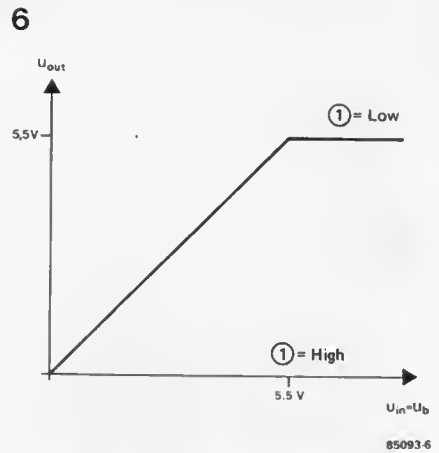
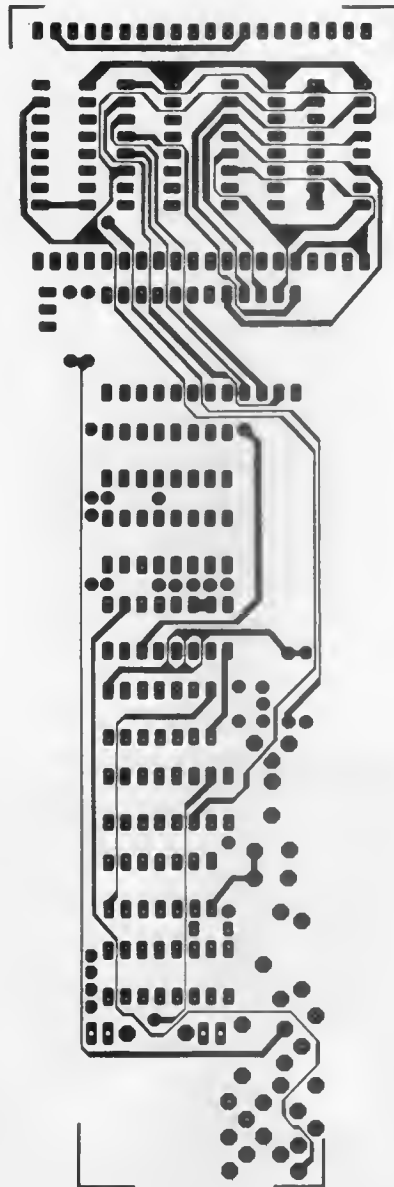

Fig. 6 Limiting characteristic of the supply voltage for EPROM IC₈.

Fig. 7 The double-sided printed-circuit board.

7a



b

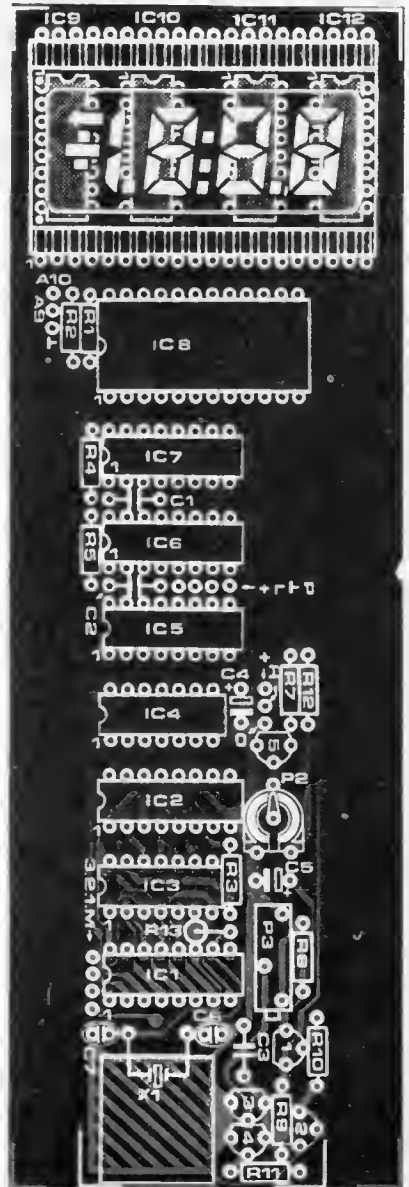

Parts list

Resistors:

- R₁; R₂; R₇; R₉; R₁₂ = 100 k
- R₃; R₄; R₅; R₁₁ = 10 k
- R₆ = 1 M
- R₈ = 4k7
- R₁₀ = 1 k
- R₁₃ = 10 M
- P₁ = 100 k multiturn preset
- P₂ = 50 k preset
- P₃ = 1 k multiturn preset

Capacitors:

- C₁ = 22 n
- C₂ = 47 n
- C₃ = 10 n
- C₄ = 10 μ; 16 V tantalum
- C₅ = 1 μ; 16 V tantalum
- C₆; C₇ = 22 p

Semiconductors:

- D₁ = LED; 3 mm; red
- D₂ = BPW34
- T₁ = BC 557B
- T₂...T₅ = BC547B
- IC₁ = 4060 or 74HC4060
- IC₂; IC₇ = 4040
- IC₃ = 4082
- IC₄ = 4073
- IC₅ = 4049
- IC₆ = 4538
- IC₈ = 27(C)16
- IC₉; IC₁₂ = 4054
- IC₁₀; IC₁₁ = 4056
- IC₁₃ = 741

Miscellaneous:

- LCD with LO BAT indication, e.g., Hamlin 3901 or 3902; or Hitachi LS007C-C or H1331C-C
- X₁ = crystal 4.433 MHz (television!)
- 4 button cells, mercuric oxide; 1.5 V each
- S₁ = 2-pole; 3-position slide or rotary switch
- S₂ = 2-pole; 4-position slide or rotary switch
- PCB 85093

Note that IC₁₃; R₆; D₂; and P₁ are not intended for mounting on the PCB.



C

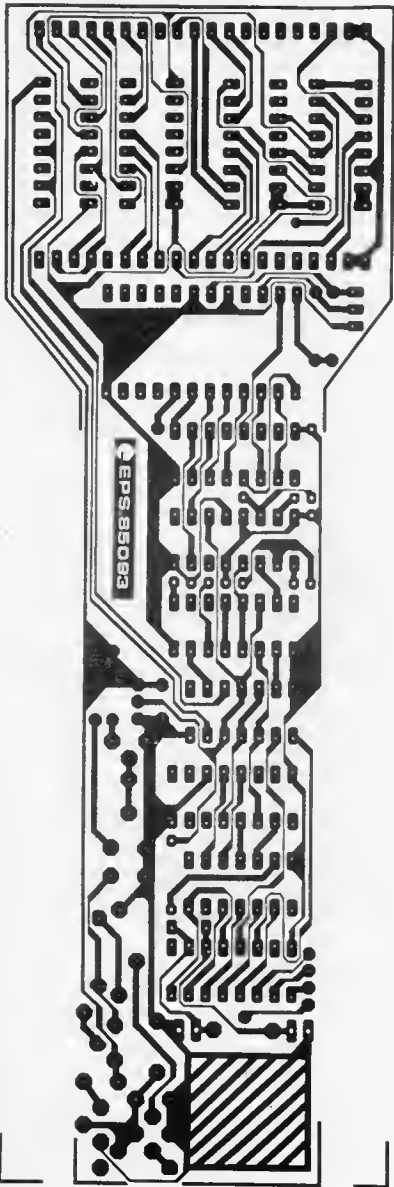

Fig. 5. Make sure that the preset can be adjusted from outside!

The remainder of the sensor is built together as shown in Fig. 5. Make sure that the photodiode and LED are in a straight line. The LED should be prevented from radiating sideways with the aid of some insulating tape or suitable sleeving.

The set of cups is made from three ping-pong balls fastened onto a carrier cut from a sheet of PTFE (Teflon) which itself is glued onto the pulley removed from the cassette motor — see Fig. 5 and Fig. 8.

The ping-pong balls are cut in half along their seam, so that a reinforcing rim remains. The resulting half balls are best fitted in place with an epoxy resin.

The printed-circuit board — Fig. 7 — has been designed to fit nicely in a hand-held case.

To keep the completed board as flat as possible, it is best to solder the drivers and the display direct to it. If the pins of the display are too short, they can be lengthened with the cut-off pins of an IC socket. It is, nevertheless, possible to fit the display and the drivers onto special flat sockets.

The unit may be constructed in the housing of a large electric torch, but a more professional case may be built on the lines of Fig. 8. Such a case is made from fibre glass, which is available in kit form from many car accessory shops for DIY car panel repairs.

Calibration

Before any of the ICs or the EPROM are inserted into their sockets, switch on the supply and set the voltage at pin 24 of the EPROM socket to 5.5 V with P_3 .

The ICs and the EPROM should now be inserted into their respective sockets (after



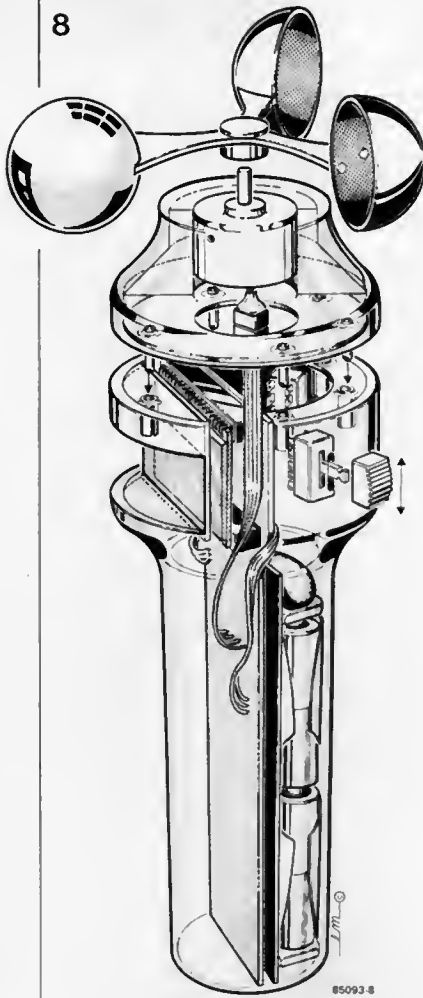

Fig. 8 Suggested construction of the complete anemometer.

the supply has been switched off!). The voltage at pin 24 of the EPROM socket must now be checked with an oscilloscope and, if necessary, P₃ should be readjusted to give 5.5 V.

The supply voltage should now be reduced to 4.5 V, after which P₂ should be adjusted to just cause a LO BAT reading on the display. If the supply voltage is increased slightly, the reading should disappear immediately.

Connect the sensor to the processing unit, and an oscilloscope to pin 6 of IC₁₃. Turn the segmented disc so that the light barrier is open, and adjust P₁ for a clean trapezium-shaped signal on the oscilloscope.

If an oscilloscope is not available, an EPROM programmed as shown in Table 1 may be used. The sensor should then be driven by a small electric motor at about 10 rev/s and P₁ adjusted until the display shows a steady reading of about 160.

The IC₇ count, *n*, (which is directly proportional to the rotary velocity of the segmented disc) and the wind velocity, *v*, are related by

$$v = nk$$

where *k* is a constant.

If at all possible, calibration of the display should be carried out in a wind tunnel but, unfortunately, this is not available to many. The next best thing is to visit your local meteorological station (consult your local telephone directory or ask your local library) on a number of days. Take a series of measurements, note the time, and then ask the station manager for the actual wind forces measured by his station.

0000	00	0F	10	0F	20	0F	30	0F	40	0F	50	0F	60	0F	70	0F
0010	80	0F	90	0F	00	01	10	01	20	01	30	01	40	01	50	01
0020	60	01	70	01	80	01	90	01	00	02	10	02	20	02	30	02
0030	40	02	50	02	60	02	70	02	80	02	90	02	00	03	10	03
0040	20	03	30	03	40	03	50	03	60	03	70	03	80	03	90	03
0050	00	04	10	04	20	04	30	04	40	04	50	04	60	04	70	04
0060	80	04	90	04	00	05	10	05	20	05	30	05	40	05	50	05
0070	60	05	70	05	80	05	90	05	00	06	10	06	20	06	30	06
0080	40	06	50	06	60	06	70	06	80	06	90	06	00	07	10	07
0090	20	07	30	07	40	07	50	07	60	07	70	07	80	07	90	07
00A0	00	08	10	08	20	08	30	08	40	08	50	08	60	08	70	08
00B0	80	08	90	08	00	09	10	09	20	09	30	09	40	09	50	09
00C0	60	09	70	09	80	09	90	09	01	00	11	00	21	00	31	00
00D0	41	00	51	00	61	00	71	00	81	00	91	00	01	01	11	01
00E0	21	01	31	01	41	01	51	01	61	01	71	01	81	01	91	01
00F0	01	02	11	02	21	02	31	02	41	02	51	02	61	02	71	02
0100	81	02	91	02	01	03	11	03	21	03	31	03	41	03	51	03
0110	61	03	71	03	81	03	91	03	01	04	11	04	21	04	31	04
0120	41	04	51	04	61	04	71	04	81	04	91	04	01	05	11	05
0130	21	05	31	05	41	05	51	05	61	05	71	05	81	05	91	05
0140	01	06	11	06	21	06	31	06	41	06	51	06	61	06	71	06
0150	81	06	91	06	01	07	11	07	21	07	31	07	41	07	51	07
0160	61	07	71	07	81	07	91	07	01	08	11	08	21	08	31	08
0170	41	08	51	08	61	08	71	08	81	08	91	08	01	09	11	09
0180	21	09	31	09	41	09	51	09	61	09	71	09	81	09	91	09
0190	00	E0	10	E0	20	E0	30	E0	40	E0	50	E0	60	E0	70	E0
01A0	80	E0	90	E0	00	E1	10	E1	00	E1	30	E1	40	E1	50	E1
01B0	60	E1	70	E1	80	E1	90	E1	00	E2	10	E2	20	E2	30	E2
01C0	40	E2	50	E2	60	E2	70	E2	80	E2	90	E2	00	E3	10	E3
01D0	20	E3	30	E3	40	E3	50	E3	60	E3	70	E3	80	E3	90	E3
01E0	00	E4	10	E4	20	E4	30	E4	40	E4	50	E4	60	E4	70	E4
01F0	80	E4	90	E4	00	E5	10	E5	20	E5	30	E5	40	E5	50	E5

Table 1 Hex dump for the calibration EPROM.

Table 2.

Beaufort scale	Description	Wind speed		
		m/s	mph	knots
0	calm	0...0.2	0...1	0...1
1	light air	0.3...1.5	1...3	1...3
2	light breeze	1.6...3.3	4...7	4...6
3	gentle breeze	3.4...5.4	8...12	7...10
4	moderate breeze	5.5...7.9	13...18	11...16
5	fresh breeze	8.0...10.7	19...24	17...21
6	strong breeze	10.8...13.8	25...31	22...27
7	moderate gale	13.9...17.1	32...38	28...33
8	fresh gale	17.2...20.7	39...46	34...40
9	strong gale	20.8...24.4	47...54	41...47
10	whole gale	24.5...28.4	55...63	48...55
11	storm	28.5...32.6	64...75	56...65
12	hurricane	32.6 +	75 +	65 +

Table 2 The Beaufort scale and correlated wind speeds.

Plot the results of each series of measurements. The resulting characteristic should be a fairly straight line with a slight drop-off at low wind speeds (this is caused by friction in the sensor). The slope of the characteristic gives the value of *k*. If the measurements were suspect, calculate the constant *k* for each and every measurement from

$$k = v/n$$

and from all the results establish a mean value for *k*.

The values thus found, and their relationship, enable the EPROM to be programmed in line with Table 3.

Note that since S₂ enables the selection of any one of the address ranges 000...1FF; 200...3FF; 400...5FF; and 600...7FF, four different codes (m/s; km/h; knots; and the Beaufort figure) may be programmed. **M**



Table 3(a).

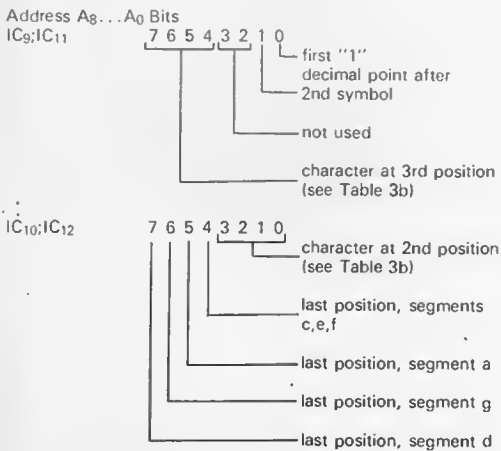

Table 3(b).

binary	alphanumeric
0000	0
0001	1
0010	2
0011	3
0100	4
0101	5
0110	6
0111	7
1000	8
1001	9
1010	L
1011	H
1100	P
1101	A
1110	-
1111	-

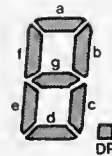

Table 3 (a) Construction of a 512-byte block in the EPROM; (b) Correlation between binary code and alphanumeric character.

luxury transistor tester

A highly important aspect of transistors is their current amplification ratio. This is often indicated by an A, B, or C behind the type number in the case of transistors. Inevitably however (by decree of Murphy himself), this is no longer legible. Using the transistor tester described here, the correct letter can be read from a display. At the same time, it can also be determined whether the transistor is up to scratch or not.

R. Storn

This particular design first appeared on Elektor's pages in last year's Summer Circuits issue. Readers voted it as one of the most interesting circuits and this article is the elected Elektorised result. The circuit has been slightly modified and a printed circuit board now accompanies it.

In technical literature, the current amplification is usually indicated as h_{FE} . For everyday purposes it is not absolutely necessary to know the precise h_{FE} value, but rather to have a rough idea of its upper and lower limits. The manufac-

I_C (collector current) and I_B (base current).

The Luxury Transistor Tester indicates the letter corresponding to the transistor's h_{FE} category. Thus an A, B, or C will appear on the seven-segment display. An 'F' will appear, if the transistor is faulty. The circuit has separate connections for NPN and PNP transistors. A switch selects the transistor type.

The block diagram

Figure 1 shows the block diagram of the

turer used to have no way of precisely determining the current amplification ratio in advance. The best he could do was make a rough estimate, then after the transistors are manufactured, they were selected to meet the required h_{FE} limits. The type number was then printed on the case. Although nowadays this can be determined in advance, the same type numbering is still used. Two transistors with the same type number do not necessarily have the same h_{FE} . That is why industry uses a letter as a suffix to indicate the general h_{FE} value. The letters define the h_{FE} according to the following values:

- 'A' for an h_{FE} between 140 and 270
- 'B' for an h_{FE} between 270 and 500
- 'C' for an h_{FE} of more than 500

The terms h_{FE} and current amplification ratio describe the ratio between

transistor tester. Its operation is quite simple. The voltage across a number of resistors is compared to a reference voltage. Here it is important to know beforehand whether the transistor is NPN or PNP. The switch that selects the transistor group also operates an LED to indicate the position of the switch. This voltage comparison determines the h_{FE} group of the transistor and displays an 'A', 'B', or 'C' whichever is appropriate. If the 'F' on the display does not disappear when the pushbutton is depressed, then the transistor is defective.

The layout

The complete layout is given in figure 2. Also shown is the parts list. The schmitt triggers in the block diagram consist of three op-amps wired as comparators.

1

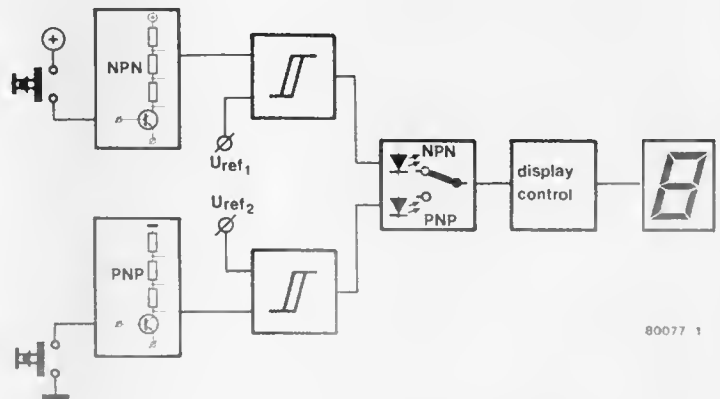

80077 1

Figure 1. The block diagram of the Luxury Transistor Tester.

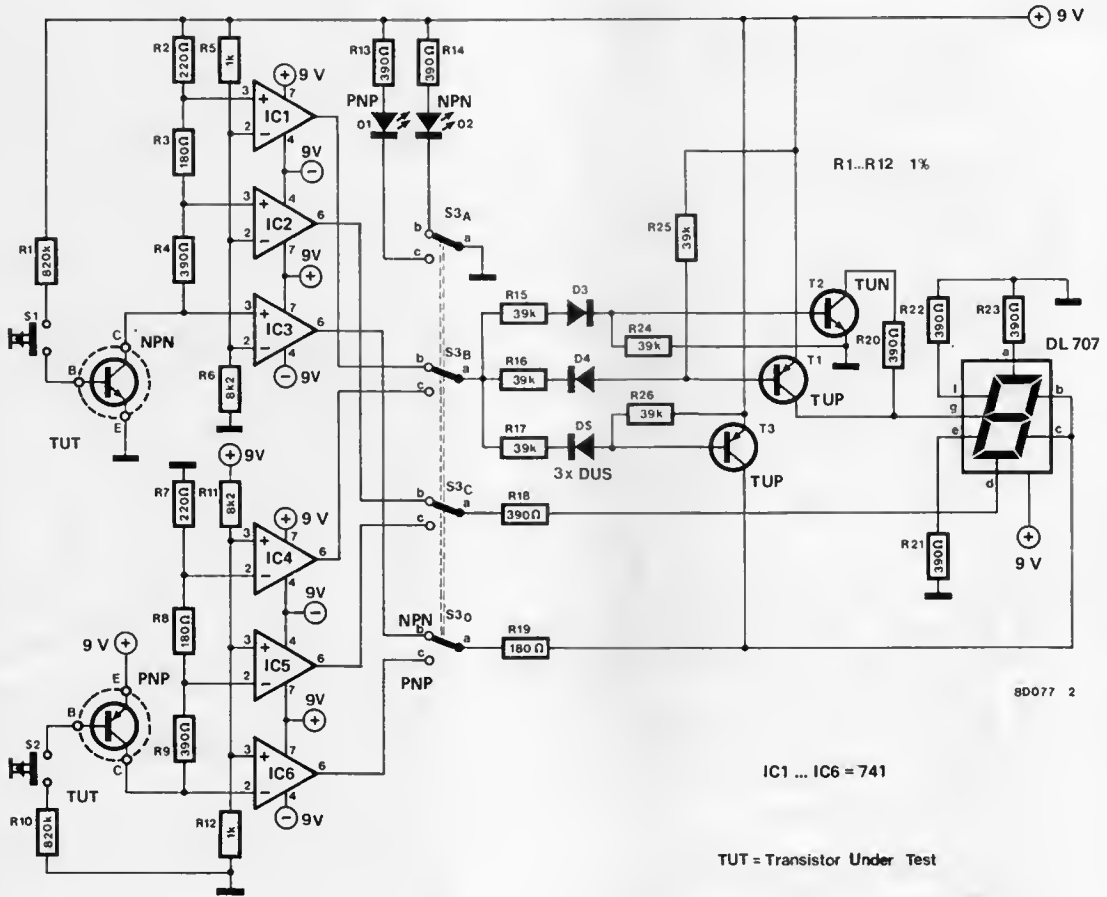

Figure 2. The complete schematic of the Luxury Transistor Tester. The design has undergone some changes since the 1979 Summer Circuits issue when this transistor tester was first published. Diodes D3 to D5 and R24 to R26 have been added along with a split supply. The diodes protect transistors T1 - T3 from high voltages that may show up at the base-emitter junction.

The upper half of the schematic, IC1 - IC3, serves to measure NPN transistors. The inverting inputs of the op-amps are connected to a reference voltage. The non-inverting inputs are connected to the collector of the transistor under test (TUT). Resistors are used as voltage dividers here. The base drive current is determined by R1 and R10. At a certain amplification factor the collector current will also be fixed. Then the three collector resistors will be under a voltage determined by the current amplification ratio and the value of the collector resistor. If the amplification factor is 400 and the base drive is 10 μ A, then the collector current will be 4 mA. With this amount of current flow, the voltage dropped across the collector resistor R4 (390 Ω) will be 1.56 V. Three collector resistors have been included and they all have a certain voltage dropped across them. In the given example, R2 (220 Ω) has 0.88 V and R3 (180 Ω) has 0.72 V. As

said earlier, R4 has 1.56 V dropped across it. This makes calculating the voltages at the IC inputs easy. The inverting inputs are all at the same potential (or voltage). The voltage at the TUT's collector will be 9 V - 3.16 V = 5.84 V (the 3.16 V is the sum of the voltages across the resistors that feed the non-inverting inputs and the 9 V is the supply voltage). The reference voltage at the inverting input is 8.02 V which is determined by R5, R6 and R11, R12. In the earlier stated example, therefore, IC3's output will be low along with IC2's. Only IC1's output will be high. This is shown by this simple calculation:
 9 V (supply) - 0.88 V (voltage at pin 3) = 8.12 V. 8.12 V is higher than the 8.02 V reference. If S3 is in the NPN position a B will appear on the display. If the output of IC1 were also to go low, the display would then be C. This would be correct as the voltage drop across the resistors would have risen as well as the

current through them. The base current in this circuit being always the same, the higher collector current could only be due to a higher current gain. If, on the other hand, the outputs of IC1 and IC2 were high, only segment d would not light and so an 'A' would appear on the display. Segments a, e and f are always on because they're used in all of the various letters that are displayed. All of the above is on the presumption that the transistor is not faulty, for if it is, then an 'F' will appear. This occurs only when all the IC outputs are high - when the reference voltage is higher than the collector voltage of the TUT. The display control (the circuit consisting of T1, T2 and T3 along with resistors R15... R19, R24... R26 and diodes D3... D5) works quite simply. If the outputs of IC2 and IC3 are low, segments d, b, and c of the display are lit. The common anode of the display is, of course, always connected to the +9 V

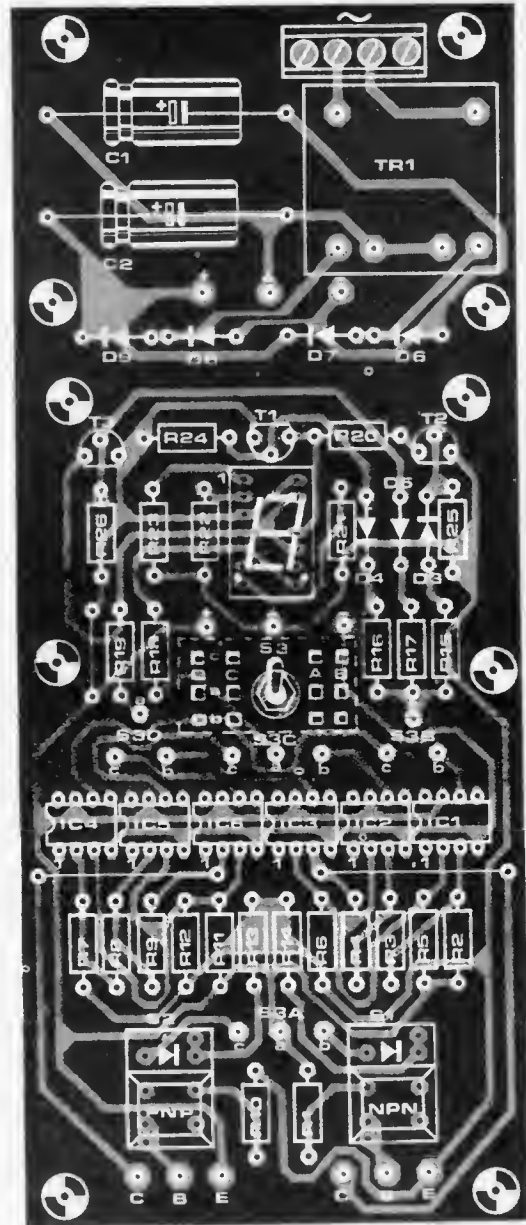
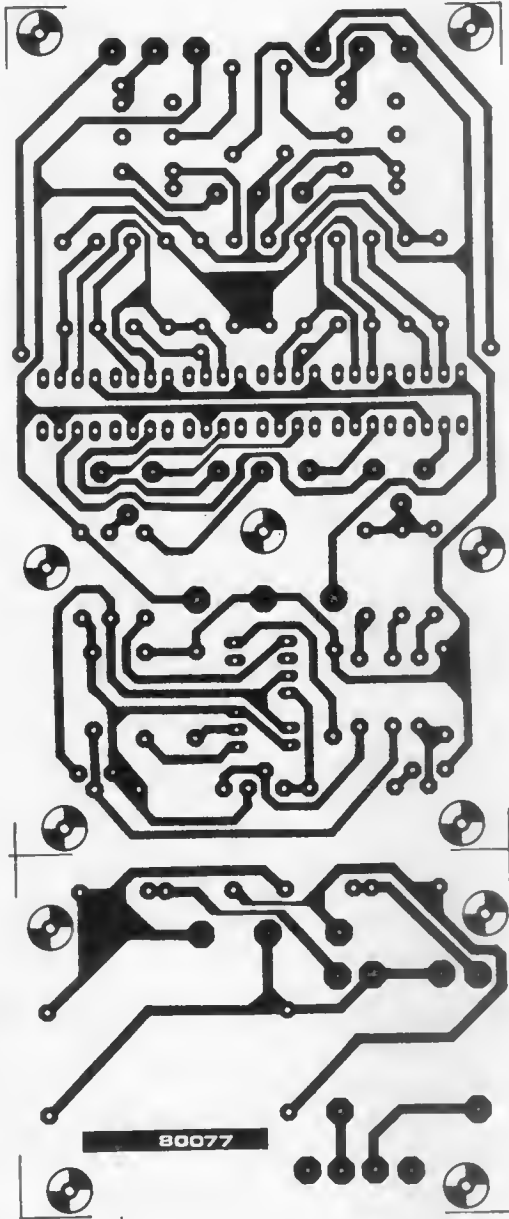

Figure 3. Printed circuit layout.

Parts List

Resistors:

R1, R10 = 820 k
 R2, R7 = 220 Ω
 R3, R8, R19 = 180 Ω
 R4, R9, R13, R14, R18, R20, R21,
 R22, R23 = 390 Ω
 R5, R12 = 1 k
 R6, R11 = 8k2
 R15, R16, R17, R24, R25,
 R26 = 39 k

Capacitors:

C1, C2 = 1000 μ /16 V

Semiconductors:

IC1 ... IC6 = 741 (Mini-DIP)
 T1, T3 = BC 557B
 T2 = BC 547B
 D3, D4, D5 = 1N4148
 D6 ... D9 = 1N4001
 Dp1 = LED-Display DL 707

Miscellaneous:

Tr = sec. 2 x 6 ... 9 V/50 mA
 S1, S2 = Digitast and LED
 S3 = 4 pole two way
 Verocase 502 (75-3960E)
 of similar

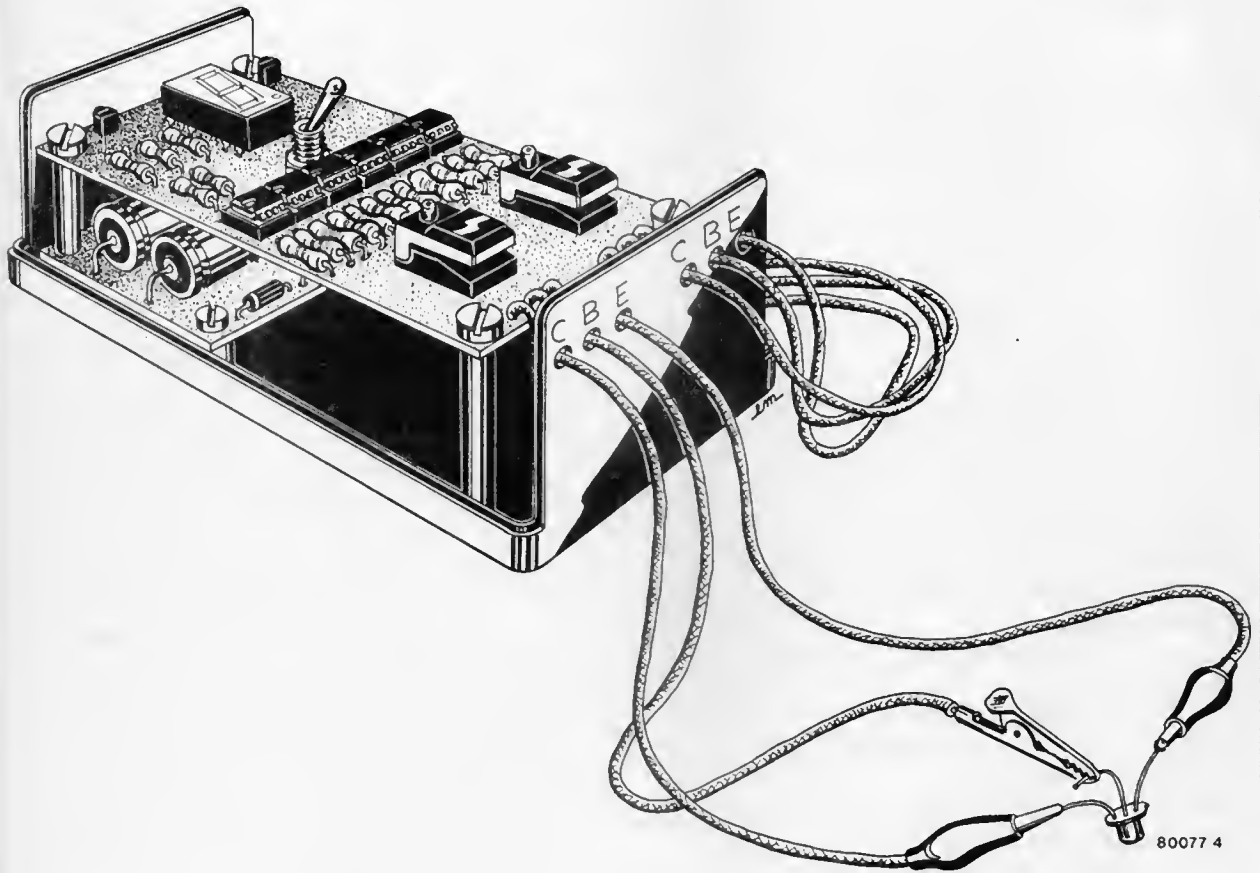

Figure 4. If the plastic case, that is mentioned in the text, is used, the whole transistor tester can be fitted into one case. Both of the LED's are mounted in the pushbutton (digitast) switches.

supply.

IC1 controls the three transistors. If IC1's output is high, only T2 will conduct so that segment g is connected to ground. Conversely, if IC1's output is low then only T1 and T3 will conduct with the result that segments b, c, and g are connected to +9 V and these segments go out.

A similar situation occurs when S3 is changed to the PNP position. The outputs of IC4, IC5 and IC6 are then connected to the display instead of IC1, IC2 and IC3.

Construction

In figure 3, both sides of the printed circuit are shown. To make construction as easy as possible, the display and switches have been included on the board. Even the transformer can fit on

it if a board mounting type can be found, otherwise a little tinkering may be necessary. The connections between the supply and the circuit itself have been deliberately omitted. This makes it possible to cut off the supply portion of the printed circuit board and mount it above (or anywhere else for that matter) the main board. The entire unit can be mounted in a Verocase type 502 (75 - 3960 E) or similar. Figure 4 shows how this is done.

Switch S3 is a 4 pole 2 way and, if desired, can be attached to the printed circuit board. For this, a hole may be drilled into the board and the tumbler can be inserted without any difficulty. If this is done it should be possible to make a slot in the case's lid so that S3 may be operated. The switch's connections must be wired to the circuit board. On the printed circuit the various

connections have been marked in the same way as the switch in the parts list. Pushbuttons used to interrupt the base drive of the TUT should be of the digitast type. Below S2 are the connections for the PNP and below S1 those for the NPN. The pin assignment code is C = collector, B = base and E = emitter.

The IC op-amps are the popular (and inexpensive) 741 type. There is however one minor disadvantage to this, six IC's are necessary. By avoiding the use of IC sockets (not needed in this case) costs can be kept to a minimum. It is however advisable to use a socket for the display. The transistors to be tested should, ideally, be connected to the board by means of clip leads. If this proves impossible, a transistor socket may be used, but this has shown disadvantages in practice.

simple sound effects

We have, somewhere in the Elektor laboratories, a sound effects department, although the exact location has yet to be discovered. There was a widely held opinion that it was found during the last Christmas office party but this was eventually discounted because a) the noises were too lifelike and b) it was not possible to simulate them electronically! We usually associate their normal products with the dying shrieks of tortured cats, horrifying howls and a whole assortment of plops, bangs, whistles etc. However on the odd occasion they do produce sounds suitable for publication and, to prove that this department really does exist, here is their latest circuit design.

The original design for this rather clever sound effects unit was built into a 19inch rack mounting cabinet which unfortunately tended to overheat to an alarming degree (see 'workshop heater' in Elektor number 184) and lacked a little on portability. Further research resulted in the following circuit which uses only two CMOS ICs and is very cheap to build. Despite its modest dimensions it will produce a range of sounds from that of an American police siren to one closely resembling the 'twittering' of birds.

Sounds simple?

As is apparent from the block diagram of the circuit (figure 1), the basic principle is extremely straightforward. The output of a twelve-bit binary counter is converted into an analogue voltage which is used to control a VCO. As the binary output of the counter increases, the control voltage ramps positive, until the counter resets and the voltage falls to zero, whereupon the count resumes and the control voltage once again starts to ramp positive, and so on. The waveform of the control voltage is thus a periodic sawtooth. The VCO produces the actual output signal of the circuit, whose pitch is determined by the instantaneous amplitude of the sawtooth control voltage. An output buffer amplifier ensures that the signal is sufficiently large to produce an audible tone when fed to a loudspeaker. The highly individual nature of the resultant sound is due to an unusual feedback configuration. The output signal of the VCO is not only used as the output of the circuit, but as the clock input of the binary counter. Thus the rate at which the counter steps through each count cycle depends upon the pitch of the output signal. In other words, the higher the sound, the faster it varies in pitch. The result is a repetitive *beup-beup* sound which starts each phrase at a low frequency and rises exponentially to a maximum pitch.

Circuit diagram

The circuit diagram of the sound effects generator is shown in figure 2, and as can be seen, it consists of only a couple of readily-available CMOS ICs and a few

assorted resistors and diodes.

IC2 forms the 12-bit binary counter. The binary value of the 8 lowest order bits (i.e. those bits which change state most frequently) is converted into an analogue voltage by means of resistors R1...R8. The VCO consists of a simple CMOS oscillator (built round N1 and N2) the RC time constant of which is varied by using transistor T1 and a diode bridge as a voltage-controlled resistor. As the control voltage fed to the base of T1 increases, more current is passed through the diodes, with the result that their dynamic resistance falls. The initial frequency of the oscillator is set with the aid of preset potentiometer P1, which is connected in parallel with the diode network.

The squarewave output of the VCO is fed both to the clock input of IC2 and to an output buffer. The latter is formed by four of the remaining inverters of IC1 connected in parallel.

Construction

A printed circuit board has been provided for the circuit (see figure 3). As can be seen, due to the low component count, the board can be kept very small. The loudspeaker can be any inexpensive 8 Ω type capable of handling 500 mW. The supply voltage of the circuit can lie between 4.5 and 10 V; at the lowest supply voltage the current consumption of the circuit is only 5 mA, which means that a 4.5 V battery could be used, thereby rendering the circuit portable. Note that the volume of the output signal is determined by the supply voltage level: the higher the supply voltage the louder the sound.

The pitch of the output signal can be adjusted by means of P1. Since the pitch directly determines the rate at which the pitch changes, reducing the resistance setting of P1 not only increases the pitch of the output signal but also causes it to increase more quickly. At the minimum resistance settings of P1 the resultant sound somewhat resembles that of a chirping bird.

The value shown for P1 in the diagram (1 M Ω) is chosen to give the maximum adjustment range. However, if desired any value from 10 k to 1 M may be used, with or without fixed series resistors.

1

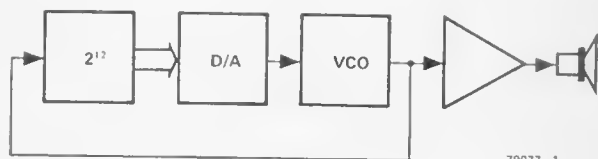

79077 1

Figure 1. Block diagram of the simple sound effects generator. The output of a binary counter is converted into an analogue voltage which is used to control a VCO. The output of the VCO forms both the output signal of the circuit proper and the clock signal of the counter.

Figure 2. Complete circuit diagram. Two CMOS ICs and a handful of discrete components are all that is required to produce an interesting range of sound effects.

Figure 3. Printed circuit board for the sound effects generator, on which all the components, with the exception of the loudspeaker, can be mounted. The circuit can be battery-powered if so desired (EPS 79077).

Parts list

Resistors:

- R1, R9 = 820 k
- R2 = 470 k
- R3 = 220 k
- R4 = 100 k
- R5 = 47 k
- R6 = 22 k
- R7 = 12 k
- R8 = 5k6

P1 = preset potentiometer, 1 M (see text)

Capacitors:

- C1 = 120 n
- C2 = 100 μ /16 V

Semiconductors:

- IC1 = 4049
- IC2 = 4040
- T1 = BC 547B, BC 107B or equ.
- D1 ... D4 = DUS

Miscellaneous:

- LS = loudspeaker, 8 Ω /500 mW
- S1 = pushbutton

2

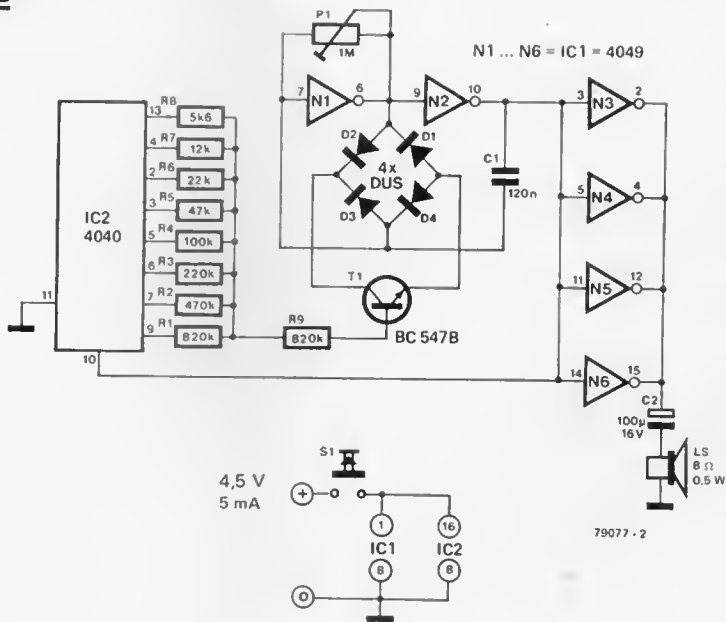

79077 . 2

3

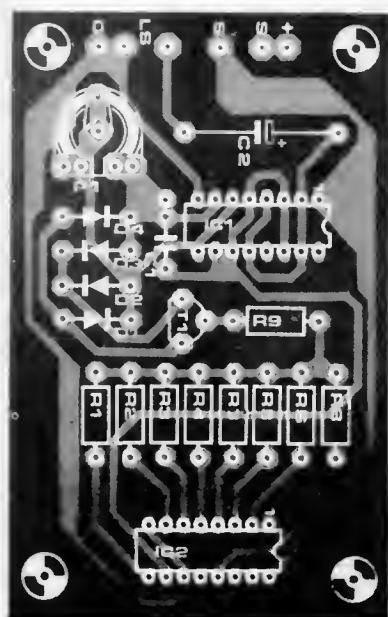
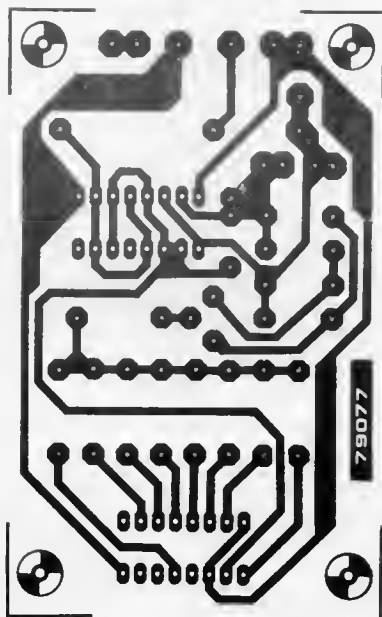

The 1000 viewdata terminals recently ordered by a major British financial services company were the most impressive example yet of the spread of the medium into everyday use in the United Kingdom. Viewdata has ceased to be a monolithic product, and is now tailored to a series of individual marketplaces such as travel and tourism, stock ordering, financial data, and software downloading where its essential virtues of simplicity, networking, and colour recommend it to non-specialist users.

Prestel, the viewdata system operated by British Telecom, is the largest of the private viewdata systems.

There are other systems too that have always been operated by private companies, such as British Leyland's (BL) car sales system, operated by its computer bureau company Istel. Then there are hybrids of the two, based on private computers but connected to the Prestel network via a gateway computer link.

Of the total number of terminals, 41 per cent are now in homes, against 14 per cent in 1982. However, it is a fair assumption that the revenues are still far more biased towards business user. Prestel has had some notable innovations in the past 18 months:

- Its Mailbox electronic mail service went national, after a trial period in London. Some 40 000 messages are now being sent each week, a figure that has been growing by 12 per cent weekly.
- Prestel Farmlink was launched, giving both local and national information, for example on crop problems, weather, market prices and pest warnings. Through gateways to other computers, the farmer can perform wages calculations and ration formulation analysis.
- A nationwide theatre ticket booking service was inaugurated by a leading London ticket agency, Edwards and Edwards.
- Prestel Homefinder was launched

of the United Kingdom's three million home computer owners, and it will be a test of the recent £250 000 television and press marketing campaign for Prestel telesoftware to see whether this customer base can be substantially enlarged.

These developments are in addition to the Homelink telebanking service whose software has been sold to the Commonwealth Bank of Australia; the Citiservice of stock exchange, commodity market and other real time prices that has been running for several years; and the extensive travel trade information that has characterized Prestel since its inception, with 5400 British travel agencies now using the service.

Prestel has found a more modest — but commercially more realistic — place than was originally anticipated in the British market for electronic information systems. But in assessing it, it is necessary to recognize its wider impact:

Viewdata in Britain

Several major British tour operators have arrangements of that kind and so far, Prestel has 18 such external gateways in operation.

New markets

So it is a mistake to equate United Kingdom viewdata with Prestel alone, just as it is wrong to condemn as unrealistic the original, over-optimistic forecasts of five years ago for the spread of Prestel to every home. The fact is that in Britain Prestel and viewdata in general have long since turned to different markets and marketing objectives. It is on these that the technology should be judged. Prestel itself continues to grow. At the last count it had 48000 terminals attached to its network and a database of over 330 000 frames of information (that is, screenfuls) on its computers. Despite the evident tribulations of its early years, it has been adding about 10 000 new subscribers a year, and there are now signs of a demand by the private as well as the business user.

specifically for estate agents to exchange details of houses for sale.

Home Computers

Perhaps the most successful single service so far has been Prestel Microcomputing, based on subscriptions for which home computer owners can download* games and other software. In association with two telesoftware suppliers, Micronet 800 — the most popular single information provider (IP) out of Prestel's 160 contracted IPs — and Viewfax 258, this service has attracted about 10 000 subscribers.

This figure, while proof of the appeal of the service, is still only a small fraction

Achievements

- It has created a more variegated United Kingdom market for viewdata.
- It has produced technical standards and standardization that have made it possible for viewdata as a mode of computing to spread to many new areas.
- It has triggered interest in viewdata in almost all industrialised countries. Many of them, through their national telecommunications authorities (PTTs), have now adopted it as part of their own systems.
- It was and is a test-bed for many new telecommunications services which are now standard parts of the value added services business, such as electronic mail, tele-ordering, gateways, and downloading.
- It has blazed the trail for British Telecom as an information and value added services company, rather than a passive common carrier. Other countries experience viewdata

*A downloader is a relatively inexpensive program that converts the data from the computer being consulted into a suitable form for the receiving (home) computer. Downloaders are commercially available for a number of popular computers, such as the BBC micro, Sinclair Spectrum, Amstrad, C64, Electron, IBM, Apple, etc.

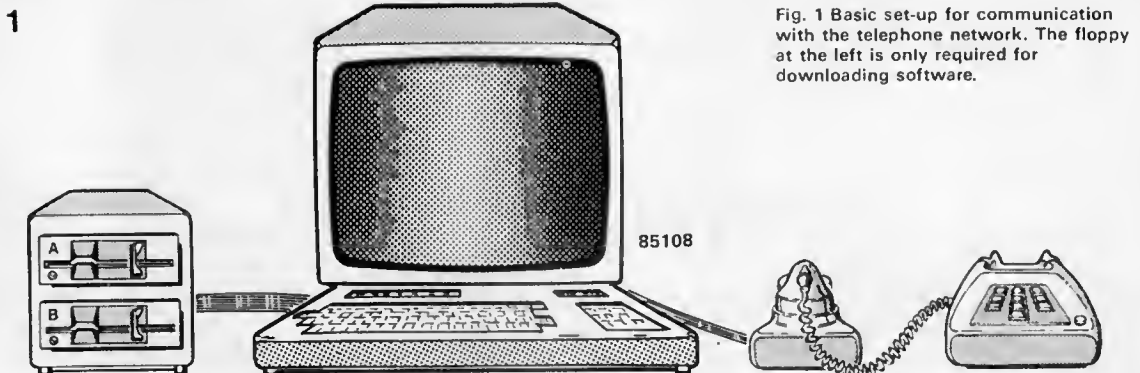

Fig. 1 Basic set-up for communication with the telephone network. The floppy at the left is only required for downloading software.



Fig. 2 Through Prestel's Homelink system, customers can order, and pay for, goods in the shops from the comfort of their own homes.

differently. France has designed its own system, technically incompatible with Prestel, and has made it the cornerstone of its telematics programme.

Based on small black and white Minitel terminals, the basic viewdata network is being created as a nationwide electronic telephone directory, replacing paper directories in the home and office. This is an imaginative but expensive approach, because it has to be heavily subsidized by the PTT.

About 300 000 Minitels are now in use, and over a million more are on order. The long run objective is that many other electronic information and transaction services will be offered over the network, and, as in the United Kingdom, there is early evidence of business rather than domestic usage of the system, such as in banking.

Substantial Use

West Germany has not taken the electronic telephone directory route, but has commissioned IBM to supply a nationwide viewdata system derived originally from Prestel. This has suffered technical delays, but has now been formally launched.

Forecasts of its growth (as with Prestel in its early years) have varied enormously, although the West German PTT, the Bundespost, is saying that it will have one million customers by the end of 1986. Others think it may be a fifth of that figure.

But it seems clear that in West Germany, as in France, viewdata will achieve substantial use, thanks to the impetus given to it by the national PTT. The British viewdata marketplace is not so unified. Alongside and intermingled with Prestel are the private systems, often operated by major trading companies. Examples are the information networks for dealers operated by two major motor manufacturers, or the stock control system operated by the Debenhams department store group.

Other systems are run by large computer bureau houses such as Thorn EMI's subsidiary, Datasolve. This has several tele-ordering services operating through a Prestel gateway, notably

Reservation for hotel reservations and Teleordering for the book trade.

Drugs and Banks

In another area, the Baric computer bureau has been helping to conduct clinical trails of new drugs, by using viewdata as a way of collecting and collating test information from doctors taking part in the trials.

Barclays Bank has its own in-house staff training scheme using viewdata screens, and the Bankers Automated Clearing Service (BACS) is using a private system supplied by Rediffusion to cope with the problem of redirecting back to its client banks queries that arise out of the millions of banking transactions processed electronically.

The Bank of Scotland, in conjunction with Prestel, has been operating a Home Banking service throughout the UK since last year.

This service enables private and business customers to check any aspect of their accounts, pay bills, and transfer money seven days a week, virtually round the clock.

There is also a special Home & Office Banking Investment Account: a high-interest bank account into which funds can be put that are not required for immediate use.

Armchair shopping

Club 403, an "armchair shopping service" operated by Viewtel Services Ltd from Birmingham, could be adapted for use in Australia, New Zealand, Canada and the USA.

Potential purchasers from these countries have been among the overseas visitors to Club 403 during its two-year trial with 1000 members. Following successful completion of the market test, Club 403 is now operating on a commercial basis in conjunction with Prestel.

The service is aimed at people who do not have the time or transport to visit the supermarket themselves, and for the elderly or disabled for whom shopping is physically impossible.

Club 403 is a package of regularly updated news, information and services available for the consumer at home. Using the latest technology a specially equipped television set can

access all kinds of local, national, and international news and order and pay for a wide range of goods and services. Club 403 members talk back to the information source to order goods or services by way of a simple alphanumeric keyboard.

Services available include: armchair grocer, butcher, greengrocer, teleflorist, teletaxi, telebanking, gourmet food service, electronic cookbook, motoring, gardening, education, jobs, library enquiries, and news pages.

The most popular service is the "armchair grocer" which provides details of almost 10 000 products from a local hypermarket. A catalogue is issued to members listing the available products with an individual code number.

A member selects the items she wishes to order by keying in the appropriate code. A shopping list of goods required on a regular basis can be stored on the computer and used every time. Goods ordered are confirmed by products description, price, and quantity on the television screen. The orders are received by the hypermarket, printed out, and sorted into a picking order to speed the collection of goods for packing. The grocery order is then despatched to the member's home.

It is fair to observe that in the United States of America, where other styles of computer networking have become firmly established, the European idea of viewdata has not yet caught on. Viewtron, a service begun in Florida, has had to lay off staff after a poor take-up. It is also true that Canada has not had much commercial success with its own viewdata design, known as Telidon, which is strong on graphics but very expensive.

It would be false, therefore, to pretend that viewdata or any other form of electronic information system will meet all home and business needs. The results of using such a system will also vary from country to country. But what has been shown by Prestel and viewdata generally is that it has a rightful place among the technologies of the electronic information era.

(LPS)

electronics select

The employment of first generation robots without any sensory power has been described as employing deaf, dumb, blind, one legged human operators with their single foot nailed to the ground. Early applications such as spraying and spot welding required relatively low accuracy of arm positioning, and even machine loading was based on an accurate location point or fixture outside the control of the robot itself.

before removing them — although much more slowly, so far, than can be done by a butcher.

In the drive towards more automation and the manufacture of high quality products, British companies are looking closely at what artificial vision systems can offer. Such is the interest that a new book, *Machine Vision* by J Hollingum, has just been published by IFS Publications, which is an associate company of the British

there is an expanding programme of robotic studies, with over £330 000 received this year in contracts and grants. The main area of work is concerned with the integration of sensory feedback into robotic assembly systems. The exploitation of information obtained from a large number of sensors within an environment allows the work-station to cope with an increasingly disorganized state, thus relaxing many of the otherwise stringent and expensive requirements for fixtures.

Experience with analysis and implementation of robotic systems has

A second generation of robots

However, equipment is now being developed to provide such senses as sight, feel, and even smell. In the security field, for example, research is taking place on sensors that can recognize odours given off by explosives.

At London's Imperial College, a robot has been developed that detects the position of bones in sides of bacon

Robot Association. Written in conjunction with British Robotic Systems, it reviews the scope for applications and suggests ways for companies to embark on the use of artificial vision.

Sensory Feedback

In the Department of Electronic Engineering at the University of Hull,

shown that a set of well chosen "simple" sensors can provide all the information necessary for the system to determine the success of an attempted assembly. Such a capability is essential for truly flexible automation.

The department has developed a camera system of low resolution (up to 256×128 pixels), which is particularly suitable for such purposes as component inspection and identification. The use of a low cost dynamic random access memory chip as a light sensor provides a means of imaging not normally obtainable by other means.

While video cameras normally used for recording are based on charge coupled devices and cost up to £2000, the Hull University camera will cost about £100 — including interface with the robot's computer control. Its low resolution is quite adequate for robot assembly applications and simple quality control inspection.

Linear Array Processor

Formed nearly four years ago, British Robotic Systems has concentrated on the application of vision systems to enhance manufacturing processes. Its first system, the Autoview Viking, is based on a linear array processor developed in conjunction with the National Physical Laboratory. The company has recently developed a more advanced system known as the Viking XA.

The original Viking system consists of an industrial television camera, a minicomputer, a monitor, interface hardware, and a command console. Specialized handling equipment and illumination to suit the application is available. By analysing the image produced by the camera, the system can automatically identify the characteristic shapes of manufactured parts and their position, orientation, and textural features, so that quality can be confirmed or the next operation in a process initiated. The sensors do this

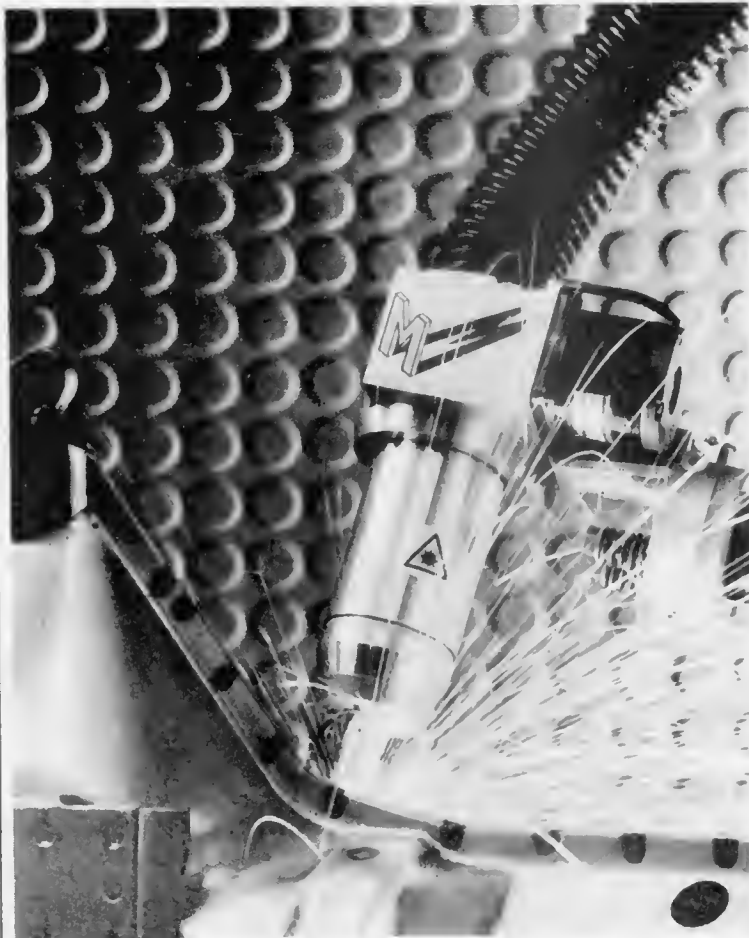

Using a combination of lasers and miniature cameras, the MetaTorch accurately accommodates variations in seam width and direction during robot arc welding operations.

electronics select

by measurement and comparison of key features and such parameters as area, radius, centre of gravity deduced from two dimensional measurements, and surface contours.

Recently accomplished tasks include automatic character reading and checking, component measurement, component identification and orientation, automatic crack detection and parts retrieval and machine loading from a bin.

The Viking XA includes an additional set of powerful software commands incorporating a PROLOG artificial intelligence (AI) language interpreter, which introduces expert system based "help" functions and AI techniques. The system has full 512x512 pixel resolution, an extended memory of 256 Kbytes, and an option for real time processing through the use of the linear array processor.

Robot Arc Welding

Having employed first generation robots in paint spraying, spot welding, and similar unpleasant jobs, it would seem most attractive to extend their use to arc welding. However, new problems arise in this application since the seam to be welded may vary slightly in width and direction. Work at Oxford University has resulted in a visual sensor that solves this problem. To exploit the development commercially, the university has set up Meta Machines to build and market the MetaTorch arc welding robot, which derives its "sight" from a compact combination of lasers and miniature cameras. These look a short distance ahead of the welding torch to locate the precise position of the joint, and the gap and offset of its edges.

The information gathered, after complex vision and geometric processing, is passed to the robot arm and welding set. These enable the torch to follow the course of the joint exactly, and automatically adjust the welding conditions to secure a strong weld. As a result of this continuous feedback of information, the MetaTorch is able to cope with irregularity in the joint caused by factors such as wear in location pins and fixtures, imperfect components, and the unpredictable springback of pressed sheet metal. The robot can even cope with changes caused by thermal distortion with occur during the course of a weld.

Although vision systems may speed up the application of robots to assembly operations, the design of products to suit production can increase robot efficiency without resorting to the inclusion of vision sensors. Some years ago, forklift truck manufacturer Lansing engineered a Unimate Puma robot without vision to produce wire harnesses used in the connection of electrical circuits in its trucks. More recently, BP Solar Systems has

developed an assembly work-station for its solar panels, of which it produces 5000 a year. This is also engineered around a Puma robot manufactured by Unimation Europe and operates efficiently without vision.

Vacuum Grippers

Thought to be the only one of its type, the assembly robot commences its sequence by pneumatically picking up a fragile solar cell disc, using one of two vacuum grippers. It then orientates the cell with an indexing mark printed on the disc face and solders conductive leads to the cell. The leads are then cut and crimped to allow for subsequent expansion and contraction. After cooling, the cell is placed on a source of intense light and its electrical output is monitored to ensure that it meets the required level of performance. Finally, it is placed in one of thirty-six positions on an assembly table with its leads correctly positioned.

When all thirty-six cells have been placed in position, the robot employs two hot air guns to solder the cells together into a continuous circuit. The entire process takes about 50 minutes. Many people regard vision and other senses as the most promising properties in the robot market. Undoubtedly, intelligent robots will help to overcome the problems of the disorganized state

of an assembly station where components have been designed for human assembly.

In some areas it may be more economic to design the components and the assembled product specifically for handling by a robot without visual or tactile senses.

(LPS)

by Arthur Fryatt

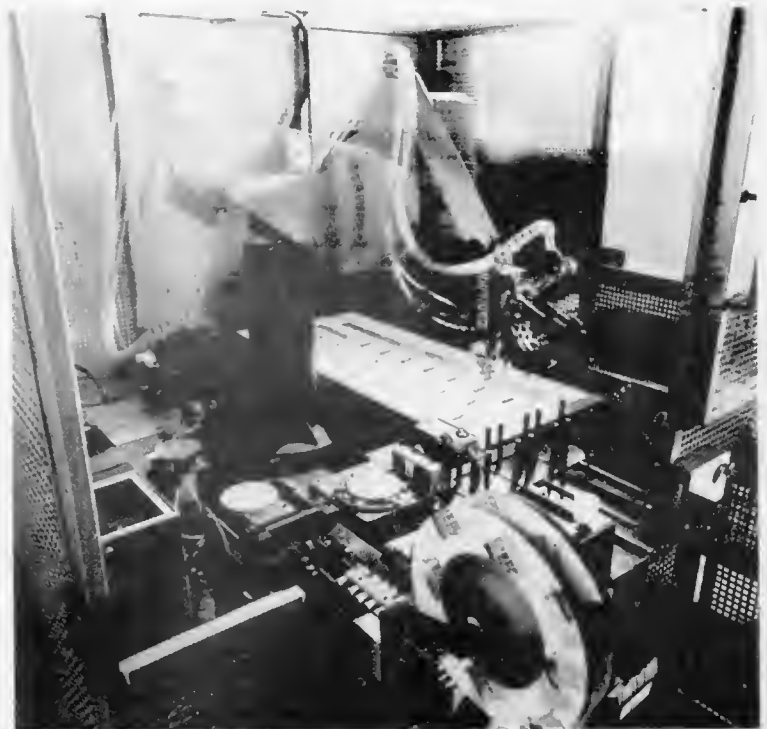

A multi-exposure photograph showing movement of the Unimate Puma robot arm during the assembly of solar panels. The complex nature of the component handling devices engineered by BP Solar Systems can be clearly seen.

electronics select

The fifth generation computer will soon be with us. But what exactly is this wondrous device whose development costs over the next 20 years will run internationally into thousands of millions of pounds?

In fact it is not necessarily a computer at all, at least in terms of the present generation of work-stations, processors, and peripherals.

It could be a robot able to distinguish between the circuit board it is sup-

posed to be picking up and the lunchtime sandwich of the maintenance engineer, inadvertently left lying beside the production line. It could be a computer that talks and questions a management decision made when an executive is having an offday. Or it could be an expert in any subject known to man.

Development Agency and with the backing of Strathclyde University, which appropriately owes its origins in part to James Watt, the professor and his team have set up the Turing Institute, named after the mathematician Alan Turing.

He was responsible for the pioneering work on computing done at Bletchley Park during World War II, which contributed to the cracking of the German Enigma codes. Professor Michie was

transputer. It is a complete computer on a single chip, and is an essential element in the fifth generation development.

The reputation of Professor Michie's team has also attracted three United States organizations, including Westinghouse Electric, to sign up under the terms of a recently created "remote affiliate" category.

Hands On Experience

The training programme for staff seconded on a long term basis involves

The thinking computer

posed to be picking up and the lunchtime sandwich of the maintenance engineer, inadvertently left lying beside the production line. It could be a computer that talks and questions a management decision made when an executive is having an offday. Or it could be an expert in any subject known to man.

Basically, though, it is a concept to amplify the intellectual brain power at the command of the worker of the next generation. It will accomplish this by an order of magnitude equivalent to the power that James Watt's steam engine provided for the workers of the first Industrial Revolution.

Steam Engine

The analogy with one of Scotland's greatest contributions to the modern world is more than coincidental. Just as the steam condenser was the key that unlocked the power of the steam engine, a programming language called **Prolog**, developed from work undertaken at Edinburgh University, is being used as the kernel artificial intelligence language by a large number of research groups in different parts of the world.

Over the past 20 years, against heavy odds and with minimal funding, the pioneering group of artificial intelligence computer engineers from Edinburgh has been held together largely through the determination of one man — Professor Donald Michie. Recently, the team moved to a new office complex in Glasgow. Here it aims to establish a European centre for training and development in expert systems, machine induction, computer vision, and advanced robotics, which are the core technologies of the fifth generation computer.

Code Cracking

With funding from the Scottish

one of Turing's young colleagues.

The Japanese decision to set up a fifth generation computer project in 1982, involving eight major companies and two national laboratories with government and private funding, gave impetus to the fifth generation concept and sparked off the race to conquer the technology.

The computer has been around for 40 years, but it is still a crude machine. It cannot understand normal speech or writing.

Today's machines do exactly what they are told — no more, no less. The aim is to produce a computer that can acquire knowledge and use it intelligently.

There is now considerable haste in the West to launch programmes to support computer research, and examples are the European **Esprit** programme and Britain's **Alvey** project, and various schemes in the United States of America.

Private Funding

The Turing Institute, apart from relatively modest financing from the Scottish Development Agency, has taken the entrepreneurial approach with private funding and will raise the finance needed for its advanced research and development work by offering its unique knowledge, its teaching capabilities, and its research facilities to individual companies and institutions through a system of industrial affiliates.

Under this subscription system, companies pay for a range of facilities and can send employees to be tutored on artificial intelligence systems for applications in their own companies. During 1983, the institute planned for eight affiliates, all from Europe. They include GMD of Bonn, ICL, two Shell laboratories, Sinclair Research, and Thorn-EMI. The latter recently took over INMOS, the semiconductor company that has developed the

formal instruction and hands-on experience. Formal instruction comes under three main headings of inference systems and logic programming, which are the basic underpinnings of the techniques used in the development of expert systems; computer vision, which takes in the principles of how a robot can be taught to recognize whatever is put before it, such as distinguishing between a circuit board and a sandwich; and expert systems and robot planning.

The institute was a pioneer of the use of inductive learning and is a world leader in the field. This involves literally teaching the computer to learn for itself on the basis of its cumulative acquired knowledge. At the Turing Institute, inductive programming is the basis for expert systems, computer vision, and robotics.

Affiliates also have access to extensive library facilities and to the research work of the institute. The institute organizes regular industrial seminars on individual aspects of artificial intelligence. Short courses and individual tutorials are planned to spread expertise in artificial intelligence systems into industry and commerce on an international level.

Expert Knowledge

Dr Tim Niblett, director of industrial studies and the executive responsible for the scheme said: "As an institute we are focusing our attention on the synthesis of expert knowledge. By transferring an expert's knowledge to a computer, the potential impact on society is at least as great as printing in relation to the book.

"At the moment it is an extremely difficult craft and the stage we are at now is where computing was 25 years ago. Asking what the problems are is really like asking what the problems are in the study of particle physics. Basically, it is making a computer understand ordinary concepts with all the com-

electronics select

plexities of meaning, syntax, and implications.

"The first generation of artificial intelligence programs involved a computer specialist putting all the knowledge of an expert into the computer by hand. We are now at the second generation, where the expert inputs his knowledge by showing examples of expert decisions. From these examples the artificial intelligence system hypothesizes expert rules, which then becomes accessible to any authorized person simply by asking the machine questions.

"So the expert knowledge is then available at all times, without the expert having to be physically present."

The institute has already been directly involved in the first inductive learning expert system that can be used on microcomputers. The **Expertease** program is being marketed worldwide by an Edinburgh company, Expert Software International, which funded Professor Michie's consultancy company to develop the basic program commercially.

Good Potential

Dr Niblett added: "Expertease is a second generation product, with good potential in a number of areas such as diagnosis of faults, company procedures and education, but its range is limited and we are now working on very much more sophisticated systems.

"Inductive learning is a way of asking the computer to induce rules on the basis of how an expert in a subject displays his skills. Many experts do not know how they make a decision. The Expert System Program is designed to induce the rules by which the expert arrived at a particular decision.

"The expert merely puts in statements of fact from his own knowledge. At its simplest it would go something like this: 'It is raining. I will take an umbrella. It is cold. I will put on a coat'. The computer therefore induces the rule that rain requires an umbrella and cold a coat, and if it is cold and raining take both. Even at that simple level, the expert has not sat down and worked out how he came to the decision. It was common sense, but it is very difficult to teach a computer common sense."

Present day programs are totally inflexible. Given a task, the computer will attempt to pursue it to its conclusion even if the task is impossible. The fifth generation systems will pursue it by working out the best alternative to achieve the result required in the same way that the human mind works.

Initially, the Turing Institute will have a staff of around 15, plus seconded staff from affiliate subscribers. One of the priorities is to attract world specialists

in the field — many of whom left Britain in the years when artificial intelligence was a poor relation of computing science. Through its association with Strathclyde University, the institute will have access to one of the largest and most advanced computer science departments in the country. The department is also involved in **Esprit** projects.

Next year, the institute hopes to double the number of affiliates. A proposal has been put to the **Alvey** project directorate to contribute to the training costs of affiliate employees, and the institute will begin promoting the scheme seriously in the United States.

Body Of Expertise

Dr Niblett added: "The growth of artificial intelligence systems over the next few years will be limited only by the number of people able to utilize the technology. With the affiliate scheme, companies can second one person at a time over a year or two for six months each, building up a body of expertise within the company.

"These people will then be able to take some of the 'shell' artificial intelligence programs and develop them for particular applications within a company. There has been tremendous interest in the affiliate scheme despite the fact that we have not really gone out to market it yet. The American response was particularly encouraging.

"I would estimate that within five years expert systems will have reached a stage of development in power and

cost effectiveness to attract the mass user. Then the market will really begin to take off. At present, the cost of artificial intelligence is high and we are still in the early stages of developing the programming. It is a new style of programming and a new set of problems.

"In Britain the demand for home computers has been the highest in the world. Once expert systems can be allied to that market there is no knowing in what direction knowledge-based systems will go.

"In the fairly near future, I would expect to see people starting to sell knowledge bases — either for use individually or using a centralized computer you can dial up for expert advice. The applications are limitless, but certainly medicine and education are two areas with enormous potential."

The Japanese fifth generation project is impressive in its scale and its integration. But the Turing Institute will play its part for Britain and Europe generally.

From a Scottish point of view, the institute, combined with projects such as the £3 million Alvey research and development programme at Edinburgh University on the speech driven word processor, gives the Scots the opportunity to contribute as much to the second industrial revolution as they did to the first.

(LPS)

by Maurice Baggott



Professor Donald Michie.

Digi-Course

Chapter 6

Binary Numbers

In the previous chapters of Digi Course we have dealt with only logical problems. The circuits we discussed could solve simple logical problems like the one we discussed in chapter 4, about the cabbage, the goat and the wolf.

For the solution of such simple problems, we really don't require electronics. However, for solving complex problems, we certainly need help of electronics. The most frequently used electronic apparatus for such applications is the pocket calculator. The pocket calculator also uses the same logical process that we have seen so far, to solve the problems. For instance, how much is $152132 + 7531B$? The result is 227450, and this is determined by the pocket calculator using the same logical process. HOW this is done is not within the scope of this chapter, and will not be discussed here. What we shall see here is the first and the last step of this calculating process, namely how the numbers from our decimal system are transformed and re-transformed into information which the logical gates can understand.

The digital technology can work with only two values or conditions: On/Off, True/False, Black/White, 5V/0V, Logical "1" /Logical "0". The 0 and 1 can also be used as genuine numbers. The fact that we have to work only with two numbers, does not create a serious problem because similar to our decimal system, larger numbers can be made up using more number of digits. In the decimal system, any arbitrary number can be represented using the standard stock of 10 digits from 0 to 9. Similarly using the two digits 0 and 1 it is possible to represent any number, though the total number of digits required will be much more compared to the decimal system. This number system consisting only of 0 and 1 is called the binary system. The binary system requires considerably large number of digits, a simple "Two" requires two digits, and is written as 10.

In order to distinguish this binary 10, which corresponds to 2 in the decimal system, the basic number the intended numerical system is also indicated as follows:

$$10_2 = 2_{10}$$

Three is obviously the total of two and one.

$$3_{10} = 2_{10} + 1_{10}$$

now the expression on the right can be translated into binary with what has been studied so far:

$$2_{10} = 10_2 ; 1_{10} = 1_2$$

The total is:

$$3_{10} = 10_2 + 1_2 = 11_2$$

11 in binary system is thus a 3 in the decimal system and not eleven. With a decimal 3 we are at the end of the binary numbers that can be expressed using two digits. To represent a decimal 4 in the binary system we need three digits.

$$4_{10} = 100_2$$

It can be seen from this, that for every additional digit added, the previous digits on the right of the new digit are reset back to zero, exactly as in the decimal system 98..99..100.

Once a digit is increased, the following numbers continue to build up according to the usual pattern:

$$5_{10} = 4_{10} + 1_{10} = 100_2 + 1_2 = 101_2$$

$$6_{10} = 4_{10} + 2_{10} = 100_2 + 10_2 = 110_2$$

$$7_{10} = 4_{10} + 2_{10} + 1_{10} = 100_2 + 10_2 + 1_2 = 111_2$$

From eight onwards, a fourth digit position becomes necessary.

$$8_{10} = 1000_2$$

$$9_{10} = 1001_2$$

$$10_{10} = 1010_2$$

Beyond nine, the decimal system requires a second digit, whereas the binary system continues with four digits upto 15 (decimal).

$$11_{10} = 1011_2$$

$$12_{10} = 1100_2$$

$$13_{10} = 1101_2$$

$$14_{10} = 1110_2$$

$$15_{10} = 1111_2$$

$$16_{10} = 10000_2$$

By now it must have become clear, that the binary system is extremely difficult to handle and would certainly have not acquired any significance if digital electronics could not work so well with binary system. The digital technology also takes care of the translation between binary and decimal system. The decoding is theoretically very simple; since every binary position corresponds to a decimal value, one must add the decimal equivalents of the positions which are occupied by "1" in the binary number.

The decimal equivalents of the binary digit positions are:

128	64	32	16	8	4	2	1
-----	----	----	----	---	---	---	---

Here we shall now see a simple circuit, which can be connected on the Digilex board, to decode a two digit binary number into its decimal equivalent from 0 to 3.

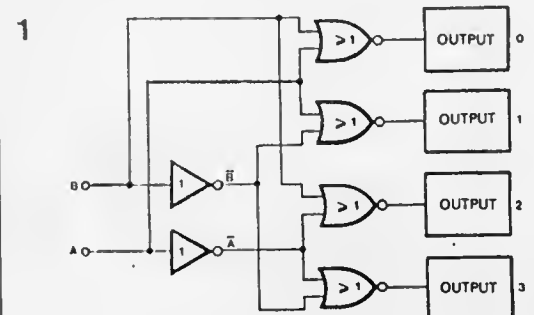

A and B are the inputs of the circuit where B represents the right digit and A represents the left digit of the two digit binary number. Complete truth table of the circuit is given below.

Table 1.

Inputs		Outputs			
A	B	E(0)	F(1)	G(2)	H(3)
0	0	1	0	0	0
0	1	0	1	0	0
1	0	0	0	1	0
1	1	0	0	0	1

While connecting the circuit on the Digilex board, the NAND gates will be used as inverters as usual.

2

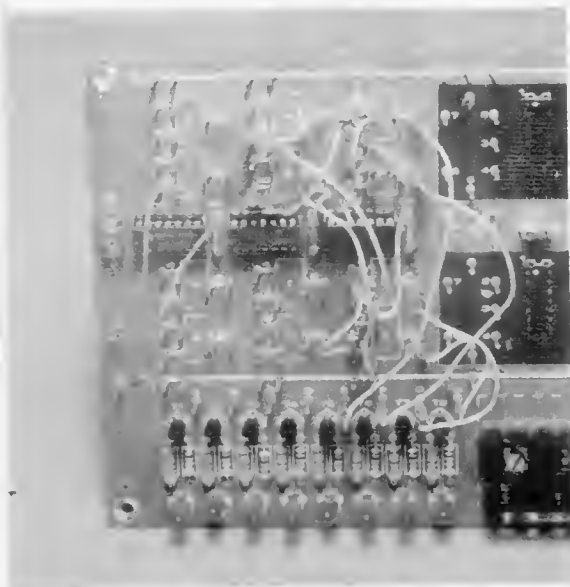
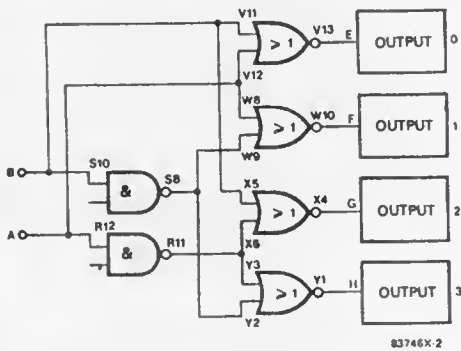

A 101101 in binary corresponds to :

$$32 + 0 + 8 + 4 + 0 + 1 = 45 \text{ in decimal.}$$

For electronically decoding and adding these equivalents, a complex circuit is necessary as the number of digits goes on increasing.

The circuits for decoding binary numbers with more digits are complex and they are never built like this using individual gates. Practical decoders are available in form of integrated circuits (7442, 7445).

The circuit for encoding a decimal number into its binary equivalent is relatively simple. One such circuit is shown below:

3

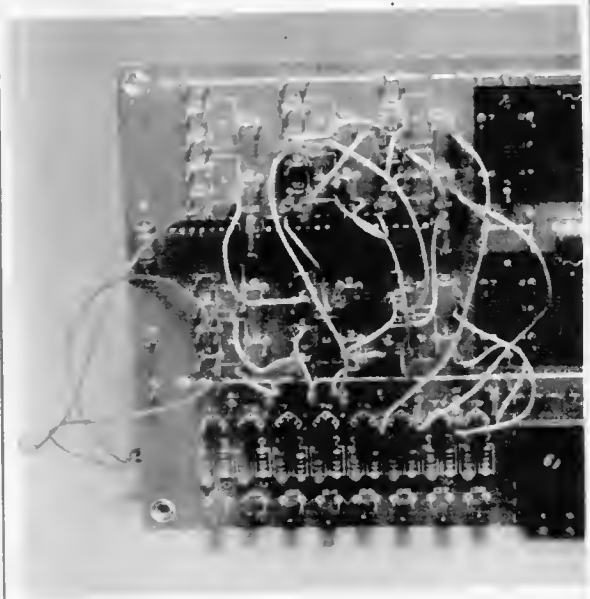
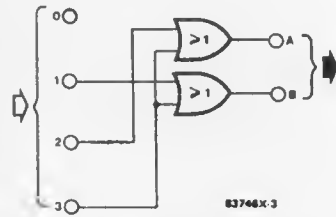

The circuit serves to encode the decimal numbers 0 to 3 into their binary equivalents. As we have seen, the first digit (A) must be 1 for decimal 2 and 3, and the second digit (B) must be 1 when decimal 1 and 3 are to be represented. For decimal 0, both A and B must be 0. This circuit can be connected on the Digilex board using NAND gates as shown in figure 4.

4

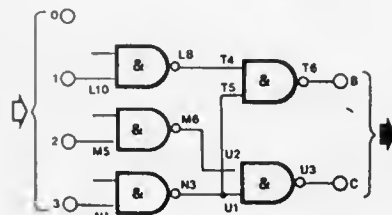

For testing the function, outputs of the encoding circuit can be connected to the inputs of the decoder. Using two Digilex boards it is possible to transmit decimal numbers 0 to 3 on wires, using only 3 wires (A, B and earth) instead of 5 wires (0, 1, 2, 3 and earth) that would have been required if decimal numbers were to be transmitted directly.

selex

The zero input to the encoder is left unconnected because when numbers 1 to 3 are absent the circuit automatically recognises 0.

The decoder circuit shown in figure 5 can decode decimal numbers 0 to 5, using the three inputs for the three digits of the binary numbers 000 to 101 (ABC). In order to make this circuit work on our Digilex board, a small compromise has to be accepted. Here all the LED indicators will glow except for the one which indicates the decimal number being decoded by the circuit.

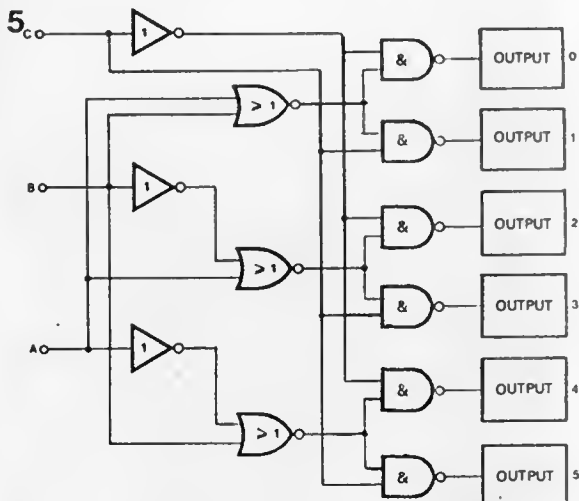

Two of the inverters can be substituted by NAND gates with one input unconnected, the third one can be substituted by a NOR gate with one input on "0".

Binary Coded Decimal

Frequently used in digital electronics is another system of representing decimal numbers. Binary Coded Decimal (BCD) is the compromise between decimal and binary systems. Instead of encoding decimal numbers into binary form completely, they are encoded position by position. BCD coded eleven thus becomes 0001 0001 and not 1011 as would have been the case in binary system. Ninety nine in decimal becomes 1001 1001 in BCD.

In the binary system, every position can either be a "1" or a "0" and in digital logic every possibility of decision making is either true or false (1 or 0). These positions represented by the binary digits 1 and 0 are called Bits (from Binary Digits the letters B and it are taken to form the word Bit). The Bit represents the smallest unit of data that can be recognised by a digital circuit or system. A micro-processor which can process 8 of such bits of data at a time is described as an 8-Bit microprocessor. A decimal number represented in 8 bits can be maximum 256. These 8 bit microprocessors can operate with 65536 different memory locations (storage places where groups of 8 bit data are stored). To address these many locations the binary number required is a 16 bit number. If we imagine the memory chip as having 65536 drawers where data is stored in groups of 8 bits each, the microprocessor will be able to open any one of these drawers by using the 16 bit number which

designates each of these drawers. These drawer numbers are called addresses of the memory locations.

Hexadecimal

These 16 bit numbers are very difficult to handle when the programmer writes down the programs to instruct the microprocessor what to do. To simplify this task the Hexadecimal system is used, which is based on numbers 0 to 15. All these 16 numbers are written using only one position by replacing numbers 10 to 15 by letters A to F. Thus a Hexadecimal A is decimal 10, B is decimal 11, C is decimal 12 and so on.

0	1	2	3	4	5	6	7	8	9	10	11	12	13	14	15
0	1	2	3	4	5	6	7	8	9	A	B	C	D	E	F

Using the Hexadecimal notation, 65536 addresses can now be written using only 4 positions. 0000 in Hex stands for decimal 0 and FFFF in Hex stands for decimal 65536. The Hex (Short form for Hexadecimal) numbers can be directly converted into binary numbers because each position in the Hex number directly corresponds to a 4 bit binary number.

Figure 6 given below shows the pin connections of a BCD to decimal decoder chip 7442.

6

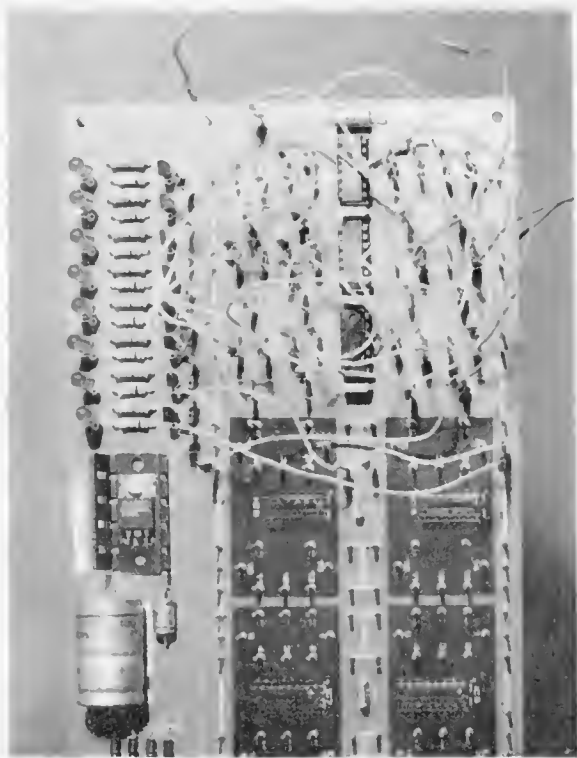
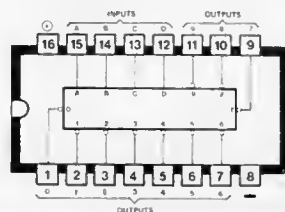

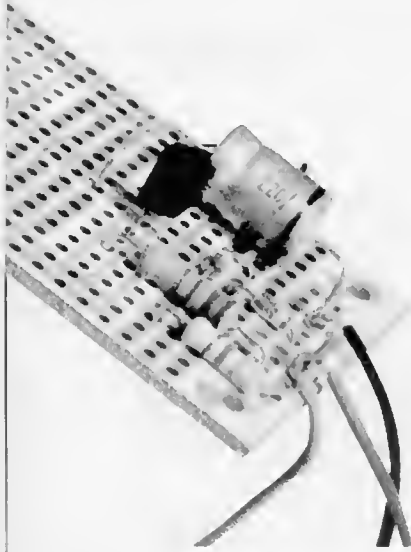

Constant Current Sources

A source which supplies constant current at its output, independent of load, is called a constant current source. Constant voltage sources are constructed mostly as complete equipment supplying constant voltage independent of the load. Constant current sources, however, are not constructed as independent equipment. They generally form a part of a larger circuit. Figure 1 shows the block schematic diagram of a constant current source.

The source passes a constant current through the load resistor R_L . From Ohm's law, we know that the voltage is the product of Resistance and Current passing through it. The voltage at the output of a constant current source thus depends on the load connected to it. The higher is this load resistance, the higher must be the output voltage to maintain a constant current output. Whenever the load resistance changes, the source must modify the voltage output in such a way that the current passing through the load resistance remains constant.

Basic Circuit

Figure 2 shows the basic circuit of such a source of constant current. The constant current is supplied to the load resistance R_L by the transistor. R_L may be any apparatus or equipment connected to the source. The diodes D_1 and D_2 as well as the base-emitter junction of the transistor are all forward biased, and they are conducting. Each of these diodes have a threshold voltage of 0.6V, thus, giving a total of 1.2 volts at the base of the transistor. As the base to emitter voltage is also 0.6V, the voltage on the emitter resistor R_e is also 0.6V. Since the three threshold voltages are independent of the load, the voltage across the emitter resistor also remains independent of the load

1

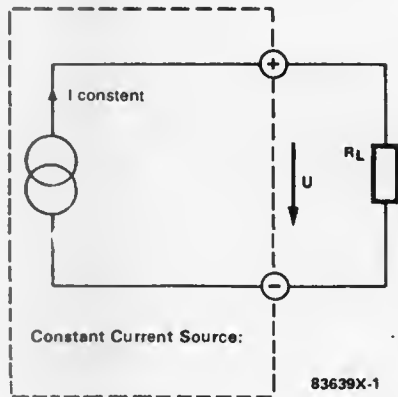

2

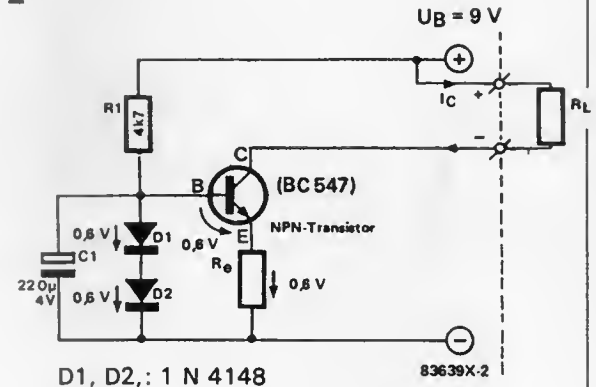

3

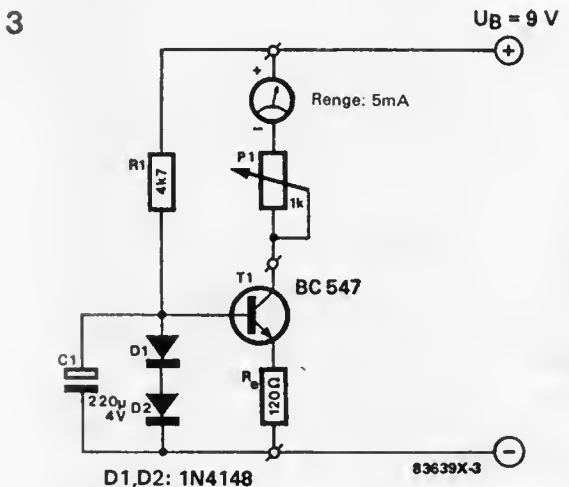

Figure 1: A constant current source automatically adjusts the output voltage in such a manner that the output current remains the same.

Figure 2: The circuit of a constant current source using NPN transistor. The emitter resistance determines the source current.

Figure 3: For testing the circuit, a linear potentiometer of 1K is connected as load.

and remains constant. Consequently, the current flowing through the transistor from collector to emitter must also remain constant, and will be given by the relation

$$I_c = \frac{0.6V}{R_e \Omega}$$

which means that the collector current which is also the load current, is decided by the emitter resistor. For instance a 5 mA current source can be constructed using an emitter resistor of 120 ohms.

For testing the circuit, a 1K linear potentiometer can be connected as load, in series with a multimeter (with 10 mA DC range). The current reading on the multimeter can be observed to be fairly constant and independent of the potentiometer setting. The circuit of figure 2 requires the load to be connected between the plus pole of the supply and collector of the transistor. In case the load requirement is such that it needs a connection at the minus pole, then the circuit must be connected as shown in figure 4. The principle of operation remains same, only change being that the transistor used here is PNP-type.

4

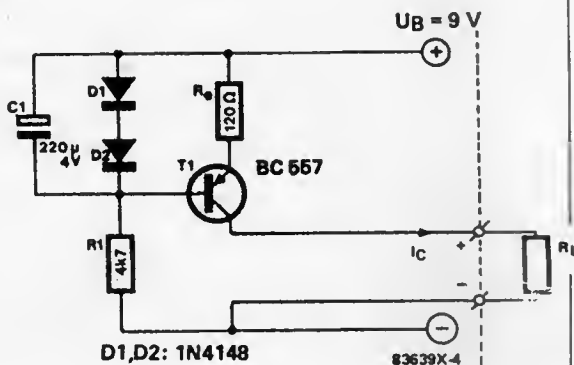

The circuit can be constructed as shown in figure 5. The source voltage to be used is a 9V battery pack. Figure 5 shows connection diagram for circuit given in figure 3 with NPN transistor. For circuit with a PNP transistor, the connection diagram can be suitably modified.

5

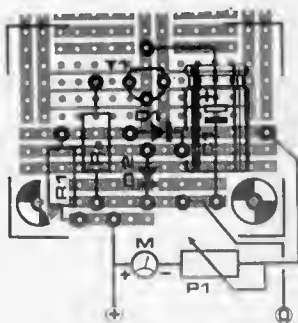

Figure 4:
The circuit of a constant current source using PNP transistor, suitable for loads requiring a connection to the minus pole.

Figure 5:
The circuit of figure 3 assembled on a selex board.

6



Mounting PCBs

Many hobbyists find the installation of boards in a cabinet more difficult than the assembly of the circuit itself. Fixing small PCBs inside a cabinet can become much simpler if one can get hold of some double sided adhesive strips.

For mounting a small PCB in the cabinet, 8 square pieces of such a strip will be required. 4 of these squares are fixed on the PCB, one at each corner. Small wooden or plastic pieces of about 4.5 mm thickness are then fixed on these four squares. Once again a square of the adhesive tape (double sided) is fixed on these insulating pieces.

This provides your PCB with four self adhesive feet.

The PCB can now be placed on the bottom plate of the cabinet and pressed firmly in the correct position. The drawing shows how the cross section will look.

With this type of simplified assembly, all the drilling is eliminated. The soft adhesive tape also helps in dampening the vibrations of the board if the cabinet is subjected to mechanical vibrations.



* See Text

83629X-1

AC Supply

".....Is it true that in the 19th century the DC current was used?"

"Yes, that is true. At that time all the power supply was DC. There was no power supply network as we have today. Small power houses supplied electricity to a few houses in the neighbourhood or to a factory. These mini power plants supplied DC voltage."

"Actually I find this much more practical".

"Why do you say so?"

"Because for all electronic apparatus we require DC voltage, we can store DC voltage more easily in accumulators. Why were these DC power houses not continued?"

"Well, I find AC current more practical. The first reason for this is that one does not have to pay attention to its polarity. Don't you remember? the AC current polarity changes every one hundredth of a second..."

"Yes,... and on every terminal of the plug we get plus and minus alternately. But even for DC we can get plugs which are designed to fit only the correct way. They are also independent of the aspect of polarity."

"What you say is correct, but another important feature of AC current is that it can be transmitted efficiently."

"What do you mean by that?"

"Transmitting efficiently means transmitting the current from one place to another without much loss of power. In the early days of electrical engineering the power houses had only small capacities. And also the distances over which these currents were transmitted were quite short. At that time it was unimportant, with which type of voltage the electricity was transmitted. However, today when gigantic quantities of current are produced and distributed over the power supply network, one must see to it that this is done in the most efficient manner."

"We can use high voltage wires, that is obvious!"

"Yes, you are right, but do you know why?"

"Well, Yes, the high capacity has high voltage."

That is wrong. High capacity does not necessarily mean high voltage. The power output is the product of voltage and current. For example take a heater which takes 10 Ampere current at 230 volts. Its power consumption is then

$$230 \text{ V} \times 10 \text{ A} = 2300 \text{ W} = 2.3 \text{ KW}$$

This power must be supplied by the power supply lines. One could also have a heater operating at 23 Volts and taking 100 Amperes, to give same amount of heat output."

"But this has nothing to do with the high voltage wires!"

"You will understand this when we apply the same formula to the power generating equipment. Let us say a power plant has 230000 KW capacity. Now if you give this power through the overhead wires at 230 V, 1000000 Amperes of current will flow through these wires!"

"One million amperes? But even the thickest wire will be fused with so much current passing through."

"Exactly, that is what will happen. So the only way to avoid this situation is to increase the voltage and reduce the current."

"But how can you increase the voltage?"

"That is what makes the AC supply more practical. We have to increase the voltage for the high voltage overhead lines and then subsequently reduce it when it comes to the plug."

"That is easy even with DC. Use two resistors as potential dividers!"

"You and your potential dividers! To divide 230000 V to 230 V, only one thousandth of the power will be used and remaining power will be uselessly heated away in your potential divider. With AC currents, however, we can use transformers to step up and step down the voltage, without losing too much energy. These transformers unfortunately do not work with DC currents."

"And this is what you meant when you said AC current can be transmitted efficiently?"

"Right, you have finally understood!"

Resistor Standards

In contrast to other electronic products like VCRs, Colour TVs, Computers etc., resistor is a product that is standardised for manufacturing. The International Electrotechnical Commission (IEC) has prepared different value tables, which all the manufacturers follow. This makes the task of a development engineer easy for selecting a particular value for his specific application. The most commonly used are E 6, E 12 and E 24 series values.

Series E 12 contains 12 different numbers: 10, 12, 15, 18, 22, 27, 33, 39, 47, 56, 68, and 82.

Multiplying these numbers by 0.1Ω, 1Ω, 10Ω, 100Ω, 1KΩ, 10kΩ, 100KΩ, or 1M Ω, a wide range of resistors is obtained and these values are said to be the E 12 series values.

All the resistances are marked with coloured bands. first two bands including the standard values from the series, and the third band of colour indicating the decimal factor (i.e. the number of zeros following the standard value). A fourth ring indicates the tolerance of the component. Tolerance used for general purpose applications is usually $\pm 5\%$. The resistor colour code was explained in our article on components. The unavoidable tolerances in the manufacturing process is one of the reasons for the peculiar values of the standard serieses. Each value of the E 12 series is about 20% higher than the previous value. This means that the values can deviate upto $\pm 10\%$ from their standard value without much overlapping.

Resistor Combinations

Parallel Combination

The effective total resistance R_g of a parallel combination of two resistors R_1 and R_2 is calculated according to the following formula:

$$f_{\parallel} = \frac{R_1 \cdot R_2}{R_1 + R_2}$$

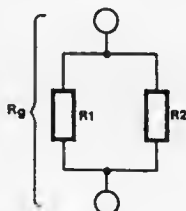

Rather than calculating the value of the parallel combination every time, we can refer to table 1 and get the effective value directly. The table 1 given here corresponds to the E 12 series of resistance values. The decimal multiplier is not included in the table, and must be taken care of while referring to the table.

Three examples are given here to explain the application of the table:

1. Let us find out the equivalent value of the parallel combination of $47K\Omega$ and $22K\Omega$ resistors. If we take out $10K\Omega$ as the common factor from these two values, we have 4.7 and 2.2 to be searched in the table. Let us see where the row 2.2 meets column 4.7 and see what appears at the intersection. The value shown here at the intersection is 1.498, i.e. approximately 1.5. Now by multiplying this by the common factor of $10K\Omega$ which we had taken out, we get the effective value of the parallel combination of $47K\Omega$ and $22K\Omega$ as $15K\Omega$. This happens to be a standard value in the E 12 series and the parallel combination can be substituted directly by a $15K\Omega$ resistor.

2. A $39K\Omega$ resistor in parallel with a $8.2K\Omega$ resistor has a common factor of $1K\Omega$. At the intersection of column 39 and row 8.2, we have the value 6.775, which can also be substituted by a standard $6.8K\Omega$ resistance.

3. Let us now see how the same table can be used the other way round. Consider a situation where you have a 220Ω resistor in the circuit and want to

reduce its value to 200Ω without removing the resistor from the circuit. The common factor here is 100Ω . Now searching for a value of 2 in the row 2.2, we find it to be in the column 22. Multiplying 22 by the common factor 100, we have the answer 2.2 K. Thus by soldering an additional resistor of $2.2K$ in parallel with the 220Ω resistor, we can effectively bring down the value of the combination to 200Ω .

Potential Divider

A potential divider or voltage divider arrangement consists of two or more resistors in series, connected across the voltage source. Here, we shall see a simple arrangement with two resistors R_1 and R_2 connected in series and across voltage U . The voltage available at the junction R_1 and R_2 is U_1 which is given by the formula:

$$U_1 = U \cdot \frac{R_1}{R_1 + R_2}$$

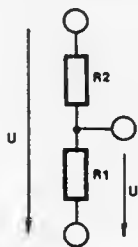

The value of U_1 can be obtained directly by referring to table 2. (For E 12 series resistance values). On the left side of the chart are the distances of R_2 from R_1 on the E 12 scale and given in the middle of the chart are the ratios corresponding to the resistance values used.

Following examples will explain how to use this chart:

1. It is obvious that a voltage divider made of two equal resistors will halve the input voltage $U_1 = 0.5 U$. As the two equal resistances have a distance of zero steps between them on the E 12 scale, we read a ratio of 0.5 against a zero steps between them on the E 12 scale, we read a ratio of 0.5 against a zero in the chart.

Table 1.

	1	1.2	1.5	1.8	2.2	2.7	3.3	3.9	4.7	5.6	6.8	8.2	10	12	15	18	22	27	33	39	47	56	68	82
1	0,500	0,545	0,600	0,643	0,688	0,730	0,767	0,796	0,825	0,848	0,872	0,891	0,909	0,923	0,938	0,947	0,957	0,964	0,971	0,975	0,979	0,982	0,986	0,988
1.2		0,600	0,667	0,720	0,776	0,830	0,880	0,918	0,956	0,988	1,020	1,046	1,071	1,090	1,111	1,125	1,137	1,148	1,157	1,164	1,170	1,174	1,179	1,182
1.5			0,750	0,818	0,892	0,962	1,031	1,083	1,137	1,183	1,228	1,268	1,304	1,333	1,363	1,384	1,404	1,421	1,434	1,444	1,453	1,460	1,467	1,473
1.8				0,900	0,990	1,080	1,164	1,231	1,301	1,362	1,423	1,476	1,525	1,565	1,607	1,636	1,663	1,687	1,706	1,720	1,733	1,743	1,753	1,761
2.2					1,100	1,212	1,320	1,406	1,498	1,579	1,662	1,734	1,803	1,859	1,918	1,960	2,000	2,034	2,062	2,083	2,101	2,116	2,131	2,142
2.7						1,350	1,485	1,595	1,714	1,821	1,932	2,031	2,125	2,204	2,288	2,347	2,404	2,456	2,495	2,525	2,553	2,575	2,596	2,613
3.3							1,650	1,787	1,938	2,076	2,221	2,353	2,481	2,588	2,704	2,788	2,869	2,940	3,000	3,042	3,083	3,116	3,147	3,172
3.9								1,950	2,131	2,298	2,478	2,642	2,805	2,943	3,095	3,205	3,312	3,407	3,487	3,545	3,601	3,646	3,688	3,722
4.7									2,350	2,555	2,779	2,987	3,197	3,377	3,578	3,726	3,872	4,003	4,114	4,194	4,272	4,336	4,396	4,445
5.6										2,800	3,070	3,327	3,589	3,818	4,077	4,271	4,463	4,638	4,778	4,896	5,003	5,090	5,175	5,242
6.8											3,400	3,717	4,047	4,340	4,678	4,935	5,194	5,431	5,638	5,790	5,940	6,063	6,181	6,279
8.2												4,100	4,505	4,871	5,301	5,633	5,973	6,289	6,567	6,775	6,981	7,152	7,317	7,454

2. An input voltage is connected across a voltage divider formed by $R_1 = 1K\Omega$ and $R_2 = 2.2K\Omega$. What is the voltage U_1 ? (across R_1). If we go from R_1 to R_2 on the E 12 scale we have to go four steps in the positive direction. Now from our chart, we have a ratio of 0.32 against the distance of 4 steps. This gives us the value of u_1 as:

$$U_1 = 0.32 \times 10V = 3.2 V$$

3. If the voltage divider in the above example is replaced by another one, with $R_1 = 1.5K\Omega$ and $R_2 = 390\Omega$ we have to go backwards by 7 steps from R_1 to R_2 . This gives a distance of - 7 steps on the E 12 scale. The ratio against - 7 steps distance is 0.79, which means that the voltage u_1 across R_1 in this case will be

$$U_1 = 0.79 \times 10V = 7.9V$$

4. A more practical example is where the ratio is known and we need to find out the combination of R_1 and R_2 . There can be a restriction of R_1 and R_2 so that the voltage source is not loaded very much by the divider. Assume a restriction to be $R_1 + R_2 = 100K\Omega$, and the required ratio to be 0.2. From the chart, we observe that the nearest ratio available is 0.21, which can be tolerated. This ratio requires a distance of +7 steps from R_1 and R_2 . From the E 12 scale we have one such combination of $22 K\Omega$ and $82 K\Omega$ which is the closest possible to satisfy the restriction to $R_1 + R_2 = 100 K\Omega$. As the deviation is negligible, we can take this as the correct solution.

The last example has practical application for designing the voltage dividers using standard resistance values from E 12 series. Even though it is possible to calculate the values of R_1 and R_2 accurately using the formula for U_1 , it is practically impossible to obtain those exact values for R_1 and R_2 in most cases. The values obtained from table 2 will be practically available values, and the tolerances given by these are generally acceptable.

Table 2.

-24	0.99	
-23	0.99	
-22	0.99	
-21	0.98	
-20	0.98	
-19	0.97	
-18	0.97	
-17	0.96	
-16	0.96	
-15	0.95	
-14	0.94	
-13	0.92	
-12	0.91	
-11	0.89	
-10	0.87	
-9	0.85	
-8	0.82	
-7	0.79	
-6	0.76	
-5	0.72	
-4	0.68	
-3	0.64	
-2	0.59	
-1	0.55	
0		0.5
1		0.45
2		0.4
3		0.36
4		0.32
5		0.29
6		0.24
7		0.21
8		0.18
9		0.15
10		0.13
11		0.11
12		0.09
13		0.08
14		0.06
15		0.05
16		0.04
17		0.04
18		0.03
19		0.03
20		0.02
21		0.02
22		0.01
23		0.01
24		0.01

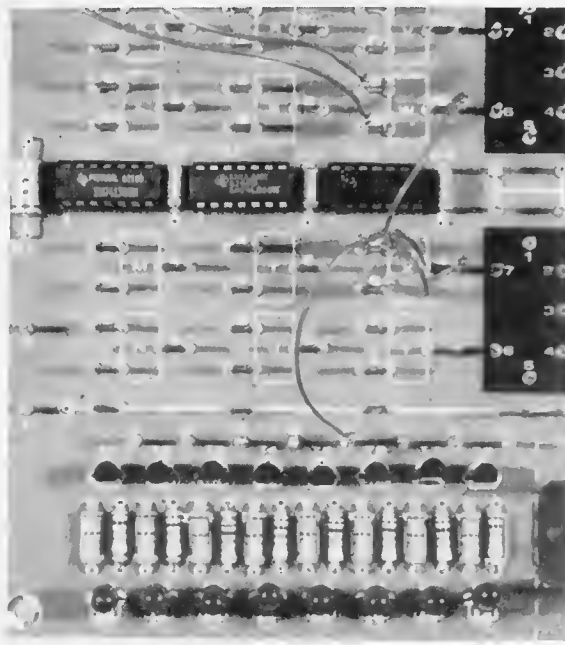

The Digilex-PCB is now available!

The Digilex-PCB is made from best quality Glass-Epoxy laminate and the tracks are bright tin plated, the track side is also soldermasked after plating. Block schematic layout of components and terminals is printed on the component side.

Price:

Rs. 85.00 + Maharashtra Sales Tax.
Delivery charges extra: Rs. 6.00

Send full amount by DD/MO/PO.

Available from:

precious[©]

ELECTRONICS CORPORATION

Chhotani Building, 52-C, Proctor Road,
 Grant Road (East), Bombay 400 007

PCB artwork for main control circuit board and lamp channel circuit board for STAGE LIGHTING system.

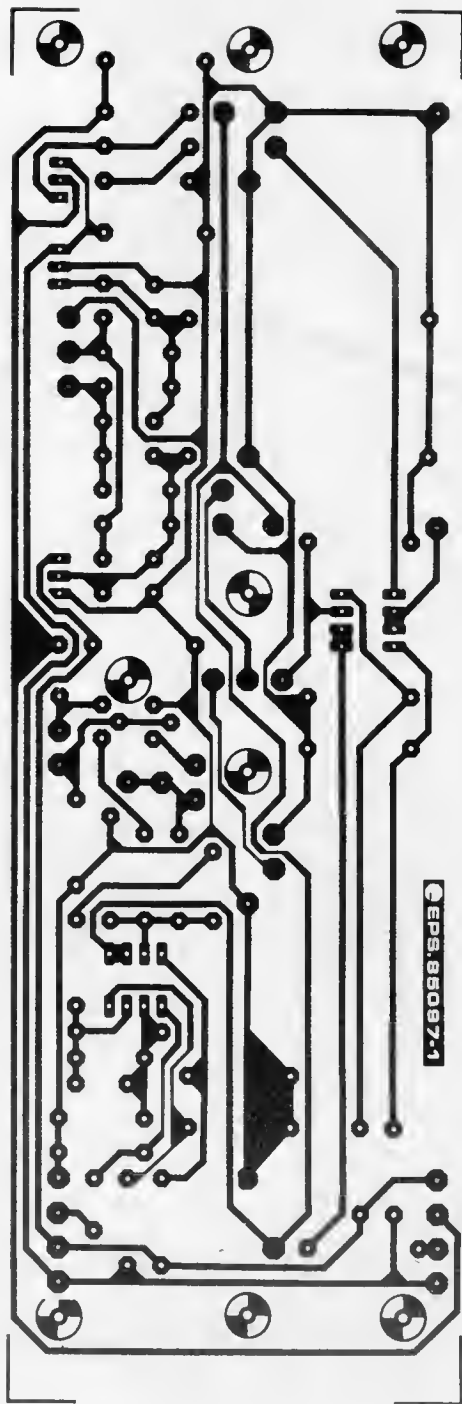
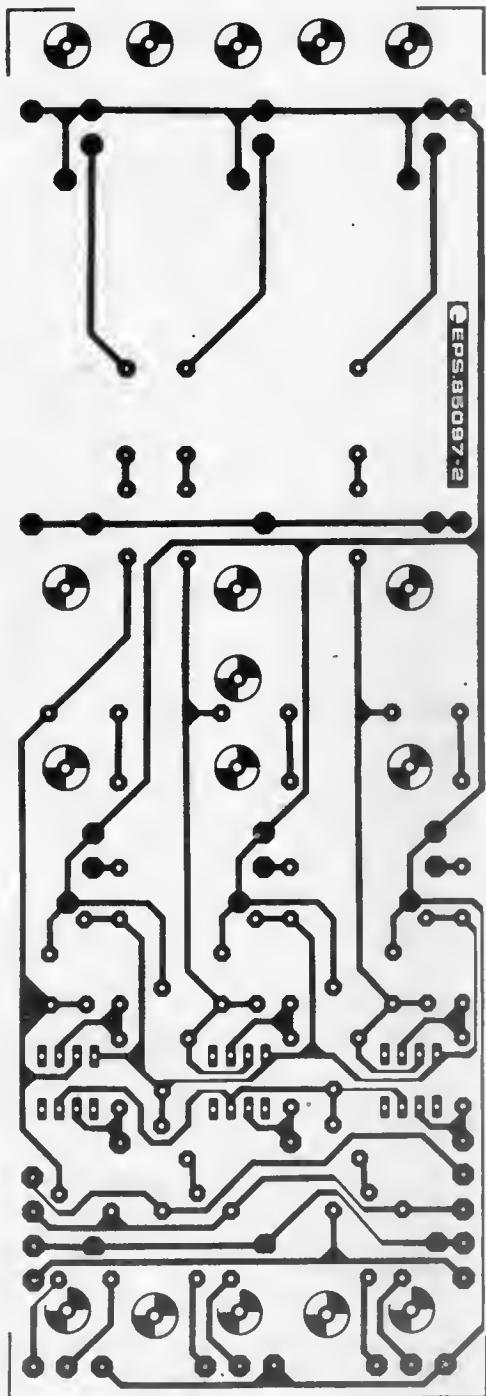

DIGITAL CONDUCTIVITY METER

Century Instruments have introduced their latest model of Digital conductivity meter, incorporating cell constant compensation from 0.01 to 1.99. This cell constant can be adjusted with the help of a potentiometer monitoring it on digital display. This facilitates the conductivity measurements of solutions having low conductance values. The range covered is from 0 to 1000 mmhos and is divided into five ranges to get better resolution and accuracy. The same instrument can be used for measurement of resistivity. Automatic temperature compensation can also be provided for direct reading of conductance



For further information, write to:
Century Instruments Pvt. Ltd.
S.C.O. 289, Sector 35-D
Chandigarh 160 036.

UNIVERSAL BUSH

MICROSIGN Universal Bush has unique flexible grommet edging which eliminates abrasion of wire insulation passing through cutouts in metal panels. The Universal Bush can be used with panel thickness upto 4.9 mm. It is very easy to install and ideal for all shapes. It can be easily cut to the required length and fitted without the aid of any special tools.

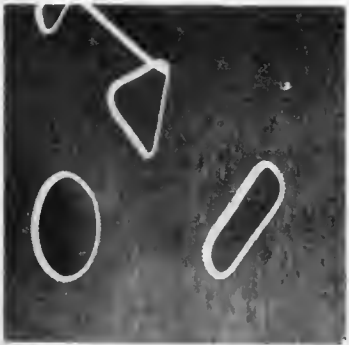

For further information, write to:
Microsign Products.
"Mahta Terrace"
Satyanarayan Road
Bhavnagar 364 001.

DIGITAL FREQUENCY METER

'BEACON' Digital Frequency Meter Model LDFC-8004 is a 4 digit Frequency meter for monitoring Mains Supply Frequency with an accuracy of ± 0.01 Hz. It is housed in a compact panel mounting case measuring 168 mm (W) \times 87 mm (H) \times 168 mm (D). The panel cutout required is 164 mm \times 84 mm. The instrument works from 230 V AC supply with $\pm 10\%$ variations. It can also be supplied for other supply voltages such as 110 V and 440 V.

new products



For further information, write to:
Beacon Industrial Electronics Pvt. Ltd.
A-13, Shri Ram Industrial Estate,
Katrak Road, Wadala
Bombay 400 031.

DIGITAL COUNTDOWN TIMER

ION Electricals have developed a digital countdown timer which can be used with any electrical appliance which requires automatic switching OFF after certain time period.

The timer is available with enclosure or without enclosure depending on the customer's requirement. CDT 59 is the OEM version, available without enclosure and CDT 59E is for direct application, available with enclosure. A built in buzzer is also provided to indicate the time out signal. This facility can be used to utilise the timer as an elapsed time reminder. The timer operates directly from 230 V AC mains supply and can tolerate a variation of $\pm 20\%$

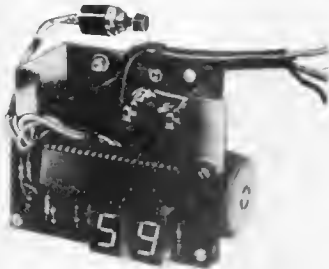

For further information, write to:
ION Electricals,
307, Ownar's Industrial Premises,
Gabrial Road, Mahim,
Bombay-400 016.

UPS SYSTEM FOR TELEX

SPECTRON have developed a new UPS system called UPEX for operating telex instrument. The system consists of a solid state inverter, battery charger and an electromagnetic change over relay.



UPEX is designed to supply uninterrupted power to the telex instrument and accessories. In case of power failure, UPEX switches over the supply on the inverter without losing even a single letter of the incoming or outgoing message. UPEX can also be used for PBX, PABX, Intercoms, Photo typesetting equipment and Electro medical instruments.

For further information, write to:

SPECTRON Salas & Sarviac Pvt. Ltd.
28, Prasad Chambers,
Karve Road, Puna-411 004.

ELECTRONIC TRAINING KITS

Jetking Kits have introduced a wide range of electronic kits. These kits are offered complete with PCB, Enclosures, all components and comprehensive instruction manuals for teaching the beginners to build the circuit successfully. The manuals are written in an easy to understand manner and extensively illustrated. Guidance on the tools used as well as detailed description of the practical methods of assembling and soldering is given:

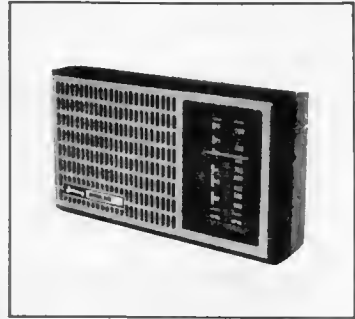

For further information, write to:

Jetking Kits India,
350, Lamington Road,
Bombay-400 007.

MODULAR COMPUTERS

A new 'MODULAR COMPUTER' is offered by Arun Electronics, in standard 19" Rack with all PCBs in Eurobus standard.

A printer, keyboard and video monitor must be connected to the rack to make the computer functional. The system has 3 slots for expansion by the user. The modular computer can also be configured as a target system by using the necessary modules, such as Processor module, I/O module and Memory module.

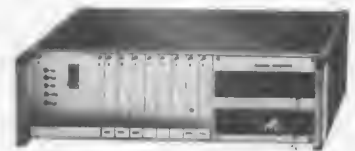

For further information, write to:

ARUN Electronics Pvt. Ltd.
B/125, Ansa Industrial Estate,
Saki Vihar Road,
Bombay-400 072.

YOUR DEPENDABLE SOURCE...

TEXONIC
INSTRUMENTS

 <p>ECC ELECTRONICS CORPORATION OF INDIA LIMITED</p>  <p>DIODES, SILICON DIODES POWER TRANSISTORS, ETC.</p>	 <p>MELTRON</p>  <p>SEMICONDUCTOR PRODUCTS</p>	 <p>KELTRON</p>  <p>ELECTROLYTIC CAPACITORS</p>
 <p>MFI MANUFACTURING INDUSTRIES LTD.</p>  <p>METALLIZED POLYESTERS POLYCARBONATE CAPACITORS COMMUTATION CAPACITORS</p>	 <p>PROTECTRON (INDIA)</p>  <p>DEFENCE APPROVED GLASS CARTRIDGES FAST ACTING A TIME DELAY FUSES, MINATURE CONNECTORS, LED LAMP HOLDERS, BNC CONNECTORS ETC.</p>	 <p>COMPONENT HO-HOLE (A DIVISION OF MFI)</p>  <p>TRANSFORMER SWITCHES BCD DECIMAL INSTRUMENT CASES</p>
 <p>PARAMOUNT INDUSTRIES</p>  <p>ELECTROMAGNETIC RELAYS 5 A. 10 AMPS ENCLOSED TYPE 20/20 30 AMPS POWER RELAY 1/2, 2/2 C/D</p>	 <p>ALCON ELECTRONICS</p>  <p>ELECTROLYTIC CAPACITORS</p>	 <p>EO ELECTRONICS</p>  <p>TERMINALS, PINS, PUSH HOLDERS, LAMP HOLDERS, CONNECTORS, WIRE PRODUCTS</p>
 <p>MEHA ENGINEERING ENTERPRISE</p>  <p>PROFESSIONAL GRADE PUSH BUTTON SWITCH</p>	 <p>HINDUSTAN CONDUCTORS (P) LTD.</p>  <p>TRANSISTORS, VWT, METS, IC'S, LEDs ETC.</p>	 <p>Afosect AFCO LTD</p>  <p>HEAT SINKS, MOUNTING ACCESSORIES ETC.</p>

TEXONIC
INSTRUMENTS

<p>9, ABHIPATTAN STREET, MOUNT ROAD, MADRAS-600 002 PH. 844405/844112</p>	<p>2, MANDOVERAPPA LANE, 8-1 P. ROAD CROSS, BANGALORE-560 002 PH. 224420/226628</p>
---	---

Our Most Important Component - SERVICE

ad-bureau-TI 2302



**P.V.C
WIRES &
CABLES**

DISTRIBUTOR



ELECTRONICS (BOMBAY) PVT. LTD.
GANESH NIWAS, 11, TARATEMPLE
LANE, BOMBAY-400 007
TEL: 363592/356529
RESI: 624931
TELEX: 011-6688 VASU-IN

Advertising Rates

Our advertisers will be pleased to know that our circulation has now reached 17,000 copies with an average readership of 6 readers per copy.

Looking at the statistics of rise in circulation, we expect the circulation to reach 20,000 copies by the end of 1985.

Our advertising rates have remained same since the first issue of Elektor India appeared on the scene in May 1983. We are now finding it difficult to continue with the same rates in view of the escalating costs of every input that goes into publishing Elektor India.

Our advertising rates will be increased soon. Advertisers will be intimated through announcement in our coming issues. However, annual contracts will be honoured till the contract period is over.

classified ads

CONDITIONS OF ACCEPTANCE OF CLASSIFIED ADVERTISEMENTS

1) Advertisements are accepted subject to the conditions appearing on our current rate card and on the express understanding that the Advertiser warrants that the advertisement does not contravene any trade act in force in the country.

2) The Publishers reserve the right to refuse or withdraw any advertisement.

3) Although every care is taken, the Publishers shall not be liable for clerical or printer's errors or their consequences.

4) The Advertiser's full name and address must accompany each advertisement submitted.

The prepaid rate for classified advertisement is Rs. 2.00 per word (minimum 24 words). Semi Display panels of 3 cms by 1 column. Rs. 150.00 per panel. All cheques, money orders, etc. to be made payable to Elektor Electronics Pvt. Ltd. Advertisements, together with remittance, should be sent to The Classified Advertisement Manager. For outstation cheques please add Rs. 2.50

Printed Circuit Boards and Kits for the projects published in 'Elektor India' and 'Electronics For You' available at SUGI ELECTRONICS, 2, Kamraj high road, Muthamii Nagar, Madras 600075

HURRY! One Chip Radio ICs' ZN 415 E Rs. 62.00; ZN 416 E Rs. 78.00 (All inclusive). Send 50% with order (M.O. or D.D.) to: INTELLIGENT ELECTRONICS, 65, SBI Colony, Gopalnagar, Nagpur 440022

Available data sheet and application of any electronic components. Minimum charges Rs. 15/-. Write to: DATA BANK, Plot No. 16, Bldg. No. 3, Flat No. 17, Bhavani Nagar, Marol Maroshi Road, Andheri (East), Bombay - 400 059.

Advertisers Index

AFCO I. & C. LTD	11.08
APEX	11.70
ARUN ELECTRONICS	11.10
COMPONENT TECHNIQUE	11.04
DEVICE ELECTRONICS	11.71
DYNALOG MICRO SYSTEM	11.76
ELCIAR	11.68
GENERAL ELECTRONICS	11.06
IEAP	11.72
JETKING	11.68
KEJRIWAL	11.72
KIRLOSKAR ELECTRODYNE	11.07
LABELLA LABORATORIES	11.66
LOGICS	11.04
MICROPACK	11.06
MOTWANE	11.11
OSWAL ELECTRONIC CO.	11.08
PADMA	11.66
PIONEER ELECTRONICS	11.06
PLA	11.67
PULSECO	11.73
ROCHER ELECTRONICS	11.10
SAINI ELECTRONICS	11.72
SIEMENS	11.09
SOLDRON	11.73
SUCHA ASSOCAITES	11.66
TESTICA	11.73
TEXES TRANSFORMERS	11.04
TEXONIC	11.70
UNLIMITED ELECTRONICS	11.10
VASAVI	11.08
VISHA	11.02
ZODIAC	11.68

corrections

versatile counter circuit

(April 1985 - p. 4.44)

Addendum. When two or more counter elements are connected in cascade, it is important that the CI lines, and the CO lines, are interconnected. These connections are shown incorrectly in Fig. 5.

VLF converter (050)

(August & September 1985 - p. 8.58)

Addendum. Pins 1, 4, 6, 9, and 14 should have been shown connected to earth.

PL 301

A loudspeaker for music lovers

(October 1985)

On page 10.37 of this article the following lines.

"..... detailed on pages 39, 40 and 45, 46"

Should be read as :

"..... detailed on pages 33, 34, 35, 36....."

Components

are normally available

with the following companies:

VISHA ELECTRONICS

17, Kalpana Building,
349, Lamington Road
Bombay - 400 007 Phone: 362650

DYNALOG MICRO SYSTEMS

14, Hanuman Terrace,
Tara Temple Lane,
Lamington Road
Bombay - 400 007. Phone: 353029, 362421

ELECTROKITS

20, Narasingapuram Street
(First Floor) Mount Road
Madras - 600 002

INTEGRATED ELECTRONICS INSTRUMENTS

8-2-174 Red Cross Road
Secunderabad 500 003 Phone: 72040

QUALITY GOES FIRST, THEN NAME!

Switch Over to **POWER-1**
For High Quality Switch Mode Power Supply

SWITCH MODE POWER SUPPLY

FOR IBMPC/XT, APPLE II, COMPATIBLE SYSTEMS
AND CUSTOM BUILT SYSTEMS

OVERLOAD AND SHORT CIRCUIT PROTECTION FOR ALL OUTPUTS



POWER-1 IS NUMBER-1



Office: Allahabad Bank Compound, Tulsi Pipe Road, Dadar (W), Bombay-400 028. INDIA.
Tel.: 46 36 50. Telex: 11-3831 IMPPA IN

Factory: B-232 Gandhi Nagar. Electronics Zone, Gandhi Nagar, Gujarat (INDIA).

Microfriend-ZLC
Low Cost

Dynalog
has
done it!

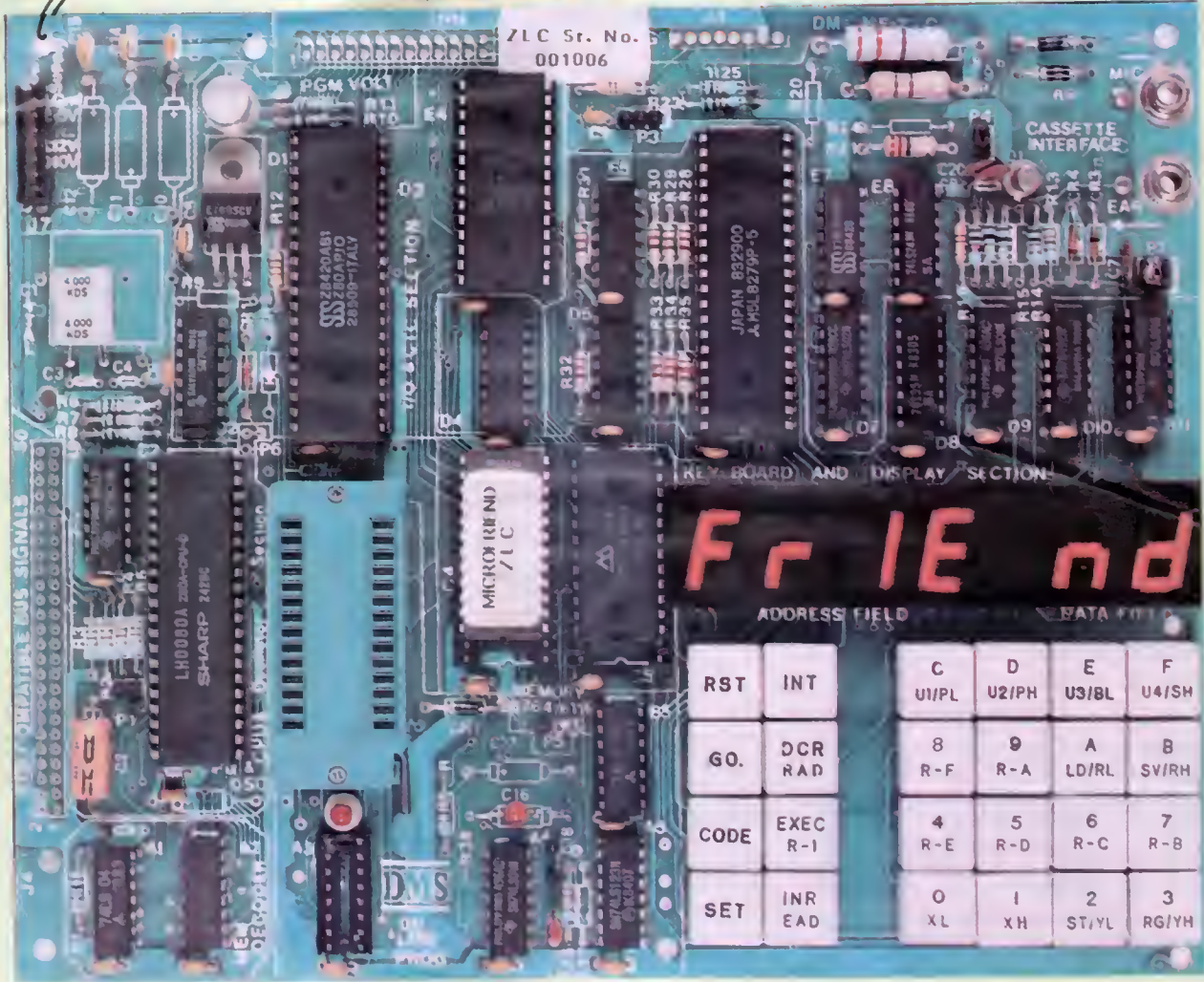

Cutting down cost without cutting into features

All standard features available on Microfriend-ZLC

- Z-80 CPU @ 4MHz, supported by Z-80 PIO and CTC.
- 4K powerful monitor in 2732.
- 24K EPROM and 8K RAM memory capacity on board.
- On line EPROM programming facility in Single Step or Block mode for 2716, 2732, 2764 and 27128.
- All Dynalog standard codes for Block Move, Fill Block, Insert, Delete, Search, Hex to Decimal, Decimal to Hex, Verify, Blank Check etc.
- RS232C, 20 mA Serial Interface.
- Audio Cassette Interface.
- STD compatible Bus signals.
- Most comprehensive documentation and Courseware



Dynalog Micro-Systems

14, Hanuman Terrace, Tara Temple Lane,
Lamington Road, Bombay 400 007

Tel: 362421, 353029 Telex: 011-75614 SEVK IN Gram: ELMADEVICE

Branches and representatives at: Pune, Bangalore, New Delhi, Hyderabad and Chandigarh

ADDMark