

125

elektor

INDIA

Rs. 7.50

October
1985

electronics

incorporating



loudspeaker
to KEF design

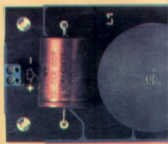

graphics
card



cleaning
VCRs

intruder
alarm

frequency
standard

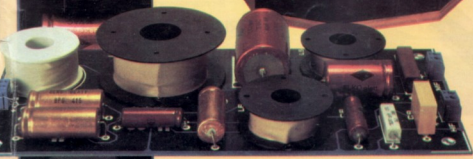

Selex

TUNER & RF PRODUCTS

NEC



Representatives in India:

RAJRISHI EXPORTS LTD.

107, Aggarwal Bhawan 35-36 Nehru Place,

New Delhi - 110 019

Tel. 641 8844 Telex - 031-3033

PUBLISHER: C. R. CHANDARANA
EDITOR: SURENDRA IYER
EDIT ASSISTANCE: ASHOK DONGRE
ADMINISTRATION: J. DHAS
PRODUCTION: C. N. MITHAGARI

ADVERTISING & SUBSCRIPTIONS

ELEKTOR ELECTRONICS PVT LTD.
 Chotani Building
 52 C, Proctor Road Grant Road (E)
 Bombay-400 007.

DISTRIBUTORS:
 Blaze Publishers & Distributors Pvt. Ltd.

PRINTED AT:
 TRUPTI OFFSET
 103, Vasan Udyog Bhavan,
 Off Tulsi Pipe Road,
 Lower Parel, BOMBAY-400 013.

Elektor India is published monthly under agreement with Elektor B.V. Holland. August/September is a double issue.

SUBSCRIPTION

INLAND
 1 Yr Rs. 75/- 2 Yrs Rs. 140/- 3 Yrs Rs. 200/-
FOREIGN
 One year Only
 Surface mail Rs. 125/- Air mail Rs. 210/-

The Circuit is for domestic use only. The submission of designs, of articles to Elektor India implies permission to the publishers to alter and translate the text and design, and to use the contents in other Elektor publications and activities. The publishers cannot guarantee to return any material submitted to them. All drawings, photographs, printed circuit boards and articles published in Elektor India are copyright and may not be reproduced or imitated in whole or part without prior written permission of the publishers.

Patent protection may exist in respect of circuits, devices, components etc. described in this magazine.

The publishers do not accept responsibility for failing to identify such patent or other protection.

INTERNATIONAL EDITIONS EDITOR: P. HOLMES

- Dutch edition: Elektor b.v.
6190 AB Beek (L),
the Netherlands
- German edition: Elektor Verlag GmbH,
5133 Gangelit, W-Germany.
- English edition: Elektor Publishers Ltd.
Elektor House, 10 Longport,
Canterbury CT1 1PE, Kent, U.K.
- French edition: Elektor Sari, Le Seau,
99270 Bailleul, France
- Italian edition: Elektor, 20092 Cinisello B., Italy.
- Spanish edition: Elektor, Av. Alfonso XIII,
141, Madrid 16.
- Greek edition: Elektor, Karaiskaki 14, Voula,
Athens.
- Turkish edition: Elektor Yayincilik ve Ticaret A.S.,
Karakoy Istanbul
- Portuguese edition: Ferreira and Bento Lda
R.D. Estrela 32, 1000 Lisboa
Portugal.

COPYRIGHT © ELEKTUUR B.V. -
 THE NETHERLANDS 1984

news & views

electronics scene 12

electronics technology

electronics select 14

fields 25

design ideas 60

projects

intruder alarm 16

With burglaries on the increase everywhere, there are millions of people wanting to protect their property. This article suggests one means of doing so.

solid-state relay 22

An alternative to the electromagnet relay for switching mains-operated ohmic loads of up to 600 watts.

PL301 26

To really enjoy music, you need the best possible loudspeaker. At the price, this KEF Electronics design is second to none.

FET millivoltmeter 39

high-resolution colour graphics card 40

The graphics card fitted to many computers is often so basic that powerful programs are needed to control it. This new series of articles offers an alternative — and better — way of meeting your graphic requirements.

frequency standard 46

A simple way of making a secondary frequency standard.

cleaning video recorders 50

Regular cleaning of video cassette recorders, particularly the recording and playback heads, is essential to ensure optimum picture and sound quality.

RS232 interface 54

Up-to-date design of an RS232 card intended for the universal I/O bus featured in the May 1985 issue of *elektor electronics*, offering a choice of TTL or RS 232 line levels.

information

new products 70

guide lines

switchboard 75

classified ads 82

advertisers index 82

Selex-5

moving coil meters 62

resistors 63

current paths 63

the ohm's law 65

digi course (chapter 5) 67

Swiss Sign

ADVANI-OERLIKON BRINGS YOU ADOR PC-4896

India's first cost-effective programmable logic controller.

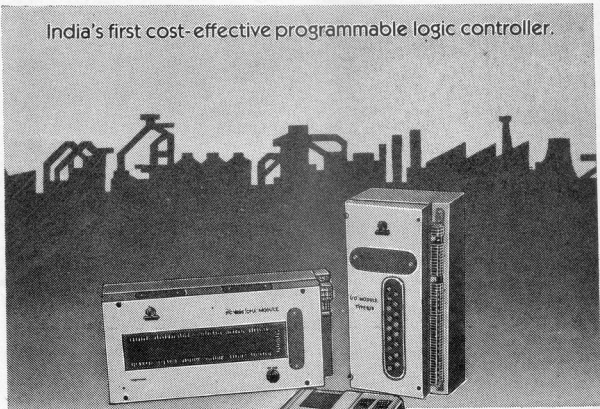

Trust Advani-Oerlikon research to design and develop India's first cost-effective programmable logic controller. Based on a microcomputer chip, ADOR PC-4896 can accept as many as 96 I/Os. Thus making it ideal for use in continuous process plants where several functions are involved: logic control, sequencing, timing, counting, etc.

ADOR PC-4896 has an edge over conventional relay panels. Simple to

programme and easy to operate, it obviates the need for trained personnel, programmers and software specialists...

while eliminating cumbersome relay/contacter hardwired systems which have to be planned and designed much in advance of a project.

ADOR PC-4896 incorporates the latest microprocessor-based design leading to low power consumption. Modular in construction and compact in size, it offers the same flexibility of computers — without the high cost.

APPLICATIONS

Cement Plants

- Control of thyristorised drive in sequence for crushing section
- Control and interlock of raw mill kiln section, coal grinding, coal/gypsum handling

Steel Plants

- Cold rolling mills
- Blast furnace firing sequence control

Petrochemical Plants

- Start/stop sequence of huge crude handling systems
- Pipeline controls

Thermal Power Plants

- Logic circuit causing main unit shutdown
- Boilers and turbines start up and shutdown process

Paper & Pulp Industries

- Automatic mixing and dispensing of ingredients.

Material Handling

- Control of powerfree conveyor systems

ADOR PC-4896.

The logic behind continuous process controls.

For enquiries, quote Key No. AO-531 and write to P.B. No. 1546, Bombay 400 001.



ADVANI-OERLIKON LIMITED

Bangalore | Baroda | Bhubaneswar | Bombay | Calcutta | Cochin | Delhi | Hyderabad | Jamshedpur | Lucknow | Madras | Pune | Raipur | Visakhapatnam

Heros AO-531

A TALE OF 8

that can be repeated
for another 800



Pace Equipment P. Ltd., Road No.18, MIDC, Marol Andheri (E), Bombay-400 093. Fabricators of Chemical Plants & equipments did not give any advertisement in the 1st edition. Let's see the 1st issue, they said. For the 2nd edition they have sent in advertisements worth

Rs.13,000/-



Dipnal Valve & Tubestos Company, 84/86, A-Nagdevi Street, Bombay-400 003. Manufacturers of Valves, Cocks & Fittings have increased their advertisement budget for 'SELPAGES' by 580%.



Indian Engineering Company, Worli Naka, Bombay-400 018. Manufacturers of Electro Technical Components have increased their advertisement budget for 'SELPAGES' by 470%.



FGP Ltd., 9, Wallace Street, Bombay-400 001. Leading manufacturers of Fibre Glass have increased their advertisement budget for 'SELPAGES' by 180%.



Intermark A-15, Wagle Industrial Estate, Road No.8, Opp. MIDC Offices, Thane (W) M.S. 400 054. Manufacturers of Speedex Slotted Angles have increased their advertisement budget for 'SELPAGES' by 100%.



Widia India Limited, 8/9th Mile, Tumkur Road, Bangalore-560 073. Manufacturers of Tungsten Carbide Tools have increased their advertisement budget for 'SELPAGES' by 300%.



Mamoowala Group of Industries, 105-B, Byculla Service Industries, Byculla, Bombay-400 027. Manufacturers of Aerated Water Machinery have increased their advertisement budget for 'SELPAGES' by 1250%.

Precision Industrial Components, 11, Keshayee Naik Road, Chinch Bunder, Bombay-400 009. Manufacturers of Industrial Fasteners have increased their advertisement budget for 'SELPAGES' by 600%.

Similar details of another 800 Advertisers can be provided.

Rates

Minimum Rs.300/-
Full Page Rs.3,600/-

Telephone: 4229481
4222685

Or write to:

SELLAIDS Publications
160, Kalyandas Udyog Bhavan,
Century Bazar Lane,
Bombay-400 025.

selpages

Setting a new trend in Industrial Advertising.



Tried & Trusted by
2,200
Advertisers.

Spark proof 100% sure spring contacts

in
**Burn Proof
Bakelite
Moulding**

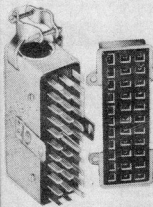

Afcoset

Afcoset Multipin Plugs & Sockets are Compact, Rectangular, and readily available in a wide range of 4, 6, 8, 12, 18 & 33 pins rated at 5 A 1000 V per contact.

AFCO INDUSTRIAL & CHEMICALS LIMITED
Kanjur Marg (East), Bombay 400 078, Tel: 582164



**SODAMINI
ELECTRO-MAGNETIC
RELAYS**
for every application

Suppliers to actual users since quarter century.

S-600



S-700 DC. (cover)
SS-700 AC.



S-2000 DC.
SS-2000 AC.



S-4000 DC.
SS-4000 AC.

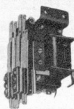

S-4500 DC
SS-4500 AC.
(Power Relays)

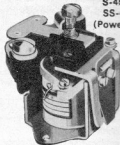

Also S-700 DP, S-1000 DC & SS-1000 AC, S-3000 S-5000 DC & SS-5000 AC Contactor.

Indian Engineering Company

Katara Mansion, Post Box 16551, Worli Naka, Bombay-400 018.
Ph: 493-9544/45, 493-5565, Tlx: 11-75217, Grams: AMPVOLT.

Dynalog's Leadership

in 8 and 16 Bit Microprocessor training/development kits....
is only a part of the Dynalog Success Story!

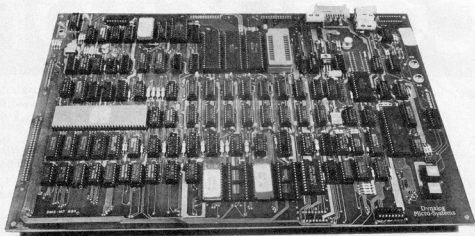

Another First

MICROFRIEND-68K 16/32 Bit

Microprocessor training/development kit
Continues the tradition of Dynalog's Leadership

MICROFRIEND-68K Highlights:

- 68000 CPU operating at 8 MHz.
- 20K FIRMWARE with single line assembler and disassembler.
- 128K Dynamic RAM.
- Onboard EPROM Programmer for 2716, 2732, 2764, 27128.
- Video Controller using MC 6845 CRT Controller Chip.
- RS 232C Serial Port with complete baud rate control.
- Centronics compatible Printer Port.
- Audio Cassette I/F with file management.
- ASCII Keyboard I/F.
- 40 I/O lines and 3 timers (16 bit) available on connectors.
- Detailed informative documentation.

Manufactured by:

DMS

**Dynalog
Micro-Systems**

14, Hanuman Terrace,
Tara Temple Lane,
Lamington Road, Bombay 400 007.

Tel: 353029, 362421
Telex: 011-75614
Gram: ELMADVICE

Sales Representatives :-

TECHNICS, 4731/21 Dayanand Road, Daryaganj, NEW DELHI-110 002. Tel : 276988

ELECTRO ENGG. ENTERPRISES, 136, 1st Flr., Kabra Complex, M. G. Road,
SECUNDERABAD-500 003 Tel : 822467

El-Ci-Ar[®]

capacitors

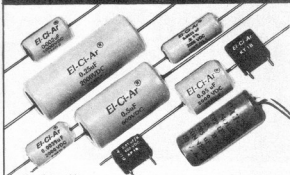

Manufactured by:

Neutroniks Pvt. Ltd.

68, Hadapsar Industrial Estate, Pune 411 013.

Phone: 70428. Gram: ELCIAR

Paper/Mixed Dielectric Capacitors:

For TVs, Medical electronic equipment, Communication equipment and Thyristor drives.

Commutation Capacitors:

For Invertors, Choppers, Textile Machineries, Induction heating equipment and other power electronics applications.

Delta Noise Suppressors:

For TVs, Radios, Audio systems and Professional medical equipment to suppress incoming RF noise.

For Mixers, Hair driers and other electrical machines to suppress outgoing RF noise.

Polypropylene Film/Foil Capacitors:

For TVs, Timer circuits and Circuit modules.

RC Networks:

For Thyristor controlled drives.

Introducing soon:

Metallised Polypropylene and Metallised Polyester Capacitors.

85, Arcadia, 195 Nariman Road, Nariman Point,
Bombay - 400 021 Phone - 221359.

Sumit

ECONOMY'S

ELECTRIC MELTING POTS



- For
- Tin, Lead & Glue Melting.
 - Wax & Plastic Melting.
 - Solder Melting.
 - Impregnating.
 - Dip Coating.
- Attractively styled
Rugged Construction.
Temperature Controlled.

Economy's Electric Solder melting pots and tanks are elegantly designed. These are made available in wide range of capacities in Round and Rectangular shapes, incorporated with INFATROL for temperature regulation. Special optional equipment including stands, valves, ladles and special controls are available to suit specifications.

Economy's Other Products:

- Electric Heaters.
- Hot Air Units.
- High temperature cables.
- Thermocouples etc.

Economy Engineering Corporation

19, Bank Street, Socawalla Bldg., 2nd floor, Fort, Bombay 400 023

Gram: "ECONHEAT" Phone: Office: 251165. Factory: 5514896.

COMTECH



HALF DIN STD. INSTRUMENT CASE FOR DPM. TYPE-T-48

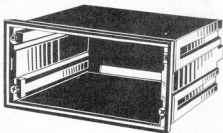

Instrument Case With Standard Clamps



- Size: 48 x 96 x 105 m.m.
- Moulded In Plastic
- Colour: Grey & Black
- Front Acrylic: Red, Green & Natural Colour.
- Arrangement For 12 Pin Connector Mounting
- Pannel Flush Mounting

For more information, contact:

COMPONENT TECHNIQUE

8, Orion Apartment, 29/A Lallubhai Park Road,

Andheri (West) Bombay-400 058 Tel: Sales: 4224066

Pradyumna 1915

SIEMENS

Modern Thyristor Converter Systems for variable speed DC Drives.

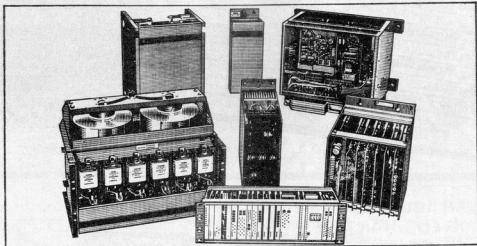

This range of converter systems is made to stringent Siemens AG specifications, and designed for light and heavy duty applications.

SITOR

- 6QG13 upto 200 A with Thyristor block and 6QG12 upto 1200 A with Disc type Thyristors.
- Reliable firing pulse, transmission assured by plug-in-connector and pulse distributor.
- Specially matched fuses for Thyristor.
- Modular construction.
- Rational stocking of spares.

MODULPAC 'C'

- Contains basic modules like Power supply controller,

Trigger set, Hand unit technology-oriented modules, tailored for special drive applications in paper printing, textiles and modern industries.

- The modules are plugged in sub-rack with mother board interconnecting them.
- The mother board and modules have been so designed that different technology modules can be plugged into the same location.
- Optimum operating characteristics, negligible temperature drifts.
- Simple operating procedure during commissioning.

SIMADYN 'C'

- Made up of modern controllers, arithmetic modules logic units incorporating experience

acquired in all industrial fields.

- Modular plug-in type cards.
- Inter-module wiring in wire wrap technique.
- Flexible to enable planning of even very large and complicated control arrangements.
- Inputs and outputs specially designed for a high degree of interference suppression and resistance to short circuits.
- Operating reliability is high due to careful selection of components and worst case circuit designs.

For any further information, please contact:

Siemens India Limited
P. O. Box No. 6597
Bombay 400 018

Siemens: Quality you can rely on.

thandar

ADTEK IDS - 7000 PORTABLE DEVELOPMENT SYSTEM
PRELIMINARY INFORMATION

UNIVERSAL, INTEGRATED, PORTABLE DEVELOPMENT SYSTEM

Z80A HOST CPU

CP/M™ OPERATING SYSTEM

5¼" 640KB FLOPPY DISK DRIVE

5" CRT, 64 x 25 CHARACTERS

ASCII KEYBOARD

IN-CIRCUIT EMULATOR

EPROM PROGRAMMER

EPROM ERASER

FREQUENCY COUNTER

HEX CALCULATOR AND CLOCK



Represented by:

BLUEJAY

P.B. No. 1018 Rajajinagar Bangalore - 560 010 INDIA
Grams: BLUEJAY Tel: 351916

- AVAILABLE READY STOCK
- LIMITED QUANTITY
- FIRST COME-FIRST SERVED

GP-250X

Programmable. Graphic Printer with serial and Parallel interfaces. 50 Cps - 80 Columns and 10" paper.

GP 700 A

Graphic Colour Printer characters and 8 bit graphic data in upto 7 colours.

BAL-500 SERIES

5¼" New slim type mini floppy drive for Apple-II 163K byte capacity.

PRINTER BUFFER

64K memory with any printers can COPY-REPRINT-SKIP-COMPRESS HOLD Page length selectable.

MONITORS

12" Green Phosphor CRT Front controls for easy operations compact stream line. case design.

CABINET

Wooden laminated which can accommodate COMPUTER-MONITOR-DISK DRIVES-PRINTERS etc can be locked and with castors for easy mobility.

Contact.

**DOMINION
RADIOS**

15, New Queen's Road, Opera House, Bombay-400 004.
Phones: 350747 382968 CABLE: "DOMIRA"

UPTRON
Capacitors

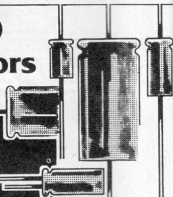

DISTRIBUTOR

epex

ELECTRONICS (BOMBAY) PVT. LTD.

GANESH NIWAS, 11, TARATEMPLE
LANE, BOMBAY-400 007

TEL: 363592 / 356529

RESI: 624931

TELEX: 011-6688 VASU-IN

THE FOUNTAIN HEAD TO SUPPLY YOU ELECTRONIC AND COMPUTER COMPONENTS

We at NIPPON INDIA know the requirements of electronic industry as well as computer components, required at short notice. You don't get lost for want of such parts as Fan, Diskette, Multimeter, Cutter, Crimper, Soldering Stations, Soldering Irons, Soldering Bits, Flat Cables, Connectors, Bread Boards, etc.

Available ex-stock/early delivery:

Air Cooling Fan 119 mm x 38 mm
Diskettes for IBM PC&PC/XT
3½ DIGIT & 4½ DIGIT
Wire Strippers and Crimpers
Temperature controlled soldering station
Soldering Iron with Bits
Flat Flexible Cables
Connectors for PCB Edge and Flat Cable
Bread Boards etc.

NOTE: FLAT CABLES CAN BE
SUPPLIED FIXED WITH
CONNECTORS AS PER
YOUR REQUIREMENT.



For further details contact:

N
NIPPON INDIA

3, Chowdhary Bldg., 1st Bhatwadi Lane,
Bombay-400 004. Phone: 362007/385007/ 350717.
Cable: NIPPONIND Telex: 011-76497 BENI IN.

electronics scene

ROW OVER NAMES

A controversy has arisen over the use of brand names for the colour television sets manufactured by multinational corporations in India. The All-India television manufacturers have opposed the use of brand names by the foreign companies as it would give "an unfair competitive edge and undue marketing advantage to the foreign companies over the domestic manufacturers".

The prime minister himself has intervened in the matter and sought the views of the department of electronics. He reportedly cited the example of Japan where foreign brand names were scrupulously avoided even though technology was imported at a very high cost. As a result, Japanese brand names have become the household names.

The department of electronics has informed the prime minister that the multinationals cannot be legally prevented from using brand names in TV industry. If TVs are to be mass produced there is no alternative but to allow the use of brand names, says the DOE.

Accepting the views of his department, Mr. Shivraj Patil, minister of state for science and technology, told the Parliament that the policy of allowing foreign companies to use their brand names will not affect the local colour TV manufacturers adversely but "will take better care of consumer through improvement in quality and technology".

Industry sources point out that colour TV marketed under a foreign brand name is priced 60 per cent higher than a similar Indian set. The small manufacturers of colour TV sets, with a capacity to produce 20,000 to 50,000 sets, face stiff conditions from the government. They are not allowed to use foreign brand names and the sets will have to conform to the standards prescribed by the DOE. Repeated representations by the industry over the brand name issue has made the government to have a second thought on the matter.

SCIENTIST'S CONCERN

Liberalised policies on import of technologies announced by the government recently have caused concern among a section of the scientific community as it fears

that this step may wipe out industries based on indigenous technology.

The Council for Scientific and Industrial Research (CSIR) which has the main task of import substitution and indigenisation may fall on the wayside in the race for acquiring foreign technology.

In the field of electronics, which tops in foreign collaboration, every Indian company is frantically searching for new products and partners from abroad to survive. In the view of an electronics expert, employed with a state electronics development corporation, "the new policy has legalised smuggling". His fear is that our companies may give up R & D and turn into traders like in Singapore and Taiwan, thereby transforming screwdriver technology into label technology.

Some private firms and government undertakings like Semiconductor Complex Ltd., are not afraid of losing their business to foreign firms. Dr. N. Seshagiri, additional secretary in the department of electronics, defended the entry of foreign firms on the ground that it would provide competition, raise quality and bring down prices.

KELTRON CHIEF

Mr. Javed Hassan, a laboratory director of International Business Machines Inc., USA, has been appointed executive chairman of the Kerala electronics development corporation. The earlier chairman, Mr. K.P.P. Namibar had relinquished his post to take over the chairmanship of the Indian Telephone Industries, Bangalore. The appointment has been made by the government of Kerala. Mr. Hassan graduated from Trivandrum engineering college in mechanical engineering. He is said to be owning a company called Innovations Inc., in U.S.A.

HIGHER DEPRECIATION

The Union finance ministry has cleared a proposal for higher depreciation allowance to the electronics industry. Mr. S.R. Vijaykar, secretary to the department of electronics stated that his department sought faster depreciation on machinery and equipment in the electronic units as the technology became

obsolete at a faster rate compared to other industries.

HARDWARE/SOFTWARE

Mr. Vijaykar, in a recent conference with newsmen discussed the computer policy in detail. A delegation of the Electronics Corporation of India Ltd., has visited Control Data Corporation of the USA and Bull of France for choosing the main frame manufacturing technology. The deal may be finalised by the end of the year.

The department has so far approved only one tie-up for the manufacture of super mini computers while another six foreign collaborations are in the pipeline. According to his estimate, the demand for computers this year would be around 10,000 pieces.

On imports of computers, Mr. Vijaykar said, popular brands which have been imported in the past few years would be allowed to be brought in and the Computer Maintenance Corporation of India should have the expertise to service them.

The government has recently cleared a proposal of the Texas Instruments to set up a software development unit for 100 per cent export. The unit will have an earth station and satellite links to ensure co-ordination with the master computer installed in the USA.

Commenting on the prices of mini computers manufactured indigenously, the DOE secretary said they had come down by 50 per cent but still domestic prices were 30 to 40 per cent higher than the international prices.

Mr. Vijaykar opined that the emphasis should now shift from data processors to process control systems and in the Indian context, investments should be made in the latter category for improving productivity.

VCR PRODUCTION

Five leading companies from Japan and Europe are keen on entering VCR manufacture in India and a high-level team has since returned after evaluating the capabilities of these companies. The final choice of the collaborator may be made before the end of the year.

It is learnt that all the five contenders agreed for equity

electronics scene

participation under the FERA guidelines and for the transfer of VCR manufacturing technology. The government has, in principle, decided to manufacture the tapedeck centrally by one joint sector company while manufacture of components and assembling may be given to other private units. Earlier indications were that Hindustan Machine Tools may be asked to manufacture the tapedeck but this decision has not yet been confirmed.

The department of electronics has estimated that the demand for VCRs would be around three lakh pieces per annum. Initially, the tapedecks would be brought in CKD condition and assembled here. The Electronics Trade and Technology Development Corporation has been entrusted with the job of selecting the VCR technology.

Currently, a large number of TV manufacturers are importing the components of VCR, assembling them and selling them under their brand names. The retail price varies from Rs. 14,000 to Rs. 18,000 per set. The government's intention is to make the VCRs available at the rate of Rs. 5,000. But, to achieve this, the existing customs duty must be drastically revised for the component industry.

WAR OF CHIPS

The chips are down. The United States and Japan are engaged in a relentless trade war over the "chips". These two countries produce 90 per cent of the world's semiconductors.

In an already depressed market, the two countries are fighting to survive now and a decade hence, in the market of computers and telecommunication equipment, which run on chips.

This year, the world sale of semiconductors is likely to shrink by 15 per cent to 22 billion dollars from last year's sale of 26 billion dollars, 46 per cent higher than the sale of 1983.

The Economist, quoting Mr. Dan Kleshen of Montgomery Securities in San Francisco, says that American sales will be down by 25 per cent to 8.7 billion dollars. The depression has been caused partly by low demand, particularly from makers of personal computers. Falling prices is another big factor. American chipmakers complain that they are unfairly excluded

from the Japanese market and that the Japanese are investing to buy market share at any cost.

America's trade deficit with Japan in integrated circuits, was 900 million dollars in 1984 as against 350 million dollars in 1983. Once Japanese equivalents become available, hitherto flourishing sales of American chips dwindle. Incidentally, Japanese chipmakers and users are mostly the same companies. However, Texas Instruments in Japan has a case apart as this is an American success story.

A new comer in the field is LSI Logic, a silicon valley manufacturer of semi-custom chips. It has set up a Japanese subsidiary called Nihon LSI Logic which will build a 100 million dollar silicon wafer plant in collaboration with Kawasaki Steel.

SALES BLOCKED

The proposals of a number of Indian organisations for importing American computers have been blocked by the US commerce department. Import of 21 large American computers for use by the government departments and public sector undertakings and 17 similar computers for use by the R & D and educational institutions have been cleared by the department of electronics, over a period of two years. But these are pending for want of export clearance from the US commerce department.

The reason for the delay is that the US government is asking for the end-user assurances which is under negotiation between the two governments.

AI CONFERENCE

A consortia of Artificial Intelligence (AI) associations recently organised the International Joint Conference on Artificial Intelligence at the University of California in Los Angeles. The conference had over 5,000 participants as against 1,500 in the previous conference.

Incidentally, the inaugural tutorial for the conference was given by Dr. Raj Reddy of the Carnegie Mellon University. The programme chairman of the conference was also an India-born professor of computer science at the University of Pennsylvania, Dr. Arvind K. Joshi.

The largest contingent of participants was from Japan which had 300 members. The conference paved way for a possible major collaboration between Japan and the US in machine intelligence. Over a dozen Indian experts, settled in the US presented papers during the conference.

LASER PRINTING

Printing industry in India is adopting modern technologies but rather slowly. Only about six or seven publishing houses in the country have the latest laser-based printing technology. Mr. Devek Crockett, chairman of the British federation of printing machinery and supplies, who is also the general sales manager of Monotype corporation Ltd., has stated that this company was offering its most successful and popular Lasercomp-Mk-2 to India. This system can automate typesetting, layout, sub-editing and other functions, apart from providing graphics.

The Winchester-based system can be modified to handle work in languages like Chinese, Arabic, Urdu, Hindi, Malayalam and others. Over 600 such systems have been installed by the corporation all over the world and a majority of the users are newspaper publishers.

SOVIET SUPER COMPUTER

The Soviet Union has started commercial production of PS 2000 computers, capable of performing 200 million operations per second.

Unlike the American system based on the "flow-line fashion", the Soviets have used concept of "collectivist principle". In the fastest computers of the US, processors responsible for individual operations are placed along the assembly line, with data passing the whole length of it irrespective of how many processors will be at work on it. The Russians proposed the collectivist principle, enabling all computers to be subordinated to a single control system, leaving certain amount of freedom and ability to sort out their data. After receiving a general command, the processors jointly set about handling a homeogenous operation, then switch over to another and so on, until the task is fully resolved.

electronics select

Radio system signals savings on rural railways

In the far northwest of Scotland, on the single track railway that winds through magnificent mountain scenery to the Kyle of Lochalsh, the installation of electronic signalling will lead to significant improvements in the economics of rural railways. By eliminating the need for 20 signalmen and level crossing keepers on the 103 km line, the new system, known as radio electronic token block (RETB) signalling, will reduce operating costs by some £77 000 a year. This is big money for a railway that depends for most of its income on tourists during a short summer season, and will make all the difference to the line's precarious finances.

Sparsely Populated Region

British Rail is pioneering the new signalling system as part of a major programme to increase traffic and cut costs on the lines running west and north from Inverness. These are routes vital to the economy of a sparsely populated region, and they absorb a hefty slice of the public service obligation subsidy British Rail receives from the government. Installed at a cost of £415 000, and with a 30% grant from the European Community, the RETB system in practice should cover its investment within two years. In the longer term, its introduction will save British Rail the £500 000 cost of cable renewal that would have been necessary to maintain the existing signalling system.

Modern power signalling has been extended to cover many of British Rail's main lines over the past 20 years, bringing improved safety and reliability, as well as reduced costs. But shortage of investment funds has meant that lightly used rural routes have not felt the benefit of the rapid technological progress recently achieved in signalling installations. Now all this is changing, as the labour intensive mechanical signalling on such lines wears out and new economic pressures demand a reduction in the number of staff needed to operate their sparse services. On the Kyle of Lochalsh line, RETB equipment replaces the single line key token system, which is a method of ensuring the safe passage of trains on single track railways that dates back to the last century. Under this system, single lines are divided up into sections of varying lengths, with signalboxes at the crossing loops — sections of double track on

which trains may pass. Of course, it is essential that only one train at a time is admitted to any single track section, and this is assured by electromechanical apparatus interlocked with the signalling equipment.

Authority To Proceed

Before he can proceed into a single track section, the train driver must receive from the signalmen a metal token or authority. No more than one such token can be released from the key token instruments in the signalboxes at each end of the single track section, and only when that token has been freed electrically from the next signalbox can the signalman clear his signals for the train to proceed. Until the token is replaced in the machine at the next crossing loop, no other token can be released, and no train movement can be signalled from either direction. Communication between signalmen and their key token instruments is achieved electrically by the use of bell codes and currents passing in an openwire pole route. The system has been proved over many years, and is widely used in countries where there was strong British influence in railway development. Its drawbacks are the need for a signalman at every crossing loop, and the burden of maintaining pole routes in unfavourable conditions. Both are costly. The RETB system was developed by British Rail's Director of Signalling & Telecommunications Engineering, in conjunction with the Research & Development Department at Derby, and with some financial assistance from the European Community. Equipment was supplied by Westinghouse Signals.

Recent developments in microprocessor technology and mobile radio have been harnessed to create a signalling system with built-in safety and security devices that give an overall level of safety as high as that of the key token system it replaces. There is no longer any need for lineside signalling or communications equipment, or for a signalman at each crossing loop. The entire route from Dingwall — to the northwest of Inverness — to the Kyle of Lochalsh is now controlled by one signalman located at Dingwall. Crossing loops at Garve, Achnasheen, Strathcarron, and Kyle of Lochalsh itself are unmanned. In all, a drastic reduction in both staff and infrastructure costs has been achieved.

The signalman at Dingwall communicates with train drivers over a radio link. This also provides communication between the signalbox microprocessor interlocking equipment and the train-borne receiver, which again is microprocessor based. When a train is ready to enter a single track section, for example from the junction at Dingwall to the first crossing place at Garve, coded messages are exchanged over the radio between the driver and signalman.

The driver requests authority to proceed to Garve and, once the microprocessor interlocking has proved the line clear, he receives it in the form of an electronic display on the small receiver mounted in his cab, showing the words "Dingwall" and "Garve". This is his electronic token, which remains illuminated until the driver "returns" it to the signalman when he is safely inside the loop at Garve. The integrity of the message that passes by radio between signalbox and locomotive, as well as the assurance that the message goes only to the train for which it is intended, is achieved by transmitting the locomotive address and associ-

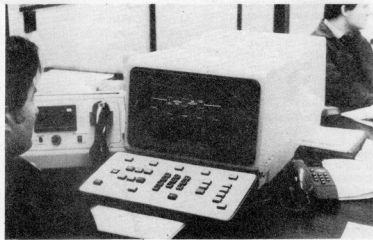

The signalman at Dingwall with his keyboard and track diagram.

electronics select

ated information in the form of a data telegram. Each cab receiver unit has a unique, four digit number for verbal recognition and display purposes, and the data telegram is subjected to rigorous and sophisticated coding techniques to ensure that any corruption of the original message causes the telegram to be rejected by the receiving microprocessor. The signalman has in front of him a keyboard unit and a visual display of the whole line. This shows him which sections are occupied, with the four digit receiver number appearing for identification purposes. A teleprinter records all keyboard entries, and voice traffic between signalman and drivers is tape recorded.

Enormous Benefit

The two way radio, of course, is available for communications at any time, and this is likely to be of enormous benefit on a remote railway where formerly the only means of communication for drivers was face-to-face with signalmen at the crossing stations. As with any radio communications system, strict attention is paid to the use of correct — and limited — terminology in voice traffic.

With the signalman eliminated at crossing loops, one problem remained to the RETB planners. Who would operate the loop points? In fact, this has been solved in the simplest way, by making the points trailable. Points at each end of the loop are held securely in position for the direction of travel, aligned for the left-hand track of the double line section.

This is done by pre-pressurized, hydropneumatic rams, which also allow the point blades to be pushed over, or trailed, by the wheels of a train moving in the opposite direction leaving the passing loop. When

a trailing movement is complete, the ram slowly restores the blades to their correct position for the next incoming train. An electronic detector proves complete closure of the point blades, at the same time actuating a yellow light indication to the driver that the points are correctly set.

As a train on a single line section approaches a passing loop, the driver first sees a reflective warning board, located at braking distance from the points indication signal. This allows him to come to a stop before the points should the signal not be displaying its yellow proceed indication. At the far end of the loop, protecting the trailing points, he encounters a reflective board bearing the words: "STOP — obtain token and permission to proceed." Here the token request sequence begins again.

Automatic Crossings

After a trial period of working alongside the key token system, the RETB equipment took over completely in October 1984 and has proved thoroughly satisfactory in operation. The entire installation will be completed later this year with the conversion of the seven manned level crossings to automatic open crossings with flashing warning lights. Already British Rail has obtained approval to extend the RETB system to the line north from Dingwall to Wick and Thurso, which is a much longer route with more crossing loops. A version is also going into service later this year on the East Suffolk line in eastern England, where RETB is providing an economic means of singling a double track route that has more than 20

level crossings.

The ability of the RETB system to cut operating costs is a highly significant development, and should ensure wider application of the equipment over the next few years. However, the economic implications extend far beyond British shores. The key token system is still in use on many main lines outside Europe and North America, often in inhospitable climatic and geographic conditions that make pole route maintenance a nightmare. British Rail's achievement of a simple, microprocessor based interlocking for single lines should find a ready export market. Once installed, the RETB equipment allows far greater flexibility in planning train movements than was possible with signalmen working fixed shifts. Although the Kyle of Lochalsh service consists of only three trains each way daily, the new system makes it possible to schedule extra trains to run at any time, without the need to arrange for costly overtime by signalmen.

Chris Bushell — LPS (1985 ES)

Did you know...

... that an estimated 75 per cent of all computer errors have been found to be the result of disturbances in the mains electricity supply? These irregularities are caused either by the generating authority or by local factors, such as heavy motor starting or severe weather conditions. They affect electronic equipment because the sudden increase or decrease in mains voltage or frequency can be read as an operational signal or as a malfunction.

and also...

... that there is a British Amateur Electronics Club and an Amateur Computer Club? Both clubs publish a regular newsletter and operate a readers letters service.

The address of the BAEC is "Dickens" 26 Forrest Road Penarth South Glamorgan Telephone: (0222) 707813

The Amateur Computer Club can be contacted at Andy Leeder Church Farm Stratton St Michael Norwich NR15 2QB

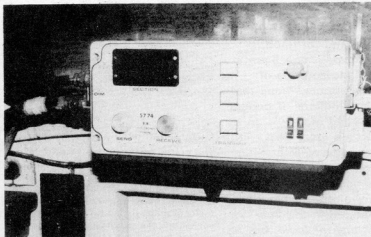

The electronic token appears on the driver's cab display.

intruder alarm

P Theunissen

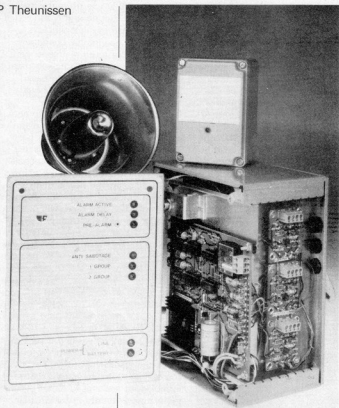

a combination of infra-red and electronics technologies

With burglaries on the increase in most parts of the world, there is a growing demand for good, reliable, yet inexpensive, security equipment. Manufacturers of burglar alarms are convinced that there are many millions of people prepared to spend money — in many instances a great deal — to protect their property. The intruder alarm described in this article is intended for use with a number of infra-red movement detectors featured in the July 1985 issue of *Elektronika*, but can also work with other types of sensor.

The alarm uses a minimum of two printed circuits: one for the control circuits, and the other for the interfaces. The latter may be repeated a number of times if required. The interface board is designed to connect either two infra-red sensors or one infra-red sensor and an anti-tamper circuit to the control board. Other than infra-red sensors may also be used. To this end, each interface offers two operating conditions: (a) NO, in which the switching contact is normally open and closes when the alarm is triggered, and (b) NC, in which the contact is normally closed and opens when the alarm is triggered. A delay has been incorporated which allows time between setting the alarm and vacating the property and between entering the property and disabling the alarm. In the latter case, a pre-alarm buzzer sounds and an LED lights to indicate that the alarm has been triggered. This arrangement is also very useful for testing the alarm. The LED remains on when the alarm has been set off. The intruder alarm works off the mains, but a 12 V battery is included as back-up during mains failure.

Basic configuration

As soon as switch S_1 (preferably a key-operated type) in Figure 1 is closed, diode D_1 lights and monostable MMV_1 generates a reset pulse that triggers MMV_2 whose \bar{Q} output then becomes logic 0. This logic level prevents an alarm pulse from interface 1 reaching monostable MMV_3 , at least for the time being. When the alarm is in this delay phase, diode D_3 (see Figure 3) lights, but the alarm is not yet triggered. When MMV_2 toggles, D_3 goes out and MMV_3 is enabled. In this condition a pulse from interface 1 will trigger MMV_3 , which causes its \bar{Q} output to go low. This results in bistable FF_1 being set, diode D_3 commencing to blink, and a buzzer starting to sound: this is the pre-alarm phase. Only when MMV_3 returns to its stable state, i.e., after a further delay, is monostable MMV_4 triggered. The second delay makes it possible to enter the property and switch off the alarm before it has sounded. As soon as S_1 is switched off, D_3 stops blinking, MMV_3 is disabled, and the alarm is reset. The various pulses mentioned here are shown diagrammatically in Figure 2.

Circuit details

The pulses mentioned in the previous paragraph are also shown on the circuit diagram in Figure 3. Terminal 2 on this diagram is the input from the anti-tamper circuit. This line is one of the wires in the multicore connecting cable between the sensor and the interfaces board. This arrangement ensures that cutting this cable by a potential intruder does not disable the alarm, but rather the contrary,

1

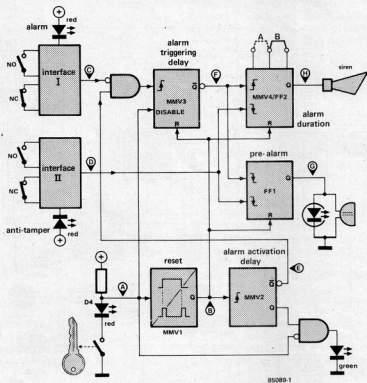

Figure 1. Block diagram of the intruder alarm with two interfaces.

2

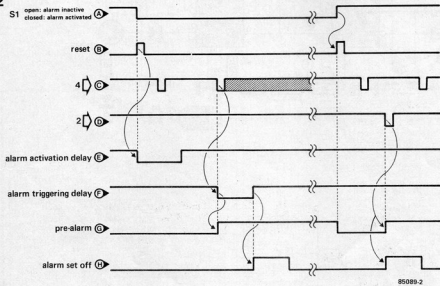

Figure 2. Pulse timing diagram.

because the anti-tamper circuit is connected direct to the board, bypassing switch S_1 . When a pulse from one of the sensors has arrived at the output of MMV_4 , or bistable FF_2 has received a clock pulse from MMV_3 , bistable FF_2 is set. Output Q then becomes, and remains, logic 1, which prevents MMV_4 being triggered again. At the same time, the output pulse is amplified in T_1 and then used to energize relay Re_1 . At this instant the siren will sound. The length of time that the relay remains energized may be preset between 10

seconds and 4 minutes by P_2 . If link B has been made, the siren will switch off after this time has lapsed; the unit can only be reset by switching off S_1 and then closing it again. If, however, link A is used, the alarm will sound again and again until the unit is switched off. This arrangement ensures that the unit conforms to regulations in many areas where an alarm may not sound longer than three minutes and may not automatically switch itself on again.

Reset circuit MMV_1 generates a pulse at its Q output whenever S_1 is opened (rising edge at TR) or closed (falling edge at \overline{TR}).

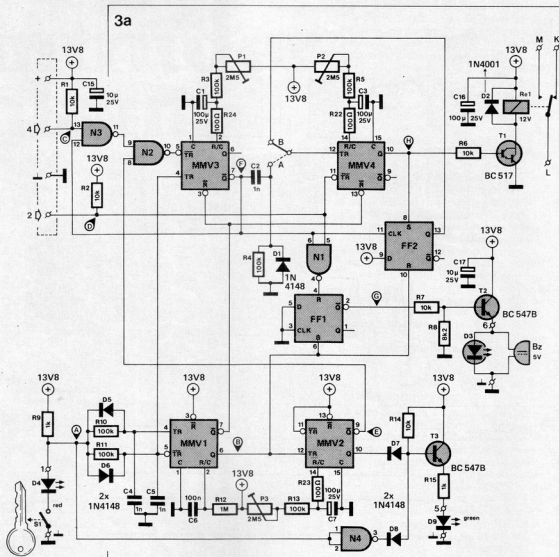
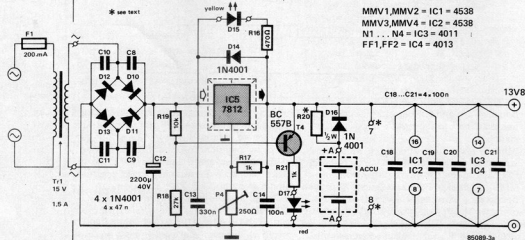
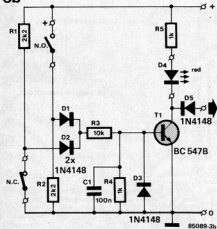

Figure 3a. Circuit diagram of the control unit complete with power supply.



3b



Power supply

The power supply — see Figure 3a — is rather more elaborate than usual, because it includes protection against mains failure. To this end, it contains two LEDs: an amber one, D_{15} , to indicate operation from the mains, and a red one, D_{17} , to show when the unit works from the battery.

During mains operation, the potential at the input of IC_5 is higher than that at the output, so that D_{15} lights. As the voltage

across C_{10} is about 19 V, the potential at the junction of R_{18} and R_{19} is around 14 V; T_4 is then off, and D_{17} does not conduct. When the mains fails, T_4 conducts and D_{17} lights.

It is best to use a 12 V lead-acid battery with a capacity of about 1 Ah: diode D_{16} may then be omitted, and R_{20} should be replaced by a wire link. It is, however, also possible to use a 12 V NiCd battery with a capacity of 0.5 Ah: in that case, D_{16} must then be connected as shown, whereas R_{20} should be omitted. When the batteries are not in use, they are trickle charged automatically.

Interfaces

The interfaces, the circuit diagram of which is given in Figure 3b, offer two operating conditions, as stated before. NO contacts should be connected in parallel; NC contacts, in series. A secondary function of the interfaces is to prevent noise generated in long leads from reaching the control circuits.

A number of interface boards may be connected in parallel: an AND gate is then formed by diode D_5 on the interface board and R_1 or R_2 , as the case may be, on the control board. This means that when one of the interface boards provides a logic 0, the relevant input of the control board is also logic low. It is thus possible

Figure 3b. Circuit diagram of an interface.

4

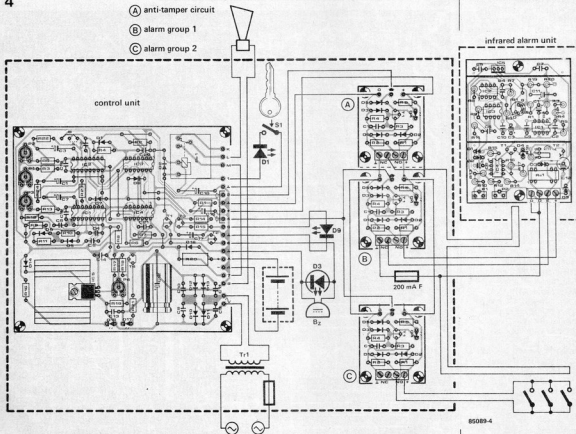
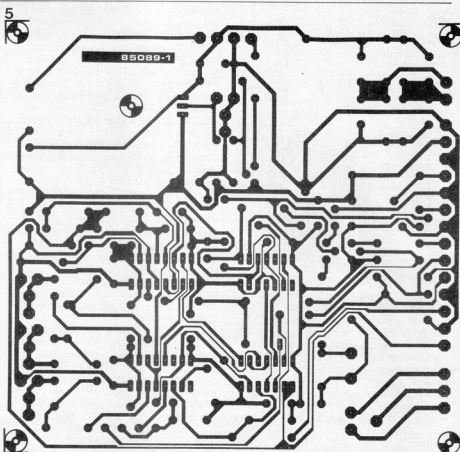

Figure 4. Wiring diagram of the intruder alarm.



Parts list

Resistors:

- R₁; R₂; R₆; R₇; R₁₄; R₁₉ = 10 k
- R₃... R₅; R₁₀; R₁₁;
- R₁₃ = 100 k
- R₈ = 8k2
- R₉; R₁₅; R₁₇; R₂₁ = 1 k
- R₁₂ = 1 M
- R₁₆ = 470 Ω
- R₁₈ = 27 k
- R₂₀* = 120 Ω; ½ W
- R₂₂* = 100 Ω
- P₁... P₃ = 2M5 preset
- P₄ = 250 Ω preset

Capacitors:

- C₁; C₃; C₇; C₁₅ = 100 μ; 25 V
- C₂; C₄; C₅ = 1 n
- C₆; C₁₄; C₁₈... C₂₁ = 100 n
- C₈... C₁₁ = 47 n
- C₁₂ = 2200 μ; 40 V
- C₁₃ = 330 n
- C₁₆; C₁₇ = 10 μ; 25 V

Semiconductors:

- D₁; D₅... D₈ = 1N4148
- D₂; D₁₀... D₁₄;
- D₁₆* = 1N4001
- D₃ = flashing LED; 5 V*
- D₄; D₁₇ = LED; 5 mm; red
- D₉ = LED; 5 mm; green
- D₁₅ = LED; 5 mm; amber
- T₁ = BC517
- T₂; T₃ = BC547B
- T₄ = BC557B
- IC₁; IC₂ = 4538
- IC₃ = 4011
- IC₄ = 4013
- IC₅ = 7812

Miscellaneous:

- S₁ = SPST switch; preferably key operated
- F₁ = miniature fuse; 200 mA; delayed action
- T₁ = mains transformer; secondary 15 V; 1.5 A*
- RE₁ = relay for PCB mounting; e.g., Siemens V23027-A0002-A... (may be available from Electrovac Ltd, Englefield Green, Egham, Surrey TW20 0HB; telephone 0784 33603 or 680 Burnage Lane, Manchester M19 1NA; telephone 061 432 4945)
- Bz = DC operated piezo buzzer; 5 V; I_{max} = 25 mA; with integral oscillator
- Heat sink for IC₅; 5 K/W
- 12 V (nominal) battery*

*See text

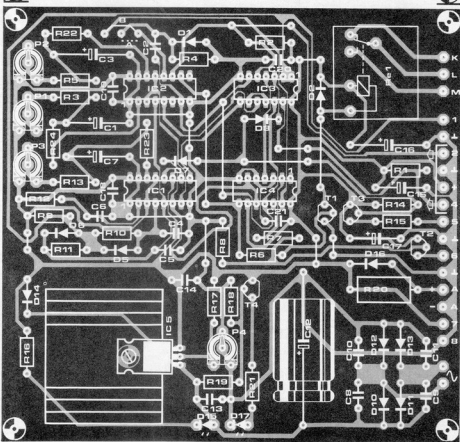
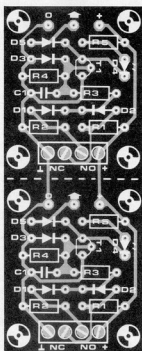
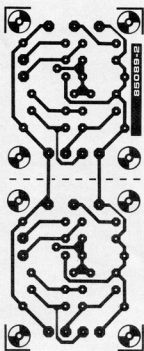

Figure 5. Printed-circuit board of the control unit.



Parts list

Resistors:

$R_1; R_2^* = 2k\Omega$

$R_3 = 10\text{ k}$

$R_4; R_5 = 1\text{ k}$

Capacitor:

$C_1 = 100\text{ n}$

Semiconductors:

$D_1, \dots, D_3; D_5 = 1N4148$

$D_4 = \text{LED}; 5\text{ mm}; \text{red}$

$T_1 = \text{BC547B}$

Miscellaneous:

4-way PCB terminal block.
(Verospeed — phone 0703
644555)
PCB 85089-2

Note that these parts are sufficient for one interface only.

*See text

to use quite a number of sensors — see also the wiring diagram in Figure 4. Each interface has its own positive and negative supply connections, which are used in the first instance for the NO or NC contacts. They can, however, also be used for supplying power to the infra-red sensors. It is advisable to fit a 200 mA miniature fuse in the negative supply line to prevent short circuits between the two supply lines in case the cable is cut.

Switch S_1 is normally fitted at the control unit; if it is required to be located elsewhere, a separate interface as in Figure 3b has to be used. The switch, still in series with D_4 , is then connected between the NO terminals on the interface (anode of D_4 to +). Interface terminals 0, output, and + should be connected to control board terminals 8; 1, and 7 respectively. The value of R_3 in Figure 3b must be lowered to 1 k Ω .

Construction and test

The printed-circuit boards for the control unit and the interfaces are illustrated in Figures 5 and 6 respectively: note that the latter is intended for two identical interfaces.

If diode D_3 is not required to blink, solder a 100 nF capacitor across the buzzer.

The power supply has been designed for use with a 12 V 6 W siren; if a 240 V siren is used, the rating of Tr_1 may be reduced to 15 V; 0.5 A.

Interconnections between the boards are

shown in the wiring diagram of Figure 4 which illustrates the use of 1½ interface board.

The control unit should be housed in a suitable, robust metal case as shown in the photograph.

Before fitting the battery, adjust P_4 to give a voltage of 13.8 V across terminals 7 and 8. Then fit the — fully charged! — battery. Close S_1 when D_5 should light and shortly afterwards go out again. The lighting time is preset between 10 seconds and 4 minutes with P_3 .

Test the anti-tamper circuit by opening an NC contact or closing a NO contact: relay Re_1 should then be energized; D_3 should blink (unless a 100 nF capacitor has been provided across the buzzer); and the buzzer should sound. The holding period of the relay, i.e., the length of time the alarm sounds, is preset with P_2 . Note that P_1, \dots, P_3 have minimum value when they are turned fully anticlockwise.

When a normal alarm group receives a pulse from a sensor, nothing should happen immediately; if, however, the anti-tamper circuit receives a pulse, the alarm should be set off immediately. A normal alarm group can only trigger the alarm when S_1 is closed: this happens after a delay of between 10 seconds and 4 minutes — preset with P_1 — when relay Re_1 is energized.

Figure 6. Printed-circuit board for two interfaces.

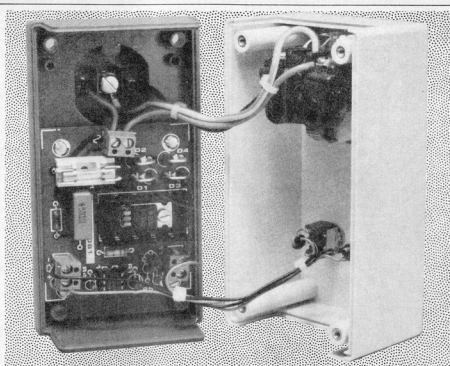

solid-state relay

In general, mains-operated loads are switched by electromagnetic relays. Such relays have been in use for many years and are, in the main, reliable and sometimes ingenious. None the less, they are slowly but surely being superseded by their even more reliable electronic counterparts. A further advantage of these solid-state devices is that they are becoming less expensive than electromagnetic relays. This article describes a simple solid-state relay for switching ohmic loads of up to 600 watts.

J Steeman

Electromagnetic relays have one or several sets of contacts which open or close when a soft-iron core is magnetized by a coil around it.

Solid-state relays involve no mechanical movement whatsoever, as switching is effected by a single silicon-controlled rectifier (SCR) or two SCRs in a common envelope — normally called a triac. This type of relay is of great importance in digital circuits. Note that the SCR was originally called thyristor.

Solid-state relays have a much better lifespan than electromagnetic types, particularly at high rates of switching. They also exhibit far less electrical noise and may be used in explosive environments since there are no contacts across which arcs can form. And, of course, they are completely free of mechanical noise.

The basic concept of a solid-state relay is shown in Figure 1a. The switch may take the form of an SCR in a bridge circuit as in Figure 1b. This configuration enables both the positive and the negative halves of the mains voltage to be switched.

Switching noise

When the moment of switching does not coincide with a zero crossing of the mains, the sudden change in current causes high-frequency impulse noise, which, for instance, may result in unwanted signals appearing on the screen of a television receiver, or becoming audible as clicks in the loudspeaker of a radio receiver.

The magnitude of the noise depends on the frequency of switching, on the instant relative to the zero crossing when switching takes place, and on the type of load being switched: it is generally greater with inductive or capacitive loads than with ohmic loads.

Switching at zero crossing

In a silicon-controlled rectifier, SCR, the forward anode-cathode current is controlled by a signal applied to a third electrode, called the gate. When a positive current is applied to the gate, and the anode is positive with respect to the

cathode, current flows through the SCR from anode to cathode. The magnitude of the gate current determines the breakover point, i.e., the anode voltage at which the SCR switches from the blocking to the conducting state. The SCR conducts as long as the current through it is greater than the so-called holding current.

This means that in a.c. applications the SCR switches off when the mains passes through zero. Consequently, a positive current (pulse) must be supplied to the gate at every half period of the mains voltage to ensure continuous conduction. For ohmic loads, the correct moment of applying the pulse to the gate is when the mains voltage passes through zero, since for such loads the voltage and current are in phase. With inductive and capacitive loads, voltage and current are not in phase, and it is, therefore, not correct to trigger the gate when the mains voltage passes through zero. The optimum trigger moment for such loads is rather more difficult to determine.

Solid-state relay

The circuit of the solid-state relay is given in Figure 2. It is triggered at the zero crossing of the mains voltage and is, therefore, only suitable for use with ohmic loads.

The relay is driven via an opto-isolator, so that the control unit (computer, time switch, and so on) is electrically isolated from the mains.

The main current loop is closed via load La, bridge rectifier D₁...D₄, silicon-controlled rectifier Th₁, and fuse F₁. The maximum forward current through the diodes is 3 A, while the SCR is rated at 5 A.

When the SCR is in the blocking state, the

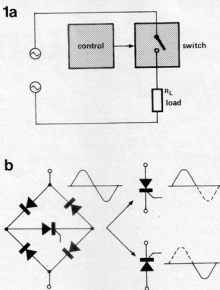

Figure 1. Basic concept of a solid-state relay. The switch in Figure 1a is formed in the present unit by four diodes in a bridge arrangement and a silicon-controlled rectifier as shown in 1b.

entire full-wave rectified mains voltage is present across it. At every zero crossing of the mains voltage, transistor T₁ produces a positive current pulse, provided switch S₁ is open and the phototransistor in IC₁ is off. When the instantaneous voltage at the gate is sufficient to switch the SCR on, the voltage across the SCR, and consequently that at the gate, drops to zero. As long as the above provisions are met, this action repeats itself at every zero crossing of the mains voltage. The various situations and associated voltages are shown in Figure 3. With both S₁ and IC₁ off, the SCR conducts, i.e., the relay is actuated. It may be switched off by closing S₁, or by applying a voltage of +5 V to the series combination of R₆ and the LED in IC₁. The opto-

2

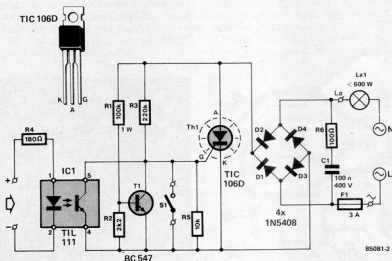
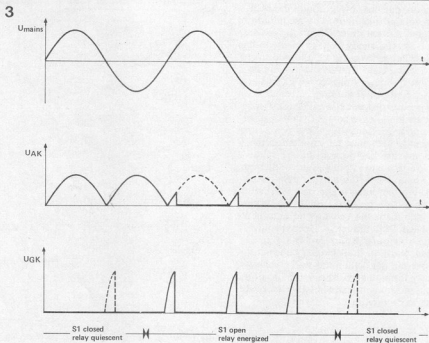

Figure 2. The circuit of the solid-state relay, which, in essence, replaces the usual mains switch. Note that all parts carry the mains voltage!



85081-3

Figure 3. Schematic representation of various operating conditions and associated voltage waveforms.

isolator may be controlled by TTL (transistor-transistor logic), but also by other signals. Note that the maximum forward current through the diode should not exceed 100 mA, while the reverse bias should be not greater than -3 V.

Construction

The relay is most conveniently built on the PCB illustrated in Figure 4. This board is intended for fitting in a $120 \times 65 \times 55$ mm plastic case, which results in a neat and compact unit. The connections to the switch, control unit, mains, and load are best made with the aid of nylon dual terminal blocks. This makes it possible for the PCB to be fitted, or removed, without the need for soldering. The SCR should

be mounted on a small heat sink. Because the unit works from, and with, mains voltages and relatively high currents, great care should be taken in the wiring. Do not forget the earth connection between the mains outlet and the unit! Switch S_1 and the input connectors for the control voltage are mounted at the top of the case. Remember that the switch should always be open when external control is used.

Finally

This solid-state relay is intended for use with ohmic loads of up to 600 W. It cannot be used for switching transformers, neon tubes, and other inductive or capacitive loads, because this would upset the triggering system. **M**

Parts list

Resistors:

- $R_1 = 100$ k; 1 W
- $R_2 = 2$ k
- $R_3 = 220$ k; $\frac{1}{2}$ W
- $R_4 = 180$ Ω
- $R_5 = 10$ k
- $R_6 = 100$ Ω

Capacitor:

- $C_1 = 100$ n; 400 V

Semiconductors:

- $D_1 \dots D_4 = 1$ N5408
- IC $_1 =$ TIL111
- $T_1 =$ BC547B
- $Th_1 =$ TIC106D

Miscellaneous:

- $F_1 = 3$ A; delayed action; complete with fuse holder for PCB mounting
- Heat sink SK13 or KL105 for Th_1
- $S_1 =$ SPST switch
- Plastic case, $120 \times 65 \times 55$ mm; e.g., OKW 9022487 (may be available from Verosped - 0703 644555)
- 3 nylon dual terminal blocks PCB 85081

Figure 4. The printed circuit for the solid-state relay.

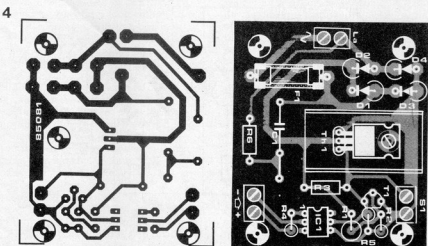

fields

In recent years there has been considerable interest in the effects of atmospheric electric and magnetic fields on living organisms, and in particular in their effect upon human health. For example, experiments carried out in West Germany into the effects of electric fields on motoring fatigue seem to indicate that the presence of an electric field inside a motor vehicle can reduce driver error.

The interior of a motor vehicle, because of its metal construction, is largely screened from external electric fields. Researchers from the West German Defence Ministry, the Max Planck Institute, and the Munich Institute for Biomedical Technology co-operated in developing a device to generate an electric field inside a car. It was found that, with the device operating, drivers made 8 to 10% less errors than normal. Furthermore, the more fatigued a driver was, the greater was the improvement in his performance when the device was switched on.

Professor König, of the Munich Technical University, writing in the German motoring magazine 'ADAC-Motorwelt', stated that, '... electric and magnetic fields exert a biological influence upon the human organism'. On the other hand, Prof. Dr. Ir. Justus Bonzel, director of the Dusseldorf Research Institute of the Cement Industry, in reply to criticisms regarding the screening effect of concrete buildings, wrote, 'The question of the influence of electric fields upon humans and animals still remains unanswered, and most scientists do not accept that a clear link exists. In spite of this, it is often asserted (and even pseudo-scientifically explained) that living in a concrete building has a negative influence on the health of the occupants, as a result of their being screened from electric fields which are present in the open air. (...)' As far as the

screening effect of building materials is concerned, it can be proven that materials such as high-quality concrete, brick, lime/sandstone and wood all screen or let through electric fields to virtually the same extent, and that the interiors of buildings made of these materials contain electric fields similar to those found in the open air.'

Which of these two conflicting viewpoints is true? Certainly, in view of the automobile experiments, it would appear that there is positive evidence that electric fields do have an effect upon health, and that the subject bears further investigation — so exactly what are atmospheric electric fields?

The ionosphere, which is a region of electrically charged air molecules, begins at a height of approximately 70 km above the surface of the earth, and has a positive potential of 300-400 kV with respect to the earth. The ionosphere and the earth's surface thus act as the plates of a gigantic capacitor, which incidentally has a 'leakage current' of about $3 \times 10^{10} \mu\text{A}/\text{cm}^2$ due to movement of ions between the ionosphere and earth.

Between the ionosphere and earth there naturally exists a DC electric field, and in addition there is an AC field with a frequency of 10 Hz. The field strength is not uniform at all points between the ionosphere and earth, but at ground level in the open air the average field strength is about 130 V/metre. A diagrammatic representation of the ionosphere is given in figure 1.

Terrain and buildings have a considerable effect on local field strength at ground level. Figure 2 shows how the equipotential lines are 'cramped' closer together on hilltops, which means that the potential gradient and hence the field strength is greater there than in the valleys, where the equipotential lines are more widely spaced.

The potential difference between the ionosphere and earth causes a constant movement of ions between the ionosphere and earth. Near ground level positive ions predominate, there being approximately 2500 positive and 450 negative ions per cubic centimetre of air, although at sea these figures may be reduced by a factor of 10, and in urban areas may be increased by a factor of 10.

The ion concentration may also vary considerably with weather conditions. For example, before the onset of a thunderstorm there is a heavy ionic concentration with a predominance of positive ions. When rainfall occurs the concentration of ions quickly falls and the negative ions predominate.

It is believed that negative ions have a beneficial effect on health and positive ions a detrimental effect. This may explain the oppressive atmosphere that attends the onset of thunderstorms, and the subsequent relief when the rain begins.

In conclusion it is fair to say that there is sufficient evidence to warrant further research into the effects of electric fields and ions on human and animal health.

Figure 1. The ionosphere begins at a height of approximately 70 km and extends to about 1000 km. The ionosphere is charged to about 300-400 kV with respect to earth and the electric field causes constant movement of ions.

Figure 2. Electric field strength is greater at the tops of hills than in valleys, as can be seen from the bunching or expansion of the equipotential lines.

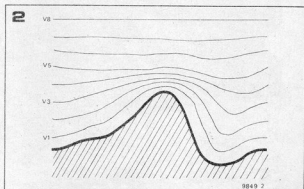
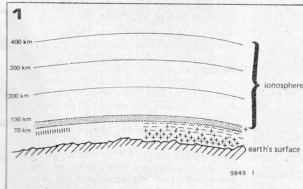



a loudspeaker
for music lovers



PL 301



The pleasure derived from music is heavily dependent on clarity. Although we may sometimes listen to live music, most of what we hear nowadays is recorded, so that even the finest musical sounds will be spoilt if the reproduction lacks fidelity or if they are accompanied by irritating noises and distortion. The item that most often lets the sound reproduction equipment down is the loudspeaker. But not the PL301, which has been designed by KEF Electronics Limited, the well-known loudspeaker designers and manufacturers from Maidstone. KEF has an international reputation for high-quality products and has, moreover, been active successfully in the DIY market for many years. This means that their products are readily available in most of the western world. Cogent reasons for building the PL301, which may not be the cheapest KEF design, but is certainly among the best!

The PL301 is a passive, three-way system. Externally, it catches the eye because of its unusual shape. In finished form, it is partly filled with sand, which makes it quite heavy. Its reproduction is characterized by strict neutrality and precision, resulting in a natural, lively sound.

Design considerations

Designing a loudspeaker box is no sinecure, since there is no detail that is not important or does not play a role in the finished product. The loudspeaker frame, the shape of the enclosure, the volume of the box, the positioning of the frame in the box, the damping, the filter, impedance correction networks, filter components — all these have to be carefully matched to one another.

KEF realized all this a long time ago. Their loudspeaker designs never have just one outstanding property, as is often the case with those of other manufacturers: the

KEF Electronics LTD
Tovil, Maidstone,
Kent ME15 6QP
England
Telephone: (0622) 672261
Telex: 96140

complete design is good. And that is certainly the case with the PL301: no outstanding strong individual points, but no weak ones either! Technical characteristics are given in Table 1.

The PL301 is a good-size three-way system in, as usual with KEF designs, a closed acoustic box. The cross-over between bass, middle, and treble frequencies is provided by a Linkwitz-Riley filter with an initial slope of 18 dB per octave.

The enclosure contains two separate compartments: one for the bass speaker, and one for the middle frequency speaker and tweeter. At first sight, this basic design looks very similar to the RR105, the most pretentious of KEF's loudspeaker enclosures. Even the speakers themselves are the same as in that model. On that basis you might think that the present design is a sort of updated or perfected (is that possible?) RR105, but you would be wrong, because the PL301 has a number of characteristic details which put it a little outside the normal KEF family. Those details are concerned with the precise positioning of the loudspeakers, the shape of the enclosure, and its freedom of resonance — together resulting in a neutral, uniform reproduction and tightly controlled bass performance.

Building the enclosure(s) takes, of course, quite some time, but this is where the DIY enthusiast has the edge over the industrial producer. The home constructor does not consider the hours he puts into the work as part of the overall cost, and he is, therefore, able to carry out labour-intensive work that a manufacturer could not tackle at a profit.

Drive units

KEF have chosen what is probably their best three-way combination: the T52B tweeter, the B110B for the middle fre-

quencies, and the B300B for the bass. These units are shown in the photograph in figure 1.

The bass speaker is one of the most recent additions to the KEF family. In earlier top-of-the-range designs, the 200 mm Type B200 or the well-known oval Type B139 was normally used. The B300B (SP1071) is a robust 300 mm unit with a resonance frequency of 23 Hz, and is

Table 1.

Technical characteristics

Frequency range	35 Hz . . . 20 kHz \pm 3 dB (see figure 13)
Maximum sound pressure	109 dB
Sensitivity	96 dB (1 watt at 1 metre)
Input power	not less than 15 watt not more than 200 watt
Impedance	8 ohms nominal (see figure 12)
Dividing network	3-way; 18 dB per octave; crossover frequencies 400 Hz and 3000 Hz
Drive units	low: KEF B300B (SP1071) middle: KEF B110B (SP1057) high: KEF T52B (SP1072)
Enclosure	closed acoustic box (3rd order)
Volume	bass compartment: 80 litres (0.08 m ³) net middle and high compartment: 3 litres (0.003 m ³) net
Dimensions	1050 mm high \times 465 mm wide \times 430 mm deep



Figure 1. Photograph of the three drive units.

2

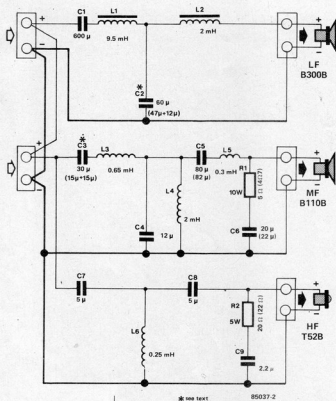

Figure 2. Circuit diagram of the crossover network.

rated at an impressive 150 watt sine wave or 200 watt music.

The T52B (SP1072) tweeter has been in KEF's range rather longer. It has a relatively large cone (52 mm diameter), whereas the speech coil is somewhat smaller (37 mm diameter). Moreover, it has a pleasantly low resonance frequency of 650 Hz.

The old guard of the three is the B110B (SP1057) middle frequency unit. This 130 mm speaker has been produced by KEF for many years, and this makes it all the more amazing how well it still stands up to modern competition. Particularly as regards pulse performance, the B110B is second to none, as our own tests indicate.

Crossover network

Although KEF still used 12 dB loudspeaker dividing networks some years ago, nowadays all crossover networks have an 18 dB per octave characteristic. Modern computer-aided design has made it possible to tune these networks precisely to the relevant loudspeaker combinations. At the same time, these computer calculations give the required frequency and impedance correction factors.

The circuit diagram of the dividing network is shown in figure 2. The crossover points lie at 400 Hz and 3000 Hz respectively. The terminal voltages across the drive units (via the filter) are shown in figure 3.

Although we will revert to this later in the

3

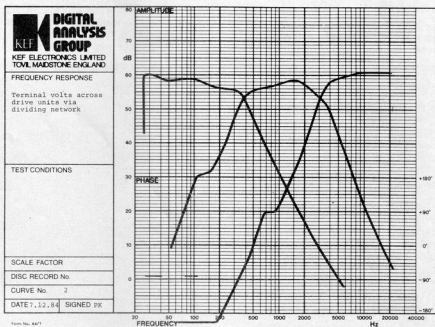

Figure 3. Terminal voltages across the drive units via the dividing network.

article, note that we have designed two different printed circuit boards. The first version is intended for KEF components only, and this board is part of the crossover network kit available from KEF. The second version, shown in figure 6, is of more interest to the pure home constructor, since this is intended for components normally available from most electronics retailers.

According to KEF, bipolar electrolytic capacitors are not nearly as bad as is generally believed. Be that as it may, but note that they have taken the properties of such capacitors into account during the design calculations of their networks. This means that it is not possible to just replace these bipolar devices by foil capacitors. At low and middle frequencies, this is not much of a problem, since the audible differences between various types of capacitor in this range are virtually nil. Matters are quite different, however, at high frequencies: in our opinion a good foil capacitor here is definitely better than an electrolytic type.

We feel, therefore, that capacitors C_7 and C_8 should be polyester, polycarbonate, or (best) polypropylene foil types. The smaller losses in these capacitors, as compared with those in electrolytic types, cause the output of the tweeter to rise by almost 20 per cent, while the impedance characteristic descends somewhat at high frequencies. These effects can be negated by connecting a 0.5 ohm, 5 watt resistor in series with both C_7 and C_8 .

Enclosure

The enclosure is divided into two compartments: one for the bass speaker, and the other for the middle and high frequency speakers, as shown in figure 7. As stated before, the PL301 is typified by its robustness, the individual placing of the drive units, and the shape of the enclosure.

The strength and rigidity is, of course, vital. Everything possible has been done in this design to prevent disturbing panel resonances. The material chosen is 22 mm plywood; there are numerous reinforcing struts, and, last but not least, the sides are double-panelled and the resulting hollows are filled with sand. It could not be better! The remaining details worth mentioning reflect, without exception, the aim of obtaining optimum radiation of the sound. Noteworthy in this respect is the placing of the middle frequency speaker above the tweeter. Why this is done is illustrated in figure 4. When both these speakers are mounted in one plane and a line is drawn between the centre of the tweeter cone and the acoustic operating point of the middle frequency speaker, it is seen that in the conventional positioning shown in figure 4b the axis of radiation lies a little below the horizontal, while in the PL301, as shown in figure 4a, it lies above the horizontal. Except when the loudspeaker

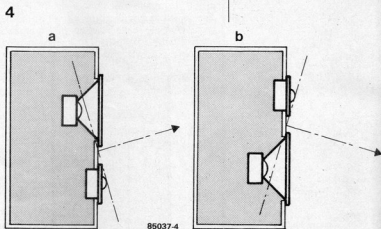

Figure 4. Axis of radiation with (a) middle frequency unit above the tweeter, and (b) the other way around.

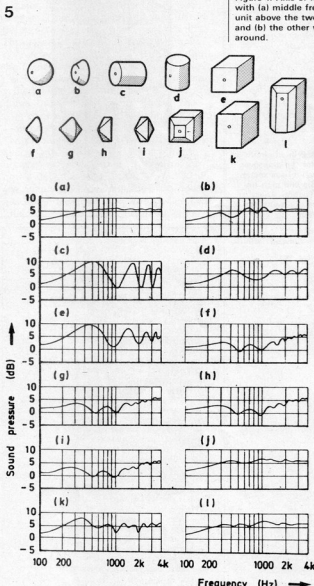

Figure 5. Various enclosure shapes and their characteristic frequency vs sound pressure curves.

6

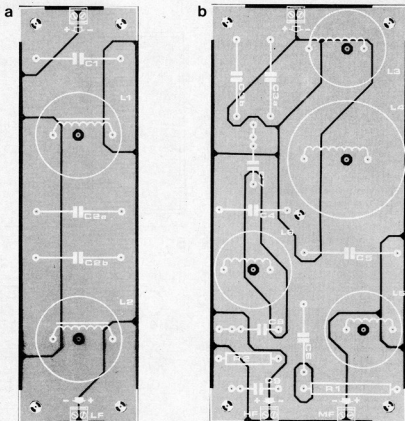

Figure 6. Printed circuit boards for the crossover network: (a) bass section; (b) middle and high frequency section. These PCBs are not available ready made.

Parts list

Drive units: KEF B300B (SP1071); KEF B100B (SP1057); KEF T52B (SP1072)
 Dividing network: KEF DN28 or home construction according to figures 2 and 6
 6 brass threaded rods M3 × 25 mm
 24 nuts size M3
 12 spade connectors size M3
 2 terminal posts with top socket or a 2-way quick-connection lever terminal
 About 2 metres of 1.5 mm² twin flex.
 Timber: 22 mm plywood according to the sawing patterns in figure 8.
 Sound-deadening material as required (available from motorists retail shops).
 Roll of rock wool 30 mm thick.
 Dr Bailey's longhair or fleece as required.
 Good-quality wood glue
 Screws or nails as required
 Steel tensioning wire
 6 dowels for grille
 2 aluminium or steel tubes, 1030 mm long × 10 mm dia.
 Grille cloths as required.
 2 brass or steel bolts M6 × 20 mm and two wingnuts size M6 for fastening the middle and high frequency compartment.
 Dry river sand as required
 Four heavy duty castors, if required

Home constructed dividing network:

Resistors:

$R_1 = 4.7 (5) \Omega / 10 \text{ watts}$
 $R_2 = 22 (20) \Omega / 5 \text{ watts}$

Capacitors:

(all bipolar electrolytic, min. 50 V working, but see text in regard of C7...C9)

$C_1 = 600 \mu\text{F}$
 $C_2 = 60 \mu\text{F}$ (47 μF + 12 μF)
 $C_3 = 30 \mu\text{F}$ (2 × 15 μF)
 $C_4 = 12 \mu\text{F}$
 $C_5 = 80$ or 82 μF
 $C_6 = 20$ or 22 μF
 $C_7, C_8 = 5 \mu\text{F}$
 $C_9 = 2.2 \mu\text{F}$

Inductors:

$L_1 = 9.5 \text{ mH}$, ferrite core: $R < 1.4 \Omega$
 $L_2 = 2.0 \text{ mH}$, ferrite core: $R < 0.5 \Omega$
 $L_3 = 0.65 \text{ mH}$
 $L_4 = 2.0 \text{ mH}$ air-cored, wire diameter 1 mm
 $L_5 = 0.3 \text{ mH}$
 $L_6 = 0.25 \text{ mH}$, air-cored, wire diameter 0.5 mm

Miscellaneous:

5 two-way moulded terminal blocks, 5 A

is at ceiling level, upward radiation is, on the whole, better than downward, because it is along a more direct line to the listening position, so that the detrimental effects of damping by floor covering, particularly carpets, are prevented. It should be mentioned here that in practice the direction of radiation deviates from that shown in figure 4 because of the effects of the phase shift caused by the crossover network.

Another noteworthy feature of the PL301 is that the upper compartment is displaced forward with respect to the bass chamber. This shift of about 450 mm may, dependent on the listening position, be reduced slightly. The forward shift permits the design of the crossover network to be optimized. The necessary phase equalization for inter-unit time delay is incorporated in the crossover design.

The interchanging of the middle and high frequency loudspeakers is closely associated with the shape of the cabinet. Most acoustic engineers are agreed that the shape of the enclosure has a vital bearing on the reproduction. Figure 5 correlates twelve differently shaped cabinets and the associated frequency response characteristics; it is derived from the well-known standard work *Acoustical Engineering* by W H Olson. Spherical shape a is clearly the ideal, but practical spheroids j and l are a good second and third; particularly shape j is hardly inferior to the spherical shape. Noteworthy is that conoids f...i score badly, whereas old faithful shape k comes out quite well.

The PL301 uses enclosure shape l, although the forward placing of the upper compartment makes the middle frequency characteristic approach that of shape j very closely. The partly slanting shape of the j and l variants is, therefore, the most conspicuous aspect of the PL301. That shape is continued in the front grille. From a practical point of view, this is an ideally shaped cabinet which has only one disadvantage: you need to be pretty good at woodworking to make it.

Construction

Starting with the dividing network, it seemed sensible to split the PCB, like the cabinet, into two parts: that for the bass section is shown in figure 6a, and that for the middle and high frequencies in 6b. The inputs of the two board are simply connected in parallel. Although building the PCBs is a fairly simple job, it is essential that you stick to the stated component values! Inductors L_1 and L_2 use ferrite cores, but all others are air-cored. The wire diameter for L_3 , L_4 , and L_5 should be 1 mm, and that for L_6 , 0.5 mm.

The capacitors, with the exception of C_9 and possibly C_7 and C_8 (see *crossover network* above) are bipolar electrolytic types. Because values of 60 μF and 30 μF are not always easily available, the board has been designed to accommodate parallel combinations for C_7 and C_8 . Normal

Note: these PCBs are not available ready made.

7

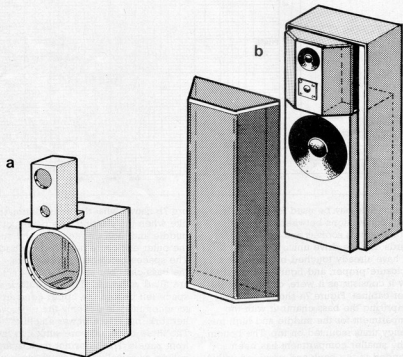

Figure 7. Artist's impression of the enclosure.

8

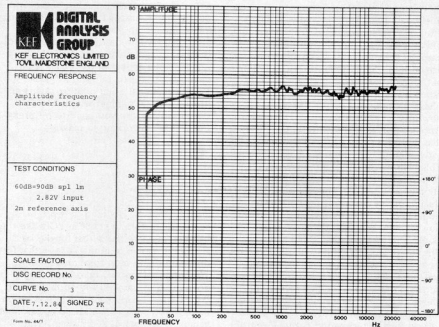

Figure 8. Amplitude vs frequency characteristic.

9

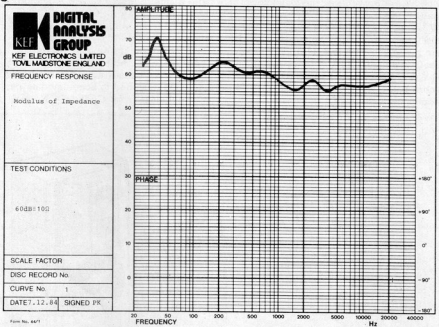

Figure 9. Modulus of impedance vs frequency characteristic.

1.5 mm² flex may be used for the (fairly short) connections between the boards and the inputs sockets and between the boards and the drive units.

We have already touched briefly on the enclosure proper, and figure 7 illustrates how it consists, as it were, of an inner and outer cabinet. Figure 7a shows the basis, comprising the bass chamber with the compartment for the middle and high frequency units mounted on top. The bottom of the smaller compartment has been extended to the back and provided with sunken holes to enable the box to be fastened to the bass chamber with a couple of heavy bolts and wingnuts. Fig-

ure 7b shows what the construction looks like when the slanting side panels of the middle and high frequency chamber and the outer enclosure have been added. The spaces between the side panels of the bass chamber and the outer enclosure are filled with sand. There is sufficient space left behind the upper compartment to accommodate not only the crossover network, but also a power amplifier. The three drive units are sunk into the front panels. This does not require any milling or chiselling, because we have used a sandwich construction of two separate sheets of plywood that are glued together. The foremost sheet has a cut-out

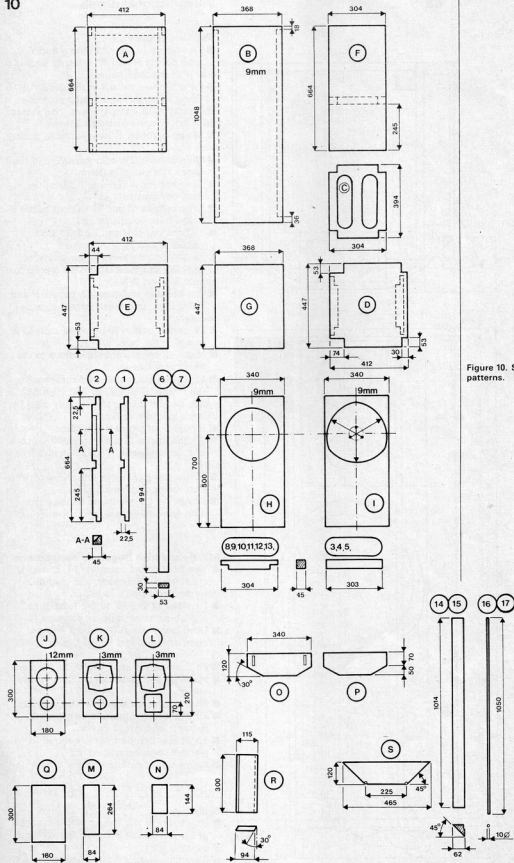
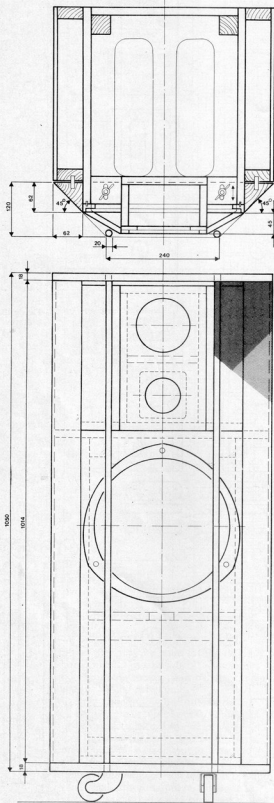

Figure 10. Sawing patterns.

**The bass chamber**

- Fit battens 1...5, and then 6 and 7, to side panels A and A'. Next, fix panels B and B' to the side panels.
- Fit anti-boom panels to the inside of those parts of B and B' that protrude above the bass compartment. This is best done with floor covering adhesive.
- Mount partition C between side panels A and A'.
- Glue batten 12 to rear panel F and then fasten this panel in place.
- Glue battens 8 and 9 to lid D of the bass compartment.
- Glue battens 10 and 11 to floor panel E of the bass compartment.
- Fit floor panel E and lid D to side panels A and A'.
- Fit anti-boom panels to the inside of panel G and then fasten this top lid to panels A-B and A-B'.
- Cut holes as indicated in panels H and I and then glue these panels together securely.
- Fit centre batten 13 between battens 2 and 2' at the front.
- Make all electrical connections to the bass drive unit.
- Fit 30 mm thick sheets of rock-wool to the inside of all panels and then fill the space behind the woofer loosely with Dr Bailey's longhair or fleece.
- Mount front panel H-I in place.
- Fill the space between panels A and B and that between A' and B' with (dry!) sand.
- Mount the bass drive unit in place with nuts, bolts, and washers.
- Finish the compartment as required with varnish, veneer, and so on.

Middle and high frequency compartment

- The front panel consists of J, K, and L; cut holes as indicated, and glue the three sections firmly together.
- Fit sides M and M' to the front panel, and at the same time fix partition N.
- Glue lower panel O and lid P to the compartment, and then fix back panel Q.
- Fit slanting panels R and R' at the front.
- Make all electrical connections to the two speakers.
- Fit the drive units in the compartment.
- Fill the compartment loosely with Dr Bailey's longhair or fleece.
- Finish the compartment as required (varnish, veneer, and so on).
- Screw the compartment to the bass unit.

Grille

- Drill holes in the top and bottom of the grille, i.e. panels S and S', for the cloth tensioning bars.
- Assemble panels S and S', together with battens 14 and 15 and cloth tensioning bars 16 and 17.

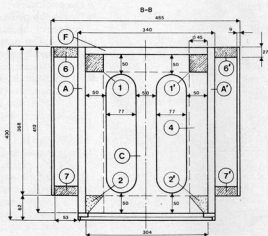
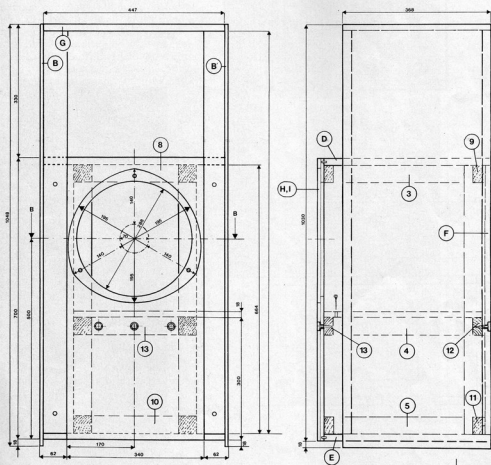
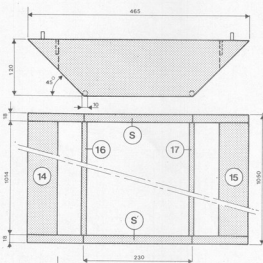
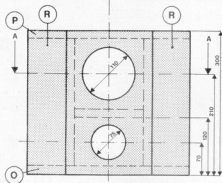
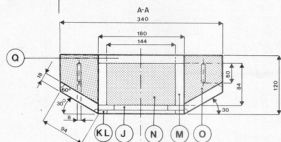

Figure 11. Construction plan.



11c

- Finish the grille as required (varnish, veneer, and so on).
- Fit dowels in the side battens — 14 and 15 — to enable the grille to be fastened to the enclosure.
- Fasten the grille cloth to the top and bottom of the grille with steel tensioning wires. The protruding edges of the cloth should be stapled to the back of the side battens.
- Fit the grille to the enclosure.



85037

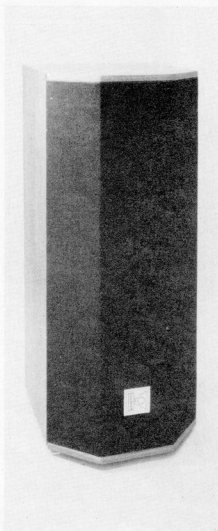

the same size as the outer diameter of the loudspeaker, while the second panel has a slightly smaller cut-out. KEF provides a paper template for cutting the holes for the drive units.

The complete cutting pattern of the enclosure with all dimensions is given in figure 10. It has been designed in a manner by which standard available sheets of wood are utilized as economically as possible. If your carpentry skills are suspect, it is wise to have the material sawn by an experienced carpenter to ensure that all parts are the right size and straight!

For the rest, you need a good quantity of first class wood glue and an assortment of screws and/or nails. Since this is in any case a project for experienced handymen, we will not go into details as to what types and sizes of screws and/or nails, or, indeed, whether you screw or nail the cabinet together. As long as all panels are fastened together securely, and the cabinet is airtight on completion, it does not matter how you do it.

The construction plan is given in figure 11: a shows the complete enclosure with outside dimensions, b shows the bass chamber complete with outer enclosure, and c gives all the details of the middle and high frequency speakers compartment complete with grille. Construction can thus be sub-divided into three different phases, detailed on pages 39, 40 and 45, 46, which can conveniently be lifted out if desired.

Finally

As stated before, the crossover network may be housed in the empty space behind the middle and high frequency compartment.

The various interconnecting wires can be taken through the (back) panels via 3 mm diameter brass threaded rods and heavy-duty spade terminals.

The photographs in figure 12 show various stages of the construction.

Impedance and frequency curves are given in figures 9 and 8 respectively, while the technical characteristics are summarized in table 1.

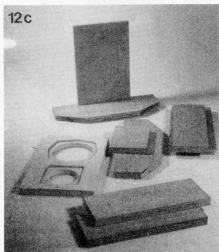
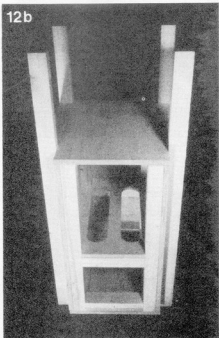
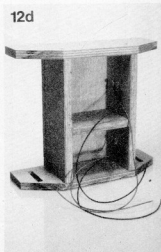
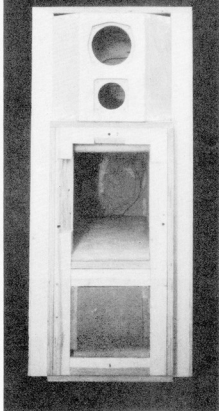

Figure 12. Photographs of various stages in the construction.



12e



12g

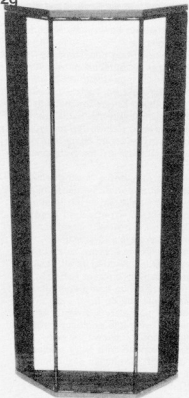

12f



12h

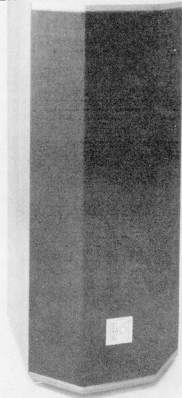

FET millivoltmeter

FET opamps have high gain, low input offset and an extremely high input impedance. These three characteristics make them eminently suitable for use in a millivoltmeter. The circuit presented here can measure both voltages and currents.

Figures 1a and 1b show the basic circuits for voltage and current measurement respectively. In figure 1a, the opamp is used in a virtual earth configuration and the gain is therefore determined by the ratio R_a/R_b and by the voltage divider circuit R_c/R_d . The exact formula is given in the diagram. The current measurement circuit, figure 1b, is also basically a virtual earth configuration; the opamp will maintain an output voltage such that the left-hand (input) end of R_a is at zero potential and, since the input current must flow through this resistor, the voltage drop across R_a equals $I \times R_a$. Therefore, the output voltage must be $-I \times R_a$. The complete circuit (figure 2) combines these two functions. The range switch S3 selects the required feedback resistor (R_a in figure 1) and the voltage divider (R_c and R_d) if the latter is required. The resulting ranges are listed in Table 1. The polarity of the meter can be reversed by means of switch S2.

A symmetrical ± 3 V supply is required, capable of delivering 1 mA. This low voltage and low current consumption means that the FET millivoltmeter can be battery-powered. This is a highly desirable feature, since the meter can then be used for so-called 'floating'

measurement. A higher supply voltage is permissible, if it is easier to obtain (4.5 V flat batteries, for instance); the maximum for these opamps is a symmetrical ± 16 V supply.

It is advisable to use 1% resistors, and P1 and P2 should preferably by high-quality preset potentiometers. R1, R2 and R3 may prove difficult to obtain, in which case a series-chain of 1 M resistors must be used.

Preset P1 is for offset compensation. With the meter input shorted, this preset is adjusted until the meter reads zero. P2 is the calibration potentiometer: a known voltage (or

current) is applied and P2 is set so that the meter reads correctly.

Figure 3 shows an optional extra: the 'universal shunt'. This consists of nothing more than a chain of resistors that can be connected across the voltage input terminals of the meter. If current is passed through any one of these resistors, a corresponding voltage drop will appear across this resistor. Since there is no voltage drop across any of the other resistors, this voltage will be indicated by the meter, Table 2 lists the resulting current measurement ranges. As before, 1% resistors should be used for the actual measuring chain (R19...R24).

Table 1

S3	U_i (f.s.d.)	I_i (f.s.d.)
a	10 mV	1 nA
b	50 mV	5 nA
c	100 mV	10 nA
d	500 mV	50 nA
e	1 V	100 nA
f	5 V	500 nA
g	10 V	1 μ A
h	50 V	5 μ A
i	100 V	10 μ A
j	500 V	50 μ A
k	1000 V	100 μ A

Table 2

S3 in position:	a	b	c
I_a (f.s.d.)	1 μ A	5 μ A	10 μ A
I_b (f.s.d.)	10 μ A	50 μ A	100 μ A
I_c (f.s.d.)	100 μ A	500 μ A	1 mA
I_d (f.s.d.)	1 mA	5 mA	10 mA
I_e (f.s.d.)	10 mA	50 mA	100 mA
I_f (f.s.d.)	100 mA	500 mA	1 A

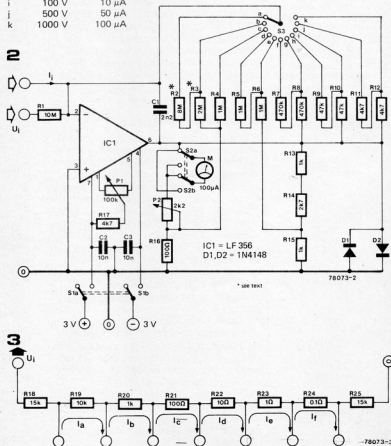
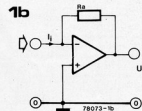
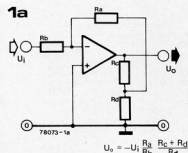

One of the most common sales plays in the computer world is to demonstrate a machine's capability for graphics. Unfortunately, the graphics card is often an optional extra or so basic that it needs very powerful programs to control it. In general, it is far better to use a separate graphics card. The one described in this series of articles offers a range of options rarely found together in one project. It is very efficient due to the clever balance of software and hardware: a balance achieved only after many months of design and tests. The major characteristics of both the hardware and the software are summarized in Table 1.

1 high-resolution colour graphics card

the first in a series of articles describing a 512x512 or 512x256 pixel, black & white or colour graphics card, complete with software

P Lavigne &
D Meyer

ASCII is the acronym for American Standard Code for Information Interchange; it is a 7-bit code that gives 128 unique combinations or characters, of which 32 are reserved for special control functions.

Basically, a graphics card is an autonomous terminal that generates graphic video images based on instructions received and decoded by the software. In a sense, it is similar to a printer receiving ASCII codes and converting these into control signals for driving its print head. The difference between a printer or x-y plotter and a graphics card is that the latter does not need a separate CPU to interpret the instructions, since it makes use of the host system's microprocessor. The processor on the graphics card is used to generate the screen memory and to make traces.

Design considerations

A graphics card has a number of advantages over a VDU card: it provides dot-by-dot (rather than block-by-block) graphics; its results have a high resolution; and it can support colour. In addition, a graphics card enables text to be included in the picture, so that, with the associated software, it is also an alphanumeric video terminal with a resolution of 32 lines of 80 columns. This latter property is more important than may appear at first sight, since it enables both the colour and the size of the characters to be easily changed, to the obvious benefit of versatility.

All pixels on the screen are accessible on an x-y matrix when the coordinates are presented to the graphics processor. The origin, $x=0$; $y=0$, is found at the top left-hand corner in text mode and at the bottom left of the graphics screen. The complete card, with colour extension, uses only 19 addresses in the host's memory. This makes it simple to include the card in any system, particularly a

pixel is short for picture element; it is also called a pel or a dot

Table 1. Technical characteristics of the graphics card.

Table 1.

HARDWARE

Processor:	GDP9366 (9365) or GDP9367
Databus:	8-bit, buffered
Addresses decoded:	19 (XX58, XX5F, XX64, XX66). The screen memory is autonomous with automatic refresh (16K per page and per colour)
Synchronization:	composite, normal or inverted (buffered TTL output)
Video:	monochrome, RGB or RGBI (buffered TTL outputs)
Lightpen:	negative pulse (buffered TTL input)
Resolution:	4 pages of 512 x 256 pixels (9366/9367) 2 pages of 512 x 512 pixels (interlaced only/9367)
Colours:	monochrome on the main board } 8 or 16 colours RGB on the extension board
Note:	The number of colours does not restrict the resolution in any way. Several extension cards may be added.
Scrolling:	vertical scroll (the software changes the display addresses sent by the GDP to the video memory)
RWM:	read/modify/write mode (EXOR gate between pen and paper)
Communication with the screen memory:	pixel-by-pixel reading (the microprocessor uses a special instruction to feed the pixel coordinates into the GDP)
Interrupts:	IRQ (3 programmable modes)
Generators:	<ul style="list-style-type: none"> ■ alphanumeric characters (on a 5 x 8 matrix). The number of characters is individually programmable for x and y axes. ■ programmable vectors (four types of trace) — see software

SOFTWARE

The graphics card is supplied complete with software (a little less than 4K of 6502 object code). This is sub-divided into two programs, one of which generates all the **text** (and is a sort of ASCII video terminal) and the other handles all the **graphics**. The software is completely autonomous and acts almost like a super reception routine for the contents of the accumulator. Note how concise the instructions are.

6502-based one, since the control interpreter was designed around this processor. The software can, of course, be changed to suit a different processor, or to enable the graphics card to be driven direct, but this involves some more work, which will be considered at a later stage. The colour extension and mother boards are both of eurocard format. The latter is completely independent and monochrome; its input is linked to the microprocessor bus, while the output provides the video signals that are fed direct to a monitor. Apart from the graphics processor and TTL circuitry, this card contains 64 K of dynamic RAM. The colour card, which will be discussed later, has four banks of 64 K memory that form an extension mounted parallel to the mother board. This card communicates with the host's microprocessor via its data bus, and with the mother board by a separate bus. It provides RGB (red, green, blue) signals that are combined with the base board's video signal to obtain 2, 4, 8, or 16 colours (or shades of grey) on a monitor with RGB or RGBI (I = intensity) inputs. It is possible to add a second

extension card (for which provision has been made) and generate, 32, 64, or 128 colours.

Functional diagram

The basic functional diagram is given in Figure 1a; that in the Figure 1b is complete with the colour extension card. The graphics card is based on the Thomson Type EF9365, EF9366, or EF9367 **graphics display processor (GDP)**. The processor generates 64 K of dynamic video RAM, which is completely separate from the memory of the computer with which the graphics card is used. The timing and clock stages control the timing of the internal signals and are in turn driven by the dot clock, which is either a 12 MHz or 14 MHz version.

The graphics card can access the microprocessor data bus either via the GDP or via the read/write latch. An internal address decoding circuit handles all communications and the graphics card, therefore, needs only nineteen addresses from the host system.

Table 1

CHR#	Text mode commands		Graphic mode commands
(1)	Transfer video buffer contents to screen	A	Set text mode
(2)	Open the video buffer	B n	Set background color to color "n"
(3)	Close the video buffer	B - n	Combine the background color with color "n"
(4)	Use graphic commands in text mode	C n	Set pen color to color "n"
(5)		C - n	Combine the pen color with color "n"
(6)		D x,y	Draw from current position to x,y destination
(7)		D x,y,x,y,...	D may be followed by several x,y destinations
(8)	Backspace (cursor left)		X,Y coordinates are given from absolute origin
(9)	Horizontal tabulation (cursor right)	E	
(10)	Line Feed (cursor down)	F	
(11)	Vertical tabulation (cursor up)	G ± n,x,y	n = 1: ; n = 2: ; n = -1: ; n = -2
(12)	Clear screen/home cursor	H	Home pen to current origin (without drawing)
(13)	Carriage Return	I	Set current location as new absolute origin
(14)		J x,y	Draw from current pen location to relative position x,y
(15)		J x,y,x,y,...	J may be followed by several x,y destinations
(16)	Set text mode	K	
(17)	Set graphic mode	L n	Set line type n; n = 0: _____; n = 1:; n = 2:; n = 3:
(18)		M x,y	Move to absolute location x,y without drawing
(19)	Reset the character size	N	
(20)		O s,r,t	Draw a circle or a disk with current absolute origin as center
(21)			s = sectors; r = radius; t = thickness
(22)			
(23)		P characters	Print alphanumeric characters without leaving graphic mode
(24)		Q d	Set the print direction; d = 0: horizontal; d = 1: vertical
(25)		R x,y	Move to relative x,y position from current pen location (without drawing)
(26)	Erase current line	S x,y	Set character size x on X axis / y on Y axis
(27)	Escape	T t	Set character type t; t = 0: normal; t = 1: tilted
(28)	Home cursor	U p,u	Select pen/eraser up/down; p = 1: pen; p = 0: eraser; u = 1: down; u = 0: up
(29)	Clear to end of line	V x,y	Get pixel status in specified x,y location
(30)		W m	Set Read-Modify-Write mode; m = 0: no RMW mode ; m = 1: RMW mode
(31)		X a,s,i	Draw a coordinate axis from current location in direction "a" using increments "s"(steps) (+ or -) and marking "i"(intervals)
		Z p	Select page "p"

Examples in BASIC:

```
PRINT CHR$(18) "M0,127,1"
PRINT "B6,C4,D255,127,255,0"
PRINT "C2,M127,63,1"
PRINT "O255,60,2"
etc...
```

Table 1 gives the instructions that are accepted by the command interpreter, which will be discussed later. These instructions are not directly intended for the GDP, which cannot interpret them either in the form given. Note that the majority of the instructions and their syntax are the same as those used with a number of plotters, such as, for instance, the Tandy. Before the command interpreter can be dealt with, it is necessary to study the mother board, followed by the colour extension card.

The **SCROLL register** enables the microprocessor to shift the addresses supplied by the GDP to the video memory in order to move the entire screen image vertically. This is particularly interesting when there is text on the screen.

The **COLOUR register** allows the colour of the pixels to be changed, and also permits the shift of the screen memory from the 512 x 256 (non-interlaced; four pages) mode to the 512 x 512 (interlaced; two pages) mode.

The **RMWS (read-modify-write select) register** enables the contents of the screen to be altered without the need of memorizing the original, which can, however, be recalled afterwards. This will be dealt with in more detail later.

The **PIXEL register** makes it possible for the microprocessor to examine the state of a pixel, the coordinates of which it has fed to the GDP. It is, of course, a read only latch.

The **second SCROLL function** (in association with the **SCROLL register**) alters the addresses sent by the GDP to the video memory so as to shift the entire image vertically.

The **RAS (row address strobe)** simply distinguishes between the two different access modes of the GDP to the video memory. In the first of these modes, eight ICs in the memory are accessed simultaneously to refresh or change the background colour or any other aspect of

the addressed byte. In the other mode a single IC is accessed to read or write a single point, i.e., when only one bit of the relevant byte is addressed.

The complete functional diagram in Figure 1b includes the extension for 8 colours, which will be reverted to later.

Black & white picture production

The image on the fluorescent screen of the cathode-ray tube (CRT) in the monitor display unit comprises hundreds of thousands of pixels. The screen is scanned in both the horizontal and the vertical direction by an electron beam moving at a rate of 64 μ s per line. The horizontal direction is termed the line, and the vertical direction, the field (also called the raster). Sawtooth waveforms are used to deflect the beam: the flyback period is blanked out.

Pulses are used to synchronize the original signal and the screen image. The line synchronizing pulses are generated during the line flyback period, and the field synchronizing pulses during the field flyback.

For optimum performance, the number of horizontal scans is made larger than the number of vertical scans. The number of lines traversed per second is the line frequency; the number of vertical scans per second is the field frequency.

2a

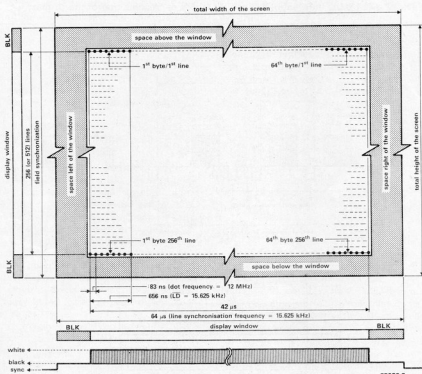

Figure 2a. Picture size and image production.

Generally, interlaced scanning is used, in which the lines of successive fields are not superimposed on each other, but are interlaced; two rasters form a complete picture or frame. The number of complete pictures per second is the frame frequency, which is, therefore, half the field frequency. The field frequency is slow enough to allow a great number of horizontal lines, and fast enough to eliminate flicker. European systems invariably use the 625 lines per frame standard recommended by the CCIR, and a field frequency of 50 Hz, whereas the system in North America uses a 60 Hz field frequency and 525 lines per frame. A graphics card defines a rectangular window within the screen area as one in which lines are scanned in $42.667 \mu\text{s}$ (see Figure 2a). If each line contains 512 pixels, it is about 83 ns wide. A complete scanning line (from one edge of the screen to the other) then contains 768 pixels. This gives a pixel frequency of 12 MHz, which is applied as a clock to a shift register. If this is an 8-bit type, the bits are input at a frequency of 1.5 MHz. At the start of a scanning line nothing happens until it reaches the left window frame: the shift register then loads the first byte and outputs one pixel every 83 ns (see Figure 2b). After $8 \times 83 \text{ ns}$, the first eight bits at the top left-hand side of the screen are either on or off. The shift register then loads the second byte, and continues outputting bits. This goes on until it has output the last bit of the 64^{th} byte for this line, when the line reaches the right-hand frame of the display window. Nothing happens then until the line

(synchronization) pulse, when the electron beam flies back to start scanning the next line. This process continues until the end of the last line at the bottom of the window has been reached. Note that the top and bottom of the screen fall outside the window.

Next, the field synchronizing pulse causes the electron beam to fly back to the point of origin at the top left-hand corner of the screen, and the whole process starts afresh.

It is clear that there are three factors determining the picture: the sync pulses, which have fixed frequencies irrespective of the contents of the picture, and the video signal proper. The latter may be considered as composed of all the pulses corresponding to the dots making up the picture. It is derived from the dot clock, which provides the timing for the output shift register. This register receives information as to brightness of the pixel in packets of eight bits — the **luminance** signal — that are loaded simultaneously to the video memory. The pulse indicating "load the next byte" arrives while the previous eight bits are being read, provided the beam of electrons is within the window. A blanking signal ensures that the screen outside the window remains completely dark.

Colour pictures

The colour information is contained in the **chrominance** signal, which is obtained by combining three binary signals, each of which represents one of the primary

Figure 2b. Composition of the video signal.

2b

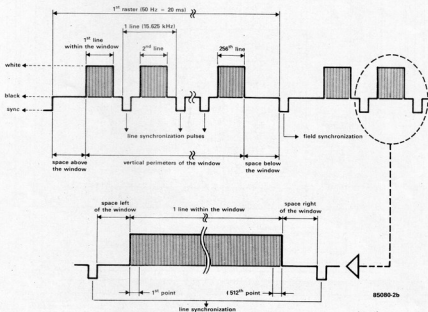

85086-2b

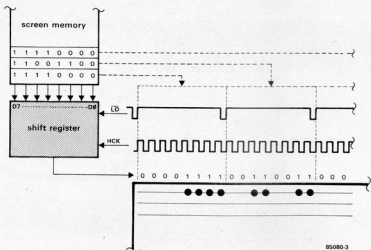

Figure 3. Production of a single-colour signal: three registers as shown are needed for a colour graphics card.

colours red, R, green, G, and blue, B. Any three primary colours can be mixed, in suitable proportions, to produce any other colour, except black. In other words, the colour is determined by the binary word formed by a combination of the three binary colour signals; this combination is also known as pel or pixel, both short forms of picture element.

The three colour signals are usually applied to the RGB inputs of the monitor. When the R input is high, and the other two low, the pixel will show up red; similarly, a high blue input and low R and G inputs will result in a blue pixel. Further primary colours are produced under the following conditions.

R (high) + G (high) + B (low) = yellow
 R (low) + G (high) + B (high) = cyan
 (greenish blue)
 R (high) + G (low) + B (high) = magenta
 (reddish blue)
 R (high) + G (high) + B (high) = white
 R (low) + G (low) + B (low) = black

The colour signals are output by three separate shift registers; this situation is shown for black and white or one colour in Figure 3. The registers are fed by three parallel banks of memories: each channel carries a signal as shown in Figure 2b. The line and field sync signals, the dot clock, and the load shift register are, of course, common to the three channels. Reiterating, there are thus **three bits with the same address** (but each in a distinct memory bank) for each pixel on the screen.

If the screen is black and its colour is required to be changed to, say, red, the R memory must be written to; if a yellow screen is required, the red and green memories should be accessed. This is, of course, true of not only the entire screen, but also of each individual pixel. The graphics card must, therefore, have a

dataline and a write select line common to the three memory banks, and also an individual select line. In practice, this requires two signals: one to indicate whether a bank is accessed or not; and the other to specify what is being done there. When the writing is green on a red background, for example, the pixels that are written must be accessed in both the green and the red memory. However, when the bit in the G memory is actuated, the same address in the red memory must be disabled. If this were not done, the pixel in the example just described would be green + red = yellow on a red background.

Note that a pixel being lit on the screen has a logic low level on the graphics card, and a high level when it is dark.

Part 2 will appear in our November 1985 issue.

Did you know...

... that FORTH is currently the hottest high-level computer programming in the language industry?

Though still relatively new, FORTH is rapidly gaining in popularity because of its reduced memory requirements, modular structure, inter-active nature, and ability to be extended to a problem-solving language.

Prime areas of application for the language are in data acquisition, process control, robotics, or any other application that requires high speed with low software overheads.

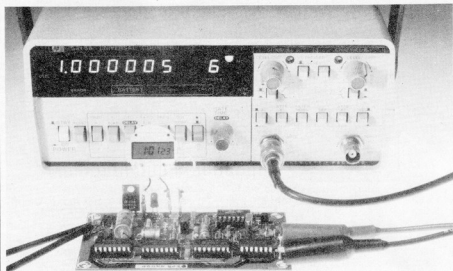

G E Dunning

A frequency standard is a stable and precise oscillator that is calibrated against national or international reference frequencies which are often broadcast as time signals throughout the day; in many countries, such reference signals are also available over the telephone. These reference frequencies deviate by not more than 1 second per 3170 years. The clock used in the SI definition of the second is 100 times better still! A frequency standard is used, for instance, to check the calibration accuracy of various measuring instruments. For this purpose, an accuracy of about 1 p.p.m. is normally perfectly adequate.

frequency standard

A quartz-controlled digital watch, synchronized to a radio or telephone reference time signal over a period of time, is a convenient and inexpensive basis for a frequency standard. Such a watch commonly deviates not more than 1...2 seconds per month from true time, which is an accuracy of better than 1 p.p.m. The quartz-crystal oscillator in a digital watch has a frequency of 32.768 kHz, which is divided by 2^{10} (= 1024) to obtain a 32 Hz signal for maintaining the LCD (liquid crystal display). It is not possible to tap the basic oscillator frequency without upsetting its accuracy, but the 32 Hz signal may be tapped with impunity.

Functional details

Phase-locked loop. The operation of the frequency standard is illustrated in the functional diagram of Figure 1. The circuit receives a reference signal of 32 Hz from the digital watch, and this is compared in a phase detector with a signal derived from a VCO (voltage-controlled oscillator). If the VCO signal differs from the refer-

ence signal in phase or frequency, the phase detector generates an error signal, which is fed to the VCO via a low-pass filter. In this way, the VCO becomes a self-adjusting stage that provides a stable and accurate 16 MHz signal. This signal is divided by 16 and 16×10^6 to give output frequencies of 1 MHz and 1 Hz respectively.

Note that the 1 MHz signal has a 32 Hz ripple caused by the control signal to the VCO. However, the peak value of this ripple is so small that it will hardly ever be noticeable in practice.

Voltage-controlled oscillator. The oscillator formed by gates N_1 and N_2 in Figure 2 is a conventional crystal-operated circuit. If, however, a variable reactor, here formed by a VMOSFET Type BS170, is added, it becomes possible to vary the frequency with the control voltage provided by the phase detector via R_7 . The use of a MOSFET as varactor (acronym of **variable reactor**); instead of the more usual semiconductor diode, has the advantage of a relatively large change in

capacitance — from 80 pF to 30 pF — for a voltage swing of 0 V to 2.5 V (see Figure 6). The maximum control voltage of 2.5 V arises when the output signal of the phase detector is symmetrical. These values enable the output frequency of the VCO to be varied from 15.999 to 16.000 MHz. The correlation between the output frequency and the control voltage is shown in Figure 7. The characteristic shows that the wanted frequency of 16 MHz is obtained with a control voltage of 1.2 V.

Phase detector. Correct operation of the frequency standard depends essentially on the proper functioning of phase detector N_3-N_4 (see Figure 2). Assuming that the inputs to N_4 are square wave signals, the duty factor, by definition, is 1:1. Slight variations in the duty factor will result from small differences in phase between the two inputs, and this will cause a change in the output voltage of the detector. The control voltage for the VCO is derived from this output: the correlation between the control voltage and the phase differ-

1

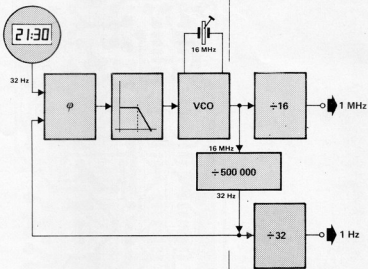

Figure 1. Functional diagram of the frequency standard.

2

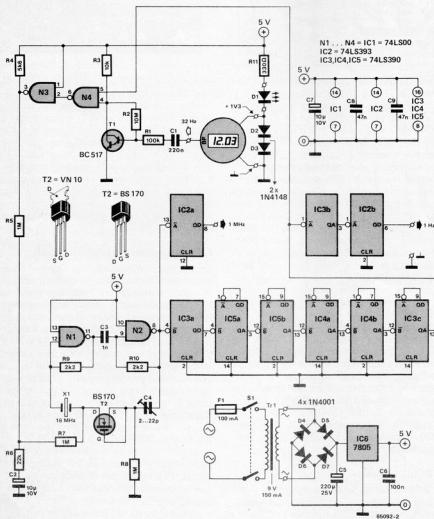

Figure 2. Circuit diagram of the frequency standard.

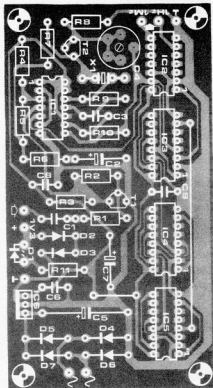
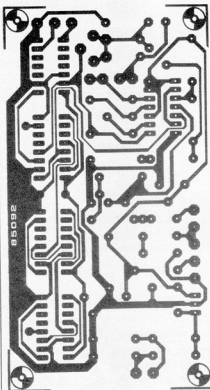

Figure 3. Printed-circuit board for the frequency standard.

Parts list

Resistors:

- $R_1 = 100 \text{ k}$
- $R_2 = 10 \text{ M}$
- $R_3 = 10 \text{ k}$
- $R_4 = 56 \text{ k}$
- $R_5, R_7, R_8 = 1 \text{ M}$
- $R_6 = 22 \text{ k}$
- $R_9, R_{10} = 2 \text{ k}$
- $R_{11} = 330 \Omega$

Capacitors:

- $C_1 = 220 \text{ n}$
- $C_2, C_7 = 10 \mu\text{; } 10 \text{ V}$
- $C_3 = 1 \text{ n}$
- $C_4 = 2 \dots 22 \text{ p; variable}$
- $C_5 = 220 \mu\text{; } 25 \text{ V}$
- $C_6 = 100 \text{ n}$
- $C_8, C_9 = 47 \text{ n}$

Semiconductors:

- $D_1 = \text{LED; as required}$
- $D_2, D_3 = 1\text{N}4148$
- $D_4, D_7 = 1\text{N}4001$
- $T_1 = \text{BC517}$
- $T_2 = \text{BS170; VN10KE; VN10LE}$
- $\text{IC}_1 = 74\text{LS}00$
- $\text{IC}_2 = 74\text{LS}393$
- $\text{IC}_3, \text{IC}_4, \text{IC}_5 = 74\text{LS}390$
- $\text{IC}_6 = 7805$

Miscellaneous:

- $X_1 = \text{quartz crystal; } 16 \text{ MHz}$
- $F_1 = \text{miniature fuse; } 100 \text{ mA; delayed action; with carrier}$
- $\text{TR}_1 = \text{mains transformer; secondary } 9 \text{ V; } 150 \text{ mA}$
- $S_1 = \text{DPST mains switch LCD quartz digital watch PCB 85092}$

ence at the inputs of the detector is shown in Figure 8. The circled cross indicates an operating point where the frequency of the signal at pin 5 of N_4 is a little lower than that at pin 4. This means that the phase difference between the two signals becomes larger, and this causes the operating point to slowly move towards the x-axis. This does not mean more stable operation, however! When the operating point has reached the turn-over point at 180° , the control voltage to the VCO begins to rise. This causes the VCO frequency, and consequently that at pin 5 of N_4 , to increase. The widening phase difference is then slowed down until an equilibrium is reached, and this happens when the frequencies at pin 4 and pin 5 of N_4 are equal. The phase-locked loop is then operating correctly.

If the output frequency of the VCO drops a little due to a temperature variation, the phase difference widens again. The control voltage increases, and the VCO output frequency rises to its correct value. Figure 7 shows that the maximum possible frequency correction is $\pm 1000 \text{ Hz}$. After division by 500 000, this becomes $\pm 0.002 \text{ Hz}$, which means that it takes the VCO a maximum of $1/0.002 = 500 \text{ s}$ to correct itself.

Circuit details

The 32 Hz signal from the watch is fed to the phase detector, consisting of gates N_3 and N_4 , via MOSFET amplifier T_1 . The error signal from the detector is applied to the voltage-controlled oscillator, com-

posed of MOSFET T_2 and gates N_1 and N_2 , via low-pass filter R_5, R_6, C_2 . MOSFET T_2 functions as a varactor, so that the oscillator frequency varies with the control voltage as mentioned. The output of the VCO is divided by 16 in IC_{2a} , and by 16×10^6 in the chain $\text{IC}_{3a} \dots \text{IC}_{7b}$. The power supply is of conventional configuration: transformer, rectifier, smoothing capacitor, and voltage regulator. If desired, the battery in the watch may be replaced by a direct supply via stabilizing diodes D_2 and D_3 .

Construction and calibration

The frequency standard has been designed for construction on the printed-circuit board in Figure 3. Voltage regulator IC_6 does not need a heat sink. Once the board has been completed, connect the negative supply (earth) line to the watch. If the watch battery is replaced by a direct power supply, the +5 V line should now also be connected via R_{11} and D_1 . The trickiest part is to solder (with a very fine soldering tip!) a length of wire to the track of the PCB in the watch at which the back plate signal is present. This is normally at the top left (seen from the front of the board) of the LCD display. It is necessary to use an oscilloscope to determine which track carries the back plate signal. This signal has either a single- or double-step rectangular waveform with a period of $1/32 \text{ s}$ as shown in Figure 4. The watch should be set for seconds display, which makes it easier to distinguish between the constant back plate signal

4

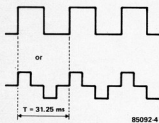

5

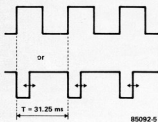

and the varying segment signal. Once the watch is connected to the main board, the signal at the junction of R_2 and R_3 should be as illustrated in Figure 5. Connect an analogue voltmeter, set to the 3 V DC range, to the junction of R_4 and R_5 . This instrument should have an input impedance of not less than $20 \text{ k}\Omega/\text{V}$. When the standard is switched on, the pointer of the voltmeter will move to and fro at a speed which is dependent on the setting of capacitor C_4 . Wait till it indicates 1.2 V or 1.8 V, depending on whether the waveform at junction R_2 - R_3 is symmetrical or asymmetrical respectively — see Figure 5. Once this situation has been reached, quickly adjust C_4 until the meter reading is constant or changes only very slowly, i.e., less than 0.1 V per 10 seconds. The phase-locked loop is then calibrated. It may happen that the voltmeter indicates 0 V or 2.5 V after a few minutes and then returns to 1.2 V or 1.8 V, as the case may be, after which it remains stable. This is perfectly normal as explained under *phase detector*.

Application

Both the 1 Hz and 1 MHz outputs are, in the first instance, intended for the calibration of a frequency counter or similar instrument: it has, for example, been used to calibrate the μP -controlled frequency meter featured in the February 1985 issue of *Elektor India*.

The 1 Hz signal may, of course, also be used as the clock for time pieces, which then hardly ever need to be adjusted. ■

6

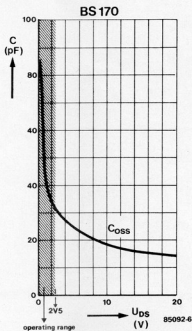

Figure 4. Back plate signal in a digital watch.

Figure 5. Signal at the junction of R_2 and R_3 .

Figure 6. Capacitance vs drain-source voltage in a BS170.

7

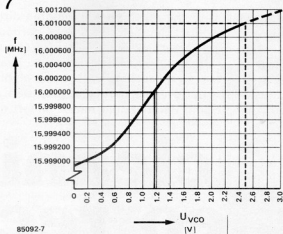

Figure 7. Frequency vs control voltage characteristic.

8

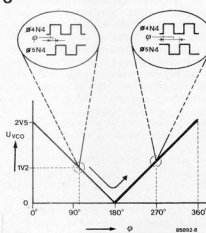
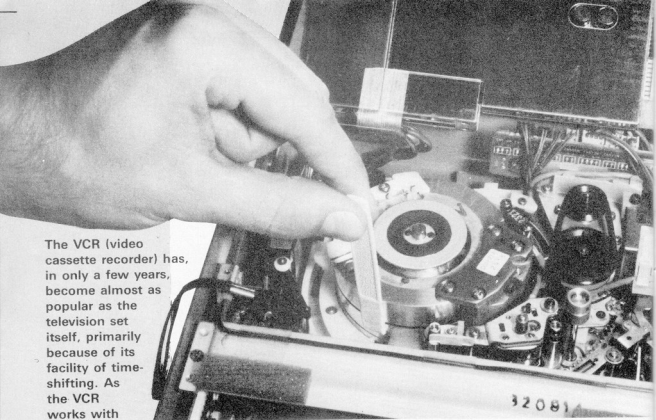

Figure 8. Control voltage vs phase difference characteristic.



The VCR (video cassette recorder) has, in only a few years, become almost as popular as the television set itself, primarily because of its facility of time-shifting. As the VCR works with magnetic

tape, the mechanism of the machine will become dirty after a time, in the same way as in a sound cassette recorder. Regular cleaning of particularly the recording and playback heads is, therefore, essential to ensure optimum picture and sound quality, and to minimize wear of these heads. Unfortunately, the heads are very sensitive precision parts, which do not stand up to a brushing with some alcohol. And there are other aspects of the VCR mechanism that require particular attention. This article aims at explaining what you can do yourself, and what should better be left to properly trained service engineers.

cleaning video recorders

H. Baggen

Although much has been written about the cleaning of a video recorder, there is little that makes the operation clear in a practical way. Cleaning tapes as well as complete cleaning outfits for VCRs have come onto the market over the past few years, but most appear to be almost completely ineffective.

Distributors, importers, and manufacturers alike are generally of the opinion that VCRs should only be cleaned in their service department. No doubt, this feeling is based on the assumption that the owner of the recorder knows little or nothing of electronic and mechanical engineering. Yet, with some technical insight, dexterity, and care, it is possible to clean your own VCR and save the not inconsiderable charge made by professional service departments for this operation. But care is the word, because video heads are very

easily damaged, and replacing them is, of course, a great deal more expensive than having them cleaned!

Where does the dirt come from?

Dirt in the video recorder is an accumulation of dust and microscopically small particles of iron oxide and base material. The iron oxide is the magnetizable basic substance used for coating the base, which, incidentally, gives the finished tape its brown colour. The base material is most likely to be polyester (more correctly polyethylene terephthalate — called mylar in the USA), but may also be polyvinylchloride (PVC), or cellulose acetate. Base particles form the largest proportion of the accumulated dirt. This is because the tape follows quite an intricate path in the machine, running along a variety of

guide rollers and pinch rollers, as well as the capstan and the recording, playback, and erase heads. Although the keying (firmness of adhesion of the coating to the base) and the abrasion resistance of modern tapes are very good, minute particles are worn off over a period of time and left in the machine. Therefore, the better the tape quality, the less frequent there is a need for cleaning the heads. Dust on the tapes (which is left behind in the machine) can be minimized by storing the tapes in closed boxes. The recorder itself should also be placed in as dust-free a position as possible. Note that the television receiver because of the strong static field around the picture tube is a dust trap.

When is cleaning necessary?

Even if the VCR stands in a dust-free position and high-quality tapes are used, there comes a time when the machine — and not just the heads — needs cleaning. Fortunately, the heads tend to keep themselves cleaner than other parts of the guidance because of their relatively high rotational speed. Cleaning of the VCR becomes necessary when the picture becomes "snowy" (as if a poor signal had been recorded), or the sound quality deteriorates (in which case the video heads need not be attended to).

How to clean

Before cleaning is contemplated, several important aspects of the operation should be noted.

- The video heads are extremely vulnerable; one false move or treatment can destroy them. And replacement costs are high!
- Use correct materials: no cotton buds; no cleaning spirit; no so-called cleaning tapes; no spray cans with head cleaner. The video heads should be cleaned with head cleaning sticks with a chamois leather tip, and other parts of the guidance with the same type of stick or non-fluffy tipped sticks or cloths. These sticks or cloths should be soaked in pure alcohol or cleaning spirit, which are available from good video dealers or chemists. Wearing of rubber gloves is recommended, because skin grease and perspiration contain acids which may affect certain guidance parts.
- If you have any hesitation about cleaning the VCR yourself, have the work done by an authorized dealer. Before cleaning can be commenced, it is essential to know the location of the various parts of the guidance system. The three current systems, VHS, Betamax, and V2000 are shown in figures 2, 3, and 4, which clearly indicate the position of the various heads and other parts. The V2000 system is either of the M-loading (= Philips), or the U-loading (= Grundig) type, as shown in figures 4a and 4b

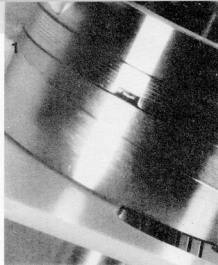

special feature

Figure 1. Everything revolves around this: the picture scanning drum with the video heads. The thin line in the hole of the drum is the video head, which rotates at 1500 rev/min.

respectively. When there is no tape in the machine, guide rollers may be in a slightly different position from those shown in the figures.

First, remove the mains lead from the mains, and any cassette from the machine. Stand the recorder in a well-lit position and remove the top cover. In some older top-loading machines, it may be necessary to first remove the cassette compartment as detailed in the relevant service notes or manual. After the top cover has been



removed, it is normally quite clear what else needs to be undone to gain free access to the guidance.

The following parts can then be cleaned with a chamois leather tipped stick or cloth soaked in alcohol or cleaning spirit: all normal (i.e., not video) heads, the capstan, all guide rollers, and pinch rollers (the material of which these latter rollers are made may, however, be affected by alcohol or cleaning spirit, so make sure that this is not the case before cleaning the rollers).

Next, carefully clean the outside of the picture scanning drum with a chamois-leather tipped stick. **Never touch this drum with bare hands!** Pay particular attention to the slant track at the underside of the drum, and to persistent dirt particles on the surface of the drum. **Take**

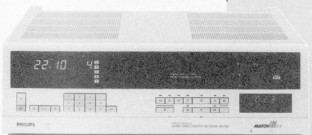

2

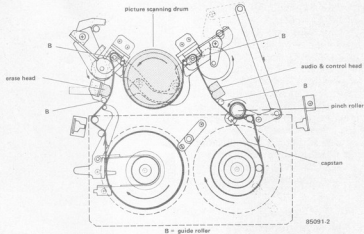

Figure 2. The guidance system of a JVC VHS recorder; that in other VHS machines is virtually identical. (Courtesy: JVC)

Figure 3. The guidance system in a Betamax video recorder. (Courtesy: Sony)

3

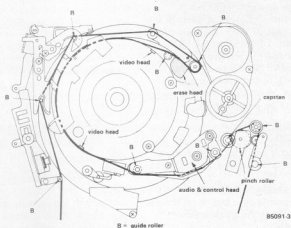
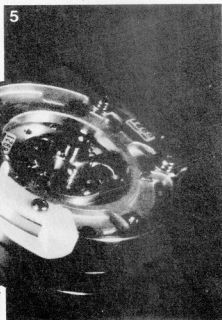

Figure 5. This photograph of a Betamax picture scanning drum shows in the centre of the drum the gap in which the heads revolve; in V2000 and VHS machines the entire upper half of the drum rotates. At the bottom is the slant track which ensures correct guidance of the tape along the drum.

5



great care not to touch the video heads! Take a clean chamois-leather tipped stick, soak this in alcohol, and, as shown in Figure 6, press it lightly against the gap at the circumference of the drum in which the heads rotate. Hold the stick steady, and turn each of the heads a few times by hand (rubber glove!). Often this can be done by turning the spindle of the drum at the top; this is, however, not possible with the V2000 system, because the top of the drum contains some sliding contacts and a contact bridge. **Do not, under any circumstances, loosen this bridge during cleaning!** In this type of recorder, therefore, carefully turn the top of the drum by hand (rubber gloves!). Do not touch the heads and do not move the stick vertically! One false move here could cause the head to snap off. Take care not to displace any guidance parts during the cleaning. For instance, do not attempt to move the tape-slack take up mechanism. In short, only do what is strictly necessary and then put the covers on again.

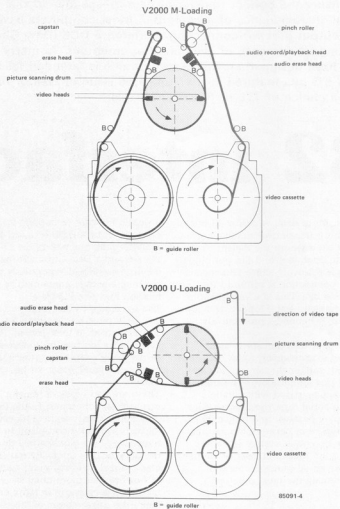

Figure 4. The guidance system in a V2000 M-loading (Philips) recorder (a), and that in a U-loading (Grundig) machine (b).

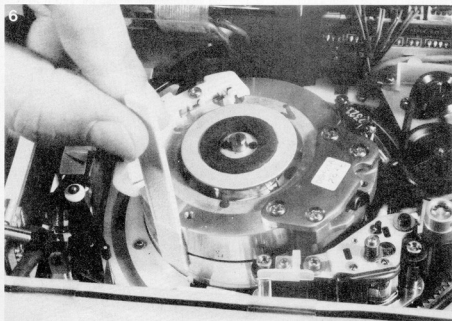

Figure 6. The critical moment: the chamois-leather tipped stick is pressed gently against the drum, after which the heads are moved by turning the disc protruding at the top of the drum by (rubber gloved) hand.

J Steeman

The name RS232 represents a number of standard conventions that aim to ensure the correct transfer of data irrespective of the individual characteristics of a computer. Most computers have a serial input & output port for connecting a printer, a DCE (Data Circuit Terminating Equipment), or even another computer. To marry the two, we have designed an RS232 card, which is intended for the universal I/O bus featured in the June 1985 issue of *Elektor India*. There is a choice of TTL or RS232 line levels.

RS232 interface

serial transfer
via the universal
I/O bus

Parallel transfer of data, whereby all bits of a character are transferred simultaneously, is normally used where the distance between the computer and the peripheral equipment is relatively short. This means that a wire connection is required for each of these bits. This is a very reliable method of transfer, but if longer distances are involved, it becomes prohibitively expensive.

Another form of data transfer is used where other than relatively short distances are involved: serial, whereby all data are transferred in sequence over one transmission line. Compared with parallel transfer, the serial form requires a rather more complex receiver and transmitter, but the connection between the various parts of the computer system remains simple. And, of course, in case of wireless data transfer, serial transmission and reception remain the most practical method.

RS232 protocol

Transfer of data between a computer and

a public network or in-plant installation is carried out by a Data Terminal Equipment <DTE> which is part of the computer system and a Data Circuit Terminating Equipment <DCE> popularly called a modem, which is connected to a transmission line. See Figure 1.

The exchange of data between the DTE and DCE must be governed by clear agreements as to their format. For instance, as the bits are transmitted sequentially, their timing and that of the complete characters must be accurately known.

There are two types of transfer: synchronous and asynchronous. In the former, a continuous data stream is transmitted, and the receiver is synchronized to the transmitter by a clock signal derived from the data, or by a specially transmitted clock signal. Asynchronous transmission is, however, far more commonly met. This method has its origin in telex engineering. Since the drive motors of the transmit and receive terminals could not be synchronized precisely over long periods, each group of data bits was preceded by a start bit and closed by a stop bit. This type of



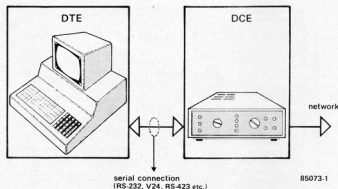

Figure 1. Generally, an RS232 or a V24 connection is used for communication between a DTE (Data Terminal Equipment) and a DCE (Data Circuit Terminating Equipment).

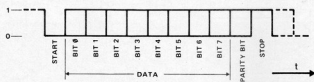

Figure 2. General shape of a serial data word, here preceded by a start bit and followed by a parity bit and optional stop bit.

synchronization is perfectly satisfactory for the relatively short duration of the data word.

An example of such a serial signal is shown in Figure 2. First is the start bit, followed by eight data bits (for instance, an ASCII character), a parity bit for error control, and finally the stop bit. The stop bit enables checking whether the transmission and reception speeds are the same.

The correct processing of the data stream exchanged between the DTE and DCE is based on a protocol, i.e., a set of conventions or regulations. The two most common, official protocols are the RS232 and the V24.

Apart from the data, there is a number of signals for the individual control of the DTE and the DCE. All these and the relevant connection to a standard D-type connector are shown in Figure 3.

DTR, DSR, and DCD are typical signals used for the establishing and terminating of a communication. The remaining signals are used, as required, during the exchange.

Assuming the communication is full duplex, i.e., both the TxD and RxD lines are in use, the DTE activates the DTR line to indicate a request for communication. The modem responds to this by activating the DSR line. If the DTE is to transmit, it activates the RTS line. The DCE acknowledges that it can process the data by activating the CTS line. Note that in full duplex operation the DTE can also receive at all times, provided that the modem has activated the DCD line. This takes place during the establishment of the communication. See also *data communication by telephone and direct-*

coupled modem in the September and October 1984 issues of *elektor electronics* respectively. The "secondary" connections are relevant to the main channel — back channel separation in modems. Translating all these actions to a ready-to-use serial connection to a computer is effected by an intelligent peripheral chip: asynchronous communications interface adapter (ACIA) Type 6551. This device is simply accommodated in the microprocessor system to provide complete RS232 and V24 compatible communication with the outside world.

Interface circuit

As may be seen from Figure 4, the ACIA does not need much more than a crystal and a number of gates for signal level matching to carry out its task. To the left of it are shown the usual connections to the computer system; here, the slot connections of the I/O bus.

The 1843.2 kHz crystal connected to pins 6 and 7 is used to provide a number of baud-rates, which are selected by the software. The RxC pin (5) is a bidirectional input and output respectively for an external clock to provide non-standard baud-rates, and for outputting the internal baud-rate generator. In either case, the clock frequency amounts to sixteen times the baud-rate.

To the right of IC₁ are the familiar RS232 lines with buffered inputs and outputs. Seen from the IC, all signals are inverted, which means that all control signals: DTR, RTS, CTS, DCD, and DSR are active high, whereas data signals TxD and RxD are active low. These levels are standard for

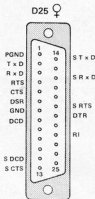

PGND protective ground
T x D transmit data
R x D receive data
RTS request to send
CTS clear to send
DSR data-set ready
GND ground
DCD data carrier detect
DTR data-terminal ready

S DCD secondary data carrier detect
S CTS secondary clear to send
S T x D secondary transmitted data
S R x D secondary received data
S RTS secondary request to send
RI ring indicator

Figure 3. Standardized RS232 connections to a 25-way D-type connector. The "secondary" connections and the RI connection are only used at the DCE side.

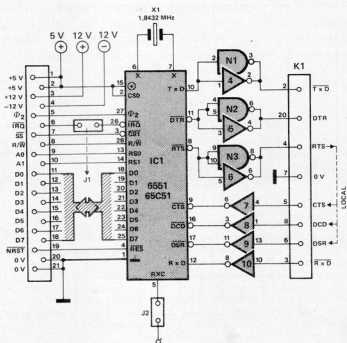

N1...N3 = $\frac{1}{2}$ IC2 = 75188; 1488
 N4...N6 = $\frac{1}{2}$ IC3 = 74LS04
 N7...N10 = IC4 = 75189; 1489

85073-4

Figure 4. Circuit diagram of the RS232 card. Links J₁ and J₂ are optional. Either RS232 drivers N₁...N₃ or TTL drivers N₄...N₆ are used.

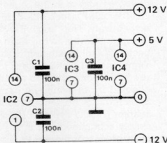

RS232 connections. There are two possible, corresponding voltage levels: TTL, i.e., high = +5 V; low = 0 V, and RS232, i.e., high = +3...+25 V (nominally 12 V) and low = -3...-25 V (nominally -12 V). It is intended that one of the groups of parallel-connected ports is selected: N₁...N₃ provide RS232 levels, and N₄...N₆ TTL levels. The receive buffers are suitable for both TTL and RS232 levels. It is, therefore, necessary to check with which levels the system to be connected operates. The printed-circuit board in Figure 5 shows both IC₂ and IC₃, which are required for TTL or RS232 levels respectively. The ± 12 V supply is not needed in TTL operation.

Operation

As stated, the circuit is based on a Type 6551 ACIA, a block diagram of which is given in Figure 6. Communication at the DTE end is effected by five registers, four of which are detailed in Figure 7. Since the inputs are connected to address lines A₀ and A₁, the registers are located

sequentially in the address range of the I/O bus. If, for instance, the interface card is placed in slot 1 of the universal I/O bus, and the start address of the I/O range is set to 4000_{hex}, the Transmit and Receive Data Registers are at 4000_{hex}, the Status Register at 4001_{hex}, the Command register at 4002_{hex}, and the Control Register at 4003_{hex}.

Transmit and Receive Data Registers

During transmission, bit 0 (LSB) is sent first. The bits not used, for instance, 5...7 where a 5-bit format has been chosen, are treated as "don't care". In the receive mode, the first received bit goes to location 0 and subsequent bits to 1, 2, and so on. The highest, not used, locations are given a 0.

Status Register

This register can only be read. Bits 0, 1, and 2 indicate respectively whether during reception errors in parity, framing, or overrun occurred. The more important bits

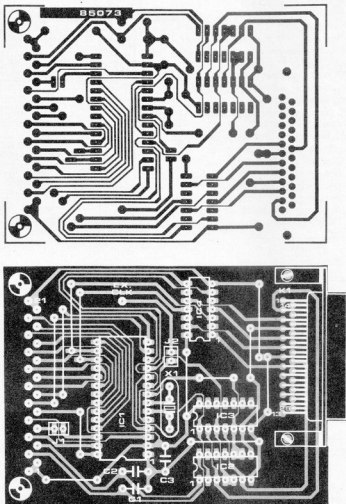

Parts list

Capacitors:

$C_1 \dots C_3 = 100 \text{ n}$

Semiconductors:

IC₁ = 6551; 65C51

IC₂ = 75188; 1488

IC₃ = 74LS04

IC₄ = 75189; 1489

Miscellaneous:

X₁ = crystal, 1843.2 kHz

K₁ = 25-way D-type subminiature connector; right-angled; female

21-way right-angled connector; male;

to DIN41617

two 2-pin pcb type terminal block

Figure 5. The printed-circuit board of the RS232 card with at one side the connector that slots into the universal I/O bus, and at the other side the standard D-type RS232 connector.

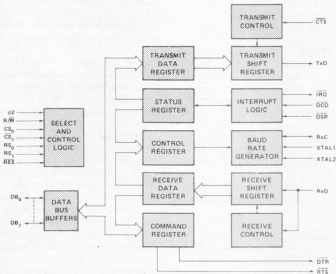

Figure 6. Block diagram of ACIA Type 6551.

design ideas

The subject of "speech and computers" has been discussed in these pages on several occasions, the last one being in the April 1985 issue. The accent then was mainly on the speech processing aspect, which is technically easier than voice recognition. It is, therefore, fascinating for all those interested in this subject that General Instrument now have available two chips — the SP1000 and the VSR1000 — that, in combination, tackle the problems of both speech processing and voice recognition. The SP1000 is a voice recognition and synthesis IC, and the VRS1000 is an 8-bit microprocessor to control the SP1000. The combination of the two chips provides the designer with complex, ready-to-use recognition and synthesis algorithms. Typical applications include robotics, aids for the handicapped, security devices, and voice-dial telephones.

coefficients as well as relevant information as to audio signal amplitude: all this information is then stored on board the SP1000 and sent to the microprocessor every 20 ms. Each spoken word is divided by the SP1000 into twelve frames, for each of which a time-weighted average of the coefficient is calculated and stored. This means that for each word a storage requirement of 108 bytes is required. A single word should last no more than 2 seconds, and the space between two words should be not less than 200 ms. In this context, it is important that the audio signal level is matched to the input of the analogue-to-digital converter, so that the latter works under optimum conditions. To this end, the SP1000 has three "gain" outputs, which are fed to an external analogue gain control. The LPC coefficients calculated by the VRS1000 are converted by the

from the text provided by the host computer; during voice recognition, it compares the LPC coefficients provided by the SP1000 with the stored vocabulary. The VRS1000 can recognize twenty words simultaneously.

Other functions of the VRS1000 are: retraining of the vocabulary; creating vocabulary subsets; storing templates on disc; and rejecting a word that is found not to be a member of the recognition vocabulary.

Accuracy of voice recognition is claimed to be better than ninety-eight per cent according to the Doddington-Schalk standard test. The search time, i.e., the time required to recognize or reject a word, depends on the size of the vocabulary: as a guide, 45 ms per word. It seems, therefore, sensible to sub-divide a vocabulary of, say, 100 words into five subsets of 20 words each; the search time will then always be less than 1 second. It should be borne in mind that the recognition accuracy is bound to suffer

voice recognition & speech processing

The nucleus of the SP1000 is a lattice filter that can be programmed for synthesis and recognition modes. In the synthesis mode, the VRS1000 feeds the filter speech data it has computed: these data control the filter characteristics. In the recognition mode, the filter extracts from an incoming audio signal the LPC (linear predictive coding) information required for the digital speech processing.

To this end, the audio signal is scanned every 160 μ s by an 8-bit analogue-to-digital converter; the resulting eight bits are fed to the SP1000, as shown in Figure 1. The filter extracts eight significant audio

filter in the SP1000 into a digitally speech-modulated signal. Only a low-pass filter and a power amplifier are then required at the output to complete the synthesis process. The VRS1000 is functionally equivalent and pin-by-pin compatible with the General Instrument Type PIC7040, which is a licensed, second-source of the Texas Type TMS7040. These ICs are 8-bit microprocessors with internal 4 K ROM. This ROM contains the entire program for the control of the SP1000.

During speech processing, the VRS1000 deals with the computation of the LPC coefficients extracted

filter with large vocabularies, since the likelihood of similar sounding words is then greater.

An advantage of the system is that a vocabulary has to be learnt: it is specific to a speaker, but can, none the less, be modified at any time. Furthermore, a number of speakers may enter their own specific vocabulary.

Since articulation, depth of voice, and speed of speech even in the same word spoken by the same speaker vary from time to time, it is possible to enter a word up to 255 times, and store the average. This, of course, results in very high recognition accuracy.

Characteristics — recognition mode

- direct access to a 20-word vocabulary
- 6.25 kHz sampling; 8 bits per sample
- extraction of 8 LPC and 1 amplitude coefficient
- maximum word duration 2 seconds
- minimum pause between words of 200 ms
- correction of temporary deviations in each of the twelve frames of a word
- storage of 108 bytes per word
- search time 45 ms per word
- recognition accuracy 98 per cent
- programmable rejection threshold
- selectable number of training passes during the loading of the vocabulary

Characteristics — processing mode

- 10 kHz sampling rate
- variable frame rate
- synthesis of 10 LPC coefficients
- synthesis of sound effects and music
- real-time interpolation of energy, pitch, and filter coefficients

Communication with the host computer is kept simple by the use of the ASCII code, so that it will normally not be a problem for individual control programs to be used. ■

Literature:
SP1000: preliminary information
Application note AN-0504
 General Instrument
 Times House
 Ruislip HA4 8LE
 Telephone: (089 56) 33355

General Instrument Corporation
 International:
 600 West John Street
 Hicksville
 New York 11802
 Telephone: 516-733-3107

design ideas

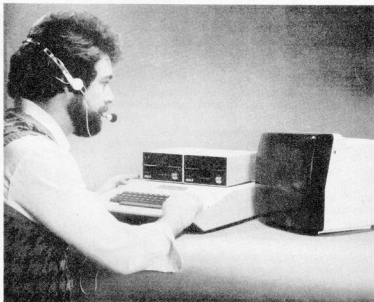
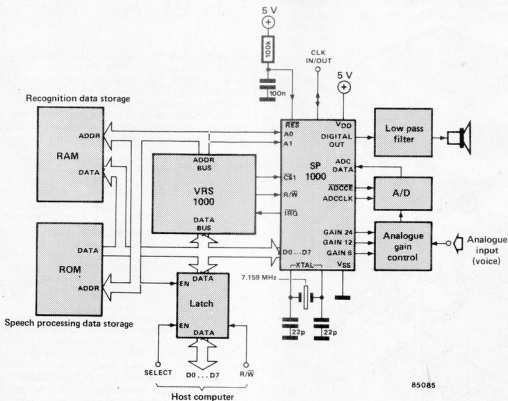

Figure 1. The functional diagram of the SP1000/VRS1000 combination shows that only a few peripheral devices are required to design a complete voice recognition & speech processing unit for use with a microcomputer.

1



Moving Coil Meters.

A moving coil meter basically consists of a coil through which the test current flows, and a modified horse shoe magnet.

The current flowing through the coil produces a magnetic field. As the coil is pivoted between the two faces of the permanent magnet, (modified horse shoe) it tries to realign itself by rotating about its own axis.

Figure 1 shows a most commonly used design of the meter movement. In order to keep a uniform and minimum air gap, the coil is wound around a cylindrical piece of magnetic material. The test current is supplied to the coil through spiral springs, which also serve to return the moving coil to its original position as soon as the current flowing through it becomes zero. All the forces acting on the moving coil are balanced in such a way that the deflection of the coil is proportional to the current flowing through it.

To indicate this deflection of the moving coil, an indicator is directly connected to the coil and indicates the deflection on the scale. A damping paddle is sometimes connected to the moving coil to prevent sudden movement of the coil and indicator. This paddle moves in a damping chamber, which appears at the bottom of the illustration of figure 1.

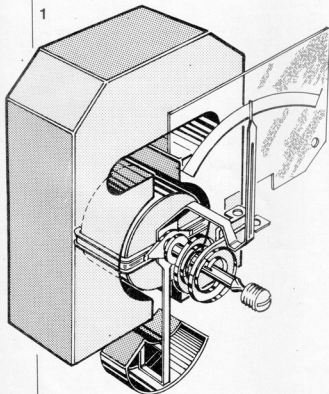

Figure 2 shows the schematic diagram and lines of the magnetic field.

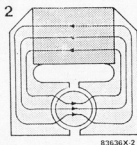

Figure 3 shows the symbol of the circuit element "Moving coil meter". The moving coil instruments are so sensitive, they can be seldom used alone. A sensitive meter movement needs just 25 μ A current for full scale deflection of the indicator. For most of the applications, these meter movements must be supplemented by resistances.

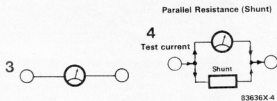
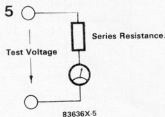

Figure 4 shows the function of the parallel resistance (shunt): It bypasses a part of the test current away from the measuring instrument and thus protects it from overload. The amount of current passing through the shunt depends on its value. The remaining current passing through the movement decides the amount of deflection of the indicator. The meter scale must be accordingly marked to read the test current.

Series Resistance



Voltage measurement with a moving coil meter is possible only with an additional series resistance. When a resistance is connected across a voltage source, the current flowing through it is governed by the Ohms law. Since we have introduced a fixed resistance in series with the test voltage and meter movement, the current varies with the voltage. This produces a deflection of the meter movement proportional to the test voltage. The measuring instrument in figure 5 measures the current flowing through the moving coil, but the scale can be marked in Volts!

Resistors

"... You know a lot about pocket radios, isn't it?"

"Well yes, what do you want to know?"

"This afternoon I had taken apart the old pocket radio. From that I have brought along a few parts, look here!"

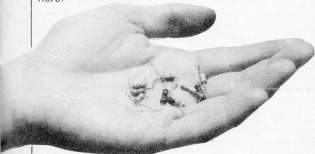

And now you certainly want to know what it is?"

"Right!"

"These things with the coloured bands are resistors. These resistors work as brakes for the current. As the material of which these are made is a poor conductor, the current cannot flow through these resistors without obstacles".

"You mean they resist the flow of current?"

"Yes, but rather it is Voltage that they resist when it tries to drive current through the resistors. When a voltage is applied across a resistor — a specific current flows, not more, nor less. The current depends upon the level of resistance offered by the resistor."

"So all these resistors allow the same current to pass through?"

"How do you say that?"

"Because they are all of equal size"

"No, it has no relation to the size. By level of resistance I mean the braking power of the resistor, if we imagine a resistor as a brake applied against the current. A resistor has resistance, and how much resistance a resistor can offer is expressed in Ohms, Ohm is the unit of resistance. Do you understand now?"

"That was a little too much resistance for me! If I understand you correctly, this is similar to the word "conductor". Cables, Wires and stranded wires are called conductors. That is because they "Conduct" the current."

"Quite right. These resistors are also conductors, but poor ones. The poorer they are in conducting current, the better they are as resistors and higher is the Ohms value."

"Why is the resistance value not expressed in Amperes?"

"Why should this be done?"

"Because each resistor allows only a specific current to pass through and current is measured in Amperes".

"No, the current is not dependant on the resistance value alone, it also depends on the voltage across the resistor."

The resistor brakes the current by offering resistance to the voltage. The higher the voltage, the lesser is the effect of resistance and the more is the current which is allowed to flow through the resistor. Let us take an example of a car on a downhill road. The driver must apply the brakes, otherwise the car would run faster and faster and come off the road. The speed of car depends on how hard is the braking. The same thing is true about the current. The higher the resistance, the lower is the current.

As the slope of the road is important to decide the speed of the car, level of voltage is important to decide the flow of current through a resistor. A high voltage level is like a steep road and a higher resistance level is like braking harder."

Current Paths

In our June '85 issue, we had seen that current can flow only in a circle (a circuit) and that it can no longer flow through this path if it is interrupted at any position.

What happens when more than one path are available for the current to flow?

We can see what happens, with a small experiment. For this we need the following:

- 2 Flat batteries of 4.5 V each
- 2 Resistors of 220Ω 1/8 Watt
- 2 LEDs

All these components can be obtained from any electronics component shop.

First, connect the circuit as shown in figure 1. A battery, a resistance and two LEDs are connected in the circuit. The LEDs glow when current flows through them.

The brightness of glow depends on the level of current flowing through them. The series resistance serves only to limit the current flow in the circuit so that LEDs are not damaged due to excessive current. The components can be connected by twisting the leads together. Polarity of LEDs must be observed correctly. The shorter lead of the LEDs is the cathode (minus pole).

1

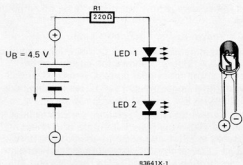

53641X.1

When the circuit is connected, a current flows through it as shown in figure 2. Both LEDs glow with equal brightness because the same level of current flows through both.

Now with the remaining components, the circuit is connected as shown in figure 3. Will the second battery also drive current through the LEDs? and if so, through which path will it flow? Observe the circuit properly and it will give us the answer. LED 3 also glows, and this means that the second battery is also driving current through the circuit. To complete the circuit the current which flows through LED3 must also flow through LED2, which is confirmed by the fact that LED2 glows more brightly than LED1 or LED3.

Figure 1.
The two LEDs light up, showing the presence of current in the circuit

Figure 2.
The current path in the simple circuit.

Figure 3.
A second circuit is added, LED 2 is included in both the circuits.

Figure 4.
Currents of both the circuits flow through LED 2.

2

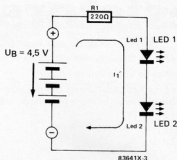

3

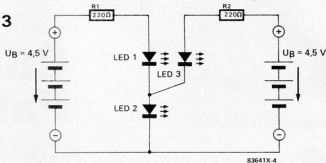

4

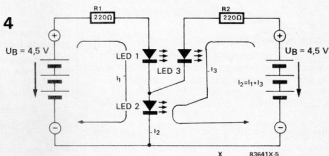

As a double check, disconnect the circuit at point x in figure 4. This extinguishes LED3 and LED2 glows less brightly than before. This also proves our observation that both the batteries drive current through the circuit paths available to them, independently of each other. They take up exactly the same current at the minus pole which they discharge or drive out through the plus pole. Both the currents find the correct paths back to the voltage sources from which they emerge.

This fact was established by the scientist Gustav Robert Kirchhoff (1824-1887) who proposed the theorem that all the currents which flow into a nodal point, must always flow out of the same nodal point again.

This is known as the Kirchhoff's Law.

Let us examine the two nodal points in our circuit of figure 3 & 4. Figure 5 shows the current paths meeting at the first nodal point. Currents I1 and I3 flow into this node and current I2 leaves this node. This gives us the relation $I_2 = I_1 + I_3$.

Based on this theoretical relation, we can explain the fact that LED2 must glow with more brightness compared to LED1 and LED3 as the current flowing through LED2 is the sum of two individual currents flowing through LED1 and LED3 respectively.

Although the terms "theorem", "nodal point" etc. sound theoretical, we can see the practical importance of the Kirchhoff's Law in studying various current paths in a circuit. A complex circuit can be understood easily when individual current paths are studied.

5

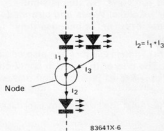

Figure 5.
The node between LED 1, and 2 and LED 3. Currents I1 and I3 flow into the node and current I2 flows out of the node.

The Ohm's Law

"Resistors" as we have just seen, are the brakes for the current. In fact these resistors can be also thought of as the intermediate levels between good conductors (like copper wires) and non-conductors (insulators like glass, ceramics, plastics etc.) These intermediate levels are of great importance to the Electronics Engineer, since he can control currents and voltages with their help. We already know - "When a voltage is applied across a resistor, a specific current flows, not more, not less. The current depends upon the level of resistance offered by the resistor."

Greg Simom Ohm (1787 to 1854), the discoverer of this interrelation, formulated from this the law which was later named after him as Ohm's Law:

The voltage (U) across a resistor is equal to the product of the resistance value (R) and the current (I) flowing through the resistor.

$$U = R \cdot I$$

Which is also stated as

$$E = R \cdot I$$

This was once called the "Basic law of Electrical Engineering". Without going into the theoretical background the significance and utility of the Ohm's law can be seen with the help of a few examples.

Figure 1 shows a 4.5 V battery connected across a 100 Ohms resistor. As the circuit is complete, the current flows through the resistor. By substituting the values of voltage and resistance into the Ohm's formula, the unknown current can be calculated as follows:

$$4.5 \text{ V} = I \times 100\Omega$$

$$\text{or } I = \frac{4.5 \text{ V}}{100\Omega} = 0.045 \text{ A} = 45 \text{ mA}$$

A milliampere (mA) is one thousandth of an Ampere. We can practically confirm this result by measuring the current on a multimeter in the 100 mA DC range.

This small experiment makes clear, how a resistor can set the current in a circuit for a given voltage value. Another interesting detail can be studied from a similar experiment by adding one more 1.5 V cell to the circuit in series with the 4.5 V which is already there. Now the voltage increases to 6 V and the Ohm's Law tells us that the current flowing in the circuit should be

$$I = \frac{6 \text{ V}}{100\Omega} = 0.06 \text{ A} = 60 \text{ mA}$$

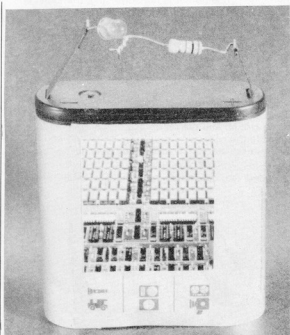
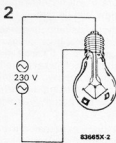
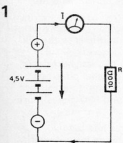

This result can again be practically confirmed by measuring with a multimeter. The current increases with increase in voltage level, for a fixed value of resistance.

Now try another variation. Increase the resistance value to 120 Ohms by substituting the 100 Ohms resistor by a 120 Ohms resistor. Keep the voltage fixed at 6 volts. The current should now be

$$I = \frac{6 \text{ V}}{120\Omega} = 0.05 \text{ A} = 50 \text{ mA}$$

The current decreases with increase in resistance, for a fixed value of voltage.

Let us once again go back to the example of a car on a downhill road. The steeper the slope, the faster is the speed of the car. The same is true for the circuit the higher the voltage, greater is the current. When the brakes are applied harder, speed of the car goes down. In case of the circuit, increase the resistance and current goes down.

When the voltage in a circuit is fixed, the resistance regulates the flow of current. A 100 W bulb consumes about 0.45 A current, when it is lighted. (see figure 2). The Ohm's law gives the value of resistance.

$$R (\text{Bulb}) = \frac{230 \text{ V}}{0.45 \text{ A}} = 511\Omega$$

Unfortunately this indicates the resistance of the filament in the lighted condition. (When it is hot.) When we switch on the bulb, it is still cold, and the filament resistance at this time is approximately 40 Ohms. This gives us the value of current that passes through the bulb for a moment at the time of switching it on as:

$$I = \frac{230 \text{ V}}{40\Omega} = 5.75 \text{ A}$$

This is more than 10 times the steady state current in the lighted condition. It is not surprising, that most of the bulbs are lost while switching them on.

Note that in our calculations so far we have not used the original form of the Ohm's law $U = R \cdot I$, but we have used the variations.

$$I = \frac{U}{R} \quad \text{and} \quad R = \frac{U}{I}$$

The original statement of the Ohm's law is used when we know the current flowing through a branch of the circuit, and the resistance in that branch, for example the collector current of a transistor, and the collector resistance. (See figure 3)

The voltage drop across the resistor can be calculated using the original statement of the Ohm's law.

$$U = R \cdot I$$

3

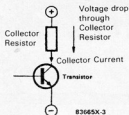

4

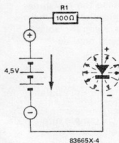
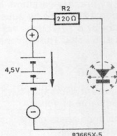

Figure 4. Resistor R1 prevents the current in the circuit from becoming very high. The current is limited to 20 to 30mA.

Figure 5. Increasing the resistance reduces the current, thus reducing the glow of the LED.



5



6

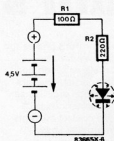

Figure 6. Two resistors in series offer more resistance to the current than a single resistor.

7

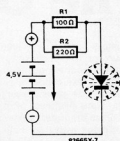

Figure 7. Two resistors in parallel offer less resistance to the current than a single resistor.

Experiments :

Experimenting is better than so much of theory! Let's turn our attention to some interesting experiments based on the Ohm's law. For this we need:

- 1 Flat battery of 4.5 V
- 1 Resistor, 100Ω
- 1 Resistor, 220Ω
- 1 LED

All these will be available in an electronic components shop. Colour of the LED is immaterial for these experiments.

Figure 4 shows the first circuit with the 4.5 V battery, 100Ω resistor and the LED. All connected in series. (Be careful about the LED polarity) The resistor is used for limiting the current through the LED within the allowed limits. In absence of this resistor the full 4.5 V battery voltage will be applied directly across the LED and it will be destroyed as a high current will pass through.

The LED is used in these experiments to give a visual indication of the level of current flowing through the circuit, because the LED glows more brightly when more current flows through it.

Observe the brightness of the glow of the LED in the first experiment and then substitute the 100Ω resistor by a 220Ω resistor. (See figure 5) Now observe the brightness of glow, it is less than that in the first experiment. Naturally so, because with increased resistance, the current has reduced. Connecting both the resistors together in series in the circuit as shown in figure 6 will further reduce the current and the LED glow will be dim.

A further possibility is connecting both the resistors in parallel as shown in figure 7. In this case the LED glows more brightly than all the previous combinations. The result initially appears surprising. However as the two resistors in parallel offer two paths to the current and effectively the total current driven by the battery increases, and LED glows more brightly.

The distinction between the series and parallel connection of resistors must be noted here - a series connection strengthens the effect of resistance, whereas a parallel connection reduces the effect.

Digi-Course

Chapter 5

Gates, Logic Circuits,

The Previous chapters in our Digi-Course series mainly covered the basic gates and the possibilities of processing logical signals.

In this chapter we shall look into circuits based on gates, which allow the signals (logical signals) to pass through or block them, depending upon the circuit conditions. The gates can be said to be some kind of "Logic Switches". The Truth table of an AND gate also shows this feature.

1

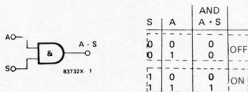

One of the inputs, designated here with S, can be considered to be the control input. With S=1 the AND gate output is same as the input A, where as with S=0 the output is constantly "0". With S=1 the AND gate allows the signal at input A to pass through to the output. With S=0 the gate blocks whatever signal may be at input A. To try this on Digilex-Board, use a NAND gate with an inverter (a NAND gets with one input unconnected).

2

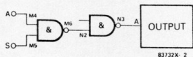

An OR gets also behaves in the same manner.

3

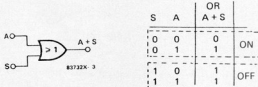

With an OR gate, a 0 on the S input allows the signal at A to pass through to the output, and a 1 on the S input blocks the gate and makes the output constantly "1". This also can be tried on the Digilex-Board, using a NOR and a NAND gate.

4

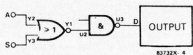

NAND and NOR gates, when individually used in this fashion, also behave as logic switches with inverted outputs.

Changeover Switch

A mechanical change over switch can be constructed from two switches with common actuating lever. Unfortunately this is not possible with the digital switches directly. (See figure 5)

5

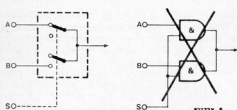

The digital equivalent needs an extra OR gate and Inverter in addition to the two "AND-switches".

6

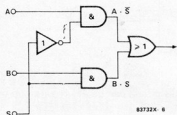

We have seen how an AND gate with a control input S behaves as an ON/OFF switch. Here the control signal S is taken through an inverter to the first AND gate and is directly connected to the second AND gate. This prevents the condition that both the "AND-switches" are ON and OFF at the same time. The outputs of the two AND gates are taken through an OR gate. The truth table of the entire circuit is given below:

Truth Table

A	B	S	A · \bar{S}	B · S	OUTPUT	
0	0	0	0	0	0	A ON
0	1	0	0	0	0	
1	0	0	1	0	1	
1	1	0	1	0	1	B ON
0	0	1	0	0	0	
0	1	1	0	1	1	
1	0	1	0	0	0	
1	1	1	0	1	1	

Unfortunately the circuit of figure 6 cannot be directly wired on the Digilex-Board, which has only NAND and NOR gates. But there is no reason to panic! We already know how to use NAND and NOR gates to simulate the required circuits.

Replacing the AND gates with NAND and Inverter combination, we obtain the circuit shown in figure 7.

7

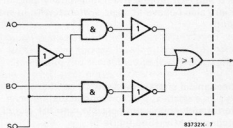

Compare the circuit enclosed in the dotted lines with the AND equivalent, we had derived in chapter 3. A NOR gate was used there instead of the OR in the present circuit. This means that the present circuit is the "NAND" equivalent.

8

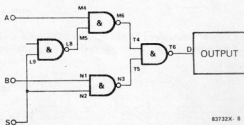

Now this circuit can be easily wired up on our Digilex-Board.

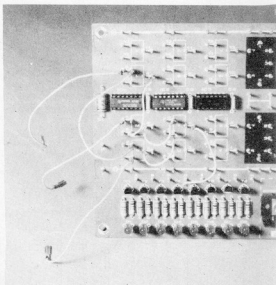

Input A : M4
 Input B : N1
 Control Input S : L9
 N2 — L9
 N3 — T5
 M5 — L8
 M6 — T4
 T6 — D

AND-OR universal gate

Figure 9 illustrates the possibility of application for the logical Changeover Switch, an AND-OR universal gate.

Inputs are named as C and D for the purpose of differentiating the circuit from the previous one.

9

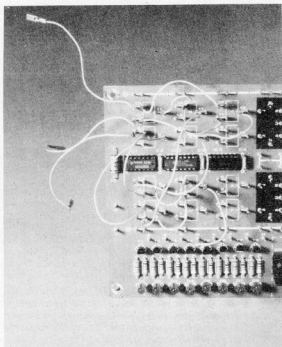
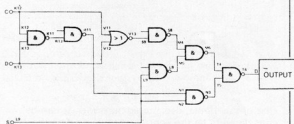

Here we have two NAND-NOR equivalent combinations for the AND and OR functions followed by the circuit of figure 8. Thus we have devised a circuit which behaves as an "OR" gate when there is a "0" on S input. The same circuit behaves as an "AND" gate when there is a "1" on the S input.

The connections on the Digilex-Board are as follows:

Input C : K13
 Input D : K12
 K11 — R13
 R11 — N1 (Input B)
 K13 — V12
 K12 — V11
 V13 — S9
 S8 — M4 (Input A)

The Changeover switch can also be realised as shown in figure 10. We shall not go into the detailed explanation of this circuit. It is left to the reader to prove the equivalence.

10

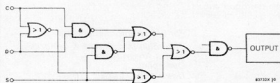

Incidentally, it will be of interest to go back to chapter 3 again, where we had studied a circuit with reversing logic: The EXOR—circuit.

11

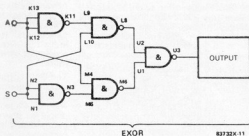

Truth Table

S	A	S⊕A	
0	0	0	Non inverted
0	1	1	
1	0	1	Inverted
1	1	0	

The truth table shows clearly that the signal on input A appears on the output in an inverted form, when there is a "1" on the control input S. In case of a "0" on the control input S, the signal on A appears directly on the output. This is also known as a controlled inverter.

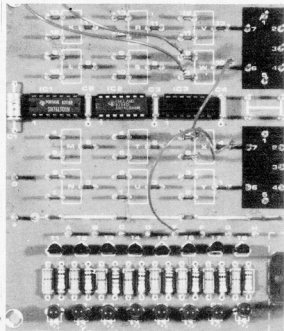

The Digilex-PCB is now available!

The Digilex-PCB is made from best quality Glass-Epoxy laminate and the tracks are bright tin plated, the track side is also soldermasked after plating. Block schematic layout of components and terminals is printed on the component side.

Price:

Rs. 85.00 + Maharashtra Sales Tax.
Delivery charges extra: Rs. 6.00

Send full amount by DD/MO/PO.

Available from:

precious[®]

ELECTRONICS CORPORATION

Chhotani Building, 52-C, Proctor Road,
 Grant Road (East), Bombay 400 007

new products

DIGITAL CLOCK MODULE

ION Electricals offer a digital clock module for OEM applications—like Emergency lights, T.V. Sets, Intercoms, Slide Projectors, Room Coolers etc. The module can be fixed inside the panel with screws.

The module is based on a single PCB measuring just 50 x 77 mm. The display indicates Hours and Minutes, with a flashing dot in between. Bars are provided for AM/PM indications. Alarm output is provided which operates only once in 24 hours.

Power required is an external transformer with 6-0-6 V secondary output. Terminals for providing 9 V DC backup battery are provided.

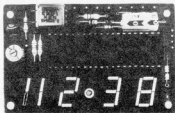

For further information, write to:

ION Electricals,
307 Owner's Industrial Premises
505 Gabriel Road,
Mahim Bombay 400 016

BOX CAPACITORS

Metallised Polyester and Metallised Polypropylene Capacitors in Box configuration are available in wide range to suit the various small Signal Circuits Applications from KEIL. These Capacitors are available in standard pitches of 7.5 mm, 10.0 mm, 15.0 mm, 22.5 mm and 27.5 mm depending on the values. Capacitors with 5.0 mm pitch also can be offered. These Capacitors, are LCSO approved.

KEIL also offers special Metallised Film Capacitors for the purpose of Radio Interference Suppression and Surge Protection, meeting all the safety standards.

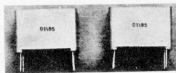

For further information, write to:-

Marketing Division
Kothari Electronics & Industrial Ltd.
'Kothari Building'
114 Nungambakkam High Road
Madras 600 034.

DATA LOGGER

Advani-Oerlikon have developed a Microprocessor-Based Data Logger for efficient supervisory control of process parameters in continuous process industries like steel, cement, petrochemical, fertilizer and power generation.

The Data Logger monitors and records various parameters such as temperature, pressure, density, speed, voltage, weight, force, flow, level, etc., and displays process information at a centralised place. The moment a set parameter is exceeded or a wrong trend is sensed, it gives an audio-visual alarm.

The Data Logger is capable of monitoring special instruments with parallel BCD outputs, transducers with pulse or contact closure outputs or contact or voltage status from alarm points.

The Data Logger has reprogramming and on-line programming facility.

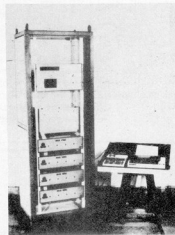

For further information, write to:

Advani-Oerlikon Ltd.
Post Box No. 1546
Bombay 400 001.

HYDROGRAPHIC CHART RECORDER.

The Hydrographic chart recorder operates on the principle of SONAR (SOUND NAVIGATION AND RANGING) and provides complete recording of the bed of water in a river, lake, sea, canal, tank etc. It can also be used for detecting fish shoals or submerged objects under water.

The equipment uses latest IC technology and operates on 12 Volt batteries. It provides an instantaneous reading of the contour of the river bed. 100 mm. wide heat sensitive paper is used for recording.

Six depth ranges can be selected on 0-160 meter selector switch and the depth can be recorded to a typical accuracy of $\pm 1\%$.

The Special controls used include sensitivity control, shallow time control, Noise Reject Gray line controls etc.

The equipment is ideal for Navigation, Depth Measurement, Locating fish, Scour Detection, Bottom profile measurement etc.

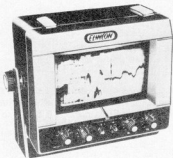

For further information, write to:

Electronic Instruments & Controls
4319 3-Ansari Road,
Daryaganj,
New Delhi 110 002.

SERVO CONTROLLED VOLTAGE STABILIZER

JIVAN Servo Controlled Voltage Stabilizer is a stepless Voltage Stabilizer with output accuracy of $\pm 1\%$ over a wide input range. It has output level control for setting the output voltage between 220 to 240V or 400 to 420V. Facility for manual operation is also provided. High and low voltages are indicated by the neon provided on front panel.

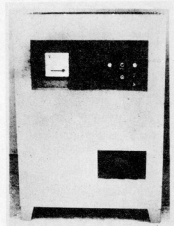

For further information, write to:

Jivan Electro Instruments
394, G.I.D.C.
Makarapura
Baroda 390 010.

SUBMINIATURE SWITCH

Elcom have introduced a subminiature DPDT toggle switch which has snap fitting facility. The switch body is moulded in polyamide. Suitable for both low and high current switching applications, the toggle switch is offered with an option of paddle or rocker lever in various colours. The standard rating is 4A, 250V AC.

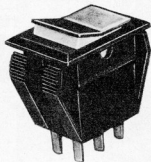

For further information, write to:

Elcom
103, Jaygopal Industrial Estate,
B, Parulekar Marg
Dadar
Bombay 400 028.

SWITCH MODE POWER SUPPLY (SMPS)

Atron Electronic Industries, have developed Switch Mode Power Supplies (SMPS) for Black & White Television Receivers. Atron SMPS units are provided with mains isolation and are available in two models. Model 'A' gives DC established output of 110V and 16V. Mains input voltage variation of 130V to 270VAC are tolerated. SMPS units are superior in performance and are less expensive than series regulated power supply units.

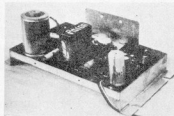

For further information, write to:

Atron Electronic Industries
62A, M.G. Road,
Secunderabad 500 003.

PCB-REPAIR KIT

Ettecks Corporation offer a PCB-repair kit, containing all the materials required for PCB-repair, in one pack.

The kit consists of Ettecks Air-drying Conductive Silver Preparation No. 1228, Paste Thinner 0070, special solder wire, soldering flux, brushes and other miscellaneous materials which are required.

The above materials are packed in a decorative wooden box for the user's convenience.

new products

The above kit is useful for various Industries, where quick, convenient and reliable repairing/servicing is required for Electronic/Electrical Equipment.

For further information, write to:

Ettecks Corporation
C-314, Industrial Estate
Peenya
Bangalore 560 058.

DPM MODULE

Bantron Electronics have introduced a compact 3½ digits DPM Module with 1" bright LED display. This is ideal for instruments with a long viewing range.

The accuracy is 0.1% ± 1 digit. The module has autopolarity, auto zero and high input impedance. Operating voltage of +5V DC. Two measurement ranges are available: 200mV and 2V.



For further information, write to:

Bantron Electronics
111A/229, Ashok Nagar
Kanpur 208 012.

MICROFRIEND—III

Dynalog has introduced the first 8085A based trainer/development system available in India having some extraordinary onboard features such as EPROM programming, Editor Assembler-Disassembler for 8085, Cross Disassembler for 8086, Centronix Compatible printer interface, Video Display Controller & ASCII Keyboard interface in addition to the features like Audio Cassette interface, STD Bus, full 64K Bytes RAM/ROM decoding. ROM based BASIC is available as an option.

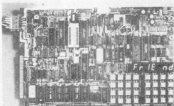

For further information, write to:

Dynalog Micro-Systems
14 Hanuman Terrace
Tara Temple Lane
Lansington Road,
Bombay 400 007.

WAVE SOLDERING

SOLDERMATIC Wave Soldering Machines with flat solder wave provide consistently high standards of Soldering performance & eliminate many of the installation, maintenance & servicing problems. All normal components can be soldered, including coils, switches, connectors, transformers, relays and discrete or integrated components-including SMDs. Range of 3 machines is available with wave widths of 220, 305 & 380 mm. These can handle boards (or row of boards) upto 430 mm. long with standard carriers. The machines are compact, and are fully equipped with foam fluxer, built-in air pump, ventilated hood. Base Units, Feed Conveyors, Return Elevators as well as Cleaning Units are available as options.

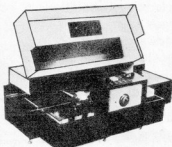

For further information, write to:

Hytech Services,
E-96, Greater Kailash-II
New Delhi 110 048.

ZIF SOCKET

'Comtech' ZIF-40 socket features enlarged contact opening for easier insertion and extraction of ICs. The contacts are on an even 2.54 mm. (0.1") spacing with 15.24 mm. (0.6") between the contact rows. A built in stopper ensures that the 'Locking Lever' can't be overstressed. Glassfilled Nylon body and Beryllium-Copper contacts ensure a faithful cyclic operation even in the arduous working conditions, with proper masking-caps the same 40 pin socket can be used for 28 or 24 pin ICs.

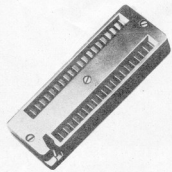

For further information, write to:

Component Technique
8, Orion, L.P. Road
Andheri (West)
Bombay 400 058.

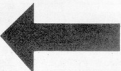
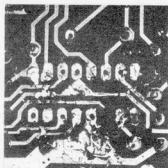

**Desoldered
Without
Diamond**

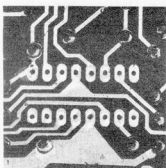

**Desoldered
With
Diamond**

Diamond Desoldering Pump

- Desolders thoroughly.
- Sturdy construction
- Replaceable Teflon Nozzle
- Largest selling in India
- Widely accepted in U.K., U.S.A., West Germany and Singapore.

Export Enquiries Welcome

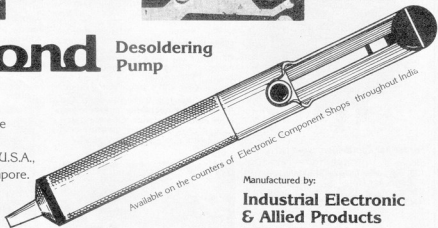

Manufactured by:

**Industrial Electronic
& Allied Products**

1423, Shukrawar Peth,
Off. Bajirao Road,
POONA 411 002, India.
Phone: 446241, Gram: SEFOTAKE.

Distributors:

precious[®] Electronics Corporation

Chhotani Building 52C, Proctor Road Grant Road (E), Bombay-400 007.

HIOKI

MADE IN JAPAN

**ELECTRICAL
ELECTRONIC TEST
INSTRUMENTS**



SOLE AGENT



HENSON VIDOC CO., (PTE) LTD.

5001 Beach Road # 08-16, Golden Mile Complex,
Singapore 0719, Tel 7460051, 2924993
Cable Address: HENVIDOC Telex: RS 34344 VIDOC

WE OFFER FROM STOCK

I.C.'s : TTL, CMOS, MOS, LSI, Microprocessor, Micro computer etc.

Zener Diodes : 400 MW & 1 Watt

LED's : Red, Green, Yellow in 5mm and 3mm dia

IC Sockets : SMK & Memorex make

Trimpots :

Multiturn Bourn's, VRN & Beckman make

Single Turn cermets :

EC as well as imported

Floppy Discs :

8" as well as mini floppy of memorex, & dyson make

Write to :



**ZODIAC
ELECTRONICS
CORPORATION**

Pushpdant Niwas 3rd Floor, 3, Chunam Lane, Dr. D. Bhadkamkar Marg, Bombay-400 007, Phone : 5137225, 5135845

Booster Manufacturers :



Now you can prove the superior performance of your products, by providing Booster Gain Meter which reads directly in db.



available in a wide range
Manufactured by:
PADMA Electronics Pvt. Ltd.

STOCKISTS

Western Region :

Precious Electronics Corporation.

Chhotani Building, 52-C, Proctor Road,

Grant Road (East), Bombay - 400 007

Phones : 367459, 369478

Southern Region :

Precious Electronics Corporation.

9, Athipattan Street, Mount Road,

Madras - 600 002. Phone : 842718

Northern Region :

Tantle Electronics Co.

422, Lajpat Rai Market,

Chandani Chowk, Delhi - 110 006

Phones : 238612, 233856

800

Watts Dissipation

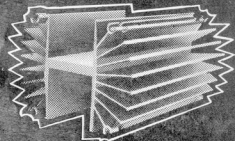

Afcoset
HEAT SINK
470EC

- For very High Power SCR's and Diodes
- 600 W dissipated by 300 mm length natural convection
- Fan cooled thermal resistance 0.12° c/w
- 16.8 mm base for quick cooling.

Afco Industrial & Chemicals Limited (Electronics Division)
Kanjur Marg (East) Bombay - 400 078. Tel : 582164, 584913.

aa8m/Afco/3

POPULAR

TESTICA T-3

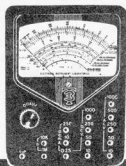

ONLY

Rs170/-

THE ONLY MULTIMETER
WITH
PROMPT SERVICE AFTER SALES

ACCURATE! ROBUST!
ECONOMICAL!

AVAILABLE AT ALL COMPONENT SHOPS

MANUFACTURERS :
**ELECTRICAL INSTRUMENT
LABORATORIES,**

339/68, RAJESH BUILDING, LAMINGTON ROAD,
BOMBAY-400 007. PHONE 36 07 49.

classified ads.

INDUSTRIAL ELECTRONICS "Please contact us for your requirements of Analogue and digital timers, frequency meters and Capacitance meters, Digital panel meters, Digital counter, Speed Switches, Frequency switch, Temp switch, Sequential timers and your specific requirements of Industrial Electronics Items. Contact: M/s. DOTES, 80/60-A, Malviya Nagar, New Delhi-110017. Tel - 654039, 650674

"MICROPROCESSOR ENGINEER" Leading electronic limited company in Bombay requires a second level engineer with in-depth knowledge of designing microprocessor based devices. Knowledge of machine language essential. Good future prospects for the right person. Emoluments:- Salary, House rent allowance, Medical Leave, Travel allowance, Bonus, Provident fund, Gratuity, etc. Apply with biodata. Personal Attention, Managing Director, P.O. Box 9122, Bombay - 400 025.

5721546 10/2449

Educational Electronics kits available. Price list Re. 1/- (We organise All India Universal Electronics Club. Membership FREE. Enrolment form Re. 1/-) - Contact: Renuka Electronics, 18, Ranganathan Street, Nehrunagar, Chromepet, Madras-600 044.

Available data sheet and application of any electronic components. Minimum charges Rs. 15/-. Write to: DATA BANK, Plot No. 16, Bldg. No. 3, Flat No. 17, Bhavani Nagar, Marol Maroshi Road, Andheri (East), Bombay - 400 059.

Imported Solar Photovoltaic Panels 12 V, 55 Watts, suitable for charging lead acid batteries. Contact: POLYCOM, 127, Silverlake Terrace, 55 Richmond road, Bangalore-560025 Telephone - 568860

For 24 electronic kits as MW Transmitter, Musical horn for scooter or car, Running light (360 Watts) etc. Contact: PERFECT ELECTRONICS-453, Ganapati Ali, Wai - 412803.

Advertisers Index

ADVANI OERLIKON	10-05
AFCO I & C. LTD.	10-06
APEX	10-10
BLUJAY	10-10
COMPONENT TECHNIQUE	10-08
COSMIC	10-84
DEVICE ELECTRONICS	10-79
DOMINION RADIOS	10-10
DYNALOG	10-07
ECONOMY ENGINEERING	10-08
ELCIAR	10-08
ELTEC BOOKS N KITS	10-76
GENERAL ELECTRONICS	10 77
HIOKI	10-72
IEAP	10-72
INDIAN ENGINEERING CO.	10-06
JETKING	10-73
KEJRIWAL	10-04
LABELLA LABORATORIES	10-04
NIPPON INDIA	10-11
PADMA	10-74
PRECIOUS MULTIMETER	10-77
RAJASTHAN ELECTRONICS	10-04
RAJRISHI	10-02
SELLAIDS PUBLICATION	10-06
SAINI ELECTRONICS	10-76
SIEMENS	10-09
SUCHA ASSOCIATES	10-77
TESTICA	10-74
TEXONIC	10-73
UNLIMITED ELECTRONICS	10-81
VASAVI	10-73
VISHA	10-83
ZODIAC	10-72

corrections

floppy centring unit (080)

August/September 1985
In the article it is erroneously stated that "all existing connection remain". This is, however, not entirely true, as the old MOTOR ON to GND connection must be removed.

direct reading digitizer (054)

August/September 1985
The article does not mention that, with the input open, P₁ should be adjusted to give an output of 000, while P₂ should be adjusted to give 900 at the output when the input is 900 mV.

Components are normally available with the following companies:

VISHA ELECTRONICS

17, Kalpana Building, 349, Lamington Road Bombay - 400 007 Phone: 362650

DYNALOG MICRO SYSTEMS

14, Hanuman Terrace, Tara Temple Lane, Lamington Road Bombay - 400 007. Phone: 353029, 362421

ELECTROKITS

20, Narasingapuram Street (First Floor) Mount Road Madras - 600 002

INTEGRATED ELECTRONICS INSTRUMENTS

8-2-174 Red Cross Road Secunderabad 500 003 Phone: 72040

Watts News?



After 30 years of communicating our finest efforts to you—we still have more news for you.

Cosmic is now breaking every sound barrier in maintaining its sophisticated electronic image by touching perfection in the manufacturing of its Tape decks/ recorders, Stereo Systems, Amplifiers, Turntables, Head-Phones.

A single dominant factor has encouraged us to keep expanding and that is consumer satisfaction. Stay tuned to us.

COSMIC
We are Sound!