

122

July  
1985

# elektor

INDIA

Rs. 7.50

# electronics

incorporating

**selex**

tone  
burst  
generator



infra-red  
movement detector  
for alarms

an IBM  
compatible  
micro

auto  
service timer

*Sumit Singh*

# elektor contents

Volume 3-Number 7

**EDITOR:** SURENDRA IYER  
**PUBLISHER:** C. R. CHANDARANA  
**ADMINISTRATION:** J. DHAS  
**PRODUCTION:** C. N. MITHAGARI

**ADVERTISING & SUBSCRIPTIONS:**

**ELEKTOR ELECTRONICS PVT LTD.**  
 Chotani Building  
 52 C, Proctor Road Grant Road (E)  
 Bombay-400 007.

**DISTRIBUTORS:** INDIA BOOK HOUSE

**PRINTED AT:**  
 TRUPTI OFFSET  
 103, Vasani Udyog Bhavan,  
 Off Tulsi Pipe Road,  
 Lower Parel, BOMBAY-400 013.

Elektor India is published monthly under agreement with Elektuur B.V. Holland. August/September is a double issue.

**SUBSCRIPTION**

**INLAND**

1 Yr Rs. 75/- 2 Yrs Rs. 140/- 3 Yrs Rs. 200/-

**FOREIGN**

One Year Only

Surface mail Rs. 125/- Air mail Rs. 210/-

The Circuits are for domestic use only. The submission of designs, of articles to Elektor India implies permission to the publishers to alter and translate the text and design, and to use the contents in other Elektor publications and activities. The publishers cannot guarantee to return any material submitted to them. All drawings, photographs, printed circuit boards and articles published in Elektor India are copyright and may not be reproduced or imitated in whole or part without prior written permission of the publishers.

Patent protection may exist in respect of circuits, devices, components etc. described in this magazine.

The publishers do not accept responsibility for failing to identify such patent or other protection.

**INTERNATIONAL EDITIONS EDITOR: P. HOLMES**

**Dutch edition:** Elektuur b.v.  
 6190 AB Beek (L),  
 the Netherlands

**German edition:** Elektor Verlag GmbH  
 5133 Gangel, W-Germany

**English edition:** Elektor Publishers Ltd.  
 Elektor House, 10 Longport,  
 Canterbury CT1 1PE, Kent, U.K.

**French edition:** Elektor Sars, Le Sneau,  
 92270 Baillou, France

**Italian edition:** Elektor, 20092 Cinisello B., Italy

**Spanish edition:** Elektor, Av. Alfonso XIII,  
 141, Madrid 16.

**Greek edition:** Elektor, Karaiskaki 14, Voula,  
 Athens.

**Portuguese edition:** Ferreira e Bento Ltda  
 R.D. Estefania 32, 1000 Lisboa  
 Portugal

COPYRIGHT © ELEKTUUR B.V.  
 THE NETHERLANDS 1985

news, views, people .....	7-12
<b>selektor</b> .....	7-14
Electric motors, drives, and controls.	
<b>tone burst generator</b> .....	7-16
Connected to any sine wave oscillator, this unit is very useful in audio measurements.	
<b>infra-red movement detector</b> .....	7-18
An unobtrusive, state of the art detector unit for use in alarm installations.	
<b>an IBM compatible micro</b> .....	7-24
An excellent way of building yourself a first class personal computer.	
<b>RAM used as EPROM</b> .....	7-32
How two 6116 RAMs can take the place of one type 2532 or 2732 EPROM.	
<b>service interval timer</b> .....	7-35
A handy unit that tells the serious motorist when his car is due for a service.	
<b>electronic pantograph</b> .....	7-42
Enables you to copy plans, drawings, etc. in graphics form on a computer monitor.	
<b>digital oscillators</b> .....	7-46
Highly stable oscillators for use in a variety of electrophonic instruments.	
<b>the short search</b> .....	7-50
A simple, but useful, unit for quickly tracing a defect in a printed circuit board.	
<b>alphanumeric display</b> .....	7-52
This one-line display is suitable for use with a number of mini-computers.	
<b>solar battery</b> .....	7-55
A means of tapping energy from the largest source known to man.	
<b>computer eye</b> .....	7-58
Enables your computer to control external equipment without a physical link.	
<b>market</b> .....	7-68
<b>switchboard</b> .....	7-73
<b>missing link</b> .....	7-78
<b>index of advertisers</b> .....	7-78
<b>component sources</b> .....	7-78
<b>selex 3</b>	
<b>soldering techniques</b> .....	7-60
<b>digi-course (chapter-3)</b> .....	7-62
<b>batteries</b> .....	7-64
<b>transformers</b> .....	7-65
<b>components</b> .....	7-67

**TECHNICAL QUERIES SERVICE**

Readers experiencing difficulties in the construction of 'Elektor India' projects, may write to us for advice, enclosing a stamped, self-addressed envelope. Failure to do so may, at best, result in very serious delays in our answer. In any case, please allow an average 2 to 3 weeks for our answer. If certain components are not immediately available in your area, look carefully through the advertisements in this issue. You'll be surprised how often you can find that elusive part.



# MICROFRIEND CAN NOW READ BASIC

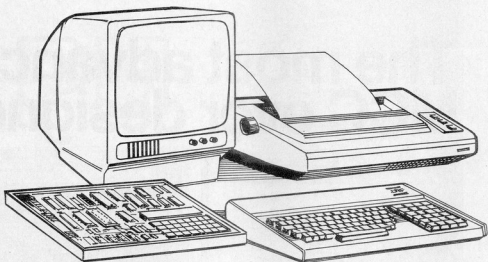

## MICROFRIEND-III

**The latest in the MICROFRIEND series of microprocessor training and development kits, now comes with a powerful software package supporting \* Micro-BASIC, Text Editor/Assembler for 8085 and Assembler for 8086**

You can build up a full fledged development system using the on board CRT controller 6845, ASCII Keyboard interface and standard Centronics parallel port interface provided on MICROFRIEND-III. Video Monitor, Printer and ASCII Keyboard are available as options.

### Other Features:

■ High performance 8085A CPU operating at 3 MHz. ■ 16K powerful Firmware in 27128. ■ 2K user RAM, expandable to 64K. ■ 48 parallel I/O lines. ■ RS 232 C and Audio Cassette I/F. ■ On board EPROM Programmer. ■ Software manipulation codes. ■ Standard STD Bus for system expansion.

Manufactured by:

**DMS**

**Dynalog Micro-Systems**

14, Hanuman Terrace, Tara Temple Lane,  
Lamington Road, Bombay 400 007

Tel : 353029, 362421,  
Telex : 011-75614  
Gram : ELMADEVICE

North Zone Rep..

TECHNICS  
4731/21 Dayanand Marg,  
Daryaganj,  
New Delhi 110 002  
Tel : 276988, 270832

Setting the standards in  $\mu$ P based technology.

# SIEMENS

## The most advanced MCC ever designed:

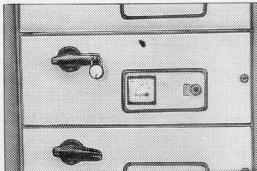

8 PU can be tested with module door closed

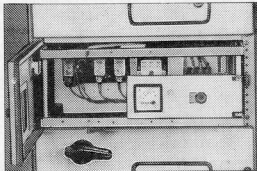

Unique lever draw-out arrangement for servicing

Only 8 PU MCCs offer you all these unique features:

### Never before Safety

- Double-break fuse-switch with positive disconnection (no fuse movement) and failproof mechanical indicator
- Testing possible with the module door closed
- Automatic safety shutters for vertical busbars when the trolley is withdrawn
- Finger touch-proof control circuit terminals, push buttons and indicating lamps

### So easy to maintain

- Trolley movement with just two fingers through unique lever arrangement/guide
- Quickest access to busbars for inspection and maintenance
- Choice of single front or space saving double front design

### Long Service Life

- Motor controlgear already well known for its reliable and durable performance
- Minimal trolley movement to reduce wear and tear of Lyra contacts
- Heavy-duty sheet steel fabrication with scratch resistant stove enamel paint

## Leadership that shows —

New Development from  
Siemens India

# 8 PU

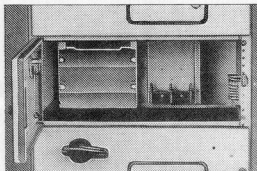

Automatic shutters isolate vertical busbars

8 PU is the latest generation of motor control centres designed and developed by Siemens and successfully proven in the field all over the world.

8 PU Factory-built assemblies correspond to IS:8623 and IEC 439 standards. They have been type-tested at CPRI, Bhopal for 50 kA.



For further details,  
please write to:-

Manager, Switchboards,  
**Siemens India Ltd.,**  
134-A, Dr. A. Besant Road,  
Bombay 400 025.

**8 PU**

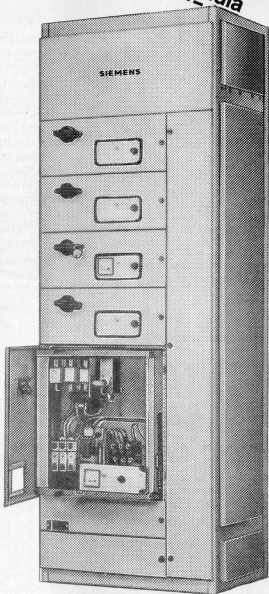

LINTAS SM 21 2335 R

## in design, in engineering

# A complete range of toggle and rotary switches from MCE.

MCE today manufactures a complete range of precision engineered toggle switches. 2A, 4A, 6A, 8A and 10A switches for every need of Indian industry.

Our 10A switches are CIL approved, a fact which speaks volumes for our production and quality control procedures.

Also available a wide variety of Rotary switches for diverse applications. Our range of toggle

switches finds wide acceptance in sophisticated export markets like West Germany.

For more details on the MCE range, contact our New Delhi office.

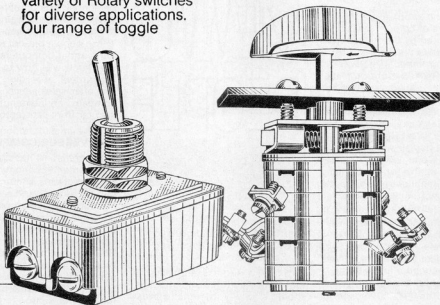

**MC**  
ENGINEERING

**MC Engineering Co. P. Ltd.**

220 Okhla Industrial Estate, New Delhi - 110 020.

Tel: 631581, 631985 Telex: 031-2148 MCE Grams: NEWMAN

## electric motors, drives, and controls

Most electrical equipment has been affected by the boom in the electronics industry, and this is certainly true in the field of electric motors and their drives and controls.

The growing sophistication of electronic components is reflected in the improved performance of the equipment they are used to control. For instance, modern thyristors have a faster switching rate and higher peak inverse voltage ratings than their predecessors, giving greater security against spurious firing caused by voltage spikes on the circuits. This has helped to provide greater reliability in motor and drive systems. Unreliability in the drives of the past was mainly caused by production techniques, which involved components being assembled by hand. Nowadays, however, most production of electronic printed circuit boards (PCBs) is carried out automatically, with the only human contact taking place during testing. Dry joints, which were probably the biggest single cause of failure, have now been virtually eliminated.

### Flux solution

The flow soldering operation normally involves the application of flux solution beforehand. The flux becomes active at soldering temperatures and can then dissolve thin films of oxide from the surface of the PCB, from the component terminations and from the molten solder. But fluxes will not overcome poor solderability of boards and components.

Foam fluxing is presently the most commonly used application technique, involving the passage over a standing wave of foamed flux, produced by aeration from a submerged porous element.

Soldering may be carried out by simple flat dipping of the PCB assembly on to the freshly cleaned surface of the solder bath. One edge of the board is preferably brought into contact with the solder first and the other edge lowered slowly, to allow flux and solvent vapours to escape. When withdrawing the PCB assembly, an angled path is again used to help in draining the solder and removing "stalactites". In wave soldering — the most popular current method — the solder is pumped out of a narrow slot to produce a standing wave, against the crest of which the PCB assembly passes on a conveyor. The conveyor is usually at an acute angle to the

horizontal to assist in draining the solder, and double waves or special waveforms may also be used to accommodate long pins or uncropped component terminations.

### No problem

Materials with good solderability ensure the capillary rise of the solder through plated holes, to make connections through to the component side when the solder side of the PCB is brought into contact with the molten solder. Penetration is improved by allowing the median plane of the PCB assembly to be level with the free solder surface, which generates a small but positive pressure to assist capillary action. Multi-layer boards with internal ground planes may require a different depth to give good hole filling, owing to the thermal sink effect of such planes.

Although improvements in soldering techniques may have been the most significant factor in the achievement of the reliability that has made the electronic drive a viable product, it is by no means the only one. Further improvements are being sought by reducing the jointing problem, and this is done by putting as much of the control circuitry as possible on to

integrated circuits. A look at recent products to enter the British market illustrates the inventiveness of the manufacturers.

For instance, a new dc drive from Thorn EMI Automation has its own computer interface network in the drive power converter. This enables the drive controller to operate with any computer. The principal advantages of the distributed control facility offered by this drive are claimed to be reduced installation costs, system flexibility, and better diagnostics.

### Local controller

It can also operate as a local machine controller with inherent intelligence for more advanced monitoring and communication with other equipment. This range of thyristor controlled dc drives offers controllers with ratings from 1 to 575 kW, in both non-regenerative and fully regenerative modes. Another new product from the same company is a range of baby drives, offering three dc power converters for ratings between 1 and 9.3 kW. The range features groundable electronic circuits, adjustable ramp, and tacho or armature feedback. Fuseless operation, current limit control, minimum and maximum speed settings, and a trip output signal are also included. Outputs from the three power converters are 7.5, 15 and 30 A. Each can operate from a 240 or 415 V supply. They are available in a boxed version with a miniature circuit breaker and a supply-on lamp.

The range of baby drives offered by Thorn EMI for ratings between 1 and 9.3 kW.

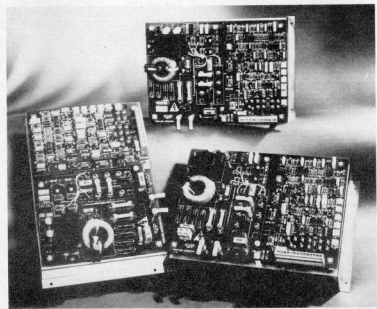

Six months development work by Power Semi-Conductors has produced a new range of open frame constructed, soft start motor controls. The 15LX, six pulse, solid state controllers are available in three versions, rated to 18.5, 45 and 75 kW at 380/440 V, 50 Hz, three phase. Acceleration of the motor can be achieved using open loop voltage control, closed loop current limit or tachogenerator feedback. LEDs indicate phase sequence, overload, full conduction, current limit, power supply on condition and firing circuit balance.

#### Auxiliary contacts

A line contactor is used for initiation of the control or, if required, auxiliary contacts can be used. An optically coupled triac fires at the end of the acceleration ramp, and its output can be used to interface with a bypass contactor.

The manufacturer claims this drive's design is unique, as it uses only four socket mounted integrated circuits throughout. The PCB is mounted directly on to isolated thyristor modules, allowing the heat sink to be chassis mounted without the need for insulating stand-offs. New ac drives and ac brushless motors have recently been announced by Contraves Industrial Products. The company's multi-axis servo controller series is claimed to advance servo drive technology through the use of control circuits realised in thick film and integrated circuits, packaged in panel mounted modules. This range covers a continuous power range from less than 1 kW to 13 kW.

Six convection cooled modules and a matching power supply can be accommodated in a 432 x 355 mm panel space. Wiring is facilitated by plug-on terminal strips, and a plug-on "personality" card carries all servo compensation components and set-up adjustments.

Powertron permanent magnet ac servomotors from the same manufacturer are interchangeable with many ac and dc motors used on robotic and automated machinery. These rare earth magnet motors are available in four frame sizes, and each is made in two or three stack lengths and windings. The total of 24 models gives the robotics designer or machine engineer a choice of 12 rated torques between 1.3 and 56 Nm, maximum speeds from 1200 to 6000 rev/min, and motor diameters of 76, 102, 140, and 190 mm. They are available with two types of mounting, in British dimen-

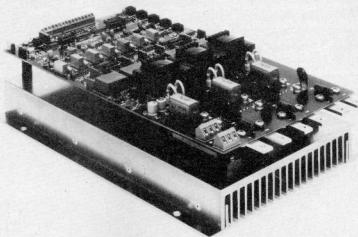

One of the range of open frame, soft start, six pulse motor controls from Power Semi-Conductors.

sions to NEMA and CEMA standards, and in metric dimensions to IEC72A and DIN standards.

#### Torque-to-weight ratio

Discodyn AC200 series servomotors, again from Contraves, have a disc-shaped rare earth magnet armature, and stator windings are mounted in a manner designed to give highly efficient heat dissipation. The company stresses the unit's high torque-to-weight ratio, short compact housing, thermal time constants from 30 to 50 min depending on motor size, low armature inertia, and theoretical acceleration as high as 35 000 rad/sec<sup>2</sup>. All motors in this series have a rated speed of 3000 rev/min and are available in four frame sizes.

Also available are ac inverter drives designed for induction motor control systems up to 20 kW. Microprocessor interface allows easy application to different motors and loads.

A new series of four quadrant motor speed controllers — the Series 460 — has been introduced by Simplatron, the controller section of Simplatrol. These controllers are said to be most suitable where accurate control ranges up to 1000:1 and current response times down to 15 ms may be required.

Greatest accuracy is attainable with a motor mounted tachogenerator rather than the armature voltage

feedback method. Not only does the true dc voltage of the tachogenerator give the necessary accuracy of information on the direction and speed of the motor, but it keeps the controller circuits free of mains potential.

The secret of this controller's fast armature current reversal lies in the design of the switching method for the thyristor bridge. A permanent low value current circulates between the two thyristor bridges, enabling both to operate simultaneously — without damage to the thyristors — and hence faster. Earlier methods required sequential, and therefore slower, switching to avoid damage from short circuiting.

#### Quick reversing

This speed of switching offers operational advantages, including quick reversing and positioning of the driven machinery. Seven models are available with output powers ranging from 0.6 to 22 kW.

Applications involving unwind and rewind stands are especially suitable for this controller. Intermediate drives in processing lines also require this degree of control where the direction of rotation is fixed and fluctuating torque demand for speed holding may mean the controller has to alternate between negative and positive current values.

Solid state ac motor drives have recently reached the point where they are now competitive with dc drives for variable speed applications, largely due to the reliability and lower prices brought by automated manufacture. As prices for this type of equipment continue to fall, sophisticated drives will be justified in ever smaller installations.

(David Knott — LPS)



A tone burst is a test signal frequently used in audio engineering, particularly in loudspeaker measurements. It consists of a train of sine waves followed by an absence of signal. The circuit suggested here can be connected to any standard sine wave generator to produce tone bursts. This arrangement makes it possible for the circuit to be kept simple and compact.

# tone burst generator

counts the sine waves

The photograph shown in figure 1a was taken from an oscilloscope displaying tone bursts of eight sine waves followed by twenty-four periods of no signal, then eight sine waves again, and so on. It is important to note that the first sine wave starts, and that the eighth sine wave ends, at a zero crossing. Fourier analysis shows that the complete signal contains integral multiples and submultiples of the fundamental sine wave.

In tests, a tone burst may be considered as a combination of a continuous sine wave and a stepped signal. This makes it possible for two parameters of a system to be measured: the sinusoidal response and the switching behaviour. It is illuminating to test an audio filter with a tone burst: it gives a new insight into the operation and quality of the filter.

As stated, tone bursts are used in testing loudspeaker systems. A tone burst and a measuring microphone make possible the precise observation of diaphragm vibrations. They also facilitate the measuring of the dynamic range of a loudspeaker (this is the region in which the cone, i.e., the diaphragm, reacts linearly to the applied input voltage). This can be a risky test without a tone burst, because the applied power may be so great that the loudspeaker breaks down. With a

tone burst, this danger does not arise, because power is then applied to the loudspeaker for short periods of time only.

## Circuit description

The sine waves are produced by a standard sine wave generator or a function generator. The circuit shown in figure 2 monitors the zero crossing of the sine waves and uses this information to determine whether the waves should be passed on to the output or not. This arrangement meets two requirements: the tone burst starts and ends at exactly a zero crossing; and the number of periods is constant irrespective of the sine wave frequency. The input stage, IC<sub>1</sub>, compares the input voltage with the potential at the wiper of preset P<sub>1</sub>. Its output is a rectangular signal, the frequency of which is identical to that of the input signal. The off-set of the device, and the effects of a not quite symmetrical supply voltage, may be compensated with P<sub>1</sub>. The 22 k resistor to the +9 V line is required because of the open collector output of the LM311.

The quadrangular pulses are applied to the clock input of counter IC<sub>2</sub>. The logic level at the Q<sub>3</sub> output of this counter changes state every eighth period, and

Figure 1a. A tone burst looks like this: at the top the complete signal; at the bottom, the sine wave only.

Figure 1b. Tone burst testing in practice: at the top the burst and at the bottom how this is reproduced by a good-quality mid-range loud-speaker.

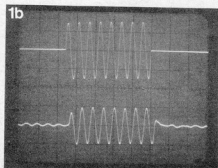
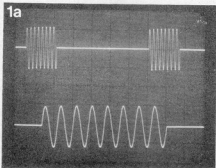

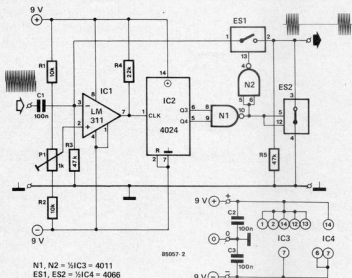

that at the  $Q_4$  output every sixteenth period. Both outputs are applied to NAND gate  $N_1$ , so that the output of this gate is logic 1 for twenty-four periods, and logic 0 for eight periods. This signal is subsequently inverted by  $N_2$ . The wave forms at the various output terminals are shown in figure 3.

The outputs of  $N_1$  and  $N_2$  drive two electronic switches,  $ES_1$  and  $ES_2$ . Because the control signal for  $ES_1$  is inverted with respect to that for  $ES_2$ , these switches work in opposition. When  $ES_1$  is closed (and  $ES_2$  is open), the input signal is passed to the output. When  $ES_1$  is open, the input signal is no longer passed to the output, while  $ES_2$ , which is closed, earths the output. Resistors  $R_3$  and  $R_5$  ensure that neither the input resistance nor the output resistance is too high when  $ES_1$  or  $ES_2$  is open.

The circuit needs a symmetrical supply of  $\pm 9$  V, which must be well regulated, and is required to deliver a current of only 5 mA. It is important that the voltage does not exceed  $\pm 9$  V, because the CMOS ICs can stand only 18 V.

### Construction and setting up

The tone burst generator is best built on the printed circuit board shown in figure 3.

Only potentiometer  $P_1$  needs to be preset, for which an oscilloscope is required. Connect the generator to a  $\pm 9$  V power supply, the sine wave oscillator, and the oscilloscope. Set the output of the oscillator to  $1 V_{pp}$  at a frequency of 1 kHz. Adjust  $P_1$  so that the last sinusoidal cycle stops exactly at the zero crossing. If it stops too early, this is visible on the screen as a vertical line towards the zero crossing. If it stops too late, the sine wave will continue in a positive direction after the zero crossing. Once this point has

### 3

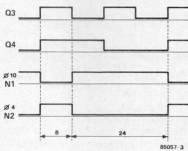

Parts list	
Resistors:	Capacitors:
$R_1, R_2 = 10$ k	$C_1 \dots C_3 = 100$ n
$R_3, R_5 = 47$ k	Semiconductors:
$R_4 = 22$ k	IC1 = LM311
$P_1 = 1$ k preset	IC2 = 4024
	IC3 = 4011
	IC4 = 4066

For Components Sources See Page 7-78

been set correctly, the tone burst will also start exactly at a zero crossing.

### Finally...

Input capacitor  $C_1$  blocks any direct voltage components that may be present in the sine wave generator output. When tone burst frequencies below 100 Hz are required, it is advisable to increase the value of the capacitor to  $1 \mu\text{F}$ . The signal to no-signal ratio of 8:24 in the present circuit may be altered by coupling different Q outputs of IC2 to  $N_1$ . For instance, a ratio of 8:8 is obtained by disconnecting pin 5 of IC2 ( $Q_4$ ) from pin 9 of  $N_1$  and connecting the latter to the +9 V line.

Figure 2. The circuit diagram of the tone burst generator.

Figure 3. Timing diagrams of the signals at various points in the circuit.

Figure 4. The printed circuit board of the generator is small enough to be built into an existing sine wave or function generator.



The detector described in this article reacts to fast temperature variations caused by the movement of people or animals in an enclosed space. All mammals radiate a certain amount of heat, and it is this that causes local variations in temperature. The radiant heat energy occupies the electromagnetic spectrum between light and radio waves, i.e.,  $0.74 \dots 300 \mu\text{m}$ , which is usually called the infra-red region. The radiant energy is picked up by a Fresnel lens, at the focus of which is a double differential pyroelectric sensor. The detector is largely unaffected by other electrical radiation. Also, it does not react to movement outside the guarded space.

# infra-red movement detector

for use in intruder alarms



The Fresnel lens is named after the physicist A. J. Fresnel (1788-1827)

The space to be monitored is divided by the lens into a number of zones as illustrated in figure 1. The number of zones depends on the number of segments of which the lens is composed. When somebody moves from one zone into another, there is a change in temperature which is collected by the lens as a variation in radiant energy. At the focus of the lens is a pyroelectric sensor which reacts to such a change by generating a small electric signal. That signal is processed and used to actuate the alarm installation.

## Lens or reflector

So far, we have spoken of the lens, but it is equally possible to use a Fresnel reflector, which is, however, much more difficult to obtain.

A Fresnel lens is composed of a number of smaller lenses so arranged that they give a very short focal length. Such lenses are used in headlights, spotlights, camera viewfinders, to name but a few.

## Pyroelectric sensor

Pyroelectricity is the property of certain crystals, such as lithium sulphate, of

developing (opposing) electric charges on opposite faces when the crystals are heated.

Infra-red intruder alarms invariably use dual element (= crystal) sensors. The elements, each measuring about  $2 \times 1 \text{ mm}$ , are connected in series and in reverse polarity to each other at c. 1 mm intervals. These crystals are represented by two capacitors connected in opposition as shown in figure 4 — IR<sub>1</sub>.

Any incident energy that crosses two elements sequentially causes positive and negative signals to be generated. The output signal will, therefore, vary over a wide range of peak to peak voltages.

Since the two crystals are of reverse polarity, any simultaneous incident energy on both elements causes no output signal, because the generated voltages negate one another. Dual element sensors therefore:

- prevent spurious operation caused by vibration;
- are highly resistant to variable environmental temperatures;
- prevent incorrect operation caused by external light sources, such as sun beams.

Apart from the two crystals, the sensor contains an n-channel field-effect transistor

1

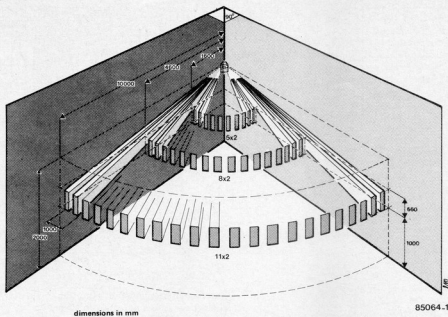

infra-red movement detector

Figure 1. This illustrates the division of a space into zones by the Fresnel lens or reflector.

2

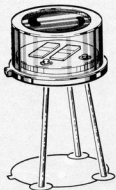

(FET) and a non-linear element that protects the input of the FET against too high voltages. The FET has a very low noise factor and serves as preamplifier and impedance adapter. The entire sensor is contained in a TO-5 case which has a window for admitting the infra-red energy. Figure 2 shows a typical sensor, type RPY94, with open and closed case. A typical field of view diagram of this sensor is given in figure 3. There are four different types of sensor suitable for use with the present circuit: their sensitivities are listed in table 1.

#### Circuit description

The signal generated by the sensor is taken from the source of the FET and

Table 1.

Type	Sensitivity V/W
SS02-CHK-1	500
IRA-E002SX4	115
RPY94	650
RPY95	450

Figure 2. Infra-red sensor type RPY94.

3

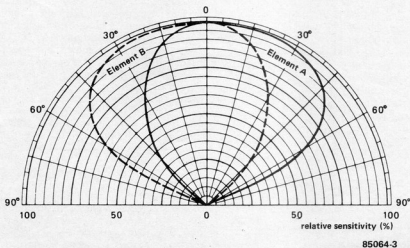

Figure 3. Typical field of view diagram in the x-x plane of dual element sensor type RPY94.

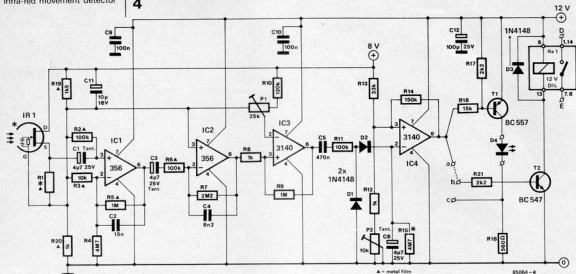
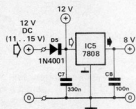

Figure 4. Circuit diagram of the infra-red movement detector.

Figure 6. Waveforms at a number of points in the circuit.



coupled to the non-inverting input of IC<sub>1</sub> via capacitor C<sub>1</sub>. This capacitor prevents signals with a frequency of about 0.3 Hz or less from reaching the input of IC<sub>1</sub>. This opamp has an amplification of about 40 dB and cuts off frequencies above 10 Hz. Resistors R<sub>1</sub>, R<sub>2</sub>, R<sub>3</sub>, R<sub>4</sub>, and R<sub>5</sub> in the feedback network are all metal film types to ensure that the low noise factor of IC<sub>1</sub> is not negated.

The second amplifier, IC<sub>2</sub>, is also configured to cut off frequencies above 10 Hz,

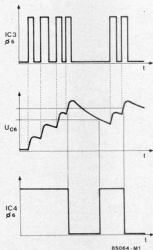

and has an amplification of about 27 dB. As the amplifiers are operated from an asymmetrical supply, an auxiliary direct voltage is required for setting the correct operating point. This direct voltage of 3.2 V is provided by divider R<sub>15</sub>-R<sub>20</sub>. The inverting input of IC<sub>1</sub> is earthed via R<sub>4</sub> so that the output of the opamp is always a few hundred millivolts more positive than the negative terminal of C<sub>3</sub>.

The signal from IC<sub>2</sub> is fed to Schmitt trigger IC<sub>3</sub>, whose threshold is set by P<sub>1</sub>. The trigger stage is followed by a diode pump consisting of R<sub>11</sub>, C<sub>5</sub>, C<sub>6</sub>, D<sub>1</sub>, and D<sub>2</sub>. Every time the output of IC<sub>3</sub> goes high (+12 V), capacitor C<sub>5</sub> is charged via R<sub>11</sub> and D<sub>2</sub>, and at the same time discharged slowly via R<sub>15</sub>. The charging current through C<sub>5</sub> is, therefore, shaped as shown for U<sub>C5</sub> in figure 6. If IC<sub>3</sub> generates so many pulses that the voltage across C<sub>5</sub> exceeds the level preset by P<sub>2</sub>, IC<sub>4</sub> toggles and its output goes low. Transistor T<sub>1</sub> then switches on and D<sub>4</sub> lights to indicate that there has been a movement.

The alarm may be actuated in two ways. If wire link a-b is closed, the low output of IC<sub>4</sub> cuts off transistor T<sub>2</sub>, so that the relay is not energized. If, however, wire link c-b is closed, T<sub>2</sub> is switched on via T<sub>1</sub> and D<sub>4</sub>, so that the relay is energized. It is, therefore, possible to have an open circuit or a short circuit at terminals D-E for setting off the alarm.

The circuit requires an operating voltage of 11...15 V: our prototype worked from 12 V. Current consumption is 25...30 mA, ignoring the relay and the LED, and some 80 mA with the relay energized and the LED lit.

## Construction

The circuit is best built on the printed circuit board shown in figure 5, which has been designed to provide the lens holder. First, cut the board as shown in photograph 1 - taking care that the copper

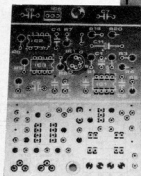
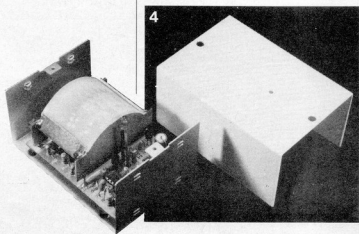
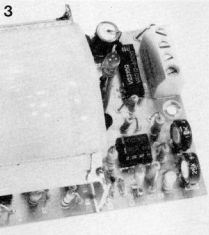
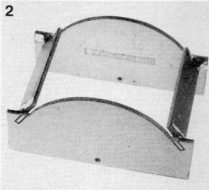
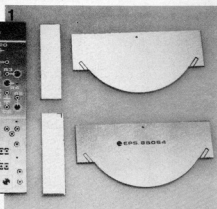

Photo 1. The sub-divided printed circuit board.

Photo 2. The structure of the lens holder.

Photo 3. The completed board fitted with lens.

Photo 4. The finished detector.



tracks are cut cleanly. The first cut should be made along the dotted line. Next, the small rectangular piece should be cut out, and then cut into two. Finally, the half-round sections should be cut out, which is best done with a fretsaw. The four sections of the board are then soldered together as shown in photograph 2. This is facilitated by the small bars etched into the copper on the larger sections adjacent to the half-round parts. These bars indicate the exact position of the sections. Care should be taken during the cutting of the board not to saw into these bars! At a later stage, the lens is fitted into the resulting lens holder.

Next, the board can be wired up; first, of course, those components that are soldered at both sides of the board:  $R_4$ ,  $R_{18}$ ,  $R_{20}$ ,  $C_6$ ,  $C_9$ ,  $C_{10}$ ,  $C_{11}$ ,  $C_{12}$ , and  $D_1$ . Then, the sensor should be fitted. These devices, like transistors, have a metal lip. When the SS02-CHK1 or the E002SX4 is used, this lip must point in the direction of  $IC_3$ ; when the RPY94 or RPY95 is used, the lip should point to the 6 of  $R_6$ . Both situations are illustrated in figure 5. Soldering in of the sensor should be done quickly, because the device is heat sensitive. The sensor should be positioned roughly 5 mm above the board.

Before the lens is fitted, apply 12 V to the circuit and check that there is a direct voltage of about 3.2 V between the output of  $IC_3$  and earth. This voltage should vary by  $\pm 1$  V when you move your hand close in front of the sensor.

The time has now come to fit the lens into place. First, solder four soldering pins into the four remaining free holes on the board. Then, slide the lens holder between the soldering pins into a position where the whole of the top of the sensor is visible through the centrally drilled holes in the sides of the holder. The lens holder is then soldered squarely onto the soldering pins. Finally, the lens is mounted into the holder with the line of segments pointing toward  $IC_3$ . If this has been done correctly, the lens is set at the proper angle.

The complete circuit should now be fitted into a small case, preferably of the type as indicated in the parts list. Before this is done, however, a hole the size of the lens should be drilled in the appropriate position in the lid of the case; this hole should be covered on the inside with a small piece (about 80 x 60 mm) of infra-red translucent window material. Also, two holes for adjusting the potentiometers and one for cable entry should be drilled in the appropriate places. Finally, the pcb is fitted into the case on two 15 mm insulated spacers.

### Calibration

As already explained,  $IC_3$  must deliver a number of pulses to ensure that  $C_6$  is charged sufficiently to enable the alarm to be set off. How many pulses are required in a certain period of time depends on



the setting of  $P_2$  and on the value of  $R_{15}$ . The higher this value, the slower  $C_6$  discharges: it keeps its charge longer and thus functions as a kind of energy store. With the value of  $R_{15}$  as in figure 4, i.e., 4M7, the time constant,  $\tau = 22$  s. In this case,  $P_2$  may be adjusted so that the alarm only goes off when at least five pulses are provided within fifteen seconds.

If you find that the circuit reacts too slowly, i.e., it is not sensitive enough, set  $P_2$  to a lower value. At the same time, reduce the value of  $R_{15}$ , but this should not be taken below 470 k.

The setting of  $P_1$  and  $P_2$ , as well as the value of  $R_{15}$ , is largely a matter of personal preference, but  $P_2$  should not be set to its minimum value to avoid the alarm being set off by any small pulse. The diode pump ensures that no false alarms can be given.

### Installation

The detector is best placed at a height of about 2 m (6 ft 6 in) at a downward angle of  $14^\circ$  from the vertical in a corner of the space to be guarded. It should not be placed in direct sunlight, nor above heating appliances. Our prototype has a reliable range of up to 12 m (39 ft). Remember also that the detector is not really suitable for use in open spaces. **M**

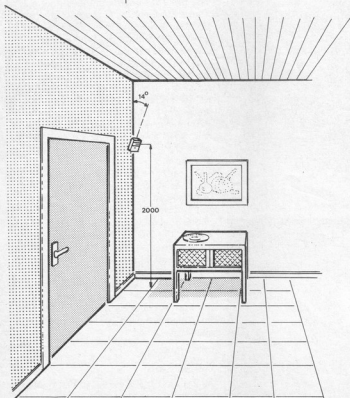

5

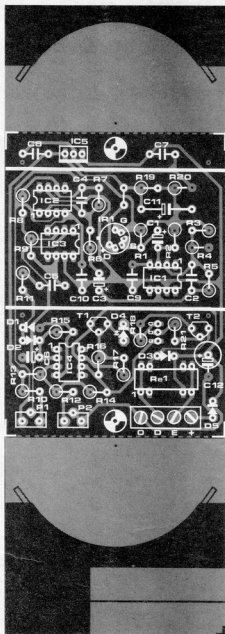

### Parts list

#### Resistors:

$R_1^* = \text{see IR1}$   
 $R_2^*, R_6^*, R_{11} = 100 \text{ k}$   
 $R_3 = 10 \text{ k}$   
 $R_4, R_{15} = 4M7$   
 $R_5^*, R_9 = 1 \text{ M}$   
 $R_7 = 2M2$   
 $R_8, R_{12}, R_{20}^* = 1 \text{ k}$   
 $R_{10} = 120 \text{ k}$   
 $R_{13} = 33 \text{ k}$   
 $R_{14} = 150 \text{ k}$   
 $R_{16} = 15 \text{ k}$   
 $R_{17}, R_{21} = 2k2$   
 $R_{18} = 560 \Omega$

$R_{19}^* = 1k5$

$P_1 = \text{preset, } 25 \text{ k, vertical mounting}$

$P_2 = \text{preset, } 10 \text{ k, vertical mounting}$

\* = metal film type

#### Capacitors:

$C_1, C_3, C_6 = 4\mu7/25 \text{ V tantalum}$   
 $C_2 = 15 \text{ n}$   
 $C_4 = 8n2$   
 $C_5 = 470 \text{ n}$   
 $C_7 = 330 \text{ n}$   
 $C_8 \dots C_{10} = 100 \text{ n}$   
 $C_{11} = 10 \mu/16 \text{ V}$   
 $C_{12} = 100 \mu/25 \text{ V}$

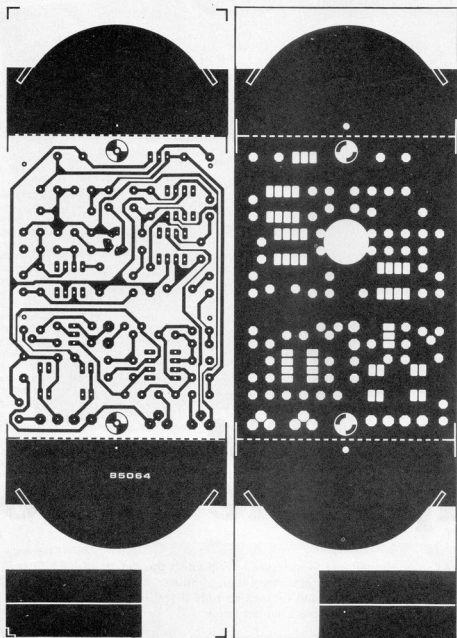

Figure 5. The printed circuit board of the infra-red movement detector.

**Semiconductors:**

D<sub>1</sub>...D<sub>2</sub> = 1N4148  
 D<sub>4</sub> = LED, red, 5 mm  
 D<sub>5</sub> = 1N4001  
 T<sub>1</sub> = BC557  
 T<sub>2</sub> = BC547  
 IC<sub>1</sub>, IC<sub>2</sub> = 356  
 IC<sub>3</sub>, IC<sub>4</sub> = 3140  
 IC<sub>5</sub> = 7808

**Miscellaneous:**

Re<sub>1</sub> = relay, 12 V, DIL  
 pcb type  
 IR<sub>1</sub> = SS02-CHK-1\*  
 (R<sub>1</sub> = 47 k)  
 IRA-E002SX4 (R<sub>1</sub> = 10 k)

(Erie-Murata)  
 RPY94 or RPY 95 (R<sub>1</sub> =  
 22 k) (Philips/Valvo)  
 Fresnel lens type MSFL24\*  
 Infra-red translucent window  
 material, 80 × 60 mm\*  
 Four-way spring-loaded  
 terminal strip for pcb  
 mounting  
 Case, 110 × 75 × 60 mm,  
 Schyller type 93.210

For Components Sources  
 See Page 7-7B

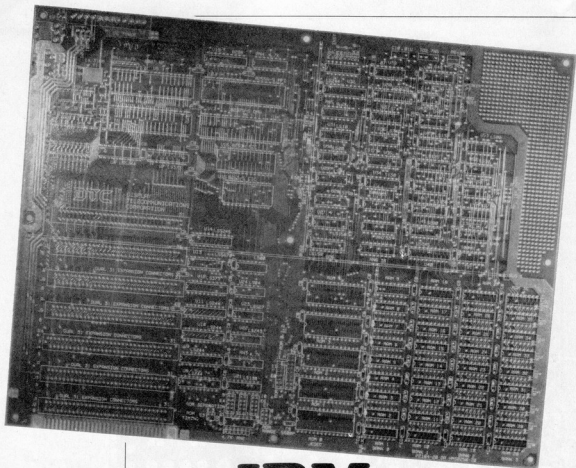

# an IBM compatible micro

As announced last month, we now publish the details of how to build yourself a first class personal computer. Note, however, that this is a project that should be tackled only if you have a fair amount of experience in electronics construction.

for home construction

The Megaboard kit produced by DTC of Texas is available with: DYNALOG MICRO-SYSTEMS 14, Hanuman Terrace, Tara Temple Lane, Lamington Road, Bombay - 400 007.

Our prototype is built partly from the Megaboard construction kit, produced by DTC (Display Telecommunication Corporation) of Dallas, Texas, USA, which is available from a number of specialist retailers.

It is advisable to strictly follow the *assembly instructions* supplied with the Megaboard kit. In addition, note the following points.

- 1) As the board is relatively expensive, it is wise to use IC sockets of prime quality.
- 2) A number of components are difficult to obtain; improvisation in some instances is, therefore, unavoidable. For instance,
  - trimmer  $C_5$  is a two-terminal type: it may be necessary to use a three-terminal type of which one of the two

rotor terminals must be cut off;

- the resistance networks may be replaced by  $\frac{1}{8}$  W resistors: in our prototype  $RN_1$  was replaced by  $3 \times 4k7$ ,  $RN_2$  by  $5 \times 4k7$ ,  $RN_6$  by  $7 \times 33 \Omega$ , and  $RN_7$  by  $7 \times 33 \Omega$ .
  - delay line  $TD_2$  has such a short delay time (7 ns) that we just replaced it by a wire link;
  - some of the jumper connections for the EPROM selection are angled: these may be made from a piece of double-pole connector strip;
  - jumper connection 1-3 is wrong — this jumper should interconnect terminals 2 and 3.
- 3) We found the instruction on how to place the shorting plugs for the EPROM

decoding somewhat vague; note, therefore, that the stated connections only apply to 2764 type EPROMs. Wire link 5-6 at  $E_8$  is superfluous, as is 5-7 at  $E_9$ . Also at  $E_9$ , wire link 13-14 should read 14-15.

4) When the board is wired up, but before the ICs are inserted into the relevant sockets, it is best to check it with a 5 V supply and a voltmeter for any short circuits or missing connections.

5) At this stage, the ICs can be placed into the appropriate sockets. Most ICs are fairly conventional types, but the PROM,  $U_{43}$ , the 100 ns delay line,  $TD_1$ , and  $U_{47}$  are not often encountered.

6) If you are using the Megaboard kit, you either have a ready-programmed PROM, or you do not need one (in case of the Super XT/PC Board to which we will revert later). If you are doing your own programming, note that Toshiba's 24S10 may be replaced by Harris's HM7611, MMI's 9301-1, or Fairchild's 93427. The hex-dump of the program can be found on page 20 of the IBM PC manual, the RAM sub-system is described on page 18, and on page 19 is shown which wire links must be placed at  $E_{11}$  for the various RAM ranges (these are not stated in the *assembly instructions*).

What has to be done at  $E_{12}$  can only be seen at the track side of the board, which (not shown on the circuit diagram) has already been provided with the appropriate connections.

A wire link has to be placed across terminals 1-2 of  $E_{11}$ ; here again, this is not mentioned anywhere.

Delay line  $TD_1$  is best replaced by the auxiliary circuit of figure 2, in which all eight driver stages have been cascaded, so that the propagation delay times of the gates provide the required delay. The encircled figures on the periphery corre-

2

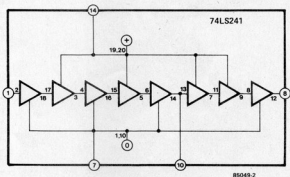

Figure 2. Delay line  $TD_1$  may be replaced by this simple circuit.

spond to the pins of  $TD_1$ ; the others are the pin numbers of the 74LS241. The practical construction of the circuit is illustrated in figure 3. Although the measured delay time is a little shorter than theoretically predicted, our prototype functioned without a hitch.

If you have difficulties obtaining the 75477 for the  $U_{47}$  position, you can use a field-effect transistor type BS 170 or VNI0KM, connected as shown in dotted lines.

### Power supply

For convenience's sake, we have used the *microcomputer power supply* previously published in the August/September 1984 issue of *Elektron* — p. 8-46. This design can be modified as shown in figure 5: the  $-5$  V can be omitted because the DRAMs do not need a symmetrical supply. As the 12 V section can provide up to 3 A, it is possible to use extension boards equipped with internal 5 V regulators.

Figure 1. Three mother boards: a virgin, a partly built, and a fully constructed model.

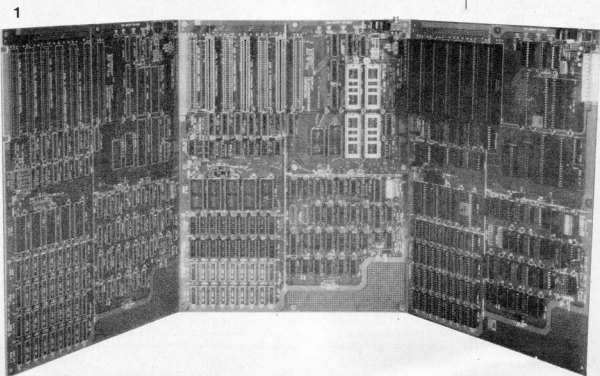

1

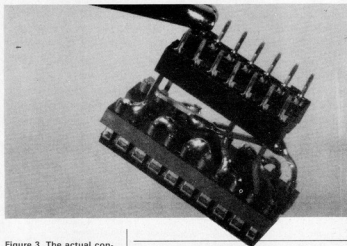

Figure 3. The actual construction of the circuit in figure 2.

Even then, there is sufficient power in reserve for the motor of a Winchester disk drive.

Adequate cooling of the power transistors is imperative; we have mounted them on a generous heat sink, so that thermal problems will not be encountered.

Furthermore, we have added the *micro-computer power supply protection circuit* originally published in the August/September 1984 issue of *Elektron* — p. 8-87 in somewhat modified form as shown in figure 7. The modification consists of  $S_2$  being replaced by a wire link and placing a push button switch in series with a 1 k resistance across  $D_3$ . The function of the new switch is to ensure that the 12 V line is always switched off before the 5 V line, so that the read/write head of the drives can never be loaded uncontrolled at switch off. This measure is not strictly

Figure 4. The type 75477 IC in the  $U_{47}$  position may be replaced by a MOSFET as shown.

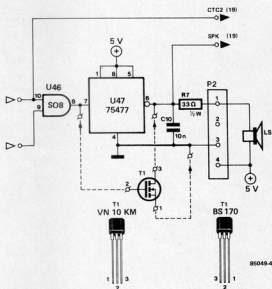

necessary with modern drives, because these are normally already provided with this protection. However, if you are not sure, or you have an older drive mechanism, it is safest to fit the switch! The original printed circuit board of both the power supply (84477) and the protection circuit (84408) can be used without modification.

### Intermediate test

The EPROM containing the BIOS (basic input output system) also has some self-test routines with which the operation of the mother board can be checked.

First, however, we advise you to thoroughly test the power supply before connecting it to the mother board: we tested ours with resistive loads for 15 hours, but in your case, two hours should do nicely. Once that has been completed satisfactorily, the supply can be connected to the board. Then, contacts  $SW_1$  and  $SW_2$  of the DIL switch on the board should be closed (= on = logic 0), which indicates to the MEGA BIOS that there is no arithmetic processor present, and that a RAM test need not be carried out. If the latter were omitted, the test program would try to test the RAM on the video card, and, of course, there is no RAM as yet.

If everything is in order, the loudspeaker should emit a short high frequency tone some seconds after the supply has been switched on, and also when the reset switch is pressed.

After that, it is best to follow the *Testing and Debugging* instructions. However, in our experience, neither a 100 MHz oscilloscope, nor a logic analyser is necessary; a 10 MHz scope is perfectly adequate.

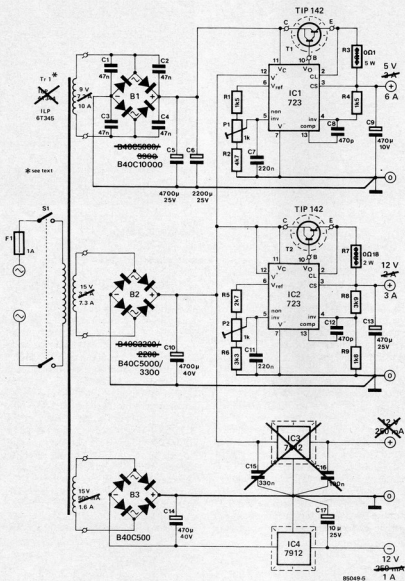

Figure 5. The power supply is an adaptation of a previously published Elektor design.

### Video/floppy controller card

There are several video/floppy controller cards on the market, either in kit form or ready made. We have chosen a black and white video controller that was provided with a printer interface. Construction of this kit was simplicity itself, but its IBM compatibility raised a problem: IBM uses a line frequency of 18 432 MHz instead of the usual 15 750 MHz. This meant we could not use a normal monitor without some modification. This modification is an interface between the card and the monitor as shown in figure 8. The printer interface will be reverted to later.

There is not much to say about the floppy controller card, other than that it is used with the Shugart bus. Only when it is connected to external drives is it necessary to

make a connection between the drive(s) and the D connector specially provided for this purpose on the card. Connections are shown in figure 9.

### Case

Be careful when buying the case: there are at least four versions of the mother board and each has its own case. The four cases are not interchangeable.

### Final test

Connect the monitor, open SW<sub>1</sub>, and switch on the mains. If everything is in order, the loudspeaker, as before, should emit a high frequency tone. During the self-test procedure, the words TESTING



6a

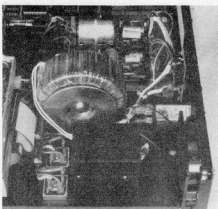

Figure 6. These photographs show how the power supply is fitted in the machine.

6b

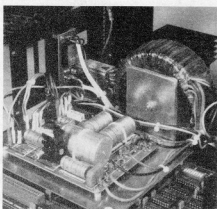

Table 1a.

Testing Memory /  
Testing Memory /  
Testing Memory /

Table 1b.

MEGA-BIOS V1.0  
© Display Tele-  
communications  
Corporation 1983

Table 1c.

Insert diskette in  
Drive A  
Press any key

Figure 7. The power supply protection circuit is also a slightly modified previously published Elektor design.

MEMORY appear on the screen, followed by an alternately left and right slanting line as shown in table 1a. After the tone has been emitted by the loudspeaker, the content of table 1b should appear on the screen, followed by the content of 1c.

At this stage, we ran a series of programs on our prototype: PC-DOS 2.0; PC-DOS 2.1; the entire commercial program of our accounts department (who use an IBM PC); an IBM word processor program; and an IBM flight simulator program. All these presented no problems at all.

MS-DOS programs may, however, give trouble, because these are often adapted to the slightly deviating hardware of other computers.

One problem we encountered here is that BASIC ROMs are not available from IBM, so that ROMs, or EPROMs, of other manufacture had to be used. Fortunately, these proved to be 99 per cent compatible. If you want full compatibility, it is possible to load an independent BASIC, for instance, GWBASIC, from a floppy disk.

### Cards, cards...

We received virgin as well as fully constructed boards from a number of suppliers, so that we had ample opportunity to assess and compare the different versions.

The original Mega board is of high quality and can be recognized by the inscription DTC. The copies we received were of similar quality, so they should prove perfectly usable. But find out what documentation is provided with the copied boards! The Super XT/PC board appears to be of very good quality, and is cheaper and smaller than the Mega board. We have not yet been able to test this fully, though.

This board can accommodate eight EPROMs against only five on the Mega board. Moreover, just one IC is sufficient to determine which EPROMs can be selected. Figure 10 clearly shows the difference in size between the two boards. With the Mega board, it is simple to choose between 64 K DRAMs (= 256 Kbyte on the mother board), and 256 K DRAMs

## 7

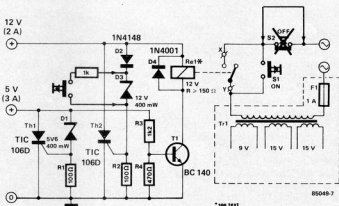

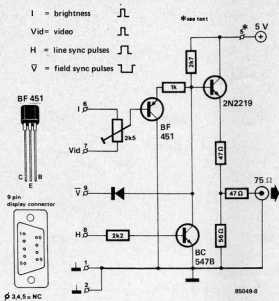

Figure 8. Interface required between the monitor and the computer.

(=1 Mbyte on the mother board). It appears that this can also be done with the Super XT/PC board, but nowhere in the documentation is it stated how.

In general terms, the documentation supplied with the Super XT/PC board is considerably less detailed than that of the Mega board. So much so, that on quite a few occasions we were glad to have the IBM PC manual to hand!

The connections to the extension cards on both types of mother board are identical to those provided in the IBM PC, so that all extension cards, including the hard disk controller of Western Digital, could be tested at once. Every one of them

worked first time without any hitch. The most important of these extension cards were:

- black and white video card with printer interface;
- graphics colour video card with printer interface;
- multi-function card (memory extension — clock — calendar — cartridge adapter — and so on);
- hard disk controller.

Other cards available include digitizers, digital to analogue converters, and others. A selection of these cards (by no means all) are shown in figure 11.

Figure 9. Connections to the external floppy drives.

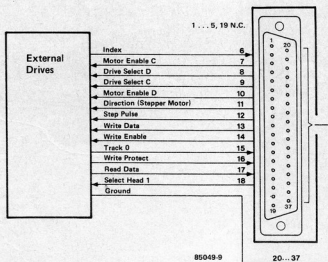

10

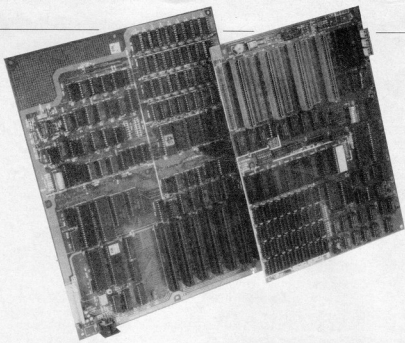

Figure 10. This photograph clearly shows the difference in size between, at the left, the Mega board and the Super XT/PC board.

### Peripheral devices

To use a computer to the full, a number of peripheral units, such as a monitor, keyboard, printer, drive, and so on is required. We have already discussed the monitor.

We have tested three different keyboards which are shown in figure 12. The Staff K4 was the least expensive, and its connections are virtually the same as those of the IBM PC. The Preh Commander PC1 has rather more keys, and can also be connected without any problems. We found the arrangement of the keys better than on the K4 and the IBM PC.

The RAFI keyboard 3.94000.022 has not only the longest type number but also the greatest number of keys. In fact, there are so many that on a first glance one doubts whether they all have a purposeful function: they have! It is, however, also the

most expensive of the three.

The best keyboard of the three? Our designers could not agree on the best compromise between performance, price, and convenience. It really is a matter of personal preference and taste.

Another important peripheral is a printer. If you do not yet possess one, we can only advise you, if you can possibly afford it, to get an IBM PC compatible type. This is because the IBM PC — and the present compatible micro — offers many graphics and special characters. If you use a normal printer with Centronics interface, you can, of course, print all the usual characters, so that BASIC and similar listings present no problems. The connections of the relevant D connector are shown in figure 13.

There are also specially modified printers available that have the IBM graphics and special characters in a PROM or EPROM.

Figure 11. A selection of extension cards for use with the IBM PC and compatible micros.

11

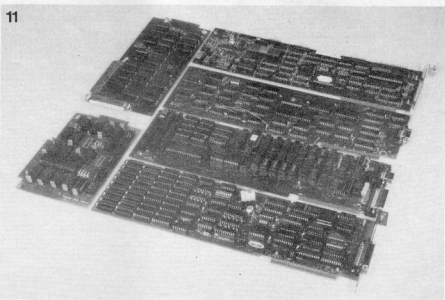



Figure 12. Our prototype together with two other keyboards we have tested.

### Summary

As we stated at the beginning, this project can be tackled by anyone with a fair amount of experience in electronics construction. The parts and components are available from specialist suppliers and, other than the few difficulties stated in the text, we had no trouble in getting them. Building this compatible yourself is cheaper than buying the ready made

article only if you already have a number of the required parts, such as the power supply, drives, and so on. If you start from scratch, doing it yourself works out at about the same expense as buying an IBM PC! But, of course, when you build it yourself, you will know the machine inside out, and gain a lot of valuable experience in computer technology. And that is worth a great deal, too!

### 13

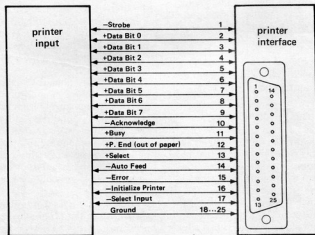

85049-13

Figure 13. Connections between the printer interface and the printer.



# RAM used as EPROM

As long ago as December 1981, we acquainted you with an easily programmed replacement for the 2716 EPROM: the IPROM. In October 1984, we introduced you to MOSTEK's 48Z02, which is compatible to both the 6116 RAM and the 2716 EPROM. It is now time to make you familiar with a replacement for the widely used type 2732 EPROM, consisting of two battery buffered 2 Kbyte RAMs type 6116, which can simply be inserted into the available EPROM socket. With a small additional extension, the circuit can also be used as a substitute for the less common type 2532 EPROM.

pseudo 2732

The principle of the circuit is quite simple: instead of in a 4 Kbyte type 2732 EPROM, the data is stored in two 2.2 Kbyte type 6116 RAMs. The 6116s are mounted on a small board which can be inserted into the socket intended for the 2732. When the power to the computer is switched off, batteries take over the supply of the two RAMs. As the current consumption of the 6116s is very small, the stored data can be retained in this way for over a year. The circuit behaves, therefore, as an EPROM that may be programmed like a RAM.

## The circuit

The circuit diagram in figure 1 shows that a total of twenty lines are simply interconnected: the complete data bus, the address bus up to terminal  $A_{11}$  of the EPROM socket, and the  $\overline{OE}$  (output enable) terminal. Each of these lines has been provided with a pull-up resistor to ensure uniform signal levels. These twenty lines do not further concern us here, as their function is the same as with an EPROM or a normal static RAM.

As regards terminals  $A_{11}$  and  $\overline{CS}$  of the EPROM socket, it is essential that the correct pin of both 6116s is connected to these, and this is ensured by a 2-bit binary decoder in  $IC_2$ . Pin 3 of  $IC_2$  is at earth potential when the power to the computer is on, and this enables the decoder. The truth table for this situation is given in table 1.

Of interest are the situations in which the  $\overline{CS}$  line goes low. If address line  $A_{11}$  is also logic low, output  $J\overline{0}$  becomes logic 0, and this results in  $IC_2$  being selected. If, however,  $A_{11}$  is logic 1, output  $J\overline{2}$  goes low, and  $IC_1$  is enabled. Pull-up resistors  $R_{21}$  and  $R_{22}$  ensure uniform signal levels. The  $\overline{NWDS}$  (negative write data strobe) signal is applied to the  $\overline{WE}$  (write enable) input of both 6116s via  $WP$  (write protect). This signal has quite different designations ( $\overline{WR}$ ,  $R/\overline{W}$  combined with  $\Phi_2, \dots$ ) in different computers, but is available in all of them: it is just a question of finding the line which, when logic low, enables loading the memory. If link  $WP$  is not closed, writing into the memory is not possible, and the stored data are then protected. Resistor  $R_{23}$  is the pull-up resistor for this line.

The necessary change-over to the back-up battery has been kept as simple as possible: when the supply from the computer is present,  $D_2$  conducts, and when it is not,  $D_1$  conducts. As the cathodes of these diodes are connected in opposition, and either the supply from the computer is higher than the battery voltage, or vice versa, there is virtually no change-over delay.

If a NiCd battery is used, this is charged via  $R_{24}$  when the computer supply is present.

When the supply from the computer is present,  $D_3$  lights, and  $T_1$  is on. The  $\overline{G}$  pin of  $IC_3$  is then connected to earth and the

decoder in IC<sub>3</sub> is enabled. Diode D<sub>3</sub> should be a red LED: the different resistance of LEDs of another colour would shift the switch-on point of T<sub>1</sub>. It is clear from the above why IC<sub>3</sub> should be an HC or HCT type: the decoder

It is theoretically possible that the circuit malfunctions, but only through a fault of the computer. It may happen that for some reason the supply voltage in the computer rises relatively slowly after switch on. The power-on reset is then actuated relatively long after switch on, and in the interval spurious pulses may cause erroneous writing into the RAMs.

RAM used as EPROM

This can be prevented by connecting R<sub>23</sub> to the junction of D<sub>1</sub> and D<sub>2</sub> instead of to the computer supply as shown in figure 1.

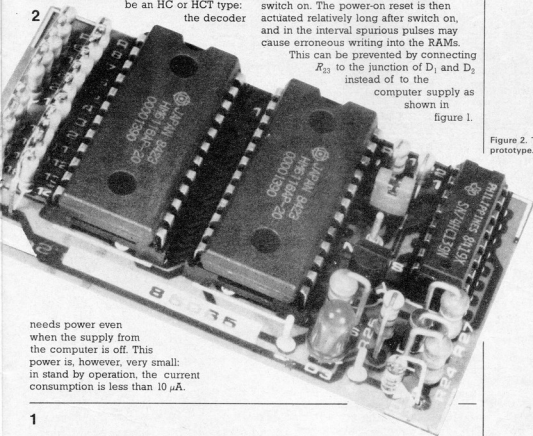

Figure 2. Top view of our prototype.

needs power even when the supply from the computer is off. This power is, however, very small: in stand by operation, the current consumption is less than 10  $\mu$ A.

1

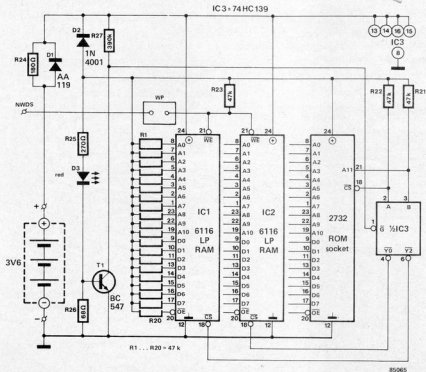

Figure 1. The circuit diagram of the pseudo 2732.



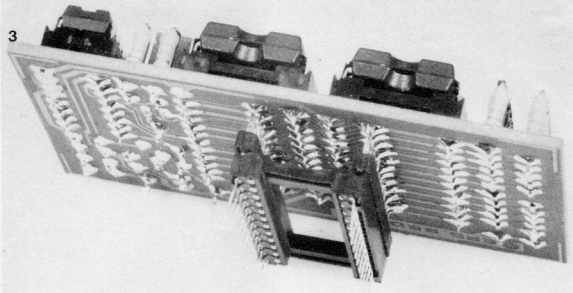

Table 1.

A <sub>11</sub> = B	CS = A	J0 = CS IC <sub>2</sub>	J1	J2 = CS IC <sub>1</sub>	J3
0	0	0	1	1	1
0	1	1	0	1	1
1	0	1	1	0	1
1	1	1	1	1	0

Table 1. Truth table of the binary decoder in IC<sub>3</sub>; for the purposes of this article, only J0 and J2 are of interest.

Figure 3. Underside view of our prototype.

Figure 4. The printed circuit board of the pseudo 2732.

Figure 5. The interconnections required for the construction of an adapter plug for use where a 2532 needs to be replaced.

#### Parts list

Resistors:  
(all resistors are 1/8 W)

R<sub>11</sub>...R<sub>21</sub> = 47 k  
R<sub>24</sub> = 180 Ω  
R<sub>25</sub> = 270 Ω  
R<sub>26</sub> = 60 Ω  
R<sub>27</sub> = 390 k

#### Semiconductors:

D<sub>1</sub> = AA119  
D<sub>2</sub> = 1N4001  
D<sub>3</sub> = LED, red, 5 mm  
IC<sub>1</sub>, IC<sub>2</sub> = 6116LP  
IC<sub>3</sub> = 74HC1139 or 74HC139

#### Miscellaneous:

NiCd or dry battery, 3V6 (3 × 1.2 V)  
Single row, 26 way, pcb type terminal strip  
Shorting plug (for WP)  
PCB 85065

For Components Sources See Page 7-7B

### Construction

The construction of our prototype is shown in figures 2 and 3. The printed circuit board used is shown in figure 4. We have used single row pcb type terminal strips for the connections at the underside of the board.

The EPROM socket in the computer should be of good quality, because the pins of the terminal strips are slightly thicker than standard IC pins. It may, therefore, be advisable to use an adapter socket as shown in figure 3.

4

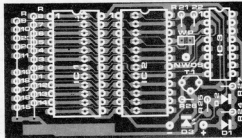
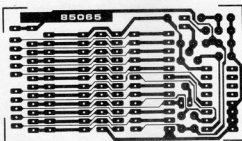

5

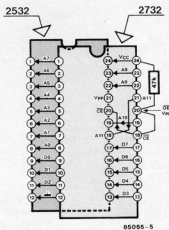

### 2532 extension

To enable 2532 EPROMs also to be replaced, it is necessary to construct an adapter plug from two 24-pin IC sockets; the interconnections are shown in figure 5. The 2732 socket must be the higher one of the combination. This adapter plug can also be used to substitute a 2732 EPROM for a 2532 type in an existing circuit (but not during programming!).

### A tip

It may be beneficial to reread the article *universal memory card* in the March 1983 issue of *Elektron (UK)*, which contains some fundamental and important information regarding CMOS RAMs, particularly the 6116. It also explains the necessity of pull-up resistors.

M

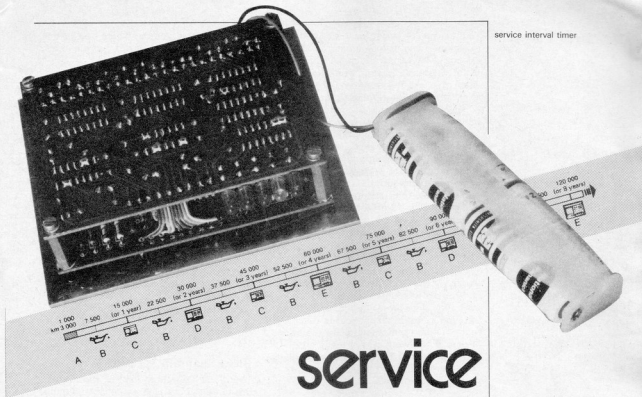

# service interval timer

One hundred years ago the horseless carriage was born, and what a birth that was, for the motor car, after a timed youth, has now become an indispensable part of our modern way of life. A century of development has, of course, brought about much improvement, fortunately so, as even a short quarter-century ago there were plenty of cars needing servicing every 500 or 1000 miles. Now the service interval for many cars is 12 000 miles. Ideal though this might seem, it is not faultless. Twelve thousand miles is more than six months driving for most people and it is easy to forget whether the last service was at 16 934 or 19 364 miles. Furthermore, mileage is only one of the factors that should be taken into account in considering when a car should be serviced. The speed and temperature at which the engine is run also play an important part.

A few (expensive) cars today provide the driver with an indication of how close the vehicle is to needing a service. Our circuit is modelled on these and bases its judgement on the three factors we have already mentioned. It then provides an indication by five LEDs, three green 'nothing to worry about', one yellow 'service not yet needed', and one red 'time for a service'.

Few and far between are the cars that today require any service attention at intervals shorter than every 6000 miles and even that is usually little more than an oil change. Service intervals are still, however, stated as if the distance covered was the only important factor. This is, of course, not so. The engine requires

regular attention but how often is a function of how hard it is used. Car manufacturers play it safe and specify a conservative service interval although they, more than anyone, know that neither hours of service nor distance covered is an infallible indication as to the engine's condition.

warns to have  
your car  
serviced

One car maker in particular, BMW, has questioned its customers extensively about how they use the car. A number of distinct types of journey were identified: short trips, starting from cold, long trips, consistently high-revolution running, and economical driving. A distinction could then be made of the most important factors affecting significant engine components. The studies revealed four factors that are of primary importance:

- the temperature at the start of a trip;
- the engine speed;
- the engine temperature; and
- the distance covered since the last service.

We will look at these in turn.

### The initial temperature

This is of vital importance to an engine's health. At our latitudes the winter is not necessarily warm (like last winter, for example). The lower the ambient temperature, the longer it takes a car to reach correct operating temperature. For the sake of our circuit, we have not made a point about measuring the engine's temperature but have just divided it into two ranges: above and below 50°C.

### Engine speed

In general, there is a point at which a car's fuel consumption increases noticeably. This occurs about half-way between the torque peak and maximum power. Every car is different, of course, but we have taken 4500 rev/min as an acceptable value.

### Operating temperature

Every engine has a specific operating

temperature at which it works best. If the actual temperature is lower than this ideal, the engine suffers.

### Distance covered

This has, until now, been the only factor quoted with reference to service intervals. As we know that just distance is not enough, we add the other factors stated and arrive at the following formula for effective distance:

$$D_e = [D(1 + P_t + P_s) / R_a] \text{ km}$$

where  $D_e$  = effective distance in km;  $D$  = measured distance in km;  $P_t$  = temperature penalty;  $P_s$  = rev/min penalty; and  $R_a$  = average engine speed for the journey. We picked the brains of the automobile industry for the values in the formula. For engine speeds above 4500 rev/min  $P_s$  has a value of 0.5; below this point  $P_s$  is 0. If the engine temperature is less than 50°C  $P_t$  is 1; above 50°C  $P_t$  is 0. What all this means for our circuit we will now see.

### Block diagram

The block diagram of figure 1 shows that this circuit contains three sensors: number of wheel revolutions = distance; temperature above or below 50°C; and engine speed above or below 4500 rev/min. It also has a section that makes a correction for the size of the wheels and this is connected to a divider and a display. We will look at each section in turn.

The distance sensor gives one pulse for every revolution of the car's wheels, which is translated into a certain number of pulses per kilometre (or mile). We consider this to be a better idea than an

Figure 1. This block diagram shows that the service interval timer is far from complicated. It takes the information provided by three sensors and calculates the effective distance covered since the last service. The way in which the car is driven determines the penalty (from 1 to 2.5) that is included.

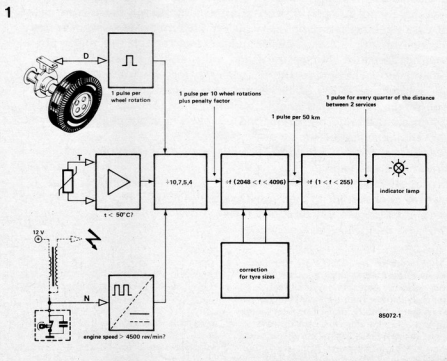

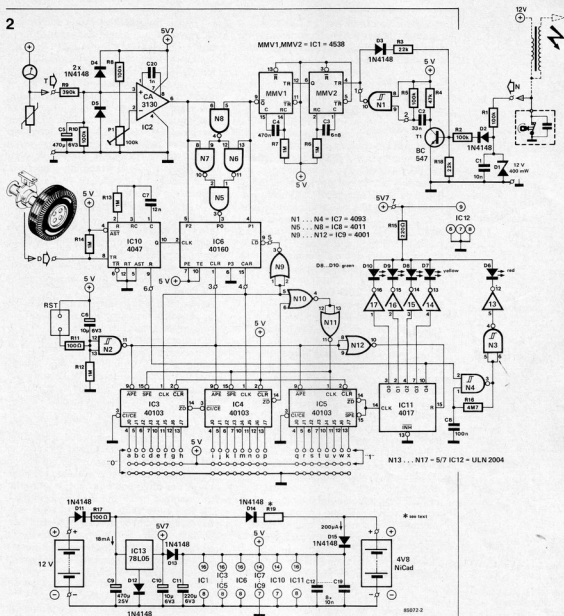

Figure 2. Although it looks a bit involved, the service interval timer circuit closely follows the block diagram. The three sensors are clearly visible and are connected via a number of programmable counters and dividers to the LED display section.

odometer giving a reading of the distance covered.

The engine temperature can be based on that of either oil or water and is one of the important operating conditions for the motor. The engine speed sensor only makes a distinction between speeds above and below 4500 rev/min. This is, of course, an arbitrary value, assuming that maximum power is developed at about 6000 rev/min. As a general rule this sensor should be set to a value of  $\frac{3}{4}$  the engine speed at maximum power.

These three sensors feed a programmable divider which introduces the penalty factors and provides one pulse per wheel revolution. This signal feeds a double programmable divider (with a compensation for tyre size) so that the resulting signal gives one pulse for every corrected 50 kilometres covered. This is then fed to

another programmable divider where the wanted divisor is set to control the decimal counter and the display.

### The circuit

The circuit of figure 2 looks a bit daunting at first sight but it is not at all complicated. We have used an existing sensor for the engine temperature by tapping the wire feeding the water temperature gauge on the dash. The output of the 3140 opamp flips from high to low as soon as the voltage applied to pin 3 becomes higher than that at pin 2. This must occur as the temperature rises to 50°C and is set by preset P<sub>1</sub>. Input P<sub>2</sub> of IC<sub>6</sub> is consequently taken either high or low. The engine-speed sensor should be well known to you by now as it has appeared

in *Elektr* before (in September 1984, to be exact). It takes the pulses provided by the car's contact-breaker (c.b.) points and shapes them into a useable form. It outputs a train of regular pulses that is applied to monostable  $MMV_1$  which, in combination with  $MMV_2$ , forms a frequency detector. The Q output of  $MMV_1$  remains high for about 6.6 ms (determined by  $T = R_6 C_3$  which corresponds to 4500 rev/min in a 4-stroke 4-cylinder engine. The actual frequency detected is 150 Hz, given by  $4500/60 \times 2$  (rev/min divided by 60 times 2 pulses per engine revolution). Below 4500 rev/min,  $MMV_1$ 's Q output is pulsed; above this value, the monostable is retrigged so the output is constantly high. The Q output of  $MMV_2$  is therefore permanently high and so also is input  $P_1$  of synchronous decimal counter  $IC_6$ , the output of which is therefore either logic 1 or 0.

The detector (a VDO pulse generator, Hall-effect device such as Siemens' HKZ101, or a reed relay and magnet arrangement) is connected to the revolution counter input. We will return to the set-up with a VDO sensor later in this article. Every time the wheel makes a complete revolution, the TR input of monostable multivibrator  $IC_{10}$  receives a pulse and then outputs a pulse whose duration is given by  $T = 2.48RC$ . In our circuit this works out at about 30 ms so that bounce in the detector will have no effect. A Hall-effect sensor is, of course, bounce-free. The Q output of this MMV then provides the clock signal for  $IC_6$ . Four NAND gates,  $N_5 \dots N_8$ , together form an XOR gate which combines the different signals provided by the temperature and engine speed sensors. If both of these factors are 'unfavourable' a logic 0 is applied to input  $P_0$ .

The three parallel inputs of the 40160,  $P_0 \dots P_2$ , accept a 3-bit binary word that can be 000, 011, 101, or 110. These correspond to decimal values of 0, 3, 5, and 6 and represent no penalty; a temperature penalty; rev/min penalty; and a combination of both, respectively. The 40160 counts from this input value up to 10. The relation between all the factors in question is shown in table 1, where we see the penalty in each case, the binary word input to  $IC_6$ , and the count needed. This latter is always the quotient of the number 10 divided by the penalty factor.

At optimal operating conditions, output pin 15 of  $IC_6$  gives one pulse per ten wheel revolutions. This CARRY OUT signal

is applied to the  $\overline{LD}$  terminal via inverter  $N_9$  so the IC starts counting again from the input value. Two programmable synchronous down-counters,  $IC_7$  and  $IC_8$ , form a 16-bit programmable divider, in which every rising edge of the clock signal decrements the count starting from the value applied to inputs  $J_0 \dots J_7$ . When the count reaches zero the  $\overline{CO}/\overline{ZD}$  output becomes active (logic 0). The values that should be fed to the J inputs are shown in table 2 and the circuit is thus tuned to the size of the wheel at which the sensor is. This is done by links a...k. As for the remaining links, l is linked to +5V and m...p to earth. This gives us a range of divisors between 2048 and 4096, but we are only interested in those between 2169 and 3236. The circumference of the wheel is taken to be the theoretical value; perfectionists may consider measuring the actual circumference but that is not really necessary.

As we have already hinted, the VDO pulse generator is a special case as it is already present on some cars' odometers (distance meters). The magnetic sensor generates six pulses for every rotation made by the speedometer cable. Where this sensor is fitted (on many Volvos, Mercedes', Opels, VWs etc.) a number between 542 and 975 is inscribed on the case.

If the sensor is numbered 700, for instance, the cable makes 700 rotations per kilometre and the sensor outputs  $700 \times 6 = 4200$  pulses in this period. For our circuit we want to reduce this to a single pulse per fifty kilometres so we multiply this number by 50 and then divide it by 10. This gives us the desired divisor of 21 000, from which we subtract 1 and convert the result (20 999) to the binary number indicating the straps must be set. This procedure is clarified by the example in the margin here.

What we achieve by all this is that the SPE output provides one pulse for a 'real' distance of 50 km. Another programmable synchronous down-counter,  $IC_9$ , is used to define the number of 50 km intervals counted before sending one pulse to decimal up/down counter  $IC_{11}$ . Keeping things metric, we have assumed that the service interval is 10 000 km so the distance between the lighting of successive LEDs is 2500 km. The divisor of  $IC_9$  is then 50. The actual programmed divisor is 49 as we must always subtract 1 from the desired value. The resulting binary value of 110001 is fed to inputs  $J_0 \dots J_7$  of  $IC_9$ . Straps v, u, and q are tied to +5V and r, s, t, w, and x to earth.

Each pulse provided by the  $\overline{ZD}$  output increments  $IC_{11}$ , making the next output active and lighting the next LED via inverters  $N_{13} \dots N_{17}$ . The final (red) LED is made to flash by the multivibrator consisting of NAND gates  $N_3$  and  $N_4$  to draw the driver's attention to the fact that a service is due.

Two sections of the circuit have not yet been described, the first of which is

2 <sup>0</sup>	=	1 (a)
2 <sup>1</sup>	=	2 (b)
2 <sup>2</sup>	=	4 (c)
2 <sup>3</sup>	=	8 (d)
2 <sup>4</sup>	=	16 (e)
2 <sup>5</sup>	=	32 (f)
2 <sup>6</sup>	=	64 (g)
2 <sup>7</sup>	=	128 (h)
2 <sup>8</sup>	=	256 (i)
2 <sup>9</sup>	=	512 (j)
2 <sup>10</sup>	=	1024 (k)
2 <sup>11</sup>	=	2048 (l)
2 <sup>12</sup>	=	4096 (m)
2 <sup>13</sup>	=	8192 (n)
2 <sup>14</sup>	=	16384 (o)
2 <sup>15</sup>	=	32768 (p)

Converting the factor to a binary value:

20 999	-	32 768	is
negative;			
$J_7$ de $IC_9$ (p)	=	0,	
20 999	-	16 384	= 4 615 so
$J_6$ de $IC_9$ (o)	=	1,	
4 615	-	8 192	is negative;
$J_5$ (n)	=	0,	
4 615	-	4 096	= 519,
$J_4$ (m)	=	1	
$J_3$ (l)	=	0;	
$J_2$ (k)	=	0	
519	-	512	= 7, $J_1$ (j) = 1
$J_0$ (i)	=	0;	
$J_7$ (IC <sub>4</sub> ) (h)	=	0	
$J_6$ (g)	=	0;	
$J_5$ (f)	=	0;	
$J_4$ (e)	=	0	
$J_3$ (d)	=	0	
7	-	4	= 3, $J_2$ (c) = 1
3	-	2	= 1, $J_1$ (b) = 1
1	-	1	= 0, $J_0$ (a) = 1.

This gives a binary number of 0101000000111 that must be programmed at the inputs of  $IC_4$  and  $IC_5$ .

Table 1. Penalty factors, corresponding binary word input to  $IC_6$  and decimal value, and the count needed.

temperature (°C)	engine speed (rev/min)		P2	P1	P0	decimal value	count needed
	<4500	>4500					
> 50	1.0		0	0	0	0	10
		1.5	0	1	1	3	7
< 50	2.0		1	0	1	5	5
		2.5	1	1	0	6	4

Table 1.

called RST (reset). This consists of a pair of contacts connected to  $N_2$ . When the car has been serviced, these two contacts are closed briefly and the whole circuit is then reset.

At the lower right-hand corner of the circuit we see a NiCd 4.8 V battery that is kept charged via  $R_{19}$ . The charging current is taken as  $1/25$  of the nominal current which is 20 mA in this case. The car battery voltage and Ohm's law ( $R = U/I$ ) give the resistance. For a 12 V car battery  $R_{19}$  will be about 600  $\Omega$ .

### Construction

The printed circuit board shown in figure 3 reduces construction to a matter of correct and careful soldering. First, however, the board must be cut into two. As usual, make sure that semiconductors and electrolytic capacitors are fitted with correct polarity and we recommend that good quality sockets be used for the CMOS ICs. Check that all the links are fitted as there are a full dozen, not including those needed for programming. Nine short lengths of flexible cable are needed to interconnect the two boards. When you are sure the circuit is working correctly, the two boards can be fixed together like a sandwich, with the components in the middle. The LEDs must be mounted such that they all face forward. For the sake of aesthetics, rectangular LEDs can be used but if the red LED is not striking enough, a round version will give a better indication.

### Connections

#### The temperature detector

The vast majority of modern cars have a water temperature gauge and the simplest solution for our circuit is to tap the wire leading from sensor to meter and feed it to the circuit at point T. Then preset  $P_1$  is

Table 2.

type of tyre	circumference	divisor for 1 pulse per 50 km	links
125 - 15	184.1	2716	01010011101
135 - 12	165.2	3625	01111010010
135 - 13	173.3	2605	01101000110
145 - 10	154.3	3236	10010100101
145 - 12	170.5	2733	01101110110
145 - 13	179.4	2383	10001000000
145 - 14	166.4	2692	01001110111
145 - 15	174.4	2572	01000001101
145 - 16	182.5	2435	10001000000
145 / 70 - 12	165.9	2995	01110101010
155 - 12	175.6	2847	01100100000
155 / 70 - 13	184.3	2723	01011101000
155 - 14	171.6	2610	01000110011
155 - 15	179.6	2563	00111001010
155 / 70 - 12	165.9	2995	01111101000
155 / 70 - 13	171.7	2909	01101011110
165 - 13	180.9	2640	01001011001
165 - 14	176.7	2582	00111011111
165 - 15	204.7	2443	00110001100
165 / 70 - 13	176.3	2834	01100010101
165 / 70 - 14	184.3	2712	01010011010
165 / 65 - 13	171.1	2922	01101101011
165 / 65 - 14	177.1	2772	01011101001
175 - 13	173.9	2577	01000010101
175 - 14	201.9	2476	00110101101
175 / 70 - 13	180.7	2767	01011010000
175 / 70 - 14	188.7	2650	01001011011
175 / 70 - 15	176.7	2542	00111101111
175 / 65 - 14	183.2	2729	01010101010
185 - 14	181.5	2615	00101100000
185 / 70 - 13	185.1	2781	01010001110
185 / 70 - 14	193.1	2589	01000011110
185 / 70 - 15	201.1	2486	00110110111
185 / 65 - 14	187.3	2679	01001101111
185 / 68 - 14	181.5	2795	01011000100
190 / 65 - 200	200.1	2499	00111000100
190 / 55 - 240	172.5	2899	01101010100
195 - 14	212.2	2356	00100110101
195 / 75 - 14	202.6	2456	00110011001
195 / 75 - 15	211.6	2363	00100111000
195 / 70 - 14	197.5	2532	00111100101
195 / 70 - 15	205.5	2433	00110000010
195 / 60 - 14	185.2	2780	01010001101
195 / 60 - 15	193.2	2580	01000011101
205 / 75 - 15	216.3	2312	00100001001
205 / 70 - 15	209.9	2382	00101001111
205 / 60 - 13	181	2762	01011001011
205 / 60 - 14	187	2646	01001010111
205 / 60 - 15	197	2520	00111101011
205 / 55 - 16	190.5	2519	00110110000
215 - 15	238.5	2167	00001110011
215 / 75 - 15	221	2262	00010101111
215 / 70 - 15	214.3	2333	00100011110
215 / 60 - 15	208.0	2470	00110110111
220 / 55 - 245	198.7	2622	01000111111
225 / 75 - 14	217.7	2297	00011111010
225 / 75 - 15	225.7	2215	00010101000
225 / 50 - 16	190.4	2520	00110110001
230 / 70 - 15	220.9	2263	00011011000
235 / 75 - 15	236.4	2170	00001110111
235 / 70 - 15	223.1	2241	00011000010
235 / 60 - 15	200.3	2480	00101100001
235 / 55 - 15	208.9	2489	00101110101
255 / 50 - 16	207.0	2484	00010110011

service interval timer

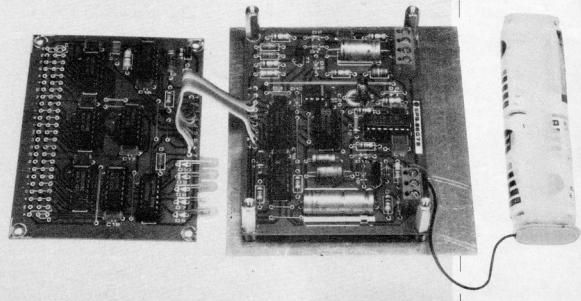

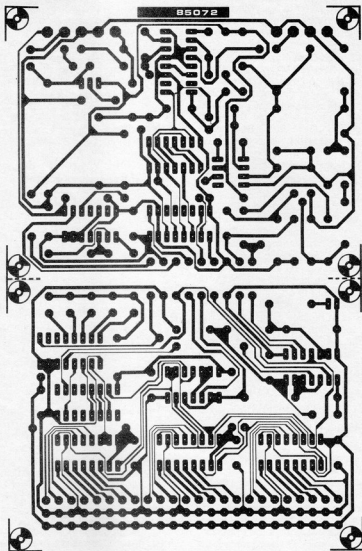

Figure 3. The printed circuit board consists of two parts that must be separated before assembly. They are then fixed together with spacers to form a sandwich.

that the sensor gives an output voltage directly proportional to the temperature, certainly in the range that is of interest to us. Such a sensor might also have to be earthed separately instead of using the single central earth that is sufficient for our circuit.

#### The distance sensor

We have already talked about the special situation presented by the VDO pulse generator. This, of course, requires no mounting as it is a standard fitting in some cars. All that is needed is to link its output to terminal D of the PCB. Failing this, either a Hall-effect sensor or a reed relay plus magnet can be mounted to give one pulse per wheel rotation. The reed relay/magnet solution requires care to avoid having the result corrupted by other magnetic effects in the car. Magnetism holds no fears for the Hall-effect sensor but, as figure 4 shows, the mounting position of this sensor is rather exposed.

#### The engine speed sensor

The engine speed measurement is based on the pulses provided by the c.b. points. All you need to do therefore is to connect terminal D to the line from the coil to the c.b. points.

#### Programming the dividers

The fitting of links a...x depends on the programming factors chosen. Start by inserting a...k to suit the size of the car's wheels. For a normal 13 inch wheel, for example (165/13, 155/13, etc.) the links must form the binary value 01001 0101 1001. It is clear from the printed circuit board itself how to program a logic 0 or a 1. Next you have to program the distance. During the description of the circuit we have taken a distance factor of one pulse per 50 km. This was chosen for simplicity's sake (and not through some zeal to banish the good old mile), but if a different value is chosen the programming is different. Actually it is far better to accept

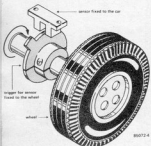

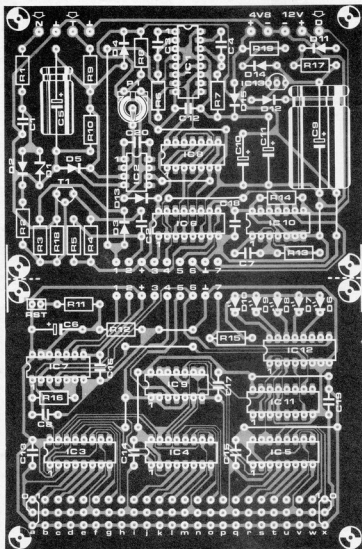

this one pulse per 50 km and add the correction you want in the next stage. In the text we have assumed a service interval of 10 000 km, corresponding to one pulse per 2500 km for the stage in question. Your car owner's manual probably states the service interval both in miles and kilometres but should this not be so or if the interval is not 10 000 km, IC<sub>3</sub> must be programmed accordingly. A service interval of 15 000 km gives a divisor of  $15000/4 \times 50 = 75$  resulting in a binary value of 10010101. The circuit can cater for service intervals up to 51 000 km and if you dare go that far without visiting a garage, don't expect any sympathy from us if you have problems.

### Fitting the circuit

The circuit should be mounted so that the driver sees the LEDs when they light and then the various connections must be made. It may also be fitted under the car bonnet where it will be seen when check-

ing the oil or water. The circuit is reset by bridging the RST contacts and the first LED should then light. All that then remains is to check that the other LEDs light at the right times (about every 2500 km in our example). In most cases, this will be 5 to 10 per cent less than the theoretical distance (between 2250 and 2375 for a theoretical value of 2500). Assuming again that we expect the LEDs to light at 2500 km intervals, the red LED can be expected at 9000...9500 km. This circuit is no intended to supplant all other forms of car maintenance. It remains just as important to check the oil and water regularly but the service interval timer will give you an idea of how mechanically sympathetic you are. Then you can plan your servicing more sensibly, and that is certainly laudable in these days of ever-increasing garage charges.

### Literature:

*Automonitor: Elektor May 1985*

### Parts list

#### Resistors:

- R<sub>1</sub>, R<sub>2</sub>, R<sub>5</sub>, R<sub>8</sub>, R<sub>10</sub> = 100 k
- R<sub>3</sub>, R<sub>18</sub> = 22 k
- R<sub>4</sub> = 47 k
- R<sub>6</sub>, R<sub>7</sub>, R<sub>12</sub>...R<sub>14</sub> = 1 M
- R<sub>9</sub> = 330 k
- R<sub>11</sub>, R<sub>17</sub> = 100Ω
- R<sub>15</sub> = 220Ω
- R<sub>16</sub> = 4M7
- R<sub>19</sub> = \*
- P<sub>1</sub> = 100 k preset
- \* = see text

#### Capacitors:

- C<sub>1</sub>, C<sub>12</sub>...C<sub>19</sub> = 10 n
- C<sub>2</sub> = 33 n
- C<sub>3</sub> = 6n8
- C<sub>4</sub> = 470 n
- C<sub>5</sub> = 470 μ/6V3
- C<sub>6</sub>, C<sub>10</sub> = 10 μ/6V3
- C<sub>7</sub> = 12 n
- C<sub>8</sub> = 100 n
- C<sub>9</sub> = 470 μ/25 V
- C<sub>11</sub> = 220 μ/6V3
- C<sub>20</sub> = 1 n

#### Semiconductors:

- D<sub>1</sub> = 12 V/400 mW zener
- D<sub>2</sub>...D<sub>5</sub>
- D<sub>11</sub>...D<sub>15</sub> = 1N4148
- D<sub>6</sub> = LED, red
- D<sub>7</sub> = LED, yellow
- D<sub>8</sub>...D<sub>10</sub> = LED, green
- T<sub>1</sub> = BC547
- IC<sub>1</sub> = 4538
- IC<sub>2</sub> = CA3130
- IC<sub>3</sub>...IC<sub>5</sub> = 40103
- IC<sub>6</sub> = 40160
- IC<sub>7</sub> = 4093
- IC<sub>8</sub> = 4011
- IC<sub>9</sub> = 4001
- IC<sub>10</sub> = 4047
- IC<sub>11</sub> = 4017
- IC<sub>12</sub> = ULN2004
- IC<sub>13</sub> = 78L05

#### Miscellaneous:

- 1 off 4.8 V NiCd battery (4.5 V might be sufficient)

For Components Sources  
See Page 7-78



A pantograph is an instrument with jointed rods for copying plans, drawings, etc., on any scale; the electronic version described in this article does so in graphics form on the monitor of a computer. It may also be used for drawing or writing direct onto the screen.

The instrument is connected to two analogue to digital (A/D) converters, which translate the coordinates into digital signals.

for use with a computer

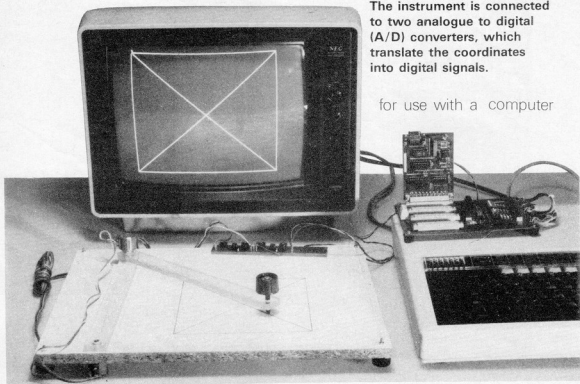

# electronic pantograph

At the point of origin in figure 1 is a potentiometer to the spindle of which one of the rods of the pantograph, of length  $R$ , is connected. When that rod is moved, the potentiometer setting is changed. If the potentiometer is positioned such that it is at zero when the rod coincides with the negative  $x$ -axis, its angle of rotation in figure 1 is  $\alpha$ . At the end of the rod is a second potentiometer, to whose spindle a second rod is connected, also of length  $R$ . The connection between the second potentiometer and second rod is such that the potentiometer is at zero when the two rods coincide. The angle of rotation of the second rod, and consequently the second potentiometer, with respect to the first rod is  $\beta$ . The coordinates of the end of the second rod,  $x_1, y_1$ , are calculated from the length,  $R$ , of the two rods, and the angles  $\alpha$  and  $\beta$ .

Since the potentiometers are potential dividers, the voltage at their wipers is directly proportional to their angle of rotation. These voltages are translated by analogue to digital converters into binary digits (=bits) from which the computer can calculate the  $x$  and  $y$  coordinates. As the total reach of the pantograph is  $2R$ , the drawing area should be a square with sides  $1.414R$  or a rectangle with a long diagonal of  $2R$ . Note that the pantograph

is intended for use in the first and fourth quadrants of a polar diagram; our prototype is for the first quadrant only.

## The electronics

The electronics required for the transfer of the analogue output of the potentiometers to the A/D converters is minimal, as shown in figure 2 for one potentiometer. The signal from pantograph potentiometer  $P_1$  is applied to the non-inverting input of operational amplifier  $IC_1$ . The inverting input of  $IC_1$  is connected to  $P_2$  which serves to set the point of origin (i.e., compensates for the offset of the opamp).

Figure 1. This diagram illustrates the operation of the pantograph. Coordinates  $x_1, y_1$  are calculated from  $R$  and angles  $\alpha$  and  $\beta$  according to the following formulas.  
 $x_1 = R[\cos(\beta - \alpha) - \cos\alpha]$   
 $y_1 = R[\sin(\beta - \alpha) + \sin\alpha]$

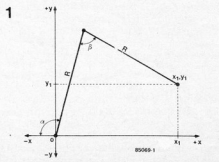

2

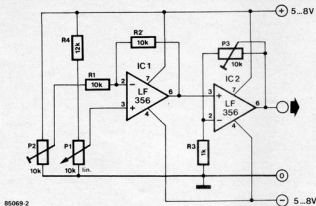

85069-2

Figure 2. Two ICs provide the coupling between each pantograph potentiometer and an A/D converter. Potentiometer P<sub>2</sub> provides offset compensation, while P<sub>3</sub> sets the amplification of IC<sub>2</sub>.

Figure 3. Possible construction of the electronic pantograph. The drawing area here only covers the first quadrant of a polar diagram.

Figure 4. Flow chart giving guidelines on how the associated program must be designed.

3

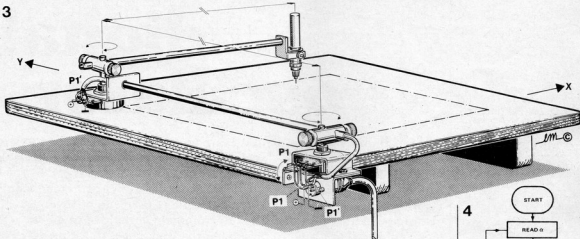

85069-3

A second operational amplifier, IC<sub>2</sub>, provides direct voltage amplification as required; the gain may be set between 0 dB and 21 dB with P<sub>3</sub>. The output of IC<sub>2</sub> is fed to the A/D converter.

Each pantograph requires two circuits as shown in figure 2: one for each of its potentiometers.

The power supply for the circuits must be well regulated: its current consumption amounts to only a few milliamperes.

The A/D converters may be constructed as described in *digitizer* in the May 1985 issue of *Elektor*. If you use this, you need only one because it has switched inputs.

### The mechanics

The mechanical part of the pantograph is fairly simple and will not be described in detail, because the construction depends largely on the materials used. It is important to use good quality potentiometers; we found the best linear behaviour in ten-turn wire-wound types. The rod connected to the potentiometer in the point of origin must be mounted so that it can move freely between the negative and positive  $y$  axes. The second rod must be fixed to the relevant potentiometer spindle so that it can move freely between 0° and 180° with respect to the other rod.

### Calibration

When the pantograph is ready and connected to the computer and monitor via the A/D converter(s) and universal I/O bus, let the rods coincide over the negative  $x$  axis (so that both  $\alpha$  and  $\beta$  in figure 1 are 0°). The computer should contain a program for the reading of the A/D converters: this is described in the *digitizer* article referred to. Then adjust the output of IC<sub>1</sub> (for both pantograph potentiometers) to exactly 0 V with P<sub>2</sub>. Finally, position the rods at maximum angle of rotation (i.e., along the positive  $x$  axis), and adjust the output voltage of IC<sub>2</sub> (for both pantograph potentiometers) with P<sub>3</sub> until the A/D converters have an output of 255.

### Finally

The program for processing the information from the pantograph depends entirely on the applications. In most cases, it will be required to display on the monitor screen the pattern being traced with the pantograph. Provided you have some experience in BASIC programming and computer graphics, such a program should not be too difficult to design.

4

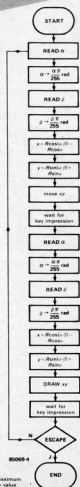

85069-4

$a$  = maximum scale value

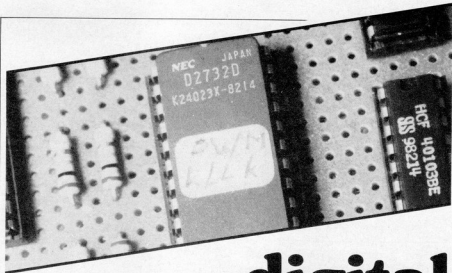

# digital oscillators

for music enthusiasts

One of the real problems in electronic organs, synthesizers, and other polyphonic instruments is the stability of the oscillators, and the more oscillators there are, the more important tight tolerances become. Every hobbyist who has ever worked on a circuit containing a number of oscillators will know what we mean. One of the methods used to solve (or avoid) this problem is the use of digital techniques and a crystal to determine the frequency. Unfortunately, this procedure brings with it a fixed phase relation between separate signals, which detracts from the naturalness of the sounds. As we were not satisfied with this, we designed three circuits that may be used to replace the voltage-controlled oscillator (VCO) in an existing design, or that may form the basis of a new design.

The duty factor of a digital (pulse) signal is the ratio of the pulse width to the pulse spacing. It is sometimes, quite wrongly, called the duty cycle.

In this article, a digitally controlled oscillator, DCO, is a circuit that generates rectangular signals with fixed or variable duty factor, the frequency of which is determined by a quartz crystal. The value of that frequency is related to that of the crystal by a microprocessor controlled programmable divider. The duty factor can be varied by the same divider.

## A first approach

Designing a DCO is no simple matter, not only in view of the theory involved, but also because of the sheer number of channels needed in a polyphonic musical instrument, such as an electronic organ,

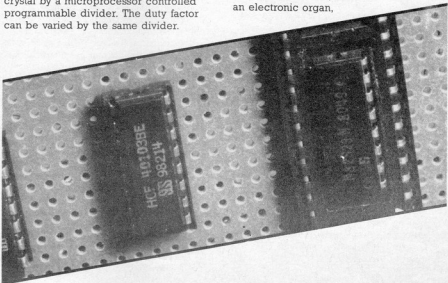

tone = a musical sound consisting of a pure note (UK)

= single sound of a given pitch and duration (USA)

note = single sound of a given pitch and duration (UK)

= a musical sound consisting of a pure note (USA)

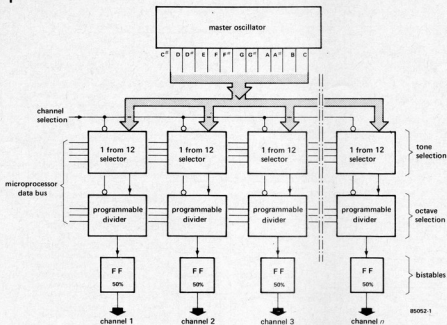

synthesizer, or piano. A single DCO is hardly ever encountered.

The schematic diagram of a possible DCO is shown in figure 1. The master oscillator generates the twelve tones of an octave from which one is selected. The frequency of that tone is divided by 1, 2, 3...n to determine the octave number above or below middle C (261.63 Hz). The duty factor of the resulting signal is fixed at 50 per cent by a bistable, after which the signal is fed to one of *n* channels.

Selection of the wanted tone, octave, and channel is effected by a microprocessor. The detailed circuit of one channel is given in figure 2: this must, of course, be duplicated as many times as there are channels required. The 74LS150 is used as a 1 from 12 decoder controlled by data lines  $D_8 \dots D_3$ . The binary input to these lines determines which of the 12 frequencies applied to inputs  $E_8 \dots E_{11}$  will be fed to pin 10. This output signal is taken to synchronous down-counter IC<sub>1</sub>, which is used here as a programmable divider.

The divisor is determined by the information present on the microprocessor's  $D_4 \dots D_0$  data lines. This information is first converted to a digital value by IC<sub>2</sub>, and results in at least one of outputs 0...7 being active at any one time. This produces preset values, and divisors, of: 1, 2, 4, 8, 16, 32, 64, and 128. Lines  $D_8 \dots D_5$  enable the required octave to be selected. To clarify all this, figure 3 shows some down-count cycles. The longer the down-count takes after APE has become active to reach zero (ZD active), the lower the frequency at the input. The bistable provides a train of very short negative pulses which have a duty factor of 50 per cent (i.e., they are square waves).

The circuit of figure 2 does not generate any signal, but is, rather, a sort of programmable interface between the microprocessor and the master oscillator. The master oscillator, the circuit of which is shown in figure 4, has buffered outputs which can, therefore, be applied to one more 1 from 12 decoders (figure 2). The set-up of figure 5 is quite different from

Figure 1. Block schematic diagram of a digital oscillator that may be the basis for a polyphonic musical instrument.

Figure 2. Each channel in figure 1 requires a circuit as shown here. The tone and the octave are selected via the data bus.

## 2

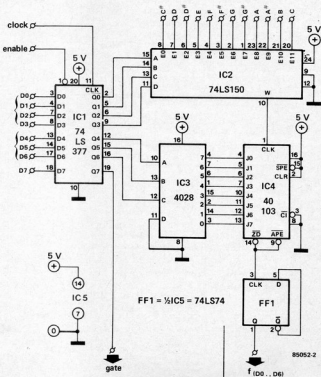

3

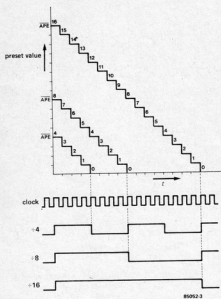

4

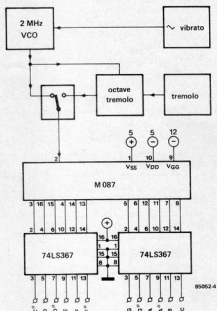

digital oscillators

Figure 3. The principle of the 40103 divider. The higher the preset value, the longer the counting process, and the lower the frequency.

Figure 4. The M087 is a master oscillator that generates the twelve tones of an octave. It may be driven by a crystal oscillator, as here, or by a voltage-controlled oscillator, possibly in conjunction with a vibrato and tremolo circuit.

Figure 5. An alternative for one channel from figure 1. Two programmable dividers ensure selection of tones and octaves.

Figure 6. The circuit diagram of the set-up in figure 5. The clock frequency is equal to the highest tone of the highest octave.

that in figure 1: it has no master oscillator, but simply a clock input, the frequency of which is a multiple of the highest tone in the top octave. This frequency is applied to two programmable dividers that select the octave and tone respectively. The circuit of this arrangement is shown in figure 6. The octave is selected by the microprocessor via retriggerable buffer IC<sub>1</sub> and then applied to a divider formed by IC<sub>2</sub> and IC<sub>3</sub>. The frequency of the output of IC<sub>3</sub> is a multiple of the tone which will be selected by programmable divider IC<sub>5</sub>.

5

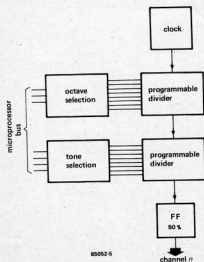

6

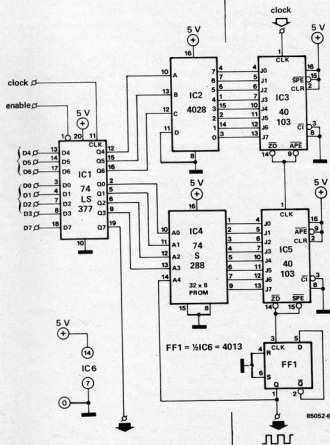

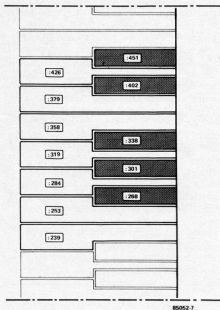

The ratio between successive tones in an octave is the 12th power root of 2, which is very nearly equal to 1.059. These ratios are provided as a matter of course in an IC like the M087, but they can also be obtained from the set-up in figure 6, consisting of divider IC<sub>5</sub>, PROM IC<sub>4</sub>, and bistable FF<sub>1</sub>.

The divisors required to resolve an octave into its constituent twelve tones are shown in figure 7. The 40103 on its own can cope neither with numbers larger than 256, nor with odd numbers, but, in conjunction with a PROM, IC<sub>4</sub>, and the bistable, it can. The basic divide information is selected via D<sub>3</sub>...D<sub>7</sub>, which are connected to address lines A<sub>3</sub>...A<sub>7</sub> of the PROM via IC<sub>1</sub>. By feeding back output Q of the bistable to input A<sub>4</sub> of the PROM, it becomes possible to split the divide process into two. During one part of the count cycle the output of the bistable is logic low, when the lowest sixteen addresses of the PROM are selected. A certain preset value for IC<sub>2</sub> then exists at the memory location selected by D<sub>0</sub>...D<sub>3</sub>. After this value has been counted, the bistable toggles, and the highest sixteen addresses of the PROM are selected. Lines A<sub>0</sub>...A<sub>3</sub> do not change, so that the preset value is then sixteen places higher than previously. After this preset value has been counted, the bistable toggles again, and the whole process starts afresh. The contents of the PROM are given in table 1. Note a small but important point here: because the SPE input is now used as the preset enable instead of the APE input, the divisor is the preset value plus 1. Therefore, the data values in table 1 are one lower than the wanted divisors.

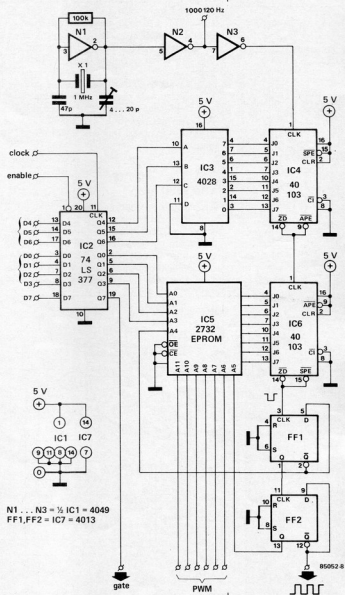

$$N1 \dots N3 = \frac{1}{2} IC1 = 4049$$

$$FF1, FF2 = IC7 = 4013$$

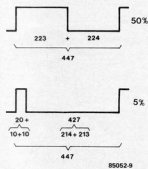

Figure 7. The divisors for resolving an octave into its twelve constituent tones.

Figure 8. This extended DCO provides twelve tones over eight octaves. The duty factor may be set between five and 50 per cent in sixty-four steps.

Figure 9. To achieve a variable duty factor, it is necessary to divide both count cycles once more: there are thus four count cycles per period.

Table 1.

A4	A3	A2	A1	A0	DATA	DATA
0	0	0	0	0	0	E8
0	0	0	0	0	1	D4
0	0	0	1	0	0	C8
0	0	0	1	1	0	BC
0	0	1	0	0	0	B2
0	0	1	0	1	0	AB
0	0	1	1	0	0	9E
0	0	1	1	1	0	96
0	1	0	0	0	0	8D
0	1	0	0	1	0	85
0	1	0	1	0	0	7D
0	1	0	1	1	0	76
1	0	0	0	0	0	E1
1	0	0	0	1	0	14
1	0	0	1	0	0	CB
1	0	0	1	1	0	BD
1	0	1	0	0	0	B2
1	0	1	0	1	0	AB
1	0	1	1	0	0	9F
1	1	0	0	0	0	8D
1	1	0	0	1	0	85
1	1	0	1	0	0	7E
1	1	0	1	1	0	77

Table 1. The content of the PROM in figure 6.

If we take as an example divisor 239 (which selects the highest tone in an octave),  $A_3 \dots A_0$  are logic 0. When  $A_1$  is low, the output of the PROM is 119 (77<sub>HEX</sub>), and when it is high, the output of the PROM is 120 (78<sub>HEX</sub>). The sum of the two is not a totally symmetrical square wave, but the very small deviation does not really matter.

If you want to experiment, it is, of course, possible to vary the ratios by programming different divisors. The phase relation between the harmonic frequencies is then also different, and this will affect the timbre.

### The final step

An extended version of the previous circuit is shown in figure 8. Here again, the main modification lies in the tone divider. The memory range of the PROM has been expanded greatly, which enables the use of digitally controlled pulse-width modulation. The total divide time remains as

before, but the divisors for the logic 1 and logic 0 periods are different. If we take as an example a divisor of 447, a duty factor of, near enough, 50 per cent will split this into 223 and 224. If, however, a duty factor of 5 per cent is wanted, the first part becomes 20 (as the logic 1 can last only one tenth as long as before), and the second 427. Once again, we have the problem of having to divide the second part into two (because the 40103 still cannot cope with numbers larger than 256). Therefore, a second bistable, FF<sub>2</sub>, has been added; its Q output is taken to input  $A_5$  of PROM IC<sub>5</sub>. In this way, a further division of both the first and the second part of the count cycle is effected.

Figure 9 illustrates what happens when a duty factor of 5 per cent is wanted. The divisors are 10 (1a), 10 (1b), 214 (2a), and 213 (2b). What was said earlier on about the relation between the sum of the stored preset values and the actual divisor is true here also. That is, preset value plus 1 is divisor. As this happens here four times, we must add 4 to the sum of 447 to obtain

## 10

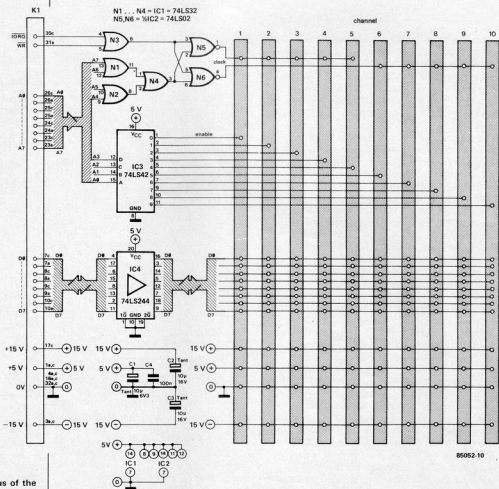

Figure 10. The bus of the polyphonic synthesizer can be connected to the DCOs in figure 2, 6, and 8 without any modification.

Table 2.

Table with multiple columns containing binary data (0s and 1s) organized in a grid format, likely representing digital oscillator outputs.

the actual divider of 451. This selects the lowest tone in an octave. It is, therefore, possible to use pulse-width modulation (PWM) by applying the modulating signal in digital form (6 bits) to the highest six address lines of the EPROM. This memory has been programmed such that the duty factor can be varied from 50 per cent to five per cent in 2^6 = 64 steps. Each step thus represents 0.7 per cent of the duty factor. Note that A11 provides the MSB (most significant bit).

Finally The circuit of figure 8 enables the selection via a microprocessor of one tone

from up to eight octaves, with the possibility of pulse-width modulation, in one channel. If you want to replace the VCO in the polyphonic synthesizer (described in a number of issues of Elektor (UK) between October 1981 and July 1982) by the DCO, the bus layout of figure 10 may be maintained. The EPROM content is given in table 2. In pulse-width modulation, the modulating signal is usually generated by an analogue low frequency oscillator and this must here, therefore, be followed by an analogue/digital converter. The use of the music quantizer (Elektor, November 1983, p. 11-18) may provide further interesting musical effects.

digital oscillators

Table 2. The content of the EPROM in figure 8.





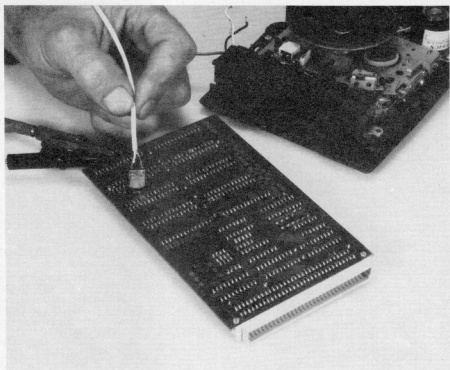

# the short search...

Like most of us, you must sometimes have cursed under your breath when tracing a fault took longer than building the circuit. Such an occurrence is particularly galling when you finally discover that the fault is not an electrical, but a "mechanical" defect, such as a hairline fracture in a printed circuit track, a dry soldering joint, and so on... It is unfortunately the mechanical defect that is so difficult to trace, often because the right test equipment is not available or simply too expensive.

...or the search for the short

Printed circuits are particularly prone to mechanical defects, especially when they contain many thin tracks. Finding the mechanical cause of a malfunctioning memory board, for instance, is certainly a time consuming job! Every conscientious hobbyist of course, checks his circuits carefully after completion, both visually and with a multimeter. But what do you do when you detect, say, a short-circuit and cannot locate it visually?

A simple test consists of removing all ICs from their holders in the suspected area and injecting an audio signal of about 1 kHz into the doubtful printed circuit tracks. The current consequently flowing through the tracks causes an electromagnetic field. This field can be detected with an old (but working!) recording head from a cassette or tape recorder: the out-

put of the head is applied to a small audio amplifier terminated in a miniature loudspeaker. When the recording head is passed over the relevant track, the audio signal is audible until the short-circuit is reached. It's as simple as that!

## Construction

As already stated, any old recording head may be used: frequency response and reproduction quality are of no consequence, as long as the head still works. An old cassette recorder of which the audio amplifier and loudspeaker (as well as the recording head) still work is ideal. The head is unsoldered from the recorder and fitted with a length of screened cable. The free ends of this cable are then

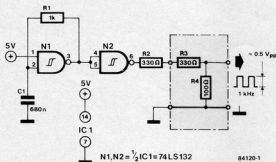

Figure 1. Simple square-wave generator with an output of about 1 kHz. The output level cannot be adjusted, but this is of little consequence, as the volume of the audio amplifier can be.

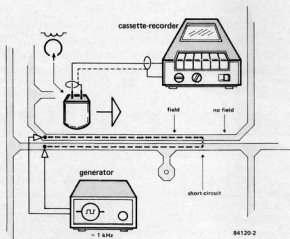

Figure 2. Example of how the search for a short-circuit may be carried out.

soldered into the position from which the recording head was removed. And that's really all. The head may, of course, be fastened onto a small length of aluminium tubing or even an old ballpen holder to make it easier to pass accurately over the printed circuit tracks.

### Testing

We can now find out what our little tester is capable of. But first we need an audio signal. If you have no a.f. generator, you may build the simple square-wave oscillator shown in figure 1. If you use an existing generator, it is recommended to connect a 100-ohm resistor in series with its output.

Short-circuit the output of the audio generator and bring it close to the recording

head (but do not touch). A signal is then induced in the head which becomes audible in the loudspeaker: the volume, where possible, may now be preset as required.

Next, connect the audio generator output to the two tracks that are suspected of being shorted (see figure 2). The search becomes a little more tricky when two adjacent pins of an IC socket are thought to be shorted because of the closeness of such pins.

If you want to test a completed printed circuit (not made by yourself), it is recommended to set the output voltage to  $0.4 \dots 0.5 V_{pp}$ . The generator in figure 1 should then be supplemented by voltage divider R3/R4 as shown.

Literature: *inCider*, October 1983

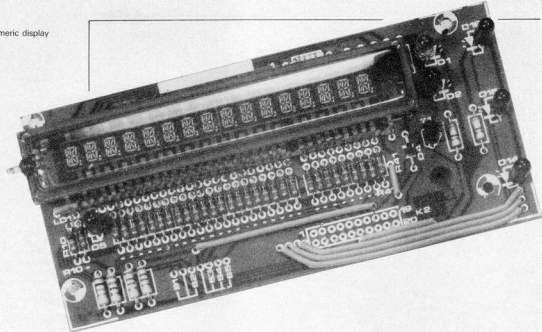

For some computer applications it is very convenient to have a one-line display with small dimensions and low current consumption instead of a complete monitor. A good example of this is the microprocessor-controlled frequency counter published in last February's issue. The sort of display and associated control electronics used there is also suitable for other mini-computer systems or circuits using a microprocessor so it is considered here as a separate unit.

# alphanumeric display

one complete line controlled by a single IC

Dedicated ICs can greatly simplify many applications in electronics. This is certainly true of the display module shown here. It consists mainly of an alphanumeric vacuum fluorescent display and a display controller IC. Numbers, letters and other characters (the whole ASCII character set, in fact) can be displayed. The text can also be made to move along the display.

The special printed circuit board developed for the display module has already been shown in the frequency counter article. A number of LEDs and switch connection points are included on the board even though they do not actually belong with the display. They do, however, make the unit more versatile and easier to tailor to other purposes. The layout of the board is universal so it can easily be used with other electronic circuits driven by a microprocessor. This latter point — that a microprocessor is used for control — is essential as the information must be sent to the display in a particular sequence.

## The circuit

There is very little to be seen in the circuit diagram of figure 1. The fluorescent display is accompanied by one IC and a few discrete components. Understandably,

the IC is somewhat special so we will have a closer look at that to make the circuit easier to understand.

The Rockwell 10937 is a controller IC for 14 or 16 digit multiplexed displays. Up to 16 digits and the associated decimal points and commas can be controlled at the same time. The display outputs can supply a maximum of 10 mA. All the timing for the display is handled by the IC itself so the processor system only has to provide the data for display and some control information.

The main parts of the IC are shown by the block diagram of figure 2. Data for display is loaded into the display data buffer via the serial data input. The timing and control block synchronizes the segment and digit output signals to ensure that the multiplexing is correct. The segment decoder contains the complete ASCII character set in a 16 x 64 bit PLA (programmable logic array). Two further blocks contain the segment and digit drivers.

Returning to the circuit diagram (figure 1) we see that the display's segments and digits are connected directly to the driver outputs of the IC. Each of the drivers is fitted with a pull-down resistor (R10...R41). Most of the remaining components are needed to power the unit. The V<sub>GS</sub> con-

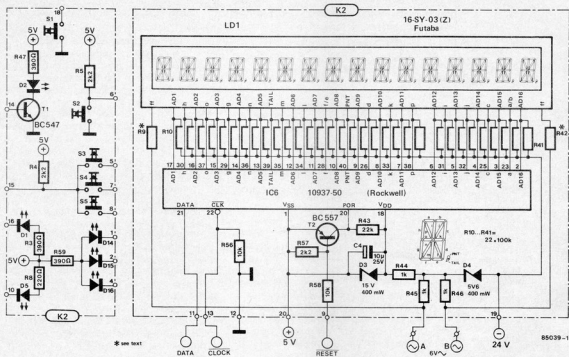

nection should be linked to the processor system's +5 V line. A -10 V supply feeds the  $V_{DD}$  connection via D3 and C4. The filament voltage for the fluorescent display is presented to points A and B. With the type of display indicated here this must be 5.8 V. A pair of resistors, R9 and R42, are used to reduce the transformer voltage to the right level. The value of the resistors is calculated by first connecting a 330  $\Omega$  resistor across the transformer and measuring the a.c. voltage across the load. Each of the resistors must then be given a value of  $[(57U-330)/2] \Omega$ , where U is the voltage measured.

The filament, which also acts as cathode, is fed a voltage of 5.6 V above the -24 V d.c. via resistors R45 and R46 and zener diode D4. This ensures that inactive segments of the display are actually turned completely off. The  $V_{SS}$  connection is the signal 'ground' line for the system. None of the power supply lines may be connected to the computer system's ground line. There is, of course, a ground connection on the printed circuit board but that is only for extras such as LEDs. In spite of the signal ground being at 5 V a '0' is still < 0.8 V and '1' is > 3.8 V with respect to the computer ground. The display can be reset by a negative pulse via R57, R58 and T2. This could also be a manual reset if a push-button is connected between R58 and the computer's ground line.

The circuit diagram includes some 'spare' switch connections, resistors and LEDs. These are free for each user's own purposes.

## 2

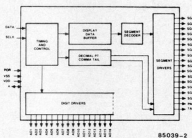

### The data format

The input data for the 10937 consists of a series of 8-bit data words. The first bit that is transmitted (b7) decides whether the IC must consider the present byte as control information or an ASCII character for the display. A '1' indicates control information and '0' represents display data.

There are three control codes:

- load the display data buffer pointer
- load the digit counter
- load the duty cycle register.

The layout of the control bytes is shown in table 1.

Load Buffer Pointer is used to move the display data buffer pointer to the desired character position so that the next character transmitted is placed in this position. To indicate the position the decimal position of the digit minus 2 is loaded into

Figure 1. This circuit diagram shows that the module contains only two major components: a 16-digit vacuum fluorescent display and a special controller IC.

Figure 2. The 10937 controls all the functions of the display. Here we see what it is made up of.

Table 1.

control word	code
LOAD BUFFER PTR (position of the character to be changed)	1010XXXX
LOAD DIGIT CNTR (number of digit position)	1100YYYY
LOAD DUTY CYCLE (on/off, brightness, timing)	111ZZZZZ ↑ control bit

XXXX gives the position of the character (4 bit word)  
YYYY gives the number of digit positions (4 bit word)  
ZZZZZ gives the number of clock periods for which a specific digit is on (5 bit word)

Table 1. This is how the control word is built up.

Table 2.

Display-Data	ASCII-Character	Display-Data	ASCII-Character
01000000	@	00100000	
01000001	A	00100001	!
01000010	B	00100010	"
01000011	C	00100011	#
01000100	D	00100100	\$
01000101	E	00100101	%
01000110	F	00100110	&
01000111	G	00100111	'
01001000	H	00101000	(
01001001	I	00101001	)
01001010	J	00101010	*
01001011	K	00101011	+
01001100	L	00101100	,
01001101	M	00101101	-
01001110	N	00101110	/
01001111	O	00101111	0
01010000	P	00110000	1
01010001	Q	00110001	2
01010010	R	00110010	3
01010011	S	00110011	4
01010100	T	00110100	5
01010101	U	00110101	6
01010110	V	00110110	7
01010111	W	00110111	8
01011000	X	00111000	9
01011001	Y	00111001	:
01011010	Z	00111010	;
01011011	[	00111011	<
01011100	\	00111100	=
01011101	]	00111101	>
01011110	^	00111110	?
01011111	_	00111111	?

↑ Control-Bit

↑ Control-Bit

Table 2. These are all the ASCII characters that are available from the 10937.

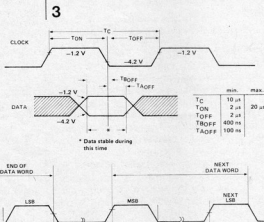

Figure 3. In this diagram of the timing for the clock and data input the voltages shown are measured with reference to the +5 V line.

this byte. The left-most display in the diagram is number 1. Below 0 the count continues downwards from 16 so digit 1 has a decimal value of 15 and digit 2 a value of 0.

The Load Digit Counter code is normally used in initialising to indicate the number of digits used. The multiplexer frequency is then modified to suit the number of active digits. For 16 digits the code used is 0.

Load Duty Cycle determines for how long the display is switched on and off and in this way the brightness can be set. Each digit has 32 clock periods available and can be switched on for a maximum of 31 of these. They must be off for at least one clock cycle out of every 32.

After a reset pulse (which is always a consequence of switching on the supply voltage) the following occurs:

■ the digit and segment drivers are all switched off

■ the Load Duty Cycle 'on' time is set to 0

■ the Digit Counter is set to 16 (bit code 0)

■ the Load Buffer Pointer is set to 15 (= digit 1).

After this the desired control information must first be provided. The order is not important:

Load Duty Cycle

Load Digit Counter

Load Buffer Pointer

Then come the ASCII codes. The buffer pointer is automatically incremented after each data word, except in the case of decimal points and commas. After digit 16 the pointer jumps to digit 1. If the digit counter is programmed so that not all the digits are used the duty cycle must be carefully chosen. If the number of digits used is 8, for example, the duty cycle must not be higher than 16, with 4 digits it is 8, and so on. If this is not done there is a danger of the display burning out.

There are a number of points to bear in mind when programming the processor. The clock and data line must be reset to zero immediately after switch-on or the circuit will act strangely. Timing also requires a certain amount of care. There must be at least 40 µs between the end of one data word and the start of the next. There must also be at least 120 µs between the start of one data word and the start of the next one (this is shown in figure 3). The display module has certain power requirements. It needs +5 V (supplied by the computer system), -24 V d.c. (with respect to the processor system's ground line) and an a.c. supply of 6 V.

The information in this article should be sufficient for you to write a program to show the desired characters on the display. Further information on the theory and background of the actual display can be found in the applicator on page 6-58 of the July 1983 issue of *Elektron*.

#### Literature:

Rockwell datasheet — 10937 alphanumeric display controller.

*Elektron* July 1983 — applicator, page 6-58.

While here on earth we discuss, seemingly *ad infinitum*, the pros and cons of alternative energy sources, there is not far from us — a mere 90.5 million miles (149.5 million kilometres) — a nuclear plant that has been going for the best part of 5000 million years and is estimated to go on for another 10 000 million years. The amount of energy this factory releases through nuclear fusion each second (it converts 600 million tons of hydrogen into helium at a temperature of 15 million degrees Celsius every second) is enough to meet our earthly needs for energy for a million years. That factory is, of course, our sun.

# solar battery

Although we know that the sun radiates all that energy into space — only an infinitesimally small part of it is absorbed by the earth and other planets in our solar system — we do not really know how to harness it on a large scale. How can we convert the solar energy falling onto earth into electric energy for powering our industries, transport, heating and lighting systems, and others?

## Heat and electricity

Who has not tried to set fire to a piece of paper with a magnifying glass? This is one of the oldest methods of converting solar energy. Archimedes used it successfully — with the aid of a parabolic mirror — in the defence of Syracuse. In a parabolic mirror, the energy falling onto a large area is optically concentrated in one point, called the focus. This leads to very high temperatures at the focus, which may, for instance, heat the water in the boiler of a steam engine that is used to drive an electric generator. A second method of gaining heat from solar energy has come about in the last decade: large solar collectors placed in south-facing roofs of buildings. In these, there is no focusing of energy; instead,

water flows through the longest possible path just under the surface of such collectors and is heated direct. This method is based on the principle of the heat exchanger.

A third method of using solar energy lies in the direct conversion of solar energy into electric current, and it is with this method that the present article is concerned. However, do not think that it will be possible to make use of a large part of the radiation released by the converting of hydrogen to helium at the core of the sun, as some simple arithmetic shows. The sun radiates equally in all directions. As the average distance from sun to earth is about 150 million kilometres, the (electromagnetic) radiation takes about 8 minutes to reach the earth. In those eight minutes, the total energy radiated by the sun has spread over the inside of a sphere of surface area  $3 \times 10^{17}$  km<sup>2</sup>. The total surface area of the earth that is being lit by the sun at any one time amounts to only  $113 \times 10^6$  km<sup>2</sup>. Even if we were able to cover that whole area with solar cells, we would receive only 3 tenthousandmillionth parts of the totally radiated energy. The rest (virtually all) is lost in the universe. However, the situation is not as hopeless as at first sight it may look, because only

the answer to our energy problems?

1

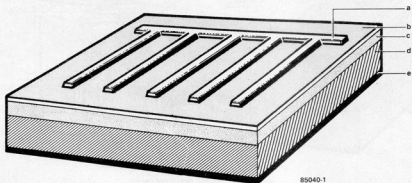

Figure 1. Schematic representation of a solar cell; note that the thickness of the front ohmic contact has been drawn highly exaggerated in comparison with the other dimensions.

- a = front ohmic contact ⊕
- b = anti-reflect layer
- c = p-n junction (Si)
- d = p-n junction (Si)
- e = contact plate (-)

85040-1

2

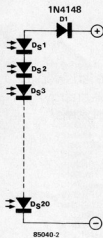

Figure 2. Circuit of the solar battery charger, consisting of twenty solar cells in series.

Figure 3. Construction of the solar battery charger showing how each cell is connected to the next by a short length of flexible stranded wire.

19 000 km<sup>2</sup> of solar cells would receive enough energy to meet the estimated world demand for the year 2000.

### Construction and operation of a solar cell

After the astronomical figures of the last section, we return to earth and the microscopic dimension of the cross section of a solar cell. The thickness of the cell shown schematically in figure 1 has been highly exaggerated in comparison with the surface dimensions.

A solar cell uses the photovoltaic effect to convert radiation from the sun into electrical energy. The photovoltaic effect arises when a junction between a metal and a semiconductor or two opposite polarity semiconductors is exposed to electromagnetic radiation, usually in the range near-ultraviolet to infra-red. A forward voltage appears across the illuminated junction and power can be delivered from it to an external circuit.

The p-n junction of which the cell consists has a relatively large surface area and relatively high efficiency (10...15 per cent). Solar cells are fabricated mainly from silicon, gallium arsenide, selenium-cadmium sulphide, and thin-film cadmium sulphide. As part of the radiation is reflected by the surface of the cell, an anti-reflect layer is incorporated to minimize reflection. The absorption coefficient is large for short wavelengths, and smaller for longer wavelengths.

The efficiency of solar cells reduces by about one half per cent for each degree centigrade rise in their body temperature, so that most cells must be suitably cooled.

Note, however, that this depends to a large extent on the material; gallium arsenide/gallium phosphide, for instance, has optimum efficiency at well over 100°C. The spectral response curve of a silicon cell indicates a useful range of wavelengths between 0.5  $\mu\text{m}$  and 1.0  $\mu\text{m}$ , peaking at about 800  $\mu\text{m}$ .

### Angle of incidence and atmospheric absorption

Placing the cells at right angles to the sun ensures that the highest possible amount of radiation falls onto the cell surface. It should, however, be noted that at our latitudes it is never possible to equal the amount of radiation that can be received in regions between the tropics of Cancer and Capricorn. The reason for this is that the distance the radiation travels through the atmosphere is shorter in these regions than at more northerly or southerly latitudes.

### Solar battery charger

The circuit of a solar battery charger, designed and tested by us, is shown in figure 2. It consists of twenty single solar cells connected in series. In the calculation of the required charging voltage, allowance must be made for the 0.6 V drop across diode D1. This diode is necessary to prevent the electrical battery discharging through the solar cells.

Specifications and technical data supplied by the manufacturers of solar cells must be treated with caution as they normally refer to optimum incidence of radiation, which, owing to climatological and

3

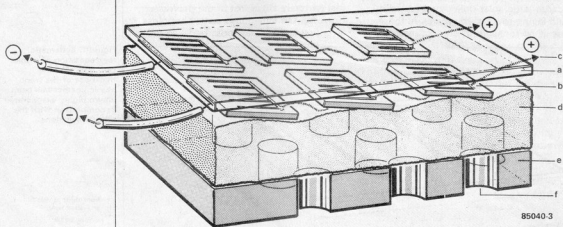

85040-3

- a = transparent or translucent plate
- b = solar cells
- c = flexible stranded wire
- d = expanded polystyrene
- e = base plate (plastic/nylon/wood/metal)
- f = holes for preventing heat currents

geographical factors, cannot always be realized. It is true that even under moderate light conditions the no-load voltage of a cell is about 0.5 V. However, the current produced by the cell is a function of the incident light radiation: this is shown schematically in figure 5 where the voltage/current characteristic of a cell moves further and further to the right with increasing radiation.

The characteristic in figure 4 shows the voltage/current relation of our solar battery charger. Measurements for this curve were taken on a sunny November day, in mid afternoon, at a latitude of about 51°N. Note that the maximum current is just about 20 mA, which is sufficient to charge a small electric battery. Increasing the load caused a voltage breakdown. It is clear that the optimum operating point is at the knee of the curve.

### Construction of the solar battery

The fragile solar cells are connected together with thin, **flexible** stranded wire. Solder one end of the short length of wire to the front ohmic contact (positive terminal) of one cell and the other end to the underside (contact plate) of the next cell as shown in figure 3. Where the solar battery is placed in the open, it is advisable to protect it from the environment by, for instance, housing it in a transparent or translucent case.

### Economics of solar cells

Although solar cells provide a promising alternative source of energy, the time is not yet ripe for terminating your contract

4

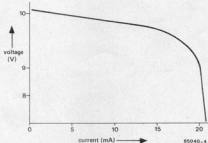

solar battery

Figure 4. Voltage vs current characteristic of the solar battery charger based on measurements on a sunny November afternoon at latitude 51° north.

with the Electricity Board. This is because for the generation of one kilowatt of power a solar battery with a surface area of 10 m<sup>2</sup> is required. As prices are still around 50p per square centimetre, that one kilowatt of power would be very expensive indeed — certainly compared with the few pence charged by the Electricity Board. None the less, solar cells have become, and will remain, the most important long-duration power supply for satellites and space vehicles.

5

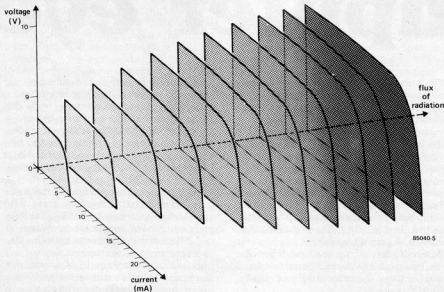
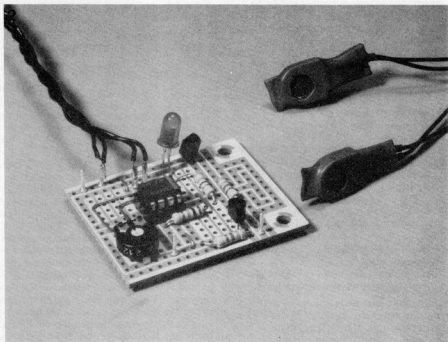

Figure 5. The voltage vs current characteristic of a solar cell is largely dependent on the incident flux of radiation. The larger the flux, the larger the current and, to a much lesser extent, the voltage.



This photograph shows our prototype of the 'computer eye' and, in the background, the LDRs fitted in shrink sleeves.



To put your mind at rest: the title does not imply that the circuit described here enables a computer to see. But if you want to use your computer for controlling external equipment without connecting this direct to the computer, the proposed circuit will 'keep an eye' on certain output signals of the computer and on that basis switch the equipment on and off. In other words, it provides an optical coupling between the computer and the equipment to be controlled. This does imply, of course, that a monitor screen is available and that the computer has some graphics facilities. Otherwise there would not be much to see for the eye!

# computer eye

control by  
monitor screen

The circuit is based on an opto-electronic comparator as shown in figure 1. The 'eye' proper is formed by two light-dependent resistors — LDRs — R1 and R2. The voltage level at their junction is applied to the inverting input of the comparator, IC1, via R4. The non-inverting input of IC1 is held at a fixed reference voltage. The comparator toggles when the level at its pin 2 is lower than the reference voltage. Transistor T1 is then on, and the relay is actuated. At the same time, T2 conducts, so that the LED, D1, lights to indicate the state of the circuit visually. When the level at the inverting input of the comparator is higher than the reference voltage, the relay is not energized, and D1 is out.

The idea is that the control program includes instructions which cause two

light areas to appear on the monitor screen as required. The intensity of one of these areas should be constant, while that of the second should be either low or high (dark or light). The preferred mode of operation is for the second area to be dark when the external equipment should be switched on, and bright when it is to be switched off.

The LDRs should be attached to the monitor screen where the two light areas appear. The voltage (about  $2V_{pp}$ ) at the junction of these resistors is a measure of the difference in brightness between the two light areas on the screen. Superimposed on this voltage is, of course, the sawtooth voltage produced by the 50 Hz line scan oscillator. Resistor R4 and capacitor C1, and to some extent P1, ensure that this sawtooth voltage does not

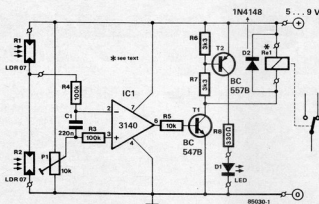

Figure 1. If you do not want to connect all kinds of equipment to your computer, you can still operate that equipment with this 'computer eye': an optocoupler which is nothing but a light-dependent comparator.

affect the correct operation of the comparator.

Construction of the circuit is not critical: all components, except the LDRs, are fitted on a small prototyping board. The LDRs are connected to this board by sufficiently long pieces of stranded equipment wire. It is recommended to fit them in suitable shrink sleeves or swathe them in insulating tape in such a way that only the light of the two areas on the screen falls onto them (see photograph). They can be attached to the screen with some self-adhesive tape. If the equipment to be controlled is switched on when it should be switched off, and vice versa, simply interchange the LDRs.

Presetting of the comparator is not critical as long as the change-over frequency of the two light areas is of the order of 1 Hz. In that case, P1 is simply set so that the relay is actuated and de-energized in rhythm with the change-over frequency. When that frequency is higher, e.g. when the circuit is used for data transfer, the presetting of P1 becomes more critical. The maximum allowable change-over frequency depends on the cut-off frequency of the low-pass filter, R4/C1, which here is less than 10 Hz. Optimum setting of P1 is then best achieved by applying a square-wave voltage at a frequency of about 8 Hz to the comparator input. Measure the output at pin 6 with an analogue voltmeter (10 V d.c. range) and adjust P1 so that this level is half the value of the supply voltage. Although the pointer of the voltmeter quivers somewhat, the setting can be carried out without any trouble. If you have an oscilloscope, it is, of course, preferable to use that for the presetting. Note that the current through the relay coil should not be too high: when a BC 547 is used for T1, it should not exceed

100 mA. That means that the resistance of the coil should be not less than 50  $\Omega$  for a supply voltage of 5 V, and not less than 90  $\Omega$  at 9 V. The rating of the relay contacts depends on the equipment to be controlled.

Current consumption of the circuit amounts to only a few mA plus the current drawn by the relay coil. For data transfer operation only, the relay is not required: the signals are then taken direct from the collector of T1.

### Did you know...?

Robot has come to mean an intelligent and obedient but impersonal machine; it is derived from the Czech *robota* — forced labour. The word robot was first used in Karel Čapek's play *Rossum's Universal Robots* (1920). (OED)

Gain is a ratio, normally expressed in dB. For an amplifier it is the ratio of output power to input power; for an aerial, it is the ratio of the voltage produced by a signal entering along the path of greatest sensitivity to that produced by the same signal entering an omnidirectional aerial. Although often used as such, it is not synonymous with amplification, which is a number indicating by how many times an electronic device increases an electrical signal. Gain is, therefore, 10 or 20 times the logarithm of the amplification, depending on whether that refers to a power or a voltage increase.

## Soldering Techniques

Soldering is the most common method of connecting electronic components and conductors together to construct a circuit. The technique of soldering is briefly introduced here.

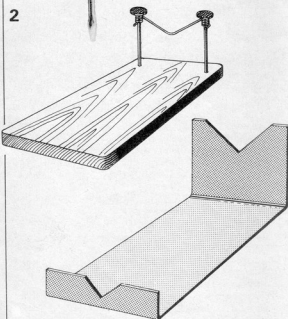
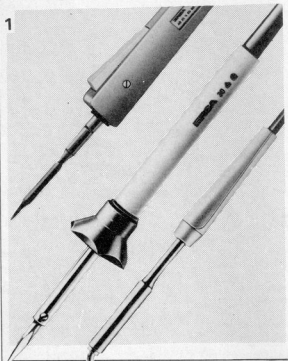

Figure 1.  
Different types of soldering irons, for the Electronics hobbyist.

Figure 2.  
Soldering iron stands can be easily made by yourself. Two simple and inexpensive designs are shown here.

### Soldering Iron and Solder Wire.

- \* A 15 or 25 W soldering iron is the most convenient for soldering work involved in SELEX projects. It can be purchased from any good electronics shop.
- \* Good solder wire consisting of 60% tin and 40% lead should always be used for good results. The core of the solder wire is made of flux which melts and evaporates while soldering and prevents oxidation.
- \* 1 mm thick solder wire should be preferably used.
- \* A stand for the soldering iron can easily be constructed or purchased.
- \* Soldering fluids/pastes etc. should be avoided. This may cause the soldered joints to corrode in future.

### Preparation for soldering.

- \* The leads of components which are to be soldered must be clean and free from oily & greasy substances. They may be cleaned with spirit if necessary.
- \* All the components should be properly positioned and the leads should be slightly bent on the track side of the PCB after inserting them through the holes.
- \* Soldering iron should be turned on, and its tip should be cleaned after it becomes hot with a piece of cloth or moist sponge to remove all oxidation residue before starting the work.
- \* Tip of the new soldering iron must be tinned at first. This is done as follows: The tip is heated sufficiently so that the solder wire quickly melts over it. The molten solder is wiped off and new solder wire is applied once again. This is repeated till the tip gets a uniform tin coating.
- \* The tip of the soldering iron should never be cleaned with chemicals or files etc.

### Soldering

- \* Both the surfaces to be soldered together are heated with the soldering iron tip.
- \* Solder wire is now applied. The molten solder must easily "Flow". Supplying the correct quantity is a matter of practice.
- \* The tip of the soldering iron is withdrawn within 1 or 2 seconds, and the soldered joint is allowed to cool. During this period there should be no movement at the joint, since it develops fine cracks in the soldered joint.
- \* A good soldered joint should look like the one shown in figure 3 (1st Sketch).

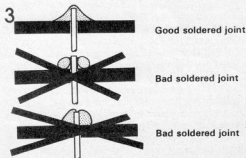

\* The components and conductors should not become too hot during soldering. This is particularly very important in case of semiconductors. The lead can be held with forceps to dissipate some of the heat.

## Conclusion

\* The lead ends which are jutting out can be snipped off at the soldered joints, with small cutting pliers. While cutting these bits of wire fly like small missiles,

take care that none of these hit your eyes.

\* To prolong the life of the soldering iron tip; it must be wiped clean and switched off after the soldering work is over, or in case you are going to stop for more than 15 minutes.

\* Dabs of soldering materials can be cleaned with petrol or nailpolish-remover. These solvents should be sparingly used as they can also dissolve the printed component layout on the PCB.

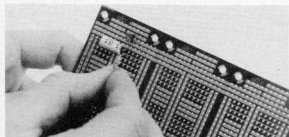

Figure 4.  
Insert the components in position.

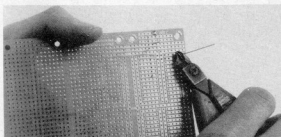

Figure 5.  
Bend and snip off lead ends.  
Snipping off can also be done after soldering.

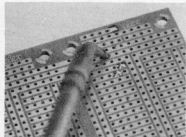

Figure 6.  
Heat both surfaces properly.

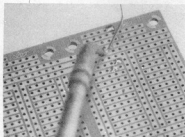

Figure 7.  
Apply solder wire.

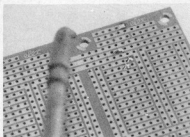

Figure 8.  
Allow to cool.

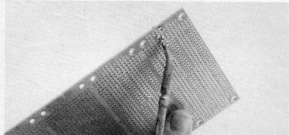

Figure 9.  
To remove excess solder while desoldering, hold the soldering iron from below against the PCB and allow the molten solder to flow downwards.

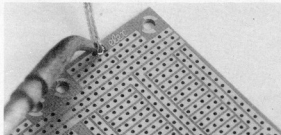

Figure 10.  
Working with solder sucking stranded wire.

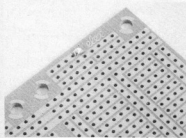

Figure 11.  
Although the component is removed, solder blocks the hole.

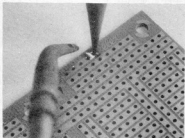

Figure 12.  
Prick the hot molten solder with pencil point.

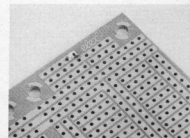

Figure 13.  
The hole is open.

# Digi-Course

Chapter : 3

## More about 'GATES'

The last chapter of this series dealt with NAND and NOR gates. Both have originated from the logical functions AND and OR respectively by adding negation (interchanging "1" and "0").

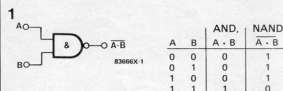

Figure 1 shows the symbol for NAND gate and its truth table. The truth table shows how the output of the gate behaves in response to the two inputs. The output and inputs are characterised by "1" and "0" where "1" means that the voltage at the corresponding connection is 5V and "0" means it is at 0V. On the Digilex Board, the input values of "0" or "1" are introduced by connecting the input terminal either to the 0V line or the 5V line.

The output states can be observed using one of the Red LEDs, by connecting the output of the gate to one of the pins A.....H.

The truth table for the AND operation is also included with the NAND truth table for comparison, in figure 1.

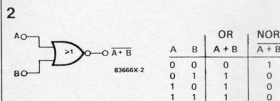
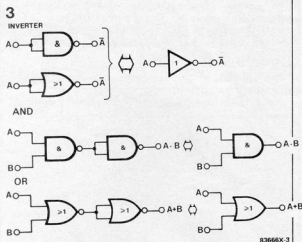

Figure 2 shows the symbol and the truth table for the NOR gate. The symbols and tables naturally remain abstract theory, so long as no concrete informations are attributed to the logic states. Let us take a small example. Consider the sentence: "Mr. OUT goes to work on the bicycle, when it NEITHER storms NOR rains." The sentence includes the same logical condition as that in the NOR gate. Now if we denote storm by "1" and no storm by "0" and feed this information at input A, and denote rain by "1" and no rain by "0" and feed this information at input B, then the output shows, whether Mr. OUT can go to work on his bicycle ("1") or not ("0").

The NAND, NOR gates are very universal. By connecting their two inputs together, they behave like NOT gates (inverters), and by connecting these inverters to the NAND, NOR gates we can get back the original gates AND and OR!



With little bit of effort, we can even find a circuit which consists only of NAND gates but behaves like an OR gate when the overall output of the circuit is seen in response to the input conditions.

For this let us study the input/output combinations of both NAND and NOR gates in detail.

Table 1

A	B	NAND $\bar{A} \cdot \bar{B}$	OR A + B
0	0	1	0
0	1	1	1
1	0	1	1
1	1	0	1

The solution to this problem seems obvious when we study the input/output combinations shown in table 1. By inverting both A and B and then carrying out the NAND operation on them, the resulting output is same as the OR output from the uninverted inputs. This is shown in table 2.

Table 2.

A	B	$\bar{A}$	$\bar{B}$	OR $\bar{A} \cdot \bar{B} = A + B$
0	0	1	1	0
0	1	1	0	1
1	0	0	1	1
1	1	0	0	1

Now constructing the circuit to implement this is very simple.

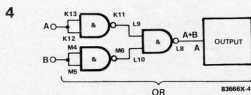

The circuit of figure 4 consists only of NAND gates but behaves like an OR gate. The points shown as K11, K12, K13 etc. in figure 4 correspond to the related terminal pins on the Digilex Board. Obviously,

even other equivalent combinations can be used. Conversely an AND circuit can now be constructed using only NOR gates. It's not difficult. Try yourself and check your answer with the solution which will be given in the next chapter in this series.

However, one question needs to be answered at this stage. Why are such circuits constructed, which need three gates to realise the function of a single, different gate? Because in this way, occasionally the ICs can be saved. For instance, when we need only one NAND gate and one OR gate in a circuit, we can do the job using just a single Quad-NAND gate IC rather than using one NAND and one OR IC. Because each IC normally consists of four gates of the same type.

## Exclusive-OR (EXOR)

Exclusive-OR is another important operation derived from the OR operation. It is an OR operation which exclusively responds to unequal input values.

Table 3.

A	B	EXOR A ≠ B
0	0	0
0	1	1
1	0	1
1	1	0

To find the circuit for this is not so simple as before. Let us start with the second line of this truth table. This line can be realised by a simple circuit as shown in figure 5.

5

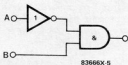

This circuit gives "1" at the output when A="0" and B="1". The third line of the truth table can be realised with a similar circuit as shown in figure 5, but with an inverter in the input B line instead of input A line.

Both these circuits can be now tried on the Digilex Board as shown in figure 6 and 7.

6

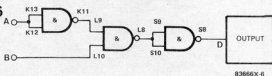

7

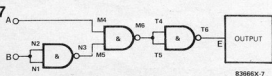

Since both these circuits have the same inputs, they can be physically tied together.

8

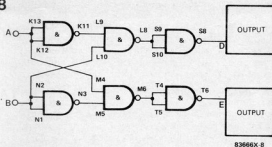

Now let us study the intermediate variables D and E. D="1" when A="0" and B="1", where as E="1" when A="1" and B="0". D and E both remain "0" whenever A=B. Now if we combine D and E by the OR operation, the result is same as that of combining A and B by the EXOR operation. If we use an OR gate circuit realised through NAND gates, the two inverters cancel each other and we are left with the circuit shown in figure 9.

9

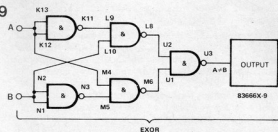

If we replace all the NAND gates in the circuit of figure 9 by NOR gates, we obtain the so-called Inclusive-OR function. This function.....but perhaps it will be more interesting to find out how this function behaves! Use your Digilex Board to construct and study this circuit. The input inverter at B must however be constructed using a NAND gate because only four NOR gates are available on the Digilex Board.

10

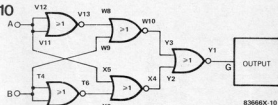

Table 4.

A	B	?
0	0	
0	1	
1	0	
1	1	

Solutions of this experiment will be given in the next chapter.

# Batteries

Batteries are safe power sources, and therefore they are well suited for experimenting. The commercially available batteries are of Zinc-Carbon type and are called dry batteries or dry cells. A new dry cell gives 1.5 Volts. It has a plus pole on the top cap and a minus pole at the bottom surface. Figure 1 shows the symbol for the battery and its internal construction.

The principle of operation of the battery is based on the chemical reaction between the Zinc casing and the Ammonium Chloride solution inside the casing. The reaction takes place whenever current is drawn from the battery through an external load. The Zinc casing is slowly decomposed during this reaction. When the battery is fully used up, the Ammonium Chloride solution is likely to come out through the decomposed Zinc casing. To avoid the danger, the modern Leak-proof batteries are clad with a sealed sheet-metal shell. In spite of this, occasionally a battery not replaced in time does start leaking.

There are many types of batteries. Figure 2 shows three different 1.5 V cells. Technically these three batteries differ only in their capacity. A large battery can supply current for a longer duration than a smaller one. shelf life of the battery depends upon the amount of self discharge.

Other properties of batteries depend essentially upon their chemical principle of operation. Other than the Zinc-Carbon type batteries, an equally popular type of battery is the Mercury battery, generally known as button cell. It can be constructed in a very small size and can hold out for long duration. The individual cell voltage is 1.4 V, in case of Mercury batteries. Mercury being a poisonous material, exhausted button cells should not be carelessly thrown away. They should be returned to the dealer for proper disposal.

The Alkali-Manganese batteries have a very low self-discharge and are able to supply a relatively stable Voltage for a longer time. Because of this,

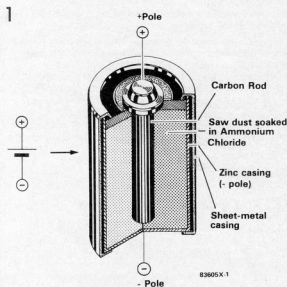

Sectional view through a battery cell. A sheet metal casing is placed around the Zinc-casing so that Ammonium-Chloride solution does not leak out when the Zinc-casing is decomposed.

however, they are about 50% more expensive compared to the conventional Zinc-Carbon batteries, one should never try to recharge these type of batteries because there is always a risk of explosion during recharging. Any apparatus which is designed for use of rechargeable batteries and equipped with the recharging circuit should never be fitted with Alkali-Manganese batteries.

2



Pencil Cell  
50 × 14.5 φ



Medium Size  
50 × 26 φ



Large Size  
60 × 33 φ

Three of the most common 1.5 V cells. The dimensions were standardised by IEC (International Electrotechnical Commission).

# Transformers

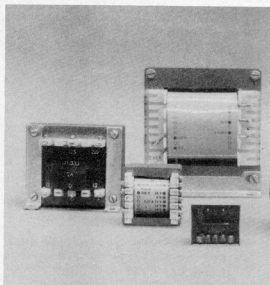

Unfortunately, the large power requirements of household and commercial appliances cannot be supplied by the dry cells. For such requirements we must turn to another source of power—namely the mains supply. The mains supply voltage is 230 Volts and is perilous to life!

Considering the battery prices, sooner or later, one has to turn to the mains supply as a cheap power source. However, we do not always need such a high voltage as 230 V. A device used for changing this level to the desired level is called a Transformer.

The mains voltage is an alternating voltage. A transformer can either increase or decrease the voltage level and depending on this function it is either called a step-up or step-down transformer. Transformers can work only with alternating voltages.

The simplest transformer has two input and two output connections. (so called primary and secondary sides) The input (primary side) is connected directly across the mains supply of 230 Volts. The output connections (secondary side) provide a lower voltage in case of a step down transformer. Such a simple transformer is illustrated in figure 1.

1

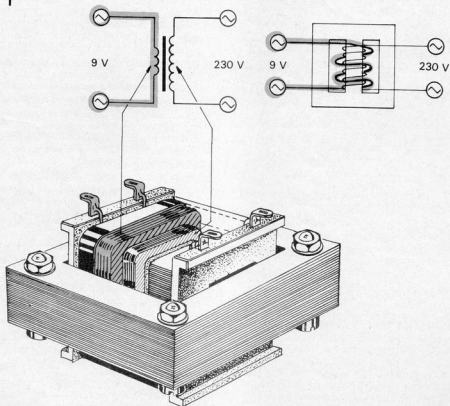

A simple transformer with one input and one output winding (primary and secondary).



The voltage available at the secondary side is very safe, as its level is low, and moreover, it is completely isolated from the mains supply as there is no interconnection between the input and output terminals. The output terminals, which have 9 Volts in this case, can be touched without any risk. The secondary voltage level depends entirely upon the design of primary and secondary windings and need not always be 9 volts. Hence, before purchasing a transformer one must know the value of secondary voltage required. (Secondary voltages above 42 V are not safe for touching!)

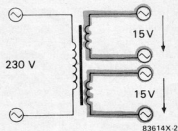

Figure 2.  
Transformer with two independent secondary voltages

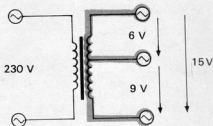

Figure 3.  
Transformer with multiple outputs.

## Mains Voltage

### Some rules to observe.

A list of rules to be observed during construction and testing jobs on circuits which carry mains voltage is given below for ready reference:

#### 1. Construction

- All conductors carrying mains voltage must be insulated in such a manner, that they cannot be touched when the enclosure is closed, not even with the help of a long thin rod or wire.
- All metallic parts which are accessible from outside, must be earthed. Even a master switch with metallic handle must be earthed though it may be installed in a plastic casing.
- The mains cord must be brought out through a securely fixed insulating grommet on the enclosure, in case the supply is not through a socket on the apparatus.
- The three cores of the mains cord must be fixed in a mechanically stable manner, and not by soldering alone.
- The green earthing wire must be longer than the other two wires, so that it is the last one to release itself in case of an accidental tearing of the mains cord.
- There must be a distance of at least 3mm between the non insulated current carrying parts, and bare conductors.

#### 2. Testing

- All jobs like assembly, soldering repairing etc. inside the open apparatus must be carried out only when the mains plug is removed. Switching off is not sufficient.
- Before starting the operation, check whether all the parts carrying current are fixed in a stable manner. Inspect the non-conductive contacts for insulation or short circuits with multimeter.
- While testing any part of circuit carrying current, the test leads must be clamped with insulated clips and the mains plug should be inserted and the power turned on. The clips should be released only after disconnecting the plug.
- While testing the low voltage sections of the circuit, all current carrying parts must be insulated in order to eliminate unintentional touching or shorting with other current carrying parts.

#### Some hints for good desoldering:

\* Remove excess solder by heating the soldered joint, while the PCB is held with component side on top, the molten solder flows on the tip of the soldering iron. Tap the PCB lightly so that the molten solder flows down completely.

\* In difficult situations, solder sucking stranded wire is used. (Also known as solder sucking wick). Place the stranded wire on the joint to be desoldered and heat both with the soldering iron. The stranded wire

sucks the molten solder. Lift the soldering iron and stranded wire simultaneously.

\* In case the holes are still blocked by solder after desoldering, heat the area with soldering iron and prick the molten solder with a pencil point to clear open the hole.

\* Solder bridges shorting two tracks can also be cleared with a pencil point. However, pencil lines on the board must be carefully erased, since graphite is conductive.

# Components

Here we introduce the symbols of various electronic components, which will be used in all SELEX circuits:

## Resistors

Resistors are designated with R. The coloured bands on the body of the resistors indicate the value of the resistance.

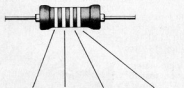
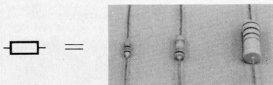

Colour	1st digit	2nd digit	Multiplier	Tolerance in %
black	—	0	—	—
brown	1	1	0	± 1%
red	2	2	00	± 2%
orange	3	3	000	—
yellow	4	4	0.000	—
green	5	5	00.000	± 0.5%
blue	6	6	000.000	—
violet	7	7	—	—
grey	8	8	—	—
white	9	9	—	—
golden	—	—	x0.1	± 5%
silver	—	—	x0.01	± 10%
blank space	—	—	—	± 20%

Example of reading the resistance values from the coloured bands:

brown—red—brown—silver = 120 $\Omega$  10%  
 yellow—violet—orange—silver = 47 K  $\Omega$  10%

(In SELEX projects the notation followed is slightly different; 47K  $\Omega$  is written as 47K, 4.7 K  $\Omega$  is written as 4K7, 1.5M  $\Omega$  is written as 1M5 and so on. The tolerance values are assumed to be 5% or 10% unless otherwise mentioned)

## Potentiometers

These are special resistors with adjustable sliding contact. The sliding contact serves as the tapping point of the potential divider formed by the resistance. In addition to the spindle & knob type potentiometers, small presettable potentiometers are also available. These are to be set by using a screw driver.

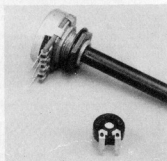
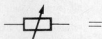

## Condensers (Capacitors)

These are charge accumulators, which allow the AC signals to pass through and prevent the flow of DC currents, when a DC voltage is imposed across a capacitor, it accumulates enough charge so as to develop an equal voltage across its terminals. This charge accumulating capacity is measured in Farads (F). Besides the capacity, the dielectric strength is also important. It should be at least 20% above the operating voltage.

Examples of capacitor values:

1n5 = 1.5 nF  
 100p = 100 pF  
 30n = 30nF = 0.03 $\mu$ F = u03

Foil type or ceramic type capacitors are generally available from 1pF to 1 $\mu$ F.

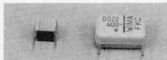
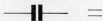

## Electrolytic Capacitors

The Electrolytic capacitors have a high capacity, and are generally available from 1 $\mu$ F. They are polarised and their terminals cannot be interchanged. The terminals are clearly marked as + and— or sometimes only the — terminal is marked. In case of small sized Tantalum capacitors the + pole is additionally emphasised with a longer wire.

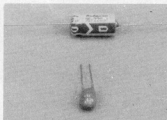
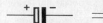

## PTH PCB

Platetch Circuits now offer a modern manufacturing facility exclusively for manufacturing PTH PCBs. These are provided with bright acid tin plating, roller tinning and gold plating. Solder masking and legend printing can also be provided.

PCB designs with fine lines and high density are manufactured with excellent line sharpness and hole centering. Complete jobs starting from lay-out, artwork, photography and PCB fabrication are executed with short delivery times.

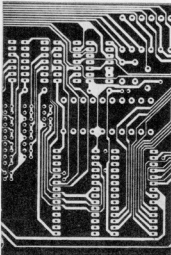

For further information, write to:  
Platetch Circuits  
110, Nirmal Industrial Estate,  
Near Sion Fort, Sion (East)  
Bombay 400 022

## DIGITAL IC TESTER

R.C. Digital IC tester 4016 is a microprocessor based instrument designed to perform functional testing of TTL, RTL, HTL, DTL, CMOS and MOS ICs of 74/54/40/74 C series ICs in 14/16 pin versions.

Preprogrammed software for about 200 most commonly used ICs is stored in the memory and is expandable to another 200 ICs through expansion boards. The testing procedure is completely automatic and messages like good/bad, IC Number etc. are displayed on a seven segment LED display.



For further information, write to:  
R.C. Information Technology Systems  
Pvt. Ltd.  
18, Police Station Road,  
Basavangudi, Bangalore 560 004

## THERMOCOUPLE TEST SET

Vaisheshika 4 1/2 digits thermocouple test set and calibrator type 7339 is a versatile instrument for calibrating pyrometers, potentiometric recorders, platinum resistance thermometers, temperature controllers etc. The instrument can also be used as thermocouple simulator with an accuracy of  $\pm 0.2\%$ . A stable potential source with a range of 0 to +100 mV and a resolution of 10  $\mu$ V is provided with the test set. A standard wheatstone bridge is also provided with the test set. Resistances ranging from 0.1 ohm to 1 K ohms can be measured or simulated with an accuracy of  $\pm 0.1\%$ . The bridge can also be used as standard decade resistance substitution box with an accuracy of  $\pm 0.1\%$ .

For further information, write to:  
Vaisheshika Electron Devices  
Near Allahabad Bank  
Ambala Cantt. 133 001

## LOGIC CLIP

Alfa Products Company have introduced their new Logic Clip LCU-16. This is a small troubleshooting instrument which fits directly on to DIP ICs and instantly displays the logic states of all the pins of the IC and under test. It can test 14 or 16 pin ICs with equal ease. The clip has its own gating logic which locates the power supply pins of the IC under test and derives its supply from the circuit directly thus eliminating the need for an additional power supply for the clip. The built in buffered inputs reduce circuit loading. These logic clips are compatible with almost all the logic families and are claimed to be truly universal.

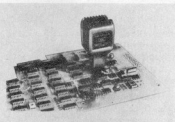

For further information, write to:  
Alfa Products Company  
FF-11, Bajaj House,  
97, Nehru Place,  
New Delhi 110 019

## CHARGED BODY DETECTOR

Monroe Electronics Inc. have introduced a novel instrument called the 'Charged Body Detector/Alarm Annunciator'. The charged body detector is basically an electrometer utilising a special multilayer tape sensor which sets up a capacitance field between the static source and the tape coupled to the charged body detector's input. The tape probe detects the electric field from a moving charged object. The sensitivity may be set from 10V to 1000V.

The instrument has capability of additional features like remote alarm outputs, event counter and alarm latch. The event counter keeps track of the number of electrostatic discharges or intrusions of charged objects into the protected area.

For further information write to:

Swadweep Instrumentation  
101, Vishnu Villa, 10th Road,  
Khar, Bombay 400 052.

## THUMB WHEEL SWITCHES

Elcom have introduced the new TC series subminiature Thumb wheel switches which can be snap fitted onto the panel. These are ideally suited for Test and Measuring Instruments and Industrial Control systems. These are available in the following variations:

One pole ten way, two poles five way, BCD, with or without limit stop, with or without extended boards and coloured wheels.

Subminiature DPDT snap fitting toggle switches moulded in polyamide have also been recently introduced. These are available for both low and high current applications.

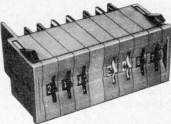

For further information, write to:

ELCOM  
103, Jaygopal Industrial Estate,  
B. Parulekar Marg, Dadar,  
Bombay 400 028

## DIGITAL TACHOMETER

Beacon Digital Tachometer LDM-5004 is a versatile, compact RPM indicator, with a range of 30 to 9999 RPM and accuracy of  $\pm 1$  RPM. The instrument can also be supplied to read linear speeds in terms of Mts/min or Ft/min. The instrument works from 5V DC but can be provided with optional power supply unit for mains operation. Various types of pick ups like magnetic, optical pick ups or proximity switches can be used with the LDM-5004 Tachometer.



For further information, write to:  
Beacon Industrial Electronics Pvt. Ltd.  
13-A, Shri Ram Industrial Estate,  
Katrak Road, Wadala,  
Bombay 400 031

## WIPER CONTROL

Penguin Electronics have developed a wiper control unit for four wheelers. This unit can operate the wipers intermittently in a preprogrammed manner. Two delay settings and two sweep settings are provided in addition to the normal operation, the delay and sweep settings are independent of each other. The controller is suitable for vehicles of both positive and negative ground systems, and is fully protected against overcurrent, reverse polarity, vibrations and temperature variations. Fitting procedure is claimed to be very easy.



For further information, write to:

Penguin Electronics  
D-105, 1st Main Road, Annanagar  
(East), Madras 600 102.

## POCKET VDU

G.R. Electronics, U.K. offer a hand held Video Display Unit with 2 lines x 40 characters capacity. All memory contents are displayable for editing by cursor. The display has the capability of displaying all 128 characters of the ASCII set. Both conversational as well as block modes are possible. 20 mA loop, RS232C or RS422 interfaces are available and the baud rates are selectable from 50 to 9600 in thirteen steps. Spare PROM capacity is available for OEM software. The VDU is powered by rechargeable Ni/Cd battery.



For further information, write to:

MRO-INDIA Systems  
No. 3, 1st 'B' Main Road,  
Gangenhalli Extension,  
Bangalore 560 032.

## COILS FOR COMPUTERS AND CTV

ABC Taiwan Electronics Corporation offer a wide range of coils for computers and CTV. The range consists of fixed coils, adjustable coils, IFTs, EMI/RFI filters, power chokes, transformers, noise suppressors and surge stoppers. The coils are made to customers specifications.

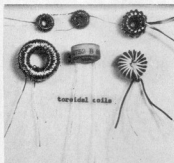

For further information, write to:

Shilpa International  
107, Parklane,  
Secunderabad 500 003.

## ALL PURPOSE MARKERS

Tiger Management Services offer all purpose markers which eliminate cumbersome processes of marking on all types of surfaces. The marking is instant drying and is non-messy. These markers are available in Red, Black, Violet, Golden and Silver colours. Inks for refilling the markers are also available.

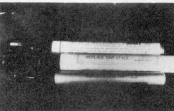

For further information, write to:

Tiger Management Services,  
No. 10, Apparsamy Koil street,  
Mylapore, Madras 600 004.

## POWER SAVER FOR INDUCTION MOTOR

Advance Industries have developed a new inexpensive solid state power saver for single phase induction motors. The unit is claimed to be useful for reducing the inefficiencies in the motors used in refrigerators, air-conditioners, pumps, washing machines, cleaners, and industrial sewing machines etc. The manufacturers estimate of reduction in no load power wastage is by a factor of 2 to 3. Considerable power savings can be achieved also when the motor is lightly running or is intermittently loaded.

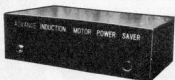

For further information, write to:

Advance Industries  
11, Tinwala Building,  
Tribhuvan Road,  
Near Dreamland Cinema,  
Bombay 400 004.

## FREQUENCY STABILISERS

Spectron manufactures a wide range of frequency stabilisers. The systems consist of stable frequency oscillators and power amplifiers. The power derived from mains is converted to D.C. using rectifiers and capacitors and then used to drive the oscillators and amplifiers. A constant output voltage is maintained with help of feedback circuits. These systems find applications in synchronous drives and computer systems.



For further information, write to:

Spectron Sales & Services Pvt. Ltd.  
63, Bharatkunj No. 2, Erandavane  
Pune 411 038.

## DPM WITH CRYSTAL CLOCK

Lasca Electronics, U.K. have introduced a new LCD DPM which employs direct chip bonding technique to reduce the size. The DPM 300 has a crystal controlled clock and a temperature compensated display drive. Some of the salient features include Auto-zero, Auto-polarity, Underrange and Overrange signals, Programmable decimal point and easy rescaling.



For further information, write to:

Electronics India Co.  
3749, Hill Road,  
Ambala Cantt. 133 001.

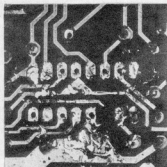

Desoldered  
Without  
Diamond

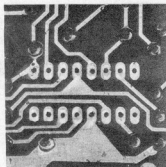

Desoldered  
With  
Diamond

# Diamond Desoldering Pump

- Desolders thoroughly.
- Sturdy construction
- Replaceable Teflon Nozzle
- Largest selling in India
- Widely accepted in U.K., U.S.A., West Germany and Singapore.

Export Enquiries Welcome

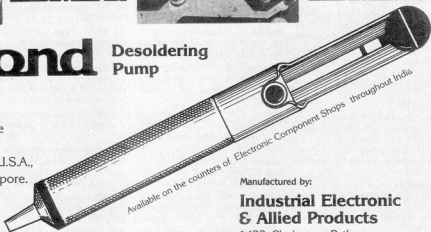

Manufactured by:

**Industrial Electronic  
& Allied Products**

1423, Shukrawar Peth,  
Off. Bajirao Road,  
POONA 411 002, India.  
Phone: 446241, Gram: SEFOTAKE.

Distributors:

**precious**<sup>®</sup> Electronics Corporation

Chhotani Building 52C, Proctor Road Grant Road (E), Bombay-400 007.

# FREE

WITH EVERY NEW SUBSCRIPTION

A copy of the booklet

THE BASIC PRINCIPLE

will be given FREE to every new subscriber. This booklet is a compilation of articles recently serialised in

**elektor** India electronics monthly

Fill in the order card in this issue and send it immediately to :

elektor electronics pvt ltd.

Chhotani Building,  
52-C, Proctor Road,  
Grant Road (East),  
Bombay-400 007.

AN INTRODUCTION TO 'BASIC'

# THE BASIC PRINCIPLE

A BOOKLET FOR BEGINNERS



Hurry ! Offer open upto 30th September, 1985.



# DIGITAL MULTIMETERS

THAT GIVE YOU THE GREATEST NUMBER OF RANGES, HIGHEST RESOLUTION, BEST ACCURACY,

MODEL  
MIC 6000 Z

ACCURACY: 0.5%  
1000 HOUR BATTERY  
OHMS: 0.1-20 megohms  
DCA: Down to 0.1  $\mu$ A-10 AMPS  
ACA: Down to 1  $\mu$ A-10 AMPS AC

- AUTOMATIC POLARITY
- FLOATING DECIMAL POINT
- LOW BATTERY WARNING FLAG
- INSTANT RECOVERY FROM OVERRANGE



MODEL AD-800

MANUAL/AUTO RANGING  
ACCURACY: 0.5%  
OHMS: 0-20 Megohms  
DCV: 0-1000  
ACV: 0-750  
DCA: 0-10  
ACA: 0-10

- OVERRANGE INDICATION
- AUTO POLARITY
- LOW BATTERY INDICATION
- POWER 2 PENLITE CELLS

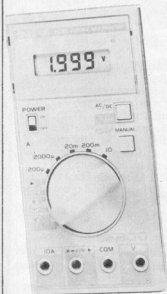

Marketed by:  
**precious** Electronics Corporation

CHHOTANI BUILDING,  
52C, PROCTOR ROAD, GRANT ROAD (E),  
BOMBAY-400 007.  
PHONE - 367459, 369478.

POPULAR

## TESTICA T-3

ONLY



Rs170/-

THE ONLY MULTIMETER  
WITH  
PROMPT SERVICE AFTER SALES  
**ACCURATE! ROBUST!  
ECONOMICAL!**

AVAILABLE AT ALL COMPONENT SHOPS

MANUFACTURERS:  
**ELECTRICAL INSTRUMENT  
LABORATORIES,**  
339/68, RAJESH BUILDING, LAMINGTON ROAD,  
BOMBAY-400 007. PHONE-36 07 49.

LOW COST  
HIGH QUALITY

## Relays-a-Plenty

 Series 112, 113, 117 30 Amps, 25 Amps, 15 Amps	 Series 106 10 Amps	 Series 108, 110 25 Amps, 30 Amps, & 30 Amps	 Series 136 to 138 15 Amps, 25 Amps, & 30 Amps	 Series 105 5 Amps
 Open type Series 118 to 124 0.5 Amps to 5 Amps	 Series 107 25 Amps	 Series 101 5 Amps	 Pack of four Series 102 5 Amps	 Pack of two Series 125 10 Amps & 25 Amps
 Series 127 25 Amps	 Series 118 to 123 0.5 Amps to 5 Amps	 Series 109 5 Amps	 Pack of two Series 125, 128 Reset Relays	 Series 128 5 Amps
 Series 102 5 Amps	 Series 104 5 Amps	 Series 128 to 134 10 Amps & 30 Amps	 Series 128 to 134 10 Amps & 30 Amps	 Series 128 to 134 10 Amps & 30 Amps

**Eagleman** with its many years of Engineering and Production experience builds relays to all quality levels. Relays from the most exacting to the simplest in operating specifications are readily available at Eagleman.

Small or large quantity orders receive the same careful attention by the people that have the "Eagle" floor.

Eagleman engineers become part of your design group in selecting the correct type of relay to meet all requirements.

**Eagleman**  
3/19-A, Kirti Nagar,  
Industrial Area,  
New Delhi-110015  
Phone: 535770.  
Grams: EAGLENT

# HM 312 MORE SCOPE

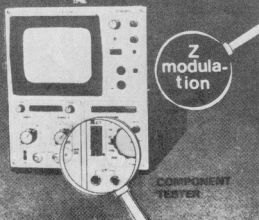

at **LESS PRICE**

The **scientific** HM 312 increases its functions to match your requirements.

Already a bestseller in the 20MHz range, the dual trace HM 312 now brings you two additions that puts it ahead of the others.

## 1. BUILT-IN SINGLE TOUCH COMPONENT TESTER 2. Z-MODULATION PLUS 3. REDUCTION IN COST

### OTHER SPECIFICATIONS:

- Bandwidth (-3 db): 20MHz/5mV  
(-6 db): 28 MHz/5 mV
- Triggering : 30 MHz
- Risetime : 17.5nS
- Timebase : 40nS-200nS
- Matched X-Y operation ● TV Trigger

FLASH 82-10

So we have brought you single touch component testing in the 20MHz range

We have shown that EXTRA features need not mean extra price. That's Service and Satisfaction from

# scientific

### SCIENTIFIC SALES

4, Jati Colony, INDORE 452 004 Ph: 22498

Telex: 0735-267 Customer Services at: Bombay  
Bangalore, Calcutta, Delhi, Hyderabad, Madras



GOOD REASONS  
FOR SUBSCRIBING TO

# elektor <sup>INDIA</sup> electronics

MONTHLY  
MAGAZINE

1. Elektor India brings you the very latest in electronic techniques.
2. These new techniques are presented in a simple easy-to-understand style.
3. Elektor India offers something to interest every reader be he beginner or expert.
4. Thanks to Elektor India's ready made PCBs, construction is made simpler than ever.
5. Last year elektor India brought you the most advanced ideas from all fields of electronics (audio, microprocessor, instruments etc.)
6. This year will usher in a whole new range of test equipment, the BASIC principle, real time analyser and more.
7. In August/September of each year, we publish our famous **circuits special issue**, containing over 100 different circuits.
8. Elektor India publishes ove 250 circuits every year
9. Elektor India is the simplest way to keep up-to date with the rapidly changing world of electronics.
10. Thousands of satisfied readers testify to the popularity of elektor India, Roughly 50% of all letters we receive name elektor India as the best electronics magazine in India.

**SUBSCRIBE NOW**  
Use the order card  
in this issue.

How electronics can be  
childs play  
for your son!



**Jetking®**  
Do-it-yourself kits

Jetking kits are designed to let your child pick up the basics of electronics while he builds a number of interesting and engrossing projects. And at Rs. 125/- it's the best way to introduce him to the electronics age:

Jetking: 350, Lamington Road, Bombay-400007.  
Phone: 357101. Jetking Electronics Pvt. Ltd.: 3830  
Pataudi House, Daryingang, New Delhi - 110002. Phone:  
260458. Jetage Electronics: Lamington Road, Bombay-  
400007. Phone: 350041. India's Hobby Centre: Opp.  
Plaza Cinema, Cornaghat Place, New Delhi: 110001. Phone 352111



APPROVED IN ELECTRONIC CLASSES OF SECONDARY SCHOOLS.

**WE OFFER FROM STOCK**

**I.C.'s :** TTL. CMOS, MOS, LSI,  
Microprocessor. Micro computer etc.

**Zener Diodes :** 400 MW & 1 Watt

**LED's :** Red, Green, Yellow in  
5mm and 3mm dia

**IC Sockets :** SMK & Memorex make

**Trimpots :**

Multiturn Bourn's, VRN & Beckman make

**Single Turn cermets :**

EC as well as imported

**Floppy Discs :**

8" as well as mini floppy of memorex,  
& dyson make

Write to :



**ZODIAC**  
**ELECTRONICS**  
**CORPORATION**

Pushpdant Niwas 3rd Floor, 3, Chunam Lane, Dr. D. Bhadkamkar  
Marg, Bombay-400 007. Phone : 5137225, 5135845

**NEXT MONTH**

**Our Bumper Double Issue**  
**AUGUST/SEPTEMBER**

**elektor**  
**INDIA**  
**circuits special '85**

With more than 100 practical projects

**NOT TO BE MISSED**



## CONDITIONS OF ACCEPTANCE OF CLASSIFIED ADVERTISEMENTS

1) Advertisements are accepted subject to the conditions appearing on our current rate card and on the express understanding that the Advertiser warrants that the advertisement does not contravene any trade act in force in the country.

2) The Publishers reserve the right to refuse or withdraw any advertisement.

3) Although every care is taken, the Publishers shall not be liable for clerical or printer's errors or their consequences.

4) The Advertiser's full name and address must accompany each advertisement submitted.

The prepaid rate for classified advertisement is Rs. 2.00 per word (minimum 24 words). Semi Display panels of 3 cms by 1 column. Rs. 150.00 per panel. All cheques, money orders, etc. to be made payable to Elektor Electronics Pvt. Ltd. Advertisements, together with remittance, should be sent to The Classified Advertisement Manager. For outstation cheques please add Rs. 2.50

Wanted Engineers and Technicians for quality control & production of Televisions and Video Cassette Recorders Manufacturing Unit. Apply to: TOSHNIWAL Post Box No. 56, H-5/12, M.I.D.C. Chikalthana, Aurangabad - 431 210.

We can send application notes or data sheet for any electronic component. Minimum charges Rs. 15/- . Write to: DATA BANK Plot No. 16, Bldg. No. 3, Flat No. 17, Bhavani Nagar, Marol Maroshi Road, Andheri (E), Bombay-59.

missing  
linka new keyboard for  
Spectrum

(April 1985, page 4-38)

The circuit diagram in figure 3 incorrectly gives the value of  $R_{35}$  as 4k7; this should be 47 k.

## P.C.B s

For

## SELEX &amp; DIGILEX

Will be announced  
next month in our

## E.P.S. Page

Components  
are normally available  
with the following companies:

## VISHA ELECTRONICS

17, Kalpana Building,  
349, Lamington Road  
Bombay - 400 007 Phone: 362650

## DYNALOG MICRO SYSTEMS

14, Hanuman Terrace,  
Tara Temple Lane,  
Lamington Road  
Bombay - 400 007. Phone: 353029, 362421

## ELECTROKITS

20, Narasingapuram Street  
(First Floor) Mount Road  
Madras - 600 002

INTEGRATED ELECTRONICS  
INSTRUMENTS

8-2-174 Red Cross Road  
Secunderabad 500 003 Phone: 72040

APEX .....	7.10
BALAJI .....	7.04
COMPONENT TECHNIQUE .....	7.04
COSMIC .....	7.80
DANNIES ELECTRONICS .....	7.10
DOMINATION RADIOS .....	7.06
DYNALOG .....	7.07
EAGLEMAN ENTERPRISES .....	7.75
ELCIAR .....	7.10
ELCOM .....	7.06
ELECTRICAL INSTRUMENT CO... ..	7.72
IEAP .....	7.74
JETKING .....	7.77
KAYTEE ENTERPRISE .....	7.70
LUXCO .....	7.71
M.C. ENGINEERING .....	7.11
OSWAL ELECTRONICS CO. ....	7.72
PADMA .....	7.70
PRECIOUS .....	7.75
PULSECO .....	7.72
SCIENTIFIC SALES .....	7.76
SAINI ELECTRONICS .....	7.04
SIEMENS .....	7.08 7.09
TECHNOMATIC LTD .....	7.02 7.05
TESTICA .....	7.75
TEXONIC .....	7.70
VASAVI .....	7.06
VISHA .....	7.79
ZODIAC .....	7.77

# 3324 COSMIC COLOURVISION

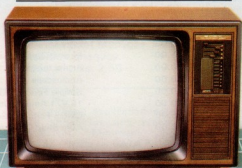

## **COSMIC** COLOURVISION 3324 offers colour with style. with it's built in electronic tuner

Three decades in the field of electronics has helped Cosmic in creating an Audio-Visual marvel

- 51 cms. The carefully manufactured multifunction unit
- High intensity picture tube offers vibrant colours with perfect sound.
  - 8 mode channel selector.
- Matches any Video system-UHF or VHF

**Off with flying colours**