

120

May
1985

elektor

INDIA

Rs. 7.50

electronics

NEW

selex

FOR BEGINNERS!

10 amp power supply

solar cell radio

X-Y plotter



Samir K. Ray

Hi-Fi connections of the Japanese kind!



Introducing the most advanced front-line Speaker Systems. Sonodyne SX 500, 600, 900—the only Speakers in India with original Japanese Woofers, Tweeters* and Midrange.

The Woofers are Japanese
The Cone Tweeters are Japanese
The Midrange is Japanese
No Indian Speaker System could
be more Japanese. And you know,
Japanese technology in electro-
nics is legendary

Among the outstanding
characteristics of Sonodyne 'SX'
Speakers a unique bass-reflex
with twin port design. An
immaculate stereo presentation
within the full frequency range,
without distortion. Low harmonic
content giving music a life-like
quality. Competitively priced, yet
incorporating superb features and
Japanese components, yet to be
found in a single Indian Speaker
System!

Sonodyne 'SX' Woofers

These cone-type high efficiency
woofers, 200 to 250 mm in
diameter, give a clean and genuine
low bass. At any volume level.

Sonodyne 'SX' Tweeters

The tweeters have been specially
matched to give you interference-
free brilliant highs

Sonodyne Midrange (SX 900)

This high-powered midrange
prevents interaction with the low
frequency transducer and delivers
crisp, clear reproduction. Free
from coloration/phase errors

Sonodyne 'SX' Bass Reflex with Twin Port Design

A special crossover network

guaranteeing an unmatched
musical reproduction and a highly
sensitive bass response.

We can go on and on about the
'SX' Series advancements,
'SX' 500/600/900 having an input
power of 50, 60, 90 Watts per
channel respectively. About the
'SX' 500, 600 having a 2-way,
2 speaker system. Or the 'SX' 900
having a 3-way, 3 speaker system.
But we'll just say that Sonodyne
Speaker Systems, are the perfect
answer for people with an ear for
music and a head for money.
Listen to them at your nearest
Sonodyne dealer today!

*Cone tweeters only.



SONODYNE—The name that's music to your ears.

Available at all leading music dealers.

Datta/97-SE368/81

elektor contents

Volume 3-Number 5

EDITOR SURENDRA IYER
PUBLISHER C R CHANDARANA
PRODUCTION C N MITHAGARI

ADVERTISING & SUBSCRIPTIONS
ELEKTOR ELECTRONICS PVT LTD.
Chotanji Building
52 C, Proctor Road Grant Road (E)
Bombay-400 007

DISTRIBUTORS: INDIA BOOK HOUSE

PRINTED AT:
TRUPTI OFFSET
103, Vasan Udyog Bhavan,
Off Tulsī Pipe Road,
Lower Parel, BOMBAY-400 013

Elektor India is published monthly under
agreement with Elektor B.V. Holland.
August/September is a double issue

SUBSCRIPTION

INLAND

1 Yr Rs. 75/- 2 Yrs Rs 140/- 3 Yrs Rs. 200/-

FOREIGN

One year Only

Surface mail Rs 125/- Air mail Re 210/-

The Circuits are for domestic use only. The
submission of designs, of articles to Elektor India
implies permission to the publishers to alter and
translate the text and design, and to use the
contents in other Elektor publications and
services. The publishers cannot guarantee to
return any material submitted to them. All
drawings, photographs, printed circuit boards and
articles published in Elektor India are copyright and
may not be reproduced or imitated in whole or part
without prior written permission of the publishers.

Patent protection may exist in respect of circuits,
devices, components etc described in this
magazine.

The publisher does not accept responsibility for
failing to identify such patent or other protection.

INTERNATIONAL EDITIONS EDITOR P. HOLMES

Dutch edition	Elektor b.v. 6190 AB Beek (L), the Netherlands
German edition	Elektor Verlag GmbH 5133 Gengeln W Germany
English edition	Elektor Publishers Ltd Elektor House 10 Longport, Canterbury CT1 1PE Kent, UK
French edition	Elektor Sars Le Sues, 55270 Baillet, France
Italian edition	Elektor 20052 Cinisello B Italy
Spanish edition	Elektor Av Alfonso XIII 141, Madrid 18
Greek edition	Elektor Karesaki 14, Voula, Athens
Turkish edition	Elektor Yayıncılık ve Ticaret A.Ş., Karakoy İstanbul
Portuguese edition	Ferret & Imd Bento Lda R O Estefânia 32, 1000 Lisboa Portugal

COPYRIGHT © ELEKTOR B.V.
THE NETHERLANDS 1984

news, views, people	5-13
selektor	5-16
The changing face of communications	
light-powered radio	5-18
A small portable receiver that is not dependent on conventional batteries.	
revolution counter	5-20
This unique instrument displays the torque characteristic of your car over the useful range of revolutions.	
X-Y plotter	5-24
A computer peripheral that gives a new meaning to 'a picture paints a thousand words'.	
the first cuckoo in spring	5-35
Continues our tradition of regularly presenting a sound-effect project.	
long interval timer	5-38
voltage frequency converter	5-38
10 A power supply	5-39
Provides a fixed output voltage between 1.2 V and 32 V at a current of up to 10 A	
stepping motors	5-42
Versatile alternative to traditional servomechanisms.	
applicator	5-48
New transistors for use in satellite TV or UHF broadband receiving systems.	
capacitance coupling	5-50
In this article an electronic system is described which can be used as part of a sophisticated light dimmer	
reading in bed limiter	5-53
market	5-62
switchboard	5-65
missing link	5-74
index of advertisers	5-74

symbols used in selex articles	5-54
bar code	5-55
digi-course (chapter 1)	5-57
bicycle siren	5-60

backstage

Elektronika—India takes you behind the scene, where engineers design, develop and test projects at the ultra modern Elektronika laboratories in Holland.



A view of the laboratories.



General projects design.



Audio design.

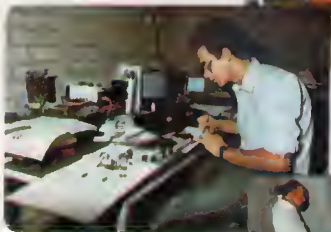

Software development



Computer hardware.

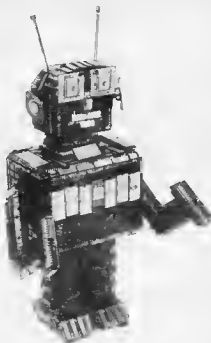

As we move into the future we find that electronics is increasingly becoming a part of our daily life. It appears that everything will ultimately function with the aid of electronics. In fact, electronics is already present in most of what is going on around us today—few people are aware of this.

It is high time the average individual is periodically enlightened on the significant role electronics is continuously playing in his/her life. And we believe that anyone who is interested and has access to an excellent introduction can understand electronics very easily. Our new section SELEX (Simple Electronic Experiments) is designed to provide this introduction in addition to teaching the fundamentals of the subject.

Our team of engineers and technical editors at Holland (see opposite page) have prepared programme "SELEX" which will be a regular feature in *elektor-India*—starting with this issue.

A final word—SELEX is an additional section to the existing magazine. This means more pages—thus the reader gets his usual editorial plus SELEX.

—Editor

Whatever your multimetering needs...

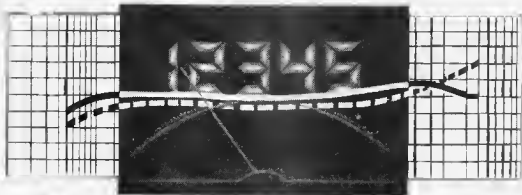

Motwane has its measure.

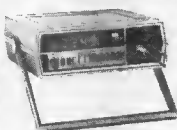

Have you ever thought of how dependant we are on electricity and what an indispensable instrument the Multimeter is today? There is not an industry, Communication and Utility service, Defence force, or even a general technician that does not use one.

Much has been made of the merits of Digital Multimeters over that of Analog ones, but in truth both enjoy basic inherent advantages. Its simply a matter of the right application. You must give your measurements the instrument they deserve.

The prime benefits of Digital Multimeters lie in their: \rightarrow Unambiguous readings \rightarrow no skill operation \rightarrow Speed \rightarrow Infallible accuracy \rightarrow Systems capability \rightarrow Minimum circuit load \rightarrow and bonus features such as True RMS, Conductance measurements and Diode testing—like the Motwane DM 450—the 4½ digital that stands tall with the

best in the world, and our DM 351—the 3½ digital whose features other companies are still designing.

Yet there is no denying the finesse of Analog meters when you need it: The trend in variations to be easily perceptible—invaluable in peaking and rulling \rightarrow Wide dynamic resistance ranges not limited by the number of display digits. \rightarrow Excellent immunity to voltage transients. \rightarrow Quick go-no go checks \rightarrow A totally panic-matic instrument—like the Motwane BX Mark III—the grand old man of Multimeters—experienced and confident, and the BX Mark I—the handheld bred with an eye on cost effectiveness and field operations.

We are the only company in India and one of the few in the world, to offer you the best of both worlds—Digital and Analog. Motwane is the certain guarantee of Quality that's exclusive, at a price that's not—by any measure.



For further details write to:
THE MOTWANE MANUFACTURING COMPANY PVT. LTD.
 at Gyan Baug, Nasik
 Road 422 101

Tel.: 86297/86084 Telex: 752-247 MMPL IN
 Grams: MOTWANE or Gyan Ghar, Plot 434 A,
 14th Road, Khar, Bombay-400 052, Grams:
 : MOTESTEM

Cut here and mail

Please send literature and quotation on your Multimeters

Name _____
 Designation _____
 Company _____
 Address _____
 Telephone _____ Telex _____

SELL ADS.MWC 12 84

Two New Numbers
to Remember !

HM 203 HM 204

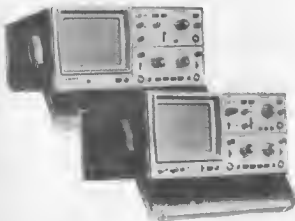

Scientific announces two new additions to its trusted and time-proven range of HM Series Oscilloscopes. HM 203 and HM 204 Dual Trace 20 MHz Oscilloscopes. These sleek new low-line portables incorporate the latest in international product design and features a 140 mm rectangular flat-face CRT with illuminated internal grid, 8 x 10 cm display, high 2 mV sensitivity and 20 MHz bandwidth, HF triggering up to 50 MHz, single touch component tester, sweep delay, and many more features never before available in this price range.

So remember HM 203 and HM 204, when you order an oscilloscope next. You will be glad you did.

scientific the affordable portables !

Manufactured by:

SCIENTIFIC MES-TECHNIK PVT. LTD.

Formerly known as SCIENTIFIC INSTRUMENTS (INDORE) PVT LTD
B 14, Pologround, Industrial Estate, Indore 452 003
Telephone: 31777, 31778, Cable SCOPE, Telex 0735 267

Customer Services at :

Bombay, Bangalore, Calcutta, Delhi, Hyderabad, Madras.

THE AUTO LOGIC MONITOR

LOGICCLIP LC-16 16 Channel Logic Monitor

- Just clip it on your IC and LogicClip instantly and accurately shows both static and dynamic logic states on a bright 16 LED display.
- As it feeds its own power, no need to make supply-ground connections or keep your hands occupied.
- Simultaneous monitoring of all 16 pins. Data and power levels, sense logic and alternates the rate of state change.
- LC-16 is compatible with all dual in-line logic: JCA, DTL, TTL, HTL, ECL, L, LS, S, CMOS types 16 pins.

TECHNICAL DATA	
Power Requirement	1.5 x 1.5 x 2.5 cm
Display	16 LED display
Operating Range	0-100 MHz
Logic States	16 channels
Power Supply	1.5 x 1.5 x 2.5 cm
Dimensions	16.50 x 22.50 x 10.00 cm
Weight	100 gm
Material	100% Plastic
Lead Time	15-20 days
Warranty	1 year

Try the LC-16 and you will wonder how you ever managed without it!

Applications

- On-chip Breadboarding testing and checking new logic systems
- Production testing and servicing of discrete logic
- Design error tests, monitoring of logic function at operating conditions
- Monitoring of integrated IC
- Identification of unused elements in green IC
- To test the relationship between time in micro ICs on different boards by using two or more LC 16
- Plus many more uses for you to find

Only Rs. 885/-

Now with imported contact clip

PULSECHO SYSTEMS
107, Normal Industrial Estate, Near Swan Fort,
Road No. 29, Sion (East) Bombay 400 022 INDIA
Telephone: 47 10 55, 48 20 87
Gram PULSECHO Malunga, Bombay 400 019
Telex C/o 011 71447 IMDEV IN

SOLDERS



- Works effectively on single/double-sided PC Boards
- Powerful vacuum suction.
- Low recoil action
- Dependable performance
- Assured results.
- Every stroke self cleaning
- Replacable tip.

LARGEST SELLING

DESOLDERING PUMP

Internationally Accepted

With Unmatched Performance

INDUSTRIAL RADIO HOUSE
12, Gandhi Bhavan, First Floor, Chunan Lane
Off. Dr. Bhadkamkar Marg, Mumbai - 400 007
Phone - 38 21 04

The changing face of communications

The modernization of the world's sixth largest national telecommunications network has been substantially accelerated with the introduction of System X. This range of micro-electronic digital exchanges was designed and developed by British Telecom and a number of telecommunications manufacturers, and is made jointly by Plessey Telecommunications and GEC Telecommunications.

The first production System X exchange came into operation last year in Coventry in the English Midlands. Within three years British Telecom plans to install at least 30 System X trunk exchanges and 1200 local exchanges. The latter will be made up of some 300 large systems, with 900 local connector units used to extend System X services to much wider areas than the localities served directly by the main local exchanges.

Despite the fact that the British network is already fully automatic, with direct national and international customer dialling to 158 countries, it shares with many other national telecommunications networks a number of serious constraints.

Two wire switching

It is dominated by two wire switching and by signalling associated with the connection path established for each call. This effects network transmission efficiency, severely restricts customer facilities, and makes centralized supervision of the network difficult.

At the same time, numerous types of

signalling system are used and, because these have to work together, this limits the capacity to convey information about the call and caller. Connection times are long for calls routed through several exchanges, and calls are subject to variable transmission losses, noise, and distortion. In addition, Strowger switches are prone to wear and require expensive maintenance. There is limited scope for further evolution and development of new facilities. The equipment has no potential for miniaturization to minimize the cost of accommodation in expensive city centre sites. Although many telecommunications experts argue that computer control is at least as important as the method chosen for routing signals through a telephone exchange's switching matrix, digital switching techniques offer real economic and operational advantages. Fully digital exchanges are very reliable, economical to build and maintain, and much more compact than their electromechanical counterparts.

The same carrier

Digital operation also makes for great flexibility in the use of the network by enabling different services — data, text, graphics and pictures, as well as speech — to be sent more cheaply over the same carrier, whether copper cable, optical fibre, microwave radio beam or satellite. When allied to a digital transmission system the arguments for the technology become irresistible. The major advantage of customer-to-customer digital operation is that once voice signals are converted from analogue to digital form they can be routed without further conversion over the whole network. This is a cheaper process, with simplified control, improved transmission quality, and reduced error rates. The result is an integrated network capable of supporting every modern telecommunications task and service. The forerunner of British Telecom (BT) — when the operation was part of the Post Office — first attempted to switch traffic telephone digitally in the mid-1960s. Due to the time required to move from a small scale experiment to a fully developed production system, an interim system had to be found. The authority thus took an evolutionary approach to the technology, with reed switched electronic exchanges such as Plessey's TXE 2 and STC's TXE 4 being introduced in large numbers in the late 1960s and the 1970s. The 1800 or so of these now in service will

form a bridge to a fully digital network.

The United Kingdom has been criticized for not making a serious commitment to digital technology earlier than it did; after all, the first pre-production System X machines did not appear in the national network until 1980. In fact, there are a number of reasons why this approach was preferred, if not inevitable.

An intricate task

Changing over from a very diversified national network primarily based on electromechanical exchanges of different types is a difficult, time consuming end intricate task. While digital technology, of a very early generation, could have been bought from overseas, the perpetuation of a viable British supply industry was considered to be in the best interest of the country as a whole. And the BT strategy had one inestimable technical advantage in that it allowed the United Kingdom to overtake developments in other countries.

The evolutionary nature of digital technology in Britain is matched by an evolutionary approach to its implementation. Wholesale substitution of new technology for old in more than 6000 exchanges is not in any case feasible because of the need to maintain uniform service and amortize existing plant. BT has identified a number of implementation strategies.

One can be termed augmentation. Under this concept, network nodes are progressively extended with digital switching. This has the advantage that disruption to the existing network is minimal, but has the disadvantage of requiring a large quantity of interface equipment. Another strategy is simple replacement of older equipment by digital exchanges. A third is to create an overlay, in which a digital network is built up side by side with an existing network and is linked to it in a controlled fashion. The last is basically the strategy adopted by BT in the majority of circumstances and will result in the most rapid penetration of new customer facilities. In essence, this overlay strategy allows digital elements to be fitted into existing analogue networks with minimal changes and, at the same time, provides a simple means of expanding the digital network.

Building blocks

The component parts of a System X exchange can be envisaged as building blocks that interact to provide the total function.



Checking System X with the aid of a visual display terminal.

The eight major blocks are:

- * The concentrator accepts customers' calls and concentrates them on to high traffic channels
- * The distributor switches calls to other destinations.
- * Signal interworking enables System X to work with the analogue exchanges.
- * The testing unit makes possible maintenance checks on customers' lines and on interconnecting circuits to other exchanges.
- * Inter-processor signalling sets up calls and "talks" to other System X exchanges using an internationally agreed standard.
- * The man-machine interface enables staff to monitor, control and maintain an exchange
- * The processor is the "brain" that provides instructions to other subsystems. It contains a number of software packages controlling such exchange functions as call processing and accounting, management statistics, overload, and maintenance control. Starting with the Spirax exchange in Coventry, the production versions of System X use a new processor which is up to ten times as powerful as the original. This gives these exchanges a very large traffic handling capacity, and up to 500 000 calls an hour can be carried with the new processor.
- * Automatic announcements guide the subscriber through the use of the sophisticated exchange facilities.

The right signals

The existing analogue exchanges use a wide variety of signalling systems in which control signals are sent over the same channels as the conversation. System X rationalizes this in a radical fashion.

Currently, analogue telephone networks employ a range of direct current (short distance), alternating current (long distance), and multi-frequency tone (transit network) signalling systems.

In present pulse code modulation systems, transmission technology time slot 16 is used for signalling for the 30 speech channels and is the first stage of a migration away from what is known as channel associated signalling to separate channel signalling. The latter is a feature of System X.

A separate System X data link of 64 kbit/s capacity puts virtually no constraint on the number of signals that can be used. Signals are transmitted rapidly to set up and clear down calls, and, most important, the data link permits signalling to continue during the call without inter-

ference. This feature is important both for data communication and for utilizing the new range of System X facilities.

Network signalling will be reduced by System X to two basic systems. The first is the direct access signalling system (DASS), which signals between the customer and the local System X exchange for the integrated services digital network (ISDN). In essence, the ISDN converges all customer services — voice, data and text — through encoding and multiplexing equipment into a common digital network. This is CCITT Signalling System 7, which deals with national and international network operation.

Star services

Ultimately, the success of System X will be determined by its popularity with users. In addition to the operational advantages already outlined, System X will offer what are termed as 'star services'. These are accessed by the subscriber using a push-button telephone in conjunction with automatic voice guidance from the exchange.

Included among those services are:

- * Abbreviated dialling
- * Call diversion to an alternate number.
- * Three way conversations.
- * Alternation between an existing call and new one.
- * Repetition of last number dialled.
- * Reminder call.
- * Call barring.
- * Charge advice.

Among the additional voice services being considered by BT is ringback, which involves getting the exchange to keep trying an engaged number and calling the subscriber when it is free; voice 'mail'; and charging calls made from other telephones to a personal account.

Other innovations

System X is only one of the many innovations for both business and domestic customers that British Telecom is introducing.

Known as SatStream, a commercial service provides private high speed digital communications between Britain and mainland Europe for companies using small dish satellite earth terminals. It provides integrated speech, data transmission, facsimile, teleconferencing and remote printing services.

International packet switching is now available to more than 50 networks and a 24 hour public electronic mail service is run by Telecom Gold, an independent company backed by BT.

Radio pagers with alphanumeric displays, which show the number to be called or provide coded information, were introduced last year, and the first public telephone on a high speed train was recently unveiled.

And, on the simplest level, the traditionally limited range of telephones available to subscribers has given way to a wide choice of shapes and styles and colours.

Cellular radio

British Telecom is also one of the main parties in the development of cellular radio. Together with Securicor, the private security company, it has won one of two licences granted to operate cellular radio in Britain. The other went to the Racal Millicom consortium. Under the cellular radio system, for mobile users of radio-telephone, a country is divided into areas and areas into small cells, each with a low power radio transmitter operating at different frequency from others in the area. A computer tracks the subscriber automatically and changes frequency when the user moves from one cell to another so that uninterrupted communications are maintained.

With this wealth of experience, BT along with the UK's telecommunications industry is expecting to gain significant business from other countries which are faced with the problems of modernizing their telephone systems, and require similar solutions to those in the UK. (LPS)



A final check for a System X component board

light-powered radio . . .

saves on batteries

All portable receivers, large and small alike, share a big drawback: their batteries! Those energy sources seem to know when that cricket match is getting really interesting, or when the play you are listening to is coming to its climax. It is then that they give up the ghost. Our tiny receiver works from solar cells and is therefore far less likely to let you down at those exciting moments, at least, as long as it is not too dark . . .

Rising costs and our endeavours to save energy mean that solar energy is in large scale use for the provision of heat and other energy in domestic and industrial buildings. And, of course, what can be done on a large scale can be done on a small scale, so that in almost every High Street you can find clocks, watches, and calculators that are powered by small solar cells. So, we thought, why not design a little radio that works from solar cells? Little, because that keeps the size of the required cells down, and makes it easy to slip the receiver in your pocket or handbag.

Circuit description

To keep the design simple and easy to build, we decided on a straight medium-

wave receiver, because this lends itself par excellence to our requirements. The circuit is based on a Ferranti ZN416. This IC is a welcome addition to the range that already includes the popular ZN414 and the ZN415 (descriptions of these appeared in the May 1982 issue of *Elektron UK* and the December 1983 issue of *Elektron India*). The ZN416 contains a complete AM receiver with enough audio output to drive headphones direct. It covers the frequency range 150 kHz . . . 3 MHz which includes the medium and long wave broadcast bands. The a.g.c. characteristic shows an increase of less than 7 dB in AF output for an increase of more than 30 dB in RF input. Due to the high input impedance of more than 4 M Ω , selectivity is pretty good: 8 kHz bandwidth at -6 dB points.

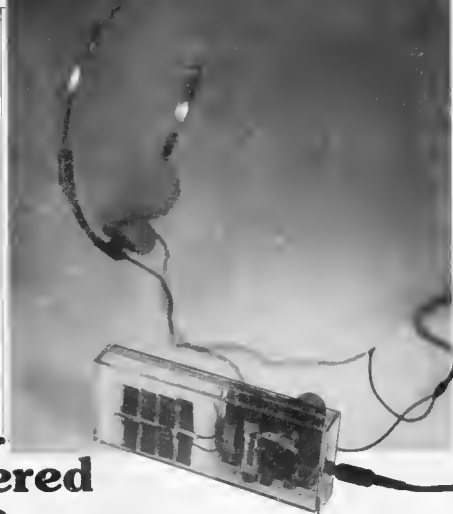

A number of external components is required to complete the design, as can be seen in figure 1. The input circuit can be tuned over the range 450 kHz...2.2 MHz, which amply covers the MW band. Inductor L1 serves also as aerial. Capacitors C2...C5 ensure optimization of the on-chip circuits. The impedance of the headphones should be greater than 32 ohms.

The power supply requirements of 1.5...2.0 V at 10...15 mA are met by four solar cells, each measuring 20x10 mm. Such cells can provide 0.5 V at up to 45 mA in good bright light. Their output current decreases with reducing ambient light. The current drawn by the ZN416 depends on the input signal and the output load, and normally varies from about 5 to 8 mA. The current consumption drops appreciably when high-impedance headphones (>2000 Ω) are used. For instance, when the output impedance is 4000 Ω , the current consumption drops to some 1.5 mA.

Capacitor C6 smoothes fluctuations in the supply voltage caused by varying light incidence onto the solar cells.

If you do not want to be dependent on light energy, it is, of course, possible to replace the solar cells by a 1.5 V U11 battery.

Construction

The receiver is most conveniently built on the pcb shown in figure 2. Make sure that the rotor, and not the stator, of C1 is connected to pin 8 of the ZN416. This may mean reversing the connections of this capacitor to the pcb.

Inductor L1 consists of a single layer of 60 turns of SWG35 enamelled copper wire close wound onto a 50x10 mm ferrite rod. Before winding the coil, stick a few layers of sellotape onto the ferrite rod. The turns may be fixed in place with nail varnish or quick drying glue. If you can get it, use litz wire instead of enamelled copper wire as this will result in a higher Q factor. The completed inductor should be fitted to the pcb with nylon thread or similar, but not with metal wire as this will reduce the Q factor to less than useful!

The completed board should be installed in a small man-made-fibre case. The on/off switch and the headphone connector are best fitted at the side of the case as shown in the photograph at the beginning of this article. The cells should be fixed with double-sided sticky tape as shown in the same photograph. They must be connected in series: their polarity is easily determined with a multimeter. Connections should be made with thin, flexible wire. Soldering should be done quickly: solar cells do not like heat!

Performance

If the radio has been constructed correctly, it should receive a number of MW stations, although this depends, to some extent, on your location. Note that solar cells can also convert energy contained in bright artificial light into electrical energy.

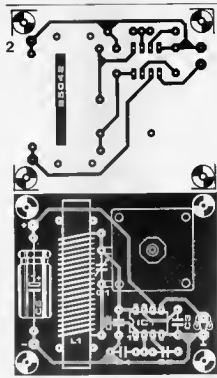
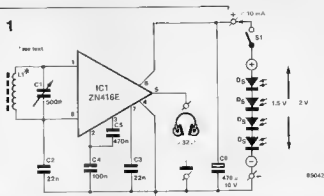

Figure 1. The circuit diagram of the light-powered radio.

Parts list

Capacitors

- C1 = 500 pF tuning capacitor
- C2, C3 = 22 n
- C4 = 100 n
- C5 = 470 n
- C6 = 470 μ /10 V

Semiconductors

- IC1 = ZN 416E (Ferranti)

Inductors:

- L1 = see text

Miscellaneous:

- S1 SPST switch
- Headphone, impedance 32 Ω
- Connector, chassis mounting, for headphones
- 4 solar cells, each measuring 20 x 10 mm (but see text)
- Man-made fibre case to individual requirements
- PCB 85042 (60 x 53 mm)

Figure 2. The printed circuit of the light-powered radio.



Another way of using the light-powered radio: on your sun hat!

If the receiver generates whistles, this may be obviated by interchanging the connections of L1. Finally, it is possible, if you want to use the radio predominantly in moderate light conditions, either to connect four additional solar cells in parallel with the existing ones, or to use larger cells.

A standard revolution counter tells us only what the number of revolutions per unit of time is. It is, however, more important to know the moment (torque), because an engine develops maximum moment at a certain number of revolutions and it is then that it works at its most efficient. The natural consequence of this is the unit presented here which shows both the number of revolutions per minute and the moment.

revolution counter...

...with torque indication

Any revolution counter may be used to economize on fuel consumption, as long as you know the relation between the number of revolutions and the moment of your car. That relation for a modern petrol engine is illustrated in figure 1. This shows that the maximum moment is available at 4000 rev/min, so that the engine then works at its most efficient. The curve also shows that this particular engine is most economically used over the range 3300...4500 rev/min.

The method we have devised of showing the driver at a glance in which range of revolutions the car engine is working is based on a LED bar indicator that has the shape of the revolutions vs moment curve of the engine. A schematic representation of such a bar, based on the curve of figure 1, is shown in figure 2. For the range below 3300 rev/min, yellow LEDs are used; for the optimum range of 3300...4500 rev/min, green LEDs; and for the range above 4500 rev/min, red LEDs.

Circuit description

To cover the useful range of revolutions, a total of thirty LEDs are proposed to ensure a reasonable resolution. All the circuit has to do is to arrange for the appropriate LED to light at any given number of revolutions. This can be done as shown schematically in figure 3: the ignition frequency, which is proportional to the number of revolutions, is taken from a point between the coil and the contact breaker and fed to a frequency-to-direct-voltage converter. The output of this converter is applied to the LED control circuits which arrange for the relevant LED to light.

The complete circuit is shown in figure 4. Resistor R11, diode D3S, and capacitor C5 shape the ignition pulses which is then applied to NAND Schmitt trigger N1. Gates N1 and N2, together with C6, R12, and P3, form a monostable multivibrator, the output pulses of which are buffered by N3 and N4. Low-pass filter

R13...R15/C7...C9 converts the output pulses of the monostable into a frequency-proportional DC voltage.

The input of the LED control circuit is formed by preset P2. The control circuit proper consists of two cascaded ICs type UAA170. As they are cascaded, and not all outputs are used for controlling LEDs, the transfer from one UAA170 to the other can be set with P1. Light-dependent resistor R9 controls the brightness of the LEDs; when it gets dark, the brightness is automatically reduced.

A small power supply, incorporating a type 78L05 voltage regulator, ensures a stable +9 V supply to the circuit.

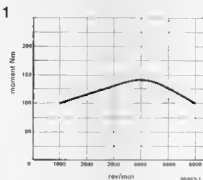

Figure 1. The rev/min vs torque characteristic of a typical modern four-cylinder, four-stroke petrol engine

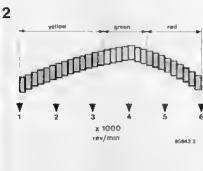
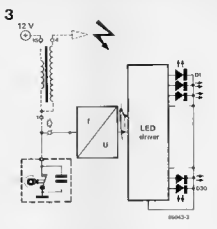

Figure 2. Schematic representation of the suggested LED bar indicator corresponding to the characteristic of figure 1.

Construction

Building the purely electronic part of the counter on the printed circuit shown in figure 5 is a piece of cake. The real difficulty lies in the construction of the LED indicator, because its shape differs from car to car, and we cannot, therefore, offer you a ready made design. The first thing to do is, of course, to find out the shape of the relevant curve for your car: this is normally given in the workshop manual. If you have not got this book, your local library is bound to have it — otherwise, you will have to ask your local car dealer.

Once you have the curve, you have to enlarge it until it is 75 mm wide. Now, not everybody will have a pantograph to hand, but many of you may remember from your school-days how you can enlarge drawings by parallel projection (ruler and triangle). If you are still stumped, you can have it done by your local photographer — but that is a rather more expensive way! The printed circuit board shown in figure 5 should be cut into two. The enlarged curve is now transferred to transparent paper. Then lay a sheet of copy paper on the copper side of the blank part of the pcb, put the transparent paper **face downward** on the carbon paper and trace the curve firmly. Where the curve crosses the copper track, carefully remove the copper, i.e., cut the track. At the centre of each copper island immediately below and above the cut drill a 0.8 mm diameter hole. The terminals of each LED are passed through the two holes from the front of the pcb and soldered to the copper. Remember to do this with correct polarity!



revolution counter

Figure 3. Block diagram showing the principle of the conversion of the ignition pulses to a linear control voltage.

Calibration

A function generator with accurate frequency scale is needed for the calibration. If the frequency scale is not very accurate, you need an oscilloscope or a frequency counter as well. The frequency

Figure 4. Circuit diagram of the revolution counter.

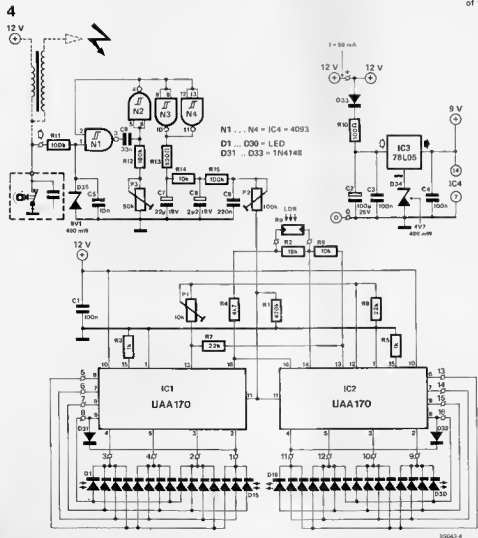

4

35043-4

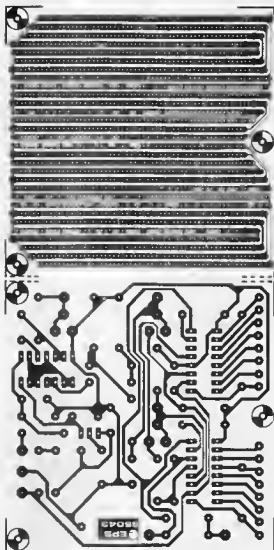

Figure 5. The printed circuit board consists of two parts: one for the drive circuit and one for the indicator.

of the pulse train emanating from the contact breaker is related to the number of revolutions as follows:

$$f = NAB$$

where f is the pulse rate; N is the number of revolutions per second; A is the number of cylinders; and B is the number of ignition pulses per cylinder and revolution. In almost all engines (notable exception: the Citroen 2CV) each cylinder is ignited at every second revolution. In the case of a four-stroke engine, B is therefore $\frac{1}{2}$.

In the following calibration procedure, we have assumed a four-cylinder four-stroke engine with a minimum number of revolutions of 2000 per minute and maximum

6000 rev/min.

At minimum revolutions,
 $f = 2000/60 \times 4 \times \frac{1}{2} = 66.67$ Hz.

At maximum revolutions,
 $f = 6000/60 \times 4 \times \frac{1}{2} = 200$ Hz.

Before commencing the calibration, set P1...P3 to about the centre of their travel, and set the function generator output to about 130 Hz. Next, adjust P2 and P3 until an LED somewhere in the centre of the curve lights. Then, adjust P1 so that changing the frequency very slightly causes a smooth transfer of lighting from the lighted LED to the immediately adjacent LED at its left or right.

Next, adjust P2 and P3 alternately so that at frequencies of 66.67 Hz and 200 Hz

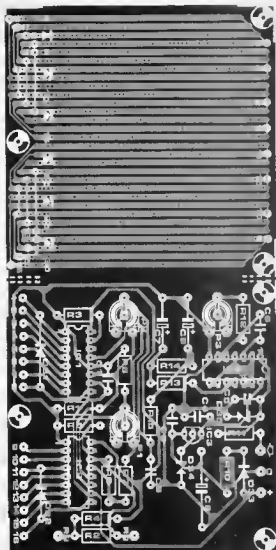

Parts list

Resistors*

R1 = 470 k
 R2 = 18 k
 R3, R5 = 1 k
 R4 = 4k7
 R6, R14 = 10 k
 R7, R8 = 22 k
 R9 = LDR 07
 R10 = 100 Ω
 R11, R15 = 100 k
 R12 = 180 k
 R13 = 820 Ω
 P1 = 10 k preset
 P2 = 100 k preset
 P3 = 50 k preset

Capacitors.

C1, C3, C4 = 100 n
 C2 = 100 μ /25 V
 C5 = 10 n
 C6 = 33 n
 C7 = 22 μ /16 V
 C8 = 2 μ /16 V
 C9 = 220 n

Semiconductors*

D1, D30 = LED
 (rectangular, 2.5 mm)
 red, green, yellow as
 required
 D31...D33 = 1N4148
 D34 = 4V7/400 mW zener
 D35 = 9V1/400 mW zener
 IC1, IC2 = UAA 170
 IC3 = 78L05
 IC4 = 4093
 PCB 85043 (160 x 80 mm)
 Case, as required

LEDs D1 and D30 light respectively. Finally, starting at 66.67 Hz, increase the frequency in steps of about 4.5 Hz and make sure that, from D1 onwards, all LEDs light in smooth succession. Note that only one LED should light at a time. If necessary, readjust P1 slightly.

Different minimum and maximum numbers of revolution give, of course, different frequencies. And, of course, your car may be a five or six cylinder model; here again, this makes a difference to the frequency. The principle of calibration remains the same, however.

Installation

Installation into the car and connecting

the revolution counter to the contact breaker terminals depends very largely on the type of car and we must leave these, therefore, to your own ingenuity.

We have deliberately made the top of the indicator pcb black, so that it can be used as the front panel of the revolution counter with the other pcb mounted behind it.

The whole may then be housed in a small suitable case. A piece of perspex over the front panel gives the unit a very pleasing appearance. ■

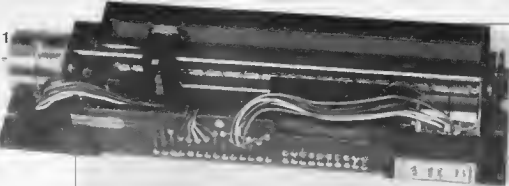

Photo 1 No, this is not a giant pen, it is a miniature X-Y plotter. The heat-sensitive paper used is 9 cm wide

Most of us would never even consider the idea of building an X-Y plotter or a matrix printer with a Centronics input. That, however, is exactly what this article proposes: a combined X-Y plotter and matrix printer. Probably the most important point is that you do not have to be a genius with your hands to construct the mechanical section. Not only that, but the electronics is straightforward and the cost of the design is not prohibitive.

The concept of this d.i.y. project is made possible by the availability of the entire printer mechanism, complete with two bi-directional motors that drive a thermal print-head. All that remains is to fix all this in place with four small bolts. The circuit is quite simple, consisting of the Centronics interface, an input data buffer, and a character generator. The software included provides the means of drawing vectors point-to-point with a high resolution.

X-Y graphic plotter

an elegant solution to the problem of how to make your own graphics printer

This project is very original, even by Elektor standards. It is a complete matrix printer and high-resolution X-Y plotter, affordable enough to be a solution for the 'impoverished' but at the same time it is a very interesting design in its own right.

The idea of making an X-Y plotter is by no means new but to achieve a good result there is one essential prerequisite, namely a very precise mechanical section.

A realistic compromise

Designing the circuit and writing the necessary software for this project comes easily to the Elektor designers. The mechanical part is a different matter, however. You cannot expect to be good at everything, after all. However, just as with our mini-printer published in the December 1984 issue, Seiko supply a complete X-Y plotter (minus electronics). This

is shown in photo 1. We used the STP411 printer mechanism for our prototype but we must stress that the electronics and the software could also be used with different mechanical modules. This leaves plenty of options open for those fortunate readers who are skilled in the arts of salvaging or even making the whole unit. Before becoming involved with the details of this project we have to define what we mean by a matrix printer and X-Y plotter. Most commercial matrix printers (Epson, Seikosha, Nec, etc.) have a (pseudo) graphics mode to enable them to print designs. The resident software, however, does not enable them to handle the coordinates of a vector on a cartesian (X-Y) grid direct, as happens with a drawing table. What these printers do is produce a hard copy of a memory (generally the screen or video memory) in which the design to be traced is stored. Just as the design exists pixel by pixel on the screen,

Characteristics

■ Bidirectional thermal printer mechanism containing:

- 2 stepping motors
- 8 or 9 element thermal print head
- friction drum to hold the paper
- worm-drive shaft to hold the print head
- 'home position' microswitch

■ 6502 CPU complete with software to control operation in:

- 7 × 5 or 9 × 5 matrix printer mode
- X-Y graphics plotter mode (with automatic test procedure)

■ Character generator stored in EPROM ready for reception of:

- alphanumeric characters (in ASCII code)
- X-Y vectorial coordinates (decimal values in ASCII code)
- control characters

■ Input buffer:

- 1½K bytes or 7½K bytes (depending on the RAM capacity — 2K or 8K)

■ Printing speed

- on average 0.5 s per line of text.

■ Horizontal resolution

- 256 or 320 dots
- 45 or 56 characters per 9 cm line.

■ Printer mechanism

- dimensions: 153 × 45 × 20 mm
- weight: 135 g
- expected lifespan: 500 000 lines ¹⁾
- expected print-head lifespan: 300 000 lines ¹⁾
- AC supply: 5 V/5 A (max.)

1) at a 50% printing speed

it exists **bit by bit** in the memory. By sending the contents of the memory one **byte** at a time to the matrix printer (which must be in graphics mode), it is possible to obtain a **copy** of the design on paper. It is, however, impossible to trace the design directly on the printer based on the vector coordinates. That is exactly what the plotter proposed here can do.

The procedure used is quite simple. We start by sending the ESC character to the printer via the Centronics port. This signifies that the following ASCII codes are not characters for printing but the co-ordinates of a vector that has to be traced. The coordinates of the vector are then sent, separated by ASCII character "m" and beginning with the origin of the vector.

For example, the vector starts at X = 2, Y = 6, and finishes at X = 15, Y = 12 (see figure 1).

The sequence of instructions needed to print the vector is:
PRINT CHR\$(27); "m"; '2'; '6'; 'm'; '15'; '12'; 'm'

It is worth noting at this point that most BASIC interpreters accept the PRINT instruction without the semi-colons between strings of characters (which are in quotes) and variables (which are not enclosed by quotes).

If the end-point of a vector is the same as its origin a single dot is printed. The parameters needed to trace vectors are as follows:

(ESC)/OX/OY/EX/EY/(CR)

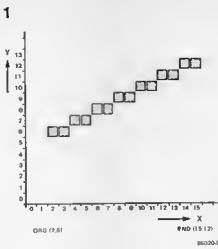

2

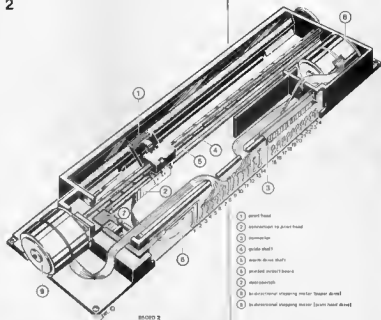
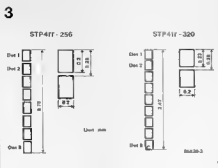

Figure 2. The Seiko thermal printer mechanism used here is only one of the many possibilities. If another mechanism is used, the circuit will almost certainly have to be changed somewhat, as will the software.



Photo 2. The print head slides on the worm-drive shaft seen here. This photo also shows the flexible connection to the print head.

Figure 3. The dimensions of the two types of printer, STP411-256 or STP411-320, are different. The higher resolution of the 320 dot version makes it more suitable for precise traces.



where OX and OY define the origin of the vector and EX and EY signify its end. That all seems very simple but the desired result is achieved only if electronics, mechanics, and software are perfectly coordinated.

The printer mechanism

The sketch in figure 2 shows the printer mechanism with its two bi-directional stepping motors, worm-drive shaft, and thermal print-head. We will not deal with this mechanism in any great detail. As photo 2 shows, it is a fine example of precision engineering but, because it has been kept as simple as possible, it is pleasantly inexpensive. The horizontal motor is connected direct to the drive shaft; every pulse to the motor causes the head to move one step to either the left or the right. The horizontal resolution is 256 or 320 dots depending on the type of mechanism chosen and the size of step is 0.35 mm in the former and 0.28 mm in the latter case (see figure 3). The manufacturer indicates that there is a 'dead' angle of two or three dots according to the type of mechanism used. This means that nothing happens for 2 or 3 pulses after the head changes direction. The software that drives the printer must take this into account.

Table 2.

Correction: 256/320

PL4 (closed = "1"; open = "0")

1-2	"1" = STP 411-320 "0" = STP 411-256
3-4	bit 2 binary coded
5-6	bit 1 7 step correction
7-8	bit 0 on paper feed

bits 2 1 0	number of steps	plugs		
		3-4	5-6	7-8
0 0 0	0	no	no	no
0 0 1	1	no	no	yes
0 1 0	2	no	yes	no
0 1 1	3	no	yes	yes
1 0 0	4	yes	no	no
1 0 1	5	yes	no	yes
1 1 0	6	yes	yes	no
1 1 1	7	yes	yes	yes

Table 1.

Centronics input	
PL2	
1	STROBE
2	DATA 0
3	DATA 1
4	DATA 2
5	DATA 3
6	DATA 4
7	DATA 5
8	DATA 6
9	DATA 7
10	BUSY
11	N C
12	Paper empty (see PL3)
13	SELECT
14	GND

Paper empty	
PL3	
1-2	PAPER EMPTY
3-4	PAPER EMPTY

Figure 4 As this block diagram shows, the circuit of the printer/plotter is actually a complete microcomputer.

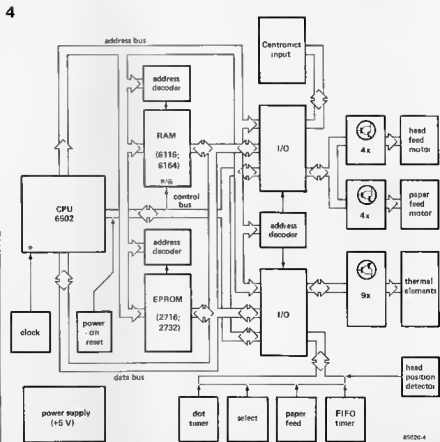

Like the head movement, the paper feeding occurs in steps, which are the same size as the steps the head makes. In this case the motor is not directly coupled to the paper drum. A miniature 'gearbox' is used that gives a reduction factor of 4:1. This means that the motor has to receive four pulses for the paper to move by one step.

This reduction (illustrated in figure 3) is also subject to a 'dead' period every time the motor direction is changed. If uncorrected, this would, of course, make rubbish of any design that is being drawn. Unfortunately, Seiko, did not mention this detail in their data sheet for the STP411, which caused a few headaches for our designers. They were, of course, very reluctant to modify the otherwise excellent mechanics to cure the problem. As it happens, this was not necessary: the software was made clever enough to iron out this little difficulty.

Our final comment about the motors is to note that each has a maximum current consumption of 500 mA at 5.5 V.

We have already mentioned that there are two different printer mechanisms available. The main difference between them is in the print head. The 256 dot version has 8 thermal elements while the 320 dot type has 9. The sketch in figure 3 shows how the size of the dots consequently varies. The current applied to the heating elements is corrected to compensate for changes in the ambient temperature. This current regulation is achieved by varying the frequency of the signal applied to the print head. The maximum current drain is 3.5 A when all the thermal elements are on simultaneously.

The final feature of the printer mechanism we will mention is the 'home' detector. This is a micro-switch which is open when the print head is at the extreme left. As our designers were not fully satisfied with this arrangement, they added a further precaution. After receiving a 'head-home' indication, the head is first moved several steps to the right, then brought left until 'home' is again detected, and finally moved three steps to the right. This is then taken to be the initial position for the head. This precaution ensures that the head's 'home' position is always correct even if the mechanism is moved or stopped accidentally by hand. So much for the mechanics of the printer; now for the electronics.

A complete microcomputer

The electronics section of this project is no less than a complete microcomputer, as the block diagram of figure 4 shows. It has a CPU (8502), random access memory (2K or 8K), read-only memory (4K or 8K), input and output ports (18 lines), a clock, and the 'home' detector already mentioned. The layout requires no comment. There are, however, some points in the

3



X-Y graphic plotter

Photo 3. The gearing mechanism on the printer has a 'dead angle' (the mechanical equivalent of hysteresis) that Seiko has neglected to mention in their literature on the STP411

Table 3.

Inputs Outputs		
6821/IC4	Port A	Centronics interface
	40 CA1 (in)	STROBE
	39 CA2 (out)	BUSY
	2 PA8	Data 0...7
	1 PA7	
	1 PA7	
	8 PA7	
	6821/IC4	Port B
18 CB1		not used
19 CB2 (out)		BUSY indicator
10 PB8		Head drive motor
13 PB3		
14 PB4		
17 PB7		Paper feed motor
6821/IC5		Port A
	40 CA1 (in)	Select/deselect
	39 CA2 (in)	FIFO timer
	2 PA9	PL4: paper feed error
	1 PA9	
	5 PA3	
	6 PA4 (out)	RFO timer
	7 PA5 (out)	Select indicator
	8 PA6 (in)	Home switch
9 PA7 (in)	Paper feed switch	
6821/IC5	Port B	Dot control
	18 CB1 (in)	Dot timer
	19 CB2 (out)	Thermal head: dot 9
	10 PB8	Thermal head dots 1...8
	17 PB7	
	17 PB7	

Table 4

		STP411-256	STP411-320		
1		Home switch			
2					
3 Green	C	Motor for head driving			
4 Green	C				
5 Blue	#1				
6 White	#2				
7 Yellow	#3				
8 Red	#4				
9 Green	C				
10 Green	C				
11 Blue	#1	Motor for paper feeding			
12 White	#2				
13 Yellow	#3				
14 Red	#4				
15	SEIKO			ELEKTR	Dot 1
16	NC				Dot 2
17	Dot 1		Dot 2		
18	Dot 2		Dot 3		
19	Dot 3		Dot 4		
20	Dot 4		Dot 5		
21	Dot 5		Dot 6		
22	Dot 6		Dot 7		
23	Dot 7		Dot 8		
24	Dot 8		Dot 9		
	Common	Common	Common		

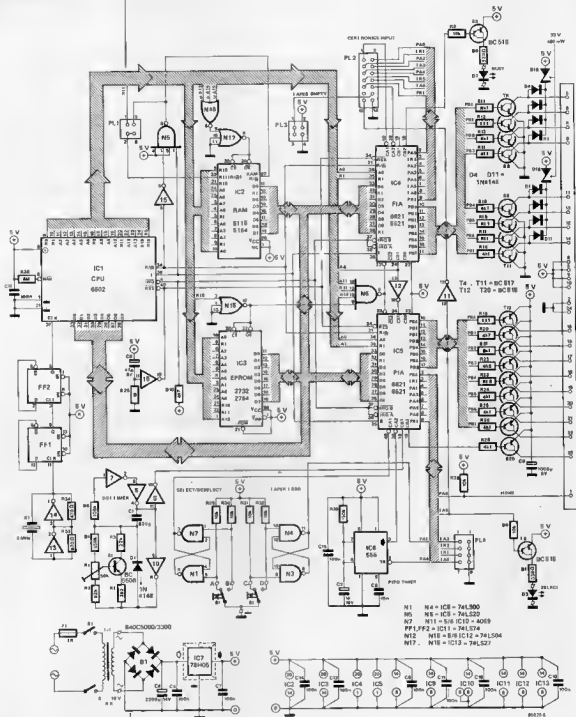

Figure 5. Although designed to suit the Seiko printer, this circuit is universal enough to be easily modified if another type of mechanism is to be used

diagram of specific importance to this project. There is a select switch to turn the plotter on and off, a manual paper-feed switch, the Centronics interface, the transistorized power stages, the clock used to control the head-current based on the ambient temperature (dot timer), and a timer (FIFO timer) that determines the printing speed for characters received via the input buffer. At the right-hand side of

figure 4 we see the printer sections: two motors (one for the paper, one for the head), the head itself, and the 'home' switch.

Once you have seen the block diagram, the actual circuit (shown in figure 5) holds few surprises. On power-up the circuit is reset by R28 and C8. The 4 MHz clock signal generated by N13 and N14 is reduced to 1 MHz by FF1 and FF2. A RAM R/W

signal is obtained via N5 and N15, while N19 provides the address decoding signal for read-only memory IC3. If an 8K EPROM chip is used, it is located in addresses E000_{HEX} to FFFF_{HEX}. If a 4K EPROM is used (as is shown here), the addresses occupied are F000 . . FFFF_{HEX}. The possibility of using 8K of ROM (twice the standard size) leaves room to expand the resident software. Address decoding for the RAM is taken care of by N17 and N18. Depending on the choice of IC2, either 2K or 8K of RAM is available, occupying addresses 0000 . . 07FF or 0000 . . 1FFF respectively. If 2K RAM is used, the input buffer is only 1½ bytes; with 8K RAM the buffer size grows to 7½ bytes. If IC2 is a 6116, pins 3 and 4 of PL1 must be linked, whereas in the case of a 6164 a link is made between pins 1 and 2. Address decoding of input-output circuits IC4 and IC5 is taken care of by N6 and N19 (up to the general selection of page 7XXX) in combination with N12. This latter NOT gate is needed to choose either:

7010_{HEX} (IC4) or 7000_{HEX} (IC5)
Simple anti-bounce flip-flops are located around S1 and S2. The logic levels output by these flip-flops is fed to lines CA1 and PA7 of IC5, via which the processor can examine them. In this way S1 switches the plotter on and off and S2 controls the manual paper feed.

The printer's Centronics interface, the pin designation of which is given in table 1, is based on port A of IC4 and connector PL2. The BUSY and SELECT LEDs are controlled by lines CB2 of IC4 and PAS of IC5. The printer mechanism we used does not signal whether there is paper present or not, so the Centronics interface does not have a PAPER EMPTY signal as such. Making one of the links in PL3 as shown below causes the inverse level at the Centronics PE line of that expected by the computer.

1-2, if the computer expects a PE signal (Centronics = PE)

3-4, if the PE signal is expected (Centronics = PE).

The compensation for the paper feed mechanism's 'dead' angle is achieved by placing links in PL4. We have dedicated a box here to deal with this. The dead angle of the 256-dot mechanism is 2 dots and of the 320-dot type is 3 dots. In practice or with use these values may change so we have allowed for a compensation of up to 7 steps.

The links at PL4 also select either the 256 or the 320 point mechanism. This is determined by the logic level on line PA3, which also ensures that the software is suitable for the version used.

All this brings us to the input-output lines and to the actual operation of the circuit. The 6821s, used here because of their favourable price, do not have any internal timer like their more expensive counterparts so a 555 is needed for this. The timer generates a pulse used to control the speed at which the 6802 deals with

Table 5.

X-Y graphic plotter

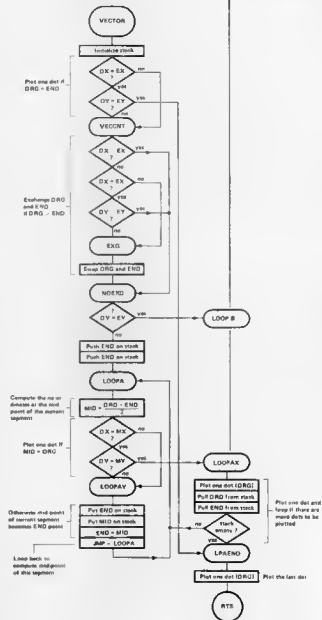

the input buffer. The processor is continually divided between two tasks: receiving and storing characters in the buffer and outputting these same characters for printing. The sequence of events can be summarized as follows.

- The printer has just been initialized and is ready to receive data; before starting to receive data the software sends a trigger pulse to monostable IC6.
- During the IC6 pulse the printer is in the receive mode; characters that appear at the input are saved in a FIFO (first in first out) buffer.
- As soon as the pulse has passed a line of characters is printed if there is one in the buffer (if a CR is present).
- The software resets the monostable and

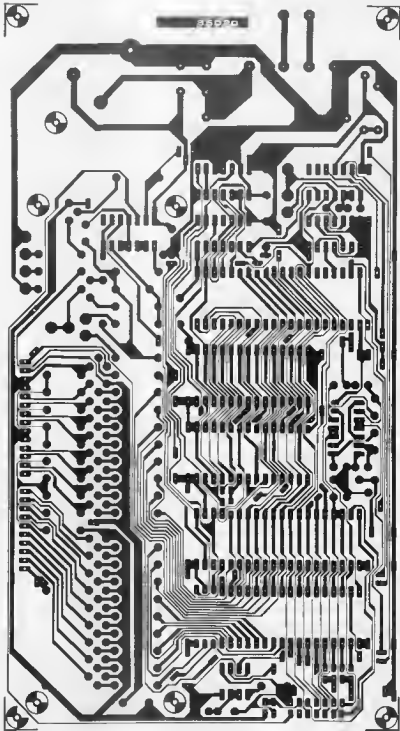

Figure 6. All the components except the mains transformer fit onto this printed circuit board. Even the Seiko printer is bolted to the board. When fitting the completed circuit into a case, be careful not to forget that the paper needs an entry and an exit point

examines the Centronics interface: if a new character has appeared it is loaded into the buffer and reception continues until the end of the pulse; if there is no new character to receive, the program continues to print the lines of characters already received until the buffer is empty or the timing pulse supplied by the 555 ends.

This cycle continues indefinitely. The soft-

ware constantly examines the buffer pointer to avoid a skip that would result in an irreparable loss of data.

The oscillator based on N6...N9 is also an essential timing element during printing its frequency determines the cyclic relationship of the pulses applied via T12...T20 to the print-head elements. The energy applied to these elements is scrutinized closely as the current cannot be

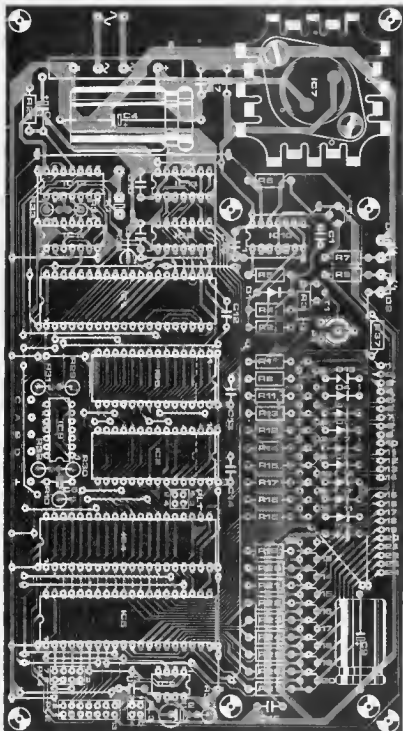

Parts list

Resistors:

R1 = 150 k
 R2, R3 = 22 k
 R4 = 2k2
 R5 = 100 k
 R6, R8, R29 = R32,
 R37 = 10 k
 R7, R9 = 330 Ω
 R10, R19 = R27, R35,
 R36 = 4k7
 R11 = R18 = 5k6
 R28 = 1 k
 R33, R34 = 470 Ω
 P1 = 50 k preset

Capacitors:

C1 = 820 p
 C2 = 1 μ /16 V
 C3 = 10 n
 C4 = 2200 μ /16 V
 C5, C6, C7, C10...C16 =
 100 n
 C8 = 47 μ /6 V
 C9 = 1000 μ /16 V

Semiconductors:

O1, D4 = D11 = 1N4148
 O2 = LED red
 D3 = LED green
 O12, D13 = 33 V/400 mW
 zener

B1 = bridge rectifier
 40 V/5 A
 T1 = BC 550B
 T2, T3, T12 = T20 = BC 516
 T4...T11 = BC 517
 IC1 = 6502
 IC2 = 6116 (6164)
 IC3 = 2732 (2764)
 IC4, IC5 = 6821 (6821)
 IC6 = 555
 IC7 = 78H05 (TO3)
 IC8 = 74LS00
 IC9 = 74LS20
 IC10 = 4089
 IC11 = 74LS74
 IC12 = 74LS04
 IC13 = 74LS27

Miscellaneous:

F1 = fuse, 1 A slow-blow
 Tr1 = mains transformer,
 9...10 V/4 A
 X1 = quartz crystal, 4 MHz
 Seiko X-Y plotter
 mechanism, STP411-256 or
 STP411-320
 heat sink for IC7, TO3 type
 dual row links: 2 off 4-way
 1 off 8-way
 1 off 14-way

PCB 85020

constantly present or it would cause a burn-out. Compensation for changes in ambient temperature is achieved with preset P1, whose wiper is connected to the base of transistor T1. Moving the wiper of P1 changes the biasing on T1 and thereby increases or decreases the frequency of the associated multivibrator.

This section of the circuit also enables the electronics for the printer to be tuned to

the different types of thermal elements that Seiko mount in the mechanism. The suffix used (A, B or C) designates the resistance of the print head. The exact value is unimportant as P1 compensates for it in any case. The smaller the resistance of the thermal elements the lower the multivibrator oscillating frequency (upon which the current directly depends).

The stepping motors are controlled via two groups of four transistors (T4...T7 and T8...T11), each fitted with a diode circuit as a protection against any reverse inductive charges the motors may generate. An article is dedicated to this sort of motor elsewhere in this issue so we will not duplicate any of the details here. Before moving on from figure 5 we would like to point out the power supply section based on IC7. This provides power for the processor and its peripherals, of course, but also for the motors and thermal elements. Because of that it dissipates a lot of heat. During printing the peak current consumption is actually about 4.5 A.

Small, but...

Of no little merit is the fact that this printer/plotter is small in size. The layout of the printed circuit board is seen in figure 6. The four corners of the printer mechanism are bolted to this board at the positions provided. Connecting the mechanism to the board is a matter of making 24 direct links between the two, on a one-to-one basis. Before doing this, however, it is wise to test the power supply (without the other components), and then the clock, anti-bounce flip-flops, and oscillator N6...N9. After mounting P1 on the printed circuit board, its wiper should be turned fully to the right. In this position the printing contrast is minimal and there is no danger of burning out the print-head elements. Initialize (reset) the circuit and check that the logic level at the bases of T12...T20 is high. These transistors are then switched off so no current can flow through the thermal elements.

The 'electronics' can now be connected to the 'mechanics'. If an STP411-320 is used, make links 1...24 as indicated. If the lower resolution STP411-256 is chosen, make all the links except 23 and then solder pins 23 and 24 together at the printer mechanism (not on the printed circuit board). The mechanism of the STP411-256 must also be modified slightly. As table 4 shows, pins 15...23 are offset on the '256' compared to the '320'. Rather than correct this by software, we prefer to move the internal connector on the printer block. The print head is connected to the chassis by a small piece of flexible printed circuit board (this can be seen in photo 4). The '320' version uses all of the ten available tracks, whereas with the '256' only nine of the lines in the female connector are used by the male connector. In

this way, there is a line free either at the left or at the right of the female connector. The Seiko version leaves the empty line at the left (pin 15 in table 4), but in our design we have moved the space to the extreme right (pin 24). This change is easily made: carefully extract the female connector from the chassis, move it one step to the left, and re-insert it. Do not use any sharp (or toothed) tools for this — it is far better to just use your fingers.

If the wiper of P1 is turned fully clockwise, this electro-mechanical assembly is now ready for the baptism of fire.

The software

The program stored in EPROM IC3 cannot be properly dealt with in this article so we will only describe it in a very general way. The software is the same no matter

Table 6

Important addresses

Owing to lack of space, we are not able to give you the complete source listing, the hex dump of the EPROM in the plotter is given instead. Vector NMI in FFFAhex and FFFBhex points to the origin of a test routine in FB41hex. The remainder of the EPROM content is divided into two: the routines for receiving and printing (alphabetically) with the character generator, and the routines for plotting the vectors. Table 6 gives the principal addresses in hexadecimal.

F099	F02C	internal jump-table
F02D...	F034	stepper look up tables
F039		delay subroutine
F041:		SIGMA initialization (reset vector)
F092:		turn paper feed stepper right
F0AC:		turn paper feed stepper left
F0BC		stop print head left
F0D6		stop print head right
F0E6:		feed paper and increment
F10D:		eat paper and increment
F138		head right end increment
F144		head left and decrement
F154		home head
F194		print character in A
F306:		print line buffer
F30A:		load head
F393:		receive a character
F41A:		printer main program
F586:		character generator
F935		graphic sigma
F976		plot origin
FA4F:		graphic handler
FB41:		test program (NMI vector)
FB90:		vector plotter

Photo 4 To use the same character generator for both types of printer mechanism (256 or 320 points), the connector of the 256-point version must be moved one space to the left.



- "/"
- coordinate of the origin on the Y-axis
- "/"
- coordinate of the end on the X-axis
- "/"
- coordinate of the end on the Y-axis
- "/"

If none of these parameters is left out or if there is an error in the syntax the complete instruction is simply ignored. Be especially careful not to forget the last "/" after the end Y coordinate.

Before starting to trace a design the pointers and timers for the plotter program must be initialized. This is achieved with the CTL-D (CHR\$4) command.

It will now be apparent just how easy this printer is to use in either mode. It is also a simple matter to combine alphanumeric characters and graphic traces.

Lines are traced using an algorithm that makes successive approximations for the coordinates of all points between the origin and the end of the vector (table 5). In theory this algorithm allows vectors to be 32768 dots. If the vectors end coordinates are lower than the origin (on one axis or both), the XY plotter itself automatically reverses the direction of the plot.

In printer mode the CTL-I (CHR\$9) instruction flips a 'switch' in the program: all characters received after this command are printed in white on a black background. The inversion continues until another CTL-I is received. Note that an ASCII LF (line feed) is not needed after CR (carriage return) but it does not affect the operation of the printer. On the other hand, the characters fed into the buffer are dealt with one line at a time so the program can determine the position of the print head when the CR arrives. This infor-

mation is then used to decide whether the next line will be printed from left to right or right to left. This so-called 'bi-directional logical seek' simply looks at which choice requires the least head movement.

Printer

This printer/plotter can be tested even without a Centronics interface. An automatic test program included in EPROM IC3 takes care of this. The test draws a three-dimensional pyramid and is started by a short negative pulse on the 8502's NMI (non maskable interrupt) input. A push-button can be connected from pin 6 of IC1 to ground for this.

The printing contrast is increased by moving the wiper of P1 left-ward. The contrast changes very gradually only.

There may be a noticeable drift at the corners of the test pyramid's base. If this is the case, insert the link between pins 7 and 8 of PL4 and give another NMI pulse. The drift is then reduced by one step. If this is not enough, insert the next link. Continue like this, following table 2, until the pyramid is as perfect as possible. When this correction is made, the push-button can be removed. Now all the printer/tracer needs is to be put into a suitable case.

Final note

If the power-on reset does not always work error free, this may be remedied by (a) replacing the 74LS04 in the IC12 position by a 74LS14, or (b) connecting an additional pull-up resistor of 1 k between the +5 V line and pin 10 of IC12 (output of N16).

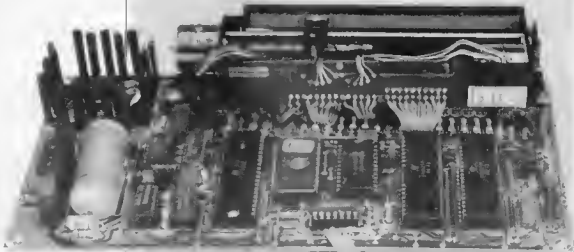

It is one of our traditions that we regularly publish some sort of sound-effect project, and what better at this time of the year than a cuckoo? It is, of course, not our intention to replace the real cuckoo, because however fascinating electronics may be, it cannot ever take the place of nature!

the first cuckoo in spring

the first cuckoo in spring . . .

With reference to the circuit diagram in figure 1, integrator A1 and trigger A2 form a triangular pulse generator. Diodes D1 and D2 chop the apex of the pulses, so that the input to A3 looks like a distorted sine wave. Oscillator A3 produces the voice of the cuckoo which is amplified by T2 and T3.

The remainder of the circuit serves to control the frequency and volume of the output. Counter/divider IC2, with its

associated gates, determines the duration of each of the two syllables of 'cuckoo', and when oscillator A3 should be switched off. The design is such that even after trip switch S2 has been opened a complete cry of 'cuckoo' is produced. After all, no cuckoo worth its salt stops in mid call!

Random number generator IC3, with its associated gates N2 and N5..N7, is not necessarily involved in the synthesis of

. makes you forget the long winter

W.D. Roth

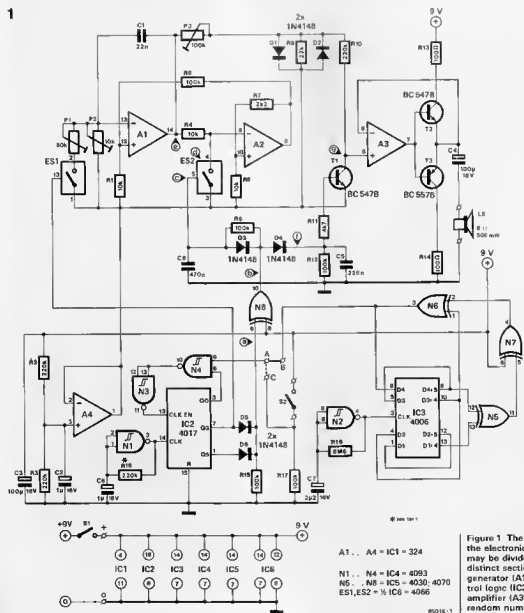

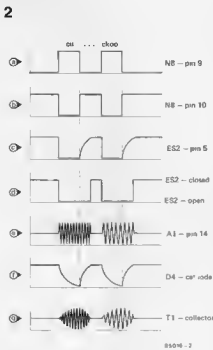

Figure 2 The various timing diagrams facilitate an understanding of the function of the circuit and may be of help in fault finding

the cuckoo cry. It is, rather, an alternative to S2; wire link A is then connected to B instead of to C. Because of its random operation, IC3 provides a much more realistic effect than is obtained when S2 is closed (and 'cuckoo' is repeated regularly).

Functional description

In the following, reference is made to the timing diagram in figure 2. Decimal counter IC2 sequentially provides a logic high at its outputs Q1... Q10 for each clock pulse fed to pin 14 by gate N1.

In this way it is possible to obtain arbitrary pulse trains which repeat themselves after every tenth clock pulse from oscillator N1. In the proposed circuit, therefore, pin 9 of XOR gate N8 is high when Q3 and Q5 are '1', and '0' during the remaining eight clock pulses (figure 2, a and b). A high logic level at Q3 causes an additional rise in the frequency of the triangular pulse generator during the first syllable of cuckoo. CMOS switch ES1, which is controlled via pin 7 of IC2, closes and connects P1 across frequency control P2: this causes a reduction in resistance at the non-inverting input of A1. Were it not for another CMOS switch, ES2, there would still be a tone audible. This switch closes when Q3 or Q5 is logic low, which inhibits the triangular pulse generator. The delaying action of R5/C8 ensures that the cuckoo sound remains audible for an instant, provided it was initialized (figure 2, c and d). This procedure is necessary because of the following.

Transistor T1 operates as a simple voltage-controlled amplifier which ensures that the sound does not abruptly come on or decay, but instead swells and dies down gently (in about 100 ms). The collector-emitter junction of this transistor may be considered as a voltage-controlled resistance. When the base voltage rises, the junction conducts harder and harder. As the junction forms a potential divider with R10, the combination of the two forms an electronic potentiometer that increases the output level of the triangular-pulse generator with rising base voltage. The output signal (at the collector of T1) corresponds to the envelope of the signal in figure 2g. Therefore, the leading and trailing edges in figure 2b trigger T1. Diode D4 and capacitor C9 form an envelope generator. The decay of the sound level is initiated by the trailing (positive-going) edge of the pulse in 2b. The output of the

3

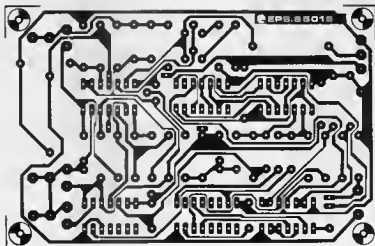

triangular-pulse generator must continue until the sound has died down and this is guaranteed by the logic level in 2d. Random number generator IC3 is an 18-stage shift register that operates in conjunction with Schmitt trigger N2 and XOR gates N5...N7. The random pulse train at pin 3 of N6 is, in fact, not as haphazard as at first may appear: it repeats itself after a certain period! The pauses between two successive trains are, however, so (relatively) long that the regularity is not easily noticed.

Calibration

Sound frequency. Control P2 is responsible for the low frequencies in the cry of the cuckoo and must, therefore, be set first. The pitch should be set by ear: it is not easy to get a live cuckoo to compare with! The setting of P1 is rather more critical, because when ESI closes the generator should oscillate a major third higher. Once P1 has been set correctly, and you alter the setting of P2, it must be readjusted, because the pitch is determined by the parallel combination of the effective values of P1 and P2.

Wave-form. To obtain as pure a sound (i.e., devoid of harmonics) as possible, it is essential that the peak value of the gener-

ator output across diodes D1 and D2 is roughly ± 0.6 V. Onset of chopping at the correct level is then guaranteed. Control P3 should, therefore, be adjusted carefully until the output from the loudspeaker sounds purest. It is advisable to connect a wire link (or closed switch) between A and C, because if you work with link A-B, you may find the intervals between the cries of our feathered friend rather too long for calibrating purposes.

Power supply

A (9-V) PP3 battery is ideal for powering the circuit. As opamps A1 and A2 require a bipolar supply, the battery voltage is divided into two by R2 and R3, and buffered by A4.

Some final tips

The cry of the cuckoo will sound more realistic if you swathe the loudspeaker in a piece of cloth and fit it in a small cabinet (so as to increase the resonance frequency). If the intervals between the cries of the cuckoo are too short or too long, the remedy lies in increasing or reducing, as the case may, the value of R16. M

Parts list

Resistors

R1, R4, R6 = 10 k
R2, R3, R10, R16* = 220 k
R5, R8, R12, R15, R17 = 100 k
R7 = 2k2
R9 = 22 k
R11 = 4k7
R13, R14 = 100 Ω
R18 = 6M8
P1 = 50 k preset
P2 = 10 k preset
P3 = 100 k preset

Capacitors:

C1 = 22 n
C2, C6 = 1 μ /16 V
C3, C4 = 100 μ /16 V
C5 = 220 n
C7 = 2 μ /16 V
C8 = 470 n

Semiconductors:

D1, D6 = 1N4148
T1, T2 = BC 547/B
T3 = BC 557B
IC1 = LM 324
IC2 = 4017
IC3 = 4006
IC4 = 4093
IC5 = 4030 or 4070
IC6 = 4066

Miscellaneous:

S1 = SPST switch
S2 = SPST push button switch
Loudspeaker 8 Ω /500 mW
PCB 85016 (110 \times 72 mm)
*see text

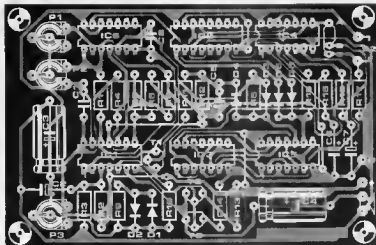
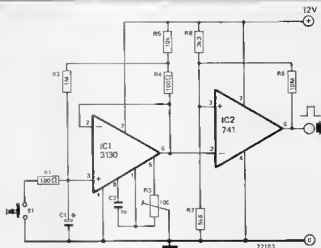

Figure 3. The printed circuit board makes construction a very simple matter indeed.

long interval timer



*see text

The drawback of most analogue timers (monostable circuits) is that, in order to obtain reasonably long intervals, the RC time constant must be correspondingly large. Thus a variable mechanical resistor values in excess of 1 MΩ, which can give timing errors due to stray leakage resistance in the circuit, or large electrolytic capacitors, which again can introduce timing errors due to their leakage resistance.

The circuit given here achieves timing intervals up to 100 times longer than those obtainable with standard circuits. It does this by reducing the charging current of the capacitor by a factor of 100, thus increasing the charging time, without the need for high value charging resistors.

The circuit operates as follows: when the start/reset button is pressed C1 is discharged and the output of IC1, which is connected as a voltage follower, is at zero volts. The inverting input of comparator IC2 is at a lower potential than the non-inverting input, so the output of IC2 goes high.

The voltage across R4 is approximately 120 mV, so C1 charges through R2 at a current of around 120 nA, which is 100 times lower than could be achieved if R2 were connected direct to positive supply.

Of course, if C1 were charged from a constant 120 mV it would quickly reach this voltage and would cease to charge. However, the bottom end of R4 is returned to the output of IC1, and as the voltage across C1 rises so does the output voltage and hence the charging voltage applied to R2.

When the output voltage has risen to about 7.5 volts it will exceed the voltage set on the non-inverting input of IC2 by R6 and R7, and the output of IC2 will go low. A small amount of positive feedback provided by R8 prevents any noise present on the output of IC1 from being amplified by IC2 as it passes through the trigger point, as this could otherwise give rise to spurious output pulses.

The timing interval is given by the equation:

$$T = R_2 C_1 \left(1 + \frac{R_3}{R_4} + \frac{R_4}{R_2}\right) \ln \left(1 + \frac{R_7}{R_6}\right)$$

This may seem a little complicated, but with the component values given the interval is $100 \cdot C_1$, where C1 is in microfarads, e.g. if C1 is 1µF the interval is 100 seconds. It is evident from the equation that the timing interval can be varied linearly by replacing R2 with a 1 MΩ potentiometer, or logarithmically by replacing R6 and R7 with, say, a 10 kΩ potentiometer.

voltage frequency converter

Using only a few components and an integrated switching circuit it is possible to construct a high-performance voltage-frequency converter. With the component values shown in the diagram, the conversion ratio has a linearity of approx. 1%. An input voltage from 0V...10V will produce a corresponding 0...10 kHz squarewave output voltage. By means of potentiometer P1, the circuit can be adjusted so that an input voltage of 0V will produce an output frequency of 0 Hz.

The components which determine the frequency are resistors R2, R3, R5, P1 and capacitor C2. Using the formulae shown in the diagram, the conversion ratio of the circuit can be altered so that the circuit can be used for a number of different applications. When calculating the product of $T = 1.1R_3C_2$ care should be taken to ensure that this is always less than half the minimum output period, i.e. the positive output pulse should always be at least as long as the negative pulse.

RAYTHEON product specifications

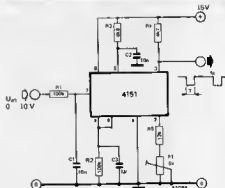

$$\frac{f_o}{U_{in}} = 0.486 \cdot \frac{1R_5 + P1}{R_2 \cdot R_3 \cdot C_2} \left(\frac{V}{V}\right)$$

$$T = 1.1 \cdot R_3 \cdot C_2$$

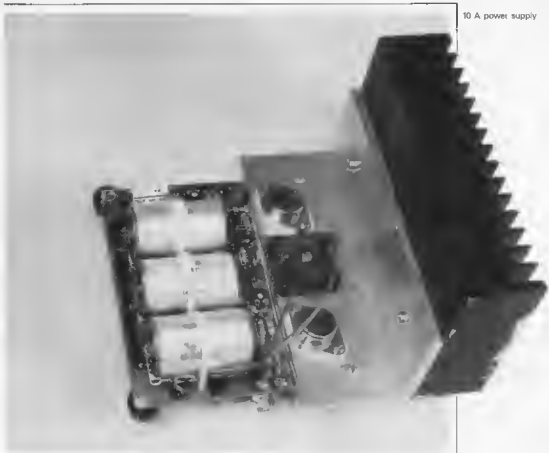

10 A power supply

Power supplies with an output rating of over 300 W, as needed, for instance, in computer systems, multiple disk drives, radio transmitter/receiver installations, and the like, can be pretty expensive. Fortunately, with the advent of voltage regulator ICs, it has become possible to build such a supply yourself at a much lower cost: without going into computations, we reckon that a saving of about fifty per cent can be made.

for wide range
of output
voltages

The power supply proposed offers the possibility of an output voltage (fixed) between 1.2 and 32 V at a current of 10 A. The output voltage depends, of course, on the transformer rating. The voltage regulator ICs have on-chip current limiting, so that, given correct and careful assembly, the unit will give long and reliable operation. The design includes a printed circuit board to facilitate construction.

Circuit description

The circuit of the proposed unit consists basically of a generating part and a regulating part. The former comprises the transformer, rectifier, and smoothing capacitors; the latter, regulators IC1...IC3

and associated components. The transformer must, of course, be in accordance with the wanted output voltage; for instance, for 5 V d.c. output, the secondary should be rated at about 9 V r.m.s. The bridge rectifier is housed in a metal case and is rated at 40 V/25 A. The electrolytic smoothing capacitors are rated for the highest output power.

The load current is divided between two type LM 338K regulator ICs. According to the manufacturer's data, each of these devices can handle up to 5 A, provided its TO-3 case is fitted to a suitable heat sink. Opamp IC3 ensures that the current is divided correctly between the two regulator ICs.

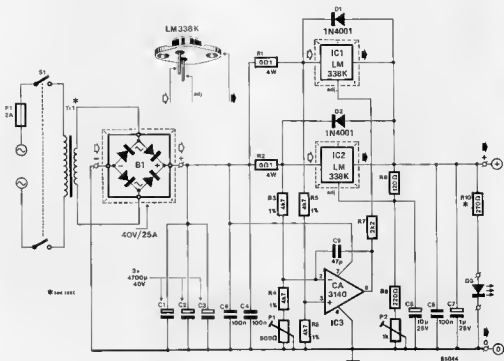

Figure 1. The circuit diagram of the 10 A power supply unit.

Construction

Apart from the mains transformer, all components are fitted on the printed circuit board shown in figure 2, but do not fit IC1 until told to do so under 'calibration'.

The first thing to prepare is the aluminium angle piece, unless you were lucky enough to find it ready made at your friendly electronics retailer! This angle piece is intended to serve as the basic cooling plate for the two voltage regulators and the rectifier. The fitting together of these parts is shown in the photograph: do not skimp on the silicone grease!

It is advisable to fasten the electrolytic capacitors to the pcb with cable ties, for which holes are provided. The fitting of the remaining components is straightforward. Note, however, that the value of the limiting resistor, R10, in series with the LED must be chosen in accordance with the output voltage as follows:

$$R10 = \{40(U_O - 1.5)\} \text{ k}\Omega$$

where U_O is the required output voltage. If the unit is installed in a case, it may be necessary to provide this with a small extractor fan to ensure adequate cooling. Connections to and from the pcb are best made in heavy-duty, stranded equipment wire; those to the board should be soldered direct to the relevant printed track. It is also possible to make the connections with vehicle-type push-on con-

nectors. The connections to the rectifier must be soldered.

Calibration

Calibration is, perhaps, the most important part of all that needs to be done is the adjustment of P1 to compensate for the offset voltage of the opamp. This is carried out with the power supply operating without a load: measure the output of the opamp with an accurate d.c. voltmeter and adjust P1 to obtain 0 V exactly. If you now connect a load across the output terminals that draws an output current of 100...300 mA, the output of the opamp should rise. Adjust P2 to obtain the exact output voltage required. Once that is done, fit IC1 and check the settings of P1 and P2 carefully.

Some final points

The power supply may be modified for different output currents by the use of different types of voltage regulator as shown in table 1.

It is important that the values of R3...R6 are within 1 per cent of one another; the actual value may be between 4700 and 5000 ohms.

Table 1.

output current (A)	voltage regulator (type)
3	LM 317K
6	LM 350K
10	LM 338K
20	LM 396

Note that if a 20 A supply is built into a case, it is definitely necessary to use an extractor fan for adequate cooling!

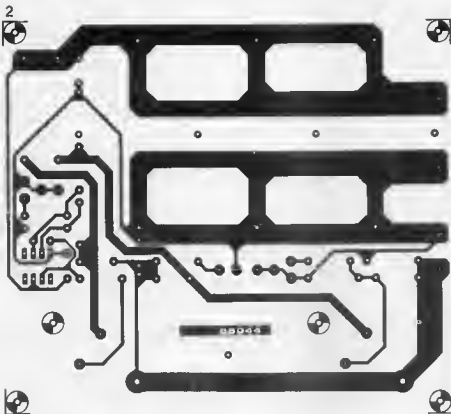

10 A power supply

Parts list

Resistors:

- R1, R2 = 0.1 Ω /4 W
- R3, R6 = 4k7/1%*
- R7 = 2k2
- R8 = 120 Ω
- R9 = 220 Ω
- R10 = *tolerance 10, 20%
- P1 = 500 Ω cermet preset
- P2 = 1 k cermet preset

Capacitors:

- C1, C3 = 4700 μ /40 V
- C4, C6, C8 = 100 n plastic foil
- C5 = 10 μ /25 V
- C7 = 1 μ /25 V
- C9 = 47 p ceramic

Semiconductors:

- B1 = bridge rectifier in metal housing 40 V/25 A
- D1, D2 = 1N4001
- D3 = LED, red
- IC1, IC2 = LM 338K
- IC3 = CA 3140E

Miscellaneous:

- F1 = miniature fuse, 2 A, complete with carrier or holder
- S1 = DPST mains switch
- T1 = *aluminium angle piece 160 mm long
- heat sink, 1 K/W, 160 mm long x 100 mm high
- vehicle-type push on connectors as required
- stranded, heavy duty equipment wire as required
- PCB 85044 (133 x 116 mm)
- If required: small extractor fan
- *see text

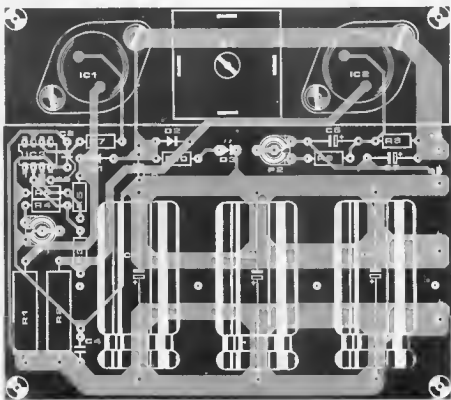

Figure 2. The printed circuit board of the 10 A power supply unit. Note that IC1, IC2, and B1 must be fitted onto an aluminium angle piece after which the whole assembly is fitted to the pcb



The growing popularity of stepping motors is only partly due to falling prices; another factor must be that they logically fit into digital thinking. It is, after all, a fact that many computer peripherals, such as disk drives and plotters, or computer-controlled equipment, like XY tables and robot limbs, make use of stepping motors. And yet there are many hobbyists who are completely unaware of the many applications for which these devices may be used. For instance, computer enthusiasts often find themselves in the opposite situation from Mary Shelley's Frankenstein: they have a brain, the CPU, but not the (whole) body. Now, with the aid of a stepping motor, they can create an interface between that brain and mobile reality.

Motors run or move in steps

Most motors run at — relatively — constant speed; others move in discrete steps. The former have two states: running or being at standstill; the latter have three modes: standstill, being activated with the rotor blocked, and moving in steps. That movement may be halting or smooth, depending upon the frequency and magnitude of the steps in relation to the inertia of the rotor.

As all motors, stepping motors are electro-mechanical converters, but because of their specific application they form a separate category. This type of motor responds in a well-defined way (that is, the turning of the spindle over one or more steps) to certain digital signals fed to their control electronics. Stepping motors may, therefore, be used as an open system, i.e., without feedback (in the form of potentiometers, encoders, tachogenerators, or the like) for control purposes. This obviates problems often encountered in feedback systems, such as instability and overshoot. A stepping motor may, therefore, replace a conventional DC servo system with feedback: a comparison between the two is given in table 1.

Principle of operation

A stepping motor may be compared with a synchronous motor as far as operation is concerned: a rotating field, here generated by the control electronics, pulls a magnetic rotor along. Stepping motors are sub-divided according to the manner in which the rotating field is generated, that is, with unipolar or bipolar stator windings, and the material from which the rotor has been constructed — permanent magnetic material or soft iron.

A bipolar stepping motor with a permanent magnetic rotor is shown schematically in figure 1. At the onset, both windings carry a current, the stator is magnetized correspondingly, and the rotor has oriented itself accordingly. If now, say the polarity of the current in A is reversed

stepping motors

make versatile servos

Now that prices of stepping motors are coming down, it may be worth your while getting (better) acquainted with these devices. If you do not mind building some control electronics, you will be able to make yourself a versatile servo unit without having to go into the realms of control engineering. The behaviour of a stepping motor is so predictable that the clumsy negative feedback devices required in servomechanisms are not needed, and this obviates that horror of control engineering: instability!

T. Wijffels

(whence bipolar), the field shifts 90° anticlockwise, and pulls the rotor along. The sequence of activation for a complete revolution is $AB\bar{A}B\bar{A}B\bar{A}B$, that is, four steps of 90° each. It is also possible, before reversing the polarity in a phase, to switch off the current to that winding. The sequence then becomes: $AB\bar{B}\bar{A}B\bar{A}\bar{A}B\bar{B}\bar{A}B\bar{A}B$. In this semi-step operation, the steps are smaller but the moment is less regular and, on average, smaller, because during half the time only one half of the number of phases is being used. Unipolar stepping motors look the same as bipolar ones, but they are wound differently. Each phase now consists of a winding with centre tap or two separate windings, so that the magnetic field can be inverted without the necessity of changing the direction of the current. If these windings are to be housed in the same space as one bipolar winding, it is evident that either fewer turns per winding, or thinner wire, must be used. In either case, the result is fewer ampere-turns, and consequently a weaker magnetic field. A unipolar stepping motor, therefore, has a smaller moment than a bipolar one of the same dimensions. A high resolution, that is, many steps per revolution, is often required. Motors for that purpose are constructed with multiple rotors and stators, and with the separate phases situated behind one another, each one shifted slightly with respect to the one preceding it, as shown in the photograph in figure 3.

The maximum stepping rate is limited because the permanent magnet rotor causes an inductive voltage in the stator. Motors with — relatively — high rotating speeds, therefore, often use soft iron rotors that have fewer poles than the stator, which is always unipolar: see figure 4. The windings are connected sequentially, sometimes in groups.

Terminology

Before turning to practical considerations about stepping motors, we want to acquaint you with some characteristics of these devices. Table 2 gives the most significant data, divided into electrical and mechanical. The choice of a stepping motor is determined in the first instance by the mechanical requirements; the electrical characteristics determine the design of the control electronics.

An important parameter is the pull-in rate, i.e., the maximum permissible step acceleration, which is closely related to the moment of inertia of the rotor. In practical applications it should be borne in mind that the moment of inertia is increased by the rotating parts that are driven by the motor and that consequently the pull-in rate is reduced.

A typical moment vs frequency characteristic is given in figure 5. It will be seen that if the frequency is increased, the moment is reduced. This is because at

Table 1. *

stepping motor	DC servo motor
control is relatively complicated	control is simple
no need for feedback (open control loop)	feedback essential (potentiometer, encoder, tachogenerator, etc.)
poor power-to-volume ratio, therefore relatively large	good power-to-volume ratio
robust, little wear	more wear because of use of brushes
good blocking characteristic	blocking requires extra brake

stepping motors

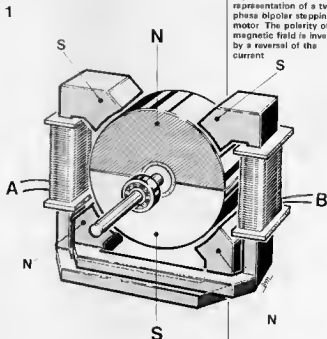

Figure 1. Schematic representation of a two-phase bipolar stepping motor. The polarity of the magnetic field is inverted by a reversal of the current

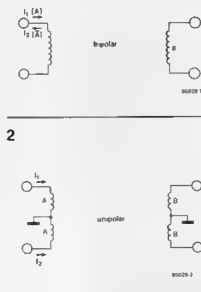

Figure 2. In a unipolar stepping motor, inversion of the magnetic field is brought about by switching the current to a second winding on the same stator.

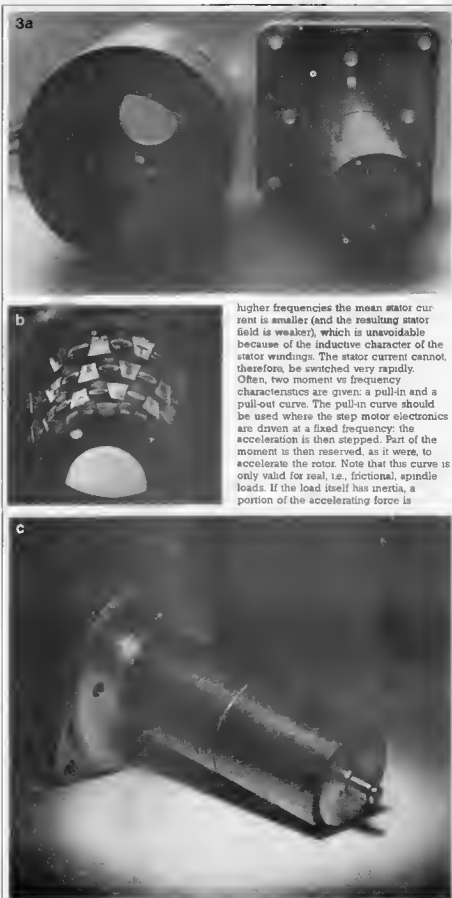

Figure 3. Construction of a high-resolution stepping motor. Four stators in one housing are slightly displaced with respect to one another (left-hand side of figure 3a). The rotor (right-hand side) is also composed of four sequential parts. Figures 3b and 3c show details of a multiple stator and multiple rotor respectively.

required to overcome this.

The pull-out curve applies to smooth accelerations and decelerations. The available moment is larger, but the drive electronics become somewhat more complex.

Control electronics

The use of stepping motors is made awkward by their need for an intelligent power supply to generate the rotating field. However, the building of the circuit should present no real problems for most of you.

The principle of the electronic circuit for driving the stepping motor is shown in the block diagram of figure 6.

The configuration of the power driver depends on whether the motor is unipolar or bipolar and on how many phases have to be controlled. A possible circuit for driving unipolar motors is given in figure 7a; this is fairly simple, since it requires only one transistor per winding (whence its original popularity). Bipolar motors need to be controlled via a bridge, i.e., four transistors per winding, as shown at the left-hand side of figure 7b. It is possible to use only two transistors per winding, but a symmetrical power supply is then required (see figure 7b, right-hand side).

As mentioned earlier, with increasing frequency the mean stator current becomes smaller, simply because a current flowing through an inductor takes time to reach its nominal value. The higher the frequency, the more important this time becomes. The use of current drive instead of voltage control improves the situation somewhat.

Table 2.

name	definition
mechanical	
stepping angle	rotation of spindle during one step, i.e., $360^\circ/\text{number of steps per revolution}$
braking moment (stall torque)	maximum moment of blocked rotor without steps being lost
moment (torque)	turning effect of a force measured by the product of that force and the perpendicular distance of the point at which the force act from the line of action of the force
pull-in rate	starting frequency without steps being lost
pull out rate	stepping rate reached after smooth acceleration
moment of inertia (symbol J)	measure of the resistance offered by a body to angular acceleration
electrical	
unipolar & bipolar self inductance (symbol: L)	types of stator winding determining for magnitude of mean current at high stepping rates, relates magnetic flux to current causing it
ohmic resistance (symbol: R)	determining for magnitude of stator current with stationary rotor
maximum stator current	determined by diameter of winding wire

4

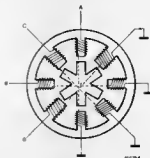

stepping motors

Figure 4. A stepping motor with a soft-iron core; this is essentially the principle of the motor in a 50 Hz clock.

5

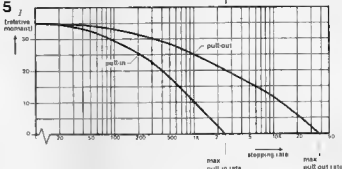

Figure 5. Moment vs. frequency (stepping rate) characteristic.

6

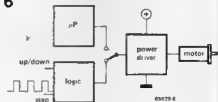

Figure 6. Block diagram of the stepping motor and the necessary control electronics.

7

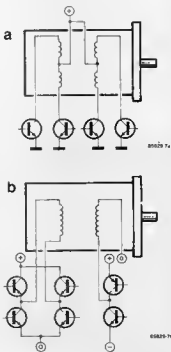

Figure 7. Possible driver stages for unipolar and bipolar stepping motors

Figure 8 shows a number of possible circuits for increasing the mean stator current.

■ In 8a, a series resistor reduces the switch-on time constant by making the load less inductive. It will, of course, dissipate some of the available power.

■ A more effective way, the so-called RC compensation, is shown in 8b. This circuit generates damped oscillations and keeps the damping factor as small as possible. The values of R and C are specified by the manufacturers of the stepping motor.

■ The use of a transistor as current source is shown in 8c. Very steep switch-on curves are possible, provided the supply voltage is high enough. Note that once the current has levelled off, the transistor is no longer in saturation and will, therefore, dissipate more power and thus requires more cooling.

■ A much better current source is shown in figure 8d. When the current reaches a certain value, the comparator switches the transistor off and the magnetic field decays slowly via the diode. When the current drops below the predetermined value, the comparator switches the transistor on again. In this configuration, the transistor does not dissipate anywhere near the power it does in 8c.

If you intend to control the stepping motor by computer, the driver stages can be connected direct to an output port, and you can then determine via the software whether the motor should run forward, or in reverse, in whole steps or in semi-steps. Moreover, by varying the time intervals between the steps, you obtain a very accurate speed regulation. Also, counting of the steps makes it possible to follow the position of the driven object. The switching sequence of the driver stages can, of course, also be obtained with discrete logic circuits. Control of the output transistors via an R-S bistable prevents prohibited situations, such as the simultaneous conducting of all four transistors in a bridge. Some additional gates can be used to set and reset the bistable, and to determine the direction of rotation.

Figure 8. Current drive increases the moment at higher stepping rates.

8

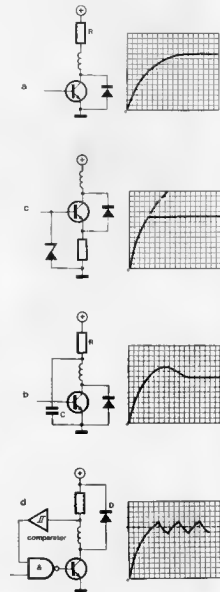

00129-6



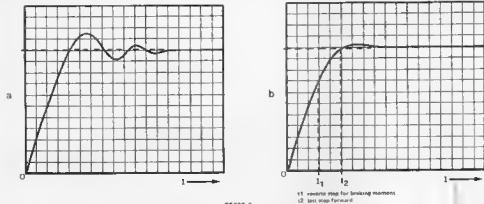

85025-9

Control of the instantaneous speed is effected by the pulse rate; the number of pulses is a measure of the displacement. There are a number of ICs on the market that are specially designed for the control of stepping motors, such as the SAA 1027, the L297 and L298, the TL 376, and the ULN 2002...2005, to name but a few.

Practical hints

The application of stepping motors requires attention to a few points. First, the inductive character of the stator: switching of the stator current causes an inductive voltage $U = L \cdot dl/dt$, which may be high enough to destroy the control electronics. This may be prevented by the use of free-wheeling diodes with unipolar windings, and varistors or anti-series connected zener diodes with bipolar windings. Another difficulty is the response of the rotor to a single step: on reaching the new position it overshoots, since a stepping motor is generally poorly damped (see figure 9a). This is a particularly disturbing effect at low stepping rates. It is because of this that stepping motors normally do not transfer power via cog-wheels. The wear on such wheels caused by the overshoot would rapidly cause cogs to be ripped off. Cogged drive belts are considerably better because of their flexibility, but often it is best to use direct drive.

It is, of course, also possible to improve the damping of the motor. This may be done mechanically by adding frictional torque, which would waste energy, or electrically by putting the motor in reverse just before the rotor reaches its new position, and then forward again a split second later — see figure 9b. The tuning of this method would be a major headache, however.

Finally, the stepping accuracy is dependent on the precision with which the stators are displaced with respect to one another — see figure 3. Fortunately, deviations are not cumulative: after a number of steps equal to the number of sequential phases, individual deviations will have

cancelled one another. If you want to position something very accurately with a stepping motor, you should try to make the number of steps between the reference point and the desired position equal to a whole number of times the number of stators.

Figure 9 (a) Overshoot, i.e., the damped oscillation of a rotor around its new position; (b) by pulling the motor in reverse at the right moment, overshoot can be minimized.

Figure 10. Externally, a stepping motor can be distinguished from a normal motor by the many (4-16) connecting wires

10

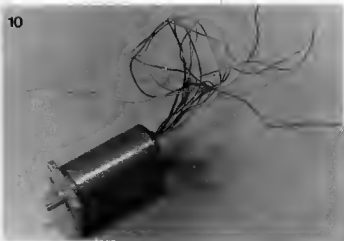

Wideband amplifier for satellite TV receivers

More and more satellites are being launched for more and more TV programmes from space. But much water has to flow under the bridge before we all can mount our own dish aerial on the roof. Much research remains to be done by the industry on dish aerials, 12-to-1 GHz converters, tuners, demodulators, and decoders. And, of course, prices will be important as well. We reckon that if a complete satellite reception system wants to do well on the consumer market, it should sell for no more than £200 to £250.

In this applicator we shall confine ourselves to one aspect of a satellite receiving system: a 1 GHz wideband amplifier. Philips have just brought out a new transistor that offers high gain, wide bandwidth, low noise, and is relatively inexpensive. Two of these transistors are sufficient to build a wideband amplifier for operation over the 950 .. 1750 MHz range. Such an amplifier is used in 12-to-1 GHz converters, and also as line amplifier in common systems where more than one receiver is connected to the dish aerial.

The BFG65

The new transistor has a number of characteristics which make it eminently suitable for use in wideband amplifiers.

- A high transition frequency, f_T , achieved by the use of shallow, ion-implanted base and emitter tracks and very thin epitaxial layers (1.2 μm instead of 3 .. 4 μm in similar transistors). The base and emitter tracks are interlocked as can be seen in the photograph.

- Low noise, a direct result of the high transition frequency coupled with a low base resistance.

- High gain, made possible by the high transition frequency and the low stray capacitances.

- Nitride encapsulation of the total active chip area for maximum protection against the environment. (Nitrides are very hard, inert compounds of nitrogen with other elements; they have a very high melting point).

The low base resistance and small stray capacitances are the direct result of a superfine electrode structure: 2.5 μm base-emitter separation; 0.75 μm emitter track width.

Further characteristics of the BFG65 are given in table 1.

A further reason that this transistor

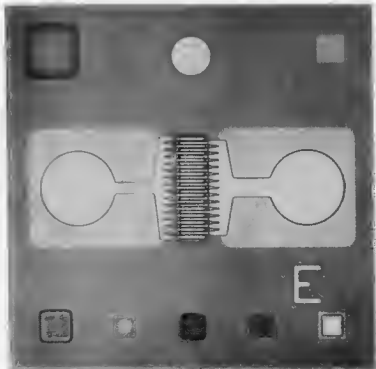

BFG65 specifications	
power gain (at 2 GHz)*	typically 11 dB
d.c. current gain (at $I_C = 15$ mA, $V_{CE} = 5$ V)	typically 100
transition frequency (at 500 MHz)*	typically 7.5 GHz
total power dissipation (up to $T_{amb} = 80^\circ\text{C}$)	< 300 mW
max. junction temperature	150°C
noise figure (at 2 GHz)*	typically 3 dB
feedback capacitance encapsulation	typically 0.5 pF SOT-103**

* $I_C = 15$ mA, $V_{CE} = 8$ V, $T_{amb} = 25^\circ\text{C}$.
 ** same chip also available as BFG66 (SOT-173),
 BFG65 (SOT-37) and BFG67 (SOT-231).

must be seen as a right step towards an affordable satellite receiver is its retail price of around £3.00.

Wideband amplifier

Two BFG65 transistors and two standard driver transistors are all that is necessary to build a 1 GHz amplifier with a gain of not less than 20 dB. Figure 1 shows the circuit diagram of such an amplifier and figure 2 a suggested printed-circuit layout.

Figure 1 shows the circuit diagram of such an amplifier and figure 2 a suggested printed-circuit layout. Note that the dimensions of the board shown are about actual size. Because of the high gain factor of the BFG65, two stages are enough for an overall amplification of not less than 20 dB. The 10-ohm resistor at the input of the chip ensures an input impedance of exactly 75 ohms. To avoid parasitic inductances, the input and output capacitors should really be chip types.

The collector-emitter voltage of each BFG65 is set to about 7 V. The emitter current of the first stage amounts to about 9 mA (ansuring minimum noise), and that of the second stage to around 15 mA. This results in an overall noise figure of not more than 4 dB in spite of the 10-ohm series input resistor.

This example clearly shows the excellent properties of the BFG65. But, of course, not everybody has an immediate need for a satellite converter, and we therefore changed the values of some components to make the circuit suitable for use as a UHF (TV) wideband amplifier. The two capacitors in series with the BFG65 collector coils must than be 22 pF instead of 1.2 pF. All resistors should be metal film types to ensure good stability. The coils should be wound from 0.5 mm silver wire. The coaxial connectors should be soldered direct to the pcb or prototyping (vero) board.

Source: *Wideband i.f. amplifier for satellite TV receiving systems* by P. Moors and T.H. Uittenbogaard; first published in *Electronic Components & Applications* Vol. 6 No. 1 1984 (a Philips Elcoma publication).

1

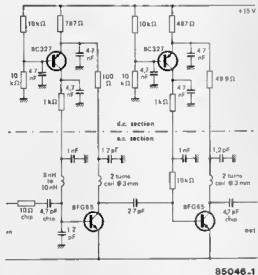

85046-1

2

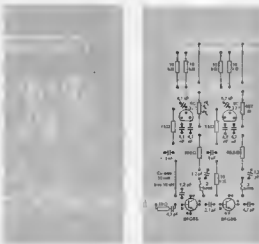

85046-2

Figure 1. Two-stage wideband amplifier using BFG65 transistors.

Figure 2. Suggested print board and component layout.

CAPACITATIVE COUPLING



A number of methods are known to permit isolation between separate but otherwise co-operating electric circuits. Perhaps the most familiar example is the ordinary transformer. A more recent development in this field is the optocoupler, but other systems using either magnetic or electrostatic coupling are also possible.

In this article an electrostatic system is described which can be used as part of a sophisticated light dimmer.

The magnetic coupling method has the disadvantage that it is difficult for the home constructor to make a neat job of the necessary transducers. Optocouplers have been used for various tasks in previous *Elektor* articles. The remaining approach, electrostatic coupling, can be accomplished very easily by etching a capacitive coupler on the printed circuit board. A design based on this approach is given here.

Circuit operation

Gates N2 and N3 form an oscillator

which is enabled, or 'gated', when pin 5 is at logic level one (1). Since N1 is an inverter, pins 1 and 2 must be at a low logic level to enable the oscillator. If it is assumed that the 'enable' signal which is applied to pins 1 and 2 has a square wave shape, the gated oscillator will produce a burst of pulses during the time the input waveform is low.

The isolation between the transmitter and receiver section of the circuit is effected by two small capacitors C_{X1} and C_{X2} . These capacitors are etched on the p.c. board.

N5 is biased to function as a normal amplifier, and when used in combination with the next amplifying stage (N6), it regenerates the burst being transmitted across the isolation capacitors. This burst is then detected by an envelope detector made up of components D1, R6 and C4. The output signal from gate N7 will now correspond to the original 'enable' signal.

This detected signal is differentiated by C5/D2/R7. It is also passed through inverter N8 and differentiated by C6/D3/R8. The pulses that result from both positive and negative differentiation are used to trigger the triac.

Tracs capable of currents up to about 1 A can be mounted on the printed circuit board. Others with higher current ratings must be 'out boarded' and will most likely need heat sinks.

The coupling capacitors

As stated earlier, the coupling capacitors can be etched on a p.c. board. An obvious choice would be a double-sided board, with one 'plate' etched on each side. However, since two-sided p.c.b.'s are expensive and hard to make at home, capacitors C_{X1} and C_{X2} are formed by using two separate boards. It is important to note that the two boards must be joined together in such a way that only one thickness of the fiberglass board is in between the copper areas that form the plates of the capacitors. If the plates are two board thickness apart, the resultant capacity will be too low and the circuit will not function properly. Also, the daughter board should be fitted directly against the mother board, with no gaps in between.

Tap sensor control

The circuit shown in figure 2 can be used as the interface between the triac controller shown in figure 1 and the 'outside world'.

The tap sensors control a set/reset flipflop constructed from two C-MOS NAND gates and a few resistors.

To prevent this FF from assuming an indeterminate state when the power is switched on, the FF is preset to the off state by C1. This can be particularly useful in areas where power cuts are frequent...

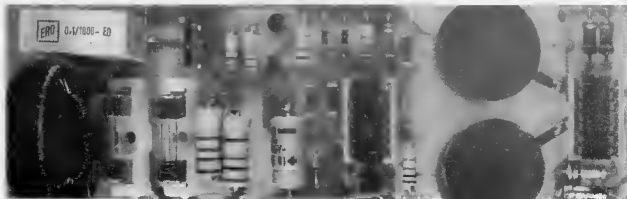

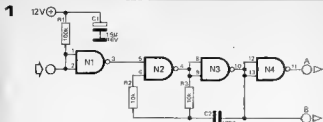

Figure 1. Triac control circuit.

N1 N4 = IC1 = 1 x CD4011
 N5 N8 = IC2 = 1 x CD4011
 D1 D3 = 1N4148
 D4 = 1N4004
 T1, T2 = 6C 547

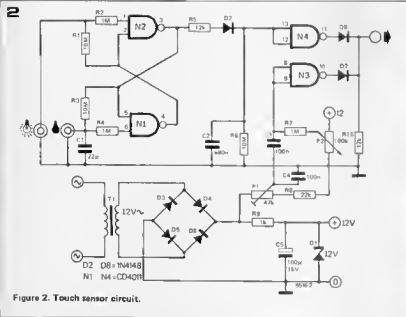
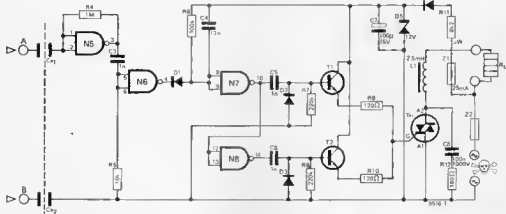

Figure 2. Touch sensor circuit.

In the initial 'off' condition the output of N2 is 'low', and the output of N4 is 'high'. This effectively blocks the 'enable' input via diode D8. When the 'on' sensor is touched the output of N2 goes 'high', charging C2 and causing the output of N4 to go 'low'. This frees the output. When the 'off' sensor is touched, C2 discharges through R6. This provides a turn-off delay of about 7 seconds. This feature is great when the equipment is used to control room lighting: after the 'off' sensor has been activated, the lights will stay on to light the path of the last person leaving the room.

Since the actual triac drive must be synchronous with the mains supply, the

gate signal supplied by the tap sensor board is picked off at the output of the bridge rectifier. This 100 Hz signal is phase shifted by P1 and C4. This phase shift is necessary to permit complete brightness control by P2.

If, after P1 has been adjusted, P2 is still ineffective over a certain portion of its range, an additional resistor may be connected in series with P2. The value of this resistor must be found by trial. It should be selected to permit the entire range (light to dark) to coincide with a complete rotation of P2.



3a

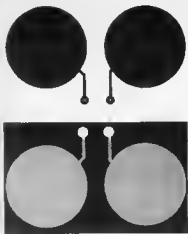

Figure 3. Printed circuit board end component layout for the triac control circuit. Note: large copper areas are C_{X1} and C_{X2} . (EPS 9516).

Figure 4. Tap sensor p.c. board and component layout (EPS 9707).

Parts list for figure 2

resistors:

R1,R3,R6 = 10 M
 R2, R4,R7 = 1 M
 R5,R10 = 12 k
 R8 = 22 k
 R9 = 1 k
 P1 = 47 k (preset)
 P2 = 100 k (lin.)

Capacitors:

C1 = 22 p
 C2 = 680 n
 C3,C4 = 100 n
 C5 = 100 μ /16 V

semiconductors:

D1 = 12 V/400 mW zener
 D2... D8 = 1N4148
 IC1 = CD4011

3b

Parts list for figure 1

resistors:

R1,R6 = 100 k
 R2,R3,R5 = 10 k
 R4 = 1 M
 R7,R8 = 220 k
 R9,R10 = 120 Ω
 R11 = 8k2
 R12 = 180 Ω

capacitors:

C1 = 1 μ 5/16 V
 C2 = 100 p
 C3,C5,C6 = 1 n
 C4 = 12 n
 C7 = 100 μ /16 V
 C8 = 100 n/1000 V (ceramic)

semiconductors:

T1,T2 = 8C547, 2N3904
 IC1,IC2 = CD4011
 D1... D3 = 1N4148
 D4 = 1N4004
 Tri = 600 V, with adequate current rating.

misc

noise suppression coil: 2.5 mH, with adequate current rating.
 Z1 = fuse, 25 mA
 Z2 = fuse, depends on load.

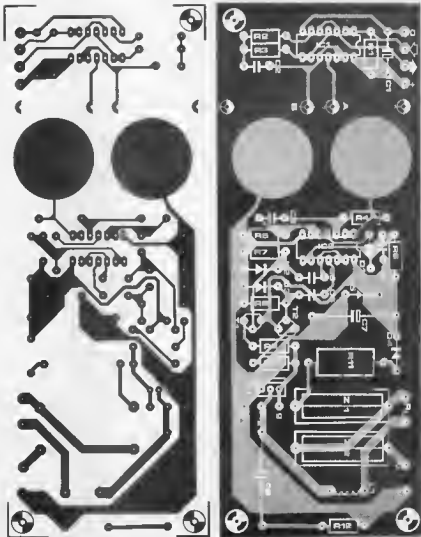

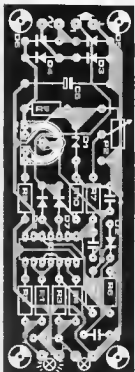
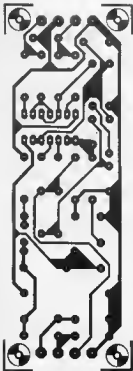

reading-in-bed limiter



At a certain age, children are often packed off to bed with the final admonition: 'All right, you can read in bed for a quarter of an hour, but then you must turn off the light and go to sleep'. However, as most parents will know, the children tend to suddenly lose all sense of time in this situation . . .

When a member of the Elektor design team was faced with this problem, he started looking for an electronic solution. The final circuit, as published here, has proved extremely effective.

In the situation outlined above, what is really required is a unit that will automatically turn off the bedside reading lamp after the specified time has elapsed. This time switch must have a few special features:

- It should only be possible for the parent(s) to switch on the lamp. This

Figure 1. Complete circuit of the reading-in-bed limiter. S1 must be a key-switch that can only be operated by the parents.

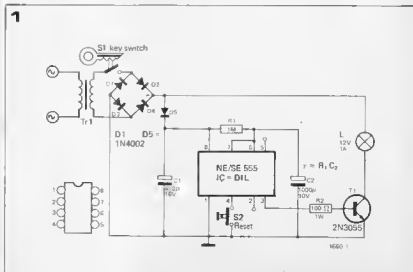

Components

Here we introduce the symbols of various electronic components, which will be used in all SELEX circuits

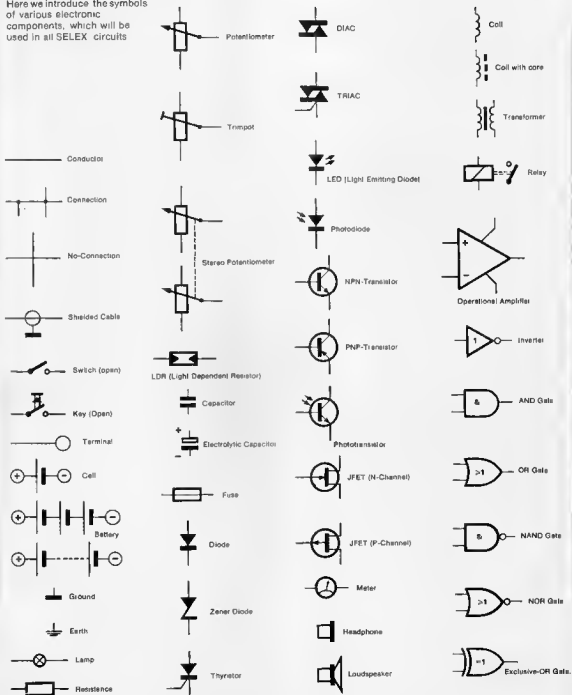

Bar-Code

"Have you read about these new cash registers?"

"Which ones?"

"The ones with the bar code system,

One day in the future, these cash registers will be seen in all the departmental stores and large shops. When you buy anything, say, a pair of jeans, the sales girl at the counter will just move an electronic pencil over the price tag and immediately the cash memo will come out from the cash register."

"What's more! not only the price will be printed on the cash memo, but even the article number and the size of jeans!"

"How do these new cash registers manage all this?"

"Where these cash registers are being used, the price tags on the articles have a zebra strip pattern. You must have noticed this strip pattern on many foreign products, even books and magazines."

"Yes I have seen this pattern!"

"This zebra strip pattern is called a Bar-Code. All figures and letters for the article number, size, price etc. are hidden in this Bar-Code. The pencil which the sales girl at the counter moves over the price tag can read this Bar-Code."

"Read the Bar-Code? You mean a small man is sitting inside the pencil and counting the strips?"

"Not quite so, in the tip of the pencil there is a source of light, which illuminates the Bar-Code. The white paper reflects the light back into the pencil. The black strips don't. The pencil thus recognises the black strips and informs the cash register about this through the cable connecting the pencil to the cash register."

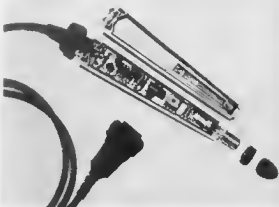

"But what does the cash register do with this information of 'Black' and 'White' coming from the pencil?"

"The cash register sees this 'Black' and 'White' as binary numbers '1' and '0'. Sometimes the broad black strips are read as 1 and narrow black strips as 0. There are several possibilities."

"Now! You are really making up stories! Can you tell me how the cash register can read JEANS, SIZE 10B, Rs. 98 75 from the ones end zeros?"

"Take it easy! Have you ever heard about digital technology?"

"No."



"The digital technology manages with only two numbers, 0 and 1. This number system is called the binary system. When you need larger numbers, you simply put together several binary numbers. I'll now show you how it is done. Let us write down the numbers 1 to 10 as binary numbers.

<i>Decimal</i>	<i>Binary</i>
----------------	---------------

0	0
1	1

So far both are same

2	10
---	----

For number 2, there is no single binary number, so we need a second digit.

3	11
4	100

For the number 4 even two digits are not enough, so we add a third."

5	101
6	110
7	111
8	1000
9	1001
10	1010

"Four digits for a simple 10! That's rather elaborate."

"That's right! But the practical aspect of this is that we can substitute these 0 and 1 easily through something else, like 'White' and 'Black' in the Bar-Code, or a lamp lighted or extinguished, or a voltage switched on or off and so on."

"In that case I can even generate numbers with a battery and a switch."

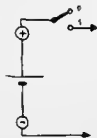

"That's right! This is Digital Technology! With an extra lamp and some wire, you can even transmit the numbers somewhere else."

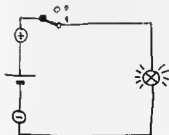

"By the way, we mostly use 5V in digital technology."

"Just a minute, I need four switches if I want to reach upto 10"

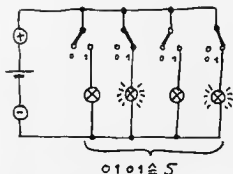

"Would it not simplify matters, just by using two wires and different voltages to represent different numbers? For instance, 0V for 0, 1V for 1 and so on upto 10V for 10?"

"Naturally, you would save the wire but then it would be quite difficult to see from the lamp how many volts are applied. Moreover, when there are voltage fluctuations in the power supply, it can spell disaster! A drop in voltage by 1 V means 9 will be read as 8"

"And the jeans will cost only Rs. 87.64 instead of Rs. 98.75! Special discount by virtue of the voltage fluctuations!"



Digi-Course

Chapter 1 .

AND, OR, NOT

We have already seen how digital technology works, when we looked at the Bar-Code in the previous pages. At first we may find it a bit odd to denote two mutually exclusive quantities by 1 and 0 and then build a complete technology on it. However this simple basic rule of digital technology makes it so much versatile and all powerful.

It is equally simple to work with binary numbers, and to link them logically. There are three basic operations that can be carried out with binary numbers.

- the AND operation
- the OR operation
- the NOT operation (Negation)

These operations are quite simple compared to the fundamental mathematical calculations like addition, subtraction etc. Within the scope of this course we shall focus our attention on the practical applications of this system of logic. For the practical implementation of these operations it is always necessary that we clearly define the logic states of the circuit, for example, 5V/0V or Switch closed/open states should be clearly attributed to the binary numbers "1" and "0"

1. The AND operation

Figure 1. shows two switches in AND configuration. The functional description of this circuit is: *When switch A AND switch B are closed, the lamp is lighted.*

Figure 1.

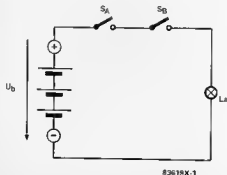

This logic function can be described in form of a table. This is called the truth table of the particular function. This covers all possible combinations of the switch positions.

Table 1

SA	SB	La
open	open	extinguished
closed	open	extinguished
open	closed	extinguished
closed	closed	lighted

For the switches as well as lamp, there are only two states possible. A switch can be either open or closed and the lamp can either be lighted or extinguished. This is ideally suited for our application to binary numbers as these are the only two mutually exclusive states possible for the switches and lamps. By attributing numbers 1 and 0 to these states as follows:

Switch closed	1
Switch open	0
Lamp lighted	1
Lamp extinguished	0

We obtain the new version of our truth table.

Table 2.

A	B	OUT
0	0	0
1	0	0
0	1	0
1	1	1

Now, a question that naturally follows is "What this switch and lamp configuration and its mathematical abstraction has to do with modern digital technology?" Certainly nothing! as long as no concrete meaning is attributed to the switch positions. Let us examine the following statement

"Only the person who informs us his address on the order card AND pays the subscription, shall receive Elektor magazine"

This statement contains two conditions, which are linked by AND, therefore, this sentence fits the description of the circuit of figure 1. The two conditions can be attributed to the two switches SA and SB.

Subscription is paid: switch SA closed
Address was informed: switch SB closed



Lamp lighted: Magazine shall be sent.

"False" and "True" in table 3 now correspond to "0" and "1" in table 2.

Table 3.

Subscription paid	Address informed	Magazine shall be sent
false	false	false
true	false	false
false	true	false
true	true	true

Although this electronic "Calculation" of the logical connection between these statements is realistic, the program of the subscription computer cannot make use of this switch and lamp configuration. In the digital technology, the so-called "Gates" implement these functions.

The AND Gate has the following symbol:

Figure 2.



The power supply lines are not shown, as all the gates in the TTL series work with 5V supply. The voltage for logic 1 is also same, i.e. 5V, whereas the logic 0 is 0V. Unconnected inputs of the gate behave as logic 1. Table 4 gives the AND Gate truth-table in form of these voltage levels at input and output.

Table 4

Inputs		Output
A	B	OUT
0 V	0 V	0 V
5 V	0 V	0 V
0 V	5 V	0 V
5 V	5 V	5 V

The input voltages can be applied from a voltage source through switches and the output voltage can be indicated by means of an LED. (Light Emitting Diode)

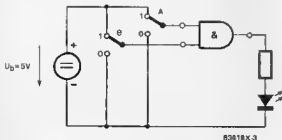

The real utility of these gates is because of the fact that the output of one gate can become an input of another gate. Figure 4 shows two AND Gates connected in such a way that the output of first AND Gate becomes an input to the second AND Gate. Now a further information can be fed at the third input, for example:

"A new issue of Elektor has come out"

Because of the third input, the total number of possible combinations is considerably increased.

(See table 5.) The output OUT of the second AND Gate becomes TRUE only when all the three conditions are fulfilled. The "False" and "True" in the table can easily be replaced by "0V" and "5V" or simply "0" and "1"

Figure 4.

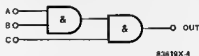
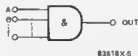

Table 5. Truth table for figure 4.

A Subscription paid	B Address informed	C New issue has come	OUT Issue shall be sent
false	false	false	false
false	false	true	false
false	true	false	false
false	true	true	false
true	false	false	false
true	false	true	false
true	true	false	false
true	true	true	true

The combination of two AND Gate in figure 4 can be replaced by a single symbol with 3 inputs or a more generalised symbol as shown in figure 5

Figure 5.



2. The OR operation

The OR operation can also be demonstrated with two switches and a lamp. When SA OR SB is closed, the lamp is lighted.

Figure 6.

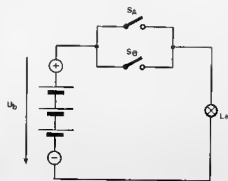

Table 6.

SA	S8	Le
open	open	extinguished
closed	open	lighted
open	closed	lighted
closed	closed	lighted

The symbol for the OR Gate is as shown in figure 7. The OR Gate gives a 5V output when any one of the inputs A OR B is at 5V

Figure 7.

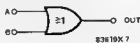

Table 7.

Inputs		Output
A	B	OUT
0 V	0 V	0 V
5 V	0 V	5 V
0 V	5 V	5 V
5 V	5 V	5 V

For better understanding of the OR operation, let us go back to our example of Elektor subscription. Examine the statement

"The subscription can be paid by Demand Draft OR Cheque"

The truth table for this statement can be written as follows:

Table 8.

A	B	OUT
Demand Draft received	Cheque received	Subscription paid
false	false	false
true	false	true
false	true	true
true	true	true

The OR Gate output indicates whether the subscription is paid or not, so it can be placed at the input B of our earlier subscription data processing circuit which now becomes a circuit with four inputs, and can handle 16 different input combinations. Table 9 shows all different combinations

Table 9.

No	Inputs				Output
	A	B	C	D	OUT
1	0	0	0	0	0
2	0	0	0	1	0
3	0	0	1	0	0
4	0	0	1	1	0
5	0	1	0	0	0
6	0	1	0	1	0
7	0	1	1	0	0
8	0	1	1	1	0
9	1	0	0	0	0
10	1	0	0	1	0
11	1	0	1	0	0
12	1	0	1	1	1
13	1	1	0	0	0
14	1	1	0	1	1
15	1	1	1	0	0
16	1	1	1	1	1

Figure 8

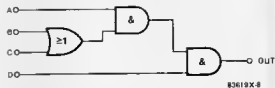

Surprisingly, there are three instances in which the magazine is supplied, because the OUTPUT shows a "1". The last two lines of the table say that somebody has paid his subscription twice. Although this is very improbable in reality; in principle it can be thought of and since our subscription department works honestly, the circuit must be extended once more. (See figure 9.)

Figure 9.

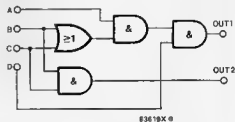

The added AND Gate picks out the double payments and reports them with a logical "1" at output 2.

3. The NOT operation

The NOT Gate is also called an inverter; because its output is exactly opposite of the input. "1" at the input gives a "0" at the output, and vice versa. This inversion is marked by a bar above the input letter.

Figure 10.

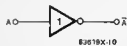

Table 10.

Input	Output
A	A̅
1	0
0	1

Our subscription data processing could also use an inverter. It prevents that the issues are delivered even when the cheque is not honoured by the bank

"... AND the cheque was NOT returned.

Is the additional function which is realised by an AND Gate and a NOT Gate at the input C.

Figure 11.

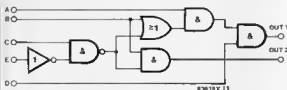

The input E is fed with a "1" if the cheque is not honoured. This gives an output "0" irrespective of the input C. The truth table for this circuit now becomes

very extensive with 32 input combinations. Why 32? With every additional input the number of probable input combinations is doubled; because for every input combination already covered, the new input can be "0" or "1".

Table 11

Number of inputs	Number of Combinations
0	1
1	2
2	4
3	8
4	16
5	32

The figures in the right column are the basic numbers of the binary system. (See Bar-Code)

Bicycle Siren

Just imagine, you are walking down the street and suddenly behind you, you hear the famous Police Siren!

"What have I done to attract the Police?" you are shocked and look back just to find a harmless cyclist who has constructed himself a Bicycle Siren.

The circuit is quite simple. IC 2 together with R2, R3, P2 and C3 forms an oscillator. A circuit which produces an A.C. output with a frequency in the audio range. However, as the output of the IC 2 is not sufficient to drive the loudspeaker, Transistor T1 is used to amplify the signal at the output of IC 2. Transistor T1 is used in the emitter follower configuration and produces a large emitter current proportional to the base current provided by the output of IC 2.

The oscillations produced by IC 2 are controlled by the setting of potentiometer P2 as well as the voltage on Pin 5 of IC 2. The voltage of Pin 5 is supplied by another oscillator circuit formed by IC 1.

IC 1 produces a slowly rising and falling voltage signal at its output pin 7, which is applied to Pin 5 of IC 2 through R5. Corresponding to rise and fall in voltage at Pin 5 of IC 2, the pitch of the siren also rises and falls, producing the exact effect of a Police Siren.

This entire circuit is powered by the dynamo of the bicycle itself, and no battery supply is required. (Quite a saving on energy!) Since a dynamo is an A.C. generator, its voltage is rectified by the bridge rectifier B1. The electrolytic capacitor C1 serves as a filter to smooth out the rectified D.C. voltage.

Construction Details:

All components used in the circuit are standard components. These are assembled on a small SELEX PCB (Size 1.). The IC socket, jumper wires and resistors are soldered first. Then the three capacitors and finally the semiconductors are soldered. A cooling fin is slid over the transistor T1 to prevent it from getting hot. The orientation of ICs should be as shown in figure 2. Three small 8 ohm speakers are connected in series for optimum sound level, but to economise on speaker cost and to make the unit compact, even a single 8 ohm speaker will do. However it should be protected by a 47 ohm resistor in series as shown in the circuit diagram.

The design of enclosure is left to the imagination of the constructor. The push switch S1 should be fixed on the bicycle handle. An additional switch for switching off the lamp will also be needed. Potentiometer P2 is used for adjusting frequency of the siren and P1 is used for adjusting the rise and fall cycle of the siren. Regular potentiometers with spindle and knobs can also be used for P1 and P2 instead of the small preset pots shown in the figure 2.

IC 1 and IC 2

The versatile timer IC 555 used in the circuit as oscillators (Astable multivibrators). The resistors R1 and P1 charge the capacitor C2, and the voltage across C2 rises slowly. When it reaches 2/3 of the supply voltage, the IC discharges capacitor C2 and

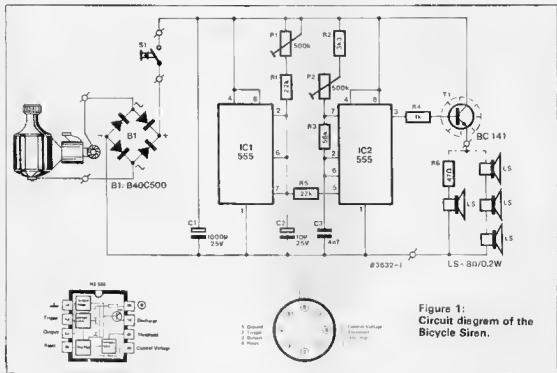
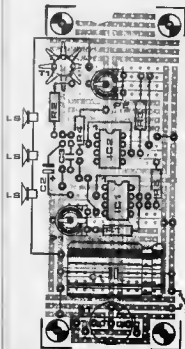

Figure 1:
Circuit diagram of the
Bicycle Siren.

Figure 2: Component layout.



Components:

- R1 = 22 K Ω
- R2 = 3.3 K Ω
- R3 = 56 K Ω
- R4 = 1 K Ω
- R5 = 27 K Ω
- R6 = 47 Ω
- P1, P2 = 500 K Ω
(Trim pots)
- C1 = 1000 μ F 25 V
(Electrolytic)
- C2 = 10 μ F 25 V
(Electrolytic)
- C3 = 4.7 nF
- B1 = Bridge Rectifier
- T1 = BC 141
- IC 1, IC 2 = 555
- S1 = Push switch
- speakers = 8 Ω , 0.2 W
- 1 Cooling fin for T1
- 1 SELEX PCB (Size 1)

1/3 of the supply voltage, at this value the discharge is stopped and charging cycle begins again. Thus the output voltage at Pin 7 of IC 1 oscillates between 1/3 and 2/3 of the supply voltage. IC 2 also functions as an astable multivibrator. However its output is controlled by voltage on Pin 5. The control voltage on Pin 5 decides the upper limit for the capacitor charging voltage and higher the upper limit, longer is the period of charging cycle.

Caution:

This siren should not be used in place of the bicycle bell, and should never be used in normal traffic!

SELEX PCBs

A standard unit PCB pattern is used for constructing all SELEX projects. SELEX PCB-Size 1 contains one standard unit. Size 2, 3 and 4 contain multiples of the standard unit pattern - 2, 3 and 4 respectively. Please note that these PCBs are not reusable, each project requires a new PCB. SELEX PCBs are available from Precious Electronic Corporation. Please refer to EPS-SERVICE page for details.

W/W POTENTIOMETERS

Technocrat Components have introduced BHS-3 wire wound potentiometers with 3 watts rating. They are housed in bakelite moulded body and the sealing is claimed to be almost hermetic.

Various models are available with shaft lengths of 10, 30 and 60 mm, and resistance values of 100 E, 500 E, 1 K, 2 K, 5 K, 10 K, 15 K, 20 K and 25 K. Non standard shaft lengths and resistance values are available only against specific bulk order.

For further information, write to:
Technocrat Components
Post Box No. 930,
Madras 600 020

EMERGENCY LIGHT

Elicon Sento have introduced 'Nite-sun' emergency light with a beam type reflector. The unit has separate battery compartment which houses a chlorida 3EV9 plastic encased wet battery or an equivalent rechargeable dry battery. The battery needs topping up once in 45 to 60 days. A solid state device is used for switching to avoid faults in switching with relays.



For further information, write to:
Elicon Sento Corporation
8/1, Palmgrove Road,
Bangalore 560 047.

TV DEFLECTION COMPONENTS

Selectronics (Gujarat) Pvt Ltd have introduced their new TV deflection components—a set consisting of Deflection Yoke, Line Output Transformer and Linearity Coil. The components are tested according to international standards specifications and are claimed to give perfect picture quality.



For further information, write to:
Selectronics (Gujarat) Pvt. Ltd
5, Ruxmani Park,
Kankane, Ahmadabad 380 022

HIGH VOLTAGE TEST PROBE

Equilab have developed a new high voltage TV test probe and meter. This is available in two series—HT 200 and HT300. These are suitable for monochrome as well as colour TVs. The series HT 200 has a sensitivity of 10 uA/KV and the series HT 300 has a sensitivity of 2 uA/KV. Accuracy available is $\pm 3\%$ to $\pm 5\%$ depending on the individual models.

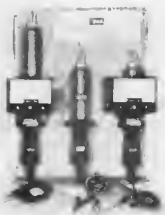

For further information, write to:
Electronic Instrument Labs,
339/68, Rajash Building,
Dr Bhadkamkar Marg,
Bombay 400 007.

TWILIGHT SWITCH

Otronc have developed an automatic light control switch which can switch the lights ON and OFF at a predetermined intensity of ambient light. The circuit is based on a Light Dependant Resistor and needs only one setting. The unit consumes 10 VA power and has a switching capacity of 10 Amps. It works directly on mains supply.

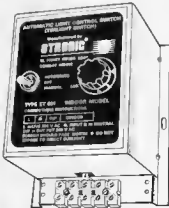

For further information, write to:
Otronc
Lawyers Chambers—Ground floor,
18, Picket Cross Road,
Bombay 400 002.

ULTRA VIOLET LIGHT SOURCE

Professional Electronic Products offer a compact UV light source for erasing EPROMs like 2708, 2716, 2758, 8765, 8748 etc. The source can erase eight EPROMs at a time. A 0 to 60 minutes timer is provided to set the time of erasure. The unit is claimed to be completely safe due to the low wattage lamp and a safety interlock system. Power consumption is about 20 Watts.

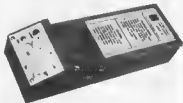

For further information, write to:
Professional Electronic Products,
Post Box 316, Delhi Road,
Mairut 250 002.

16 PIN IC CLIP

Comtech have introduced their T-16 IC clip for 16 pin DIL packages. It provides easy access to ICs through non-shorting electrical contacts with positive mechanical clamping. Selectively gold plated spring brass contacts are designed for wiping action. The contact-comb with its insulating barriers provides easy positioning and prevents accidental shorting of adjacent leads.

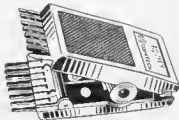

For further information, write to:
Component Technique
8, Onon Apartments,
29/1, Lalitubhai Park Road,
Andhari (West), Bombay 400 058

NON CONTACT VOLTMETER

Swadep Instrumentation have marketed a new 20 KV Non contact electrostatic voltmeter manufactured by Monroe Electronics Inc. of U.S.A. The electrostatic voltmeter permits measurement of Electrostatic surface potentials upto 20 KV without physical contact to the surface under test, with an accuracy of better than 0.1%. Response is better than 35 milliseconds to 20 KV and the drift is less than 2V/hour non cumulative. The instrument is available against actual users import licence.

For further information, write to:
Swadep Instrumentation
101, Vishnu Villa, 10th Road,
Khar, Bombay 400 052.

STOP!



BEFORE YOU BUY

A μ P Training / Development Kit

Make sure
you are getting
all that you need.

MICROFRIEND

Series gives you all that you need

- Powerful hardware and software features to meet all your requirements.
- Most comprehensive, easy to understand courseware documentation. Complete with data sheets of ICs used.
- Instant service back up from expert engineers.

MICROFRIEND-I: 8085 CPU, 4K Firmware, 2K RAM, Expandable to 24K ROM or 12K RAM, EPROM Programmer for 2716, 2732 and 48016, 46 PIO lines, TTY-20 mA, RS232C I/F, Audio cassette I/F, 8155 Timer, 6 digit display and keypad, STD Bus for expansion

MICROFRIEND-ZI: 280 A CPU with specifications same as Microfriend-I

MICROFRIEND-68: 6802 CPU with specifications same as Microfriend-I.

MICROFRIEND-II: 8085 A CPU, 4K Firmware, 2K RAM, Expandable to 24K ROM or 12K RAM, 48 PIO lines, TTY-20 mA, RS232C I/F, Audio cassette I/F, 8253 Timer, 6 digit display and keypad, 50 Pin buffered Bus for expansion.

MICROFRIEND-III: 8085 A CPU, 8K Firmware with Editor Assembler, 2K RAM, Expandable to 52K RAM or ROM, EPROM Programmer for 2716 2732 2764, 27128 and 27256, 48 PIO lines, 80 x 24 Video Controller using MC 6845, ASCII Keyboard I/F, Centronics Printer and Audio cassette I/F, RS232C I/F using 8251, 8253 Timer, 32 Key Keypad and 6 digit display, STD Bus for expansion

MICROFRIEND-ZLC: 280 A CPU, 4K Firmware, 2K RAM, Expandable to 8K ROM or RAM, 16 PIO lines, Audio cassette and Serial I/F, EPROM Programmer for 2716 to 27128, Z80 CTC Timer, 6 digit display and keypad.

MICROFRIEND-65: 6502 CPU, 4K Firmware, 2K CMOS RAM, 64K DRAM, Memory expandable to additional 16K, EPROM Programmer for 2716 to 27128, RS232C Serial I/F, Audio cassette I/F, 8253 Timer, 6 digit display and keypad, STD Bus for expansion

MICROFRIEND-86: 8086 CPU, 16K Firmware, 4K RAM, Expandable to 48K RAM or ROM, 128K DRAM, EPROM Programmer for 2716 to 27128, RS232C Serial I/F, Audio cassette I/F, 8253 Timer, 72 PIO lines, 8 digit display and keypad, MULTIBUS for expansion.

MICROFRIEND-867B: 8086 CPU, Socket for optional 8087 and 8086 CPU, 16K Firmware, 4K RAM, Expandable to 48K RAM, or ROM, EPROM Programmer for 2716 to 27128, 72 PIO lines, RS232C Serial I/F, Audio cassette I/F, 8253 Timer, 8 digit display and keypad, 50 Pin Buffered Bus for expansion.

MICROFRIEND-68K: 68000 CPU, 20K Firmware, Single line Assembler and Disassembler, 32K DRAM, Expandable to 256K, EPROM Programmer for 2716 to 27128, 80 x 24 Video Controller using MC 6845, RS232C Serial port with complete baud rate control, Centronics compatible printer port plus one more PIO port, Audio cassette I/F, ASCII keyboard I/F

PLUS A WIDE RANGE OF OPTIONAL ATTACHMENTS TO EXPAND THE SYSTEM.

Manufactured by:



Dynalog Micro-Systems

14, Hanuman Terrace, Tara Temple Lane,
Lamington Road, Bombay 400 007

Tel: 353029, 362421,
Telex: 011-75614
Gram: ELMADVICE

North Zone Rep:

TECHNICS
4731/21 Dayanand Marg, Daryaganj,
New Delhi 110 002
Tel: 276988, 270832

Setting the standards in μ P based technology.



Cable Faults' break the life line of your Telephone Resurrection of the dead phones involves time consuming operations like detecting fault in several kilometers of underground cable pair and a lot of trial and error digging P & T guys had to toil really hard until APLAB 3039 Cable fault locator arrived on the scene

Now within minutes and with an unprecedented accuracy of one metre in kilometres, one can pin point the fault

location, dig at the right place and give back to you your life line

Aplab 3039 was born out of its extensive R & D. Germans, French, Americans, Belgians and Austrians used over 1000 units of APLAB 3039 as a standard PTT field kit Today Indian P & T also serves you faster with our assistance— with 3039!



Aplab

'APLAB HOUSE' A - 5/6, WAGLE INDUSTRIAL ESTATE, THANE - 400 604, INDIA.
PHONE : 59 18 61 - 2 - 3 TELEX : 011 - 71979 APEL IN

APLAB/2/84

Luxco car stereo speakers bring concert hall performance to you — crystal clear Hi-Fi stereo, well above the wind and traffic noise.

Make driving a pleasure with

LUXCO

car stereo speakers



Manufactured by
LUXCO Electronics
Allahabad—211 003

Chief Selling Agents
LUXMI & CO.

56 Johnstonganj
Allahabad—211 003
Phone 54041, Telex 540-286

Distributors for Delhi & Haryana
Railton Electronics
Radio Place, Chandni Chowk
Delhi-110 006
Phone 239944 233187

Distributors for Maharashtra,
Gujarat and South India

precious[®]
Electronics Corporation

- Chitari Building, 52, Proctor Road, Grant Road (East), Bombay-400 007
Phones 367459 369478
- 9 Athipattan, Street, Mount Road, Madras—600 002, Phone 842718

Wanted stockists all over India

sound technology from a sound source

3324 COSMIC COLOURVISION



COSMIC COLOURVISION 3324
offers colour with style
with it's built in electronic tuner

Three decades in the field of electronics has helped Cosmic in creating an Audio-Visual marvel

- 51 cms. The carefully manufactured multifunction unit
- High intensity picture tube offers vibrant colours with perfect sound
 - 8 mode channel selector
- Matches any Video system-UHF or VHF

Off with flying colours