

115

December
1984

elektor

INDIA

Rs. 7.50

electronics

SIC
(R 2)

**universal
NiCad charger**

**10W valve
amplifier**

**TV receiver
as monitor**

mini printer

**readership
survey results**



Volume 2 - Number 12

EDITOR: SURENDRA IYER
PUBLISHER: C R CHANDARANA
PRODUCTION: C. N. MITHAGARI

ADVERTISING & SUBSCRIPTIONS

ELEKTOR ELECTRONICS PVT LTD.

Chotan Building
52 C, Proctor Road Grant Road (E)
Bombay-400 007

DISTRIBUTORS: INDIA BOOK HOUSE

PRINTED AT:

TRUPTI OFFSET
103, Vasan Udyog Bhavan,
Off Talsi Pipe Road,
Lower Parel, BOMBAY-400 013

Elektor India is published monthly under agreement with Elektor B.V., Holland, August/September is a double issue

SUBSCRIPTION

INLAND

1 Yr Rs 75/- 2 Yrs Rs. 140/- 3 Yrs Rs 200/-

FOREIGN

One year Only

Surface mail Rs. 125/- Air mail Rs. 210/-

The Circula are for domestic use only. The submission of designs of articles to Elektor India implies permission to the publishers to alter and translate the text and design and to use the contents in other Elektor publications and columns. The publishers cannot guarantee to return any material submitted to them. All drawings, photographs, printed circuit boards and articles published in Elektor India are copyright and may not be reproduced or imitated in whole or part without prior written permission of the publishers.

Patent protection may exist in respect of circuits, devices, components etc described in this magazine

The publishers do not accept responsibility for failing to identify such patents or other protection

INTERNATIONAL EDITIONS EDITOR: P. HOLMES

Dutch edition	Elektout b v #190 AB Beek LL, the Netherlands
German edition	Elektor Verlag GmbH, 6123 Gießen, W-Germany
English edition	Elektor Publishers Ltd Elektor House 10 Longport, Canterbury CT1 1PE, Kent, U.K.
French edition	Elektor Snc Le Sersu 59270 Baillul, France
Italian edition	Elektor, 20092 Conesio B, Italy
Spanish edition	Elektor Av Alfonso XIII 141, Madrid 16
Greek edition	Elektor Karaskaki 14, Voula Athens
Turkish edition	Elektor Yayincilik ve Ticaret A. S., Karakoy Istanbul

COPYRIGHT © ELEKTOR B.V. —
THE NETHERLANDS 1984

readership survey results	12-14
news, views, people	12-16
selektor	12-18
New materials for optical memories.	
the story of valves	12-20
Although not as common as they used to be, valves are still available and are essential for some applications. Here we review what used to be common knowledge among electronics hobbyists and see what valves are, where they are used, and how to look for a fault if they do not work	
circuit boards and soldering	12-24
How to make printed circuit boards at home and techniques for good soldering	
mini printer	12-28
A full Centronics interface connects this thermal printer to almost any computer. It prints 40 characters per line at a speed of 80 c.p.s. Versatility combined with low cost make this printer a must for any personal computer user.	
burglar deterrent	12-35
A LED to alarm would be housebreakers. It protects your valuables without waking half the neighbourhood and without annoying the Police by falsely crying 'wolf'.	
RS232/V24: the signals	12-39
The signals recommended by this standard are dealt with in this article. Particular reference is made to those needed for communication between computers via modems.	
use your TV receiver as a monitor	12-42
The special video amplifier featured here will enable most TV sets to be converted into a proper computer monitor. Colour and monochrome versions are both catered for.	
telephase	12-48
Detects the presence, or absence, of voltage in an electrical conductor without even having to touch it.	
valve amplifier	12-50
Stricken by a bout of nostalgia, one of our more mature designers suddenly remembered something called valves. Imagine our surprise at being offered a valve amplifier. We were even more surprised, however, to hear the high quality of the sound.	
universal NiCad charger	12-55
The NiCad charger described in this article is able to charge all of the smelzer series of cells	
merket	12-58
switchboard	12-63
missing link	12-70
index of edvtisers	12-70



Attention:

semiconductor manufacturers

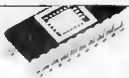
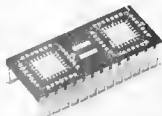
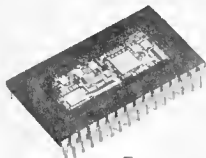

For an ever expanding spectrum of microelectronic applications—

We can offer co-fired substrates and interconnects with precise tolerances for high-lead-count packages, complex motherboards and a wide variety of intricate modules.

For technical and commercial details, write to:

SUDHIR SURTI

2B, Parekh Mahal, Vir Nariman Road,
Churchgate, Bombay 400 020.

Phone: 297895, 250352

KD

COLOUR TV MANUFACTURERS

FOR YOUR REQUIREMENT OF:



FLYBACK TRANSFORMERS

CONTACT:



DANNIES ELECTRONICS ENTERPRISE

Importers and Exporters

77, High Street # 10-12, High Street Plaza,
Singapore 0617.

Phone 3372297, 3397696 Telex: RS 28612 ESQUIRE

We are manufacturing electronic components and are interested in diversifying our activities.

Are you interested in developing or suggesting microprocessor based commercially viable projects?

Suitable ideas will be taken up for mutual benefit.

Please rush with your ideas to
M/s R.P. Associates,
3/35 Lokmanya Nagar, Pune - 411 030.

ALL YOUR COMPONENT REQUIREMENTS

CAN BE MET
FROM A SINGLE SOURCE
IN SINGAPORE



Device Electronics Pte. Ltd.

We stock:

elektor
Magazines

IC IZUMIYA IC INC.
P.C.B. Drafting Aids

TELEDYNE
RELAYS

RCA
Semiconductors

**KONTAKT
CHEMIE**
Cleaners

RAYTHEON
Semiconductors

FAIRCHILD
Semiconductors

TEXAS INSTRUMENTS
Semiconductors

VRN Trimming
Potentiometers

Bread Boards
Metal Film Resistors

SSS
Semiconductors

Transistors
Zener Diodes

Bulk Importers/end users in India may
kindly forward their specific enquiries

To
Device Electronics Pte. Ltd.
101 Kitchner Road # 02-04, Singapore Electrical,
Electronics and Hardware Centre, Singapore 0820.

TELEX: DEVICE RS 33250
PHONE: 2986455

We also invite enquiries for items not mentioned above.



VU METERS

FOR EVERY APPLICATION

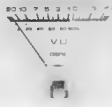

Manufactured and Marketed by
PADMA ELECTRONICS (P) LTD.

PRN Building, 24, Theradikadar Street,
 Tiruchirapalli—620 002, Tamil Nadu.

Sonika

DOT MATRIX
 PROGRAMMABLE GRAPHIC PRINTERS
 WITH SERIAL & PARALLEL INTERFACES.

FLOPPY DRIVE
 SLIM TYPE 5 1/4" FOR APPLE II +

MONITORS
 CRT 12" — Green — P31 phosphor.

Small Quantity available, Exstock.

Contact

**DOMINION
 RADIOS**

15, New Queen's Road, Opera House Bombay-400 004
 Phones 350747 382968 CABLE 'DOMIRA

MICRO PROFESSOR

- MPF-1 8 Z-80 Based Microprocessor Training Kit with various options.
- MPF-II A new "Apple Compatible" 6502 based personal computer.
- 64 K memory, Colour graphics, Audio Cassette, TV & Printer Interface. Optional Floppy drive interface & full size keyboard.

BRISK
 394, Lamington Road,
 BOMBAY-400 004.

Tel:
 35 40 16
 35 85 37

Dependable, Versatile and carefully engineered Oscilloscopes 3030 and 3131 from Aplab

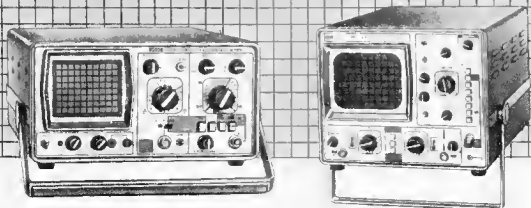

**Improved designs with maximum performance
at minimum cost**

Aplab is the largest Indian manufacturer and exporter of worldclass Oscilloscopes.

NOW AVAILABLE EX-STOCK

Aplab 3030

- 15 MHz compact single trace oscilloscope *
- DC-15 MHz bandwidth *
- 5mV/div. sensitivity *
- Built-in component tester *
- One x 10 probe free *

Aplab 3131

- 15 MHz dual trace triggered oscilloscope
- DC-15 MHz bandwidth
- 5mV/div. sensitivity on both channels
- Built-in component tester
- Two x 10 probes free

Other models available at short deliveries

- 3033-15MHz, Battery operated • 3034-15MHz, Dual, Battery operated • 3035-10MHz, Wide screen
- 3337-30MHz, Dual • 3339-30MHz, Dual, VDU scope • 3536-50MHz, Delayed sweep, Dual • 3537-50MHz, Dual • 3538-50MHz, Dual Storage scope

Applied Electronics Limited

Aplab House, A-5 Wagde Industrial Estate, Thane 400 604. Phone: 591861 (3 lines) Telex: 011-71979 APEL IN
8/A Gandhi Nagar, Secunderabad 500 003. Phone: 73351.
22C, Manohar Pukur Road, Calcutta 700 029.

Nos. 44 & 45 Residency Road, Bangalore 560 025. Phone: 578977 Telex: 0845-8125 APLB IN
MF-3 Stutee Building, Bank Street, Karol Bagh, New Delhi 110 005. Phone: 578842 Telex: 031-5133 APLB IN

Aplab — Leadership through technology

New materials for optical memories

Optical recording for information-processing systems

The storage of information by optical methods has many advantages over the conventional method of magnetic recording. Philips research laboratories are currently studying tellurium-selenium alloys, organic compounds, and magneto-optical materials that can function as optical memories. Depending on the material used, digital data (alphanumeric data and digital audio) and video information can be stored. The advantages are rapid access to the information and a very large storage capacity. It is becoming apparent that the scope for the application of optical recording is very varied. It will be possible to meet the specific requirements of new categories of users.

Magnetic materials for use as a memory for storing information have been studied for many years at Philips research laboratories. One result of the fundamental studies of iron oxides is magnetic tape for many applications, including storage of large quantities of alphanumeric data and audio and video recording. As the use of magnetic tape increases and user requirements become more specific, various failings of this medium become apparent. The storage capacity is limited and the information is only reliable for a certain time owing to demagnetization. But sometimes the law requires that information should be stored for a long time. It then becomes necessary to copy the information every few years to guarantee its reliability. A further disadvantage of magnetic tape is that it may take a long time to locate a particular item.

Philips research have long been seeking new methods of storage. The electro-optical techniques originally developed for LaserVision and the Compact Disc have provided a good starting point, since they are used for the storage of images and sound and are centrally produced. However, it is also possible for the user himself to store and retrieve information. In some cases, this information stored locally can be erased and replaced by new information. The major advantages of the new optical techniques are the larger storage capacity and more rapid access to the information. In brief, an electro-optical recording system consists of a disc the size of an LP covered with a sensitive layer

in which a laser makes microscopically small pits. Depending on the basic material, a particular physical effect occurs during read-out by the laser so that the information becomes available in coded form. The nature of the material determines whether digital data (alphanumeric information and digital audio) or video information can be stored. This depends on the required signal-to-noise ratio. The requirements for video in this respect are more difficult because of the large number of grey levels. For digital data (only two levels) things are much easier. The material also determines whether the information can be erased.

As optical recording obviously had much to offer, an intensive search began for materials on which information could be stored with the aid of a laser. Philips research laboratories are currently studying three classes of material that seem suitable for the optical recording of information: tellurium-selenium alloys, organic compounds, and magneto-optical materials. The last two groups are still almost completely at the research stage. Much more is known about tellurium alloys and, indeed, these have already been used in, for instance, the data disc for the digital optical recorder used in the Megadoc system that Philips introduced earlier this year. Despite great differences between the new media, there are a number

of characteristic similarities in the recording and reproduction systems. Whichever disc is used, the system works best with a diode laser that operates in the infrared (about 800 nm region). This laser creates a physical change in the storage material (hole formation or a phase change in a tellurium-selenium alloy, pit formation in an organic compound, and magnetization direction in a magneto-optical material). All such areas have a cross-section of about 1 micron, as the photographs show. The power of the laser for writing in information is about 10 mW at a pulse length of 50 ns. The read-out power is about 0.5 mW for all materials.

Tellurium-selenium alloys

One of the new materials for the storage of information is a polycrystalline tellurium-selenium alloy to which small quantities of other elements have been added, e.g. arsenic to give better control of the melting point and the stability of the material. A thin layer of the alloy is applied to a substrate. A narrow laser beam is used to melt this material locally so that holes are created with the same depth as the layer. During the read-out process, with a less intense laser beam, the presence or absence of holes produces differences in the reflection of the laser light. These differences in reflection represent the information in coded form.

1

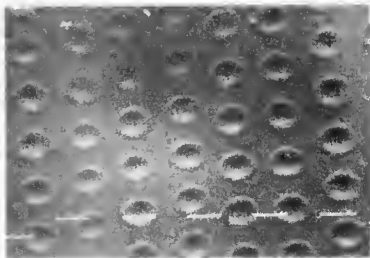

Photo 1 The surface of a disc for Digital Optical Recording on a tellurium-selenium alloy. The horizontal grooves are the pre-printed tracks for the 1 μ m-diameter pits used for recording digital data. Local widening of the pre-printed tracks gives the addresses that permit rapid retrieval of the recorded information

Research has been concentrated on determining the composition of the alloy and on finding an efficient technique for applying a very thin layer of the alloy to a disc. The 'shelf life' of the discs is extremely good. Life tests have shown that the stored information can be guaranteed for at least ten years without any need for special environmental conditions. Shelf life will be greatly increased in a controlled environment.

The signal-to-noise ratio that can be achieved is so high that the disc with a tellurium-selenium alloy is ideally suitable for use as a storage medium for both digital data (alphanumeric information or digital audio) and video recording. The data disc for the digital optical recorder uses this technology. A compatible player is made by Van der Heem Electronics to a design by Philips Research Laboratories in Eindhoven (the Netherlands). Disc and player form one section of the Megadoc electronic data-storage system made by Philips Data Systems. A second type of player is currently being developed by Optical Peripherals Laboratory (U.S.A.), a joint venture of Control Data Corporation and Philips.

The use of tellurium alloys also makes it possible to record information on a disc, erase it, and then use the disc again to record new information. By choosing the energy output of the laser appropriately (compared with the level necessary for the 'hole' disc) the polycrystalline material is melted locally, but no holes are formed. After the laser pulse the molten areas cool down so quickly that they solidify in a metastable amorphous phase. These amorphous domains reflect differently from the crystalline surroundings on read-out. Erasure takes place when a laser with a sufficiently high energy level transforms the amorphous domains into the crystalline phase.

In most applications the disc can be used and erased many times. In principle, storage of both digital data and video recording is possible because of the high signal-to-noise ratio. These materials for erasable storage are now at the transition stage between research and development.

Organic compounds

Organic dyes exist that absorb a great deal of light and have a high reflectance even when applied in very thin layers. These thin layers of organic compounds seem to be a promising alternative to tellurium-

2

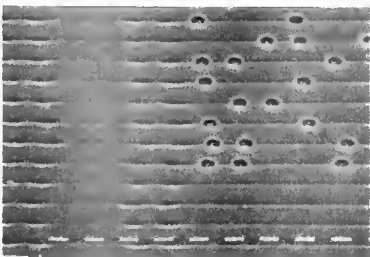

Photo 2. Pattern of pits on the surface of an information storage disc with organic dyes in the coating

selenium alloys. The memory effect is again obtained by melting the material locally with a laser to create small pits. The difference from the tellurium-selenium alloy is that these pits do not normally penetrate through to the substrate. The reflectance varies with the depth of the pit. The difference in reflection created by the pattern of pits is used when the information is being read. This melting process is irreversible, so the disc can only be written once. The shelf life is good: it has been found that these organic compounds retain the information just as well as the 'hole' discs with tellurium-selenium alloys. A great deal of research has been done on the 'light-fastness' of the material, which ensures that its characteristic properties remain unchanged. These compounds have also been found to be very resistant to heat and moisture. One attractive feature is the simple spin-coating process for applying the organic compound to the disc. This type of disc has many applications. The signal-to-noise ratio obtained experimentally is high enough for the storage of both digital and video information.

Magneto-optical materials

Amorphous magnetic gadolinium-iron cobalt compounds have been known for a long time. A laser can be used to heat the material locally, reverse the polarity of small areas and freeze it in this state. This technique makes it possible to 'write' on a magnetised layer in a pattern of

areas of opposite magnetization directions. This type of pattern can then be read out with polarized laser light. The direction of polarization of the reflected light is rotated slightly with respect to the polarization of the original laser beam as a result of the Kerr effect. The 'written' areas on the disc can therefore be distinguished from the unwritten ones, and information can be read out. The information can be erased just as easily as it is written. The areas to be erased are heated by the laser, while an external magnetic field is applied with the same direction as the original magnetization of the layer; the magnetization of the heated area reverts to its original direction after cooling. The information can be written, erased, and rewritten as often as required. The present research is much concerned with the operational life of the stored information. The stability of the material is very important here.

At present the signal-to-noise ratio is only moderate, so this storage method is suitable for digital data only (alphanumeric information and digital audio signals). It could very well be possible to improve the signal-to-noise ratio sufficiently for the recording of video signals.

(944 S)



Once upon a
time...

the story of valves

Before the arrival of the transistor all amplifiers, transmitters, receivers, etc., were made with valves. In the eyes of many 'modern' people valves were (and are) fragile and unreliable and had a short lifespan. Not all that long ago, however, there was no alternative. Before the valve there were simply no amplifiers, and the transistor was only invented in 1948. But think about this: without FM transmitters (which contain valves) would there be any point in having a compact transistorised FM receiver?

What exactly is a valve? Many of our more mature readers know, of course, but some of the youngsters may think something along the lines of: "Oh yes, one of those old-fashioned fragile glass things with all sorts of complicated-looking bits and pieces inside". This definition is not strictly wrong but it leaves out rather a lot. True, a valve is made of glass but, in spite of its appearance, it is not all that fragile, nor is it necessarily 'old-fashioned'. Valves are actually indispensable for certain applications (even today) and in others — such as hi-fi for example — they are on the way back 'in'. (To see this you need look no further than the valve amplifier elsewhere in this issue).

What, then, is a better definition for a valve? The transistor's predecessor is seen as a device in which electrons are fed into one side and come out on the other side. Between the two electrodes is a control electrode that can pass or inhibit the flow of electrons as desired. A major difference between this and the transistor is that no current flows through the control electrode. In this respect valves are more similar to (MOS)FETs than to bipolar transistors.

Are there other notable differences between valves and transistors? Plenty! It is quite normal for a valve to become warm even in its quiescent state; its innards must glow, actually, in order to generate the

cloud of electrons needed. Although mechanically it is vulnerable, the valve is very robust in an electrical sense: it is almost indestructible! If something does go wrong then the impending failure can almost always be predicted beforehand simply by looking carefully at the tube. It does not just suddenly kick the bucket like a transistor!

That, basically, is a sum-up of the most important points about valves. Up to now Elektro has had very little to do with valves but none the less some of our old hands are very knowledgeable on the subject. When we picked their brains this is the story that came to light.

Under the magnifying glass

An essential part in the operation of any valve is the movement of charge carriers (electrons) in a virtual vacuum. A valve consists of a glass tube containing a simple or complex electrode system. The electrodes must include at least a cathode and an anode.

The cathode often has the shape of a nickel tube covered with a layer of barium strontium oxide. It is warmed to a temperature of about 700...800°C by a filament in the tube. The surface then attains a dark red colour. The filament is electrically isolated from the cathode by means of a layer of aluminum oxide but the heat conduction is very good.

The heat increases the motion of the electrons in the cathode. As a result of this some of the electrons will reach a speed greater than the so-called 'emission velocity' and will leave the surface (this is thermal emission, also known as the Edison effect). An electron cloud (known as the space charge) then forms around

the cathode. This cloud has a negative charge so the cathode is positively charged. A balance between cathode and electron cloud is reached, depending on the cathode temperature and material.

If a metal plate which has a positive potential with respect to the cathode (an anode in other words) is now placed at a certain distance from the cathode it attracts some of the electrons. The cathode then redresses the balance by releasing more electrons into the space charge. (From now on we will forget the interaction between cathode and electron cloud and simply refer to 'the cathode'). From the previous paragraph we see that electrons flow from cathode to anode (this is the anode current). Even if the anode is not positive with respect to the cathode a (small) current will still flow because the electron cloud is negative with respect to the anode. This valve, called a diode, has no threshold voltage. As the anode is not heated no current will flow in the vacuum if the anode is negative with respect to the cathode. Current flows in one direction only so this diode can act as a rectifier.

Triode, pentode, and other valves

A three-electrode valve (triode) is made by placing a third electrode at a certain position between cathode and anode. This third electrode is normally in the form of a spiral with a fairly large pitch and is called the grid or control grid. If the voltage presented to this control grid is negative with respect to the cathode then the electric field between cathode and control grid will oppose and possibly even completely suppress the field between cathode and anode. The voltage

1

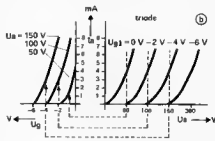
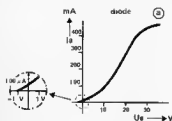

Figure 1a. The I_a/U_a characteristic of a diode, a triode, a tetrode and a pentode.

Figure 1b. In a diode the anode voltage must be slightly negative in order to suppress the anode current completely. At zero volts there is already a small anode current flowing. This sort of valve were perfect for a diode voltmeter, to name but one application.

Figure 1c. The triode characteristic clearly shows that for a small change in grid voltage (e.g. 2 V) a much larger anode voltage change (50 V) is needed in order to keep the anode current constant.

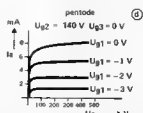
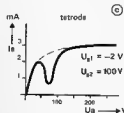

Figure 1c. This tetrode characteristic displays a marked dip where the anode voltage is lower than the screen grid voltage. The dip is caused by secondary electrons that flow from the anode to the screen grid.

Figure 1d. The pentode characteristic is notably flatter than the previous ones. It displays a certain similarity to a transistor's I_c/U_c characteristic

g41231

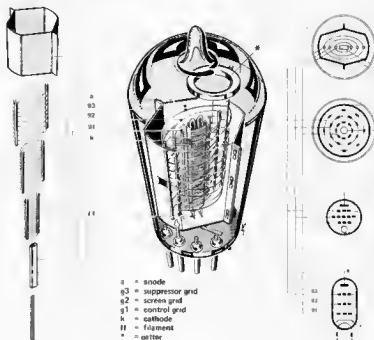

Figure 2. A cross-section through a pentode. The various electrodes are drawn separately at the left-hand side. The graphical symbols on the right give a stylized image of the build up of the valve.

- a = anode
- g3 = suppressor grid
- g2 = screen grid
- g1 = control grid
- k = cathode
- h = filament
- r = getter

84122-2

on the control grid thus affects the anode current. If the magnitude of the negative control grid voltage is increased it can shut off the valve completely. By applying an alternating voltage to the control grid the anode current is made to vary in time with the alternating signal.

The grid is much closer to the cathode than the anode so the anode voltage (which gives an attractive force) must change more than the grid voltage (repulsive force) in order to compensate for any fluctuations in the grid voltage and thus keep the anode current, I_a , constant. The ratio between these two changes is called the amplification factor and is given by the letters μ or g . The ratio between a small change in grid voltage and the resultant change in anode current (if the anode voltage remains constant) is called the mutual conductance or slope (S) of the valve. The valve can be used as an amplifier if a d.c. or a.c. resistance is connected in series with the anode line.

The anode and control grid of a triode form a capacitor. The anode circuit and control grid circuit are therefore capacitively coupled. The capacitive reactance decreases as the frequency increases. At high frequencies this can result in transfer from the anode circuit to the grid circuit so the whole circuit may oscillate. An extra grid, whose voltage remains constant with respect to the cathode, can be included between the anode and the control grid. This fourth electrode, called the screen grid, reduces the transfer characteristic drastically. The screen grid must not inhibit the anode

current so it is fed a suitably high positive voltage.

Electrons that manage to pass the screen grid are speeded up by the attraction to the anode. In some cases the speed may become so great that the impact energy is too much for the anode. The impact of a single electron can then cause the anode to release a number of electrons. The electrons thus released (secondary electrons) can either return to the anode or go to the screen grid. In the latter case the anode current characteristic displays a marked 'dip', at which point the circuit displays negative resistance properties and a tendency to oscillate.

A further electrode may be introduced between anode and screen grid to oppose the flow of electrons from the former to the latter. This so-called suppressor grid is generally connected to the cathode. Its purpose is to reduce the speed of secondary electrons so that they reverse direction and return to the anode. This sort of valve, with five electrodes, is called a pentode.

Other types of valves were also common, such as: the hexode (6 electrodes), the heptode (7 electrodes) and the octode (8 electrodes, six of which were grids). Numerous combinations were also made, producing the duodiode pentode, triode hexode, triode heptode, and so on.

Pros and cons

Normal radio valves were, of course, inferior to transistors in some respects. Transistors, for example, require no power



Figure 3. These are the graphical symbols used to depict some of the most common types of valve.

84123-3

to drive a filament but valves can handle much higher voltages and temperatures. Breakability of valves was not really such a problem as transistors cannot survive too much rough handling either. Just as with filament lamps, the anticipated lifespan was a compromise. Where long life was necessary (and more important than low cost) special types of valves could be specified, such as SQ (Special Quality), LL (Long Life), and telephony valves, all of which had an expected lifespan of at least 10,000 hours. Apart from the ability to handle more power, the most important difference between transistors and valves is size. Valves are much larger so the case housing a valve amplifier, for instance, must be larger than its transistorised counterpart and it must have plenty of holes or slits to allow cooling air to enter. For the most part valves have been replaced by transistors. They are generally only used now in high-power transmitters and for high frequency heating in industry. Valves still appear in other forms as magnetrons in radar transmitters and microwave ovens, as klystrons in TV transmitters and, of course, as cathode ray tubes in TV receivers

Practical tips

Compared to transistors, some problems in equipment containing valves are fairly

dissipation is much too great. There are many possible reasons for this, such as:

- the design is bad so the valve is overloaded;
- incorrect circuitry at the anode side with not enough energy dissipation;
- the valve does not have enough negative grid voltage, with the result that the anode current is too large (caused by, for example, a short circuit in the cathode decoupling capacitor, far too much resistance in the grid line, an internal short between cathode and control grid, and so on).

A violet glow within the anode shows that the valve is 'soft', which means that there is some gas inside the tube, its vacuum is not correct so the valve is approaching the end of its life. In some valves, however, this glow is normal, especially at high voltages. A violet glow may also be noted outside the anode, particularly along the length of the electrode system. This phenomenon is generally harmless. To finish, here are two practical observations. First of all, a valve should be mounted in a good-quality socket. Do not use a cheap one and do not solder it directly to a printed circuit board. Secondly, valves must have enough ventilation. They can take a lot of punishment but long-term overheating will kill even the best of valves.

4

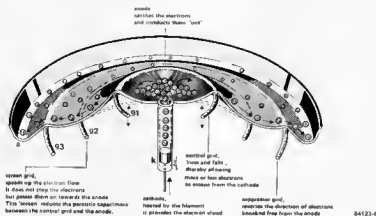

easy to track down.

After power is applied it is easy to look at all valves and see if they are glowing. If so this means that the filament is intact and that it is being fed a voltage.

In a tetraode or pentode the screen grid (the second out from the middle) must never glow. A red glow from inside, which may only be visible from some viewpoint underneath, signifies an overload of the screen grid. The power must be switched off straight away. The likelihood in this case is that there is no voltage at the anode of the tube, probably due to a break in the wire to this electrode.

If the anode also starts to glow the power must be removed instantly because something is really wrong. The anode

The set up shown here (figure 4) was sometimes used when studying the operation of a valve. It consisted of a fairly taut sheet of rubber, in which the changes of potential at the different electrodes are represented by rises and falls in the surface. As the middle was higher than the outside rim the effect of gravity helped simulate the various forces on the electrons.

Steel balls were released from the middle (the cathode) and rolled outwards. The braking effect of a grid was mirrored using metal rings to raise the rubber surface at places. A ball that had to roll up an incline was slowed down, only to speed up again when rolling down the other side of this 'grid'

K

circuit boards and soldering

Printed circuit boards

What exactly is a printed circuit board? Well, basically it is an insulating substrate on which components are mounted, and to which are bonded copper conductors in the required circuit interconnection pattern. A typical printed circuit board starts life as a piece of 'copper laminate board'. This is a sheet of synthetic-resin-bonded paper (SRBP) or epoxy-bonded fibre glass, to which a continuous coating of thin copper foil is fixed by adhesive. Once the required circuit connection pattern has been designed it is transferred to the copper surface in the form of an acid-resistant ink. The board is then immersed in an etchant solution that dissolves away the areas of copper not protected by the resist, leaving only the circuit track pattern. The resist is then cleaned from the board, holes are drilled to mount the components, the component leads are inserted through the holes and soldered to the copper tracks.

Professionally produced printed circuit boards can, of course, be considerably more sophisticated. As an aid to inserting components in the correct locations a component layout is frequently printed on the top face (non-copper side) of the board. The track pattern may also be printed, in ink, on the top of the board as an aid to circuit tracing. The copper side of the board may be completely covered with a 'solder mask', except for small areas around the holes through which the component leads protrude. This means that the copper track can only be soldered in the area of these 'pads', and the solder mask prevents accidental solder splashes from adhering to other areas of the board.

The pads themselves are frequently covered with a thin plating of tin, which aids soldering and prevents oxidation of the copper if the board is stored for some length of time before use. Alternatively a thin coating of a special lacquer may perform a similar function.

If a circuit is particularly complicated it may be impossible to make all the required interconnections on one side of the board, in which case a 'double-sided' board may be used, which has copper tracks on both sides of the board. To avoid the necessity of wire

In terms of ease of constructing electronics projects, enthusiasts have never had it so good as they have it today. In the bad old days of twenty or thirty years ago, circuits were constructed on laboriously-manufactured metal chassis using valveholders, tagstrips and wire. Nowadays the functions of support for and interconnection of components are frequently fulfilled at one fell swoop by the indispensable printed circuit board.

links to make connections between the top and bottom of the board, 'plated-through holes' are often employed. This means that metal is electroplated through a hole from a pad on one side of the board to a pad on the other side. An interesting possibility offered by double-sided printed circuit boards is that components can be mounted on both sides of the board. Boards available from the Elektor Printed Circuit Board Service (EPS) are typical examples of current p.c.b. practice (see figure 1).

Home-made p.c. boards

Home production of all but the simplest p.c. boards involves considerable outlay and a fair amount of skill, which is why Elektor offers ready-made boards for many projects. However, it is appreciated that some readers will wish to 'have a go' themselves.

By far the most difficult aspect of printed circuit board production is the design, i.e. transforming a theoretical circuit into a practical p.c.b. layout. Unfortunately there are no hard and fast rules for this, and skill only comes with practice. The best plan is probably to study professionally produced layouts such as those in Elektor, and to build up one's skill gradually starting with simple circuits.

If a p.c.b. layout is already given then no design problem exists, and the design can be transferred to the copper laminate board.

First of all the board must be cut to the correct size. Then the copper surface must be scrupulously cleaned to ensure even etching. This can be done using a Brillo pad, wire wool and soap or an abrasive cleaner such as Vim or Ajax. After cleaning the board should be washed thoroughly to remove any traces of the cleaner and dried using a lint-free cloth.

To make a 'one-off' board for a not-too-complicated circuit the simplest method is to draw the layout directly onto the copper using an etch-resist pen or an acrylic marker pen. For complicated shapes such as ICs, etch-resist transfers are available. These are simply rubbed off the backing sheet onto the copper.

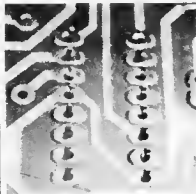
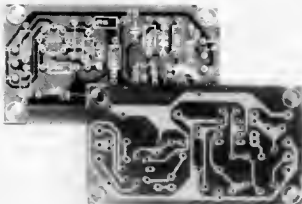

Figure 7. Boards from the Elektor Printed circuit board Service are typical examples of modern p.c.b. practice.



Etching

Once the layout is complete the board is immersed in an etchant solution. Various exotic chemicals are used in industry, but for the home constructor ferric chloride remains the standard etchant. This is available in solution, either concentrated or ready for use, and the supplier's instructions should be followed. Ferric chloride is also available in crystalline form, in which case a solution must be made up. A suitable solution for etching is 500g of ferric chloride crystals to one litre of water. When making up the solution the crystals should always be added to the water, never the other way round. One litre of etchant is sufficient to etch 3000 to 4000 sq cm of board.

Ferric chloride is extremely corrosive and it is advisable to wear protective clothing such as rubber gloves and a plastic apron when using it. If ferric chloride comes into contact with the skin it should be washed off immediately. If it contacts the eyes these should be washed with copious amounts of cold water and medical assistance sought immediately.

All utensils used to contain ferric chloride should be of glass or plastic, never use a metal container. If it is to be stored for any length of time, the container must be air-tight. Ferric chloride is hygroscopic, which means that if given half a chance it will capture moisture out of the air until it overflows a normal container!

Etching can be speeded up by warming the solution. The easiest way to achieve this is to place the dish containing the etchant in a bowl of warm water. Whilst the board is in the solution it should frequently be agitated to bring fresh solution into contact with the copper and to dislodge the 'sludge' of iron that is displaced from the solution as the copper dissolves.

The board should be checked periodically to see how the etching is proceeding. It should not be left in the solution once etching is complete as the etchant will begin to undercut the edges of the copper track where the resist does not protect it.

Once the board has been etched the resist can be scrubbed off and holes for

the components can be drilled. The components should be mounted and soldered before the copper has time to tarnish, and the copper should be protected by a coat of lacquer immediately after the circuit has been tested. If the board is to be stored for some time before mounting components then it should be given a coating of special printed circuit lacquer, available from Doram. This is somewhat more expensive than ordinary decorative lacquers, but the board can be soldered through the lacquer, whereas ordinary lacquers inhibit soldering.

Photographic methods

If several boards of the same design are to be made, or a complicated layout is to be copied from a magazine, then it is worth considering photographic methods. There are several ways of transferring a layout onto copper laminate board photographically.

The method for making a board from one's own layout design is to draft the layout onto transparent or translucent film (available from shops selling artists' materials) using black, self-adhesive draughting tapes and pads. This is known as a positive master.

The cleaned copper laminate board is then coated with a positive photo-resist such as Fotolak, according to the manufacturer's instructions. The master artwork is placed in contact with the resist and the resist is exposed to light (which may be ultraviolet or visible light depending on the type of resist) through the master artwork.

The exposed board is then placed in a developer bath (or sprayed with developer depending on the type of resist) when the exposed portions of the resist (those not covered by the black track of the artwork) are developed away.

The board is then washed and etched in the normal way.

Negative photoresists are also available; if these are used then the unexposed portions of the resist are developed away. Of course, a negative photoresist entails the use of a negative master, i.e. a black background with transparent areas for the track pattern. This must be produced by making a contact print of the positive

master onto photographic film. Only readers who do their own photographic processing will have the necessary equipment, and it is not intended to discuss this method further.

Layouts printed in magazines may also be photographed, and the photographic negative can be enlarged to the correct master. Here again, readers who carry out photographic processing will know how to do this. Alternatively, any local photographer should be able to carry out this work for a modest charge.

Soldering

Having purchased or made a printed circuit board, there is then the problem of making a reliable electrical (and mechanical) connection between the component leads and the copper tracks on the board.

Soldering involves the use of a metal that will melt at a relatively low temperature (usually about 200°C), which will form a molecular bond with the component leads and the copper track. The temperature must be fairly low since components are susceptible to damage by excessive heat, as is the adhesive used to bond the copper to the printed circuit board.

Electrical solder is an alloy of lead and tin. Pure lead melts at 232°C and tin melts at 327°C, but an alloy of the two metals, paradoxically, melts at a lower temperature than either of the constituents. The temperature at which the alloy melts depends on the proportions of the two constituents. The lowest melting point for a tin/lead alloy is 183°C, and is obtained when the proportions are 63% tin to 37% lead. An alloy with the lowest possible melting point is known as a eutectic mixture (Greek: eutēktos - easily melted). A eutectic alloy of tin and lead changes from a solid to a liquid at exactly 183°C. If the mixture is not eutectic then the alloy will not melt at exactly this temperature but will exhibit a range of temperatures where it has a 'plastic' consistency. This is shown in figure 2.

It is not a good idea to have solder with too large a plastic range. If the soldered joint is moved whilst it is cooling from the liquid state, through the plastic state to the solid state, this can result in the

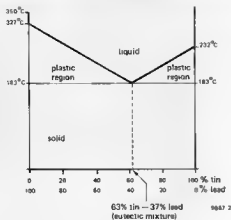

alloy solidifying with an extremely crystalline structure which has poor mechanical strength and high electrical resistance. The actual proportions of electrical solder are normally 60% tin to 40% lead. Small quantities of other metals are also added, such as antimony to improve mechanical strength.

Even this is not the whole story of solder, however. The component lead and p.c.b. track are covered with a layer of oxide that prevents the solder from 'wetting' the metal and forming a molecular bond. Even scrupulous cleaning of the board and component leads will not help, because an oxide layer only a few molecules thick will form instantaneously on a clean metal surface. To enable soldering to be carried out, flux is required. This consists of an organic resin that improves the wetting properties of the solder and an activator that dissolves oxide. Electrical solder for general use is produced in the form of a wire of circular cross-section. The flux is an integral part of this wire in the form of three or more cylindrical cores of flux running down the centre of the solder, as shown in figure 3.

To make a soldered joint the components to be joined (e.g. a component lead and circuit board pad) are heated simultaneously with a soldering iron to a temperature higher than the melting point of the solder. The solder wire is then fed into the joint, not to the soldering iron as the excessive heat will vaporise the flux too quickly and will cause the solder to oxidise.

At about 160°C the flux becomes active and cleans the surface of the components. At around 200°C the molten solder displaces the flux from the metal surfaces and wets them, forming a molecular bond. The soldering iron is then removed and the joint is allowed to cool without moving it.

A good soldered joint should have a smooth, shiny appearance and a concave surface, and the solder should flow smoothly into the surface of the two components. Excessive amounts of

solder and large blobs with convex surfaces are signs of a poor joint. A cross-section of a good soldered joint is illustrated in figure 4.

When making electrical soldered joints, no flux is required other than that contained in the solder, and the use of acid-based fluxes, such as those used in plumbing and metalwork, should be avoided since they are corrosive and electrically conductive.

Soldering irons

Soldering irons have come a long way since the days when they had to be heated up on a gas ring, and a large and bewildering range of types is now available.

The cheapest type of soldering iron, which will be perfectly adequate for the home constructor's purposes, is the continuous heat type. This typically consists of a thermally and electrically insulated handle, from which protrudes a stainless steel shaft containing a ceramic encapsulated electrical heating element. The business end of the iron - the 'bit' - is a hollow copper cylinder that slides over the shaft and is secured by a spring clip. The tip of the bit may be a variety of different shapes depending on the intended application, and a selection of different bits are shown in figure 5. Large bits are obviously used for heavy-duty work and small bits for fine work.

The element of a continuous heat iron is connected permanently to the supply, and there is no control over the bit temperature. This means that the iron will cool down whilst actually making joints, since heat is drawn from it to heat up the joint and melt the solder, but it will become very hot when not being used. This can mean that the first joint made after the iron has been standing idle may be overheated. The problem can be reduced by using a metal stand for the soldering iron, which will act as a heat sink and will ensure that the iron does not become too hot whilst idle. Continuous heat irons are available in various wattage ratings, but for general



Figure 2. Illustrating the melting points of different alloys of tin and lead and the plastic region exhibited by non-eutectic mixtures.

Figure 3. Electrical solder has cores of flux running down the centre of it. No additional flux is required with this type of solder.

Figure 4. Illustrating the principal points of a good soldered joint.

1. p.c.b. substrate
2. copper layer
3. alloy of solder and copper track (only a few molecules thick)
4. solder
5. alloy of solder and component lead
6. component lead
7. the maximum angle the solder makes with the track should be less than 30°.

Figure 5. A selection of soldering iron bits.

Figure 6. When making a joint the component and pad should be heated with the soldering iron and the solder run into the joint, not onto the iron.

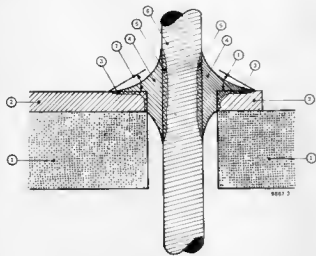

use a 20-25 W model, together with a selection of different bits, should prove adequate. If a great deal of fine work is to be undertaken then it may also be worth considering a 10-15 W model, and if any metal work is to be undertaken (e.g. screening enclosures for r.f. circuits) a 60 W iron will be useful.

The smaller wattage rating irons are often available in different voltage ratings. For general use a mains powered iron is probably the best bet, but if the enthusiast's interest involves outdoor work such as car electronics, mobile radio or field servicing then a 12 V iron may prove useful.

Temperature-controlled irons

The use of a soldering iron whose bit temperature is controlled allows more precise control over joint quality, and helps prevent delicate components from being damaged by overheating. There are two principal types of temperature-controlled irons. The first type uses a thermistor to sense bit temperature and an electronic control circuit to switch the power on and off. The temperature of this type of iron may be continuously varied by a potentiometer that alters the switching temperature of the control circuit.

The second type of temperature-controlled iron is made by the Weller company and utilises an unusual property of magnetic materials. Above a certain temperature known as the Curie point, ferromagnetic materials cease to be magnetic. The bit of a Weller iron contains a small slug of ferromagnetic material. When the iron is cold this attracts a magnet, which closes a switch and applies power to the element. When the Curie point is reached the slug becomes non-magnetic and the magnet is released, opening the switch.

To alter the bit temperature of a Weller iron it is necessary to change the bit for one which has a slug of material with the required Curie point.

Soldering iron bits

Soldering iron bits almost invariably used to be made of copper, since this is a good conductor of heat. However, each time a soldered joint is made a little copper dissolves in the solder, and eventually a copper bit becomes pitted and has to be filed down. Modern bits are generally made of copper, plated with some harder metal such as iron or nickel, which does not dissolve. These bits should never be filed, but should periodically be wiped on a damp sponge, while hot, to remove excess solder and dross.

Before using any bit for the first time, it must be tinned - coated with a fine layer of solder - to prevent oxidation and improve thermal contact with the joint when in use. The iron should be switched on and the solder held in contact with it. As soon as the solder melts it should be run over the entire tip of the bit. Any excess solder may then be wiped off.

Soldering techniques

Having chosen a suitable soldering iron and the correct bit for the job, it is important to use solder of the correct diameter. If the solder is too thick it will be difficult to control the feed rate into the joint and the joint may become flooded with solder. On the other hand, if the solder is too thin then a much greater length must be fed into the joint and it will take longer to make each joint. Fine solder is also more expensive (per unit weight) than thick solder.

For general purpose use 18 SWG solder should prove adequate, and for fine work such as soldering ICs 22 SWG solder should be used.

When soldering components into a printed circuit board the following sequence should be adhered to:

1. Any terminal pins should first be inserted into the board.
2. Small, horizontally mounted components such as resistors and diodes should then be inserted into the board. During the soldering operation



the board can be laid, component side down, on a piece of plastic foam, which will hold the components in place. Alternatively, the leads can be bent outwards at an angle of about 45° to hold the components in place.

3. When the components have been inserted into the board the leads can be cropped off fairly close to the board, using wire cutters.
4. To solder components, apply the tip of the iron to the component lead and the pad simultaneously and run solder onto both (see figure 6). When sufficient solder has run onto the joint remove the solder and the iron and allow the joint to cool.
5. The procedure can then be repeated for ICs or IC sockets, transistors and large or vertically mounted components.
6. To improve the appearance of the board any excess flux can then be removed with methylated spirit.

If components have to be removed from the board for any reason, this should be done with great care to avoid damaging the copper track. Grip one lead of the component to be removed with a pair of pliers, reheat the joint until the solder melts then pull the lead clear. Repeat for the other lead(s). To remove ICs it is best to use a 'solder sucker' to remove solder from every pin of the IC, thus leaving the IC free to be removed.

Before inserting a new component it is essential that all the holes should be free of solder. This can be ensured by using a solder sucker, or by heating up the pad and inserting a pencil point into the hole. The board should be allowed to cool completely before inserting the new component, as otherwise there is a danger of lifting away the copper track from around the hole due to weakening of the adhesive by heat.

If all the preceding recommendations are followed there is no reason why the constructor should not enjoy a high success rate when using printed circuit boards.



Figure 1. The prototype of the completed mini printer.

mini printer

with Centronics interface

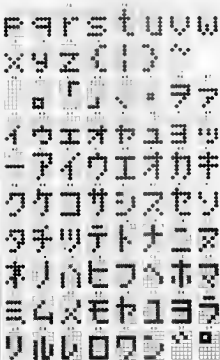

Many home computer enthusiasts dream of the day they will be able to get themselves a printer. Programming and editing on the monitor can be very tiring — to say the least. In many cases the Centronics interface is already available or, as in the Commodore 64, programmable. All that is needed, therefore, is a printer. As the article describes the principle of a dot matrix printer in some detail, it is also of interest to those who have no intention of building the printer.

For most listings, the eighty or even 126 characters per line as provided on most dot matrix printers are not really necessary. For disassembler listings, forty characters per line are ample. And therefore, the only real limitation of our Mini Printer compared with its bigger, commercial brothers is that it prints only forty characters per line. This is adequate for most BASIC programs, too, but if you want to print a BASIC program from a commercial cassette or diskette that has more than forty characters per line, simply format it by adding line numbers. Table 1 gives an example of how this is done.

Price and specification

We obviously do not want to compare the Mini Printer with an Epson or NEC printer which may cost up to eight or ten times as much. What is important is the performance of the Mini Printer, and, as can be seen from the technical data in table 2, that stands up very well.

At this stage, some of you will ask: "That's all well and good, but what about the mechanism and the processor? Are they included in the price, or where do I get them from?" Not to worry — both are catered for. Actually, they caused this project to take off, for some time ago we were provided by Seiko with one of their basic, low-cost mini printers. Once our designers had assessed and modified it, and Seiko had expressed their willingness to supply the processor and hardware on a one-off basis, we had the nucleus of the design presented in this article.

Hardware and chemistry

As shown in the photograph in figure 2, the mechanism of the printer is an ingenious piece of precision engineering. The motor drives not only the spiral guide roller for the print head but also the paper feed, which is made possible by the special construction of the guide roller. The motor speed is monitored constantly by a tachogenerator built into the motor housing.

The print head contains seven thermo needles (miniature heating elements) one above the other. During printing those needles that are to place a dot onto the paper are actuated simultaneously. The thermo paper is continually pressed against the print head by the paper guide. A thermo-chemical reaction, which discolours the paper, takes place at the position of those needles that are heated. As the paper is white with a dark background, dark dots are caused on the paper. Note that this thermo-active paper may be obtained from stationers and department stores: it is **not metallized paper!**

Block schematic

The print mechanism must be driven so that an ASCII unit at the input of the Centronics interface is converted into a character on the paper. This cannot be

achieved by a simple conversion, because there are also intervals of various lengths between the characters to be considered, as well as the control of the return mechanism and the shifting of the paper feed once a line has been completed. All this is taken care of by the single-chip central processing unit (CPU) type 8048: when this is programmed for our purposes it is type-coded 8048C289. As can be seen from the block schematic in figure 3, the CPU is at the centre of a number of additional stages which are actually contained in only a few components. The Centronics interface matches the CPU input to the Centronics standard. The 'print format' determines the number of characters per line. 'Control' enables the manual control of the paper feed and reset. The clock for the printer is generated separate from that for the CPU.

Table 1

```
2118 08<LEFT>08, 11<ASC>08:IF 0ASC'A'1 OR 0ASC'0' THEN088
```

```
2118 08<LEFT>08, 11<ASC>08
2111 3F 0ASC' A'1 OR 0ASC'0'1 THEN088
```

Table 2.

Technical Data

- Centronics interface with STB, READY, ACK, D0-D7
- CPU: single-chip microcomputer 8048C289
- dot matrix print head, 7 needles (styl)
- 5 x 7 dot matrix
- characters separated by two spaces
- contents: 150 characters
- speed: 80 characters per second (c.p.s.)
- 13, 16, 17, 20, 24, 25, 32, or 40 characters per line (presettable or programmable)
- printing direction: left to right
- width of thermo paper: 79 mm
- switches for paper feed and reset
- power supply requirements: 5 V ± 5%, current consumption 3 A maximum during printing, 130 mA on standby; power supply on printed circuit

mmprint@r

Table 1. Example of how to convert a BASIC program of more than forty characters per line into one that can be printed on the mini printer.

Table 2. Technical data.

Figure 2. It is clear from this photograph that the printing mechanism is a fine piece of precision engineering that you could not hope to build yourself.

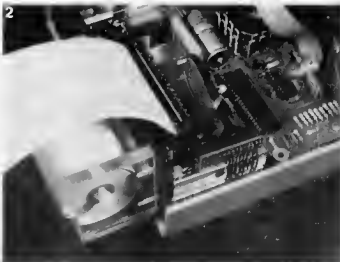

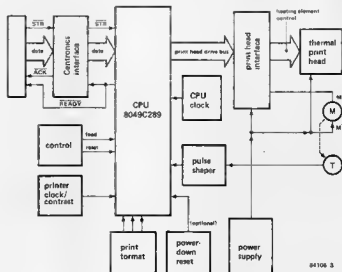

Figure 3. The block schematic shows to what an extent the printer is centred on the CPU.

Table 3

CHARACTERS PER LINE WIRE BRIDGE	13	16	17	20	24	25	32	40
P20	no	yes	no	yes	no	yes	no	yes
P21	no	no	yes	yes	no	no	yes	yes
P22	no	no	no	no	yes	yes	yes	yes

Table 3. How to set the number of characters per line with the appropriate wire bridge(s).

By adjusting the printer clock, the contrast, that is, the darkness with which the dot is printed on the paper, is changed. Moreover, the supply voltage and the ambient temperature also affect the circuit, so that the contrast ensures an even print quality.

The 'power down reset' stage will be discussed in detail in the circuit description. The 'power supply' is shown connected to the print head interface, the thermo print head, and the motor only, because these elements between them consume by far the larger part of the current, but it powers the other parts of the circuit as well, of course. The 'print head interface' transforms the logic level of the CPU output into a sufficiently large current for the individual thermo needles, and also controls the motor and the print head. Finally, the 'pulse shaper' converts the sinusoidal output of the tachogenerator into rectangular signals at TTL level.

Circuit description

The various blocks of figure 3 are easily recognized in the circuit diagram in figure 4 which again is dominated by the CPU. The Centronics interface consists of pull-up resistors R24...R31 and R37, as

well as the two monostable multivibrators, MMV1 and MMV2. The strobe signals provided by different computers vary between a half and several microseconds. As the 8049 requires a signal of about 50 milliseconds, the strobe signal, \overline{STB} , is stretched appropriately in MMV1. In the Centronics standard, at the \overline{READY} signal the level of the signal is determinative, whereas at the \overline{ACK} signal, the trailing edge of the pulse is. Most computers, including the Junior, and interface elements such as the PIA8255, need the trailing edge and therefore use the \overline{ACK} signal for acknowledgment. Here, it is derived by MMV2 from the \overline{READY} signal generated by the CPU.

The print format, that is, the number of characters per line, is determined by wire bridges P20...P22 as shown in table 3. If you want, a DIL switch may be used instead of the bridges, or the port lines may be controlled by TTL levels so that the number of characters can be changed every line. The fewer characters per line are chosen, the wider and bolder they become.

The reset and paper feed signals, controlled by push button switches S2 and S1 respectively, are actuated on negative logic levels. Both these networks need a current limiting resistor, R4 and R5, but

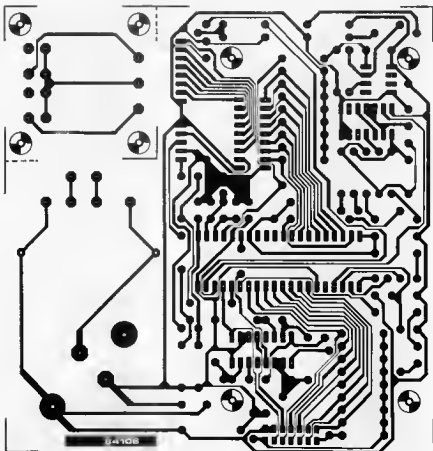

Figure 5. Construction of the electronics part of the printer becomes fairly simple on this PC board.

ting the relevant outputs of IC2 to earth. The pulse width of the needle point outputs is determined by the frequency of the printer clock and the CPU. The processor checks whether the corresponding heating element has been in operation recently. If so, the element is still warm and should not be supplied with heating current for too long, otherwise it may burn out. Therefore, the CPU holds the relevant output active (i.e. at logic 0) for only sixteen clock pulses, starting with the fifth of the dot cycle. If the element has not been heated recently, the CPU output remains at logic 0 for twenty clock pulses, starting with the first of the dot cycle.

When the data bus is in the high-impedance state, pull-up resistors R16...R23 are connected to it via port P27 and T2. This is essential as the 8049 does not have internal pull-up resistors. Always make sure, therefore that the inputs of IC2 are unambiguously at logic 1 when the data bus of the CPU is inactive.

Terminal R of the print head interface controls the print head in position 'home'. Capacitor C13 is necessary to decouple the motor power line from that to the heating elements, which has the added benefit of contributing to even quality of printing.

The pulse shaper for the tacho signal is formed by D2, T1, R12, R13, and C8. Ignoring the threshold voltage of the diode, the shaper functions as follows. During the positive half cycle, D2 blocks, whereupon T1 gets a sufficiently high base current via R13 to start conducting. During the negative half cycle, D2 conducts, so that the base of T1 is negative, and the transistor is cut off. A rectangular signal at TTL level, the frequency of which is equal to that of the sine wave at pin 1 of the 8049, therefore exists at the collector of T1.

Capacitors C6 and C7, and inductor L1, are the externally required components for the internal clock of the CPU. The

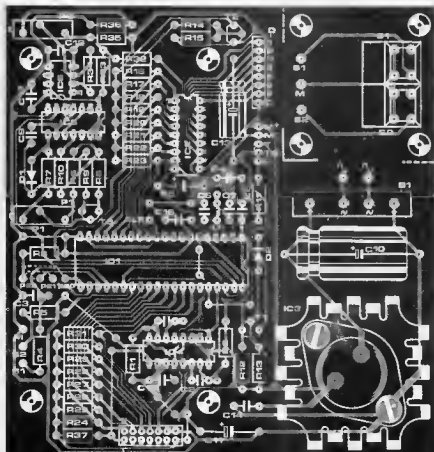

ports list

Resistors:

- R1, R2, R14 = 27 k
 R3, R4, R5, R11 = 1 k
 R6 = 150 k
 R7, R8 = 22 k
 R9, R32 = 2½k
 R10 = 100 k
 R12, R13 = 100 k
 R15...R31, R37 = 10 k
 R33 = 15 k
 R34 = 3M3
 R35 = 18 k
 R36 = 6k8
 P1 = 50 k multiturm cermet
 preset rectangular:
 19 x 4.8 x 6.4 mm
 P2 = 5 k multiturm cermet
 preset rectangular:
 19 x 4.8 x 6.4 mm

Capacitors:

- C1, C2 = 1 n
 C3, C4 = 10 n
 C5, C11 = 1 µ/16 V
 C6, C7 = 33 p
 C8 = 560 p
 C9 = 820 p
 C10 = 2200 µ/25 V
 C12, C14, C17 = 100 n
 C13 = 1000 µ/10 V

Semiconductors:

- D1, D2 = 1N4148
 T1, T3 = 8C 5508
 T2 = 8C 5608
 IC1 = 8049C289*
 IC2 = LB1256*
 IC3 = 78H05
 IC4 = 74LS221
 IC5 = 4068
 IC6 = ICL8211** (Intersil)

Miscellaneous

- L1 = inductor, 270 µH
 S1, S2 = single-make push
 button**
 B1 = rectifier bridge
 B40CS000 (40 V, 5 A)
 Thermal printer, Saito
 type MTP401*
 Heat sink, for TO-3
 14-way DIL socket (for
 Cantronic input; this
 component is optional as
 connection may be made,
 if desired, by soldering flat
 ribbon cable direct to the
 board)
 8-way SIL ribbon cable
 connector (same comments
 as for 14-way DIL socket)
 Case, 205 x 165 x 85 mm
 Printed circuit board 84105

*Available from
 Roxburgh Electronics Ltd
 22 Winchelsea Road
 Rye
 East Sussex
 TN31 7BR

** see text

clock frequency is around 6 MHz: its exact value depends on the tolerances of the external components. The precise value is, however, not important as the 8049 is on 'hold' for most of the time.

The power down reset circuit is based on the precision voltage comparator ICL8211. The circuit ensures that during short breaks in the supply voltage the program of the CPU is not confused which might conceivably give rise to the heating elements being actuated inadvertently and so cause the print head to burn out.

To do so, the circuit generates a reset pulse during supply breaks: a printing error is better than a burnt-out print head! Strictly speaking, however, the circuit is not necessary because in most cases mains power failure is completely taken care of in the power supply. In any case, in the absence of mains voltage, the power on reset is actuated when the printer is switched on. And if the worst comes to the worst, a print head costs

only a few pounds. It is, however, important that if the power down reset circuit is not used, the RESET terminal, pin 4, of the CPU is taken to earth via CS: there should be no other connections to this pin!

The power supply is a conventional circuit with fixed voltage regulator, for which in this case a 78H05 (with aluminium TO-3 housing!) is used to cope with the current requirement of the printer.

Construction

Note: owing to space shortage on the printed circuit the designations of P20...P22 on the board in figure 5 are cramped together: the outer terminal is not for P22 but is the common one for the three bridges leading to R3.

IMPORTANT: Before soldering multiturm preset P1 in position, set it to the centre of its travel, that is, to about 25 k measured with a multimeter. This setting should not be changed until calibration! It is there-

6

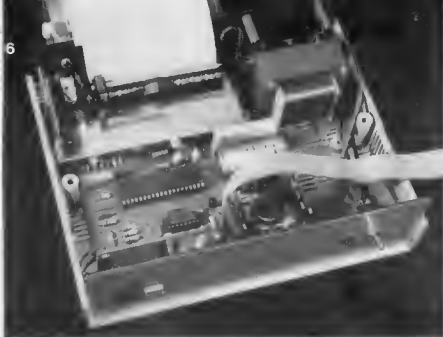
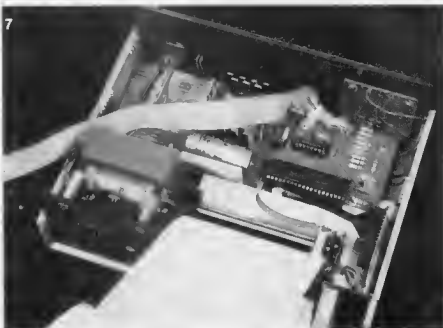

Table 4

1	STB
2	D1
3	D1
4	D2
5	D3
6	D4
7	D5
8	D6
9	D7
10	ACK
11	READY
12, 14	earth
13	+ 5 V

Table 4. Pinout of the Centronics input socket on the PC board.



Figures 6 and 7. These photographs show how we have installed our prototypes into an appropriate case

fore best to mount this component last and preset it immediately prior to soldering it in position.

Before commencing work on the printed circuit, have a look at the photographs in figures 6 and 7 which show how we assembled our prototypes. The printing mechanism is fitted on a metal plate above the printed circuit and is fastened to the rear panel of the case. This arrangement saves a lot of space and the case can therefore be smaller and less expensive. The connection between the output terminals on the printed circuit and the socket on the side panel (for the flexible print head cable) is best made in flat ribbon cable.

We have designed a simple holder for the paper roll and this is fitted at the rear panel of the case behind the paper entry

and exit slits. The position of these slits is shown in figure 10. If the holder is positioned accurately, the beginning of a new paper roll (cut straight beforehand) is simply inserted into the entry slit, the paper feed picks it up (press S1), and it then emerges from the exit slit. It is thus not necessary for the case to be opened to change the paper roll.

Either touch-type or normal push button switches may be used for S1 and S2. In either case the relevant part of the PC board (clearly marked on figure 5) must be cut off and fitted behind an appropriate cut-out in the front panel. Cutting part off the board enables the use of a variety of mains transformers.

It is, of course, perfectly feasible to assemble the printer to your own design: the only thing you have to be careful with

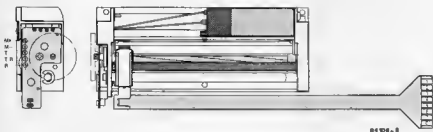

is to ensure that the paper does not pass across the heat sink of the voltage regulator or the mains transformer. Finally, it is recommended that in spite of the temperature-compensated oscillator circuit some air vents are provided in the case.

Table 4 shows the pinout of the Centronics socket on the printed circuit, while figure 8 shows the connectors to the printing mechanism and the print head.

Calibration

IMPORTANT: before the printer is connected to the mains, make certain that PI has been preset as instructed under 'construction'; failure to do so may result in a burnt-out print head! Also, before the calibration is commenced, the printer must be connected to the Centronics output of a computer. The computer is then programmed to give forty letter characters in a line. Switch on the printer and let the computer pass the line of characters to the printer: the print head should now move across the paper. In most cases there will also be a print-out on the paper, most probably too bold or too faint, and as likely as not there will not be forty characters across the paper width. There will either be forty characters across part of the width of the paper, or there will be fewer than forty printed in too wide a font. Careful adjustment of PI and repeated test print-outs will result in optimum setting of the potentiometer and this is evidenced by the printing of forty clean characters in line across the width of the paper. During this calibration it will become quite clear how the printer clock affects both the number of characters per line (or rather, their width on the paper) and the contrast (i.e. how bold or faint the characters are printed).

If you have incorporated the power down reset circuit, this should next be calibrated. First, pull out the mains plug and that of the print head! Next, connect a regulated power supply across C11 and adjust P2 so that pin 6 of IC6 becomes logic 0 as soon as the output of the power supply drops below 4.5 V. Take care that the voltage does not exceed 5 V during the calibration.

Finally, test the paper feed switch, whereupon the lid can be closed onto the case: the printer is ready for use.

9

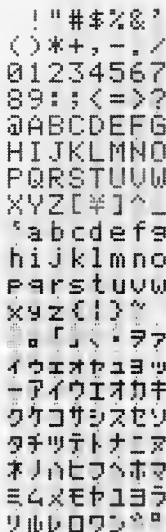

Figure 8. The connections to the printing mechanism and to the print head.

Figure 9 The sum total of the characters available in the mini printer. Above the characters is shown the hex code for those who, apart from the dot-matrix symbols and multiple printouts also want to use graphical symbols.

Hex Code	Character
01	0
02	1
03	2
04	3
05	4
06	5
07	6
08	7
09	8
0A	9
0B	:
0C	;
0D	<
0E	=
0F	>
10	?
11	@
12	A
13	B
14	C
15	D
16	E
17	F
18	G
19	H
1A	I
1B	J
1C	K
1D	L
1E	M
1F	N
20	O
21	P
22	Q
23	R
24	S
25	T
26	U
27	V
28	W
29	X
2A	Y
2B	Z
2C	[
2D	¥
2E]
2F	^
30	_
31	
32	a
33	b
34	c
35	d
36	e
37	f
38	g
39	h
3A	i
3B	j
3C	k
3D	l
3E	m
3F	n
40	o
41	p
42	q
43	r
44	s
45	t
46	u
47	v
48	w
49	x
4A	y
4B	z
4C	(
4D)
4E	
4F	
50	
51	
52	
53	
54	
55	
56	
57	
58	
59	
5A	
5B	
5C	
5D	
5E	
5F	
60	
61	
62	
63	
64	
65	
66	
67	
68	
69	
6A	
6B	
6C	
6D	
6E	
6F	
70	
71	
72	
73	
74	
75	
76	
77	
78	
79	
7A	
7B	
7C	
7D	
7E	
7F	
80	
81	
82	
83	
84	
85	
86	
87	
88	
89	
8A	
8B	
8C	
8D	
8E	
8F	
90	
91	
92	
93	
94	
95	
96	
97	
98	
99	
9A	
9B	
9C	
9D	
9E	
9F	
A0	
A1	
A2	
A3	
A4	
A5	
A6	
A7	
A8	
A9	
AA	
AB	
AC	
AD	
AE	
AF	
B0	
B1	
B2	
B3	
B4	
B5	
B6	
B7	
B8	
B9	
BA	
BB	
BC	
BD	
BE	
BF	
C0	
C1	
C2	
C3	
C4	
C5	
C6	
C7	
C8	
C9	
CA	
CB	
CC	
CD	
CE	
CF	
D0	
D1	
D2	
D3	
D4	
D5	
D6	
D7	
D8	
D9	
DA	
DB	
DC	
DD	
DE	
DF	
E0	
E1	
E2	
E3	
E4	
E5	
E6	
E7	
E8	
E9	
EA	
EB	
EC	
ED	
EE	
EF	
F0	
F1	
F2	
F3	
F4	
F5	
F6	
F7	
F8	
F9	
FA	
FB	
FC	
FD	
FE	
FF	

Figure 10. Rear panel: positions in our prototype of paper entry and exit slots.

10

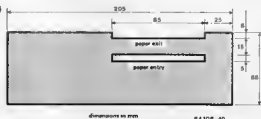

Every week the local papers carry tales of burglaries and break-ins, sometimes in our own street or neighbourhood. Most of these crimes are the work of the 'amateurs' or opportunists of the criminal world and they, unlike their 'professional' counterparts, should be quite susceptible to some sort of deterrent, even if it is very simple. A popular ploy has been to mount an empty burglar alarm box on the side of the house but as the number of affordable burglar alarms has increased recently most people are now more likely to fit the full system. The problem then is the large number of alarms falsely crying 'wolf', with the result that real burglaries often go unnoticed. The circuit proposed in this article does not give false alarms; in fact it gives no alarm at all. Instead it produces a light signal that will never call out the Police unnecessarily, which in itself is a distinct advantage.

burglar deterrent

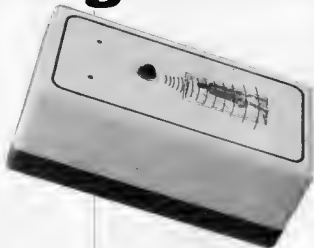

a pseudo
burglar alarm
with a 'noisy'
LED

A clever defence lawyer may call a burglar caught in the act "the victim of an imperfect (or unjust, or whatever) society" and try to prove that society is the real cause of all crime. Be that as it may, coming home to find your house burgled and ransacked is an experience most people will gladly forego. Often the worst thing is knowing that somebody has literally invaded your privacy. To prevent this sort of occurrence many homeowners decide to instal (or, more likely, pay somebody to instal) a burglar alarm. The trouble is that it is generally not at all easy to fit a really effective alarm, and you invariably have to pay dearly for this sort of security. If we go right back to the basic problem it is clear that although detecting a burglary while it is in progress is very laudable it is certainly not to be preferred to preventing the criminal from even beginning in the first case. Nowadays a crook ('amateur' or 'professional') who sees a burglar alarm box tacked to the side of a house knows that he will just have to work quickly and make a getaway before the neighbours are properly awake. If, on the other hand, he looks in

the window and sees a nondescript case with an erratically flashing LED in the side he will be forced to think about all the technological secrets that LED could be hiding. It could be an infra-red sensor, or maybe it indicates ultrasonic waves bouncing around the room, or maybe... (Mental gear-wheels engage in a criminal mind.) Soon an unwished-for thought shouts for attention: 'But why is it flashing at all? ... Does it know I'm here? ... Has it told anybody?' At this stage your average criminal will (hopefully) let instinct take over and leave while the going is good. If he does the circuit has performed its purpose at least as well as an alarm; if not, the chances are that no alarm would have deterred him anyway.

The basic circuit

This circuit is a burglar deterrent unlike the run-of-the-mill alarms, as the block diagram of figure 1 shows. Connected directly to the mains is the power supply section, consisting of two parts: a voltage dropper and rectifier, and a regulator. This is directly followed by a clock, which feeds a noise generator formed from a shift register. The resultant noise signal is applied to the last stage, the 'display' via a control section.

A noisy LED

Unusually, for a mains-powered circuit, there is no transformer to be seen on the circuit diagram of figure 2. This means that certain tracks on the printed circuit board carry 240 V a.c. so be careful about working on the circuit, or trouble-shooting it, while the power is switched on. Whenever the mains power is removed capacitor C1 is discharged through resistor R8. If this were not done there would be a chance that the voltage across this capacitor could give somebody a

BASIC (PART 2)

Numbers, simple arithmetic and variables are the main elements in a BASIC program. They are all dealt with extensively in this second part of the series. We will also discuss the memory, commands, error detection, editing, spacing, comparisons and the LET and PRINT statements. Quite a 'program'!

The first part in this series introduced BASIC. The difference between compilers and interpreters was explained and the importance of flow charts was stressed. A simple example illustrated the use of numbered program lines, the statements ENO and PRINT were introduced, and the RUN command was explained.

The next step is to find out what to write on the program lines: what numbers, arithmetical operations, variables etc. will the BASIC interpreter understand? Furthermore, it is not possible to write good programs without some understanding of computer memory capabilities. These 'basics' will be dealt with here.

Since programs are inevitably associated with errors, error detection must also be discussed; at the same time, a discussion of spacing and editing will help to enter programs correctly in the first place, and correct them if necessary at a later date. Finally, two useful statements will be discussed: LET and PRINT. The latter was already introduced in part 1, but some further uses for this statement remain to be explained.

Computer Memory

In a BASIC computer, part of the available memory space is used for storing 'control programs' — the BASIC interpreter, for instance. This section of memory cannot normally be erased: it uses so-called 'Read Only Memories', or ROMs (see figure 1). Storing information in a ROM is a one-only process, usually taken care of by the manufacturer. From then on, this information can be read out as often as described, but it cannot be altered or erased.

The rest of the memory will normally consist of 'RAMs' (Random Access Memories). These offer

the possibility of storing, reading out, altering and erasing information at will. However, the information will also be lost if the supply voltage fails, so a more permanent form of storage is useful: magnetic tape (reel-to-reel or cassette) or 'floppy disc'. Although these are extremely useful for storing complete programs, they are not much used when running programs: the information is not readily available — in other words, 'Random Access' in the full sense of the word is not possible.

All in all, when it comes to writing and running programs the RAMs are the section of memory that is of primary importance. Only part of this section will normally be used for storing the current program (with any further information required for it); this subsection is called the program memory. It will normally be possible to erase the program memory while retaining information in other subsections (other programs, for instance).

When using NIBL, the total RAM area is divided into so-called 'pages'. Programs can be stored on one or more of the pages 1 to 7. A more detailed description of the NIBL memory is contained in a separate article.

Control commands

When control commands are keyed in to the computer, they will be carried out immediately — unlike 'statements', which are keyed in as part of a program and only become operative when the program is being executed. (Note, however, that when statements are keyed in without a (program) line number, they are treated as described in part 1).

When the computer prints a 'prompt' symbol, it expects further information from the user (via the keyboard). This information can be either a command or a new program line; after keying it in, the user operates the CR key (carriage return), whereupon the command is carried out (or the program line stored).

This much we knew, from part 1. It is now time to find out what commands the (BASIC) computer will recognise.

RUN

This command was introduced in part 1 of this series (page B7). As explained, once a complete program has been stored in the memory the command RUN can be given. The computer will then start to execute the current program, starting at the first line (i.e. the lowest line number).

In some cases (NIBL and the Motorola M6800 BASIC, for instance) some further 'ground-work' is done by the computer before it actually starts on the program proper. After receiving the RUN command, it first changes all 'variables' to zero and resets all 'program parameters' ('variables' and 'program parameters' will both be discussed later).

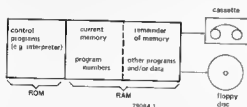

Figure 1. The various sections of computer memory.

BASIC (PART 2)

LIST

This command is similar to 'PRINT' or, more accurately, the non-existent command 'PRINT PROGRAM'. When the computer receives the LIST command, it will respond by printing out the entire current program as stored in its program memory.

Let us take the first program on page B7 (part 1) as an example. We will assume that, having typed in the program and giving the command 'RUN', we discovered that there was a mistake in the program: the intention was to add 5+7, so the answer should be 12. We therefore request the computer to print out the program: LIST. Discovering the error in program line 10, we can correct it by simply typing in the correct information; to make sure, we can repeat the LIST command; finally, a RUN command will result in the desired answer appearing. The total print-out, starting with the keying in of the incorrect program, will be as follows:



```
> 10 PRINT 5 + 6
> 20 END
> RUN
11
BRK AT 20
> LIST
10 PRINT 5 + 6
20 END
> 10 PRINT 5 + 7
> LIST
10 PRINT 5 + 7
20 END
> RUN
12
BRK AT 20
>
```

Several BASIC 'dialects' contain additional variations of the LIST command. These vary, however, from one dialect to another. In NIBL, for instance, 'LIST n' (where n is a line number) means: list the

program from line number n on - even if line number n itself is not used. An example:



```
> 10 PRINT 1 + 8
> 20 PRINT 1 + 9
> 30 PRINT 1 + 10
> 40 END
> LIST 25
30 PRINT 1 + 10
40 END
>
```

In the Motorola BASIC dialect for the 6800, however, the same command has a different meaning: LIST 30, for example, merely causes the contents of program line 30 to be printed out. Several dialects recognise a variation that is unknown to NIBL (or, for that matter, the DCE Tiny BASIC for the 8080): 'LIST n, m', where n and m are both line numbers. In this case, the print-out of the program starts at line n and terminates at line m.

PAGE

As stated earlier, the NIBL computer memory is subdivided into 'pages'. When a NIBL computer is first switched on, it automatically turns to page 2 and starts to execute the program that is stored there. This can be useful when using the computer as a 'process controller' that must get to work as soon as it is switched on. Of course, this presupposes that the information on page 2 is stored in ROMs. If it was stored in RAMs it would be lost when the computer was switched off! If the NIBL computer is not being used in this type of application, it will discover that page 2 is blank. It then automatically turns back to page 1 and prints a 'prompt' symbol.

If a program is now typed in, it will be stored on page 1. However, this may be undesirable (for instance, page 1 may be required for some other program), in which case the command 'PAGE = n' can be given*. This causes the computer to turn to page n (n = 1 ... 7) so that the program can be stored there.

In general, we can jump from any page to (the top of) any other by giving the command PAGE = n. Alternatively, a minor variation of the same command can be used: 'PAGE = PAGE + n', or 'PAGE = PAGE - n'. This is best clarified by an

* Note that the PAGE command on a NIBL computer should not be confused with the 'page' key on the Elek terminal: the latter refers to 'pages' in the memory of the terminal, not in program memory.

BASIC (PART 2)

example. Assume that the computer is presently working on page 3. 'PAGE = PAGE - 1' is then interpreted as PAGE = 3 - 1; in other words, as PAGE = 2. The computer will therefore turn to page 2. Note that, as always, the new page number must be between 1 and 7 - no other page numbers exist!

SCRATCH, DELETE, PURGE, NEW

Different dialects, different words - but the same command.

SCRATCH (sometimes abbreviated to SCR) causes the computer to erase the current program and the display. Some BASIC dialects also recognise the command 'SCRATCH ALL': in this case the entire user-programmable memory is wiped clean. 'DELETE', 'PURGE' and 'NEW' are other words used for the same command in different dialects. NIBL, for instance, only recognises the word NEW.



No matter what page is actually in use when the command NEW is given, the computer will always go to page 1 and erase this page in preparation for storing a new program. If a different page is required, this must be specified by giving the command 'NEW n'. This will cause the specified page to be erased instead, in readiness for a new program.

CLEAR

A program may require the use of 'variables' and 'stacks', as will be described later. After running the program, these may contain all sorts of information that is no longer required (intermediate results, etc.). Before running the program a second time, this information can be erased by means of the command 'CLEAR'.

SYNTAX ERROR

'There's many a slip...' - certainly when it comes to writing programs. Even when the program itself is perfect, there is always the possibility of typing errors when keying it in. The slightest mistake of this kind - printing RAN instead of RUN, say, or PRANT instead of PRINT - will make the command or statement completely unintelligible to the computer. Fortunately, it will usually recognise typing errors and print out a warning to the operator. One example of an error indicator is the phrase 'SYNTAX ERROR'

(although computers are sometimes programmed to use less polite language...).

SYNTAX ERROR' (sometimes abbreviated, as in NIBL, to SNTX ERROR) indicates 'bad language': the phrase keyed in does not exist in that particular BASIC dialect. Other error indicators also exist, as we will see; for instance, any attempt to divide by zero usually results in a very explicit warning on the screen.



... completely unintelligible to the computer ...

Editing

If (typing) errors are noticed while keying in a program, these will normally be corrected by operating the 'back space' key (←). For instance, after keying in 'PRINK', this error can be corrected by operating the back space key and then typing T. The K will be replaced by the T, and the correct phrase (PRINT) will be stored in the memory. Similarly, if one forgets to use capitals, this can be corrected by operating the back space key as often as necessary to return to the beginning of the word: pri ← ← ← PRINT.

Alternatively, as described earlier, a complete program line can be corrected by again typing the same line number, followed by the correct information. Similarly, a complete line can be deleted by typing in the line number followed by CR (carriage return).

Most BASIC dialects include other editing facilities, but the exact details are usually dictated by the type of keyboard used. NIBL, for instance, includes the command 'CONTROL/U' - i.e. the Control and U keys are depressed simultaneously. In this case, the 'current line' (the line being typed at that moment) is erased from the display - but not from the program memory. This facility is particularly useful if the wrong line number has been keyed in: the error can be corrected without losing instructions already stored under that line number in the memory.

Spacing

When typing in programs, it is often useful to add spaces here and there - between statements, for instance. Although the computer hasn't the faintest idea what they mean and will normally



BASIC (PART 2)

ignore them, it does store them in its memory and will print them out when requested to 'LIST' the program.

The main reason for adding spaces, therefore, is simply to make the program 'legible' for the operator. However, there are a few places where spacing is forbidden:

- within words that are part of statements or commands. For instance, PR INT is wrong, it must be PRINT. However, PRINT5 and PRINT 5 are both permitted.
- within numbers (including line numbers). The program line '150 PRINT 2500' is correct, but '1 50 PRINT 2500' and '150 PRINT 2 500' are both wrong. It should be noted, however, that '150 PRINT "2 500"' is correct: the computer isn't interested in the text between quotation marks, and simply prints out what it finds there.

Some other cases where spaces are forbidden will be dealt with as we come to them.

On the other hand, some BASIC dialects demand correct spacing in one or two places; for example, before and/or after statements or commands. This will not normally be a problem: one will normally add spaces at these points in the interest of legibility! For example (and using a few statements that will be described in part 3, just to add to the confusion!), the following would be almost unintelligible:

```
10 IFA = BLETA = B - C
```

However, adding a few spaces turns it into what is almost 'plain English':

```
10 IF A = B LET A = B - C
```

As a final note: if one space is permitted, more than one are also allowed. In the above example, say:

```
10 IF A=B LET A=B-C
```

Numbers

In BASIC, numbers can be written in the usual way. There are, however, a few points that should be noted.

Whole numbers (integers)

Numbers that do not include fractions are referred to, quite logically, as 'whole' numbers (for integers). 23 is a whole number, 23.1 is not. Numbers can be either positive or negative. If they are positive, they may be preceded by a '+' sign; negative numbers must be preceded by a '-' sign. As mentioned earlier, no spaces are permitted within numbers. A few examples:

Correct: 3, +3, +123456789, -3, -567.

Wrong: 123 456.

Fractions (reals)

More properly, decimal fractions: numbers that include a decimal point. As before, '+' and '-' signs may or must be included, respectively. Several BASIC dialects get confused by a leading zero before the decimal point: .38 is alright, but 0.38 is not. Once again, a few examples:

Correct: 2 2, +1.23, -55.5, - 44

Wrong: 2%, -%.

NIBL doesn't recognise the decimal point, so that only whole numbers can be used. Any attempt to include a decimal point will be rewarded by the print-out 'CHAR ERROR' (from 'character error').

Number range

In most BASIC dialects, the maximum number of digits in a number is nine - not including the '+' or '-' sign and/or decimal point. For instance: -123456.789. The largest number that can be written in this way is 999999999; the smallest (positive) number is .000000001.

The number range in NIBL is rather more limited: only (whole) numbers between -32767 and +32767 are permitted. These limits are not as arbitrary as they may appear at first sight: they correspond to the largest number that can be written in a 16-bit binary system. If a larger number is keyed in, the computer will respond with the warning 'VALU ERROR' (from 'value error'). For instance:

```
> PRINT 44253
VALU ERROR
>
```

Scientific notation

In some cases, the range of numbers outlined above may prove too limited. For this reason, many BASIC dialects also include an extension facility: 'scientific notation', also known as 'E numbers'. Basically, this consists of a normal number, followed by the letter E and then two more digits.



These last two digits determine how many places the decimal point is shifted to the right (positive number after the E) or to the left (negative number after the E). In other (mathematical) words, the number is multiplied by a power of ten, as defined by the two-digit number. A few examples may serve to clarify this:

4.35E5 = 435000

1234 5E-3 = 1.2345

Regrettably, this type of notation is not possible in NIBL.

Numerical accuracy

The accuracy with which a computer deals with numbers (e.g. when storing them in memory or when performing calculations) depends both on

BASIC (PART 2)

the interpreter and on the computer itself. Normally speaking, the accuracy will be somewhere between 5 and 7 digits; any larger number of digits will be 'rounded off'. In other words, the number 123456789 may be rounded off to 123450000, 123456000 or 123456700.

Arithmetic

Five arithmetical operations are defined in BASIC: +, -, *, /, and ^ (power). Their meaning is listed in table 1, together with some examples.

Table 1.

operation	example	result	explanation
+	3 + 5	8	addition
-	3 - 5	-2	subtraction
*	3 * 5	15	multiplication
/	6 / 2	3	division
^	2 ^ 3	8	involution (raising to the n th power)

When several operations are included in the same formula, they are performed in the well-known order: first involution, then multiplication and/or division, and finally addition and/or subtraction. For example, 6 + 4/2 would be calculated as follows:

$$4/2 = 2; 6 + 2 = 8.$$

If the addition (or subtraction) is to be performed first, this must be indicated by including this operation in brackets. (6 + 4)/2 is calculated as follows:

$$6 + 4 = 10; 10/2 = 5.$$

Comparisons

Numerical comparisons, such as 'is A greater than or equal to B', are often required in programs. The various comparison symbols used in BASIC are listed in table 2, together with a few examples. As can be seen from this table, the result of a comparison can be only one of two things: true ('1') or false ('0').

Table 2.

symbol	meaning	example	result
=	(A) equals (B)	3 = 4	false (0)
<> or ><	(A) does not equal (B)	3 <> 4	true (1)
>	(A) is greater than (B)	3 > 4	false (0)
<	(A) is smaller than (B)	3 < 4	true (1)
>= or >=	(A) is greater than or equal to (B)	3 >= 4	false (0)
<= or <=	(A) is smaller than or equal to (B)	3 <= 4	true (1)

In those cases where two possible symbols are shown (e.g. <> or >< for 'does not equal') NIBL uses the first of these alternatives, as shown in the examples.

In most BASIC dialects, including a space between the two parts of one symbol is not permitted. For instance, >= should not be typed as > =.

Variables

A variable is quite simply a name, or 'token' to

which a numerical value can be attached, POWER, say, or A5. The use of variables can be illustrated with an example. Let us assume that we want to calculate the maximum output current (I) of some circuit, and that this current depends on the supply voltage (U) and some load resistance (R) as follows:

$$I = \frac{U}{2R}$$

It is not difficult to write a suitable program:

```
> 10 PRINT U/2*R
```

```
> 20 END
```

In this program, U and R are variables. After giving them numerical values — for instance, U = 10 (volts) and R = 5 (ohms) — the program can be started by giving the RUN command and the correct result will be typed out. The complete print-out, including a minor sophistication added on program line 15, will be as follows:

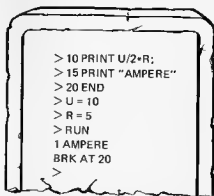

The advantage of using variables is that new calculations can be performed for different values of the variables, without having to rewrite whole sections of the program. The print-out given above could be continued, from the line immediately following 'BRK AT 20', as follows:



At this point it should be noted that the program example given above will not run correctly on all computers. The reason is that, in some BASIC dialects, the RUN command causes all variables to be reset to zero before the program is started. This is useful, in that it eliminates the risk of accidentally running a program with 'old' values for the

BASIC (PART 2)

variables; however, it also means that variables can only be assigned values within the program — not beforehand. This can be accomplished quite easily by adding as many program lines as required before the first program line of the program proper; in the above example, for instance, and adding a LIST command to check the program before running it:

```

> 5 U = 2000
> 6 U = 2
> LIST
5 U = 2000
6 R = 2
10 PRINT U/R-2;
15 PRINT "AMPERE"
20 END
> RUN
500 AMPERE
BRK AT 20
>
  
```

In these program examples, the letters U and R were chosen as 'tokens' for the variables. A few BASIC dialects permit the use of several letters for a token: POWER, say, or ALPHA. In most cases, however, only one letter is permitted, followed (if required) by a single digit. In other words, variables can be correctly named A, D, D1, Z9 — but AZ, G12 etc. are not allowed. In this way, up to 286 different variables can be 'named'. In larger programs, so many may in fact be used that one can easily forget what each 'name' stands for. This can be extremely awkward: the computer won't give any warning (it doesn't know that its operator is getting confused...), so the program will run normally — the only trouble being that the results are all wrong!

To avoid this type of problem, it is advisable to make a list of all the variables used, with their 'token' and true meaning. A systematic list like that shown in figure 2 is usually the best.

When using NIBL, this type of confusion is less likely to occur: the only 'names' permitted are the 26 letters of the alphabet.

The type of variables discussed so far are sometimes referred to as 'simple numerical variables'. A second type also exists: so-called 'string variables', where the variable does not represent a number, instead, it represents a 'string' of characters (letters and numbers). This group will be discussed later.

LET

LET is a so-called assignment statement: it is used to 'assign' a certain value to a variable. In the

Figures 2. It is advisable to keep track of the variables already used, by listing their 'true' meaning in a table of this type.

A	A0	A1	A2	A3	A4	A5	A6
B	B0	B1	B2	B3	B4	B5	B6
C	C0	C1	C2	C3	C4	C5	C6
D	D0	D1	D2	D3	D4	D5	D6
E	E0	E1	E2	E3	E4	E5	E6
F	F0	F1	F2	F3	F4	F5	F6
G	G0	G1	G2	G3	G4	G5	G6
X	X0	X1	X2	X3	X4	X5	X6
Y	Y0	Y1	Y2	Y3	Y4	Y5	Y6
Z	Z0	Z1	Z2	Z3	Z4	Z5	Z6

79084 Z

previous program examples, this was done by keying in 'U = 2000', for instance. Although most BASIC dialects tolerate this (mis-)use of the '=' sign, it is not the 'official' way to give a numerical value to a variable. It is more correct to use the LET statement. The complete instruction is then keyed in as follows: first 'LET'; then the 'name' of variable; then the '=' sign; and, finally, the 'expression' — i.e. the (numerical) value or operation that the variable must be made equal to. A few examples:

```

LET A = 15
LET A = B
LET A = 3 + 4
LET A = B + C
  
```

As illustrated, one variable may be made equal to another — or to some mathematical operation in which other variables are included. Even more surprisingly, perhaps, the same variable may appear on both sides of the '=' sign! For example:

```
LET A = A + 1
```

In this case, the new value for the variable (A) is derived from the previous one. If the value was 4, say, this instruction will change it to 4 + 1 = 5. Some BASIC dialects (not including NIBL) offer the possibility to assign a value to several variables simultaneously. The instruction

```
LET A = B = C = 15
```

will cause all three variables (A, B and C) to assume the value 15.

In most BASIC dialects, use of the word LET is optional; in other words, it is 'unofficially' permissible to write 'R = 5' instead of 'LET R = 5'. This abbreviated form is also recognised in NIBL.

More about PRINT

The PRINT statement was introduced in part 1. Let us briefly sum up the possibilities discussed so far:

BASIC (PART 2)

PRINT "5 + 6 ="

In this case, the text included in quotation marks is printed exactly as it stands: 5 + 6 =.

PRINT 5 + 6

The 'expression', i.e. the mathematical operation, that follows the PRINT statement is first carried out and the result is then printed: 11.

PRINT

Since no text or operation follows the PRINT statement, nothing is printed on the corresponding line. Effectively, therefore, a one-line gap is left in the print-out.

Normally, a PRINT statement is automatically followed by CR and LF (Carriage Return and Line Feed). If required, these can be suppressed by adding a semi-colon between PRINT statements:

10 PRINT "TOM"; "DICK"; "HARRY"

20 PRINT "TOM";

21 PRINT "DICK";

22 PRINT "HARRY"

The print-out obtained from program line 10 is the same as that from the other three lines taken together: TOM, DICK and HARRY are printed on the same line.

At this point, one further possibility of the PRINT statement can be explained: use of a comma between PRINT statements:

PRINT 121, 122

The result is that the various 'texts' are printed in so-called zones — equivalent to tabulation on a typewriter. A standard zone contains 15 characters, so that in the example given above '121' is printed at the beginning of the line and '122' in the 16th, 17th and 18th positions. The length of a line is 72 characters, so it contains just less than five zones (more accurately, the fifth zone consists of only 12 characters). Use of zones can be extremely useful when printing tables.

Use of the comma for printing in zones is not possible in NIBL.

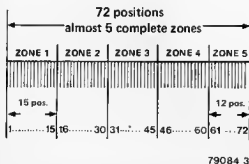

Figure 3. Within a PRINT statement, commas can be used to divide the print-out into so-called zones.

Questions

- Why is an interpreter program rarely stored in RAM?
- What is the effect of the SCRATCH command?
- When is a CLEAR command used?
- What errors are contained in the following program lines?
 - 150 LI ST 5
 - 1 0 PRINT 18
 - 160 PRINT CHAIR
 - 170 PRINT 1253 14
 - 190 LET A = 0.31
 - 200 PRINT 4 35E1.2
- What are the results of the following calculations:
 - 3-2+8+15/3
 - 17-24/3/2
- What error is contained in the following statement:

```
LET A15 = 12
```

Answers to questions in part 1.

- Tiny BASIC is a simplified version of 'standard' BASIC; for this reason it is less versatile. Tiny BASIC is intended primarily for microprocessors; however, the modern tendency is toward 'standard' BASIC for all applications.
- Tiny BASIC is often used for microprocessors since the necessary interpreter program requires less memory space.
- The main difference between a compiler and an interpreter is that the latter translates programs line for line and causes the instruction to be carried out immediately, whereas a compiler first translates the entire program.
- The advantages of an interpreter are that it requires less memory space (since the translation does not have to be stored in memory) and that certain programming errors are indicated immediately. The disadvantage is that parts of the program that are used several times within the program have to be re-translated every time. This takes up more computer-time.
- The various BASIC 'dialects' are tailored to suit particular microprocessors, in an attempt to shorten the corresponding interpreter programs as much as possible.
- A flow chart is an important aid when developing a program; furthermore, at a later date it helps to gain rapid insight into the program.
- A prompt is a character, printed out by the computer to signify that it is waiting for further information from the keyboard.
- The program lines are numbered to indicate (to the computer) in what order they must be carried out.
- Operating the CR key indicates the completion of the preceding instruction or command; simultaneously, it initiates 'Carriage Return' in the print-out.
- The computer will print the result of the operation, i.e. 12.

BASIC (PART 2)

Summary of symbols, statements and commands used in part 2.

RUN	This command causes the computer to execute the program.	
LIST	This command initiates a print-out of the program.	
LIST n	The program is printed out from line n.	
LIST n,m	The program is printed out from line n to line m.	
PAGE n	This command (in NIBL) causes the computer to jump to page n, redefining the computer to store (or modify) a program there.	
SCRATCH, DELETE, PURGE, NEW	These commands cause the program memory to be erased. This command (in NIBL) erases page n in the memory, preparatory to storing a new program.	
NEW n		
CLEAR	This command can be given before re-running a program. Indicates that an error has been made in the BASIC language used.	
SYNTAX ERROR SNTX ERROR	Indicates that a character is being used in a place where it is not permitted.	
CHARACTER ERROR CHAR ERROR		
VALUE ERROR VALU ERROR	Indicates that a number is too large, or consists of too many digits.	
←		
E	Backspace. This key is used when correcting keying errors.	
	Symbol used in scientific notation. The number following the E defines the number of places over which the decimal point must be shifted.	
+	addition	} mathematical operations
-	subtraction	
*	multiplication	
/	division	
↑	involution	
=	equals	} comparison symbols
<> or ><	is not equal to	
>	greater than	
<	smaller than	
> or = >	greater than or equal to	
< or = <	smaller than or equal to	
A...Z A1...Z9 LET	} 'names' of variables	
LET		
	Statement, by means of which a value can be assigned to a variable.	
PRINT "TEXT"	This statement causes the text included in quotation marks to be printed out.	
PRINT 2A + 3	The expression following 'PRINT' is carried out and the result is printed.	
PRINT ...;...;	The semi-colon can be used to separate groups of symbols and/or expressions to be printed. A semi-colon at the end of the statement causes a following PRINT statement to be carried out on the same line.	
PRINT ...,,...	By using commas, the print-out can be divided into 'zones'.	

GLOSSARY (PART 2).

assignment statement

Instruction to give a variable some (numerical) value; for example: LET A = 1.

control command

Instruction that is carried out immediately, not as part of a program.

current line (program)

The program line (or program) that is being keyed in at that moment.

editing

Entering and correcting programs (via the keyboard).

error indication

Some programming errors can be detected by the computer, in which case it will print out a warning.

floppy disc

Flexible magnetic disc, used to store large amounts of information.

integer

A whole number, without (decimal) fractions.

listing

After receiving a LIST command, the computer will print out the current program. This print-out is called a listing.

page

Subsection of memory in a NIBL computer.

RAM

Random access memory: a section of memory in which data can be stored as required.

ROM

Read only memory: a section of memory in which data has been stored during the manufacturing process. This data cannot be erased.

simple numerical variable

A variable to which a numerical value can be assigned; this value can be altered, as required, while the program is running.

string variable

A variable to which any group of characters can be assigned — a word, for instance.

variable

A 'name' or 'token', to which a number or group of letters can be assigned. See: simple numerical variable and string variable.

nasty shock if they touched the pins on the plug-top.

A 10 V zener diode limits the amplitude of the half-wave rectified power signal and this is then buffered by smoothing capacitor C2 before being fed into voltage regulator IC1. The output of this 78L05 provides the 5 V needed to supply the circuit. Two EXOR gates, N1 and N2, make up the clock oscillator we mentioned when describing the block diagram. The frequency of oscillation, with the values stated here for R2 and C7, is about 2 Hz but this may vary depending on the source of IC2. Changing the frequency is quite simple as its magnitude is roughly $1/(2RC)$. The clock signal is applied to pins 1 and 9 of a double four-bit static shift register. These two registers are cascaded to form a single eight-bit shift register, with the eighth bit supplying the control signal for the LED. The purpose of this is to form a noise generator. Two bits from the second shift register are fed back to the D input of the first register via an EXOR gate so that the final effect is that the signal output at Q7 has the form of a pseudo mains noise. When the power is first applied to the circuit the section based on N3 automatically resets the second shift register to zero by taking its D input high. Initially N3 functions as an inverter but after a delay introduced by the RC time of R3 and C5 it becomes a

1

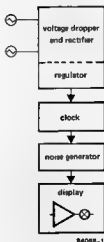

burglar deterrent

Figure 1. This circuit is totally unlike any normal burglar alarm, but this is hardly surprising as it is intended as a deterrent, no more and no less.

non-inverting buffer. From then on the information from IC3a's highest output (Q3) is passed straight via pin 7 to the first register of IC3b. With each successive rising edge of the clock signal the data is shifted one place to the right. The same effect is seen with the information transmitted via N4 to pin 15 of IC3. Every 128 clock periods the pseudo mains noise generation cycle repeats itself. This cycle

2

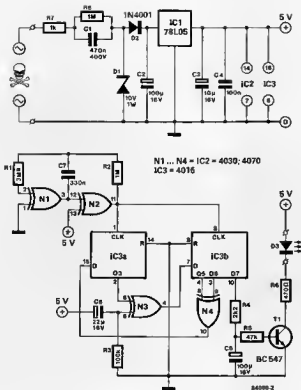

Figure 2. Although we hope this circuit will protect your valuables there will be no need to hook anything to pay for the components. This low cost means that several of these deterrents can be built and placed at strategic points in your home.

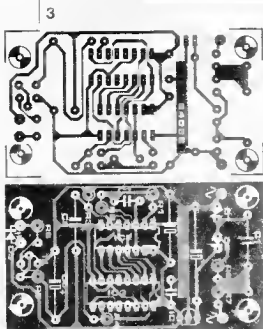

Figure 3. Building this circuit should cause no problems using the printed circuit board design given here. The photograph at the bottom of this page will also be of assistance.

Parts list

Resistors:

R1 = 3M Ω
 R2, R8 = 1 M Ω
 R3 = 100 k Ω
 R4 = 2k Ω
 R5 = 47 k Ω
 R6 = 100 Ω
 R7 = 1 k Ω

Capacitors:

C1 = 470 n/400 V
 C2, C8 = 100 μ /16 V
 C3 = 10 μ /16 V
 C4 = 100 n
 C5 = 22 μ /16 V
 C7 = 330 n

Semiconductors:

D1 = zener diode,
 10 V/1 W
 D2 = 1N4001
 D3 = LED, red
 T1 = BC547
 IC1 = 78L05
 IC2 = 4030
 IC3 = 4015

time is slightly longer than a minute, which should be quite sufficient as we would not expect any would-be housebreaker to stay around long enough to notice the repetition.

The pseudo noise signal is applied to integrator R4/C6 where it is 'smoothed' somewhat. In this way the transistor (T1) conducts and the LED's light waxes and wanes rather than flashing violently.

Construction

It is a simple matter to assemble the burglar deterrent on the printed circuit board shown in figure 3. As usual we recommend that good quality sockets

should be used for IC2 and IC3. Note that all resistors and diodes are mounted vertically and that capacitor C1 should be fitted last. As part of the board carries mains voltages the case used must be made of plastic. Before locating the integrated circuits in their sockets check that the supply of +5 V is present on pins 14 and 16 of IC2 and IC3 respectively. If this is correct all that remains is to fit the ICs and close the case. Plug the circuit into a mains socket and the LED should light to show that the deterrent is working.

Using the burglar deterrent

The burglar deterrent is put into service by plugging it into the mains. Probably the most important point in this respect is where it is placed. A suitable location must be chosen so that any would-be housebreaker will see the LED flashing and assume that he has been detected. The impression can be heightened by making a suitable front panel for the case. Let your imagination run wild — that is what the burglar is supposed to do. If the LED does not seem to be striking enough it can also be replaced (together with resistor R5) by a small 6 V/50 mA bulb painted red. Possibly the idea of having 240 V present on the printed circuit board does not appeal to you. If this is the case the section consisting of R7, R8, C1, D1 and D2 may be replaced by a mains transformer rated at 8 V/100 mA and a bridge rectifier (or four 1N4001 diodes).

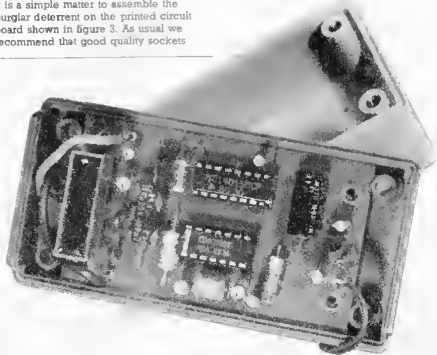

The direct-coupled modem featured in last month's issue of *Elektor* provides a new (for us) and very important application for the RS232/V24 norm. It is unlike any demands we have made of this protocol before as it makes use of a number of auxiliary control signals that have rarely been needed in *Elektor* circuits up to now. This means that they are less familiar to us than the normal signals. For that reason we decided to have a close look at the CCITT recommendation and along the way we will see why, when this is a serial 'interface', so many lines are needed.

The RS232/V24 standard is seen as the original serial interface. It was introduced to define a specific connection, namely that between terminals and modems. In the words of the CCITT (Consultative Committee for International Telegraph and Telephone) it is intended "for interchange between data-terminal equipment and data circuit-terminating equipment". To avoid becoming too 'wordy' a number of abbreviations will be used. The most common are: DTE (Data Terminal Equipment) for the two interfaced 'machines' that produce and/or process the information (computer, terminal, etc.); DCE (Data Circuit-terminating Equipment) for the interfaced equipment that transmits or receives information but does not process it. This latter is the modem (Modulator/DEModulator), which is sometimes referred to as the data set.

It is clear that using the RS232/V24 between two computers, or between a computer and a printer, if that is possible, is a departure from its original purpose. The specific signals needed for communication between a terminal and a modem will, of course, be completely different to those required when a computer wants to drive a printer.

The electrical characteristics of the RS232/V24 and the pin-out of its 25-pin connector are not repeated here. They have already been dealt with in detail in *Elektor*, most recently in the May 1984 issue (page 6-59), and on infocard 64.

RS232/V24 is a standard for interfacing a modem to data processing equipment

An RS232/V24 interface will be found at each end of a telephone line used for communication between two DTEs. At one side it is between the data transmitting computer (or terminal) and its modem and at the other end it is located between a second modem and the data receiving computer or terminal.

Data connections to a modem are bidirectional and much more complex than the one way lines needed with printers or VDUs. Furthermore the data is fed into the telephone network so there is a whole battery of protocol signals with clearly defined functions. This makes it possible to automate the processes of accepting a call, making a call, replying to requests

RS232/V24: the signals

and even choosing a transmission rate. The format of the signals and the number used depends on the options chosen. Possible choices are: one-way or two-way communication, with or without verification, synchronous or asynchronous, automatic call or answer, and so on.

A look at all the signals recommended by this standard

CCITT	Function	DTE	DCE	
102	Signal ground or common return	↔	↔	ground
102a	DTE common return	↔	↔	
102b	DCE common return	↔	↔	
103	Transmitted data	→	→	data
104	Received data	←	←	
118	Transmitted backward channel data	→	→	
119	Received backward channel data	←	←	
105	Request to send	→	→	control (condition)
106	Ready to send	←	←	
107	Data set ready	→	→	
108/1	Connect data set to line	→	→	
108/2	Data terminal ready	→	→	
109	Data channel received line signal detector	←	←	
110	Data signal quality detector	←	←	
111	Data signalling rate selector (DTE)	→	→	
112	Data signalling rate selector (DCE)	→	→	
116	Select standby	→	→	
117	Standby indicator	←	←	
120	Transmit backward channel line signal	→	→	
121	Backward channel ready	←	←	
122	Backward channel received line signal	←	←	
123	Backward channel signal quality detector	←	←	
124	Select frequency groups	→	→	
125	Calling indicator	→	→	
126	Select transmit frequency	→	→	
127	Select receive frequency	→	→	
129	Request to receive	→	→	
130	Transmit backward tone	→	→	
132	Return to non-data mode	→	→	
133	Ready for receiving	←	←	
134	Received data present	←	←	
140	Loopback/Maintenance Test	→	→	
141	Local loopback	→	→	
142	Test indicator	→	→	
191	Transmitted voice answer	→	→	
192	Received voice answer	←	←	
113	Transmitter signal element timing (DTE)	→	→	clock
114	Transmitter signal element timing (DCE)	→	→	
115	Receiver signal element timing (DTE)	←	←	
128	Receiver signal element timing (DCE)	←	←	
131	Received character timing	←	←	



Figure 1. This is the procedure for a call, whether it is manual (when the user dials the number) or automatic (ACU). The ringing is detected by the receiving modem, which then signals the DTE by activating the CIN line.

Figure 2. The DTE in the transmitting station tells the modem to prepare to transmit (RTS) and then, when it receives the RFS reply, it transmits the data (TMD). The modem in the receiving station signals to its DTE when it detects the carrier.

All the RS232C/V24 signals are listed in table 1. The numbers indicated represent what the CCITT refers to as circuits (by which they mean lines or signals). Data and ground lines require no explanation so we will not deal with them here. Circuits 118 and 119 (back channel) are effectively dealt with by the two modem articles, in the last two months' issues. The other signals (for control, state and clock) are regrouped here according to their functions.

Unit ON, incoming call, automatic answering ON

The signals used are:
 DSR (Data Set Ready)
 CDSL (Connect Data Set to Line)
 DTR (Data Terminal Ready)
 CIN (Calling Indicator)

In the case of communications via the telephone network the unit that makes the call must first get a line: this can be done manually (by the operator or user) or automatically (Automatic Calling Unit), as can the answer. If the call is not made automatically the modem must receive a

CDSL signal. It then connects to the telephone line and indicates that it is ready to transmit by activating the DSR line. For its part the terminal must indicate that it is primed for action by activating DTR. The DTE + DCE unit that initiated the call is then ready and simply waits for an answer.

If the unit that is called has a bell detector its modem activates the CIN line and its DTE reacts with the CDSL signal. When the call is accepted this modem activates its DSR line to let its DTE know that the connection has been made. This procedure is summarised in figure 1. The automatic call unit (ACU) should conform to V25, which recommends a specific protocol. As that is a different norm we will not deal with it here.

When the physical connection between the two modems has been made the data transmission procedure can begin. No matter how the connection was made the DTR and DSR signals at both ends of the line should be active. One unit is then ready to transmit, the other to receive.

Transmitting the data

While data is being transferred, during which time we assume that CDSL, DTR and DSR are active, the following signals are the ones that interest us:

TMD (Transmitted Data)
 RCD (Received Data)
 RTS (Request To Send)
 RFS (Ready For Sending)
 DCD (Data Carrier Detector)

The actual serial data travels on RCD and TMD between DTE and DCE at each end of the line (see figure 2). Between the two units, on the actual telephone line in other words, data can only travel in one direction at a time. Two different modes of communication are possible: duplex and half-duplex (or simplex, as the CCITT call it). Half-duplex communication is strictly one-way. When a modem has finished transmitting data it must immediately remove its carrier from the line to give the second modem a chance to transmit its answer.

The transmitting modem is started by means of the RTS signal given by its DTE. In half-duplex mode this signal automatically blocks the modulator in the DCE at the other end of the line. When the carrier is present the transmitting modem activates the RFS line (also called Clear To Send) to let its DTE know that it is ready to send data. When the carrier is detected by the DCE demodulator this is immediately signalled to the receiving DTE by making the DCD line high.

Transmission of data can start (TMD) as soon as the RFS line is active. The data appears on the RCD line and is demodulated by the receiver modem.

In duplex mode the carrier is not removed after the data has been sent. The difference between duplex and half-

duplex modes is more than simply a matter of protocol between modems. The mode used must be agreed, either verbally or by means of a program, before transmission of data can start.

Synchronization and time bases

The signals mentioned up to now can only be used for communication between asynchronous modems. Each has its own clock and synchronization is achieved by means of start and stop bits that precede and follow each character. Synchronous modems, on the other hand, use the following signals:

TSET (Transmitter Signal Element Timing)

RSET (Receiver Signal Element Timing)

These signals allow the modulator and demodulator clocks to be synchronized. Also present is a circuit to change the baud rate (DSRS). This is generally used if the transmission is very noisy, whereby a lower baud rate may be temporarily selected.

The STF (Select Transmission Frequency) and SRF (Select Reception Frequency) signals are used by duplex modems to decide the frequencies used by main and back channels. If one of these uses the upper frequency band the other automatically uses the lower band.

This leads us to the signals that relate to the back channel. Their functions are identical to those of their main channel counterparts. Apart from the data transmission and reception lines (Transmitted Backward Channel Data and Received Backward Channel Data) there is TBCS (Transmit Backward Channel) line Signal) to start back channel transmission, the corresponding reply when the DCE is ready (BCR - Backward Channel Ready) and the carrier detector on the back channel, BCRS (Backward Channel Received Signal). These three signals are seen in figure 3.

The other circuits

In addition to the signals already mentioned there are some that are less frequently used. Both the main and the back channels have a signal to indicate the quality of the modem's transmission when no distortion is noted. There is a mode changer and indicator (standby), a selector for the frequency groups, a Request To Receive signal, a back carrier selector and some test signals whose use is obvious. These latter are circuits 140...142, which allow the quality of the transmission to be tested by looping together either the local unit (DTE + DCE) or the two units via the telephone line (DTE + transmitter DCE and receiver DCE). The three connection possibilities are indicated in figure 4.

3

RS232C/V24 the signals

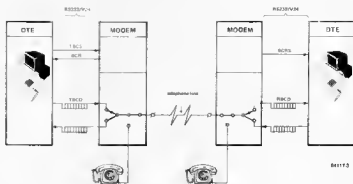

4

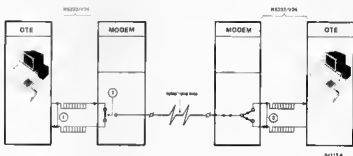

Many of the signals we have been talking about are for control or indication of a condition so it is worth noting that a control circuit must have a voltage of at least 3 V if it is active (on). Anything less than this and the circuit is inactive. In the case of data lines, on the other hand, a logic 1 is indicated by a voltage lower than -3 V and a logic 0 by a voltage greater than +3 V. These are the V24 recommendations so it might be wise to check that all the equipment used conforms to these norms before placing too much trust in them.

Figure 3. The back channel is brought into operation by the TBCS and BCR signals. The modem in the receiving station signals the presence of the back channel carrier to its DTE and sends it the data received on this channel (RBCKD).

Figure 4. Certain specific signals recommended by the V24 norm allow verification loops to be set up. These possibilities are available, namely the local interface, the local line, and the telephone line and receiving modem.

use your TV-receiver
as a monitor

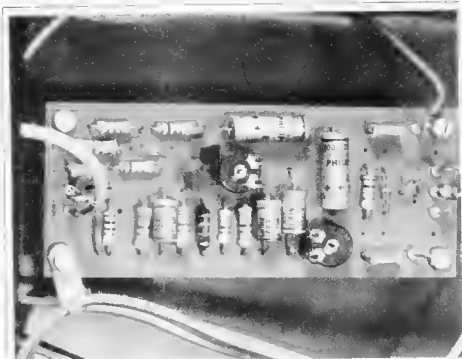

from an idea
by C.G. Mangold

If you have a modern television receiver that is not only suitable for remote control, but is also fitted with a video input, there is no need to read this article! However, if you want to convert a second or perhaps your portable TV receiver into a monitor, the versatile amplifier described here could be what you have been waiting for!

use your TV receiver as a monitor . . .

. . . with this
versatile
amplifier

Most television receivers cannot be controlled by an external video signal: only those fitted with an A/V (audio/video) or SCART connector (see *Elektor India*, October 1984 issue) can.

Right from the outset we must tell you that if your television receiver is not fitted with an isolating mains transformer (the most likely case), it should be as a first priority. An isolating transformer can be installed in most sets immediately after the mains on/off switch (see figure 1).

A second prerequisite is a full circuit diagram of the TV receiver; without that you cannot proceed. Many sets are pro-

vided with one nowadays, but if you have none, you should be able to get it from your local dealer or the manufacturer's service/spares department.

Video output

Although monitors normally only have a video input, an output may prove very useful, as may be seen from figure 2. Here, the output of the demodulator in the TV receiver is taken via the video output to the video colour inverter featured in our November 1984 issue in an experimental set-up. If you use this set-up for your own experimental work, note that the 100-ohm preset is imperative to attenuate the signals into the video inverter; furthermore, it is advantageous to use an amplifier between the output of the inverter and the video input of the TV set. This amplifier may either be the present one, or that described on page 1-30 of our January 1984 issue. Before you can start experimenting, it is necessary to make a small modification in the TV set as shown in figure 3. This consists of breaking the connection between

Figure 1. This is how an isolating transformer is connected. In most cases it may be fitted near the mains on/off switch in the TV set.

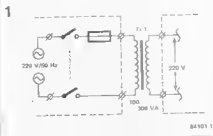

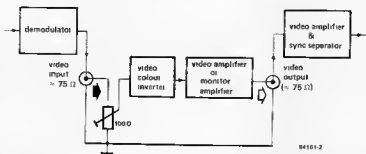

use your TV-receiver
as a monitor...

Figure 2. An example of where a video output is required: the video signal is applied to the video colour inverter and then back into the set, possibly via an amplifier.

the demodulator and the video amp/sync separator. The modular construction found in most modern TV receivers makes it easy to find this connection.

The signal level at this point should be 2...3 V_{pp}. The break in the video signal path will affect the AGC (automatic gain control) setting in the u.h.f. tuner. This may be noticeable from either a deterioration in the picture quality or even a complete absence of signal. It is therefore necessary to establish for certain whether the ACC is affected or not. If it is not, the ACC connection to the u.h.f. tuner and i.f. amplifier can remain, but if it is, the ACC connection should be broken as shown and replaced by Manual Gain Control P1 via switch S. The gain must then be set separately for each transmitter owing to differences in field strength. Fortunately, this situation is likely to arise only in older black-and-white sets.

It is quite easy to fit the video output socket onto the inner back cover of the TV set. The d.c. voltage onto which the video signal is superimposed serves to set the operating point of emitter follower T1 (see figure 3). The video signal proper is

applied to the BNC (or jack) socket via C3 and R5. If its amplitude is greater than 3 V_{pp}, it must be attenuated to that level by P4. This preset is normally so adjusted that the emitter of T1 is connected direct to C3. The signal at the base of T1 should be not greater than 6 V_{pp}. The power supply for T1 must be taken from somewhere inside the TV set: the u.h.f. tuner normally works from 12 V so that a suitable supply can almost certainly be taken from this unit.

Video input

We have now come to the heart of the matter. A TV receiver can only be used as a monitor if it is fitted with a video input. A basic circuit for this is given in figure 3: if this is adequate for your purposes, all well and good, but most of you will probably have set your sights a little higher. First, let's have a look at the basic circuit of the amplifier in figure 3. The transistor amplifier has two tasks: (a) to raise the video signal to the required level, (which is set with P3), and (b) to superimpose the video signal onto the appropriate d.c.

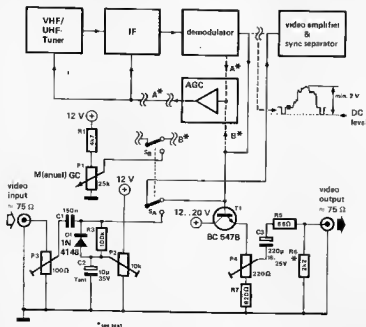

Figure 3. Schematic of a television receiver with a simple video input and output. The block diagram shows where the video signal lines should be cut. Instructions on the application of the two versions of the circuit are given in the text.

use your TV-receiver as a monitor...

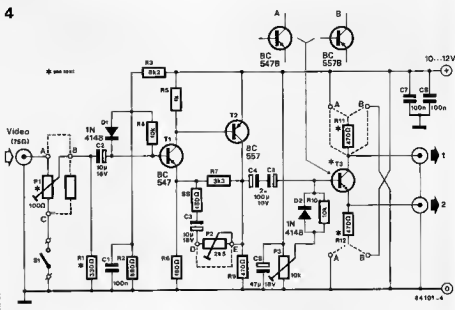

Figure 4. The circuit of the monitor amplifier may be built in so many ways that it is suitable for all possible situations. The various versions are explained in the text.

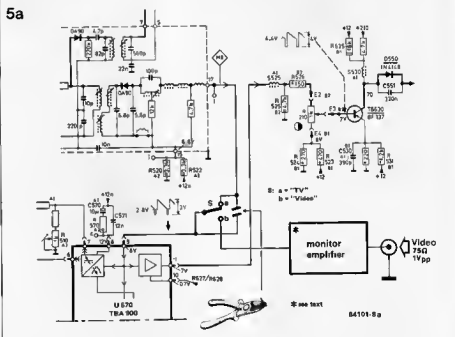
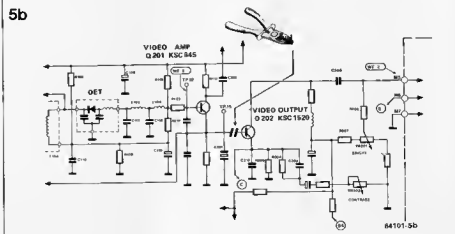
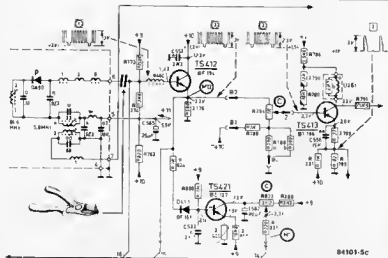

Figure 5. Examples of application of the monitor amplifier in black-and-white or colour television receivers. Explanations are given in the text.



5c



use your TV-receiver
as a monitor ...

voltage which determines the level of the line sync pulses and is also used to bias T1. The d.c. level is set by P2: in this amplifier to 12 V.

The requirements of a fairly sophisticated, universally usable video amplifier may be summarized as follows:

- input impedance about 75 ohms;
- suitable for use with video signals above and below 1 V_{pp};
- adjustable d.c. and a.c. levels;
- output signal amplitude (normal and inverted) up to about 8 V_{pp};
- output stage should be usable with the multitude of video amplifiers found in TV sets.

All these requirements are met by the circuit given in figure 4. The parallel connected input resistors P1 and R1 ensure an input resistance of at least 75 ohms and not more than 100 ohms (with S1 closed).

5d

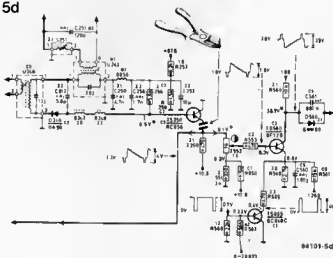

5e

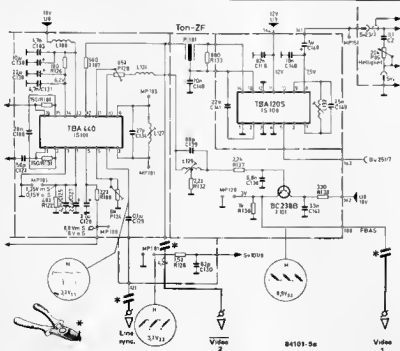

Table 1

version	normal	inverted	with collector resistor	without collector resistor
A	-	-	0 8 V (emitter of T3) (2)	0 10 V (emitter of T3) (2)
		x	6 12 V (collector of T3) (1)	
B	-	-	6.5 10 V (emitter of T3) (2)	2 10 V (emitter of T3) (2)
			2 6 V (collector of T3) (1)	

Table 1. D.C. levels in the two versions of the monitor amplifier.



Figure 6 A modified circuit of a video amplifier for type TX television sets. The BF869 (or equivalent) must be mounted on a heat sink!

Preset P1 allows attenuation of too large input signals, while too small input signals are amplified by T1/T2 (gain presettable with P2). The maximum output level this amplifier can provide is about $8 V_{pp}$. The amplitude of the a.c. output signal is determined by the setting of presets P1 and P2, while the level of the d.c. voltage depends on the setting of P3 and clamping diode D2. Values obtained in our prototype are given in table 1: the setting limits are dependent upon the output signal.

Transistor T3 is a buffer which provides either a normal or an inverted signal to the output socket. This stage can also be connected as an emitter follower.

The versatility of the circuit in figure 4 may be demonstrated by a few examples.

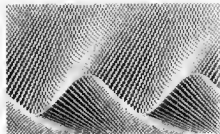

Figure 5 shows sections of circuit diagrams of a number of black-and-white and colour television receivers.

Integrated circuit TBA900 is often found in mains-operated black-and-white receivers. The video signal is applied to pin 9 of this IC (see figure 5a). The connection to this pin should be broken and taken to the pole of a change-over switch. One of the contacts of this switch is connected to the video signal line in the TV set (for instance, to "M8"), and the other to the output of the monitor amplifier. In this case T3, R11, and R12 (figure 4) may be omitted and the output signal taken from C5+. Set the a.c. level to $3 V_{pp}$ with P2, and the d.c. level to 2 V with P3.

HAVE YOU REMEMBERED THE MAINS ISOLATING TRANSFORMER?

A second example may be seen from figure 5b which shows part of a portable B/W receiver fitted with a mains isolating transformer. The circuit of figure 4 is connected as shown for version A (that is, T3 = BC 547B collector of T3 to the positive line, emitter of T3 to the negative supply line via R12). As the level of the video signal should not exceed $1.3 V_{pp}$, preset P2 must be replaced by wire bridge DE and the level of the output signal (for an input signal of $1 V_{pp}$ into 75 ohms) preset by P1. The d.c. level is set to 6.8 V with P3.

A third example concerns an older B/W set partly using valves (see figure 5c). The video input here should be located somewhere in the vicinity of TS412. Again, as in example 1, version A of figure 4 should be used. The change-over switch is connected as in example 1 but with the first contact connected to terminal 6 in figure 5c instead of to "M8". The d.c. level should be set to 2 V with P3.

Our fourth example concerns the quite common Philips type TX B/W portable, although the following considerations apply equally to the portable B/W sets of most other manufacturers. The relevant part of the circuit is shown in figure 5d. In this case, the circuit of figure 4 is connected in version B (that is, T3 = BC 557B, collector of T3 to earth or negative supply line, and emitter of T3 direct to output socket 2 because R350 (figure 5d) serves here as the emitter resistor. The pole of the change-over switch is connected to R350, and the two contacts to the emitter of T3 (that is, output 2 in figure 4) and TS380 (a test point in the TV set) respectively.

A further modification, to improve the picture quality in type TX sets, is shown in figure 6. As you will see, the TS560 stage in the original circuit has been replaced by a cascode stage which increases the bandwidth of the set up to 15 MHz. This will be especially appreciated by computer owners who want to read 24/25 lines with up to 80 characters. The modified circuit is easily built onto a small prototyping (Vero) board. Transistor BF869 (or equivalent) must be mounted on a heat sink.

A fifth example is given in figure 5e and this time it concerns a portable colour TV which needs special treatment! First, it needs an isolating transformer and, second, the video output is designed to figure 7. Again, the circuit is easily constructed on prototyping (Vero) board and then connected to point B on the monitor amplifier. Note here that the sync pulse for the line time base must be generated separately otherwise the picture quality will suffer.

Construction and calibration

If your desired setup is covered by one of the examples given, the completion of the printed circuit shown in figure 8 should be straightforward. It becomes a little more difficult when your equipment is dissimilar to any discussed so far. In such a case, it is best to start with the simple arrangement of example 3 and then attack the problem with the monitor amplifier.

DO NOT FORGET THE ISOLATING TRANSFORMER!

The completed printed circuit can in most sets be mounted onto the inside of the back cover together with the video input socket and change-over switch. All signal lines should be in coaxial cable, while simple stranded wire may be used for the supply lines. The wiring between the television receiver and the printed circuit may give rise to high-frequency (greater than 20 MHz) oscillations in some cases. These oscillations do not affect the picture but if they are present, a 470 ohm resistor may be put in series with the output line. It goes without saying, of course, that whenever a connection in the set is cut this should only be done once you are

7

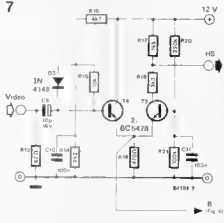

use your TV receiver as a monitor

absolutely certain that it is the right one. Calibration and presetting instructions have already been given under the various examples. If your case falls outside these examples, follow the circuit diagram of your particular TV receiver. The calibration is fairly simple and can be carried out with a good multimeter and by keeping a sharp eye on the screen. An oscilloscope with which the various waveforms can be checked is, of course, an advantage.

Parts list

- | | |
|-----------------------------------|---------------------------------|
| Resistors | C2, C3 = 10 μ /16 V |
| R1* = 330 Ω or 68 Ω | C4, C5 = 100 μ /16 V |
| R2 = 680 Ω | C6 = 47 μ /16 V |
| R3, R4, R10 = 10 k | Semiconductors |
| R5 = 1 k | D1, D2 = 1N4148 |
| R6, R8 = 180 Ω | T1, T3* = 6C 547B |
| R7 = 3k3 | T2, T3* = BC 557B |
| R9, R11*, R12* = 470 Ω | Miscellaneous |
| P1* = 100 Ω preset | BNC sockets as required* |
| P2 = 2k5 preset | SPST switch* |
| P3 = 10 k preset | Single-pole change-over switch* |
| Capacitors: | Printed circuit board 84101 |
| C1, C7, C8 = 100 n | *see text |

Figure 8. Component layout and track side of the printed circuit board for the monitor amplifier. Before commencing work on this, check with figure 5 which version you need!

8

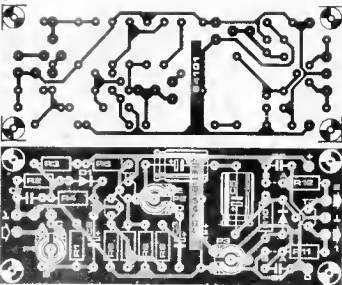

At last, here is a small unit that provides a quick, safe, and simple way of checking the presence or absence of a voltage in an electrical line without the necessity of physical access to the conductor. And, what's more, it's really cheap to build.

Telephase will enable the detection of a break in any normal, non-shielded, 'live' electric cable or wire. It is suitable for use with a.c. voltages from about 60 V to 250 000 V. With a little practice, it should be possible to gauge the voltage level from the distance between the detector and the wire at which the indicator LED extinguishes.

F. Pipitone

telephase

a simple voltage detector

Circuit description

The circuit is based on a type 4049UB hex inverter. The sensor is formed by a small piece of thin (about 0.2 mm) tin plate. The electro-magnetic field surrounding the live conductor or source induces a very small voltage in the sensor. This voltage is sufficient to start a low-frequency oscillator formed by inverters N1/N2 and associated components. The onset of oscillations may be preset, within a narrow range, by P1. The oscillator signal is applied to N4...N6 via N3. Inverters N4...N6 are connected in parallel to allow sufficient current for LED D1 to light.

Power is provided by two 1.5 V size N batteries. Current consumption is determined primarily by the type of LED used. As the unit will normally not be used for long periods at a time, the batteries should last 6...12 months.

Construction

The unit is constructed on a printed circuit board: if our EPS84100 is used, no special problems should arise. Note that the sensor and the batteries are connected to soldering pins.

The sensor is made simply from a piece of tin plate about 0.2 mm thick and 40 x 15 mm in area to make it fit neatly in the proposed case.

The on/off switch is mounted in the side of the upper part of the case: make sure that it is clear of the battery and adjacent to the S1 terminals on the PC board after assembly.

The completed unit is then assembled in a case of 100 x 50 x 25 mm; a Vero case 202-21027E is ideal.

Operation

Switch the unit on when the LED should

Figure 1. This diagram shows clearly that the circuit of the Telephase is based on just one IC.

1

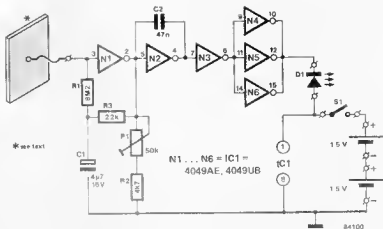

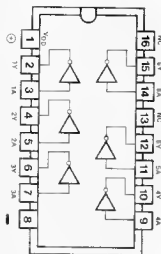

64100-2

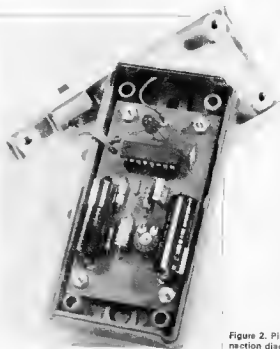

Figure 2. Pinout and connection diagram of the 4049UB

light briefly to indicate that the Telephase is ready for use.

Test the unit by pointing the sensor end at a known live source, such as a mains outlet socket or cable. Switch the Telephase on and bring it in close proximity of the outlet or cable. The LED should now remain lighted.

The Telephase is now ready for checking whether a cable or appliance is live or not. Always point the sensor end of the unit at the source being checked.

Approximate distances at which various

voltages may be checked are given in table 1.

Note, that it may happen that the LED suddenly extinguishes, although the cable being checked is alive and well! This may be caused for instance, by the live and neutral conductors being twisted which gives rise to zero nodes in the electromagnetic field. If the LED therefore suddenly goes out, check the immediate vicinity to make certain that the Telephase is not situated at such a node.

Table 1.

a.c. voltage (V)	110	240	440	1000	5000	9000
distance (cm)	1 . 2	3 . 4	6 . 8	10 . 15	20 . 30	30 . 45

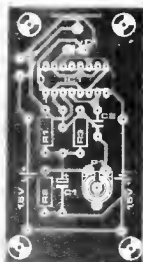
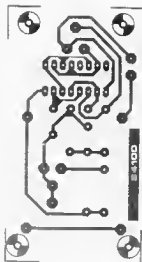

Parts list

Resistors:

- R1 = 8M2
- R2 = 4k7
- R3 = 22 k
- P1 = preset 50 k

Capacitors:

- C1 = 4u7/16 V
- C2 = 47 n

Semiconductors

- D1 = LED, red, 5 mm
- IC1 = 4049UB

Miscellaneous

- S1 = SPST switch case, 100 x 50 x 25 mm, e.g. Vero 202-21027E
- two batteries, IEC R1 or UM5 or MN9100, 30 x 12 mm die
- piece of tin plate, 40 x 15 mm, about 0.2 mm thick
- printed circuit EPS84100

Figure 3. Component layout and track side of the printed circuit.

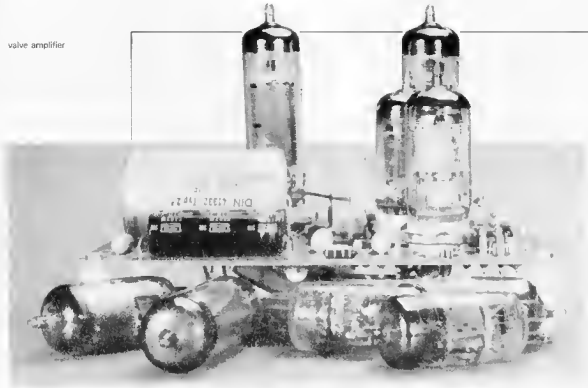

valve amplifier

A 10 Watt hi-fi amplifier with just four valves

Of late there seems to be a renewed interest among audio enthusiasts for valves. Valve amplifiers are 'in'. Those in the know now say, as, indeed, they always have, that valves sound better than transistors. The fact that we have designed a valve amplifier does not necessarily mean that this is our opinion. Appreciation of sounds is, in any case, purely a personal matter so everybody simply has to decide what he personally prefers. That is now very easy, at least for anybody who builds this 'good-old-fashioned' amplifier it is.

With the invention of the transistor, valves lost their 'monopoly' as the active element in electronics. They have never completely disappeared, however, and for many applications, especially where a lot of power has to be handled, they are

indispensable. Even in cases where where the transistor might seem to be the logical choice, however, valves are still to be found. Some audiophiles, as we have already mentioned, prefer tubes but ham radio users have also refused to let the 'new-fangled' transistor supercede their beloved valves.

The HF people favour tubes for their indestructibility and power handling characteristics, the audio enthusiasts for other reasons. They consider that valves have a different (and better) sound than transistors. Whether this is so or not there is certainly a resurgence in interest for valves. Just one of the indications of this is seen in the increasing number of valve power stages in the high-end sector. We have also been bitten by the valve bug, as witnessed by this amplifier. The power output is quite small (10 watt) but this could be just the beginning. We may even come up with a heavier version at some stage in the future (but that is not a

Specifications

nominal output power: 10 watt into 4, 8 or 16 ohm
 maximum output power: 12 watt
 harmonic distortion: 0.5%
 (50 Hz . . . 20 kHz)
 signal/noise ratio: depends on individual circumstances
 input sensitivity: 200 mV_{rms}
 input impedance: 1 MΩ
 damping factor: 25
 frequency characteristic:
 20 Hz . . . 40 kHz ± 1 dB (at 1 watt)
 feedback: about 26 dB

promise). The valves themselves are still readily available so that will not be a problem; the ones we use are actually advertised in this issue.

A classic circuit

Those who grew up with valves will recognise the 'classic' layout of the circuit diagram. It is shown in a modernised form in figure 1: this is how it would look if it could be built with semiconductors. Our showing it like this is, of course, a complete reversal of the situation of a quarter century ago when designers converted the new-fashioned transistor circuit diagrams back to valves in order to understand what was going on.

Compared to modern circuits, the layout of figure 1 looks extremely simple. All it has, basically, is a preamplifier stage (T1), a differential stage (T2) and two power transistors. Such a layout would be impossible to achieve with normal bipolar transistors; at very least a few drivers would have to be included. This is one obvious advantage that valves have. As far as modern semiconductors are concerned, only the MOSFET can be considered in any way comparable to tubes. Having seen how simple the circuit design is, we can now move on to the actual circuit diagram, as shown in figure 2. If we ignore compensation networks, decoupling capacitors and so on, we see that the circuit is essentially the same as that of figure 1. An EF86 pentode (V1) acts as a preamplifier, a double-triode ECC83

1

valve amplifier

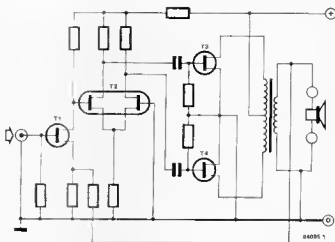

(V2) forms a differential amplifier, and finally two EL84 pentodes make up a push-pull stage, which drives the loudspeaker via an output amplifier. The EF86 is connected as a triode and has a gain of about twenty times. Filter R6/C3, which is in parallel with anode resistor R5, ensures that the gain is reduced at high frequencies. This is necessary in order to achieve stability. The phase shifting needed for driving the power elements (V3 and V4) is provided by the ECC83 double-triode with cathode coupling. This

Figure 1. If it were possible to make this amplifier with semiconductors the way it would look like is very simple.

Figure 2. The circuit diagram for this amplifier is very unusual for Elektor. The reason for this is, of course, the fact that it contains four valves. Note that the values of C2 and R4 depend on the impedance of the loudspeaker used.

2

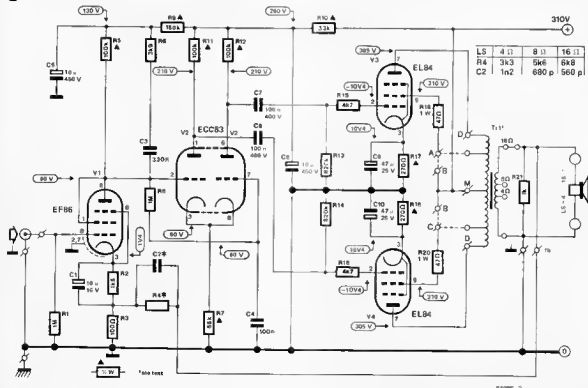

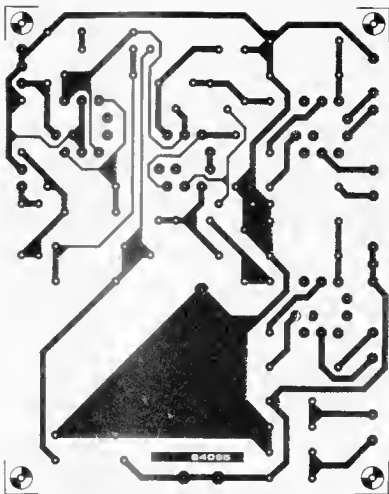

Figure 3 In common with many of our designs all the components, except for the transformers, fit onto a single printed circuit board.

'differential stage' is used because it keeps distortion to a minimum and enables a direct coupling to be made to the preamplifier tube. The reasoning is easy to understand knowing that the grounds in the double-triode must have a positive potential due to the large voltage drop across cathode resistor R7.

The power stage consists of a conventional push-pull circuit with two EL84s set to an anode voltage of 310 V. There is no need for V3 and V4 to be paired as each has its own cathode resistor (R17, R18). The improvement here would, in any case, be very small. The resistors in series with the grounds (R15, R16) and the screen grids (R19, R20) improve the stability. Some output transformers have special screen gnd tap-off points on the primary side. If these are available points A and C should be connected to them and the power stage will then be 'ultra-linear'. If the transformer used does not have this facility A and C should simply be connected to the positive supply at points B.

The signal from the secondary side of the output transformer is fed back to the non-decoupled part of the cathode resistor of V1. The values given to the feedback network (C2/R4) depend on the impedance of the loudspeaker used. The relevant values are given in the table at the top right-hand corner of figure 2.

The power supply is straightforward and follows the well-known transformer, bridge rectifier, electrolytic, formula. In this case we have used a supply transformer intended for use with valves. This has two secondary windings to provide the anode voltage of 250 V at a minimum of 75 mA and the filament current of 2 A at 6.3 V.

Construction

Although this sort of project would have been constructed differently before, there is now no reason why it cannot be mounted, as a transistor amplifier would be, on a printed circuit board. The valve mounting sockets for insertion into printed

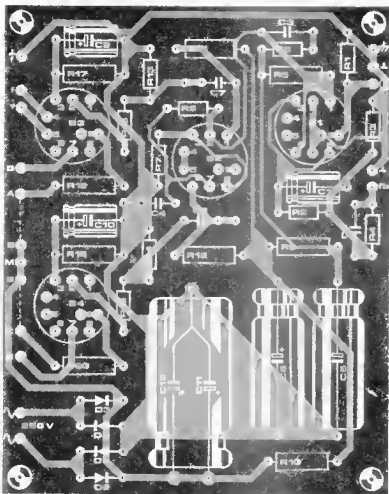

circuit boards have been available for a long time and the other components are the same as a modern amplifier would use.

The printed circuit board that we have designed for this project is seen in figure 3. In spite of its compactness everything fits on the board, except for the two transformers and R21 (which is soldered across the loudspeaker terminals). In general, construction is just the same as for any other Elektor project but there are a few points to note. The board does not contain any tracks to feed the valve filaments so these must be wired by hand. Make sure the cable used for this is capable of handling the filament current of 2 A. It is also wise to twist these two wires together. The filament connections are pins 4 and 5 for V1, V3 and V4, but pins 4, 5 (already joined on the board) and 9 for V2.

Plenty of room has been left on the board for mounting smoothing capacitors C11 and C12. We used a double capacitor

here (2 x 50 μ /450 V in a single case) but a single 100 μ /450 V type may be used instead. When fitting the components to the printed circuit board simply follow the sequence normally used. The valves are delicate, of course, so fit them last.

We have already mentioned the transformers briefly. The mains transformer must have at least two different secondary windings as we need 250 V at 75 mA and 6.3 V at 2 A. The output transformer must have an impedance of 2 x 4 k Ω at the primary side, preferably with screen-grid tap-off points. The impedance at the secondary side depends on the loudspeaker that is to be used. Well-informed suppliers will know what you want if you just ask for a 10 watt valve output transformer, or a transformer for a 2 x EL84 push-pull stage. If you were in the habit of 'salvaging' parts from radios when valves were in fashion there may be a suitable transformer lying at the bottom of your junkbox. Don't reject it simply because of its vintage; it may be just what is needed.

Parts list

Resistors

- R1, R8 = 1 M, $\frac{1}{4}$ W
- R2 = 1k8, $\frac{1}{4}$ W
- R3 = 100 Ω , $\frac{1}{4}$ W
- R4 - see figure 2
- R5, R11, R12 = 100 k, $\frac{1}{2}$ W
- R6 = 3k9, $\frac{1}{4}$ W
- R7 = 68 k, $\frac{1}{2}$ W
- R9 = 180 k, $\frac{1}{2}$ W
- R10 = 33 k, $\frac{1}{2}$ W
- R13, R14 = 820 k, $\frac{1}{2}$ W
- R15, R16 = 4k7, $\frac{1}{2}$ W
- R17, R18 = 270 Ω , 1 W (carbon)
- R19, R20 = 47 Ω , 1 W (carbon)
- R21 = 1 k, $\frac{1}{2}$ W

Capacitors:

- C1 = 10 μ /16 V
- C2 - see figure 2
- C3 = 330 p (polyester)
- C4, C7, C8 = 100 n/400 V
- C5, C6 = 10 μ /50 V
- C9, C10 = 47 μ /25 V
- C11, C12 = 50 μ /450 V (may be combined in a single package)

Semiconductors

- D1.. D4 = 1N4007

Valves

- V1 = EF86
- V2 = ECC83
- V3, V4 = EL84

These valves are available from (among others) East Cornwall Components. See page 11-11 of this issue.

Miscellaneous:

- F1 = fuse, 1 A slow blow (with holder)
- S1 = double-pole mains switch
- T1 = output transformer for 2 x EL84, primary 2 x 4 k Ω , preferably with screen grid tap-off points
- secondary 4, 8, or 16 Ω
- T2 = mains transformer, 250 V at 75 mA and 6.3 V at 2 A
- 4 off socket for valve
- 1 off phone socket (for input)
- 2 off output sockets (e.g. wandel plug type)

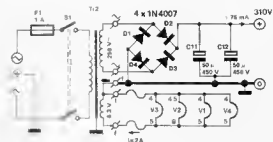

Figure 4 Although slightly unusual in appearance, the layout of this power supply is straightforward

Case and wiring

In a mechanical sense it is very easy to 'finish' this amplifier and make it into a very attractive project. Unlike power transistors, valves do not have to be mounted on heatsinks. This makes the choice of a case easier. As long as everything fits inside, any sturdy metal case will be suitable. It is important to have enough ventilation slots in the case as the valves dissipate a lot of heat and this must be dispersed. If the case is just big enough to fit all the components it is a good idea to fit all the components on its side. The valves will then be horizontal and can pick up as much cooling air as possible.

A very important part of building any amplifier is the wiring. If this is not done carefully the chances are that a lot of hum will be generated and that can be very difficult to get rid of. In principle the same rules apply when wiring any amplifier, whether it has transistors or valves. The most important points are: Always use a single central ground point

and wire all the amplifier's ground connections directly to this. The ground should be connected to the metal case either from the central point or directly at the input; try both and use whichever gives less hum. Lines from the input socket to the board must be made with screened cable. Finally, keep all the wiring as short as possible so as to minimise loss.

Make sure that the correct polarity is used for the feedback connection from the output amplifier. If the loudspeaker connections are reversed the amplifier will be heard to oscillate.

Before applying power check that the anodes of V3 and V4 are connected to '+' (via Tr1 if applicable). Failure to do this will mean that the screen grid will take on the job of the anode and this is something that is not recommended (not even by 'Murphy's handbook of self-destructive valves and other associated phenomena!').

Final points

By now the printed circuit board should be completely assembled and all the appropriate 'bits and pieces' should be correctly wired up. It is time for the 'acid test'. When power is applied to the amplifier it should work properly. No calibration or adjustment is needed. Before use, however, check that the test voltages shown in figure 2 agree with those measured on the printed circuit board. If they do not, then recheck everything on the board and all the wiring because there is undoubtedly a mistake in it somewhere. If you want a stereo valve amplifier remember that all the components must be duplicated. This means that not only do you need two printed circuit boards but also two mains transformers and two output transformers.

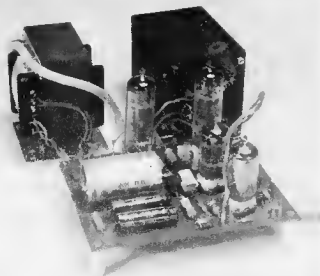

universal NiCad charger

one charger for all NiCad cells



NiCad cells are an economic alternative to batteries, but if you have to buy a special charger for each type of cell, this cheap alternative turns into an expensive one. The solution to this problem is a charger that is able to charge the whole range of cells. As you may have suspected, this article deals with such a device. To prevent any damage to the cells, the charger is also protected in the event of an incorrect connection.

It is not possible to connect NiCad cells in parallel in order to charge them from one power source simultaneously because of the tolerance in the charge characteristics and the various initial charge conditions of the cells. The charge current can only be determined exactly if the cells are connected in series. The current depends on the capacity (number of mA) of the cells. Most of them can be charged in 14 hours with a current that is $0.1 \times$ number of mAh. This current will ensure that the cells won't be damaged if they are left on charge for too long, and for a charge of at least 14 hours, it doesn't matter whether the cell is completely exhausted or not. It will be obvious that a universal charger must have an adjustable output current, because each different type of cell requires a specific charging rate.

The circuit diagram

Figure 1 shows the complete circuit diagram of the universal NiCad charger. A current source is built around the transistors T1, T2 and T3, which provide a constant charging current. The current source only comes into operation when the NiCad cells are connected the right way round (positive to + and negative to -). It is the task of IC1 to verify the connection by checking the polarity of the voltage at the output terminals. When the cells are connected correctly, pin 2 of IC1 won't be as positive as pin 3. Therefore the output of IC1 becomes positive and supplies a base current to T2, which switches on the current source. The desired level of the current source can be set with the aid of S1. A current of 50 mA, 180 mA and 400 mA can be preset when the values of R6, R7 and R8 are known. Putting S1 in position 1 means that the penlight cells will be charged, position 2 is for C cells and it is the D cells' turn in position 3.

The current source functions very simply. The circuit is a current feedback system. Suppose that S1 is in position 1 and IC1 output is positive. T2 and T3 are now supplied with a base current and start to conduct. The current through these transistors produces a voltage across R6, thus causing T1 to conduct. An increasing current across R6 means that T1 will conduct more thereby reducing the base drive current to transistors T2 and T3. The latter transistors will now conduct less and the original current increase is opposed. A fairly constant current through T3 and the connected NiCad cells is the logical result.

Two LED's that are mounted on the current source show whether and how the NiCad charger is working. IC1 supplies a positive voltage when the cells are connected correctly and DB will light. With an incorrect connection, pin 2 of IC1 will be more positive than

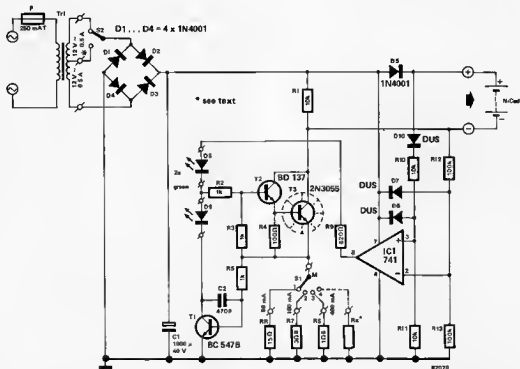





Figure 1. The universal NiCad charger consists of a switchable current source (T1, T2, T3) and a comparator (IC1) that checks the polarity of the cells. Two LED's (D8, D9) indicate whether the supply voltage is sufficient, whether the cells are charged with the correct current and fast but not least, whether the cells are connected correctly.

Table 1.

	name and international type indication	IEC, nr. battery	IEC, nr. NiCad cell	Charge current for sintered cells	S1 in position
	penlight AA	R6 (1.5 V)	KR 15/51 (1.2 V)	45 ... 60 mA	1
	baby C	R14 (1.5 V)	KR 27/50 (1.2 V)	165 ... 200 mA	2
	mono D	R20 (1.5 V)	KR 35/62 (1.2 V)	350 ... 400 mA	3
	power-pack PP3	6F22 (9 V)	— (7.5 V) (8.4 V) (9 V)	7 ... 11 mA	4

Parts list

Resistors:

R1, R10, R11 = 10 k
 R2, R3, R5 = 1 k
 R4 = 100 Ω
 R6 = 15 Ω
 R7 = 3.9 Ω
 R8 = 1.8 Ω
 R9 = 820 Ω
 R12, R13 = 100 k

Capacitors:

C1 = 1000 µ/40 V
 C2 = 470 p

Semiconductors:

T1 = BC 547B
 T2 = BD 137
 T3 = 2N3055
 IC1 = 741
 D1 ... D5 = 1N4001
 D6, D7, D10 = DUS
 D8, D9 = LED (green)

Miscellaneous:

Tr1 = transformer 2 x 12 V/0.5 A
 S1 = 3 position switch
 S2 = 2 position switch
 heat sink for T3 (TO-3 housing)

The table illustrates which battery can be replaced by which NiCad cell (with sintered cells). The capacity of the cells differs with each manufacturer.

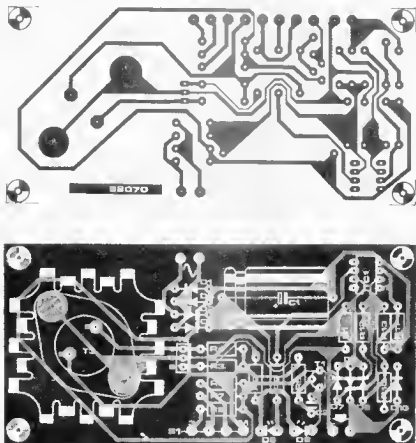

Figure 2. The track pattern and component overlay of the universal NiCad charger. Transistor T3 must be mounted on a heat sink.

pin 3, so that the upamp, which is wired as a comparator, has 0 V output. Now the current source isn't switched on and LED D8 will not light. The same holds good for the case when no cells are connected, since pin 2 will have a higher voltage than pin 3, caused by the voltage drop across D10. The charger will only work when a cell containing at least 1 V is connected.

LED D9 indicates that the current source is functioning as a current source. This may sound a little strange, but an input current produced by IC1 isn't sufficient, there also has to be a voltage level high enough to stabilise the current. This means that the supply must always be higher than the voltage across the NiCad cells. Only then will there be a high enough level for the current feedback T1 to function, causing D9 to light.

Practical points

Figure 2 illustrates the track pattern and

component overlay of the printed circuit board. Except for the transformer, all components can be mounted on the board. A heat sink for T3 is a must, since the transistor will run warm, especially when only a few cells are being charged. It is therefore recommended that a transformer with a centre tap is used, so that a lower supply voltage can be selected by means of S2. This centre tap not only prevents T3 from getting overheated, but it also saves a lot of energy. Diode D9 lights to indicate that there is sufficient supply voltage.

As stated before the penlight cells are charged with a current of 50 mA when S1 is in position 1. C and D type cells can be charged with 180 mA and 400 mA respectively (positions 2 and 3). The value of R6, R7, or R8 must be changed if other charging currents are required. The desired value can be found by dividing 0.7 V by the charging current. For example, for a charging current of 100 mA a resistor value of

$0.7 \text{ V} : 0.1 \text{ A} = 7 \Omega$ is required. Currents up to 1 A are possible, however it must be remembered that T3 will require a larger heat sink. We will not complain or object if you replace S1 by a switch with more than 3 positions.

Resistor Rx in figure 1 is shown in the position for one further current rate if desired.

Charging NiCad cells takes about 14 hours. It is wiser to use sintered cells, because they won't be damaged if this limit is passed.

SPEAKERS FOR COLOUR TV

LUXCO Electronics have introduced a new range of speakers for colour TV. These speakers are designed and manufactured to meet the specific needs of colour TV manufacturers. The magnet of the speaker is shielded with a compensating magnet of high permeability to reduce stray magnetic fields which cause distortion in the picture.

The frequency response is FO-10,000 CPS and the resonant frequency is 130 CPS. These speakers are available in three different models—

10 x 15 LCT 6 D, 8 x 13 LCT 5 and 10 LCT 5 D



For further information, write to:
LUXMI & CO
56, Johstonganj,
Alishabad-211 003.

KNOBBS

MARVEL Industries introduce a complete range of knobs for electronic instruments and entertainment products. The range includes aluminium enodized diamond-cut knobs and plastic moulded knobs with diamond cut aluminium anodized fronts. Knobs are also manufactured as per customer's specifications.

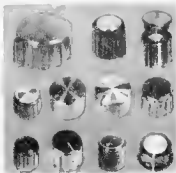

For further information, write to:
Marvel Industries
208, Allied Industrial Estate,
Mahim, Bombay 400 016

HEAT SINKS

JAIN Electronics offer a range of 20 heat sink designs manufactured from Aluminium alloy 6063-T6. The designs are suitable for high, medium

and low power transistors, SCRs and diodes, heat sinks for ICs have also been developed. Transistor insulating sets and heat sink compound are also available. Technical data of dimensions, weight, thermal resistance etc are available in form of a catalog.

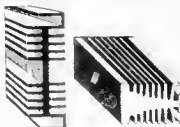

For further information, write to:
Jain Electronics
F-37, Nand-Dhem Industrial Estate,
Marol, Bombay 400 059

DC TO DC CONVERTER

SBAJ introduce their new DC to DC converter with input - 50 Volt to - 24 Volt DC 6 Amp. It is designed with P.W.M. technique with over current over voltage and short circuit protection with LED indication. All filters and transformers are designed with ferrite cores. The efficiency is claimed to be 90%. The DC to DC converter finds application in Railway Telephone and Posts & Telegraph departments.

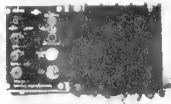

For further information, write to:
Sbaj Electronics
19, Mother Grit Bldg,
Opp Novelty Cinema,
Grant Road, Bombay 400 007.

RESISTANCE THERMOMETER

The Resistance Thermometers from CHOWDHRY Instrumentation Pvt Ltd are electrical thermometers which cover a range between -220°C to +750°C. The range can be extended up to +850°C in special cases. Resistance elements are manufactured using Platinum, Nickel or Copper and formers can be of Mica Ceramic or Glass. The elements are provided in protecting tubes and thermowells. Special elements are available for

monitoring winding temperature and surface temperature.

For further information, write to:
Chowdhry Instrumentation Pvt Ltd,
110, Model Bast, New Delhi 110 005

DATA LOGGING PRINTER

The new Data Logging Printer from ELECTRONUMERICS is suitable for logging of fast changing digital data and multichannel analogue data. 32 digit BCD data in single channel or divided in 2 to 4 channels of 16 or 8 digits each can be accessed and printed at the set interval. The logging interval can be as short as one millisecond. The print initiation can be through a push button on front panel or through an external trigger pulse. Fast paper feed and paper loss detection facilities are provided in the printer.



For further information, write to:
Electronumerics
Kammegondanehalli
Opp HMT Industrial Estate,
Jalahalli West, Bangalore 560 015

MAGNETIC COILS

Shepherd Transformers manufacture Mahavir brand magnetic coils, which have the main application for creating temporary magnets. The coils are manufactured in various sizes, shapes and capacities according to the customer's specifications. Wound on bakelite formers, the coils are also insulated with interlayer insulation. Epoxy moulding can also be provided for HV coils.



For further information, write to:
Shepherd Transformers
Shed No 4 Vallabh Society
90 feet Road, Ghatkopar (East),
Bombay 400 075

VHF/UHF TUNER

SIEL Electronics of Italy have introduced a new VHF/UHF electronic tuner type F-500 for use in colour TV receivers. The tuner covers VHF and UHF channels of C.C.I.R. system. The circuit uses MOSFETs and chip components. Input filters are provided with IF and FM suppression circuits. Oscillator radiation, frequency drift and microphonics meet international standard specifications. The tuner is fully tropicalised and can work satisfactorily up to ambient temperature of 50°C. The mounting can be directly on the PCB of 2.5 mm grid.



For further information, write to
Rao & Associates
79 2nd Main
Dalcone Colony
Bangalore 560 038

MODULAR JACK RETAINER

The FCC-68 Modular Jack Retainer and Receptacle Housing has been introduced by Molex Inc. This is a new addition to the Molex connector product series. The jack retainer 90080 is designed to be custom harnessed. The body is moulded in gray polypropylene and the contacts are selectively plated with electro tin in the ID area and gold in jack contact area. The retainer is to be used with Molex receptacle housing 90079, which is moulded in polyester.

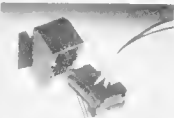

For further information, write to
Jay Electric Wire Corporation Ltd
202, Maker Tower 'E' 20th floor,
Culfa Parade, Bombay 400 005

PCB SUPPORT

SEE offers non-conductive printed circuit board supports. These are designed for secure and rapid installation. The supports have a plug-in fastening method and allow quick access for maintenance or equipment modifications. Its tension retaining system allows positive fastening with the advantage of being detachable when required.



For further information, write to
Suresh Electrics & Electronics
Post Box No. 9141
3 B Camac Street,
Calcutta 700 016

SOLDERING IRON STAND

The makers of 'Slendron' Soldering Irons have introduced a Stand for their soldering irons.

The stand consists of a heavy cast iron base, painted in oven baked hammer tone finish. The thick plating of coil prevents corrosion and the soldering iron holder is made of turned aluminium. A sponge is also provided for cleaning. The stand can be mounted on a table or a vertical surface.

The stand is useful on production line for easy access and for prevention of damage to expensive raw material due to unexpected contact with the soldering iron.



For further information, write to
Bombay Insulated Cables & Wires Co
74, Podar Chambers,
S.A. Berlin Road, Fort,
Bombay 400 001

PHOTOMETERS

United Detector Technology, U.S.A. have added a new photometer S 351 F to their existing S 351 series of radiometers and photometers for laser, fiber-optics, CRT luminance and UV power measurements. The S 351 F has a photometric detector with a 15° field-of-view lens and ambient light shade. CRT luminance can be measured directly by holding the detector against the CRT. The shade is made of soft rubber and does not scratch the face of CRT.



For further information, write to:
Toshni-Tek International
267, Kilpeck Garden Road,
Madras 600 010.

DIGITAL CLOCK

ION Electricals offer a mains operated digital clock module with quartz crystal oscillator for high accuracy. The operation is independent of mains frequency or mains voltage variation. The clock is designed to display time in 12 hours mode with AM or PM indication. 15 mm green fluorescent display is used, which can be changed to orange or blue using suitable filters. Back up battery can also be provided. The module is available in open construction and can be fixed in any suitable enclosure.



For further information, write to
ION Electricals
307, Owner's Industrial Premises
505 Gabriel Road,
Mahim, Bombay 400 016

Now!

LUXCO

SPEAKERS FOR:

COLOUR TV

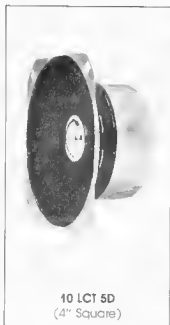

10 LCT 5D
(4" Square)

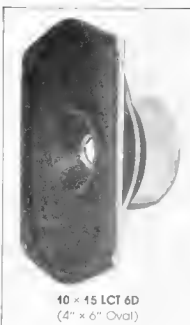

10 x 15 LCT 6D
(4" x 6" Oval)



Suitable for Toshiba Kit.
8 x 13 LCT 3
(3 1/4" x 5" Oval)

Speakers for B/W TV: 10 x 15 LG 6 TV (4" x 6" Oval), 10 LG 5 TV (4" Square),
7 x 10 LG 2 TV (2 1/2" x 4" Oval), 8 x 13 LG 5 TV (3 1/4" x 5" Oval),
8 LG 1 TV (3 1/4" square) For Portable TV

The LUXCO Range also covers speakers for:



Transistors, Tape recorders, Stereo systems,
Car Stereos, Intercoms and P.A. systems

- Manufactured by
LUXCO Electronics
Allahabad—211 003
- Sole Selling Agents:
LUXMI & CO.
56, Johnstonganj
Allahabad—211 003
Phone: 54041, Telex: 540-286
- Distributors for Delhi & Haryana:
Railton Electronics
Rada Place, Chandni Chowk
Delhi-110 006,
Phone: 239944, 233187

- Distributors for Maharashtra,
Gujarat and South India:

precious[®]
Electronics Corporation

- Chotani Building, 52, Proctor Road,
Grant Road (East), Bombay-400 007.
Phones: 367459, 369478
- 9, Athipattan, Street, Mount Road,
Madras—600 002, Phone: 842718

Wanted stockists all over India

sound technology from a sound source

CONDITIONS OF ACCEPTANCE OF CLASSIFIED ADVERTISEMENTS

1) Advertisements are accepted subject to the conditions appearing on our current rate card and on the express understanding that the Advertiser warrants that the advertisement does not contravene any trade act in force in the country.

2) The Publishers reserve the right to refuse or withdraw any advertisement.

3) Although every care is taken, the Publishers shall not be liable for clerical or printer's errors or their consequences.

4) The Advertiser's full name and address must accompany each advertisement submitted.

The prepaid rate for classified advertisement is Rs. 2.00 per word (minimum 24 words). Semi Display panels of 3 cms by 1 column. Rs. 150.00 per panel. All cheques, money orders, etc. to be made payable to Elektor Electronics Pvt. Ltd Advertisements, together with remittance, should be sent to The Classified Advertisement Manager For outstation cheques please add Rs. 2.50

Electronics Tools like Soldering Irons, Pliers, Cutters, Screw Drivers, Tweezers at Competitive Prices. Contact Aradhna Electronics (P) Ltd., 10, Srinath Complex, Sarojinidevi Road, Secunderabad 500 003

APLAB	12.13
ARUN ELECTRONICS ..	12 69
BALAJI	12.12
BRISK	12 06
COMPONENTS TECHNIQUE ..	12 68
COSMIC	12.72
DANNIES ELECTRONICS ..	12 04
DEVICE ELECTRONICS ..	12 05
DOMINION RADIOS	12 06
ELCIAR	12 68
ESSEN DEINKI	12 10
IEAP	12.10
INDUSTRIAL RADIO HOUSE ..	12 12
ION ELECTRICALS	12 69
KELTRON	12.09
LAKSHON ELECTRONICS ..	12 12
LUXCO	12.67
MELTRON	12 07
MFR.	12 65
PADMA ELECTRONICS (P) LTD	12 06
PHILIPS	12 11
PRECIOUS	12.02
R P ASSOCIATES	12.04
SAI ELECTRONICS	12 69
SUDHIR SURTI	12 04
VASAVI	12.10
VISHA	12 71
ZODIAC	12 68

missing link

VDU card

(October 1983, page 10-38)

Where is spoken of the possibility of using a 15 MHz crystal for optimum performance, please read 16 MHz crystal.

mating logic families

(March 1984, page 3-36)
The formula for $R_{(min)}$ on page 2-51 should read:
 $R_{(min)} = \frac{[V_{oc(max)} - U_{OL(min)}]}{I_{OC} - \Sigma I_C}$

direct-coupled modem

(November 1984) page 11.34

C15 should be a tantalum capacitor of 1 μ F/16 V with its + terminal connected to R52. It happens occasionally that FF3 sets on switch-on; this may be prevented by connecting a 470 pF capacitor between pins 7 and 11 of IC7. On switch on, FF3 must then be reset.

lamp saver

(October 1984) page 10 48

Parts list, version 2. T1 should be BC 549C, BC 550C and T2 should be BC 559C, BC 560C.

musical doorbell

(Aug / Sep 1984 page 8 B0 circuit 77)

The correct value of R4, R5 and R6 is 4K7 as printed in the circuit diagram. The value given in the parts list is wrong.

COSMIC

super hi-fi stereo speaker systems
for balanced sound and true reproduction

from 30 watts to 600 watts total power output.



COVOX 1500

Components: 2 full range woofers, 16 cms., 1 tweeter
* 40-18,000 Hz
** 30-40 Watts.

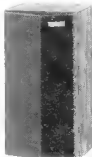

COVOX 2500

Components: Enclosure-infinite baffle, sealed, 1 acoustic-suspension woofer 16 cms., 1 acoustic-suspension mid-range, 1 cone-type tweeter, with divided network,
* 30-18,000 Hz.
** 40-60 Watts



COVOX 3500

Components: Enclosure infinite baffle, sealed, 1 acoustic-suspension woofer 20.32 cms., 1 acoustic-suspension mid-range, 1 tweeter, with divided network
* 30-18,000 Hz
** 60-100 Watts

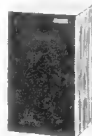

MODEL JBL

Components: 1 full range woofer and mid-range combined, 20.5 cms., 1 tweeter, with divided network.
* 30-20,000 Hz
** 60-200 Watts

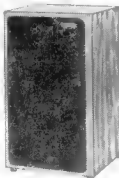

COVOX 4500

Components: Enclosure infinite baffle, sealed 1 acoustic-suspension woofer 25 cms., 1 acoustic-suspension mid-range 16 cms., 1 tweeter, with divided network
* 30-20,000 Hz.
** 60-200 Watts

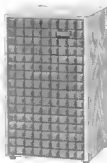

COVOX 5000

Components: Enclosure-infinite baffle, sealed, 1 full range woofer and mid-range combined 25.4 cms., 1 tweeter, with divided network.
* 30-20,000 Hz
** 100-200 Watts.



COVOX 6000

Components: Enclosure-infinite baffle, sealed, 1 acoustic-suspension woofer 30.5 cms., 2 mid-range, 1 tweeter, with divided network
* 20-20,000 Hz
** 200-300 Watts.



COVOX 7000

Components: 1 full range woofer and 1 mid-range combined 30 cms., 1 dome tweeter.
* 20-20,000 Hz
** 200-600 Watts.

* Frequency Response Range ** Matching Amplifier Nominal Impedance 8 ohms.

International quality created for India by **COSMIC**