

108

May
1984

elektor

INDIA

Rs. 7.50

electronics

- Z 80 simulator • pulse generator •
- variable a.c. power supply •
- intelligent EPROM eraser • real-time analyser (2) •
- optical memories • floppy driver • chip select •
- signal injector • the B F 494 •



Sumner's Shop

contents

selektor	5.15
Continuing our look into what future electronics may bring us.	
optical memories	5.18
Why has the optical computer-memory fallen behind the optical audio-memory? We try to find an answer and bring you the latest developments.	
controlling the floppy-disk drive motor	5.22
A circuit to extend the life of certain floppy-disk units, among them our own DOS for the Junior Computer.	
pulse generator	5.24
If you work with digital circuits, a pulse generator is virtually indispensable. We have designed one that's not too difficult to build and not too heavy on your pocket.	
using the pulse generator	5.32
A look at the practical side (use and functions) of the pulse generator on page 5.24 We show that a pulse generator is not only for use with digital circuits.	
intelligent EPROM eraser	5.34
A circuit which automatically arranges the erasure of EPROMs in the correct time: no longer, no shorter.	
Z80 simulator	5.39
One of the principal features of a microprocessor, its speed, can be a handicap when a circuit containing a CPU is tested. Our simulator gets around this problem and can even be used, in a limited sense, with processors other than the Z80.	
metronome extension	5.43
How to expand our metronome (December 1983) to give one percussive sound with sixteen beats.	
real-time analyser	5.44
We continue with part 2 of this useful audio instrument: this month, the 'mother board' and the display.	
variable a.c. power supply	5.52
A power supply with a difference: it provides an a.c. output with variable current limiting.	
idlist	5.55
This program for cataloguing the files on your data storage tapes also has a useful error-checking facility.	
chip selekt	5.56
A further selection of new integrated circuits to keep you abreast of developments.	
tape contents detector	5.58
This detector tells you at a glance whether a digital cassette has been written into or not.	
the BF 494	5.59
signal injector	5.60
market	5.61
switchboard	5.67
EPS service	5.70
missing link	5.74
advertisers index	5.74



Our front cover shows the Z80 simulator which has come into being partly because microprocessors (6502, Z80, etc.) are also used for applications other than computers. As its name implies, it simulates all the functions of the Z80 CPU, such as providing various control signals, feeding data onto the data bus, and controlling the address bus. It does this either at normal speed (dynamic mode) or one step at a time (manual mode). This makes it an invaluable aid for testing any circuit which normally contains a Z80, or, in a limited way, any other 8-bit microprocessor

A selection from next month's issue:

- short-wave pocket radio
- EPROM copier
- real-time analyser (part 3)
- floppy-disk tester
- mini cresendo
- video display for the real-time analyser

elektor decoder

Volume 2 - Number 5

EDITOR: SURENDRA IYER
PUBLISHER: C. R. CHANDARANA
STUDIO: CHANDRAKANT BHOMKAR
PRODUCTION: CHANDRAKANT N. MITHAGARI

ADVERTISING & SUBSCRIPTIONS

ELEKTOR ELECTRONICS PVT. LTD.
3, Chunam Lane, D. Bhadkamkar Marg,
BOMBAY - 400 007.

DISTRIBUTORS: INDIA BOOK HOUSE

PRINTED AT:

TRUPTI OFFSET
103, Vasan Udyog Bhavan,
Off Tulsī Pipe Road,
Lower Parel, BOMBAY-400 013.

Elektor India is published monthly under
agreement with Elektor B.V. Holland,
August/September is a double issue.

SUBSCRIPTION

INLAND

1 Yr Rs. 75/- 2 Yrs Rs. 140/- 3 Yrs Rs. 200/-

FOREIGN

One Year Only

Surface mail Rs. 125/- Air mail Rs. 210/-

The Circuits are for domestic use only. The submission of designs, or articles to Elektor India implies permission to the publishers to alter and translate the text and design, and to use the contents in other Elektor publications and activities. The publishers cannot guarantee to return any material submitted to them. All drawings, photographs, printed circuit boards and articles published in Elektor India are copyright and may not be reproduced or imitated in whole or part without prior written permission of the publishers.

Patent protection may exist in respect of circuits, devices, components etc. described in this magazine.

The publishers do not accept responsibility for telling to identify such patent or other protection.

INTERNATIONAL EDITIONS EDITOR: P. HOLMES

Dutch edition	Elektor b.v. 6190 AB Besik (L), the Netherlands
German edition	Elektor Verlag GmbH, 5133 Gengenit, W-Germany
English edition	Elektor Publishers Ltd. Elektor House, 10 Longport, Canterbury CT1 1PE, Kent, U.K.
French edition	Elektor Snt, Le Seeu, 59270 Bailieul, France.
Italian edition	Elektor, 20092 Cinisello B., Italy
Spanish edition	Elektor, Av. Alfonso XIII, 141, Madrid 16
Greek edition	Elektor, Kerassaki, 14, Voula, Athens
Turkish edition	Elektor Yayincilik ve Ticaret A. S., Karakoy Istanbul
Austrian edition	Elektor Australia Pty Ltd., 11-174 Military Road, Neutral Bay, Sydney.

COPYRIGHT © ELEKTOR B.V. — THE NETHERLANDS 1984

What is 10n?
What is the TQ Service?
What is a missing link?

Semiconductor types
Very often, a large number of equivalent semiconductor types exist with different type numbers. For this reason, 'abbreviated' type numbers are used in Elektor wherever possible.

- '741' stand for μ A 741, LM 741, MC 1741, MIC 741, RM 741, SN 72741, etc

- 'BC 107B', 'BC 237B', 'BC 547B' all refer to the same 'family' of almost identical better-quality silicon transistors. In general, any other member of the same family can be used instead.

BC 107 (-8, -9) families:
BC 107 (-8, -9), BC 147 (-8, -9),
BC 207 (-8, -9), BC 237 (-8, -9),
BC 317 (-8, -9), BC 347 (-8, -9),
BC 547 (-8, -9), BC 171 (-2, -3),
BC 182 (-3, -4), BC 382 (-3, -4),
BC 437 (-8, -9), BC 414

BC 177 (-8, -9) families:
BC 177 (-8, -9), BC 157 (-8, -9),
BC 204 (-5, -6), BC 307 (-8, -9),
BC 320 (-1, -2), BC 350 (-1, -2),
BC 557 (-8, -9), BC 251 (-2, -3),
BC 212 (-3, -4), BC 512 (-3, -4),
BC 261 (-2, -3), BC 416.

Resistors and capacitor values

When giving component values decimal points and large numbers of zeros are avoided wherever possible.

The decimal points is usually replaced by one of the following abbreviations:

p (pico-) = 10^{-12}
n (nano-) = 10^{-9}
 μ (micro-) = 10^{-6}
m (milli-) = 10^{-3}
k (kilo-) = 10^3
M (mega-) = 10^6
G (giga-) = 10^9

A few examples:
Resistance value 2k7, 2700 Ω
Resistance value 470: 470 Ω
Capacitance value 4p7: 4.7 pF
or 0.000 000 000 004 7 F...
Capacitance value 10 n: this is the international way of writing 10,000 pF or 0.01 μ F, since 1 n is 10^{-9} farads or 1000 pF.

Resistors are $\frac{1}{2}$ Watt 5% carbon types, unless otherwise specified. The DC working voltage

of capacitors (other than electrolytics) is normally assumed to be at least 60 V. As a rule of thumb, a safe value is usually approximately twice the DC supply voltage.

Test voltages

The DC test voltages shown are measured with a 20 k Ω /V instrument, unless otherwise specified.

U, not V

The international letter symbol 'U' for voltage is often used instead of the ambiguous 'V'. 'V' is normally reserved for 'volts'. For instance, $U_b = 10$ V, not $V_b = 10$ V.

Mains voltages

No mains (power line) voltages are listed in Elektor circuits. It is assumed that our readers know what voltage is standard in their part of the world!

Readers in countries that use 60 Hz should note that Elektor circuits are designed for 50 Hz operation. This will not normally be a problem; however, in cases where the mains frequency is used for synchronisation some modification may be required.

Technical services to readers.

• EPS: Elektor printed-circuit board service

Many Elektor articles include a layout for a printed circuit board. Most, but not all, of these boards are available ready-etched and pre-drilled. The EPS in the current issue gives a list of available boards.

• Technical queries

Technical queries relating to articles published in Elektor may be submitted in writing.

Letters should be addressed to Dept. TQ Please enclose a stamped self-addressed envelope.

• Missing links

Any important modifications to, additions to, improvements to, or corrections in Elektor circuits are generally published under 'Missing Links' at the earliest opportunity.

Multiple Choice Test from Philips

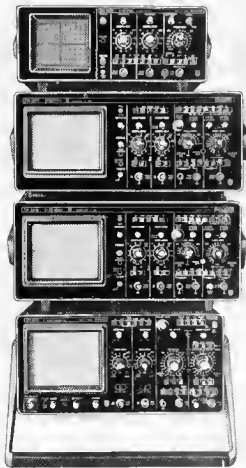

Now you have a wider choice in Philips oscilloscopes, so you can better tailor the scope to your application.

Need a 15 MHz/Single time base scope? Choose the PM 3226. A 50 MHz with delayed time base? Choose the PM 3217.

The new 35 MHz scope PM 3218 has a delayed time base, maximum sweep of 10 ns/div and a trigger hold-off facility that eliminates double triggering on digital signals, making it unnecessary to use the time base in the uncalibrated mode.

The PM 3262, 100 MHz dual trace oscilloscope not only permits the display of high speed current mode logic signals but due to its extensive features, it permits you to take measurements in any electronics environment.

Now, more than ever, we went to make your next scope. And your next digital & analog multimeter. And your Timer/Counter System. We are going to give a wider multiple choice to make your selection even easier.

For more information contact

Philips India

Test & Measuring Instruments Division
Plot 80, Bhosan Industrial Estate
PUNE 411 026



Test & Measuring
Instruments

PHILIPS

Philips — the trusted Indian household name for over fifty years.

COM/8700 R-2

function generator with digital setting



Waveforms:

Model 21 from WAVETEK is the most advanced function generator design in the last 20 years

It has digital synthesis of wave forms (including havers waves and ramps) below 11 kHz, with 1000 horizontal points and 250 vertical points per cycle. You can stop a wave at any point, hold it, then resume. Or you can use the generator's output as a 1000:1 frequency divider for ultra low frequency generation.

Sine, triangle, and square waveforms are available at all frequencies, and they can be triggered or gated

±0.09% accuracy

Exclusive Features:

- 3½ digit display for setting the frequencies over the entire range of 100 µHz to 11 MHz.
- Built in counter and a digital memory circuit to give accuracy as high as ± 0.09%
- Stabiliser button provided to stabilise the accuracy.

WAVETEK

9045 Balboa Ave. P.O. Box 85265,
San Diego, CA 92138

For further information, contact

TECHNICAL TRADE LINKS AFLAB & IMPORT REPRESENTATION GROUP

42 Navketan Indl. Estate, Mahalaxmi Cross Road,
Andheri (East), Bombay 400 083, INDIA.
Phone: 632 2412
Telex: 011-71426 XNLT IN, 011-71979 APEL IN



IMPORT SUBSTITUTION



POWER DEVICES HEAT SINKS

Extruded: for two side cooling

Pressure die cast: for single side cooling

'KH' • RIR • USHA • OTHERS

Selenium/Silicon Rectifiers/Diodes

Assemblies/Stacks & Electronic Components

Manufactured by

ELECTRONICS AND INDUSTRIAL ANCILLARIES

252, Raja garden New Delhi 110015 Phone : 505524

Marketed by

DOMINION RADIOS

15, New Queen's Road Opera House, Bombay-400 004
Phones 350747 382968 CABLE 'DOMIRA'

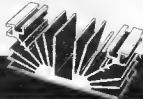

MECO

with
IMPORTED

PANEL INSTRUMENTS ACRYLIC COVERS

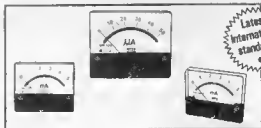

Add a touch of class with NEW flush mounting type MECO Panel Meters with unique, crystal clear, IMPORTED Acrylic Covers which enhance the beauty of the Electronic equipment on which these are mounted.

Available in a full range of moving coil DC and moving coil AC (rectifier) types, in sizes 80 x 80, 100 x 80 and 120 x 100 mm

MECO INSTRUMENTS PRIVATE LTD.

Bharat Industrial Estate, T. J. Road, Sewree, Bombay-400 015.
Phones: 447422 442435/440747/443206 Telex. 011-71001

MECO for Precision, Accuracy & Reliability.



FOR ELECTRONIC COMPONENTS

when you need them



FAST

SEMICONDUCTORS • INTEGRATED CIRCUITS • MICROPROCESSOR & MEMORY CHIPS • DISPLAYS
OPTO ELECTRONIC DEVICES • CRYSTALS & OSCILLATORS • TRIMPOTS • TRANSISTORS
DIODES • TANTALUM CAPACITORS SWITCHES • CONNECTORS • SCR's etc.

Manufacturer's Include

Advanced Micro Devices, Analog Devices, Apex Microtechnology, CTS, Fairchild Semiconductor,
Fujisoku, Fujitsu, General Instrument, Grayhill, Harris, Hitachi, Intel, Intersil, Matsushita, Mitomo, Mitsubishi,
Motorola, Mostek, National Semiconductor, NEC, P.M.I. R.O.A., Raytheon, Rockwell, Statek Corp., S.G.S.,
Signetics, Silicon General, Siliconix, Synertek, Texas Instruments, Toshiba, Unirude, Western Digital, Zilog.

ELMATRONIC DEVICES

Head office:

14, Hanuman Terrace, Lamington Road, Bombay 400 007.
Tel : 362421 Gram: ELMADEVICE Telex: 11-5614

Bangalore:

16, Hotel Kamadhenu Anexe, Trinity Circle, M.G. Road,
Bangalore 560 008

Pune:

17-A/2, Karve Road, 30, Prasad Chambers, Pune 411 004 Tel. : 35983
Gram ELMADEVICE Telex: 0145-505 ELMA

Trivandrum: Resident Representative:

Mr. Koshy Eapen, "Roshni", University Road, P.O
Palayam, Trivandrum - 695034. Tel.: 64029.

Texla presents the most advanced and sophisticated Colour TV

CP-201E

Special features:

- Black stripe picture tube for the most beautiful colour reproduction
- Feather touch electronic push button channel selector
- Controls hidden behind a panel for that sleek, 'No knobs' look
- Fully moulded ABS body, back and front to fit into the most modern cabinets and occupy the pride of place without looking predominant.
- Oval speakers 12cm x 8 cm with hi-fi sound to make you get the live performance effect
- Channels 2-12 VHF and 21-69 UHF
- Ideal monitor for computers (Home or Institutions)
- 51 cms screen
- 90V-270V A/c mains operation
- Can be used as a TV games monitor
- The luxury of home movies VCR facility

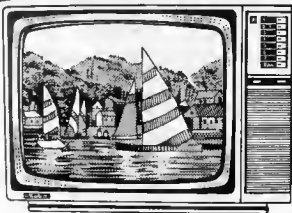

The most popular colour TV in the country

new/ND/7/84

POPULAR

TESTICA T-3



ONLY

Rs. 160/-

THE ONLY MULTIMETER WITH PROMPT SERVICE AFTER SALES ACCURATE! ROBUST! ECONOMICAL!

AVAILABLE AT ALL COMPONENT SHOPS

MANUFACTURERS : ELECTRICAL INSTRUMENT LABORATORIES,

339/68, RAJESH BUILDING, LAMINGTON ROAD, BOMBAY-400 007. PHONE: 36 07 49.

SATO

Labels for components include: (K1-18), (K1-17), (K1-16), (K1-15), (K1-14), (K1-13), (K1-12), (K1-11), (K1-10), (K1-9), (K1-8), (K1-7), (K1-6), (K1-5), (K1-4), (K1-3), (K1-2), (K1-1), (K1-0), (K1-18), (K1-17), (K1-16), (K1-15), (K1-14), (K1-13), (K1-12), (K1-11), (K1-10), (K1-9), (K1-8), (K1-7), (K1-6), (K1-5), (K1-4), (K1-3), (K1-2), (K1-1), (K1-0).

K. HARSHA INDUSTRIES (Pvt) Ltd.
 6-205, 206, JEWELLRY CHOCOLATE, NEW DELHI-110007

SOLE AGENTS: **SALCO RADIO TRANSISTORS CO.**
 212, LAURENTIA, MARINE DRIVE, CHENNAI

Mastering the Soldering Art.. 3 Brilliant products from



**MULTICORE
SOLDERABILITY
TESTER**



**ROKEN WAVE SOLDER
MACHINES**

Soldering today is a high speed, complex process. Hundreds of bondings are effected in one single pass over a wave soldering machine. Single and Multilayer PCBs, Metal Clads, Plated through holes, Component leads, ICs, Micro-chips, all get involved in a dense pack circuitry.

To achieve Soldering perfection one must be sure of Solderability. Solder used and solder Machine employed.

BT Solders offer the finest product at each level.

MULTICORE SOLDERABILITY TESTER:

Manufactured by Multicore Solders Ltd., (U.K.); Microprocessor controlled with automatic print out; performs accurately.

- 1) Edge Dip Test (Ease of wetting)
- 2) Globule Test (Quickness of wetting)

3) Wetting Balance Test (Quality of soldering)

ROKEN WAVE SOLDER MACHINES:

Manufactured by
ROKEN ELECTRONICS (EUROPE) LTD., U.K.,
Compact versatile machine with Cast Alloy solder pot and pump, 4 carriers with infinitely variable speed control complete with Foam Fluxer, Timer and Temperature controls. Adjustable wave blocks for Multiple Wave Shapes.
ROKEN - for cost effective highest quality soldering.



Solder Wires Sticks & Fluxes:
Manufactured under collaboration with Multicore Solders Ltd. U.K.

Rosinol 5 core solder wire, sticks, Foam Fluxes, Solvent Cleaner for quick soldering, better wetting & perfection at every joint.

For your requirements write :

BT SOLDERS PVT LTD

37/4, Cunningham Road Cross, Bangalore-560 052 TEL : 76770 GRAM : 'ANUSANDAAN'

NEW CAPACITOR UNIT

India's first plant to manufacture 'flat type' ceramic capacitors was inaugurated by Gujarat Chief Minister Madhvasinh Solanki at Umbargaon in Valsad district recently. The Rs. 1.25 crore plant, set up by Gujarat Mulco Electronics, a joint venture of Mulco Electronics, Bombay and Gujarat Industrial Investment Corp. will manufacture 60 million pieces of ceramic capacitors a year when the production reaches full capacity in about three months. The conventional disc type capacitors will also be manufactured. A unique feature of the plant, according to GIIC, is that it will make the dielectric, the main raw material for manufacture of capacitors; unlike other capacitor manufacturers in the country who import it. Mr Manubhai M. Madhwani, chairman of Gujarat Mulco Electronics and head of the Madhwani group of Uganda, said the new venture would have no marketing problems since, according to him only 100 million pieces of capacitors were made in the country at present against an estimated annual demand of 240 million.

CONVERSION OF TV SETS NOT FEASIBLE

The Department of Electronics has asked the public sector electronic firms not to waste time and energy in experiments to convert black-and-white television sets into colour sets. It pointed out that such experiments were not techno-economically feasible. The conversions involved changing major components like the picture tube and involved an expenditure of more than Rs 3000/- a set. Such conversions were not competitive as an indigenously assembled colour TV set was available for about Rs 5500/-. It noted that none of the firms claiming to have developed conversion technology had come forward with commercial offers to undertake the job for the public. There was no technology involved in these conversions except part-by-part manual change, it added.

BEL LPTV TRANSMITTER

The first low power TV transmitter, developed by Bharat Electronics Ltd. (BEL) has been successfully evaluated and despatched to Doodarshan. This is one of the 69 low power transmitters which BEL will be supplying to Doodarshan for its crash programme to extend TV coverage to 70% of the country's population by the year end. BEL is also supplying

the technology for the exciters for low power transmitters to GCEL who are manufacturing the remaining LPTs required for the plan. ECIL and KELTRON are assisting BEL in this by supplying subsystems as per BEL's designs. Apart from the low power transmitters, BEL will be supplying 19 high power transmitters to Doodarshan during the next twelve months. During the current plan period BEL has delivered 9 high power transmitters and one medium power transmitter.

ELECTRONIC EXCHANGE FOR ONGC

A 200-lines microprocessor-based electronic private automatic exchange system, exclusively for the corporate communication of the Oil and Natural Gas Commission (ONGC), is to be switched on shortly. The Rs 40-lakh, 'total communication package' with voice and data transmission capability, was fabricated by British Physical Laboratories (BPL). The system will link up ONGC offices at Delhi, Bombay, Calcutta, Madras, Dehra Dun, Beroza, Nazeer in Assam and possibly Vishakhapatnam in view of the oil exploration in the Godevari basin. The system features conference facility which does not require the physical presence of the participants in one particular place and priority interrupt facility to enable ONGC's top brass to contact someone in the lower rung of hierarchy even when the latter's line is busy.

A SEATS BY COMPUTER

Indian Airlines has received its first consignment of terminal equipment to work in conjunction with the UNIVAC computer system for real time reservations. The airlines had placed an order with Uptron of around Rs. 72 lakhs in July 1983, of which equipment worth Rs. 27 lakhs was delivered in February end this year. This is expected to revolutionise the airlines reservation concept and result in on-the-spot reservations. Trial runs are expected to start shortly after the terminal system is put in line with the main computer for speedier and accurate information regarding airlines reservation on a national scale.

COMPUTER-LINKED STOCK EXCHANGE

India will be the first developing country in the world to have computer interlinking of stock exchanges when major stock exchanges will be interlinked by

computer in the near future, to facilitate a greater price interaction in traded scrips. When the system goes into full operation, it will display about 350 out of the 450-odd scrips traded in the market. According to Mr R.R. Nair, Research and Data Processing General Manager of the Bombay Stock Exchange, display time and frequency will be adjusted according to the classification of scrips from 'the most traded' to 'the least traded' scrips. To begin with, the interlinking will be confined to Bombay, New Delhi, Calcutta, Ahmedabad and Madras and extended to all the 12 stock exchanges in the country later. The installation and operation of the system will be handled by the Press Trust of India (PTI); the interlinking will be established via the P & T cables and, wherever possible, via satellites.

COMPUTERS FOR SCHOOLS.

India is likely to place an order for 500 computers and ancillary equipment from Britain for immediate installation in 250 schools as part of a major project in computer education. Britain's "microe in schools" computer teaching programme is likely to become the basis of a Rs 3 crores pilot project being organised by the departments of electronics and education. The Union government will also be having British software and teaching programmes for computer education in primary and secondary schools. The department of electronics plans to install equipment for computer education in 250,000 schools by the end of the decade.

INDIAN FIRMS BAG DEALS AT HANOVER

Business contracts have been signed between some Indian firms, now displaying their products at the Hanover fair, and foreign buyers.

Electronic companies have negotiated orders for telephones and equipment. A French firm has signed a deal for portable television sets. A Pakistani firm and buyers from West Germany and Denmark have ordered oscilloscopes and relays. Mr. Mohammad Yunes, chairman of the Trade Fair Authority of India, said many foreign delegates did not know that India was capable of making sophisticated goods.

microelectronics promises better TV pictures

The picture quality of television receivers can be greatly improved, and dormant possibilities realized, by the use of microelectronic memories. Philips of Eindhoven, the Netherlands, have developed, and are currently testing, an integrated circuit which can carry out the entire processing of the composite information for a television picture. The technique employed makes possible modifications to the video signal during processing. This would, for instance, mean the eradication of flicker, 'snow', and the cross-effects of inadvertent mixing of the brightness and colour information. Furthermore, the television memory offers the facility of stopping the picture at any moment, or zooming in on a detail of the image. It makes also possible the drastic shortening of the delay between teletext pages. The attraction of the chip is that it does not require any modification to either the receiver or the transmitter, which will simplify its introduction greatly.

The TV standard

The system for transmitting the TV picture information, the so-called TV standard, was established some 35 years ago for monochrome transmissions (black and white pictures). The choice of 625 lines per frame, and 25 interlaced pictures (frames) per second, was a compromise between the requirements of picture quality during normal viewing and technical and economical feasibility.

The choice of a frame frequency of 25 Hz (that is, 25 pictures per second) ensures a reasonably continuous movement and also minimizes interference from the 50 Hz mains supply. Interlacing provides 50 rasters per second (that is, a field frequency of 50 Hz), which is a compromise to prevent frame flicker at high brightness. The field frequency needs to be low enough to allow as many horizontal lines as possible and at the same time sufficiently high to eliminate frame flicker. Unfortunately, interlacing results, particularly with large screens, in line flicker.

The 625 horizontal lines which compose our TV picture cannot be seen separately at distances greater than 4...5 times screen height, which gives the impression of a uniform picture. Together with a height/width ratio of 3:4, and the requirement for good definition, this results in a video bandwidth of more than

5 MHz. This was considered acceptable both technically and economically, as was the bandwidth of 7...8 MHz for the transmitted signal (because there was then plenty of space available). This standard has been accepted throughout western Europe during the intervening years.

With the introduction of colour television, one of the first requirements was that colour transmissions could be received (without colour) on monochrome receivers. Throughout the world three systems have been developed for the decoding of the colour information, each of which has its own advantages and disadvantages, but they all are clearly a compromise which falls short of requirements under certain circumstances.

It is important, however, that in none of these systems has the required bandwidth been enlarged. Because the colour signal can be accommodated in a smaller bandwidth than the brightness signal, it is possible to contain the decoded colour information within the bandwidth of the black and white signal. This is normally acceptable, but may result in a mixing of the brightness and colour information. This then becomes evident in the cross-effects already mentioned.

Straitjacket

Although these standards for the TV signal were perfectly acceptable when they were laid down, technical developments since then have been such that these same standards are now often felt as a straitjacket. The larger screens and increased brightness of modern TV tubes in particular have given rise to this feeling. The 625 lines no longer give a sufficiently detailed image, while the 25 frames per second show a disturbing tendency to flicker.

Remedies

All these imperfections could, of course, be removed by changing the system. This would, however, require a network of new transmitters as well as new receivers. At the same time, compatibility with the old system would, of course, have to be retained, which again results in limitations. Moreover, such drastic measures would require international agreement, and this can be discounted for some time to come. Now, a number of improvements have become possible, which require access to the receiver only. These

make use of large electronic memories which contain all the necessary information for a complete video signal. New developments in microelectronics have enabled Philips researchers to realize an integrated circuit which is ideally suitable for use in a TV receiver. The use of normal computer memories would be more complicated and require more circuits. The chip now under test is a video memory with a capacity of 308 Kbit and an area of 34.8 mm², which is 2...3 times smaller than a comparable computer memory, and is therefore easier to develop and cheaper to produce. Such a large memory allows the increase of the field frequency from 50 to 100 Hz. The information on the even lines, which is transmitted in 20 ms, can then be stored in the memory. These lines are then repeated twice: the memory is therefore read twice in succession in 10 ms. This process is then repeated with the odd lines. This prevents field flicker, but not line flicker. Another method, providing alternate even and odd lines every 10 ms, prevents line as well as field flicker with still frames. This means, however, that a larger memory is required which can store the information for the entire video signal, that is, odd as well as even lines, in 40 ms. This will probably give difficulties with moving pictures because one has to fall back all the time on previous movement phases. Electronic means to combat this problem are being sought urgently. By using a memory in the decoding system it is also possible to reduce cross-effects and noise considerably. The signal processes by means of the video memory discussed so far are aimed at an improvement in picture quality. It is, however, also possible to realize new functions in the TV receiver. For instance, once the frame information has been stored in the memory, it is possible to stop the picture or zoom in onto some detail. It also becomes possible to remove the delay between teletext pages.

Philips press notice

World's smallest Microcomputer

The smallest self-contained CP/M compatible microcomputer in the world has been launched by DVW Microelectronics Ltd. of Coventry. Weighing just over 1 kg and the size of a paperback book the Husky Hunter offers advanced microcomputing power in a package that can be carried anywhere. It has the

largest RAM memory of any portable on the market, say the makers.

The computer's CP/M compatibility enables the user to select from the vast range of commercially available CP/M programs developed for desktop computers or to write a program in the machine's own interpretive Basic programming language. An eight-line 320-character LCD screen acts as a window on a larger 'virtual' display that emulates popular CRT terminals and this enables application software designed for desk-top systems to be operated without modification. The user can move this display window around the screen at will. A memory of up to 208 K provides a resource equivalent to that of traditional disc drives, without their bulk, weight or fragility. This memory, up to ten times that of other hand-held micros, makes the device suitable for many professional applications.

The micro is the only hand-held device with genuine graphics capability, says the manufacturer. Its large screen (240 x 64 dot) is able to draw complex graphic and animated pictures and show text presentations with variable character size and field constructions. Facilities include synchronous and asynchronous protocols and the implementation of the standard IBM 2780 bi-sync format means that the micro can 'talk' to at least 70% of the world's mainframe computers without intermediate hardware.

Designed to be used in the field, the micro has a robust diecast aluminium alloy case, sealed against moisture and immersion. The keyboard has 54 rubber keys arranged in four rows which are fully waterproof. There is a

choice of four mains-rechargeable Nickel/Cadmium batteries with an average 14-hour operating life, or alkaline batteries and there are back-ups charged from the main cells. The complete unit weighs 1.15 kg and measures 216 mm x 156 mm x 32 mm.

Made in Britain

First undersea fibre optic cable

Cable for the world's first undersea optical fibre link, between the UK and Belgium, is to be manufactured by Britain's Standard Telephones and Cables (STC) company under a contract worth £7,250,000. The cable, which will be able to carry nearly 12,000 telephone calls and digital computer data, is to be laid in the spring of 1985 by British Telecom's cable ship 'Alert'.

Three pairs of optical fibres will each carry digital information at speeds up to 280 Mbits per second, giving a capacity of 3,840 64 Kbits per second circuits, and total cable capacity of 11,520 circuits. Use of single-mode transmission enables a single ray of laser light to travel a greater distance along the cable before regeneration is needed at a repeater. Three submerged repeaters will be installed at intervals of about 30 kilometres along the 122 kilometres between terminal stations.

Half of the investment for the cable link, called UK Belgium 5 because it is the fifth cable link between the two countries, is made by British Telecom International. The remainder comes from three telecommunications authorities — those of Belgium and the Netherlands together with

Germany's Deutsche Bundespost. The cable is the result of co-operation between British Telecom's research laboratories at Martlesham Heath and STC's research laboratories at Harlow, near London, where investment in optical fibre research and development has been maintained at consistently high levels over recent years.

STC has already been awarded orders worth nearly £40,000,000 by the consortium of 28 telecommunications authorities which is to install a transatlantic cable (TATB) going into operation in 1988. The contract covers supply of a 520 kilometre segment from Widemouth Bay on England's south-west coast, to a junction box just off the European continental shelf.

LPS.

Full-channel teletext gives fast access

A teletext system having up to 16 000 pages of information and giving access in as little as 16 ms has been developed by Jasin Electronics Ltd. of Leicester. The system uses the whole television channel bandwidth, unlike the systems employed in conjunction with regular television broadcasts in which data are transmitted in the otherwise redundant lines between frames. The specifications of full-channel teletext are standard and therefore the system can be used alternatively for conventional television programmes if necessary. Maximum access time is 1 second per 1000 pages, although for certain individual pages, access takes as little as 16 ms.

The company is prepared to design and install systems for any purpose and to any specification. Most users in the UK are large organisations which need to disseminate information rapidly. (One of the earliest and most typical installations was at London's Heathrow Airport.) Pages can be created easily in full colour with graphics. Not all the pages in a system need to originate in the same studio; pages may be compiled from several locations. Other teletext services, such as those provided by broadcasting services, may be incorporated into the full-channel system.

Full-channel teletext systems can include feedback from the receivers. This makes possible such facilities as customer authorisation and billing, message services, ordering of goods and services and travel reservations.

Made in Britain.



At the right a floppy disc drive unit. At the left the optical memory drive unit OPTIMEN developed by Shugart, which was unveiled in prototype form in the USA towards the end of 1983. Anticipated cost of production models (if they appear in the next 12 months): about \$6000!

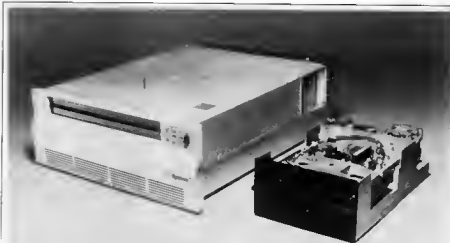

Optical memories

electronic filing cabinets

Beethoven's Fifth and Schubert's Unfinished are nowadays available on compact disc, the optical audio-memory. It is a curious fact that the compact disc has appeared so much earlier than optical memories for computers, although not so long ago the latter were expected to be first on the market. But here we are today with the compact audio disc reasonably well established but with no indications as to when optical computer memories will appear on the market. Even the most optimistic prognoses from the industry contain no hints whatsoever, although there have been murmurs that a read-only optical memory may appear on the American market during 1984 at a cost of around 6000 dollars.

As you may remember, the history of large-quantity data storage began with punch cards, punched tape, and the magnetic core memory. Then came the

magnetic film store, the magnetic disc, and the magnetic drum. Nowadays, the most widely used memory is that based on magnetic tape. Operation of this memory is reasonably well-known, as it is basically the same as that of tape and cassette recorders. Figure 1 shows the operation of a magnetic tape memory in schematic form: only one track is shown, although in most equipment nine tracks (that is, the same number as there are read/write heads) are available. The capstan is located immediately next to the read/write head. The light barriers in the vacuum guidance ensure that the tape loops are correctly positioned. Should their position change, the tape is wound or unwound slightly until the loops are back to normal. The photocells 'recognize' the beginning and end of the tape.

Apart from magnetic tape, there is also the magnetic drum. This type of memory consists basically of a cylinder coated with magnetic material. The surface area of the cylinder is divided into tracks. Each track has its own read/write head.

The classical magnetic disc is made of aluminium which is coated with a layer of magnetizable iron oxide. The data are recorded (written) on, and retrieved (read)

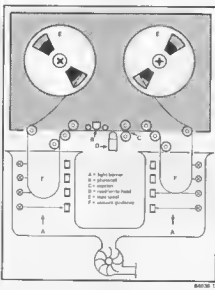

Figure 1. Magnetic tape belongs to the family of 'magnetic cost' memories. The magnetic tape memory functions basically as a multi-tape machine.

from, circular tracks. The flexible magnetic disc, called floppy disc, is used principally by hobbyists and in small office equipment.

Of late, everybody has been talking about the Winchester disc. This is a memory with extremely high storage density and capacity. In contrast to the classical magnetic disc, it has one smooth side, but functions in all other ways in an identical manner. The magnetic head lies on the disc when this is at rest. When the disc starts to rotate, however, the head, because of its shape, rises and floats above the moving surface at a height of about $0.5 \mu\text{m}$.

Optical memory

In optical systems, the disc is scanned by a laser beam, as, for instance, the compact disc and the video disc. The video disc is made of perspex which is coated with a thin layer of photosensitive lacquer. The disc is then pressed against a master which produces a spiral track of indentations, called pits, as shown in photo 1. It is then exposed to ultraviolet light to harden the photo-resist. Subsequently, it is loaded into a vacuum chamber where it is immersed in aluminium vapour for about 30 minutes. This vapour produces a fine reflective coating on the disc. Finally, the disc is coated with a protective layer of clear lacquer. During play-back, the track is scanned by a laser beam starting at the centre and moving to the periphery. The laser light is bent and deflected at the edges of the pits to such an extent that it is no longer detected by the photodiode. For all practical purposes, the light of the laser beam is thus intensity-modulated by the pits. The laser light is polarized linearly, so that the beam reflected by the disc and the primary beam are well separated. This type of memory is evidently not of much interest to the hobbyist, as it is similar to a PROM.

So, what advantages can we expect from optical memories? The answer to that question is contained in the following description of two systems which are to be launched this year.

MEGADOC

The MEGADOC optical memory system has been developed by Philips of Eindhoven, the Netherlands, who also pioneered the compact disc and the video disc. The system is intended to be launched at this year's Hannover Fair. The basis of the system is a 12-inch diameter disc with a storage capacity of 1 Gbyte per side. This enables the recording of the contents of 80 000 A4 size pages on one side!

The MEGADOC system consists of a disc drive unit, monitor screen, facsimile printer, and the memory unit which can hold up to sixty-four optical discs. Such a complement would enable the recording of more than six million A4 size pages. According to the manufacturers, the

MEGADOC system offers the following advantages:

- very high storage capacity and density;
- fast and simple recording of documents;
- unimpaired high quality of retrieved information;
- fast location of wanted data.

Apart from the hardware, there will, of course, also be a software package for the control and operation. No doubt, the system will be of great interest to public records offices, financial institutions, insurance companies, large multinationals, libraries, and all other organizations which maintain large archives.

OPTIMEN

This system, developed by Shugart, is very similar to that of Philips. It also uses a

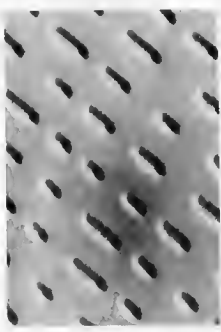

Photo 1. The surface of a non-erasable optical memory disc.

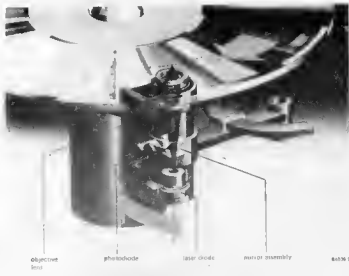

Figure 2. Optical memory discs are scanned and written by a laser beam. The structure of such a disc is shown in photo 1.

Figure 3. The collection and telescope lens assemblies focus the light emission of the laser diode. Correction prisms shape this to an annular beam. The routing mirror assembly deflects the beam through a polarizing beamsplitter/ $\frac{1}{4}$ plate assembly, where the plane of polarization is shifted 90° . The beam then finally arrives at the objective lens. The reflected light is taken from the objective lens, aligned parallel, and falls onto the $\frac{1}{4}$ plate. The plane of polarization is again shifted 90° , and the beamsplitter directs the light to the focus error prism. The detector provides the control signal for head adjustment.

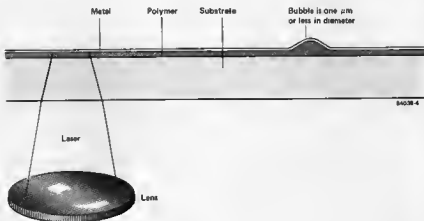
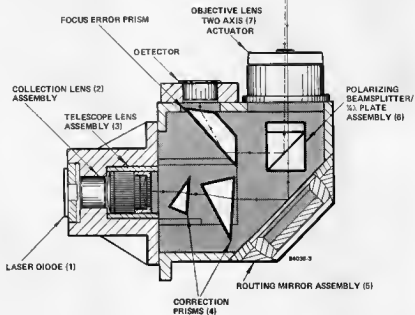

Figure 4. A bubble arises where the laser beam hits the surface of the optical memory disc. Such a bubble represents a bit.

12-inch diameter disc with a storage capacity of 1 Gbyte per side. The laser used is a gallium-aluminium-arsenite type which produces a coherent light beam with a capacity of 20 mW. The beam is focused into a point of only about $1\ \mu\text{m}$ by a special lens (see figure 3). This results in a storage density of 14500 bits per inch, which is similar to that of magnetic memories. The advantage over magnetic memories is, however, that the storage density is also the track density. Table 1 shows that in this way a surface density some seven hundred times that of an 8-inch floppy disc can be obtained! During the storing of the data, the write head (that is, the optical system) focuses the point of light onto the metallic surface of the disc. The laser beam heats the

metal and the ensuing heat is transferred to the acrylic material underneath the metallic layer. This causes a bubble which can be read by the laser (see figure 4).

CD-ROM

Optical memory techniques offer the possibility of mass reproduction of software. Philips and Sony are therefore already working on the basic model of a CD-ROM. This is a combination of the compact disc, redeveloped as a digital device, and a ROM. The capacity of such a digital disc is of the order of 550 Mbyte, which is about five-hundred to a thousand times larger than that of a floppy disc! In other words, this makes it possible to store 120 000 A4 size pages onto one

compact disc. Such a digital disc could be read on a modified compact disc machine which would at last make an inexpensive high-capacity memory available for popular use. Unfortunately, this is a little while off yet.

Floppy disc replacement?

We should not forget to mention that further development of the floppy disc is also taking place. At the end of 1982, Toshiba of Japan presented a 3-inch floppy disc with a storage capacity of 3 Mbyte per side! In contrast to the conventional longitudinal magnetization of the disc, the Toshiba disc is vertically magnetized by means of an annular magnetic head. Unfortunately, this interesting technique appears to have died a natural death.

A similar situation exists around the development of an erasable optical memory disc. Also at the end of 1982, Philips presented the laboratory prototype of a 5-cm disc drive mechanism. This has so far come to nothing owing to lack of standards for optical drive mechanisms. The Philips project is based on a magneto-optical memory with thermo-magnetic storage. The principle of this conception is best explained with reference to figure 5: it makes use of so-called rare earths of which the magnetic properties are temperature-dependent. As in the OPTIMEM system, a laser beam heats material but here it causes a magnetic field to be produced. This changes the direction of magnetization. After the spot has cooled off, the magnetic state persists. You could, for example, define this as a logic '1'. If the data is to be changed, that is, erased, the same spot is again heated by the laser beam, a magnetic field arises, and the original direction of magnetization is resumed. Reading of the data is made possible by the use of the magneto-optical Faraday effect: when the laser beam hits the data location, the direction of polarization of the light changes. This direction is ascertained by the analyser and converted into a logic '1' or '0' by a detector. This memory holds only 10 Mbytes. The read rate is of the order of 250 Kbits/s, while writing takes place at a speed of about one bit per 3 μ s.

Systems similar to that of Philips have been developed in Japan by Sony and Kokusai Denshi Denwa. About six months ago, these companies revealed prototypes of a 30-cm disc which can store up to 30 Gbit. These systems function in the same way as that of Philips, but the discs are coated with different materials. Before you rush to your local electronics dealer, we should point out that, unfortunately, there is as yet no suitable hardware on the market, and at the time of writing no information could be obtained as to when production is likely to start. None the less, we remain optimistic and look out for the first erasable 5 Mbyte optical memory for hobbyists.

Table 1

Comparison of surface densities

	bpi	tpi	surface density
DS/DD-8-inch-Floppy	6 800	48	0.3×10^6
5.25-inch-Winchester	8 800	800	7.0×10^6
IBM-3390-Technik	15 200	800	12.2×10^6
OPTIMEM 1000	14 500	14 500	210×10^6

bpi = bits per inch
tpi = tracks per inch

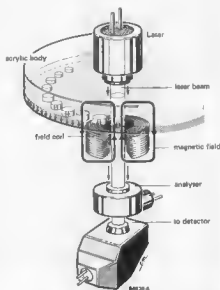

Figure 5. Erasable optical memory discs utilize the thermo-magnetic properties of so-called rare earths. The direction of magnetization shifts when the laser beam heats the material which lies in a magnetic field.

Photo 2. MEGADOC, the 'electronic filing cabinet', which is to be introduced on the Hannover Fair 1984 by Philips, pioneers of the optical disc.



A look at the technical specifications of certain diskette units will show that the MTBF (Mean Time Between Failures) indicated by the manufacturer is only valid as long as the drive motor only runs for a fraction of the total operating time. The interface published by Elektor has no way of operating the motor for only a short time. The circuit proposed here enables the motor to run only when the floppy disk drive is selected, and it is stopped again about a dozen seconds after the unit is deselected.

controlling the floppy disk drive motor

increase the
lifespan of
certain diskette
units

The floppy disk interface for this Junior Computer published in Elektor (UK) 91, November 1982, was a perfectly feasible and affordable disk drive, but it did not allow the drive motor to be stopped, even when the floppy disk was not being accessed. This certainly makes the access time as small as possible, as there is no delay while waiting for the speed to stabilize, which is necessary every time the motor is started from rest. It could, however, be expected to reduce the longevity of both the motor and the diskettes themselves since the read head is permanently in position.

On a second before and twelve seconds after

When pin 16 of the connector on a floppy disk drive is logic 'low', the drive motor turns. It does not instantaneously reach its operating speed, of course, so the addressing signal (SEL) cannot be used as a DRIVE MOTOR ENABLE or the first few pulses written to or read from the diskette would be useless. Furthermore, this method of operation switches off the drive motor as soon as the unit is deselected, and this is a disadvantage if the unit is accessed several times in quick succession.

1

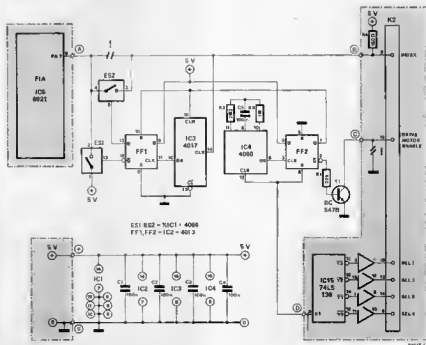

Figure 1. The first index pulses are inhibited by IC3, FF1 and ES2. The other components make the motor run when a unit is selected, and keep it running for about twelve seconds after the diskette has been deselected. This prevents time being wasted when the floppy disk drive is accessed several times in quick succession. Also, the whole circuit can be disabled by connecting the line between the CLR of IC4 and the R of FF2 to the positive supply, via a switch for example.

It would be far better if the motor continued to rotate for a short while. These considerations lead us to the circuit shown in figure 1, whose key is switch ES2 (and its 'shadow' ES1) driven by flip-flop FF1, which is itself controlled by counter IC3. When a peripheral unit is to be activated, signal G1 (pin 6 of IC15 on the interface) goes high. This signal initializes counter IC4 and flip-flop FF2, whose Q output also goes high. Switching transistor T1 is saturated and pin 16 of connector K2 goes low so the motor selected starts to run. Then the first index pulses arrive, but they are not stable. These do not reach the interface as ES2 is open. The first five pulses are counted by IC3 and then its Q4 output goes high. This causes FF1 to flip and PA7 receives the index pulses, which have now stabilised, via ES2.

During this time, IC4 and FF2 remain initialized. As soon as the unit is deselected, signal G1 goes low again and IC4 begins to count the pulses provided by its own oscillator. About 12 seconds later, output Q6 of the 4060 is activated, causing FF2 to flip and T1 switches off. The motor of whichever unit was selected then stops. At the same time, a logic 'high' appears at the Q output of FF2 to reset counter IC3 and flip-flop FF1. The result is that ES2 opens and ES1 closes, and the cycle is then complete.

The possibilities

The 'after' time can be changed by modifying the value of the RC network forming the time-base for the 4060 (note that $R3 = 2 \dots 10$ times $R2$). The length of the 'before' time can also be changed by reducing or increasing the number of index pulses counted before ES2 is closed. All this requires is to connect pin 11 of FF1 to some output of IC3 other than Q4.

If only the motor for the unit selected is to run, a switching transistor (like T1) could be included per selectable unit, and this would be controlled by a NOR gate (4001) that combines the Q signal of FF2 and the appropriate selection signal, SEL 1 ... 4. This implies, of course, that line 16 (Drive Motor Enable) cannot be common, but must have a separate line for each unit in service.

The modifications required on the printed circuit board for the interface card are shown in figure 2. The line between pin 8 of connector K2 and pin 9 of IC3, and the line between pin 16 of K2 and earth, must be broken. Don't forget to remake the connection from earth to pins 6, 8, and 10 of IC12 and capacitor C11. When the circuit from figure 1 has been made up, on a piece of veroboard, for example, it must be connected to the interface printed circuit board at points A ... D and '+' and '0'.

A few hints

The best way of making a neat break in

2

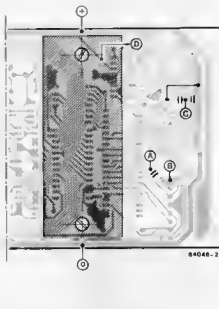

controlling the floppy disk drive motor

Figure 2. When the circuit of figure 1, built on a piece of veroboard or something similar, is fixed to the track side of the floppy disk interface printed circuit board, it is unlikely to interfere with any other boards on the bus. Having broken the connection to ground at pin 16 of the output connector, don't forget to remake the links to the appropriate components.

3

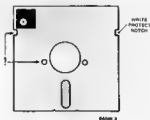

Figure 3. The reverse side of a single-sided floppy disk can also be used if a write protect notch and an index hole are carefully cut in the dust cover in the same relative positions as the existing ones.

the track on a printed circuit board is also the least dangerous for the neighbouring tracks. All that is needed is to make two clean cuts in the copper, spaced about one or two centimetres apart, and then heat this until it lifts. And while we are on the subject of tips, here is another: a single-sided diskette is often magnetised on both sides and there is no reason not to use the reverse side, except, of course, that a second write protect notch must be cut and another index hole added (with a perforator or paper punch) in the diskette's dust cover. By the way it is not a good idea to try to remove the diskette from its cover! Great care must be taken to avoid scoring, or otherwise damaging, the floppy disk surface. These modifications will be simplified by first making up a template, as shown in figure 3. Then, after a few minutes work, your stock of diskettes will have become doubly useful and doubly important.



An electronics home workshop is usually started with a universal meter. Then follow a variable (regulated) power supply, a sine wave generator, and an oscilloscope. After that, who knows? There are hobbyists' workshops which would make many a professional green with envy. It is, however, fairly certain that among what follows is a pulse generator which is virtually indispensable when you work with digital circuits.

pulse generator

A pulse generator, like every measuring instrument, must be of good quality, and this is one of the starting points of our development described. Reliability, without exotic frills, and operating facilities for coping with most imaginable requirements, are others. To start with, however, a recap of pulse terminology which may refreshen many a memory!

A *pulse* is a voltage or current which increases from a constant value to a maximum and decreases back to the constant value in a comparatively short time. The constant value (which may be zero) in the absence of a pulse is called the *base level*. A pulse may be *rectangular*, *triangular*, *square*, *sawtooth-shaped*, and so on.

The portion of the pulse that first increases in amplitude is the *leading edge*. The time interval during which the leading edge increases between ten and ninety per cent of the pulse height is called the *rise time*. The pulse decays back to the base level in a finite *decay time* between the same limits as the rise time. The major portion of the decay time is termed the *trailing edge* of the pulse. The time interval between the rise time and decay time is the *pulse width* (sometimes called *pulse duration*). The amplitude of the pulse taken over the pulse width is the *pulse height*.

Features

■ pulse REPETITION TIME

1 μ s
10 μ s
100 μ s
1 ms
10 ms
100 ms
1 s

VAR: 0.1 ... 1(CAL)

MANual trigger
EXtErnal trigger (2 ... 20 V)
jitter \leq 0.5% (at PRT = 1 ms)

■ PULSE WIDTH

1 μ s
10 μ s
100 μ s
1 ms
10 ms
100 ms
1 s

VAR: 0.1 ... 1(CAL)

SYMMetrical
jitter \leq 0.1% (at width of 1 ms and duty factor = 80%)
duty factor variable up to 100%

■ OUTPUT voltage

TTL
VAR (1 ... 15 V)
EXtErnal OUTPUT CONTROL
VOLTAGE (1 ... 15 V)
choice of inverted and non-inverted output signal

■ CONTROL ERROR indication

■ SYNC OUTPUT (TTL)

■ TRIGGER INPUT (20 V max)

■ rise time about 10 ns (load = 50 Ω in parallel with 33 pF)

A group of identical pulses is a *pulse train* which is normally named, according to the type of pulses it contains, square wave, triangular wave, sawtooth wave, and so on. The time interval between corresponding portions of the pulses in a train, for instance, the decay times, is the *pulse spacing* or *pulse-repetition period*, T . The *pulse-repetition frequency* or *pulse rate* is the reciprocal of the period (that is, the rate at which pulses are transmitted in the train) and is measured in hertz.

The *duty factor* (NOT duty cycle!) of a pulse train is the ratio of the average pulse width to the average pulse spacing in a train and is normally expressed in per cent. A rectangular pulse train is often erroneously called a square wave: it becomes a square wave only, however, when the duty factor is fifty per cent.

A *spike* is an unwanted pulse of relatively short duration superimposed on the main pulse; *ripple* is unwanted small periodic variations in pulse height. *Jitter* is minor variations in the pulse spacing.

The pulse generator described here produces rectangular pulses or waves. The pulse rate as well as the pulse width are variable. Such a generator is basically quite simple as shown in figure 1 and consists of three main parts: a voltage-controlled oscillator (VCO), a monostable multivibrator (MMV), and an amplifier. The VCO generates pulses at a rate which can be varied over a wide range. These pulses are used to trigger the MMV. If the mono-period of the MMV is variable, the pulse width may be varied at will. The amplifier raises the output pulses of the MMV to the required height, and that's all there is to it!

Two additional facilities indicated in figure 1 should, in our opinion, be fitted to each and every pulse generator however simple: external trigger input and manual mode. The latter enables single pulses to be generated by pressing a spring-loaded push-button. A three-position switch enables selection of the three modes: VCO, external trigger, and manual.

The concept

To be sure, an instrument as shown in figure 1 is somewhat spartan, and some other very desirable, if not necessary, facilities have therefore been added: these are partly technical necessities because we have painted the picture in figure 1 a little too simple, and partly niceties which make using the generator a little easier.

The technical necessities concern the variability of the VCO and MMV. It is, unfortunately, not possible to achieve a sufficiently wide range of pulse rates and pulse widths with just one potentiometer. A switch and a potentiometer form a minimum combination and this has far-reaching consequences on the design of the VCO.

Of the 'niceties', we would mention the

1

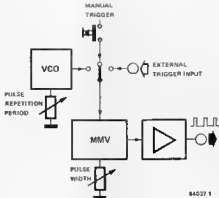

pulse generator

Figure 1. A pulse generator in its simplest form: the VCO enables setting the pulse repetition period and the MMV the pulse duration.

variable output voltage which is normally not provided on inexpensive generators; a switch which sets the output voltage to TTL level; and finally, a facility to make the output voltage identical with the supply voltage of the circuit under test which is a very convenient feature for testing CMOS circuits which do not operate from 5 V.

Next, we felt it would be useful to provide selection of inverted and non-inverted output pulses, and of variable or fixed (50 per cent) duty factor. Finally, there is an indicator for operational errors, and a separate sync output (TTL level) which is intended for use as a trigger signal for an oscilloscope or as drive signal for an eventual frequency read-out.

The block schematic

Adding these additional features transforms the block schematic of figure 1 to that shown in figure 2.

The VCO should have a fairly wide operating range which can be achieved by either switching the VCO itself or by a chain of dividers in the VCO output. As can be seen, we opted for the dividers. The VCO is controlled by potentiometer P1 which enables the VCO output period to be varied between 0.1 μ s and 1.0 μ s. This output is fed to six cascaded decade scalars. With P1 in position I(CAL), that is, a VCO output period of 1.0 μ s, REPETITION TIME selector S1 enables the selection of pulse periods of 1 μ s ... 1 s in decadic steps. Periods between these steps may be set by P1. Selector S1 also enables selection of MANUAL pulses and an EXTERNAL trigger signal. The manual pulses are generated by flip-flop FF2 when spring-loaded switch S2 (MANUAL) is pressed. The external TRIGGER INPUT signal is provided via amplifier T1/N1. As the output of the VCO is a pulse train (often called wave) with a duty factor of 50 per cent, a square wave is available at the wiper of S1 and thus is, of course, a perfectly suitable SYNC OUTPUT (TTL) signal. It is also applied to a monostable multivibrator (MMV) which provides the

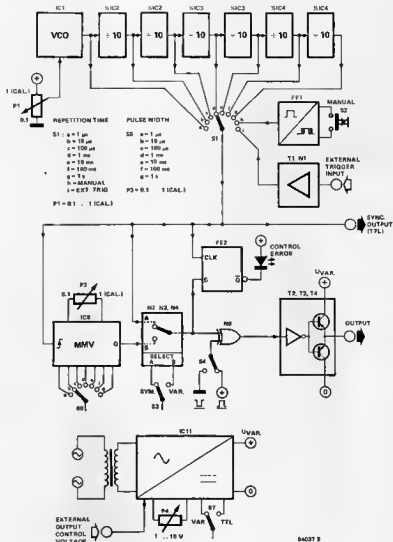

Figure 2. The block schematic of the pulse generator described in this article. The designations correspond with those in the circuit diagram.

variable pulse width. The MMV is fired by the leading edge of each pulse in the wave emanating from S1. The pulse duration may be varied between 0.1 μ s and 1 s by PULSE WIDTH selector S5 and potentiometer P3. The output signal of the MMV, together with the square wave from S1, is fed to an electronic switching circuit, N2...N4, from where either a square wave (SYM) or rectangular wave (VAR) may be selected by S3. The signal is then taken to XOR gate N6 which enables selection of inverted or non-inverted signals by S4.

The output stage, T2...T4, ensures that the TTL level of the output signal can be converted into a variable or externally controlled level. This is effected by IC11 in the power supply. The IC provides the output stage with a variable supply voltage which is controlled by an external voltage, or by potentiometer P4, or by VAR/TTL selector S7. When S7 is in position TTL, the output voltage is about 4.8 V,

while in position VAR it may be varied between 1 and 15 V by P4. When an external control voltage is connected, the output voltage is identical to it. When, for instance, work is being carried out on a CMOS circuit, it is sufficient to connect the supply voltage of that circuit to the EXT. OUTPUT CONTROL VOLTAGE.

Flip-flop FF2 is a divider circuit which detects and signals operational errors by the CONTROL ERROR indicator LED. This happens, for instance, when a longer pulse duration is selected (S5) than is possible with the pulse period selected (S1). As the circuit diagram is not much different from the block schematic for this circuit, it's as well to describe the operation here.

During normal operation the \bar{Q} output of FF2 is logic 1. The flip-flop is clocked at each leading edge of the MMV signal, because its D input is connected to the Q output of the MMV (provided S3 is in position VAR). This leading edge arrives

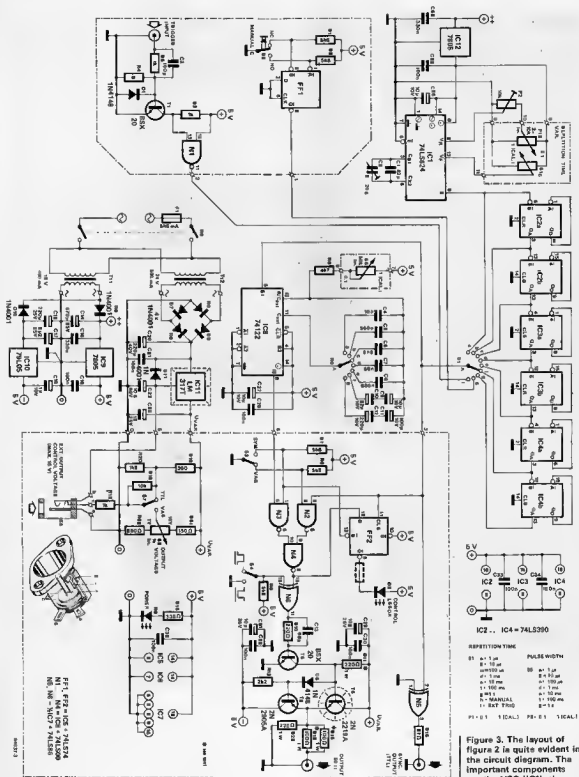
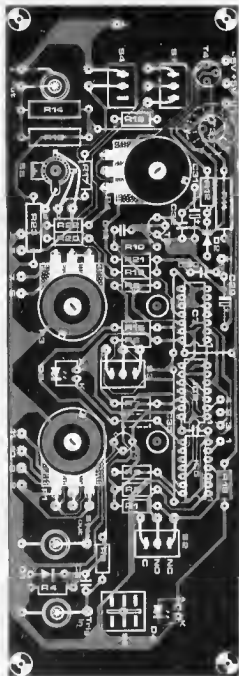
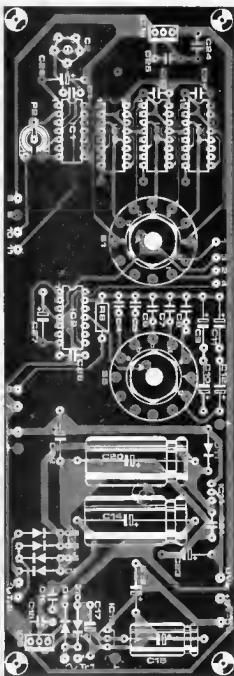

Figure 3. The layout of figure 2 is quite evident in the circuit diagram. The important components are the VCO (IC1), the decade scaler (IC2...IC4), and the MMV (IC5). A clever power supply provides a variable output voltage



slightly later than that of the sync output signal at the CLK input of FF2. At the instant the CLK input becomes logic 1, the D input is still logic 0; the Q output therefore remains high and the LED stays extinguished. If the selected pulse duration is longer than the pulse period, the output of the MMV (and therefore the D



input of FF2) will still be logic 1 when the next clock pulse arrives at FF2. The flip-flop then changes state and the LED begins to blink indicating that an error has been made. With S3 in position SYM, this type of error cannot occur because the D input of FF2 then always goes logic high after the CLK input.

Parts list

Resistors:

R1,R2,R6,R7,R9 = 5k
 R3,R4,R5,R17 = 1 k
 R8 = 4k7
 R10 = 220 Ω
 R11,R23 = 220 Ω /1 W (not wire-wound!)
 R12 = 2k2
 R13,R14 = 100 Ω /1 W (not wire-wound!)
 R15 = 47 Ω
 R16 = 330 Ω
 R18 = 10 k
 R19 = 390 Ω
 R20 = 1k5
 R21 = 150 Ω
 R22 = 680 Ω

Capacitors.

C1 = 82 p
 C2 = 2...20 p (trimmer)
 C3 = 100 p
 C4 = 10 p
 C5 = 560 p
 C6 = 8n8
 C7 = 68 n
 C8 = 680 n
 C9,C26,C27,C31 = 10 μ /10 V
 C10 = 22 μ /10 V
 C11 = 100 μ /10 V
 C12 = 220 μ /10 V
 C13 = 68 pF
 C14 = 470 μ /25 V
 C15 = 220 μ /25 V
 C16,C24 = 330 n
 C17 = 2 μ /25 V
 C18,C21,C25,C28,C30,C32...C35 = 100 n
 C19 = 1 μ /10 V
 C20 = 220 μ /40 V
 C22 = 10 μ /40 V
 C23 = 1 μ /25 V
 C29 = 10 μ /25 V

Semiconductors

IC1 = 74LS624
 IC2,IC3,IC4 = 74LS390
 IC5 = 74LS74
 IC6 = 74LS00
 IC7 = 74LS96
 IC8 = 74122 (not LS!)
 IC9,IC12 = 7805
 IC10 = 79L05
 IC11 = LM 317T

Figure 4. The circuit has been divided over two printed-circuit boards: the one illustrated here contains the parts of the circuit in dashed lines.

Figure 5. This board contains the remainder of the circuit. To ensure good stability it has been made double-sided: the large copper area at the components side is an earth plane.

T1, T2 = 8SX 20
 T3 = 2N2219A
 T4 = 2N2906A
 D1, D2 = 1N4148
 D3 = flashing LED
 D4 = LED
 D6 . . . D11 = 1N4001

Potentiometers & switches:

P1 = 10 k lin. stereo
 P2 = 10 k preset
 F3 = 50 k lin.
 P4 = 1 k lin.
 S1, S5 = 12-position,
 1-pole, rotary switch
 S2 = push-button, change-
 over contact
 S3, S4, S7 = single-pole
 change over switch
 S6 = double-pole mains
 switch
 S8 = integral with jack
 socket (see below)

Miscellaneous:

Tr1 = mains transformer,
 secondary 12 V/400 mA
 Tr2 = mains transformer,
 secondary 24 V/400 mA
 F1 = fuse, 500 mA, delayed
 action
 3 BNC round chassis
 sockets panel mounting
 1 jack socket with integral
 change-over contact
 2 heat sinks for IC11 and T3
 Vero case, 205 x 140 x
 75 mm, code 75-1411D
 Printed-circuit boards
 84037/1 and 84037/2
 Front panel foil 84037/F

Figure 6. This front panel
 layout is available as a
 self-adhesive foil through
 the EPS service. It is, of
 course, not essential for
 the operation, but
 aesthetically right.

The circuit diagram

As we have already gone through many details in the description of the block schematic, analysis of the circuit diagram in figure 3 will be quite brief.

At the top left is the VCO, IC1, which obtains its drive voltage from IC12, a voltage regulator type 7805. At the top centre is the chain of decade scalars, IC2 . . . IC4, while the MMV, IC8, is located in the centre of the diagram. Stepped adjustment of the pulse duration is effected by switched capacitors C4 . . . C12. At the right of the MMV you see the three NAND gates N2 . . . N4 which, together with S3 enable the switching between square-wave and rectangular-wave output. At the extreme right you'll find the EXOR gate N6 and pulse inverter switch S4, followed by the output stage consisting of T2 . . . T4.

At the bottom is the power supply complete with output voltage control (S7 and P4) and the input for the external control voltage (S8).

The remaining parts of the circuit are error detector FF2 with indicator LED D3, MANUAL push-button S2 with debounce flip-flop FF1, and the pre-amplifier for external trigger signals consisting of T1 and N1.

A note about the VCO: its pulse repetition frequency is controlled by a stereo potentiometer, P1, the two halves of which are connected in opposition. This enables the VCO output to be adjusted over a range of a decade, which would be impossible with a single potentiometer.

The MMV is an IC type 74122 (NOT a 74LS122) which allows a duty factor of up to 100 per cent. As the pulse duration is variable down to 0.1 μ s, the 74LS122 would be working at the limit of its capabilities. A few notes about the power supply. To

obviate cross-effects, the supplies to the various sections of the generator have been kept separate wherever possible. For instance, IC1 has its own regulator, while the supply to the MMV is taken from regulator IC9 by independent lines.

The output stage has a separate supply, the voltage level of which may be adjusted with P4 if S7 is in position VAR; in position TTL the supply voltage is fixed at about 4.8 V. The level set by P4 is about 1.25 V above that of the desired output voltage: this is so arranged to compensate for the voltage losses in the output stage. The input socket for the external drive voltages is provided with a change-over contact, S8. As soon as a plug is inserted into the socket, S8 opens, so that the external voltage is applied to the centre terminal (c) of the socket. The output voltage of the generator is then identical to the external drive voltage plus the compensating voltage of 1.25 V.

The printed-circuit boards

The generator uses two printed-circuit boards (figures 4 and 5) which, together with the front panel, form a three-tier sandwich (see figures 7 and 8).

The sections of the circuit diagram (figure 3) contained in dashed lines are located on the front pc board (figure 4), the remainder on that shown in figure 5. The latter is a double-sided board, so that the components side functions as a large earth plane.

With the exception of the three BNC sockets and the mains transformers, all components, inclusive of the switches and the potentiometers, are mounted directly onto the boards. Switches S1 and S5 are soldered onto the rear board (figure 5), whereas the remaining switches and the

6

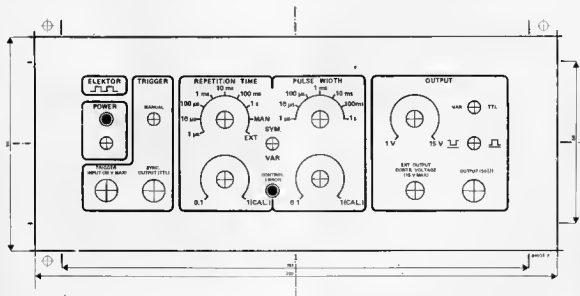

potentiometers are mounted onto the other board. Suitable holes have been provided in the front board to allow the spindles of S1 and S5 to pass through. Note that the screw thread of the switches and potentiometers should not protrude more than necessary (about 3...4 mm) to prevent difficulties during the mounting of the front panel.

A number of components have to be soldered at both sides of the rear board: this is in all locations where no isolating islands have been provided in the copper at the component side.

An extra hole has been drilled beside pin 8 of IC2...IC4: this serves to pass a piece of blank wire with which the two sides should be electrically connected together.

Keep the connections of the components on the double-sided board free of the earth plane unless, of course, they should be connected to earth.

All points on the double-sided board which are to be connected to the other board should be provided with pc half pins; those for the transformer connections are best fitted at the track side. DO NOT fit pc pins to the other board to prevent your running into difficulties during the final assembly.

Voltage regulator IC11 must be mounted at the track side of the double-sided board with its heat sink and spacers! (see figure 6). Because of possible space problems, it is best to fit C11 and C12 also at the track side of the board.

Make sure that the metal housing of P1 and P3 is in good contact with the earth plane.

Because of cooling requirements, mount R13 and R14 floating (about 5 mm) above the board.

LEDs D3 and D4 must be mounted such that they can be pushed, housing and all, through the hole provided below the relevant terminals. If you use a normal instead of a flashing LED, the wire bridge beside R7 (indicated by a resistor in dashed outline) should be replaced by a 330 Ω resistor.

Calibration

When both boards have been completed, they may be connected together as indicated. This is best done with lengths of flexible wire 3...4 cm long. Do not yet fit IC1...IC8 into their sockets.

■ Connect transformer Tr1 to the mains and check on the boards that the ± 5 V supplies are available.

■ If that is all right, connect Tr2 to the mains, set S7 to VAR and check whether the generator output can be adjusted between 2 and 16 V with P4.

■ If that's also all right, measure the voltage across C26 which should be about 5 V.

■ Next, insert IC1 in the relevant socket and check that a rectangular pulse is present at pin 8. Set P1 in position 0.1 and adjust the frequency to 10 MHz with trim-

mer C2. Turn P1 to 1(CAL) and adjust the frequency to 1 MHz with P2.

■ Insert IC2...IC4 into their respective sockets and measure the frequency at the wiper of S1. When this switch is turned from position a to position g, the frequency should descend in decadic (± 10) steps from 1 MHz (a) to 1 Hz (g).

■ Next, insert IC5 into its socket and set S1 to position h. The wiper of S1 should then be logic low until S2 is pressed when the level should be 1.

■ Then, insert IC8 into its socket and set S1 to position b and S5 to position a. Check at pin 4 whether the pulse width can be varied between 100 ns and 1 μ s with P3. With S1 in position c and S5 in position b, it should be possible to vary the pulse width between 1 μ s and 10 μ s.

■ Finally, insert IC6 and IC7 into their respective sockets. All settings should now work as indicated on the front panel. If the pulse width is not in exact accordance with the stated values, it may be made so by changing the value of the relevant capacitor, C4...C12. The larger the capacitor, the longer the pulse width.

Final assembly

Note that the final assembly can be carried out in many different ways, but if you follow our suggestions and guidance you should not encounter any undue problems.

We have used a Vero box consisting of a top and bottom moulding in plastic with front and rear aluminium panels which are positively retained in the two halves. Bosses and guides are moulded into the case for printed-circuit board mounting. Note, however, that a small part of the four corners of the board in figure 5 must be filed away at an angle of 45°.

pulse generator

Figures 7 and 8. These photographs illustrate the final assembly. The size of the printed-circuit boards was determined by the Vero case used for our prototype.

7

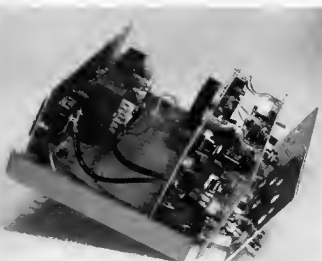

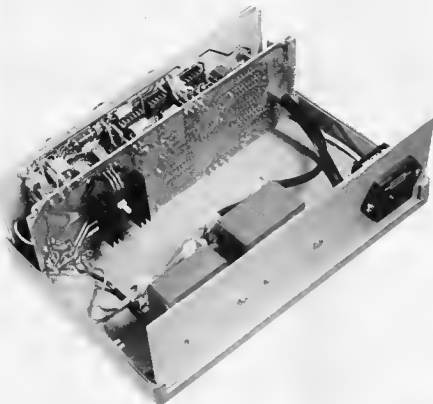

The assembly is illustrated in figures 7 and 8. Right at the front is, of course, the front panel; then follows the first pc board between the bosses and first set of guides, and finally the pc board of figure 5 in the guides. Make sure that the track side of the first board does not make contact with the front panel and that the connections to the mains switch are well insulated. As a further precaution, spray the back of the front panel with a proprietary insulating lacquer. To prevent a short-circuit at the sync output plug, stick some insulating tape around the hole in the front pc board (track side) provided for that plug.

The two mains transformers should be fitted in the lower half of the case and the fuse carrier in the rear panel. A suitable hole must be drilled in the rear panel for mains cable entry.

Since all potentiometers and switches are mounted on the pc boards, all that remains to be done is to drill suitable holes at the right location in the front panel. These holes should have a diameter slightly larger than that of the screw threads of the relevant component. The front pc board may be used as a template.

The components that are mounted on the front panel itself are the three BNC input and output sockets. Switch S8 is an integral part of the external output voltage

9

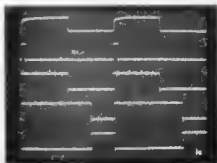

control socket. This component is passed through the front pc board and then stuck to it with fast drying glue.

To ensure adequate ventilation, drill a number of holes in the top and bottom of the case (between the two pc boards), as well as in the rear panel.

Finally, attach the self-adhesive foil to the front panel, the layout of which is given in figure 6.

Figure 9. Although the use of the pulse generator is described in detail elsewhere in the issue, this photograph illustrates the capabilities of the generator. At the top is the square wave available at the SYNC OUTPUT (TTL); under this a signal with short pulse width, then a square wave (S3 in position SYM), and a signal with a relatively long pulse width. At the bottom the inverted mode of the signal right above it (S4I). The horizontal scale is $2 \mu\text{s}$ per division, the vertical one is 5 V per division.

Elsewhere in this issue we have described our pulse generator project and dealt with all the constructional details. In this article, we will look at some of the possible uses for, and the various functions of, a pulse generator. We will, of course, concentrate on our own design, but the principles are the same for virtually all designs.

using a pulse generator

with particular reference to the Elektor pulse generator

The name 'pulse generator' tends to conjure up images of an instrument that is primarily (if not entirely) intended for use with digital circuits. It is, of course, perfectly suited to providing all sorts of pulse shapes for digital circuits, but apart from this there are many more applications that must be considered. In this article we aim to give a few practical examples of these, as well as a few general observations about using a pulse generator. It should be noted, however, that some points are intended solely for the Elektor design.

General (digital) use

The output impedance of the pulse generator (like most other generators) is $50\ \Omega$. To get the optimum pulse form, this output should be fed to a $50\ \Omega$ load. A $50\ \Omega$ cable should be used to connect generator and circuit, and the termination at the circuit should, again, be $50\ \Omega$. If this is not done there is a risk of degradation of the waveform by overshoot on the pulses. The difference is clearly visible in figure 1. The upper trace shows the output

through a cable which does not have $50\ \Omega$ impedance, the lower trace shows the same signal fed through the correct cable. In the second case the output amplitude is halved, but this is to be expected when a $50\ \Omega$ output is loaded with $50\ \Omega$. Actually for most applications, the wave form will be good enough without the $50\ \Omega$ load. The pulse generator will often be used in combination with an oscilloscope, so there may be a temptation to use an oscilloscope cable to connect the pulse generator to a circuit. We strongly advise against this as the impedance of the oscilloscope probe cable is very high. This could cause problems particularly in TTL circuits because of the relatively 'large' currents that can flow so that the logic levels may not be reached. The output voltage of the Elektor pulse generator can be set to TTL level or switched to another position where the output level is variable with a preset. In the TTL position the output is, of course, 5 V.

For CMOS circuits that work at some voltage other than 5 V, the pulse amplitude can be set to the correct level by adjusting P4 with reference to an oscilloscope. A special input has been provided to automatically adapt the output voltage to the supply level of the circuit: the External Output Voltage Control input. A special lead could be made up for this input, it will need a small plug (with the earth in the middle) at one end and two crocodile clips at the other end for connecting to the voltage supply of the circuit. If this control input is used, the output voltage is automatically equal to the supply voltage, irrespective of the position of switch S7. The generator does not have to be terminated with $50\ \Omega$ both for CMOS and TTL circuits as minimal distortion of the square wave is not important here.

The sync. output provides a square wave that can be used to trigger an oscilloscope or to measure the frequency of the output signal. This enables the oscilloscope to be properly triggered while the 'real' output is kept free to supply the 'measuring' pulses.

A few digital applications

For TTL and CMOS circuits the pulse generator can be used, among other things, for the following points:

- Simply to provide pulses (such as clock

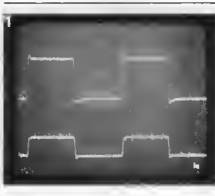

Figure 1 If the output of the pulse generator is loaded with $50\ \Omega$ the pulse shape will improve, but the output voltage is then halved.

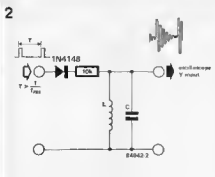

Figure 2. The resonant frequency of an LC circuit can be defined with the aid of this little circuit.

signals). Refer also to the photo in the article on the pulse generator.

— To provide a single noise-free pulse (SI in position MAN, S3 in position VAR., and press S2 for each pulse). The pulse width of the output signal can be set between 100 ns and 1 s.

— Edge delay. A positive edge applied to the trigger input will appear delayed at the output if SI is set to EXT, S3 to VAR., and S4 to L. The delay time can be set with S5 and P3.

This delay can, for example, be used as the trigger delay for an oscilloscope. Assume we want to examine a video signal. We then trigger the pulse generator with the vertical sync. The output of the generator supplies the external trigger signal for the oscilloscope (which is switched to external triggering). The video signal is simply fed to the Y input. By varying the pulse width of the generator the whole of the video information can be shifted across the screen (the time-base of the oscilloscope could be set to 20 μ s/division for example).

Other possibilities

There are, of course, other non-digital uses for the pulse generator:

— Defining the resonant frequency of an LC circuit (see figure 2). The sync output of the generator supplies the external trigger signal for the oscilloscope. The photo in figure 3 shows what will be displayed on the screen. Given the period, T, of the oscillation, the resonant frequency is easily found from $f_{res} = 1/T$. Remember that the capacitance of the probe is in parallel with the LC circuit and this must be taken into account if the value of the capacitor is small.

— Defining RC times (see figure 4). If the input voltage is selected so that the voltage swing of the output signal is exactly eight divisions (vertically), the RC time is the time needed to rise from zero to five divisions. The value of R must always be much larger than 50 Ω .

— A fairly specific but interesting application: testing the quality of a supply. In the example we give in figure 5, the supply to be tested is alternately loaded with 4.7 Ω and 100 Ω — with a 5 V supply this gives currents of 1 A and 50 mA respectively. The pulse generator is used here to provide the switching signal for the transistor. The stability of the output impedance can then be examined on the oscilloscope (figure 6). The upper trace shows the driving signal, and the second trace is the voltage across the load. The lower trace in figure 6 shows how a 470 μ F electrolytic capacitor in parallel with the load cleans up the output. All that remains is the voltage variation resulting from the output impedance of the supply (and leads). The impedance is then: $Z = \Delta U/\Delta I$. If the supply is not very stable some oscillations will remain visible every time the load is changed.

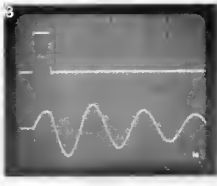

using a pulse generator

Figure 3. This is what appears on the oscilloscope if the circuit from figure 2 is connected to the generator. The upper trace is the input signal, and the lower trace is the output oscillation of the LC circuit.

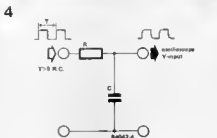

Figure 4. This is how RC times can be measured.

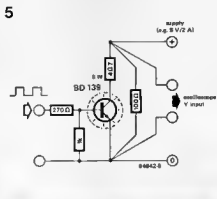

Figure 5. This circuit is used as an aid to examine the quality of a supply. It is used to alternately load the supply with 4.7 Ω and 100 Ω .

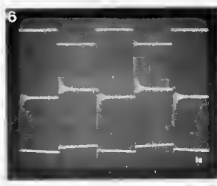
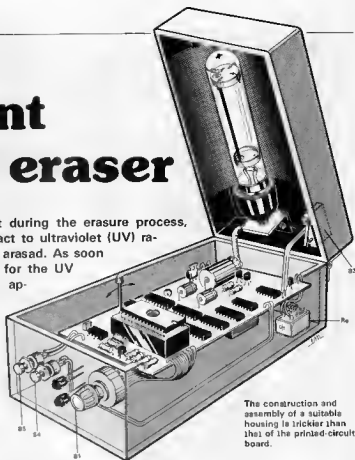

Figure 6. When the circuit of figure 5 is connected to the generator, this is what appears on the oscilloscope. The upper trace shows the driver signal for the BD 139. Under this is the voltage across the load, in this case the high frequency behaviour is not very good. Connecting a 470 μ F electrolytic across the load improves the situation, as the lowest trace shows.

— The generator, of course, provides good pulses with straight edges for testing power amplifiers. The stability of the amplifier can then easily be established and the slew rate measured. There are many more applications for a pulse generator that we have not mentioned. The examples given here merely serve to show that a pulse generator is a many-sided instrument.

intelligent EPROM eraser

The circuit described checks that during the erasure process, that is, when the EPROM is subject to ultraviolet (UV) radiation, even the last bit has been erased. As soon as this is so, the circuit arranges for the UV radiation to be continued for an appropriate period to ensure that the long-term stability of the new data is guaranteed. In other words, erasing is only carried out for as long as it is really necessary; no longer, no shorter. Furthermore, the circuit indicates whether the EPROM (new or used) is in good working order.



The construction and assembly of a suitable housing is trickier than that of the printed-circuit board.

Erasure of EPROMs can be a confusing matter: one manufacturer states an erasure period of ten minutes, the next one of a couple of hours. You might get the impression that the first gives short times on commercial grounds, while the second is overcautious. This is, however, not necessarily so: because of differences in manufacturing and materials, there is bound to be divergence in erasure times quoted by various manufacturers. Apart from all that, the erasure time is dependent upon the intensity of radiation, which decreases with age and wear of the UV lamp, and the distance of the erasure window from the lamp. In the circuit shown in figure 1, the post-erasure time of radiation has been fixed at three times the period necessary for the erasure of all the bits. It is possible to shorten the post-erasure time, but please read to the end of the article first.

It may happen that an EPROM is defect and that consequently total erasure is impossible: this is indicated by an LED in the circuit.

Floating-gate EPROM

The most common type of EPROM nowadays is the floating-gate EPROM, in which the basic memory cell is a metal-oxide semiconductor which has two gate-electrodes separated by a layer of silicon dioxide. The lower gate is entirely surrounded by oxide: it 'floats' in it, whence the name. A charge can be placed on the floating gate by applying a voltage of

about 20...25 V between the gate electrode and the drain while the substrate material is held at a much lower voltage. Some electrons gain sufficient energy to cross the potential barrier of the insulating silicon dioxide and charge the floating gate. Silicon dioxide is such an excellent insulator that the charge, without external influences, could be kept virtually forever, but most manufacturers guarantee a period of ten years. The charges can be removed by exposure to UV radiation which causes the silicon dioxide to become sufficiently conductive to allow the stored charges to leak away.

As stated, a good-quality EPROM can retain its charges for many, many years, but this is, of course, only so if it is programmed under suitable conditions. Suitable here means well-protected from daylight and UV radiation and an ambient temperature not higher than 70°C.

Erasure conditions

During erasure, the erase window of the EPROM is exposed to radiation from an UV lamp operating at a wavelength of 0.2537 μm at a distance of 2...3 cm. A typical dose (energy) of UV radiation required with a 27xx EPROM is 15 J/cm². The intensity of radiation is stated in $\mu\text{W}/\text{cm}^2$: if this is, say, 12 000 $\mu\text{W}/\text{cm}^2$, the erasure time is 20.8 min. The time actually required may deviate substantially from this figure as explained before; EPROM manufacturers are always at pains to point to the decreasing intensity of the UV lamp

An intensity of radiation of 12 000 $\mu\text{W}/\text{cm}^2$ gives an energy of 0.012 J/cm² every second, as 1 J(oule) = 1 W(at)1(s)econd. The required dose (energy) is 15 J/cm² and this will therefore take 15/0.012 seconds = 1250 seconds = 20 min 50 sec

over its life.

Furthermore, it should be noted that you cannot simply stop erasing when all the bits have become '1', because both the erasure and the subsequent recharging are temperature dependent. This cannot be explained in a few words, so please take our word for it. All manufacturers therefore state a post-erasure time of three times the erasure time. A shorter post-erasure period may well suffice but, to coin a phrase, prudence is the mother of long-term stability.

The circuit diagram

If we now look at the circuit diagram (figure 1), we see that IC1 and IC2 form an address counter. At the onset of operation, all outputs of these counters are logic '0', and the lowest address of the EPROM is checked by IC3. This is an eight-input NAND gate of which the output is inverted by N1, so that the overall function is AND. As soon as all data on the data bus of the EPROM are logic 1, the output of N1 (pin 3) is also high. This opens gate N2 which operates as a switch. The output pulse of oscillator N3/N4 is then applied to the clock input of IC1. Output Q0 of the address counter goes high and the next address is checked by IC3 and N1. If all the bits of this are logic 1, the following address is checked. And so it goes on until an address is reached which contains one or more logic zeros. The clock input to the address counter is then disabled by N2 until the address contains nothing but 1s.

A point to note: the sequence in which the store addresses are read is not the natural ascending order of the binary numbers as that would lead to many unnecessary bridges on the printed-circuit board. In any case, it would have been meaningless, because, as there is no program being read, the order is irrelevant: it is only necessary that all addresses are being read.

The checking process only comes to an end when all the addresses on the EPROM have been read a couple of times, that is, when output Q5 of the address counter is logic 1.

Fortunately, the time required for this double-security procedure is relatively short: when after the first reading of the addresses all bits are '1', the few subsequent check readings take only seconds. As soon as output Q5 of the address counter is 1, four things happen:

- output Q5 is inverted by N5 and stops oscillator N3/N4;
- the inverted output Q5 disables oscillator N7;
- output Q5 starts oscillator N6;
- test counter IC8/IC9 is switched from upward to downward counting.

Let us now have a closer look at the measuring section. CMOS-ICs 8 and 9 are presettable 4-bit up/down binary counters, of which the direction of counting depends upon the level at their U/D terminal (pin 10). The connection between

pin 7 of IC8 and pin 5 of IC9 combines the two circuits into a cascade counter. Both U/D outputs are connected to the inverted output signal at Q5 of the address counter.

Everything has now been switched over by the Q5 output signal. Gate N6 provides the clock, and the counter is counting downwards.

As the clock frequency of oscillator N6 is only about a third of that provided by N7, it takes three times as long for the counter to reach 0 again. Note that this factor is determined by the value of R4. Each kilohm gives a post-erasure time of one per cent of the erasure time. Thus, if R4 is 10 k, the post-erasure period is one tenth of the erasure time.

It now remains to ensure that the UV lamp is switched off by the relay when the counter reaches 0. This is, however, not as simple as it sounds, because how can a distinction be made between 0 at the onset of upward counting and reaching 0 in the downward mode?

The solution to that little problem takes us to the third functional part of the circuit. The output (pin 3) of the NOR flip-flop consisting of N9 and N10 is made logic high by the reset switch at the start of erasure. A logic 1 at pin 1 will cause it to change state. NOR gate N12 provides this level when both its inputs are 0. During upward counting, line U/D is at high level, so that N12 retains its state. During downward counting the output CO (carry out) is also logic low, but when the counter jumps from 0 to -1, it emits a short low-level pulse. And because line U/D is also at low level during downward counting, N12 gives a short high-level pulse which causes flip-flop N9/N10 to change state, the relay is actuated, and the UV lamp is switched off. At the same time, the low level at pin 3 of N10 causes driver transistor T2 to conduct so that (green) LED D2 lights to indicate that erasure has been completed. Red LED D1 indicates a defect EPROM or one of which the erasure time is longer than one hour. The control circuit for driver transistor T1 is identical to that of the relay or that of D2, except that line U/D instead of U/D is used.

So far, so good. And then we discovered during the testing of the prototype that it did not work! Certain bytes were being set to 0 (sic). So we took a couple of brand-new EPROMs and checked these in the prototype. And lo and behold, we appeared to have stumbled upon a new way of programming: with UV light! Fortunately, the process cannot be controlled, otherwise we would immediately have lodged a patent application.

We can assure you that this is not an April Fool's Day hoax, nor are we getting soft in the brain. It seems, however, that solid-state physics plays tricks when the supply voltage to the EPROM is left switched on continuously during erasure. Whether this is engendered by too high an operating temperature or by internal

Parts list

Resistors

R1, R5 = 100 k
R2, R6, R8, R10, R17 = 10 k
R3 = 22 k
R4 = 270 k
R7, R9 = 220 k
R11, R12, R13 = 47 k
R14 = 820 k
R15 = 8k2
R16 = 1 k

Capacitors:

C1 = 100 p
C2, C3 = 220 μ /10 V electrolytic
C4 = 1000 μ /15 V electrolytic
C5 = 10 μ /10 V electrolytic
C6 = 22 μ /16 V electrolytic
C7 = 10 n
C8 = 100 n

Semiconductors:

T1, T2 = BC 560
T3 = BC 550
T4 = BC 328
D1 = LED, red
D2 = LED, green
D4 . . . D7 = 1N4001
IC1, IC2 = 4040
IC3 = 4068
IC4 = 4011
IC5 = 4093
IC6, IC7 = 4001
IC8, IC9 = 4516
IC10 = 7805
IC11 = 555

Miscellaneous:

T-r = mains transformer, secondary 8 . . . 9 V, 500 mA
F1 = fuse, 500 mA
Re = relay, 5 V, a c contacts
Ls1 = UV lamp, 6 W
S1 = rotary switch, 3 pole, 5-position
S2 = mains on/off switch
S3 = push-to-make switch, lid operated, spring-loaded
S4 = push-button switch, push-to-make, spring-loaded
S5 = push button switch, push-to-make, spring-loaded
Case
IC socket, 24 or 28 pin
Fuse carrier, panel mounting type
Printed-circuit board type 84017

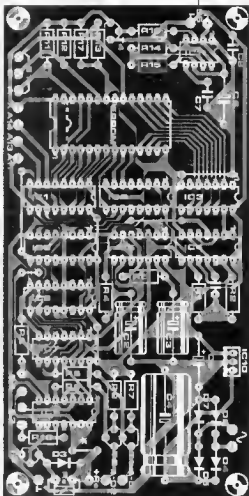
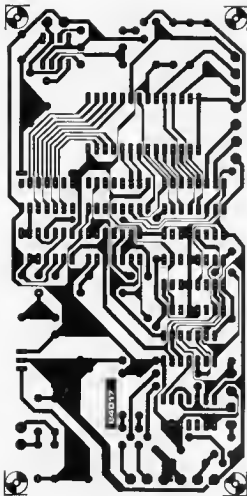

capacitances in the EPROM which are charged by the supply voltage and in that way cause programming pulses, we cannot be certain; it's probably a combination of the two. We have, however, ascertained that the effect disappears when the supply voltage to the EPROM instead of continuous is pulsed.

This is effected by means of a switching circuit based on a type 555 timer-IC(11). The duty factor (width/period ratio) has been fixed at 1:100 by means of R14 and R15. The pulse duration is about 130 ms; the pulse spacing, about 13 s. In the case of an erased EPROM, the total test cycle can be run through a couple of times during one of these periods, because the frequency of oscillator N3/N4 is high enough. In other words, the operation of the circuit as a whole is delayed very slightly, but the erasing process has become error-free.

At the same time, we have taken the opportunity to add switch S5. When this is closed, the supply voltage is continuously connected to the EPROM; we'll return to this under 'operation'.

Construction

If you use the printed-circuit board shown in figure 2, the construction of the electronics part of the eraser should not present too many difficulties. When it comes to the mechanical construction, however, things become a little trickier as may be evident from the drawing on the title page (note that this is given for illustrative purposes only!). The total height of the case is dependent on several factors: the mounted height of the board, that of the EPROM socket, and so on. In any case, with the lid closed, the UV lamp should be about 2...3 cm above the erase window of the EPROM. With the exception of S3, all switches, the two LEDs, and the fuse carrier (F1) should be fitted in the front wall of the case. When choosing the case, bear in mind that in addition to the above, it also has to house the mains transformer, and that it should be possible to close it light-tight (UV light is harmful to your eyes!). Switch S3 should be fitted such that it is closed when the lid of the case is completely shut, but always open otherwise.

Figure 2 The electronic part of the EPROM eraser is easily built with the use of the printed-circuit board shown here.

pulse width = pulse duration

pulse spacing = pulse repetition period

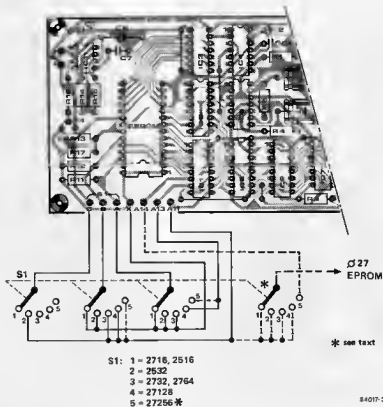

Figure 3. This peri view of the printed-circuit board clearly shows the connections of the EPROM selector switch S1 as well as the switch positions for the various types of EPROM

As soon as the lid is even slightly open, and S3 therefore also, the relay cannot be actuated so that your eyes are protected against UV light.

The EPROM socket should be a 24 or 28 pin type: this depends, of course, on the types of EPROM likely to be used. The type of EPROM is selected by S1: as drawn, the circuit is suitable for erasing 2516, 2S32, 2716, 2732, 2764 and 27128 EPROMs. It may also be modified to enable erasing type 27256 EPROMs, although these are not yet freely available: S1 should then be a 3-pole 5-position rotary switch and the pulse duration of IC11 changed from 130 ms to 6S ms. The switch positions and wiring for the various EPROMs are shown in figure 3.

NOTE: the Texas TMS 2716, which needs additional operating voltages, cannot be erased without a further modification. If this, or similar, type of EPROM needs to be erased, a switch should be connected between the collector and emitter of T3. In this way, it will be possible to carry out erasure as stated in the Texas data sheet with the aid of a watch or alarm clock. Make sure, however, that the mains supply is switched off before you open the case, as S3 is inoperative!

Operation

Insert the EPROM into its socket, select the type with S1, close the lid, switch on the mains with S2, press reset switch S4, and wait until D2 lights (there's no need to sit near the eraser for this).

Switch off the mains, open the lid, and remove the EPROM from the socket. Before taking it into use again, it is strongly recommended to let it cool off for at least half an hour, as this is beneficial for the long-term stability of the data. If D1 instead of D2 lights, do not throw the EPROM into the wastepaper basket straight away. If it is a Texas type, repeat the erasure by pressing the reset switch again: Texas indicates a total erasure time of two hours for many types. It may therefore happen that after one hour not all bits have become logic 1; this will particularly be so if the erase window is not sufficiently clean.

Furthermore, check that the distance between the UV lamp and the EPROM is correct, that the UV lamp is not past it, and that the EPROM window is clean. If all that is in order, you may safely throw the EPROM into the wastepaper basket. Apart from erasing used EPROMs, the unit may also be used to check new ones. Insert it into the socket, leave the lid and therefore S3 open, switch on the mains supply, and close S5 (check). Then press the reset switch briefly. Shortly afterwards — even with the 27128 it only takes seconds — LED D2 lights to indicate that the EPROM is blank. If not, you better go back to the dealer to change the EPROM.

The prime objective of a microprocessor is to operate quickly. However, when the operation of a circuit (memory, input/output, etc) must be tested, it is preferable to be able to move slowly, step-by-step, in order to isolate and examine suspect occurrences. There is expensive equipment available for this, of course, but our simulator performs the same task. Furthermore, our design has both a manual mode and a dynamic mode. A sequencer provides the Z80 signals with the correct timing relationships, whether in continuous or step-by-step mode.



Z80 CPU simulator

Microprocessors, such as the 6502 and Z80, are often used in specific automation applications other than computers. They are not suitable for programming in the large sense of the word, and they are very limited as regards communicating with the outside world, except in specific applications. Two cases in point are the darkroom computer (using a 6502) and the digital polyphonic keyboard for a synthesizer (using a Z80). The operation of such a device cannot be checked with an 'interactive' monitor program as the software is ignorant of the environment surrounding it. That is why this CPU simulator came into being. It could be considered as a sort of *hard-wired monitor program*, which is used to simulate (and check) the operations normally carried out by the processor. Even though our simulator was designed for the Z80, it could, with some restrictions, also help users of other CPUs by programming address and data lines. This applies particularly, of course, to the step-by-step mode.

Generating the signals

The polarising circuit for address lines A15...A0 with the corresponding logic levels, is shown in figure 1a. All it is, in fact, is an inverter, a LED, a switch and a resistor, per address line. Below this is an analogue circuit for the data lines. This time the buffers are bi-directional, and the direction of data transfer is determined by flip-flop N33/N34 which is controlled by S1.

When the data are placed on the bus by the simulator, the LEDs indicate the logic levels of switches S-DIL3. If, on the other hand, the data are read from the bus, buffers N17...N24 are blocked, and the logic levels come from the system bus. Looking closely at flip-flop N33/N34, we see that N34 is also fed the \overline{RD} signal so that 'write' mode can only be selected when \overline{RD} is inactive (i.e. logic 'high'). This leads us to figure 1b, which, as could be expected, provides the \overline{WR} , \overline{RD} , MREQ and \overline{IOREQ} signals. This circuit consists of two sub-assemblies: at the left are the anti-bounce flip-flops to generate the signals, and at the right is the logic for combining the static and dynamic signals, and a circuit for displaying and preventing errors. Notice that there is one line common to all the flip-flops, and if this is low it prevents all static operation. The true output of each flip-flop is then high and the complementary output is low.

At the right, the same combination of three gates and an inverter is repeated for each of the four control signals. The signals provided by the flip-flops, which are manually controlled, and the dynamic signals given by the simulator in real-time are combined by AND gates N45...N48. Any prohibited configurations, such as \overline{WR} and \overline{RD} or MREQ and \overline{IOREQ} active at the same time, are prevented by OR gates N49...N52. The inverter and the NAND gate signal any errors that may be detected. The pins indicated are, of course, the numbers on the Elektor bus, and this should be taken into account if this simulator is used with another system.

μP addresses, data, and control signals in either static (manual) or dynamic (real-time) mode.

Real-time cycles

The circuit shown in figure 2 has two modes of operation: continuous and step-by-step. In the latter case, it only produces one cycle at a time. The cycle in question is one of the four cycles from figures 3 and 4; reading or writing to memory or to a peripheral device. In the other mode it produces the same cycles, but in an uninterrupted stream. The possibility also exists of introducing a WAIT signal during each cycle.

The cycle generator is clocked by the stable multivibrator around inverters I and 2, and this signal is also available in PHIEZ form, the well-known Z80 time-base.

The type of cycle selected is determined by the user by means of changeover switches S3 and S4, which are connected to flip-flops N1/N2 and N12/N13 respectively. The sequencer proper consists of IC1, IC2, and gates N3...N7, N14, N15 and inverter 5.

The BCD counter, IC1, is fed the clock signal (on pin 2) and it feeds the binary inputs of BCD to decimal decoder IC2. At least one of the decimal outputs 1...3 of the 74LS42 applied to N5 is logic low during the first counting cycle (see the diagram of figure 5, signals 3...5). Then they all remain high until the start of the next counting sequence. Thus we get a base signal equal to three clock pulses; when this is inverted by N4 it becomes MREQ, as long as S4 is in position 'MEM'. If S4 is in the 'I/O' position, however, the signal becomes IOREQ via N15.

It is clear from figure 3 that the RD (read) signal of the Z80 occurs at the same time as MREQ and IOREQ. The base signal we mentioned a moment ago (the output of N5) also controls gate N3 which gives the RD signal, provided S3 is in the correct position.

The WR (write) signal is slightly more involved than the rest. In fact, if WR coincides with IOREQ, a clock cycle appears after MREQ. Consequently, a particular logic set-up is needed to generate this signal. In order for the output of N4 to be low, switch S3 must be the right position (to give a high at pin 9 of N4) and also the output of N6 must be high. As the timing diagram shows, this only occurs on the one hand if IOREQ is active (WR coincides with IOREQ) and on the other hand when MREQ is active, but then only during the last two clock cycles; output 1 of IC2 is applied to N7 after inversion by I5, so that the first clock cycle is eliminated. The combination of gates N8...N10 are used for generating a WAIT signal. This is done if IC1 is stopped counting by taking pin 7 (PE) low during a read or write cycle.

The other enable input of IC1, TE (pin 10), is taken high via R5 as long as S2 is not in the step-by-step position. If this is the case, however, TE is controlled by output 9 (pin 11) of IC2. In other words, whenever IC1 counts the tenth pulse in a sequence output 9 of IC2 goes low and this stops

1a

Z80 CPU simulator

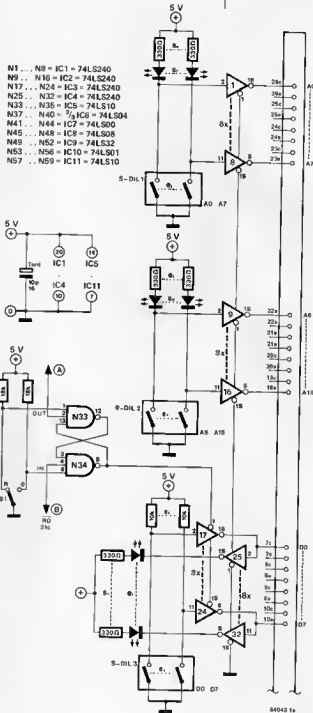

IC1 from counting. Pressing S1 resets IC1 to zero and starts it counting again. This is how we generate a single cycle at a time without affecting the timing relationships between the signals. The length of time that S1 is pressed is of little importance as long as output 0 of IC2 is not used.

Figure 1a. The simplest part of the simulator is also the most effective. The DIL (or other) micro switches allow the user himself to select the logic levels on the address lines, and those on the data lines in 'writes' mode. The levels are indicated by means of LEDs.

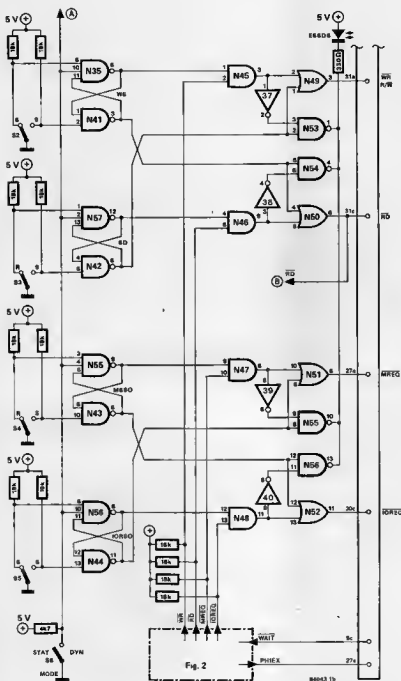

Figure 1b. In manual mode switch S6 must be open or the flip-flop will be blocked. If you only want to use the circuit in this mode, gates N45 . . . N48 are omitted. Then, of course, you have to do without the dynamic mode of operation obtained with the aid of the circuit of figure 2.

Why simulate?

A simulator is some device which allows a real function to be artificially represented. In our case it is a substitute for a CPU (which must then, of course, be removed from circuit), and it reproduces all its

signals, as we have seen. It is simply connected to the system's bus, and the supply voltages are also tapped from here. If there is no bus, all the signals are wired to a wire wrapping type IC socket and this is mounted in the actual socket for the CPU IC. The result is that, equipped

Figure 2. The signal generator consists mainly of a clock (I1/I2), a sequencer (IC1, IC2, N5...N7 and I5I) and the circuitry for switching between access to the memory or to peripherals, and between reading and writing (N1...N4, N12...N15).

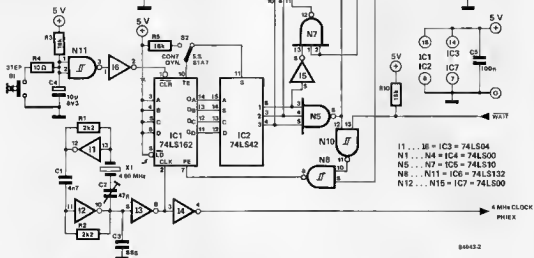

Figure 3. The timing diagram for the read and write to memory cycles shows a time lag between the MREG and WR signals, and this is simulated by a particular combination of logic elements.

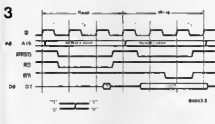

Figure 4. The read and write to peripherals cycles represented simultaneously here cannot appear together either in the 280 or in the simulator, which rejects forbidden configurations both in static and dynamic mode.

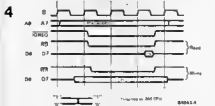
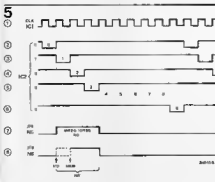

Figure 5. The function of the sequencer is obvious from this timing diagram. Output 9 of IC2 is not used in order to prevent the length of time for which S1 is pressed from affecting the duration of the counting cycle.



with this simulator in place of the processor, a fairly complicated circuit such as the polyphonic keyboard can easily be checked with quite simple test equipment which would be useless in other circumstances (logic probe, multimeter, single or double trace oscilloscope, etc.). It is impossible to establish a universal test protocol as this depends entirely on the type of circuit and the tests that have to be made. However, as the simulator possesses enough 'intelligence' to prevent forbidden configurations, there is no danger of this sort of problem. Even though we have so far avoided any mention of using this simulator for troubleshooting processor systems other than micro computers, this simulator is, in fact, perfectly suited to checking memory cards, VDU cards, and so on.

The metronome featured in our December, 1983, issue (page 12-36) can be programmed to give two simultaneous pulse trains each with eight beats. If you find this inadequate for your requirements, we present an extension which will enable you to obtain one pulse train with sixteen beats. In addition, we will tell you how it is possible to time two or more instruments simultaneously.

metronome extension

metronome extension

variations in tick-tack

The first requirement is met by a small logic circuit with which all sixteen switches (S1a...S8a and S1b...S8b) are 'scanned' alternately. This circuit consists of IC6 and IC7. An integral flip-flop in IC6 has its clock input (pin 3) connected to the 'carry-over' output (pin 12) of IC1. As the metronome printed-circuit board has no provision for this connection, it has to be made by means of a short length of circuit wire. The flip-flop ensures that after the first eight steps output Q, and after the next eight steps, \bar{Q} , becomes logic 1. The output state (pins 1 and 2) of IC6 is communicated to pin 5 of NAND gate N10 and pin 1 of NAND gate N9 respectively. The other input of these gates is connected to terminals Q and S on the metronome printed-circuit board respectively. When pin 2 of IC6 is high, gate N9 passes the output information of gate N2; when pin 1 is high, the output of N4 becomes available at pin 4 of gate N10. So, irrespective of whether Q or \bar{Q} is low, there is always a logic 1 at one of the inputs of NAND gate N11. As the two inputs of this gate can never be low simultaneously, our logic circuit produces a previously programmed 'tick' sixteen times in succession.

The sixteen 'ticks' are used to drive a filter; without N11, the output sound during the first eight 'ticks' would be different from that produced during the next eight 'ticks'. This means that the output of N11 is connected to either terminal T or terminal R on the metronome printed-circuit board. **DO NOT FORGET TO REMOVE THE WIRE BRIDGE BETWEEN S and T AND Q and R!**

More 'tick' and 'tack'

The original metronome is intended for one or two instruments. It is possible to extend the circuit 'downward' by adding more metronome printed-circuit boards from which IC1 and associated components have been omitted. The switches are then controlled by the inputs from data lines Q0...Q7. These additional printed-circuit boards may also be provided with the extension for sixteen beats. The filter is then omitted and the board, including extension, is connected to the redundant band-pass filter (IC4 or IC5) on the original metronome board. The function of switch S9 (selection of time-signatures) is retained at all times.

1

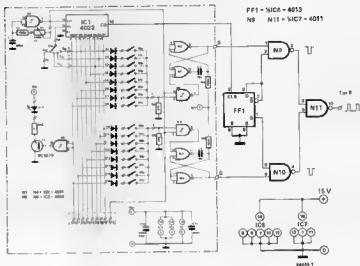

2

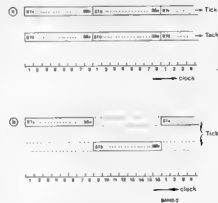
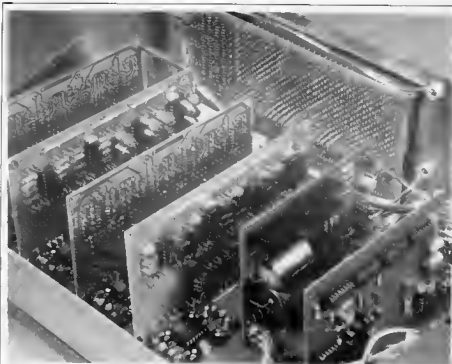

Figure 1. The simple extension circuit enables the production of sixteen ticks instead of two times eight as in the original metronome. If more metronome boards are connected together, it may be necessary to enlarge the power supply.

As already mentioned in the December article, the tone and timbre of the percussive sounds may be altered to individual requirements. It is even more interesting to connect the output to the trigger input of a synthesizer instead of to a filter: the sound nuances are then almost unlimited.

Literature:

Drum Interface, Elektor (UK), November 1982, page 11-20.



Last month we started this real-time analyser project and described the printed circuit boards for the input amplifier and filters. This month we have a couple of bigger boards, the base board, which serves as a mother board for all the others, and the display board containing the complete read-out section (LEDs plus electronics). With these two boards the analyser is effectively finished, except for one or two refinements.

real-time analyser

base board and
display board

The two sections we will describe in this article are not only physically large, they are also very important within the total concept of the real-time analyser. As we spent a lot of last month's article describing the layout of the project, we will skip it this time and just get on with the technical side of the two boards.

The base board

For once, it will probably be easier to understand this circuit if we first look at the printed circuit board and then examine the circuits that are fitted to it. The board is shown in figure 3, but this is not the actual size as it is, in fact, slightly larger than one of our pages. This board serves as the 'mother board' for the seven others, and contains a separate supply for the read-out and the thirty active rectifiers for the filters.

The circuit diagram does not show very much, and there is a good reason for this. As the board contains thirty identical active rectifiers, it would be an unnecessary complication to indicate more than one of

these and the power supply.

Each rectifier is built up around an op-amp with a diode in its feedback path. This combination behaves as an 'ideal diode' with no threshold voltage. This 'diode' half-wave rectifies the filter signal. The feedback to the op-amp travels via the wiper of P1 to enable the amplification to be adjusted. The relationship between P1 and R2 is chosen so that the controllable range is about 10 dB. Some means of adjustment is necessary to provide compensation for voltage differences between the filters due to component tolerances and the open-loop bandwidth of the op-amps used.

The active rectifier is followed by a resistor and an electrolytic capacitor. This capacitor, which is charged via R1 and discharged via R1, P1 and R2, forms a 'memory' for the rectifier to keep the measured voltage displayed for a short time (it has a short charging cycle and longer discharging cycle). The charging time is trimmed to the centre frequency of each filter, which means that the charging

(part 2)

1

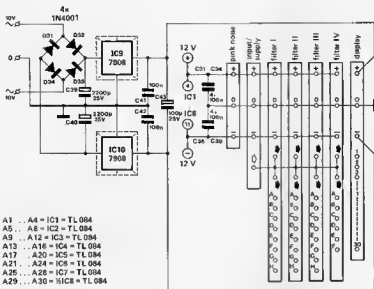

resistor has a different value in each rectifier (for the first rectifier it is R1). The component numbering for all the rectifiers is given in the table in figure 1. The discharging resistance (P1 + R2) is the same for all rectifiers. Because the charging resistance is in series with P1 and R2 during discharging, the discharging time is slightly longer for the lower filters than for the higher ones.

With the component values stated, the charging time is a compromise between peak and average value measuring. This was intentionally done to enable the analyser to measure both music and noise signals. The read-out gives approximately the peak values of a music signal,

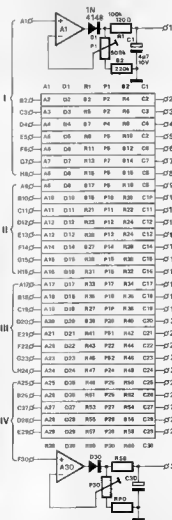
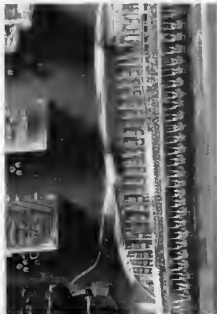

Figure 1. The circuit of the rectifiers and the supply, which are contained on the base board. The component numbering of the thirty rectifiers is given in the table.

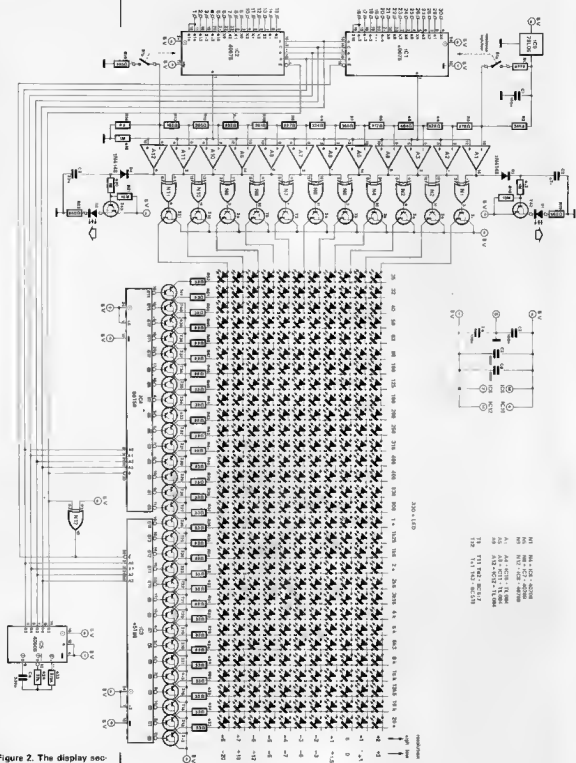

Figure 2. The display section of the analyser. Multiplexing the 330 LEDs and scanning the thirty filters is handled by IC1... IC5. A comparator circuit (A1... A12) splits the measured voltage into steps of 1 dB for larger, depending on the position of S1).

whereas if pink noise is used the average value of the measured voltages is shown to prevent the display from continually jumping.

The charging time can also be modified to suit any particular needs. If the real-time analyser is only to be used to examine audio signals, the rectifiers can be converted into peak meters by reducing the values of the odd-numbered (charging) resistors, R1...R59, by a factor of 10. For purely noise applications, the read-out can be made somewhat 'clamer' by giving all the odd numbered resistors values of 220...470 k.

The power supply here is identical to that on the input board, except that the regulators used here are 8 V types and the voltage supplied from the transformer is 10 V a.c. It should be noted that this power supply is not required if the real-time analyser is to be used with the video display that will be published (hopefully) next month. The LED display is then, of course, also superfluous.

The way in which the various boards are fitted together is shown in figure 5. This requires some clarification, but that is something we will get around to in due course.

The LED display

Compared to the base board, the circuit for the display section seems very full. That is not really surprising considering that 30 LED columns are needed to display the output voltages of all 30 filters. The most obvious part of the circuit is the 11 x 30 LED matrix. In last month's article we went into the reason for using all these LEDs and, in practice, both the dimensions and the price of this 'discrete' display seem quite reasonable.

Quite a large multiplexer system is needed to switch all these LEDs. First we have the 16-to-1 line multiplexers, IC1 and IC2, which are connected 'in series' so that all thirty outputs from the rectifiers are connected in turn to the read-out. Each multiplexer has one unused output and they are both clocked by the signal from IC5. This counter/oscillator provides the control signals for the channel select inputs, A, B, C, D and E (enable). The E signal to IC1 is inverted by EXOR gate N12 so that only one of the two multiplexers is enabled at a time. The timing components around IC5 (R53, R54 and C4) ensure that each channel of the multiplexers is selected for 0.2 ms.

The LED columns are multiplexed via 16-to-18 line decoders IC3 and IC4. The address inputs, A0...A3, and enable inputs E of both ICs are connected to outputs Q3...Q7 of the 4060 (E of IC3 via N12). The operation of this circuit should now be fairly clear. Whenever a particular filter output is selected via the multiplexers, the LED column corresponding to this filter is activated by taking the appropriate output (Q0...Q14) low. The multiplexers and decoders therefore keep the thirty filters and the LED columns synchronized.

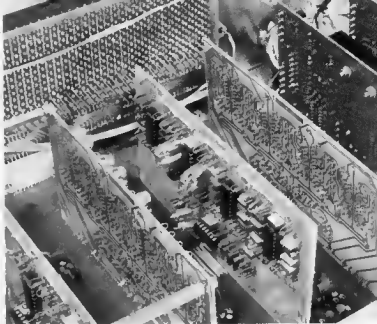

Because of the large number of LED columns that must be multiplexed, the peak current flowing through each LED is very high: about 300 mA! The average current per LED is about 10 mA. Using a suitable type of LED and keeping the multiplex frequency high makes this possible without adversely affecting the lifespan of the LEDs. Because of the large currents, the outputs of the decoders feed into darlington's T12...T41, and the actual current is defined by the value of resistors R23...R52.

As we have implied, the type of LED used is very important and there are relatively few LEDs that can handle such a high peak current. Mostly they are normal red LEDs. Other colours may not be used. High efficiency LEDs are also out; their maximum permitted current is 50...100 mA which is much too low. The moral of this is to look for LEDs that have a peak current of 1 A.

The outputs of the multiplexers, which are connected together, are followed by a comparator circuit built up around A1...A12. The inverting inputs of the op-amps are connected to a precise voltage divider (R2...R14). This divider is fed a 5 V reference level from voltage regulator IC9. The non-inverting inputs of the op-amps are all connected to the outputs of the multiplexers. If the input signal (which is to be measured) at the non-inverting input is greater than the voltage on the inverting input, the output of the op-amp will go high. The values in the voltage divider are selected such that the comparison occurs in steps of 1 dB, while a voltage of 0.5 V is taken as an internal 0 dB level. The LED rows are driven by the op-amps via EXORs N1...N11 and darlington's T1...T11. The EXORs ensure that only one LED, per column, lights at a time, the idea being to keep the current consumption within reasonable limits. If the signals offered to the display are outside its range, one of two auxiliary LEDs will light. Darlington T42 switches

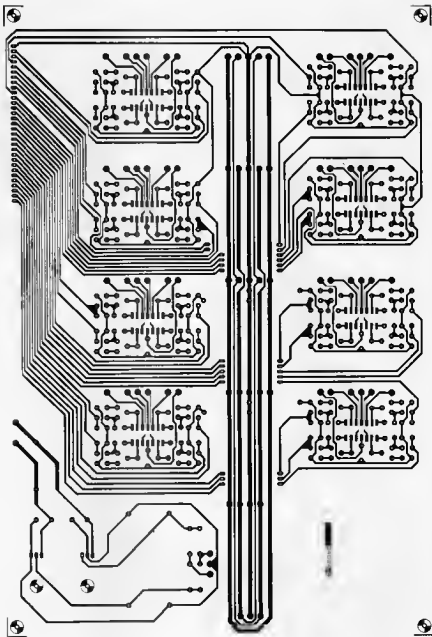

Figure 3. The base board is shown here, but, because it is very big, it is not given full size

on LED D1 if the signal is 'above' the display, and D3 lights via T43 if the signal is 'below' the display or if there is no signal at all present. A capacitor and a diode are included in each case to keep the LED lit long enough for it to be seen. The resolution of the display can be switched to a coarser range by means of S1. Flipping this switch places an extra resistor in parallel with the upper and lower resistors in the divider chain. The range is then from +3 to -20 dB instead of +2 to -8 dB. When reading the display

it is important to remember that the LEDs light to indicate that the input voltage level is within a certain range, not that the voltage is above the nominal value represented by the LED. If, for example, a -2 dB LED lights it means that the input voltage is between -2.5 and -1.5 dB. In the other switch position, the -7 dB LED handles the range of -6...-8 dB.

Construction

Assembling these two printed circuit

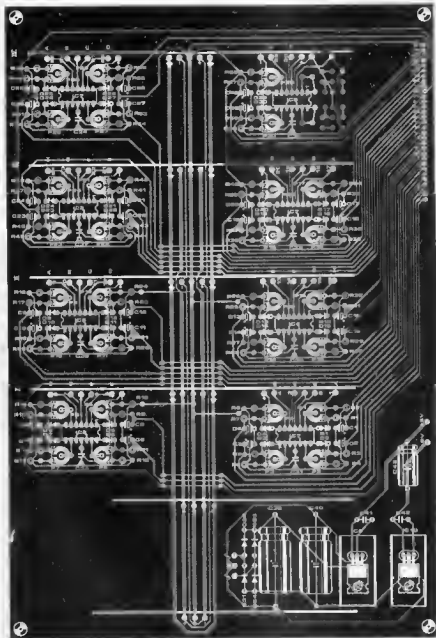
**Parts list:**

- Base board (84024-4)

Resistors.

R1 = 100 k
 R3 = 68 k
 R5 = 56 k
 R7 = 47 k
 R9 = 39 k
 R11 = 27 k
 R13 = 22 k
 R15 = 18 k
 R17 = 15 k
 R19 = 12 k
 R21 = 10 k
 R23 = 6k8
 R25 = 5k6
 R27 = 4k7
 R29 = 3k9
 R31 = 2k7
 R33 = 2k2
 R35 = 1k8
 R37 = 1k5
 R39 = 1k2
 R41 = 1 k
 R43 = 690 Ω
 R45 = 560 Ω
 R47 = 470 Ω
 R49 = 390 Ω
 R51 = 270 Ω
 R53 = 220 Ω
 R55 = 180 Ω
 R57 = 150 Ω
 R59 = 120 Ω
 R2, R4, R6, etc... R60
 = 30 × 220 k
 P1 P30 + 500 k preset

Capacitors*

C1 ... C30 = 4μ7/10 V
 tantalum
 C31 . C38, C41, C42 =
 100 n
 C39, C40 = 2200μ/25 V
 C43 = 100μ/25 V

Semiconductors*

D1 ... D30 = 1N4148
 D31 ... D34 = 1N4001
 IC1 IC8 = TLO84
 IC9 = 7808
 IC10 = 7908

Miscellaneous:

2 Heatsinks for IC9 and
 IC10, 10°C/W

boards is a very straightforward process. The base board, as we have said, contains the supply section and the thirty rectifiers. The two voltage regulators must be mounted on a heat sink. Soldering pins (veropins) should be fitted where the other boards are to be mounted (with the exception of the display board). The wiper of each preset should now be rotated to the limit on the 'diode side'. All the components, except for the LEDs and resistors R23 ... R52, can be soldered in place without further ado. Only after

this is finished should the LEDs be fitted. These should be mounted a row (30 LEDs) at a time. Care taken now to line the LEDs up correctly will pay dividends later when the completed display is something to be proud of. Finally, resistors R23 ... R52 are soldered on the reverse side of the board. Each resistor is soldered vertically and is connected to the pin of the last LED in the row.

Provision has been made for mounting the range changeover switch on the board, but this is only feasible if it has a long

Parts list

Display board (84024 3)

Resistors

R1	= 64k Ω 1%
R2	= 34k Ω 1%
R3	= 576 Ω 1%
R4	= 523 Ω 1%
R5	= 464 Ω 1%
R6	= 412 Ω 1%
R7	= 365 Ω 1%
R8	= 324 Ω 1%
R9	= 287 Ω 1%
R10	= 261 Ω 1%
R11	= 232 Ω 1%
R12	= 205 Ω 1%
R13	= 182 Ω 1%
R14	= 165 Ω 1%
R15	= 215 Ω 1%
R16, R17, R20	= 1 M
R18, R21	= 10 M
R19, R22	= 560 Ω
R23	= R52 = 33 Ω
R53	= 270 k
R54	= 27 k

Capacitors

C1, C5	.. C8 = 100 n
C2, C3	= 22 n
C4	= 330 p

Semiconductors:

D1, D3	= LED, 3 mm red
D2, D4	= 1N4148
330 un-numbered LEDs, red 3 mm (e.g. COV 85N81)*	
T1	.. T11, T42 = 8C517
T12	.. T41, T43 = BC 518
IC1, IC2	= 40678
IC3, IC4	= 4515B
IC5	= 4060B
IC6	.. IC8 = 4070B
IC9	= 78L05
IC10	.. IC12 = TL084

Miscellaneous:

S1a, S1b	= double pole changeover switch
----------	------------------------------------

*see text

Figure 4 The display board is double sided with through-plated holes. The finished appearance is greatly improved by ensuring that the LEDs are all in line. Resistors R23 .. R52 are mounted on the reverse side of the board, with one lead of each resistor soldered directly to the relevant LED column. There is no separate hole on the board for this, as spec on the board, which is shown here in reduced size, is at a premium.

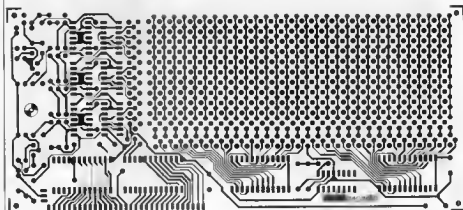
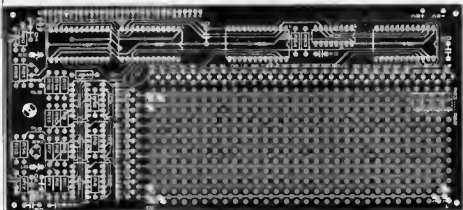
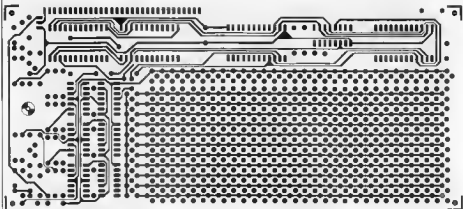

operating spindle. Otherwise it is better to mount this switch directly on the front panel.

Assembly and testing

The positions and orientations of the various boards relative to the base board are indicated in figure 5. If you have been paying attention up to now the connection

points for the pink noise board, the input board and the filter boards should have solder pins. Similarly, the connection points on each board should have solder pins. The input board is the first to be connected to the base board, with the component side facing the power supply on the mother board. This simply involves soldering the veropins together. The connections to the transformer can now be made; two 15 V \sim lines and earth to the in-

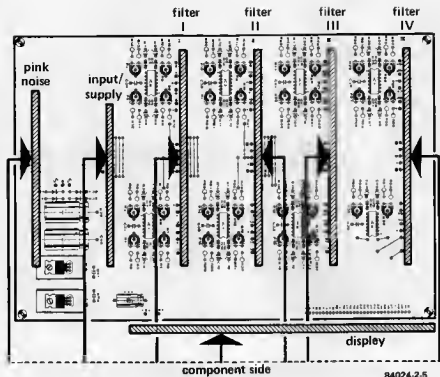

Figure 5. Here we see how the various boards are mounted onto the base board.

put board, and two 10 V~ lines and earth to the appropriate points on the base board. The supplies can now be checked. When the mains has been switched on there should be + and -12 V at the + and - points on the input board. The supply connections for the display board must have + and -8 V with respect to the 0 V on the base board.

If everything is correct so far, the power can be switched off and we can continue with mounting the filter boards. These should already be numbered, with the lowest filters on board I and the highest on board IV. Note that the component side of boards I and III face towards the input board, whereas the track side of boards II and IV face this board.

Finally, the display board must be connected. It is a good idea to make this link with a sufficient length of cable (and possibly a connector) to facilitate access to the back of the display. You will probably be grateful for this later. Remember that there are two supply connections at the left side of the board.

The analyser is now finished, except for one 'extra' — namely the pink noise generator —, so we can now actually 'fire it up' and see if it works. The two switches and the potentiometer must be connected to the input board. With S1 we

select 'line', S2 is in the +10 dBm position, and the power can then be switched on. If the whole circuit is working, a large number of LEDs should light and slowly drop out of sight below the display. Connecting a sine wave generator to the line input and running through the frequency range will verify the operation of all the LEDs. Select an appropriate frequency for each filter in turn and vary the input voltage to check that each LED lights. In principle, the rectifiers can now be adjusted by feeding a 0.775 V_{RMS} a.c. signal to the input (S3 at 0 dBm) at the centre frequency of some filter and then setting the appropriate rectifier so that the 0 dB LED is lit. Not everybody can get their hands on a sine wave generator, however, so we will leave this subject of adjustment until next month. Then we will have the pink noise generator, and we can deal with adjustment in detail.

The important thing is that the analyser now functions. To try it out, you can feed a music signal, from a radio, for example, into the input and look at what the display shows. Even though it is not yet accurate, you can already get quite a good idea of the frequency content of various audio signals. However, to expand this to serious measurements, you will have to be patient for one more month.

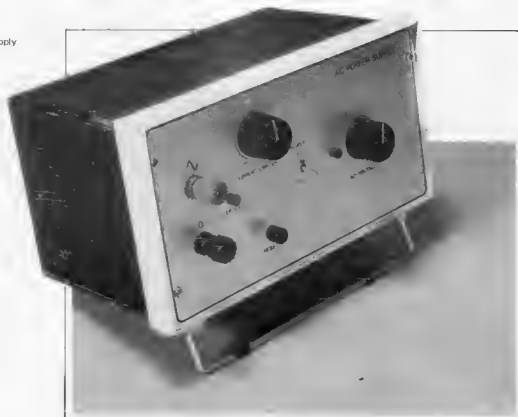

a.c. power supply

alternating
current with
built-in
protection

Just for a change, this is a power supply that provides not d.c. but a.c. voltages. The most important characteristic of the circuit is its adjustable current limiting. If the current exceeds a preset value, the power is instantaneously switched off. That makes the circuit a very useful aid for trying out newly built or repaired circuits. It is designed to reduce the anxiety symptoms that often appear just before you plug in some circuit.

This circuit was actually designed because we wanted it ourselves. It often happens when trying out a new circuit that not everything is exactly as it should be. This results in high-speed changing of blown fuses, always assuming of course that the correct fuses are to hand. Inevitably, Murphy has a part to play, and there is nothing more annoying than being snookered by something as trifling (but essential) as a fuse. Also, it doesn't do your technical self-esteem any good to keep blowing fuses.

There comes a point where this simply gets to be too much, so it's on with the thinking cap to come up with a design for an a.c. power supply with adjustable current limiting. It then takes the place of the supply transformer in the new (or just repaired) circuit, and the first tests can be done with a voltage lower than the

nominal circuit voltage. If there is something wrong and the current tries to exceed the maximum desired level, the supply automatically switches off. The problem can now be sought at leisure without any risk of permanent damage.

The circuit

As we have already said, this circuit was born of a purely practical need. We started with a transformer with a large number of secondary tapings (figure 1). The output voltage is changed in steps of 3 V by means of S3. It is, of course, your prerogative to use a transformer with different voltages if you wish. The current supplied by the transformer flows through R1 via the rectifier, with the result that a pulsed d.c. voltage is seen across this resistor. This d.c. voltage, which is pro-

portional to the value of the a.c. current, serves as the driver voltage for the current limiting circuit.

The lower part of the circuit is the current limiting, and this has to be powered from a separate transformer. Failing to do this could cause problems when the a.c. is connected to the protection circuit. The protection circuit itself is very simple. A voltage regulator (IC2) is followed by a comparator circuit which compares the voltage across R1 to a voltage set with P1 and P2. The maximum value of current limiting is set with preset P1. Depending on the transformer used, this will normally be adjustable between 2.7 and 5.4 A ($I_{RMS} = 1.9 \dots 3.8$ A). This value can then be further adjusted so that the actual range of values for current limiting is 0.27 ... 5.4 A (peak value) or 0.2 ... 3.8 A (rms value). Short noise pulses are no danger to transformer, circuit, or fuse so C3 prevents the current limiting from occurring under these conditions.

As soon as the maximum (set) value of current is reached, the output of the comparator flips. A pulse is then fed via R6 and R7 to the gate of thyristor Th1, which fires and powers the relay. The relay now cuts off the primary winding of transformer Tr1, and LED D6 lights to in-

dicate that current limiting has taken place.

Once a thyristor is caused to conduct it continues to do so after the gate pulse has passed, which means that the only way to 'reset' the circuit is to press S1. Before doing this it is wise to try to find the reason for the problem, and also set the current limiting to a different value if necessary.

Construction

Building this a.c. power supply should not cause any problems. Most of the time will probably be involved in the 'mechanical' work: housing the supply transformers in a case, making a front panel with connectors, switch, and indicator LEDs, and finishing the whole unit off. The printed circuit board for this project is shown in figure 2. The left side of the component layout shows the input and output for the supply, and these are connected respectively to the ground of Tr1 and one of the connectors on the front panel. These points can, of course, be freely interchanged. The cathode (k) connection for the 'power' LED (D7) is also clearly visible. The anode connection for this LED is tapped off the 3 V winding of Tr1. If a different transformer is used, the current limiting resistor ($R8 \approx U/0.04$) will have to

a.c. power supply

1

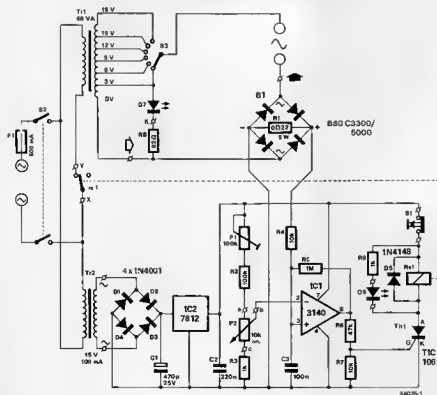

Figure 1. Most of the circuit for the a.c. power supply shown here is used for the current limiting.

Figure 2. The printed circuit board layout and component overlay for the circuit are shown here.

Figure 3. This is how the circuit looks when it is all put together.

Parts list

Resistors

- R1 = 0.22 Ω /5 W or 2 x 0.47 Ω /3 W in parallel
- R2 = 100 k
- R3, R9 = 1 k
- R4, R7 = 10 k
- R5 = 1 M
- R6 = 47 k
- R8 = 82 Ω
- P1 = 100 k preset
- P2 = 10 k 1m pot.

Capacitors:

- C1 = 470 μ /25 V
- C2 = 220 n
- C3 = 100 n

Semiconductors

- D1, D4 = 1N4001
- D5 = 1N4148
- D6 = LED, red
- D7 = LED, green
- B1 = bridge rectifier, silicon in line 80 V at 5.0/3.3 A e.g. B80C5000/3300 (available from Gernotronics)
- IC1 = 3140
- IC2 = 7812
- Th1 = TIC 106

Switches

- S1 = push to break push button
- S2 = double pole mains switch
- S3 = single pole six way wafer switch, must be rated 5 A

Miscellaneous

- T1 = transformer, 60 VA, secondary = 3 V, 6 V, 9 V, 12 V, 15 V, 18 V
- Tr2 = transformer, 15 V/100 mA
- F1 = fuse, 500 mA slow blow
- Re1 = relay, 12 V/B A (Maplin order no. HY20W)

2

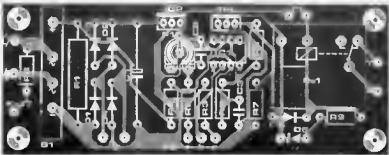
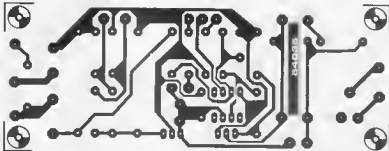

3

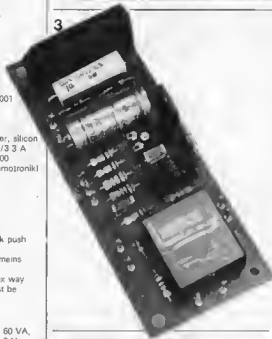

be changed. If the voltage is higher than 3 V it is also a good idea to connect an ordinary silicon diode in series with D7, as a protective measure.

The relay contact (points X and Y) of Rel1 is connected in series with the primary of transformer Tr1 (so there are mains voltages on the printed circuit board). Make sure that the relay does not also cut off the primary of Tr2 when it operates. The voltage regulator (IC1) and thyristor (Th1) do not need to be mounted on heat sinks as they are not likely to get very warm in this circuit.

A final note: problems can be caused with this kind of (experimenting) supply circuit when connecting to the earth line of some types of equipment. The best thing to do, therefore, is to house this supply in a metal case and connect the mains earth to the case, but do not connect it to either the a.c. supply section or the protection circuit.

4

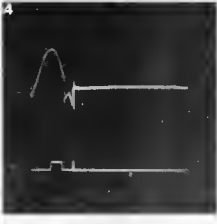

Figure 4. When we test the power supply with the aid of an oscilloscope, we see how the current limiting circuit trips if the current exceeds a pre-determined value.

It may seem somewhat unusual, now that the Junior Computer has its own floppy disk interface, to publish a program for the cassette interface. Even though many Junior users do have a DOS on their computer there are still others who only use cassettes. And then there are even some who use both systems in parallel, but not without the occasional eloquent exclamation about the difficulty of remembering the exact contents of all the cassettes. This program, like some of our other recent software offerings (especially last month's GET & GO), is a modification of an existing program (certain TM and PM routines) to achieve something new on your familiar computer. It makes a complete list of all the identification numbers (ID), complete with start and finish addresses, of all the files stored on a cassette. Each search operation also doubles as a systematic check of the data in a file.

To run the program, simply load it and start it at address \$0200. Load a cassette into the player and press some key on the keyboard... and wait for IDList to display the information you require and signal any possible incorrect data. Stopping IDList in the course of a run is simply a matter of pressing 'BREAK', and then, to restart it, pressing 'R'.

Familiar labels

Once again we plead lack of space as an excuse for not providing a complete source listing for this program. The hex-dump in table 1 contains all the software, including messages and the author's

The more you use your personal computer, the greater the number of filled cassettes you accumulate, and only by keeping a detailed catalogue can you hope to keep track of anything. Unfortunately there are few people, even among micro computer users, who have the patient, meticulous soul of a librarian. What you need is a program which likes nothing better than sorting out the tangled mess of data on a cassette. And if this program just happened to check the data at the same time your proverbial cup would be running over.

IDList

signature (starting at \$0369). The \$77 found at \$0368 and \$03FB is an end-of-file indicator. The main part of the program contains a lot of instructions borrowed from RDTAPE, as TM users will undoubtedly see. For those who may be interested in disassembling this program, here is a list of the labels used. Even though some of them are not used in TM, they do not require any explanation. \$0200: START \$0203: RESET \$0206: BRKST \$022A: INIT \$0247: RDTAPE (see the source listing of Tape Monitor) \$0310: IDSA \$032D: SUMERR \$033B: CORDAT \$0349: MESSB \$0357: MESSND \$0358: CLS \$0362: CLSA.

gives the Junior Computer an automatic search procedure to locate identification numbers on magnetic tape

P. Jenkins

	0	1	2	3	4	5	6	7	8	9	A	B	C	D	E	F	
\$0200:	4C	2A	02	20	BC	14	2C	00	1A	10	FB	A2	FF	9A	86	F2	
\$0210:	A0	80	20	49	03	A9	5F	0D	7C	1A	A9	10	18	0D	7D	1A	
\$0220:	82	05	F0	A9	00	85	FA	4C	6A	10	A9	03	8D	7C	1A	A9	
\$0230:	02	0D	7D	1A	20	58	03	EA	EA	EA	A0	00	20	49	03	20	
\$0240:	AE	12	A0	40	20	49	03	A9	32	0D	02	1A	0D	70	1A	A9	
\$0250:	7E	0D	03	1A	A9	7F	0D	81	1A	A9	00	0D	6E	1A	0D	6F	
\$0260:	1A	A9	FF	0D	6B	1A	2C	80	1A	10	61	20	C2	0B	6E	6B	
\$0270:	1A	AD	6B	1A	20	E0	0B	C9	16	D0	EB	A0	0A	0C	69	1A	
\$0280:	2C	80	1A	10	47	20	36	0C	20	5D	0C	C9	16	D0	D2	CE	
\$0290:	69	1A	D0	EC	2C	00	1A	10	33	20	36	0C	20	5D	0C	89	
\$02A0:	2A	F0	07	C9	16	F0	ED	4C	47	02	20	5D	0C	20	F3	0B	
\$02B0:	8D	79	1A	20	F3	0B	20	4B	0C	05	FA	0D	70	1A	20	F3	
\$02C0:	00	20	4B	0C	05	FB	0D	71	1A	4C	CF	02	4C	03	02	2C	
\$02D0:	00	1A	10	F0	20	F3	0B	30	62	FF	0F	20	4B	0C	E6	FA	
\$02E0:	D0	02	E6	FB	20	64	0C	4C	CF	02	20	F3	0B	0C	D6	1A	
\$02F0:	D0	30	20	F3	0B	4D	6F	1A	D0	33	20	0C	14	20	10	03	
\$0300:	A5	F0	20	0F	12	A5	FA	20	0F	12	20	E8	11	4C	47	02	
\$0310:	AD	79	1A	20	0F	12	A0	8A	20	49	03	AD	71	1A	20	0F	
\$0320:	12	AD	70	1A	20	0F	12	A0	8E	20	49	03	AD	70	20	BC	14
\$0330:	20	10	03	A0	5E	20	49	03	4C	47	02	20	BC	14	20	10	
\$0340:	03	A0	6F	20	49	03	4C	47	02	B9	69	03	C9	03	F0	07	
\$0350:	20	34	13	C0	4C	49	03	60	A9	0C	20	34	13	A9	04	0D	
\$0360:	F7	1A	2C	D5	1A	10	FB	60	77	22	49	44	4C	49	53	54	
\$0370:	22	0D	0A	42	59	20	50	41	55	4C	20	53	20	4A	45	4E	
\$0380:	40	49	4E	53	20	20	0D	0A	54	55	52	4E	20	4F	4E	20	
\$0390:	54	41	50	45	20	20	50	4C	41	59	29	20	41	4E	44	20	
\$03A0:	50	52	45	53	53	20	41	4E	59	20	4C	45	54	54	45	52	
\$03B0:	03	0D	20	0D	0A	49	44	20	20	20	53	54	41	52	54	20	
\$03C0:	20	45	4E	44	0D	0A	03	43	40	45	43	4B	53	55	4D	20	
\$03D0:	45	52	52	4F	52	0D	0A	03	43	4F	52	52	55	50	54	45	
\$03E0:	44	20	44	41	54	41	0D	0A	03	0D	0A	42	52	45	41	4B	
\$03F0:	0D	0A	03	20	3A	20	03	20	2D	20	03	77	2C				

Table 1. This is the hex-dump for IDList, that should be loaded at \$0200. It not only shows the identification numbers, start and end addresses of the files on the tape, but also checks the data end signals for any possible differences from the check-sum (CHKL/CHKH: \$1ABE/1A6F).

Please note that the following ICs may not yet be commercially available. They are given here to keep you abreast of developments.

infra-red remote-control preamplifier type XL 486

(Plessey Semiconductors Limited)

The XL 486 has been designed to form an interface between an infra-red receiving diode and the digital input of remote-control receiving circuits. It contains an output pulse stretcher for use with microprocessor decoders.

Features

- Fast-acting automatic gain control (a.g.c.) to improve operation in noisy environments.
- Output pulse stretcher for use with microprocessor decoders.
- On-chip stabilizer allows operation with ML 920 remote-control receivers.

Electrical characteristics

(typical over temperature range 0°C...70°C with supply voltage, $U_D = 4.5 \dots 9.5$ V unless otherwise stated)

Supply current (pins 4, 7)	5 mA ($U_D = 5$ V)
Regulated input voltage (pins 7, 13)	6.4 V
Differential sensitivity (pins 1, 16)	5 nA
Common mode rejection (pins 1, 16)	30 dB
Maximum signal input (pins 1, 16)	4 mA (pk)
A.G.C. range	68 dB
Unregulated input voltage (pins 7, 13)	16 V
Output pull-up resistor (pin 9)	86 k
Stretched output pulse width (pin 6)	2.4 ms

bicycle computer based on microprocessor type MCI46805G2

(Motorola Semiconductor Products Inc.)

The MCI46805G2, complemented by a liquid-crystal display (LCD), two push-button switches, and two sensors, forms a novel bicycle computer. The two sensors are required to provide an interrupt and to pulse certain counters. Each sensor is a normally open reed switch which is actuated by a magnet mounted on the wheel and the pedal crank respectively.

The program for the computer is included on the chip and uses 1300 of the available 2100 bytes. Functions of the computer that can be selected and displayed are:

- **instantaneous speed** to the nearest mile or kilometre per hour;
- **average speed** (calculated by dividing the distance travelled by the time) to the nearest mile or kilometre per hour;
- **resettable trip odometer**, giving the distance since the last trip odometer reset (or power-on reset) to the nearest tenth of a mile or kilometre;
- **resettable long distance odometer**, giving the distance since the last long distance odometer reset;
- **cadence**, that is, the number of rev/min of the pedal crank;
- **English or metric units**
- **wheel size**, that is, the current wheel circumference to the nearest 1/4 inch.



XL486: microprocessor interface pcb

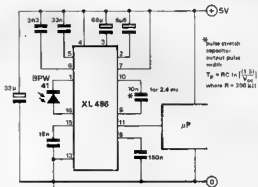

XL486: microprocessor interface application

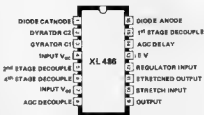

XL486: pin connections

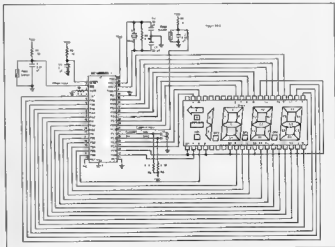

bicycle computer: schematic diagram

real-time clock plus RAM type MC146818

(Motorola Semiconductor Products Inc.)

This chip combines three features: a complete time-of-day clock and one hundred year calendar, a programmable periodic interrupt and square-wave generator, and 50 bytes of RAM. It has two distinct uses: (a) as an independent battery-operated CMOS circuit offering RAM, time, and calendar, and (b), with a CMOS microprocessor to relieve the software of the timekeeping workload and to extend the available RAM where appropriate.

Features

- Internal time base and oscillator.
- Counts seconds, minutes, and hours of the day.
- Counts days of the week, date, month, and year.
- Operation from 3...6 V supplies.
- Binary or BCD representation of time and calendar.
- 12 or 24 hour clock with AM and PM in 12-hour mode.
- Automatic end-of-month recognition.
- Automatic leap year compensation.
- Microprocessor bus compatible.
- Multiplexed bus for pin efficiency.
- Three interrupts (separately maskable and testable):
 - time-of-day alarm, once per second to once a day;
 - periodic rates from 30.5 μ s to 500 ms;
 - end-of-clock update cycle.
- 24-pin dual-in-line package.

stereo/dual TV sound processing circuit type TDA 3800

(Philips)

Features

- 2nd i.f. limiter/amplifier and FM demodulator (5.742 MHz) for the second sound channel.
- Level adjustment of the demodulated signal for channel matching.
- Pilot carrier processing with digital identification, hysteresis, and short switching times.
- Mode selection of stereo/audio or sound I/sound II with storage of selected mode.
- Two dual channel, independently control table a.f. outputs.
- Low-resistance a.f. outputs.
- Switched output for controlling external video/audio equipment.

Electrical characteristics

(typical values measured at an ambient temperature of 25°C and a supply voltage of 12 V with an input signal of 1 kHz unless otherwise stated).

Onset of limiting, pins 28-18	50 μ V
AM suppression	60 dB
Attenuation of the demodulator output signal AF2 at audio/video mode	75 dB
AF1 input voltage, pins 1-15	8 V
AF1 input resistance, pins 1-15	14 k
Maximum a.f. output signals (r.m.s.)	2 V
Signal-plus-noise to noise ratio	80 dB
Crosstalk attenuation, in stereo mode	40 dB
in dual sound mode	60 dB

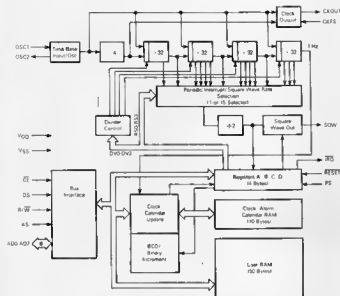

MC146818: block diagram

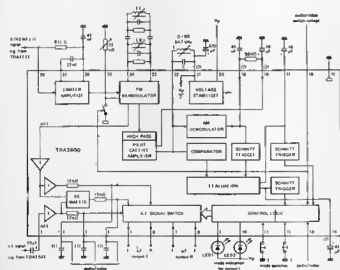

- (1) De-emphasis 4.7 nF
(2) TDA3800A applications using active filters

TDA3800: block diagram and test circuit

tape contents detector

for digital cassette recorders

M. Hafner

BCD = binary coded decimal

Figure 1. The circuit consists of three common-ordinary ICs and a handful discrete components. If these are all fitted on a small piece of wiring board, it will be possible with a little luck to house the detector in the recorder case.

The circuit about to be described makes it possible to ascertain whether a digital cassette has been written into or not. It has been tested on a Commodore computer, with a ZX81, and with a Junior Computer. Not only does it enable you to distinguish between blank and recorded tape, but also, by alternate switching between play-back and fast forward wind — or rewind — to find the beginning of a program on the tape.

When used with the Commodore or Junior Computers, the circuit shows by means of three LEDs whether the tape is blank (D2), contains a leader (D1), or has been recorded (D3). The leader, or pilot tone, is a signal which precedes the recorded information, or, in the Commodore, is interjected between the program coding (name, length, and so on) and the actual recorded data. The leader is not available with the ZX81 which in itself is a serious disadvantage. On the other hand, it makes the construction of the detector a lot easier, as shown below.

The circuit

The input of the detector (see figure 1), is connected to the output of the cassette

recorder. The signal from the recorder is taken via C6 to the input (pin 3) of a tone decoder, IC1, and to the input (pin 2) of a monostable, IC2. There are three possible states:

■ No signal. The output of IC1 (pin 8) is then logic 1, and that of IC2 (pin 3) is logic 0. The signal at the inputs (pins 12, 13, 14, 15) of the BCD-to-decimal decoder, IC3, is then a binary signal 0010 (as 12 and 13 are connected to earth which is logic 0). This causes the output (pin 3) for the decimal number '2' to be actuated, that is, to become logic 0. A current then flows through R3 and LED D2 into this pin; the LED lights to indicate that the cassette is blank.

■ Leader present. The constant frequency of the pilot tone is recognized by IC1, causing its output to go low. At the same time, IC2 receives a stream of trigger pulses, which causes its output to go high. The binary number at the inputs of IC3 is then 0001, which makes pin 2 go low. A current then flows through R3 and LED D1: the LED lights to indicate 'leader present'.

■ Data present. The output of IC1 remains logic high, because the input frequency lies outside the bandwidth of the tone decoder. The monostable remains triggered, so that its output remains logic 1. The binary number at the inputs of IC3 is 0011 causing pin 4 to become logic 0. The LED D3 then lights to indicate 'data present'.

The centre frequency, f_c , of IC1 is determined by P1 and C5 and can be calculated from $f_c = 1/P_1C_5$ (Hz) where P1 is the preset value of P1. The bandwidth, B, of the tone decoder is calculated from $B = 1070 \sqrt{U_1/I_c C_4}$ (Hz), where U_1 is the r.m.s. value of the input signal in volts, C_4 is the value of C4 in μ F, and I_c is the centre frequency in Hz. It should be noted that U_1 should be smaller than 200 mV. When the ZX81 is used, D1, IC1, P1, R2, and C5...C8 can be omitted. Pin 14 of IC3 is then connected to the positive supply line.

Calibration

This section need not be read by ZX81 users, as in their case there is nothing to be calibrated. Otherwise, connect your home computer to the cassette recorder and write a program of a few dozen single figures (as close together as possible) onto the tape: this gives you a leader on the cassette. Rewind the tape, and then play back. Starting from centre setting, adjust P1 slowly until LED D1 lights for 2...10 seconds for each leader.

1

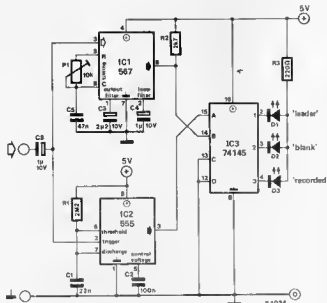

THE BF 494

A CASE IN POINT

Editor's lament:
Oh why, tell me, why
Can our readership's eye
More clearly descry
Than an author, or I,
Any slip, imperfection,
Or faulty connection?

The BF 494 is an extremely useful HF transistor, and it is used in many Elektor circuits for this reason. The specifications are quite good and the price is quite reasonable, which means that it can be used as a kind of 'Universal HF Transistor'. Applications range from

found that these two reliable sources had different ideas about the BF 494. A few 'phone calls to the two parties concerned taught us that, in this case, the Philips data are accurate. Pro-Electron, for once, appears to have slipped up. Figure 2 therefore gives the official pinning for the BF 494. As a final note we would like to remark that we were highly impressed by the rapid and energetic action undertaken by the 'Association Internationale Pro-Electron' to locate and remedy the mistake. We will continue to rely on their data handbooks in the future, albeit perhaps not quite so blindly...

Figure 1. The BF 494 according to Pro-Electron.

Figure 2. The BF 494 according to Philips. Note the interchanged collector and emitter connections.

116

(TO-92)

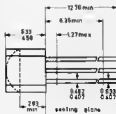
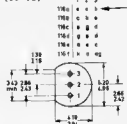

1

Low power HF transistors

Transistors HF - HF-Transistoren

BF

TYPE	RATINGS (at Tamb = 25°C, unless otherwise stated)						CHARACTERISTICS (at Tamb = 25°C, unless otherwise stated)														P D O T L I B E Z T	
	V _{CE0}	V _{CE0}	V _{EB0}	I _C	P _{tot}	T _j	h _{FE}		h _{FE}		C _{ob}		V _{CEsat}		I _C	I _B	F	V _{CE}	I _C	I _B		F
	V	V	V	mA	mW	°C	min	max	min	max	min	max	min	max	min	max	min	max	min	max		min
BF494	30	20	5	30	300	130					260	10,85	10	0,14	1	10	4	10	1	100	1	116a

9784 1

oscillator and mixer stages in AM and FM receivers to HF and IF amplifier stages.

However, there is a problem. As several observant readers have pointed out, the pinning shown in the transistor list in E17, p.947, is at variance with the pinning used on the Elektor printed circuit boards. As we mentioned in the 'Missing Link' last month, the information in the transistor list was incorrect; this has been corrected in the more recent lists. The reason for the slip is perhaps interesting. We took extreme care to keep the list in exact accordance with the 'Standard Handbook' issued by Pro-Electron. When the reader's enquiries started coming in, we compared the Pro-Electron data (figure 1) with the pinning shown in the Philips data handbook (figure 2). To our surprise we

2

SILICON PLANAR EPITAXIAL TRANSISTOR

BF494

Dimensions in mm

MECHANICAL DATA

TO-92 variant

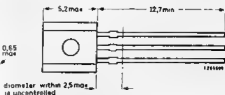
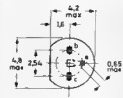

diameters within 25µm ± uncontrolled

9784 2

signal injector

J.W. van Beek

Many people consider the use of signal injectors to be something of a 'brute force' method of faultfinding. However, a signal injector can easily be carried around in the pocket and is often the service engineer's 'first line of defence' when undertaking repairs in the customer's home. Certainly a signal injector is much more portable than an array of sophisticated signal generators.

Most of the cheap signal injectors on the market produce a squarewave output at about 1 kHz. Since the squarewave is rich in harmonics extending up into the Megahertz region these are useful for testing r.f. circuits, as well as using the fundamental for audio testing.

The signal generator described here differs slightly in that the 1 kHz squarewave is keyed on and off at about 0.2 Hz, which makes it easier to trace.

Figure 1 shows the complete circuit of the signal injector. The keying oscillator consists of an astable multivibrator built around two CMOS NAND gates N1 and N2. This switches on and off T1, which drives a LED to indicate when the signal is on. The 1 kHz squarewave generator also consists of an astable multivibrator, which utilises the two remaining NAND gates in the 4011 package. This astable is gated on and off by the first astable. The output of the 1 kHz oscillator is buffered by transistors T2 and T3, the output being taken from the collector of T3 via a potentiometer P1 which serves to adjust the output level. The maximum output is approximately equal to the supply voltage (5.6 V). Diodes D1 and D2 provide some protection for T2 and T3 from external transients, and C6 isolates the circuit from any DC voltage in the circuit under test. If the signal injector is to be used to test circuits having high voltages present, especially mains (e.g. television sets) then C6 should be rated at 1000 V working, in which case it will be too large to mount direct on the p.c. board, the layout for which is given in figure 2. It is also a good idea to mount the complete circuit inside a box made of insulating material, especially when working on live chassis equipment such as a television set. D1 and D2 should be types capable of handling any transient voltages and currents likely to be encountered.

Power for the circuit can be provided by four 1.4 V mercury batteries. The exact type of battery chosen is up to the individual constructor, but should neither be so small that the battery life is too short, nor so large that the complete instrument is too bulky. ■

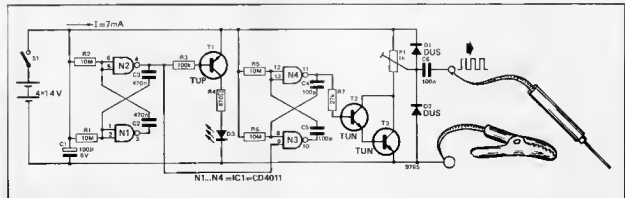
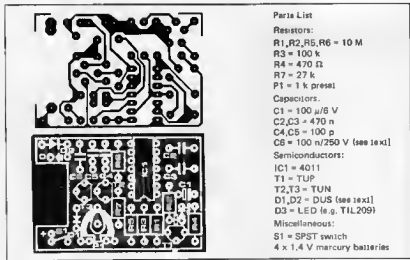

INDICATING LAMPS

Signal indicator lamps are manufactured by Instrument Control Devices and are available in two types - with a neon bulb and resistance connected externally or with a LED Snap-in fixing feature eliminates hardware and facilitates installation. The flat lens, available in red, green and amber colours, provides uniform illumination. The lamp holder, moulded in high grade plastic, has an anti-rotation lock. The instrument finds applications in control panels, test equipments and all types of signal indicators.



For further details, write to
Instrument Control Devices
14, Manorama Niwas
Datar Colony, Bhandup
Bombay 400 078

JUNCTION SHELL

ITT Cannon has introduced a plastic D-Subminiature junction shell which snaps together for quick assembly without screws. The new clicking junction shell allows users to quickly attach D-Sub connector to cable without using screws. Available in 5 sizes, both halves of the shell are identical to eliminate presorting. Other features include an angravid pistol grip design to make handling easier, non-flammable 94V-0 material and straight or 90 degree outlet capability.



More details from
Jost's Engineering Co. Ltd.
60, Sir P.M. Road
Bombay 400 001 (Tel: 25 81 50)

CONDUCTIVE SILVER

Eilecks Corporation have developed conductive silver preparation No. 1228, for brushing/spraying application on substrate materials like wood, paper, phenolic and glass laminated epoxy boards, fibre reinforced plastics, metals, etc. It develops adhesion and conductivity after 1-2 hours at room temperature and can also be cured at 60-80° for 30 minutes to one hour. It is suitable, according to the manufac-

turers, for RF-shielding, imparting conductivity to the surfaces of plastic masters used for electroforming, PCB repairs, filling air-gaps in telemetry antennas, improving the grounding/earthing of VHF/UHF housings, etc.

For more information, contact
Eilecks Corporation
C-314, Industrial Estate, Peenya
Bangalore 560 058

FLEXIBLE GROMMET

Novoflex Cable Care Systems make a wide range of different sizes of flexible grommet rings, which enable electrical engineers to protect wires, cable cords against damage from sharp panel edges and to insulate holes of steel sheets. Highly flexible, they have good resistance to fluids, mineral and vegetable oil, acids, alkalies, aromatic fuel and ozone. They are suitable for use in control panels, electrical and electronic equipments and appliances, medical and testing equipments, etc.



For more information, contact
Novoflex Cable Care Systems
Post Box No. 9159
Calcutta 700 016

CHARGED BODY DETECTOR

Munroe Electronics Inc., of U.S.A. have designed charged body detector, model 248, which is basically an electrometer utilising a special multilayer tape sensor. This tape probe detects the electric field from a moving charged object or person, and trigger any of several alarm modes if the signal exceeds a pre-set sensitivity level. Sensitivity may be set from approximately 10 V to 10,000 V. It has additional features like remote alarm, output event counters and alarm latch.



More details can be had from
Swadep Instrumentation
101, Vishnu Villa
10th Road, Khar
Bombay 400 052

STROBOSCOPE

Portable stroboscope, type 4912, from Bruel & Kjaer, Denmark, is a compact hand-held instrument for qualitative investigation and accurate measurement of various kinds of rapid repetitive motion in trouble shooting and in design and development situations. It has three modes of operation. In the free running mode, the stroboscope lamp flashes at the frequency set by the internal frequency generator and indicated on a 4-digit display. In the "Tacho" mode, it performs solely as a tachometer and in the "Ext. Trigger" mode, it can be used as a combined stroboscope and tachometer. Total weight: 1.3 kgs. Available against AU import licence.



For more information, contact
Jost's Engineering Co. Ltd.
60, Sir P.M. Road
Bombay 400 001 (Tel: 25 81 50)

INTERCOM

Product Promoters offer 'Telesink', a low-priced end convenient intercom system. It operates on one common 9V Eveready battery or on 230 V (auto change over) and, according to the promoters, does not require any servicing for several years. Available from 2 to 12 lines or more, in various colours.



For further details, write to
Product Promoters
Post Box 3577, Lajpat Nagar
New Delhi 110 024

PEAK-READ INDICATOR

Measurements Group, Inc., of U.S.A. have announced the introduction of a new peak-read indicator, model 3600, which provides a simple method of accurately measuring peak values of both recurrent and nonrecurrent dynamic events. It can be used in conjunction with any static strain gage indicator, transducer indicator or signal conditioning system which provides an analog output in the 1.0- to 11.0-volt range. It features an LCD display with full-scale range of $\pm 19,999$ counts, easy-to-use colour-coded push-button controls and is powered by six "C" cell batteries. Available under OGL to R & D laboratories and AU import licence to others.



For further details, contact
TM Strass Measurements & Engineering Pvt. Ltd
Sterling Centre
16/2, Dr. Anna Besant Road
Bombay 400 018

POWER OP AMP

APEX introduces the PA 51 and PA51A high current Power Op Amps designed for cost sensitive applications, requiring up to 10 amps drive to resistive, capacitive or inductive loads. The class C output stage configured with monolithic darlington transistors, insures a very rugged device while holding quiescent power dissipation to a bare minimum in typical applications they power motors, actuators, coils or heaters.

With resistive loads and case temperatures of 25 degrees C, the available power can be as high as 300W DC for a single supply of 320V peak AC using dual supplies. Internal thermal resistance of 1.8 degrees C/W from junction to case, allows a maximum internal power dissipation of 95W at a case temperature of degrees C. Two external resistors program the current limits, thus facilitating conformance to safe operating area criteria.

The PA51 is suitable for dual supplies up to $\pm 36V$ in the industrial temperature range. Both amplifiers a monolithic bipolar input stage and

internal compensation for use at all gain settings. These hybrid integrated circuits utilize thick film conductors, ceramic capacitors and silicon semiconductors to minimize reliability, minimize size and give top performance. Ultrasonically bonded aluminum wires provide reliable interconnections at all operating temperatures. The 8 pin TO-3 package is hermetically sealed and isolated to allow mounting without use of thermally expensive washers.

A fully screened MIL-STD-883B version of these product is also available.

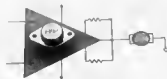

For further information Contact,

ELMATRONIC DEVICES
14, Hanuman Terrace,
Tara Temple Lane,
Lamington Road,
BOMBAY 400 007.

Tel 362421 353029
Gram ELMADEVIC
Tatex 11-5614 SEVK-IN

DUAL TRACE SCOPE

Vasavi Electronics have introduced a two-channel oscilloscope with 8 x 10 cm screen 1 mv sensitivity and 5/15 MHz bandwidth. The instrument, model VOS 26, is light and compact, with aluminium mechanical parts, anodised panels and epoxy-painted non-screwing press for covers. The Bailly stand side handle is suitable for use in flat or upright position. X-Y operation at 10 mv - 30v/cm on both channels, time-base coupled ALTERNATE/CHOP modes, mean level triggered auto, selectable level NORM are some of the features of the model.

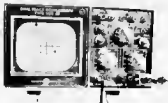

Further information can be had from

Vasavi Electronics
162, Vasavi Nagar
Secunderabad 500 003

MOTOR MONITOR

Advani-Oerlikon have developed a Motor Temperature Monitor (model Ador-8S), for monitoring temperatures of windings and bearings of rotary machines which use TRDs as sensors.

The unit which continuously senses and monitors temperatures and prevents motors from burning due to excessive heat, has applications in industries like cement, steel, textile, fertilizer and other industries where high power motors are in use.



For more details

Advani-Oerlikon Ltd.
Post Box No. 1546
Bombay 400 023

SOLID STATE RELAY

Electronic Relays have come out with a miniature type dual-in-line solid state relay in Dip configuration, compatible with any standard IC base. The manufacturers claim that, with this relay, there is no arcing, contact bounce and chattering. Overall size is 19 mm x 12 mm x 11 mm.



For more details, contact

Electronic Relays (India) Pvt. Ltd
10.2, Lalbagh Road, Richmond Circle
Bangalore 560 027

COMMUNICATION CAPACITORS

Toshniwal Instruments have introduced SCR commutation capacitors, useful in silicon controlled rectifier circuitry which often requires a specially designed AC capacitor to provide commutation. This turn-off function can be accomplished by a pulsed energy release from an SCR commutation capacitor. Some of the features are: extended foil, low inductance construction, heavy internal leads, large brushing studs and wide area swedging to assure lowest possible equivalent series resistance for realisation of maximum values of peak current.

For further information, write to
Toshniwal Instruments Madras
267, Kilpauk Garden Road
Madras 600 010

Digital logic pulser

The PLS-1 logic pulser will superimpose a dynamic pulse train (20 pps) on a single pulse onto the circuit node under test. There is no need to unsolder pins or cut printed-circuit traces even when these nodes are being clamped by digital outputs. This product is a multi mode high current pulse generator packaged in a hand-held, shirt pocket portable, instrument. It can source or sink suffi-



cient current to force saturated output transistors in digital circuits into the opposite logic state. Signal injection is by means of a push button switch near the probe tip. When the button is depressed, a single high-going or low-going pulse of 2µs wide is delivered to the circuit node under test. Pulse polarity is automatic: high nodes are pulsed low and low nodes are pulsed high. Holding the button down delivers a series of pulses of 20 pps to the circuit under test.

*Toolranga Limited,
Upton Road,
Reading,
Berkshire, RG3 4JA,
Telephone: 0734 22245*

(2894 M)

80 column needle mechanism

DED of Lydd has introduced a true 80 column mechanism which can also print at 96 and 132 characters per line. Previously designers have had to allow space for a complete free-standing unit which can be expensive and reduces the software flexibility.

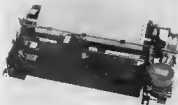

The D119 has a 9 needle head with stepper motor drive for the pen carriage and paper feed. Paper can be fed forward and reverse. Printing is bi-directional in character mode and unidirectional in high resolution graphic mode. Print speed is 100 characters per second. It accepts paper 4 1/2 to 10 inches wide and has both friction feed and pin feed as standard as well as printing on original pins two copies. A4 single cut sheets can also be fed. The ribbon is in cassette form for ease of changeability. Each cassette can print 2 million characters minimum. The two stepper motors and print head only require 24 V DC hence power sup-

ply requirements are simplified. This rugged mechanism has very high reliability and measures 380 mm wide, 209 mm deep and 74 mm high (excluding lever arm). It weighs 3.1 kg.

*DED,
Mill Road,
Lydd,
Kent TN29 9EL,
Telephone: 0679 20636*

(2892 M)

Isolation amplifier

Offering a new and safe way of making measurements on floating circuits up to 1,500 V from ground. The input amplifier offers sensitivities from 10 mV/division to 5 V/division 50 V with probe set to X10; AC or DC coupled. Signals from the input amplifier are coupled to the output amplifier by a pair of differentially connected opto-couplers thus ensuring good linearity and high common mode rejection. The output remains constant at 100 mV/division giving a useful gain boost for older less sensitive



oscilloscopes. The amplifier will find great acceptance in such diverse fields from power engineering examining SCR and triac gate firing pulses, switch mode power supplies, eliminating ground loops to medical research where complete isolation between subject and measuring instrument is essential. Battery operation from PP3 batteries means that the amplifier can quickly and easily extend your oscilloscope's performance at any time.

*Otter Electronics Ltd.,
Otter House,
Weston Underwood,
Olny,
Buckinghamshire MK46 5JS
Telephone: 0234 712445*

(2893 M)

New catalogues

Marshall's 1984 catalogue contains 56 pages filled with over 8,000 line items, and crammed from cover to cover with new products, new data and new ideas. This is one of the biggest catalogues ever produced by Marshall's and costs 75p to callers, £1.00 post paid within the U.K., and £1.50 for the rest of the world.

*Marshall's,
85 West Regent Street,
Glasgow G2 2DQ,
Telephone: 041 322 4133*

Electrovalve A Z product list is regularly updated and is available free to anybody on request. Its 36 pages contain everything from adhesives to zener diodes and everything in between.

*Electrovalve Ltd.,
28 St Judes Road,
Englefield Green,
Surrey TW20 0HR,
Telephone: 0784 33603.*

µ Amplifier

Now signals as minute as 100 µV from DC to 2 MHz can be viewed and measured on most oscilloscopes. The amplifier offers sensitivities from 100µV/division to 50 mV/division with AC or DC input coupling and maintains a constant output of 100 mV/division. To make full use of the high sensitivity a differential input is pro-



vided so that common mode signals can be minimised, also to improve the display bandwidth limiting switch is provided to reduce the upper frequency limit to 20 KHz or 1 kHz. This amplifier will find many uses in audio and video work enabling monitoring of signals direct from playback heads and measuring ripple. Even physiological signals come within the amplifier's wide performance. Battery operation from PP3 batteries means that the amplifier can quickly convert your oscilloscope for very low level signal observation.

*Otter Electronics Ltd.,
Otter House,
Weston Underwood,
Olny,
Buckinghamshire MK46 5JS,
Telephone: 0234 712445*

(2886 M)

6502 Micro controller

Control 65 is a small low cost micro controller allowing 'stand alone' terminals to have intelligence and flexibility. A +5 V supply is all that is required to make the 75 mm x 100 mm PCB into a versatile controller offering 16 TTL compatible Input/Output lines, up to 8kB of EPROM decoding, 2x8 of user RAM plus the popular 6502 microprocessor. Onboard links allow 2716, 2732 EPROM type devices to be used. PIO interrupts are serviced for fast I/O response times.

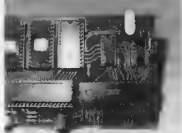

Applications within industry are countless and also extend into educational and experimental spheres, thus providing an ideal opportunity to gain familiarity with the 6502 microprocessor. It can easily be programmed using Interface 84 (Multiplexed RAM Card) from most computer systems.

*J. P. Designs,
37 Dyster Row,
Cambridge, CB5 8LJ,
Telephone: 0223 522234*

(2895 M)

New portable digital thermometer

A new portable digital thermometer has been launched in the UK for only £56.00 by Portec Instrumentation, Luton, Bedfordshire. Designated the PI-8208, the new instrument provides 1°C resolution and 0.4% accuracy throughout its -30°C to +750°C measurement range and carries two-year guarantee.



Readings are displayed on a large 12.7mm liquid crystal display, which also carries warnings of a faulty thermocouple connection or a low battery condition. The instrument can be powered by a single MN 1604 battery which gives a typical life of 600 hours, or by a PP3 battery which provides 360 hours' typical use. The PI-8208 is compact and lightweight, and will fit easily into the pocket. Robust construction of the splash-resistant case enables the instrument to withstand the most rugged operating conditions throughout industry and the laboratory.

*Portec Instrumentation Limited,
3.5 George Street West,
Luton,
Beds. LU1 2BJ,
Telephone: 0582.32613*

(2731 M)

Calculator-style DMM

The first new Simpson calculator-style digital multimeter is now available in the U.K. from Bach-Simpson (UK) Limited. Features of the 470 include: - Twenty five ranges including 1000 volts DC, 750 volts AC and 20 amps AC/DC and all voltage and resistance ranges being protected against transients up to 6 kV at 100 microseconds. Convenient recessed 'human-engineered' thumbwheel knobs control ranges and functions. An audible tone feature on the 2000 ohm range provides fast checks for shorts and continuity. A diode test provides quick, good-bad checks of semiconductor junctions. The easy-to-read, high-contrast, 3-1/2 digit, 7 segment LCD display also features a 'low battery' indicator - bat-



tery life being a year with average use. The high-impact, sealed case is 1.8 x 3.4 x 7.1" and a two-way fold-out stand provides for convenient benchtop use or for hanging in an upright position. Total weight is less than 1 lb.

The 470 is supplied complete with UL-recognised, colour-coded test leads with screw-on crocodile clips, 9 V battery and instruction manual. Optional accessories include a Simpson Amp-Clemp AC current adapter, as well as temperature, RF and high voltage probes, and Simpson universal test lead system.

*Bach-Simpson (UK) Limited,
Trent Estate,
Wadebridge,
Cornwall PL27 6HD,
Telephone: 020-881.2031*

(2733 M)

Desk top XY recorder

The WX1000 from Environmental Equipments (Northern) Limited is a lightweight, portable, XY Recorder with a chart area of 250 mm x 180 mm.

It is easy to set up and use in all types of locations and will operate in any inclined position, horizontal or vertical, an ideal requirement for laboratory and field work. Built-in X and Y amplifiers are an integral

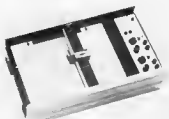

part of the chassis providing measuring ranges of 0.5 V/cm up to 5 V/cm, with $\pm 0.5\%$ accuracy of full scale.

The disposable fibre tip pen can be raised and lowered remotely by applying an external control signal, and can be cycled up to 5 times per second.

The WX1000 can be rack mounted, if required, with optional mounting hardware which is available at nominal cost.

*Environmental Equipments (Northern) Limited,
Environ House,
Welsh Row,
Nantwich,
Cheshire, CW5 5ES,
Telephone: 0270.625115*

(2745 M)

Miniature manual line pushbutton switches

Honeywell control systems micro switch division have introduced a new series of miniature manual line pushbutton switches.

The MML pushbutton switches deliver a large measure of design freedom in a miniature size package. Options include 1 or 2 pole circuitry, momentary-action or 2 level alternate action, electronic control switches with LEO back-illuminated display in red, yellow or green, power control switches and matching indicators.



Many design options are possible with the MML series and the modular ordering system provides flexibility to select LEDs, buttons, electrical rating, and circuitry/operating action combinations to meet application needs.

These MML pushbutton switches have an attractive, low-profile appearance and assure space and styling needs of future computer/business, instrument end communication equipment.

*Micro Switch Division,
Honeywell Control Systems Limited,
Honeywell House,
Charles Square,
Brecknell,
Berkshire RG12 1EB,
Telephone: 0344.24555*

(2732 M)

The stabilising influence on erratic power supply



Aplab 9100 Series Servo Controlled Voltage Stabilizers

Aplab presents a wide range of voltage stabilizers with high efficiency and reliability to condition erratic mains from damaging your expensive equipment. Advanced design employing silicon devices make them highly dependable and sought after.

Quality components and manufacturing practices make Aplab 9100 Series Servoline Stabilizers meet even JS 55555 Military Specifications.

Excellent regulation and good correction rate with optional wider input capability, make Aplab 9100 Series Servoline unique in industry.

Applied Electronics Limited

Aplab House, A-5 Wagde Industrial Estate, Thane 400 604 Phone: 591861 13 Inset, Telex: 011-71979 APEL IN

8/A Gandhi Nagar, Secunderabad 500 003 Phone: 73351

22C Manohar Pukur Road, Calcutta 700 029 Phone: 473877 Telex: 021-3246

Nus 44 & 45 Residency Road, Bangalore 560 025 Phone: 578977, Telex: 0845-8125 APLB IN

MF-3, Stutee Building, Bank Street Kanol Bagh, New Delhi 110 005 Phone: 578842, Telex: 031 5133 APLB IN

Aplab — Leadership through technology

ATTENTION

elektor INDIA READERS

**NOTE:
ASK FOR PROFORMA INVOICE
FROM ONE OF THE FOREIGN
ADVERTISERS IN THIS ISSUE
TO ENABLE YOU TO REMIT
THE AMOUNT.**

Import of electronic spares and components (BUT NOT CONSUMER ELECTRONIC ITEMS) by any person for his personal use or by any institution for its own use, is permitted under the current import trade control regulations, (vide Clause No. 11 (1) (gg) of the Import Control Order 1955 as amended up to 15-4-1983), provided that the cif value of the goods imported at any one time shall not exceed Rs. 1000/-. Payment in respect of such goods will be remittable through authorised Banks.

SOURCE: Hand book of Import/Export Procedure & Import & Export Policy 1983-1984.

for your copies of Elektor INDIA

THE elektor INDIA CASSETTE BINDER

This cassette style will help to keep your copies of Elektor India clean and in order, even though you refer to them time and time again. The chamfered corner of the cassette allows instant recognition of each month's issue without the need to thumb through pages of previous month's issues. Because no wires or fastenings are used copies can be easily removed and replaced and each cassette will hold one year's volume of Elektor India. Their smart appearance will look good on any laboratory shelf.



PRICE Rs. 25/
inc. Regd. post & packing
Available from
precious[®]

ELECTRONICS CORPORATION

3, chunam lane, dr. d. bhadkamkar marg,
bombay-400 007. phones: 367459; 369478.

CONDITIONS OF ACCEPTANCE OF CLASSIFIED ADVERTISEMENTS

- 1) Advertisements are accepted subject to the conditions appearing on our current rate card and on the express understanding that the Advertiser warrants that the advertisement does not contravene any trade act in force in the country.
- 2) The Publishers reserve the right to refuse or withdraw any advertisement.
- 3) Although every care is taken, the Publishers shall not be liable for clerical or printer's errors or their consequences.

- 4) The Advertiser's full name and address must accompany each advertisement submitted.

The prepaid rate for classified advertisement is Rs. 2.00 per word (minimum 24 words). Semi Display panels of 3 cms by 1 column, Rs. 150.00 per panel. All cheques, money orders, etc. to be made payable to Elektor Electronics Pvt. Ltd. Advertisements, together with remittance, should be sent to The Classified Advertisement Manager. For outstation cheques please add Rs. 2.50

Electronics Tools like Soldering Irons, Pliers, Cutters, Screw Drivers, Tweezers at Competitive Prices. Contact Aradhna Electronics (P) Ltd., 10, Srinath Complex, Seroinidevi Road, Secunderabad 500 003.

APLAB	5.11, 5.65
B.T. SOLDERS	5.13
COSMIC	5.76
DOMINION RADIOS	5.08
ELMATRONIC	5.09
GENERAL SALES AGENCY	5.73
IEAP	5.12
INDUSTRIAL RADIO HOUSE	5.71
IRA	5.12
IZUMIYA IC INC	5.02
KELTRON	5.07
ELECTRO COMPONENTS CO	5.71
LUXCO	5.14
MECO	5.08
PHILIPS	5.05
PULSECO	5.12
RELIANCE	5.72
SATO	5.10
TANTIA	5.72
TECHNOMATIC LTD	5.72
TESTICA	5.10
TEXLA	5.10
TECHNICAL TRADE LINKS	5.08
VASAVI	5.73
VISHA	5.72
ZODIAC	5.71

missing link

7-day timer/ controller

(May 1983 - page 5-34)

It happens occasionally that the first minute of the day (00.00...00.01) lasts for 1 min. 15 sec. If your timer suffers from this, replace the 47 pF capacitor in the C9 position by one of 33 pF.

Tape timer

April 1984 - page 4-42)

Note that the base resistor in figures 4a and 4b should read 100 k.

The diode bridge in figure 5 consists of diodes type 1N4001.

The caption of figure 5 should be extended as follows.

.. NiCd cells (c). These cells should be of the sintered type. The value of charging resistor R_C sintered type. The value of charging resistor R_V is calculated from $R_V = 50 / \text{capacity of cells in Ah (ohms)}$.

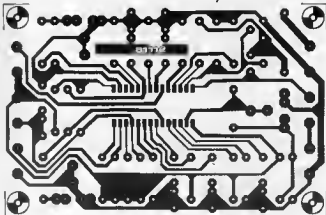

SOUND GENERATOR

(April 1984 - Page 4-48)

A new smaller version of the 76477 is now available. The PCB design for this chip is given here. Pin connections are the same.

pro power COSMIC

Choice of
**30 Watts to
600 Watts**

HI FI INTEGRATED
STEREO AMPLIFIERS

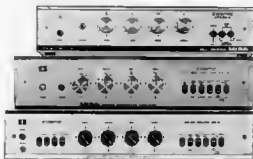

CO 40 DELUX MK II
40 Watts * 0.5%

CO 60 DELUX MK II
60 Watts * 0.5%

CO 100 DELUX MK II
100 Watts * 0.5%

MINI
SERIES



MINI LAB 150
180 Watts * Less than 0.08%

LAB SERIES — Panorama Control

LAB 3000 MK II
200 Watts
* Less than 0.05%

LAB 5000 MK II
300 Watts
* Less than 0.05%

LAB 6 x 1000
600 Watts
* Less than 0.01%

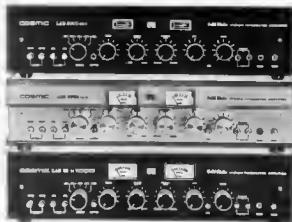

* Harmonic Distortion at
Rated output at 1 KHz

Cosmic amplifiers are masterpieces of technological sophistication, giving true fidelity and perfect clarity of output. Cosmic pro power amplifiers are available in a range from 30 watts total output to 600 watts total output.

Select from the widest range of amplifiers in India, matched with appropriate speakers, and play your kind of music on turntables and tape decks - all by Cosmic, the pioneers in stereo systems in India, with over a quarter century of experience in manufacturing and marketing quality sound equipment.

International quality created for India by **COSMIC**