

107

April
1984

elektor

INDIA

Rs. 7.50

electronics

real-time analyser

find your way out of the

elabyrinth

**sound
generator**

petrol saver
cuts your car expenses



Hi-Fi connections of the Japanese kind!

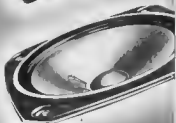
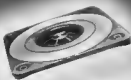

Introducing the most advanced front-line Speaker Systems. Sonodyne SX 500, 600, 900—the only Speakers in India with original Japanese Woofers, Tweeters* and Midrange.

The Woofers are Japanese.
The Cone Tweeters are Japanese.
The Midrange is Japanese.
No Indian Speaker System could
be more Japanese. And you know,
Japanese technology in electro-
nics is legendary.

Among the outstanding
characteristics of Sonodyne 'SX'
Speakers: a unique bass-reflex
with twin port design. An
immaculate stereo presentation
within the full frequency range,
without distortion. Low harmonic
content giving music a life-like
quality. Competitively priced, yet
incorporating superb features and
Japanese components, yet to be
found in a single Indian Speaker
System!

Sonodyne 'SX' Woofers

These cone-type high efficiency
woofers, 200 to 250 mm in
diameter, give a clean and genuine
low bass. At any volume level.

Sonodyne 'SX' Tweeters

The tweeters have been specially
matched to give you interference-
free brilliant highs.

Sonodyne Midrange (SX 900)

This high-powered midrange
prevents interaction with the low
frequency transducer and delivers
crisp, clear reproduction. Free
from coloration/phase errors.

Sonodyne 'SX' Bass Reflex with Twin Port Design

A special crossover network

guaranteeing an unmatched
musical reproduction and a highly
sensitive bass response.

We can go on and on about the
'SX' Series advancements.
'SX' 500/600/900 having an input
power of 50, 60, 90 Watts per
channel respectively. About the
'SX' 500, 600 having a 2-way,
2 speaker system. Or the 'SX' 900
having a 3-way, 3 speaker system.
But we'll just say that Sonodyne
Speaker Systems, are the perfect
answer for people with an ear for
music and a head for money!
Listen to them at your nearest
Sonodyne dealer today!

*Cone tweeters only.



SONODYNE

—The name that's music to your ears.

Available at all leading music dealers.

Dataram-SE36B/83

Sum's Singh

contents

Selektor	4-12
A look at what is happening with satellite TV in the U.K. at the moment.	
petrol saver	4-15
Most carburettors waste a certain amount of petrol unnecessarily. By reducing this wastage you also reduce your motoring costs. This circuit achieves this by making a carburettor work more efficiently.	
triac control board	4-18
This triac-controlled mains lamp firing circuit was primarily designed for use with our programmable disco lights display but it could also be used as an interface between a computer and mains powered equipment, or to expand existing circuits.	
UHF video and audio modulator	4-24
To convert the video signal from a home computer into a suitable signal for a UHF TV set, a modulator is needed. The design here provides good video and also has high quality audio.	
GET & GO	4-28
Enables the Junior computer to automatically start programs after loading them from cassette.	
Elabyrinth	4-30
For those of you who thought the electronic game died when the computer game was born, we have designed a game that does not use even one microprocessor. That should not be held against it, though, and we still think you will be 'amazed'.	
varistor protection circuits	4-37
Voltage dependent resistors are not very commonly used by electronics hobbyists but due to their specific characteristics they are eminently suitable for protecting electronic circuits and semiconductors from overvoltages.	
real-time analyser (part 1)	4-40
A real-time analyser is an audio measuring instrument that defines which frequencies are present in an audio signal and in what strengths. This month's article deals with the general description and the input and filter sections.	
sound generator	4-48
However strange a sound effect may be, our readers always seem to be able to find plenty of usas for it. The device featured in this article is able to imitate many sounds from the twittering of birds to machinegun fire, from the screeching of brakes as a car runs out of control to the inevitable crash ... and all from a single IC.	
applikator	4-56
Single-chip colour decoder - the TDA 1365	
market	4-60
EPS service	4-64
switchboard	4-69
missing link	4-74
advertisers index	4-74



Our front cover this month shows Elabyrinth our electronic maze game. We toyed with the idea of calling it 'Red Tape' as we have often thought that dealing with ERT (Executive Red Tape) is somewhat akin to trying to find your way out of a maze. Indeed, looking at the front cover picture, we even see a striking resemblance between the open jaws of our Elabyrinth and some of the ERT lovers we have met over the years. So if you see anybody lurking in your area who bears a likeness to our front cover, don't panic, it is probably only your local (this section has been deleted as we cannot afford a libel suit right now - Ed.).

- A selection from next month's issue:**
- real-time analyser (part 2)
 - a.c. power supply
 - intelligent EPROM eraser
 - pulse generator
 - microprocessor simulator



AE

Electrical Measuring Instruments

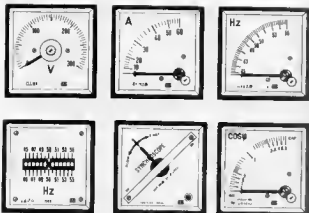

TECHNICAL EXCELLENCE

A word more often used but less often substantiated, but with AE its different. You will find the true full measure of our technical excellence in all our products.

Take our measuring instruments for instance. We make very wide range of:

MOVING IRON:

200 mA-200 A end in 6" round 600 Amps
10 V-600 V end with ext. PT 1000 Volts.

MOVING COIL:

50 μ A-30 Amps & with external shunt 12000 A
(50, 80, 75, 150, 300 mV)
10 mV-300 V end with external mol. 1000 Volts

FREQUENCY:

50, 60 400 Con. Freq. at 110, 220, 440 Volts.
Vibrating Reed as well as Pointer type.

WATT & VAR COS ϕ :

At 0.5, 1, 5, 10, 15 Amps
82.5 110, 125, 220, 250, 440, 500, 600 Volts.
Dynamometric as well as transducer type.

All these instruments conform to IS 1248-8B, BS 89-70 IEC 51-60, VDE 0410, DIN 43700, AS 1042-73 end of course, have the unimpeachable AE technology behind them. Always they will measure upto your expectations.

INSTRUMENT SELECTION CHART

TYPE	PANEL OUTPUT	SCALE LENGTH	FUNCTIONS													
			V _{AC}	V _{DC}	I _{DC}	I _{AC}	Hz	W	VAR	COS ϕ	Speed	Position				
78472	07407	80mm	*	*	*	*	*	*	*	*	*	*	*	*	*	*
80160	80401	80mm	*	*	*	*	*	*	*	*	*	*	*	*	*	*
106144	106470	120mm	*	*	*	*	*	*	*	*	*	*	*	*	*	*
72171	87407	80mm	*	*	*	*	*	*	*	*	*	*	*	*	*	*
83110	83101	100mm	*	*	*	*	*	*	*	*	*	*	*	*	*	*
106042	126470	80mm	*	*	*	*	*	*	*	*	*	*	*	*	*	*

BRANCH OFFICES

DELHI SIDDIO BUILDING, 110 006
PHONE : 521818, 521478, 526003

CALCUTTA BENTICK HOUSE, 700 001
PHONE : 269735 or 274693

SECUNDERABAD CHANDRALOK COMPLEX, 500 003
PHONE : 75224

BANGALORE DADLANI'S MANSIONS, 560 027
PHONE : 220136

MADRAS BROADWAY, 600 108 PHONE : 23979

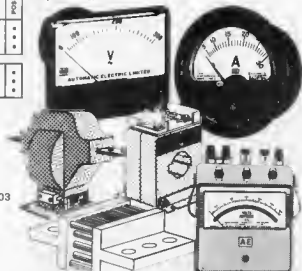

AE Automatic Electric Ltd.

"RECTIFIER HOUSE" P O BOX NO. 7103, 80M.8AY-400 031.
PHONE: 8829330-33 TLX .11-71546

ELCOT-SUNOARAM TIE-UP

The state-owned Electronics Corp. of Tamil Nadu (ELCOT) plans to join hands with Sundaram Industries of the TVS group, to manufacture TV picture tubes, both B & W and colour. The project, which is to be located in a backward area, involves a cost of Rs. 70 crores for colour tubes and Rs. 5.4 crores for B & W; annual capacity will be 10 lakhs colour and 3.5 lakhs B & W tubes. TVS is a leading group of automobile ancillaries manufacturers and the present joint venture signifies a major diversification for them. ELCOT too, will take a big step from its present line of activities which is confined to digital electronic watches and aluminium electrolytic capacitors.

COMPUTERISED STAFF MANAGEMENT

The Madhya Pradesh directorate of public instruction will soon switch over to a computer-based personnel information system, with the National Productivity Council providing the necessary technical assistance. The directorate handles about 75600 schools and over two lakh teachers; The new system will help it obtain immediate and precise information

on the institutions and the staff and make prompt decisions regarding transfers, promotions, recruitments, etc. The system, which is likely to become operational from the next academic year, is expected to speed up administrative procedures and lead to better planning of the educational and compilation of statistical reports.

MELTRON FORGES AHEAD

Maharashtra Electronics Corporation Ltd., (MELTRON), which made its entry in the electronics field about seven years ago, is turning the corner after wiping out its accumulated losses as on March 31, 1983 and hopes to earn reasonable profit in the current year, according to Mr S.K. Kakodkar, its newly-appointed managing director. It has made its mark in professional electronics; its audio-visual division now supplies international quality equipments to All India Radio and Oordarshan. This division has plans to make other associated studio equipments like mixing consoles, closed circuit TV systems, colour TV sets, etc. Plans are afoot to make VCRs too. Its radio communications division at Nagpur manufactures VHF/UHF

transreceivers and radio relay systems in collaboration with BBC Brown Boveri.

B & W TD COLOUR

Goa Electronics Ltd. (GEL), a fully-owned subsidiary of the Electronics Development Corporation (EDC), has developed a technology to convert a B & W TV set into a colour TV at an expenditure of Rs. 3000/-. Trials conducted by the engineers have so far been successful and the company hopes to commence on a commercial scale soon.

TN CAPACITOR UNIT

Dr. M.S. Sanjeevi Rao, union deputy minister of electronics, recently commissioned an aluminium electrolytic capacitors plant set up in the state sector by the Electronics Corporation of Tamil Nadu (ELCOT) in the SIPCOT industrial complex at Hosur in Oharmapuri district. The Rs. 1.68 crore plant employing sophisticated Japanese machinery has a licensed capacity of 50 million capacitors per annum. ELCOT sources said that the capacitors manufactured at Hosur were found to conform to international standards. These precision capacitors are used in electronic industrial testing equipment and a wide range of electronic consumer items.

DUTY DRAWBACKS ON ELECTRONIC ITEMS AFFECTED

Effective from November 18, 1983, duty drawback rates on many electronic items have been either reduced or withdrawn. Details are as follows

Item	Previous drawback	Present drawback
TV picture tubes 12" and above	Rs. 90-00 per tube	Rs. 70-00 per tube
Metallised plastic film capacitors upto and including 0.22 MFD	10% of FOB value	7.5% of FOB value
Metallised plastic film capacitors above 0.22 MFD	35% of FOB value	26.25% of FOB value
Plastic film capacitors NOS	15% of FOB value	5% of FOB value
Magnetic assemblies incorporating cast alloy permanent magnets, viz pot magnets, magnetic welding clamps, links, magnetic lifting devices, magnetic racks, cages, door catches, blocks, bases, hold fasts, holder positioners, floaters	Rs. 45.90 per kg of weight of cast alloy permanent magnet	Rs. 44-00 per kg of weight of cast alloy permanent magnet
Transmitting tubes, germanium transistors, diodes, connectors	10%	Withdrawn
L.C. displays, silvered mica plates, capacitors, resistors, potentiometers, relays, piezo electronic crystals, inter-connecting devices	15%	Withdrawn
Light emitting diodes, lamp displays, electrical valves & tubes, (including receiving tubes but other than transmitting tubes), electrolytic capacitors	20%	Withdrawn
Integrated circuits, ceramic capacitors, cathode ray tubes, display tubes below 14", selenium rectifiers, plates and stacks	25%	Withdrawn

Satellite TV

Monday 16 January, 1984, saw another milestone in the history of British television with the inauguration of Satallita Television's Sky Channel. The first transmission to Britain was 'piped' to about 10,000 subscribers on a private cable network in Wiltshire.

Satellite Television is a private company, in which News International (owned by Mr. Rupert Murdoch) holds a 65 per cent share. The company began transmitting in 1982 via the European Space Agency's Orbital Test Satellite, but its programmes are now broadcast via the European Communications Satellite ECS-1. Sky Channel is already received by more than half a million cabled homes in Norway, Finland, and Switzerland, as well as hotel rooms in France, Finland, and Switzerland. As the British government is intent on liberalizing the rules for British cable television, British cable TV systems will be allowed (provided they pay Satallita Television 10 pence per month per subscriber) to distribute it over their wires. As Sky Channel's programmes will carry advertising, cable viewers will get them free: Sky Channel is not pay-TV.

Low-powered satellites such as ECS-1 require a dish aerial of 2 . . . 3 metres in diameter for best reception. It is, however, possible to

receive the transmissions with dishes of only about 1 metre diameter. This will make it almost as easy for the individual to receive Sky Channel as a high-powered DBS (direct-broadcast satellite) service. There could be difficulties, however: low-powered satellites are legally classified as telecommunications satellites. To receive their transmissions, you need a special licence! At the time of writing, the government does not appear to know whether it will invoke the law or not. . .

Some history

During their 1977 meeting in Geneva, the ITU (International Telecommunications Union - a UN agency) allocated five channels in the 11.7 . . . 12.5 GHz band to each country. This band accommodates 40 channels. Each channel has a bandwidth of 27 MHz, while channel spacing has been set at 19.2 MHz. At the same meeting positions for a number of satellites were allocated. These are geostationary above the equator at 6° intervals (but of course not every position is, or will be, filled). The satellite position for the United Kingdom, Ireland, Iceland, Spain, and Portugal is 31° west, while that for Belgium, France, West Germany, Italy, Luxembourg, the Netherlands, and Switzerland is 19° west (25° west is not used). In 1982, some years after countries

like the USA, USSR, and India had taken similar decisions, the home secretary finally gave the go-ahead for satellite TV in Britain with two BBC stations to start transmitting in 1986.

Originally, the BBC had planned to begin broadcasting on the two channels (only films on one, general interest on the other) during the autumn of 1986. But over the past twelve months doubts about the commercial viability have grown, culminating last December in rumours that the governors of the BBC wanted to shelve the project. A later statement said, however, that it had been decided that the BBC would continue to explore all possibilities for the completion of the first British DBS service by late 1986.

BBC vs IBA

At about the same time it was stated that the BBC are discussing with the IBA (Independent Broadcasting Authority) a plan for sharing the £ 350 million estimated costs of the proposed system. This would presumably entail joint operation of the satellite.

Ever since the government decided in early 1983 to back the IBA's C-MAC (multiplexed analogue component type C) system in favour of the BBC's EPAL (extended phase alternation line) proposal, there have been many meetings between the

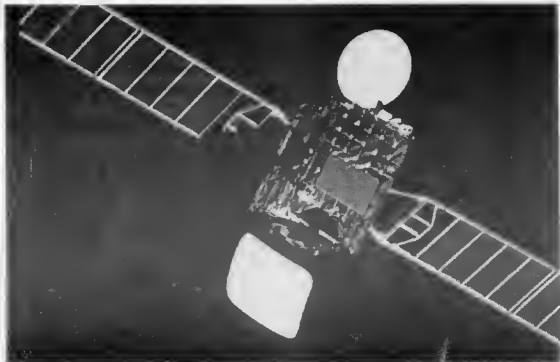

two broadcasting organizations. However, as the IBA has been granted its own satellite system (to start in the late 1980s), it is likely to be cool to a proposed sharing. Unit Satellites (UNISAT), the consortium of British Aerospace, GEC-Marconi, and British Telecom, which is building the satellites (one operational, one back-up), is of course anxious that a speedy solution be found to ensure the continuation of the project in which they are reputed to have invested about £ 50 million already. As stated, early in 1983 the British Government took the somewhat startling decision to accept IBA's C-

The basic system for transmitting TV picture information was established some 35 years ago for monochrome transmissions. The choice of 625 lines per frame and 25 interlaced pictures (frames) per second was a compromise between picture quality and technical and economical feasibility.

The 625 horizontal lines composing our TV picture cannot be seen separately at distances greater than 4...5 times screen height. Together with an aspect (width/height) ratio of 4/3 and the requirement for good resolution, this results in a video bandwidth of 5.5 MHz. When a video signal with

IBA's Multiplexed Analogue Component type C (C-MAC) system is totally different from PAL and SECAM and cannot therefore be received with existing equipment (nor can such equipment be suitably modified). In the PAL and SECAM systems the chrominance signal is resolved into two quadrature components (red and blue signals: green is obtained by adding and subtracting the red and blue signals with the luminance signal). In the PAL system the two quadrature components are used for phase and amplitude modulation of the 4.43 MHz chrominance sub-carrier which is interleaved with the video signal. In the SECAM system the two components are transmitted sequentially on alternate lines. Each is fed to a delay line which stores it for one line end then mixes it with the incoming one. Each displayed line is therefore a mixture of the present and previous lines. The colour resolution in SECAM is reduced compared with PAL, but SECAM does not suffer from cross luminance.

In the C-MAC system, the chrominance and luminance signals are transmitted sequentially but not on alternate lines. Both signals are time-compressed and the 64 μ s line period is divided into 9 μ s for the sound data, 17 μ s for the chrominance signal, and 35 μ s for the luminance signal, with 1 μ s gaps between the three.

By almost unanimous agreement, the sound of satellite broadcasts will be digital. In the C-MAC system, the whole channel is switched into the digital mode during the interval between picture lines for transmission of the 9 μ s sound data burst.

The C-MAC system will continue to use the same number of lines and frames as current terrestrial television. This means that, for instance, projector TV will remain almost as dead as the proverbial dodo: when projected onto a large screen, 625 lines are not a pretty sight! A pity, because the new high-definition standard (1125 lines and an aspect ratio of 5:3) for use with satellite broadcasts as developed by the Japanese Broadcasting Corporation seemed at last to have overcome this great drawback of present-day television. However, Philips of Eindhoven, the Netherlands, are working on a new IC which may become our last hope for some time to come for a real improvement in picture quality.



MAC system rather than the BBC's proposal for extended PAL. The chosen system is totally incompatible with any other television system; no doubt television receiver manufacturers will welcome this as it opens a huge new market for (new) dual-standard receivers, converters, and what have you.

EPAL vs C-MAC

A composite video signal comprises two parts: the luminance signal (brightness) and the chrominance signal (colour). The luminance signal is obtained by combining the outputs of the three colour channels — red, green, and blue — and is then used for amplitude modulation of the main picture carrier frequency. This produces the black-and-white image. The chrominance signal is obtained by combining, in a colour encoder, portions of the separate video signals into sum and difference signals. In PAL and SECAM systems, two quadrature components of the chrominance signal are produced and used for phase and amplitude modulation of the chrominance sub-carrier.

this bandwidth is used for the amplitude modulation of a carrier, sidebands of +5.5 MHz and -5.5 MHz are produced: a total bandwidth of 11 MHz. However, in vestigial-sideband transmission (which is used almost universally), by attenuation of spectral components, one of the sidebands is reduced to 1.25 MHz (at least in the U.K., Ireland, France, and Belgium; in most other western European countries to 0.75 MHz). The bandwidth is therefore reduced to 6.75 MHz. Add to this the FM modulated sound and, of course, some space for the separation of adjacent channels, and it becomes evident that the internationally agreed channel width of 8 MHz does not leave much room for the chrominance signal. Fortunately, as the human eye is much less sensitive to colour detail than to light and shade, the chrominance signal can be of considerably lower definition than the luminance signal. None the less, the two signals sometimes mix which results in so-called cross luminance: the display of false colours in the image.

The ever increasing cost of petrol has ensured that fuel consumption is something few drivers can ignore. The size of the average car is steadily reducing but these smaller cars are becoming more comfortable to compensate for their dimensions. More importantly, however, they are also becoming more efficient, especially as regards fuel consumption. That is all very well for those fortunate few who can afford to simply go out and buy an efficient new car but the rest of us have to do what we can to reduce our fuel bills with our 'old' cars. The circuit described here can help do this by cutting down on the amount of petrol wasted in a car engine.

petrol saver



The importance of fuel economy in cars can no longer be denied when the motor manufacturers of the world are working ever harder to make their products go further on less fuel. The 'in' fad at the moment is advanced aerodynamics complete with flush glass bonded to the body, and car salesmen make full use of a car's low Cd figure (drag coefficient: a measure of the car's aerodynamic efficiency) to entice prospective customers. Certainly, when combined with low weight, good aerodynamics do make a car more efficient, and therefore more economical. Other manufacturers take a different approach to motoring economy and prefer to tackle the notoriously bad efficiency of the internal combustion engine. Engine control computers are now so common that they only invoke comments as to their particular advanced features over their competitors'. It is all very well to read about these wonderful new cars in the motoring press but for most of us that is as far as we will get for a long time. So let's forget about the pie in the sky and see what can be done to make our present 'steed' more economical. Like more than one car manufacturer, we decided to try and reduce the wastage of petrol. Most carburetors have idling jets

through which a small amount of fuel is fed to keep the engine running when the throttle is closed. When the driver's foot is on the accelerator this fuel is mixed with the main fuel flow and so it produces power. When the driver lifts his foot from the accelerator the throttle is closed but the idling jets continue to direct a certain amount of fuel to the engine. This is unnecessary until the engine is almost at idling speed. This wastage can, however, be reduced.

Since about 1975 most new cars have been equipped with a solenoid valve on the fuel line to the idling jets. The purpose of this is to stop the supply of fuel when the ignition is off, thus preventing 'running on'. The circuit here was designed to control this valve so that it is always closed above a certain engine speed.

Can I use it?

Before rushing out to buy the parts for this circuit you should first determine whether it is suitable for your car or not. Obviously the first thing to look at is whether the car has an electric fuel cut-off valve on the fuel line to the idling jets. If not, then our old friend Murphy has struck again.

prevents your car from idling away its fuel

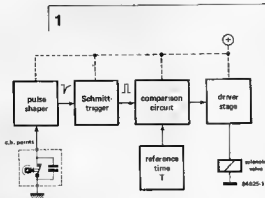

Figure 1. The block diagram here shows the main parts of the circuit and gives an indication of its operation. The speed of the engine is sensed and compared with a reference value and this information is used to determine whether the fuel cut-off valve for the idling jets should be opened or closed.

If the valve is fitted then try the following: start the engine and let it run at somewhat above tick-over. Pull the plug off the valve (i.e. remove the power) and stick it back on. Release the accelerator and the engine should idle. If not, the valve is not suitable for use with this circuit (Murphy-2, The Opposition-0). Those of you who are still reading this may now rejoice and start building.

The block diagram and circuit

The basic operation of the circuit can be seen from the block diagram of figure 1. A signal is picked up from the c.b. (contact

breaker) points and is fed via a pulse shaper to a schmitt trigger. This then gives a measure of the engine speed as one pulse is output to correspond to each opening of the c.b. points. This signal goes to a circuit that compares the time between two pulses with a reference time and based on this comparison it opens or closes the fuel cut-off valve via the driver stage.

Relating this to the circuit diagram of figure 2, we see that the terminals a and b are connected across the c.b. points. Every time the points open this information is transmitted via the filter network to T1 so this transistor conducts for a short time. This provides a signal that is fed to one of the inputs of the schmitt trigger N1. The output of N1 generates one pulse corresponding to each opening of the c.b. points and this output is fed to the trigger inputs of MMV1 (TR) and MMV2 (TR). What happens next depends on the time, t , between two successive pulses.

If the engine speed is high the time between two pulses (t) will be smaller than the reference time (T) set with C5 and P1. This is shown in the timing diagram of figure 3a. The falling edge of the first pulse triggers MMV1 causing its Q1 output to go 'high'. This, in turn, makes the reset input (R2) of MMV2 high for a time equal to T . This input is therefore still high when the rising edge of the next pulse triggers MMV2. The 'low' level of Q2 then closes

2

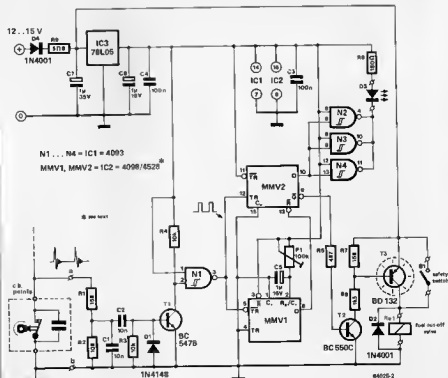

Figure 2. The circuit as shown here uses freely available common components. It takes its power from a fused 12 V line in the car and senses the engine speed from the signal from the c.b. points.

the valve via the driver stage built around T2 and T3. Simultaneously the Q2 output of MMV2 takes pins 6, 9 and 13 of IC1 high and causes the LED to go out. The falling edge of this second pulse retriggers MMV1 and this renews the time T. If the engine speed is low MMV1 is triggered and takes the R2 input of MMV2 high, but before the next pulse arrives this reset line has gone low again. Again, this is indicated by timing diagram 3b. The Q2 output then lights the LED via N1, N2 and N4. More importantly, of course, the Q2 line is 'high' so T2 and T3 conduct and open the valve.

Construction and calibration

The parts used in this circuit are all commonplace and readily available. The only question about components concerns the choice of IC2. As we have shown on the circuit diagram, this can be either a 4098 or a 4528 ss in principle both types are the same. Obviously, though, there are some differences or they would not have different type numbers. If the 4098 is used the MMV time, T, can change whenever the time (t) between trigger pulses is approximately equal to T. This change in T appears as a hysteresis in the on/off switching frequency of the valve and is dependent upon the value of C5. This phenomenon is unknown to the 4528 so if this IC is used the performance of the circuit will be more predictable. However, as the hysteresis inherent in the 4098 means that the valve is not constantly opened and closed if T is approximately equal to t, we recommend that this be used instead of the 4528.

The circuit is not very complicated so building it on a piece of vero board should not be any problem. The LED (D3) to indicate that the valve is open must be mounted in the car dashboard if it is used. The same is true of switch S1. This is a safety feature to enable the circuit to be by-passed. Without this facility any failure in the circuit would cause the valve to close so the engine would stall instead of idling. The circuit must be connected to the fused side of a 12 V line that is live when the ignition is switched on. With its few components, the circuit draws little current so it is hardly likely to drain the car's battery.

In order for the circuit to operate as we want, P1 must be set so that the valve operates at about 1500 r.p.m. There are two ways of doing this. The *in situ* method involves fitting the circuit in the car and running the engine at about 1500 r.p.m. The potentiometer is then adjusted until the valve operates at this value. The second method of calibration requires that the frequency of the signal from the c.b. points first be calculated (frequency = r.p.m. x number of cylinders in the engine). A signal at this frequency is fed into the circuit at points a and b and P1 is adjusted so that the Q2 output (pin 9) of IC2 just goes high.

3a

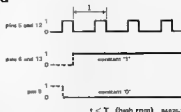

3b

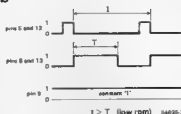

4



petrol sever

Figure 3a. The timing diagram here indicates the relationships between the signals on various pins of IC2 when the engine is turning quickly.

Figure 3b. When the engine speed is low the various signals at IC2 look like this. The '1' on pin 9 keeps the fuel line valve open.

Figure 4. This sketch shows what most fuel cut-off valves look like. It is generally located on, or close to, the carburettor

Using the circuit

As far as the driver is concerned there are no instructions for how to use this circuit so he need not even know the circuit is in use except that the car's fuel consumption should drop. There are a few points to note however. This circuit has no effect below 1500 r.p.m. so below this speed the engine simply works as normal. Above 1500 r.p.m., however, the fuel supply to the idling jets is cut off so that when the car is on over run (i.e. with the throttle closed) the petrol consumption is nil. This is where the saving is made so this circuit is best suited for cars that are often in this condition. This occurs most frequently in city driving or in a hilly countryside. The usefulness of the circuit also depends to a certain extent on the driving style of the driver. Freewheeling, with the car out of gear on the over run, apart from being a potentially dangerous practice defeats the purpose of the circuit as the revs then drop very quickly below 1500 r.p.m. and the idling jets again get their fuel supply. The fuel consumption is then no longer nil.

Now if we could just find a way of making the petrol consumption nil when the car is accelerating... but maybe that's just too much of a pie in the sky.

The circuit described here is a triac-controlled mains lamp firing circuit consisting of eight independent channels. Each channel contains an opto-isolator to maintain complete isolation between the control circuit and the mains power supply.

The board was primarily designed for use with the 'programmable disco light display' published in the March 1984 edition of *Elektor*, but it has many more applications. It will, for instance, be ideal for use as an interface between the I/O outputs of a computer and mains powered equipment. It can also be used to expand existing circuits which have only an LED display.

The circuit consists of eight channels on one printed-circuit board each of which is a self-contained mains lamp firing circuit. Complete isolation between any control circuit and the mains supply is ensured by the use of opto-isolators.

This also means that the circuit can be used with any other control system that is capable of driving an LED.

As will be seen from the diagram of figure 1, the circuit is very simple with each channel consisting of an opto-isolator, a driver transistor, and a triac. The LED in the isolator is driven from the control circuit. In the quiescent state, that is, when the LED is not lit, the transistor in the isolator is effectively open circuit. The driver transistor is then held hard on by the base current derived via the base resistor connected to the negative supply line C (A). In this condition the gate of the triac is held to the 'zero' line D (B) and the triac therefore cannot fire.

If the control circuit now causes the LED to light, the transistor in the isolator will switch on, causing the driver transistor to switch off. The triac will now derive a gate current via the resistor connected to the negative supply line and the triac will fire. The gate current is about 5 mA and remains constant as long as the LED in the opto-coupler is lit. This is an advantage that enables the use of relatively low load currents, lower in fact than the holding current of the triac. This allows low-wattage (e.g. 5 W/240 V) mains lamps to be used.

The maximum power handling of each channel depends on the cooling of the triac and the heat sinks should therefore be chosen for the expected load. The TIC 206 triac without a heat sink will handle up to 250 W. If a TV 4 or 5 type (17°C/W) heat sink is used, the load can go up to 500 W for each channel. A better heat sink still, the TV 21 type (10°C/W), will allow a load of up to 750 W. It is advisable that some form of heat sink is used even with low power requirements or the printed-circuit board material may deteriorate over a period of time. The printed-circuit board is suitable for fitting in a standard 19 inch rack mounting

controls eight
mains lamps

triac control board

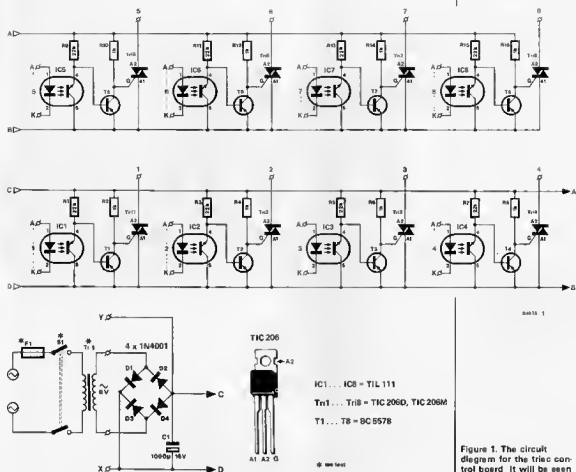

Figure 1. The circuit diagram for the triac control board. It will be seen that all eight channels are identical.

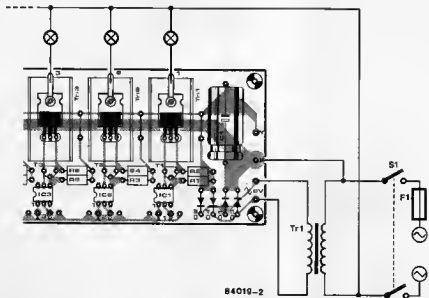

Figure 2. In general, the mains wiring of a single triac control board should follow that shown here.

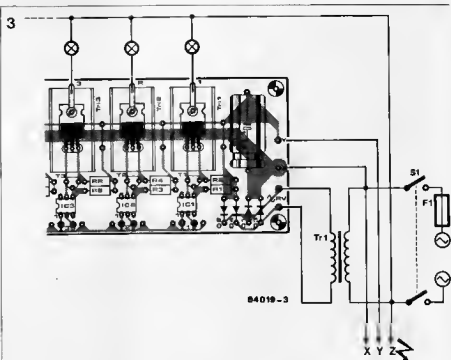

Figure 3. If a single triac control board is used in conjunction with the Programmable Disco Light Display, the mains wiring should be as shown here.

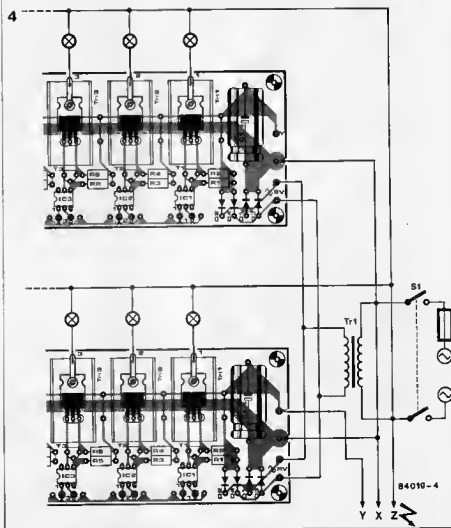
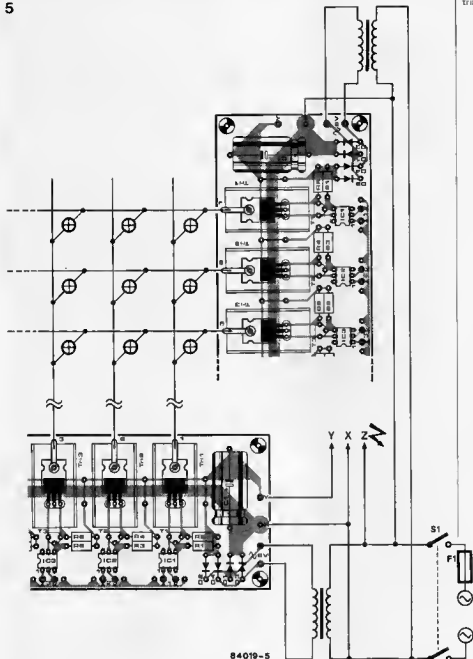

Figure 4. The mains connections for the Disco Light Display and two triac control boards are given here.



cabinet. This may appear rather large but it must be remembered that a fairly substantial area will be required for mounting the display connectors and wiring.

Display connection

It is important that the utmost care is taken when the display is connected to the (potentially lethal) mains supply. It must be pointed out that there are a whole host of regulations in force covering this topic, enough in fact to deter all but the most strong minded from attempt-

ing it at all! Without wishing to appear too gloomy, it is only fair to point out that insurance companies can get rather paranoid about the possibility of an accident involving this type of equipment at a public venue. A great deal of care must therefore be taken when wiring the display plugs and sockets. Use only approved mains plugs and sockets of the correct current rating. The P551 and P552 8-way plug and socket from the Bulgin range will be useful in this respect. The common return power line should be made separately via a very substantial connector, or by commoning a number of pins together.

Figure 5. The wiring for triac control boards in a matrix. It must be noted that in this case the X terminals are not connected together and that two transformers are required!

Figure 6. One form of matrix display that provides an attractive appearance is shown here. Many others are of course possible.

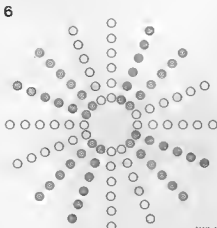
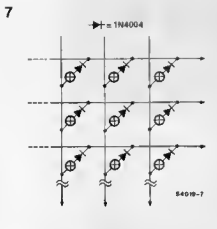

Figure 7. When individual switching of lamps is required, a diode should be connected in series with each lamp as shown here. Note that all diodes are connected in the same direction.



Display configuration

The triac control board can be used for many applications and, in general, the wiring should follow that given in figure 2. If the triac control board is to be used with that of the Elektor Programmable Disco Light Display, the wiring should be as illustrated in figure 3 for a single triac control board or figure 4 for two boards. Three or more boards are connected in the same way.

A number of display configurations are possible up to a maximum of 225 lamps. For a matrix display (15 rows each containing 15 lamps) the wiring is rather more complex as can be seen in figure 5. It should be noted that, in this case, the X terminals are wired independently to the live and neutral of the mains.

The X terminals are not connected together. Any number of boards (up to the maximum) can be connected in the form of a matrix but care must be taken at all times with the connections to the mains supply.

A minor problem can occur in the form of faint lighting of the lamps that should not be lit. This problem is removed if all horizontal lamps are always driven simultaneously. The vertical channels may however be programmed in any sequence. It is also possible to reverse this,

in other words, switch all vertical channels together with the horizontal sequence being arbitrary. Either possibility may be included in the same program.

If it is required to switch all lamps individually without any but the driven ones being lit, it is necessary to connect a diode (e.g. 1N4004) in series with each lamp. Make sure that these diodes are all connected in the same direction (see figure 7). The driven lamps will then be powered at half the mains supply voltage (which will mean less light, of course) and tend to flicker slightly.

The printed-circuit board

To enable you to make full use of the printed-circuit board of the triac control circuit some explanation is necessary. As stated, opto-isolators are used to control each triac. Generally, either all anodes (common anode configuration) or all cathodes (common cathode) are connected together. When the triac control circuit is used with the Programmable Disco Light Display, all the anodes of the opto-couplers are commoned and connected to the +5 V supply on the main board. The cathodes are then connected to the channel outputs (1...30) on the main board, or to the anodes of the indicator LEDs on the front panel if these are used. In the latter case, the cathodes of the indicator LEDs are then connected to the channel outputs on the main board. The triac control board has a 'spare' line which, if the appropriate links are fitted, can function as either the common anode or common cathode line. For the sake of convenience, the width of the triac board is similar to that of the Disco Light Display. The lamp connection of the triac is not made on a board terminal but on the triac housing with a solder tag (see figure 8). The X terminal of the board is the common mains connection and, as large currents flow through this point, a simple solder connection here is not adequate. A 3.5 mm hole should be drilled at this point and a screw terminal fitted for connection to the mains supply.

The specifications for the fuse F1 and the mains on/off switch depend on the maximum load of the total lamps in use.

Always err on the high side. The transformer Tr1 must be able to supply at least 100 mA for each triac control board. If a number of boards are used, one transformer will be sufficient, provided it can supply at least the number of boards times 100 mA. All the 6 V a.c. connections can then be wired in parallel. Note, however, that with matrix control two transformers are required.

An unbalanced supply of about 7 V d.c. is available between points X and Y (which are at the mains potential). If the Disco Light Display is used, its zero-crossing detector is powered from this voltage. If a number of triac boards are in use, the zero-crossing detector is supplied from one triac control board only as shown in

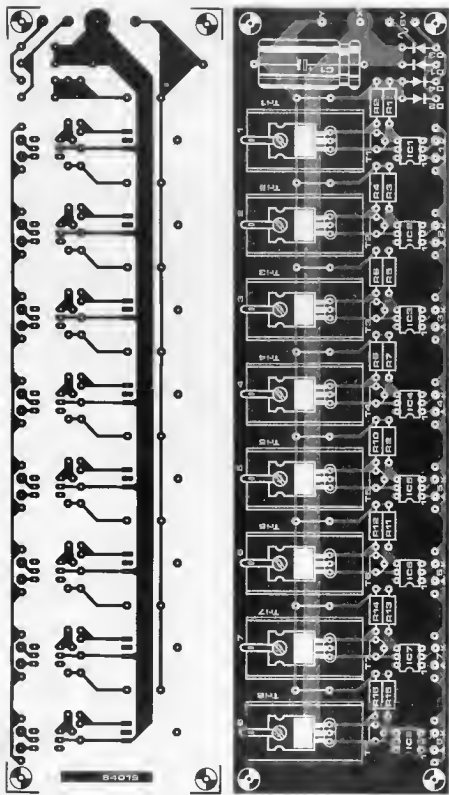
**Parts list:****Resistors:**

R1, R3, R5, R7,
R9, R11, R13, R15 = 22 k
R2, R4, R6, R8, R10,
R12, R14, R16 = 1 k

Capacitors:

C1 = 1000 μ F/16 V

Semiconductors:

T1... T8 = BC 557B
T11... T18 = TIC 206D
or TIC 206M
D1... D4 = 1N4001
IC1... IC8 = TIL 111

Miscellaneous:

T1 = mains transformer
6 V secondary (see text)
F1 = fuse (see text)
S1 = mains on/off switch
(see text)
Heat sinks (see text)
Printed-circuit board 84019

figures 4 and 5.

If the triac control board is to be used for other applications, the LED in the opto-coupler must then be provided with a cur-

rent of at least 5 mA to ensure reliable operation: this normally means that a biasing resistor must be used. The voltage drop across this LED is about 1.2 V.

Figure 8. The component layout and track pattern of the triac control printed-circuit board. A 'spare' line is provided to act as either the common anode or common cathode line for the opto-couplers.

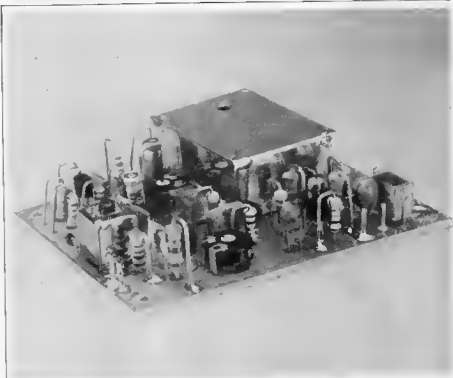

TV systems in use in western Europe

Andorra	PAL B
Austria	PAL B/G
Azores	PAL B
Belgium	PAL C/H
Cyprus	PAL B
Denmark	PAL B
Finland	PAL B/G
France	SECAM E/L
G.D.R.	PAL B/G
G.F.R.	PAL B/G
Greece	SECAM B/G
Iceland	PAL B
Ireland	PAL I
Italy	PAL B/G
Luxembourg	PAL G
and	SECAM L
Monaco	SECAM E/L
Netherlands	PAL B/G
Norway	PAL B/G
Portugal	PAL B/G
Spain	PAL B/G
Sweden	PAL B/G
Switzerland	PAL B/G
Turkey	PAL B/G
U.K.	PAL I

Modulators which convert the video signal from a home computer into a suitable UHF television signal must nowadays meet stringent requirements. This is, of course, not for fun, because modern TV receivers are tuned to the selected channel by a synthesizer. This means that deviations from the correct channel frequency cannot be tolerated and the modulator must therefore be accurately tunable to a given channel. To meet this demand we have developed a modulator which not only meets these requirements as regards video, but which also provides good-quality audio.

UHF video and audio modulator

for all television standards

A video signal has a shape as shown in figure 1a: when this is modulated by the signal from the television transmitter, the negative-amplitude modulation shown in figure 1b ensues. Our modulator must therefore generate a similar signal which is then fed to our television receiver on a specific channel. This is normally channel 36, 'guarded' by channels 35 and 37, which is also used by most video recorders. Note that these are the only three channels which have not been allocated for television transmission.

TV standards

Most European countries operate their television networks in accordance with the

recommendations of the CCIR. These embrace amongst others 625 lines per frame (picture) and 25 interlaced frames per second. Interlacing is a system in which the lines of successive rasters (fields) are not superimposed on each other but are interlaced: two rasters therefore constitute one frame. The frame frequency is therefore half the field frequency.

There are, however, differences as regards vision modulation and sound modulation: the first may be negative or positive and the latter FM or AM. These differences are highlighted in table 1, from which it is seen that, at least as far as UHF transmissions are concerned, in western Europe only France, Greece, and Monaco differ from the rest. Negative vision modulation means that the

carrier amplitude reaches its highest value when the video signal amplitude is lowest, that is, when the synchronization (sync) pulse is present (see figure 1a). With positive vision modulation it is exactly the opposite. A glance at the block diagram in figure 2 will show that the outlay for the modulator is very modest. Basically, an oscillator is modulated by the video signal and produces a signal which is suitable for feeding to the aerial input of the TV receiver. However, we have incorporated three additional features: (a) the possibility of modulating the oscillator positive or negative; (b) the facility for adding a modulated audio signal to the video signal, and (c) the choice between amplitude and frequency modulation of the audio signal. These features will make the modulator usable in any TV system.

Overtone oscillator (see figure 3)

An AT-cut quartz crystal, although manufactured for operation in its fundamental mode, can be induced to oscillate at a much higher frequency. In our modulator a 5th-overtone crystal operates between 146 and 150 MHz. It is followed by a quadrupling circuit which has an output frequency range of 584...600 MHz covering channels 35...37.

The crystal is tuned to its fifth overtone by inductor L3 and capacitors C7...C9; trimmer C8 enables the exact setting of the required frequency.

Modulation of the video signal is effected by feeding the signal to the base of quadrupler T2 via inverter T1 and inductor L1 (negative modulation) or directly to the base of T2 if positive modulation is required (points A and B are then connected together). The modulated output of T2 is tuned to four times the oscillator frequency by means of tuned band-pass filter L4-C13. Inductor L4 is a film type (that is, deposited onto the printed-circuit board) which is frequently used in UHF techniques.

Audio modulation

Compared with the vision modulation, the audio modulator constructed around IC1 appears rather more complicated. The well-known symmetrical mixer SO42P is used as AM/FM modulator. You may well say: 'How do you use a symmetrical mixer as a modulator?'. Well, the answer is that we have made the SO42P asymmetrical by means of resistor R10.

The mixer operates at a frequency of 5.5...6.5 MHz, depending on which television standard is in use in your particular country (see table 1). In the U.K. and Ireland standard I is used, and in those countries the vision/sound separation is 6.0 MHz. The frequency is generated by the internal and external circuits connected to pins 10...13 of IC1.

The IC operates as an AM modulator when the audio signal drives the two internal differential amplifiers on pin 8 direct. The amplitude of the output signal on pin 2 then varies in rhythm with the AF input.

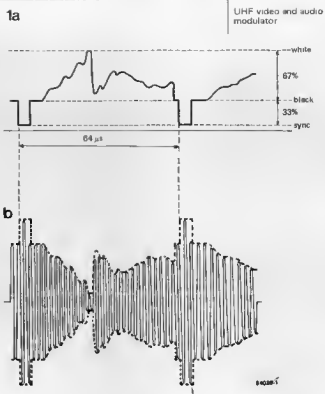

Figure 1. Construction of a video signal (1a) and a carrier negative-amplitude-modulated with this signal (1b).

The SO42P functions as an FM modulator if the audio input signal changes the frequency of the oscillator on pins 10...13: this is effected by means of variable capacitance diodes D1, D2.

The output of the modulator is taken through a ceramic 6.0 MHz band-pass filter to a capacitive divider, C6/C5, and then fed to the base of T2.

Construction

As is usual with printed-circuit boards for VHF and UHF applications, that for the modulator is double-sided. Therefore, do remember to solder the earth connections of the relevant components also

Table 1. Characteristics of television systems.

Table 1

System	Number of lines	Channel width MHz	Vision bandwidth MHz	Vision sound separation MHz	Vision side-band MHz	Vision modulation	Sound modulation
B	625	7	5	+5.5	0.75	Neg	FM
C	625	7	5	+5.5	0.75	Pos	AM
D	625	8	6	+6.5	0.75	Neg	FM
E	819	14	10	+11.15	0.75	Pos	AM
F	819	7	5	+5.5	0.75	Pos	AM
G	625	8	5	+5.5	1.25	Neg	FM
H	625	8	5	+5.5	1.25	Neg	FM
I	625	8	5.5	+6	1.25	Neg	FM
K	625	8	6	+6.5	0.75	Neg	FM
K'	625	8	6	+6.5	1.25	Neg	FM
L	625	8	6	+6.5	1.25	Pos	AM
M	525	6	4.2	+4.5	0.75	Neg	FM
N	625	6	4.2	+4.5	0.75	Neg	FM

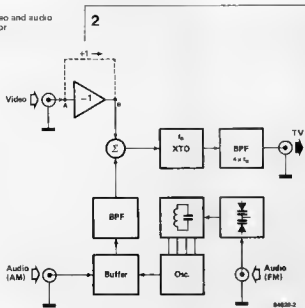

Figure 2. Block diagram of the UHF video and audio modulator. The carrier frequency is amplitude-modulated by the video and audio signals.

Figure 3. The circuit of the modulator appears more complicated than it is. The video signal is routed via T1 and crystal oscillator X1. The audio signal, whether AM or FM, is fed to mixer IC1. The video and audio signals are added together in T2.

- P1 Depth of modulation — video
- P2 Depth of modulation — audio
- C8 Oscillator frequency and amplitude
- C13 Output circuit tuning (affects amplitude of the output signal)

at the component side. To keep the board to reasonable dimensions, the resistors and capacitors are mounted vertically. The housing of inductor L5 must be soldered to the earth plane at the components side. The earth connections of trimmer C13 must be soldered at both side of the board.

3

The centre terminal of this component should be bent and then soldered at the components side to film inductor L4. The crystal oscillator should be screened by a suitable size piece of tin plate bent at right angles and soldered to the earth plane at the components side. You will notice that capacitor C12 is in the way, but this can be overcome by drilling a small hole in the screen and feeding one of the terminals — fitted with a piece of insulating tube — of the capacitor through the hole. The circuit can then be fitted in an appropriate metal case, which has been provided with suitable connectors for the video and audio inputs, the UHF output, and the input for the supply voltage. A final point: the capacitor fitted by the manufacturers inside the housing of coil L5 must be removed!

Alignment

Connect the modulator between the video output of the computer and the television set and apply a suitable supply voltage. Tune the television receiver to channel 36, and then the modulator to 591.25 MHz. The setting of C8 and P1 is, of course, critical and is best done as follows. Turn P1 fully clockwise (no modulation) and then adjust C8 carefully until the television screen shows a black image. Then adjust P1 to obtain a picture to your personal liking. When you are satisfied that the picture is the best obtainable, apply a video signal

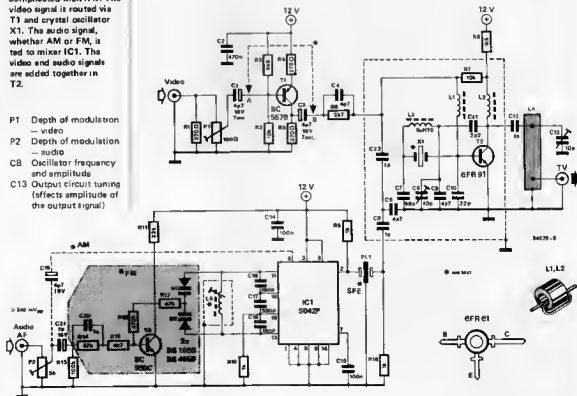

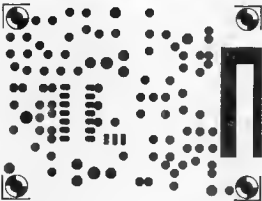
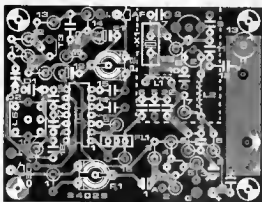
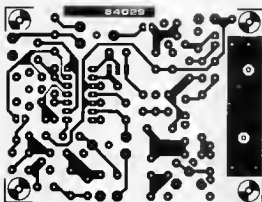

(but only the test card from your video recorder or local transmitter, or a test line from your computer). Again, adjust C8 and P1 alternately to obtain the best possible image. Note that turning P1 anti-clockwise increases the modulation, and also that there are several positions of C8/P1 which give 'the best possible image'. Next, C13 is adjusted for minimum noise after partially removing the aerial plug from the TV receiver (but not so far that the image completely disappears).

The audio noise from the loudspeaker should disappear when the ferrite core of L5 is properly adjusted. Then apply an audio signal and re-adjust the core to give minimum distortion at the largest signal input. Here again, alternate adjustment of L5/P2 is necessary. This completes the modulator and you can concentrate once again on your programming!

UHF video and audio modulator

Figure 4. The printed-circuit board for the modulator is double-sided. All earth connections should therefore be soldered at the components side. The crystal oscillator should be screened with a suitable piece of tin plate.

Parts List

Resistors:

R1,R4,R5 = 270 Ω
 R2,R7 = 10 k
 R3 = 5k Ω
 R6 = 2k7
 R8 = 1k5
 R9,R10,R16 = 1k
 R11 = 22 k
 R12 = 470 k
 R13 = 4k7
 R14,R17 = 47 k
 R15 = 100 k
 P1 = 100 Ω preset
 P2 = 5 k preset

Capacitors:

C1,C3,C19 = 4 μ /16 V tantalum
 C2 = 470 n
 C4,C5,C9 = 4p7
 C6,C12,C22 = 1 p
 C7 = 68 p
 C8,C13 = 10 p trimmer
 C10 = 22 p
 C11 = 2p2
 C14,C15 = 100 n
 C16,C18 = 180 p
 C17 = 330 p
 C20 = 1 n
 C21 = 1 μ /16 V

Inductors:

L1,L2 = 2 turns SWG 27 enamelled copper wire on ferrite bead
 L3 = 0.15 μ H
 L4 = film inductor deposited onto printed-circuit board
 L5 = TKX/CA 34735EMD (available from Ambient) (Note: the capacitor in the housing must be removed)

Semiconductors:

D1,D2 = 88 1058 or 88 4058
 T1 = 8C 557B
 T2 = BFR 91
 T3 = 8C 550C
 IC1 = 84029P

Miscellaneous:

FL1 = ceramic filter type SFE6
 X1 = 5th-overtone crystal 147.8125 MHz
 Printed-circuit board 84029

Personal computer users often like to try to change the operating system of their machines, however slight the changes may be. This, of course, is a way of personalising the machine and making it more suitable for the user's own particular needs. The modification described here is both elegant and efficient. It improves TM (Tape Monitor) by adding a new function to automatically start programs read from cassette. This function explains the title of this article: 'GET' = load the program, and 'GO' = run it!

P. Barrat

GET & GO

automatic program start for the Junior Computer after loading from cassette by TM

The software given here lets the Junior Computer automatically start programs after transferring them from magnetic tape via the cassette interface and TM to random access memory. The principle is that, during the RDTAPE routine, the return address saved on the stack by the JSR RDTAPE instruction (executed as soon as the user presses the GET key during TM) is replaced by the start address (SA) of the program read from the cassette. After loading, the processor leaves the RDTAPE routine by means of the RTS instruction and finds on the stack, not the address it left in order to execute RDTAPE, but rather the start address of the program it has just read from cassette. Therefore it goes to this address to run the program. This presupposes, of course, that the start address of the block of data transferred to RAM is also the start address of the program, and also, that the stack is empty (stack pointer equal to \$FF) when the GET key is pressed (executing the RDTAPE routine). This last condition is met when TM is used 'normally' as we will see later.

DUMPB

In order to achieve the desired effect a DUMPB routine has been created. This is simply a modified copy of the DUMP routine of TM and it registers on cassette a heading containing three specific items of data: address \$01FE which acts as a load pointer, the start address of the program, which RDTAPE places at addresses \$01FE and \$01FF - the top of the stack in other words -, and byte \$20 which RDTAPE will not accept, so it starts RDTAPE anew, normally this time. DUMPB ends by jumping to TM resulting in the DUMP routine being executed normally. Comparing the listing of table 1 with the listing of DUMP (on page 194 of JC book 4), it is clear that the instructions for initializing CHK1 and CHK2, and also for POINT and SA (\$0A0A...\$0A19), have been omitted and an instruction to initialize the stack pointer at \$0730 (TXS on the listing in table 1) has been added.

We then see that DUMPB outputs address \$01FE to the tape (which RDTAPE considers as a load vector), and then changes the start address of the block of data to be loaded before storing it in its turn on the

tape. This correction is needed to ensure that the RTS instruction works properly at the end of RDTAPE. The last character given by DUMPB is \$20. The JMPTM instruction now leads to the normal procedure during which DUMP loads the program from the cassette.

Reading

From the listing of RDTAPE (page 197 of JC book 4) the sequence of operations after loading the heading prepared by DUMPB can easily be followed. Having read the synchronization characters, the start character of the file (*), and the identification number ID, subroutine RDTAPE reads address \$01FE as a load vector (POINT). It then immediately loads the two next bytes which it then places in \$01FE and \$01FF, thus changing its own return address on the stack. The new address is none other than the start address of the program that is to be loaded. The next byte loaded by RDTAPE is the 'space' character (\$20). This, however, does not get past the BMI instruction at \$0B73 (page 196 in book 4) so RDTAPE is started again and this time it simply reads the program registered by DUMP after executing DUMPB. At the end of the load, the RTS instruction at \$0B9A leads the processor to look for the return address on the stack.

As we have seen, it finds the start address of the program it has just loaded and it then proceeds to run this.

Using DUMPB

In order to avoid having to modify TM, the author of DUMPB used quite an imaginative solution. The instructions in table 1 should be loaded in memory starting at \$0700 (or whatever address you like) and the NMI vector (\$1A7A, \$1A7B) positioned at the start address of DUMPB (\$0700 in our case).

Then TM is just used normally, except that the ST/NMI key on the hexadecimal keyboard is now used for the SAVE function with DUMPB.

Finally we would like to draw your attention to the fact that while using this automatic start, the configuration of the output ports is still that of RDTAPE and not that of the hexadecimal monitor. ■

		PAGE 01	
0010:	0700	ORG	00700
0020:			
0030:			
0040:		XPROGRAM	DUMP#
0050:			
0060:			
0070:		DEFINITIONS	
0080:			
0090:	0700	LD#ER	% I#R60 HALF PERIOD BUFFER OF 2400 HZ
0100:	0700	HIGHER	% L#ER HALF PERIOD BUFFER OF 3600 HZ
0110:	0700	FIRST	% I#A76 3600 CYCLE BUFFER
0120:	0700	SECOND	% FIRST #01 2400 HZ CYCLE BUFFER
0130:	0700	Q#A#G	% I#R78 1/0 TENS.
0140:	0700	SY#N#T	% I#R74 SYNC. COUNTER
0150:	0700	OUT#C#H	% #0A#3 OUTPUT CHAR. TO TAPE
0160:	0700	OUT#B#T	% #0R#99 OUTPUT BYTE TO TAPE
0170:	0700	S#A#L	% I#A78 START ADDRESS
0180:	0700	S#A#H	% S#A#L #01
0190:	0700	I#D	% I#R79 ID OF FILE
0200:	0700	P#A#D	% I#R#88 PORT A
0210:	0700	P#A#D#D	% P#A#D #01
0220:	0700	R#B#D	% P#A#D #02 RORT 0
0230:	0700	P#B#D#D	% P#A#D #03
0240:	0700	T#M	% #0956 DUMP
0250:			
0260:			
0270:	0700 A#P 7D	DUM#P	LD#A#H #7D HALF PERIOD OF 3600 HZ
0280:	0702 8D 4C IA	STA	HIGHER
0290:	0705 A#P C3	LD#A#H	% C3 HALF PERIOD OF 2400 HZ
0300:	0707 8D 4D IA	STA	LD#ER
0310:	070A A#P 83	LD#A#H	% 83 3 HALF PERIODS OF 3600 HZ
0320:	070C 8D 74 IA	STR	FIRST
0330:	070F A#P 82	LD#A#H	% 82 2 HALF PERIODS OF 2400 HZ
0340:	0711 8D 77 IA	STR	SECOND
0350:			
0360:	0714 A#P 47	DUM#P	LD#A#H #47 PORT B PATTERN
0370:	0716 A2 FF	LD#A#H	% FF PORT B IS OUTPUT
0380:	0718 9D 82 IA	STR	P#B#D
0390:	071B 9D 78 IR	STR	Q#A#G
0400:	071E 9E 83 IR	STX	P#B#D
0410:	0721 A#P 88	LD#A#H	% 88 PORT A PATTERN
0420:	0723 A2 7F	LD#A#H	% 7F P#A#...P#A# IS OUTPUT
0430:	0725 8D 88 IR	STA	P#A#D
0440:	0728 9E 81 IR	STX	P#A#D#D
0450:	072B A2 FF	LD#A#H	% FF
0460:	072D 8E 74 IA	STX	SY#N#T 255 SYNC CHARACTERS
0470:	0738 9A	T#X#S	#ESET STRCK POINTER
0480:			
0490:	0731 A#P 16	SY#N#C	LD#A#H #16 SYNC. CHARACTER
0500:	0732 28 A3 BR	JSR	OUT#C#H OUTPUT IT
0510:	0736 CC 74 IR	DEC	SY#N#T STILL MORE SY#N#C?
0520:	0739 D8 F4	B#N#C	SY#N#C
0530:	073B R#P 2A	LD#A#H	% #A ORD#N FILE CHARACTER
0540:	073D 28 A3 BR	JSR	OUT#C#H OUTPUT IT
0550:	0748 AD 79 IR	LD#A	I#D OCT CURRENT I#D
0560:	0743 28 88 BR	JSR	OUT#B#T OUTPUT IT

PAGE 02

0570:	0746 A#P FE	LD#A#H	% FE
0580:	0748 28 88 BR	JSR	OUT#B#T
0590:	074E A#P 81	LD#A#H	% 81
0600:	074D 28 88 BR	JSR	OUT#B#T ADDRESS = 88 I#F
0610:	0750 AC 78 IA	LDY	S#A#L GET START ADDRESS
0620:	0753 88	DEY	
0630:	0756 98	T#Y#A	
0640:	0755 28 88 BR	JSR	OUT#B#T OUTPUT ADJUSTED START ADDRESS
0650:	0758 C8	INY	
0660:	0759 98	T#Y#R	
0670:	075A 38	SEC	
0680:	075E E#P 81	S#B#C#H	% 81
0690:	075D AD 71 IA	LD#A	S#A#H
0700:	0768 E#P 88	S#B#C#H	% 88
0710:	0762 28 98 BR	JSR	OUT#B#T
0720:	0765 A#P 28	LD#A#H	% 28 SPACE
0730:	0767 28 A3 BR	JSR	OUT#C#H OUTPUT A SPACE
0740:	076A 4C 56 BR	J#M	T#M EXECUTE DUM#P
0750:			
0760:			

SYMBOL TABLE 3400-3472

DUM#P	0700	DUM#P	0714	FIRST	I#A76	Q#A#G	I#A78
HIGHER	I#R#C	I#D	I#A79	LD#ER	I#A#D	OUT#B	I#A#G
OUT#C#H	#0A#3	P#A#D	I#A#1	P#A#D	I#A#8	P#B#D	I#A#3
P#B#D	I#A#2	S#A#H	I#A71	S#A#L	I#A78	SECOND	I#A77
SY#N#T	I#A74	SY#N#C	0731	T#M	0856		

HEX(DU#R)

	0	1	2	3	4	5	6	7	8	9	A	B	C	D	E	F
0700:	AD	7D	8D	4C	IA	A#P	C3	8D	1A	R#P	83	8D	74	IA	A#P
0710:	82	8D	77	IA	R#P	A2	A2	FF	8D	82	1A	8D	78	IA	8E	93
0720:	1F	A#P	88	A2	7F	8D	88	1A	8E	81	IA	A2	FF	8E	74	IA
0730:	9A	A#P	16	28	A3	8A	CC	74	IA	D8	F4	A#P	2A	28	A3	8A
0740:	AD	79	IA	28	8A	A#P	FE	28	88	8R	A#P	81	28	88	8A
0750:	AC	79	IA	88	99	28	8E	8A	C8	78	28	E#P	81	AD	71	IA
0760:	E#P	88	28	88	8A	A#P	28	28	83	8A	4C	56	88			

Table 1. This short program is all that is needed to make the Junior Computer start programs automatically after loading from cassette by TM (tape monitor).

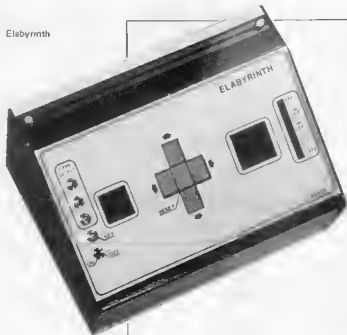

Elabyrinth

Even King Henry VIII, when he was not busy with other activities, liked to solve puzzles. No 'crosswords' for him, of course, as his preference tended more towards the large maze cultivated for him in the garden of his Hampton Court retreat on the bank of the Thames. This maze is still there today and, like the buildings themselves, is open to the public. Consisting of a complex pattern made up of hedges, the maze is tended by a constantly decreasing number of gardeners and summer visitors are sometimes shocked to hear gardener-like cries of 'Help' coming from somewhere within . . . Seems to us an electronic version might be slightly safer!

an electronic maze to test your brain power

Figure 1. This is the layout for one of the eight labyrinths programmed into the EPROM. The dashed lines indicate 'falls'. The letters are a code for the extra information signalled to the player by a set of LEDs.

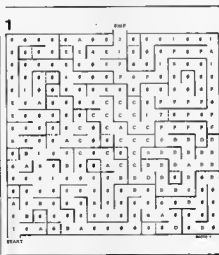

Puzzle-solvers are well acquainted with the idea of a maze. It is made up of a complex pattern of passages and corridors, the object of the exercise being to find the route from the entrance to the exit. With a maze drawn on paper this is relatively simple because of the 'bird's eye view' effect. This makes it easy to see the complete situation at the same time and 'dead ends' are easy to avoid. If an easily solved 'paper' maze is actually laid out in hedges or walls, however, it becomes far from easy to find the way out. It is then a matter of frequent 'U-turns' and it is really memory-taxing trying to remember where you have and where you have not been. Whenever you come to a dead end you must first find back the way you came before you can head in the right direction.

In short, a 'real' maze, or labyrinth, is a lot more difficult, but also much more interesting and exciting than the paper puzzles of the same name. In order to make an interesting electronic version of a maze it is clear that one of the most im-

portant prerequisites is that the player may not under any circumstances be able to see the whole map of the labyrinth. This must be kept secret and can only be indicated, as in a real maze, step-by-step as the player 'walks' around.

How is it played?

Unlike the Hampton Court version where all you need is a pair of hedge cutters in case of emergency, this Elabyrinth requires a short description of how the game is laid out and how it is played. We started with a piece of software to design the map for a maze, or strictly speaking mazes, as we made eight versions and programmed them into a 2716 EPROM. The layout of one of these is shown in figure 1 and we will return to this later. The player does not see the whole map but has a control panel at his disposal. This looks more or less as it is shown in figure 2.

The player moves through the maze using push buttons S1 . . . S4: S1 to go left, S2 for right, S4 for forward and S3 for backward. If you get stuck, pressing the reset button (S6) returns the player to the start position. The LED display consisting of D1 . . . D12 indicates the walls around the player. The player can only move in a direction in which there are no LEDs lit, in other words where there is no wall.

An example will help clarify the situation. Imagine the player is in some (unidentified) corridor that looks like that shown in figure 3. Following the direction of the arrows in the corridor the LEDs will light in the sequence shown in figure 4. In the

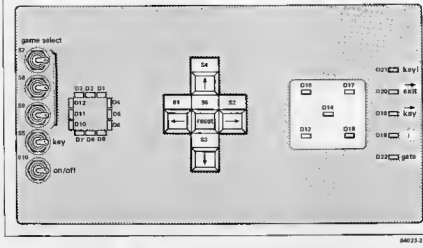

84023-2

beginning (completely left) the upper and lower rows of LEDs light (4e). We go right (S2) and get the same display again (4b). Go one more step right and the bottom and right LEDs light (4c). We cannot now go right so we go forward (S4) and then we only have a wall to the left (4d). If we continue to go forward a wall appears before us (4e). We must now go right and that brings figure 4f to the display. If we go one more step right we get the display shown in figure 4g.

That should explain the most important functions of the control panel, but, as figure 2 shows, there are several other elements on the panel that require some explanation. Starting with switches S7, S8 and S9: these are used to select which of the eight labyrinths stored in the EPROM we want to solve. The on/off switch is S10, while S5 decides whether we are playing with the 'handicap key' or not (we will return to this later). Five LEDs, D13...D17 form a sort of rough map of the maze to indicate from time to time in which approximate section of the labyrinth the player is.

Finally, at the far right, is another row of LEDs whose function is to signal various events. One of the perils of playing this game is the possibility of falling into a hidden hole, and this is indicated by LED D18. We will return later to this subject of 'falling'. If the player is heading in the correct direction to locate the hidden key, D19 will light at certain points in the maze. Heading in the right direction for the exit is indicated at various points by D20 lighting. If the player has found the key or if the handicap key option has been switched off via S5, LED D21 will be lit. Lastly, D22 indicates that the player is standing in front of the gate which cannot be passed unless it is opened with the key.

The LED display, D1...D12, apart from showing the positions of the walls has one more function: if the player succeeds in escaping from the labyrinth, all the LEDs in the display will flash.

3



84023-7

Figure 3. A typical section of a maze.

4

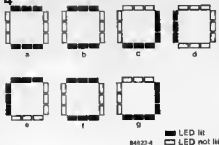

84023-4

Figure 4. The LED display D1...D12 shows the sequence as the player moves through the maze from figure 3 in the direction of the arrows.

5

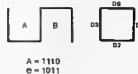

A = 1110
B = 1011

84023-8

Figure 5. Programming the blocks. '0' = no wall, '1' = wall. The sequence is: left - bottom - right - top = D3...D0.

6

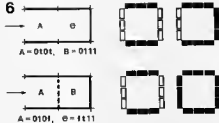

A = 0101, B = 1111

84023-6

Figure 6. Another little section of the labyrinth with the associated display indication. The upper example is a normal 'dead-end' and the lower one shows a 'fall'.

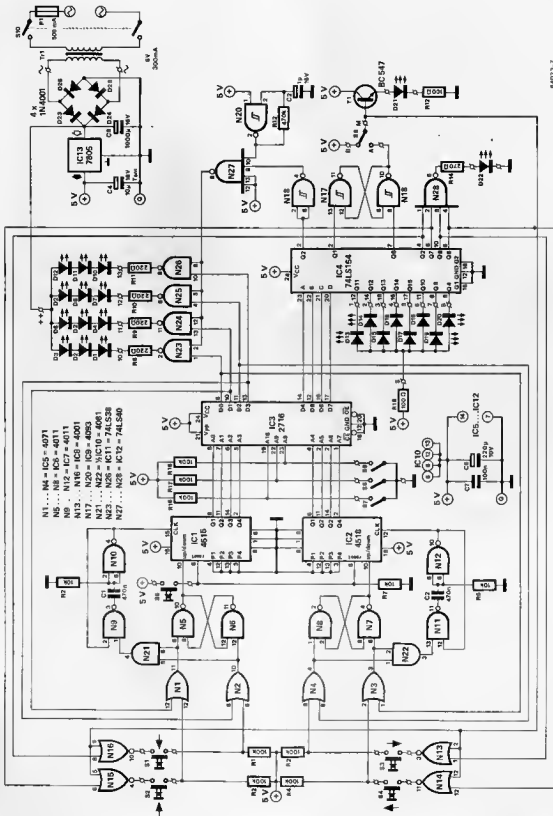

Figure 7. The heart of the circuit shown here is the 2716 EPROM (IC3).

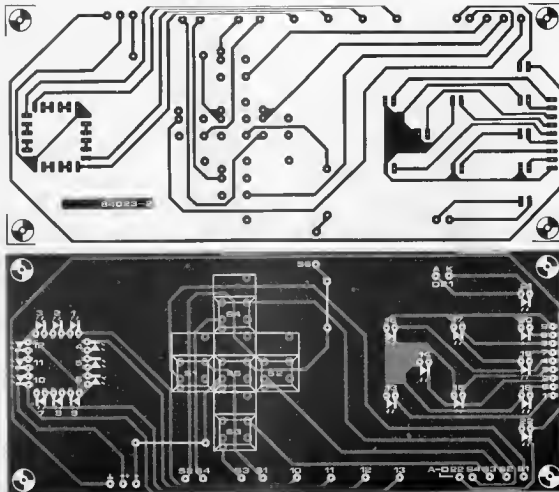

Figure 8. All the push buttons, switches and LEDs are mounted on the 'control' board.

are clear from the drawing in figure 1 (letters A...F, numbers 1 to 9). The second use for the four unused bits is to introduce certain hazards in the maze.

Hazards

There are two different kinds of hazard built into this game. These, as we have already seen are 'falling' and the 'handicap key'.

Let us deal with falling first. Falls are hidden traps indicated in figure 1 by dashed lines. These lines can be considered as diodes: you can go through the lines in one direction but then you cannot go back. This is very frustrating, of course, but in most cases we have given a clear warning. If the player is standing on the edge of one of these yawning chasms, LED D18 (generally — not always!) lights. If the player chooses to ignore the warning he will be irrevocably trapped. The way the falls work is shown in figure 6. The upper sketch shows a normal dead end and the indication on the LED display if the player walks from block A into block B; nothing unusual happens. The lower drawing is slightly different as there is a fall

between block A and block B. The LEDs give the same image for block A as previously. If the player takes a step to the right, all four walls suddenly light. He is then hopelessly imprisoned and can only escape by pressing the reset button to start the game again. The trick in programming this one-way wall is very simple. The dashed line is not programmed as a wall for block A but is for block B.

Now to the handicap key, which is switched on by means of S5. This hazard is based on a gate and a key, shown just right of centre (dotted line) and lower right respectively in figure 1. More gates can, of course, be programmed although one can cause enough problems on its own.

When the player comes face to face with the gate (D22 then lights), he can only cross it if he has the key in his possession. If he has not got the key, he must first look for the block containing the key, aided by D19, which lights to indicate that he is heading in the right direction. When the 'key' block is found, D21 lights to show that the key has been found. The player can now head for the gate with a vengeance knowing that the key will open

Parts list

Resistors
R1 . . . R4, R16 . . . R18 =
100 k
R5 . . . R7 = 10 k
R8 . . . R11 = 220 Ω
R12 = 470 k
R13, R15 = 100 Ω
R14 = 270 Ω

Capacitors:
C1, C2 = 470 n
C3 = 1 μ /16 V
C4 = 10 μ /15 V tantalum
C5 = 1000 μ /16 V
C6 = 220 μ /10 V
C7 = 100 n

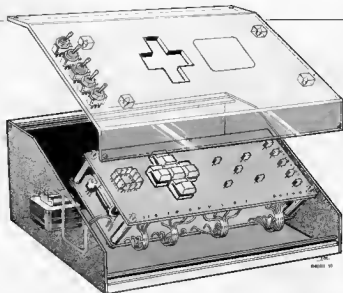

Figure 10. This drawing gives an indication of how this whole project fits together. The 'control board' is covered by a piece of red-coloured perspex in which holes are cut to accommodate the switches and push buttons.

Table 2.

1 START
2 EXIT
3 GATE ←
4 WAY TO EXIT (→EXIT)
5 WAY TO KEY (→KEY)
6 KEY
7 GATE →
8 GATE ↑
9 GATE ↓
A DANGER (!)
B LOWER LEFT
C MIDDLE
O LOWER RIGHT
E UPPER LEFT
F UPPER RIGHT

B F = POSITIONS

Table 2. The meanings of the hexadecimal information characters in the maze of figure 1.

'gate', the input of the NOR gate is fed a logic '0' by the demultiplexer. The other input of the NOR gate will be logic '0' or '1', depending on whether the key has been found or not. If the key has been found this input will be '1' and the output will be '0'. If the key has not been found, however, the output will be '1', and the player will not be allowed to move in this direction because the push button will be blocked. In the maze shown in figure 1 only one 'gate' is used. Whenever pins 4, 8, 9 or 10 are '0' the output of NAND gate N28 will be '1' and LED D28 will light.

A number of hexadecimal figures are programmed to specify the 'extra' information that is indicated by LEDs D13...D22. These are: for D13...D17: B...F; for D18: A; for D19: 8; for D20: 4; and for the key, or D21 in other words: 6. As figure 1 shows, each character is programmed into a number of different locations in the labyrinth. When the player reaches one of these blocks, the hexadecimal code will be sent to demultiplexer IC4 in binary form. One of the outputs will then go low and the relevant LED will light.

Whenever the player is close to a wall the appropriate output (9, 10, 11 or 13) of the EPROM becomes '1'. This signal goes to one of the four NAND gates N23...N26. As long as the player has not yet reached the exit from the maze, the outputs of these gates will be '0' and the LED display D1...D12 will work normally. When the exit is reached pin 3 of IC4 will go to '0'. The signal from oscillator N20 then feeds the inputs of N23...N26, so the walls of the LED display flash.

Construction

The circuit plus power supply (excluding transformer) is built up on two printed circuit boards, one of which is an 'electronics board' and the other is a 'control board'. These two boards are shown, along with their component overlays, in figures 8 and 9. The electronics board is quite straightforward and just requires the

usual care and attention to detail that any board does. The control board is designed in such a way that it can serve directly as a control panel. The best switches to use for S1...S4 and S6 are Digitast, while the layout lends itself to using rectangular LEDs for D1...D12, as this is aesthetically better. The other LEDs can be any normal common type.

The two boards must be interconnected at no less than 25 points. This sounds more difficult than it actually is as all the points are clearly marked and, if the boards are mounted relative to each other, the appropriate points on both boards more or less line up. Using ribbon cable where possible will keep this wiring tidier. The construction of our prototypes followed the lines shown in figure 10. The 'sandwich' shown consists of the two printed circuit boards and a front panel made of translucent plastic or perspex, coloured red and with openings cut for the Digitast switches S1...S4 and S6. The other switches, S5 and S7...S10, are mounted directly on the front panel. The three sections of the sandwich are fixed together using spacers to form a complete unit. Then all that is required is to connect up the supply transformer of 9...12 V at 300 mA.

Finally

This Elabyrinth is a difficult game, that's for sure, but then if it was simple it would quickly become boring. In case of emergency or the first time you play, finding the way out is greatly simplified by keeping a pencil and some squared paper at hand and mapping the maze as you go through it. Even though our maze is not intended to be modelled on the version at Hampton Court we think King Henry VIII would have approved of it. Our design even has some distinct advantages. It is portable, does not require trimming every week and of course you're not so likely to get rained on while playing it. ■

varistor protection circuits . . .



. . . a safeguard for semiconductors

Voltage dependent resistors, also called varistors, are hardly known or used by electronics hobbyists. A pity, because due to their specific characteristics they are eminently suitable for the protection of electronic circuits and semiconductors against overvoltages. To make these useful components better known, this article describes their operation and characteristics and gives some typical applications.

Varistors, conventionally classified as 'non-linear resistors', are produced from silicon-carbide, zinc oxide (zincite), or titanium oxide. Granules of these materials are sintered at high temperatures in a vitreous ceramic. One outstanding feature of voltage dependent resistors (VDRs) is that their resistance/voltage characteristic (figure 1a) is symmetrical, that is, independent of polarity. This is due to the fact that although any single contact in the resistor mass may rectify, random distribution of large numbers of contacts in series and parallel results in equal numbers of contacts rectifying in opposite directions. This makes them eminently suitable for AC applications where protection diodes cannot be used. The operation of a varistor is best understood by considering it as two zener diodes connected back-to-back. Below a certain voltage the current is small because the resistance is large. When the voltage rises, the resistance decreases and the current increases exponentially (figure 1b).

The relation between the voltage, U , and the current, I , of a varistor may be expressed by $U = CI^\beta$, where U is in volts, I in amperes, and C and β are constants of the resistance material. Practical values for C range from 14 to a few thousand; values for β are given in table 1. When the voltage and current are plotted on a double logarithmic scale, the U/I characteristic becomes a straight line with slope β . This characteristic deviates from a straight line only when the current is very small.

To be able to use a certain type of VDR, it is not strictly speaking necessary to know its characteristic. It is normally sufficient to know some data, such as:

- the voltage level at the 'knee', that is, the voltage where the varistor begins to operate. The sharpness of the knee in the characteristic is a function of the material used: zinc oxide varistors, for instance, have a more sharply defined knee than silicon-carbide types. Titanium oxide varistors have a relatively low knee level (from 2.7 V). The knee voltage is stated for a certain current, which depends on the value of the VDR.
- β (see figure 2). This constant is smallest for zinc oxide varistors, which means that even a small increase in voltage causes a very large increase in current.
- maximum peak current or maximum pulse energy that can be dissipated. The latter is, of course, a very important parameter in protection circuits!
- continuous loading, which is of importance where the varistor is used in a regulator circuit or with fast pulse rates.

Applications

Varistors are particularly used for the suppression of high-energy noise pulses, such as lighting or those generated when an inductive circuit is switched off. This switching may be effected by a (magnetic) switch, a fuse, or a semiconductor. If this semiconductor is a thyristor (also called silicon-controlled rectifier or triac), you would expect no trouble because

this component switches off only at the mains zero-crossing point so that no counter-e.m.f. is induced. This is, however, not entirely true, because the switching occurs as soon as the current drops below the holding value (the current necessary to keep the thyristor conducting). The holding value is not zero and a small counter-e.m.f. is therefore induced. In most cases the magnetic energy, $1/2LI^2$, is dissipated in a diode and the resistive part of the self-inductance (I is the current at the moment of switch-off and L is the total inductance in the circuit).

Often, however, the self-inductance is AC controlled, which makes the use of a diode impossible: a varistor is then the only solution.

A typical thyristor protection circuit using a varistor is shown in figure 4. In position 1 the varistor is connected immediately across the inductive load and attacks the noise at source. Note that the self-inductance of the connection to the thyristor, in combination with the parasitic capacitance of the (cut-off) thyristor, forms a series circuit in which oscillations may occur. It

Figure 1. The resistance of a varistor (voltage dependent resistor) is dependent on the applied voltage (a). The current increases exponentially when the voltage is raised (b).

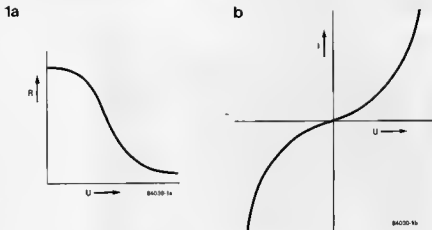

Figure 2. Plotting voltage and current on a logarithmic scale enables the determination of β . This is the standard characteristic supplied by the manufacturer.

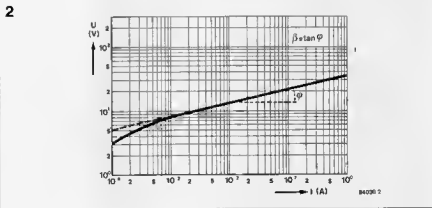
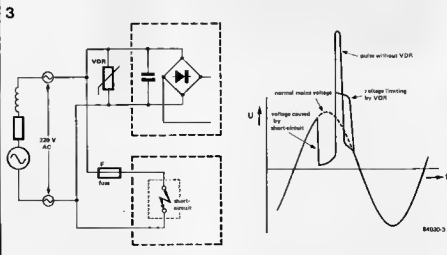

Figure 3. The generation of noise pulses on the mains voltage. When a fuse switches off a device, it causes a momentary rise in the mains voltage. Other equipment, if not protected, may be damaged by this pulse.



is not simple to calculate the consequences because the VDR, taking its parasitic capacitance and self-inductance into account, has a fairly complicated equivalent circuit.

With the varistor in position 2 (figure 4), that is, across the thyristor, it may be that the noise suppression is slightly less than in the first method. On the other hand, the thyristor itself is better protected.

If you choose the first method, that is, suppression at source, it is advisable to place a varistor at position 3 also. This serves to suppress any noise which may enter the circuit via the mains supply.

Some further applications of the varistor are shown in figure 6, where a, b, and c are intended as protection against overvoltage or voltage break-through. Application d is different as it gives voltage regulation in a similar way as can be realized with a zener diode. A special feature of the varistor is that the polarity of the input voltage is immaterial. In principle, it is possible to convert a sinusoidal input voltage into a rectangular output voltage. Note, however, that a varistor in a regulator circuit must be able to dissipate quite a lot of power. A few more points which need watching when you select a VDR for a particular application are given below.

■ The peak voltage which the protected component can stand without being damaged. The level of the knee voltage of the VDR must be lower than this peak voltage.

■ The maximum voltage, U_p , across the VDR under normal conditions (in AC applications: $U_p = 1.414 U_{rms}$). As a rule of thumb, the current through the VDR at this voltage must be smaller than 1 mA.

■ The maximum transient current.

■ The power dissipated in the VDR during a noise pulse. With the VDR connected across an inductance, this power is always smaller than $1/2LI^2$.

Table 1

Compound	β	Voltage range	Application
zinc oxide (ZnO)	0.025	50 V ... 500 V	suppression of high-energy noise pulses
silicon carbide (SiC)	0.3	5 V ... 25 kV	continuous noise loading, e.g. in voltage regulator circuits
titanium oxide (TiO ₂)	0.25	2.7 V ... 70 V	protection of low-voltage equipment

varistor protection circuits ...

Table 1. Comparison of various types of varistor.

4

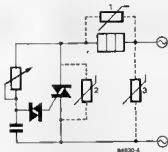

Figure 4. Protection of a thyristor in an electronic relay: VDR1 suppresses the noise at source and VDR3 suppresses externally generated noise. Alternatively, the VDR (2) may be connected across the thyristor itself.

5

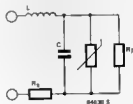
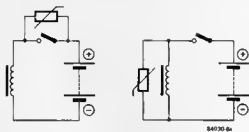

Figure 5. Representative diagram of a VDR with a self-inductance (incl. that of the terminals) L, parasitic capacitance C, series resistance R_s , and parallel resistance R_p .

■ The average dissipation, particularly if the pulse rate is high or if the knee voltage is not much higher than the normal operating voltage.

6a



b

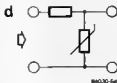
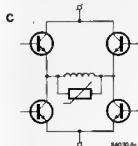
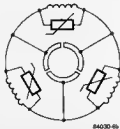

Figure 6. Some further applications of a varistor: a: contact protection, analogous to thyristor protection; b: commutator protection in a d.c. motor; c: protection of a bridge circuit with inductive load; d: voltage regulation or limiting (peak chopping).

A real-time analyser is an audio measuring instrument that defines which frequencies are present in an audio signal and in what strengths. To do this the audio spectrum is broken up into so-called harmonic bands. It is in fact an ideal measuring instrument for audio enthusiasts. The term 'real-time' indicates that the whole frequency range is analysed simultaneously, and this method ensures extremely accurate and quick measurements.

real-time analyser

part 1

a high quality measuring instrument for analysing the audio frequency spectrum

A real-time analyser is not something most people are likely to use every day. In general it would be considered a fairly specialised instrument so perhaps we should first of all clarify exactly what it is and what it does.

As we said in the introduction, the real-time analyser is an instrument that is purely suited for measurements in the audible frequency range, from about 20 Hz to 20 kHz. This audio spectrum is divided by this analyser into 30 frequency bands, each of which has a bandwidth of $\frac{1}{3}$ octave.

The centre frequency of the lowest band is 25 Hz and the centre frequency of the highest band is 20 kHz. The signal strength of each of these thirty bands is shown on a display.

A real-time analyser can be compared to a spectrum analyser, even though they operate quite differently. The real-time analyser gives just as accurate a frequency analysis as a spectrum analyser but it has the advantage that it examines an incoming signal immediately and completely. A spectrum analyser generally

1

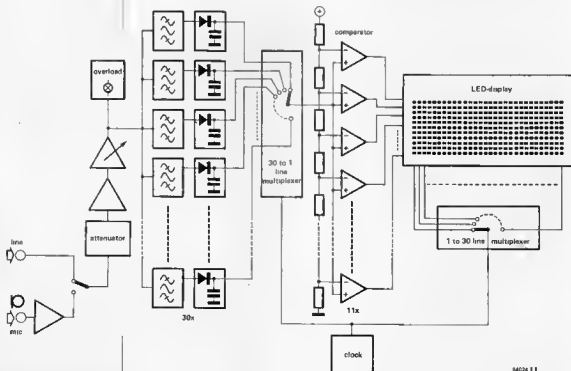

Figure 1. The block diagram for the real time analyser. Note that not all thirty band filters and rectifiers are shown here.

SACON 11

uses a swept filter system whereby the whole frequency range is run through in sequence. The signal to be measured must then be constant for a certain length of time. This is not needed with a real-time analyser as each signal is analysed in one go.

The range of the real-time analyser means that its use is almost exclusively limited to audio. This branch of electronics is very popular with hobbyists and thus can make a real-time analyser an indispensable instrument. The frequency characteristic is important in every part of an audio installation. Most amplifiers today are linear right up through the frequency range so these can generally be ignored. The frequency response of pick-ups, tape recorders and, of course loudspeakers, is very interesting and useful to know. The 'curve' for any particular audio element can easily be shown on the display thanks to the built-in pink-noise generator. Admittedly this measurement can also be done with a spectrum analyser, but the advantage of the real-time analyser is that the result of a measurement is immediately visible on the display and that audio signals (which are not periodic) can also be analysed.

This real-time analyser can also be used in combination with a $\frac{1}{2}$ harmonic equaliser. These are now being offered by a few manufacturers at reasonable prices, and the combination of these two instruments can enable a stereo system to be as perfectly tuned as is possible in any listening area.

After using this real-time analyser to study an audio system, you don't have to simply pack it up and put it into a cupboard somewhere until you change some part of the system. It can also be used as a sort of super-de-luxe output analyser for a power amplifier or recorder. The real-time analyser can, of course, be very useful in the field of speech analysis.

The real-time analyser is a precision instrument. This is a result, not only of the complex layout of the circuit and the large number of components this demands, but also of the components themselves, which must be of a high quality. The circuit will operate best using the components stated and care is required during construction as even a couple of the (more than 300) resistors misplaced can have a drastic effect on the accuracy.

The circuit is built up on a number of different printed circuit boards: the base board, a pink-noise generator board, an input board, four filter boards and a display board. This, of course, makes it a large project so we decided to divide it over several months.

The layout of the circuit

Now we are starting to get down to the nitty gritty of this project, the block diagram of which is shown in figure 1. The analyser has two inputs: one for the

line signal and one for a microphone (acoustic measurements). The microphone amplifier brings the microphone signal up to line level. The next element is an attenuator with graduated steps of 10 dB. After the necessary amplification, the incoming signal goes to the thirty $\frac{1}{2}$ harmonic filters with centre frequencies of 25...20 000 Hz. Each band filter is followed by an active half-wave rectifier. The outputs of the rectifiers are fed to a 30 to 1 multiplexer whose output is connected to a comparison circuit. This circuit compares the signal supplied by the multiplexer to a number of reference voltages, and the output of the comparator ICs drive the eleven rows of the display. The display consists of a matrix of 330 LEDs, arranged in 30 columns of 11 rows. The columns are switched by means of a 1 to 30 line multiplexer.

Both multiplexers in the circuit are connected to a common clock circuit which ensures that they continually work through all 30 lines and that the two are synchronized. If the first filter is connected to the comparator via the multiplexer, then the other multiplexer activates the first LED column. For the second filter, the second column is selected, and so on.

There are a few extras included in this circuit that are not shown on the block diagram. These enable the resolution of the display to be changed, and different LED indications can be selected to make life easier for the user, and, of course, there is the previously mentioned pink-noise generator that is an integral part of this analyser.

Some may wonder why we used a LED display rather than a fluorescent type. A fluorescent display would probably have been both easier to incorporate and better looking but at the moment there are none available that are suitable for this application. The LED solution would probably cost less in any case. Furthermore there will also be an option of a video interface for the analyser, and this will give a choice of displays.

The block diagram makes the circuit seem fairly simple. In practice it is quite straightforward but the sheer numbers of some components makes the total circuit rather big.

In the beginning...

This first 'instalment' deals with the input, power supply and filter circuits. The next article will be concerned with the base board with the rectifiers, a pink-noise generator and a display board which also contains the multiplexers and the comparator circuit. Later we will also describe a circuit to enable the output of the analyser to be shown on a television screen.

The input stage

The input section of the analyser is shown

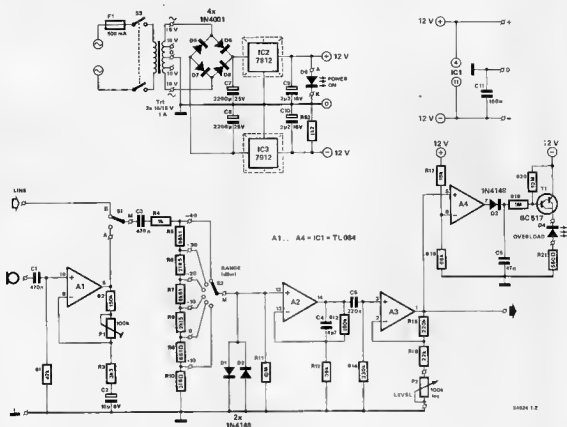

Figure 2. The input circuit and the power supply. The incoming signals are brought to a suitable level here before going on the filters.

in figure 2, with the two inputs for line signal and microphone at the left hand side. One of these inputs is selected via switch S1.

The circuit around A1 is a microphone pre-amplifier with an input impedance of 47 k, which is suitable for most types of microphones. The amplification can be varied between about 50 and 75 times with P1, or, if desired, it can also be changed by selecting a suitable value for R2. (The amplification is defined by: $A = (R2 + P1 + R3)/R3$.)

The attenuator is built up around S2 and 1% resistors R5...R10. The steps are quoted in dBm, where 0 dBm corresponds to 775 mV_{rms}. If a microphone is used to pick up a signal the output voltage of A1 should be adjusted with P1 so that a level of 0 dBm is given by the instrument at an SPL (sound pressure level) of 100 dB. The -10 dB position then corresponds to an SPL of 90 dB, and so on.

The input of op-amp A2 is protected from high input voltages by means of diodes D1 and D2 and resistor R4. This op-amp is set to have a fixed amplification of just less than 6 x. It is immediately followed by a second amplifier stage whose gain can be

varied between 3 x and 11 x by means of P2. This potentiometer serves as a 'variable adjustment' in combination with the attenuator. If the wiper of P2 is turned as much as possible towards R16 (maximum amplification) the calibrated values of the attenuator are valid. This potentiometer then enables the input level to be continuously variable over a range of 10 dB from the selected attenuation position. With the values indicated the complete input stage amplifies an input signal of 7.75 mV_{rms} (-40 dBm position) to give an output value of about 0.5 V_{rms}. The output of A3 drives all thirty filters. The output of this input stage is also equipped with an overload indicator. This circuit, based on A4 and T1, gives a warning by lighting LED D4 when the input amplifiers are over-driven. This indicates that the input signal must be reduced or that the attenuator must be switched to a less sensitive position. The actual circuitry involved simply consists of a comparator (A4), which compares the output signal of A3 with a reference voltage derived via R17 and R18. The output signal from the comparator is 'extended' by D3 and C6 so that the LED will light even when the over-

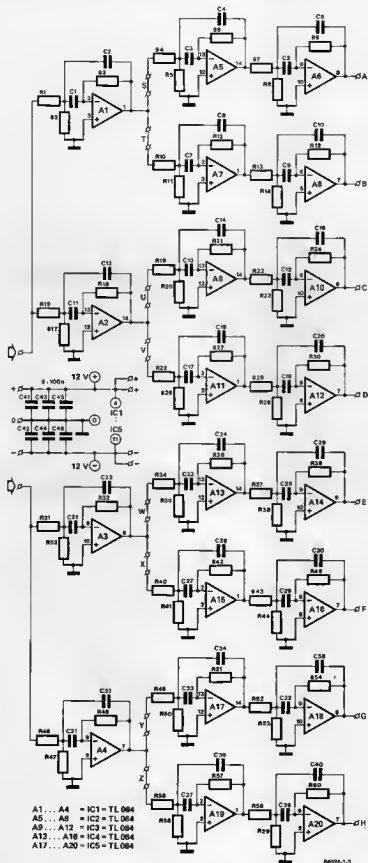

A1... A4 = IC1 = TL084
 A5... A8 = IC2 = TL084
 A9... A12 = IC3 = TL084
 A13... A16 = IC4 = TL084
 A17... A20 = IC5 = TL084

Third harmonic filters

Centre frequency: f_0
 -3dB-points: f_1 and f_2

$$f_2 = 2 \frac{1}{f_1}$$

$$f_1$$

$$f_0 = \sqrt{f_1 f_2}$$

f_1 and f_2 are symmetrical

around f_0 so:

$$f_1 = f_0 \cdot 2^{1/n}$$

$$f_2 = f_0 \cdot 2^{1/n}$$

The band frequencies are defined by

$$f_0 = 10^{(n-1)/n} \text{ Hz, where}$$

$$n = \text{band number}$$

$$n = 14 \dots 43$$

for example:

$$n = 14 \rightarrow f_0 = 25 \text{ Hz}$$

$$n = 30 \rightarrow f_0 = 1000 \text{ Hz}$$

$$n = 43 \rightarrow f_0 = 20 \text{ kHz}$$

Because $2 = 10^{0.3010} \approx 10^{0.3}$ so:

$$2^{1/n} \approx 10^{0.3/n}$$

$$2^{1/n} \approx 10^{0.3/n}$$

For the changeover points:

$$f_1 \approx 10^{(n-0.5)/n}$$

$$f_2 \approx 10^{(n+0.5)/n}$$

where $n = 14 \dots 43$

Example:

$$n = 30$$

$$f_0 = 10^{(30-1)/30} =$$

$$= 10^1 = 1000 \text{ Hz}$$

$$f_1 = 10^{(30-0.5)/30} = 10^{0.983} =$$

$$= 891.25 \text{ Hz}$$

$$f_2 = 10^{(30+0.5)/30} = 10^{1.017} =$$

$$= 1122.02 \text{ Hz}$$

Figure 3. This shows the contents of one filter board, containing eight of the thirty filters. Some filter sections (A1, A2, A3 and A4) are used for two filter bands.

Figure 4. The sketch here shows how one filter is formed by connecting three band filters in series. The result is a very precise filter with a flattened top.

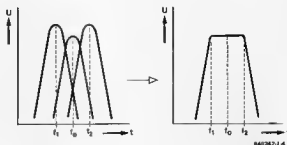

driving peaks are very short. The power supply for the real-time analyser is located on the input board. This is clearly seen in figure 2. Two voltage regulators ensure a stable symmetrical supply of + and -8 V. The current which can be provided by the supply, almost 1 A, is quite sufficient for the circuit.

The filters

One of the most difficult points of any real-time analyser is the filters needed. Because the bands are very narrow and must be very close to each other, the band filters must be very precise. For this reason we need three op-amps per filter, which for 30 filters adds up to a total of 90 op-amps. By using a few tricks we managed to reduce this total to 75, as we will see shortly, so if we use quad op-

amps the number of ICs required begins to seem a bit more reasonable.

All the filters have the same layout so we have only indicated a few of them in figure 3. The eight filters shown are the contents of one filter board. There are four filter boards in total, the last of which contains only six filters.

The notes in the margin on the previous page indicate the theory behind the filters used in this analyser. With a centre frequency of 1 kHz, for example, the -3 dB points of the relevant filter are at 891 Hz and 1123 Hz. The next filter has a centre frequency of 1.26 kHz, rounded off to 1.25 kHz, and its -3 dB points are at 1123 Hz and 1414 Hz. And so it goes on! The international (ANSI) specifications for 1/2 harmonic filters in professional measuring equipment require that the -40 dB points of a 1 kHz filter lie at 562 Hz and

Figure 5. Printed circuit board and component layout of the input and power supply board. The voltage regulators must be mounted on a heat sink.

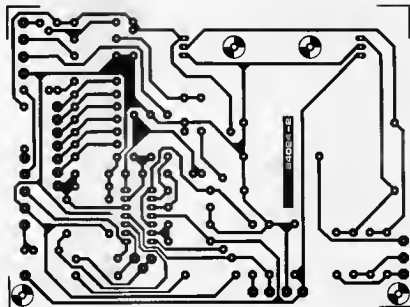

1.81 kHz. This gives an idea of the precision needed in such filters. For correct operation, the precision of the filters is of critical importance, otherwise a signal with a frequency of 1 kHz would not only be visible on the 1 kHz LED column but also on the adjacent columns. With three normal op-amps a band filter can be made that meets ANSI standards in practice. By 'in practice' we mean that the filter reaches the -40 dB points with an accuracy of a few dB.

One filter in the circuit diagram, for example, consists of op-amps A1, A5 and A6. Each op-amp is set up as a multiple feedback band-pass filter. The three filter bands are slightly shifted with respect to each other, as figure 4 shows. One of the filters lies precisely on the centre frequency, f_0 of the third harmonic, whereas the centre frequencies of the other two filters are exactly at the changeover points, f_1 and f_2 of this third harmonic band. Carefully choosing the Q factor and amplification of each filter can ensure that the final result is an extremely narrow band filter with a very flat 'top'. The Q factor of all the filters here is slightly more than four, the amplification of the 'middle filter' is 1 and of the 'side-band filters' 1.4. The calculation involved for an equivalent filter is quite complex, even with the aid of the ubiquitous computer. In principle, an equivalent set-up should give even greater precision, but it would require an even higher Q factor. This is not feasible if we want to use ordinary, fairly cheap, op-amps. The formulae for such an equivalent filter have already been dealt with in Elektor (June 1983, spectrum display) so we will not go any further into this sort of

single element filter here.

The upper sideband filter of one band is identical to the lower sideband filter of the following band, so one filter can do double duty, as shown in the diagram. This makes A1 the high sideband filter for the A1, A5, A6 band and the lower sideband filter for the A1, A7, A8 band. This saves 15 band filters over the range of 30 filters.

The accuracy of the components for the filters is very important. This explains the use of components with tolerances of 1% or 2.5%, but we will deal with this further under construction.

Construction

Even though the circuit has certainly not been described in full yet, we can already begin putting some of the boards together. They cannot be tested, however, until the construction of the analyser has advanced a bit further. This applies in particular to the filter boards.

We cannot stress strongly enough the importance of keeping to the components listed in the parts list for this analyser. The tolerances stated must be used and we also recommend that good quality sockets be used for the ICs.

In the input and supply circuits, contained on the same board, there are only a few 1% resistors used. Their values are indicated by four colour rings in place of the usual three. Ideally these should be sorted out and if possible measured with a multimeter before mounting anything on the board. The voltage regulators must be mounted on a heat sink. Switches, LEDs and so on should not be connected until

Parts list, input and supply board

Resistors:

- R1 = 47 k
- R2 = 150 k
- R3 = 3k3
- R4 = 1 k
- R5 = 68k1 1%
- R6 = 21k5 1%
- R7 = 6k81 1%
- R8 = 2k15 1%
- R9 = 681 Ω 1%
- R10 = 316 Ω 1%
- R11, R20 = 10 M
- R12 = 10 k
- R13 = 180 k
- R14 = 330 k
- R15 = 220 k
- R16 = 22 k
- R17 = 18 k
- R18 = 68 k
- R19 = 1 M
- R21 = 560 Ω
- R22 = 1k2
- P1 = 100 k preset
- P2 = 100 k log pot

Capacitors:

- C1, C3 = 470 n
- C2 = 10 μ /16 V
- C4 = 4p7
- C5 = 220 n
- C6 = 47 n
- C7, C8 = 2200 μ /25 V
- C9, C10 = 2 μ 2/16 V
- C11 = 100 n

Semiconductors:

- D1 ... D3 = 1N4148
- D4 = LED, red 3 mm
- D5 ... D8 = 1N4001
- D9 = LED, green 3 mm
- T1 = BC 517
- IC1 = TL 084
- IC2 = 7808
- IC3 = 7808

Miscellaneous:

- F1 = fuse, 0.5 A, with fuse holder
- Heatsink for IC2 and IC3, e.g. SK 13 (17°C/W - 35 x 17 x 13 mm)
- S1 = single pole toggle switch
- S2 = single pole 6-way wafer switch
- S3 = double pole single throw switch
- T1 = mains transformer, 2 x 15 V/1 A with 10 V tappings

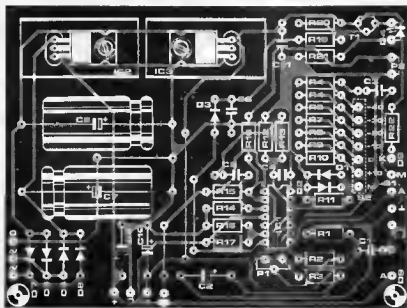

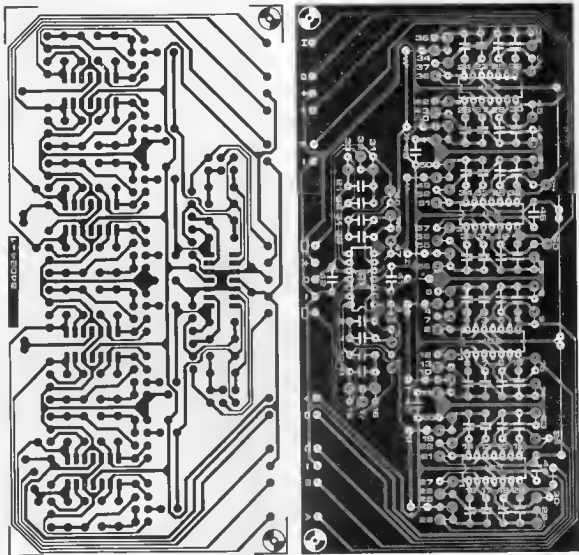

Figure 6. The filter board is shown here. Four of these boards in all are needed, three with eight filters and one with six, to make up the thirty filters.

Parts needed for the filters

Resistors (all 1%):

3 x 887 Ω	3 x 2k49	3 x 41k2	6 x 105 k
3 x 1k00	3 x 2k55	3 x 42k2	3 x 107 k
3 x 1k13	3 x 2k80	3 x 46k7	9 x 118 k
3 x 1k27	3 x 2k87	3 x 52k3	3 x 130 k
3 x 1k40	3 x 3k16	6 x 53k6	3 x 133 k
3 x 1k43	3 x 3k24	6 x 59k0	3 x 147 k
3 x 1k58	6 x 3k57	6 x 60k4	6 x 150 k
3 x 1k62	3 x 4k02	9 x 69k5	3 x 165 k
3 x 1k78	3 x 21k0	6 x 75k0	6 x 169 k
3 x 1k82	3 x 29k7	3 x 76k3	6 x 187 k
3 x 2k00	3 x 32k4	6 x 82k5	3 x 210 k
3 x 2k05	3 x 33k2	3 x 84k5	3 x 215 k
3 x 2k21	3 x 34k0	6 x 93k1	6 x 237 k
3 x 2k26	3 x 38k3	6 x 95k3	3 x 267 k

Capacitors.

20 x 220 nMKH 5%
30 x 100 n MKH or polystyrene 2.5 or 5%
20 x 22 n MKH or polystyrene 2.5 or 5%
30 x 10 n polystyrene 2.5%
20 x 2n2 polystyrene 2.5%
30 x 1 n polystyrene 2.5%
24 x 100 n

Semiconductors

19 x TL 084

Table 1.
Parts list for the filter boards

	board I	board II	board III	board IV
R1	79k	297	422	665
R2	3k4	1k1	1k7	2k8
R3	210 k	75 k	110 k	187 k
C1, C2	220 n	100 n	10 n	1 n
R4	55k	3k1	32k	845
R5	40k	1k3	2k26	3k7
R6	267 k	59k1	180 k	237 k
C3, C4	220 n	100 n	10 n	1 n
R7	118 k	41k2	66k5	100 k
R8	227 k	1k27	2 k	3k18
R9	237 k	62k5	130 k	210 k
C5, C6	220 n	100 n	10 n	1 n
R10	80k4	21 k	32k2	53k
R11	2k95	887 Ω	1k4	2k21
R12	188 k	88 k	82k1	1k7
C7, C8	220 n	100 n	10 n	1 n
R13	95k3	32k7	52k3	82k5
R14	2k87	1 k	2k88	2k40
R15	187 k	68k5	105 k	180 k
C9, C10	220 n	100 n	10 n	1 n
R16	48k7	78k8	29k7	42k2
R17	2k05	3k2k	1k13	1k78
R18	12k1	21 k	7k1	118 k
C11, C12	220 n	22 n	10 n	1 n
R19	85k4	55k3	3k1	53k6
R20	2k56	4k32	1k43	2k26
R21	188 k	887 k	82k1	180 k
C13, C14	220 n	22 n	10 n	1 n
R22	78 k	118 k	41k2	48k5
R23	2k26	3k57	1k27	2 k
R24	187 k	22 k	62k5	130 k
C15, C16	220 n	22 n	10 n	1 n
R25	38k3	82k4	21 k	32k2
R26	1k62	2k58	887 Ω	1k4
R27	107 k	1 k	88 k	32k1
C17, C18	220 n	22 n	10 n	1 n
R28	85 k	36k3	32k7	52k3
R29	1k82	2k87	1k	1k56
R30	118 k	887 k	68k5	105 k
C19, C20	220 n	22 n	10 n	1 n
R31	65k5	48k7	78k8	28k7
R32	2k8	2k08	3k2k	1k13
R33	187 k	130 k	21 k	7k1
C21, C22	220 n	22 n	2k2	1 n
R34	84k5	62k4	35k3	3k1
R35	3k87	2k56	4k02	1k43
C23, C24	100 n	22 n	267 k	32k1
R36	100 n	22 n	2k2	41k2
R37	100 k	76 k	118 k	1k27
R38	3k18	2k26	3k57	52k3
R39	219 k	180 k	237 k	1k
C25, C26	100 n	22 n	2k2	1 n
R40	53k6	36k3	82k4	21 k
R41	2k21	1k82	2k58	887 Ω
R42	1k7	1 k	118 k	88 k
C27, C28	100 n	22 n	2k2	1 n
R43	82k5	88 k	65k5	32k7
R44	2k48	1k82	2k87	1 k
R45	188 k	118 k	187 k	68k5
C29, C30	100 n	22 n	2k2	1 n
R46	42k2	68k5	48k7	—
R47	118 k	2k8	2k08	—
R48	118 k	187 k	130 k	—
C31, C32	100 n	10 n	2k2	—
R49	82k6	68k5	82k4	—
R50	2k26	3k57	3k56	—
R51	180 k	237 k	188 k	—
C33, C34	100 n	10 n	2k2	—
R52	68k5	120 k	75 k	—
R53	2 k	3k18	2k26	—
R54 r	130 k	210 k	100 k	—
C35, C36	100 n	10 n	2k2	—
R56	53k2	53k8	78k8	—
R56	1k40	2k21	1k82	—
R57	52k1	1k7	187 k	—
C37, C38	100 n	10 n	2k2	—
R56	52k3	53k8	10 k	—
R56	1k58	2k48	1k82	—
R56	100 k	180 k	118 k	—
C39, C40	100 n	10 n	2k2	—
C41 C46	100 n	100 n	100 n	100 n
IC1	TL 084	TL 084	TL 084	TL 084
IC2	TL 084	TL 084	TL 084	TL 084
IC3	TL 084	TL 084	TL 084	TL 084
IC4	TL 084	TL 084	TL 084	TL 084
IC5	TL 084	TL 084	TL 084	TL 084
A—	25 Hz	180 Hz	1800 Hz	6300 Hz
B—	315 Hz	200 Hz	1250 Hz	8200 Hz
C—	80 Hz	250 Hz	1600 Hz	10 000 Hz
D—	50 Hz	315 Hz	2000 Hz	12 500 Hz
E—	83 Hz	400 Hz	2500 Hz	18 000 Hz
F—	100 Hz	500 Hz	3150 Hz	20 000 Hz
G—	180 Hz	820 Hz	4000 Hz	—
H—	120 Hz	800 Hz	5000 Hz	—

the whole circuit has reached the stage where a case can be selected and a front panel layout made.

The only part of this board that can be tested is the power supply. The values measured for — and + 8 V must not vary by more than 0.5 V from the nominal value.

As we have already stated, the filters are built on four of the boards shown in figure 6. The values of the components used on each board are itemized in table 1. Board no. IV is not completely filled.

Instead of our usual parts list, we have simply listed everything here by value and number required. This is particularly handy for sorting out the resistors.

All resistors on the filter boards must be 1% types. The capacitors should ideally all be 2.5% types, but in practice that can cause some problems. Capacitors with this tolerance tend to be quite large, or at least they are for some of the values that we need here. This could make the dimensions of the filter boards excessively big. To alleviate the problem we came up with this compromise: all capacitors up to and including 10n are 2.5% polystyrene types; larger values can be 5% MKH or MKM capacitors. In practice the accuracy of these 5% types is usually better than 3%. If the analyser is to be kept so inexpensive as possible, all the filter capacitors could be MK types. The board has been designed to allow for this possibility. The accuracy of the analyser can still be kept to an optimum if the capacitor values are measured with a capacitance meter and those closest to the desired values are used.

All the resistors and polystyrene capacitors are mounted vertically on the board. The ICs should come from a reliable manufacturer, but here again there is a cheaper alternative. On the two 'lowest' boards LM 324s may be used in place of the TL 084s. As these two ICs are pin compatible this does not cause any problem on this score.

It is a good idea to number the boards I, II, III and IV as they are constructed in order to avoid confusion later.

That is all for this month. Next month you can expect the display board and the base board and then the whole lot will start to look more like a complete analyser.

multiple sound effects generator

a single IC full of sound surprises

Yes, a single IC is all (well practically all) that is required to produce a cacophony of sound effects. The device is able to imitate virtually every sound under the sun, from the twittering of birds to machinegun fire, from the sound of a plane overhead to the high pitched squeal as it plummets to the ground out of control, from the screeching of brakes as a car runs out of road to the inevitable crash . . . All in all an amazing repertoire of everyday (?) sound effects.

A great many letters have been received in response to the various sound effects generators that have been published in *Elektor* over the years, which shows that such circuits are still very popular. However strange or frivolous the sound may be, people always seem to be able to find plenty of uses for it. Sound freaks will be delighted to know, therefore, that Texas Instruments have developed an IC specifically for them, the 'complex sound generator' SN 76477N.

It comes in a 28 pin DIL package and contains all the ingredients required to serve up a whole menu of interesting and refreshing sound effects. A resistor here, a capacitor there and a couple of transistors constitute the only other components required. The latter simply amplify the output signals to a level sufficient to drive the loudspeaker.

This IC is by no means new. In fact it was first described in the September 1978 edition of *Elektor* under the heading *Applikator*. We were then mainly interested in the theoretical and technical aspects of the device. Now, however, we shall concern ourselves more with the practical side of things.

The IC was found to produce a total of seven basic (and different) sound effects. There are, therefore, a minimum of seven different circuits involved, but as they all have certain things in common, it was possible to design a single printed circuit board on which they can all be incorporated. Each individual effect requires a slight modification to the combination of components used.

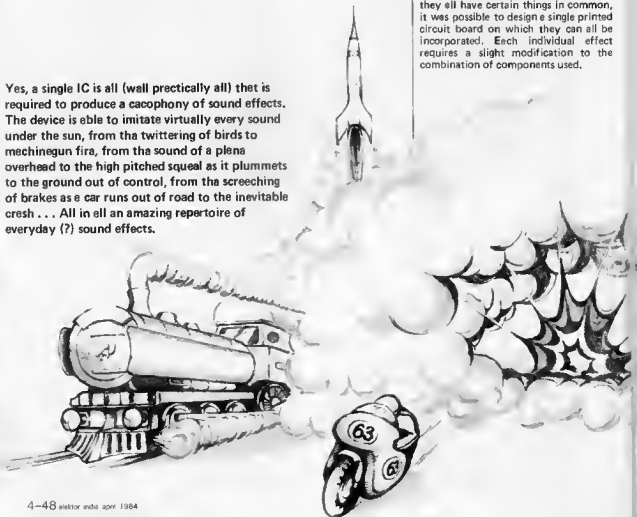

The IC

Since the 'internals' of the IC have already been discussed in detail in the September 1978 issue, it will suffice to give a brief survey of the most important features. Readers who wish to delve a little deeper into the technology involved are referred to the article mentioned above. It includes all the various formulae and tables that are of interest.

The block diagram of the 'complex sound generator' IC is given in figure 1, together with a few external components that are required. A closer examination reveals that there are three fundamental signals produced. These signals are obtained from: the Super Low Frequency oscillator (SLF), the Voltage Controlled Oscillator (VCO) and the noise generator.

The SLF section contains an oscillator which covers the super low frequency range between 0.1 Hz to 30 Hz. Under special circumstances it can also be used at higher frequencies. The frequency of oscillation is determined by the values of Resistor R_5 and capacitor C_5 (connected to pins 20 and 21 respectively). Also shown is the fact that the SLF oscillator provides two output signals. The first is a squarewave signal which is processed by the mixer stage and the second is a triangular waveform which can be used to control the VCO by way of the external VCO/SLF select switch.

The VCO block consists of an oscillator whose frequency is totally dependent

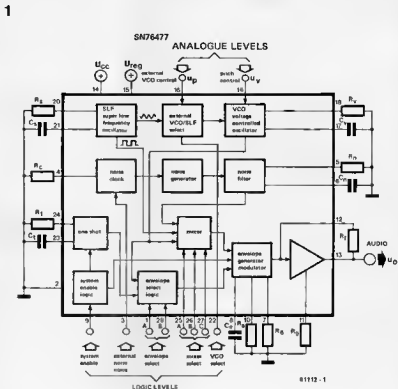

Figure 1. The block diagram of the 'complex sound generator'.

on the input voltage. This can be either the SLF oscillator output signal or an external signal applied to the U_D input at pin 16 of the IC. Which one it is to be is determined by the logic level at the VCO select input (pin 22). In addition, a signal at the U_D input enables the VCO output to be frequency modulated. The voltage at U_V (pin 19), on the other hand, affects the duty cycle of the squarewave produced by the VCO and thus the timbre of the resulting audio signal. The free-running frequency of the voltage controlled oscillator is determined by the external components R_V and C_V (pins 18 and 17 respectively).

The pseudo-random white noise generator is triggered by the noise clock whose internal current level is determined by the value of R_C (pin 4). The resultant signal is then passed through the noise filter. The turnover point of this low pass filter can be altered by selecting different values for the components R_N and C_N (pins 5 and 6 respectively). Alternatively, the nature of the noise signal can be changed by applying an external clock signal to the input at pin 3.

So far so good. Now for the remaining sections. A logic 'one' level at pin 9 causes the system enable logic to suppress the output signal from pin 13 of the IC... When this same input is

2

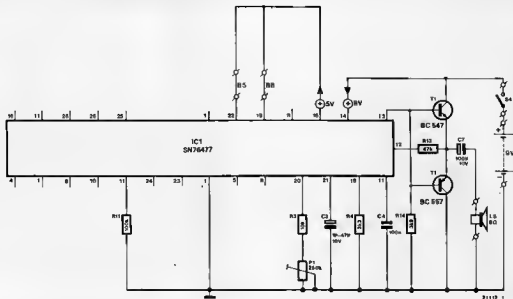

Figure 2. The siren/spaceship circuit. The amplifier stage constructed around T1 and T2 and the on/off switch S4 are used in each different circuit.

3

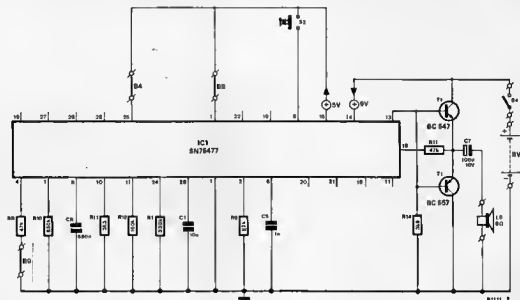

Figure 3. The gun shot circuit. By repeatedly depressing S2, the effect will be similar to that of machinegun fire.

Parts lists

Figure 2.

resistors:

R3 = 10 k
R4 = 3k3
R12 = 100 k
R13 = 47 k
R14 = 3k9
P1 = 250 k preset

capacitors:

C3 = 1 μ ... 47 μ /10 V

C4 = 100 n
C7 = 100 μ /10 V

semiconductors:

T1 = BC 547
T2 = BC 557
IC1 = SN 76477 (Texas)

miscellaneous:

S4 = single pole switch
loudspeaker 8 Ω /0.2 W
wire links: B5, B6

Figure 3.

resistors:

R2 = 330 k
R6, R13 = 47 k
R9 = 82 k
R10 = 680 k
R11 = 3k3
R12 = 100 k
R14 = 3k9

capacitors:

C2 = 10 n
C5 = 1 n

C6 = 680 n
C7 = 100 μ /10 V

semiconductors:

T1 = BC 547
T2 = BC 557
IC1 = SN 76477 (Texas)

miscellaneous:

S2 = pushbutton switch
S4 = single pole switch
loudspeaker 8 Ω /0.2 W
wire links: B4, B5, B9

4

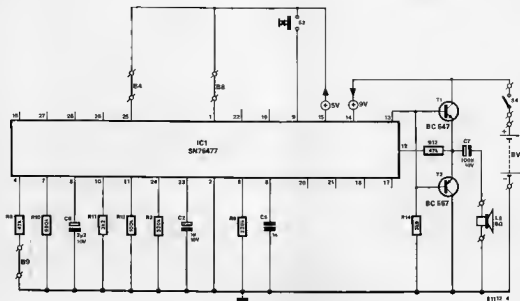

Figure 4. The explosion circuit. Basically, this is little more than a drawn out gun shot.

5

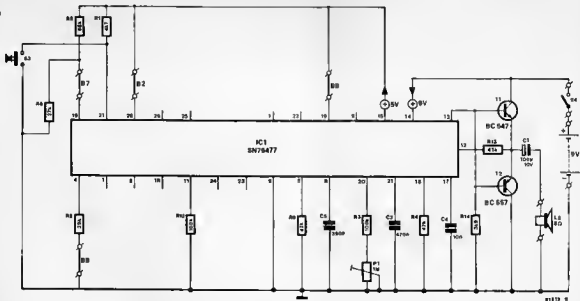

Figure 5. The steam train and whistle circuit. The speed of the train can be controlled by means of P1 while S3 activates the whistle.

Figure 4.

resistors:
R2 = 330 k
R8, R13 = 47 k
R9 = 220 k
R10 = 680 k
R11 = 3k3
R12 = 100 k
R14 = 3k9

capacitors:
C2 = 1 μ /10 V
C5 = 1 n

C6 = 2 μ 2/10 V
C7 = 100 μ /10 V

semiconductors:
T1 = BC 547
T2 = BC 557
IC1 = SN 76477 (Taxis)

miscellaneous:
S2 = pushbutton switch
S4 = single pole switch
loudspeaker 8 Ω /0.2 W
wire links: B4, B5, B9

Figure 5.

resistors:
R1 = 4k7
R3, R12 = 100 k
R4, R9, R13 = 47 k
R5 = 88 k
R6 = 27 k
R8 = 39 k
R14 = 3k9
P1 = 1 M preset

capacitors:
C3 = 470 n

C4 = 10 n
C5 = 390 p
C7 = 100 μ /10 V

semiconductors:
T1 = BC 547
T2 = BC 557
IC1 = SN 76477 (Taxis)

miscellaneous:
S3 = pushbutton switch
loudspeaker 8 Ω /0.2 W
S4 = single pole pushbutton switch
wire links: B2, B6, B7, B9

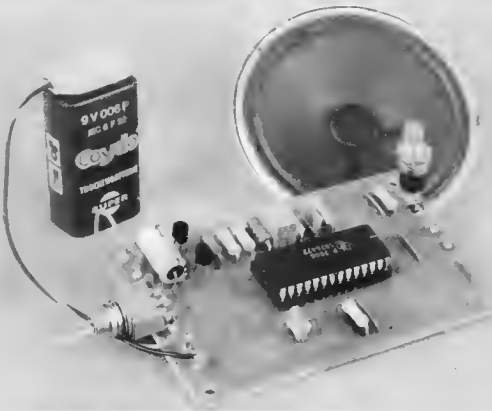

taken low, the one shot (monostable multivibrator) is triggered. This is used to generate 'single' sounds such as that of gunfire. The duration of the output pulse of the one shot is determined by the values of resistor R_T and capacitor C_T (pins 24 and 23) and can be anything up to a maximum of ten seconds.

The output signals from the SLF oscillator, the VCO and the noise generator are all fed to the mixer stage. According to the logic levels presented to the mixer select inputs (pins 25, 26 and 27) one, or a combination of, the three signals are passed on to the next section, this being the envelope generator/modulator. Here the mixer output signal is amplitude modulated with either the VCO output signal or the one shot depending on the logic level applied to the envelope select inputs (pins 1 and 28). If the VCO signal is selected, both amplitude and frequency modulation are possible.

Finally, we come to the output amplifier. The gain of this stage is determined by the values of resistors R_f and R_g (pins 12/13 and 11 respectively). In the given circuit examples this amplifier is immediately followed by a symmetrical output stage made up from a complementary pair of transistors. These in turn drive the loudspeaker.

The sound effects

Clearly, the SN 76477N IC is extremely versatile. The signals that can be generated by component combinations and

modulation possibilities are more than sufficient to produce a whole host of aural phenomena.

Seven different basic variations were constructed and a universal printed circuit board was designed accordingly. There is no need for readers to restrict themselves to the examples given here however. Feel free to experiment with different values of resistors and capacitors to modify and in some instances even improve on the effects.

One major advantage is that all the circuits can be supplied from a single 9 V battery or from an unregulated power supply. This is because the IC contains its own internal regulator (not shown in figure 1, so you'll have to take our word for it!) which derives a stable 5 V from the original input voltage (pin 14 : 9 V in, pin 15 : 5 V out). Obviously, the current consumption will depend on the volume of the output signal, but should not exceed more than about 20 mA.

The various circuits will now be reviewed briefly, regarding the IC itself more or less as a 'black box', so as not to have to go into too much detail for each variation.

Siren (figure 2)

This is a nice straightforward circuit for a start. Only three resistors and two capacitors are involved, in addition to the loudspeaker amplifier which is the same for all the examples and is connected to pins 11...13. The VCO is

controlled by the triangular waveform from the SLF oscillator. This results in a characteristic siren effect provided the frequency of the SLF oscillator is kept low (by means of potentiometer P1). If, however, the pitch of the SLF oscillator is increased, the effect is similar to that of a science fiction space rocket 'zipping' through unknown galaxies.

The effect can be modified by changing the frequency of the VCO by means of R_4 and C_4 and that of the SLF oscillator with C_3 , R_3 and P1.

Gun shot (figure 3)

The sections we have just mentioned (VCO and SLF oscillator) are not required for this effect. White noise, together with a sharp attack, is what is needed for the gun shot. When switch S2 is pressed the one shot is activated via a negative going pulse on pin 9. Low frequency noise is fed to the output via the envelope generator/modulator. The attack and decay time constants are determined by the components R_{10} , R_{11} and C_6 . The sound of the gun shot is made more realistic as the noise generator actually produces a sound similar to that of thunder. By repeatedly depressing S2 the sound of machinegun fire can be simulated.

Explosion (figure 4)

Basically the circuit is identical to that of the gun shot, only this time the noise

6

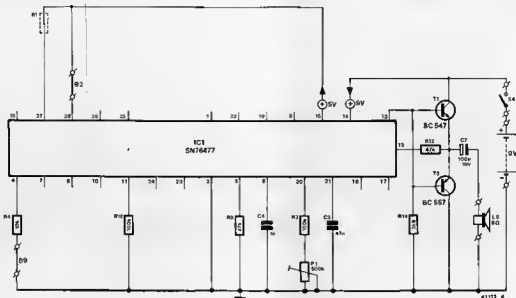

Figure 6. The aeroplane circuit. Sounds rather like the 'runway train'!

7

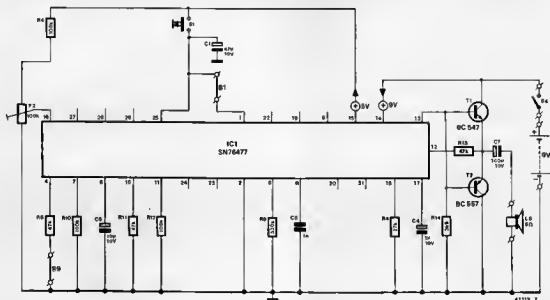

Figure 7. The racing car end crash circuit. The sound of the car engine is controlled by means of P2. The car will 'crash' when S1 is depressed.

Figure 6

resistors:
 R3, R12 = 100 k
 R8 = 10 k
 R9, R13 = 47 k
 R14 = 3k9
 P1 = 500 k preset

capacitors:
 C3 = 47 n
 C5 = 1 n
 C7 = 100 μ /10 V

semiconductors:
 T1 = BC 547
 T2 = BC 557
 IC1 = SN 76477 (Texas)

miscellaneous:
 64 = single pole switch
 toudspeaker 8 Ω /0.2 W
 wire links: 82, 89, R1

Figure 7.

resistors:
 R4 = 27 k
 R5, R10, R12 = 100 k
 R8, R11, R13 = 47 k
 R9 = 330 k
 R14 = 3k9
 P2 = 100 k preset

capacitors:
 C1 = 47 μ /10 V
 C4 = 1 μ /10 V
 C5 = 1 n

C6 = 10 μ /10 V
 C7 = 100 μ /10 V

semiconductors:
 T1 = BC 547
 T2 = BC 557
 IC1 = SN 76477 (Texas)

miscellaneous:
 S1 = pushbutton switch
 S4 = single pole switch
 loudspeaker 8 Ω /0.2 W
 wire links: B1, B9

8

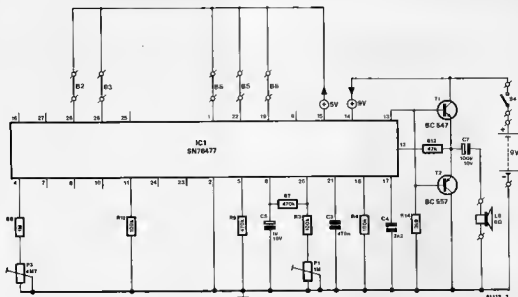

Figure 8. The down chorus circuit. By carefully adjusting P3 the 'bird song' can be tuned in nicely!

9

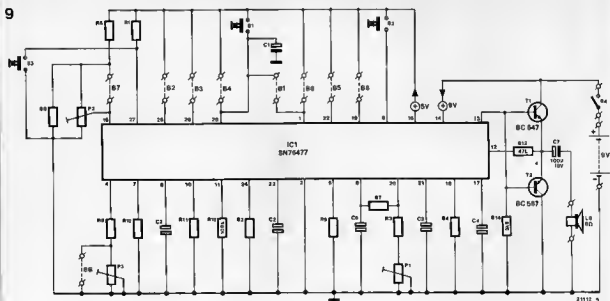

Figure 9. A general survey of all the components that can be fitted onto the print circuit board.

Figure 8.

resistors:

R3, R4, R12 = 100 k

R7, R9 = 470 k

R8 = 1 M

R13 = 47 k

R14 = 3k9

P1 = 1 M preset

P3 = 4M7 preset

capacitors:

C3 = 470 n

C4 = 2n2

C5 = 100 μ /10 V

C7 = 100 μ /10 V

semiconductors:

T1 = BC 547

T2 = BC 557

IC1 = SN 76477 (Texas)

miscellaneous:

S4 = single pole switch

loudspeaker B Ω /0.2 W

wire links: B2, B3, B5, B6, B8

is a little lower in frequency and somewhat drawn out due to the longer time constants that are used for the attack, decay and one shot.

Steam train and whistle (figure 5)

Since the sound produced by a steam train consists mainly of white noise, this effect will present no problems to our IC. As soon as the on/off switch S4 is closed, an intermittent white noise signal will appear at the output. The rhythm of the signal will be determined

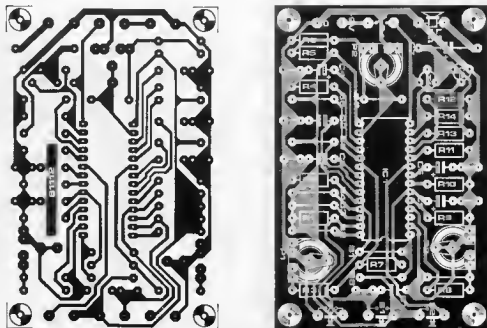

Figure 10. The printed circuit board has been designed to accommodate all of the circuits described. In each case any superfluous components can be omitted.

by the frequency of the SLF oscillator and the resulting sound will resemble a steam train (if any of you can remember what they used to sound like!) The speed of the train can be altered by adjusting the frequency of the SLF oscillator by means of potentiometer P1.

The whistle is generated by the VCO. When switch S3 is depressed the VCO is switched through to the output. The frequency of the whistle is determined by the values of R4, R5, R6 and C4. To be honest, the whistle sounds a lot less authentic than the steam train. Unfortunately, the only way to improve on it would be to include many more external components, which we feel would defeat the object of the exercise, this being to keep the circuit as simple as possible.

If this particular sound effect is to be used for a model railway, the frequency of the SLF oscillator should be directly related to the speed of the locomotive. This can be done by replacing potentiometer P1 with a light dependant resistor (LDR) which is optically coupled to a 6 V/50 mA lamp that is connected across the rails (with a 1 k preset potentiometer wired in series). When the voltage on the rails (speed) is increased, the lamp will burn brighter, so that the resistance of the LDR will drop and the frequency of the SLF oscillator will therefore rise (OED).

Aeroplane (figure 6)

Since an aeroplane makes a sound very

similar to that of a fast steam train, the circuit diagram is very much the same as that of figure 5. The only differences being that the SLF oscillator will have a much higher frequency and the VCO is not required, we have yet to hear an aircraft with a steam whistle!!

Racing car plus crash (figure 7)

The roar of the engine is provided by the VCO whose frequency is determined by potentiometer P2. Depressing switch S1 will interrupt the motion of the car with a shattering 'crash' effect. For this, capacitor C1 is fully charged and the attack/decay system is activated. During this period low frequency white noise is passed on to the output. When S1 is released the car (or its ghost!) will start up once more after the short delay required for C1 to discharge.

Dawn chorus (figure 8)

Again, this mainly involves the VCO and the SLF oscillator. The VCO is controlled by the negative going edge of the triangular waveform provided by the SLF oscillator. As a result, the signal produced will slowly drop in frequency. Nothing happens during the positive period of the triangle, so that there is a short break. The frequency of the VCO is determined by the setting of potentiometer P1.

Since the effect thus obtained is rather monotonous, the noise generator has been called in to help and R7...R9, P3 and C5 have been included. Poten-

tiometer P3 is adjusted so that the noise generator produces a low frequency output signal. Then the random sawtooth signal generated across C5 is fed to the frequency determining input of the SLF oscillator. This livens up the birds considerably.

The setting of P3 is quite critical, as it has to be turned very slowly and carefully until the dawn chorus becomes sufficiently lively. If required, the values of R8 and P3 can be altered to give a somewhat less critical control.

Construction

As mentioned previously, the various sound effects circuits require very few components (one IC and a handful of external components). Once these have been mounted on the printed circuit board (see figure 10), all that remains is to connect up a small loudspeaker and a battery - then the fun can begin!

The printed circuit board can be used for all of the circuits described in this article (and doubtless a few more besides). In each case it is simply fitted with the components indicated in the parts list. Any parts marked on the component overlay, but not mentioned in the particular parts list can be omitted.

For those of you who would like to do a little experimenting, figure 9 provides a general survey of all the components for which there is room on the board. This makes it a lot easier to 'translate' the circuit diagram in relation to the board and vice versa.

single chip colour decoder

Following last month's colour encoder, we now offer you a colour decoder based on the Plessey TDA 1365. This is a bipolar integrated circuit intended for use as a complete TV colour signal processor. Designed to decode PAL signals directly, it can be extended to decode SECAM signals with automatic standards switching. Additional information is available from the manufacturers for simplifying the minimum component circuit to demodulate the NTSC standard, adding a simple tint control, incorporating an on-screen display, and an alternative output stage for larger screen televisions which have Teletext or other on-screen display.

The TDA 1365, which is encapsulated in a 28-pin dual in-line, plastic package, contains all the circuitry required for luminance and chrominance signal processing with the facility of DC control of brightness, contrast, and colour, as well as the facility for fast data blanking and colour killer.

Figure 1 shows the internal block diagram and some relevant CRT pictures. Note that these pictures also apply to figure 3.

The application has few external components with minimal external adjustments (see figure 3). The circuit is supplied from a single 12 V supply with a low power dissipation.

The main advantage of using the Plessey TDA 1365 with Teletext

is its capability for fast data blanking. This data blanking at pin 2 of the device allows the Teletext 'mix with picture' to be used without the usual flaring of the characters. This is simply achieved by feeding pin 2 with the text information. This will open-circuit the TDA 1365 outputs in the character period so that the character and picture beam currents cannot add together. The flaring effect often seen with other on-screen displays is due to addition of these beam currents which causes incorrect focus of the characters.

Operation

The chroma signal is burst-gated to detect the peak amplitude of the burst. The detected voltage is used

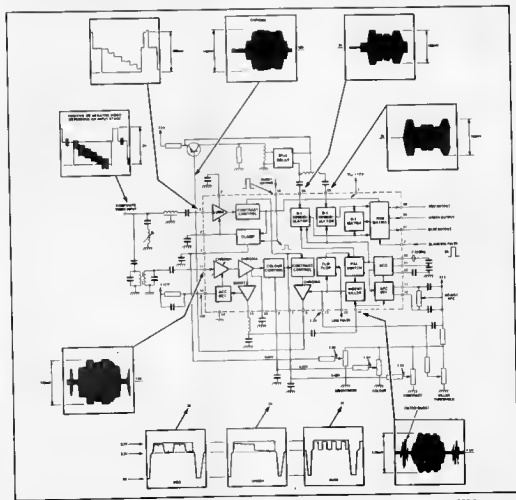

84038-1

Figure 1. Block diagram of the TOA 1365 showing voltages and signals.

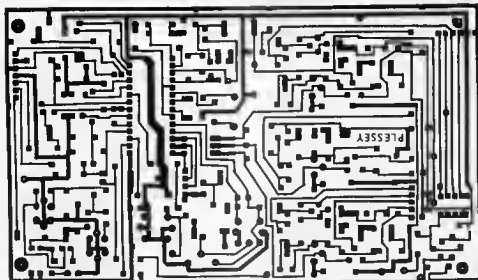
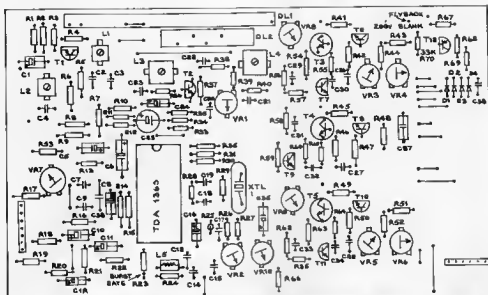

84038-2

Figure 2. The component and copper sides of the completed wiring board of the decoder. If Teletext is not required, omit R53 . . . R70, C29 . . . C36, VR7 . . . VR10, TB . . . T12, and D1 . . . D4.

as the automatic colour control (ACC) signal which permits the gain of the chroma amplifier on pin 9 to be maintained at optimum value. The gated burst is also taken from pin 15, delayed by an external inductor and fed back into the TDA 1365 on pin 16 to form the input of the subcarrier phase control. The colour burst synchronizes a phase-locked loop to the 4.4336 MHz

colour subcarrier frequency providing a reference phase for the demodulation process. The alternating phase of the burst signal is compared with the burstgate pulse, with the line flip-flop, PAL switch, and ident killer, this allows the ident phase to be corrected. A colour killer threshold voltage of 6.2 V at pin 13 ensures colour kill on a very noisy signal.

The blanking pulse input at pin 2 is used to blank the outputs in the line and frame flyback periods. As this is a fast blank input it can also be used with Teletext for character blanking. The chroma output at pin 9 is demodulated to the R, G, and B output signals. To produce the U and V signals an external transistor, T2, is used

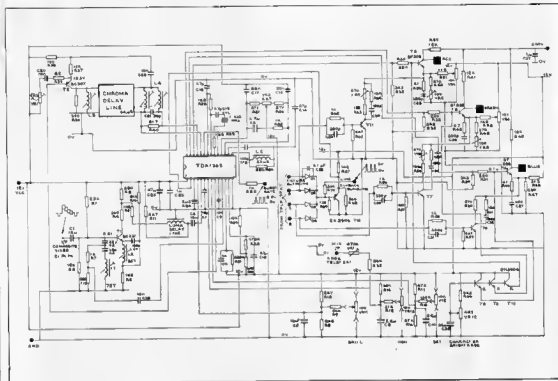

84058 3

Figure 3. Circuit diagram of the colour decoder with Teletext inputs.

Parts list

If Teletext is not required, omit R53 . . . R70, C29 . . . C36, VR7 . . . VR10, T6 . . . T12, and D1 . . . D4.

Resistors*

R1 = 22 k
 R2 = 680 Ω
 R3, R6, R29, R67 = 1k2
 R4, R68 = 560 Ω
 R5, R20 = 15 k
 R7, R23, R25, R56, R58, R62 = 1 k
 R8, R10, R66 = 8k2
 R9 = 56 k
 R11, R12, R40 = 2k7
 R13 = 820 Ω
 R14 = 68 k
 R15, R26, R27 = 27 k
 R16, R17 = 47 k
 R18 = 120 Ω
 R19 = 6k8
 R21 = 220 k

R22 = 470 k
 R24, R30, R31, R32 = 220 Ω
 R28 = 1k5
 R33, R34, R35 = 3k3
 R36 = 390 Ω
 R37, R38 = 150 Ω
 R39 = 82 Ω
 R41, R45, R49 = 12 k 4 W
 R42, R46, R50 = 47 Ω
 R43, R51, R69 = 1k8
 R44, R52, R60 = 270 Ω
 R47 = 330 Ω
 R48, R57, R59, R65 = 4k7
 R53 = 50 k
 R54, R63 = 180 Ω
 R55, R61, R64 = 10 Ω
 R70 = 33 k
 VR1 = 2k2
 VR2, VR10 = 4k7
 VR3, VR5 = 100 Ω
 VR4, VR6, VR11, VR12, VR13 = 10 k
 VR7 = 470 k
 VR8, VR9 = 470 Ω

Capacitors:

C1, C5, C6 = electrolytic
 10 μ/16 V
 C2 = 22 p
 C3 = 68 p
 C4, C30, C32, C34 = 180 p
 C7 = 18 p
 C8, C10, C35 = electrolytic
 2μ2
 C9, C20, C22, C38 = 10 n
 C11 = electrolytic
 1 μ/16 V
 C12 = electrolytic 470 n
 C13 = 100 p
 C14, C18, C19, C36 = 47 p
 C15, C17 = 22 n
 C16 = electrolytic
 4μ7
 C21 = 39 p
 C23 = 100 n
 C24 = electrolytic
 22 μ/16 V
 C25 = electrolytic
 47 μ/16 V

C26, C27, C28 = 680 p
 C29, C31, C33 = 330 p
 C37 = 100 n

Inductors:

L1 . . . L4 = see figure 3
 L5 = 33 μH

Semiconductors

T1 = 8C 237
 T2 = 8C 307
 T3, T4, T5 = 8F 258
 T6 . . . T11 = 2N3904
 T12 = 2N3906
 D1 . . . D4 = 1N4001

Miscellaneous:

XTL1 = 4.43 MHz
 Luma delay line = Valvo 817 V5 400/1
 Chroma delay line = Mullard DL700 SB451
 Colour decoder IC = Plessey TDA 1385

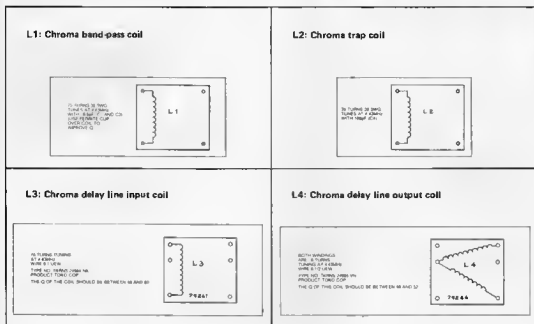

84038 4

Figure 4. Winding details for coils L1 . . . L4.

to drive a PAL delay line of 64 μ s. The delayed line (line N-1) is added to, and subtracted from, line N to produce 2 V and 2 U signals. These signals are fed to pins 24 and 25 which are the inputs to the R-Y and B-Y demodulators respectively. The G-Y signal is produced internally by adding together proportions of the R-Y and B-Y signals. The luma signal at pin 5 is fed through the contrast control and then black-level-clamped to produce a brightness control. This luma signal 'Y' is then added to the R-Y, B-Y, and G-Y signals to produce the R, B, and G outputs at pins 26, 27, and 28 respectively. The colour outputs are then amplified to over 80 V by three single common-emitter amplifiers, T3 . . . T5, and then fed to the TV tube to produce a clear colour picture. Pins 4, 7, and 8 provide controls for brightness, contrast, and colour respectively. They require only a small d.c. voltage (divided down from the user control pots) to provide a wide control range.

Alignment

Colour circuit.

- Set VR1 . . . VR13 to centre of range.
- Connect blanking and burst gate pulses.
- Apply a 2 V_{pp} composite video signal (negative-going sync pulses) to the video input.
- Adjust the chroma band-pass coil for maximum chrominance on pin 11. The burst amplitude at this point should be 150 mV_{pp}.
- Adjust the chroma trap coil for minimum chrominance on luminance at pin 5. The luma amplitude at this point should be 800 mV_{pp}.
- Short out R20 and connect a 470 nF capacitor from pin 16 to earth. Adjust the APC control, VR2, for 4.43 MHz at pin 20. Remove capacitor from pin 16.
- With the contrast and saturation at maximum, apply a 2 V_{pp} chroma subcarrier to the input of the circuit, and adjust L3 for maximum subcarrier at pin 25.
- With two $\times 10$ probes on pins 24 and 25, adjust VR1 for maximum on pin 25 and minimum on pin 24. The amplitude at pin 25 should be 200 mV.

- Adjust L4 for further minimum at pin 24.
- Remove short-circuit from R20 and re-apply composite video signal to input.
- Output stage.
 - Reduce contrast control VR11 to a low level and reduce saturation control VR12 to minimum. Adjust VR4 and VR6 until all tint is removed from picture.
 - Increase contrast (VR11) to a high level and adjust VR3 and VR5 to remove all tint. Set contrast, saturation, and brilliance as required. Teletext set-up.
 - Select Teletext clock cracker page.
 - Adjust VR10 until tinted text appears.
 - Adjust VR8 and VR9 until all tint is removed from text.
 - Adjust VR10 for optimum character brightness. Note, however, that if character brightness is set too high, flyback lines will be seen on picture.
 - Adjust VR7 for optimum reduction in contrast when the set is switched from TV to mixed picture. ■

TRANSDUCERS

Pulsecho Systems manufacture ultrasonic air transducers (Bimorph type) under the brand name 'Pulsair 40', stated to be available for the first time in the country. These air transducers operate at 40 KHz and find application in ultrasonic leak detectors, burglar alarms, level indicators/controllers, movement detectors, batch counters, door closers, package routers, remote controls of machines and equipment such as TV sets, etc.



For further information, write to
Pulsecho Systems
107, Nirma Industrial Estate
Near Sion For, Sion (East)
Bombay 400 022 (Tel: 47 1055/482087)

ILLUMINATED MAGNIFIER

Trans Marketing have recently introduced an illuminated magnifier, model TLM-1, with a precision 5" dia lens. It has an area magnification of X4 and is free from distortion over the entire work area. A 20-watt circular fluorescent lamp surrounding the lens gives a shadowless illuminated field. The magnifier is suitable for use in fine assembly work in electronics and light engineering industries and for close visual inspection.



More details can be had from
Trans Marketing Pvt. Ltd.
Sterling Centre,
16/2, Dr. Annie Besant Road
Bombay 400 018

SOLOERING STATION

An electronic temperature controlled soldering station, EHTCS, has been developed by Thermal Sensors, for micro electronic component soldering (LSI chips, MOS devices and other sensitive components). The soldering iron is a compact one (the heater and

temperature sensor assembly being housed in a 3.5 mm dia stainless steel tube); bit tip sizes range from 1.5 mm, 2.5 mm, 3.5 mm diameters to a maximum of 4.5 mm, the bits being the slip-on type. The iron operates at a nominal 15 watts but can draw up to 30 watts if the temperature control circuit finds it necessary.



For more information, contact
Thermal Sensors
37A, Electronics Complex, Kushaiguda
Hyderabad 500 762

DENSITOMETER

Electronics Instrumentation offer 'Intron' densitometer, designed to measure the optical density in black-and-white films. The device consists of a light source powered by a DC regulated power supply and a photocell or multi-dynode high sensitivity photo-multiplier as light detector. The detector is housed in the probe arm and shielded from ambient light. Optical density of the film can be obtained by inserting it between the light sources and the detector. The instrument has a density range of 0 to 4 and the least measurable density is 0.01.

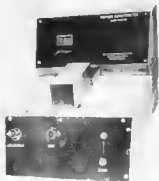

More details from
Electronics Instrumentation
11, Saparang, St. Anthony Street,
Kahle
Bombay 400 029 (Tel: 612 2004)

POWER SUPPLIES

Barathronics have designed regulated power supplies using 3-pin IC regulators, which are available in

various fixed voltage ranges. Specifications are: Line regulation $\pm 10\%$, load regulation ± 50 mV; output noise voltage - 40 mV, operating temperature - 25°C to 70°C, output current capacity - 1 A (max); output voltage ranges - ± 5 V, 6V, 9V, 12V, 15V, 18V, 24V.



For further details, write to
Barathronics
53, Temple Street, Malleswaram
Bangalore 560 003

INSULATING BRACKETS

Insulating 'L' brackets, offered by Instrument Control Devices, are moulded in high grade engineering plastic, and have many applications in electronics and electrical equipments. Suitable for mounting vertically PC boards, heat sinks, etc., they are available with plain holes type LP for fixing with No 4 self tapping screws and with tapped holes type LT for fixing with 6 BA screws.

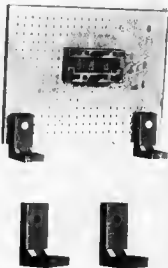

Further information can be obtained from
Instrument Control Devices
14, Manorama Niwas, Datar Colony,
Bhandup
Bombay 400 078

M. W. RECEIVER

Electronics Hobby Centre have introduced an MW band transistor set, working on two penlite cells. Moulded in non-breakable plastic, in a toy shape, it is available in ivory, red and yellow colours.



For further details, contact

Electronics Hobby Centre
F-37, Nanddham Industrial Estate, Marol
Bombay 400 059

CABLE GLAND

Novolux Cable Industries have come out with a cable gland made of thermoplastic, claimed to be inert to salt water, gasoline, common solvents, etc. Consisting of only four components, it does not have to be dismantled before use. The product has been tested by National Test House and can withstand temperature variations of -35°C to +100°C.

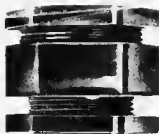

More details can be had from

Novolux Cable Industries
Post Box No. 9159
Calcutta 700 016

CONDUCTIVE MATERIAL

Elitacks Corporation have recently developed, for the first time in the country as claimed by them, a cermet conductive palladium-silver preparation, which they market under the name Elitacks 4335. It is a highly thixotropic paste with a viscosity of 400,000-500,000 CPS (Brookfield, model RVT, spindle No. 7, spindle speed, 10 RPM) at 25°C. Suitable in screen printing applications

of different types, it can be used as a general purpose conductor in thick-film hybrid microcircuits.

For further information, write to

Elitacks Corporation
C-314, Industrial Estate, Peenya
Bangalore 560 058

INFORMATION DISPLAY SYSTEM

Litek Engineers of Pune have introduced 'Advision', a video display unit providing continuous rolling display of messages stored in an Eprom. With 128 x 128 dot resolution, the frame display is of 8 lines, each of 16 characters. Total message storage capacity is 2000 lines (32000 characters). The sharp display steadily scrolls and rolls over at the end of the message. Scrolling speed is adjustable from 15 seconds to 450 seconds. Any TV receiver can be used as display terminal. New message can be filled in at nominal cost.

ADVISION
A New Medium
for
Advertisement
Ideal for show
in theaters &
other places...

For further details, contact

Intak Engineers
7, 8, Vr Bharat, New Timber Market
Pune 411 002 (Tel: 28722)

BIDIRECTIONAL PRINTER

Hi-Tek Electronics are to market a new printer manufactured by Sujata Data Products under the name SDP 80. This is an 80 CPS bidirectional logic seeking printer, offering both alphanumeric and graphic formats in 7 x 8 dot matrix, 228 ASCII character sets are offered with normal alphanumeric fonts, symbols, samigraphic and fanfold as well as single sheet. Normal printing size, 80 column per line, with compressed print of 142 column per line.

For details, contact

Hi-Tek Electronics Pvt. Ltd.
141, 'A' Wing, 14th Floor
Mittal Court, Neriman Point
Bombay 400 021

PORTABLE STRAIN INDICATOR

Measurements Group Inc. of U.S.A. have placed on the market a portable strain indicator, model P-3500, which provides direct reading of strain, pressure, torque, load and other engineering variables. Main features of

the device are: a 4 - 1/2 digit LCD readout, can be operated from either batteries or line voltage, includes a transducer connector with remote sense capability, as well as an analog output and built-in strain gauge bridge completion. The instrument is available to R & D laboratories under OGL and to other under AU import licence.



Further information can be had from

TM Stress Measurements &
Engineering Pvt. Ltd.
Sarking Centre,
16/2, Dr. Anna Bessel Road
Bombay 400 018

LEADLESS CHIP CARRIER

Jost's Engineering have come out with a ceramic single-layer leadless chip carrier (LLCC) which, according to the manufacturers, will contribute to higher packing densities and lower cost. The new pin frame from ITT Cannon is stated to be the economic and technical alternative to the surface and dip mounting of JEDEC Type C leadless chip carrier (LLCC) and printed circuits, featuring PCB layout advantages.

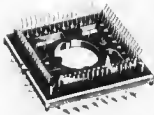

More information can be had from

Jost's Engineering Co. Ltd
60, Sir P.M. Road
Bombay 400 001 (Tel: 25 81 50)

INTRODUCING

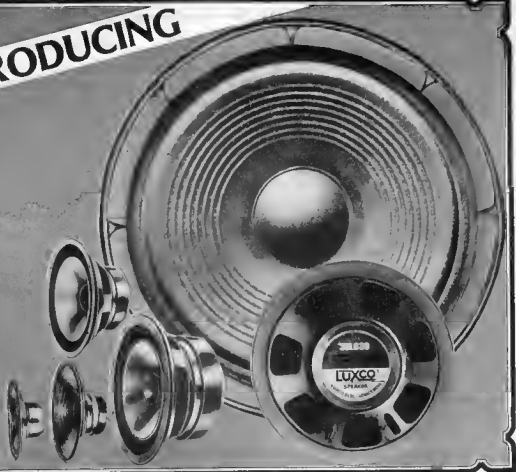

LUXCO[®]
LOUD SPEAKERS

**12" HI-FI
SPEAKER**

**Now Available -
High Performance
Woofers &
Full Frequency Range**

The new 12" speaker is yet another addition to Luxco's growing range of Hi FI speakers. This speaker will complement the existing high performance luxco tweeters and midranges very well.

Manufactured by: **LUXCO Electronics**, Allahabad, Telex : 540-286

Sole Selling Agent: **LUXMI & CO.** 56, Johnstonganj, Allahabad 211 003 Phone : 54041

Distributors for Gujarat & South India:

precious[®] Electronics Corporation

- 3, Chunam Lane, D. Bhadkamkar Marg, Bombay 400 007. Phone : 367459/369478
- 9, Athipattan Street, Mount Road, Madras 600 002. Phone : 842718

Distributors for Delhi & Haryana:

Railton Electronics Radio Place, Chandni Chowk, Delhi 110 006. Phone : 239944/233187

Wanted Stockists all over India

POPULAR

TESTICA T-3

ONLY



Rs.160/-

THE ONLY MULTIMETER
WITH
PROMPT SERVICE AFTER SALES
**ACCURATE! ROBUST!
ECONOMICAL!**

AVAILABLE AT ALL COMPONENT SHOPS

MANUFACTURERS:

**ELECTRICAL INSTRUMENT
LABORATORIES,**

339/68, RAJESH BUILDING, LAMINGTON ROAD,
BOMBAY-400 007. PHONE 36 07 49.

Dear Engineer,
Electronics is growing fast through
Manufacturing Industries, Research Labs or
Repair Shops where you need —
fast bonding adhesives and quick suction
Desoldering Pump.



Diamond DESOLDERING PUMP

Antistatic,
Guaranteed
swift suction,
Elegant finish,
Airtight packing,
Largest selling,
widely accepted,

**No Comparison
Desoldering Pump.**

ADHESIVE Thresal

- For countless applications in Electronic, Instrumentation Industries, Repairs Shops, Hobbyist
- Renders the fixtures vibration proof

DISTRIBUTORS:

- PRECIOUS ELECTRONICS CORPORATION
3, CHUNAM LANE, LAMINGTON ROAD, BOMBAY-7
9, ATHIPATTAN STREET, MOUNT ROAD, MADRAS-2
- SALES & AGENCIES P N BANK BUILDING,
3575 NETAJI SUBHASH MARG, NEW DELHI-2
- GENERAL RADIO CO. 8 MADAN STREET, CALCUTTA-72

Professional grade
electronic
components

*Choice of users
for over a
decade*

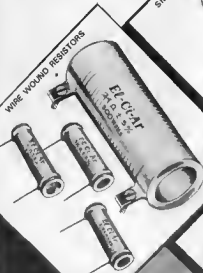

WIRES WOUND RESISTORS

SNUBBER CAPACITORS

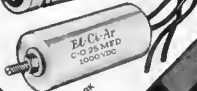

RC NETWORK

COMMUTATION CAPACITORS



FILM-FOIL CAPACITORS

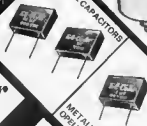

El-Ci-Ar

ELECTRONIC
COMPONENTS

PAPER CAPACITORS



MIXED DIELECTRIC
CAPACITORS



METALLIZED POLYPR.
DIENELENE CAPACITORS

Electro Components Co.
88 HADAPSAR INDUSTRIAL ESTATE, PUNE 411 013

TEL 70428-70914
CABLE EL-CI-AR

WAVETEK®

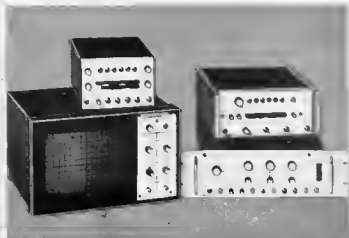

TV Test Instrumentation

- All world TV Standards
- Expanded Resolution of Traps
- Combination IF-Chroma-Sound
- Complete In-Plant Distribution
- UHF/VHF Programmables

Wavetek TV Instruments are available for TV alignment to all standards of the world. Specialized options for all units provide the ultimate in price-vs-performance for the production line, quality control and the engineering laboratory.



TECHNICAL TRADE LINKS

APLAB'S IMPORT REPRESENTATION GROUP
42 Navketan Indl. Estate, Mahakali Caves Road, Andheri (East),
Bombay - 400 093, India. Phone: 632 2412 Telex: 011 - 71426 XNTL IN,
011 - 71979 APEL IN

For further complete details call or write to:

TECHNICAL TRADE LINKS

'APLAB'S IMPORT TRADE REPRESENTATION.

Exclusive Agents in India
for WAVETEK INDIANA, INC.

Electric Powered Powercord Wire-Wrapping Tool

The Model OK-9 with its special reinforced Lexan® housing, is an attractive, powerful and easy-to-use tool. Its rugged motor and positive gear drive are designed for high production, long life and low maintenance.

The tool is also available incorporating a "Back Force" device to prevent over-wrapping which might otherwise occur with small wire diameters.

WIRE SIZE	22-32 AWG/0.65-0.2 mm
WEIGHT	10.5 oz./300 gm
SPEED	4,000 RPM ± 10%
POWER CORD	Two-wire, 9ft./3m

**AVAILABLE UNDER OGL
APPENDIX 2, SECTION 11
OF IMPORT POLICY 83/84**

CONTACT:

BALAJI ENGG. CO.

195, BRIGADE ROAD
BANGALORE-560001
PHONE: 52411

O.K. INDUSTRIES, INC.



OK-9

BRANCH:

BALAJI ENTERPRISES

B/15, Prasanth Apartment
Machine Tyre Road
Secunderabad-500 003 Phone: 77490

CONITIONS OF ACCEPTANCE OF CLASSIFIED ADVERTISEMENTS

1) Advertisements are accepted subject to the conditions appearing on our current rate card and on the express understanding that the Advertiser warrants that the advertisement does not contravene any trade act inforce in the country.

2) The Publishers reserve the right to refuse or withdraw any advertisement.

3) Although every care is taken, the Publishers shall not be liable for clerical or printer's errors or their consequences.

4) The Advertiser's full name and address must accompany each advertisement submitted.

The prepaid rate for classified advertisement is Rs. 2.00 per word (minimum 24 words). Semi Display panels of 3 cms by 1 column, Rs. 150.00 per panel. All cheques, money orders, etc. to be made payable to Elektor Electronics Pvt. Ltd. Advertisements, together with remittance, should be sent to The Classified Advertisement Manager. For outstation cheques please add Rs. 2.50

Electronics Tools like Soldering Irons, Pliers, Cutters, Screw Drivers, Tweezers at Competitive Prices. Contact Aradhna Electronics (P) Ltd., 10, Srinath Complex, Sarojinidevi Road, Secunderabad 500 003.

AUTOMATIC ELECTRIC LTD.	4.05
AGRONICS	4.10
APLAB	4 07, 4.73
BALAJI	4 67
COSMIC	4.76
DYNALOG	4.09
ELECTRO COMPONENTS	4 65
IEAP	4 65
INDUSTRIAL RADIO HOUSE	4.06
KELTRON	4.11 4.63 4.71
LUXCO	4.62
MARVEL PRODUCTS	4.06
PARVAIL	4.10
PRECIOUS	4.66, 4.70
SANKALP	4.06
SONODYME	4.02
TECHNICAL TRADE LINKS	4.67
TECHNOMATIC LTD.	4.75
TESTICA	4.65
VASAVI	4.70
WATTS	4.70
ZODIAC	4.10

missing link

Prelude (part 3)

(May 1983 - page 4-52)

In tone control circuit (figure 1 on page 4-53) the values of R16 and R16' are given erroneously as 6k Ω , as correctly shown in the parts list on page 4-54 these values should be 1 k.

digital cassette recorder

(February 1984 - page 1-29)

In the parts list on page 1-33 the values of four resistors are shown incorrectly: R11, R26, R29 should be 470 Ω ; NOT 470 k; R27 should be 330 Ω and NOT 330 k.

power controller for model railways

(December 1983, page 11-26)

The operation of the emergency brake is incorrectly described in this article. It should read 'The brake is operated by setting S2 to position 'stop' and opening S3 at the same time'. Also the transistors have not been listed in the parts list. They are T1, T2 = BC 547B, T3, T4 = 8D 679, T5, T6 = 8D 680.

Infocord No. 70

In the diagram two IC's are shown as 4013, this is wrong. Both the IC's are 4017

COSMIC

super hi-fi stereo speaker systems
for balanced sound and true reproduction

from 30 watts to 600 watts total power output.



COSMOX 1500

Components: 2 full range woofers, 16 cms., 1 tweeter.
*40-18,000 Hz
**30-40 Watts

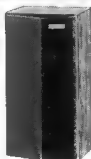

COSMOX 2500

Components: Enclosure infinite baffle, sealed, 1 acoustic-suspension woofer 16 cms., 1 acoustic-suspension midrange, 1 cone-type tweeter, with divided network,
*30-18,000 Hz.
**40-60 Watts



COSMOX 3500

Components: Enclosure infinite baffle, sealed, 1 acoustic-suspension woofer 20.32 cms., 1 acoustic-suspension mid-range, 1 tweeter, with divided network
*30-18,000 Hz.
**60-100 Watts.



MODEL JBL

Components: 1 full range woofer and mid-range combined, 20.5 cms., 1 tweeter, with divided network.
*30-20,000 Hz.
**60-200 Watts



COSMOX 4500

Components: Enclosure infinite baffle, sealed, 1 acoustic-suspension woofer 25 cms., 1 acoustic-suspension mid-range 16 cms., 1 tweeter, with divided network
*30-20,000 Hz.
**60-200 Watts.



COSMOX 5000

Components: Enclosure infinite baffle, sealed, 1 full range woofer and mid-range combined 25.4 cms., 1 tweeter, with divided network.
*20-20,000 Hz.
**100-200 Watts.



COSMOX 6000

Components: Enclosure infinite baffle, sealed, 1 acoustic-suspension woofer 30.5 cms., 2 mid-range, 1 tweeter, with divided network.
*20-20,000 Hz.
**200-300 Watts.

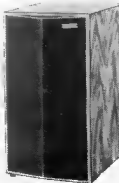

COSMOX 7000

Components: 1 full range woofer and 1 mid-range combined 30 cms., 1 dome tweeter
*20-20,000 Hz.
**200-600 Watts.

*Frequency Response Range ** Matching Amplifier Nominal Impedance 8 ohms.

International quality created for India by **COSMIC**