

106

March
1984

elektor

INDIA

Rs. 7.50

electronics

Elektor's King

NEW:
Chip Select
programmable
disco lights
mating CMOS
with TTL



Capacitance
Meter

From varicaps
to large
electrolytics



Suminda Singh

contents

Selektor	3-13
Future developments in the field of ICs.	
6502 tracer	3-16
A program to help understand or debug other programs.	
diesel tachometer	3-18
Operating from a timing signal supplied by the alternator, this rev counter can be used with diesel or petrol engines.	
programmable disco display lights	3-21
Designed primarily for use in a disco, this 32 program light display is also suitable for parties at home or for advertising purposes.	
video combiner	3-30
Based on a recently introduced IC, the TEA 1002, we offer a design which combines the various components of a video signal into a composite signal.	
digitester with a difference	3-32
By lowering the operating frequency of the circuit under test, this meter enables you to test digital circuits under operating conditions.	
reversing buzzer	3-34
A small circuit to help prevent you inadvertently shortening your car.	
memory timing	3-35
As a follow-up to last month's address decoding we now deal with the all-important control signals.	
matting logic families	3-38
We show you how CMOS and TTL devices can be used together in one circuit.	
capacitance meter	3-42
A relatively inexpensive meter to enable you to check capacitors from varcaps to large electrolytics.	
Basicode 2 for Junior plus VDU card	3-48
Many J.C. users will find this combination of Basicode 2 and the VDU card very interesting!	
constant voltage source	3-49
This cleverly thought-out circuit keeps the light intensity of a lamp substantially constant over the life of the battery.	
CS chip select	3-52
Some new, restyled, and up-dated ICs recently received by us, some of which may not yet be commercially available.	
video sync box	3-54
Unlike many similar designs, this one generates not only all sorts of video signals, but also an optional colour bar.	
automatic battery charger	3-57
Market	3-59
switchboard	3-65
missing link	3-72
EPS service	3-72
advertisers index	3-74



A new look for our cover this month which does not, however, mean a new look inside. We will continue to offer you in each issue a host of practical projects chosen from across the whole spectrum of electronics interspersed with articles of a less practical, but none the less interesting, nature in the field of electronics. Above all, we will continue to endeavour to keep up the high standards that readers of Elektor India have come to expect.

Also new this month is the capacitance meter illustrated. This is the first in a range of test instruments which we will publish at (hopefully) regular intervals. All instruments in this range are designed to fit the same family of standard cases and, as our cover shows, they even look quite handsome! We also start a new section this month: 'Chip Select'. This section will be published at irregular intervals, alternating with 'Applicator', and is intended to bring to your attention new or improved ICs which have recently been supplied to us by manufacturers or distributors.

A selection from next month's issue:

- real-time analyser
- UHF quartz modulator
- tape contents controller
- electronic labyrinth
- triac control board
- petrol saver

MICROFRIEND

choosing the right friend makes all the difference

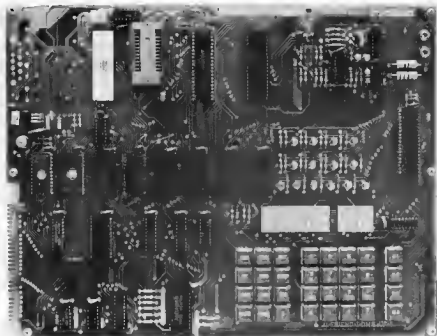

Two people become friends because they sense in each other a strength and trust that can help them both

In today's jostling realm of microprocessors, we at DMS offer our customers a serious and courteous friendship that stands the test of time.

Take for example, our MICROFRIEND series μ P trainer system an ideal combination of friendly firmware & Hardware, designed not only to work for you but with you. All the way. Like a friend should.

As an ideal μ P training system, our 'MICROFRIEND' based on 8085A & Z 80A are the only trainers available today in the market offering lot of outstanding features incorporated on single board like PROM Programmer, RS232C I/F, STD Bus, 46 I/O lines, Audio Cassette I/F backed-up by 4K Powerful system Monitor, 2K CMOS User RAM and onboard expansion with 6 more 24 Pin sockets using 2716/6116 or 2732 & many more.

If 16 bit trainer is your requirement, you are just in time. Our MICROFRIEND 86 is now ready to roll into the market with the advanced performance and highly innovative features you've been expecting from DMS.

Our creativity in μ P based products has set the pace in the industry from the start

If, in this every-man-for-himself business environment, our 'MICROFRIEND' sounds too good to be true, try him. Your friend in the realm of microprocessors.

Write or call now for complete information.

DMS

**Dynalog
Micro-Systems**

Head Office.

14, Hanuman Terrace, Lamington Road, Bombay 400 007
Tel.: 36 24 21 Gram: ELMADEVICE Telex: 11-5614

Factory:

17 A/2, Karve Road, 30, Prasad Chambers, Pune 411 004.
Tel.: 35983 Gram: ELMADEVICE Telex: 0145-505-ELMA

Bangalore:

15, Hotel Kamadhenu Annexe, Trinity Circle,
M. G. Road, Bangalore: 560 008

Marching along the trail in μ P based technology.

INTIMATE FRIENDS OF AN ELECTRONIC ENGINEER

Diamond
DESOLDERING
PUMP

ADHESIVE

Thre Seal



ANTI-STATIC
GUARANTEED
SWIFT SUCTION
ELEGANT FINISH
ATTRACTIVE PACKING
LARGEST SELLING
WIDELY ACCEPTED
NO COMPRESSOR
DESOLDERING PUMP

TRUSTED ADHESIVE
FOR COUNTLESS
APPLICATIONS IN
ELECTRONIC
INSTRUMENTATION
INDUSTRIES
REPAIRS, SHOPS
RESEARCH LABS AND
TECHNICAL INSTITUTES
RENDERS THE FUTURE'S
VIBRATION PROOF
AVAILABLE IN
TUBES, TINS & DRUMS

DISTRIBUTORS

PRECIOUS ELECTRONICS CORPORATION
1 CHINAM LANE, LAMINGTON ROAD, BOMBAY 400 007
PHONE: 36748, 36847/8 GRAM DEEPTILAMP (GURGAON BOMBAY)
9 ATHIPATTAN STREET, MOUNT ROAD, MADRAS 600 002
PHONE: 84271/9 GRAM DEEPTILAMP (MADRAS 600 062)

GRACE/0271

FOR ACTIVE ELECTRONIC COMPONENTS

- | | |
|------------------------|---|
| RECTIFIERS | • Ordinary And Fast Recovery |
| DIODES | • Low And High Power |
| ZENERS | • Voltage Regulator And Reference |
| THYRISTORS | • Ordinary (Converter) Fast Switching (Inverter) |
| TRIACS | • Plastic And Metal (High And Low Power) |
| DIACS | • Glass And Epoxy |
| TRANSISTORS | • Power, Small Signal, Switching, Darlington
• F.E.T.S And U. J.T.'S |
| RELAYS | • A/C-D/C Industrial And General |
| TRIMPOTS | • Low Ohms To High Megh Ohms |
| HELIPOTS | • Lin. 1 TO 25, Vol 1% To 5% |
| VARIABLE
CAPACITORS | • Axial And Radial |

Authorized Stockists For

PHILIPS, MELTRON, NAYAR ELECTRONICS,
EGL & HINDUSTAN

PARVAIL
ENTERPRISES

7, KAMAT BUILDING, SHAMRAO VITHAL MARG,
LAMINGTON ROAD, BOMBAY-400 007,
TELE-385135, 367601.

IMPORTANT

SUBSCRIPTION RENEWALS ARE ON!
HAVE YOU RENEWED YOURS?

Rates are still the same :

- 1 One year
Rs. 75-00

- 2 Two years
Rs. 140-00

- 3 Three years
Rs. 200-00

Remember :

- To use the card in this issue
- To quote your subscription number
- To mention that it is a renewal
- To send your renewal at least one month in advance
- Timely renewal ensures continuous receipt of issues without irritating breaks

elektor
electronics



From ECIL India's first miniature metal film resistor at an amazingly low price

ECIL now claims another first by introducing the lowest priced resin coated metal film resistors. Though inexpensive, these unmounted resistors meet the most stringent industrial and defence requirements. Customers will also be happy to know that the E-24 series is available ex-stock.

Specifications

Value range	: 100 to 1 meg ohm
Standard values	: E-24 and E-96 series
TCR	: 200 and 100 ppm/ $^{\circ}$ C
Power rating	: 0.25 W at 70 $^{\circ}$ C
Size	: 6.5 x 2.3 mm
Stability	: 1%

For further enquiries contact:



Electronics Corporation of India Limited

(A Govt. of India Enterprise)

Passive Components Marketing,

ECIL Post, HYDERABAD : 500 762

Phone: 852231 -258, 852569 Telex. 0155-254 Grams: ECIL HD

FDSECL12382

NOW
THE LATEST BOOKS-KITS
ARE AVAILABLE WITH US

DATA BOOKS :

signetics

SEMICONDUCTORS

TEXAS INSTRUMENTS
INCORPORATED



NATIONAL

RCA

INTERSIL

MOTOROLA
CMOS for computers etc.

FAIRCHILD

ON I.C.'S, TRANSISTORS, TRIACS,
SCR'S, DIODES, DPTO-OEVICES
KITS :

EDUCATIONAL, HOBBY,
ENTERTAINMENT, AUDIO, VIDEO,
CLOCKS

PLEASE WRITE FOR DETAILS

ELTEK
BOOKS-N-KITS
6, RITCHIE STREET, 1ST FLOOR,
MOUNT ROAD, MADRAS- 600 002

eltek

CALONIX
PROFESSIONAL GRADE
MINIATURE SWITCHES

1. TOGGLE
2. ROCKER
3. LEVER

**TESTED &
APPROVED**

LIFE GUARANTEED
AMERICAN KNOW HOW
JSS 51201 SPECIFICATION



Marketing & Exports Dept

CALONIX ELECTRONICS PVT. LTD.

Office: 79, NAGINDAS MASTER ROAD, 1ST FLOOR,
FORT, BOMBAY-400 023. PHDNE: 273274-274651.

FACT.: B66'4, G.I.D.C. IND. ESTATE, MAKARPURA,
BARDDA 390 010.

DEALERS TO BE APPOINTED.

WE ARE ALSO REPRESENTATIVES FOR QUALITY ROTARY SWITCHES

MANUFACTURED BY

COLE INSTRUMENTS CORPN. U.S.A.

IMPORTS AGAINST 'AU' LICENCE

ZETA PLOTTERS

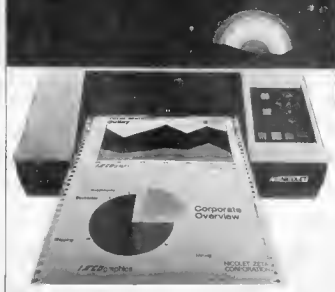

**AN 8 COLOR
PEN PLOTTER
WITH THE
SPEED AND
PRECISION OF
FAR COSTLIER
MACHINES.**

SALIENT FEATURES :

1. High performance plotters with built in intelligence.
2. Fast Plot turn around with no time outs.
3. Vivid, multicolour business graphics.
4. Scientific and engineering photo without pear
5. Eight colour, carriage - mounted pens, eliminate time - consuming pen changes.
6. Supported by the leaders of the software industry.
7. The most flexible 'D' format 8-pen plotter ever
8. Plotters as sophisticated as the computers, they are designed to support.
9. A plotter anyone can operate.
10. The plotter everyone will want to use.

From

Nicolet



TECHNICAL TRADE LINKS

APLAB'S IMPORT REPRESENTATION GROUP

42, Navketan Industrial Estate, Mahabai Caves Road, Andheri (East), Bombay 400 093 Phone 632 2412, Telex 011 71426 XNLT IN, 011 - 71979 AP&L IN

Multiple Choice Test from Philips

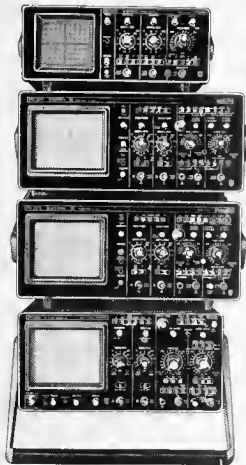

Now you have a wider choice in Philips oscilloscopes, so you can better tailor the scope to your application.

Need a 15 MHz/Single time base scope? Choose the PM 3226. A 50 MHz with delayed time base? Choose the PM 3217.

The new 35 MHz scope PM 3218 has a delayed time base, maximum sweep of 10 ns/div. and a trigger hold-off facility that eliminates double triggering on digital signals, making it unnecessary to use the time base in the uncalibrated mode.

The PM 3262, 100 MHz dual trace oscilloscope not only permits the display of high speed current mode logic signals but due to its extensive features, it permits you to take measurements in any electronics environment.

Now, more than ever, we want to make your next scope. And your next digital & analog multimeter. And your Timer/Counter System. We are going to give a wider multiple choice to make your selection even easier.

For more information contact:

Philips India

Test & Measuring Instruments Division
Plot 80, Ghosari Industrial Estate
PUNE 411 026



Test & Measuring
Instruments

PHILIPS

Philips — the trusted Indian household name for over fifty years.

CBM/8700 R-2

COLOUR TV AWARD

The Electronic Component Industries Association (ELCINA) has announced a new award this year for the best Indian designed colour television set with the maximum indigenous content. The winning design team will be awarded a first prize of Rs. 25000-00 and the firm supporting and funding the project will receive a trophy. There is also a second prize of Rs. 10000-00. Last date for receipt of entries is 30th April 1984. The Association's other annual awards are for R & D, import substitution, export promotion in the field of electronic components and indigenising of capital goods for the manufacture of electronic components (Inclusiva of in-house efforts). Since last year these awards have been thrown open to non-members also; last date for receipt of entries is 1st March 1984.

Distribution ceremony of the awards for 1983 will be held in the last week of March 1984. The address of the Association is:

Electronic Component Industries Association
408, Sahyog, 58, Nahru Plaza
New Delhi 110019.
Tel. 681397; cable: ELCINA

INDO-JAPANESE DICTATION SYSTEMS

Sony Corporation of Japan has joined hands with World Business Machines of New Delhi, to introduce microcassette dictation systems into the country. The systems, which are to be marketed under the brand name 'World Memo 120', include an IC-controlled dictation machine and a speed adjustable microcassette scribe. According to Mr D.S. Sahaney of the Indian company, the systems will be the first in the country to have additional operation features like 'pause, quick arasa and fast forward'. The technical arrangement with Sony will allow the Indian company to import the latest microcassette technology from Japan.

ONGC USES INSAT-1B

Oil & Natural Gas Commission has started making use of its satellite earth stations at Uran and Bombay High for data communication through INSAT-1B. The earth stations were set up jointly by the Post & Telegraph Dept., and the Radar & Communication Project Office (R/PCO) of the Ministry of Defence which is executing project TITAN for ONGC. With the

establishment of the link of the TITAN project, the activities of the BHN platforms and the BHS platforms are being monitored by the Uran field control centre. A computer installed at the Bombay High South (BHS) platform acquires telemetry data relating to oil and gas extraction and production in the BHS complex. This data is passed through a microwave link to BHN platform from there through INSAT 1B to Uran and finally through a UHF link to the Bombay Offshore project headquarters in South Bombay.

EDS SYSTEM AGREEMENT SIGNED

The Union Government has signed an agreement with CIT-Alcatel, a French public company, for setting up factories to manufacture five lakh units of electronic digital switching (EDS) system in a year to improve the telecom network in the country. At a recent press conference, Mr V.N. Gadgil, Union minister of state for communications, said that one of the factories would be set up in Bangalore and the other in Gonda in U.P., and expressed the hope that production in both the factories would commence within one and a half years.

PRIORITY FOR ELECTRONICS

Keeping in view the immense growth possibilities of the electronic industry in the country, the Union Government is to accord top priority for the development of its infrastructure. Its export performance too was such as to create sanguine expectations for the future. Commenting on these trends, Dr. M.S. Sanjeev Rao, Union deputy minister for electronics, told a recent seminar, on electronics held in Ahmedabad, that the potentialities of exports of electronic goods and systems were inexhaustible. In 1982, the country exported electronic goods worth Rs. 89 crores; experts opine that it could be three times more in 1983. The rate of the industry's growth too has been phenomenal. Starting with a total production of Rs. 65 crores in 1965, it went up to Rs. 365 crores in 1975, Rs. 802 crores in 1980 and reached Rs. 1306 crores in 1982. The growth is likely to gain further momentum, especially in view of the government's decision to extend TV coverage facilities to more than 70 per cent of the country's population in 1984/85, from the present

coverage of only 30 per cent population, by setting up 140 new transmitters and linking them through INSAT satellite. To cope with the problems arising out of the sudden spurt of growth, the government will lay a firm foundation for this infant industry by way of indigenous production facilities of basic chemicals, components and other raw materials, besides providing large industrial estates in the states. Further, it has plans to support long-range research programmes both in universities and institutes of technology, and also set up three major computer-aided electronics design institutes for application of chips and developing circuit designs.

IMPACT OF CONCESSIONS

The fiscal concessions given to the electronic industry by the Government in August last year have started showing encouraging results in that price reductions ranging between 10 to 35 per cent in components have been affected. Items of which prices are reduced are picture tubes, semi-conductor devices, magnetic sound heads, plastic film capacitors, etc. These price reductions have, in turn, resulted in appreciable reduction in the prices of certain end products like B/W TV sets, cassette recorders, stereo decks, etc.

Among the companies which have reduced prices of their products are Talatube Electronics Pvt. Ltd (picture tubes), Bharat Electronics Ltd. (picture tubes, germanium transistors, silicon signals), Paico Electronics & Electricals India Ltd. (transistor sets, cassette recorders, speaker systems, components, etc.).

SOFTWARE CENTRE

Hindustan Computers Ltd. (HCL) has established an advance software development centre in Madras, so as to provide complete software and training support to its customers. Equipped with four computers, the centre has pioneered the use of computers to generate other computer programmes. A special team of Indian experts is responsible for this breakthrough in software technology. The centre provides training in computer operations and languages to users, tests hardware and software items prior to their introduction in the field and develops special programming packages to suit particular industries.

future developments in ICs

Industrial developments are governed by economic feasibility on the one hand and physical possibilities on the other. This is no exception in the IC industry. As yet, there are no fundamental limits, as far as physics is concerned, to further reductions in the size of ICs. It follows that, for the time being at least, development in the field of ICs is governed totally by economic aspects.

Four cost factors play a role in determining the price of ICs: those of the crystal, development, testing, and packaging. At this time these four are about equal. There is, however, a tendency for development costs to take a larger share of the total, unless special attention is paid to this.

With no natural limits in sight (as yet), new methods to produce smaller structures are found continually. This is well illustrated by the development of substrates which can be processed, and the width of the tracks which can be realized on them. The diameter of substrates has grown in steps: it is already clear that processing of 6 in (15 cm) crystals is physically possible. The tracks industry can produce are getting narrower and narrower. In the early 1960s track-widths were of the order of 100 μm . Present-day techniques allow widths of 4...2 μm to be realized (figure 1).

The tendency towards larger substrates and narrower tracks means, of course, a sharp increase in the capital cost of manufacturing tools. The equipment required for the production of 20 000 chips per month cost between £3m and £4m in 1980; by 1990 those figures will have trebled. But by then, the chips will be larger and more complex and therefore worth more.

Complexity

The factor which has the greatest effect on costs is the component density: the number of components which can be housed on a single crystal. As the track-width is reduced by 10 per cent each year, the surface area of a transistor decreases by 20 per cent per year. Because the individual connections will occupy relatively more space, the average component density rises less rapidly than one would expect from these figures: about 15 per cent per year. On the other hand it is possible to produce larger chips with a satisfactory turn-over.

Each year the producible chip area

1

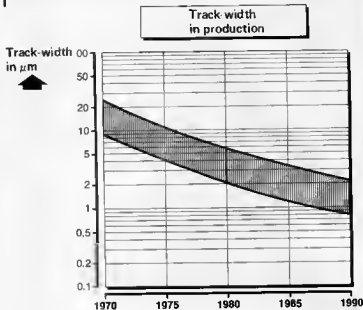

2

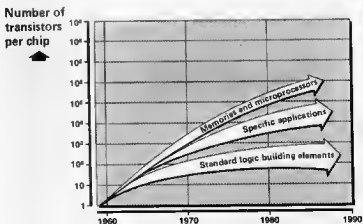

increases by about twenty per cent, which means that in principle the complexity of the designs can increase by 37 per cent. This possibility is fully utilized in certain sectors, such as memories. There is no reason why ever larger building elements should not be used in the construction of memories. In many other applications it is not so simple. With increasing complexity, a building element

becomes more and more specific and it therefore becomes harder to find units in equipment which have enough applications in common to guarantee sufficiently large production runs (figure 2). It is for that reason that in practice the average complexity of newly introduced building elements increases by only twenty per cent per year (figure 3).

Miscellaneous cost considerations

The increasing component density will also be a factor in the cost of testing a transistor. The complexity of ICs can become so great that it becomes extremely difficult to test individual transistors. The result may be an explosion in the cost of testing. This problem is tackled in several ways: by modifying test strategy, by making more allowance for testing during the design stages, and by introducing special test circuits onto the chips. The last two measures generally mean that test costs are exchanged for higher crystal costs. It is expected, however, that by adopting these measures the cost of testing will not rise, and may actually show a slight fall.

The price of packaging is virtually constant. As the contents of the chip become more complex, the number of pins will inevitably increase which means a rise in costs. Intrinsic material costs will, of course, rise as well. However, automation of the packaging processes in manufacture can compensate completely for these cost increases. All the same, the apportioned cost of the package in the price per transistor will decrease by about twenty per cent per year, because the number of transistors per package increases.

Summary

Undoubtedly there are many challenging tasks in store for the researchers. It would be regrettable, if only from the point of view of available resources, if national governments in Europe would engender local, subsidized IC industries which would all develop similar products. In this field also, European co-operation is of the utmost importance.

Extract from Philips press notice

3

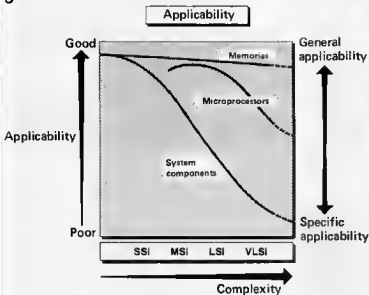

Cost reductions

The required area per transistor, including connections, is reduced by about 13 per cent per year. In spite of the higher capital costs mentioned earlier, the production costs per unit of area fell by about ten per cent per year. This is because larger substrates are being used. The combination of these two factors means that the cost of the transistor itself drops by around twenty per cent per year. The other cost factors should show a similar tendency.

What's being done

The problem is attacked in two ways: firstly, by increasing the productivity of designers and, secondly, by aiming at an increase in production per design. The latter means that more effort is required towards standardization and the use of universal components instead of specific ones.

Design productivity can be increased in various ways: in the first instance by the use of Computer Aided Design (CAD) in which the computer is used in practically all phases of the design process.

Planning

Furthermore, by changes in the design planning. In principle, the IC designer has a large degree of freedom in virtually every detail of the design. Making profitable use of

this freedom takes time, however. Limiting the possibilities of the design increases efficiency, but will, of course, often mean that the design is realized at a higher abstract level.

Freedom in the design can be further limited by planning a chip on the basis of a pattern of a large number of standard basic functions, where the designer can only determine which circuits are connected and how.

On the other hand, it is necessary that the productivity of the designer increases. Greater complexity renders the designs more and more specific to certain applications. This results in a larger need for diversity: in other words, a growing number of more complex circuits will have to be designed.

Designs

It is to be expected that the design community — which is independent of the IC producers — will grow rapidly. Design firms will come into being to design ICs which can be produced simultaneously by a number of manufacturers. If, for instance, the design task is the development of a new family of ICs, the complexity may be such that in practice it cannot be realized by a single company in an acceptable period of time. Joint developments by a number of companies will therefore become commonplace.

Being able to see what a processor does as it runs a machine code program is a great aid in understanding the program, in fault finding, in testing, and in fact in everything a programmer does when developing some new software. The program given here makes it possible to do this automatically. At each step the contents of the CPU registers, the stack and its pointer are displayed for the corresponding instruction.

J. Ruppert

6502 tracer

program
analysis
software for
Junior
Computer and
other
6502-based
systems

This program is aimed not only at users of the Junior Computer but also at the owners of any 6502-based system. It occupies about 1/4 K of memory and uses two bytes in page zero. Very few changes are needed to adapt it to a system other than the Junior.

How is it used?

The program operates as a sort of 'step by step monitor'. This means in effect that any program the user wishes to analyse, or debug, is executed instruction by instruction with the contents of registers A, X, and Y, the status register flags (NV DIZC)

and the stack pointer being displayed each time. It is notable from the list of flags (NV DIZC) that the 'break' flag is not included; the reason is that the '6502 TRACER' program accepts all instructions except those which are the result of, or which result in, an interrupt (BRK, IRQ and NMI).

As table 3 shows, it is much easier to analyse a program (the example here contains a lot of register and flag manipulations) with the aid of the information displayed by the tracer program in the three right hand columns. The first, at the extreme right, refers to the stack: \$FF is the least significant byte of the pointer (the most significant byte is \$01). Near the end of the listing there are a few addresses stacked during JSR or RTS instructions. The next column gives the logic levels of the status register flags NV DIZC. Finally, beside this the contents of the A, X, Y and processor registers are to be found. The step by step tracing of the program in these columns is followed in the first two columns by the disassembled listing of the addresses and instructions. The fact that all jumps and branches are included explains why the program returns from address \$020D (DO/FA) to address \$0209 but the Z flag remains low.

Table 1. 6502 TRACER is an analysis program that must run in RAM, but there is nothing to stop you from storing it in some other kind of memory and simply transferring it to RAM to run it.

table 1

JUNIOR																
M																
HEXDUMP: 500,721																
#	1	2	3	4	5	6	7	8	9	A	B	C	D	E	F	
#500:	58	28	95	86	A9	80	A8	8F	99	13	87	48	D8	FA	09	CC
#510:	86	28	A5	86	C8	C8	36	D8	F5	A9	26	8D	7E	1A	A9	85
#520:	8D	7E	1A	4C	A2	85	6D	17	67	8D	28	87	68	68	8C	
#530:	1C	87	8E	1D	07	8A	8E	1A	07	D8	58	A8	83	89	15	87
#540:	28	A8	86	28	A3	86	C8	C8	86	08	11	AD	16	87	D8	89
#550:	28	A3	86	28	A3	86	4C	43	85	CE	16	87	C8	89	D8	DD
#560:	AD	28	87	29	CF	8D	13	87	A2	8E	8E	13	87	98	84	A9
#570:	31	D8	92	A9	2E	28	A5	86	CA	D8	EF	28	A3	86	AD	14
#580:	87	28	A6	86	A9	2D	28	A5	86	8A	E8	FF	88	14	68	8D
#590:	16	87	28	A8	86	E8	FE	48	85	68	46	28	A8	86	AD	16
#5A0:	87	48	A8	88	28	95	86	A5	EE	28	A8	86	A5	ED	28	A8
#5B0:	86	28	A3	86	61	ED	8C	1A	86	8C	18	86	8C	1A	87	8C
#5C0:	19	87	28	A8	86	8C	1E	87	98	8D	16	87	CE	16	87	88
#5D0:	81	ED	99	19	66	99	18	87	98	D8	F4	E6	ED	D8	82	E6
#5E0:	EE	CE	1E	87	D8	F5	AD	16	87	29	8F	D8	13	AD	18	87
#5F0:	C9	28	F8	29	C9	48	F8	2E	C9	68	F8	2E	29	18	D8	62
#600:	AD	18	87	C9	4C	F8	2C	C9	6C	F8	3D	A6	1D	87	AC	1C
#610:	87	AD	28	87	48	AD	18	87	28	D8	88	88	88	A5	ED	48
#620:	A5	EE	46	4C	33	86	68	8D	28	87	68	85	EE	68	85	ED
#630:	4C	3D	86	AD	1A	86	85	ED	AD	16	86	85	EE	A9	86	ED
#640:	19	86	28	9A	86	4C	86	46	AD	1A	86	85	ED	AD	18	86
#650:	85	EE	A8	88	61	ED	AA	C8	61	ED	85	EE	8A	85	ED	4C
#660:	3D	86	AD	28	87	48	AD	18	87	8D	68	86	28	D8	83	4C
#670:	82	46	58	D8	AD	1A	86	38	11	18	65	ED	85	ED	98	82
#680:	E6	EE	A9	88	8D	1A	86	4C	88	86	18	65	ED	85	ED	88
#690:	F1	C6	EE	94	3D	A9	8D	28	A5	85	A9	8A	28	A5	86	68
#6A0:	4C	8F	12	A3	28	4C	34	13	A8	81	C9	88	F8	1A	C9	88
#6B0:	F8	16	C9	68	F8	12	A8	83	C9	28	F8	6C	29	1F	C9	19
#6C0:	F8	86	29	8F	AA	8C	93	87	8C	21	E7	68	36	35	38	32
#6D0:	28	2D	28	54	52	41	43	45	52	8D	8A	41	44	52	2E	28
#6E0:	2D	49	4E	53	54	52	2E	2D	28	3A	41	29	3A	59	28	3A
#6F0:	58	28	4E	56	31	31	44	49	5A	43	28	53	54	41	43	48
#700:	28	8D	8A	82	82	81	82	82	82	82	81	81	82	81	81	83
#710:	83	83	83	83	83	83	83	83	83	83	83	83	83	83	83	83
#720:	31	82														

How does it work?

The length of this article does not give us the scope to provide a complete source listing of this tracer program, so we will have to be content with the hex dump shown in table 1. It is, however, quite important to have some pointers about how to use the software.

Before a run the start address of the program to be tested must be stored at addresses \$00ED and \$00EE which act as a pseudo program counter. The program under test may be in back-up memory but the tracer program must be in RAM: as shown here it starts at address \$0506. Between addresses \$0500 and \$0523

several buffer bytes acting as a pseudo stack that starts at \$0713 (we will return to this later) are initialized, the column headings are displayed and the IRQ vector is positioned (the IRQ routine begins at address \$0526).

The tracing program starts at \$05A2, by displaying the program counter address, loading the op-code, filling the op-field with 00s, and calculating the length of the instruction (the routine used begins at \$06A8 and is quite similar to the LENACC routine in the Junior Computer). The op-field is a four-byte zone (\$0619...\$061C) where the analysis program places in turn each of the instructions of the program under test in order to execute them. As these instructions never contain more than three bytes they are always followed by at least one 00 and this functions as a BRK. Immediately after executing an instruction of the program under test, therefore, this BRK causes the IRQ routine at \$0526 to be run.

The pseudo program counter (\$00ED and \$00EE) is incremented at \$05DB. This incrementation depends on the format of the preceding instruction, with the number of bytes making up the instruction being stored in address \$071E. Any jump instructions in the program must be filtered out to be dealt with separately and this begins at \$05E6. From \$060B onwards stacking of registers A, X and Y for the program under test starts. The op-field, located at \$0619, contains the instruction to be analysed and because every instruction is always followed by at least one BRK it is also followed immediately by the IRQ routine. As could be expected, this begins by storing the conditions of the processor registers. Then it displays their contents and proceeds to the next instruction.

The special instructions for executing jump commands are located at \$061D. The addresses for relative jumps are calculated at \$0672 and \$068A. The addresses of the Junior Computer's PREBT and PRCHA routines are contained in \$06A1, \$06A2, \$06A6 and \$06A7, so these must be changed if the program is to be used with a different 6502 system.

The commands for printing the headings of the columns are at \$06CC to \$0702. The format of each instruction that is to be run is determined by comparing it to the values contained in the look-up table located from \$0703 to \$0712. There are a number of buffers between \$0713 and \$0721 that are used by the tracer program to store the stack pointer, the contents of the top of the stack, the op-code under test, the number of bytes in the instruction, and so on...

These were the most important points about this program and the rest is easily deciphered with the aid of a disassembler.

table 2

JUNIOR

M

HEXDUMP: 200,23A

```

# 1 2 3 4 5 6 7 8 9 A B C D E F
0200: A9 03 A8 AA A9 09 85 00 FF 18 65 62 CA DF FA 2A
0210: 6A 38 E5 00 88 D8 FA E5 00 D8 F8 00 F6 26 F0 02
0220: F0 04 F8 FC F0 F8 20 38 02 38 EA AC 45 02 02 EA
0230: 20 34 02 60 60 4C 00 03 4C 00 02

```

JUNIOR

M

HEXDUMP: 2F0,30F

```

# 1 2 3 4 5 6 7 8 9 A B C D E F
02F0: 00 00 00 00 00 00 00 00 00 00 00 00 00 00 00 00
0300: B0 FC B8 F8 6C 07 03 00 02 00 00 00 00 00 00
0310:

```

table 3

ED

\$00ED 27 00.

\$00EE 09 02.

\$00EF 1C 500

\$500 50 R

\$502 - TRACER

ADR.	-INSTR.	1A	1Y	1X	1W	1D1Z	1ZC	STACK
\$200	A9 03	03	00	00	00	00	00	FF-
\$202	A9	03	03	00	00	00	00	FF-
\$203	AA	03	03	03	00	00	00	FF-
\$204	A9 09	09	03	03	00	00	00	FF-
\$206	05 00	09	03	03	00	00	00	FF-
\$208	F8	09	03	03	00	00	00	FF-
\$209	18	09	03	03	00	00	00	FF-
\$20A	65 00	18	03	03	00	00	00	FF-
\$20C	CA	18	03	02	00	00	00	FF-
\$20D	DF FA	18	03	02	00	00	00	FF-
\$209	18	18	03	02	00	00	00	FF-
\$20A	65 00	27	03	02	00	00	00	FF-
\$20C	CA	27	03	01	00	00	00	FF-
\$20D	DF FA	27	03	01	00	00	00	FF-
\$209	18	27	03	01	00	00	00	FF-
\$20A	65 00	38	03	01	00	00	00	FF-
\$20C	CA	38	03	00	00	00	00	FF-
\$20D	DF FA	38	03	00	00	00	00	FF-
\$20F	2A	0C	03	00	00	00	00	FF-
\$210	6A	36	03	00	00	00	00	FF-
\$211	38	36	03	00	00	00	00	FF-
\$212	E5 00	27	03	00	00	00	00	FF-
\$214	00	27	02	00	00	00	00	FF-
\$215	DF FA	27	02	00	00	00	00	FF-
\$211	38	27	02	00	00	00	00	FF-
\$212	E5 00	18	02	00	00	00	00	FF-
\$214	00	18	01	00	00	00	00	FF-
\$215	DF FA	18	01	00	00	00	00	FF-
\$211	38	18	01	00	00	00	00	FF-
\$212	E5 00	09	01	00	00	00	00	FF-
\$214	00	09	00	00	00	00	00	FF-
\$215	DF FA	09	00	00	00	00	00	FF-
\$217	E5 00	00	00	00	00	00	00	FF-
\$219	D8	00	00	00	00	00	00	FF-
\$21A	F8 00	00	00	00	00	00	00	FF-
\$21C	F8 00	00	00	00	00	00	00	FF-
\$214	F8 F8	00	00	00	00	00	00	FF-
\$21E	F8 02	00	00	00	00	00	00	FF-
\$222	F8 FC	00	00	00	00	00	00	FF-
\$220	F8 04	00	00	00	00	00	00	FF-
\$226		20	30	02	00	00	00	11 FD-#229
\$230		20	34	02	00	00	00	11 FB-#233
\$234	60	00	00	00	00	00	00	11 FD-#229
\$233	60	00	00	00	00	00	00	11 FF-
\$229	38	00	00	00	00	00	00	11 FF-
\$22A	EA	00	00	00	00	00	00	11 FF-
\$228		4C	35	02	00	00	00	11 FF-
\$235	4C	00	00	03	00	00	00	11 FF-
\$300	D8 FC	00	00	00	00	00	00	11 FF-
\$2FE	B8 02	00	00	00	00	00	00	11 FF-
\$302	D8 F8	00	00	00	00	00	00	11 FF-
\$2FC	B8 06	00	00	00	00	00	00	11 FF-
\$304	6C	07	03	00	00	00	00	11 FF-
\$200	A9 03	03	00	00	00	00	00	11 FF-
\$203	AA	03	03	00	00	00	00	11 FF-

Table 2. These few instructions could be used to test the program of table 1. The result obtained should be the same as table 3.

Table 3. This is what should appear on the screen (or printed) if the program of table 2 is run with the aid of TRACER. Before starting the letter at \$0500 the start address of the program under test (\$0200) must be placed in page zero (\$00ED and \$00EE).

A tachometer is probably the single most important 'meter' in a car's dashboard (unless you're in the habit of running out of fuel). It informs the driver how hard the engine is working and, when used correctly, it is an aid to economy, performance and engine longevity (to name but a few). These things are, of course, no less important to the driver of a diesel car than to his petrol-powered counterpart, but most electronic tachometers cannot be used with diesel engines. The reason for this is that they take their 'timing' from the ignition circuit, which diesel cars do not have. The engine speed of a diesel car can, however, be measured by 'picking the brains' of another part of the electrical system, namely the alternator.



diesel tachometer

connected to the alternator measures r.p.m. in virtually any (12 V) diesel or petrol engine car

The difficulty with fitting a tachometer to a diesel engine car has not escaped the car manufacturers' notice. Many diesel cars sold today have an extra (so-called 'W') connection available on the outside of the alternator, and the purpose of this is to enable the engine speed to be measured without unnecessary complication or cost. Petrol cars are, of course, not a problem as the tachometer timing is conventionally taken from the ignition system (the contact breaker points). The diesel engine, however, does not use spark plugs to ignite the fuel/air mixture and this is the root of the problem with fitting a tachometer to a diesel car. Some different value must be found, therefore, that is directly proportional to the engine speed. This should preferably be an electrical value to make connection to

the electronics easier. The ever-present alternator looks like a good possibility. Because it is driven from the crankshaft via the fan belt it turns at a speed which is directly proportional to the engine speed. The 'circuit' of an alternator is shown in figure 1b, and this is typical of the layout used in the vast majority of modern cars. The diagram shows that a 'pick-up' for the engine speed need only be connected to one of the points U, V or W. Most manufacturers select W and feed this to the outside of the alternator.

When a car is available with either petrol or diesel engine the alternator is generally the same for both versions, so even petrol cars often have the W connection available at the outside of the alternator. If your car lacks this W connection don't panic, under the section 'W connection' we will return to this problem to show how such a connection could, if needed, be made. At the input of the circuit diagram of figure 1a we see roughly what the signal taken from the alternator looks like. The actual form of the signal is unimportant; what is of interest is that the frequency of the signal depends on the engine speed. This frequency is from about 125 Hz to 1250 Hz depending on the type of car but variations can be taken care of by our circuit. Having got a signal at the input, all that remains is to convert the frequency variations at the input into voltage variations, which brings us to the circuit of our tachometer.

The circuit

As the circuit diagram of figure 1a shows, this tachometer contains nothing complicated as regards electronics. The supply is taken from the car battery via R1 and protection diode D1. The input resistance and input current (1.5 mA maximum) are defined by resistors R2 and R3. The pulse signal coming from the W connection is limited to 12 V by means of zener diode D2. Any high frequency noise that might be present is shunted to earth by C2. The signal is then fed to the inverting input of op-amp IC1 which operates as a schmitt trigger. The hysteresis of this schmitt trigger is about 6 V, and the signal at its output (pin 6) is a rectangular waveform with an amplitude of $6 V_{pp}$ and a frequency corresponding to that of the input signal. The signal oscillates about the 6 V line. Differentiating network C5/R8 converts the rectangular waveform into the 'peaked' signal shown at the junction of these two components. The positive peaks are limited to about 0.65 V by D3. The negative peaks, on the other hand, are used to trigger MMV IC2. The width of the output pulse from this 555 can be varied with P1 between 150 and 450 μ s. The output signal from IC2 is limited to 5.6 V by zener D4 and is then integrated by R11 and C6 before being fed to the moving coil meter M1. As a result of this integration, and also to a certain extent because of the inertia of the meter, M1 gives a stable read-out of the engine speed.

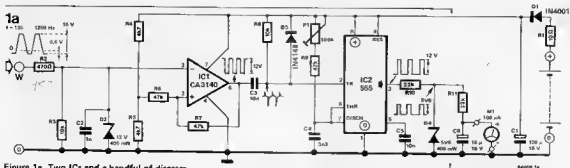

Figure 1a. Two ICs and a handful of discrete components are all the electronics needed for this circuit, as the diagram here shows.

Figure 1b. Most modern alternators have the configuration shown here, with a rectifier consisting of six diodes.

Construction and calibration

The printed circuit board layout for this circuit is shown in figure 2. The connection points from the circuit have purposely been made big so that the normal automotive type connectors and push-on clips can be used.

No holes have been drilled in the board for the meter connections, but large copper areas have been left for this purpose. Holes can be drilled to suit the type of meter used, and the board can then be fixed directly to the rear of the moving coil meter. It goes without saying that the meter must be connected with the right polarity. The meter needs a suitable scale, of course; this could be made by using one of the dry transfer systems available.

There are three possible methods of calibrating the circuit (no, we don't mean do-it-yourself, get somebody else to do it, or don't do it at all). The handiest method is to use a hand-held tachometer, which is probably borrowed from a garage (if you grease the right palms). If you also enlist the help of an assistant things will be considerably speeded up. Run the engine at about 2/3 of its maximum speed. Your helper measures the engine speed at the crankshaft with the borrowed tachometer and tells you what the reading is. You then adjust the Elektor tachometer to this value with P1.

The second method of calibration involves a bit of arithmetic but in this case no reference tachometer is needed. Knowing the rpm/mph ratios of the car in various gears enables you to calculate the engine speed corresponding to a certain road speed in a certain gear. Then find a straight level road and drive at a steady speed for which you have calculated the engine speed. Your (indispensable) helper now adjusts the tachometer to the appropriate reading. The disadvantage of this method is that you are using the car's speedometer as a reference so the reading is almost certainly going to be a few percent incorrect.

The third calibration method involves measuring the diameters of the pulleys on crankshaft and alternator carefully and thereby calculating the ratio of engine speed to alternator speed. An example of this is given in figure 3. From the technical

1b

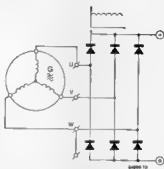

2a

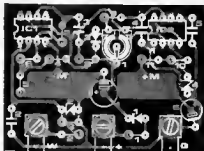
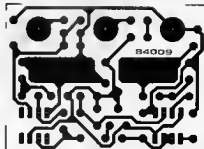

2b



Parts list

Resistors:

- R1 = 10 Ω
- R2 = 470 Ω
- R3, R8 = 10 k
- R4, R5 = 4k7
- R6, R7, R9 = 47 k
- R10, R11 = 22 k
- P1 = 100 k preset

Capacitors:

- C1 = 100 μ/16 V
- C2 = 1 n
- C3, C5 = 10 n
- C4 = 3n3
- C6 = 10 μ/16 V

Semiconductors:

- D1 = 1N4001
- D2 = 12 V, 400 mW zener
- D3 = 1N4148
- D4 = 5V6, 400 mW zener
- IC1 = CA3140
- IC2 = 555

Miscellaneous:

- M1 = moving coil meter, 100 μA f.s.d.

Figure 2a. The large copper areas on the printed circuit board shown here are to facilitate fixing the board directly on the back of a moving coil meter.

Figure 2b. This is a suitable scale to use for the meter on the tachometer.

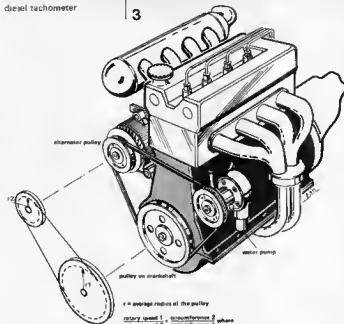

Figure 3. The ratio between the radii (radiuses?) of crankshaft and alternator pulleys can be used to determine the ratio of engine speed to alternator rotary speed.

Figure 4. The power/rpm and torque/rpm curves shown here tell a lot about the way an engine works. Studying them briefly can help a driver make the most intelligent use of a tachometer.

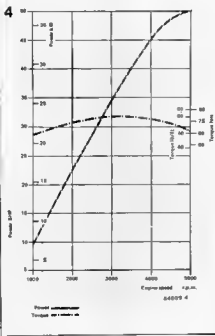
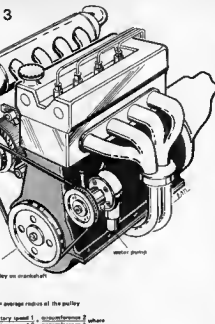

Table 1

Data $r_1 = 15$ cm
 $r_2 = 12$ cm
 number of poles, $p = 12$
 engine speed, $n = 3000$ rpm

Calculation: $f = \frac{r_2}{r_1} \cdot \frac{p}{2} \cdot \frac{1}{60} \cdot n$

$$f = \frac{15}{12} \cdot \frac{12}{2} \cdot \frac{1}{60} \cdot 3000$$

$$f = 375 \text{ Hz}$$

Table 1. Knowing the radii of the pulleys on the crankshaft (r_1) and alternator (r_2), the frequency of the signal given by the alternator at a certain engine speed (here 3000 rpm) can be calculated.

data about the alternator, the ratio between the rotary speed and the frequency of the 'W' signal can be worked out. If, for example, it is a 12-pole type then the frequency is exactly six times as high as the speed. An example of such a calculation is given in table 1. The tachometer can now, on the basis of this information, quite simply be adjusted by feeding in a signal from a sine wave generator with an amplitude of about 14 V.

The 'W' connection

Alternators that do not have a W connection as standard can often be modified using special adapter sets. (Bosch, for instance, market a kit, no. ET-1 127 011 062, for VW and Audi diesels.) The best thing to do is look at the make and type of alternator and then ask at the appropriate garage if an adapter kit exists. An adapter kit is not, however, strictly necessary. The rectifier in the alternator generally consists of a six-diode bridge as shown in figure 1b. Points U, V and W are all located at the anode-cathode junction of two diodes. For our purposes there is no difference between the points and you can feed any one of them to the outside.

Using the tachometer

We are not, of course, going to tell you how you should drive, but nonetheless it may be no harm to see how a tachometer (any tachometer) can be put to its best use. A lot of information about a car's engine can be gleaned by looking at graphs such as those shown in figure 4. These show the relationship between engine speed and both power and torque for a common diesel car, the Volkswagen Golf. The engine speed ranges from about 1000 to 5000 rpm. As one of the curves shows, the power rises almost linearly with (engine) speed up to about 4000 rpm. After this the power does not rise at the same rate so acceleration will be less. This is very important to know for overtaking, for example. Torque is also dependent upon engine speed, but in this case maximum torque does not correspond to maximum engine speed. The engine is at its most efficient, and most economical, at maximum torque. This fact is used every day by people who wish to drive economically. It is a common fallacy that only racing drivers need a tachometer. Certainly those for whom high speed driving is a profession do place a great importance on the information they get from the tachometer, but so can every driver on the road. Mechanical suffering is becoming more and more difficult to hear in today's well sound proofed cars, or at least that is the plea of the (obviously cloth-eared) driver who has his car ticking over at much too high a level and insists on thrashing it before it is fully warmed up. If you see him give him the message - don't put the pedal to the metal when the car is still cold. After all, can you work properly before you're well awake in the morning?

The essential ingredients for any self-respecting disco are well known, plenty of the right type of music, an abundance of coloured lights and gently top up the remaining space with people.

Any hi-fi will provide the music but the light display is rather more specialized. There are of course many variations on the theme ranging from the mediocre to 'way-out' and invariably classified by price. The disco light display described in this article is a very advanced design with many desirable features but can still be built at a very reasonable cost.

programmable disco light display

programmable disco light display

Light displays are very popular for many applications other than discos. They are excellent in the home, for instance, as a means of providing 'atmosphere' at parties or social gatherings. They are also very useful for advertising purposes for the enterprising businessman.

It cannot be denied that the more interesting a disco light display is, the more complex the electronics tends to be. This is mainly due to the fact that each light source, in most cases a mains powered lamp, must be controlled separately, resulting in a 'channel' usually consisting of some form of logic decoding, a mains interface, and a firing circuit. This channel must then be duplicated for however many lamps are involved. Regrettably, we have not been able to do away with this problem. Ironically, however, it may be seen as an advantage simply because it allows for the easy expansion of the overall system — especially if the control electronics are designed with this in mind! It will become apparent that the circuit in this article can be as large as your imagination or your wallet allows!

A major disadvantage of the average disco light display is that the available light patterns are an integral part of the control circuit, possibly the contents of a memory IC, which must be purchased. This means that the pattern cannot be changed very easily, if at all. At this point we can start to sing the praises of the circuit here because this disco display is fully programmable. Furthermore, program changes can be made at any time by simply operating switches (no IC changes). The circuit also contains its own memory allowing up to 32 different programs to be stored.

There are numerous other highly desirable features of the circuit that put this disco

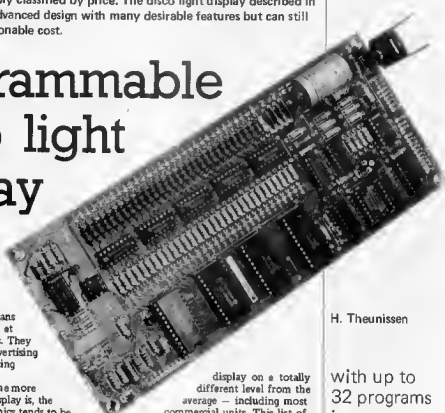

display on a totally different level from the average — including most commercial units. This list of do's and don'ts explains all...

- Entirely user programmable at any time.
 - Up to 30 channels can be accommodated.
 - Program selection can be run fully automatically or manually.
 - 8 switched program run times available.
 - Internal memory divided into:
 - 16 (2 'banks' of 8) programs of 128 steps,
 - or 32 (4 'banks' of 8) programs of 64 steps.
 - Overall size of memory optional.
 - Battery back-up for memory.
 - Programs, banks and current memory address indicated by LED displays.
 - Opto isolation from mains.
 - All lamps switched at zero-crossing point of mains to reduce interference.
 - Personal choice of display configuration (a matrix configuration makes possible a display with 225 lamps!)
- So much for what the circuit can do, now how about what it doesn't do!
- It doesn't cost an arm and a leg.
 - It does not require any programming skill.
 - It does not require a great deal of practical ability to build it.
 - It doesn't play the Hokey Cokey (although some may not consider this to be a major disadvantage) yet!

To sum up then, the circuit contains all of the desirable features (that we could think

H. Theunissen

with up to
32 programs
in memory

of at least) and yet it can be operated without 'computer' experience. The complete display can be as small or as large as desired; it may even be expanded at a later date.

Basic principles

Those readers who have already sneaked a quick look at figure 3 (this of course includes everybody) may be getting somewhat alarmed at what most articles would refer to as a 'slightly complex' circuit diagram. This impression is just a figment of the imagination as can be proved with the aid of the block diagram of figure 1.

Since it is the memory that holds all the information, this forms the heart of the circuit and all other 'blocks' either feed to or from it. The structure of the contents of the memory is illustrated in figure 2. It will be seen that it is divided into 'banks' (two or four depending on desired memory size) each of which in turn is divided into 8 programs. This simple method allows the total memory to be divided into reasonable program lengths and provides an excellent means of finding any given program quickly - especially if the program and bank counters are given 7-segment display read-outs! The address counter, as its name suggests, determines the address of that part of the program which is being displayed at any one time. Obviously the same can be said of the bank and program counters.

The block with the elegant title of 'mains sync' is a shade more subtle in both its activities and its purpose in life. Basically it provides a synchronization signal for the circuit at the frequency of the mains supply. Simple, you say - but wait. It also ensures that the clock signal is synchronized to the zero-crossing point of the mains frequency and, by so doing, it eliminates the need for all those zero-crossing detectors that usually accompany each lamp-switching triac in the mains interface of the display. The answer to the next question is that, since the clock is synced to the zero-crossing point of the mains, all data changes at the output of the memory will always occur at the same point. The lamps will therefore always switch on (or off) at the zero-crossing point!

One further point before we leave the block diagram. The printed-circuit board designs for the display drive circuits do not appear in this article but they should grace the next issue.

The circuit diagram

The mains zero-crossing point detector is formed by IC1 (gates N1...N3) in the circuit diagram of figure 3. The mains supply is present between the X and Z terminals and is applied to N1 via a voltage divider consisting of resistors R1...R3. The inputs of N1 contain two diodes which chop the waveform of the mains supply to provide a square wave with an amplitude that is equal to the supply voltage of IC1.

The output of IC1 is differentiated by means of C1/R5 and C2/R6 and fed to the two inputs of N3. The resulting output of N3 is a pulse of about 200 μ s at every zero-crossing point of the mains frequency. This pulse

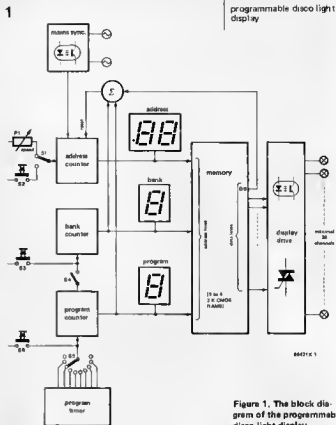

Figure 1. The block diagram of the programmable disco light display. Memory size can be chosen by the user.

train is then fed, via a driver transistor, T1, and an opto-coupler, IC2, to the clock input of FF1. This ensures complete isolation between the mains supply in the zero-crossing detector stage and the rest of the circuit. It is for this reason also that the power supply - connected between X and Y - for the detector stage is derived from the triac control board. The memory address counter is IC7 which will increment the address data by one at every clock pulse received at its clock input at pin 10. The clock signal for this purpose is generated by means of the variable fre-

2



Function table

- S1: A - RUN MODE
- B - PROGRAM & STEP MODE
- S2: STEP (increment address counter)
- S3: BANK increment (+1)
- S4: BANK automatic increment ON/OFF
- S5: PROGRAM RUN TIMES in minutes
- S6: MANUAL PROGRAM increment (+1)
- S7: DATA WRITE
- S8: WRITE PROTECT (key switch)
- S9: Mains switch
- S10: RESET switch
- S11...S40: DATA switches
- P1: RUN speed control

Figure 2. This illustrates the manner in which the memory is structured to provide easy access to any program.

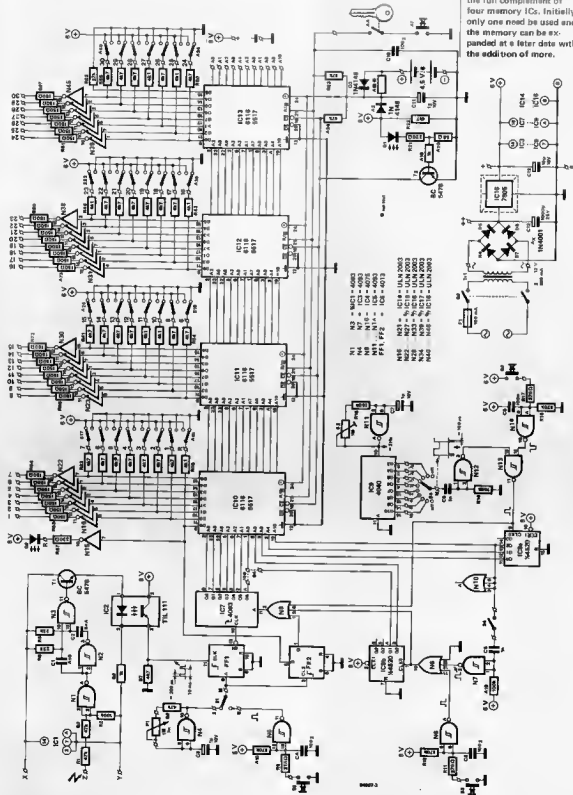

Figure 3. The circuit diagram shown here of the disco light display includes the full complement of four memory ICs. Initially only one need be used and the memory can be expanded at a later date with the addition of more.

quency oscillator formed by gate N4. If, for instance, the display pattern were a running light, the speed at which the lights run could be increased or reduced by P1. However, the clock signal is not fed directly to the address counter but via F1 which, you will remember, is itself clocked by the zero-crossing point detector. The end result is that any change in the address counter is directly synced to the mains zero-crossing point. Switch S1 is included to allow the address counter to be 'stepped' by means of pushbutton on S2. This is of course necessary during programming.

One half of IC8 (IC8a) forms the program counter which has a continuous count-up cycle from 0...7. That is, it counts up 8 steps (8 programs) and then resets to 0 only to begin the cycle again. The program counter is clocked by the program timer, IC9, which provides 8 different program run times ranging from 7.5 seconds to 16 minutes, selected by switch S5.

The program counter can also be incremented by one step at a time by means of switch S6 which, incidentally, overrides the timer output. It should be realized that if S5 is switched to one of its off positions, any given program will run indefinitely until it is changed manually by S6.

The remaining half of IC8 (IC8b) forms the bank counter which, depending on the program size, continually counts up in either 2 or 4 steps. This counter can also be stepped manually by means of pushbutton S3. To obtain fully automatic operation, that is, a continuous cycle through all the programs in the memory, switch S4 can be closed and at the highest program count, the bank counter will be incremented by one.

It will be seen that the counters for program end bank are interconnected via an OR gate, N8. This ensures that each time either the bank or program counters are updated the address counter is reset to zero; after all, it is only reasonable that a new program should begin at the beginning! For those who are wondering what that strange little thing perched on the line to S4 is, it is simply a redundant gate.

We now come to the memory itself, of which the full complement of four 2K CMOS-RAMS are shown in the circuit diagram (IC10...IC13). In normal operation these are of course in the 'READ' mode and the contents of the address, determined by the address, program, and bank counters, are used to switch on (or off as appropriate) the output to the display itself. Normally then, the R/W pins of each memory are held high by resistor R23. This line must therefore be taken low whenever a program is to be entered or modified and this is carried out by switch S7 via switch

S8. Switch S8 is a safety 'lock-out' key switch which, although not absolutely necessary, is strongly recommended to prevent accidental damage to a program. How and when to use S7 will be covered a little later on.

The power supply for the memory ICs is taken from the 5 V line via diode D2. Should the 5 V supply fail (when the equipment is not in use for instance), the 4.5 V battery will preserve the contents of the memory via D3. At the same time, the absence of the 5 V supply will switch off transistor T2 and inhibit the memory outputs by causing the CE inputs of the memory ICs to go to logic 1 via resistor R24. In short, the memory will be inoperative (in the low power mode) but the contents of the memory will be preserved. The current consumption is so low in this condition that the battery will last quite literally for years but should still be changed every 12 months or so. A NiCd (three cells of 1.2 V) can also be used in which case resistor R18 (270 Ω) is required to provide a charging current. This resistor is not needed with a dry battery.

Each of the data lines of the memory ICs is fed to the LED in an opto-coupler on the triac board via a driver, N15...N45, and an indicator LED. The indicator LED provides a direct read-out of the data at that particular address. This is of course essential during programming. The data lines are also fed to the programming switches S10...S40 via resistors. When S7 is pressed, and S8 is switched on, the data set by these switches is written in the memory at the address indicated.

One final detail before we leave the circuit diagram of figure 3. The D0 output of IC10, switch S10, and the associated LED (via driver N15) all have a particular significance. It will be seen in 'programming' below that the length of a program (or sequence) can be a maximum of 128 or 64 steps. However, this may be more than required and therefore some means of programming the end of a sequence and returning to the beginning must be provided. This is where data line D0 of IC10 comes in. In the normal course of programming D0 will be logic low until the end of a sequence when a 1 will be entered at this location (by S10). When the display is up and running, a 1 appearing at D0 will be synced with the address oscillator by FF2 and used to reset the address counter to zero via N8. The display sequence will then start from the beginning again. LED D8 serves to indicate this 'reset' pulse when it occurs. The reset bit (D0 of IC10) is not synced with the zero-crossing-point pulses. However, as the reset only occurs at the end of a program, this will cause negligible inter-

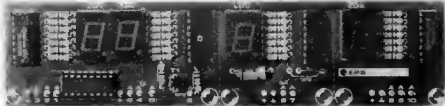

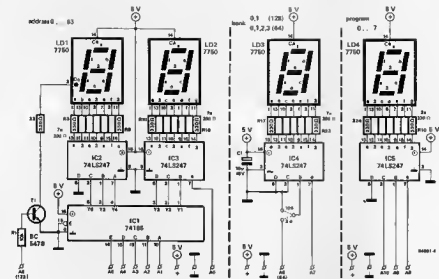

Figure 4. The address, program and bank indicator circuit diagram is shown here. The address lines are connected to those on the main circuit of figure 3.

ference.

The circuit diagram for the four LED displays, LD1...LD4, is shown in figure 4. The printed-circuit board layout for this circuit is shown in figure 6. The address reference A0...A10 refer to those at the right of the main circuit diagram of figure 3. An appropriate link must be made to set the program step-length at the input to the decoder for LD3. If the program step-length is 128 steps, transistor T1 switches on the decimal point of LD1 for address counts above 63.

Construction

If the printed-circuit boards illustrated in figures 5 and 6 are used, construction of the electronics section of the disco display should prove no problem. However, before assembly can begin, the final design format must be decided upon. This refers in particular to the LED read-out display board which, it will be noticed, can be divided into three separate sections. This has been done to allow the maximum flexibility of the design as it was considered that many readers may wish to build the display controller into an existing piece of equipment. The complete printed-circuit board as shown in figure 6 will match the suggested front panel design illustrated in figure 7.

After assembly has been completed, not forgetting the two links (64 or 128 step program length), the two boards should be interconnected. This can be carried out by short lengths of wire or, if preferred, ribbon cable can be used. All the address lines as marked on the two boards, with the exception of A6, must be connected. For a

64-step program this is taken to the point marked A6 on the board containing display LD3. If a 128-step program has been chosen, it must be connected to A6 on the board containing displays LD1 and LD2.

There are three + terminals and three 1 terminals on the display board. These are separately interconnected: one + and one 1 is connected to the + and 0 terminals respectively on the main board near C12. If the display board is separate, each + and 1 should be connected with the + and 0 on the main board. The common point for the anodes of the indicator LEDs should be taken to the + terminal near C12. The cathodes are connected to channel outputs 1...30. Another set of + and 1 terminals will be found on the main board: these are for the switches. The switch connections should preferably be commoned after the switches have been mounted on the front panel as this requires only two wires to be returned to the main board.

Normally, the channel indicator LEDs are connected in series with the LEDs in the opto-couplers on the triac board. To enable the circuit to be tested at this stage, some form of current limiting must therefore be included as a temporary measure. Two diodes type 1N4001 are therefore connected in series with the 5V supply and the common anode connection of the indicator LEDs. The LEDs should have a forward voltage of about 1.6V. If the indicator LEDs are dispensed with and only the opto-coupler LED is used, the display pattern is, of course, shown by the display itself: resistors R58...R87 should then be 330Ω. It will be remembered that the supply for the mains zero-crossing point detector is derived from the triac control board: this

Max. no. of channels	ICs required
7	10-14-15
15	10-11-14-15-16
23	10-11-12-13-14-15-16-17
30	10-11-12-13-14-15-16-17-18

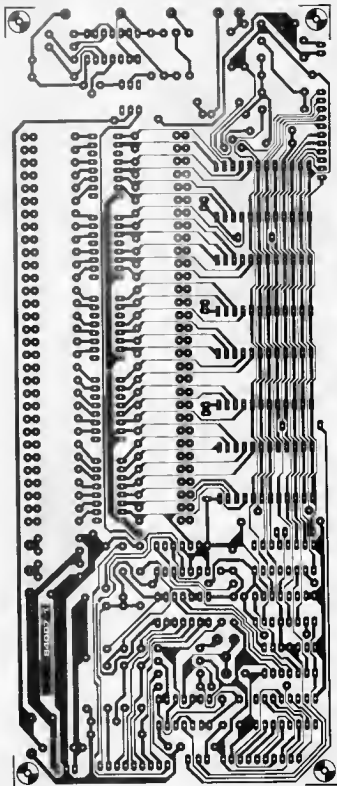
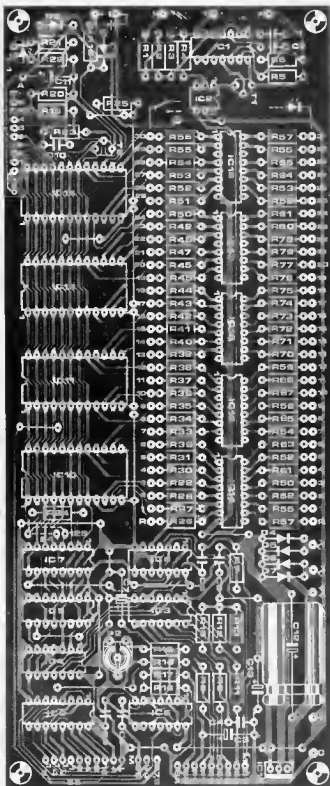

Figure 5. The component layout and track pattern of the printed-circuit board for the circuit diagram of figure 3.

will be clarified in the next issue when the triac unit as a whole will be described. To enable the main board to be tested at this stage, the zero-crossing point detector can be supplied from the main board. DO NOT FORGET to remove these connections

when the triac board is connected. The supply connections are: X to + and Y to 0 (near C12) and Z to one of the secondary a.c. terminals of the mains transformer (that is, one of the ~ terminals on the main board).



A final construction point: IC19 must be fitted on a small heat sink.

Programming

When the circuit is first switched on (prior

to any programming), the memory ICs will contain garbage, but you know that, of course!

Display sequences will obviously depend on the contents of the memory and the chosen program format (64 or 128 steps). Further-

programmable disco light display

Parts list.

Resistors:

R1,R2,R8,
R23...R25 = 47 k
R3,R13,R14 = 100 k
R4,R19 = 1 k
R5,R6 = 22 k
R7,R22 = 4k7
R8,R11,R17 = 470 Ω
R10,R12,R16 = 470 k
R15 = 150 Ω
R18 = see text
R20 = 56 Ω
R21 = 220 Ω
R26...R56 = 4k7
R57 = 330 Ω
R58...R87 = 150 Ω

Capacitors:

C1,C2 = 6n8
C3,C7,C11 = 1 μ /10 V
C4,C5,C9,C10 = 100 n
C6,C8 = 1 n
C12 = 1000 μ /25 V
C13 = 10 μ /10 V

Semiconductors:

T1,T2 = BC 547B
D1 = red LED
D2,D3 = 1N4148
D4...D7 = 1N4001
D8 = LED
Optional: 30 LEDs for
channel indication
IC1,IC3,IC5 = 4093
IC2 = TTL 111
IC4 = 4075
IC6 = 4013
IC7,IC9 = 4040
IC8 = 4520
IC10...IC13 = 6116 or
6517
IC14...IC18 = ULN 2003
IC19 = 7806

Miscellaneous:

P1 = 1 M lin. potentiometer
P2 = 1 M preset
S1 = single pole two way
toggle switch
S2,S3,S6,S7 = push-to-
make switch
S4 = single pole toggle
switch
S5 = 12 way wafer switch
S8 = single pole key-lock
switch
S9 = double pole mains
toggle switch
S10...S40 = single pole
two way toggle switch
Tr1 = mains transformer
9...12 V, 800 mA
secondary
4.5 V battery
F1 = fuse 500 mA slow
Heatsink for IC19 (SK13,
KL105)
Printed-circuit board
84007-1

NOTE. remember that some components are not required and others in smaller numbers if all channels are not used.

Parts list.

Resistors:

R1 = 10 k/1/8 W
R2... R30 = 330 Ω /
1/8 W

Capacitors:

C1 = 10 μ /16 V

Semiconductors:

T1 = BC547B
IC1 = 74185
IC2... IC5 = 74LS247
LD1... LD4 = 7750
Printed-circuit board
84007-2

Figure 6. The printed-circuit board for the address, program and bank counters can be divided into three parts if preferred.

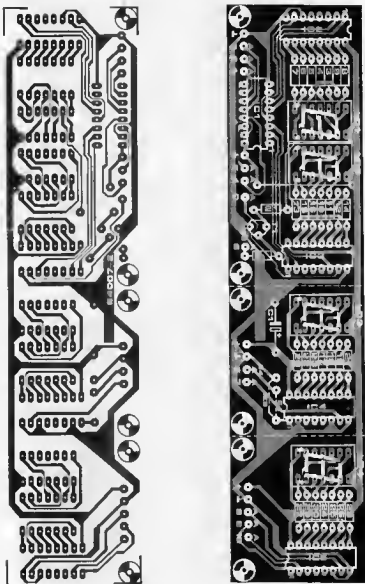

more, a full memory will allow a total of 30 channels (lamps) and these can be arranged in any number of pleasing designs including a dot-matrix for alpha-numerics (that means letters and numbers, sir!). Having decided upon the display format and the sort of programs that are to be used, the links at the A6 address line must be fitted as described under 'construction'. Before starting the programming, it is advisable to commit the desired sequences or patterns to paper as even 64 steps can get decidedly confusing.

To adjust preset P2, set switch S5 in position $\frac{1}{2}$ (minute) and adjust preset P2 so that the program display jumps on one every 30 seconds.

Off we go then. Set switch S1 to position B (step mode), S4 to OFF, and S5 to off to prevent the program from jumping on during loading. Switch on the switch-key S8 and

press S6 and S3 to get the right program and bank. The address display should read 00; if not, press S3 or S6 until the right program and bank are indicated on the display. The program data is set by switches S10... S40 (or whatever number you have decided upon). Any one of these switches set to 5 V denotes a logic high and causes the appropriate lamp to light. A switch set the other way gives a logic 0 and the corresponding lamp does not light. Are you still with us? Set the program data and press switch S7. The data lines are now inputs and the memory ICs will be fed with a write pulse and accept the data set with the switches. When S7 is released, the data lines revert to being outputs and the set pattern will be indicated by the channel LEDs. Now press S2 once (to increment the address by one), set the data switches, and again press S7. If an error was made during the entering of



84007-7

Figure 7. A suggested design for a 19 in (483 mm) front panel for the programmable disco lights. This panel matches the complete printed-circuit board of figure 6.

the data, simply set the correct data and press S7 again. This works, however, only before S2 has been pressed. If S2 has been operated, press S6 until the same program is indicated on the display. Then go to the faulty address by means of S2, alter the data, press S7, and proceed to the next address by pressing S2.

As mentioned previously, data line D0 will remain logic low until the end of a pattern. On the address following the last line of the sequence, set S10 to 5 V (logic high); this can also be done on the last line of the sequence itself (together with the program data) if preferred. With some display patterns (especially running light patterns) it improves the display continuity, but it really is a matter of choice. Try some simple patterns to see the effect. And that's all there is to it apart from a few pointers. At the end of the programming, do not forget to switch off the key-switch otherwise (in the case of disco's) you might find yourself arriving at a booking with this terrific new display you have been raving about only to find that you have a completely garbled memory. Not good for the old ego, chaps! Don't be too worried about making a false entry during programming as mistakes can be easily rectified. You do not have to reprogram the entire memory, just the line containing the error. Unless of course, you have a major disaster on your hands. In this case, turn the telly off and lock the door before starting!

It is possible to include delays and acceleration in your program by repeating the same data in several addresses. This makes a very effective display when properly done but it does require careful planning with due regard to program length (64 or 128 steps). Remember not to be caught out by the address counter read-out. This just indicates from 0 to 63. If a program length of 128 steps is opted for, the decimal point of LD1 signifies the 'upper' 64 step range.

Set S1 to position A when the program should run; adjust the run time with F1. It may happen that when the run time is increased (that is, smaller resistance of P1), the pattern on the display does not run smoothly (stutters) or even stops altogether. This is caused by the frequency of N4 being too high in relation to that of the zero-crossing pulses. Because the trigger levels of different makes of 4093 show wide variations, this erratic running may or may not occur. The adjustment range of P1 should be set by means of R8 and/or C3 so that stuttering or stopping of the pattern just does not occur.

A point worth noting! The disco display is completed, programmed, and ready to go to work... However, when it is switched on, nothing happens: no lights, no LEDs, just panic! Fear not, gentle DJ, all will be as it should be if you just press the program step switch, S6, and a program will start from the beginning.

To end, we are sure you don't need reminding that the mains supply is a little 'conspicuous' in this circuit. Please take care, as we have no desire to reduce our circulation by stopping yours!

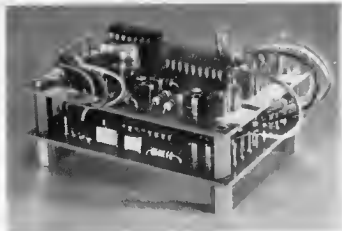

video combiner

PAL (Phase Alternation Line) is a colour TV system generally adopted in Europe. In France, however, the SECAM (Séquentiel Couleur A Mémoire) system is used.

The colour burst signal is a phase and amplitude reference signal which is used to demodulate the chrominance signal.

The luminance signal contains brightness information; it is obtained by combining the outputs of the three colour channels and then used for amplitude modulation of the main picture carrier frequency.

The chrominance signal is obtained by combining, in the logic decoder and chroma encoder, portions of the separate colour logic levels into sum and difference signals. Two quadrature components of the chrominance signal are produced and used for amplitude modulation of the chrominance subcarriers.

The TEA 1002 is a PAL colour encoder with video combining stages. It converts a number of appropriate input signals into a complete video signal, that is, one containing synchronizing pulses for the line and field scans, luminance and chrominance signals, blanking pulses, and a colour burst signal.

The required input signals are derived from the 'video sync box' described elsewhere in this issue. The printed-circuit boards for that box and the present circuit are of the same dimensions so that they can be built conveniently into one unit.

The TEA 1002

The 'innards' of the TEA 1002 are shown in schematic form in figure 1. The logic decoder generates colours according to the logic levels at pins 1...4 (see table 1). If only black and white signals are required, pins 2...4 are simply strapped

together. In that case, neither the chrominance subcarrier oscillator (pins 13, 14) nor a signal at the CBF (colour burst flag) input (pin 15) is required.

together. In that case, neither the chrominance subcarrier oscillator (pins 13, 14) nor a signal at the CBF (colour burst flag) input (pin 15) is required.

The circuit diagram

The circuit may be divided into three parts (see figure 2): the PAL switch (FF1), the combiner proper (IC2), and a buffer stage (T1).

The PAL switch, flip-flop FF1, is controlled by the line synchronizing pulses at its clock input (pin 3). (See also 'video sync box' elsewhere in this issue.)

The TEA 1002 (IC2) contains a chrominance (chroma) and a luminance encoder. The luminance is dependent on the voltage level at pin 9, which is preset by P1. If this voltage is greater than 4 volts, a 75 per cent colour signal (as defined by the EBU — European Broadcasting Union) is generated. When the voltage falls below 3 volts, the brightness is increased to 95 per cent, which, no doubt, will normally be preferred as it gives a clearer picture. It should be noted that the voltage at pin 9 should not rise above 5 volts to prevent saturation of the buffer, T1.

The TEA 1002 also contains a divider which produces a 3.54 MHz clock signal from the 8.86 MHz subcarrier oscillator. The clock (pin 17) may be used to synchronize other circuits. The oscillator can

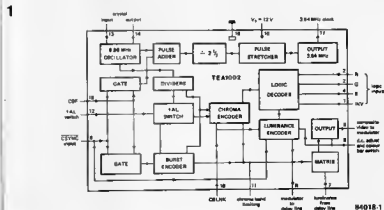

Figure 1. This block schematic of the TEA 1002 clearly shows the complexity of the circuitry required to produce a composite colour video signal.

be pulled to its correct frequency by adjusting capacitor C1 for minimum interference (least ragged image fringe). Setting C1 to its mid-position will in practice normally be sufficient.

The output level of the buffer stage, emitter follower T1, is preset by means of P2. With values shown, the output impedance is around 75 ohms. The output level is normally adjusted to give 1 V_{pp} across 75 Ω, that is, 2 V_{pp} emf.

Construction and application

The printed-circuit board, shown in figure 3, has the same dimensions as that for the video sync box, so that the two boards can conveniently be built into one compact unit. The various terminals on the boards are located such that the length of the interconnecting wires is kept to a minimum. The circuits should, of course, be preset before making the interconnections.

The board has provision for an optional wire bridge. If this is used, the logic levels at pins 2...4 ('0') produce standard colours and the chrominance signal is at normal level. If the wire bridge is omitted, the colours are inverted (see table 1) and the chrominance signal is reduced by 6 dB.

Power supply requirements are 12 V at 100 mA maximum.

The combiner lends itself to a variety of applications. For example, when used with a personal computer with video interface (which has colour information available (in the form of Red, Green, and Blue signals)) it makes possible the production of a composite video signal.

In combination with the video sync box, the combiner can produce a colour bar which is suitable for use as a test signal, as a space marker for video recorders, or with local cable systems. For these uses, the R, G, and B pins on one printed-circuit

2

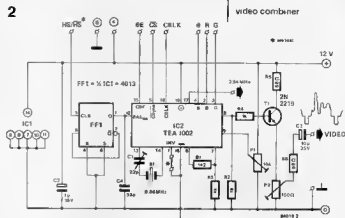

Table 1.

inputs				colour
pin 2 R	pin 3 G	pin 4 B	pin 1 INV	
0	0	0	0	black
1	0	0	0	red
0	1	0	0	green
1	1	0	0	yellow
0	0	1	0	blue
1	0	1	0	magenta ¹⁾
0	1	1	0	cyan ²⁾
1	1	1	0	white
0	0	0	1	grey
1	0	0	1	cyan ²⁾
0	1	0	1	magenta ¹⁾
1	1	0	1	blue
0	0	1	1	yellow
1	0	1	1	green
0	1	1	1	red
1	1	1	1	black

¹⁾red-blue

²⁾blue-green

board must be linked to the corresponding ones on the other board. Finally, the combination may in appropriate cases form the link between electronic equipment and a colour TV.

Figure 2 From this circuit diagram it is evident that once all the complex functions are performed by the TEA 1002, the remainder of the design becomes relatively simple.

Table 1. Correlation between logic levels at pins 1...4 and the colour produced.

3

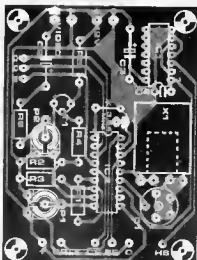
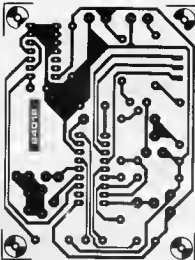

Parts list

Resistors:

- R1 = 1k Ω
- R2, R3, R4 = 1 k Ω
- R5, R6 = 68 Ω
- P1 = 10 k preset
- P2 = 100 Ω preset

Capacitors*

- C1 = 22 p trimmer
- C2 = 10 μ /35 V
- C3 = 1 μ /16 V
- C4 = 33 p

Semiconductors:

- IC1 = 4013
- IC2 = TEA 1002 (available from Technomatic Ltd)

Miscellaneous:

- X = crystal, 8.86723 MHz

Figure 3 The printed circuit board for the video combiner. Note the wire bridge described in the text near the centre of the board.

The testing of digital circuits can be quite a headache. Our old faithful, the multimeter, is quite useless because of the operating frequencies: the logic levels change so rapidly — thousands or millions of times per second — that even a digital multimeter is unable to cope. This problem can be solved in two ways: buy a higher quality test instrument or lower the operating frequency of the circuit under test. If you opt for the last, you will find our digitester just the thing!

digitester with a difference

universal test
aid for digital
circuits

Digital circuits normally operate at speeds which make it impossible for normal test instruments to be used for checking or fault finding. For instance, in an analogue multimeter, the inertia of the pointer prevents the reading of the level of a pulse train. The normal digitester does not help here either; it may well give an optical indication of the logic level at the pin of an IC, but only as regards a static or slowly changing situation. When rapid changes occur, the digitester is also quite useless. This is, however, not because of inadequacies in the instrument, but rather because of the slowness of our eyes. When an LED blinks at only 20 Hz, few of us see this as a series of light pulses: most will just see a continuous light.

It is by now evident that to test digital circuits or to be able to experiment with them it is necessary to slow down the speed of operation. The easiest way to do this is to disable the internal clock of the circuit and replace it by an external one operating at a much lower frequency. In some cases, it is even better to work with just one pulse at a time, instead of with a pulse train.

The circuit

Fewer ICs than shown in figure 1 are required to generate a single pulse or pulse train of low frequency. None the less, the additional ICs used here make for a more 'comfortable' circuit. So, let's see...

The generation of a single pulse is effected primarily by NAND gates N1...N4. Gates N1, N2 form a flip-flop of which the logic level at outputs Q1 and Q1 is dependent on the position of switch S1. As drawn, Q1 is logic low (0) while Q1 is logic high (1). The high signal at Q1 is indicated optically by LED D1 via gate N18. A second single pulse is generated by gates N3, N4: their logic levels at outputs Q2 and Q2 are optically indicated by LEDs D3 and D4.

The two bistables, N1/N2 and N3/N4, de-

bounce switches S1 and S2 which ensures that only one pulse is present at their outputs. This pulse can be used in the circuit under test as clock, counter, reset, and so on.

Apart from single pulses, there is, of course, a need for low-frequency pulse trains. The generator required for this is formed by NAND Schmitt trigger N9, resistor R13, and capacitor C1. With values shown, the frequency is around 50 Hz. A second pulse-train oscillator, formed by N10, R14, and C2, operates at the much lower frequency of 2 Hz, which is optically indicated by LED D5.

So much for the description of the required generators. But what if you want to apply a single pulse followed by a pulse train to a circuit? It would not do to have to change from one output to another. No, for this purpose we have added an electronic switching circuit consisting of S3, NOR gates N5...N7, NAND Schmitt Triggers N8, N11, and NAND gates N12/N13 and N16/N17. The output, pin 8 of N17, depending on the setting of S3, is either the Q2, the 2 Hz, or the 50 Hz signal. The logic output level is optically indicated by LED D6:

- if D6 lights continuously and independent of the setting of S2, the output is a 50 Hz pulse train;
- if it blinks rhythmically, the output is a 2 Hz pulse train;
- if it lights depending upon the setting of S2, the output is the logic level of Q2.

All outputs are buffered, which enables up to 30 TTL circuits to be connected to them.

Finally, the function of switch S4. When this switch is open, the output of N17 is open, that is, it contains the signal selected by S3. If S4 is closed, however, the output of N17 is logic low and the signal selected by S3 is therefore not available at pin 8.

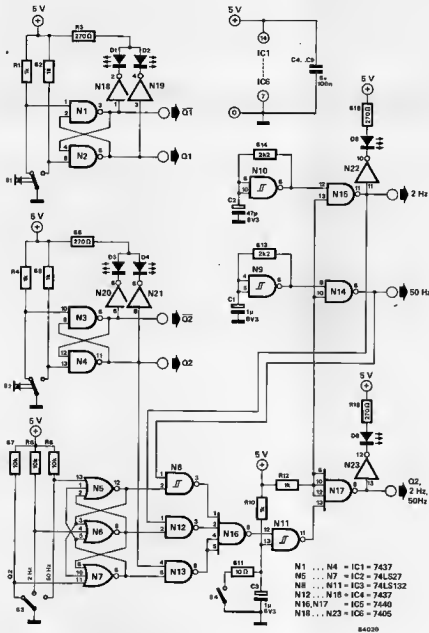

Construction

As you have seen from the circuit diagram, the digitizer needs a supply of 5 V. This is best obtained by means of a 5 V voltage regulator; a 500 mA type will do nicely. The supply voltage to each of the ICs should be individually decoupled by a 100 nF capacitor.

The power supply is best built into a case together with the digitizer so that you have an independent, self-contained test instrument for digital circuits.

If you want to use the digitizer with CMOS logic, it will be necessary to adapt the (TTL) outputs to the CMOS logic under test. This is relatively simple and is described in some detail in the article 'mating logic families' elsewhere in this issue.

Figure 1. The digitizer comprises five functional circuits: two single-pulse generators, two pulse-train oscillators, and an electronic switch.

Almost every new car manufactured in the world today is fitted with reversing lights. Great idea! Not only do they help you see where you are reversing in the dark, but they also make your intentions clear to anybody behind the car. In some Asian countries it is even a legal obligation for every car to have an externally audible reversing indicator. The one problem with these ideas is that the car driver does not directly benefit from them.

reversing buzzer

'clunk, click, buzz ...'

It is an undeniable fact of human nature that we often forget or neglect the care and caution instilled into us while learning a new skill. Nowhere is this more obvious than in driving a car. We frequently tend to do what is convenient rather than what is correct. Just one small, but common, 'fault' is starting the car in gear with the clutch depressed. Then you only have to release the clutch and away you go... But in which direction? It can prove very 'surprising', to say the least, when you expect to move smoothly forwards but instead find the driver of the 'slightly shortened' car behind you tapping on your window to express his

opinion of your character in a somewhat heated manner.

The circuit

The circuit here also gets excited when you start the car in reverse gear but all it does is buzz at you in displeasure. When the ignition is switched on the car battery voltage is applied to the circuit and the oscillator around N2 starts. This provides one of the inputs to N3. If the car is in reverse gear, the second input of N3 is taken high via R7, and this causes the buzzer to sound.

Figure 1. The circuit, as shown here, uses normal components that most people will probably have lying around. It can easily be built on a small piece of veroboard and needs only three external connections, +12 V, ground and a connection to the reversing light circuit. This last line must have +12 V when the reversing lights are lit. A workshop manual or your friendly neighbourhood mechanic may help to find a suitable place to tap this line.

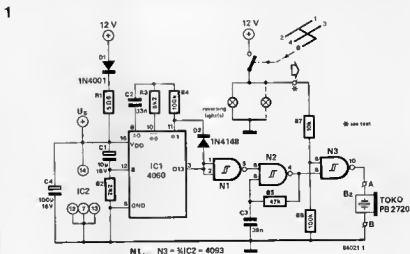

2

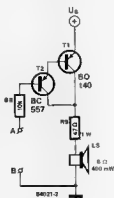

Simultaneously, pin 12 of the CD 4060 is taken high and this chip is reset. This IC is a 14-stage binary counter and oscillator, the frequency of which is set by external components (C2, R3 and R4). After a certain time (about six seconds), the Q13 output (pin 3) of IC1 goes high and stops oscillator N2 by taking its input (pin 5) low via N1. This, of course, stops the buzzer and ensures that it does not sound every time the car is put into reverse gear, which would be very annoying.

An alternative to using the buzzer is the small circuit shown in figure 2, consisting of a loudspeaker driven by a darlington pair. Transistors T1 and T2 may also be replaced by a single-package darlington such as a BC 516.

Figure 2. This 'circuit' can be used in place of the buzzer, and so get rid of the only 'difficult' component in the whole design.

The problems of address decoding in a microprocessor system are generally summarised in the question 'where, when and how is the memory accessed?'. Our first article on address decoding did not answer the 'when' part of this question. For this reason we decided a second article was needed to deal with the timing of operations and signals. We also decided to have a look at an example of modifying an existing decoding system.

memory timing

A logic combination of most significant address lines can be used to provide an enable signal that is only active for certain configurations of the lines used. As we have already seen in our first article, this signal is applied to one or a number of memory ICs accessed by the least significant address lines, which, in fact, control the chip's internal address decoder. Data is transferred via the data bus.

No matter how high the clock frequency of the processor, the address and data signals do not appear either instantaneously or simultaneously. On the one hand there is always what is known as a set-up time for the signals and on the other hand even the clock signal itself takes a finite time to appear. This is an added complication, but fortunately the difficulties are somewhat reduced by the presence of control signals supplied by the processor. These signals are used to synchronize the address decoding and read or write operations.

Timing of Z80 and 6502 signals

As the timing diagram of figure 1 shows, the MREQ, RD and WR signals of the Z80 do not appear at the beginning of read or write operations. When the MREQ and RD signals are not 'low' during a read operation (left half of the timing diagram), the address signals A0...A15 cannot be considered stable. The same applies to a write cycle when MREQ is not active. The upshot of this is that the MREQ signal and address decoding signal must always be combined before being applied to a memory IC.

As the right half of figure 1 shows, the WR signal is followed after a significant delay by MREQ and the beginning of the phase to establish the data signals. These latter can only be considered stable after WR appears. It should be noted that the WR line becomes inactive again a half clock cycle before the address and data words change (TS of the write cycle). The WR signal could also be used as is to change the memory from read to write mode and vice versa (R/W).

The timing diagram for Z80 signals corresponding to an input/output instruction is shown in figure 2. Note in passing the presence of a spontaneous wait cycle generated by the processor itself to allow the — generally slow — input/output circuits to produce a WAIT signal if necessary. Here again, the address and data signals can only be considered stable after the appearance of control signals.

In the 6502 timing diagram shown in figure 3 the essential enable signal is $\Phi 2$. As soon as this signal is 'high' the address signals, and, immediately after them, the data signals, can be considered stable. The same is true of the signal to change between read and write modes (R/W). As this processor has no specific I/O instructions, it also lacks any particular control signals for this type of circuit.

A RAM-R/W signal is often found on 6502 systems, and this is obtained by combining the $\Phi 2$ and R/W signals. This can then be applied as and when desired to memory ICs to change between reading and writing. For EPROM chips the $\Phi 2$ is combined with the address decoding signal (this is shown as gates N41 and N44 on the interface card of the Junior Computer). For inputs/outputs, various combinations of $\Phi 2$, R/W and the address decoding signal are possible. The R/W signal (and possibly $\Phi 2$) could also be used for switching the bi-directional data buffers (the READ and WRITE mode-switching signals on the Junior Computer interface card are obtained from, among others, the R/W signal).

We must stress the importance here, for the designer, of carefully noting the timing of the control signals which must be catered for by the logic for decoding and enabling memory ICs.

Modifying an existing decoding system

After so much theory we will now deal with a practical example of using an existing system: the interface card of the Junior Computer, in fact. The aim of the modification is to reduce the importance of the doubly addressed zone between F800 and F9FF (or 1800...19FF in the DOS ver-

microprocessor control signals and their sequence

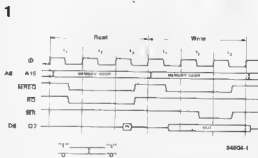

Figure 1. The timing diagram of the Z80 shows that the address and data information is only usable in a limited period within each read or write cycle. Note that the timing diagrams are taken from the Synertec data book and may be different from another manufacturer's IC.

Figure 2. The Z80 gives a specific IORQ signal for input/output instructions. Even though they are represented simultaneously in this timing diagram, the read and write operations can never occur at the same time.

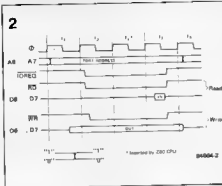

Figure 3. The address and data signals and the R/W line of the 6502 can be considered stable as soon as the $\Phi 2$ signal is high.

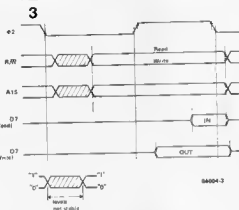
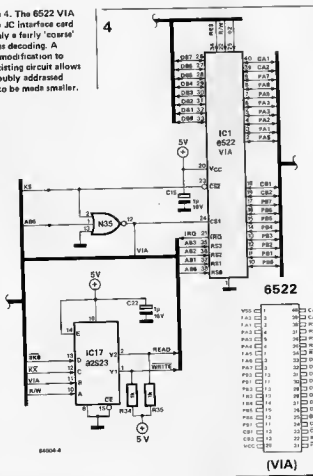

Figure 4. The 6522 VIA on the IC interface card has only a fairly 'coarse' address decoding. A small modification to the existing circuit allows the doubly addressed zone to be made smaller.



sion), and to be able to address a new input/output circuit there.

The 6522 VIA (IC1 on the interface card) occupies addresses F800...F9FF (1800...19FF), but this is a bit wasteful as 16 addresses are sufficient to address all the registers of this IC. The K6 signal is active between F800 and FBFF (1800...18FF). Address line A9 permits the zone of F800...F9FF occupied by the VIA to be distinguished from the FA00...FBFF (1A00...1BFF) area occupied by the 6532 on the main board. It would be nice to 'regain' the unused addresses for a new input/output circuit, as long as there are not too many modifications required.

Looking at the 'circuit' of figure 4, we recognize it as a section of the circuit for the interface card containing the VIA, gate N35 and PROM IC17. Signal K6 applied to the CS2 input is active between F800 and FBFF (1800...18FF), while the CS1 input receives a signal called VIA (active at logic 'high') obtained from K6 and address line AB9, between F800 and F9FF; this same signal is applied to the PROM and thus enables the buffers in read or write mode while the address signals are present on the bus. Every little detail must be taken into account!

The same components are seen in figure 5, along with a new 6520 PIA and a slight modification to the address decoding. The VIA signal is unchanged; it is still applied to the CS1 input of the 6522 and to the PROM (if this signal were modified then so also would the enable signal for the bidirectional buffers be changed). The CS2 signal for the 6522 is now supplied by AB8, and this means that the VIA no longer occupies addresses F800...FBFF (1800...18FF). Line AB8 is also connected to the CS0 input of the 6520 PIA for which our VIA signal (still obtained from K6 and AB9) provides the CS1 signal (active logic high, just like CS0). The third enable input of the 6520, CS2, is activated by the AB9 signal, so that the PIA is addressed between F900 and F9FF. This IC can be put anywhere as long as it is after the bidirectional data buffers (IC11 and IC12 of the interface board). Table 1 shows a summary of the operation of the new configuration in the form of a truth table.

Instead of mounting the new PIA on the bus, it could also be soldered directly on top of the 6522 on the interface board. This operation, relatively perilous in itself, has the advantage that it makes things much simpler. The lines common to both ICs are DB0...DB7 (pins 33...26), RES (pin 34), $\Phi 2$ (ENABLE; pin 25), +5V (pin 20), earth (pin 1), R/W (pin 22) of the 6522 - pin 21 of the 6520, RS0 (A0; pin 38 of the 6522 - pin 36 of the 6520), RS1 (A1; pin 37 of the 6522 - pin 35 of the 6520) and IORQ (pin 21 of the 6522 - pins 37 and 38 of the 6520). The connection between K6 and pin 23 of the 6522 (CS2) must be broken; this pin is then connected to AB8. Pin 23 of the 6520 (CS2) must be connected to AB9, pin 24 (CS1) to the VIA line (pin 24 of the 6522), and pin 22 (CS0) to AB8 (pin 23 of the 6522).

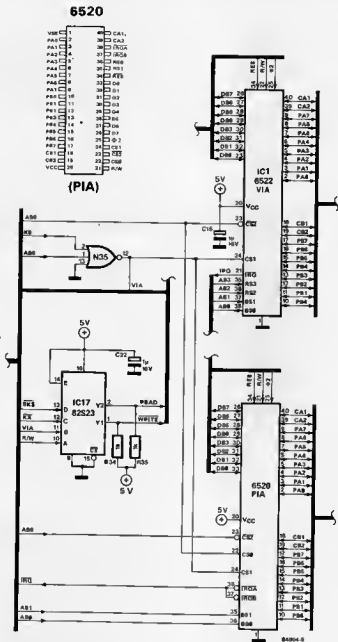

Figure 5. By applying the A88 signal (instead of K6) to the CS2 input of the 6522 VIA the doubly addressed zone where this circuit is located is divided in half. The second half can then be used to address a new I/O circuit. A 6520 PIA is used here but it could just as easily be a second 6522 VIA.

Finally, we must give some indication about how to access the registers of the 6520 PIA.

The addressing is as follows:

\$F900 : PAD or PADD (data or direction register A)

\$F901 : CRA (command register port A)

\$F902 : PBD or PBDD (data or direction register B)

\$F903 : CRB (command register port B)

When the CRA bit is high the register addressed at \$F900 is PAD, the data register. If this bit is low the register addressed is PADD, the data direction register. The same applies for CRB, with PBD and PBDD.

In spite of this somewhat peculiar addressing method, the operation of the 6520 ports

Table 1

K6	A9	A8	VIA	zone addressed	I/O
1	X	X	0	XXXX	
0	1	X	0	\$FA00 .. \$BFFF (\$1A00 .. \$1BFF)	6522
0	0	0	1	\$F800 .. \$8FF (\$1800 .. \$18FF)	6522
0	0	1	1	\$F900 .. \$9FF (\$1900 .. \$19FF)	6520

is the same as those of the 6522 except for some details (essential for some applications) which we will not go into here. Complete information on the 6522 is, in any case, contained in the Elektor book about this IC.

Table 1. The new I/O address decoding of the Junior Computer shown here as a sort of truth table shows how the zone is divided between the three ICs.

Connecting digital ICs within the same logic family will rarely cause any problems, as long as such things as fan-out and parasitic line and input capacitance are taken into account. It is quite a different matter, however, to try to use the different logic families, TTL (standard, LS and ALS) and CMOS, together. There is a great temptation to do just this as the possibilities for combinations becomes even greater with logic families continually being expanded. The new family of high speed CMOS (HCMOS) recently released onto the market prompts even more questions about the compatibility of its two variations with existing logic circuits. Maybe a lot of problems will be solved if we simply answer the question 'How digital is digital?'

mating logic families

it was all very easy when there was only TTL

The popularity of digital electronics is very easy to understand. What could be simpler than a system in which there are only two values, '1' or '0'? Certainly this makes design and fault finding much simpler, but there are also some other considerations. As long as the elements of a design are kept 'in the family', with only TTL or only CMOS, for example, the manufacturers have already sorted out the problem of matching different gates. The logic levels are well defined and the input and output currents are virtually the same. Combining different logic families, however, is a completely different kettle of fish. Then our old friend Murphy appears with a vengeance and seems to have taken a personal dislike to your design, whatever it is. With a bit of determination, however, even Murphy can be defeated (temporarily at least).

How the families compare

There are, of course, some advantages to having different logic families. It becomes easier, for instance, to combine speed

with economy. The appearance of different logic families is largely based on the attempts to achieve ever shorter switching times and smaller power consumption. Within the scope of a short article we cannot deal with all logic families, and this would, in any case be overdoing it a bit as we are only interested in logic elements that are already, or will soon be, readily available. A summary of the families to be dealt with and their most notable characteristics is shown in table 1. These data should only be considered as an indication and not as exact values. The only function of this table is to aid the general comparison so the values can vary depending on the circuit and even the manufacturer.

The values of logic '1' and '0' have to be specified as a certain voltage and the symbols we will use to make this definition are shown in figure 1. In order for the circuit to operate under the least favourable conditions (the worst case) UOH must always be larger than UIH and UOL must be smaller than UIL. A summary of the voltages needed for the various logic families is given in table 2. The CMOS levels are only given at 5 V because we want to ensure compatibility with TTL.

Table 1

series	TTL			CMOS		
	7400	74LS	74ALS	4000	74HC	74HCT
supply voltage	5 V	5 V	5 V	3-18 V	2-6 V	5 V
dissipation per gate	10 mW	2 mW	1 mW	2.5 nW	2.5 nW	2.5 nW
gate delay time	10 ns	9.5 ns	4 ns	40 ns	9 ns	9 ns

Possibilities for combination

First we will see which families are matched purely on the basis of input and output levels. Most notable is the fact that interconnecting elements within the TTL group causes no problems. In one case the noise margin is even improved; this happens if LS or ALS is used in place of standard TTL.

Connecting TTL to HCMOS is no problem either as this version of high speed CMOS is TTL compatible. Furthermore the user does not even need to know he is working with CMOS because its gates appear to be extra-efficient LS/TTL devices. The supply voltage tolerance with HCMOS is larger than with TTL (10% instead of 5%), which simply means that the

Figure 1. Here we define the logic levels as fixed voltages. Between 'high' and 'low' is a 'no man's land'.

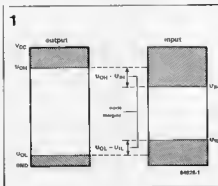

Table 2.

VCC	TTL	LSTTL	ALSTTL	CMOS	HCTMOS	HCMOS	
	5 V ± 5%	5 V ± 5%	5 V ± 5%	3-18 V 5 V	5V ± 10%	2-6 V 5V ± 10%	3 V
U _{IH} - logic 1 input level (min.)	2.0 V	2.0 V	2.0 V	3.5 V	2.0 V	3.15 V	2.1 V
U _{IL} - logic 0 input level (max.)	0.8 V	0.8 V	0.8 V	1.5 V	0.8 V	1.1 V	0.6 V
U _{OH} - logic 1 output level (min.)	2.4 V	2.7 V	2.7 V	4.5 V	3.7 V	3.7 V	2.2 V
U _{OL} - logic 0 output level (max.)	0.5 V	0.5 V	0.4 V	0.4 V	0.4 V	0.4 V	0.4 V
I _{IL} - input sink current (max.)	1.6 mA	-0.36 mA	-0.2 mA	0.005 μA			
I _{IH} - output source current (max.)	40 μA	20 μA	20 μA	0.005 μA			
I _{OL} - output sink current (min.)	16 mA	8 mA	4 mA	0.4 mA	4 mA	4 mA	4 mA
I _{OH} - output source current (min.)	-400 μA	-400 μA	-400 μA	-0.4 mA	-4 mA	-4 mA	-4 mA

TTL supply can be used for HCMOS but the reverse is not necessarily true. It is not quite so easy to connect TTL to CMOS. The U_{OH} in TTL is lower than the U_{IH} in CMOS with a supply of 5 V. This means that a logic 1 at a TTL output will not be interpreted as 'high' by a CMOS input.

The same applies if we want to use HCMOS and TTL with a supply of 5 V. In this case U_{IH} (for HCMOS) is a minimum of 3.15 V, which is much too high for TTL. All is not lost, however, as the supply voltage for HCMOS can be anywhere between 2 and 6 V. If the HCMOS section of a circuit is operating on a supply of 3 V then U_{IH} is 2.1 V (70% of 3 V). Now TTL can provide a logic 1, with a margin of 0.3 V. One situation that can arise here, however, is that the TTL output level can be higher than the HCMOS supply voltage. In this case the current flowing through the 150 Ω input resistor and the input protection diode is limited by the resistor and by the collector resistance in the output circuit of the TTL gate. As long as the input current does not exceed 20 mA nothing untoward should happen. What logic 0 means in this case is three things: U_{IL} is a maximum of 0.6 V (20% of 3 V), while the U_{OL} for TTL is 0.5 V which leaves a margin of 0.1 V. Fortunately it is not such a problem to drive TTL from CMOS or HCMOS, as long as the supply is 5 V. The input levels for TTL do not have to be very precise; U_{IL} is relatively high and U_{IH} fairly low. The CMOS output voltages are therefore quite suitable for the TTL inputs, but care must be taken to ensure that the CMOS can handle the

relatively high TTL input current. This applies particularly to driving standard TTL from ordinary CMOS, we will deal with this further under 'fan-out'. If the CMOS is operating at a higher supply level then obviously a level adapter circuit is needed at the connection to TTL or HCTMOS.

Fan out

As regards input current distinction must be made between TTL and CMOS. The input of a TTL gate consists of a (multi-emitter) transistor whose base is connected to VCC via a resistor, as shown in figure 3. Consequently a floating input is always seen as a logic 1. The output is logic 0 if the input is earthed, then a current, the sink current, flows from the input. The sink current is 1.6 mA in standard TTL, 0.4 mA for LSTTL and 0.2 mA with ALSTTL. These values are also stated in table 2. The output of the driving gate must be able to handle this current. This, of course, presents no problems for TTL as the outputs are designed with this in mind, but CMOS is a different matter. Within the CMOS family the outputs are not expected to deliver large currents. The only current that will flow is the charging current for the input capacitance (and otherwise only the input leakage current) which has a value of a few nA. As a general rule the fan out, even between different families, can be calculated by dividing the maximum output current by the required input current. These currents are defined for both logic levels (see table 2 again). Because of the set-up of the

2

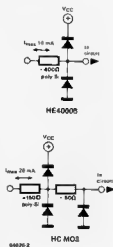

Figure 2. Input protection circuits for HCMOS and CMOS circuits.

3

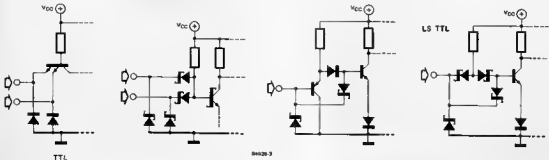

Figure 3. Various configurations of (LS) TTL inputs. If the input is made 'low' a relatively large current flows from the input (the sink current).

TTL input circuit I_{IL} is considerably greater than I_{IH}. As a consequence of this lack of symmetry the fan out at both logic levels must be calculated and the smaller value taken as the limit. Using the data in table 2, the fan out for various different combinations is easily found. A separate table (table 3) has been

Table 2.

to \ from	TTL	LS TTL	ALS TTL	HCT MOS	HC MOS	CMOS
TTL	10	10	10	20	20	20
LS TTL	10	5	5	20	20	20
ALS TTL	10	5	5	20	20	20
HCT MOS	10	2	2	20	20	20
HC MOS	10	2	2	20	20	20
CMOS	10	2	2	20	20	20

- 1: with 78 and 74LS buffers the fan out is three times as large
- 2: 74HC and 74HCT ICs with bus driver outputs have a fan out 1 x greater at 193Ω
- 3: Normally CMOS cannot handle the normal TTL sink current but this depends on make and type.
- 4: Theoretically infinite, but in practice limited by the maximum permissible delay times
- 5: Direct connection not possible because of different logic levels
- 6: May only be combined if the CMOS section works from a supply of 3 V

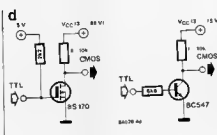
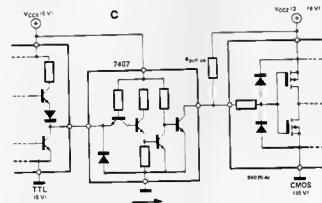
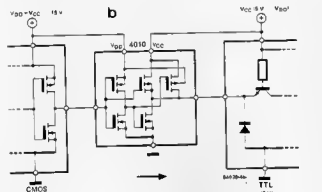
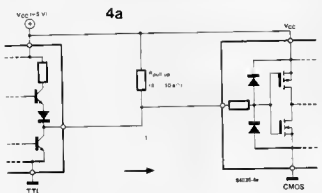

Figure 4. Different adapter circuits.
 4a: from TTL (5 V) to CMOS (5 V)
 4b: from CMOS (at, for example, 15 V) to TTL (5 V)
 4c: from TTL (5 V) to CMOS (at 15 V, for example)
 4d: two discrete versions of 4c

drawn up to show a summary of the results. This fan out is only shown for the combinations whose logic levels adapt directly to each other, as indicated by table 4.

Because of its large sink current, TTL can be heavily driven. The fan out, for driving normal TTL, is, as a rule, low. Not even CMOS can handle the sink current of 1.6 mA. As a result of this it is not possible to connect CMOS directly to TTL, even though their voltage levels are similar. There are, however, some CMOS ICs available with buffered outputs that can sink a current of 1.6 mA. Otherwise the CMOS outputs could also be connected in parallel until the I_{IL} required is reached. The data sheets from the relevant manufacturer should be studied for more details about this.

There are less problems with driving LSTTL and ALSTTL because of their smaller sink current. CMOS can also drive LSTTL and ALSTTL directly.

The input requirements of all the MOS families are so modest that the fan out is theoretically very high (several thousand). In practice this is limited by the input capacitance and the lead capacitance. If the maximum frequency stated by the manufacturer is to be attained (generally given by C_L = 10, 15, 50, or 100 pF), then the fan out is defined by dividing C_L by the input capacitance. As a general rule 10 pF per input can be taken as the norm. Remember, of course, that the input capacitance is very dependent on the technology used; CMOS ICs manufactured by metal gate techniques have a larger input capacitance than those made using silicon gate technology. Also, a length of ribbon cable or a track on a printed cir-

cut board can form a considerable capacitance. In all these cases it is up to the user to set an acceptable delay time and therefore the fan out.

Adapter circuits

In order to connect TTL (standard, LS and ALS) to 5 V supplied CMOS and HCMOS, the TTL must be able to provide the logic 1 level needed by the CMOS (at least 3.5 V). This is simply done using a pull up resistor, as figure 4 shows. A small value results in a high speed as parasitic capacitances are then charged more quickly. The minimum resistance possible is decided by the maximum load for the output. In theory the number of inputs driven by this output must also be taken into account, but if they are MOS inputs, which have negligible input current, that can simply be ignored. The minimum value of the pull up resistor is defined by:

$$R(\text{min.}) = [V_{CC}(\text{min.}) - U_{OH}] / [I_{OH} + \sum I_{IH}]$$

The second term in the denominator, the sum of the input currents, can be neglected if we are talking about MOS inputs.

There is also a maximum permissible value for the pull up resistor. Because of leakage currents at the output (if, for example, several open collector outputs are connected together) and the input, there is a voltage drop across the pull up resistor at logic 1. As the output voltage may never be less than U_{IH} , the maximum value of the pull up resistor is defined by:

$$R(\text{max.}) = [V_{CC}(\text{min.}) - U_{OH}] / [\sum I_{OH} + \sum I_{IH}]$$

Here again the second term of the denominator can be ignored for MOS inputs.

What all this means, in effect, is that the pull up resistor must have a value of 1...10 k Ω . Generally these formulae can be applied to the pull up resistors of open collector outputs whether they drive CMOS or HCMOS or not.

The situation is quite different if one logic device operates at a different supply level, which also means different logic levels. A single 4009, 4010, 4049 or 4050 buffer can be used as a high-low adapter, for example from 18 V CMOS to 5 V TTL. Each package contains six buffers, and in the case of the 4009 and 4049 they are also inverters. These buffers, which can drive up to 2 TTL inputs or 9 LSTTL inputs, can also be used, for example, to drive standard TTL from CMOS.

And so to the last combination possibility: from 5 V TTL to CMOS working at a higher level, or HCMOS at 6 V. This is also fairly straightforward if we are working with open collector outputs. In some cases the output transistor's UCE is higher than VCC. Examples of this are the 7406 and 7407 with 30 V open collector outputs and the 7416 and 7417 with 18 V open collector outputs. The value of the pull up resistor must be carefully chosen so that

Table 4

to from	TTL	HCT MOS	HC MOS (5 V)	CMOS (5 V)	CMOS (6 V)
TTL	●	●	○	■	■
HCT MOS	●	●	○	■	■
HC MOS (5 V)	●	●	○	■	■
CMOS (5 V)	○	○	○	○	○
CMOS 6 V	○	○	○	○	○

- Logic levels are right but sink current must be taken into account. Buffers are needed.
- Possible as long as the HCMOS section has a supply of 5 V.
- Not possible without extra adapter circuitry.

the sink current does not become too large.

The fan out of the 74XX buffers listed above is three times the standard fan out, so the pull up resistor is unlikely to be too small. The disadvantage of this is that unnecessarily small pull up resistors can draw a much larger current for a negligible increase in speed.

A discrete buffer stage could, of course, be built using a transistor and two resistors to drive CMOS from TTL. This effectively creates an open collector output. Two possibilities for this are shown in figure 4d, the first having the advantage of a faster switching time.

Finally

It is not a good idea to leave unused TTL inputs floating, even though they normally act as if they were logic 1. If, for example, a certain LSTTL IC with a floating input is changed for its HCTMOS equivalent this causes problems. The very high input impedance means that the logic level will not be defined and the circuit will not work (properly). The moral of this is that unused inputs should always be tied to one logic level; for TTL use a pull up resistor (1...10 k Ω) to VCC, connect directly to earth or to an input that is used (LS inputs can be connected directly to +5 V). With all MOS versions connect unused inputs to VCC, earth or an input that is used.

It is virtually impossible to list how to interconnect all the various logic families from different manufacturers who specify different testing conditions for their gates. However, that was never our intention, and we think that this summary of the present possibilities should at least enlighten the hobbyist as to what can be done with what is available today.

ECL
Emitter Coupled Logic, fast unsaturated logic.

TTL (7400 series)
Ternistor Transistor Logic, circuits with transistors in saturation. Slower than ECL.

HTTL (74H series)
High speed TTL

LTL (74L series)
Low power TTL

STTL (74S series)
Schottky TTL. The use of Schottky diodes prevents the transistors from being driven too far into saturation. This increases the switching speed.

LSTTL (74LS series)
Low power Schottky TTL.

ALSTTL (74ALS series)
Advanced Low power Schottky TTL. These are the fastest and most economical TTL devices.

CMOS (4000 series)
Complementary Metal Oxide Semiconductor, fairly slow but very economical logic family.

HCMOS (74HC series)
High speed CMOS, CMOS with LSTTL switching times

HCTMOS (74HCT series)
High speed TTL compatible CMOS, low power consumption

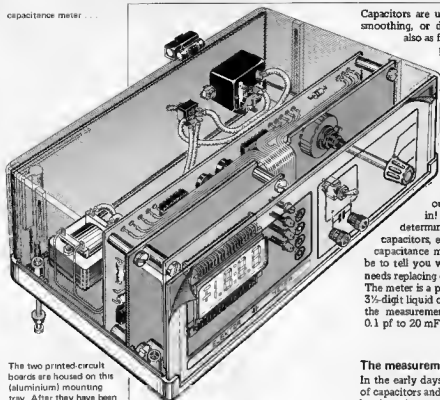

The two printed-circuit boards are housed on this (aluminium) mounting tray. After they have been interconnected, the metering board is connected to the front panel. The resulting entity can then conveniently be slid into the grooves provided in the case.

Capacitors are used mainly as blocking, smoothing, or decoupling elements, and also as frequency determining components in HF and AF engineering. If capacitors are to be used in filters, they should be as close as possible to the calculated value. That normally means the use of high stability capacitors, but the precise value can of course, be determined by some sort of measuring instrument, and this is where our capacitance meter comes in! It will enable you to determine the exact value of the capacitors, easily and conveniently. The capacitance meter will, of course, also be to tell you whether a suspect capacitor needs replacing or not.

The meter is a precision instrument with a 3½-digit liquid crystal display which enables the measurement of capacitances from 0.1 pF to 20 mF in six ranges.

The measurement of capacitance

In the early days of electronics, the values of capacitors and inductors were determined by impedance measurement in bridge circuits. Such measuring bridges contained, apart from an oscillator, power supply, and sensitive meter amplifier, also very precise and therefore very expensive reference capacitors or inductors. Furthermore, operating these bridges correctly was not a simple matter. None the less, there can be no doubt about the superiority of them. For instance, they make possible the quick determination of factors other than the value, such as the Q factor and inherent losses, which are equally important for the calculation of the impedance of a circuit. However, these factors are not normally of great importance to us.

capacitance meter...

... to find those elusive farads!

- Measuring ranges: 200 pF; 20 nF; 2 µF; 200 µF; 2000 µF; 20 mF (all f.s.d).
- Accuracy, 1 per cent (if calibrated with a 1% reference capacitor — otherwise larger); 10 ... 15 per cent in the 20 mF range.
- Read-out on 3½-digit liquid crystal display (LCD).
- Capacitor leakage current does not effect reading.
- Measurement of capacitances below 1 pF.
- Measurement of capacitances of varicaps.
- Measuring time not greater than 1 s.
- Measurement at nominal frequency according to manufacturers' specification (except in the 20 mF range).
- Can be used with test leads (except in the 200 pF range).

Simple and easy-to-operate capacitance meters usually require the unknown capacitor, C_x , to be inserted into an oscillator circuit. The frequency of the resulting signal is measured with a frequency counter or a voltmeter (after conversion to a proportional voltage). An appropriately calibrated scale on these instruments makes it possible to read off the value of the capacitor directly (see, for instance, *Elektr*, December 1981: 'capacitance meter module' page 1218). A different method of measurement is illustrated in figure 1. The point of this method is that the unknown capacitance, C_x , after differentiation of the input signal (by C_x/R_g), is determined by a voltage measurement. By making the value of R_g much smaller than the impedance X_C ,

the value of C_X can be calculated from

$$C_X = U_1 / 2\pi f_0 R_3 U$$

in which π , f_0 , R_3 , and U are known constants, so that only the value of the measured voltage, U_1 , needs to be inserted.

You don't, of course, want to be bothered with pen, paper, and pocket calculator every time you measure a capacitor, but want to read off its value directly. The diagram of figure 1 is therefore extended into that of figure 2.

The triangular output of the generator is passed to C_X which has been connected in a differentiating circuit. The output of this circuit is a square wave of which the amplitude is proportional to the value of C_X (like U_1 in figure 1). The square wave is rectified in a phase-selective synchronous rectifier: the level of the resulting voltage is measured by a digital voltmeter.

The phase-selective rectifier operates as follows. The square wave output of the differentiator is applied to electronic switch ES5 in phase with the rectangular output of the generator, and to electronic switch ES6 in antiphase with the rectangular output of the generator. The switches are synchronized with the triangular waveform and only pass the positive portions of the square waves. The two resulting square waves are added to provide a d.c. voltage.

The relationship between the waveforms is illustrated in figure 3. The 'rooftops' on the rectangular waveshapes are caused by the leakage current through C_X . This current, which is caused by the triangular output of the generator, does not affect the measurement. Firstly, it largely disappears in the build-up of the average level (figure 3B), and, secondly, it is not accepted by the phase-selective rectifier because it is 90° out of phase with the triangular current. In an ideal circuit, the triangular signal superimposed onto the d.c. voltage (figure 3C) does not rise at all.

The circuit diagram

The waveform generator is built up from two opamps: a Schmitt trigger (IC1) and an integrator (IC2). When the output of the integrator reaches the upper trigger level of the Schmitt trigger, the input to the integrator is inverted. The output level of IC2 then decays until the lower trigger level of the Schmitt trigger is reached. In this way, IC1 produces a rectangular signal and IC2 a triangular one.

The output voltage of IC2 is the test signal for C_X and is connected to the inverting input of the differentiator IC3. The output of the differentiator is therefore a rectangular voltage, the level of which is proportional to the value of C_X .

The phase-selective rectifier consists of electronic switches ES5 and ES6 which obtain their signals direct from IC3 and inverted from IC4. The control signal for the switches is taken from IC1 and fed direct to ES5 and inverted (by ES4) to ES6. The output signals of ES5 and ES6 are added and taken to the digital voltmeter via R20 (see figure 5).

1

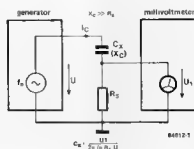

capacitance meter ...

Figure 1. Illustration of how a voltage measurement may be used to determine the value of a capacitance. For instance, if $U = 3 \text{ V}$, $f_0 = 1 \text{ kHz}$, $R_3 = 100 \Omega$, and U_1 (measured) = 3 mV , $C_X = 1.6 \text{ nF}$.

2

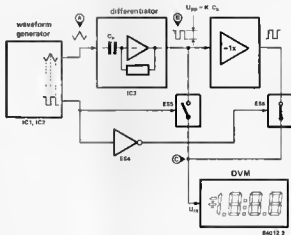
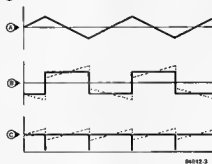

Figure 2. This set-up functions in a similar way to that in figure 1, but a phase-selective rectifier and digital voltmeter have been added.

3



The low-pass filter formed by P1, R6, and C2 derives a small triangular signal from the square-wave output of IC1, which is applied to the input of IC3 via C3. As the test signal is in antiphase with this voltage, the unavoidable parasitic capacitance at the test terminals is simply 'spirited away'. In practice this means: adjust P1 with open test terminals so that the DVM reads '0'. If the wrong measuring range has been selected, IC5 switches on electronic switch ES7 at a certain input level. When that happens, a large d.c. voltage is applied to

Figure 3. The triangular voltage A is generated by a waveform generator. After this has been differentiated by C_X , a rectangular voltage B results which may have a superimposed component (dashed lines) caused by leakage currents. The rectified voltage C is almost free of this leakage-induced component which is largely removed by the rectifier circuits.

the DVM via R21 and the meter shows an overflow.

When the value of C_X is too high for the selected measuring range, IC3 no longer functions as differentiator but rather as comparator for the triangular signal at its input. The result is that a rectangular signal appears at the output of IC3 which is 90° out of phase with respect to the signal which would have appeared under correct conditions. The rectifier will then not have an output, and the DVM reads '0'.

Some more points about the measuring ranges and the test signals. Switch S1 is the range selector. For capacitors between 0 and 2 μF , the amplitude of the triangular signal is about 1.8 V_{pp} at a frequency of around 1000 Hz. Switches ES1 and ES2 are then closed. This enables the measurement of all non-electrolytic capacitors in three ranges; the test conditions conform to the manufacturers' specifications. Three ranges are also available for the measurement of electrolytic capacitors. These measurements are carried out at lower frequency and voltage ($f = 100 \text{ Hz}$, and $U_1 = 18 \text{ mV}_{pp}$) and are also in accordance with manufacturers' conditions of test. In the 'f' range, the frequency is reduced to 10 Hz (ES3 closed), because the current at 100 Hz would be about 72 mA which is too much for the opamp. The consequence of this is that

the accuracy in this range is only 10 . . . 15 per cent. Fortunately, this is not so bad, because the exact value of electrolytics in this range is normally not very important. If it is required to measure an electrolytic capacitor in range 'c', switch S2 raises the test signal by about 1.5 V to ensure that the test voltage in this range is always positive. In the other ranges, the very small negative voltage of about 9 mV_{pp} causes no harm.

The circuit of figure 5 is basically that of the 'LCD panel meter' featured in the October 1981 issue of *Elektron*. However, in the present circuit the decimal point is switched by S1b and associated diode matrix. Moreover, the selected range is indicated by LEDs D3 . . . D7.

Construction

First of all, mount (but do not solder) all resistors up to and including R11 and all capacitors up to and including C9 onto the metering board shown in figure 6. It's best to use soldering pins for this to simplify the soldering after calibration.

Next, fit all components (except R1 and R7) to the display board shown in figure 7. The display and LEDs must be located on the track side; solder the LEDs so that they are well separated from the display. For

$$f_a \dots c = \frac{R_2}{4R_1C_6(I_{P2} + R_6)}$$

$$f_{d,e} = \frac{R_3}{4R_1R_7C_6}$$

$$f_f = \frac{R_3}{4R_1R_7(C_4 + C_6 + C_6)}$$

4

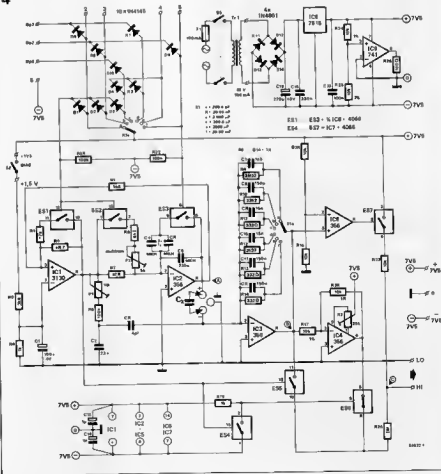

Figure 4. In this circuit of the meter board the wave-form generator consists of IC1 and IC2, the differentiator of C_X and IC3, and the phase-selective rectifier of ES4, ES5, ES6, and IC4. Switches S1 and ES1 . . . ES3 provide range selection. Switch S2 provides an off-set voltage at the C_X (test) terminals. IC5 and ES7 together form an 'overflow' detector.

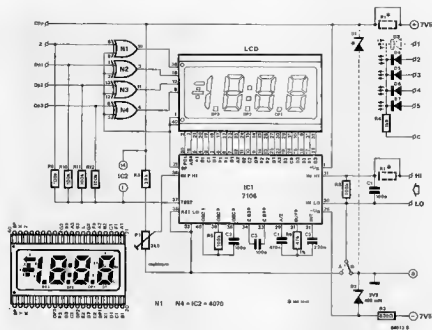

Figure 5. The digital voltmeter in the familiar configuration with IC1 and an LCD. This circuit can be used independently as an LCD panel meter.

the time being, substitute wire bridges for R1 and R7. Do not yet solder diodes D1 and D3. Lastly, fit wire bridge B.

The mechanical construction is best carried out with an eye on the sketch in figure 8. We have used a Vero case into which the aluminium mounting tray can simply be inserted after the calibration. Both printed-circuit boards are mounted onto this tray: the display board at the front and the meter board at the rear. This method also ensures the screening of these circuits from one another.

Terminals with identical markings on the two boards should be interconnected with short lengths of wire, but keep terminals '1', 'CDp', and 'Z' on the display board free. The terminals for connecting C_x should be connected to the meter board by twin screened cable. The screen should be soldered ONLY to the common earth terminal (1) near the C_x pins.

Finally, the time has come to connect S2 to the meter board and the earth terminals on the front panel and mounting tray to earth. Then mount the mains transformer, mains on/off switch, and the fuse carrier and fuse in the case. Keep the transformer as far away as possible from the meter board. After sticking the transfer onto the front panel, this and the mounting tray may be inserted into the grooves provided on the case.

Calibration

First, set the range selector, S1, to position 'f' and adjust preset P3 for zero reading of the display. Next, set S1 to 'a' and adjust preset P1 on the meter board for zero reading of the display.

Switch off the mains supply to the capacitance

meter and solder a high stability (1%) resistor of 330 k Ω in the R12 position and a capacitor of 150 pF in the C10 position (both on the meter board). Then connect a 1.5 μ F (not electrolytic!) capacitor to the C_x terminals. Set S1 to 'd', switch on the mains supply, and note the indicated value. Then set S1 to 'c', and adjust P2 so that the display indicates the same value as just noted. The position of the decimal point is irrelevant. Remove the 330 k Ω resistor and 150 pF capacitor and solder a 3.3 k Ω resistor and 15 nF capacitor in their place. Finally, connect a 10 nF, 1% tolerance, capacitor across the C_x terminals, set S1 to position 'b', and adjust P1 on the display board so that the display reads exactly 10.00 nF. If the 10 nF capacitor used has a larger tolerance, measuring results will also have a larger tolerance. This completes the calibration; all components should now be soldered into place.

Applications

The capacitance meter can also be used as interface for a digital voltmeter: the display board is then, of course, not required. Resistor R20 should be 100 k Ω instead of 1 M Ω and a multi-turn preset of 1 M Ω should be connected between terminals HI and LO. The wiper of this preset becomes the output of the interface. The new preset will be used instead of P1 (on the display board) for calibrating the circuit. There is only one (minor) snag: the decimal point is not in the right position! So, remember this!

It is also possible to use the capacitance meter for the measurement of varicaps, but it will then have to be provided with a variable voltage source. A design for

Meter board:
P1 sets display to '0' in range a
P2 calibrates ranges c and d
P3 sets display to '0' in range f

Display board:
P1 calibrates to reference value

Figure 6. Component layout and track side of the printed-circuit board for the metering unit. The range selector is soldered onto this board to reduce parasitic capacitances.

Parts list — metering board

Resistors:

R1 = 5k6
 R2 = 47 k
 R3 = 4M7
 R4, R19 = 1 k
 R5 = 3k9
 R6, R22, R23 = 100 k
 R7 = 10 M
 R8 = 8k2
 R9 = 3M3, 1%
 R10 = 33 k, 1%
 R11, R13, R14 = 330 Ω , 1%
 R12 = 3k3, 1%
 R15, R16, R21 = 10 k
 R17, R18, R24, R25 = 10 k, 1%
 R20 = 1 M
 R26 = 100 Ω
 P1 = 1 M preset
 P2 = 5 k multi-turn preset
 P3 = 25 k preset

Capacitors

C1 = 100 μ /4 V
 C2 = 22 n
 C3 = 4p7
 C4, C5 = 1 μ
 C6 = 220 n
 C7 = 1p6
 C8 = 150 p
 C9, C10 = 15 n
 C11, C12 = 150 n
 C13, C14 = 1 μ /16 V
 C15 = 220 μ /40 V
 C16 = 330 n
 C17 = 100 n
 Capacitor 10 nF \pm 1%
 (for calibration)

Semiconductors

D1 ... D10 = 1N4148
 D11 ... D14 = 1N4001
 IC1 = CA 3130E
 IC2 ... IC5 = LF 356N
 IC6, IC7 = 4066
 IC8 = 7815
 IC9 = 741

Miscellaneous

S1 = printed-circuit switch,
 2 pole, 6 way
 S2 = SPST switch
 S3 = DPST mains switch
 T1 = mains transformer,
 18 V/150 mA secondary
 F1 = 100 mA slow blow
 mini fuse with carrier
 Case, Varo 202-21035F
 Printed-circuit board
 84012-1
 Transfer for front panel

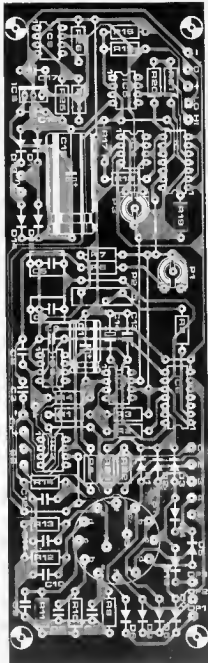
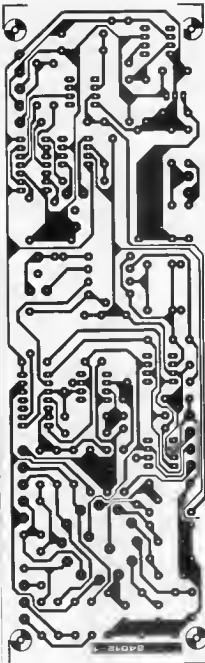

this is shown in figure 9. The indicated capacitance is proportional to the applied voltage which makes it possible to determine the diode characteristic. Care should be taken not to apply a voltage below 2 V, otherwise the diode may conduct. Because of the metering a.c., the measurement may show an error of a few per cent. Since pin 6 of IC3 is connected to the pole of S1a, it would, of course, be possible to run a

wire from there to a 'varicap' terminal on the front panel.

Important!

Before connecting any capacitor, more especially electrolytics, to the C_x terminals, make sure that it is completely discharged by connecting a resistor in parallel with it! Do not use test leads on the lowest range ('a'):

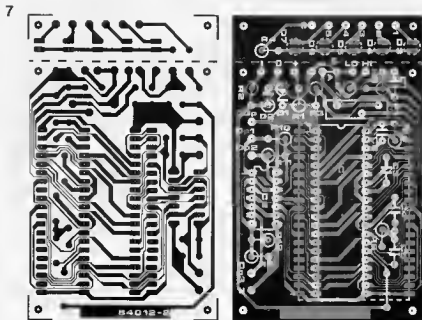

capacitance meter.

Figure 7. Component layout and track side of the display unit. The LCD and LEDs are fitted to the track side. Diodes D1 and D3 are not required here.

Parts list — display board:

Resistors:

- R1, R7 = wire bridge
- R2 = 820 Ω
- R3 = 22 k
- R4 = 1k5
- R5, R8... R12 = 100 k
- R6 = 47 k
- P1 = 2k5 multi turn preset

Capacitors:

- C1, C3 = 100 n
- C2 = 100 p
- C4 = 470 n
- C5 = 220 n

Semiconductors:

- D1, D3 = not used
- D2 = zener diode 3V3/0.4 W
- D4... D7 = LED
- IC1 = ICL7106
- IC2 = 4070
- LCD = liquid crystal display type NDP530-035A-S-RF-1C

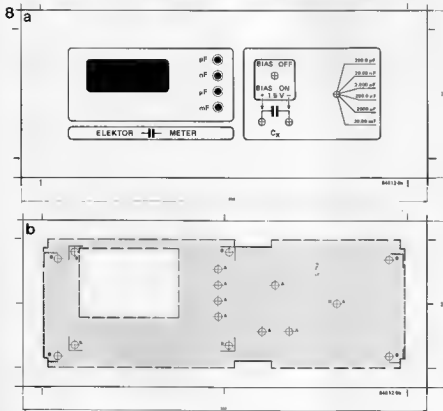

Figure 8. The mounting tray and front panel. It is, of course, possible to use a different (or no) mounting tray if the case shown in the parts list is not used.

Summarizing . . .

... some of the outstanding points of the capacitance meter:

- All capacitances are measured at the correct frequency.
- Leakage currents have negligible influence on the measurement results.
- The effect of wiring capacitances has been reduced to such an extent that capacitance values smaller than 1 pF may

be measured.

- After the capacitor under test has been connected, the display indication will appear in less than one second: this remains true for values up to 1000 μ F!

Sources: 'Capacitance-to-voltage converter', W.B. de Ruyter, *Wireless World*, June 1983, page 68.
'LCD panel meter', *Elektor*, October 1981, page 10-32. U.K.

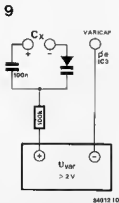

Figure 9. Test circuit for the determination of the characteristic of varicap diodes.

Two of our recent projects, the VDU card and the Basicode-2 interface, can both be used individually with the Junior Computer. However, there are bound to be some JC users who are interested in using these two 'extras' together. The program given here was designed to do just this and thus provide the best of both worlds. Two versions of the software have been developed, for the extended Junior and for the DOS Junior.

Basicode-2 for Junior plus VDU card

Junior Computer + VDU card + Basicode-2 = the best of all worlds

The description of Basicode-2 and the adaptation to use Basicode-2 with the Junior Computer in particular have already been dealt with in Elektor UK102, October 1983. All details of the hardware and software needed are given there so we will not go into that again here. The only change needed to use Basicode-2 with the Junior Computer and VDU card is to modify the standard subroutines. Two tables of these subroutines are given in this article: one for the extended Junior with VDU card and the other for DOS Junior with VDU card.

A few changes

Some modifications or additions to the 'old' subroutines are needed. Subroutine 110 is changed. We have written a small machine-code program to speed up the positioning of the cursor (to HQ, VE). Whenever a jump to line 20 is made in a Basicode-2 program (as always happens), then a piece of machine-code is first written into RAM. If the program then comes to subroutine 110 at any stage this machine-code program is called and the cursor is brought very quickly to the position defined by HQ and VE. Subroutine 120, requesting the position of the cursor on the screen, is possible with this combination even though it did not work with the Junior/Elektterminal combination.

The only routine that is still unworkable is subroutine 200. The Junior simply cannot determine if a key is pressed at a particular moment. A GOSUB 200 in a program must therefore be changed. Actually there are two routines that do not work, the second being subroutine 250. However, the bleep that should be generated by a GOSUB 250 can hardly be considered essential for the correct operation of a program. One further important note. If the Basicode-2 translation program is used with the DOS Junior, great care should be exercised when using the DISK"..." command. If, for instance, a BASIC program is loaded from the floppy with the command DISK"LO..." and this program is then to be saved on tape in Basicode-2 format, the 'save' may not work because DISK"..." causes page zero to be 'swapped'. The result of this is that the pointers needed in the Basicode-2 translation program are not longer correct. There is a very simple solution for this. After removing anything from (or storing anything on) the floppy disk the number 1 is typed and a (CARRIAGE) RETURN given. A dummy line has then been included and the pointers are again correct. Everything will then operate correctly provided there is nothing on line 1, otherwise a different (blank) line number must be used.

Table 1. These are standard subroutines for the extended Junior with the VDU card.

Table 2. This is a list of the subroutines to use for the DOS Junior with the VDU card.

1	LIST
10	BDTD 0900
20	BDI \$P\$ B, \$B, \$D, \$F\$, \$I, \$J, \$K, \$L, \$M, \$N, \$O, \$P, \$Q, \$R, \$S, \$T, \$U, \$V, \$W, \$X, \$Y, \$Z, \$[, \$], \$^, \$_, \$~, \$`
30	BDI AARD, 120, 240, 360, 480, 600, 720, 840, 960, 1080, 1200, 1320, 1440, 1560, 1680, 1800, 1920, 2040, 2160, 2280, 2400, 2520, 2640, 2760, 2880, 3000, 3120, 3240, 3360, 3480, 3600, 3720, 3840, 3960, 4080, 4200, 4320, 4440, 4560, 4680, 4800, 4920, 5040, 5160, 5280, 5400, 5520, 5640, 5760, 5880, 6000, 6120, 6240, 6360, 6480, 6600, 6720, 6840, 6960, 7080, 7200, 7320, 7440, 7560, 7680, 7800, 7920, 8040, 8160, 8280, 8400, 8520, 8640, 8760, 8880, 9000, 9120, 9240, 9360, 9480, 9600, 9720, 9840, 9960, 10000
40	BDI 0001, 0002, 0003, 0004, 0005, 0006, 0007, 0008, 0009, 0010, 0011, 0012, 0013, 0014, 0015, 0016, 0017, 0018, 0019, 0020, 0021, 0022, 0023, 0024, 0025, 0026, 0027, 0028, 0029, 0030, 0031, 0032, 0033, 0034, 0035, 0036, 0037, 0038, 0039, 0040, 0041, 0042, 0043, 0044, 0045, 0046, 0047, 0048, 0049, 0050, 0051, 0052, 0053, 0054, 0055, 0056, 0057, 0058, 0059, 0060, 0061, 0062, 0063, 0064, 0065, 0066, 0067, 0068, 0069, 0070, 0071, 0072, 0073, 0074, 0075, 0076, 0077, 0078, 0079, 0080, 0081, 0082, 0083, 0084, 0085, 0086, 0087, 0088, 0089, 0090, 0091, 0092, 0093, 0094, 0095, 0096, 0097, 0098, 0099, 0100
50	BDI 0000, 0100, 0200, 0300, 0400, 0500, 0600, 0700, 0800, 0900, 1000, 1100, 1200, 1300, 1400, 1500, 1600, 1700, 1800, 1900, 2000, 2100, 2200, 2300, 2400, 2500, 2600, 2700, 2800, 2900, 3000, 3100, 3200, 3300, 3400, 3500, 3600, 3700, 3800, 3900, 4000, 4100, 4200, 4300, 4400, 4500, 4600, 4700, 4800, 4900, 5000, 5100, 5200, 5300, 5400, 5500, 5600, 5700, 5800, 5900, 6000, 6100, 6200, 6300, 6400, 6500, 6600, 6700, 6800, 6900, 7000, 7100, 7200, 7300, 7400, 7500, 7600, 7700, 7800, 7900, 8000, 8100, 8200, 8300, 8400, 8500, 8600, 8700, 8800, 8900, 9000, 9100, 9200, 9300, 9400, 9500, 9600, 9700, 9800, 9900, 10000
60	BDI 0000, 0100, 0200, 0300, 0400, 0500, 0600, 0700, 0800, 0900, 1000, 1100, 1200, 1300, 1400, 1500, 1600, 1700, 1800, 1900, 2000, 2100, 2200, 2300, 2400, 2500, 2600, 2700, 2800, 2900, 3000, 3100, 3200, 3300, 3400, 3500, 3600, 3700, 3800, 3900, 4000, 4100, 4200, 4300, 4400, 4500, 4600, 4700, 4800, 4900, 5000, 5100, 5200, 5300, 5400, 5500, 5600, 5700, 5800, 5900, 6000, 6100, 6200, 6300, 6400, 6500, 6600, 6700, 6800, 6900, 7000, 7100, 7200, 7300, 7400, 7500, 7600, 7700, 7800, 7900, 8000, 8100, 8200, 8300, 8400, 8500, 8600, 8700, 8800, 8900, 9000, 9100, 9200, 9300, 9400, 9500, 9600, 9700, 9800, 9900, 10000
70	BDI 0000, 0100, 0200, 0300, 0400, 0500, 0600, 0700, 0800, 0900, 1000, 1100, 1200, 1300, 1400, 1500, 1600, 1700, 1800, 1900, 2000, 2100, 2200, 2300, 2400, 2500, 2600, 2700, 2800, 2900, 3000, 3100, 3200, 3300, 3400, 3500, 3600, 3700, 3800, 3900, 4000, 4100, 4200, 4300, 4400, 4500, 4600, 4700, 4800, 4900, 5000, 5100, 5200, 5300, 5400, 5500, 5600, 5700, 5800, 5900, 6000, 6100, 6200, 6300, 6400, 6500, 6600, 6700, 6800, 6900, 7000, 7100, 7200, 7300, 7400, 7500, 7600, 7700, 7800, 7900, 8000, 8100, 8200, 8300, 8400, 8500, 8600, 8700, 8800, 8900, 9000, 9100, 9200, 9300, 9400, 9500, 9600, 9700, 9800, 9900, 10000
80	BDI 0000, 0100, 0200, 0300, 0400, 0500, 0600, 0700, 0800, 0900, 1000, 1100, 1200, 1300, 1400, 1500, 1600, 1700, 1800, 1900, 2000, 2100, 2200, 2300, 2400, 2500, 2600, 2700, 2800, 2900, 3000, 3100, 3200, 3300, 3400, 3500, 3600, 3700, 3800, 3900, 4000, 4100, 4200, 4300, 4400, 4500, 4600, 4700, 4800, 4900, 5000, 5100, 5200, 5300, 5400, 5500, 5600, 5700, 5800, 5900, 6000, 6100, 6200, 6300, 6400, 6500, 6600, 6700, 6800, 6900, 7000, 7100, 7200, 7300, 7400, 7500, 7600, 7700, 7800, 7900, 8000, 8100, 8200, 8300, 8400, 8500, 8600, 8700, 8800, 8900, 9000, 9100, 9200, 9300, 9400, 9500, 9600, 9700, 9800, 9900, 10000
90	BDI 0000, 0100, 0200, 0300, 0400, 0500, 0600, 0700, 0800, 0900, 1000, 1100, 1200, 1300, 1400, 1500, 1600, 1700, 1800, 1900, 2000, 2100, 2200, 2300, 2400, 2500, 2600, 2700, 2800, 2900, 3000, 3100, 3200, 3300, 3400, 3500, 3600, 3700, 3800, 3900, 4000, 4100, 4200, 4300, 4400, 4500, 4600, 4700, 4800, 4900, 5000, 5100, 5200, 5300, 5400, 5500, 5600, 5700, 5800, 5900, 6000, 6100, 6200, 6300, 6400, 6500, 6600, 6700, 6800, 6900, 7000, 7100, 7200, 7300, 7400, 7500, 7600, 7700, 7800, 7900, 8000, 8100, 8200, 8300, 8400, 8500, 8600, 8700, 8800, 8900, 9000, 9100, 9200, 9300, 9400, 9500, 9600, 9700, 9800, 9900, 10000
100	BDI 0000, 0100, 0200, 0300, 0400, 0500, 0600, 0700, 0800, 0900, 1000, 1100, 1200, 1300, 1400, 1500, 1600, 1700, 1800, 1900, 2000, 2100, 2200, 2300, 2400, 2500, 2600, 2700, 2800, 2900, 3000, 3100, 3200, 3300, 3400, 3500, 3600, 3700, 3800, 3900, 4000, 4100, 4200, 4300, 4400, 4500, 4600, 4700, 4800, 4900, 5000, 5100, 5200, 5300, 5400, 5500, 5600, 5700, 5800, 5900, 6000, 6100, 6200, 6300, 6400, 6500, 6600, 6700, 6800, 6900, 7000, 7100, 7200, 7300, 7400, 7500, 7600, 7700, 7800, 7900, 8000, 8100, 8200, 8300, 8400, 8500, 8600, 8700, 8800, 8900, 9000, 9100, 9200, 9300, 9400, 9500, 9600, 9700, 9800, 9900, 10000
110	BDI 0000, 0100, 0200, 0300, 0400, 0500, 0600, 0700, 0800, 0900, 1000, 1100, 1200, 1300, 1400, 1500, 1600, 1700, 1800, 1900, 2000, 2100, 2200, 2300, 2400, 2500, 2600, 2700, 2800, 2900, 3000, 3100, 3200, 3300, 3400, 3500, 3600, 3700, 3800, 3900, 4000, 4100, 4200, 4300, 4400, 4500, 4600, 4700, 4800, 4900, 5000, 5100, 5200, 5300, 5400, 5500, 5600, 5700, 5800, 5900, 6000, 6100, 6200, 6300, 6400, 6500, 6600, 6700, 6800, 6900, 7000, 7100, 7200, 7300, 7400, 7500, 7600, 7700, 7800, 7900, 8000, 8100, 8200, 8300, 8400, 8500, 8600, 8700, 8800, 8900, 9000, 9100, 9200, 9300, 9400, 9500, 9600, 9700, 9800, 9900, 10000
120	BDI 0000, 0100, 0200, 0300, 0400, 0500, 0600, 0700, 0800, 0900, 1000, 1100, 1200, 1300, 1400, 1500, 1600, 1700, 1800, 1900, 2000, 2100, 2200, 2300, 2400, 2500, 2600, 2700, 2800, 2900, 3000, 3100, 3200, 3300, 3400, 3500, 3600, 3700, 3800, 3900, 4000, 4100, 4200, 4300, 4400, 4500, 4600, 4700, 4800, 4900, 5000, 5100, 5200, 5300, 5400, 5500, 5600, 5700, 5800, 5900, 6000, 6100, 6200, 6300, 6400, 6500, 6600, 6700, 6800, 6900, 7000, 7100, 7200, 7300, 7400, 7500, 7600, 7700, 7800, 7900, 8000, 8100, 8200, 8300, 8400, 8500, 8600, 8700, 8800, 8900, 9000, 9100, 9200, 9300, 9400, 9500, 9600, 9700, 9800, 9900, 10000
130	BDI 0000, 0100, 0200, 0300, 0400, 0500, 0600, 0700, 0800, 0900, 1000, 1100, 1200, 1300, 1400, 1500, 1600, 1700, 1800, 1900, 2000, 2100, 2200, 2300, 2400, 2500, 2600, 2700, 2800, 2900, 3000, 3100, 3200, 3300, 3400, 3500, 3600, 3700, 3800, 3900, 4000, 4100, 4200, 4300, 4400, 4500, 4600, 4700, 4800, 4900, 5000, 5100, 5200, 5300, 5400, 5500, 5600, 5700, 5800, 5900, 6000, 6100, 6200, 6300, 6400, 6500, 6600, 6700, 6800, 6900, 7000, 7100, 7200, 7300, 7400, 7500, 7600, 7700, 7800, 7900, 8000, 8100, 8200, 8300, 8400, 8500, 8600, 8700, 8800, 8900, 9000, 9100, 9200, 9300, 9400, 9500, 9600, 9700, 9800, 9900, 10000
140	BDI 0000, 0100, 0200, 0300, 0400, 0500, 0600, 0700, 0800, 0900, 1000, 1100, 1200, 1300, 1400, 1500, 1600, 1700, 1800, 1900, 2000, 2100, 2200, 2300, 2400, 2500, 2600, 2700, 2800, 2900, 3000, 3100, 3200, 3300, 3400, 3500, 3600, 3700, 3800, 3900, 4000, 4100, 4200, 4300, 4400, 4500, 4600, 4700, 4800, 4900, 5000, 5100, 5200, 5300, 5400, 5500, 5600, 5700, 5800, 5900, 6000, 6100, 6200, 6300, 6400, 6500, 6600, 6700, 6800, 6900, 7000, 7100, 7200, 7300, 7400, 7500, 7600, 7700, 7800, 7900, 8000, 8100, 8200, 8300, 8400, 8500, 8600, 8700, 8800, 8900, 9000, 9100, 9200, 9300, 9400, 9500, 9600, 9700, 9800, 9900, 10000
150	BDI 0000, 0100, 0200, 0300, 0400, 0500, 0600, 0700, 0800, 0900, 1000, 1100, 1200, 1300, 1400, 1500, 1600, 1700, 1800, 1900, 2000, 2100, 2200, 2300, 2400, 2500, 2600, 2700, 2800, 2900, 3000, 3100, 3200, 3300, 3400, 3500, 3600, 3700, 3800, 3900, 4000, 4100, 4200, 4300, 4400, 4500, 4600, 4700, 4800, 4900, 5000, 5100, 5200, 5300, 5400, 5500, 5600, 5700, 5800, 5900, 6000, 6100, 6200, 6300, 6400, 6500, 6600, 6700, 6800, 6900, 7000, 7100, 7200, 7300, 7400, 7500, 7600, 7700, 7800, 7900, 8000, 8100, 8200, 8300, 8400, 8500, 8600, 8700, 8800, 8900, 9000, 9100, 9200, 9300, 9400, 9500, 9600, 9700, 9800, 9900, 10000
160	BDI 0000, 0100, 0200, 0300, 0400, 0500, 0600, 0700, 0800, 0900, 1000, 1100, 1200, 1300, 1400, 1500, 1600, 1700, 1800, 1900, 2000, 2100, 2200, 2300, 2400, 2500, 2600, 2700, 2800, 2900, 3000, 3100, 3200, 3300, 3400, 3500, 3600, 3700, 3800, 3900, 4000, 4100, 4200, 4300, 4400, 4500, 4600, 4700, 4800, 4900, 5000, 5100, 5200, 5300, 5400, 5500, 5600, 5700, 5800, 5900, 6000, 6100, 6200, 6300, 6400, 6500, 6600, 6700, 6800, 6900, 7000, 7100, 7200, 7300, 7400, 7500, 7600, 7700, 7800, 7900, 8000, 8100, 8200, 8300, 8400, 8500, 8600, 8700, 8800, 8900, 9000, 9100, 9200, 9300, 9400, 9500, 9600, 9700, 9800, 9900, 10000
170	BDI 0000, 0100, 0200, 0300, 0400, 0500, 0600, 0700, 0800, 0900, 1000, 1100, 1200, 1300, 1400, 1500, 1600, 1700, 1800, 1900, 2000, 2100, 2200, 2300, 2400, 2500, 2600, 2700, 2800, 2900, 3000, 3100, 3200, 3300, 3400, 3500, 3600, 3700, 3800, 3900, 4000, 4100, 4200, 4300, 4400, 4500, 4600, 4700, 4800, 4900, 5000, 5100, 5200, 5300, 5400, 5500, 5600, 5700, 5800, 5900, 6000, 6100, 6200, 6300, 6400, 6500, 6600, 6700, 6800, 6900, 7000, 7100, 7200, 7300, 7400, 7500, 7600, 7700, 7800, 7900, 8000, 8100, 8200, 8300, 8400, 8500, 8600, 8700, 8800, 8900, 9000, 9100, 9200, 9300, 9400, 9500, 9600, 9700, 9800, 9900, 10000
180	BDI 0000, 0100, 0200, 0300, 0400, 0500, 0600, 0700, 0800, 0900, 1000, 1100, 1200, 1300, 1400, 1500, 1600, 1700, 1800, 1900, 2000, 2100, 2200, 2300, 2400, 2500, 2600, 2700, 2800, 2900, 3000, 3100, 3200, 3300, 3400, 3500, 3600, 3700, 3800, 3900, 4000, 4100, 4200, 4300, 4400, 4500, 4600, 4700, 4800, 4900, 5000, 5100, 5200, 5300, 5400, 5500, 5600, 5700, 5800, 5900, 6000, 6100, 6200, 6300, 6400, 6500, 6600, 6700, 6800, 6900, 7000, 7100, 7200, 7300, 7400, 7500, 7600, 7700, 7800, 7900, 8000, 8100, 8200, 8300, 8400, 8500, 8600, 8700, 8800, 8900, 9000, 9100, 9200, 9300, 9400, 9500, 9600, 9700, 9800, 9900, 10000
190	BDI 0000, 0100, 0200, 0300, 0400, 0500, 0600, 0700, 0800, 0900, 1000, 1100, 1200, 1300, 1400, 1500, 1600, 1700, 1800, 1900, 2000, 2100, 2200, 2300, 2400, 2500, 2600, 2700, 2800, 2900, 3000, 3100, 3200, 3300, 3400, 3500, 3600, 3700, 3800, 3900, 4000, 4100, 4200, 4300, 4400, 4500, 4600, 4700, 4800, 4900, 5000, 5100, 5200, 5300, 5400, 5500, 5600, 5700, 5800, 5900, 6000, 6100, 6200, 6300, 6400, 6500, 6600, 6700, 6800, 6900, 7000, 7100, 7200, 7300, 7400, 7500, 7600, 7700, 7800, 7900, 8000, 8100, 8200, 8300, 8400, 8500, 8600, 8700, 8800, 8900, 9000, 9100, 9200, 9300, 9400, 9500, 9600, 9700, 9800, 9900, 10000
200	BDI 0000, 0100, 0200, 0300, 0400, 0500, 0600, 0700, 0800, 0900, 1000, 1100, 1200, 1300, 1400, 1500, 1600, 1700, 1800, 1900, 2000, 2100, 2200, 2300, 2400, 2500, 2600, 2700, 2800, 2900, 3000, 3100, 3200, 3300, 3400, 3500, 3600, 3700, 3800, 3900, 4000, 4100, 4200, 4300, 4400, 4500, 4600, 4700, 4800, 4900, 5000, 5100, 5200, 5300, 5400, 5500, 5600, 5700, 5800, 5900, 6000, 6100, 6200, 6300, 6400, 6500, 6600, 6700, 6800, 6900, 7000, 7100, 7200, 7300, 7400, 7500, 7600, 7700, 7800, 7900, 8000, 8100, 8200, 8300, 8400, 8500, 8600, 8700, 8800, 8900, 9000, 9100,

Elektron staff are a versatile lot! The present design came into being because one of our designers is a fervent spelaeologist, more popularly known as a caver. Regularly he risks life and limb in all sorts of dark caves, only to emerge hours later into daylight, covered in mud, sweating, and dead-tired, but happy and content. A good, reliable light source is, of course, indispensable for those treks in the dark. Many of the caver's lamp units in use today are powered by rechargeable (lead-acid or NiCd) batteries. Such batteries are inexpensive over their life — provided they are used often and regularly — and provide a near-constant output voltage. Dry batteries are relatively inexpensive to buy, offer small volume and low weight, and can easily be carried as spares. The last three points are, of course, of inestimable value during caving and in many other applications! Unfortunately, dry batteries have a serious drawback: their output voltage falls linearly with time, so that at the beginning of their life the lamp burns brightly, while long before they are exhausted, the lamp begins to resemble a glowworm! Not only is this highly undesirable from a safety point of view, but it also makes for low efficiency. Our versatile designer decided, therefore, to design a voltage source for battery-operated lamps which offers a substantially constant output at high efficiency.

constant voltage source . . .

The design is basically a dc/ac converter based on a cleverly thought-out circuit which keeps the power supplied to the lamp, and therefore the light intensity, virtually constant over the normal life of the battery. The circuit itself has very low power consumption so that the efficiency of the whole is high.

The principle

To control power at high efficiency, it is best to make use of pulse-width control. As the power supplied to the lamp must remain constant, the control should work so that the pulse width increases as the battery voltage decreases. To be sure, it is quite simple to design a pulse-width control whereby the pulse width is inversely proportional to the supply voltage. That is, however, not the solution to the requirement, because the power to the lamp is given by $P = U_b^2/R$, where U_b is the battery voltage and R is the resistance of the lamp. What is required is compensation of U_b^2 , and this is achieved by using two pulse-width controls, operating at different frequencies, but with identical duty factors (see figure 1). One reference voltage determines the pulse-width setting of both controls (the pulse width remains inversely

proportional to the battery voltage). The outputs of the controls are multiplied in an AND gate, resulting in a signal of which the pulse width is inversely proportional to U_b^2 .

The circuit

The constant voltage source is based on one IC — a quad comparator type LM 339 — and a couple of transistors (see

. . . for battery operated lamps

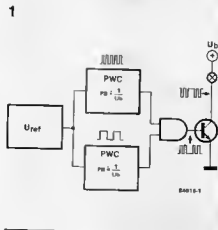
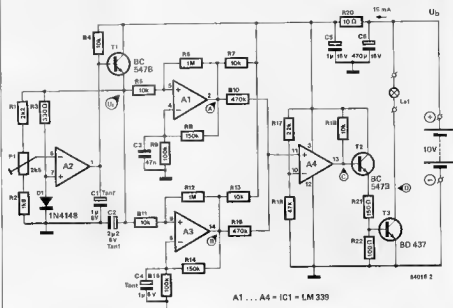

Figure 1. Simplified block schematic to show the ingenuity of the voltage source: two pulse-width controls together with a multiplier ensure that the power fed to the lamp is kept constant.



A1 ... A4 = IC1 = LM 339



Figure 2. The circuit diagram: a voltage comparator with open-collector outputs and three discrete transistors are the active components on which the voltage source is based.



figure 2). One stage of the LM 339, A2, in conjunction with transistor T1, forms a voltage reference source for pulse-width controls A1 and A3. The voltage source is formed by diode D1 to which the output of T1 is applied via R3. The reference voltage is set by P1. For a supply voltage, U_b, of 10 volts, the reference voltage, U_r, can be preset between 1.0 and 3.0 V by P1.

The two pulse-width controls (PWCs) operate at frequencies of about 1.2 kHz and 3.6 kHz respectively. The frequency separation is necessary to prevent (visible) interference between their output signals. The outputs of A1 and A3 are fed to the non-inverting input of A4 via R10 and R16. Opamp A4 is connected as an AND gate so that its output is only '1' if both A1 and A3 have a '1' at their output.

The circuit terminates in an economical output amplifier based on transistors T2 and T3. Power transistor T3 is a type BD 437 which has a low collector/emitter saturation voltage.

With values shown in figure 2, the constant-voltage source is suitable for lamps of 3.5...6.3 V consuming not more than 1 A. A graph of the efficiency, η, of various



3

Some arithmetic

In the following,

U_b = battery voltage

U_e = effective value of pulse voltage

D = duty factor of BOTH pulse-width controls

P = power supplied to lamp

R = resistance of lamp

The duty factor, D , is inversely proportional to U_b

Each PWC delivers a (pulse) voltage of which

$$U_e = U_b \sqrt{D}$$

Multiplier A4, an AND gate which only recognizes logic levels, multiplies pulse-widths but NOT voltages; its output is, therefore

$$U = U_b \sqrt{D} \sqrt{D} = U_b D$$

The power supplied to the lamp is therefore

$$P = U_b^2 D^2 / R$$

As both U_b and D are expressed as second-order quantities which are inversely proportional, and R is constant, it is evident that P is independent of U_b .

lamps versus U_b is given in figure 3. The circuit is suitable for use with input voltages, U_b , of 3.5...15 V. The average current consumed is about 15 mA.

Calibration

Calibrating the voltage source is fairly simple. Connect a suitable lamp to the lamp terminals and a variable, stabilized power supply to the battery terminals. Set the output of the power supply to the nominal voltage of the lamp used.

A: 3.8 V/300 mA
B: 4.5 V/500 mA
C: 4.0 V/1 A

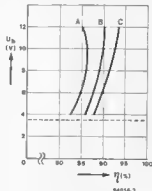

Figure 3. Characteristics showing the efficiency of three different lamps versus the battery voltage; the efficiency rises with larger lamp currents.

Connect an oscilloscope to pin 2 of IC1 and adjust P1 until A1 just commences to oscillate.

If no instruments other than a multimeter are available, the voltage source may be calibrated as follows. Connect a suitable lamp to the lamp terminals, and the multimeter (resistance range) between pin 6 of IC1 and the junction of P1-R1. Adjust P1 for minimum resistance. Remove the multimeter and connect a suitable battery to the battery terminals. Adjust P1 for good brightness of the lamp.

K

TELEPHONE BELL IC TYPE MC34012

(Motorola Limited)

The MC34012 is intended primarily as replacement for the usual telephone bell and is therefore of particular interest to Elektor readers who want a second telephone bell. The MC34012 presents a load to the telephone line which is smaller than that of a "real" second telephone bell.

The input of the chip is connected to the usual input wires to the telephone bell, and its output to a piezo-electric buzzer (e.g. a Toko type). As soon as the ringing signal (intermittent a.c.) on the line exceeds 35 V, the IC is turned on and the buzzer emits a pleasant tone. Note that the IC needs no power supply as the necessary energy is drawn from the ringing signal! The chip does not respond to d.c. voltages such as the speech signals after the telephone receiver has been lifted. The quiescent current is therefore zero!

DIGITAL CLINICAL THERMOMETER IC TYPE ZN 412

(Ferranti Electronics Limited)

The recently announced ZN 412 contains all the necessary linear and digital functions to enable a clinical thermometer to be constructed with a minimum of external components. The multiplexed data outputs of the chip are capable of directly driving a 3-digit seven-segment LED display. These outputs are controlled by an integral A/D processor which converts the output of an external probe into a digital number. A temperature range of 35.0...47.5°C can be displayed with an accuracy of 0.1°C and a response time of 5 seconds. The ZN 412 includes a self testing facility, battery status indication, reset, and display hold. Supply requirements are 4.5 V at 14 mA.

Shown at the far right is a prototype of a digital clinical thermometer based on the ZN 412.

PRECISION CENTIGRADE TEMPERATURE SENSORS SERIES LM 35

(National Semiconductor Corporation)

The series LM 35 temperature sensors are precision ICs which have two important advantages over the usual sensors in that they are already calibrated and start at 0°C. Their output voltage is directly proportional to the temperature measured in degrees centigrade (10 mV/°C). The usual sensor must invariably be calibrated to obtain the required voltage/temperature slope and starts at 0 K (-273°C). The low output impedance of the LM 35 series (0.1 ohm for a 2 mA load), linear output, and precise, inherent calibration make interfacing these sensors to read-out or control circuits very easy. Power supply may be single or symmetrical: the operating voltage may lie between 4 and 30 volts. Accuracy is typically 0.5°C. Owing to the low current consumption of 60 µA, the internal heat dissipation amounts typically to only 0.08°C in still air.

CS - chip selekt



MC34012 APPLICATION CIRCUIT

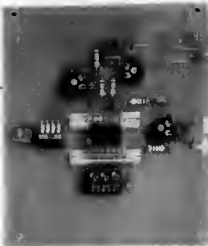
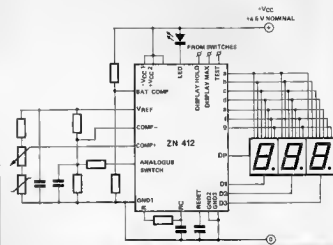
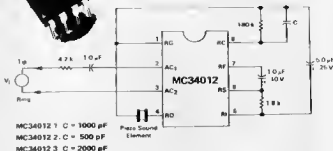

TO-46 Metal Can Package

Case is connected to negative part



TO-92 Plastic Package



CS - chip selekt

COMPLEX SOUND GENERATOR ICS TYPES SN 76488 & SN 76495

(Texas Instruments Inc.)

These circuits are up-dated versions of the SN 76477 which was featured in our March 1981 issue. The SN 76495 is a simplified version in a 16-pin housing, while the SN 76488 retains a 28-pin package. The main advantage of the present circuits over the SN 76477 is the on-chip audio amplifier which can deliver up to 125 mW into an 8-ohm load. Like the SN 76477, both circuits are compatible with computer systems. Unlike their predecessor, however, they operate from a 7.5...10 V supply. An on-chip regulator provides a stabilized 5 V supply for driving external circuits, or for use as high logic level.

Shown at the left is a typical demonstration circuit of the SN 76495.

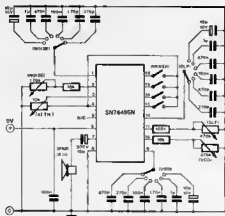

POWER SWITCHING REGULATOR IC TYPE L 296 (SGS-ATES)

The L 296 is a high-power monolithic switching regulator (the first in the world according to the makers) which can supply a current of 4 A at voltages of 5.1...40 V. As the IC is capable of operating at switching frequencies of up to 200 kHz, external components such as inductors and capacitors can be kept small and therefore relatively inexpensive. Features include soft start (which slows down the rise time of the output voltage when the power is switched on), programmable current limiting (with the load current sensing resistor on the chip), reset output (intended primarily for microprocessors), and thermal shutdown at junction temperatures above 150°C.

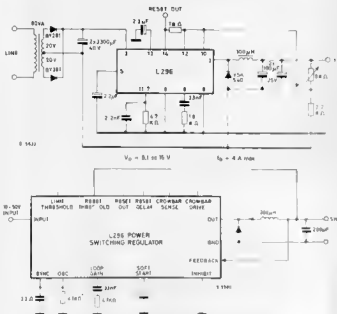

MAINS-CARRIER TRANSCEIVER IC TYPE LM 1893

(National Semiconductor Corporation)

As the name implies, mains-carrier transceivers use the mains supply lines to transfer information between remote locations. The LM 1893 bipolar chip performs as a mains interface for bi-directional (semi-duplex) communication of serial bit streams of virtually any coding. During transmission, a sinusoidal carrier is FSK modulated and superimposed on the mains voltage via an on-chip driver stage. During reception, a PLL type demodulator extracts the information from the mains. Some of the features of the LM 1893 are: transmission rate of up to 4800 baud, choice of carrier frequency between 50 and 300 kHz, TTL and CMOS compatible logic levels, and regulated voltage to power logic.

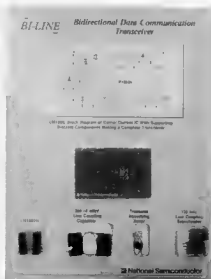

The synchbox is a circuit for use with a video-audio modulator (VAM) or a video combiner. It provides all kinds of signals that are needed to build up a complete video signal. A synchbox can be used, for example, to fill up the space between two recordings on a video tape. The 'noise' that would then normally appear can thus be replaced by a black image or a colour bar.

video synchbox

with colour bar

This synchbox is an independent video signal source using an oscillator signal of 125 kHz to produce a number of basic signals that can be used for all kinds of video equipment and circuits. An external crystal-controlled signal can be used to clock the circuit if very high stability is demanded. Using the signals from the synchbox a black image (for video recorders) or even good quality colour bar can be produced.

The circuit

In the circuit diagram shown in figure 1 all signals are formed from the output signals of the 4040 (IC1). This IC, together with gates N4, N8 and N9, function as a 'divide by 2496' circuit. A simple clock oscillator (N2, N3) supplying a frequency of 125 kHz, feeds the input of the divider. Using this

signal the divider provides a raster frequency of 50.08 Hz. The raster frequency is normally 50 Hz, but because we want a non-interlaced image (that does not shake) we have chosen a raster time that is 32 μ s shorter than normal. The number of lines per raster is then 312 instead of the normal 312½. Without a lot of extra electronics interlacing is not possible with this circuit. The line frequency is the normal value of 15625 Hz, and this is necessary as the PAL delay line in colour television sets is tuned exactly to this value of 64 μ s. Longer or shorter line times give rise to colour faults on the screen as colours run into each other. The line frequency (horizontal synchronization, HS) is derived by adding the oscillator signal from N2/N3 and outputs Q0, Q1 and Q2 of IC1. Because of the fairly symmetrical block of the 125 kHz clock a synchronization pulse of about

Figure 1. The circuit diagram clearly shows the simplicity of the circuit. Only a few CMOS ICs are needed to generate the necessary signals.

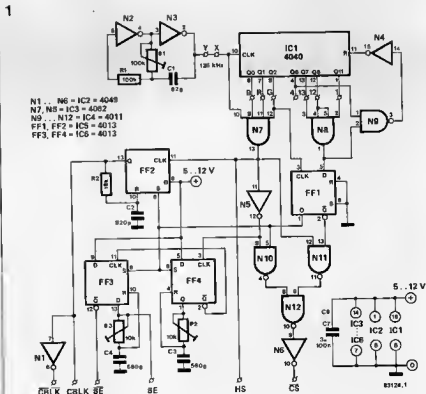

4 μ s width appears at the output of N7. The raster synchronization pulse is derived directly from the line synchronization signal by inverting the latter during the raster synchronization time. The advantage of this is that the line synchronization signal remains safe during the raster synchronization. The electronics in the TV set automatically ensures that the inverted line synchronization is recognized as the raster synchronization.

Switching between line and raster synchronization is handled by FF1 which is clocked at the line frequency from output Q2 of IC1. The positive edge of this clock signal occurs in the middle of the line time so the raster synchronization, which lasts for eight line times, always starts and ends with a half line. The outputs of FF1 are connected to N10 and N11, which in turn feed N12, thus combining the line and raster synchronization.

Note that the raster synchronization signal eventually has the same polarity as the HS signal (as a quick glance at the timing diagram of figure 2a will confirm). The HS signal is also fed to the outside world, where it is used in colour video systems to control the PAL switch. The CS signal (Composite Synchronization) is not suitable for this because it contains an extra positive and negative edge during the raster synchronization (see figure 2a). One of these two edges will trigger the PAL flip-flop (in the VAM or video combiner) one extra time which is enough to con-

fuse the receiver and activate the colour killer. The problem is avoided by using the HS signal.

The carrier for the colour information must be regularly synchronized in order to keep the colours reproducible. This happens directly after the line synchronization by means of a burst signal (consisting of a number of periods of colour carrier with a fixed phase). The BE (Burst Enable) signal (or \overline{BE}) is used to activate this burst. This signal is generated with the aid of two monostable multivibrators formed from FF3 and FF4. The inverted trailing edge of the HS signal triggers FF3, and the output of this flip-flop gives a pulse of 1.6 μ s (set with P2). The same trailing edge of HS triggers FF4 and this in turn gives a BE pulse of 2.25 μ s (set with P3). This is shown by the small timing chart in figure 2b. Small deviations from these times are rarely a difficulty as neither a shorter delay between synchronization and burst nor a longer burst pulse are likely to cause any problems.

A blanking signal is not absolutely necessary but it is often handy. In our circuit this signal is produced by FF2, which, again, operates as an MMV. The pulse width is set to about 12 μ s with R2 and C2. During the raster synchronization the pulse widths of FF2, FF3 and FF4 are defined by FF1 as this then disables the set inputs of the three flip-flops. A false burst pulse is then given by the BE output, but this causes no adverse effects as

video synchro

Figure 2. The timing diagram of the output signals provided by the video synchro.

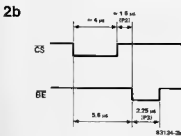
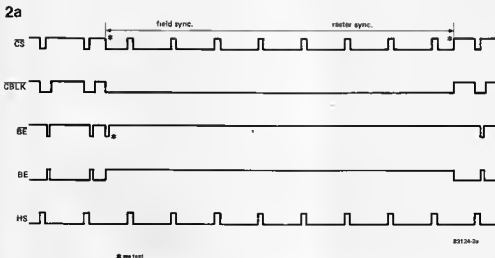

it appears in the middle of the line time. Simultaneously the signal at the set input of FF2 causes a raster blanking signal \overline{BLK} (composite blank) to be generated.

Construction

The printed circuit board layout for this circuit is shown in figure 3, and if this is used construction should give absolutely no problems. We do, however, recommend that sockets be used for the ICs.

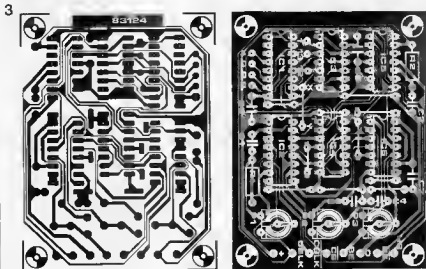

Figure 3. The printed circuit end component layouts for the circuit are shown here.

4

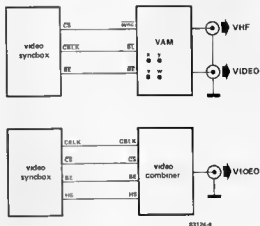

Figure 4. This is how the video syncbox is connected to the VAM and video combiner respectively.

The supply for the circuit can be between 5 and 12 V, and current consumption is only a few milliamps. To use this circuit with the video combiner elsewhere in this issue we suggest that that article be read before building the syncbox. An oscilloscope is needed for adjusting the three presets. Failing this they will simply have to be set up 'by eye'.

Use

The syncbox is only useful when combined with some other suitable circuit. It could, for example, provide the control signal for a simple pattern generator, or it could be used with the video/audio modulator (VAM) from Elektor, February 1983, or the video combiner in this issue.

Outputs BE, CBLK and CS of the video syncbox must be connected to the BE, BL and sync inputs of the VAM. Links V-W and X-Y on the VAM board must be re-

moved. If the VAM is only used in combination with the video syncbox, IC4 and IC5 of the VAM may be removed.

A blank image (for example to fill up a video tape) can be obtained by connecting the BL input (or the R G B inputs) to ground. For a colour bar there are three extra connections between syncbox and VAM needed. Points R, G and B of the syncbox must be connected to the R, G and B inputs of the VAM. The three inputs per colour of the VAM can be connected together. The resulting colour bar has the following colours in this sequence (from left to right), blue-red-magenta-green-cyan-yellow. White and black do not appear on the screen. Different colour combinations and patterns can be made by using different outputs of the 4040. If the syncbox and video combiner are used together the 'common' points on both boards must be linked. In this case points R, G and B need only be connected if a colour bar is required with this combination.

Parts list

Resistors

- R1 = 100 k
- R2 = 18 k
- P1 = 100 k preset
- P2, P3 = 10 k preset

Capacitors

- C1 = 82 p
- C2 = 820 p
- C3 = 560 p
- C4 = 680 p
- C5 . . . C7 = 100 n

Semiconductors:

- IC1 = 4040
- IC2 = 4049
- IC3 = 4082
- IC4 = 4011
- IC5, IC6 = 4013

automatic battery charger

Recharging lead-acid batteries is often assumed to be an extremely straightforward matter. And that is indeed the case, assuming that no special demands are being made on the life of the battery. On the other hand, if one wishes to ensure that the battery lasts as long as possible, then certain constraints are placed upon the charge cycle.

Figure 1 illustrates the ideal charge current characteristic for a normal 12 V lead-acid battery which is completely discharged. During the first phase (A-B), a limited charging current is used, until the battery voltage reaches approximately 10 V. This restriction on the charging current is necessary to ensure that the charger is not overloaded (excessive dissipation). For the next phase (C-D), the battery is charged with the '5-hour charging current'. The size of this current is determined by dividing the nominal capacity of the battery in ampere-hours (Ah) by 5. At the end of this period the battery should be charged to 14.4 V, whereupon the final phase (E-F) starts. The battery is charged with a much smaller 'top-up' current, which gradually would decrease to zero if the battery voltage were to reach 16.5 V.

The circuit described here (see figure 2) is intended to provide a charge cycle which follows that described above. If the battery is completely discharged (voltage < 10 V), so little current flows through D3 that T1 is turned off.

The output of IC1 will be low, so that the base currents of T2 and T3, and hence the charging current, are determined solely by the position of P1.

If the battery voltage is between 10 and 14 V, D3 is forward biased and T1 is turned on. The output of IC1 still remains low, so that the charging current is now determined by both P1 and P2. If the wiper voltage of P3 exceeds the zener voltage of D1, then due to the positive feedback via R4, the output voltage of IC1 will swing up to a value determined by the zener voltage of D1 and the forward voltage drop of D2. As a result T1 is turned off and the charge current is

once again determined by the position of P1. In contrast to phase A-B, however, the higher output voltage of IC1 means that current through P1, and hence the charging current, is reduced accordingly.

Since D2 is forward biased, the effect of resistors R2 and R3 will be to gradually reduce the charging current still further, as the battery voltage continues to rise.

To calibrate the circuit, P3 is adjusted so that the output of IC1 swings high when the output (i.e. battery) voltage is 14.4 V.

By means of P1 the 'top-up' charge current is set to the 20-hour value (capacity of the battery in Ah divided

1

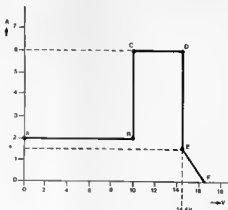

78517 1

2

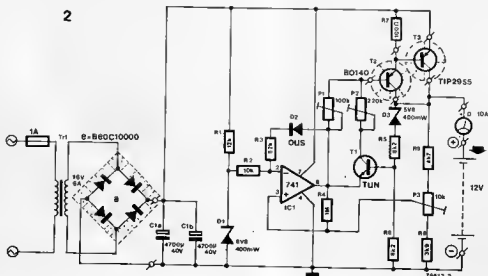

78517 2

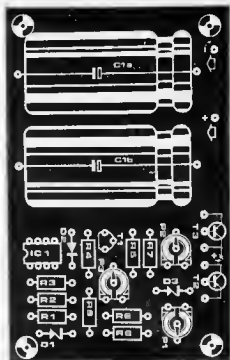
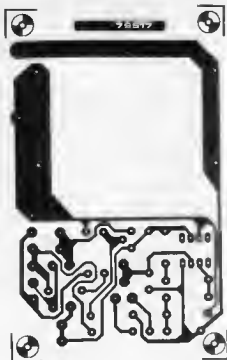

Parts list.

Resistors:

- R1 = 12 k
- R2 = 10 k
- R3 = 82 k
- R4 = 1 M
- R5, R6 = 8k2
- R7 = 100 Ω
- R8 = 3k9
- R9 = 4k7
- P1 = 100 k preset
- P2 = 220 k . . . 250 k preset
- P3 = 10 k preset

Capacitors:

- C1a = C1b = 4700 μ /40 V

Semiconductors

- T1 = TUN
- T2 = BD138, BD140
- T3 = TIP2955
- D1 = 6V8, 400 mW zener diode
- D2 = DUS
- D3 = 5V6, 400 mW zener diode
- IC1 = 741

Miscellaneous

- Tr = 16 V, 8 A mains transformer
- B = B80C10000 bridge rectifier
- fuse = 0.5 A sto-blo

by 20) for voltages between 14.5 and 15 V. Finally, with a battery voltage of between 11 and 14 V, P2 is adjusted for the nominal (5-hour) charging current.

The initial charging current (phase A-B) is set by the value of the 'top-up' current, and depending upon the characteristics of the transistors, will be approximately 30 to 100% greater.

*Siemens Components Report
Volume XIII, No. 1 March 1978.*

W. Ferdinand

When starting a car journey after dark it is useful to have a device which will keep the interior lighting on for a while after the doors have been closed, and so make it easier for the occupants to fasten safety belts and insert the ignition key. This can be done with the simple time-switch circuit shown.

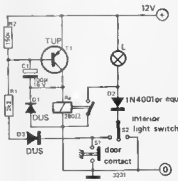

afterburner

ANTENNAS

Maxtronic are handling the line of antennas manufactured by Centurin International, Inc. of USA, which come in six styles of construction, viz high band, low band, UHF Whip, Stubby VHF, mini VHF and new UHF Y4 wave. They are capable of handling greater than 50 watts of power continuously at 50 OHMS G Ω impedance. Manufacturers also offer telescoping antennas and the traditional Rubber Ducky antennas available in 25 different connector styles, besides adapter cable assemblies, right angle adapters and scanner antennas.



More information from
Maxtronic
Box 332 GPO
Hyderabad 500 071

AUTO SWITCH

Gujarat Electronics & Controls have developed an automatic light control switch designed to put on the lights at dusk and switch them off at dawn, irrespective of sun set/rise timings. Using ICs and working on the principle of light dependent resistor, it is provided with starting and final delays to overcome the effect of cloud and lighting respectively. Has auto off/manual switch and neon indication and comes in single phase supply models in 10A and 25A.



For further details, contact
Gujarat Electronics & Controls
9, Advani Market, Outside Delhi Gate
Ahmedabad 380 001

POCKET TRANSISTOR

Navabharat Radio Agencies have come out with a new transistor in their Jetking range claimed by them as the slimmest medium wave pocket transistor. It has 1 diode and 6 transistors and operates on two penlite cells. It is provided with an earphone and a wrist strap for single-hand operation.



More particulars from
Navabharat Radio Agencies
350 Laxminagar road
Bombay 400 007

CABLE TIES

Novoflex Cable Industries have developed cable ties for use in all sophisticated electronic equipment like computers, communication equipments, nuclear and process control instrumentation, inverter, power supplies, etc., as also in consumer electronic equipments such as televisions, stereo systems, PA systems, intercoms, VCRs etc. The manufacturers claim that the cable ties are of unique design, possess high tensile strength and flexibility. They are available for bundling diameter of 1.6 mm to 51 mm.



More details can be had from
Novoflex Cable Industries
Block A-14, 7th Floor,
Chatterjee International Centre
33-A, Chowringhee Road,
Calcutta 700 071

TABLE LAMP-CUM-CLOCK

Electronics Hobby Centre have developed a new product, viz table lamp-cum-clock. The clock has a quartz movement and the table lamp is provided with a dimmer system. Approx. base size is 23 x 11 x 4 cms and height of lamp 29 cms.

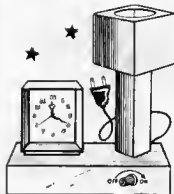

For further details, write to
Electronics Hobby Centre
F-37, Nand-dham Industrial Estate
Marol, Bombay 400 059

PCB ASSEMBLY JIG

PCB Assembly Jig (Universal), introduced by Time Engineers, is an aid for PCB assembly, designed to increase productivity with ease. The device has adjustable grooved sliding rails to accommodate PCBs of different sizes. After the PCB is mounted, components of various sizes are loaded and the foam pad clamped, the foam exerting sufficient pressure all over the PCB to secure components in their respective positions. The jig is then turned to obtain convenient working angles for soldering.



Further particulars may be had from
Time Engineers
P. Box No. 58
MIDC Rly Station, Satara Village Road
Aurangabad 431 001

DIGITAL MILLI-OHM METER

Vasavi Electronics have introduced a digital milli-ohm meter, with four terminal measurement and 0.1 milliohm resolution to facilitate accuracy of low resistance measurement. Other specifications are: battery/ mains operated, light-weight and handy, has 3 1/2 digit 0.5 inch bright LED display



Further details can be had from
Vasavi Instruments Corporation
162 Vasavinegar
Secunderabad 500 003

THERMISTORS

Electronics Unlimited manufacture a range of thermistors, the type EUBC incorporates a directly heated head of semiconductor material in a solid glass pellet, connection being by means of two dummet wires. The whole unit is encapsulated in brass and sealed in silicone with silicone-coated fibre glass sleeve. As this type of thermistors is intended to operate at temperatures upto 300° C, the dummet wire is untinned to render it suitable for welding or brazing. Normally available in a tolerance of ±20%, they can also be supplied in ±1%



More details from
Electronics Unlimited
70, Krishna Kuri, Gan. Thimmayya Road
Pune 411 001

ELECTRONIC IGNITION

CVP Lektronics have developed an electronic ignition system for cars which, according to them, does away with starting troubles prevalent in the conventional system, particularly on cold mornings or when battery is weak. Some of the advantages listed by the makers are: easy starting even at very low temperature, less current consumption, eliminates burning of contact breaker point. The system also comes with a built-in burglar alarm:



More information from
CVP Lektronics
6, Second Main Road, Raja
Annamaleipurem
Madras 600 028

DIAL CLAMP

Instrument Control Devices have introduced the dial clamp, designed to prevent delinking of the dial when locked by the captive knurled nut. The single-hand operation consists of half turn rotation of the thumb nut either clockwise or anti-clockwise to lock or unlock the dial respectively. The manufacturers recommend its use in temperature controllers and process controllers to prevent accidental rotation of the dial.

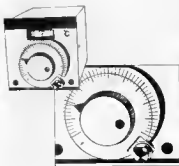

Further particulars can be had from
Instrument Control Devices
14 Manorama Niwas
Datar Colony, Bhandup
Bombay 400078

MOTOR PROTECTOR

Product Promoters have promoted Miller Electro Protector with advanced electronic circuitry and sensing, the main function of the device being to protect electric motors against excess or low current, high, low or unbalanced voltages, excess load, short circuit and absence of one phase. When current or voltage are beyond safe limits and rated values, the device will cut off the mains supply and restart automatically after proper supply is restored. It has been approved by National Physical Laboratory, etc., and models are available for all kinds of electrical equipments and upto 100 HP.



Detailed information from
Product Promoters
Post Box 3577
New Delhi 110 024

DIGITAL WATTMETER

Norma Messtechnik GmbH, of Austria, manufacture a precision digital wattmeter, model D 4155, for measurement of active power of single and polyphase electrical circuit at any load. Accuracy of the instrument is monitored through automatic reference test. Salient features are: input voltage - 110, 220, 440, 550 V; input current - 1, 2.5, 10 A upto 200 A via shunt; power range - 220 W to 11 kW; frequency - 15 Hz - 1 kHz; accuracy - ±0.1% of range; display - 4 1/2 digit.



For further information, contact
Inde Asocietas PREE Dapl.
202, Vikram Tower, Rajendra Place
New Delhi 110008

Deeper profile BIMCONSOLES

Complementing their existing range of low line BIMCONSOLES, BOSS Industrial Mouldings have now introduced a deeper profile range of small and medium size desk consoles. Ideally suited to applications where meters, keyboards or switches are incorporated, adequate space is also available on the side and rear panels for mains sockets and connectors etc.

Available in 4 sizes ranging from 178 x 210 x 76 to 483 x 210 x 102 mm, these sloping front units have been ergonomically conceived to permit comfortable operation of switches and keys etc, yet still offer excellent display visibility.

Utilising a two piece, all aluminium,

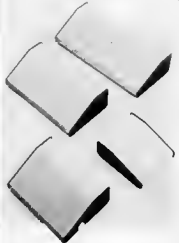

construction in which the base and top are nominally 2 mm and 1.6 mm thick respectively, the standard colour scheme is brown base and beige top panels, with the whole units held rigidly together by screws running through rubber feet into hank bushes on the base.

Alternative colour schemes, together with special ventilation slots, keyboard cut-outs or switch punchings etc, can be included, subject to normal commercial viability criteria.

Boss Industrial Mouldings Ltd.,
James Carter Road,
Mildenhall,
Suffolk, IP28 7DE
Telephone: 0538 716101

(2837 M)

LCD digital multimeter

The TM356 is a battery-operated laboratory quality 3½ digit multimeter with a large 0.5" liquid crystal display.

It has a full measurement capability of DC and AC volts, DC and AC current, resistance and diode check in 29 ranges permitting measurement of voltages from 100 µV to 1000 V (750 V AC), current from 100 nA to 10 A, and resistance from 100 mΩ to 20 MΩ.

Battery life from alkaline 'C' cells is typically in excess of 3000 hours and a low battery indicator shows when approximately 10% of life remains.

The instrument is housed in a tough ABS



moulded case with carrying handle/stand making it suitable for portable applications as well as bench work. Weight is 1200 gms including batteries.

Thandar Electronics Limited,
London Road,
St. Ives,
Huntingdon,
Cambridgeshire, PE17 4HJ
Telephone: 0480 64646

(2830 M)

Electronic tag for motor cars has many roles

Several European motor car manufacturers are evaluating an electronic monitoring tag from Eureka Systems of Slough, for use in assembly operations.

The same tag can also play a major part in protecting vehicles against theft after they have left the factory, and then go on to prevent fraud and misuse of fuel which has been paid for by the driver's company.

Eureka's system is based on a battery-operated tag, about the size of a postage stamp, which continues to transmit its own identity code to electronic sensors for upwards of seven years.

Permanently applied to the body shell of a car, for example, a Eureka tag can report its progress as the car moves down the assembly line. Thereafter, the movements of the completed vehicle can be logged as it leaves the factory for storage parks.

Even when sold to its eventual owner, the tagged car may continue to be monitored by sensors which can be placed at road junctions, petrol stations, and similar

sites. These sensors may be programmed to flash warnings to the local police immediately the tag of a car reported stolen is identified.

Each tag can be programmed to accept additional information at any time, so that it can also be used to instruct a petrol pump to deliver petrol to a company car only when authorised. If there is a pre-set limit for the vehicle, the pump will give just that amount. Otherwise the pump will automatically shut off once the tank is full and the value of the petrol delivered may instantly be debited, through the Eureka system, direct to the vehicle's owner. (LPS).

Eureka Systems,
Dorney House,
Upton Road
Slough, SL1 2AD
England.
Telephone: 0753 37722
Telex: 849243

13 amp socket tester

For the professional and the householder, this pocket sized tester can save a lot of time. Just plug in and switch on. Two neon give 6 test conditions: circuit correct, live fault, earth fault, live/neutral reversed, live earth reversed and neutral fault. To test a plug fuse, remove fuse and insert in tester. Neon gives fuse OK. Full instructions included. Available from:

Galatree International Ltd.,
Scotland Street,
Llanwrst,
North Wales.
Telephone: 0492 641298

(2839 M)

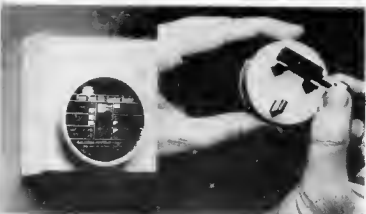

More instrument cases

BOSS Industrial Mouldings Ltd have now increased their range of Instrument Cases by adding another size model to their BIM 3000 Series. Being of all metal construction and available in 2 sizes of 250 x 167.5 x 68.5 mm high and 250 x 187.5 x 78 mm high they incorporate a rigid matt black stove enamelled 18 swg chassis to which red, grey or orange stove enamelled 14 swg top and bottom covers are independently attached.

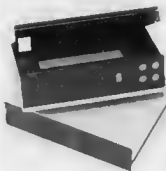

The chassis design includes integral brackets etc, for supporting components, pcb's and other assemblies and these BIMCASES can be supplied with special ventilation slots, cut-outs and punchings to individual customer requirements.

*Boss Industrial Mouldings Ltd,
James Carter Road,
Mildenhall,
Suffolk IP28 7DE.
Telephone: 0638.716101*

(2645 M)

Temperature measurement for soldering tips

A new portable, rugged, fast temperature measuring system, the Wellar WTT 1000, which is designed for low mass miniature soldering tip temperature measurement, is introduced by Cooper Tools.

The WTT 1000 does not heat sink the measured item as it has its own internal



heat source and a dust sensor system which measures both temperature and heat flow, giving an accurate reading on the digital display in under 10 seconds. The output voltage at full load is softed 24 VAC and zero voltage thyristor ensures no high voltage spikes or magnetic field will be present at the tip.

*Cooper Tools Limited,
Sedling Road,
Weir,
Washington,
Tyne and Wear NE38 9BZ.
Telephone: 0632.466062*

(2654 M)

Digital thermometer

Thandar Electronics announce the introduction of a second thermometer to their instrument range. The TH 302 is capable of reading in centigrade or fahrenheit to 0.1° resolution with a measurement range from -40°C to 1100°C. Housed in the

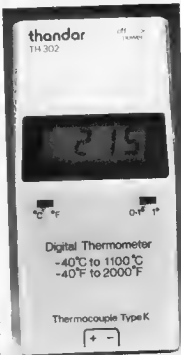

proven Thandar case with 0.5" LCD display the thermometer is supplied complete with fast response bead thermocouple and alkaline batteries. It accepts any type K probe and Thandar offers a range of probes that satisfy most requirements in immersion, surface and semi solid measurement. The TH 302 is priced at £79.00 plus VAT.

*Thandar Electronics Ltd,
London Road,
St Ives,
Huntingdon,
Cambs.
PE17 4JH
Telephone: 0430 64646*

(2694 M)

Low cost multimeter

A low-cost version of the successful T-series handheld digital multimeters has been introduced by Beckman Instruments. Designed to meet the needs of technicians, electricians, engineers and hobbyists the new Beckman T90, at only £43.45 (plus VAT), is the lowest priced professional quality instrument currently on the market.

The choice of functions and ranges was



determined by extensive market research to enable those seldom required by the majority of users to be omitted. As a result the T90 offers six resistance ranges from 200 Ω to 20 MΩ plus a separate diode test function, five dc voltage ranges from 200 mV to 1000 V (0.8% accuracy), two ac voltage ranges of 200 V and 600 V (1.5% accuracy) and five dc current ranges from 200 μA to 2 A. There is no ac current range.

All functions and ranges are selected by a single rotary switch, the meter being fitted with an on/off switch. The 3 1/2 digit liquid crystal display, which is easy to read under all lighting conditions, features automatic decimal point and polarity plus overload and low battery indication.

The use of high-quality components, including a CMOS integrated circuit, and a high shock resistant case guarantees long trouble-free life. All ranges are well protected against overloads and the instrument is covered by a one year, comprehensive world-wide guarantee. The T90 will operate continuously for 200 hours from a standard 9V battery. Size is 150 x 90 x 30 mm and weight only 285 g, including battery. A comprehensive selection of accessories is available including current clamps, a high voltage probe, an RF probe, temperature probes and a durable vinyl carrying case.

*Beckman Instruments Limited,
Mylin House,
11 Wagon Lane,
Sheldon,
Birmingham B26 3DU.
Telephone: 021 742 7761*

(2698 M)

When you own a computer system, electro-medical equipment, laboratory equipment, paper copiers, photography equipment...or if you plan to buy one, you know how imperative and essential it is that your equipment gets protection that's absolutely reliable. Your search for protection that's totally invincible has ended.

KELTRON SERVO-CONTROLLED VOLTAGE STABILISERS

- Backed by years of electronic expertise.
- Easily available in the market.
- Wide range from single-phase 1 KVA to 3-phase 45 KVA. Specifications made to order to suit your needs.
- Wide spread after-sales service network all over the country.

THE CURRENT CHOICE FOR ABSOLUTE PROTECTION

Keltron SCVS-although you pay a little more for it, you have the satisfaction of knowing that you are paying for superior quality and high reliability. For a product that is made with the highest grade components in the market. Leading manufacturers and institutions have proof of Keltron's unsurpassed quality. So, why hesitate?

Give your equipment, absolute protection and optimum voltage, with a Keltron SCVS.

KELTRON SERVO-CONTROLLED VOLTAGE STABILISERS



KELTRON

Know-how to serve the people.

Kerala State Electronics Development Corporation Limited

Consumer Electronics, Division, Sasthamangalam, Trivandrum-695 010, Phone 63106

elektor switchboard

FOR SALE - circuits with servicing tips for various Japanese pushbutton telephone/dialers. Subhankar Dutta, P-94, Lake Road, Calcutta 700 029.

REQUEST - full details about Ham radio operator licence. Prabir Deb Nath, C/o: H.S. Debnath, (Dutt Kumar's House), Badamtala, P.O. Bengal Enamel (Paltā), 743 122.

WANTED - tried simple circuit of TV games in exchange of other circuits or against payment. C. Samy, 11, Balaram Street, Adyar, Madras 600 020.

WANTED - IC TDA 7000 and coils for personal FM project (Dec. 83); also tried circuitry for DMM, against cash. Vijay N. Phadke, 83 Ganesh Baug, 208 Dr. Ambedkar Road, Matunga, Bombay 400 019.

WANTED - information and circuits of walkie-talkie using indigenous components and PCB photo linear. Subhash P. Singh, 183/7, Sheel Kunj, University of Roorkee, Roorkee 247 667.

FOR SALE - Ham rig and walkie-talkie. I also need IC's DC 53C, OM 961 and 7137. T.S. Lahri, 172-36-A, Chandigarh 160 036, Tel.: 29825.

INTERESTED - in specially built transformer for electronic units. N.M. Shetty, Rahimathai Bldg No.2, Room No 39, 1st Floor, Tulsiwadi, Bombay 400 034.

NEED - photoflash or sine-to-square wave converter circuit for transmitter. Vasantkumar, 3208/2, 'B' Block, M.C.C., Davangere 577 004.

INTERESTED - to purchase good DMM and scope. Indicate source, make, specifications and price. Deepak Rai, 57/A, Neelambeta Road, N.I.T., Faridabad 121 001.

WANTED - electronic flashgun circuit of Polaroid Polartron 8400 and power transistor used in same. Jose R D'Cruz, Kalliarackal House, Thazhuthala, Kottiyam P.O., Quilon 691 571.

WANTED TV antenna construction details to receive foreign stations as also list of books on the subject. Terence Fernandes, Bth Panjat, Rokadia Cross Lane, Borivli (West), Bombay 400 092.

WANTED A/D & D/A costly multi-channel ICs. Please quote. R.P. Kapoor, II-H/14, Lapet Nagar, New Delhi 110 024.

WANTED - VHS electronic TV tuner, pushbutton telephone dialler, circuit, UHF/VHF converter. Tanwan make Natom MW IC pocket radio. P.S. Chelokia, 2284, Sector 35-C, Chandigarh 160 036, Tel.: 32670.

HELP! - Can anyone supply simple circuit diagram of MW transistor receiver? Hans V. Shetty, MT 'C' type quart Bldg. No 148-2/4, Sada, Marmagao Harbour 403 804.

FOR SALE - sparingly used word processor upgradable computer. Epson MX80 printer. Instalment payments acceptable. Avinash Narwaker, 10, Dhanlaxmi, Hanuman Road, Vile Parle (East), Bombay 400 057.

WANTED - walkie-talkie circuit and circuit for small MW transmitter with good range. Sunil Dharm, Kothi No 382, Phase II, S.A.S. Nagar, Mohali, Ropar 160 055.

INTERESTED - in contacting shortwave listeners involved with amateur (ham) radio and electronics hobbyists. Present Rajagopal, C/o: V.R. Subbu, 391, R.I. Road, V.V. Puram, Bangalore 560 004.

WANT - to exchange (purchase programmes and listings for Sinclair ZX - Spectrum. Also keenly interested in games. D. Sridhar, 5/85, A.U.E.C.H., Andhra University, Waltair 530 003.

WANTED - circuit of audio power booster. Anant Kumar Tudu, 6, ASB/2 Line, P.O. Mosa-boni Mines 832 104, (Bihar).

INTERESTED - in contacting electronics hobbyists to exchange circuits, books, magazines, etc. Ramesh Bard, 33, Phears Lane, Calcutta 700 073.

WANTED - 8-bit microcomputer from 1 to 16 KB RAM TV and cassette interface, new or used for VHF TV. Santosh Agarwal, M-20, Greater Kailash II, New Delhi 110 048.

NEEDED - IFT/details for 1965 make Standard transistor radio model No. H-5010. Rajiv Singhal, V 2287, Gali Pahar Wali, Dharampura, Delhi 110 005.

WANTED - full details about hams, remote control toy circuits for planes, etc., in exchange for other circuits. K. Udaya, C/o: Dr. S. Rajasekara, Halbhavi Compound, U.B. Hills, Malmaddi, Dharwar 580 007.

WANTED - two osc. coils for Cosmo tapedeck model CO6500 or any other osc. coils with circuit diagram. Eric Fernandes, Rose Blossom, 1st Floor, C-26, Shitaladevi, Mahim, Bombay 400 016.

WANTED - Harmon & Kardon valve No. 7355 for US make stereo amplifier. V. Moorthy Raju, T. Nagar, No 5, Crescent Park Street, T. Nagar, Madras 600 017.

FOR SALE - unused latest Canon A1 electronic camera equipment, (automatic flash etc.). Atul K. Pansare, 6-D, Madhav Nagar, 115-A, Bhavanishankar Road, Bombay 400 028.

WANTED - basic manual for Casio PB 100, original/xerox and software for same, also Sinclair ZX 81 or Spectrum. Cash purchase. S.S. Nagpal, 205, Ashana, Opp Prapat Society, Off J.P. Road, Andhan (W), Bombay 400 058.

FOR SALE - secondhand valve type PA amplifier and matching preamp with tape, mc, rec inputs. Output 60W Anand Shirali, Flat A, Bldg. 6, Ohake Colony, J.P. Road, Andhan W, Bombay 400 058.

WANTED - circuit diagrams of 'Triumph' model RR-3000 by Currys Ltd., Japan and two nos IC HA1406. Please furnish address of Currys Bharat J. Choksi, 13/332, Matru Ashish, Athwalines, Surat 395 001, Tel: 87406.

WANTED - circuit diagrams for walkie-talkie and TV, both with good range. Amat Shah, 20, Tilotama, R.C. Church, Bombay 400 005.

REQUIRE - circuit diagrams of stereo echo amplifier, PDM amplifier and graphic equaliser. Sajan S., Satebhavan, Thazham, Chathannoor P.D., Quilon 691 572.

NEED - circuit of frequency meter, digital or analog with indigenous available components. G.G. Kulkarni, Sadhana Co-operative Society Vanda Park Road, Vile Parle East, Bombay 400 057.

FOR SALE - light-weight stereo head-phones, eight months old. Rs 80-00. Remit Rs 10-00, balance by VPP Pradeep V., C/o: M.V. Bhat, No. 30, Hariharas Nikaya, 10th Main II Phase, Gokula, Triveni Road, Mathikere, Bangalore 560 054.

WANTED - tried circuit diagram of continuously variable RF signal generator, solid state or valve, type but without coils or crystals. V.K. Mittal, 15-23-A, Road No 10, Old Railway Colony, Ratlam; 457 001.

GUIDANCE - requested from experienced ham operators, preferably local, for becoming ham operator. P.V. Mohamed Rafi, Quick Tempe Service, IInd Main Road, R.C. Puram, Bangalore 560 021.

FOR SALE - 15-tunes musical door-bell. Rs 65-00, postage extra. Remit Rs 10-00, balance by VPP Post-free if full value is sent in advance. I Somasundaram, 439/4, ICF South Colony, Madras 600 038.

WANTED - FM wireless mc. circuit and good quality recording playback tape pre-amp circuit with pcb Vivek, "Ambela", 51, Behnd Tin Industries, Bangalore 560 018.

WANTED - IC 415E and full kit of personal FM receiver, except headphones, published in Elektor Oct 83. Reminder Singh, C/o: Industrial Hardwares, Guru 8azār, Chowk Sudan, Jalandhar 144 001.

WANTED - ZX Spectrum min 16K ram with manuals, printer, programmes, etc. Parash Sheth, 48, Navvay Nivas, 167 Lamington Road, Bombay 400 007, Tel: 890324.

FREE EXCHANGE - of software offered to Sinclair ZX Spectrum owners. Sonny R Arya, Sador Sedan, 150/A, Rd No.9, Bldg No 2, Wadala, Bombay 400 031.

WANTED - Elektor or any other circuit to convert single beam oscilloscope into 8 or 16 channel. Bhargav B. Shukla, 21, Pevansut Society, Jivraj Park, Ahmedabad 380 051.

WANTED - Elektor UK edition issue of April 1983 (No 96). Subhash Achi, Kismet Lodge, Jangli Maharej Road, Pune 411 004.

FOR SALE - LED walkman Rs 50/-; electronic parrot Rs 75/-; new, unused 100W frequency controlled inverter Rs 360/-; P & P included-D.M. Gopinath, 56/7, Nandidurga Road, Bangalore 560 046.

OBLIGE - me with tried circuit of IC LM381 with details. Also interested in making own cross-over networks. K.K. Chawla, C-25, Dayanand Colony, Lapet Nagar IV, New Delhi 110 024.

FOR SALE - Garrard synchro-belt record changer model SLX with Pickering magnetic cartridge. Send offers. Swapan Das, 2/7, Bibeknagar, Calcutta 700 075, Tel: 72 21 68.

WANTED - 22 mH ad, bias trap coil and MEF 104/101 FET. Also circuit of any stereo recorder. N. Krishnaswamy, 259, Tapt. Hotel, IIT, Madras 800 036, Tel: 414 892.

THE AUTO LOGIC MONITOR

LOGICCLIP LC-16 16 Channel Logic Monitor

- Just clip it on your IC and Logicclip instantly and accurately shows both static and dynamic logic states on a bright 16 LED display
- As it finds its own power no need to make supply ground connections or mess your hands occupied
- Simultaneous monitoring of all 16 pins with fast dynamic watch, freeze stop and regenerate the max. 80 short circuits
- LC-16 is compatible with all ICs in logic type: K0, DTL, TTL, HTL, ECL, L, LS, S, CMOS, upto 18 pins

TECHNICAL DATA

Power consumption	Less than 200 mW
Operating temperature	0°C to 55°C
Storage temperature	-20°C to 70°C
Relative humidity	20% to 90% (non-condensing)
Dimensions	100mm x 100mm x 25mm
Weight	15 grams
Supply	5V to 15V DC
Maximum voltage	10V



Try the LC-16 and you will wonder how you ever managed it without it!

Applications

- Design Debugging, testing and checking new logic designs
 - Production testing and servicing and direct read logic equipment of logic function in existing equipment
 - Maintenance of individual IC
 - Identification of unused elements in given IC to bring the maximum hardware time to state
 - ICs on different boards try same time or more LC-16
- Price enquiry please refer to the IC card.

Only Rs. 885/-

Price valid till 31/03/84. Components etc. are 20% extra. Shipping charges extra. Minimum order Rs. 1000. Payment by cheque/bank draft only. Delivery by air.



PULSECHO SYSTEMS

107, Nirmal Industrial Estate, Near Sun Fort,
Road No 29, Sion (East), Bombay 400 022 INDIA
Telephone 47 10 55, 48 20 87
Gram 'PULSECHO' Matunga, Bombay 400 019
Telex C/o 011 71447 (MDEV IN)

SFPL Electrolytic CAPACITORS



- Long life grade in screw and lug terminals. Low Voltage range 6.3 V-100 V. High Voltage range 150 V-450 V

- Exclusive features: very low ESR, ESL, tan δ D. C. leakage current. Wide temperature range and high ripple current carrying capability
- Ideally suitable for industrial & Military applications.

Please contact:

Cresta Instruments

714, Parekh Market, 39, Kennedy Bridge
Opera House, Bombay 400 004. Phone: 387933
Cable: "Physequip"; Telex: 011-5573

Professional grade electronic components

Choice of users for over a decade

Et-Ci-Ar ELECTRONIC COMPONENTS

Electro Components Co.
68 MADAPSAR INDUSTRIAL ESTATE, PUNE 411 013

TEL 70428-70914
CABLE EL-CI-AR

elektor INDIA BUYERS GUIDE



ELECTRO FUN

25, McLeod St, Calcutta-700 017

BOOKS * KITS * PARTS



Amar

RADIO CORPORATION

Authorised Dealers & Stockists For Electronics Components & PHILIPS (Elcoma & Service) 11/1, Thiglar Periyanna Lane Silver Jubilee Park Road BANGALORE-560-002.

GEETA ELECTRONICS

Available All Types of Electronics Components
2nd Floor Chandra Building,
Avenue Road Bangalore-560-002

SUNDARAM ELECTRONICS

Printed Circuit Boards

Factory: L-5, Intronics Campus
MADRAS-600041 Phone 413272
Show Room : Raheja Complex
Basement Shop 21, 834 Mount Rd
MADRAS-600 002



ELECTROKITS

Dealers in:
HOBBY KITS & ELECTRONIC
Components.

20, Narasingapuram Street (1st flr)
Mount Road, MADRAS 600 002

Emshah ELECTRONICS

FOR ALL YOUR REQUIREMENTS,
OF ELECTRONIC COMPONENTS,

Rejmehal Road, Vadodera 390 001 Tel: 52921-51380



Dynatron Electronics

FOR A WIDE RANGE OF
SEMICONDUCTOR DEVICES, &
OTHER ELECTRONIC COMPONENTS

3, Chunam Lane, Dada saheb Bhadkamkar Marg, Bombay 400 007.

MAXIM ELECTRONICS

DEALERS IN ALL TYPES OF
ELECTRONIC COMPONENTS
101, SONA SHOPPING CENTRE 60 FI. ROAD
NASIK CITY 422 001 (MAHARASHTRA)

DEALERS IN ELECTRONIC COMPONENTS

TEXONIC INSTRUMENTS

9, ATHIPATTAN STREET
MOUNT ROAD
MADRAS 600002
PH: 84480/844712

2, MANOHARAPPA LANE,
3-2 P. ROAD CROSS
BANGALORE 560002
PH 77310

precious^o Electronics Corporation.

FOR A WIDE RANGE OF
SEMICONDUCTOR DEVICES, &
OTHER ELECTRONIC COMPONENTS

9-Athipattan Street Mount Road
MADRAS-600 002. Phone 842718

AKAI

ELECTRONICS

PRIVATE LIMITED

ELECTRONIC KITS IMPORTERS & EXPORTERS

Genesh Niwas, Tara Temple Lane, Off. Lamington Road,
BOMBAY 400 007 Phone : 38 30 88



AVAILABLE ALL TYPES OF
ELECTRONIC COMPONENTS
FOR * EDUCATION
* DEFENCE
* INDUSTRIES.

TRIO RADIO
& ELECTRONIC CORPN.
453 SUNSHAR PATH, PUNE - 411 002
PH. 447120

Imperial Radio & Electric Corp.

Stockist of : Bush, Murphy, Philip, and other Electronic Spares

371, Lajpat Rai, Market, Chandni Chowk, Delhi-6
Phone . 237271 235381

eltek

PLEASE WRITE FOR DETAILS

ELTEK

BOOKS-N-KITS

6, RITCHIE STREET, 1ST FLOOR,
MOUNT ROAD, MADRAS-600 002

BRISK ELECTRO SALES P. LTD.

BOMBAY 400 004

PHONE 354016

RELAYS—SWITCHES—CONNECTORS
—ELECTROLYTIC & PLASTIC FILM
CAPACITORS—RESISTORS—
HIGH POWER DIODES—
THYRISTORS AND OTHER
SEMI-CONDUCTOR DEVICES.

BRISK SALES CORPORATION

BOMBAY-400 004

PHONE 358537

'APPLE' COMPATIBLE PERSONAL
COMPUTER AND Z-80 BASED
TRAINER—SEMI-CONDUCTOR
DEVICES—HERMETICALLY SEALED
AND EPOXY DIPPED TANTALUM
CAPACITORS.

MICRO PROFESSOR

Z-80 Based
Microprocessor
Training KIT along
with Basic Interpreter.

Options Available:

- Z-80 CTC &
- Z-80 PIO Chips
- EPROM

Programmer Board

- Speech Synthesizer &
- Sound Generator Board
- Printer
- Bread Board

Also Available
UDS System



BRISK

394, Lamington Road,
BOMBAY-400 004.

Tel:
35 40 16
35 85 37

WE OFFER FROM STOCK

I.C.'s : TTL, CMOS, MOS, LSI,
Microprocessor. Micro computer etc.

Zener Diodes : 400 MW & 1 Watt

LED's : Red, Green, Yellow in
5mm and 3mm dia

IC Sockets : SMK & Memorex make
Trim pots :

Multiturn Bourn's, VRN & Beckman make

Single Turn cermet's :

EC as well as imported

Floppy Discs :

8" as well as mini floppy of memorex,
& dyson make

Write to :



ZODIAC ELECTRONICS CORPORATION

2/12, Hirji Bhamal Trust Bldg, M.G. Road, Ghatkopar (E),
Bombay 400 077. Phone No. : 36 43 79

SOLDER AID

Compact new "SA-3" series temperature controlled solder stations are ideal for all soldering applications. Special tip mounted sensor and sophisticated control circuitry ensure fast response and exceptional stability within 5% over the broad range of 110-500°C (200-930°F). Available for either 115V or 230V 50/60-Hz input, the SA-3 series comes complete with special 24 volt 48 watt low-leakage iron and is grounded for MOS and CMOS applications. The unit is extremely simple to use, featuring lighted power and heater indicators, proportional temperature control, and temperature indicating meter, plus iron holder and tip cleaning sponge, all in a rugged and compact enclosure. Supplied with SAT-3-01 conical tip. For replacement tips see chart.



O.K. INDUSTRIES, INC.

CONTACT :

BALAJI ENGG. CO.
195, BRIGADE ROAD
BANGALORE - 560001
PHONE: 52411

BRANCH:

BALAJI ENTERPRISES
B/15, Prasanth Apartment
Machine Tyre Road
Secunderabad-500 003
Phone: 77490

New! about the index cards

Starting with this issue we will publish a series of INDEX CARDS.

The front side of the card will feature the contents of *elektor* India from the January 1984 issue onwards. The reverse side will feature projects and articles that appeared in *elektor* India during 1983, subject wise.

The Preserved Cards Will Be A
Valuable Reference Source

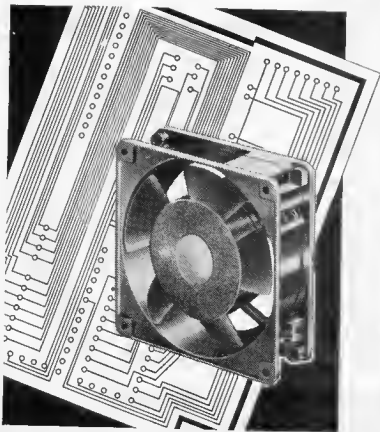

A Companion for your electronic component cooling application – ROTARY FAN

For your high technology computer application and the electronic switch system, the real necessity is of a quality air cooling rotary fan which has significantly long service life. It is because of the use of quality insulating material, low winding temperature, high output torque and the highest grade sleeve bearing, the fan can be used over a wide temperature range (-30°C to +70°C) without any worries.

 **british**
ELECTRICALS

3, Chowdhary Building,
1st Bhatwadi,
Bombay 400 004.
Phone : 362007/385007.

PISCES/BE/3528

Faithful reproduction One good reason is enough

COSMIC

STEREO CASSETTE TAPE DECKS
STEREO CASSETTE TAPE RECORDERS
STEREO TURNTABLES.



CO-8500 D STEREO CASSETTE TAPE DECK

Frequency Response: 30-12000 Hz (LN tape), 30-16000 Hz (CrO₂ tape) **Signal to Noise Ratio:** Better than 45dB
Wow & Flutter: Less than 0.2% WRMS **Heads (2):** One High Density Super Permalloy REC/PB One Erase



CO-360 STEREO CASSETTE TAPE RECORDER WITH BUILT-IN AMPLIFIER

Frequency Response: 30-12000 Hz (LN tape), 30-16000 Hz (CrO₂ tape) **Signal to Noise Ratio:** Better than 40dB
Wow & Flutter: Less than 0.2% WRMS **Heads (2):** One High Density Super Hard Permalloy REC/PB One Erase

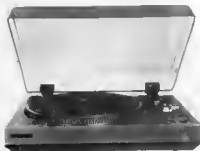

HS 410 DD DIRECT DRIVE STEREO TURNTABLE

Platter: 30cms. diameter with Built-in Stroboscope for 5K Hz and 60Hz. **Motor:** Servo controlled - Direct Drive **Wow & Flutter:** Below 0.04% RMS JIS C5521 **Cartridge:** Magnetic with diamond stylus

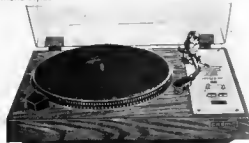

CD-GRAM 4000 DD MK II DIRECT DRIVE STEREO TURNTABLE

Platter: 30cms. diameter with Built-in Stroboscope **Motor:** Servo Controlled - Direct Drive **Wow & Flutter:** Below 0.07% RMS JIS C5521 **Cartridge:** Magnetic with diamond stylus.



CD-703 D STEREO CASSETTE TAPE DECK

Frequency Response: 30-13000 Hz \pm 3dB (LN tape), 30-16000 Hz \pm 3dB (CrO₂) **Signal to Noise Ratio:** Better than -54dB (LN tape), Better than -56dB (CrO₂ tape), NR Delay Switch ON Improves upto 10 dB above 5 KHz **Wow & Flutter:** Less than 0.06% WRMS **Heads (2):** One Glass Surface Ferrite REC/PB One Erase



CO-5100 D STEREO CASSETTE TAPE DECK

Frequency Response: 30-13000 Hz \pm 3dB (LN tape), 30-16000 Hz \pm 3dB (CrO₂ tape) **Signal to Noise Ratio:** Better than -60dB (LN tape), Better than -63dB (CrO₂ tape) NR Delay Switch ON Improves upto 10 dB above 5 KHz **Wow & Flutter:** Less than 0.06% WRMS **Heads (2):** One High Density Super Hard Permalloy REC/PB One double gap erase



STUDIO STANDARD SERIES K8 STEREO CASSETTE TAPE DECK

Frequency Response: Metal tape - 20Hz to 20KHz (30Hz to 17 KHz \pm 3dB); CrO₂ tape - 20Hz to 18KHz (30Hz to 16KHz \pm 3dB); LN tape - 20Hz to 15 KHz (30Hz to 15 KHz \pm 3dB) **Signal to Noise Ratio:** Metal Tape - better than -59dB (NR OFF) better than -65dB (NR ON); (CrO₂ tape - better than -57dB (NR OFF) better than -63dB (NR ON) LN tape - better than -55dB (NR OFF) better than -60dB (NR ON) **Wow & Flutter:** Less than 0.055% WRMS **Heads (2):** One Sennett REC/PB One double gap erase



CO-GRAM 2000 BD BELT DRIVE STEREO TURNTABLE

Platter: 28cms diameter, Aluminum alloy die cast **Motor:** 4 pole synchronous motor - Belt Drive **Wow & Flutter:** 0.15% WRMS **Cartridge:** Magnetic with diamond stylus.

International quality created for India by **COSMIC**