

elektor

up-to-date electronics for lab and leisure

D 71683

103

November 1983

85 p.

IR 130p.- (incl. VAT)
\$ 2.75

**PWM power controller for
model railways**

**CPU+VDU=
intelligent
video
terminal**

**Metronome
with
optional
quavers**

**A new AM
receiver IC:
the ZN415**



selektor	11-21
doorbell — or telephone — operated flash light	11-23
With this flash light you can see when the doorbell or telephone rings: a boon for the herd-of-hearing.	
power controller for model railways	11-26
Model trains can behave like real trains: build this controller and prove it for yourself.	
decoupling in digital circuits	11-30
Decoupling of supply lines is often forgotten in digital circuits and yet it is easily carried out.	
CPU card	11-32
An independent, single-board computer on eurocard format designed for universal application.	
decimal-to-binary converter	11-40
Your programmable pocket calculator can be made doubly useful with this converter which provides an eight-bit binary output.	
missing link	11-41
PC board pages	11-42
movement detector	11-45
The special feature of this detector is that it is a passive device. Its operation is akin to that of the human eye.	
electronic two-tone metronome	11-48
Indispensable for those who want more complex tones and rhythms than are available from a mechanical metronome.	
pseudo stereo	11-52
A new chip which gives the FM mono radio receiver featured in the September issue a new dimension!	
universal terminal	11-56
Combining the CPU card described elsewhere in this issue and the VDU card published last September can result in a universal terminal with a low cost-to-capability ratio.	
ultrasonic/infrared barrier	11-58
Piezo ceramic ultrasonic barriers have been largely ignored in favour of infrared ones — yet, they work just as well as their counterpart.	
trick battery	11-60
A battery so unusual that it will fool most, if not all ...	
Crescendo revisited	11-62
Some useful hints for all those who have constructed the Crescendo	
applicator	11-63
A new receiver IC from Ferranti, the ZN415, requires only a small number of external components to make a complete AM radio.	
market	11-64
switchboard	11-69
EPS service	11-80
advertisers index	11-82



The CPU card described in this issue can be put to many uses. One of the more interesting possibilities is to combine it with the VDU card featured in the September issue to form an intelligent video terminal. This has an RS 232 connection, VT 52 protocol, adjustable image format and full graphics capabilities. In fact, it provides just about everything you are likely to need of a terminal.

Stavros Ling

A selection from next month's issue:

- phaser
- video amplifier
- frost warning device
- 64-way bus expander
- symmetrical power supply

electronize

AUTO-ELECTRONIC PRODUCTS

KITS OR READY BUILT

TOTAL ENERGY DISCHARGE ELECTRONIC IGNITION



IS YOUR CAR AS GOOD AS IT COULD BE?

- ★ Is it **EASY TO START** in the cold and the damp? Total Energy Discharge will give the most powerful spark and maintain full output even with a near flat battery
- ★ Is it **ECONOMICAL** or does it "go off" between services as the ignition performance deteriorates? Total Energy Discharge gives much more output and maintains it from service to service.
- ★ Has it **PEAK PERFORMANCE** or is it flat at high and low revs where the ignition output is marginal? Total Energy Discharge gives a more powerful spark from idle to the engine's maximum (even with a cylinder).
- ★ Is the **PERFORMANCE SMOOTH**, the more powerful spark of Total Energy Discharge overcomes the "buzzy" effect of contact bounce and electronic filter smooths the effects of contact bounce etc.
- ★ Do the **PLUGS** and **POINTS** always need changing to bring the engine back to its best? Total Energy Discharge eliminates contact arcing and erosion by removing the heavy electrical load. The timing stays "spot-on" and the contact condition doesn't affect the performance either. Larger plug gaps can be used, even wet or badly fouled plugs can be fired with this system.

★ **TOTAL ENERGY DISCHARGE** is a unique system and the most powerful on the market - 3 1/2 times the power of inductive systems, 3 1/2 times the energy and 3 times the duration of ordinary capacitive systems. These are the facts:

Performance at only 6 volts (max. supply 16 volt)	
SPARK POWER — 140W, SPARK ENERGY — 36mJ	
SPARK DURATION — 500µS, STORED ENERGY — 136mJ	
LOADED OUTPUT VOLTAGE	
50pF load — 38kV, 50pF + 50k — 26kV	

We challenge any manufacturer to publish better performance figures. Before you buy any other make, ask for the facts, it's probably only an inductive system. But if an inductive system is what you really want, we'll still give you a good deal!

- ★ ALL ELECTRONIZE electronic ignition feature, EASY FITTING, STANDARD/ELECTRONIC CHANDEOVER SWITCH, STATIC TIMING LIGHT and OESIGNED IN RELIABILITY 14 years experience and a 1 year guarantee.
- ★ **IN KIT FORM** it provides a top performance system at less than half the price of comparable ready built units. The kit includes pre-drilled fibreglass PCB, pre-wound and varnished ferrite transformer, high quality 2uF discharge capacitor, case, easy to follow instructions, solder and everything needed to build and fit to your car. All you need is a soldering iron and a few basic tools.

Most **NEW CARS** already have electronic ignition. Update **YOUR CAR**

ELECTRONIZE ELECTRONIC CAR ALARM



HOW SAFE IS YOUR CAR?

More and more cars are stolen each week and even a steering lock seems little help. But a car thief will avoid a car that will cause him trouble and attract attention. If your car has a good alarm system — well there are plenty of other cars to choose from.

LOOK AT THE PROTECTION AN ELECTRONIZE ALARM CAN GIVE

- ★ **MINIATURE KEY PLUG** A miniature jack plug attaches to your key ring and is coded to your particular alarm.
- ★ **2025 INDIVIDUAL COMBINATIONS** The key plug contains two 1% tolerance resistors, both must be the correct value and together give 2025 different combinations.
- ★ **ATTRACTS MAXIMUM ATTENTION** This alarm system not only intermittently sounds the horn, but also flashes the headlight and prevents the engine being started.
- ★ **60 SECOND ALARM PERIOD** Once engaged the alarm will sound for 60 seconds, unless cancelled by the key plug, before resetting ready to be triggered again.
- ★ **30 SECOND EXIT DELAY** The system is armed by pressing a small button on a dashboard mounted control panel. This starts a 30 second delay period during which the owner can open and close doors without triggering the alarm.
- ★ **10 SECOND ENTRY DELAY** When a door is opened a 10 second delay operates to allow the owner to disarm the system with the coded key plug. Latching circuits are used and once triggered the alarm can only be cancelled by the key plug.
- ★ **LEO FUNCTION INDICATOR** An LED is included in the dashboard unit and indicates the systems operating state. The LED lights continuously to show the system is armed and in the exit delay condition. A flashing LED indicates that the alarm has been triggered and is in the entry delay condition.
- ★ **ACCESS LOOP BONNET/BOOT SWITCH - IGNITION TRIGGER** These operate three separate circuits and will trigger the alarm immediately, regardless of entry and exit delays.
- ★ **SAFETY INTERLOCK** The system cannot be armed by accident when the engine is running and the car is in motion.
- ★ **LOW SUPPLY CURRENT** "DRIVE-IT" is also low power! Operational amplifiers achieve a normal operating current of only 2 mA.
- ★ **IN KIT FORM** it provides a high level of protection at a really low cost. The kit includes everything needed, the case, fibreglass PCB, random selection resistors to set the code and full set of components etc. In fact everything down to the last washer plus easy to follow instructions.

fill in the coupon and send to

Please send more information

ELECTRONIZE DESIGN Dept J Magnus Rd Wilnecote Tamworth B77 5BY tel 0827 281000

TOTAL ENERGY DISCHARGE (6 or 12 volt negative earth)

- Assembled ready to fit £26.70 £19.95
- D.I.Y. parts kit £15.50 £14.95

TWIN OUTPUT for cars and motor cycles with dual ignition

- Twin, Assembled ready to fit £36.45 £29.95
- Twin, D.I.Y parts kit £24.55 £22.95

INDUCTIVE DISCHARGE (12 volt only)

- Assembled ready to fit £15.95 £12.75

Prices include VAT £1-DDPP(UK) per Unit. J

CAR ALARM (12 volt negative earth)

- Assembled ready to fit (All wires and connectors incl) £37.95
- D.I.Y parts kit £24.95

I enclose cheque/postal order OR debit my Access/Visa card

NAME

Address

Address

Code

If you missed
out on Breadboard
'79, '80, '81 and '82.....
Now's the time to catch up with
THE PREMIER SHOW FOR THE
ELECTRONICS ENTHUSIAST!



CUNARD INTERNATIONAL EXHIBITION
CENTRE, CUNARD HOTEL, HAMMERSMITH,
LONDON W6.

Friday November 25th 10am-6pm
Saturday November 26th 10am-6pm
Sunday November 27th 10am-4pm

Improved Venue

Offering improved facilities to the visitor, including car parking and ease of access by rail, tube and car, all in a modern attractive setting.

Holiday Weekend

Why not bring your partner to the show and enjoy a weekend in London? A complete hotel package is available to our visitors to the exhibition with all inclusive rail tickets. Send now for details of what we, the organisers, can offer you.

Write to:

Breadboard '83
ASP Exhibitions
145 Charing Cross Road
London WC2H0FE

This year's features include

- Computer controlled model railway competition. (send off for entry form now)
- Kits components and tools to build all sorts of projects
- Robotic display
- Components and tools at bargain prices
- Technical advice on electronics projects and Ham Radio technique
- Computer Corner - Try before you buy!
- Lectures by professionals covering aspects of electronics and computing
- Holography and Producing Printed Circuit Boards.
- Pick of the projects - Demonstration of the best from ELECTRONICS TODAY INTERNATIONAL, HOBBY ELECTRONICS AND ELECTRONICS DIGEST.

TOROIDALS

The toroidal transformer is now accepted as the standard in industry, overtaking the obsolete laminated type. Industry has been quick to recognise the advantages toroidals offer. In size, weight, losses, isolation and cost, thanks to L.P. PRICE.

Our large standard range is complemented by our SPECIAL DESIGN section which can offer a prototype service within 7 DAYS together with a short lead time on quantity orders which can be programmed to your requirements with no price penalty.

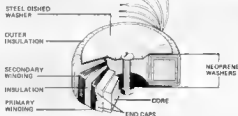

25 VA 82 x 34mm Regulation 19%	50 VA 80 x 35mm Regulation 13%	125 VA 90 x 40mm Regulation 11%	225 VA 110 x 43mm Regulation 7%	500 VA 140 x 60mm Regulation 4%
08N10 540 1.78 08N11 840 0.67 08N12 1240 1.23 08N13 1540 0.80 08N14 1840 0.68 08N15 2140 0.78 08N16 2440 0.85 08N17 2740 0.95	08T10 840 2.12 08T11 1240 1.04 08T12 1540 0.78 08T13 1840 0.63 08T14 2140 0.58 08T15 2440 0.66 08T16 2740 0.72 08T17 3040 0.78	08U10 840 2.80 08U11 1240 1.30 08U12 1540 0.90 08U13 1840 0.70 08U14 2140 0.60 08U15 2440 0.60 08U16 2740 0.65 08U17 3040 0.70	08V10 840 3.80 08V11 1240 1.80 08V12 1540 1.20 08V13 1840 0.90 08V14 2140 0.80 08V15 2440 0.85 08V16 2740 0.90 08V17 3040 0.95	08W10 840 5.20 08W11 1240 2.50 08W12 1540 1.60 08W13 1840 1.20 08W14 2140 1.00 08W15 2440 1.05 08W16 2740 1.10 08W17 3040 1.15
70 x 20mm Regulation 18%	30 x 30mm Regulation 12%	140 VA 100 x 40mm Regulation 8%	300 VA 110 x 50mm Regulation 6%	825 VA 140 x 75mm Regulation 4%
08X10 540 1.80 08X11 840 0.70 08X12 1240 1.30 08X13 1540 0.85 08X14 1840 0.70 08X15 2140 0.80 08X16 2440 0.88 08X17 2740 0.95	08Y10 840 2.20 08Y11 1240 1.10 08Y12 1540 0.80 08Y13 1840 0.65 08Y14 2140 0.60 08Y15 2440 0.65 08Y16 2740 0.70 08Y17 3040 0.75	08Z10 840 2.90 08Z11 1240 1.40 08Z12 1540 1.00 08Z13 1840 0.80 08Z14 2140 0.70 08Z15 2440 0.70 08Z16 2740 0.75 08Z17 3040 0.80	08AA10 840 3.90 08AA11 1240 1.90 08AA12 1540 1.30 08AA13 1840 1.00 08AA14 2140 0.90 08AA15 2440 0.95 08AA16 2740 1.00 08AA17 3040 1.05	08AB10 840 5.30 08AB11 1240 2.60 08AB12 1540 1.70 08AB13 1840 1.30 08AB14 2140 1.10 08AB15 2440 1.15 08AB16 2740 1.20 08AB17 3040 1.25

- Why a Toroid?**
- * Smaller size & weight to meet modern "miniature" requirements.
 - * Low electrical induced noise demanded by compact equipment.
 - * High efficiency enabling conservative rating whilst maintaining size advantages.
 - * Lower operating temperature.
- Why L.P.?**
- * Excellent delivery for small quantities.
 - * Gold service available. 21 days manufacture for urgent deliveries.
 - * 5 year no quibble guarantee.
 - * Realistic delivery for volume orders.
 - * No price penalty for call off orders.

Prices including P&P and VAT

VA	Size	£	VA	Size	£
15	0	8.70	180	5	11.87
30	1	7.54	220	6	13.84
50	2	8.80	280	7	14.17
80	3	9.84	340	8	16.30
120	4	10.51	625	8	29.82

Mail Order - Please make your crossed cheques or postal orders payable to L.P. Electronics Ltd.

Trade - We will open your credit account immediately upon receipt of your first order.

Post to: L.P. Electronics Ltd., Dept. 4
Graham Bell House, Roper Close,
Canterbury, Kent CT2 7EP
Tel. (0227) 54 778 Telex: 965 780

Put 110V primary across "0" in place of "X" in type number.
For 220V primary (European) insert "1" in place of "0" in type number.
For 240V primary (UK) insert "2" in place of "X" in type number.
IMPORTANT! Regulation: All ratings quoted are FULL LOAD!
Please send regulator type to secondary voltage to show off load voltage.



The NUMBER 1 catalogue for the electronics,
computing, communications, audio and
video engineering enthusiasts

GET YOURS NOW !!

ambit
INTERNATIONAL

200, North Service Road,
Brentwood, Essex CM14 4SG

ambit INTERNATIONAL

NB
Current Until
1984



Telephone: (0277) 230909 Telex: 995194 Ambit G
200, North Service Road, Brentwood, Essex CM14 4SG

Use the voucher alongside and deduct £1 from a **prepaid**
order from the Ambit catalogue where the total
value exceeds £15 (excluding VAT)

★ Alternatively — use it to obtain a **FREE COPY**
of the Ambit Catalogue (minus the discount vouchers
supplied to purchasers paying the RRP of 80p)

£1
or FREE catalogue

This voucher may be redeemed for £1 against each £15
of the total order value excluding VAT

T.V. SOUND TUNER BUILT AND TESTED



£24.95 + £2.00 p&p
E.T.I. kit version of above without chassis, case and hardware. £12.95 plus £1.50 p&p.

In the cut throat world of consumer electronics, one of the questions designers apparently ponder over is "Will anyone notice if we save money by chopping this out?" In the domestic TV set, one of the first casualties seems to be the sound quality. Small speakers and no tone controls are common and all this is really quite sad, as the TV companies do their best to transmit the highest quality sound. Given this background a compact and independent TV tuner that connects directly to your Hi-Fi is a must for quality reproduction. The unit is mains operated. This TV SOUND TUNER offers full UHF coverage with 5 pre selected tuning controls. It can also be used in conjunction with your video recorder. Dimensions: 11 1/4" x 8 1/2" x 2 1/4".

PRACTICAL ELECTRONICS STEREO CASSETTE RECORDER KIT

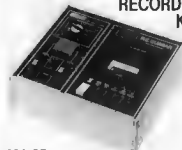

£32.95 + £2.75 p&p

NOISE REDUCTION SYSTEM • AUTO STOP • TAPE COUNTER • SWITCHABLE 2 Ω • INDEPENDENT LEVEL CONTROLS • TWIN V.U. METER • WDW & FLUTTER 0.1% • RECORD/PLAYBACK C WITH ELECTRONIC SWITCHING • FULLY VARIABLE RECORDING BIAS FOR ACCURATE MATCHING OF ALL TAPES

Kit includes tape transport mechanism, ready assembled and back painted cassette mount, togs and all resistors, parts & a comprehensive testable separator, full covers, loop cover, an audio scale and matrix transformer. You only supply solder and hook up wires.

Featured on April 1983 P.E. Reader 500. Free with kit. Self assembly illustrated wood case. £4.50 + £1.50 p&p.

SPECIAL OFFER!
£31.00 plus £2.75 p&p
Complete with case

STEREO CARTRIDGES



PHILIPS
Mounts a cartridge with diamond stylus. Model No. GA-397 III. Output 2mV. Separation 22dB. Stylus 0.5mm diameter. **£3.95 each plus 80p P&A**



GARRARD
Somerton Ceramic cartridge 76mV. With 10µm Sapphir stylus. **£2.95 plus 80p p&p**

SPEAKER KIT 2 WAY 10 WATT

8" bass/mid range and 3" tweeter. Compatible with active and passive components and cabinets. Cabinet comes in 11x11x4 1/2 inch Form 10x10mm Finish. 4x4 inch 4 covered wood simulate. 1/2 1/4 x 2 1/4 x 4 1/4 inch. **ONLY £12.50 plus £1.75 p&p**



All mail to **21K HIGH STREET, ACTON W3 6NG.** Note: Goods despatched to U.K. postal addresses only. All items subject to availability. Prices correct at 30/9/83 and subject to change without notice. Please allow 14 working days from receipt of order for despatch. RTVC Limited reserve the right to up-

MONO MIXER AMP

Ideal for Church Halls & Club houses. **£45.00** + £2.00 p&p

50 WATT 5 Ω individually mixed inputs for two pick ups (C or A) or max 1 two moving coil microphones and two auxiliary for tape tuner, organ, etc. Eight slider control for pre level and two for master bass and treble. Four extra credits controls for mix and aux inputs. Size 12 1/2" x 6 1/2" x 3 1/2". 300 Power output 50 watts R.M.S. (8 ohm) for use with 4 to 8 ohm speakers. Attractive black vinyl case with matching face and knobs. Ready to use.



Matching AKG Microphone 10 suit. (with speech and music later). Complete with lead. **ONLY £95 plus 75p p&p**

VHF STEREO TUNER KIT



SPECIAL OFFER!
£13.95 Plus £2.50 p&p

This easy to build 3 band stereo AM/FM tuner kit is designed at construction with Practical Electronics July 81 issue. For ease of construction and alignment it incorporates three modular modules and an I.C. IF System. **FEATURES:** VHF, MW, LW Bands, transistor mixing and AFC on VHF. Tuning meter. Two back printed PCB's. Ready made chassis and case. Accur. AM ferris rod, FM 75 or 300 ohms. Stabilised power supply with C core mains transformer. All components supplied as to kit. P.E. specification. Front case size: 10 1/2" x 2 1/2" approx. Complete with diagrams and instructions.

HI-FI TWEETER BARGAIN

GOODMANS TWEETERS
8 ohm soft dome radiator tweeter in 2 1/2" x 1 1/2" for use in up to 40W systems, with 2 element crossover. **£3.95 each 1 p&p £11 or £6.95 pair 1 p&p £15.00**

AUDAX 8" SPEAKER

HIGH QUALITY 40 WATTS RMS BASS/MIDRANGE
Ideal for either Hi-Fi or Disco use this speaker features an aluminium voice coil & heavy 70 mm diameter magnet. Frequency res. 20Hz to 7KHz. Impedance: 8 Ω



£5.95 + £2.20 p&p

date these products without notice. All enquiries send S.A.E

125W HIGH POWER AMP MODULES

£10.50 **£14.25**
+ £1.15 p&p

The power amp kit is a module for high power transistor 5000 volt, guitar amplifier, public address systems and even high power domestic systems. The unit is protected against short circuiting of the load and safe in an open air cool condition. A large safety margin built by use of only rated components result a high powered rugged unit. The 4C board is back painted, etched and ready to drill for ease of construction and the aluminium chassis is perforated and ready to use. Supplied with all parts, circuit diagrams and instructions.

ACCESSORY: Stereo/mono mains power supply kit with transformer. **£10.50 plus £2.00 p&p**



SPECIFICATIONS
Max. output power (RMS): 125W
Operating voltage (DC): 50-30V max
Load: 4-16 Ohms
Sensitivity (output measured @ 100 volts): 20KHz
Sens. 100V for 100 Watts: 400mV @ 4KHz
Typical T.H.D. @ 50 Watts: 4 Ohms: 0.1%
Dimensions: 205 x 90 and 190 x 36 mm

STEREO CASSETTE DECK

Stereo cassette tape deck transport with electronic Manual advance a triple band new and optional dual solid w/retro versatility.

£11.95 plus £2.50 p&p
Just requires mains from former and most popular sockets and a volume control to complete. Supplied with full connection details.

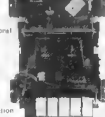

AUDAX 40W FERRO-FLUID HI-FI TWEETER

K1000 on 5KHz
22kHz: 60mm
20mm: 8 Ohm
£5.50 + 60p p&p



Telephone or mail orders by ACCESS ELECTRONIC



ALL CALLERS TO: 323 EDGWARE ROAD, LONDON W2. Telephone: 01-723 8432. 15 minutes walk from Edgware Road Tube Station! Now open 6 days a week 9 - 6. Prices include VAT

When electromagnetic waves came to light

by C.L. Boltz

Born 150 years ago, James Clerk Maxwell made many profound and classical contributions to physical science during his relatively short life. His great mathematical skill, combined with a deep sensitivity of the relationships between physical forces and matter, gave him a remarkable ability to reduce the abstract to logical form. His most important work of all is enshrined in his famous equations which indicated the existence and behaviour of electromagnetic waves, thereby laying the foundation of radio and explaining the nature of light.

James Clerk Maxwell was a genius in what he called natural philosophy but today we call physics. Even now we are still reconsidering many of his discoveries. What is known in all the textbooks as the Young-Helmholtz theory of colour vision should now, in some experts' opinion, be the Young-Maxwell theory, and this is but one example from his very wide field of researches. Maxwell's story is not one of rags to riches, for he was a Scot whose father was a laird, a lawyer and Fellow of the Royal Society of Edinburgh. Young James grew up in affluence. Nor was he a child prodigy, such as Mozart. Indeed, his fellow pupils at school called him 'defy'. But only to the age of 13, for then, suddenly, his abilities blossomed and he was consistently first in many subjects. He wrote poetry, including a blank-verse poem about spinning tops, inspired by a quotation from Virgil's *Aeneid*. He continued to write verse all his life, much of it humorous, for he was a man given to laughter and he never made an enemy.

The first hint of his ability in mathematics came when he was 14. A well-known artist in Edinburgh wanted to find a way of drawing perfect ovals. One oval is the shape of the longitudinal mid-section of an egg, rather like an ellipse but wider at one end than at the other. A method of drawing ellipses by means of a pencil, a piece of string and two fixed centres was already known. School-boy Maxwell went home and dis-

covered a way of modifying it to trace out an oval. His father showed this to Scottish physicist Professor Forbes, who had it printed in the *Proceedings of the Royal Society of Edinburgh*. Maxwell expended it and Forbes read it to the Society in 1864, when Maxwell was 15.

Early papers

At 16 he was at Edinburgh University and soon producing a paper on *The Theory of Rolling Curves*. Another was on *The Equilibrium of Elastic Solids*. So far, all his work was mathematical (geometrical). At 19 he was at Cambridge, for most of the time at Sir Isaac Newton's old college, Trinity. He at once produced a paper on *The Transformation of Solids by*

created the science of quantitative colorimetry. He first of all used a spinning top to merge colours together. He also used, as primary colours, red, blue and green (instead of yellow, as so many had done and thereby run into difficulties because they had not distinguished subtractive colour-mixing from additive). By superimposing coloured papers he could get whatever proportions of mixture he wished. In addition he had black and white discs to cover the centre. The procedure was then to vary the proportions of primary colours until they matched the neutral grey of the mixture of black and white. By this technique he obtained equations of the form

$$0.37R + 0.26B + 0.37G = 0.28W + 0.72BI$$

where R, B, G, W, and BI stand for red, blue, green, white and black. Equations very similar to this are used today in defining colour.

Maxwell used many people, including his wife, as subjects to assess colour-matching. He discovered that most of them, though their assessments differed slightly, were broadly in agreement, but a small minority disagreed markedly: they were 'colour-blind'. He found that this minority could match the gray with only two hues, and so he agreed with Young, the English physicist and physician, that there were three receptors in the eye, of which the colour-blind lacked one.

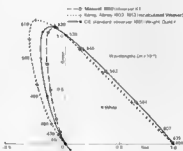

Bending and, significantly, a memoir on Faraday's Lines of Force. Because of his methods, however, it is pointless to pursue his achievements in chronological order. Some six years elapsed between his first and second papers on electricity and some twelve years between his second and third papers on the kinetic theory, so it is simpler to consider his achievements in terms of the subject, though even then we have to leave out many of his original contributions in different fields.

Colour perception

He first became interested in colour-perception when a schoolboy and was taken to meet William Nicol, a noted Scottish natural philosopher, who gave the boy a couple of the Nicol polarizing prisms. Edinburgh was rich in colour experimenters at the time and Maxwell began serious work in about 1849, at the age of 18, though his first published paper appeared in 1855 as an appendix to a work on colour-blindness. According to a recently-published encyclopaedia, James Clerk Maxwell

Colorimeter

He went much further, returning to his prime love, geometry. He designed and made a colorimeter — his 'colour box' — using true spectral colours, the purest we know. With this he was able to get finer measurements. He then showed that colour-mixing could be shown on a diagram, a triangle in his case, for as all the values of the three primaries must add up to one, a display of only two on a two dimensional diagram would suffice to describe a colour. White was the result of blending the three primaries, so all colour-mixing could be related to the white spot. In other words, as he said, it was geometry. This idea, associated with the notion of a 'standard' observer, led in the hands of D.W. Wright of Imperial College, London, and J.Guild of the UK National Physical Laboratory, to the universal CIE (Commission Internationale d'Eclairage) standards now in use, making eye colour precisely repeatable anywhere. Maxwell's triangle was what we now

selektor

call a chromaticity diagram. If we use hypothetical colours purer than those obtainable in practice, to get over Maxwell's difficulty that negative values had to be included in the colour equation sometimes, and if we plot on the CIE x, y axes the values of a series of spectral colours in chromaticity, we get the locus in an almost triangular form, familiar to all colour scientists. When we do this we find that the CIE values are extraordinarily close to those obtained by Maxwell. That is because Maxwell was abnormally delicate and accurate in all his practical work; he was an artist in his own right. He achieved a great deal more in colour science and in 1860 he was awarded the Rumford Medal by the

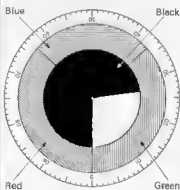

Royal Society for his earliest papers. This account of his work must be looked on as a brief sketch only. While he was Professor at Marischal College (now Aberdeen University), from 1856 to 1860, he spent time on a celebrated work on the rings of Saturn. The topic, investigation of the motions and stability of Saturn's rings, had been set in 1855 at Cambridge for the highly prestigious Adams Prize. Maxwell spent a great deal of time and concentrated thought on this over four years and concluded that the rings were composed of particles of matter. He won the prize.

Theory of gases

Two important researches occupied him for some 20 years, appearing in various stages of development in papers to learned societies before they emerged as treatises. One was concerned with the kinetic theory of gases, work that started in 1859 and was not finished when he died in 1879. He was, of course, a leading mathematician and he was concerned, as were several outstanding conti-

mental scientists, with the way in which heat travelled and how to bring under mathematical control the problem of millions of molecules in a volume of gas. He knew about the work of Clausius, the German physicist who made important contributions to thermodynamics, and that of Stokes, the British mathematician and physicist who had published a great deal on the subject of motion in viscous fluids. But we have to remember that Maxwell, like many others, was breaking new ground [it is impossible now to reproduce the basis of knowledge on which creative physicists then had to begin work, with so little then discovered]. He applied statistical techniques for the first time and was an important contributor to what we now know as Boltzmann statistics. Two of the papers he wrote have been described as his greatest.

The other major research was that which most students of physics associate with his name under the general title of *The Electromagnetic Theory of Light*. This title was not Maxwell's. He started out to devise mathematical relationships to satisfy the qualitative insights of Michael Faraday, who, following Ampère's and Oersted's work, had demonstrated for the first time (and thereby founded the whole of electrical engineering) what he called electromagnetic induction, in the year of Maxwell's birth. Faraday, who knew no mathematics, pictured the phenomenon as due to 'tubes of force' for he could not conceive of 'action at a distance'.

Maxwell was trying to explain how affects could be transmitted through an insulating medium and, as he developed his ideas over the years, he discarded notions of vortices and he applied analogies of dynamics — force, momentum and so on. His progress was charted in five papers starting in 1855 and ending in 1868. By this time, having held a professorship at King's College, London University, he had retired to cultivate his Scottish estate and was writing his complete *Treatise on Electricity and Magnetism*, first published in 1873.

He knew that if one set of units was based on an electrostatic charge and another system on the magnetic pole, then the relationship that the unit of, say, current in one system bore to the equivalent unit of flow in the other system had the dimensions of a velocity. Several researchers did experiments to find the size of the velocity. So did Maxwell, and there was strong suspicion that it was the

same as that of light in *vacuo*. Then, in 1865, he excitedly found that the disturbance that caused electromagnetic induction travelled with the speed of light and was a wave motion. This was the crucial discovery. Further work showed also that light would exert mechanical pressure.

Science of radio

These were original discoveries. It was not until 1887 that a remarkable young German physicist, Heinrich Hertz, showed experimentally that Maxwell was right. In so doing he laid the foundations of all radio science and engineering. In 1900, the Russian scientist Lebedev

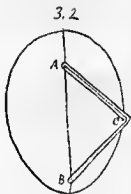

confirmed Maxwell's prediction of a radiation pressure.

By this time Maxwell was dead. He had been persuaded out of his laird-like country life in 1871 to take charge of a new laboratory in Cambridge. It was the Cavendish Laboratory, now world-famous as a world leader for a century. Even in this activity, building up a research laboratory, his ideas were original. In 1878 he became ill with cancer of the abdomen and died in his 50th year.

This brief sketch has missed out all the honours that came to him and many of the discoveries he made in various fields, but one important thing needs to be said. It is just this: his wife played an important part in his researches and, therefore, must have been the first woman scientist in the history of the world.

It was, of course, known before the outbreak of disco fever that flash-lights can be used in fields other than photography. The following design uses a common-or-garden battery-operated electronic flash to indicate when the doorbell or the telephone rings.

doorbell - or telephone - operated flash-light

... ideal for
the hard of
hearing

The hard of hearing are often unable to hear the doorbell or telephone ringing, but many of us who aren't can find ourselves in that situation. For instance, when your

new, powerful vacuum cleaner is being used, or the radio or TV is a bit too loud. In those circumstances, it is very useful to see when the doorbell or telephone rings.

1a

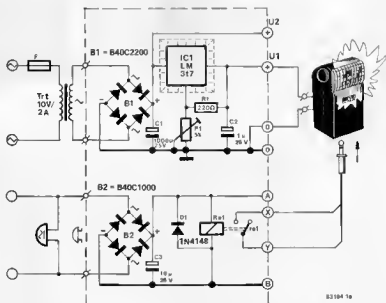

Figure 1a. In this part of the circuit diagram can be seen the power supply, the doorbell converter, and the relay for operating the flash-light.

b

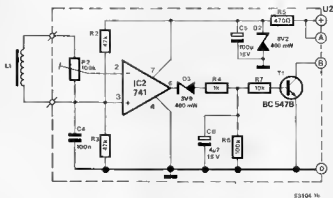
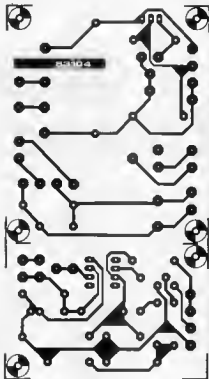

Figure 1b. The circuit diagram of the telephone converter: (A) and (B) are connected to the corresponding terminals in figure 1a. In this version, B2 and C3 in figure 1a are not used.

Figure 2. The printed circuit board of the design; in the doorbell version, the lower part of this board may be cut off and discarded.



Parts list

Resistors:

- R1 = 220 Ω
- R2, R3 = 47 k
- R4 = 1 k
- R5 = 470 Ω
- R6 = 100 k
- R7 = 10 k
- P1 = 5 k preset
- P2 = 100 k preset

Capacitors:

- C1 = 1000 μ /25 V electrolytic
- C2 = 1 μ /25 V electrolytic
- C3 = 10 μ /25 V electrolytic
- C4 = 100 n ceramic
- C5 = 100 μ /16 V electrolytic
- C6 = 4 μ /18 V electrolytic

Semiconductors:

- IC1 = LM 317 (T0-220 plastic package)
- IC2 = 741
- T1 = BC 547B
- B1 = bridge rectifier B40/C2200 *
- B2 = bridge rectifier B40/C1000 *
- D1 = 1N4148
- D2 = zener diode 8V2/400 mW
- D3 = zener diode 3V9/400 mW

Miscellaneous:

- Tr1 = mains transformer 10 ... 12 V/2 A
- L1 = telephone pick-up coil with suction pad
- Re1 = pcb miniature relay type 8056 112 V) or type 8055 16 V) available from M/S Components
- Heat sink for IC1 (T0-220)
- Inexpensive electronic flash-light
- F = 0.2 A slow blow fuse
- * available from Bradley Marshall Ltd.

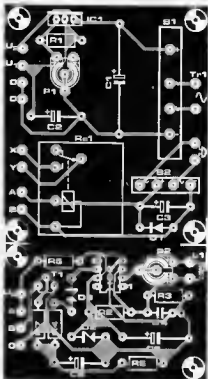

Optical 'sound indicators' are, of course nothing new, but they normally have the disadvantage that you must look in their direction before you can see them working. It is hardly likely that you won't notice a flash-light.

So much for the principle of the thing. Next comes the question of cost. Any inexpensive, battery-operated electronic flash-light will do nicely: the rest of the circuit is built from readily available, popular components.

The circuit diagram

Figure 1 shows that the circuit consists of three distinct parts: the power supply, the converter for the doorbell with relay for operating the flash-light (figure 1a), and the converter for the telephone bell (figure 1b). It is not necessary that, for each application, all three parts are required, but more about that later.

Nothing much needs to be said about the power supply. It is a standard design with an adjustable type LM 317 voltage regulator (IC1). The only important point here is that the LM 317 needs to be mounted onto a heat sink. If you use a flash-light which is normally powered by two 1.5 V batteries, the output voltage, U₁, of the supply should be set to about 3 V; in the case of four 1.5 V batteries, set the supply output,

U₁, to about 6 V. Any batteries should, of course, be removed from the flash-light. The unregulated output U₂ is used for the telephone-bell converter and will be discussed later.

The doorbell converter

Figure 1a shows that a converter need not always be a complicated design: here it consists of just a bridge rectifier, smoothing capacitor, relay, and protection diode. The converter has been designed for use with both a.c. and d.c. operated doorbells: the bridge rectifier C3 is charged when the bell is rung. As soon as the voltage across the capacitor exceeds the operating voltage of Re1, this relay operates, contact rel changes over, and the flash-light goes off. In the meantime, C3 discharges through the relay coil until the voltage across it drops below the operating voltage of Re1, which then releases. If, however, the caller keeps his finger on the bell, C3 does not discharge and the relay remains actuated.

The telephone-bell converter

The terminals (A) and (B) shown in figure 1b are connected to the corresponding terminals in figure 1a (more on this under 'construction'). The unregulated output, U₂, of the power supply is stabilized by

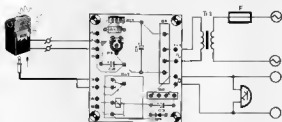

#3104-3a

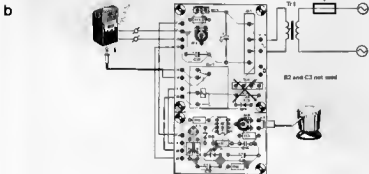

#3104-3b

Figure 3. This figure shows the various external connections for the two versions: 3a for the doorbell end 3b for the telephone.

zener diode D2 and capacitor C5. From the consequent stabilized voltage level of 8.2 V a reference voltage for the non-inverting input of opamp IC2 is derived by potential divider R2/R3. This is also applied to the inverting input via L1 and P2 (L1 is the inductor etched to the telephone by means of a suction pad). With P2 set correctly, the output (pin 6) of IC2 is low as long as L1 is not excited. When the telephone rings an alternating voltage is induced in L1, causing the potential at the non-inverting input of IC2 to periodically exceed that at the inverting input. This results in a square-wave signal at the output of the opamp. The amplitude of this output is limited by zener D3.

The square wave voltage charges capacitor C6: as soon as the consequent voltage level across this capacitor reaches a certain value, T1 conducts. A current then flows through Re1 (which, of course, is effectively connected in series with the collector of T1), contact rel closes, and the flash-light goes off.

Construction and prasetting

If the printed circuit board is used, the construction should give no problems whatsoever. If a doorbell indicator only is required, the lower part of the board is not used end can, if desired, but cut off.

In most cases, a 12 V relay will be required, but it may be that your particular doorbell is a 6 V type and then, of course, a 6 V relay must be used.

The telephone-bell converter always uses a 12 V relay. In this version, rectifiers B2 and electrolytic C3 are omitted from the printed circuit board.

The external connections for the doorbell version are shown in figure 3a, those for the telephone application in figure 3b. In the telephone version it is possible to saw the printed circuit board in two end mount the part containing the telephone converter proper near the telephone and connect it to the other part of the board (which can be mounted anywhere unobtrusively) by means of a 4-way cable. The flash-light itself can be fitted in any required position. Using P1, set the power output to the value required for the flash-light (3 V or 6 V). In the telephone version adjust P2 so that the relay just does not operate. It may, however, happen that because of the off-set voltage in IC2 this is not possible. In that case, connect a 1 k Ω resistor in series with L1 and another of 1 M Ω between the junction of L1/P2 and U2. Finally, ask a friend to phone you and check that the flash-light goes off. It may be necessary to try out several positions of the suction pad containing the coil on the telephone.

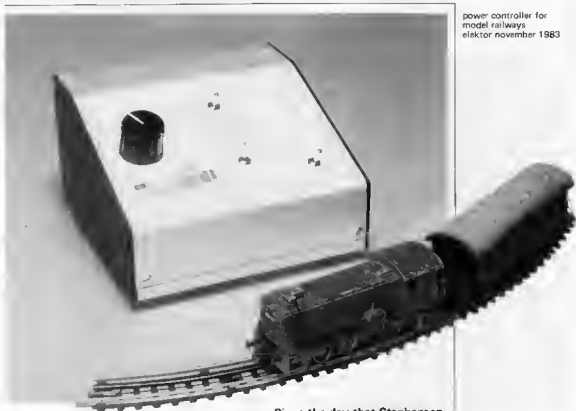

Since the day that Stephenson began taking an interest in coal, 'model railways' has grown into one of the most popular of hobbies: the creation of a world in miniature that lives and breathes on railway lines. The illusion can be woefully shattered, however, when an engine is actually put in motion. All too often the locomotive takes off like a startled rabbit, much to the consternation of the mini-passengers. If this were to happen in real life, time-tables would become irrelevant. Our power controller shows that it can be different.

power controller for model railways

A power controller is, of course, intended to regulate the speed and direction of a model train. Ideally, it should give continuously variable control from a mere crawl to full speed.

Before transistorized circuits became commonplace, controllers were of two types: the rheostat or variable resistor and the variable transformer. The rheostat, connected in series with the locomotive motor, provides some control of the current and therefore of speed. The variable transformer enables the voltage supplied to the locomotive, and therefore its speed, to be varied. Both types of controller have a specific disadvantage with which you may well be only too familiar. When, with your miniature train standing in the station ready

to leave, you advance the speed control, initially nothing happens. You advance the control still further: still nothing happens. Suddenly, your train bolts from the station, clearing it in about 60 milliseconds flat! Any illusion of reality has been destroyed! Real trains pull away (relatively?) smoothly and take time to reach normal cruising speed, an effect which can be simulated in your model railway with our power controller. Strictly speaking, the name 'power controller' is a misnomer, as the numerous possibilities it offers make it more of a 'train controller'. Be that as it may, what does the controller do? To start off with, it allows the train to move off as in reality: slowly at first, and gradually picking up speed until the predetermined speed is reached. Then,

of course, if something goes wrong during the journey, it offers an emergency brake. Thirdly, the train is made to stop as in real life by means of a simple push button. And finally, to make everything as real as possible, it provides a 'dead man's handle'. As model railway enthusiasts know, train drivers must keep this handle or foot pedal pressed down continuously during the journey. If it is released, that means that something is wrong with the driver. To prevent accidents, the train then stops immediately.

The dead man's handle does not have to be kept depressed continuously in our controller, but it does have to be pressed regularly. The features mentioned are available for both forward and reverse movements. Modern electronics has made possible great advances in electric motor control. Of the various techniques employed nowadays, two stand out from the rest: closed-loop operation and pulse-width modulation (PWM) control. In the former the controller monitors the conditions under which the loco-

motive is working and adjusts the output of the controller as appropriate. A PWM controller delivers a series of pulses of full power and the speed is regulated by varying the width of the pulses.

In our design we have chosen PWM control in combination with RC time-constants. Not only does this offer high efficiency, but also pretty precise control. Furthermore, it can be designed with readily available components, so that its cost is kept relatively low. During the design planning it was realized that there are two model railway systems: d.c. and a.c. It proved impossible to design a 'universal' controller and we therefore had to make a choice. As it appears that the d.c. system is by far the most popular, we opted for this. Also, to keep the controller - and therefore its cost - within bounds, we designed it for the control of one train only.

The full-power pulses delivered by a PWM controller are normally fixed, often at the rate of 100 per second (100 Hz) as this is easily derived from full-wave rectified mains.

power controller for model railways
elktor november 1983

S1 = dead man's handle
S2 = stop/start control
S3 = unimpeded/delayed leaving or stopping control; in combination with S2 also emergency brake
S4 = forward/reverse control

Figure 1. The circuit diagram of the power controller. It is a simple matter to 'tailor' the performance of the controller to individual tastes.

1

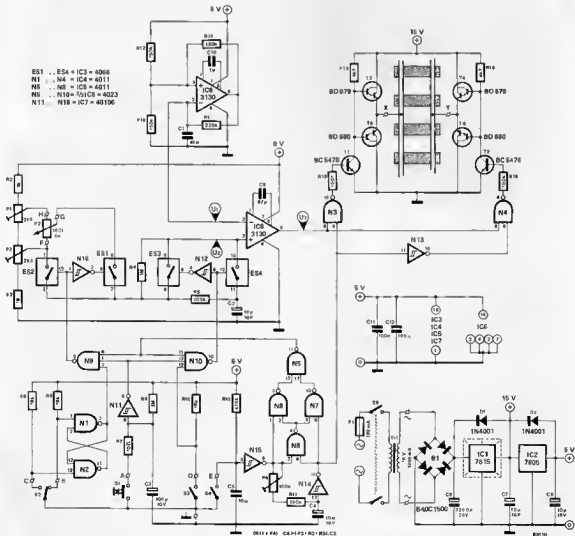

As stated, speed is controlled by changing the width of the pulses: at low setting of the controller, the pulses are short compared with the spaces between them. As the controller is advanced, the pulses become wider and the space correspondingly narrower.

The circuit diagram

The power supply consists mainly of two voltage regulators: a 7815 (IC1) and a 7805 (IC2) as shown in figure 1. The first provides the supply voltage for the model railway and has, therefore, little to do with the circuit of the controller. The +5 V supply for the controller proper is provided by IC2.

It is clear that IC1 has the heavier load and it must therefore be provided with a heat sink. It is, of course, also necessary that the supply transformer can cope with its two-fold task. Both regulators are protected against short-circuits and thermal overloads. The sawtooth waveform required for pulse-width control is provided by IC9. It should be noted that this waveform (U₁ in figure 2) is not taken from the output of the IC, as that is a square wave, but from the inverting input, pin 2. Opamp IC8 compares the sawtooth waveform with the d.c. level (U₂ in figure 2) at the wiper of P2. This potentiometer therefore makes it possible to set the pulse-width of the square wave output of IC8 (U₃ in figure 2) and therefore the speed of the train. If, however, the controller is set to 'automatic', the position of P2 determines only the final speed of the train. The range of speeds is set by P1 - maximum - and P3 - minimum.

The automatic gradual take-off is achieved as follows. As soon as switch S2 is set to position 'start' (and assuming S3 is closed), capacitor C2 charges slowly via P2 and R5. This causes a gradually rising voltage at the non-inverting input of IC8 via ES4. The pulse-width of the square wave output of this IC (U₃) becomes broader until the maximum width, preset by P2, is reached. Dependent upon the direction of travel, these square waves drive T1 or T2 which in their turn cause darlington transistors T3 (T4) or T5 (T6) respectively to conduct. If for one reason or another you want to let the train take off unimpeded, open switch S3 to make the output of gate N10 low. This causes ES4 to open and ES3 to close so that the combination C2/P2 is by-passed and the train will bolt out of the station.

Automatic gradual braking of the train occurs in a similar manner: S2 should then be in the position 'stop' with S3 closed. In that situation, the bistable consisting of N1 and N2 changes state so that pin 3 of N1 becomes low and the output of N9 goes high. This causes ES2 to close and ES1 to open. The voltage across C2 then decays slowly until the value preset by P3 is reached. The effect of this is exactly the opposite of that when the train is leaving: the square wave pulses become ever narrower until the train has come to standstill.

The emergency brake provided in the controller is a combination of two switches: S2 and S3. The brake is operated by setting

S2 to position 'stop' and closing S3 at the same time. The delay combination C2/P2 is then by-passed and the train comes to an immediate stop.



power controller for model railways
elektor november 1983

Parts list

Resistors:

R1 = 220 k
R2, R3 = 1 k
R4, R6 = 1 M
R5, R11, R13, R14 = 100 k
R7 = 10 Ω
R8, R9, R10 = 18 k
R12 = 47 k
R15, R16 = 4k7
R17, R18, R19 = 150 k
P1, P3 = 2k5 preset
P2 = 100 k lin.
P4 = 100 k preset

Capacitors:

C1 = 47 n ceramic
C2, C4, C7, C8 = 10 μ/16 V electrolytic
C3 = 100 μ/10 V electrolytic
C5 = 10 n ceramic
C6 = 2200 μ/25 V electrolytic
C9 = 47 p ceramic
C10 = 1 n ceramic
C11, C12 = 100 n ceramic

Semiconductors

D1, D2 = 1N4001
IC1 = 7815
IC2 = 7805
IC3 = 4066
IC4, IC5 = 4011
IC6 = 4023
IC7 = 40106
IC8, IC9 = CA 3130
81 = 8 40/C 1500 available from Bradley Marshall

Miscellaneous:

S1 = push button switch
S2 = single pole change-over switch
S3, S4 = SPST switch
S5 = double-pole mains switch
Tr1 = mains transformer: 15 V/1.2 A
F1 = fuse, 100 mA
Heat sink for IC1, 35 x 20 x 15 mm, 170°C/W

Another way to stop the train is by means of the dead man's handle, without, of course, any positive action on your part. Because, what happens if this handle, switch S1, is not regularly depressed? Capacitor S3 is charged slowly via R6 until the voltage across it reaches the trigger threshold of inverter N11 which causes the output of this gate to become logic low. Consequently, the output of N9 goes high and ES2 closes. At the same time the output of N16 becomes logic 0 and ES1 opens. The non-inverting input of IC8 is then also low. As in reality, the train now comes to a smooth, gradual halt.

Finally, switch S4 enables the direction of travel to be reversed. Of course, it is not possible to just reverse the polarity of the supply voltage. First, the train has to gradually slow down, come to a standstill and then, depending on the position of S3, gradually accelerate in the opposite direction.

When S4 is closed, the output of N15 becomes logic 1, which causes the output (pin 11) of the XOR consisting of N5...N8 to go low. The output of N9 then becomes logic 1, ES2 closes, ES1 opens, and the train begins to slow down. At the same time, capacitor C4 is charged via P4 and R11. This delay is necessary to enable the train to come to a standstill before the direction of travel is reversed. Once the voltage across C4 has become high enough to make the output of N14 logic low, reversal takes place. But, remember that this may only occur when the train stands still! It is therefore important that the stopping time is shorter

2

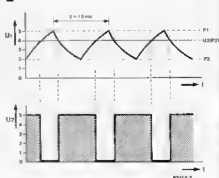
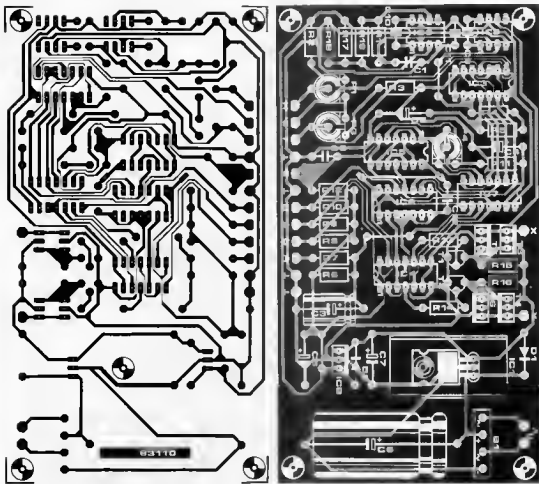

Figure 2. The principle of pulse-width modulation (PWM) control. The width of the square-wave pulses, and therefore the speed of the train, is dependent upon the level of U₂.



than the charging time of C4 which depends on the position of P4.

When the output of N14 has become logic 0, the output of the XOR as well as that of N3 will go high. The change of state at the output of N5 results in N9 also changing state, so that ES2 opens and ES1 closes. At the same time, the output of N4 goes high because the output of N13 has become logic 1. Transistor T1 then conducts hard, but the train none the less leaves slowly because the output of N4, and therefore T2, changes state in the rhythm of the square wave pulses which slowly become wider. The supply current for the locomotive then flows from T4 through the motor to T5. If switch S4 is opened, the same thing happens but in the opposite direction: the current then flows from T3 through the motor to T6.

Different trains, different times

It is, of course, nonsense to allow a modern intercity at top speed to be overtaken by an older generation steam locomotive. By the

same token, a fully laden goods train just cannot accelerate to the same degree as the London to Edinburgh express. If you want to make everything as realistic as possible, you must, of course, make sure that such disparities cannot occur. Again, the controller will help you: both the time required to come to a standstill and that for accelerating to top speed can be preset to individual requirements. The determining components for these are C2 and R5, the values of which can be varied as required. The top speed of the train can be set with P2 anywhere between dawdling and flying. The frequency with which the dead man's handle (S1) must be depressed can also be determined by yourself: the time determining components are R6 and C3.

Figure 3. The layout and track-side of the printed circuit board for the controller. The various switches can be mounted on a small panel so that the 'driver' has all important controls, including the dead man's handle, at his fingertips.

The time is given by the product C2R5: as drawn it is 1 second

One important factor that is often sorely neglected in digital circuit design is decoupling the supply lines. The best known method of decoupling is by means of a small capacitor connected across the power supply pins of an IC. However, supply lines themselves also play a part in introducing interference, and this is the aspect of decoupling to which this article is dedicated.

decoupling in digital circuits

The power supply voltage in digital circuits must normally lie within fairly narrow limits in order to guarantee correct operation of the circuit. In TTL circuits this is particularly critical, and the supply must not deviate by more than + or - 5% from the nominal value of 5 V. There is no real difficulty in keeping the supply within these 5% limits, but we must also ensure that no voltage peaks greater than this 5% can exist in the circuit.

Any wire, power lines included, has a specific self-inductance and a specific resistance. The resistance is usually no problem. The supply lines can easily be made a bit heavier, and that gets around that difficulty. The self-inductance is not so easily seen, but it is none the less present.

What actually happens in a digital circuit? The power supply lines can be represented here by a self-inductance in series with a resistor, as figure 1a shows. If the IC in this figure switches it causes an immediate large change in the current flowing through the supply lines. The self-inductance voltage in each line can be calculated from the formula: $U = -L(di/dt)$. Because the switching edges of the IC are quite steep, the current changes very quickly (di/dt is a measure of this change). This also means that the voltage in each line can change a lot (because of the fairly low self-inductance of such a supply line). These voltage variations can have the result that the supply exceeds its permitted limits and the IC does not operate correctly.

In order to reduce this problem as much as possible, a decoupling capacitor is often connected across the IC as in figure 1b. In this way a transmission line is actually created, with an impedance of $Z = \sqrt{L/C}$. This formula indicates immediately how we can reduce the impedance of the line as much as possible: by making C larger and/or L smaller. Bigger capacitors are one solution, but they are not generally cheap. Furthermore, these large capacitors are not very good at high frequencies (about 100 MHz). A better idea would be to place smaller decoupling capacitors at various points on

the supply line. A further possibility is, of course, to reduce L. This can be done by connecting several supply lines in parallel, as figure 1c shows (just to refresh your memory: when coils are connected in parallel the self-inductance is reduced). To achieve this we can use a supply field or supply 'grid'.

When there is more than one IC in question (see figure 2) it does not make the job any easier. The further up the supply line we go from left to right, the worse the interference becomes. Each IC has to contend with not only the interference that it generates itself, but also that produced by all previous ICs as well. Here also a supply grid would be a better solution. The situation then becomes that shown in figure 2b. This is the way of keeping the self-inductance of the supply lines as low as possible.

The diagram of figure 3a shows a well thought-out layout for the supply lines in a digital circuit. This makes use of not one, but two grids, one for the positive supply and one for the ground. In this set up every IC does not have to have its own decoupling capacitor. One capacitor every second IC is more than enough. This is shown separately in figures 3b and 3c, for an IC with a capacitor and one without a capacitor. The drawing of figure 3b makes

Figure 1a. The supply line in a digital circuit can be considered as a resistance in series with a self-inductance.

Figure 1b. The supply of an IC can be decoupled with a capacitor, as shown here.

Figure 1c. The self-inductance can be reduced by connecting several supply lines in parallel.

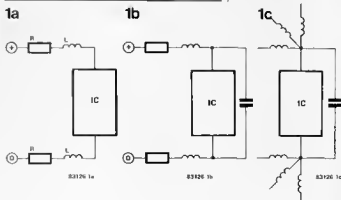

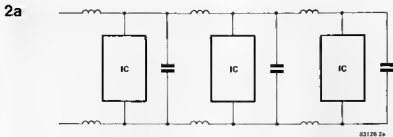

Figure 2a. This is the situation that occurs if several ICs are mounted after each other on the same supply line. This set-up is not recommended even if each IC has its own decoupling capacitor.

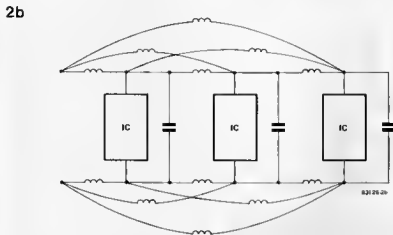
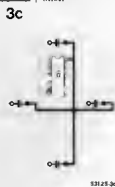
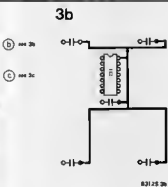
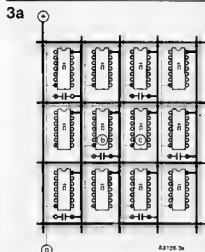

Figure 2b. Supply fields or grids can be used to greatly reduce the self-inductance of the supply lines.



use of all the points mentioned here: more supply lines to the IC connection and a decoupling capacitor that is almost directly on the supply connections of the IC. In the other situation (figure 3c) we see that the IC without its own capacitor makes use of the capacitors on the four ICs around it. When combined with the multiple supply lines, that also gives excellent decoupling. A somewhat larger capacitor (10 ... 47 μ) should be placed fairly centrally in each circuit or printed circuit board. This suppresses low frequency voltage changes that can occur because of the resistance of the supply line to the board. This is nothing to do with HF decoupling, but it is just as

important.

Another point: in digital circuits there is often a large area where all the sections of supply lines are the same length, as in figure 3a. This means that all the inductances are equal. If all the decoupling capacitors also have the same value a ladder network is set up, and this causes the voltage to rise! So: use different values of capacitors.

The technique described here is not just so much more theory, to file somewhere 'for future use'. It does work, and it is definitely worth trying the next time you are building a digital circuit, even if it is only an experimental board.

Figure 3a. This is an extremely good set-up, using two supply grids. This layout works so well that we only need one decoupling capacitor per two ICs.

Figure 3b. This is part of the grid of figure 3a showing an IC with a decoupling capacitor.

Figure 3c. This is an IC in the grid of figure 3a without its own capacitor.

The most appropriate description of this new CPU card might well be: an independent, single-board computer in eurocard format. Much effort has gone into ensuring that the card is truly universal. The choice of a 6502 microprocessor is a natural: well-known from the Junior Computer, it has the advantage that a range of well-tried hardware and software is readily available.

This new CPU card may well be considered the most versatile in the Elektor microprocessor programme. And not without reason. However, before we have a closer look at its characteristics, let's see what applications it offers: that should give you some idea of its versatility.

- Single-board control computer for:
 - machine control;
 - processing guard;
 - morse decoder;
 - telephone selector;
 - simulator or emulator;
 - PROM/EPROM programmer.
- In combination with other μP cards:
 - with VDU card: a universal terminal (see elsewhere in this issue);
 - with VDU card, dynamic RAM card, and a floppy disk interface: an intelligent terminal (see the article 'VDU card' in our September 1983 issue where this set-up was already suggested).

The block schematic

The microprocessor is shown at the left-hand side of figure 1: it can be either type 6502 or its CMOS low-power version, the 65C02 (see 'applikator' in our October issue). The clock generates frequencies of 1, 2, and 4 MHz: the required clock frequency can be selected by means of a wire bridge. The address bus is fully buffered and available either direct or inverted. The data bus is also fully buffered. The control bus is not buffered, but that is, of course, normally not necessary.

Then follow two VIAs (Versatile Interface Adapter), type 6522 or 65C22. The operation and construction of these fairly complicated ICs are fully described in our VIA 6522 book. Briefly, this IC offers two 8-bit bidirectional input/output ports, four handshake lines (by which data interchange is controlled), two programmable 16-bit timers or counters, and an 8-bit serial shift in/out register.

Next, the 6551 or 65C51 ACIA (Asynchronous Communication Interface Adapter) is also a versatile IC. Here it is used for the RS 232/V 24 interface (baud rate, serial/parallel conversion, error detection, and so on). In other words, the ACIA arranges the serial data transfer. Some additional gates are connected between the 6551 and the RS 232 connector to provide any necessary level matching (the RS 232 operates from a positive and a negative supply).

There is space on the card for one RAM-IC and one EPROM-IC. For the RAM there is a choice between a 2 kbyte and an 8 kbyte CMOS memory. There are also various possibilities for the EPROM: 2, 4, 8, or 16 kbyte.

The VIAs and the ACIA have a common address decoder, while the memory-ICs each have their own. Also, all ICs are connected to the address and data buses, and, with the exception of the EPROM, to the control bus.

A reset circuit ensures that the computer is automatically reset when the power supply is switched on. Manual resetting is also possible.

CPU card . . .

. . . based on
the 6502



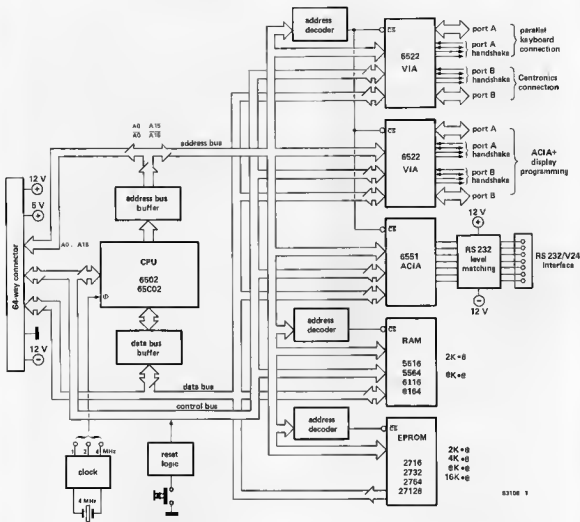

A 64-way connector, into which the control bus, the buffered address and data buses, ± 12 V, and +5 V are terminated, is provided for connection to the Elektor bus.

Returning to the VIA connections: on the first VIA, port A is used for a parallel keyboard connection and port B for a Centronics connection. On the second, ports A and B are both used for the programming (by means of shorting-plugs) of the ACIA, of the image size (only in combination with the VDU card), and some others, all of which are enumerated in table 1.

The electrical diagram

A look at figure 2 will soon show that there is not all that much to add to the description of the block diagram. At one side there is again the 6502 IC with beside it the three-state buffers N11... N58 for the address and data buses. The clock consists of two

Features of the CPU card

- 6502/65C02 CPU
- 2 x 6522 VIA
- 1 x 6551 ACIA
- 2 or 8 k RAM
- 2, 4, 8, or 16 k EPROM
- complete address decoding
- fully buffered address and data buses
- 64-way Elektor bus
- DMA possibility
- clock frequencies of 1, 2, and 4 MHz
- four 8-bit ports
- four 16-bit timers
- two serial data ports
- eight handshake lines
- parallel keyboard connection
- Centronics connection
- RS 232 connection
- all I/O lines terminated into connectors

Figure 1. The block schematic of the CPU card. Note the large number of connections!

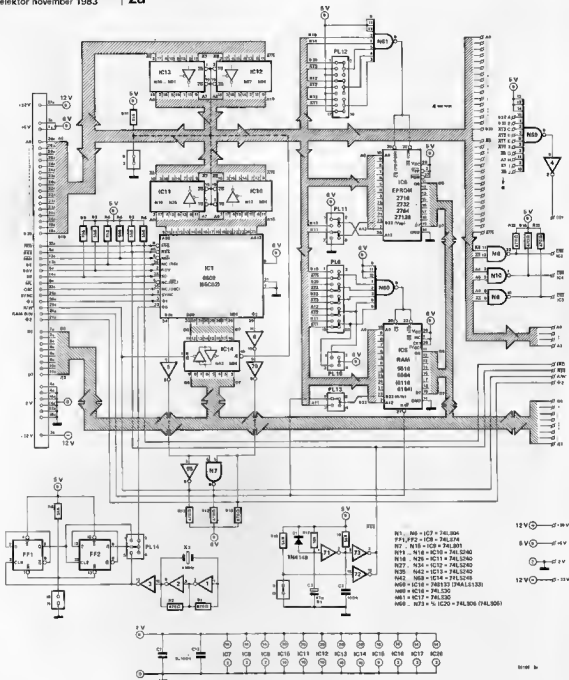

gates, N1 and N2, followed by two dividers, FF1 and FF2. Shorting plug PL14 enables selection of the required clock frequency. If, for instance, you want to use an external clock, dividers FF1 and FF2 can be made inoperative by connecting point M to N. Close to the clock you see the reset circuit consisting of gates N71 . . . N73. When the +5 V supply is switched on, the RC network R17/C1 ensures a half second delay before the reset input of the CPU is actuated. If required, a spring-loaded push-button switch

may be connected between points P and Q to provide a manual reset facility. The address decoder for the VIAs (IC2 and IC3) and the ACIA (IC4) consists of gate N59; that for the RAM (IC5) is N60, and for EPROM IC6 it is N61. A crystal is connected to the ACIA for the generation of various baud rates. Gates N62 . . . N68 are level equalizers which translate the symmetrical signals of the RS 232 to asymmetrical 5 V ones for the CPU and vice versa.

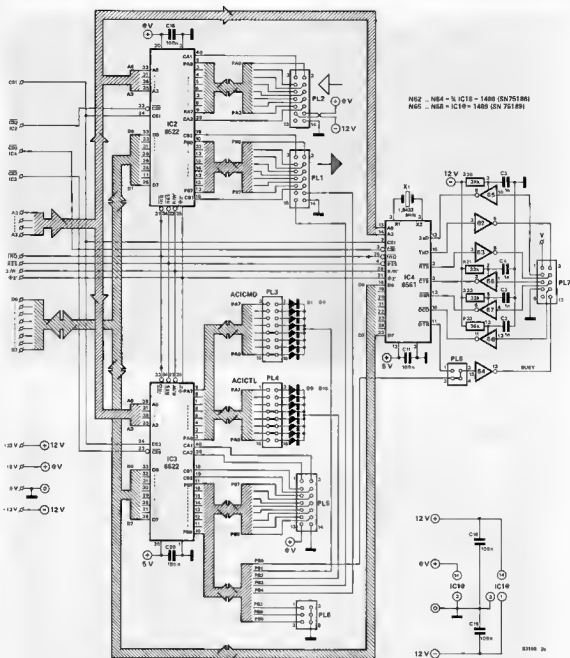

When bipolar ICs are used, power dissipation amounts to 100 mA at ± 12 V and 1 . . . 1.5 A at ± 5 V. If, however, CMOS circuits are used, current consumption drops to about 100 mA overall, so that it is then possible to supply the CPU from primary cells or rechargeable batteries.

Construction

The printed-circuit boards for the CPU card are shown in figures 3 and 4. Two for a

single-board computer? you will say. Well, unfortunately, because of our determination to make the card truly universal (which made necessary the use of shorting plugs to pre-program the card) we just could not get the whole CPU on one board of eurocard format, and in the end we had to compromise on one large (eurocard) and one small board.

Both boards are double-sided, so, before mounting any components, check with a multimeter that all through-plated holes are

Figure 2. If the 'blocks' in figure 1 are replaced by ICs the circuit diagram shown here results. It looks more complicated than it is because of the messy connections.

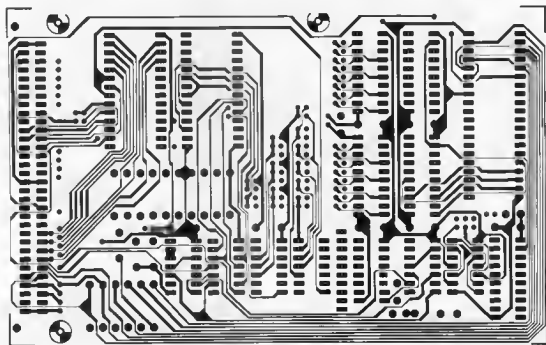
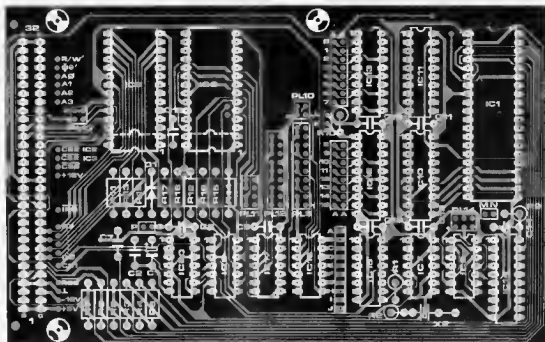
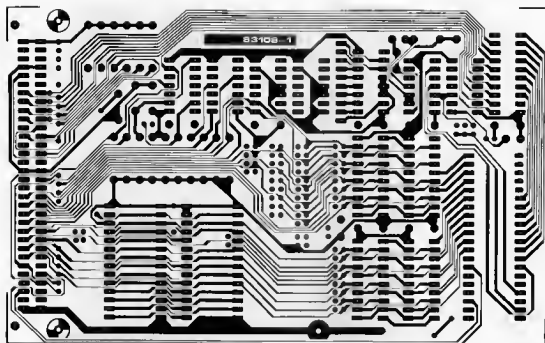

Figure 3. The double-layered main printed circuit board which houses the CPU, RAM, EPROM, clock, and reset logic.

sound. If so, solder all resistors, capacitors, crystals, IC sockets, and connectors in their respective positions. Apart from the 64-way connector, which should be a DIN 41612 male, it is recommended to use terminal

strips for which shorting plugs are available: examples are shown in the parts list. Once everything is soldered in place, insert the ICs into their respective sockets. If a 2716 or 2732 EPROM is used, the 24-pin



Parts list	C2, C7 . . . C25 = 100 n ceramic	IC7 = 74LS04	Miscellaneous	(10-89 1321)
Resistors:	C3 . . . C6 = 1 n ceramic	IC8 = 74LS74	X1 = crystal, 1.8432 MHz	25 off shorting plugs for above, e.g. Molax no. 7859 *
R1, R2, R11 . . . R16 = 470 Ω		IC9 = 74LS01	64-way connector to DIN 41812, male	*Available from Technomatic Ltd.
R3 . . . R10, R18, R19 = 5k6	Semiconductors:	IC10 . . . IC13 = 74LS240	2 off terminal strip 40 x 2 pins, e.g. Molax 8624-A-102 *	
R17 = 10 k	D1 . . . D16 = 1N4148	IC14 = 74LS245	1 off terminal strip 16 x 2 pins, e.g. Molex 8824-A-102 *	
R20 . . . R23 = 39 k	IC1 = 6502 (85C02)	IC15 = 74S133 (74 ALS133)		
Capacitors:	IC2, IC3 = 8522 (65C22)	IC16, IC17 = 74LS30		
C1 = 47 μ/6 V electrolytic	IC4 = 6551 (65C51)	IC18 = 1488 (SN75188)		
	IC5 = 5518, 5564	IC19 = 1489 (SN75189)		
	IC6 = 2718, 2732, 2764, 27128	IC20 = 74LS06		

Table 1

connector	interconnection	function		
PL1	—	parallel-keyboard connection	PL7	—
PL2	—	Centronics-connection	PL8	1-2 3-4
PL3	see table 2	ACIA programming 5, 6, 7 or 8 databits 1, 1.5 or 2 stopbits internal/external clock	PL9	dependent upon application
PL4	see table 2	ACIA-programming enable/disable-interrupt enable/disable IRQ-line transmitter-control normal/echo-mode even/odd/no parity mark/space-parity	PL10	RAM address decoding (an example is given in 'universal terminal' elsewhere in this issue)
PL5	—	output of port and control lines	PL11	dependent upon application
PL6	see 'universal terminal' elsewhere in this issue	image format: only in combination with VDU card	PL12	Eprom address decoding (see, for instance, the article 'universal terminal').
			PL14	clock frequency: 4 MHz 2 MHz 1 MHz
			—	5-6 1-2 3-4
			—	M-N
			—	P-Q
				interconnect if external clock is used with spring-loaded push-button for manual reset otherwise wire-bridge for automatic reset at power 'on'

IC is inserted so that its pin 1 mates with pin 3 of the socket. Then, depending upon your individual requirements, and with the aid of Table 1, place the shorting plugs as appropriate.

Next, using three spacers, mount the small board onto the larger one. The necessary connections between the two — D₀ . . . D₇, A₀ . . . A₃, CS₀, CS₁, CS₂, Φ₂, R/W, RES, IRQ, +12 V, -12 V, +5 V, and

Table 1. The various pre-programming possibilities of the CPU card: all required connections are included.

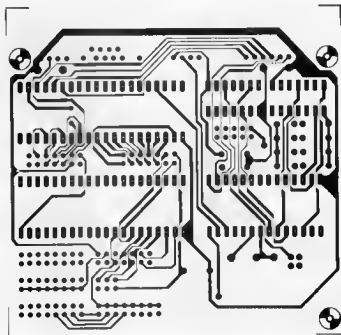
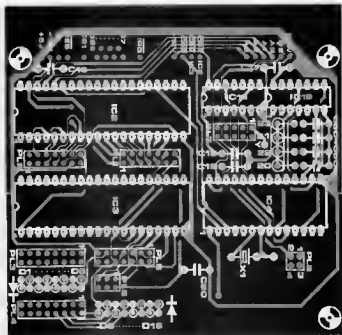

Figure 4. The auxiliary printed circuit board which contains the VIAs and the ACIA.

1 — should then be made with short lengths of wire. Finally, mount the ICs onto the smaller board and place shorting plugs as appropriate. Suitable connectors, like that for the

RS 232, may be added as required. Do not forget to connect the address decoder N59 by means of short wires. This completes the CPU card. The choice of memory capacity of EPROM and RAM, as

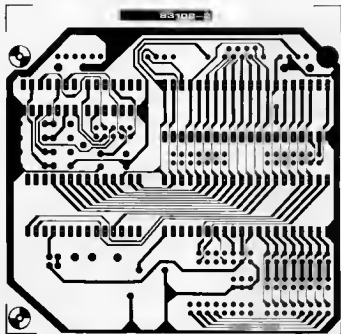

Table 2

connector	pin nos	function	connector	pin nos	function	
PL3	1-2	number of stop bits	PL4	1-2 3-4 5-6	parity bit	
	0 (= open)	1 stopbit		- - 0	none (= don't care)	
	1 (= closed)	2 stopbits (1.5 for a word length of 5 bits)		0 0 1	odd	
	3-4 5-6	word length		0 1 1	even	
		0 0		8 bits	1 0 1	mark
		0 1		7 bits	1 1 1	space
		1 0		6 bits	7-8	mode:
	1 1	5 bits		0	normal	
	7-8	baud rate generator:		1	echo	
		0		extern	9-10 11-12	transmitter-controls:
	1	intern		0 0		transmitter interrupt disabled
	9-10 11-12 13-14 15-16	baud rate:		0 1		RTS-level high, transmit. off
		0 0 0 1		50 baud		transmit. int. enabled
		0 0 1 0		75 baud	RTS-level low, transmit. on	
		0 0 1 1		109.92 baud	transmit. int. disabled	
		0 1 0 0		134.58 baud	RTS-level low, transmit. on	
0 1 0 1		150 baud	transmit. int. disabled			
0 1 1 0		300 baud	RTS-level low, transmit. break			
0 1 1 1		600 baud	13-14	IRQ-interrupt:		
1 0 0 0		1200 baud		0	enabled	
1 0 0 1		1800 baud		1	disabled	
1 0 1 0		2400 baud		15-16	receiver + interrupts:	
1 0 1 1		3600 baud	0		disable	
1 1 0 0		4800 baud	1		enable	
1 1 0 1		7200 baud				
1 1 1 0	9600 baud					
1 1 1 1	19200 baud					
0 0 0 0	16 (external clock)					

Table 2. Expansion of the ACIA programming by means of short-circuits in connectors PL3 and PL4.

well as of the program the EPROM shall contain, is, of course, dependent upon the application and size of the system in which the CPU card is to function. Lastly, we would draw your special atten-

tion to Table 1. This table shows clearly which connections have to be made for specific applications and its importance to such a versatile circuit as this CPU card cannot be overstated!

decimal-to-binary converter...

From an idea by
G. Amshoff

... for
programmable
pocket
calculators

Table 1
Program for decimal-binary
conversion for TI57

Keying sequence

```

Start
1
EE
8
STO 4
LRN
STO 1
STO 7
2
2nd Lbl 1
2nd x > t
GTO 2
x
2
=
GTO 1
2nd Lbl 2
2nd x = t
GTO 3
STO 2
GTO 4
2nd Lbl 3
x
2
=
STO 2

2nd Lbl 4
2
2nd INV Prd 2
2nd C. t
RCL 1
—
RCL 2
=
STO 3
2nd x > t
GTO 5
2nd x
2nd Pause
EE
CLR
GTO 6
2nd Lbl 5
RCL 4
RCL 3
STO 1
2nd Lbl 6
1
x<t
RCL 2
2nd INV x = t
GTO 4
+/-
R/S
RST
LRN
End
    
```

The home-made converter described in this article will make your programmable pocket calculator doubly useful by providing an eight-bit binary output which, for instance, may be loaded into a computer. Moreover, the output can be readily extended to 16 or 24 bit.

Principle

As pocket calculators invariably have no factory-fitted interface facility, one had to be designed. In an analogy to photocouplers, light-dependent resistors (LDRs) were chosen which are fastened light-tight with thick, black insulating tape onto two digits of the calculator display. The basis of the converter is, of course, the translation of decimal numbers into binary ones. True, it is quite simple to do this with any calculator (and pen and paper), but here it is achieved automatically by suitably programming the calculator. The program for a TI 57 is given in Table 1. Although the article is written around the TI 57, it is equally applicable to any programmable calculator though some minor details may have to be changed. The TI 57 will give a clock pulse on the exponential digit and the logic state at the right-hand digit. At logic '1', the display is dark, while at '0' 'π' is displayed.

The circuit diagram

The (low) output of the LDRs is amplified in simple, single-transistor stages to ensure correct drive to the memory and display ICs (see figure 1). The remainder of the circuit is simplicity itself. An eight-alement shift register type 74LS164 is used which can store up to 255 binary numbers. If larger numbers are required, the memory can be extended as often as possible: the capacity of the computer sets, of course, a limit in practice. With extensions, it may be necessary to make the transistor stages more sensitive. The monoflop type 74LS121 is the most effective guard against display jitter. Additional gates may be connected in place of the LEDs which draw a current of only 15 mA.

Construction and adjustment

Except for the LDRs, the converter may be constructed on a piece of VERO or other prototyping board: it is not critical. The LDRs are, of course, mounted onto the calculator display (LDR1 over the exponential digit and LDR2 over the right-hand digit) with thick, black tape to ensure absolute light-tightness. Even then, the

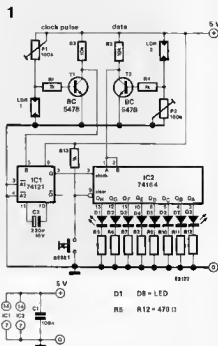

converter should not be used in locations where the ambient light is subject to large variations.

Correct operation of the converter can be checked as follows:

- arrange for the program to convert a relatively large number, say, 1024, so that it runs for a measurable period.
- Using a universal meter, measure the voltage at the collector of T1 - this should be about 2 V, if not, adjust P1 to obtain this voltage.
- Next, measure the voltage at pin 6 of IC1: this should always be 0, except at the moment a pulse is received when the meter briefly deflects. Readjust P1 carefully so that the meter gives a deflection for every clock pulse.
- Finally, adjust P2 to obtain 2 V at the collector of T2. The LEDs should now indicate the logic levels of the decimal number converted: for instance, 253₁₀ = 11111101. If not, readjust P2 slightly.

Final note

In addition to the possibility of feeding the eight-bit word to a computer, an additional electronic circuit can further process the binary numbers. By means of extra gates, it is then possible to control, for instance, the turnouts of a model railway. With a little skill and thought it is also possible to devise other applications. Happy experimenting! ■

Floppy-disk interface for the Junior

(December 1982, page 12-48)

Figure 3 contains an error (see page 12-50). Pin 7 of the lower IC should not be cut but be connected to ground.

Upper and lower case on the Elekterminal

(January 1983, page 1-56)

Figure 1 (page 1-57) fails to show that the CE of the 2716 which replaces IC11 must be connected to ground. If this is not done, the EPROM remains in the three-state mode.

Drum interface

(November 1982, page 11-20)

The connections to pins 6 and 7 of IC2 (see figure 2) must be interchanged the junction R9-C4 must be connected to pin 7 and the other side of C4 to pin 6.

If for each drumbeat a number of trigger pulses are generated, connect a 50 k preset in series with R8.

In-car ionizer

(October 1982, page 12-45)

The value of P1 is given as 47 k in the parts list; its correct value is 10 k as shown in figure 1.

Single-channel infrared remote control

(January 1982, page 1-52)

In figure 2 on page 1-52, FF1 is shown as a flip-flop, whereas it should be a monostable. This can be corrected by connecting pin 11 of IC2 to ground.

Music quantizer

(October 1983, page 10-33)

The type numbers of IC4 and IC7 in figures 4 and 5 respectively have been interchanged: IC4 = 74LS377 and IC7 = 74LS373. The parts list is correct

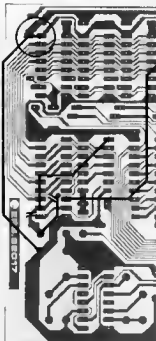

64 k on the 16 k dynamic RAM card

(September 1983, page 9-31)

A drawing error has crept into figure 3 on page 9-31: the new connection to be made at the bottom left-hand of the pcb should be as indicated in the circled area.

Crescendo

(December 1982, page 12-32)

The circuit diagram on page 12-32 contains an error: the voltage at the cathode of Q3 should be +0.7 V and that at the anode of D4, -0.7 V.

SERVICE

PC board pages

The following pages contain the mirror images of the track layout of the printed circuit boards (excluding double-plated ones as these are very tricky to make at home) relating to projects featured in this issue to enable you to etch your own boards.

- To do this, you require: an aerosol of 'ISODraft' transparentizer (available from your local drawing office suppliers; distributors for the UK: Cannon & Wrin), an ultraviolet lamp, etching sodium, ferric chloride, positive photo-sensitive board material (which can be either bought or home made by applying a film of photo-copying lacquer to normal board material).
- Wet the photo-sensitive (track) side of the board thoroughly with the transparent spray.

- Lay the layout cut from the relevant page of this magazine with its printed side onto the wet board. Remove any air bubbles by carefully 'ironing' the cut-out with some tissue paper.
- The whole can now be exposed to ultra-violet light. Use a glass plate for holding the layout in place only for long exposure times, as normally the spray ensures that the paper sticks to the board. Bear in mind that normal plate glass (but not crystal glass or perspex) absorbs some of the ultra-violet light so that the exposure time has to be increased slightly.
- The exposure time is dependent upon the ultra-violet lamp used, the distance of the lamp from the board, and the photo-sensitive board. If you use a 300 watt

UV lamp at a distance of about 40 cm from the board and a sheet of perspex, an exposure time of 4...8 minutes should normally be sufficient.

- After exposure, remove the layout sheet (which can be used again), and rinse the board thoroughly under running water.
- After the photo-sensitive film has been developed in sodium lye (about 9 grammes of etching sodium to one litre of water), the board can be etched in ferric chloride (500 grammes of $FeCl_3$ to one litre of water). Then rinse the board (and your hands!) thoroughly under running water.
- Remove the photo-sensitive film from the copper tracks with wire wool and drill the holes.

doorbell-operated flash light

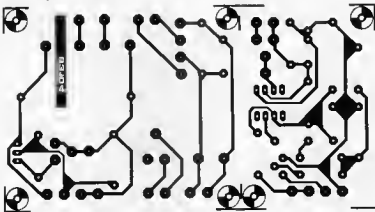

matronoma (af amp and power supply)

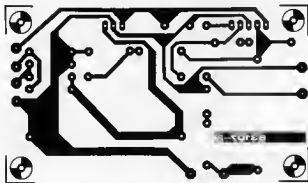

pseudo stereo

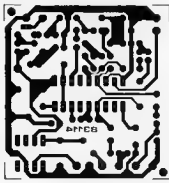

metronome (main board)

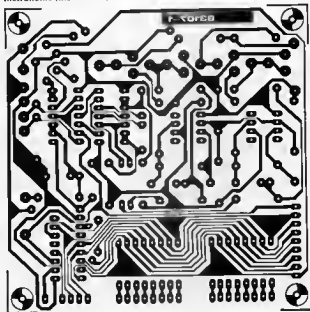

model railway controller

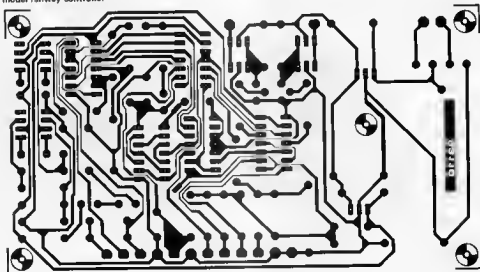

Note: the double-sided boards for the CPU card are not included, for reasons of space.

service

PC board pages

The special feature of this movement detector is that it is a passive device: it does not use a transmitter like a light barrier. The fundamental principle of its operation is very similar to that of the human eye.

movement detector
elektor november 1983

movement detector

The sensor consists of two photo diodes which have the same task as the rods in the retina of the human eye. These diodes are mounted close together in a light-proof box and a lens in the box projects an image of the space being watched onto the diodes (see figure 1). When the brightness of the environment changes, for instance, through increasing clouds, twilight or the like, the light falling onto both the diodes is reduced equally. If something moves within reach of the lens (and it may only be the budgerigar), the light onto the diodes is reduced in dissimilar proportion. The circuit is extremely sensitive to very small differences in light intensity.

In view of this characteristic, the device is particularly useful as a guard against theft and break-in, for instance, as supplement to the burglar alarm. It is for that reason that an alarm-tone generator has been included. Apart from that, the device is very useful wherever it is difficult to provide a source for a light barrier. It is, for example, possible to use the circuit to control a mechanically operated door so that it opens on the approach of a person.

The circuit of the detector is shown in figure 2a. The cathodes of the photo diodes are at +15 V, while the anodes are fed via simple active filters, which provide a (first) protection against interference. The diodes should be connected to the rest of the circuit by as short a length of coaxial cable as possible. Any e.c. appearing at the bases of

transistors T1 and T2 is taken to earth via capacitors C1 and C2 respectively. Correct design of these stages ensures sufficient suppression of mains hum and similar interference.

The d.c. outputs of the filters are applied to differential amplifier IC1. As long as nothing moves in the space being monitored, the voltages at the two inputs of IC1 are virtually equal and the output of the amplifier is therefore very small. Even a slight difference between the outputs of the diodes, caused by a movement within the field of the lens, leads to a rapid and unmistakable change in the output voltage of the differential amplifier. The amplification factor of the next stage, IC2, is about 20. When a distinct, strong movement is observed by the lens, IC2 goes into saturation. The output signal of IC2 is passed through an additional filter. This is a low-pass filter with a cut-off frequency below 50 Hz so that it prevents any hum or other very low frequency signals from being passed on to the following amplifier stages consisting of op-amps A1 and A2.

At this point we are able to detect movements in the area under surveillance. As we have seen, any movement results in a rapid rise of the output level of A1 while interference is kept to a minimum by the filter. There is, however, a problem still remaining. The somewhat unusual configuration at the input of A2 is necessary because the output of IC1 is, in fact, a d.c. level — even with the

optical guard

Figure 1. A robust and light-tight mechanical construction is vital.

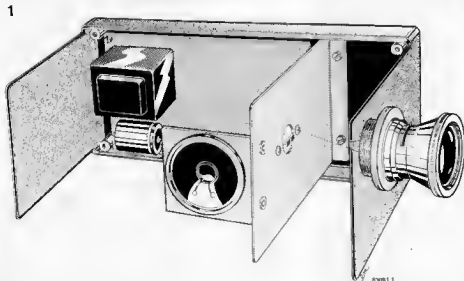

1

2a

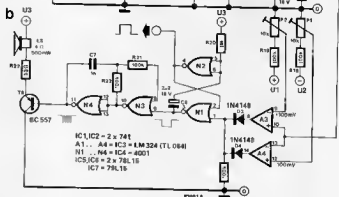
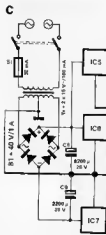
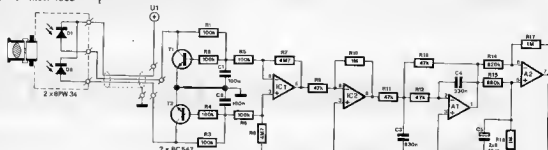

Figure 2a. Circuit of the movement detector.

Figure 2b. Circuit of the simple alarm-tone generator.

Figure 2c. Circuit of the power supply.

circuit in the quiescent state! This rules out the use of a simple comparator to provide us with an unambiguous output signal. Op-amp A2 is therefore used as a slightly modified differential amplifier. The signal is passed directly to its inverting input, but is filtered by C5 and R16 at its non-inverting input. This additional low-pass filter does not introduce a noticeable time delay. With a constant input level, the output of A2 will be 0 V. However, a rapid rise in input level will produce an output which is similar to that shown in figure 3.

The trip threshold of comparator stage A3/A4 can be set with P1 and P2. A3 and A4 change state when the positive or negative threshold respectively is exceeded. The outputs of the two comparators rise to

+15 V in either case. Diodes D3 and D4 form an OR gate for the output of both triggers. Figure 3 shows why this apparently complicated design was chosen. On a relatively strong start signal, the output of A2 decays very rapidly. On a relatively weak movement in the area and a consequent negative-going output of A2, the positive trigger threshold may not be reached. The chosen design ensures better sensitivity and improved protection against interference.

Construction

Construction of the case should be carried out rather more carefully than is usually required; it must be absolutely light-tight, with the exception of the lens, of course. If it is not, you might as well have saved

3

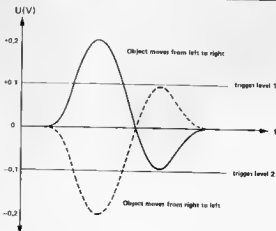
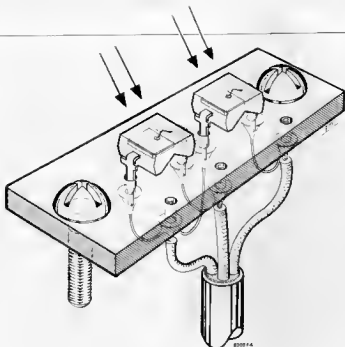

Figure 3. Output of the differential amplifier: the amplitude depends upon the amount of movement.



movements detector
elektor november 1983

yourself the trouble of ensuring that the circuit has such a high sensitivity! With this point in mind, it is advisable to mount all the electronics in the case. Figure 1 shows how a case can be constructed from two sheets of aluminium. The best method to ensure light tightness is to seal the small gaps where the sheets of aluminium meet with thick, wide, self-adhesive tape. A very neat solution for the lens is to take one from an old camera: you must, of course, remove the diaphragm or make sure that it is permanently open! It may also be possible to purchase a second-hand one very cheaply. Before removing the lens from your new SLR camera, look through the catalogues of electronics surplus suppliers: they often include lenses.

The two photo diodes are mounted close together on a piece of Vero board (see figure 4). As shown in figure 1 it should be possible to move the board within certain limits. The correct distance between the diodes and lens is found as follows: hold a piece of white paper as close as possible in front of the diodes and move the board until the image of an object at the required maximum surveillance distance is sharpest. The board can then be fixed in place. As sharpness of image is not too critical, the board can be fixed for 'infinite' distances as on a camera: the effective operating range then extends from about 6 feet to infinity in front of the lens.

In practical tests the device reacted on slight movements at a distance of up to 30 feet. Crawling into the area proved impossible without detection as was proved one Monday morning at the entrance to the editorial office! The device worked equally well in neon light, daylight and twilight. Only in absolute pitch darkness did it stop working, although the photo diodes are sensitive to infra-red radiation. Unfortunately, the heat radiation from the human body lies in a part of the infra-red spectrum to which the photo diodes are not sensitive.

If required, however, the surveillance area may be 'lighted' by invisible infra-red light. The coverage area of the prototype extended over an angle of 30° only, but this can, of course, be improved by the use of a wide-angle lens or by using more than one pair of diodes. For each pair of diodes the circuit up to and including R9 must be duplicated. IC2 can then be connected as a summing amplifier.

Alarm-tone generator

The circuit of the alarm-tone generator as shown in figure 2b must be taken as an example only, as the output pulse of the detector can be used to drive a horn loud-speaker. Gates N1 and N2 form a monostable which stretches the input pulse from A3 or A4 to about 1 second. Gates N3 and N4 form an astable which oscillates only when pin 8 of N3 is low: its operation thus depends on the inverted output signal of N1. The output of the astable drives a loud-speaker via amplifier T3. The tone can be altered within narrow limits by changing the value of C7.

Power supply (figure 2c)

The power supply is conventional but for one aspect: the supply for the alarm-tone generator has been provided separately. This was found necessary to prevent feedback between the two parts of the device. If a different alarm-tone generator with its own supply is used, IC5, C10 and C11 in figure 2c can be omitted.

footnote

Although the circuit was designed to be as sensitive as possible, it regrettably failed to detect any signs of movement in the staff of the editorial office between the hours of 08.30 and coffee-break! This problem was effectively cured by recalibrating the coffee-break to 08.32!

Figure 4. The photo diodes must be mounted close together on a small piece of Vero board.

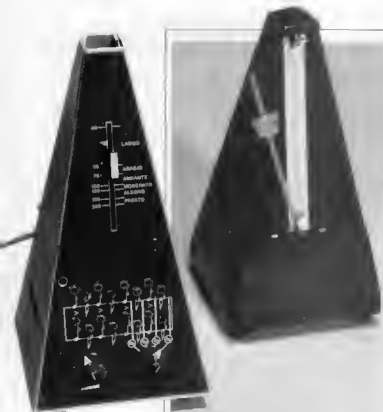

A metronome is of vital importance in, among others, the study and practice of music, dance, and the morse code. Some people have a natural 'feel' for rhythm; others have to work at it. But without a metronome that would be a very difficult task indeed. A metronome is an apparatus for fixing the tempo (Italian for speed) of a composition (music) or of a regularly recurring series of tones (morse, for instance). The commonest form in use is still the clockwork one of Maelzel who invented it in the early part of the nineteenth century. The indication at the head of a piece of music, M.M. = 100, for instance, means that the beat is to be taken at the speed of Maelzel's Metronome set at 100 beats to a minute. However, such a metronome produces but a simple 'tick tack' at speeds between 40 and 208 times per minute and is, moreover, relatively expensive. The electronic metronome we have designed has a two-tone output and can produce rather more complex rhythms than its mechanical counterpart.

electronic two-tone metronome

allegro ma non troppo (al tempo giusto)

A metronome has two functions: first, it should produce a regular rhythm and, second, it should indicate the beat of a composition. Maelzel's metronome consists of a clockwork-driven pendulum of which the period is adjustable by means of a small weight. One of the problems of the aspiring musician is the recognizing of accents, another that of dividing beats into strong and weak, and yet another that of the structure of the beat, and so on. In these, the mechanical metronome is not of much help. Our electronic metronome gives two percussive sounds of adjustable frequency and timbre and of which the rhythm can be freely set by means of switches.

The circuit diagram

It will not surprise many that the design is given rhythm by a clock, Schmitt trigger N5 at the top left-hand of figure 1a. Potentiometer P1 controls the speed of the beats.

The clock pulses are applied to pin 14 of IC1, a binary counter with eight outputs type 4022. Outputs Q0...Q7 become logic high sequentially in the rhythm of the clock frequency. The enable input (pin 13) of the counter is connected to ground and is therefore permanently logic low. Reset input (pin 15) is, however, used to modify the number of pulses per measure or count-cycle, which is how the various time-signatures are derived: 7/8, 3/4, 5/8, and 4/4 (the signature 3/4 also enables 6/8 to be obtained). As shown in figure 1a, these time-signatures are selected by selector switch S9.

The Q-outputs of IC1 are connected to a double matrix of 2 x 8 diodes, D1...D16, and 2 x 8 switches, S1...S8. Depending on which of the switches are closed, one or more of the output pulses of IC1 are applied to the rest of the circuit. This symmetrical arrangement enables two dif-

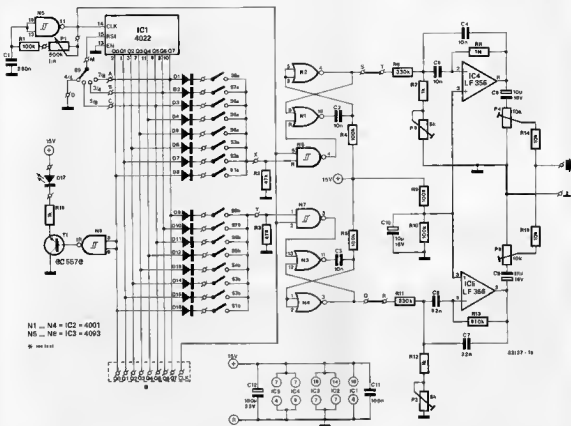

ferent, but synchronous, series of pulses to be obtained which are then used to produce two different tones. The tones are actually damped oscillations generated by band-pass filters IC4 and IC5 at the leading edge of the incoming pulse at their inverting input (pin 2). To prevent the trailing edge of the pulse also causing the generation of a - different - tone, two monostables, N1/N2 and N3/N4, precede the band-pass filters. The result is a clean-sounding tone without a hint of stutter. As it is, of course, possible that two or more outputs of IC1 are selected, it could happen that the logic high at the input of one of the monostables lasts for two or more clock pulses, as shown in figure 3. The monostable is, of course, not able to separate two sequential pulses. For that reason, Schmitt triggers N6 and N7, preceding N1 and N3 respectively, shorten the pulses emanating from the diode matrices and superimpose them on the clock pulses in a NAND-function. That the pulses are inverted and become phase-shifted does not detract from the proper operation of the circuit. We now have two separate pulse-sequences derived from the same clock frequency, and this takes us to the analogue part of the metronome. The values of capacitors C4/C5 and C7/C8 (note that C4 = C5 and C7 = C8) together with those of presets F2 and F3 determine the centre frequency of band-pass filters

1b

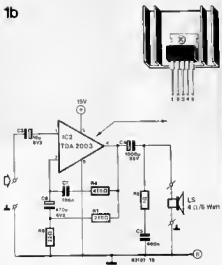

Figure 1a. The clockwork mechanism of a traditional metronome has been replaced in our electronic model by a counter, IC1, and a clock, N5. The choice of strong beats (low tones) or weak beats (high tones) is made by means of 2 x 8 switches. The two tones provided are passed through high-Q band-pass filters.

Figure 1b. The s.f. power amplifier consists of little more than one IC. The integral loudspeaker (4 Ω/5 W) must not be too small otherwise it will not reproduce low notes.

1c

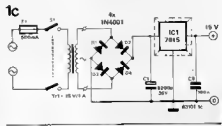

Figure 1c. The stabilized power supply can provide up to 1 A output current which is necessary during the 'tick-tack'.

Figure 2. An example of a programme for the metronomes. Each closed switch of row B corresponds to a low tone, while those in row A correspond to a high tone. An open switch represents an interval. In this programme it is assumed that selector switch S9 is set to position 'D' (4/4).

number	1	2	3	4	5	6	7	8
switches A								
switches B								
instrument A								
instrument B								
count	1	2	3	4	end	1	2	end
	da	(and) da	(and) da	da	da da	da	da da	da da

Figure 3. If two adjacent switches are closed, one wide pulse appears at pin 6 of N6. It is, of course, necessary to split this (pin 4, N6). Moreover, the resulting pulses must be compressed (pin 4, N2) to prevent the circuit resetting to both the leading and the trailing edges.

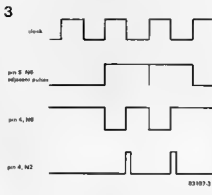

Table 1. Possible scale division for potentiometer P1 which is identical to that used on traditional metronomes.

40	
42	
44	
46	
48	
50	Largo
52	
54	
56	
58	
60	
63	Larghetto
66	
69	
72	Adego
76	
80	
84	
88	Andante
92	
96	
100	
104	
108	
112	Moderato
116	
120	
126	
132	
138	Allegro
144	
152	
160	
168	
176	
184	
192	Presto
200	
208	

IC4 and IC5 respectively, and therefore the tone and timbre of the percussive sounds generated. The higher the value of the capacitors, the lower the tone. For instance, with a value of 330 n, the sound is like that of a kettle-drum, provided the remainder of the design (loudspeaker!) can reproduce such low notes. Resistors R8 and R13 determine the damping factor: the higher their value, the higher the damping — from the sound of a snare-drum to the boom of a kettle-drum. Presets P2 and P3, apart from setting the centre frequency of the band-pass filters, determine together with resistors R14 and R15 the mixing ratio of the two tones as required.

To facilitate easy recognition of the preset rhythm, an LED, D17, is controlled from output Q0 of IC1 via N8 and T1. This LED thus lights at every first tone of a sequence. To make the metronome self-contained, an a.f. power amplifier, built around a TDA 2003, has been provided as shown in figure 1b.

The power supply, as shown in figure 1c, is a simple circuit based on a type 7815 regulator. As the metronome itself does not draw more than about 10 mA, and IC2 in quiescence not more than 200 mA, it might appear as if the mains transformer is overrated at 1A secondary current. This is, however, not the case, because at each 'tick' or 'tack' the current passing through IC2 may well reach a value of 1 A, depending upon the setting of the volume. This also explains why IC1 and IC2 should be mounted onto a common heat sink.

Extension possibilities

It will not have escaped the attentive reader that the diagram in figure 1a shows a num-

ber of terminals which are intended for connection to external equipment. These are the output of counter IC1, the clock frequency, the outputs of the monostables (S and Q), and the inputs of the two band-pass filters (T and R). More about this external equipment in a later issue...

Construction and calibration

The use of the printed circuit boards shown in figures 4 and 5 makes construction of the metronome a fairly simple matter. The metronome proper is contained on one of the boards, the power supply and power amplifier on the other. The most complicated part of the construction is perhaps the wiring of the eight switches which, together with the LED, the potentiometer P1, and selector switch S9 are mounted on the front panel of the box. Terminal S should be connected to T, and Q to R, by means of a wire bridge. Terminals Q0...Q7 and CLK are not used — for the time being...

The connection between the output of the metronome and the a.f. amplifier should preferably be made with screened audio cable. The loudspeaker leads need not be screened, but should be of sufficient diameter (say, 0.25 mm²). Calibration consists merely of finding the right balance of the amplitudes of the two signals (by means of P4 and P5) and their timbre (by means of P2 and P3). Guidelines for these cannot be given, as they are entirely a matter of personal preference. When turning P3, it may happen that hum suddenly becomes audible: this occurs when the centre frequency of one of the band-pass filters is 100 Hz (twice the mains frequency). The remedy to this is simply turning P3 a little back or on.

1 and 2 and 3 and 4 and...

We have now come to operating the metronome. A simple example of a programme is shown in figure 2: switches S1B, S3B, S5A, S6A, S7B, and S8A are closed, all the others are open. Selector switch S9 is in position 'D', that is 4/4. You then count 1 (and) 2 (and) 3 and 4 and 1 (and) 2 (and)...

Potentiometer P1 can, as in a traditional metronome, be provided with a calibrated scale — a suitable scale division is given in Table 1.

4

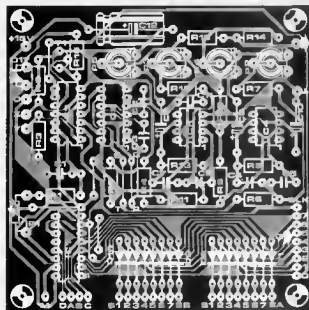
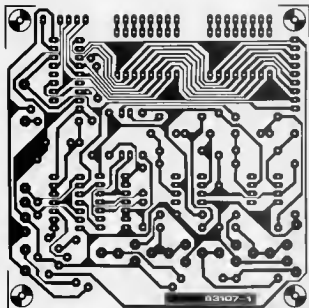

Parts list (metronome proper)

Resistors
 R1,R4,R5,R9,R10 = 100 k
 R2,R3 = 47 k
 R6,R11 = 330 k
 R7,R12,R16 = 1 k
 RB = 1 M
 R13 = 470 k
 R14,R15 = 10 k
 P1 = 500 k lin.
 potentiometer
 P2,P3 = 5 k (4k7) preset
 P4,P5 = 10 k preset

Capacitors:
 C1 = 680 n
 C2 ... C5 = 10 n
 C6,C9,C10 = 10 µ/16 V

C7,C8 = 22 n
 C11 = 100 n
 C12 = 100 µ/25 V

Semiconductors:
 D1 ... D16 = 1N4148
 D17 = LED
 T1 = BC557B
 IC1 = 4022
 IC2 = 4001
 IC3 = 4093
 IC4,IC5 = LF 356

Miscellaneous:
 S1a ... S8a, S1b ... S8b =
 SPST toggle (16)
 S9 = 4-position, single
 wafer, rotary switch

Parts list for a.f. amplifier and power supply

Resistors:
 R1 = 220 Ω
 R2 = 22 Ω
 R3 = 1 Ω
 R4 = 470 Ω

Capacitors:
 C1 = 2200 µ/35 V
 C2,C7 = 100 n
 C3 = 10 µ/6V3
 C4 = 1000 µ/25 V
 C5 = 680 n
 C6 = 470 µ/6V3

Semiconductors:
 D1 ... D4 = 1N4001
 IC1 = 7815
 IC2 = TDA 2003
 (U.L.N. 3703Z)

Miscellaneous:
 S1 = mains on/off switch
 Tr1 = mains transformer
 15V/1 A
 F1 = fuse carrier and
 500 mA fuse
 Loudspeaker (car-radio
 type) 4 Ω/5 W
 Heat sink, common, for
 IC1 and IC2

5

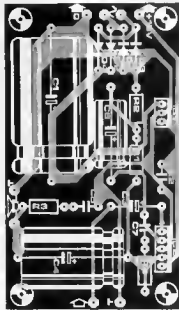
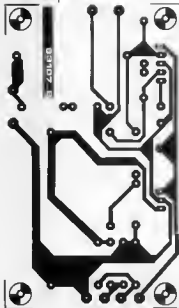

Figure 4. The printed circuit board of the metronome proper. Terminals S and T, as well as Q and R (which are provided for possible future extension), must be shorted by means of a wire bridge. Terminals Q0 ... Q7 and CLK, also for future extension, are not used. This board and that shown in figure 5 must be interconnected by means of a screened audio cable.

Figure 5. The printed circuit board for the a.f. amplifier and the power supply. Both ICs must be provided with a heat sink — preferably a common one.

pseudo stereo



for the
personal FM

The personal FM radio receiver published in the September 1983 issue was based on the TDA 7000 from Philips and has proved to be very popular. The good news is that this IC has been followed by another from the same source, the TDA 3810, and this can be used to put the personal FM receiver in an entirely different light.

We know that the TDA 7000 is for mono reception only and therefore stereo reception is out of the question... almost! If not actual stereo, how about a 'pseudo stereo'? This is where this article and the TDA 3810 come in!

Shortly after the introduction of the 'TDA 7000 single-chip FM receiver' IC, Philips follow it up with another new chip which, even though it is hardly likely to cause an uproar in 'The House', is still a very nice 'first' in many respects. It is, in fact, an interesting 18 pin IC, the TDA 3810, which converts a normal mono signal into a pseudo stereo signal, or a normal stereo signal into so-called spatial stereo.

This 'spatial' possibility (also called 'super stereo') is, of course, for enthusiasts, but pseudo stereo is, certainly when combined with the TDA 7000, a very interesting idea. This is all the more so as the 'stereo' effect is very good (we have already heard it!) and this also completely avoids the noise problem associated with true stereo personal receivers. Above all, this pseudo stereo IC is a lot cheaper than a full stereo decoder!

The design

The block diagram for the TDA 3810, along with the external components that are needed, is given in figure 1. It shows that the pseudo stereo circuit splits the incoming mono signal (connected to pins 2 and 17) into two channels. One channel goes straight to the output. In the second, however, all frequencies between 300 Hz and 2 kHz are delayed. The value of this delay is frequency dependent (for example, at 800 Hz it is 500 μ s), and that gives the listener the illusion of stereo. Frequencies below 300 Hz and above 2 kHz from the second channel are passed unchanged to the output so that one speaker does not have a wider frequency range than the other. Because the effect is a matter of personal taste, the low-pass filter used has been kept off the chip to enable each user to set it to suit himself.

In stereo there is a difference of 60 dB between the channels. The spatial stereo effect is achieved by adding an anti-phase cross-talk between the channels. This 'anti-cross-talk' (about 50%) increases the apparent distance between the two loudspeakers.

Because using the TDA 3810 means that there is an extra element in the path of the audio signal, no effort was spared when the IC was designed to ensure that the figures for signal/noise ratio and distortion are as good as possible. The end result is a signal/noise ratio of 70 dB, which is quite good, and the harmonic distortion measured in the prototypes was less than -80 dB. Stereo noise is totally unknown to the TDA 3810, as is annoying 'switching noise' that occurs if a stereo receiver tuned into a weak stereo signal constantly switches between mono and stereo.

There are two switches connected from pins 11 and 12 to ground and these are used to switch between mono and pseudo stereo and between ordinary stereo and spatial stereo. Two LEDs can be directly driven from pins 7 and 8, by means of built in driver stages, to indicate whether the circuit is in pseudo or spatial stereo mode. The IC needs a voltage supply of between 4.5 and 16 V and has a current consumption of about 7 mA.

The three tables give the specifications for the TDA 3810. Table 1 is the maximum

ratings, table 2 the normal specifications, and table 3 is a sort of truth table for how the various functions relate to the positions of the switches and the indications on the LEDs.

The stereo extension

The TDA 3810, with its pseudo stereo capability was developed with the intention of combining it with the TDA 7000 to provide a very small FM receiver with a 'better than mono' sound at a relatively low cost. The printed circuit board for the stereo extension is fully compatible with the personal FM receiver, the full details of which was published in our September issue. The added circuit effectively replaces the volume control of the FM receiver so that the TDA 3810 decoder is connected between the receiver IC and the LF amplifier. Apart from that the only addition now required is an extra LF amplifier since we now have two channels.

Because the complete extension circuit, including the added LF amplifier, is contained on one printed circuit board, converting our personal FM from mono to pseudo stereo is straightforward. Now, of course, the case we built for the original receiver is no longer big enough but the whole assembly can still remain a very compact receiver.

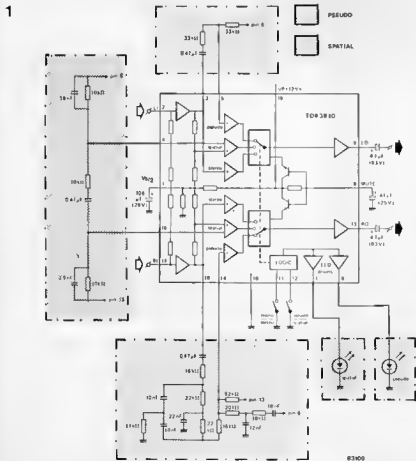

Figure 1. The block diagram of the TDA 3810, complete with the necessary external components. The pseudo stereo effect is achieved by a selective delay of a specific part of the audio spectrum, and spatial stereo by adding 'anti-cross-talk' to the audio signal.

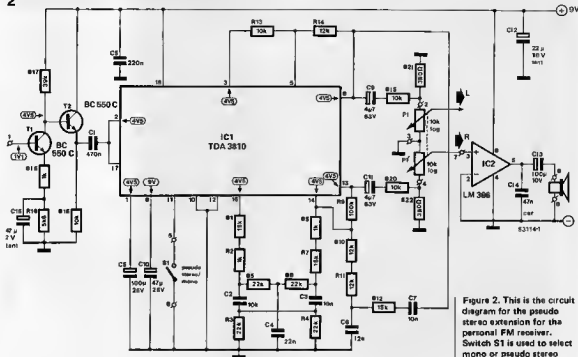

Figure 2. This is the circuit diagram for the pseudo stereo extension for the personal FM receiver. Switch S1 is used to select mono or pseudo stereo operation.

Table 1

Maximum ratings

Supply voltage (pin 18)	V_p	max. 16 V
Supply current (pin 18)	I_p	max. 12 mA
Storage temperature range	T_{stg}	-25 to +150°C
Operating ambient temperature range	T_{amb}	0 to +70°C
Thermal resistance from crystal to ambient	$R_{th\ cr-a}$	80 K/W

Table 1. The most important maximum ratings of the IC (to IEC 134) standard. These must be adhered to strictly!

Table 2

Characteristics

$V_p = 12$ V; $T_{amb} = 25^\circ$ C; test circuit (figure 1) in stereo mode (pin 11 to ground) unless otherwise specified.

parameter	symbol	min.	typ.	max.	unit
Supply voltage range (pin 18)	V_p	4.5	—	15	V
Supply current	I_p	—	7	12	mA
Reference voltage	V_S	5.3	6	6.7	V
Input voltage (pin 2 or 17)					
THD = 0.5%	$V_{i(rms)}$	2	—	—	V
Input resistance (pin 2 or 17)	R_i	50	75	—	k Ω
Voltage gain (V_o/V_i)	G_v	—	0	—	dB
Channel separation (R/L)				0.5	dB
Total harmonic distortion					
$f = 40$ to $16,000$ Hz; $V_o(rms) = 1$ V	THD	—	0.1	—	%
Power supply ripple rejection	RR	—	50	—	dB
Noise output voltage (unweighted) left and right output	$V_{n(rms)}$	—	—	10	μ V
Spatial mode* (pins 11 and 12 not grounded)					
Antiphase crosstalk		—	50	—	%
Voltage gain	G_v	1.4	2.4	3.4	dB
Logic inputs (pins 11 and 12)					
Input resistance	R_i	70	120	—	k Ω
Switching current	$-I_i$	—	95	160	μ A
LED drivers (pins 7 and 8)					
Output current LED indication	I_o	10	12	15	mA
Forward voltage	V_F	—	—	6	V

*The effect of pseudo stereo is determined by the external filters.

Table 2. Technical specifications of the TDA 3810. These were measured from the test circuit in figure 1.

The current consumption increases by about 5... 9 mA, so the total consumption for the pseudo stereo personal FM radio is about 24... 30 mA, depending on the volume.

The circuit

The circuit for the extension is shown in figure 2. The heart of the circuit is the TDA 3810 and the external components between this IC to convert mono into pseudo stereo. The mono signal comes into this IC at pins 2 and 17 and is thus split into two channels. One channel goes straight to the output, but in the second one all frequencies between 300 Hz and 2 kHz are subject to a frequency dependent delay. Other frequencies pass unchanged to the output. The phase shifting needed for the pseudo stereo effect is achieved with the circuitry between pins 6, 14 and 16. The output of the TDA 7000 has to be brought to a suitable level so that the pseudo stereo decoder gives the best possible signal/noise ratio, and for this a voltage amplification of about forty times is needed. This is exactly what the input stage of T1/T2 provides, and it also ensures that the de-emphasis network at the output of the TDA 7000 is not loaded.

After the signal is amplified by the T1/T2 stage it enters IC1 and when this IC has done its thing the processed signal appears at pins 6 and 13. The signals then go via a voltage divider and stereo pot P1 to the two LF amplifiers, one on the extension board (IC2 and the associated components) and the identical one already on the board of the personal FM.

One final point about the circuit. There is, as we have already pointed out, a facility in the TDA 3810 for driving an LED to indicate when this IC is operating in pseudo stereo mode. However, as LEDs consume a fair amount of current, we decided to do without it and avoid wasting any of the 9 V battery's power. We have included a switch (S1) to change from mono to pseudo stereo, as the mode depends only on whether pin 11 is connected to ground or not.

Construction

The printed circuit board for the pseudo stereo extension (figure 3) is near enough exactly the same size as that of the personal FM. Depending on the case used, the two boards can be mounted side-by-side or they can be made into a 'sandwich'. Part of the reason that the board is so small is that all the resistors are mounted vertically. This means that locating everything correctly before soldering requires more care than usual.

It is quite easy to check if the circuit is correct on the basis of the test voltages given. If some of the voltages measured differ from the stated values then obviously something is amiss. Most likely this is due to some resistors being interchanged, but it could be something else (you never can tell, what with Murphy hovering in the background).

The voltage at the base of T1 should be about 1.1 V. However, as this is the output of the TDA 7000, there may be some

Table 3

	switch pin 11	mode	switch pin 12	SPATIAL LED pin 7	PSEUDO LED pin 8
MONO	H (off)	PSEUDO	L (on)	off	on
	H (off)	SPATIAL	H (off)	on	off
STEREO	L (on)	--	X	off	off

L = LOW = 0 to 0.5 V H = HIGH = 2 V to Vp

pseudo stereo
elektor november 1993

X = state is immaterial

Table 3. This is a sort of truth table of the relationships between the different functions, the positions of the switches and the indication of the LEDs.

Figure 3. The printed circuit board layout shown here has the same dimensions as the personal FM board. All resistors must be mounted vertically.

Figure 4. This is a small interface circuit needed at the input of the pseudo stereo extension to adapt it to equipment other than the personal FM receiver.

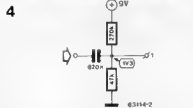
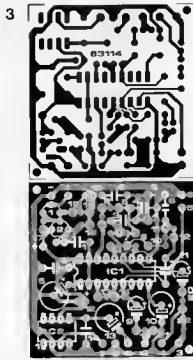

deviation in this value so a better checkpoint is the collector of T1. If the voltage here deviates by more than 1 V from the anticipated value of half the supply voltage (i.e. 4.5 V) then R16 must be changed. Connecting the pseudo stereo board to the personal FM board is no problem. The volume control pot (P2) on the radio must be removed and a 22 kΩ resistor is soldered between points 3 and 5. Also C18 must be replaced by a wire bridge. The input to the pseudo stereo board is now connected to point 3 on the radio board and the output for the left channel (the wiper of P1) to point 4. Now only the two power supply lines have to be connected and the job is done.

A final note: if the pseudo stereo extension is to be used separately from the personal FM then obviously the input level will have to be adapted. This can be done using the small interface circuit shown in figure 4. ■

Parts list

Resistors:

(1/8 W)
R1, R7 = 15 k
R2, R8, R15 = 1 k
R3... R6 = 22 k
R9 = 100 k
R10, R11, R14 = 12 k
R12 = 18 k
R13, R18 R20 = 10 k
R16 = 5k6
R17 = 39 k
R21, R22 = 390 Ω
P1, P1' = 10 k log stereo pot

Capacitors:

C1 = 470 n
C2, C3, C7 = 10 n
C4 = 22 n
C5 = 100 μ/25 V
C6 = 12 n
C8 = 220 n
C9, C11 = 4μ7/63 V
C10 = 47 μ/25 V
C12 = 22 μ/10 V tantalum
C13 = 100 μ/10 V
C14 = 47 n ceramic
C15 = 47 μ/2 V tantalum

Semiconductors:

T1, T2 = BC 550C
IC1 = TDA 3810
IC2 = LM 386

Miscellaneous:

St = single pole toggle switch
Two loudspeakers, 8 Ω,
½ W

The combination of the CPU card featured elsewhere in this issue and the VDU card published in our September number, with the addition of a keyboard, a monitor, and the necessary software results in a universal terminal which is really inexpensive for its capabilities. The terminal has an RS 232 connection with VT 52 protocol and can therefore be coupled directly to any computer provided with such a connection. An example is the 16-bit Force II which, in conjunction with this terminal, gives an excellent cost/performance ratio.

universal terminal...

... linking
the computer
to the user

This universal terminal should not be thought of as just a replacement for the Elekterminal. Connecting the latter to a large computer gives immediate problems because it does not provide handshake lines. The present terminal, however, provided as it is with an RS 232 connection and VT 52 protocol, can be connected to a large computer without further ado. (The VT 52 protocol is a communication agreement extensively used in industrial terminal applications.) As the RS 232 is a serial connection, it is also possible, by means of a modem, to communicate with a so-called host computer anywhere in the world over a telephone line.

Moreover, this universal terminal, in contrast to the Elekterminal, provides an adjustable image format and graphics possibilities.

construction consists of combining a CPU card and a VDU card by, for instance, the Elektor bus board, and connecting a monitor (or normal TV receiver) to the VDU card, and a keyboard to the CPU card. The required software for the system can be contained in a 2732 EPROM for which there is a convenient slot on the CPU card.

It is also possible to connect a printer with Centronics interface to the terminal. Furthermore, some preliminary work has been done towards a light-pen connection, but this option will have to wait until a future issue.

The CPU card is programmed by means of shorting plugs, for instance, as regards image format and memory index. The shorting-plug positions for these specific applications are given in table 1. The memory index will then look as shown in figure 2. The image format must, of course, be chosen in relation to whether a proper monitor or a TV set is used. If the latter, it is recommended that fewer characters per line are selected than with a monitor.

The address decoding of the 2k RAM and 4k EPROM used in the present project is also arranged by means of shorting plugs as

Figure 1. The layout of the universal terminal with all possible connections. Connecting a 16-bit computer (for instance, a Force II which is based on a 68000 CPU) yields, to the best of our knowledge, the cheapest 16-bit computer system available.

Construction

The general layout of the terminal is shown in figure 1. As can be seen, all constituent parts have already been described: in 'CPU card' elsewhere in this issue, and in 'VDU card' in the September issue. Basically, the

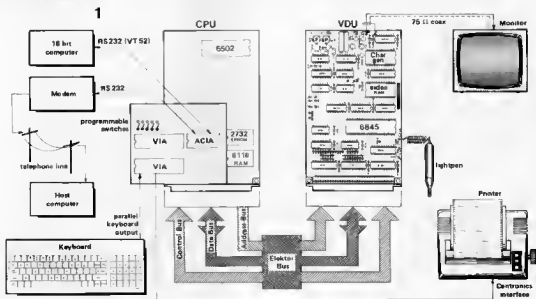

indicated in table 1.

Furthermore, a number of connections have to be made on the CPU card between the outputs of the address buffers and points A...J to obtain the chip-select signal for the various ICs. These connections should be made by short lengths of wire soldered to the appropriate connector pins, according to the circuit diagram of the CPU card.

The programming of the ACIA (PL3 and PL4 on the CPU card) should be carried out with the aid of the manual of the computer used, and table 2 in the CPU card article.

Software for the terminal

Appropriate software is, of course, indispensable for the correct operation of the terminal. An associated program (ESS 525) is available from Technomatic Ltd. This program consists of the following parts:

- Console Command Processor, which ensures that the various commands are executed
- Video routines and sub-routines (cursor control, and so on) which are necessary for the proper operation of the VDU card
- Table of commands, which ensures that keyed-in commands are 'understood'
- Centronics output routine, which is necessary for printer control
- Image format table with which the preset image format is realized.

The Console Command Processor reads the keyboard and distinguishes between normal text and commands, a list of which is given in table 2.

A source-listing of the relevant program together with additional information (VDU Paperware) will become available through our book service in a few months' time. The additional information refers to the combination of the VDU card with the CPU board and to the CRT controller, the ACIA, and the character generator.

Table 1

connector	interconnection	function
PL6	none	image format setting:
	5-6	80 x 24
	3-4	80 x 16
	3-4, 5-6	64 x 24
	1-2	90 x 22
	1-2, 5-6	48 x 12
	1-2, 3-4	24 x 24
	1-2, 3-4, 5-6	user programmable
PL9	3-4, 7-8, 11-12	RAM address decoding for addressing 0000-07FF
PL10	none	
PL13	1-2	
		EPROM address decoding for addressing F000-FFFF
PL11	1, 2, 5-6	
PL12	1-2, 7-8, 17-18	

2

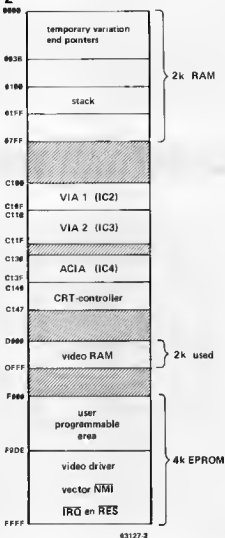

universal terminal
elektron november 1983

Figure 2. Summary of the memory index.

Table 2

	code	keyed	command
VT 52	0000	[CR]	carriage return
	000A	[LF]	line feed
	000B	[BS], [CTRL H]	back space
	1040	[ESC] [H]	cursor home
	1041	[ESC] [A]	cursor up
	1042	[ESC] [B]	cursor down
	1043	[ESC] [C]	cursor right
	1044	[ESC] [O]	cursor left
	1040	[ESC] [K]	erase to end of line
	104A	[ESC] [J]	erase to end of screen
CP/M	000B	[CTRL-K]	cursor up
	000C	[CTRL-L]	cursor right
	0011	[CTRL-Q]	erase to end of screen
	0010	[CTRL-X]	erase to end of line
	001A	[CTRL-Z]	clear screen & home
	001E	[CTRL-7]	cursor home
	000A	[CTRL-J]	cursor down
	0010	[CTRL-P]	select/deselect centronics
	1052	[ESC] [R]	delete line
	102A	[ESC] [x]	clear screen & home
103A	[ESC] [j]	clear screen & home	
1054	[ESC] [T]	erase to end of line	
1074	[ESC] [t]	erase to end of line	
1050	[ESC] [Y]	erase to end of screen	
1070	[ESC] [y]	erase to end of screen	
0000	[CTRL-F]	select/deselect auto LF	
0002	[CTRL-B]	select/deselect half duplex	

Table 1. This shows how the CPU card is programmed for this application by means of shorting plugs. Programming of the ACIA is carried out with the aid of the manual of the computer used and table 2 of the CPU card article in this issue.

Table 2. Commands for the cursor control and the erasing of (parts of) the screen. (CTRL... means that a key is pressed while the control key is pressed and ESC... indicates the successive pressing of the escape key and another as shown.)

Infrared barriers are used in counters, alarm equipment, automatic door-openers, remote control, and in countless other applications. It is therefore not surprising that almost every electronics hobbyist has at one time or another experimented with infrared diodes. Piezo-ceramic ultrasonic oscillators have been around even longer and yet nobody seems to have bothered to design an ultrasonic barrier with characteristics which compare well with those of its infrared counterpart. So far, that is! We have, and we feel it's worth passing on to you.

ultrasonic/infrared barrier

There is, of course, a reason why until now no ultrasonic barriers have been available which can compete on equal footing with infrared ones: it is much easier to realize good immunity to noise in the infrared devices. There is, after all, more audible than visible noise! None the less, we decided to go ahead with the development of an alarm which can, however, make use of either an infrared or an ultrasonic detector. Now, we are not going to claim to have invented sliced bread, but research in our laboratories has shown that an ultrasonic barrier works perfectly all right, even in the presence of the 'usual' ambient noises. How come? Well, because of the principle of transmission and reception we have used: the transmitted signal is frequency modulated and is then 'recognized' and demodulated by the receiver. Sounds simple, doesn't it? But it is the same principle as used in FM broadcasting!

The block diagrams of figures 1 and 2 show that the principle is rather simple. The transmitter consists of two square-wave generators and a power stage which drives

either the ultrasonic transducer or an infrared diode. The first of the generators oscillates at 50 Hz: the switching frequency. This is then used to frequency-modulate the carrier produced by the second generator. The receiver is only slightly more complicated. The signal received at the input, either by the infrared photocell or the ultrasonic transducer, is fed to a selective amplifier and then to the discriminator. At this point the LED will indicate that the carrier has been 'recognized'. The discriminator is followed by a tone decoder which 'recognizes' the switching frequency and indicates this by actuating a second LED. The receiver terminates in a relay which, if everything goes according to plan, can trip a counter, open the garage doors or bring the police at the double, depending of course, on what the system is used for!

The circuit diagram

Two 555 timers form the basis of the transmitter circuit of figure 3. They are wired as astable multivibrators (square

Figure 1. The transmitter consists basically of two square-wave generators which operate as a frequency modulator. The modulated signal is amplified in a power stage before being applied to the barrier.

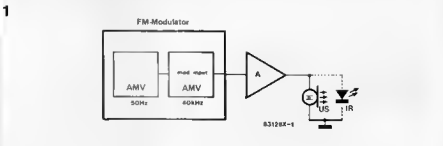
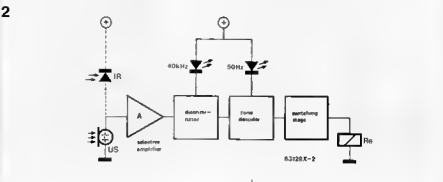

Figure 2. The receiver essentially comprises two tone decoders of which one operates as discriminator and the other as signal decoder. The relay in the output can be used to switch on an alarm.



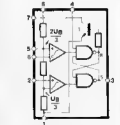
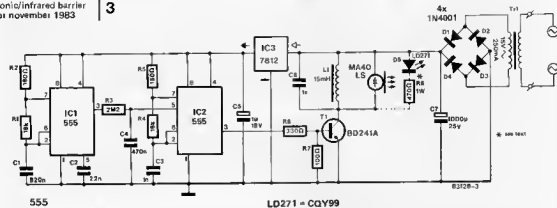

Figure 3. The circuit diagram of the transmitter also shows that it is of simple design: a power supply, two timer ICs, and a power transistor which drives either an ultrasonic or an infrared barrier are the main constituents.

Figure 4. The receiver is, of course, somewhat more complex than the transmitter, but due to two PLL-ICs the complexity has been kept to a minimum. The input signal is derived from an ultrasonic or an infrared barrier. A switching stage in the output operates a relay when D4 extinguishes — that is, when the barrier is broken.

wave generators) and together form a frequency modulator. The first (IC1) oscillates at about 50 Hz and the second at about 40 kHz. The output of IC1 is fed, via R3, to IC2. This effectively shifts the trigger level of IC2 up and down within a defined range. If the voltage difference is not too large, the output of IC2 is frequency modulated with fairly good linearity. As numerous harmonics are generated during modulation with square-wave voltages, the output of IC1 (pin 5) is 'rounded off' by means of R3 and C4.

The frequency-modulated output of IC2 is fed to the output stage, transistor T1. This functions as a selective amplifier operating in the ultrasonic region if wired as shown in figure 3. For infrared operation, an LD 271 emitter diode, together with R8, is connected in place of the tuned circuit consisting of the MA40LS ultrasonic transducer, L1, and C6. In both cases the output stage is powered from the unregulated supply ensuring sufficient separation between the output amplifier and the modulator. There is no necessity for frills in the power

supply, only the bare essentials are needed. The usual IC voltage regulator holds the supply for the modulator section to 12 V. The circuit for the receiver is slightly more complex. The input can of course use an ultrasonic transducer, the MA40LS as shown or, if infrared operation is preferred, the transducer is omitted and the dotted circuit consisting of D10, R21 and C19 is included. The signal from whatever device is chosen, infrared diode or ultrasonic transducer, is amplified by about 26 dB by transistor T1. The two diodes D1 and D2 are included to ensure that the amplified signal at the collector of T1 is limited practically symmetrically before being passed to transistor T2. Transistor T1 forms a selective amplifier which, as it were, 'drags' the carrier from amidst all the other incoming signals. Pin 3 of IC1 is therefore provided with a signal which can be demodulated. To prevent any interaction between the stages, careful decoupling is necessary. For transistors 1, 2 and 3 this is carried out by means of R3. For ICs 1 and 2, R6/C9, and R12/C15 are used respectively.

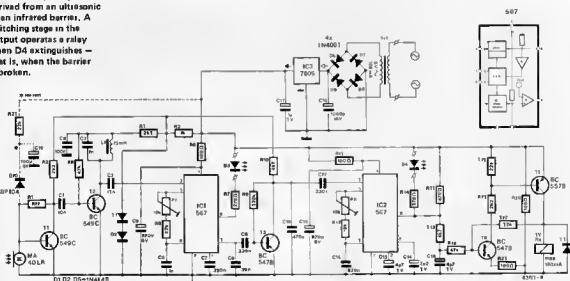

BP104 = BPW41

The phase-locked loop (PLL) in IC1 is used as a frequency discriminator. The mid-frequency of the internal oscillator can be preset by means of P1, R8, and C5, and is, of course, around 40 kHz! Capacitor C6, in conjunction with the internal resistance of the IC, forms the smoothing filter between the phase detector and the oscillator. As usual, in a PLL, the f.m. signal at pin 3 is compared with the oscillator output by the phase detector. The resulting error signal at the output of the detector (pin 2) is used to tune the oscillator until the error has disappeared. The demodulated signal of around 50 Hz is then available across C6. At the same time, the internal comparator switches its output (pin 8) to logic 0 which causes LED D3 to light, indicating that the 40 kHz carrier has been received. The 50 Hz signal is amplified in T3 and applied to tone decoder IC3. On receipt of this 50 Hz signal, the output at pin 8 of IC3 is low and causes LED D4 to light. At the same time, the base of T4 is practically at earth potential. Consequently, T4 and T5 are cut off, and the relay is inoperative. When the barrier is broken, the output (pin 8) of IC2 goes high, T4 and T5 conduct, and the relay switches on a suitable alarm bell or similar device.

Construction and calibration

The design is sufficiently simple to enable the transmitter and receiver to be constructed on prototyping (Vero) board. It is, however, also possible to use the printed-circuit boards for the 'Alarm Extension' published in our September 1983 issue (don't forget the PC board pages in that number if you want to make your own boards!).

Once the barrier has been constructed, it must, of course, be calibrated. But first a note of warning: it is only possible to have both transmitter and receiver using an ultrasonic OR an infrared barrier — mixing the two is not possible.

No calibration of any part of the transmitter is necessary. It is, of course, necessary to align the 'beam' between the transmitter and receiver! The maximum operational distance of an infrared beam, without lens, is some 6 m, with a lens approximately 50 m. The distance of an ultrasonic beam can only be determined experimentally in situ.

Set both presets in the receiver to their mid-position. If neither of the two LEDs lights, adjust P1 until D3 does. Then if D4 still does not light to indicate that the beam is closed, adjust P2 until the LED lights. Then break the beam to ensure that the relay — and the alarm! — operates.

Final warning: as the barrier can be used without any further ado as an alarm, remember that even a large insect, or a housepet can break the beam during the night and the consequent alarm can wake up the entire household!

Everybody enjoys a good joke . . . except maybe the victim. The question is whether the victims of this circuit will see anything to laugh about, but that is your problem. What we have here is an apparently normal battery which is quite abnormal when a meter is connected across it. This 'battery' is so unusual, in fact, that the victim is likely to dismantle his multimeter to see what is burned out.

trick battery
elektron november 1983

L. van Boven

trick battery

It all revolves about the fact that anybody metering a battery will attribute any unusual results to the multimeter — after all, who would suspect something like that of an ordinary battery?

The idea is to hand this trick battery to a friend or acquaintance and ask him to check it with his multimeter. Chances are he will

Figure 1. A part from the diagram of the 'trick circuit', we also see here how everything is connected together. IC1 and IC2 serve as polarity switches and are controlled by the 'emperor-meter' R2/T1.

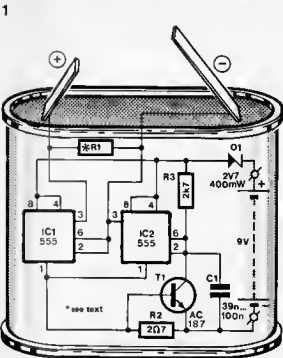

begin by measuring the voltage. This will be a steady 4.5 volts. Now the short circuit current, and . . . wait a minute . . . shouldn't the needle of the meter go the other way? How can it do that? Try the voltage again: yes, that is still correct and the plus and minus are connected where they should be. Now the current again: and the needle still goes the wrong way! The only possible conclusion seems to be that there is something seriously amiss with the meter. So the instrument is swiftly taken apart to have a look for the damage.

This is probably the best time to reveal the joke, before your victim does some real damage by trying to repair some imaginary fault.

The circuit

What we have here is no ordinary battery, that is obvious even from the title of this article. We started with a normal flat (in more than one sense) 4.5 V battery which is first hollowed out and then 'refilled' with a 9 V battery and a small 'trick circuit'. This circuit operates as a sort of current controlled switch. As long as there is very little current passing through the circuit there is a voltage of 4.5 V at the connections of the battery - and it even has the correct polarity. So when the voltage is measured everything seems to be right. When the current from the trick battery is measured a much greater current flows and this causes the polarity of the connections to be reversed.

The trick circuit is shown in figure 1. The switch is made up of two 555s which are connected here as inverting 'power schmitt triggers', whose input is the junction of pins 2 and 6. The 'amperemeter' consists of resistor R2 and transistor T1.

The operation is straightforward. At rest or when the voltage between the positive and negative connections is being measured very little current flows, and hardly any voltage is dropped across R2 so T1 does not conduct. The voltage at the input of IC2 is therefore far greater than the upper triggering level and pin 3 will be low. As a result, the output voltage of IC1 is high and the voltage at the connections is just the same as for a normal battery.

When measuring current the voltage drop across resistor R2 causes T1 to conduct. The output of IC2 therefore changes around, while IC1 inverts this signal and will then have a low level at its output. The positive and negative of the trick battery are now interchanged and the current flows in exactly the opposite direction as previously. During switch over there is, of course, a moment when the voltages at the outputs of IC1 and IC2 are the same. The current then drops and the circuit then tends to return to its initial state. The current immediately increases again and in order to prevent the circuit from continually switching from one state to the other C1 is needed. This keeps the input of IC2 low during the switching, and T1 is also prevented from conducting. To make everything look as real as possible,

the output voltage must be exactly 4.5 V. The voltage is already about this value but it is not precisely 4.5 V. This can be improved by loading the output with R1. Admittedly this is not a very elegant solution, but it works. Some experimentation is needed to find the right value of resistor. We found 330 Ω suitable for our prototype.

Construction

This circuit is so simple that it can be easily and quickly constructed on a piece of veroboard. The majority of the work involves preparing the battery. First the cap on the top is removed. Using a sharp knife the black material is separated from the walls of the battery and then it should

trick battery
elektor november 1983

2



Figure 2. This photo gives an idea of how the prototype was constructed.

be possible to remove the innards with a pliers. Then the 9 V battery is put inside along with some packing material to make the battery about the right weight. The circuit is then placed in on the top. If the circuit is fitted with a battery clip, the trick battery can be disconnected after 'use'.

The photo of figure 2 shows the prototype and gives an indication of how everything fits together.

Crescendo revisited

It is almost a year since we published the Crescendo MOSFET power amp and in that time we have discovered a few tips we think are worth passing on to our readers:

1. Wirewound resistors were specified for

R27...R30. However, the self-inductance of R27 and R28 in particular can give rise to short oscillations during positive half cycles, in other words when T11 and T12 are conducting. There are two methods of getting around this problem. Leave the wirewound resistors as they are and connect a capacitor of 1 nF between the source sides of R27 and R28 (see figure 1). Alternatively replace each of R27...R30 by five 1 Ω 1 W carbon resistors connected in parallel.

2. The low-pass filter at the input passes frequencies up to about 160 kHz (assuming the output impedance of the preamplifier is low relative to R2). This should be lowered to about 50 kHz. This reduction helps to reduce the amount of undesirable input signals passed but does not cause any discernible loss in sound quality.

To calculate the value of C3:

$$C3 = \frac{3.2}{R_O + R_2} \text{ [nF, k}\Omega\text{]}$$

where R_O is the output impedance of the preamplifier. If the Prelude preamplifier is used C3 is 820 pF.

3. An aluminium bracket acts as a thermal connection between the MOSFETs and the actual heatsink. For this, 3 mm is a reasonable thickness, 4 mm is perfect. In any case it should not be thinner than 3 mm.

4. For the class-conscious who would like the AB setting of the output stage to tend more towards A, in order to improve the theoretical, and maybe the actual, sound quality, it is handy to know that the quiescent current can readily be increased to 400...500 mA. This is taking tip no. 3 into account, of course.

5. There is a mistake in the test points on the circuit diagram of figure 2 (page 12/32). The polarity of the ±0.7 V test points must be changed. So, the junction of R23/24 is 0.7 V and the junction of R25/R26 is -0.7 V (see figure 1).

Figure 1. Here we reproduce part of the circuit diagram of the Crescendo showing the resistors mentioned in tip no. 1 (R27...R30) and the interchanged test points of tip no. 5.

1

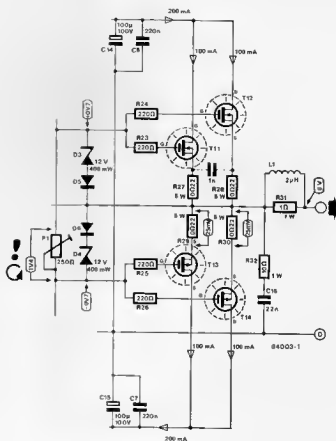

ZN 415 — a complete AM radio tuner

Ferranti have recently introduced their contender for the 'smallest radio in the world': the ZN 415, an extended version of their well-known ZN414 circuit. Because of its really small size and the few external components required to make up a complete radio receiver, this new IC is bound to become very popular.

Although ICs should normally be treated as black boxes, we felt you might be interested in knowing 'what goes on inside?' Basically, the ZN 415 consists of a ZN 414 — itself a transistor radio frequency tuner — and a two-stage a.f. amplifier (see figure 1). The tuner covers the frequency range 150 kHz... 3 MHz which includes the medium and long wave broadcast bands. A.F. output is 1.0... 1.5 mW into 64 Ω. Because of its high input resistance (of the order of 4 MΩ), selectivity is good: 8 kHz bandwidth at -6 dB points. The a.g.c. characteristic shows an increase of less than 7 dB in a.f. output for more than 30 dB r.f. input. The circuit is packaged in B-pin DIL.

Although the IC is capable of driving good-quality headphones satisfactorily, we felt it would be interesting to add a tuned aerial circuit, an a.f. amplifier to drive an 8 Ω loudspeaker, and a volume control which is lacking on the basic IC (see figure 2). This made it necessary to increase the required supply voltage to 9 V (the IC itself operates from 1.5 V) so that a PP3 would do nicely. Power dissipation is of the order of 120 mW. Note that reception via 64 Ω headphones is still possible.

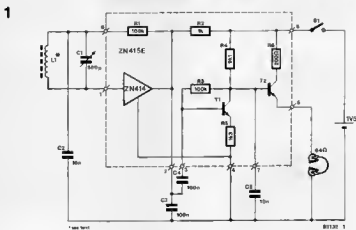

Figure 1. Basic application of the ZN 415.

If reception on medium wave only is required, the aerial can be constructed from a single layer of 55 turns close wound on a 60 x 12 x 3 mm ferrite rod using enamelled copper wire. If both medium and long wave are wanted, a 150 x 12 x 3 mm ferrite rod is needed. The aerial for the medium wave is then a single layer of 48 turns close wound and that for the long wave a multi-layer of 280 turns enamelled copper wire 36 SWG. Details of these windings are shown in figure 3. Also, of course, a switch to select between the two bands must be incorporated.

Literature:
 Ferranti Semiconductors —
 Advance Product Information:
 ZN 415E an AM Radio Receiver

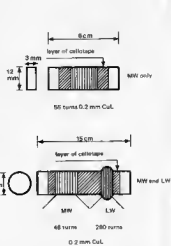

Figure 3. Details of aerial coil windings.

2

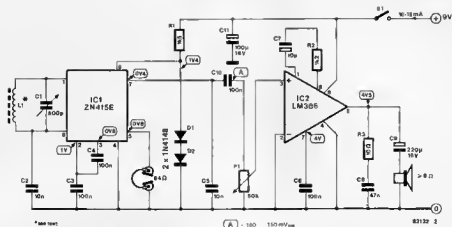
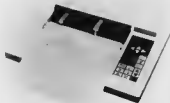

Figure 2. Circuit diagram of the extended AM receiver.

market

Intelligent microscribe

The new 4500 Microscribe recorder combines intelligent control and a classical one or two pen servo pen recorder to provide increased capabilities at lower cost. This results from the use of microprocessor control and LSI circuitry, giving inherent dependability and when joined with the time-proven non-contact capacitance servo rebalance system, unprecedented reliability is assured.



All parameters, chart speed set, span set, zero chack, chart repeat, chart start/stop, pen up, pen down and event mark are easily set on the membrane 'touch' control panel, as well as being addressable through a combined RS232/standard parallel printer port for remote control. This option lets your system do the 'set up'. For OEM applications, the ROM and control panel can be economically modified to suit your needs.

A reliable and readable LCO display continuously informs the operator of recorder parameters (such as 1 mV to 20 V/20 cm span, 60 cm/min to 1 cm/hour chart speeds) and status. Vital system functions, including absence of paper, are monitored and fault messages are presented, when errors are detected. A comprehensive self test routine begins at start up and continues during operation, assuring that all parameters are valid and functions properly executed.

Power may be from 115/230 V AC mains, 50/60 Hz or 12 V DC external battery. An internal standby battery provides 'keep alive' power to the processor in case of power interruptions or voltage fluctuations.

*House of Instruments,
Clifton Chambers,
62, High Street,
Saffron Walden,
Essex CB10 1EE.
Telephone 0799 24922*

(2781 M)

Portable miniature terminal

Terminal Technology have announced a new 80-character display terminal, the Microscribe MT 80, as an addition to their range of portable mini-terminals.

The new CMOS technology terminal is primarily aimed at OEM applications, and fields service repair use. The ability

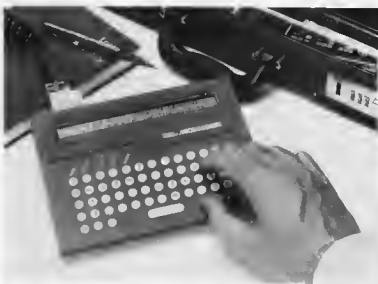

to run diagnostic routines, retrieving and storing results simultaneously, is expected to be of particular benefit to service engineers. In OEM applications, the Microscribe is suited for use as a low-cost dedicated terminal on peripherals requiring periodic operator input, and for displaying status messages and prompts.

The terminal can be down-line loaded, with special function keys to call up frequently used subroutines. The industry standard RS 232 interface is used, with X-on/X-off and data transfer rates up to 9600 baud for optimum compatibility.

The two-line by 40-character display of the latest Microscribe makes it particularly suited to applications involving lengthy or complicated text — for example in electronic mail or information retrieval systems. Microscribes have been successfully linked to such databases as Telecom Gold and Dialog.

The standard features of the terminal include a proper QWERTY keyboard with full travel keys, tactile end audio 'keyclick', and considerable on-board memory — up to 32K soon, with a current maximum of 10K.

Microscribe is very easy to use, with a software driven set-up mode which interactively guides the user through the set-up procedure. Loss of data is avoided by a fail-safe memory protect feature, so that even when the main rechargeable nickel cadmium batteries are exhausted, the RAM data is held intact for up to 1000 hours. The main power supply itself should typically last for three to four weeks between charges.

The terminal weighs 500 g, and measures 190 by 140 by 26 mm, making it probably the smallest true computer terminal available.

*Terminal Technology Ltd,
Clarence House,
Clarence Place,
Newport,
Gwent NP7 7AA.
Telephone: 0633 214128/9*

(2769 M)

Ultra-low distortion oscillator

Accuracy, versatility and repeatability are available with the Krohn-Hite Model 4500 1 Hz to 100 kHz Ultra-Low Distortion Oscillator. It generates a sine wave with less than .001% (—100 dB) distortion,



less than 5% peak to peak amplitude. Five pushbuttons of decade multiplication with an infinite resolution single turn dial calibrated in Hz from 1 to 10 provides continuous frequency coverage. Also, a vernier dial covering ± 5% of the frequency range is provided for intricate adjustments.

The unit delivers up to 7 volts RMS open circuit to main and inverted outputs of 600 ohm impedance. A main output of 50 ohm impedance is also provided. Exceptionally flat response (.05 dB) virtually eliminates the need to constantly monitor output voltage levels. A four position pushbutton attenuator calibrated in 20 dB steps together with a 30 dB vernier provides a total dynamic range of 90 dB. Amplitude and frequency stability varies less than .001% with a 10% change in line voltage.

When combined with Krohn-Hite's Ultra-Low Distortion Analyzer 6800/5900 series, it provides a complete distortion measurement system.

*Kaithley Instruments Limited,
1 Boulton Road,
Reading,
Berkshire, RG2 0NL.
Telephone: 0734 861287*

(2770 M)

Scotchlok connectors

3M has introduced a self stripping T-Tap female quick-slide connector which enables a mid-span connection to be achieved without stripping insulation. Designated the Scotchlok 952 connector it requires no special tools and is merely clipped into place with a pair of pliers. The T-Tap provides a fully insulated connection when used with 3M male quick-slides and this feature increases safety, makes installation foolproof and eliminates the need for second step insulation. The 952's tap leg is removable to make the connection as easy and flexible as possible.

The product is available in sizes for wires ranges from 16/0.20 — 44/0.30 (0.4 — 3.0 sq mm) and is suitable for circuits fused up to 20 amps.

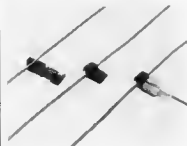

Electro-Products Group,
3M United Kingdom PLC,
3M House,
PO Box 1,
Bracknell,
Berks RG12 1JU.
Telephones: 0344 58755

(2778 M)

AM/FM function generator

OK Industries' new FG-201 function generator provides a 1 Hz to 1 MHz frequency in six ranges together with highly

accurate sine, triangle and square wave forms. Furthermore, the instrument also offers FM modulation (VCO sweep) and full AM modulation.

Other features of the FG-201, which provides full capability at a low cost, include independently variable square wave output — simultaneously and in phase with the separate sine triangle output so that it can be used both as an individual signal source as well as a trigger or synchroniser. It has a low 50 ohm source impedance for all outputs and a lower switch selectable impedance of up to 5 ohms for sine/triangle.

Output, level, gain and offset are continuously variable and the unit will deliver ± 10 V peak-peak into any load of 50 ohms or greater. The specification also includes RF1 shielding and rugged steel enclosure, and the unit is complete with a BNC-to-Microhook test interface cable. Units are available for 110 or 220 V a.c. 50/60 Hz.

OK Industries UK Ltd.,
Dutton Lane,
Eastleigh,
Hants.
Telephone: 0703 610944

(2779 M)

Programmable power supply

PR 655 is a versatile series regulated DC power supply that can be constantly varied from 0 to 18 V/0 to 5A by normal coarse and fine manual controls or from a varying external resistance when in the remote programming mode.

Manufactured by Trio to their very high standard and available from House of Instruments, PR 655 is highly stable with large independent dual meters for both current and voltage indication. Voltage and current variations as well as ripple and noise have been reduced to a minimum. Other features include remote sensing;



fixed current protection circuit; series/parallel master/slave mode; LED indication of regulated voltage and current operation; and rack mounting capability. Front panel switching is provided to disconnect output terminals for voltage and current adjustments to be made with the load connected. PR 655 measures 209 (W) x 200 (H) x 293 mm (D), weighs approximately 10 kg and is fully guaranteed for 2 years. Free data is available on request.

House of Instruments,
Clifton Chambers,
62, High Street,
Saffron Walden,
Essex CB 10 1EE.
Telephone: 0799 24922

(2777 M)

Meteor counter

The 'Meteor 600' is the first in a series of Digital Frequency Counters just announced by Black Star Ltd. With typical frequency measurement range of 2 Hz — 700 MHz, sensitivity of < 25 mV at 600 MHz and resolution down to 0.1 Hz, the Meteor



600 also features 8 x 1/2" bright LED displays, 3 gate times, 2 inputs, trigger level control and an integral low-pass filter. The counter is housed in an attractive, sturdy, custom-moulded A.B.S. case with tilt stand. The 'Meteor 600' can be operated from rechargeable batteries or mains and is supplied complete with mains adapter/charger and comprehensive instruction manual. A wide range of optional accessories is available.

Black Star Ltd.,
9A Crown Street,
St. Ives,
Huntingdon,
Cambs PE17 4EB.
Telephone: 0480 62440

(2780 M)

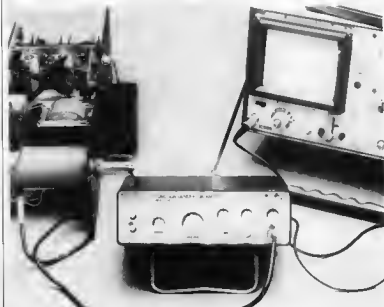

Back number service



E54, February 1978
Infrared Light Gate/Throwing
Some Light on LEDs/Fire-
The Elektor Music Synthesizer
18/Slowdown/ICMOS FETs on
Generator/Zero 1 Tested Develop-
ment Timer/Experimenting with
the SC/MF (4)

E37, May 1978
Infrared Systems for Satellite
Communication/Digital River
Station Ultra/Mini Short-wave
Receiver/Vocoder (2)/Parasitic
Switch/Colour Modulator/Cas-
caded Boards and Soldering/Uni-
versal Logic Tester

E39, June 1978
1/4 GHz Coaxial Constant Am-
plitude Squares to Saw
tooth Converter/Servo Foliety
Charger/Memory Disc/Mix
Coaxial/Digital Clock Using the
SC/MF/Programmable Call Gen-
erator/TV Sound Modulator/
As com to Servo Switch/Traffic
Light Controller/Easy Misc



E54, October 1978
Plan Transistorizing Sems/Im-
pudence Bridge/New Programs
for the SC/MF/Digital Rev Cou-
ter/Digital/Signal relayed Logic
Switch/PCB for Variable Freq
Box/Gate Driver/Signal Gauge/
Flayed TV Ganes/Programmable
Generator



E54, October 1978
Plan Transistorizing Sems/Im-
pudence Bridge/New Programs
for the SC/MF/Digital Rev Cou-
ter/Digital/Signal relayed Logic
Switch/PCB for Variable Freq
Box/Gate Driver/Signal Gauge/
Flayed TV Ganes/Programmable
Generator



E67, November 1980
An I.D.20 Indicates an
Economy Guide/Daught Direc-
tor/Low to Reduce Dry Call
Batteries/Energy Saving Know-
how/Simple Fuel Economy
Meter/Automatic Pump Control
/Long Life Technique in Light
Bulbs/Automatic Curtain Con-
trol/Fridge Alarm/Know the ins
and outs of your Central Heating
System/Energy Saving Motor
Control/Coffee Machine Switch/
Operational Hours Counter

E55, November 1979
Topspin/Fish Squawker/For
Enrica the Easiest Way/Re-
move Coastal Music Switch/
Home Tans and Economiser/
1 Played TV Games (2)/Short
wave converter/Incapacitor/Low
Voltage Demmer/ See your
Fornit/Servo-controlled Motor

E59, February 1980
Aerial Booster/Fat Dpams in
the Fornite/TV Interference
Suppression / Elektor Vocoder
(2)/Aerial Amplifier/Display/
Extensive Delay Technology/Ex-
tending the 1/4 GHz Coaxial/
Digital Thermometer

E62/64 July/August 1980
Semms Circuits Double Issue
containing over 100 projects

E65, September 1980
SC RAM +4.8 or 16K EPROM
on a Single Card/Precision Power
Unit/Electronic Linear Ther-
mometer/The Josephson Con-
ductor/VDU Punched Control
Board/Elektor Measuring Multi-
purpose/High Speed Resistor for
Electronics/Musical Box/Elec-
trichology/Curve Tracer/Using
the Vocoder



E94, October 1980
Programmable Slide/Fader/Touch
Doorbell/Diverted Capacitors
Music TV Games/The Junior
Computer Memory Card/Video
Control Slide Projection/Video
Pattern Generator/LCD Tuning
Scale/Dual Slide Fader



E67, November 1980
An I.D.20 Indicates an
Economy Guide/Daught Direc-
tor/Low to Reduce Dry Call
Batteries/Energy Saving Know-
how/Simple Fuel Economy
Meter/Automatic Pump Control
/Long Life Technique in Light
Bulbs/Automatic Curtain Con-
trol/Fridge Alarm/Know the ins
and outs of your Central Heating
System/Energy Saving Motor
Control/Coffee Machine Switch/
Operational Hours Counter



E68, December 1980
Canned Circuits 2/3 of the best
circuits which include Midnight
Raid Detector/A Fish in the
Cart / Camerata / Camera De-
vice

E70, February 1981
Audio Power Meter/Mouse Re-
duction / Process Times / High
voltage from 723 / Junction
Growing Up/The Vocoder/Un-
wired Detector / Emergency
Beats for the Power Supply/
150 W DC to DC Converter for
the Car/Low Noise 2 Metric
Pre Amp/2% Dist DV of Measure-
ment



E72, April 1981
Transist Matchmaker/Universal
Fast Power Supply/Intels/Hi-
munity Sensor/Logic Analysis II/
Cryticals on the Sincroscope/
Junior Cookbook

E73, May 1981
Computing Clock / Frequency
Divider/The Felly Fleeted
Junior Computer/Talk to Com-
puter/Choke Alarm/Bar Codes/
Logic Analysis/Well-form Gen-
erator/Sophisticated Software
for the Junior Computer/Read-
ing Bar Codes



E77, September 1981
DFM - DVM/Revolution Coun-
ter/Digital Barometer/dB Con-
verter/TV Games / Extended
Discs Light Converter/QUAD
ESL/50 Analog LED Display/
Vari/Amplifier for Power Sap
per/Chattering Chops/Traffic
Light/Infrared Up/down/Alu-
minium

E99, September 1982
Get Detector/Repeat Loading
Games/The Elektor Connection/
Inductive Sexton / Desktop
Computer Fert / Applications/
Home Telephone System/Syn-
thesised Sound Alarm/Chords
Receiver for the Rugby MSF/
Three Phase Tester



E90, October 1982
OSM Demodulator/L.C.D. Ther-
mometer/Ultra Sonic Distance
Measurement/Electrolytics Run
Dry/Darkroom Complete Part
2/Short Wave Band Shifting for
SSB Receiver/6 Channels with
the SSF Receiver / Active Aerial /
Transistor and IC Data

E91, November 1982
Osm Interface Talking Disc/
Model Train Lighting/Guides
Turns/Catapult/Poppy Disc In-
terface for the Junior/Cub-
icle Bell/Mini-Organ Extension/
Kitchen Timer



E92, December 1982
Trioscope/Precision Fovost Sep-
ply/The XL System/Chocanor/
Home Telephone - Heaps/3
Switching/Car/Incapacitor/Poppy
Disc Interface for the Junior
Part II/A Drown and One Sound/
Stopwatch Overdrive for Model
Railway



E92, January 1983
Microchips/accessories for
the Crescendo power amplifier/
Darkroom computer/Ipse/Chips
for digital audio/3A computer
supply/High-efficiency digital sys-
tem/Tomorrow's menu/Upper
and lower case on the Elektor
menu

E94, February 1983
Preduce part IV/AM - video/
audio modulator / Main bene-
ditima/Preduce case A head-
phone amplifier/Use precision/
Acoustic microphone modern/
Double disc/Chips for digital
audio part 2

E96, April 1983
Low power digital thermometers/
MIC/Mini phone preamp/Mem-
ory switches/Miniature RC
equalizer/7-day timer/control-
ler/Junior computer timer/Pre-
duce part 3/20 programmable
darkroom timer/Talking clock
extension

E97, May 1983
Walterite/ASCII keyboard/Pre-
duce part 4/Multimeter/RC
part 1/What is power?/Parallel
aerial keyboard connection/Mouse
converter/701 voltage regulation
and 701/Noise encoding with the
Z80A

E98, June 1983
Energy meters/Switching channel
for radio control/RTTY de-
coder/RTV decoder/Electro-
aerial switch/Spectrum display/
Mastrotto part 2/Video self-
generator/Mouse and video tele-
type (RTTY)

E99/100, July/August 1983
Semms Circuits Double Issue
containing over 100 projects

E101, September 1983
Video Spectro / Autoloid /
54s on the 16k Dynamic RAM
Card / High-speed CMOS / VDU
Card / Personal FM / Precision
Voltage Divider / Alarm Exten-
sion / Junior Synthesizer /
Simple MOSFET Test

E102, October 1983
Bascode 2 / Music Queue/Issue /
Solid-state Darkroom Lighting /
High voltage Regulator / Assem-
bly / Programmable Fovost
Supply / Bascode 2 Interface
for the Junior Computer / Ele-
tronics Voltage Regulator / Bit
rate Eliminator / Transistor
Selector / FSK/Issue / EPROM
map using the Junior Computer

Back numbers of Elektor currently available are detailed above, with a brief description of their contents. Prices are as follows: any one issue (except July/August) £ 1.30
additional issues, each £ 1.10
July/August (Summer Circuits) £ 2.60
Prices include postage and packing. Overseas orders requiring airmail postage add £ 1.50 per issue (£ 2.00 for July/August issue)
(Prices subject to change without notice)

THE NEW MAPLIN CATALOGUE FOR 84!

NOW WITH PRICES ON THE PAGE

More data, more circuits, more pictures, in the brand new 480 page Maplin catalogue. Take a look at the completely revised Semiconductor section or the new Heathkit section with descriptions and pictures of dozens of kits and educational products from digital clocks to 16-bit business computers. The much expanded computer section itself, gives details of hundreds of pieces of software for Atari, BBC, Commodore 64, Dragon, Spectrum and VIC20. In addition to all this you'll find hundreds of fascinating new items spread through the rest of the catalogue.

As always, the Maplin catalogue is tremendous value for money and now has prices on the page!

Pick up a copy at any branch of W.H. Smith or in one of our shops for just £1.35 or send £1.65 including postage to our Rayleigh address. On sale from 1st Nov 1983

PROJECTS FOR THE HOME CONSTRUCTOR

Choose from our huge range of value-for-money projects. Projects like our Modem, Mosfet Stereo Amplifier, Home Security System, Frequency Counter and Home Computer add-

on kits. Full construction details in our Project Books and brief specifications in our new catalogue. Dozens of fascinating new projects coming soon including a Keyboard for the ZX Spectrum with electronics to make all shifts, single-key operations. Full details in Project Book 9 on sale 11th November 1983. Order As XA09K. Price 70p.



NEW MAPLIN STORE IN SOUTHAMPTON

Opening on 1st November 1983, our new south coast store is at 46-48 Bevoys Valley Road, Southampton (Tel: 0703 25831). You will find our full range of components, projects and computers on sale. We are within easy reach of the city centre with good parking close by. Call in and see us soon.



Post this coupon now for your copy of the 1984 catalogue. Price £1.35 + 30p post and packing. If you live outside the U.K. send £2.20 or 11 International Reply Coupons. I enclose £1.65.

Name

Address

E11 83

MAPLIN ELECTRONIC SUPPLIES LTD

Mail Order: P.O. Box 3, Rayleigh, Essex SS6 6LR. Tel: Southend (0702) 552911 • Shops at: 158-161 King Street, Hammermith, London W6. Tel: 01 746 0926 • 8 Oxford Road, Manchester. Tel: 061-236-0261 • Lynton Square, Perry Barr, Birmingham. Tel: 021-356-7292 • 282-284 London Road, Westcliff-on-Sea Essex. Tel: 0702-554900 • 46-48 Bevoys Valley Road, Southampton. Tel: 0703 25631.

*Opens 1st November 1983.

All shops closed Mondays.

All prices include VAT and carriage. Please add 50p handling charge to orders under £5 total value (except catalogue).