

elektor

up-to-date electronics for lab and leisure

99/100

July/August 1983

70c
4 (incl. postage)

summer circuits '83
more than 100
practical projects



contents

sounds high
18/7/83

1	resistance comparator	7-28	53	offset-less rectifier	7-64
2	constant light source	7-29	54	RC generator	7-65
3	thermometer	7-30	55	interior temperature control for cars	7-66
4	microprocessor 'stethoscope'	7-31	56	VFD with variable inductor	7-87
5	symmetrical harmonic oscillator	7-31	57	amplified triac drive	7-88
6	stepped-voltage generator	7-32	58	action flash	7-68
7	power back-up for CMDS ICs during power failures	7-32	59	temperature indicator	7-69
8	doorbell memory	7-33	60	lie detector	7-69
9	capacitance meter	7-34	61	electronic pocket-pinball	7-70
10	electronic tuning fork	7-34	62	simple sawtooth generator	7-71
11	noise and vibration detector	7-35	63	optical voltage indicator	7-71
12	car PDM amplifier	7-38	64	heatsink thermometer	7-72
13	logarithmic amplifier	7-37	65	on/off with a single push button	7-74
14	reproducible delay	7-38	68	inexpensive 45 MHz crystal filter	7-74
15	stable zener	7-38	67	low-cost CMOS lock	7-75
16	symmetrical voltage from a doorbell transformer	7-39	68	glitch suppressor	7-76
17	LED current source	7-39	69	window comparator	7-76
18	solar tracking system	7-40	70	sea murmur simulator	7-77
19	emergency mains cut-out	7-41	71	busy indicator for the Junior Computer	7-77
20	simple baud rate generator	7-41	72	simple stabilizer	7-78
21	flashing running light	7-42	73	electronic switch for audio signals	7-78
22	2650 single step	7-43	74	vector control for the Junior Computer	7-79
23	1 MHz time base without crystal	7-44	75	four quadrant multiplier	7-79
24	machinegun-sound generator	7-44	76	microprocessor aid	7-80
25	centronics interface	7-45	77	dexterity game	7-81
28	joystick interface	7-46	78	40 watt main amplifier	7-82
27	auto trigger	7-46	79	zero-crossing detector	7-83
28	LED 'amplifier'	7-47	80	negative printhead supply	7-83
29	economic LED	7-47	81	distance meter for thunderstorms	7-84
30	simple regulated power supply	7-48	82	common base mixer	7-84
31	software RAM tester	7-49	83	drill speed controller	7-85
32	hFE tester	7-49	84	single pole toggle switch	7-85
33	prelude buffer	7-50	85	simple D/A converter	7-88
34	battery economizer	7-51	86	synchronous, constant-amplitude sawtooth generator	7-87
35	electronics and plant physiology	7-52	87	preset the hard(ware) way	7-88
38	d.c. voltage doubler using a 4049	7-53	88	variable zener	7-88
37	voltage booster regulator	7-54	89	voltage monitor	7-89
38	stay awake alarm	7-54	90	mini compressor	7-89
39	anti burglar lights	7-55	91	6809 DRAM controller	7-90
40	mains wiring tester	7-58	92	acoustic 'flag' for the RS 232 interface	7-91
41	very narrow crystal filter	7-58	93	simple PA system	7-91
42	signal purifier for SSB telegraphy receiver	7-57	94	5 V logic tester	7-92
43	horse paces simulator	7-68	95	microphone amplifier with preset tone control	7-93
44	video pattern generator	7-58	96	current source for photodiodes	7-94
45	car lights warning device	7-60	97	faultfinder for ASCII keyboard	7-94
46	code-lock with door opener	7-60	98	microprocessor faultfinder	7-95
47	DC-DC converter	7-61	99	thermal indicator for heat-sinks	7-98
48	darkroom light	7-61	100	high and low tester	7-97
49	portable egg timer	7-62	101	capacitive switch	7-98
50	frequency comparator	7-62	102	simple power supply regulator	7-98
51	cricket simulator	7-63	103	universal AFC	7-99
52	pulse/pulse train generator	7-64	104	key beep	8-00
			105	180 watt DC/AC converter	8-00

BBC MICRO COMPUTER SYSTEM

Please phone for availability

88C Model B £ 399 (inclusive VAT)
Carriage £ 8.Modal A to Model B Upgrade Kit £ 80
Fitting Charge £ 15

Partial Upgrades also available.

WORDWISE 8K ROM	£ 39
TELETEXT ADAPTOR	£195
TDRCH Z80 DISC PACK	£780
88C WORD PRDCESSOR 'VIEW'	£ 52

Phone or send for our BBC Inlet

BBC
OFFICIAL
DEALERNEW LOW
PRICES

NEC PC 8023BC

100CPS, 80 cols
Logic Seeking,
Bidirectional,
Forward and
Reverse Line Feed,
Proportional
Spacing, Auto
Underline, Hi-Res
end Block Graphics, Greek Char. Set.Only £ 345
+ £ 8 carr.

PRINTERS

SEIKOSHA
GP 100A80 cols 30 CPS
Full ASCII & Graphics
10" Wide PaperNow only £ 180
+ £ 8 carr.
GP 250A £235 + £8 carr.

EPSON FX80 and 100F/T3

EPSON RX80 and FX80
RX80 100 CPS 80 col
Tractor Feed £298FX80 160 CPS 80 col
F & T Feed £389
MX100 F/T3 £425
(£8 carr./printer)RX80 £ 298
FX80 £ 438
(£ 8 carr Printer).

PRINTER ACCESSORIES
Parallel Printer Lead ... £ 13.50
Serial Lead ... £ 10.—
EPSON SERIAL INTERFACE
2K BUFFER ... £ 60.—
NEC SERIAL BUFFER £ 70.—
2,000 sheets 9 1/2" x 11"
fanfold paper £ 13.50 + £ 3.50
carr.

VARIETY OF PRINTER INTERFACES IN STOCK

RIB8DNS FDR PRINTERS

GP100A ... £ 6.50
EPSON MX80 ... £ 7.50
NEC PCB035 ... £ 7.50
Teletype Roll £ 4.— + £ 2.50
carr.

AMPHENDL

CONNECTORS

37 way Centronix Type £ 5.50
(IDD or Solder Type)
26 way IEEE Type £ 5.50
Teletype Roll Holder £ 15.—
+ £ 2.— carr.

CASSETTE RECORDER

BBC Compatible Cassette Recorder
with Counter and Ramote
Control £26.50 + £1.50 carr.
Cassette Leads £3.50
Cassette 50p each £4.50
for 10 + £1 carr.
Senyo Data Recorder Model
DB1101 £39 + £1.50 carr.

DISC DRIVES FOR THE FORTH COMPUTER

5 1/4" Teac FD55 Slim Line Mechanisms
FD055A 40 track SSDD 250kbytes unformatted
bars: £135 Cased: £155
2 x FD55A 40 track SSDD 500kbytes unformatted
cased + psu £350
FD55E 80 track SSDD 500kbytes unformatted
bars: £180 Cased: £205
2 x FD55E track SSDD 1 Mbyte unformatted
cased + psu £475
5 1/4" Mitsubishi M4853 Slim Line mechanism
80 track OSD0 1 Mbyte unformatted
bars £225 Cased: £245
2x M4853 2 Mbytes Cased + psu £590
Single drive cable £8 Dual Drive cable £12
Other parts for FORTH COMPUTER available send SAE
for details

SOFTY II INTELLIGENT PROGRAMMER

The complete micro processor development system for Engineers and
Hobbyists. You can develop programs, debug, verify and commit to
EPROMS or use in host computer by using softy as a romulator. Powerful
editing facilities permit bytes, blocks of bytes changed, deleted or inserted
and memory contents can be observed on ordinary TV.
Accepts most +5V EPROMS
Softy II complies with PSU, TV Lead and Romulator lead £ 169

UV ERASERS

UV18 up to 8 Eproms ... £ 47.50
UV140 up to 14 Eproms ... £ 81.50
UV17 with Timer ... £ 60.00
UV141 with Timer ... £ 78.00
All erasers
are fitted
with mains
switches and
safety inter-
locks.

RUGBY ATOMIC CLOCK

This Z80 micro controlled clock/calendar receives coded time data from
NPL Rugby. The clock never needs to be reset. The facilities include B
independent alarms and for each alarm there is a choice of melody or alter-
natively these can be used for electrical switching. A separate timer allows
recording of up to 240 lap times without interrupting the count. Expan-
sion facilities provided.
Complete Kit ... £ 120 + £ 2.00 carr.
Ready Built Unit ... £ 145 + £ 5.00 carr.
Reprints of ETI articles at £ 1.00 + s.a.p.

MICROTIMER (HOUSEKEEPER)

6502 based Programmable clock timer with
* 224 switching times/week cycle
* 24 hour 7 day timer
* 4 independent switch outputs directly interfacing to
thyristor/triacs
* B digit 7 seg. display to indicate real time, ON/OFF and
Reset times
* Output to drive day of week switch and status LEDs.
Full details on request. Price for kit £57.00

BBC ETKS

Basic on BBC ... £5.95
30 House Basic ... £5.95
Programming the BBC
Micro ... £6.50
BBC Micro An Expert
Guide ... £6.95
Asy Lang Progr. for BBC £8.95
6502 Machine Codes for
Beginners ... £6.95

MONITORS

MICROVITEC 1431 14" Colour
£ 249 + £ 8 carr.
MICROVITEC 2031 20" Colour
£ 319 + £ 8 carr.
KAGA 12" Colour RGB £255
+ £ 8 carr.
Lead for KAGA £ 10
Lead for KAGA/SANTO RGB£10
SANYO Hi Res Green Monitor
£ 99 + £ 8 carr.

SEE OUR INSIDE FRONT COVER PAGE ADVERTISEMENT FOR COMPONENT PRICES

TECHNOMATIC LTD

MAIL ORDERS TO: 17 BURNLEY ROAD, LONDON NW10 1ED
SHDPS AT: 17 BURNLEY ROAD, LONDON NW10
(Tel: 01-452 1500, 01-450 6597, Telex: 9224800)
305 EDGWARE ROAD, LONDON W2

PLEASE ADD 40p p&p & 15% VAT

(Export: no VAT, s&p at Cost)

Orders from Government Depts. & Colleges etc. welcome

Detailed Price List on request.

Stock items are normally by return of post.

Does your components source offer:

- ★ 24 hour service on all in-stock items
- ★ ON-LINE Stock Enquiry Service
- ★ Human tele-sales from 8am to 8pm
- ★ 24 hour ON-LINE DATEL Service for direct stock interrogation from any RS232/300BAUD terminal
- ★ Order Processing with Automatic Backorder Processing and Due-In Date Advice
- ★ A Price-on-the-Page Catalogue that's revised 3 times a year

...it doesn't?

Then you aren't dealing with ambit, are you?

GET THE COMPLETE PICTURE AT YOUR NEWSAGENT DURING JULY — OR DIRECT

— ORDER YOUR COPY NOW —

★ STILL THE ONLY CATALOGUE FOR THE COMPLETE RANGE OF COMPONENTS BATTERIES, CRYSTAL FILTERS, RF POWER, MOSFET, TOKO COILS, CHOKES, ALPS PLOTTERS, SOLENOID CASSETTE MECHS ETC.

COMPONENTS FOR ELECTRONICS, COMMUNICATIONS & COMPUTING

ambit[®]

INTERNATIONAL

WORLD OF RADIO & ELECTRONICS

— CATALOGUE —

31£ DISCOUNT VOUCHERS

80p

144 PAGES



SUMMER '83

★ FIRST WITH ON-LINE COMPUTER SHOPPING

★ FIRST FOR INNOVATION

★ FIRST FOR VALUE

★ FIRST FOR CHOICE

★ FIRST FOR SERVICE

ambit[®]

INTERNATIONAL

200 North Service Road, Brentwood, Essex CM14 4SG
 Tel: (Consumer Sales/Enquiries) 0277-230909.
 Tel: (Industrial Sales/Enquiries) 0277-231616.
 Tlx: 995194 AMBIT G. Data 24hrs (RS232/300 baud) 0277-232628.



NEW & FREE

FROM GSC



NEW AND FREE FROM G.S.C.

NEW an exciting range of projects to build on the EXP300 breadboards.

NOW anybody can build electronic projects using "Electronics-by-numbers", its as "Easy as A, B, C with G.S.C.I"

FREE project
MUSICAL DOORBELL OF THE 3RD KIND
You've seen the film, now haunt your visitors with the tune!

Each time the doorbell is pushed the eerie tune plays out, then switches off to conserve battery power.

HOW DO YOU MAKE IT.

Our **FREE** project gives you clear "step-by-step" instructions. For example "take Resistor No.1 and plug it into hole numbers B45 and B47".

"Take IC No.1 and plug it into hole numbers E35 to E42 and F35 to F42, (pin 1 on the IC goes into F35)"

"Take . . ./Well! why not "clip-the-coupon" and get your **FREE** step-by-step instruction sheet and your **FREE** 12 projects with each EXP300 bought and your **FREE** catalogue and

EXPERIMENTER BREADBOARDS

The largest range of breadboards from GSC. Each hole is identified by a "zero-number" system. EACH MICREL SILVER CONTACT GAMMERS & LIND-TIME GUARANTEE

All modular construction means that any Experimenter breadboard can be "snap-locked" together to build breadboards of any size.



EXP355
The "one-chip" breadboard
Takes IC, 14, 16 and up to 22 pin IC's
Has 120 contact points including 2 bus bars.



EXP360
The "optional breadboard"
For limited points
you can have **FREE**
12 "Electronics by
Numbers" PROJECTS



EXP380
The most "utility thought" breadboard
Don't miss out on our "NEW AND FREE" projects
They can be built on the EXP380



EXP390
The "memory/40 microprocessor" board



EXP400
The "one-chip microprocessor" board

EXP400
"Snap-on" four extra bus bars

P84
The ultimate breadboard kit

P8100
The most I/O for the least money

NEW AND FREE FROM G.S.C. 24 HOUR SERVICE.

Tel: (0790) 21892 with your Amnia, American Express, Barclaycard number and your order will be put in the post immediately.

TO ORDER JUST CLIP THE COUPON

Experimenter Breadboards	List Price Inc. 8 & 9 + 12% VAT	Quantity Required
Exp 325	£ 3.16	
Exp 330	£ 4.83	
Exp 300	£ 8.05	
Exp 500	£ 9.49	
Exp 650	£ 5.75	
Exp 48	£ 3.74	
P8 6	£13.80	
P8 100	£17.54	

NAME
ADDRESS

I enclose cheque/PO for £
Debit my credit card No
Expiry date

Please send free catalogue 1 tick Dept. 2p

GLOBAL SPECIALTIES CORPORATION



GSC Unit 1, Stone Mill Ind. Estate
Saffron Walden, Essex CB11 3AG
Telephone (0799) 21892 Telex 817473

ELECTRONIC KITS

ALL
NEW
to the
VELLEMAN
RANGE

Velleman electronic kits have gained respect for their high quality and the varied range which covers many applications in the vast field of electronics. All kits are designed and developed using the latest technology, giving them appeal, not only to the hobbyist and enthusiast but also to the experienced engineer.

The fully illustrated Velleman Kit Journal is available free of charge upon request and has full technical specification on each kit in the range. All kits are graded by difficulty from 1 to 3 and can be purchased direct or from the stockists listed below.

.. and remember, we have a 'rescue service' for instances where enthusiasm exceeds ability!



K2584 Precision timer
Timing from 1 sec
to 99 mins 59 secs /
Actual size 235 x 110mm

K2585 Serial Controller / Emulator
(Designed primarily for use with
K2578 Velleman Eprom programmer)
Actual size 100 x 160mm

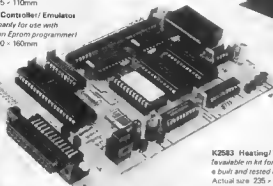

K2583 Heating / Temperature Controller
(Available in kit form or as
a built and tested unit)
Actual size 235 x 110mm

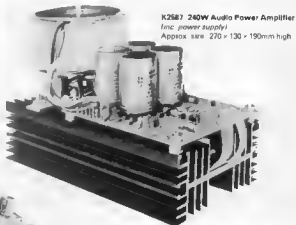

K2587 240W Audio Power Amplifier
(inc. power supply)
Approx size 270 x 130 x 190mm high

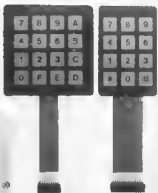

**KBS16 and KBS12
Membrane Keypads**
(Available with
or without legend)
Actual size
65 x 100mm
100 x 100mm

OTHER NEW KITS recently introduced

- K2580 Electronic powerswitch dimmer
- K2581 Stereo volume and tone control
- K2582 Stereo audio Input selector
- K2585 Code-lock
- 2588 3 Channel sound to light unit



VELLEMAN UK. Ltd

P.O. Box 30, St. Leonards-on-Sea,
East Sussex TN37 7NL, England.
Telephone: (0424) 753246



VELLEMAN STOCKISTS

Baxol Tele Exports Ltd., Ballinaclesh, Post Rathdrum,
Co. Wicklow, Rep. of Ireland.
Bradley Marshall Ltd., 325 Edgware Road, London W2 1BN.
S & R Brewster Ltd., 86-88 Union Street, Plymouth, Devon.
Marshall's Electronics, 85 West Regent Street, Glasgow, Scotland.
Retail outlets are required in most major towns and cities
Write for full details, including retail discounts.

FREE SOLDERING IRON
with orders of
£25.00 and over
when accompanied
by this
voucher.

Please send me your free catalogue of Velleman electronic kits:

Name

Address

EK7/B

THE COMPLETE PACKAGE! MICROPROFESSOR PLUS THE STUDENT WORK BOOK

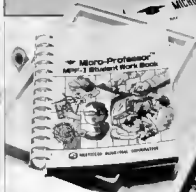

A low cost tool for learning, teaching and prototyping.

Micro-professor is a low-cost Z80 based micro computer which provides you with an interesting and inexpensive way to understand the world of microprocessors.

Micro-Professor is a complete hardware and software system and is a superb learning tool for students, hobbyists and microprocessor enthusiasts, as well as an excellent teaching aid for instructors of electrical engineering and computer science courses.

Micro-Professor **£99.50**
(+£4.00 p&p)

Now with the Student Work Book available Flight offer you the complete package. An easy to follow manual that will help further your understanding of microprocessors.

Student Work Book **£16.00**

FLIGHT
Electronics Ltd.

Micro-Professor is a trade mark of Multitech Industrial Corporation. Z80 is a trade mark of Zilog Inc.

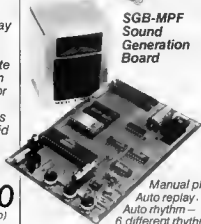

**SGB-MPF
Sound
Generation
Board**

*Manual play,
Auto replay,
Auto rhythm —
6 different rhythms,
Sound Synthesizer
and Hi-fi speaker.*

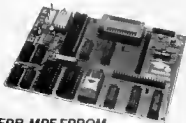

**EPB-MPF EPROM
Programming Board**
For all +5V 1KB/2KB/4KB EPROMS
Read/Copy/List/Verify Capability.

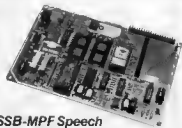

**SSB-MPF Speech
Synthesizer Board**

A vocabulary of up to 400 words based on the TMS 5200 chip.

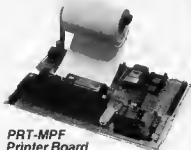

**PRT-MPF
Printer Board**

Memory dump utility. BASIC program listing. Z80 disassembler.

Please send me	Qty
Micro-Professor	£99.50
Student Work Book	(+£4.00 p&p) £16.00
SGB-MPF board	£79.50
EPB-MPF board	£99.50
SSB-MPF board	£99.50
PRT-MPF board	£86.25

I enclose cheque/P.O. for £.....

Name

Address

EKR 7/8

Mail Order only
Prices include VAT. Please allow 28 days for delivery



By phone or post

FLIGHT ELECTRONICS LTD.
Quayside Rd. Southampton,
Hants SO24AD. Telex. 477793.
Tel. (0703) 34003/27721.

From the world's largest manufacturer of scientific instruments



Beckman instruments are used worldwide in medicine and science, in industry and environmental technology, where precision and reliability are vital: from the Beckman photo-spectrometer in a space probe scanning for signs of life to a Beckman clinical electrolyte analyser.

World's widest range of hand-held multimeters

This same perfection in design and manufacture goes into Beckman digital multimeters, themselves widely used in testing, measurement, research and engineering because of their accuracy and their intelligent features.

Now the electronics enthusiast has access to the same standard of reliability in the T90, T100 and T110 models.

Digital performance at analogue cost

All models undergo 100% factory testing. Their accuracy is guaranteed to be held over a long period and reliability is outstanding, thanks to fewer components and interconnections. All components are of the highest quality and include a CMOS integrated circuit and gold inlaid switch contacts.

The digital display can be read at a glance, and all functions are selected with a single rotary switch, rather than with confusing rows of push buttons.

Battery life is exceptional - 200 hours at continuous operation.

The T90 gives an accuracy of 0.8% VAC and is remarkable value for money at £43.45 (+VAT).

The T100 is a full range function meter with 0.5% accuracy at £49.00 (+VAT), while the T110 offers even greater accuracy of 0.25% plus an audible continuity indicator at £59.00 (+VAT).

To feel like a professional you can order your Beckman straight off the coupon, or send for full technical data.

BECKMAN

World leaders in multimeters

Beckman Instruments Ltd
Electronic Components UK Sales and Marketing Organisation
Mylen House, 11 Wagon Lane, Sheldon, Birmingham B26 3DU.
Tel: 021-742 7921 Telex: 336659

I want to go digital!

Please send me;

- T90 meters at £50.60 (inc. VAT, p&p)
- T100 meters at £57.00 (inc. VAT, p&p)
- T110 meters at £68.50 (inc. VAT, p&p)

I enclose a cheque/P.O. payable to:
Beckman Instruments Ltd for £

Please send me full data on the Beckman
enthusiast's multimeter range. (Tick box if required)

NAME _____

ADDRESS _____

Please allow 14 days for delivery

B.K. ELECTRONICS

SPECIAL OFFER

DIGITAL CAPACITANCE METER

LCD DIGITAL MULTITESTER

MINIATURE AUTORANGING D.M.M.



DM 2350/C

KD615

DM 6013

INCLUSIVE OF
POST & PACKING
AND VAT.

DM6013 DIGITAL CAPACITANCE METER

£52.75

High accuracy measurement of capacitance over a wide range of values. Fast sample time, easy to read LCD display. Rugged construction — easy operation.

Display -	3½ digit LCD x 13 mm to 1999
Ranges -	8 ranges, full scale values 200pF to 2000µF
Sample time -	0.5 second
Measurement capability -	0.1 pF to 2000µF
Accuracy -	0.5% full scale ± 1 digit

Features	Zero adjustment, overload protection, slide switches for single handed operation
Accessories	Pair test leads with alligator clips, spare fuse
Power -	1 x PP3 battery (not supplied)
Calibration -	By internal adjustment
Dims -	175 x 80 x 35 mm

KD615 LCD DIGITAL MULTITESTER

£39.99

Multifunction 3½-digit tester including transistor tester and 10A d.c. range. Over-range, low battery and polarity indication. Full fuse overload protection. Supplied complete with carrying case, test leads, battery and instruction manual.

d.c. Volts -	0.2 - 2 - 20 - 200 - 1000V ± 0.8% impedance 10M
d.c. Amps -	0.2mA - 2mA - 20mA - 200mA ± 1.2%; 10A ± 2%
a.c. Volts -	200 - 750V ± 1.2% - Impedance 5M

Resistance -	200 ohms - 2k - 20k - 200k - 2M - 20M ohms ± 1%
Transistor check -	hFE 0 - 1000 PNP or NPN; I _{BE} 10µA, V _{CE} 2.8V.
Dims -	196 x 93 x 42mm

DM2350/C MINIATURE AUTORANGING D.M.M.

£52.00

Super compact autoranging digital multimeter featuring continuity buzzer and large (10mm) clear 3½-digit display. Full fuse overload protection. Carrying case, leads, battery, spare fuse and instruction manual supplied.

d.c. Amps	0 - 200mA ± 1.2%; 20A with shunt (included)
d.c. Volts -	0.2 - 2 - 20 - 200 - 1000V ± 0.8% impedance 10M
a.c. Amps -	0 - 200mA ± 1.4%; 20A with shunt (included)

a.c. Volts -	2 - 20 - 200 - 000V ± 1.0% impedance 10M
Resistance -	200 ohms - 2k - 20k - 200k ± 0.8% 2M ohms ± 2%
Dims -	130 x 65 x 20mm

B.K. ELECTRONICS Dept. EK

UNIT 5, COMET WAY, SOUTHBEND ESSEX, SS2 6TR.

★ SAE for current lists ★ Official orders welcome ★ All prices include VAT
please phone 0702-527572



hFE
TEST
10A
RANGE

AUTO-
RANGING
POCKET
SIZE



I wonder . . .

... Who ever dreamed up the name 'Summer Circuits'? We've been working on them since last September, and they just happen to appear in this July/August issue! Whether or not that coincides with something that faintly resembles Summer is beyond our control (but we're working on it). 'More than 100 practical projects - now that's more like it. A definite statement of fact. We've even numbered the circuits to save you the trouble of counting! Actually one circuit is an obvious (?) dud, in the best Elektor Summer circuits issue tradition. There are also a few software items. We didn't know whether to count them as 'practical projects', so we added a few more circuits just to play it safe (what with the Trades Descriptions Act . . .). These big numbers did cause some problems with our two-digit adding machine, but we carried on regardless.

There is a persistent myth surrounding this issue, to the great amusement of our editorial staff. Some people seem to think we print a double issue so that we can go on holiday for a month. No such luck. As you read these lines we should have the September issue all wrapped up, and we're already working on October and November! There's no rest for the wicked, as the saying goes. Not that we're complaining, mind: we belong to the privileged minority who know about all those wonderful projects several months before anybody else. That means we can buy the components before the shops are sold out. (Not that we don't warn them: any interested retailer can get our 'retailers preview' five or six weeks in advance. Ask at your local shop - they may have the September preview under the counter!) Another myth: most of the circuits are cribbed from manufacturers application notes. Tut-tut! We wouldn't stoop so low. Application notes are useful, but on the rare occasion that we find something worthwhile it is clearly indicated as such. External authors are also credited. Few and far between, admittedly, but we only accept circuits that are reasonably original and that can be made to work after a bit of in-house re-designing. That eliminates the majority (unfortunately) of the hundreds of submissions we receive every year. However we do use as many as we can, so keep those ideas coming in.

Where do all these circuits originate then? Well, let me put it this way: if each member of our design group contributes one circuit per month for a year, we can just about do it.

Now I really must stop. If you want to know how Elektor is actually made, drop me a line. Given sufficient interest I might waste a few pages on the topic! For the present, I'm sure you'd rather take a look at the circuits. Have fun! I hope they'll keep you busy till September.

Your Editor

P.S. Last year I mentioned that I wanted to build that no-I-won't-tell-you-which circuit. Believe it or not: it works!

Ed.

P.P.S. I've just noticed that this issue is 'number 99/100': half way through, it turns into our hundredth Elektor! Maybe we ought to celebrate . . . but no: let's just get cracking on no. 101.

P.H.

2

1

resistance comparator

This multimeter accessory is not just a bleeper; in spite of its simplicity. The circuit indicates by a bleep whether a resistance being measured with the multimeter is smaller than a predetermined value; it can also be made to do so when the measured resistance is larger than the reference value.

The device compares the voltage drop across the resistance under test with a reference voltage. Required components are a quad op-amp, a diode, a crystal buzzer, a capacitor, two electrolytics, two trimmers and four resistors. Power is provided by a 9 V battery.

In the circuit diagram shown in figura 1 the voltage drop across R_x , which is in parallel with the multimeter, is taken from sockets A/C and B/D. The high internal resistance of the multimeter is hardly affected by the parallel connection of the comparator because A1 is connected as an impedance converter. Stage A2 compares the voltage at the output of A1 with a level preset by potentiometer P1. If the voltage at the + input of A2 is larger than the

value set by P1, the output level of A2 is nearly equal to the positive supply voltage. Diode D1 conducts and capacitor C1 cannot discharge. Op-amp A3, in conjunction with C1, R1 and preset potentiometer P2, forms a square-wave oscillator of which the trigger level is set by P2. The square-wave voltage at the output of A3

is applied to the crystal buzzer via R2.

The earth potential of the circuit is determined by the output of A4. This voltage divider R3/R4 at the input of A4 is symmetrical, therefore the 9 V of the battery is converted in a simple manner to 2×4.5 V.

The simplest method of calibration is to connect a resistor of, say, 1 k between the two test probes end adjust P1 such that the bleeping tone just disappears. If a smaller resistance is now connected between the probes, the bleep will be heard again. It must of course be borne in mind that the comparator, as well as the resistance under test, have a tolerance.

If it is required that the circuit indicates larger resistances than that of the reference, the inputs of A2 must be interchanged.

Figure 2 illustrates how the comparator can be built into a small case which plugs directly into the sockets of the multimeter. The test leads are then plugged into sockets fitted at the top of the case.

The frequency and volume of the bleep tone can be set with P2; they are, of course, to some extent interrelated.

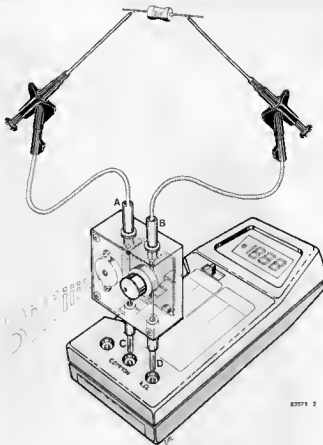

82571 2

1

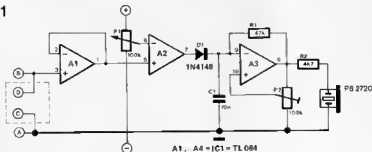

A1, A4 = IC1 = TL 084

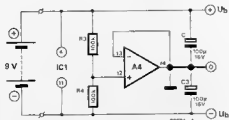

82571 1

2

constant light source

In many occupations it is important that the light incidence at a certain location remains as nearly constant as possible. When the sun appears from behind the clouds (it happens sometimes!), it causes an increase in light in a room or onto an object. Such varying ambient light is tiring on the eyes for many people when painting, reading, and so on. If ambient light does not vary too widely, the light source described here may offer a solution. The circuit controls a light bulb so that the brightness of the bulb is matched with the incidence of ambient light. The bulb will therefore light more brightly if the sun disappears behind the clouds again. The circuit can of course be connected to the lighting of a living room or study; if it gets darker outside, the lights in the room will then compensate. This circuit is a real solution if you don't like working or sitting in semi-darkness.

The principle is fairly simple: a sensor measures both the incidence of the light bulb connected to the circuit and the ambient light. As soon as the ambient light changes the

intensity of the bulb is changed accordingly so that the total light level remains the same. The heart of the circuit is a rather

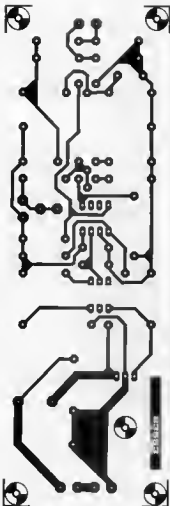

Parts List

- Resistors:
 R1, R2, R3 = 10 k
 R4 = 5k6
 R5, R6 = 10 Ω
 R7 = 56 k
 R8 = 180 Ω
 R9 = 1 k (1 W)
 R10 = 1 k
 P1 = 100 k preset potentiometer

- Capacitors:
 C1, C4, C5 = 100 n
 C2 = 470 μF/25 V
 C3 = 100 μF/25 V
 C6 = 180 n
 C7 = 100 nF/400 V

- Semiconductors:
 D1 ... D5 = 1N4001
 T1 ... T3 = BC547B
 Tr1 = TIC 226D
 IC1 = OPL 100
 IC2 = OPI 3020 (MOC 3020)
 (IC1, IC2 from Norbain Opto-electronics)

- Miscellaneous:
 F) = 3.15 A
 L1 = choke 50 ... 100 μH

- Heat-sink for IC2 (35 x 20 x 15 mm)
 Tr 1 = mains transformer
 6 ... 12 V/150 mA

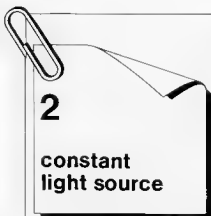
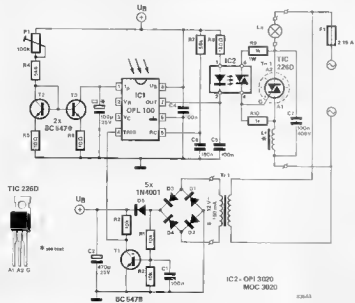

unusual IC, the OPL 100 from TRW-Optron. It is housed in an 8-pin DIL package with a transparent top and includes control electronics together with a light sensitive diode. A constant current produced by T2 and T3 and preset by P1 serves as a reference to IC1. The integrated circuit will control the pulse width of its output (and therefore the brightness of lamp La) such that the current supplied by pin 1, which is directly proportional to the quantity of light falling onto the sensor, is equal to the current flowing through T3 and preset by P1. If the ambient light decreases, the current supplied via pin 1 will drop. As the adjusted current through T3 is then larger than the current supplied through pin 1, the voltage at pin 1 drops and this causes the pulse width of the output signal to change. Triac Tri 1 conducts for a longer period for each cycle of the mains

frequency and the lamp will glow more brightly until the ambient light returns to its original level. Capacitor C3 ensures that the control of the circuit is smooth. The value of this capacitor also determines the speed at which the circuit reacts to light variations. The smaller the value of C3, the faster the reaction of the circuit, but the value should be kept above 1 μ F.

The mains supply frequency is used to switch T1 and this transistor then ensures synchronization of the control pulses for the triac provided by IC1 with the mains supply. The optocoupler, IC2, ensures that the circuit is electrically isolated from the mains supply.

Take care with the choice of transformer! During the testing of our prototype we found that a small, inexpensive (printed circuit board) transformer caused quite a phase shift. Even during full sunlight inci-

dence on the sensor, the lamp continued to light, albeit dimly. The phase shift in a good quality transformer is minimal; the lamp can then be controlled over the full range of 180° (in each half period). The maximum power drawn from the circuit should not exceed 500 W (resistive load) which is ample for most applications.

Footnote

Light flux, measured in lumens, is the rate at which light is passing to, from, or through a surface or other geometrical entity.

Light incidence, measured in lux (lumens per square meter), is the flux per unit area, normally perpendicularly incident upon a surface.

Light intensity, measured in candela, is the flux per unit solid angle radiating (or diverging) from a source of finite area.

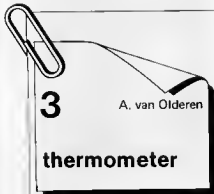

A common or garden diode like the 1N4148 is in principle an excellent sensor for a reasonably accurate electronic thermometer because the voltage drop across the diode decreases by 2 mV for every degree Centigrade rise in temperature. As can be seen in figure 1, a constant reference voltage is applied to the non inverting input of the op-amp. The current flowing through the resistor, and therefore through the diode, is also held at a constant level. Variations in the output voltage of the op-amp can occur only

as a result of a change in the voltage drop across the diode and this in turn can only be caused by temperature variations. The output voltage is therefore directly proportional to the temperature of the diode. In the complete circuit diagram shown in figure 2, the op-amp is A2 and the diode is D1. The reference voltage is derived from IC1 via voltage divider R3/P1/R4. The output voltage of A2 is amplified by op-amp A3. The non-inverting input of A3 is also held at a constant level (again derived from R3/P1/R4) and the values of R6 and R8 have been chosen so that 0 V corresponds to 0°C ambient. To enable the measuring of temperatures above and below zero without the use of a symmetrical power

supply, a rather uncommon solution was arrived at. The first requirement was a regulator, IC1, which provides a reasonably constant reference voltage for A2 and A3. An additional amplifier, A1, generates, together with R1 and R2, a voltage of +2.5 V relative to the negative supply line. This 2.5 V line is then used as the 'earth' for the rest of the circuit. Pin 11 of IC2 is therefore at -2.5 V and pin 4 at +6.5 V with respect to this 'earth'. The supply to the op-amps is therefore 'symmetrical'. The current consumption of the circuit is about 5 mA so that for incidental temperature measurements a 9 V battery will be adequate. If continuous use is required, a simple mains supply will have to be used; this need not be stabilised in view of IC1.

Most voltmeters will be suitable as an indicator. If the Universal Digital Meter described in our July/August 1981 issue (circuit60) is used, a battery will not be required as the supply can then be taken from points U₀ and 0. The thermometer will then have a range of -9.99... +99.9 degrees Centigrade. The circuit is calibrated by setting P1 to obtain 0 V at 0° Centigrade and then P2 to obtain 0.999 V at 99.9° Centigrade.

1

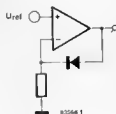

2

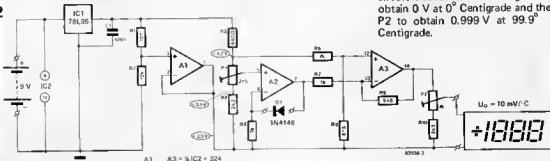

4

microprocessor 'stethoscope'

It is often necessary to see exactly what logic activity is occurring on the address, data or control busses of a microprocessor system. This is easily done by displaying it on an oscilloscope but not everybody can lay their hands on an oscilloscope at short notice. The 'stethoscope' here enables a microprocessor system to be tested without the need for an oscilloscope. Of course it is not intended as the be-all and end-all of test equipment, but then even a doctor's stethoscope has limitations. The actual circuit is fairly simple. The stethoscope probe is connected to the clock input of a divider. The frequency of the input signal is divided by a certain factor. This factor depends on what output of IC1 is selected with S1 and can be between 488.3 Hz/MHz (with S1 in position 1) and 15625 Hz/MHz (S1 in position 6). By changing the position of this switch we can

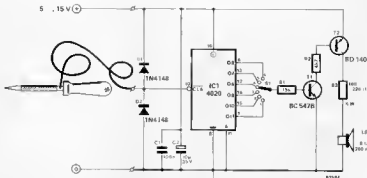

ensure that there will always be an audible output equal to the 'divided' input frequency. For example: assume we want to trace a clock signal of 1 MHz to see if it is present at various test points. If S1 is in position 1 then a tone of about 488 Hz will be heard.

The clock signal is an example of a periodic signal which is always present. If periodic signals are to be present on the three busses then the microprocessor must be working on a program (loop). This could be part of the monitor program, for example a routine to test whether any key has been pressed. Special test programs can also be used and there are thousands of possibilities, depending

CLC
LOOP BCC LOOP
(18 90 FE)

CLC
LOOP BCC LOOP
(18 90 FD)

1	$\div 2^{11}$	(2048)	\rightarrow	488,3	Hz/MHz
2	$\div 2^{10}$	(1024)	\rightarrow	976,6	Hz/MHz
3	$\div 2^9$	(512)	\rightarrow	1953,1	Hz/MHz
4	$\div 2^8$	(256)	\rightarrow	3906,25	Hz/MHz
5	$\div 2^7$	(128)	\rightarrow	7812,5	Hz/MHz
6	$\div 2^6$	(64)	\rightarrow	15625	Hz/MHz

on what is to be tested. For instance the 6502 programs shown below can be used to test data lines and address lines. Test programs can be placed directly (without modifications) in virtually any location of memory. Because the processor reads periodic opcodes and operands the R/W signal will appear periodically. As there are a certain number of clock periods needed for a number of periodic instructions we can expect this to be reflected in a number of outputs whose dividing factor is reduced.

This stethoscope is powered by the circuit it tests. The probe itself is not very expensive as it can be made from a small screwdriver.

5

symmetrical harmonic oscillator

The remarkable thing about this oscillator is not that it operates on the third overtone of a crystal nor that it is symmetrical, but that it does not use a tuned circuit. Oscillators without tuned circuits normally operate on the fundamental crystal frequency: as soon as it is required to work on harmonics, a tuned circuit becomes necessary to resonate at the desired

overtone. The circuit described is reminiscent of an astable multivibrator, but it uses a novel way of connecting the crystal: between the emitters of the two transistors and in series with a small trimmer capacitor ($C_5 = 40$ pF). It is the trimmer which enables the tuning of the oscillator to the fundamental as well as to the third harmonic of the crystal.

The circuit has been designed for crystals with a fundamental frequency of 6...20 MHz and this gives an oscillator frequency between 18...60 MHz: a pretty good range. Moreover, the oscillator can be built around most normal RF transistors. Finally, the output voltage of 500 mV_{pp} is sufficient for most applications.

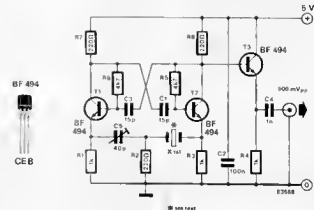

6

stepped-voltage generator

This circuit converts an input signal into one that is composed of a number of discrete steps but which remains otherwise identical to the input signal. Because the steps are of equal height, the harmonic content of the output signal will be dependent upon the amplitude of the input signal. This characteristic is extremely useful in the making of electronic music.

The circuit uses quantised pulse-width modulation for the adding of the step-shaped input signal. Pulse-width modulation is obtained by comparing a triangular voltage with the analogue input signal by means of a comparator; the quantising, that is the adding of the steps, takes place by replacing the triangular voltage with a stepped voltage.

The stepped-voltage generator consists of three gates, N1...N3 and transistor T1. N1 operates as an astable multivibrator, that oscillates at a frequency depending on the value of C1 and R1. Transistor stage T1 functions as a charger circuit: each time the output of N1 is logic 1,

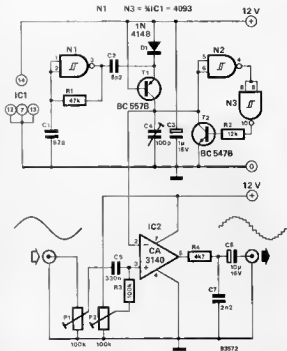

the transistor transfers the charge on C2 to capacitor C4. During the next half cycle C2 is recharged via D1. In this way the voltage across C4 increases in discrete steps, the height of the steps being determined by the ratio C2:C4. When the voltage across C4 rises above a certain value, N2 switches transistor T2 on via gate N3 and discharges capacitor C4. When the capacitor is completely discharged, N2 switches off T2 and C4 continues to charge again in discrete steps.

The stepped voltage is set to the inverting input of IC2 which is connected as a comparator. Low-pass filter R4/C7 in the output of

IC2 converts the pulse-width modulated signal back to an analogue one. The d.c. voltage level at the non-inverting input is set by potentiometer P2 to half the magnitude of the stepped voltage. The setting of P1 is dependent upon the input signal which must be attenuated such that the maximum value at the slider of P1 is always smaller than the maximum value of the stepped voltage. The number of steps can be selected by varying the value of C4. It is possible to use a varicap in place of C4 with the varicap voltage being controlled by the music program or the input signal. Interesting and individual effects can be obtained in this way.

7

power backup for CMOS ICs during mains power failures

Even very brief mains power failures cause problems for electronic circuits. Stored data are lost and the operating statuses are no longer what they were before the power failure. Mains power failures cannot be prevented, but methods can be employed to provide a voltage backup for the duration of the fault. For this reason, mains-powered equipment is often fitted with backup batteries (nicad or lithium cells) to maintain operation during a mains power failure. In view of the low currents (microamperes) required for data storage with modern RAMs, there is an alternative backup method which is well worth considering: power backup with an electrolytic capacitor for energy storage!

The circuit diagram shows just such an application. The 'power stand-by' capacitor C1 is 4700 µF and with a maximum load current of 10 µA, the discharge time at an output voltage of 5 V is approximately 53 minutes. The operating voltage of the circuit itself is 15 V, 10 V higher than the output voltage. As long as the 15 V supply voltage is applied, capacitor C1 charges up to the value of the operating voltage via diode D1. Simultaneously, a bias voltage of approximately 2.3 V is applied to the gate of field effect transistor T1 via voltage divider R1/R2. This ensures that T1 is turned on and capacitor C2 is charged up. The output voltage at the source terminal of the second

field effect transistor remains a constant 5 V. The two FETs can be thought of as a voltage divider. If the supply voltage falls, electrolytic capacitor C1 will become the temporary power supply. Since the gate voltage is removed from T1 it turns off. Capacitor C2 is no longer being charged. However, it can only discharge very slowly because T2 has a very high input resistance. The voltage across C2 remains almost constant. Capacitor C1 supplies the operating voltage required for T2 so that it conducts and maintains the output voltage at 5 V. Capacitor C1 discharges very slowly, as a function of its insulation resistance (RINS approximately 1 M) and the load current flowing. The output voltage at the source lead of T2 remains a

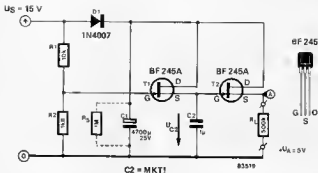

constant 5 V, until the voltage across C1 has also dropped to 5 V. If this voltage drops even further, FET T2 remains turned on but the output voltage decreases proportionally. For correct functioning of the

circuit, it is very important to select an MKT type of foil capacitor for C2. (M stands for metallised and KT is the standard designation for polyester foil).
(Siemens Application)

8 doorbell memory

On occasion it may be useful to know when a visitor has called in your absence. This is especially true in the case of an enforced absence when a visitor is expected. Confusion reigns supreme on these occasions. The circuit here helps to rectify the situation by providing a 'memory' for the doorbell. On your return a LED will advise you whether or not a visitor called. The circuit is powered by the bell transformer via diode D1 and capacitor C1. This provides a d.c. voltage level sufficient for the 'memory'. Under normal conditions (with no one ringing the doorbell) transistor T1 will be switched off and T2 will be conducting to provide a form of latch for T1. Obviously LED D3 will never light under these conditions! Now our visitor arrives! With a joyful cry of 'Avon calling' they press the doorbell — only to lapse into total embarrassment when there is no answer! However our circuit now leaps into action. Via D2 and R1, the doorbell switch S1 provides a base drive current to T1 which switches off T2 and, in passing, LED D3 on. Now the transistor

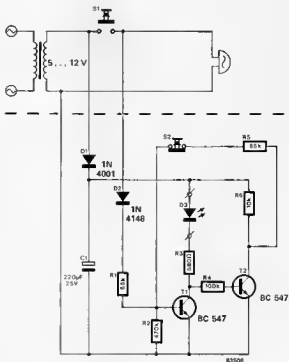

'latch' (T2) swings the other way and T1 is held on by the current path to the positive supply through S2 (normally closed) R5 and R6. The unfortunate visitor goes away totally deflated but the LED will indicate his 'past presence'! On your return the LED will be noted and the circuit 'reset'. This is carried out by simply pressing S2 which breaks the base currents path holding T1 on causing this transistor to switch off. In doing so the LED will be switched off and T2 will be switched on. The 'latch' will be back in the original position where T1 is held off by the fact that R5 is effectively

in parallel with R2. A further refinement would be to provide an automatic reset when the front door is opened. In this case S2 is a switch operated by the opening door. However the LED must then be mounted outside the door (possibly in the doorbell switch housing) or the LED will be off by the time you get into the house to look! On the other hand a second circuit could be built as a 'memory' for the 'automatic' memory and then it would be no problem to open the door! This second circuit will of course require a reset switch!

9

capacitance meter

In this capacitance meter, the value of a capacitor is determined by giving it the same charge as a reference capacitance and then comparing the voltages across them. This relies on the formula $C = Q/V$ where C is the capacitance in Farads, Q is the charge in Coulombs and V is the voltage in volts. If therefore two capacitances have equal charges, their values can be calculated when the voltages across them are known.

Two circuits ensure that reference capacitor C_r and the capacitor to be measured, C_x , are charged equally. The circuit for C_r consists of C2, D1 and T1 and that for C_x of C3, D2 and T3. Each time the output of gate N2 rises, the charges of capacitors C2 and C3 are transferred to C_r and C_x by transistors T1 and T3 respectively. When the output of N2 drops, C2 and C3 recharge via diodes D1 and D2. Gate N2 is controlled by astable multivibrator N1 which operates at a frequency of about 2 kHz: C_r and C_x are therefore charged at that frequency.

The voltage across C_r is compared by IC2 with a reference voltage derived from the power supply via R3/R4. When the voltage across C_r exceeds the reference voltage, comparator IC2 inverts which inhibits N2 and causes N3 to light LED D3. The charges on C_r and C_x are now equal and the meter indicates by how

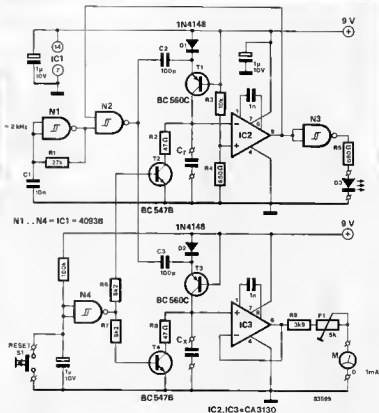

much the voltage across C_x differs from that across C_r . Buffer IC3 presents a very high load impedance to C_x . Pressing reset button S1 causes both C_r and C_x to discharge via T2 and T4 respectively, after which the charging process restarts and the circuit is ready for the next measurement.

The meter is calibrated by using two identical 10 nF capacitors for C_r and C_x . Press the reset button and, when the LED lights, adjust preset P1 to give a meter reading of exactly one tenth of full scale deflection (fsd). That reading corresponds to $1 \times C_r$. If, therefore, $C_r = 100$ nF and $C_x = 470$ nF, the meter will read 0.47 of fsd.

To ensure a sufficient number of charging cycles during a measurement, C_r and C_x should not be smaller than 4.7 nF. To measure smaller values, capacitors C2 and C3 will have to be reduced. For instance, to enable a capacitor of 470 pF to be measured, C2 and C3 have to be 10... 20 pF. The circuit is reasonably accurate for values of C_x up to 100 μ F. Above that value the measurement will be affected by leakage currents. To measure capacitors of up to 100 μ F, the values of C2 and C3 should be increased to 1 μ F.

Current consumption is minimal so that a 9 V battery is an adequate power supply.

10

electronic tuning fork

A standard tuning fork produces a tone of 440 Hz, that is, the international A (orchestral pitch). It is not very difficult to make an electronic alternative. An oscillator, a divider, a loudspeaker and a battery are all that is required. To be useful, an 'electronic tuning fork' must, of course, be a compact unit.

As the use of special, and therefore costly, crystals was precluded, a little research showed that it would be possible to use relatively simple and standard components. It appeared that the required frequency can be derived from a readily avail-

able 1 MHz crystal which, by means of a trimmer, can be pulled to 1,000,120 Hz which is the nearest frequency containing a whole number times 440 Hz.

The oscillator is constructed around gates N1, N2 and tuned to 1,000,120 Hz (with a frequency counter if possible), by means of trimmer C2. The oscillator output is fed to IC2 which divides by 2273 ($2^9 + 2^5 + 2^5 + 2^7 + 2^{11}$). A practically symmetrical signal of 440 Hz is then available at output Q11 of IC2.

This signal is then buffered by gates

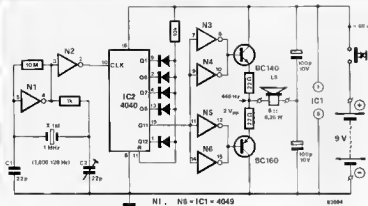

N3...N6 and the balanced output stage gives a level sufficient to drive a small loudspeaker. In spite of the current consumption of 65 mA, a standard 9 V battery (preferably alkaline-manganese) will suffice, because tuning forks are by their nature used for short periods only. If the fork is used for longer periods, it might be advisable to consider a rechargeable battery. ■



11

noise and vibration detector

Whether it is the hi-fi next door, the cat purring quietly, or a knock at the door, the detector described here does not miss a thing. Whenever it picks up a sound or vibration, it emits an ear-piercing tone.

The circuit is based on the use of an 8 Ω loudspeaker as microphone/loudspeaker. As the signals from this microphone are very small, they are amplified in A1 and rectified. The resulting DC signal is then compared with a reference voltage in A2. When a noise or vibration is picked up by the microphone, the voltage at the inverting input of A2 (pin 6), rises suddenly to about 4 V and then slowly decays to 0 V. The decay time depends on the time constant R6/C3.

The voltage at the non-inverting input of A2 (pin 5) is held constant at 0.7 V by R3/R4. When the input at pin 6 rises above 0.7 V, the output of A2 (pin 7) instantly switches to -4 V, which causes the squarewave oscillator A3 to start. The frequency (tone) of the oscillator can be adjusted by preset potentiometer P1. The oscillator output (pin 8) is fed to amplifier stage T1 which drives the loudspeaker. The oscillator will continue to run however, so C3 charges steadily and will keep the output at pin 7 of A2 negative.

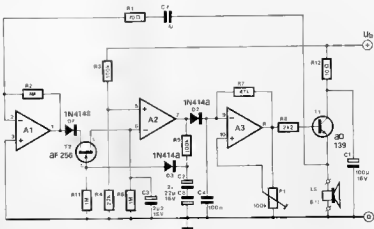

A1, A4 - IC1 - TL084

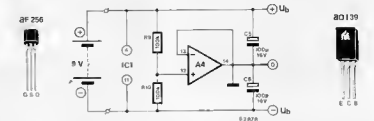

As this is not the purpose of the circuit, the incoming signal must be interrupted somewhere in the chain. To do this, an FET, T2, is used as a switch. As soon as the output of the comparator becomes negative, D3 conducts, T2 is cut off and the incoming signal is interrupted. When C3 has discharged to the extent that the voltage across it drops to below 0.7 V, the output of A2 (pin 7) becomes positive, D3 is cut off and T2 conducts. This should, however, not happen too rapidly, otherwise there is the risk that a false alarm may be given. Therefore, the gate (drive input) of T2 is connected to earth via capacitors C2 and C8. The consequent delay assures that the circuit is not reactivated before half a second after the loudspeaker has gone quiet.

The earth potential is fixed by the voltage divider R9/R10 and impedance converter A4, which derive a symmetrical supply of ± 4.5 V from the 9 V battery. When T1 conducts, the supply voltage will drop a little because a battery cannot deliver energy as well as a mains power supply. It can therefore happen that the output signal of A3 is superimposed on the supply voltage. This undesired feedback should be prevented by C5 and C6. If in spite of these capacitors difficulties are encountered, it may be beneficial to increase the values of R5, C2 and C8 by trial and error. If that fails to improve matters, increase the value of capacitors C5 and C6. ■

12

car PDM amplifier

This power amplifier, designed for use in a car, delivers 10 W into 4 Ω and because it uses the principles of PDM (pulse duration modulation) its efficiency is nearly 100%. Basically it is an expanded version of the regenerative PDM amplifier described in Elektor July/August 1982. The block diagram is shown in figure 1. An op-amp drives a schmitt trigger, the output of which is integrated and fed back to the inverting input of the op-amp. The system regulates itself so that the voltage is the same at both inputs of the op-amp. That can only happen if the pulse width (or pulse duration) is variable, otherwise the circuit tries to change the oscillating frequency as a method of regulation.

The heart of the PDM system (figure 2) is made up of IC2, N1...N6, T1 and T3. To build this up into a power amplifier an out-of-phase control signal is formed by N7...N12. This is not the ideal situation as these are not part of the feedback loop and also there is some cross-over distortion because switching takes a finite time. However the quality is improved somewhat by using a symmetrical feedback loop consisting of the

Parts list

Resistors:

- R1,R2 = 47 k
- R3,R4 = 22 k
- R5,R6 = 100 k
- R7,R8 = 270 k
- P1 = 5 k log potentiometer

Capacitors:

- C1,C2,C8,C9 = 100 n
- C3,C4 = 1 μ/16 V
- C5 = 470 p
- C6 = 680 n
- C7 = 220 μ/25 V
- C10 = 220 n
- C11 = 100 p

Semiconductors:

- T1,T2 = BD 131, BD 241A
- T3,T4 = BD 132, BD 242A
- IC1 = CA 3140
- IC2 = CA 3130
- IC3,IC4 = 4049B

Miscellaneous:

- L1,L2 = 40 μH, 3 A inductors
- 4 heatinks for the power transistors

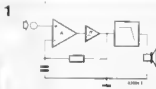

components around IC1. This digital amplifier operates much the same as an analogue equivalent, which would have to be much bigger. The BD 131/132 transistors give an output of 10 W with a total harmonic distortion of 0.3%. The maximum power

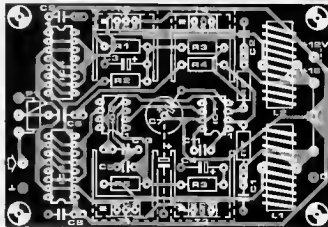
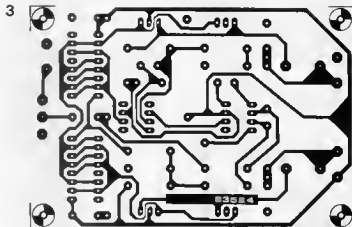
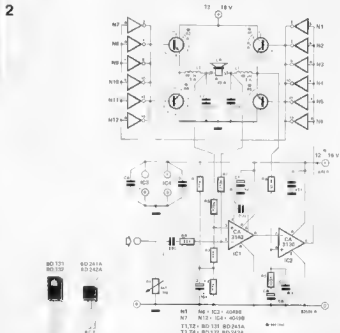

without clipping (10% distortion) is about 12W. If BD 241/242 transistors are used these figures are not quite so good because the cut-off frequency (actually the 3 dB frequency) is much lower. With a total harmonic distortion of 0.3% the output is only 8 W and the maximum power available without clipping is 10 W. The minimum input signal to the circuit is 800 mV and current consumption is about 1.5 A. Because of all the 'noise' on car voltage lines the supply must be filtered. Generally this only requires

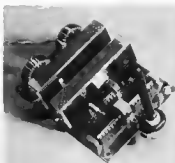

a simple LC filter with a 2200 μ /25 V capacitor and a 1 mH inductor with a low coil resistance. In principle more than one amplifier can be used and fed from a single low-pass filter. Because it has to be mounted in a car this amplifier should be put in a sturdy case. There is a difference in size between the BD 131/132 and BD 241/242 transistors and this must be taken into account during construction. The photo shows the method of mounting heatsinks and clearly the end result is a very compact amplifier. **M**

13

logarithmic amplifier

The performance of the operational amplifier, the circuit diagram of which is shown in figure 1, is best seen from its input/output characteristic shown in figure 2. For small input voltages, the amplification is high; when the input voltage rises, the amplification drops off and finally remains almost static for further increases in input voltage. Some applications of a logarithmic amplifier are: driving a graphic recorder in weather stations, and in remote control systems (for instance, to avoid a too sudden and strong deflection of a servo arm). When used in conjunction with other equipment, the logarithmic amplifier is very flexible:

2

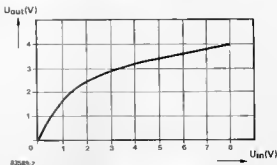

analogue instruments as well as a row of LEDs can be connected to its output. Operational amplifiers A1 and A2 form a non-inverting pre-amplifier. As the input signal of A3 should not under any circumstances become negative, the input level of the circuit can be shifted with potentiometer P1 as required. At the same time, this stage works as a high-

impedance input buffer for A3. As shown, the amplifier accepts inputs up to 8 V. If a higher value is required, the amplification factors of A1 and A2 can be suitably modified.

The 'logarithmic' part of the circuit consists of A3 and transistor array IC2: the voltage at pins 4 and 5 of the array is related logarithmically with the output signal of A2.

The output stage of the circuit consists of amplifier A4 which amplifies the inverted signal from A3. As the amplification factor of this stage can be altered by means of preset potentiometer P2, the output of the circuit can be matched to the load. To preset P2, connect a multimeter to the output of the circuit and a signal at maximum level to the input: adjust P2 to the required output voltage. **M**

1

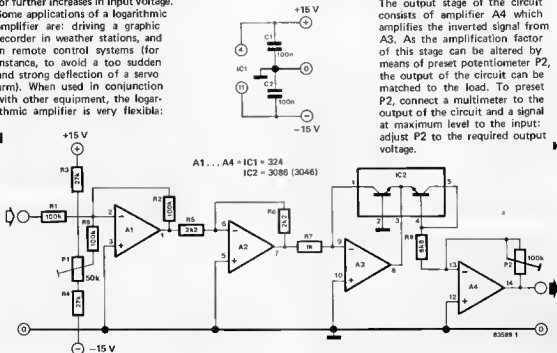

14

reproducible delay

There are many occasions when a switching delay is required. One way of achieving this is to use an RC network and an inverter (see figure 1). This is quite practical and obvious as there are nearly always some gates 'left over' in a circuit. Unfortunately, every electronic component has a definite tolerance and so it is virtually impossible to determine the delay precisely in advance. However a considerable improvement can be achieved by connecting two inverter/RC networks in series as shown in figure 3.

The nominal threshold voltage of the inverter in figure 1 is half the supply voltage and has a tolerance of $\pm 30\%$. Figure 2 shows the signal input to the gate. If this input is between $U_C = 0.35 U_B$ and $U_C = 0.65 U_B$ the inverter may consider it either logic '0' or '1'! These voltages occur when a capacitor is charged through a resistor after a period of 0.43τ and 1.05τ respectively. (τ is the time constant of the circuit and is equal to $R \times C$). The nominal threshold voltage $U_C = 0.5 U_B$ is reached after a time of $t = 0.69 \tau$.

If the two inverters and RC networks of figure 3 are used, each RC network must produce the same delay, equal to half the total value of figure 1. The total delay will then be $\frac{1}{2} \times 0.43 \tau + \frac{1}{2} \times 1.05 \tau = 0.74 \tau$ at its worst case! This is a lot closer to the nominal value of 0.69τ .

The foregoing should make it clear why the circuit of figure 4 gives such consistently reproducible results. However, for really satisfactory operation, CMOS inverters must be used. The reason is that these gates have a threshold value of about half the supply voltage. Further,

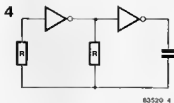
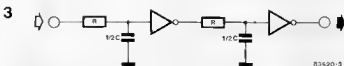
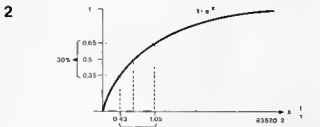
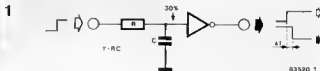

their output will always be either zero or the supply voltage. Schmitt triggers should not be used! If the delay times using 4000 series CMOS are found to be too long the new 74HCXX series can be used. These are pin and function compatible to the 74LSXX series and just as fast!

15

stable zener

As everybody knows the voltage drop across a zener diode is dependent on the current passing through the diode. Therefore, depending on the type and power of the device, there can be very noticeable deviations from the nominal zener voltage. This can be a problem,

especially in circuits where a stable d.c. voltage is essential. The most logical way of solving the problem is to keep the current through the diode constant so that the zener voltage can not change. In order that the load connected to the zener diode draws a constant current, the zener can be supplied by means of a current source. Then the current through the current source is made dependant on the zener voltage.

In our circuit we use a zener diode with a zener voltage of 6 V. Other zener values could be used if resistors R1... R4 are changed to suit another value. The maximum input voltage is mainly limited by the power which can be dissipated by T1 and T2. The d.c. input voltage must be at least as high as the sum of the zener voltages of D1 and D2. The current source consisting of T1,

R1 and D1 ensure that the current through D2 remains constant. Transistor T2, resistor R2 and zener diode D2 in turn form a current source for zener D1 so that the current through

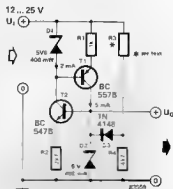

this diode also stays constant. Diode D3 and the voltage divider, consisting of R3 and R4, ensure that this circuit can 'start' (just as a thyristor made of transistors).

As soon as the voltage is switched on a current flows through D3 causing

T2 (and therefore T1) to conduct. The value of R3 must be selected such that diode D3 blocks as soon as the voltage across the zener diode has stabilised. So care must be taken that the voltage at the anode of D3 is less than the zener voltage of D2 plus the

diode's own voltage drop of 0.6 V. This is defined by the formula

$$\frac{R4}{R3 + R4} \times U_1 < U_{D2} + 0.6 \text{ V.}$$
 Also the voltage at the junction of R3 and R4 must be at least 1.2 V, otherwise T2 will never conduct. **M**

16

R. Storn

symmetrical voltages from a doorbell transformer

This circuit is of interest not merely because it uses a bell transformer with a single secondary winding to provide symmetrical voltages for low-current applications but also because the final output voltages are greater than the normal bell transformer (220 V/8 V) output. In fact the final output can be as much

as twice this value. This multiplication is achieved using two voltage doublers each consisting of two diodes and two capacitors, connected head to tail. Each diode/capacitor couple takes every alternate half cycle of the sinusoidal voltage such that the output voltage U is (theoretically) equal to $2\sqrt{2} U_{\text{eff}}$, where U_{eff} is the effective output voltage of the transformer.

A current of 150 ... 200 mA and 1 V of ripple can be expected using the capacitor values shown here. In

order to increase this current without a similar increase in ripple the values of the capacitors may be made greater but C1 must be approximately the same as C2, and C3 about the same as C4.

To get a stable symmetrical output of $\pm 15 \text{ V}$ two voltage regulators, a 7815 and a 7915, should be used. This will then allow a bell transformer to be used for any small circuits with operational amplifiers requiring a symmetrical supply of 14 or 15 V and a current of 0.1 ... 0.2 A. **M**

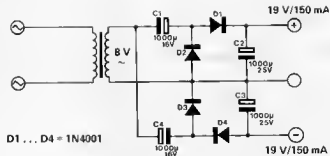

83632 1

17

LED current source

If an LED is used in a circuit, the current for that LED is normally set with a limiting resistor. The LED can then be switched on and off by means of a transistor. However, the method shown in figure 1 does not take into account any variations in the supply voltage. A small variation in the LED current can be very conspicuous especially when high efficiency LEDs are used.

1

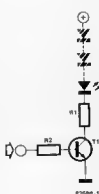

2

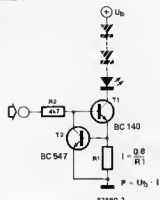

The addition of just one transistor can transform the circuit of figure 1 to a current source which can be switched on an off (for instance, with TTL levels). The circuit of figure 2 shows that resistor R1 has been moved to the emitter of T1. When a drive voltage is applied to the input of T1, this transistor conducts which causes a current through R1. Transistor T2 controls

the base current of T1 such that the voltage drop across R1 remains at 0.6 V. The current, I , through the LEDs and R1 is calculated by $I = 0.6/R1$. If, for instance, R1 is 12 Ω , the current through the LEDs is 50 mA. Bear in mind that the dissipation of T1 is somewhat higher than in the circuit of figure 1, but against that, the dissipation in R1 is not as high. **M**

18

solar tracking system

There are some hopes that the sun will become a main source of energy in the 21st century. By then, sources of oil will be almost exhausted and will only play a minor part in the supplying of energy. The present interest in solar energy is therefore not surprising. Some work has already been done with solar cells and solar panels. However, these only operate with optimum performance when positioned exactly at right angles to the sun. Unfortunately, this situation is not usual in our latitudes unless the solar panels are rotated with respect to the sun. The efficiency of a solar panel system can be improved if the panels track the sun, and remain as long as possible at the most favourable angle of incidence.

The circuitry required is relatively simple. It uses a window comparator which keeps the drive motor idle, as long as the two LDRs are subjected to the same illumination. Half the

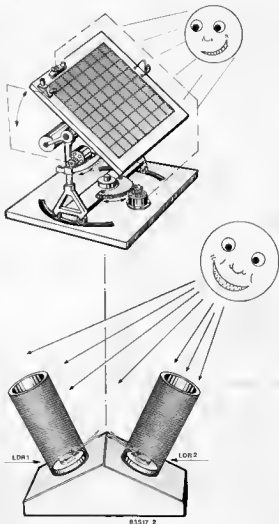

83517 2

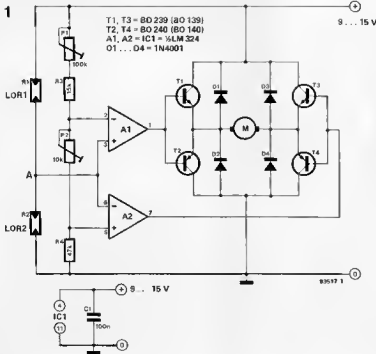

83517 1

operating voltage is then applied to the non-inverting input of A1 and to the inverting input of A2. When the position of the sun changes, the illumination affecting LDRs R1 and R2 is different, if they are at an angle to each other as shown in figure 2. In this case, the input voltage for the window comparator deviates from half the supply voltage, so that the output of the comparator provides information to the motor for clockwise or anticlockwise rotation. Transistors T1...T4 in a bridge circuit cater for reversing of the motor. Diodes D1...D4 serve to suppress voltage peaks which can be produced when the motor is switched.

Preset potentiometers P1 and P2 are used for alignment. They are adjusted so that the motor is idle when the LDRs are subjected to the same illumination. If less light reaches LDR R2 than LDR R1, the voltage at point A rises to more than half the supply voltage. The result is that the output of A1 goes high and transistors T1 and T4 conduct. The motor then

runs. If the illumination of the LDRs is then changed so that the voltage at point A drops to less than half the supply voltage, output A2 goes high and transistors T3 and T2 must conduct. The motor then rotates in

the opposite direction. Small geared motors of the type used for models, with a suitable voltage and maximum operating current of 300 mA, are suitable for driving the solar panels. The use of this control circuit makes

it possible to control the solar panel in one plane. Of course, in order to track the sun from sunrise to sundown, two control circuits will be required: one for horizontal and one for vertical tracking.

19

emergency mains cut-out

If the voltage of the mains supply of a computer rises too high, components on the printed circuit boards can easily be damaged or even destroyed. This emergency cut-out placed between the mains supply and the load interrupts the supply when the voltage level exceeds a predetermined value.

For many reasons it is possible for the output voltage of a power supply to rise to a dangerous level. The emergency cut-out described here has been set to the maximum supply

voltage of 5.25 V that is stated by the manufacturers of TTL ICs. Zener diode D1 starts conducting just before the stated zener voltage is reached. A small current flows in the anode-gate circuit of thyristor Th1; the level of this current can be set with preset potentiometer P1 connected in parallel with the gate-cathode circuit of Th1. When the mains supply rises, the current through the zener diode becomes large enough to cause the thyristor to fire. The firing level lies between 5.2 ... 6 V.

As soon as the thyristor fires, the mains supply voltage drops substantially because the thyristor virtually

short-circuits the mains supply. In the case of a supply without current limiting, fuse F1 prevents the current attaining too high a value. The rating of the fuse depends, of course, on the load requirement.

During testing and adjusting of the circuit, it is important that the thyristor continues to conduct after it has been fired until its current has dropped to zero. The firing voltage level can be set by means of a mains supply with a current limiter before it is put into use. If it proves impossible, for instance because of the tolerances of the zener diode, to set the firing voltage to the required value, try using a 5.1 V zener diode.

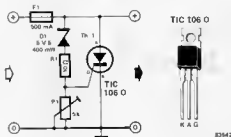

20

simple baud rate generator

The generator described is a good-value-for-money alternative to the commercially available types; it uses only one CMOS-IC and provides up to seven different baud rates. Each serial data interface requires a baud rate generator: terminal, printer, tape Interface... It is often not possible to use the same generator for input and output, so it would be useful to add one to, for instance, the UART in the computer or the

UART in the terminal. To keep the costs of such an addition down, we have developed a generator which uses just one IC, two resistors, one preset potentiometer and a capacitor. The CMOS 4060 is a 14-stage binary counter with an internal oscillator which only requires the frequency determining RC components. As the reset is connected to earth, the counter begins to count upwards when the supply is switched on. A clock frequency then becomes available at the outputs: the higher

the number of the output, the lower the frequency available at it. In the circuit shown the frequencies available at the various outputs are:

- Q4 = 9600 baud
- Q8 = 600 baud
- Q5 = 4800 baud
- Q9 = 300 baud
- Q6 = 2400 baud
- Q10 = 150 baud
- Q7 = 1200 baud

If the outputs are wired as shown in the circuit diagram, the required baud rate can then be selected by means of a wire link.

The oscillator frequency can be set precisely with P1, and measured either at pin 9 of the 4060 or at one of the outputs Q4...Q10. With the values shown, the frequency at pin 9 should be 38.4 kHz; at the outputs Q4...Q10 the relevant baud rate.

It is often required that the clock frequency is 16 times the baud rate (for instance, with asynchronous operation of the 6850, 8251, Z80-SIO...). In that case, C1 must be replaced by a 27 nF capacitor and the oscillator frequency must be set to 614.4 kHz.

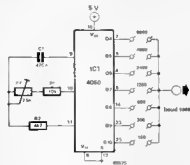

21

flashing running light

Roadworks are usually marked during the hours of darkness by yellow flashing lights. These may often be linked together to form a 'running' flashing light. Road diversions and the like are then clearly visible. The circuit described here provides a similar effect but for use in model roadways for instance.

The speed of the 'running' row of LEDs is determined by the frequency of the clock generator N1.

Depending on the type of IC used, this frequency will be of the order of 6 Hz \pm 30% when potentiometer P1 is in mid position. The output of the clock generator is fed to the Johnson counter IC1. The outputs of this counter become logic 1 in sequence. The counter is reset to the start when Q4 goes to logic 1. This explains the link between pins 15 and 10 of IC1. Outputs Q0... Q3 are connected to four monostable multivibrator circuits consisting of N2... N5. The multivibrators are triggered by the negative going edge of Q0... Q3 and the pulse period can be preset with potentiometers P2... P5 which of course determine how long each group of LEDs will light. These periods need to be more or less equal to ensure smooth running of the lights.

The circuit uses four groups of four LEDs each. The LEDs in each group will light simultaneously. Figure 2 shows how the LEDs should be connected for road markings in a bend; LEDs D16, D15, D14 and D13

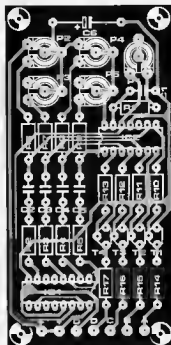
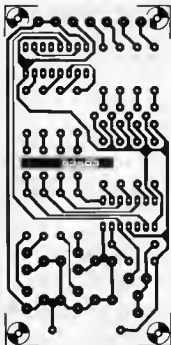
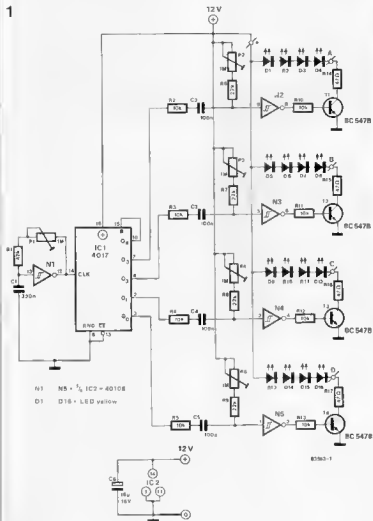

Parts list

Resistors:

- R1 = 47 k
- R2, R5, R10... R13 = 10 k
- R6... R9 = 22 k
- R14... R17 = 47 Ω
- P1... P5 = 1 M preset potentiometer

Capacitors

- C1 = 330 n
- C2... C5 = 100 n
- C6 = 10 μ /16 V

Semi-conductors:

- T1... T4 = BC547B
- D1... D16 = LED yellow
- IC1 = 4017
- IC2 = 40106

2

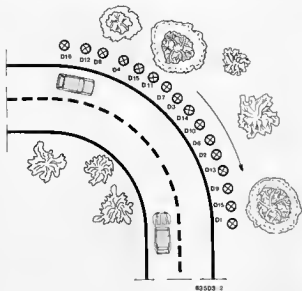

light first, followed by D12, D11, D10 and O9, and so on.

Schmitt triggers N2... N5 are not capable of supplying sufficient current for the LEDs and therefore the buffers T1... T4 are included. The current through the LEDs is about 30 mA during each flash; the average current taken by the circuit operating at the highest frequency is of the order of 30 mA. When, however, the flash period is longer than the running period, the current consumption may rise to a maximum of 100 mA.

The printed circuit board (see figure 3) is fairly compact. The preset potentiometers are neatly grouped together and all terminals are located at one edge. The four groups of LEDs are connected to pins A... O which are clearly marked on the circuit diagram and the board.

22

2650 single step

It can be very handy if the micro-processor can be put into single step mode when debugging home made programs. This little extra can be realized by constructing the circuit described in this article. Readers who own a 2650 μ P — amongst them a lot of game computer owners — have had to do without this facility... until now.

The 2650 can be put into single step mode by making the μ P believe that it is connected to a very slow memory. Consequently, the address and data bus remain valid during each read or write mode until a switch is pressed. In this way, all addresses and data can be checked step-by-step without running into problems.

The circuit, consisting of two flip-flops, a switch and a logic gate, uses the OPREQ (operation request) and OPACK (operation acknowledge) signals to combine them into a 'new' OPACK signal. The 'old' OPACK signal is combined to output Q of FF2 via OR gate N1. The original OPACK line must be broken and particular attention paid to ensuring

that the pull up resistance at the PVI side remains. OPREQ is logic 0 before each memory cycle, thus setting the 74LS74 and making OPACK logic 1. The memory cycle starts when OPREQ, together with OPACK, is logic 1: this indicates that the processor must wait until OPACK is made logic 0 by pressing S1. Flip-flop FF1 is used to debounce switch S1.

A multimeter can be used to check the data and address bus once this extension has been installed. However, owing to the interrupts, some 'weird' things may take place inside

the games computer. As the processor directly carries out an interrupt after the reset has been pressed (address bus = 0000, data on F1), it seems as if there's something wrong. It is, therefore, advisable to get rid of the interrupt between CPU and PVI, but remember, when doing this, that the pull up resistance at the CPU must remain. Once this is done, reset the program and there will be no further problems.

Last but not least, a practical hint: it is recommended to use a push button with change-over contact for S1.

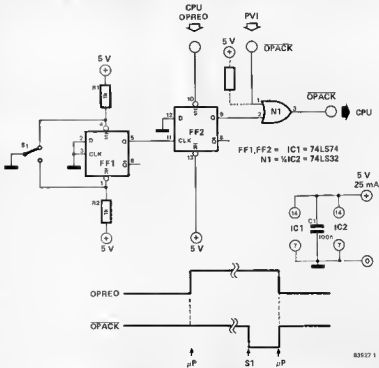

23

1MHz time base without crystal

Clock generators, for instance, those used in microprocessor systems, are normally crystal controlled. Although crystals have become cheaper over the years, they are still expensive items. A ceramic resonator offers an inexpensive alternative. The sixth significant digit is not often of great importance in a 1 MHz time base, but high frequency stability is. And that is guaranteed by a ceramic resonator (or filter, as it is often called). The circuit shown produces a clock frequency of precisely 1.07 MHz and is eminently

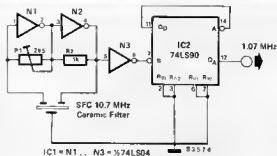

suitable as clock generator for a microprocessor system. There is not much to say about the circuit which consists of two ICs, a resistor, a trimmer and the ceramic resonator. The oscillator proper consists of N1, N2, P1, R1 and the ceramic filter: its output is applied to inverter N3 which improves the slopes of the signal. The signal is then fed to input B of decimal counter IC2. As output QD is fed

back to input A, the frequency of the output available at QD is exactly one tenth of the oscillator frequency. IC2 can also be connected as a 5 : 1 divider to give a clock frequency of 2.14 MHz, which may be of interest to Z80 enthusiasts. The circuit also works very well with a 455 kHz ceramic filter. To ensure correct operation of the oscillator at this low frequency, preset potentiometer P1 has been included. The clock frequency is, in this case, 45.5 kHz (or 90.1 kHz if a 5 : 1 division was decided upon). A final note about the 74LS90. Contrary to usual practice, the power supply pins are: pin 5 (+) and pin 10 (-).

24

machinegun-soundgenerator

Computer games are even more fun when they are accompanied by sound effects. As most such games have a more or less destructive character, a machinegun-sound generator will often come in very handy. The circuit consists of three nearly identical generators of which the output signals are added in a particular ratio. This gives the impression that there are three machinegun posts. Each sound generator consists of three astable multi-vibrators (AMVs) which are connected in series by diodes. Each AMV can only oscillate if the output of the preceding AMV is logic 0. Two of the generators have a preset potentiometer

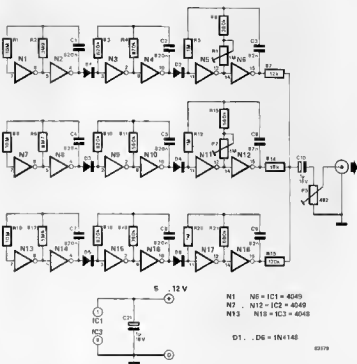

associated with the final pair of AMVs to enable control of the frequencies. These frequencies determine the 'speed' of the gun fire. The

output level can be set with potentiometer P3. The current consumption of the circuit is not greater than 2 mA for a supply voltage of 5 V.

The simulated gun fire sounds best if the final amplifier is adjusted for maximum bass and minimum treble. The volume should be set so that the amplifier does not

clip, as this will produce unnatural sounds.

If you don't like the sound of machinegun fire, the circuit can be used to imitate the sound of a

woodpecker. This is rather more peace loving, but it will be difficult to find an exiting computer game heavily involved with woodpeckers!

25

centronics interface...

with the 6522 VIA

In spite of the advantages of a visual display unit for a computer this, now common, medium has not entirely eclipsed its predecessor-paper; in fact one of the most important computer peripherals is the printer. With this in mind, the 1982 July/August issue contained a circuit for using a printer with the Elektorterminal (Elektor No. 87/88, page 7-91).

Here we deal with the same basic idea but with a more up to date, versatile project which, moreover, is better suited to the Centronics interface used by most current printers. We refer to Centronics as the norm because reading through the users manuals supplied by various manufacturers it is obvious that the only difference between them is that the wiring of the connector is different or certain signals are just left out completely. So it is a good idea to check the wiring of the connector of any printer before using it.

For our interface we have only kept the signals which are common to all current models: there are 8 data lines (the Centronics interface has parallel input), a data checking bit (DATA STROBE), the BUSY line which is active to signal that the printer cannot receive any data, and the SELECT line which determines whether the printer is in use or not. And of course there are also the earth connections and the shielding wires (twisted pairs).

Secondary signals are possible such as Paper Out (or Paper Empty), Fault, ... and so on but as we are not using them anyway there is no need to list them.

On the Junior Computer interface card the VIA 6522 has two ports which can be used without any

PB0...PB7 : 8 BITS DATA OUTPUT
PA7 : BUSY INPUT
PA6 : SELECT INPUT
CB2 : DATA STROBE OUTPUT

24E2 A2 FF PAROUT LDXM SFF
24E4 8E 02 F8 STX PBDD PB IS OUTPUT
24E7 E8 INX
24E8 8E 03 FB STX PADD PA6 & PA7 ARE INPUTS
24E8 A2 A0 LDXM \$A0 OUTPUTS
24E8 8E 0C FB STX PCR CB2 OUTPUTS DATA STROBE

24F0 2C 01 FB BUSY 01T PAD GET SELECT BIT
24F3 10 8B BPL RTS EXIT IF SELECT IS LOW
24F5 70 F9 BUSY WAIT FOR BUSY LINE LOW
24F7 AD 63 23 LDA AHOLDGET CHARACTER
24FA BD 00 F8 STA PBD PRINT IT WITH STROBE
24FD 60 RTS RTS

VIA 6522

PRINTER

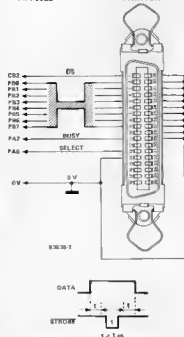

PA7 is an input to receive the BUSY signal, while PB6 transmits information to the computer regarding the mode of the printer: if SELECT is at a high logic level the user knows that the printer is printing; if SELECT is logic low then the printer is not printing! It should be noted that the SELECT line is also influenced by the 'out-of-paper' detector: when the printer runs out of paper it deSELECTs itself.

Included here along with the pin designations is a small set of instructions, in the form of a subroutine, which enables the best use to be made of this parallel interface. Note that the configuration of input and output ports is renewed every time the subroutine begins, which means with each character. The ASCII code of the character to be printed must be present in the accumulator when the subroutine starts, as the contents of registers X and Y are not safeguarded.

The LDA AHOLD instruction found at the end of PAROUT is needed with the DOS on the Junior Computer, which calls this subroutine, but what appears is not in fact the code of the character to be printed in the accumulator, which is contained in AHOLD. DOS-Junior users should note that another small modification is needed as well as including the subroutine at address \$24E2. This occurs at address \$2317 where \$9E must be replaced by \$E1. The IO instruction described in the Ohio Scientific users manual allows very versatile control of the printer: IO,08 should be used if only the printer is in use; IO,09 if the parallel and serial outputs are used simultaneously.

complication. As can be seen from the diagram, lines PA0...PA5 are left free, and could be used to control particular signals for example! Everything else is quite straightforward: the eight data bits (PB0...PB7) can handle the complete set of ASCII characters (7 bits), and also allow particular features of the printer to be used (for example graphic symbols, Greek letters, Japanese... or whatever). Line CB2 of the 6522 provides the data checking signal, consisting of a pulse of at least a microsecond transmitted at least one microsecond after the data bits are fixed on port B. Line

26

joystick interface

It happens from time to time that it would be nice to read the position of a potentiometer with a microprocessor. For those many computer enthusiasts we have designed a simple circuit to do this. Only one 555 and one input line to the processor are needed. Care must be taken in the construction to prevent hum. The interface should also be of interest to other computer enthusiasts who just want to experiment with their equipment.

Integrated circuit IC1 oscillates continuously: capacitor C1 is charged via resistor R1 and potentiometer P1 and then discharged through P1. This means that the discharge time is dependent on the setting of P1 and this, in turn, means that the time during which the output of IC1 (pin 3) is logic 0 is directly proportional to the resistance of P1. If the resistance of P1 becomes less than 10k Ω , there is a likelihood that oscillations will cease. When the microprocessor measures the time that the output of IC1 is low, it produces a number which is directly proportional to the resistance of P1. This can be done easily by incrementing a register until

37E8		00170	INPUT	EOU	37E8H
A000	010000	00180	START	LO	8C, 0000
A003	1E00	00190		LO	E, 80H
A005	21E837	00200		LD	HL, INPUT
A008	7E	00210	LOOP0	LD	A, (HL)
A009	A3	00220		AND	E
A00A	20FC	00230		JR	Z, LOOP0
A00C	7E	00240	LOOP1	LO	A, (HL)
A00D	A3	00250		AND	E
A00E	20FC	00260		JR	NZ, LOOP1
A010	03	00270	ZERO	INC	BC
A011	7E	00275		LO	A, (HL)
A012	A3	00280		AND	E
A013	20F8	00300		JR	Z, ZERO
A015	C9	00310	STOP	RET	
0000		00320		ENO	
00000	TOTAL ERRORS				

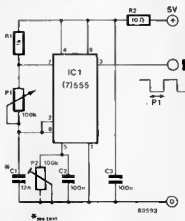

the output of IC1 becomes logic 1 again. A large value of P1 gives a high count.

The program is a sub-routine which can be placed on any free address in a Z80, 8080 or 8085. Instructions LD A, (HL) and AND E read the level at pin 3 of IC1 which in this case was connected to the seventh data bit (E contains 80₁₆). During loop 0 there is a delay until the output of IC1 becomes 1; this is necessary because it may happen that

the routine is started during a '0'. Subsequently, during loop 1 there is a delay until the output of IC1 is low. Thus the real count-loop zero continues as long as pin 3 of IC1 is logic 0. Counting takes place in a double register (8C) but can equally well be done in a single register. In the latter case, the run is slightly faster, that is, 27 instead of 29 clock pulses.

Input is the address to which the output of IC1 is connected. In line 190 the input mask in register E is set: only bit 7 is read.

Finally, the calculation of C1. If P1 has a value of 100k Ω , BC must contain for instance, 100₁₀, for which $100 \times 29 = 2900$ clock pulses are required (for a 4 MHz clock this would be 725 μ s). The time, t_0 , during which the output of IC1 is 0 is given by $t_0 = 0.69 P1 C1$. In the case being considered, C1 would be 10.5 nF; in practice the next standard value of 12 nF would be used and P2 adjusted until the register has the correct value.

If you have to buy IC1, choose the 7555 CMOS version which causes far less interference to the power supply!

27

auto trigger

This circuit gives an output voltage when the input voltage rises above a certain reference level which is derived from the positive and negative peak voltages of the input signal. Therefore the trigger circuit is

fairly independent of the amplitude of the signal and could be used, for example, as a trigger for an oscilloscope.

Op-amp IC1 is connected as a buffer stage and its non-inverting input is

set to half the supply voltage by means of R1...R3 and C2. The reference voltages are derived from the (buffered) input signal, via D1, D2, C3 and C4. Capacitor C4 charges through D1 to the supply

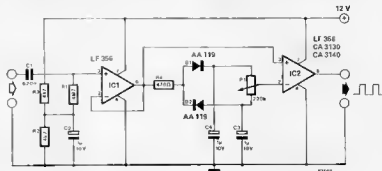

voltage plus the positive peak voltage of the input signal. C3 is charged through D1 and P1, but in this case diode D2 ensures that the voltage across C3 is not more than half the supply voltage minus the peak negative voltage. The values chosen in this part of the circuit are such that the reference voltages across the capacitors stay very constant

when the input signal has a frequency of more than about 10 Hz. The signal output from IC1 travels directly to the non-inverting input of comparator IC2. The inverting input of this comparator is connected to the wiper of P1, and this potentiometer is used to set the reference voltage. This reference level can be anywhere between the positive and

negative voltage peaks of the input signal. As long as the voltage level of the input signal is now above the reference value IC2 will deliver an output voltage (which is in practice equal to the supply voltage). If the level of the input signal falls below the reference level the output of the op-amp falls back to zero.

28

LED 'amplifier'

The light emission of an LED is normally pretty low. If more brightness is required, the following circuit will help. The LED to be 'amplified' is replaced by an LED in an opto-coupler which switches a lamp (for instance, a signal lamp) connected to the mains supply. When the LED in the opto-coupler conducts, the photo transistor conducts. This causes a gate current to flow to the triac via R1: the triac fires and the lamp lights. Resistor R1 is connected to 30 VDC which is derived from the mains supply

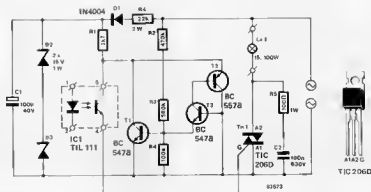

via D1 and R4. Two zener diodes, D2 and D3, limit the voltage across buffer capacitor C1 to 30 V. The three transistors T1... T3 ensure that the triac can only be fired at the moment the mains supply changes from positive to negative, thus reducing interference problems. When the voltage in the positive half-cycle of the mains supply rises above 7 V, the voltage at the junction R3/R4 becomes high enough to cause T1 to conduct. The cur-

rent through R1 is then fed to T1 so that the opto-coupler can no longer feed a gate current to the triac. The same thing happens during the negative half-cycle but then T2 and T3 conduct when the voltage across R2, R3 and R4 goes more negative than -7 V. This is a form of zero voltage switch and it ensures that firing of the triac can only take place when the mains supply is about 0 V.

29

economic LED

The usual method of operating an LED from a voltage which is higher than its forward voltage is well known. A limiting resistor is used to limit the LED current to its rated value. Calculating the value of the resistor is simple enough: supply voltage minus LED forward voltage divided by the maximum current rating of the LED. The formula is:

$$R = \frac{U_B - U_{LED}}{I_{LED}}$$

Thus the voltage difference between supply voltage and forward voltage is dropped by the limiting resistor.

However, the disadvantage is that the power dissipated by the limiting resistor is fairly high if the supply voltage is relatively high. Thus, for example, with a supply voltage of 24 V and a current of 25 mA the

1

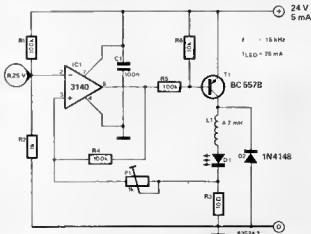

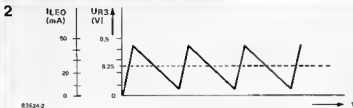

power dissipated is greater than 0.5 W. There is an alternative: the circuit shown here only requires 0.1 W. It is effectively a switched current source.

The current source is based on transistor T1 and the oscillator uses a 3140 operational amplifier. When transistor T1 conducts, a current flows via coil L1, LED D1 and resistor R3 to earth. The current curve is shown in figure 2. As soon as T1 turns on and a current flows, the current rises together with the voltage at R3 from zero volts. This voltage is now applied to the non-inverting input of the operational

amplifier. A reference voltage of approximately 0.25 V is applied via voltage divider R1/R2 to the inverting input. If the rising voltage at the non-inverting input reaches the level of the reference voltage, the output of the operational amplifier switches to a high voltage potential. Transistor T1 turns off and the current through the LED flows via diode D2. As shown in figure 2, the current drops; the voltage at R3 therefore drops also. Once the current and voltage are sufficiently low, the operational amplifier switches over again and the transistor turns on. This operation is repeated

periodically. The switching point is adjusted with preset potentiometer P1. This governs the changeover voltage at pin 3 of the operational amplifier which, in turn, governs the maximum LED current. It should not exceed 50 mA.

The frequency of the oscillator (which is also the switching frequency for the transistor) is determined by coil L1 and by the switching hysteresis adjusted with P1. With the specified value of 4.7 mH the switching frequency is about 15 kHz with a period of approximately 65 μs. Two other switching frequencies using different coil inductances can be found in the following table:

Coil	T	F
2.2 mH	35 μs	30 kHz
10 mH	150 μs	6 kHz

P1 should be adjusted to obtain the lowest frequency at which the circuit still starts to oscillate

30

simple regulated power supply

If you compare the expense and the rating of this power supply you will get a surprise, because the output voltage and current are fully adjustable between 0...18 V and 0...1.8 A respectively and costs

smoothing capacitor (C2). Diode D5 and capacitor C1 produce a negative auxiliary voltage, which is stabilized by zener diode D6 and capacitor C4. The negative voltage provides the negative supply for the two ICs. All this is necessary to enable the output voltage to be adjusted down to zero volts. During the construction of this part of the circuit bear in mind that the positive lead of electrolytic capacitor C4 is connected to earth!

Regulation is provided by IC1 and IC2. Capacitor C3 suppresses any residual transients at the input of IC1 and it should therefore be connected as closely as possible to IC1 (similarly C4 and IC2).

The reference level output from pin 4 of IC1 goes to the voltage

divider made up of R5 and P2 (this pot sets the value of the output voltage). IC2 is connected as a differential amplifier and compares the signals at its two inputs. The difference between the inputs is the voltage drop across 'current' sensor R4. This IC feeds the current sensing input (pin 2) of the L200. P1 in the feedback loop of the 741 is used to vary the output current of the circuit.

IC1 must be mounted on a suitable heat sink as it dissipates nearly all the power of the circuit. The power supply can quite easily be built into a case and a voltmeter and ammeter mounted on the front panel. In view of the accuracy of the circuit these should ideally be digital meters, but virtually any type will do.

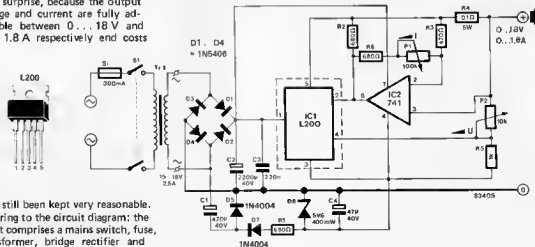

have still been kept very reasonable. Referring to the circuit diagram: the input comprises a mains switch, fuse, transformer, bridge rectifier and

31

software
RAM tester

Elsewhere in this issue we have a circuit designed to aid fault-finding in microprocessor systems. However, there are fault-finders and fault-finders and here we have one of the latter types. In fact it is a RAM-test program and it is aimed at helping amateurs or hobbyists who do not want (or cannot afford) special test equipment.

Many RAM-test programs are simple and can trace simple faults such as defective memory locations. However, they do not show up all the possible faults such as a defective

AB96 2189A6	00180 START	LD	HL, TEST	;MEMORY TEST LOCATION
AB93 7E	00116 LOOP	LD	A, (HL)	; READ MEMORY
AB84 EEF7	00126	XOR	#FFH	; COMPLEMENT
AB86 77	00139	LD	(HL), A	; WRITE MEMORY
AB87 18FA	00148	JR	LOOP	; AGAIN
	00158			
AB8F	00168 TEST	EQU	4	
0000	00170	END		

address decoder or buffer, timing faults or any of the various other problems that can (and do) occur. Of course a logic analyser would make the job of trouble shooting a lot easier, but for many people such equipment is in the category described as 'Very nice, but...'. So here is a program that uses the computer to trace faults in RAMs and display them on the oscilloscope screen. What could be simpler? The program example (for a Z80) shows the principle of this type of software. The address of the memory location under scrutiny ('TEST') is loaded into HL. In the program loop (called 'LOOP' for some strange reason) the contents of this memory location is read, and then inverted (so '1' becomes '0' and vice versa) and finally it is written into the same memory location. This operation is repeated ad infinitum. The write pulse of the system is used to trigger an oscilloscope. Thus the scope is triggered once every time the 'LOOP' is executed and thus the data is displayed on the screen.

Correct data will keep alternating between '1' and '0', if the data is not correct (for example if a '1' is continually read), the processor continually writes exactly the opposite (a '0'). This is, of course, immediately evident on the oscilloscope. By 'following' the data with the probe of the oscilloscope as it travels through the system, the problem point can be traced. The suspect IC can then be replaced or whatever measures necessary can be taken to cure the fault.

This program could easily be expanded so that HL is incremented by one every time the loop is executed, so the next memory location will automatically be selected unless a fault is detected. This would make a separate RAM-test program superfluous. Obviously either read or write instructions could be used with absolute addressing, in which case the HL register is not needed for addressing. Alas, not every processor, has this facility.

32

h_{FE} tester

This h_{FE} tester is interesting because of its simplicity and because it enables the β of both PNP and NPN transistors to be measured. Furthermore the measurement is independent of the supply voltage of the tester. As the diagram shows, the base current of the transistor under test travels via R1. Its base current I_B is thus equal to $\frac{U_{XY} - U_{BE}}{R1}$. The voltage drop across the collector resistor is h_{FE} × I_B × R2. P1 is used to set a reference voltage derived from voltage U_{XY} - U_{D1} (or D2 for a PNP transistor). This means that the setting of the potentiometer is directly proportional to the h_{FE} of

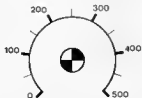
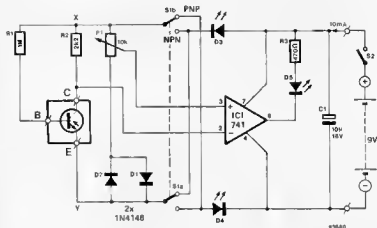

the transistor under test and is independent of supply voltage. The voltage across R2 and the voltage set with P1 are compared by

IC1 which is connected as a comparator. Potentiometer P1 is now set so that the LED at the output of the op-amp just lights or is just dimmed. At this setting the voltage across the potentiometer is equal to the voltage across R2. Switch S1 is used to switch from NPN to PNP (or vice versa) by reversing the polarity of voltage U_{XY}. LEDs D3 and D4 in the supply lines ensure that the input voltages to be measured are within the common mode range of the op-amp used.

33

prelude buffer

In the final Prelude article, Prelude p.s. in the May issue, we described a buffer stage that can be used at the inputs and record output of the unit. As promised here we have the design for the printed circuit board (figure 2) for this buffer. The circuit diagram is repeated again in figure 1. The buffer consists of a super emitter follower, in which the actual emitter follower is formed by connecting T1 and T2 in cascode. The load of the emitter follower is a current source, consisting of another cascode connection (T3 and T4). The resultant circuit has excellent linearity and very low output impedance: effectively zero ohms.

There are significant advantages to be gained by the use of these buffers: Crosstalk between the channels and between the various inputs is reduced to a negligible level (better than 60 dB).

The External-In input can also be provided with level control by using one of these buffers.

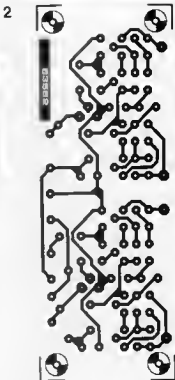

The output impedance of Tape Record 1 and 2 and Ext. Out will no longer be dependent on the preset potentiometers.

The original presets on the connection board (P2... P5, P2'... P5') have an effect on the crosstalk; to what extent depends on the position of the wiper. This is because they increase the source impedance of whatever audio equipment is

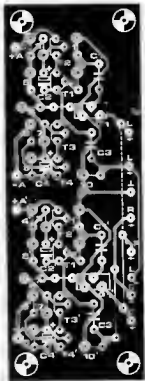

Parts list

Resistors:

- R1, R1' = 100 k
- R2, R2' = 2k2
- R3, R3' = 47 k
- R4, R4' = 15 k
- R5, R5' = 3k3
- R6, R6' = 12 k
- R7, R7', R8, R8' = 1k5
- R9, R9' = 820 Ω
- R10, R10' = 330 k
- P1, P1' = 50 k (47 k) preset potentiometer

Capacitors

- C1, C1' = 330 n
- C2, C2' = 10 μ/16 V
- C3, C3' = 680 n
- C4, C4' = 22 μ/10 V

Semiconductors

- T1, T2, T3, T4, T1', T2', T3', T4' = BC 550C

connected, by up to 62.5 k (with the wiper in mid position). A buffer board gets around that particular problem. That is not to say that an input buffer is always necessary. Forgetting about unused inputs for the time being, an input buffer is unnecessary in all cases when the source impedance of the signal source plus preset or voltage divider is not greater than about 2 k (when dealing with crosstalk the aim is to reduce the source impedance to 2k, but there is no need to reduce it any further).

Because the printed circuit board should be as small as possible, all resistors are mounted vertically, and the same goes for C2, C2', C4 and C4'. The boards should be connected as close as possible to the inputs and outputs. Where a channel is fitted

1

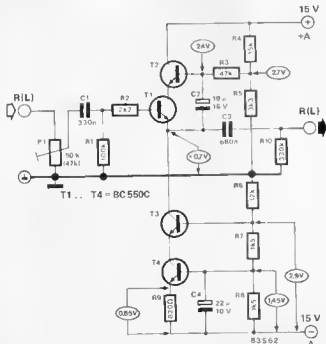

with a buffer the original preset potentiometer is removed and the wiper and the connection which was not grounded are bridged with a wire. Buffers are not needed for the MM outputs as their impedance is already very low.

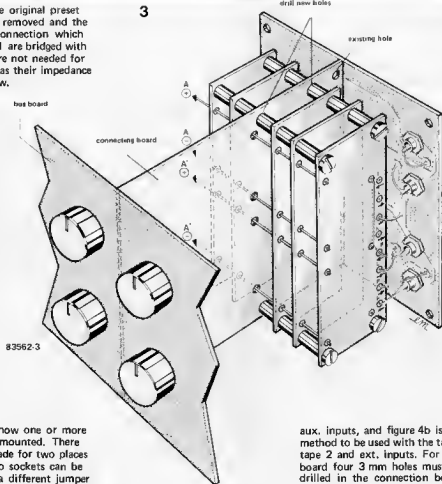
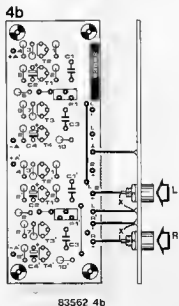
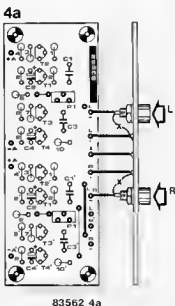
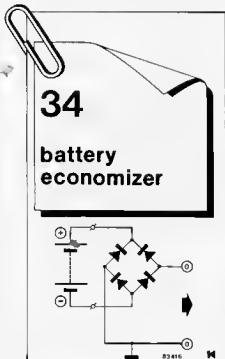

Figure 3 shows how one or more buffers can be mounted. There is a provision made for two places where the phono sockets can be connected, but a different jumper must be included for each. This is either the one shown dotted, or its solid equivalent. Figure 4a

shows how the buffer can be connected in series with the tuner and

aux. inputs, and figure 4b is the method to be used with the tape 1, tape 2 and ext. inputs. For one board four 3 mm holes must be drilled in the connection board. Break the connection between the phono sockets and the back panel of each input to be buffered and connect the buffer board with two short pieces of wire. Connect the \perp point to ground on the back panel. The supply voltages $\pm A$ and $\pm A'$ can be taken from the MC board. **M**



35

electronics
and plant
physiology

That trees and plants have a soul has been known to plant lovers and gardeners for a long time. For all those who have never given this a thought and who have never done more to plants than water them, we give here a circuit which will make it possible to get into closer contact with those oft-forgotten members of his or her 'family'. Many will dismiss this experiment as belonging to the realms of parapsychology, but it has already been possible to measure a non-periodic signal

between 1 and 40 Hz with an amplitude which varied between 0 and a few microvolts. These signals can without any doubt be traced back to plant activities.

The oscilloscope traces are often not directly connected with manipulation of plants. Particularly at the beginning of a series of experiments, a violent reaction could be observed in the plant before the traces shown in figure 3 could be made. Whatever caused the traces, it is certain that in order to understand plant behaviour and make further measurements, an amplifier with a high degree of amplification and noise suppression is necessary.

The input circuits (see figure 1) are therefore high-input impedance amplifiers, A1 and A2; the input impedance is 1 M ($R1$ and $R2$). The signal is subsequently applied to a differential amplifier, A3, which has an amplification factor of about 10. The amplification of the input amplifiers has therefore been kept low, so that A3 can not be driven to saturation. Mains hum and high frequencies are filtered from the output of A3 and this is done by means of active low-pass filter A4, the cut-off frequency of which is about 50 Hz. A passive high-pass filter (C3, R13) then removes any DC components which have not been filtered by A4; the cut-off frequency of this filter is about 1 Hz. Subsequently, the signal is fed to a non-inverting amplifier, A5, of which the amplification factor is about 1000. Because of the high input impedance of A5, it does not have much effect on the high-pass filter.

As each amplifier stage reintroduces

2



noise and mains hum onto the signal, these must again be filtered in a low-pass and a high-pass filter. It would be possible, with a suitable oscilloscope, to make measurements across R19, were it not for the fact that we want to connect a recorder or VCO or something similar and the signal will therefore have to undergo further amplification. This is effected by A7. The total amplification of the circuit can be adjusted by means of potentiometer P1 between 85 dB and 120 dB. At maximum amplification, the '1 V per scale division' range of the oscilloscope will measure 1 microvolt.

To prevent mains interference in

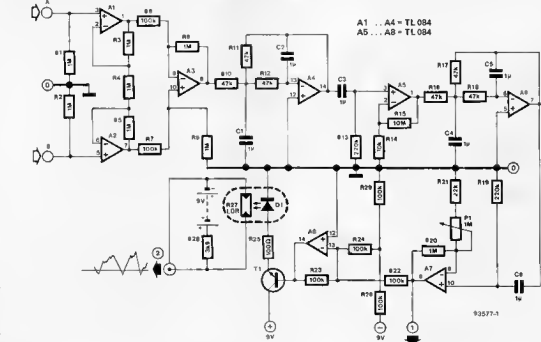
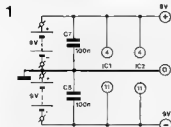

3

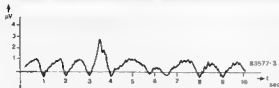

this highly sensitive amplifier, the supply is provided by two batteries. And to really be able to make full use of the sensitivity, mains interference should also be filtered from the oscilloscope or recorder or VCO mains supply. This could be done with an opto-coupler but an LED and LDR in a light-proof box will do nicely. The absorption circuit of the LDR could be supplied from a mains power unit, but here again a battery would be preferable to prevent interference finding its way to the amplifier.

If you want to obtain measurements which can be used as proof, a series of measurements will have to be made over a period of time (including when you're not home).

This cannot, unfortunately, be done by just an oscilloscope, but by a data recorder. This is, however, a very expensive piece of equipment and can be substituted by a VCO of which the signals are recorded on tape.

And now for the method of measurement. The first that's needed is a signal detector and the simplest is a set of gold-plated pins from an IC socket. Better are small sensor plates which have been lightly covered with conductive paste before they are attached to the plant. Three pins or sensors are required: the central one must be connected to the screen of the connecting cable; the other two go to inputs A and B. It is important that both these

conductors are separately screened, the screen being connected to earth at the amplifier end. The detectors should be attached to branch or plant stem not more than 2...3 cm from one another (figure 2). The recording equipment must be earthed at the mains input. It also advisable to build the amplifier into the smallest possible case; an earthed metal one is not absolutely necessary, but it cannot do any harm. With properly functioning equipment, the output signal should resemble the traces shown in figure 3: these give the required information as to the voltage variations occurring in plants and trees. The resolution in case of a data recorder should, of course, be such that a readable trace is produced: paper feed speeds of 0.5...1 cm per second are ideal, but in order to keep paper costs down, it is advisable to use lower speeds.

Finally, we would be most interested in hearing from readers about their researches into plant physiology. ■



36

G. Ramm

d.c. voltage doubler using a 4049

This simple circuit can produce a d.c. voltage which is approximately twice the supply voltage, in the no-load condition. The 4049 IC contains a total of six inverters. Two of them, N1 and N2, form an oscillator together with R1 and C3, of which the frequency is about 10 kHz. The remaining inverters, N3...N6, are connected in parallel and operate as a buffer stage to reduce the load dependence of the circuit.

Depending on the clock signal of the oscillator, point A in figure 1a is connected to the earth rail for a particular time per period and to the supply voltage for a particular time. Whilst point A is connected to earth, capacitors C1 and C2 charge up to the supply voltage via diodes D1 and D2. The oscillator then switches point A to the supply voltage potential during the remain-

Table.

Supply voltage (V)	I _{OUT} (mA)	U _{OUT} (V)		U _{a.c.} (mV _{pp}) Figure 1a	Efficiency (%) Figure 1b	
		1a	1b		1a	1b
10	5	17	-7.5	30	68	49
	10	16	-6.5	60	70	52
	15	14.5	-5	90	88	44
15	5	27.5	-12.5	40		
	10	26.5	-11.5	75		
	15	25.5	-10.5	115		

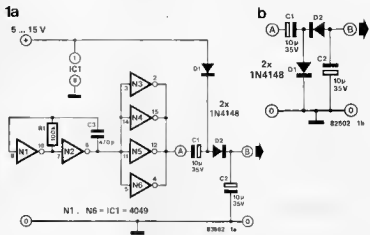

ing period, capacitor C1 transfers a part of its charge to capacitor C2. This causes the voltage across capacitor C2 to rise to almost twice the supply voltage.

If D1 is connected to earth and the polarities of diodes D1, D2 and capacitors C1, C2 (figure 1b) are reversed, the output at A will be a negative voltage and, in the no-load

condition, it will be at the same level as the supply voltage. In both cases, unfortunately, the output voltage is dependent upon the load. As the load increases, the output voltage drops; in contrast, the superimposed a.c. level rises. The table shows the values measured in the circuit for load currents of 5 mA, 10 mA and 15 mA. ■

37

voltage booster regulator

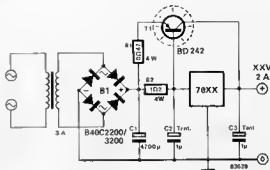

There are various ways and means of drawing more current from a voltage regulator IC than it was originally intended to supply, but most methods have their disadvantages. If, for instance, a power transistor is connected in parallel with the IC, the supply will no longer be protected against short-circuits. That can, of course, be remedied by adding a current sensor in the shape of an extra transistor which, during overload conditions, cuts off the base current to the power transistor. But this solution suffers from a heavy power loss during short-circuit conditions, which is not really acceptable either. The circuit given here shows that a simpler solution is possible: the power transistor, T1, is provided with an emitter resistor! This ef-

Output Current (A)	Tr current (A)	B1 (Type)	C1 in µF	R1 in Ω/4 W	R1' in Ω/4 W	R2 in Ω/4 W	T1 (Type)	T1' (Type)	Heat-sink in K/W
2	3	B 40 C 2200/3200	4700 (2 x 2200)	0.47	—	1.2	BD 242	—	5
3	4.5	B 40 C 3200/5000	6800 (3 x 2200)	0.39	—	2.2	MJ 2500	—	3
4	6	B 40 C 5000/7000	10 000 (2 x 4700, 4 x 2200)	0.27	—	2.2	MJ 2500	—	2
5	7	B 40 C 5000/7000	10 000	0.22	—	2.2	MJ 2500	—	1.5
7	10	B 40 C 10 000	15 000 (3 x 4700)	0.27	0.27	2.2	MJ 2500	MJ 2500	2 x 2
10	14	B 40 C 10 000	22 000 (2 x 10 000, 4 x 4700)	0.18	0.18	2.2	MJ 2500	MJ 2500	2 x 1.5

fectively solves the problem, because the current through T1 is then proportional to the current supplied by the voltage regulator. If the 78XX regulator and T1 are mounted onto the same heatsink, the transistor is also thermally protected! The output voltage is dependent only on the type of voltage regulator used and, as drawn here, the circuit is

suitable for currents up to 2 A. If higher values are required, some components need to be changed according to the table. For currents above 7 A, transistor T1 must be replaced by two parallel-connected transistors each of which has an emitter resistor, R1 and R1' respectively. **M**

38

stay awake alarm

Do you turn over in the morning and then often oversleep? This circuit could prevent you being late for work, but it can also be used as an egg timer (soft-boiled only). When you first wake up, switch on this alarm: nothing happens at first, but after a time lapse of between 20 seconds and 4 minutes, adjustable by potentiometer P1, a soft warning tone sounds. If you're still awake, press the reset button. If you do not,

because you fell asleep again, the alarm tone, which is a lot louder than the warning tone will really tear you away from those dreams. You can press the reset button again and doze off for another alarm cycle, or if you're really awake you can switch the alarm off! Operation of the circuit is as follows: N5 functions as a clock generator for the seven-stage binary counter IC1. After every 16 clock pulses output Q4 of IC1 changes state from '1' to '0' or vice versa. After 128 pulses output Q7 is logic '1', but as Q4 is then logic '0', the output of gate N1 remains '1'. Now the inputs to N3 are '1' so the output of N4 is also '1' and this drives the audio oscillator consisting of N7, R5 and C4 which in turn drives transistor T2 and sounds the warning tone. Sixteen clock pulses later, Q4 again becomes logic '1', and the output of N4 becomes logic '0'. Audio oscillator N7 is cut off and the warning tone stops. At the same time, however, the output of N2

becomes '1' and actuates alarm tone oscillator N6. This drives T1 and the alarm tone sounds. After yet another 16 clock pulses, output Q4 is '0' again, and the output of N1 is logic '1'. Again, the warning tone is sounded. And so on... If the reset button is not pressed, output Q7 is again logic '0' after 256 clock pulses. The outputs of N1 and N3 both become logic '1' and N2 and N4, '0': both oscillators are now cut off and the situation is as it was on switch on. As the logic 1 level for the reset signal is taken from output Q7, the counter can only be reset via S1 when Q7 is 1. If you want to cheat, you can, of course, unsolder R3 from the IC and connect it directly to the 9...15 V supply. Neither T1 nor T2 conducts when the oscillators are off so this reduces the quiescent current to only about 0.2 mA. As shown, the current drawn is about 4.3 mA during the warning tone and 120 mA while the alarm tone sounds. The loudness of

both tones can be adjusted to meet individual requirements by changing the values of R6 and R7, but neither should be less than 10 Ω. The oscillator frequencies can also be varied by means of C3/R4 and

C4/R5 respectively. Instead of output Q4 it is also possible to use outputs Q3 or Q5. When Q5 is used, the change-over between warning and alarm tones takes twice as long as when Q4 is

used, whereas Q3 gives half the time lapse of Q4.

1

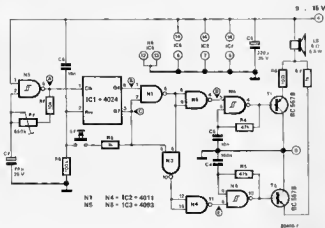

2

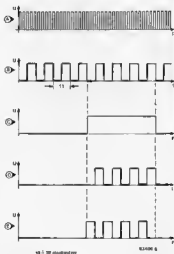

39

anti burglar lights

Burglars are often grateful for the fact that someone goes on holiday for a couple of weeks and leaves the home unattended. We often make it very easy for the burglar as well: if, for instance, no light is seen in the house for, say, a week, it is pretty certain that nobody is at home.

This circuit was designed to mislead potential burglars: the anti burglar light switches on one or more of the house lights when it gets dark and leaves them on for 1...5 hours. During that time the lights are switched on and off at random.

When darkness sets in, the resistance of the light dependent resistor (LDR) R1 increases causing the output of gate N6 to go to logic '0'. The point at which this occurs can be preset with P1. The reset input (pin 12) of counter IC1 is then also logic '0' and IC1 begins to count. The counter contains an internal clock oscillator the frequency of which is determined by capacitor C2, potentiometer P2

and resistor R4. P2 enables the adjustment of the frequency between 0.9 Hz and 4.5 Hz. From the time that IC1 starts to count, the output of IC1 will be logic '1' but the output of N7, and therefore transistor T1, will remain unaffected until a logic '1' also appears from N8. This will obviously be generated by IC2 and its associated gates. During the time that IC1 is counting it is feeding clock pulses to IC2. These are taken

from the Q9, Q10 or Q12 outputs (pins 13, 15 or 1) of IC1. The outputs of IC2 together with gates N1...N4, N8 and N9 form a quasi random generator that, via gate N7, controls transistor T1 and switches the house lights on and off. This hopefully puts off our burglar friend by giving the appearance that the house may not be as empty as he would have liked! After a certain period of time (1 to

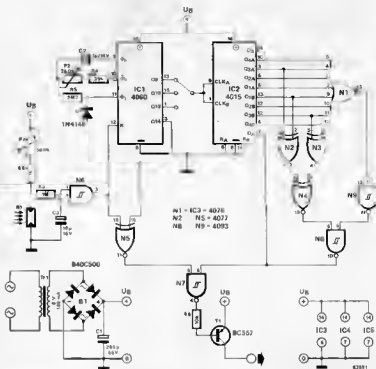

5 hours), output 14 of IC1 eventually returns to logic '1'. This causes a number of things to happen. Via diode D1 it stops the internal clock oscillator. This then holds Q14 at logic '1'. Now gate N7 is inhibited thus switching off the house lighting. All will remain at peace with the house (our phantom occupants are in bed) until the following evening when the process begins again. By now our less than happy burglar has gone off to less active residences! Calibration of the random generator is fairly simple. The sensitivity of R1, that is the light level at which

N6 decides to switch, is set by P1. The total operation time (of IC1) is set by P2 while the random 'pattern' is determined by which of the Q outputs of IC1 is used to clock IC2. If the random generator is not required then obviously IC2 and its collection of gates can be omitted. However, do not forget to connect pin 6 of N7 to the positive supply line. The house lights can be switched on and off by means of a relay connected to T1. Take care that the maximum current drawn by the relay

does not exceed 50 mA. In the event that more current is required at this point, T1 and the mains transformer must be upgraded. One final note. The LDR should not be mounted in a situation where street lights or car headlamps could cause false triggering of the circuit. If this should happen the house lights could go on and off all night. Our insistent burglar could come to the conclusion that there is an all night party going on and decide to join after all ...

40 A. Scragg

mains wiring tester

Here we have yet another simple circuit, consisting of two neon lamps (with built in series resistors) a push-button and an optional 100 k resistor. Can this circuit really be considered as a piece of 'test equipment'? Of course it can. In fact simple ideas are the ones that are

used over and over again until they become indispensable. Consider how simple a phase tester is! However, those devices can only show whether the 'live' mains connection is good or not, which leaves the user guessing about the negative and earth lines ... But not any more! The mains wiring tester shown here will enable all three lines to be checked by simply pressing a button.

When the circuit is connected to the mains both neons will light dimly. If the push button is now pressed one lamp will go out completely and the other will light properly. This in fact tells us three things: there is a phase present, the 'live' line is the one with the lit neon, and all three lines (live, neutral and earth) are working.

In correctly wired domestic systems, the live and neutral connections are known in advance. In this case a further 100 k resistor can be added

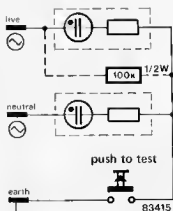

as shown. The lower neon should then light initially; operating the push button should cause the upper neon to light. Any other result indicates a fault!

41

very narrow crystal filter

Good filters can be expensive and a manufactured one with a band-pass characteristic as good as the circuit described here would leave you considerably lighter in the pocket. In spite of its performance, the circuit uses only standard components and is ideally suited for applications in CW receivers. As the circuit diagram shows, the filter is of the normal

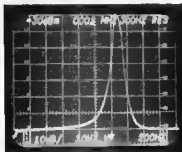
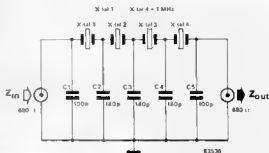

ladder configuration with standard 1 MHz crystals. However, ample proof of the performance is provided by the photograph taken on a spectrum analyser. It shows that the 6 dB pass-band is only 120 Hz, while that at 60 dB is only 400 Hz! The insertion loss of 4 dB is reasonable. Furthermore, as the tolerance of 1 MHz crystals is relatively small, the filter can be 'repeated' very easily.

42

P. von Berg

signal purifier for SSB telegraphy receiver

It is a well-known fact that the readability of radio telegraphy signals is often affected by interference. One of our readers therefore had the idea to design a circuit which will remove most of the interference. The (compressed) AF output of the receiver is fed to two tone decoders, IC1 and IC2, which are connected in parallel to increase the bandwidth. The pass bands of the tone decoders overlap to give a resulting pass band of 100Hz centred around 800 Hz. The exact position of the pass bands can be set with potentiometers P2 and P3. Ideally, the receiver used should have its optimum AF sensitivity at 800Hz.

The output of N1 will be logic 1 if a signal between 750...850 Hz is applied to the inputs of the tone decoders. As long as this situation continues, N2 will pass the output of an external oscillator to the clock input of counter IC4. This counter moves one step for each pulse. After 256 clock pulses its output Q9 will become logic 1, causing bistable FF1 to change state: output Q of this flip-flop will then become 1. Consequently, output Q of FF1 becomes 0, gate N3 is blocked and the counter resets. The counter does not react to pulses at its input as long as the reset input is held at a logic 1.

The fact that outputs Q9 of IC4 and Q of FF1 are logic 1 indicates that an AF signal was applied to the inputs of the two tone decoders 256 pulses before. As soon as the AF signal ceases the output of N1 (0) triggers MMV2. Output Q of this monostable then becomes 1 and causes bistable FF2 to change state. The consequent logic 0 at output Q of FF2 then allows IC5 to start counting. After 256 clock pulses its Q9 output becomes 1, thus clearing FF1 via N4. The Q output of FF1 going to a logic '0' indicates the end of the AF input signal plus a delay of 256 clock pulses.

When FF1 is cleared, its output Q becomes 1, so that NAND gate N3 'opens' counter IC5. The cycle can now start afresh.

The frequency of the external oscillator lies between 1 kHz and 30 kHz: because of the likelihood of morse signals being received, this frequency should be set so that the period of time taken by 256 clock pulses is shorter than the time taken by one morse dot.

If it happens that the output of N1 becomes logic 1 (due to an interference signal), it will become 0 again, to trigger monostable multivibrator MMV2, before IC4 has counted 256 pulses. This will clear MMV2 and via the output of N3 (logic 1) IC4 will stop counting. Flip-flop FF2 is not affected by the Q output of MMV2 becoming 1 because it is blocked by the Q output of FF1 via 'gate' D1/D2. The blocking of IC4 thus causes the interference signal to be eliminated.

When counter IC4 causes FF1 to change state after 256 clock pulses, FF2 is no longer blocked. If MMV2 is triggered by a negative interference voltage, FF1 changes state and causes IC5 to start counting. This counter then clears FF1 after 256 clock pulses. However, before the count has reached 256, the negative interference signal has ceased, which causes MMV1 to be triggered. Output Q of MMV1 becomes 0, output Q of FF2 becomes 1 and this blocks counter IC5. And that eliminates the negative interference...

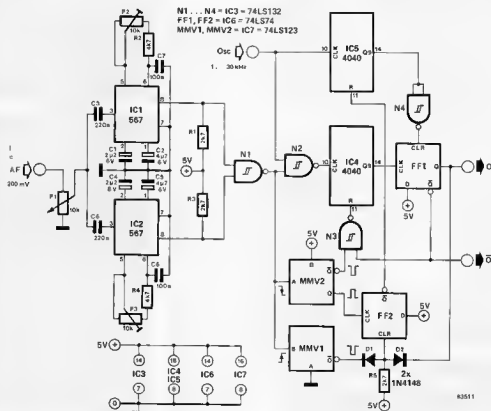

43

B. Darnton

horse paces simulator

In horse riding it is very important to know exactly what the horse is doing with its legs at all times. A simple electronic circuit can be used to demonstrate, with LEDs, an idealised order of footfalls to indicate when each foot comes to the ground. The only problem is how do you explain to your horse that he has been replaced by an electronic circuit?

The circuit diagram for this device is given in figure 1, and it is obvious that no complicated electronics are involved. Despite this simplicity the circuit does have a few nice features. Obviously every horse moves in a slightly different manner, and this also depends on the age and level of training of the horse (and its rider), so what we have here is an idealised version of how a horse moves. One LED is used for each foot; when the LED is lit the foot is on the ground. There are basically four different ways of moving catered for, walking, trotting, centering and galloping and each lights the LEDs in a different sequence. The speeds at which the LEDs are lit is also controllable and there is even a "one step at a time" mode.

The circuit contains a counter (IC2) driven by a 555 timer (IC1). The latter provides a clock signal, the frequency of which can be changed by varying P1, thus determining how fast the sequence of lighting LEDs is. The actual sequence is realised by the counter. The outputs of IC2 (pins 2, 3, 4 and 7) are connected to driver transistors T1...T4, the open collectors of which are connected to an encoding module. It is the design of this encoding module which determines which LEDs are illuminated at any particular time. Because there are four different sequences (walk, trot, center and gallop) there are also four different encoding modules. These can either be designed as separate entities to be plugged into the control board or all four can be incor-

porated into the control unit printed circuit board and switched using a 4 pole 4 way switch as shown. Each of these modules simply consists of wiring, with a different layout used for each.

Each of the counter outputs goes high (logic "1") in turn and this causes the appropriate transistors to conduct. This then drives the LEDs, D1...D4. Switch S1 is used to select either clock-controlled or step-by-step operation, and in this letter case S2 is used to advance to the next step.

D1 = right fore leg, D2 = left fore, D3 = left rear end, D4 = right rear leg.

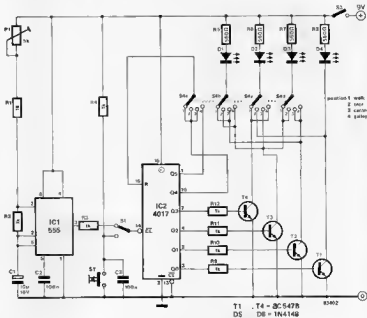

T1, T4 - BC547B
DS DB - 1N4148

44

video pattern generator

Focussing by eye is possibly acceptable with a B/W set but the resultant pattern will be an egg-shaped

'circle'. This haphazard method of tuning is totally out of the question with a colour TV set and a pattern generator is essential in this case. IC manufacturers Farranti saw the need for such a device and have introduced a complete video pattern generator on a single chip. When combined in a circuit with a few external components this IC delivers an excellent synchronization signal (CCIR standard) and five possible patterns. With S2 included in the circuit there are actually seven patterns available. The trick in getting an extra two patterns is quite simple. Considering that 'no pattern is also a pattern', white (switch position A) and black (G) are also

possible. The other patterns are (with switch positions of S2 shown in parentheses): vertical lines (B), dots (C), crosshatch (D), horizontal lines (E) and degrees of grey (F). The breadth of the vertical lines and the intensity of the shades of grey can be set with P2 and P1 respectively.

Mixing the video and synchronization signals is done by T1. Both the video signal and blanking signal (via D5) are supplied to the base of this transistor. The synchronization signal is set by means of P3 and P4 during the blanking signal (with T1 not conducting). The relationship between video and synchronization is set with P3, output level is set with P4.

Parts list

Resistors:
 R1 = 5k6
 R2, R3 = 10 k
 R4 = 330 Ω
 R5 = 2k7
 R6 = 3k3
 R7 = 1 k
 R8 = 68 Ω
 P1 = 10 k preset
 P2 = 100 k preset
 P3, P4 = 1 k preset

Capacitors:
 C1 = 470 μ /16 V
 C2 = 330 n
 C3, C5 = 100 n
 C4 = 47 p
 C6 = 1 μ /18 V
 C7 = 22 μ /16 V
 C8 = 22 p trimmer

Semiconductors:
 T1 = BF 494
 T2 = BC 547B
 D1 ... D4 = 1N4001
 D5 = 1N4148
 IC1 = 7805
 IC2 = ZNA 234

Miscellaneous:
 X1 = 2.5 MHz crystal
 F1 = 63 mA slow blow fuse
 Tr = 9 V 0.25 A transformer
 S1 = double pole mains switch
 S2 = single pole 12 way rotary switch

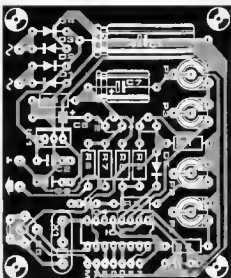
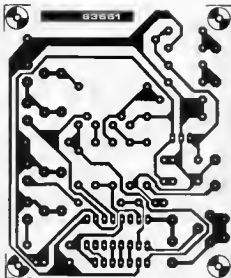

The signal output from this preset is again buffered by T2, so that with a load of about 75 Ω a signal of 1 V_{pp} is possible. The current consumption of the whole circuit is about 150 mA. The simple stabilised supply consisting of IC1 and the associated components can easily deliver this without the need for a

heat sink. Construction of this video pattern generator is simplified by the use of printed circuit board layout shown here. The power supply is also included on this board and only the transformer and switch S2 are mounted off the board.

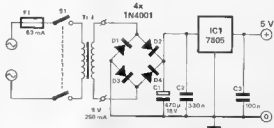
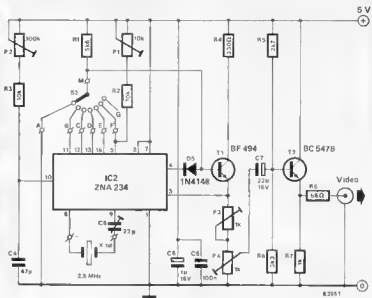
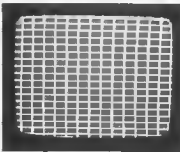
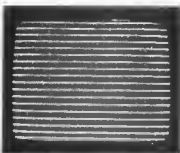

45

J. Glauser

car lights warning device

Anyone who has ever forgotten to switch the car lights off, after having driven in poor weather conditions, and returned later in the day to find the car battery flat will appreciate this circuit.

The circuit sounds a buzzer when you turn off the engine and have forgotten to switch off the head lights. When required, the circuit can be reset with push button S1.

This may be necessary, for instance, when you have your headlights on, get stuck in a traffic jam and turn the engine off to keep the carbon monoxide level down.

When you turn the ignition key and start the engine, the dynamo or alternator runs, relays are operating, the electric fan comes on, the automatic radio aerial extends... All these produce large voltage spikes

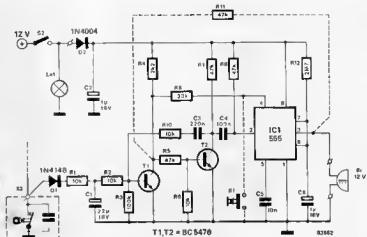

on the car's electrical system and any electronic circuit must be protected against these.

The circuit is connected to contact breaker S3 and the lighting switch S2. At first sight the use of the contact breaker as an indicator for 'engine running' may seem surprising but, during the testing of the circuit, it became apparent that if the ignition switch is used instead, the circuit will not work properly. The cause for this was found to be variations in the battery voltage.

The pulses from the contact breaker charge capacitor C1 via resistor R1. Once C1 is fully charged, there is a stable dc voltage at the collector of transistor T2: the trigger input (terminal 2) of the timer IC

(555) is then not driven. When the engine is turned off, C1 discharges, T1 is cut off and the base-emitter voltage of T2 rises. This causes the collector voltage of T2 to drop to 0. This voltage change is converted into a trigger pulse for the timer IC by differentiating network R9/C4.

The IC is then operative and causes the buzzer to sound; with values as shown the warning tone will last for three seconds. The time can be lengthened increasing the value of C6.

The circuit does, of course, not operate with the car lights switched off as it is powered from the car lights switch!

46

code-lock with door opener

Anyone who has ever locked him or herself out with the frontdoor key inside will appreciate the electronic door-opener described here. If you can memorize four digits in a row and do not mind an investment in an electric door-opener and a small electronic circuit, you will never need a frontdoor key again. The door can be opened by pressing the keys on a keyboard fitted beside the

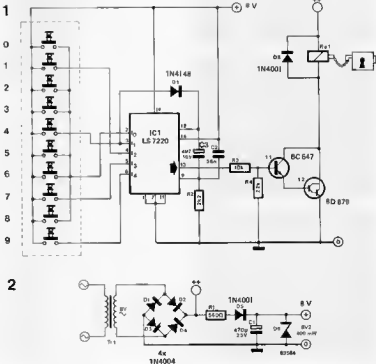

frontdoor. If you don't know the four-digit code, you cannot open the door. Of course, this doorlock cannot prevent the door being broken open, just as a normal lock cannot do so.

The electronics for this code lock is based on an integrated circuit specially manufactured for this purpose: the LS 7220.

The keyboard has ten keys for the digits 0...9, four of which are used to key in the code; they are connected to pins 3...6 of the IC. The remaining keys are connected to Reset input pin 2. The circuit

diagram shows the connections for code number 4179 (pins 3...6 determine the sequence of the code: in the sample, pin 3 is connected to key 4, pin 4 to key 1, and so on).

When the correct code is keyed in, output pin 13 of the IC connects the positive supply line to T1 and T2. These transistors then conduct and operate the door-opener. Resistor R2 and capacitor C3 determine the time during which the door-opener remains active. If the door is not opened during that time, the code must be keyed in afresh. If

required, this time can be lengthened by giving C3 a higher value.

The supply voltage for the circuit and door-opener can be provided by a commercial 8 V bell transformer in conjunction with a simple smoothing and stabilizing circuit as shown in figure 2. The electrical door-openers that are commercially available are normally operated by the AC output of a bell transformer, but will, of course, work perfectly well from the DC voltage provided by the supply shown. **M**

47

A. Bovee

DC-DC converter

When using a digital measuring instrument with another electronic circuit it is often necessary or desirable to completely separate the supply for the meter from that for the rest of the electronics. The problem can be solved by using two separate supplies, but it can also be done using a single supply and a DC-DC converter. The type of converter described here is quite compact and can deliver a current of about 50 mA.

The circuit consists of an astable multivibrator (IC1), which switches the voltage supply for a transformer (Tr1) on and off via a transistor (T1).

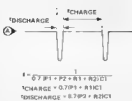
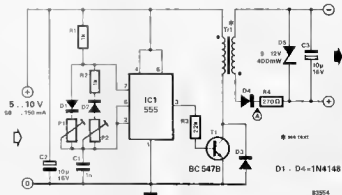

The transformer secondary voltage is half-wave rectified and smoothed. The output voltage is then limited by zener diode D5.

The transformer used should have a ratio between the windings of 1:1.

The firing transformer used for thyristors is ideal for the job, but a

small audio transformer (from a pocket radio) is also suitable. The frequency and pulse width of the circuit can be adapted to the type of transformer used by means of P1 and P2. Firing transformers give the best results at frequencies of about 100 kHz, while audio transformers usually work best between 0.5 and 40 kHz. The transformer must, of course, be connected with correct polarity.

The frequency is found as follows:

$$f = \frac{1}{0.7 \times (P1 + P2 + R1 + R2) \times C1}$$

$$t_{\text{charge}} = 0.7 \times (P1 + R1) \times C1$$

$$t_{\text{discharge}} = 0.7 \times (P2 + R2) \times C1$$

48

darkroom light

Working in a darkroom is always fraught with problems. You surely know Murphys Law of ..., but let's not go into that here. Suffice

it to say that normal lights cannot be used in a darkroom when photographs are being developed — not even if you drop your glasses!

The circuit here is a simple, inexpensive design for a darkroom torch (or light) that can be mounted in a case small enough to fit into your pocket even with a 9 V battery included. It gives enough light for note-taking or finding this or that in a darkroom, but the light is emitted by three special yellow LEDs which can safely be used near black/white or colour paper. Red LEDs are used for orthochromatic material (we had to look it up too, it means 'giving correct relative intensity to colours in photography'). An energy

saving circuit is included that automatically switches the lamp off when the ambient light is above a certain level.

The diagram for the circuit makes it look like a mini power supply. When the circuit is switched 'on' with S1 T2 conducts and provides, in turn, a base drive current to transistor T1. This transistor then supplies the base current for T2 via R5 and P1. Switching S1 'off' causes C1 to deliver a negative pulse to the base of T2 and this transistor then stops conducting. T1 also stops conducting and the LEDs go out.

The energy saving circuitry requires the addition of just one component, the LDR. When enough light falls

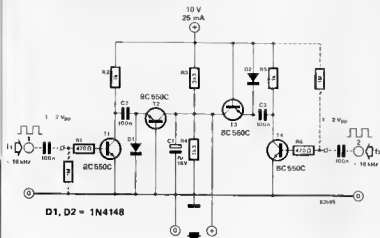

prevented by the activities of the other side of the circuit. Here the input at T4 drives another diode pump consisting of T3, C3 and D2 that is attempting to charge C1, again in short pulses that correspond to the frequency at input 2. The end result is that the charge level on C1 'averages' out to provide a reference level that is a comparison of the two input frequencies! It will be obvious that if the two input frequencies are the same, the charge and discharge cycles of C1 will be identical and therefore the voltage level across C1 will be equal to half the supply voltage. If the frequency of input 1 is lower than that of input 2, the reference voltage will be lower than 5 V. If input 1 has a higher frequency the reference voltage will be higher than 5 V. ■

51 cricket simulator

This simulator gives a faithful reproduction of the chirping of a cricket. The circuit comprises four oscillators of which the first, N1, produces the basic high note. The frequency of this note is set by potentiometer P1 such that it lies within the resonant range of the crystal buzzer: the tone is then loudest. To obtain the typical chirping noise, the 4 kHz square wave output of N1 is amplitude modulated by a frequency of 10...20 Hz. This frequency is produced by oscillator N2 and the modulation takes place in digital frequency changer N4. To make the and-result realistic, the 'cricket' must, of course, not chirp continuously but with suitable pauses. This is effected by oscillator N7/N8 and frequency changer N6. The oscillator output has a duty cycle ratio which is directly proportional to the ratio of the two sections of potentiometer P4, and can therefore be changed as desired. The duration of the total oscillator cycle is about 30 seconds, but because of tolerances this can vary appreciably. If the pauses can not be set long enough, C4 should

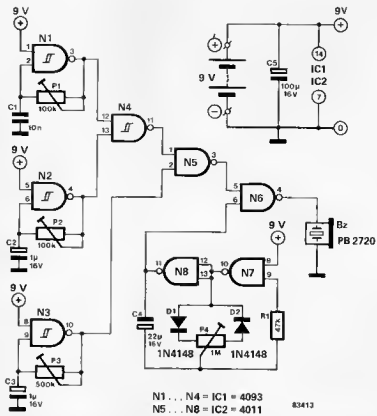

be replaced by a larger value. The initial adjustment to the circuit is that of P1 to achieve the basic tone. For this the buzzer must be connected directly to the output of gate N1 (pin 3 of IC1). The buzzer is then connected to pin 11 of IC1 and P2 is adjusted to obtain the typical chirping tone of a cricket. Next, connect the buzzer to pin 3 of IC1 and adjust P3 so that the chirping noise is heard three to six times per second, according to

taste. Finally, connect the buzzer to the output of the simulator and the (artificial) cricket is ready for use. Depending upon the value of C4 and the setting of P4, it may take a little while before the cricket emits its first chirp. As the current consumption of the circuit is only about 1 mA, the cricket can chirp away quite happily for a long while on a 9 V battery. ■

52

pulse/pulse train generator

This circuit has two modes of operation. If the pushbutton is just pressed once a single noise-free pulse appears at the output; the pulse can be positive or negative depending on whether the positive or negative output is chosen. If the push button is pressed and held then, after a short delay, a pulse train is produced which continues until the button is released. This dual-function operation makes this a very handy circuit which can be used, for example, where a counter must be driven either step-by-step or at a fixed

frequency.

The whole circuit consists of an anti-noise network (R2/C1), a pulse shaper (N1), an oscillator (N2) and two Schmitt triggers (N3 and N4) which enable it to produce both positive and negative pulses. When S1 is pressed once R2/C1 eliminate any interference which might be present (switching noise for example), and then Schmitt trigger N1 delivers a clean pulse which is further cleaned up by N3 (and ultimately N4) and finally appears at the outputs. If S1 is held longer, there follows a certain time delay (which can be varied by R4 and P1) to such a level that oscillator N2 starts. This gate then produces a pulse train signal whose

frequency is adjustable with P2. This pulse train then travels via N3 and N4 to the outputs.

R3 and D1 ensure that C2 discharges quickly so that if S1 is quickly pressed and released repeatedly the oscillator will not start. If the range of P1 is found to be too small then C2 can be changed for another value, and the same applies for P2 and C3. The approximate oscillator frequency is given by the formula

$$\frac{1}{(R5 + P2) \times C3}$$
 The actual frequency also depends on the triggering threshold of the IC used, and this can vary from manufacturer to manufacturer. Total current consumption of the circuit is only a few mA.

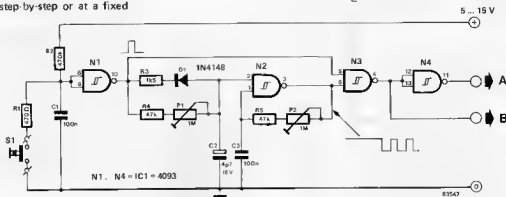
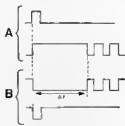

53

offset-less rectifier

In an active rectifier the offset of the op-amp can cause the rectified output voltage to be incorrect. This is especially bad in applications where precise measurement is essential. The offset can, of course,

be set to zero but this very correction can cause temperature changes and ripple in the supply voltage

which can cause even more problems. The rectifier circuit shown here is

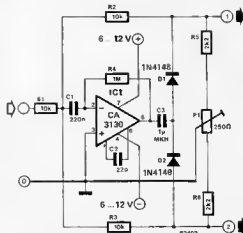

not affected by offset, because the input and output of the op-amp are isolated from d.c. voltages by means of two capacitors (C1 and C3). If the circuit is imagined without these two capacitors it appears as a normal active rectifier. The feedback for the positive half cycle is by means of D1 and R2, and feedback for the negative half cycle is via D2 and R3. R4 controls the d.c. setting of the op-amp. At the output we get the rectified a.c. voltage component of the input voltage supplied. Between output 1 and

output 2 the full rectified sinusoidal signal is available; the rectified positive half cycle is between output 1 and ground and the rectified negative half cycle is between output 2 and ground. In measuring these values the supply for the meter must be totally isolated from the supply for the op-amp. Note that IC1 reverses the phase of the input signal so the negative half cycle becomes positive (output 1) and the positive half cycle becomes negative (output 2). Potentiometer P1 is used to set the 'symmetry' of

the positive and negative regulated signals. For precision applications the whole circuit should be built using 1% tolerance resistors and the diodes should be compared to see that they have the same voltage drops. The maximum input voltage is 4 V_{pp}, frequency range is up to 20 kHz. The op-amp is powered by a symmetrical supply of between 6 and 12 V. Current consumption is very small (a few mA) so a battery could be used to power the circuit.

54

W. Meislinger

RC generator

This tone generator uses two RC networks (all-pass filters) connected in series to achieve the necessary phase shifting. The frequency range is from 20 Hz to 20 kHz and distortion is kept to a minimum by the extensive use of amplitude stabilisation.

Op-amps A1 and A2 are the bases for two phase shifting networks in the circuit diagram of figure 1. A stereo potentiometer P1 sets the frequency so that each network shifts the phase of the signal by 90°. Switch S1 selects the required range; 20 Hz ... 200 Hz, 200 Hz ... 2 kHz or 2 kHz ... 20 kHz. Op-amp A3 gives a further 180° phase shift and amplifies the signal so that the system will keep oscillating. Capacitor C5 is included in the feedback loop of A3 to suppress HF oscillation above 100 kHz.

The output of both A2 and A3 are rectified by diodes D1 and D2 before being passed, via P3, to the inverting input of A4. This op-amp compares the feedback signal to a reference voltage set by zener diode D4. The output of op-amp A4 causes the FET T1 (which acts as a variable resistor) to conduct to a greater or lesser extent. This controls the gain of A3 and maintains its output amplitude at a constant level. Capacitor C3 in the feedback loop of A4 integrates the input signal to this op-amp while C4 and R12 are included to suppress rapid fluctuations in the control system. Diode

D3 protects the FET against any high positive voltages.

The printed circuit board layout for the RC generator is shown in figure 2. C3 and C4 are mounted vertically on the board. The circuit requires a

symmetrical supply of between 10 and 15 V. Current consumption is about 8 mA (positive supply) and 12 mA (negative supply).

The circuit is adjusted as follows. Set P3 to its mid position and adjust P2

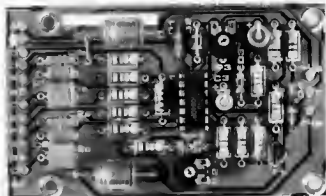
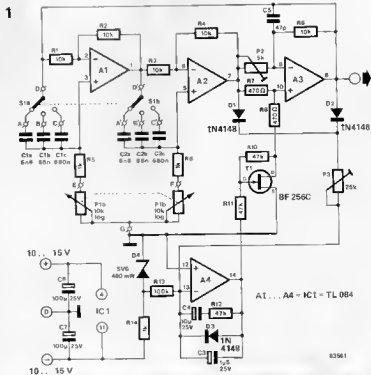

Parts list

Resistors:

- R1 ... R4, R8 = 10 k
- R5, R6, R14 = 1 k
- R7, R9 = 470 Ω
- R10 ... R12 = 47 k
- R13 = 100 k
- P1 = 10 k log stereo potentiometer
- P2 = 5 k preset potentiometer
- P3 = 25 k preset potentiometer

Capacitors:

- C1a, C2a = 6n8
- C1b, C2b = 88 n
- C1c, C2c = 680 n
- C3 = 1.5 μ/25 V
- C4 = 10 μ/25 V
- C5 = 47 p
- C6, C7 = 100 μ/25 V

Semiconductors:

- D1, D2, D3 = 1N4148
- D4 = zenardiode 5,6 V/400 mW
- T1 = BF 256C
- IC1 = TL084

Miscellaneous:

- S1 = 2 pole, 3 way rotary switch

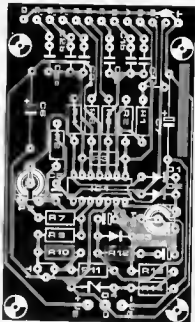
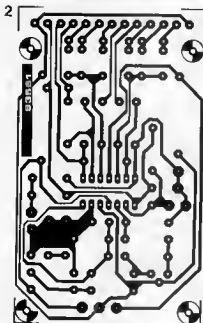

so that the d.c. voltage at the output of A4 is between -1 and -2 V. Then P3 is adjusted to provide an output voltage from A3 of 1.5 V_{rms}. The distortion measured in the prototype

was extremely low; at 1 kHz it was about 0.01%, rising to 0.03% at 20 kHz. At 20 Hz the distortion was 0.1%. Amplitude stability within any range was about 0.1 dB.

55

interior temperature control for cars

The single most important part of any car is its driver and it stands to reason that the better the driver, the better the overall standard of road safety will be. Of course we could just leave the car to its own devices with a bit of help from a computer, but we all know what computers can do... No, there are some things better left undone. The alternative is to help the human driver to do a better job. This circuit is not a design to produce perfect drivers but it does aim to improve the environment in a car.

Basically the circuit enables the desired temperature in the car to be set between two limits. The

ambient temperature is sensed by an NTC thermistor with a nominal value of 47 kΩ at 25°C. The value of the thermistor at any time is used to set the level at one of the inputs of an op-amp in the L121. This op-amp sets the triggering level of the internal logic which drives the IC output stage. Potentiometer P2 controls the second input of the

same op-amp and is used to adjust the temperature at which the circuit operates.

When the temperature inside the car increases the resistance of the thermistor decreases and the voltage on pin 3, the non inverting input of the op-amp, also decreases. After a period of time the level set by P2 is reached and the logic control

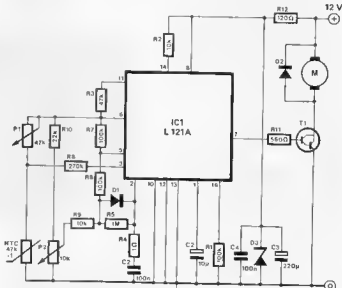

T1 = BOW 93; 80X 66; MJ 3001
D2 = 1N5406; 8A 133

circuit in IC1 is triggered. This drives transistor T1 causing it to conduct and switch on the cooling fan motor. Cool air is then blown into the car. As soon the temperature falls to a certain level, set with

P1, the circuit switches the fan off again. The circuit is powered directly by the car battery but zener diode D3 is needed as a protection against the spikes that always occur on car

voltage supply lines. Note that the thermistor must be mounted in a suitable location in the car (best found by trial-and-error).

SGS Applications

56

A.B. Bradshaw

VFO with variable inductor

An LC oscillator as shown in figure 1 is not exactly something new: transistor T1 is connected in a common base configuration and its emitter functions as virtual earth. Transistor T3 is a voltage follower buffer; its emitter voltage, in conjunction with the impedance of the series LC circuit, determines the collector current of T1. If therefore the resistive losses at resonance of the LC circuit are smaller than the collector resistor R4, the LC circuit will oscillate. The level of the oscillator output voltage across R9 is determined by the value of R9, the collector current of T1 and the current through R8. An LC oscillator with variable capacitor tuning has been around for some time as well: change C (C3) in figure 1 to a variable type and you'll be able to adjust the oscillator frequency over a certain range. An LC oscillator with variable inductor tuning as shown in figure 2 is not so usual. Two coils, L1 and L2, are mutually coupled (coupling factor, $k = 1$). If the currents through

2

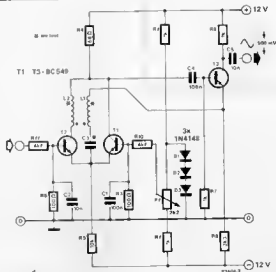

3



set for maximum resistance, T2 is cut off, L2 does not oppose L1 and the total self inductance of the circuit is maximum: the oscillator frequency is then minimum. When the base voltage of T1 is reduced, T2 begins to conduct, L2 starts to oppose L1 and the oscillator frequency rises. When T1 and T2 are balanced as far as dc supply is concerned, the self inductance of the circuit is theoretically zero: the consequent, infinitely high oscillator frequency is, however, unattainable because the oscillator has stopped long before this frequency is reached. In a practical circuit, with C3 = 500 pF and L1 = L2 = 365 μH, the oscillator can be tuned between 370 and 520 kHz; if C3 = 56 pF and L1 = L2 = 5.5 μH, the frequency range is 9...12 MHz. In view of the stringent requirements as to the magnetic coupling between L1 and L2, these coils must be bifilar wound as indicated in figure 3. For instance, a value of 365 μH is obtained when the number of turns, N = 191, wound on a former of diameter, d = 2 cm, and a coil length, l = 4 cm. The variable inductance oscillator instead of the familiar variable capacitance version is not just 'nice to know', but has sound practical applications. After all, it makes it possible to control frequency by means of voltage control of the base potential of T2: you can now tune the IF stages of an FM receiver visually, for instance, and in general you can sweep or wobblelate to your heart's delight!

the coils are in anti-phase, the magnetic field of L2 will oppose that of L1: the self inductance of L1 appears to become smaller. Therefore, the larger the magnetic field of L2, the higher the oscillator frequency. As the current through L2 is kept to a fraction of that through L1, the magnetic field of L2 cannot exceed that of L1. The reduction in magnetic field-strength is effected by replacing T1 in figure 1 by a long-tailed pair, T1 and T2, in figure 2. As you probably know, the collector currents in a long-tailed pair are in anti-phase; their ratio is determined by the dc voltage applied to the base of T1. This voltage is set by resistors R1 and R2, diodes D1...D3, and potentiometer P1. When the wiper of P1 is

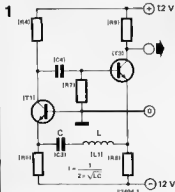

57

amplified triac drive

A well-known shortcoming of virtually all electronic components is their sensitivity to temperature changes. It is true that triacs are not too bad in this respect, but they do not like low temperatures: they just stop working! This is caused by the fact that triacs require a higher gate current at low temperature. Triacs are often triggered by opto-couplers which are not capable of supplying these higher currents. The circuit described, in contrast to 'normal' triac triggers, contains an amplifier which ensures sufficient gate current under all temperature conditions.

The amplifier is formed by transistor

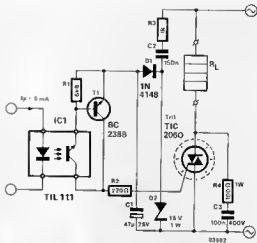

T1, which raises the signal from the opto-coupler to more than adequate level. The use of capacitor C2 as a 'dropping' reactance ensures that the dissipation in the drive circuit is virtually nil; it also prevents the circuit presenting a dc load to the mains supply. The switch-on current surge is limited to a safe value by resistor R3. As the drive circuit is supplied directly from the mains, the mains voltage must, of course, be reduced to an acceptable level. This voltage is therefore rectified by D1

and smoothed by C1. Zener diode D2 stabilizes the supply to the circuit to 15 V. As soon as transistor T1 conducts, capacitor C1 discharges via T1 and the triac gate, provides a gate current of about 40 mA. The discharge time, and consequently the trigger pulse, is not greater than 1 millisecond, RC network R4/C3 protects the triac against high voltage peaks.

Siemens application.



58

action flash

Vary fast acoustic electronic-flash releases as used by professional photographers and in quick-motion film apparatus for action filming are

beyond the means of most amateur photographers. Simpler acoustic releases are normally not fast enough: a picture of a burst balloon is not very interesting; one of a bursting balloon is!

If you want to film events which happen in a split second and which make a sound at the same time, the circuit described is just right for you. To make possible the filming of events which are over before the sound reaches the camera, we have designed a simple light barrier through which, for instance, a drop of water can be made to fall (see below). The level at which the electronic flash fires is then preset by either P1 (acoustical) or P2 (light barrier). The output is connected to

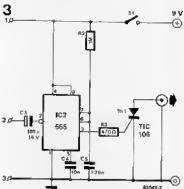

the timing input of the electronic flash unit. The power supply is no problem: as the current consumption of the circuit is only about 30 mA, a 9 V battery will last quite a time.

First a few words about the circuit. IC1, an audio amplifier IC, is used as microphone amplifier with a maximum amplification of 200. IC2 is used here as a monostable multivibrator. If a pulse caused by a noise input arrives at pin 2 of IC2, it triggers the multivibrator. The output of the multivibrator (at pin 3) triggers thyristor Th1 which in turn triggers the thyristor in the electronic flash unit. Where the light barrier is used, the part of the circuit to the left of terminals 1...3 in figure 1 is

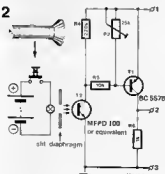
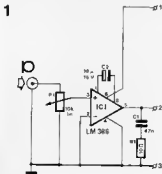

replaced by the light barrier circuit shown in figure 2.

And finally a few hints on the use of the circuit. When you are photographing (naturally, in a darkened room) a falling drop of water at the

moment of impact, try out various colour filters. A (dim) coloured light source can produce interesting effects. Try also to let the drop fall onto a mirror; if the photograph comes out well, it should be one

of the more remarkable ones in your collection. If unwanted reflections from the mirror spoil the photograph, try out various filters and also change the angle between the axis of the camera and the mirror. ■

59

temperature indicator

The temperature indication of a heat sink on a power transistor in high power circuits can be extremely useful. A simple, inexpensive temperature indicator would be ideal for this purpose since accuracy is not an important factor.

In the design for the temperature indicator here, the voltage drop across a diode that is held at ambient temperature is used as a reference level. The temperature detection is carried out by a transistor mounted on the heat sink and/or close to the power transistor in question. In the circuit diagram the temperature

detector is transistor T1 and its base emitter voltage is compared to the reference level at the junction of D1 and R1 via the preset P1. The transistor will remain switched off as long as its temperature remains below a certain level, a level that is effectively set by P1. The base emitter voltage of the transistor will drop by about 2 mV for a rise in temperature of about 1 degree Centigrade. When the base emitter voltage of the transistor drops below the voltage level at the wiper of P1 the transistor will conduct and light the LED D2. This will happen gradually and thus provide an indication over a fairly wide range. The values of R1 and R2 are of course dependent upon the supply voltage, U_b , and can be calculated as follows:

$$R1 = \frac{U_b - 0.6}{5} \text{ k}\Omega$$

$$R2 = \frac{U_b - 1.5}{15} \text{ k}\Omega$$

For optimum performance of the circuit it is important that the reference diode is situated in the free air at room temperature — definitely not above the heatsink! The transistor should be mounted on

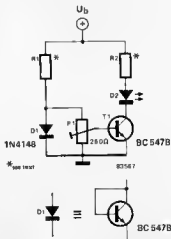

(or even in, if drilling the heatsink is acceptable) the heatsink as near the heat dissipating element as is practical. It must be remembered however that the maximum expected temperature should not exceed 125°C if you value your transistor.

The current consumption of the temperature indicator will be little more than the LED current, about 20 mA, and then only when things are starting to cook! ■

60

lie detector

The principle of a lie detector may be considered well-known: emotional states are not only betrayed by a faster heartbeat and trembling hands, but also by an increase in skin surface moisture. Because the skin becomes moist, its resistance will be lower, and it is this that makes the lie detector react. The lie detector described here actually gives two readings: one for when a 'guinea pig' is asked difficult questions and one

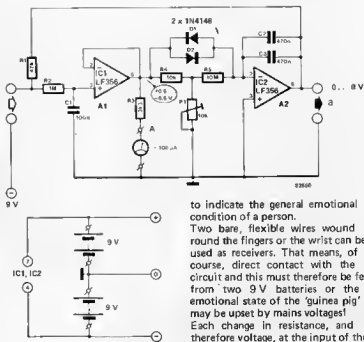

to indicate the general emotional condition of a person.

Two bare, flexible wires wound round the fingers or the wrist can be used as receivers. That means, of course, direct contact with the circuit and this must therefore be fed from two 9V batteries or the emotional state of the 'guinea pig' may be upset by mains voltages! Each change in resistance, and therefore voltage, at the input of the

circuit will be amplified by op-amp A1, which also acts as a buffer; its consequent output signal will cause a current through R3 and the meter which will give a reading. The most suitable meter for this purpose is the type used in FM receivers as tuning indicator: that is, with a centre zero. Capacitor C1 ensures the suppression of any hum present. The general emotional condition of a person can be ascertained by measuring the average resistance of the skin over a period of time. This

indication is provided by a meter connected to point B in the circuit. Op-amp A2 is connected as an integrator and enables the circuit to adjust automatically to the average skin resistance. The period of time during which the skin resistance must be measured is determined mainly by R5, C2 and C3. Until this time has lapsed, a meter (a universal meter is suitable) connected across output B will not give any reading, although diodes D1 and D2 ensure that the circuit reacts as quickly as possible.

Potentiometer P1 enables setting of the delay time of the circuit. Because the skin resistance varies from person to person, it may be necessary to alter the value of resistor R1. As a further refinement, this resistor can be replaced by a potentiometer if desired. Too high a reading on the meter at output B indicates that the skin resistance of the 'guinea pig' is low (which is characteristic of people with clammy hands) and it would be advisable to reduce the value of R1. ■

61

H.J. Walter

electronic pocket-pinball

This highly portable pocket-pinball game may not exactly be a substitute for its big brothers in the amusement arcades, but it still provides a lot of fun.

The circuit is relatively simple: three CMOS ICs, nine LEDs, six resistors, one capacitor, one push-button and a 9 V battery. Together with R1, R2 and C1, NOR gates N1...N3 form a clock generator whose signal is applied to decimal counter IC3. For as long as the player presses pushbutton S1, clock pulses are counted. When the button is released, the counter is inhibited for the incoming clock signals and only one of LEDs D1...D7 will light. The carry output of the decimal counter toggles flip-flops FF1 and FF2 which are configured as 2-bit binary counters. Depending on the counter status, the player is entitled to a free ball (LED D8 lights) or he can double the score (LED D9 lights).

Obviously, this simple circuit is not equipped with a points counter. The points gained by each player must therefore be noted on a piece of paper. The values are indicated next to the corresponding LEDs on the circuit diagram. If only one of LEDs D5...D7 lights, the ball is out of play; with '0' it was through the middle, and with '25' to the right or left. It is then the turn of the next player. If, however, D8

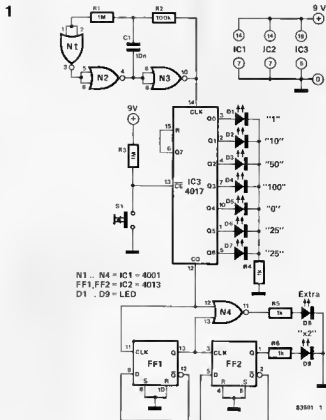

N1...N4 = IC1 = 4001
FF1, FF2 = IC2 = 4013
D1...D9 = LED

83591 1

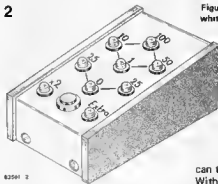

Figure 2. Front panel of our model. The white circle represents the pushbutton.

lights in addition to the '25' LED, the player has gained a free ball. He

can try his luck again. With a little care, the front panel can be designed with the LEDs positioned in such a way that the game resembles the full-scale pinball machine (figure 2). ■

62

R. Oppelt

simple sawtooth generator

Sawtooth generators are frequently required in most branches of electronics. We therefore feature a new design for the circuit which makes use of components which can be found in almost every box of goodies (or 'rubbish' to unbellavars!). The basic version of the circuit as shown in figure 1 uses a 9 V battery as supply. The circuit itself can be readily understood: capacitor C1 is linearly charged by constant current source T1, R1, P1. Transistors T2 and T3 are used as substitute for a silicon controlled rectifier (SCR) and if you bear this in mind, the circuit is somewhat easier to understand. The 'SCR' is not, as usual, fired by a pulse. Instead, the 'gate' is biased by voltage divider R3/D2 and once the 'anode to cathode' voltage ex-

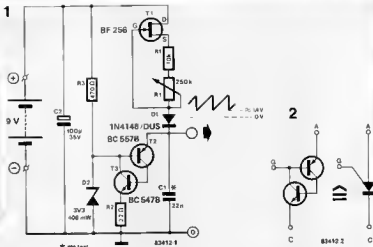

ceeds this bias, the 'SCR' conducts. C1 then discharges rapidly through the 'SCR' and current limiting resistor R2. When the voltage across the capacitor has dropped to about 1.4 V, the current through the 'SCR' has become low enough for it to cut off. C1 again charges and the cycle repeats. The resulting sawtooth output voltage is shown in figure 1. The frequency of the output voltage can be adjusted over a range of about 10^2 ; with the values shown the frequency range is 5... 500 Hz. The smaller C1, the more rapidly it will charge, and the higher the frequency. The circuit was tested in our laboratories with frequencies up to 100 kHz,

but higher frequencies are possible. The amplitude of the sawtooth voltage is determined by the 'gate' bias across zener diode D2 and it can therefore be modified by changing this diode. It should, however, be borne in mind that the zener voltage must not be more than half the supply voltage to ensure correct operation of the generator. If an exponential ramp is required instead of a linear one, T1 can simply be omitted and R1 connected directly to the supply voltage. C1 will then charge directly from the supply end automatically provide an exponential waveform.

63

optical voltage indicator

This circuit indicates, by means of a flashing LED, when a voltage being monitored or measured falls below a predetermined value. The only active component is an op-amp which functions as comparator and as oscillator. The voltage to be monitored is applied to terminal A and the reference voltage to terminal B. As long as the voltage at the non-inverting input of the op-amp is larger than

that at the inverting input, the output of the op-amp is 12 V and the LED does not light. If the voltage at terminal A, and therefore U^+ , drops below the reference voltage, U^- , the op-amp inverts and the LED lights. A feedback loop, R2/R1, causes U^- to be reduced somewhat. Capacitor C1 charges via R3 and the output of the op-amp. Diode D1 cuts off, so that the voltage at terminal B no longer affects U^- . When U^- has dropped

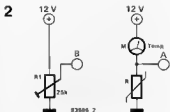
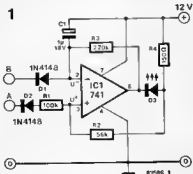

till it is just below the level of U^- , the op-amp changes state again, the LED extinguishes and, because of feedback via R2, U^- is increased a little. C1 discharges until U^- becomes just larger than U^+ ; the output of the op-amp becomes logic 0 and the LED lights again. In this way the LED will flash on and off as long as the voltage to be monitored or measured lies below a predetermined value. The circuit can be used, for instance, as a coolant temperature indicator in a car: if the temperature becomes too high, the LED will start to flash. For this purpose, the network shown in figure 2 is connected to the circuit in figure 1. The temperature indicator

(sometimes thermometer) and temperature sensor are already fitted in the car. Calibration is carried out as follows. Switch on the car electrics (but not the engine) at the ignition

switch. Connect across the temperature sensor a resistor with a value which causes the needle to just get into the red sector of the meter. Then adjust P1 so that the LED

just starts to flash. Do not forget to remove the resistor from across the temperature sensor once calibration is completed.

Siemens applications

64

heatsink thermometer

This thermometer was designed for measuring the temperature of a Crescendo power amplifier, but it can, of course, be used for other power amplifiers and indeed for other applications.

The thermometer does not only display the temperature of the heatsink on two displays, but it also provides a switched output which, for instance, can be used to switch on a fan if the temperature rises above a pre-determined value.

The circuit consists of four parts: a reference voltage source, IC1, the sensor, IC4, the display section, IC2

and IC3 and the switch section, IC5. IC1, a 723, provides a stable supply voltage for the sensor and switch section. This voltage is about 8 V. The temperature sensor provides a temperature dependent voltage of 10 mV/K. At 0°C, for instance, the voltage across IC4 amounts to $273 \times 0.01 = 2.73 \text{ V}$ (0°C = 273 K). The display section is constructed around two old faithfuls: ICs CA 3161E and CA 3162E. IC2 contains the A/D converter and the multiplexing circuit for the displays. IC3 is the BCD seven-segment decoder driver. Only two displays are used, so that the temperature can be read in degrees. IC2 measures the difference between the voltage provided by the sensor and the reference voltage set by pot P1.

This is necessary to eliminate the '273 degrees below 0', that is, the voltage of 2.73 V. To make this possible, the read-out section and the measuring/switching section are powered separately. The earth of IC2 and IC3 is connected to the wiper of P1 which is at a potential of 2.73 V, while the input of 'meter' IC2 is connected to sensor IC4. In this way, the 2.73 V is compensated so that the voltage measured by IC2

Parts List

Resistors:

- R1, R4 = 470 Ω
- R2, R5 = 2k2
- R3 = 68 Ω
- R6 = 18 k
- R7 = 8k2
- R8 = 5k6
- R9 = 33 k
- R10 = 22 k
- R11 = 15 k
- P1 = 2 k 10 turn preset
- P2, P3 = 10 k 10 turn preset
- P4 = 50 k 10 turn preset

Capacitors:

- C1 = 470 μ/25 V
- C2, C5, C6, C8 = 4 μ/7/10 V tantalum
- C3 = 100 μ/25 V
- C4 = 100 p
- C7 = 270 n

Semiconductors:

- D1...D8 = 1N4001
- LD1, LD2 = 7750, 7751 (CA)
- T1, T2 = BC 559B
- T3 = BC 547B
- IC1 = 723
- IC2 = CA 3162E
- IC3 = CA 3161E
- IC4 = LM 335Z
- IC5 = LF 356
- IC6 = 7805

Miscellaneous:

- Tr1 = mains transformer 2 x 9 V/0,5 A (isolated secondaries), heatsink for IC6

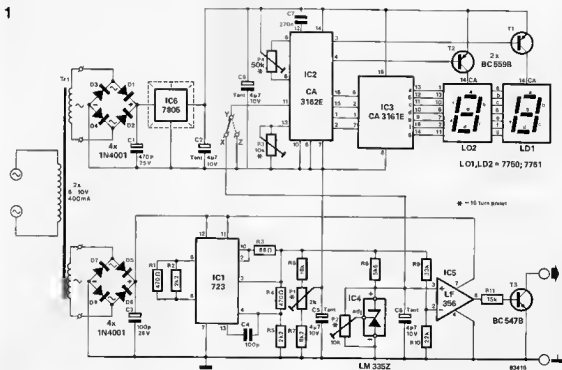

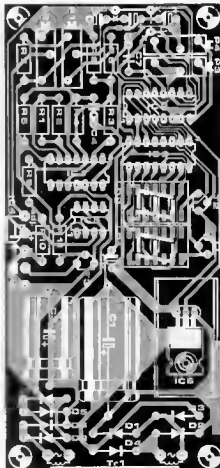
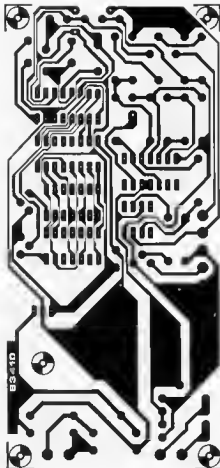

rises at 10 mV per degree centigrade from 0° C and the displays read degrees centigrade.

The last, but not least, part of the circuit is the comparator and switching output (IC5 and T3). The voltage provided by the sensor is compared by IC5 with a voltage derived by R9 and R10 from the reference voltage of IC1. When the sensor voltage rises above this secondary reference voltage, the output of IC5 changes state and the transistor conducts. T3 can, for instance, by means of a relay switch on a fan to provide additional cooling of the power transistor. It is also possible to switch off the loudspeakers by means of the protection relays in the amplifier, so that the dissipation in the power transistors is greatly reduced, assuming, of course, that the loudspeaker drive was the cause of the overheating! With values of R9 and R10 as shown, the comparator changes state at about 80° C. This depends also, of course, on the reference voltage provided by IC1 which has quite a tolerance. The temperature at which IC5 changes state can be altered by changing the value of R9. If the thermometer is built on the printed circuit board shown, nothing

much can go wrong. It is important, however, that the earth of the supply for IC1, IC4 and IC5 is connected to the earth of the power amplifier. The power supply for the thermometer must be self-contained with a transformer having two isolated secondaries. The sensor must be fitted as close as possible to the power transistors on the heatsink.

If you want to build the circuit on a board of your own design, bear the following points in mind. The two power supplies must be kept isolated from one another. The only two connections between the meter and the measuring section are clearly indicated on the circuit diagram. IC2 and IC3 have a separate supply line from the output of the 5 V regulator, while the emitters of T1 and T2 must have a separate supply line from the output of IC6. IC3 must have its own 0 V line from the regulator. These precautions are necessary to prevent IC2 being affected by interference caused by high peak currents occurring during the multiplexing of the two displays.

An accurate, preferably digital, meter is required for adjustment of the thermometer. First link Y and Z together and adjust pot P4 to obtain a reading of 00 on the displays. Then

remove the link and apply a d.c. voltage of about 0.9 V to Y. Next adjust P3 to obtain a display of the same value as that at Y (measured with the accurate meter!). Bear in mind that the last digit is not displayed! For instance, if the voltage at Y is 883 mV, the display will read 88. Then link Y and X together. Measure the voltage across C5; if necessary, this should be adjusted to 2.73 V with pot P1.

As regards the temperature sensor, if you're happy with an accuracy of about 3° C, pot P2 can be omitted. If you want a more precise thermometer, the sensor should be immersed in melting ice and P2 adjusted to give a display of 00. It is also possible to immerse the sensor in water at about 37° C, and measure the temperature of the water with a clinical thermometer. P2 is then adjusted to give a display equal to the reading of the clinical thermometer.

If it is required that the loudspeakers are switched off at temperatures above 80° C, the collector of T3 should be connected to the base of T5 in the protection circuits described in 'Accessories for the Crescendo power amplifier' featured in our January 1983 issue.

65

on/off with a single push button

A very useful function expressed in a simple circuit that is suitable for many applications. Basically the output of the Schmitt trigger N1 changes (toggles) when the switch is closed momentarily. This toggle function is achieved in such a simple circuit by the fact that the inputs of the trigger are held between the switching threshold levels. If we assume that the output logic

level (Q) of the trigger is at logic 1, capacitor C1 will charge via R1. When switch S1 is closed the input of the trigger will now be taken to logic 1 (because the capacitor is fully charged) and the Q output will of course become logic '0'. The capacitor will now discharge but not completely because the closed switch will hold the level at that existing at the wiper of P1. However this drop in voltage at the input of the gate will not cause its output to change state again because the input level will still be above the lower switching threshold of the Schmitt trigger.

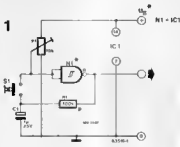
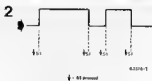

This "intermediate" voltage level will remain while the switch is closed. When the switch is eventually released, C1 will then discharge completely. The 0 V across the capacitor will not effect the trigger since it is no longer connected to the capacitor (the switch is open). Now when the switch is closed the 0 V will reach the input of the gate and its output will once again change state. It is essential that P1 is set correctly for the circuit to function but it will be found in practice that this presents no problem.

Various types of Schmitt trigger are suitable for this circuit: 4093, 40106, 74LS14, 74LS132. If TTL ICs are used, the supply voltage must be $5V \pm 0.25V$; for CMOS ICs it should lie between 5 V and 15 V.

66

inexpensive 45 MHz crystal filter

A receiver with an intermediate frequency, IF, which is higher than the highest received frequency, f_{cr} , has the great advantage that the separation between the received frequency and the image frequencies, $f_c \pm 2f$, is large. A filter with a high centre frequency and narrow pass-band which is eminently suitable

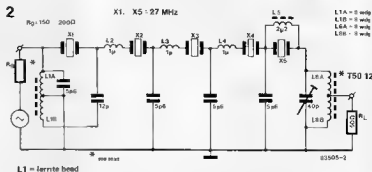

for SSB reception can be built from relatively few components. Oscillator crystals often have one or more spurious resonances and this makes their application in filters undesirable because of the risk of unwanted pass-bands. The broader the filter response, the greater this risk becomes. It is possible to use 27 MHz third-overtone crystals (standard in most CB equipment) in their fifth overtone mode. Figure 1 shows the circuit

of a coarse 45 MHz filter using two 27 MHz crystals. The photo shows that the attenuation outside the passband is far from satisfactory: there is hardly any difference between the required and the unwanted passbands. With the use of more crystals, the pass-band of the filter becomes narrower and the likelihood of spurious frequencies coinciding becomes smaller.

Figure 2 shows the circuit of a ladderfilter using five crystals, which reduces the likelihood of spurious pass-bands greatly. The 6 dB bandwidth of the filter of figure 2 is about 3 kHz, while that of the 40 dB points is only 5 kHz. The input impedance, R_g , lies between 150 Ω and 200 Ω and the output impedance is 50 Ω . Its insertion loss is 7 dB.

Coil L1 is a bifilar winding of 2 x 8 turns of enamelled copper wire of 0.2 mm diameter. As this coil is

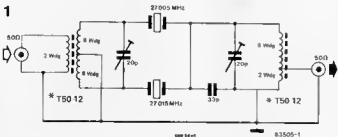

not critical, it may be wound on a ferrite bead. Moulded RF chokes may be used for L2 . . . L5. Coil L6 is again a bifilar winding, 2 x 8 turns, enamelled copper wire of 0.2 . . . 0.5 mm diameter on a T50-12 former. The filter can be built on a small piece of Vero board. The coils must be screened from one another by earthed screens. The crystal housings must also be earthed.

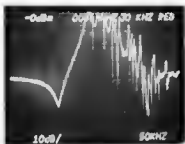

Further signal processing is best done at a much lower second IF of, say, 10 kHz, obtained by mixing the 45 MHz IF with the output of a crystal oscillator operating at 45 MHz ± IF2. The oscillator can also use a CB type third overtone crystal operating in its fifth overtone mode.

67

low cost CMOS lock

A decimal keypad, a CMOS IC, three transistors and an opto-coupler . . . that is about all that is needed to make this electronic lock with a three digit combination. Locking is achieved by means of a cascade of analogue switches, each of which is connected, through a programming matrix, to one of the keys on the keypad. Suppose line A is connected to key 2, line B to key 9, and line C to key 5. If key 2 is now pressed ES1 closes and stays closed because of the current delivered to it through R7. If key 9 is then pressed ES2 closes and remains closed (because ES1 is already closed). Now all that is needed is to press key 5, whereupon ES3 closes thus activating the opto-coupler, whose transistor then conducts.

The keys not used in the ABC code must all be connected to the D line. When one of these keys is pressed, in error or in ignorance, line D sets ES4 to an active high logic level (which it keeps because of R6) and T1 conducts and thus disables the circuit completely; in fact even if ES1 is again activated, by the relevant key, it will not auto-hold as long as T1 is conducting. To start again, pushbutton S1 must first be pressed, thus opening ES4 and blocking T1. It is also useful to be able to reset the lock externally and this is achieved by means of T2, which is connected parallel to the reset circuit and controlled by the # key. Key # could be used as an

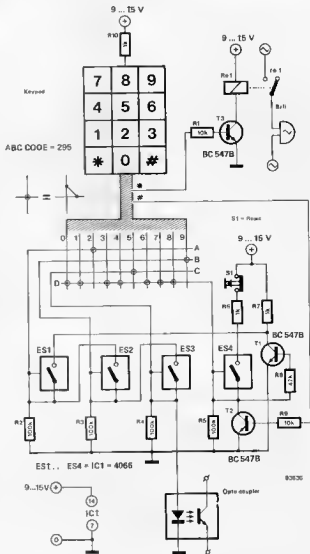

ordinary bell push, activating relay Ra through transistor T3; thus driving the bell transformer. One further word about the operation of the lock: consider again our combination of 295, and assume that the first key pressed was not 2 but 9, which is not wrong, merely misplaced. The 8-9 connection

causes ES2 to close but it cannot remain closed when key 9 is released because ES1 is open. An opto-coupler is used here in preference to other alternatives which might be chosen in other applications, and proves to be simple, inexpensive and effective in this circuit.

68

glitch suppressor

A 'glitch' is a very short duration pulse usually caused by the differences in path times of various signals in a digital circuit. They can be the very devil to find (if at all) and create havoc in complex digital circuits. The circuit described here was designed to suppress glitches in the output signal of a word recognizer, where it is essential that the logic analyzer is not triggered by the spurious signals.

The circuit consists of a monostable multivibrator (MMV) and six inverters. If pin B of the MMV is connected to +5 V (wire bridge

in position 2), glitches will not be detected. A signal at the input of N1 is inverted and applied to inputs $\bar{A}1$ and $\bar{A}2$ of the MMV. The multivibrator is triggered by the leading edge of the input signal and emits a pulse of about 7 μ s (duration determined by the values of R1 and C1).

With the wire bridge in position 1 as shown, the circuit will suppress glitches of 80 ns and shorter, a time based on the delay line in inverters N1 ... N6. The output of N6, and consequently the input at pin B of the MMV, is logic 0. As long as this situation persists, the MMV will not

react to signals at its inputs $\bar{A}1$ and $\bar{A}2$. If a pulse appears at the input of the circuit, it will arrive at inputs $\bar{A}1$ and $\bar{A}2$ after about 10 ns (that is, the delay of N1).

After about 90 ns the pulse will arrive at the output of N6, so that this output, and therefore input B, becomes logic 1 and inputs $\bar{A}1$ and $\bar{A}2$ are 'open'. If the input pulse is shorter than about 80 ns, it is no longer available at $\bar{A}1$ and $\bar{A}2$ by the time the delayed pulse arrives at input B. In this way the MMV will only pass signals which are longer than 80 ns.

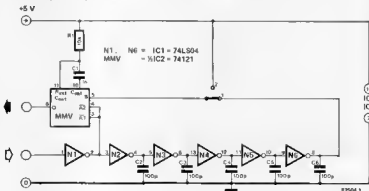

87504 1

69

R. de Boer

window comparator

This window comparator uses only three CMOS inverters, two resistors, two preset potentiometers and one diode. Of course, the simplicity of the circuit means that some concessions must be made with regard to quality. High-frequency input signals with short rise and decay times cannot be properly processed. Nevertheless, the circuit provides an inexpensive and simple alternative to the usual window comparators. The circuit itself (figure 1) does not require much of a description. The switching thresholds are adjusted with preset potentiometers P1 and P2. The adjustment of P1 governs the lower switching threshold U_L , whilst that of P2 governs the upper switching threshold U_H and thus

1

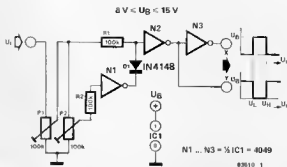

83610 1

establishes the window width $U_H - U_L$. Figure 2 clarifies the function of the circuit. The voltage values indicated apply to a supply voltage of 10 V. A triangular voltage is shown at the input of the window comparator, as well as the output voltage at point X. If the input voltage exceeds the lower value U_L set with P1, the voltage at output X goes to logic 1

via inverters N2 and N3. If the input voltage reaches the upper threshold U_H set with P2, inverter N1 ensures that the voltage at output X goes to logic 0 again. The output remains in this state until the trailing edge of the input voltage drops below U_H again and the output goes back to logic 1. It reverts to logic 0 as soon as the input voltage reaches the lower threshold U_L .

2

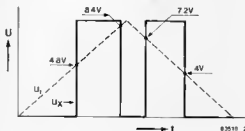

83510 2

70

sea murmur simulator

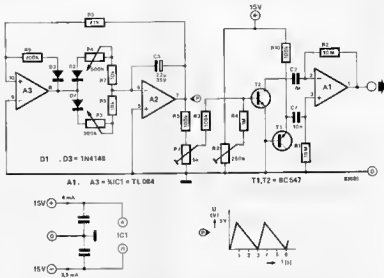

The heart of the circuit is the 'murmur source' consisting of T1 and R10. This produces a signal which is amplified in voltage controlled amplifier A1 and the following external AF amplifier.

Transistor T2 is used as a current-controlled resistance which controls the amplification of A1: the smaller the resistance, the stronger the output signal.

The loudness of the surf also depends on the output of the triangular pulse generator consisting of integrator A2 and trigger A3. The output of the trigger is connected to the input of the integrator. Diode D3 is included to prevent the output signal of A3 going negative. This is necessary otherwise the lower parts of the triangular waveform from T1 would then be cut off and instead of a regularly increasing and dying down of surf you would have nothing but interrupted breakers. The slopes of the triangular signal can be adjusted by means of potentiometers P3 and

P4. Diodes D1 and D2 allow the positive and negative slopes to be adjusted independently. The potentiometers also determine the frequency: the smaller their total value, the higher the frequency. The ratio of the two potentiometers determines the symmetry of the signal. During the calibration of the circuit, connect the wiper of P1 to earth and then adjust P2 for a soft murmur in the loudspeaker. If P2 is opened further, the volume should increase. The background 'whispering' of the sea is now set. Disconnect the wiper of P1 from earth and vary the setting of the potentiometer. The sound of the breakers should then increase and die down at the frequency of the

oscillator. Then adjust P2 until possible clipping is avoided. Bear in mind that P1 and P2 affect each other so that further fine adjustments may be necessary. Now the 'shape' of the waves can be adjusted with P3 and P4. Experiments have shown that a wave normally lasts a couple of seconds from crest to crest. The rise is usually 5 to 10 times shorter than the fall and the required wave shape is therefore more a sawtooth than a triangle. Setting P3 to about 470k and P4 to around 100k gives a wonderfully realistic effect. These components are variable because this enables the circuit to be used for other applications, for instance, as a steam locomotive simulator. M

71

W. Schaaij

busy indicator for the Junior Computer

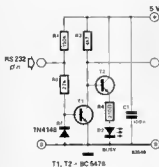

RS 232 printer interface and a few minor changes to the Printer Monitor software.

As can be seen from the diagram, the additional circuit is not very extensive. The input of the circuit is provided by the 'busy' signal from the printer which is available at pin 11 of the RS 232 connector. The first transistor, T1, serves as a level

interface between the RS 232 and TTL.

When the input voltage is positive (logic '0') T1 will conduct and pin PB6 of the V1A will also be at logic '0'. When a busy signal is received from the printer, the input will become '1', T1 will switch off and the PB6 line is taken to +5 V by R3. Transistor T2 will conduct and light LED D2 provides the 'printer busy' indication. Resistor R1 ensures that no busy signal is given to Junior (and the LED cannot light) if the input is open circuited.

The modifications to the Printer Monitor EPROM are:

after 133A	20	F4	14	JSR BUSY
				.
				.
add 14F4 BUSY	AD	00	18	LOA PBOVIA
14F7	29	4E		AN0IM 548
14F9	08	F9		PB6 VIA = 97
14FB	A0	B2	1A	LOA PBOPIA
14FB	68			RTS

A 'busy' indicator can be useful if a printer is being used with the Junior computer. It simply requires the addition of a small circuit to the

72

simple stabiliser

This is a very simple but nonetheless reliable stabiliser circuit which can be used in place of a 78XX series IC regulator.

The heart of the circuit is based on a type CA3130 operational amplifier, A1, and one transistor. The reference voltage, U_{ref} , is derived from the output by means of R1 and zener diode D1 and is therefore very stable. Operation

is simple: if the output voltage, U_{out} , shows a tendency to rise, the potential difference at junction R2/R3 will increase. The voltage at the non-inverting input of A1 will then become higher than that at the inverting input, because the latter is held at U_{ref} by zener D1. The output of A1 therefore increases resulting in T1 being cut off and in a reduction in the output voltage of the stabiliser. If U_{out} drops below the nominal value, the above operation is reversed. The advantage of this circuit is the low voltage drop between input and output, which is dependent solely on the saturation voltage of T1. The unstabilised input voltage does not therefore need to be more than 0.5 V higher than the required output voltage.

The calculation of the various parameters is simple: assuming a current of 1 mA through R2/R3 and a zener current of 5 mA, we arrive at the following formulas which everyone can compute without even a pocket calculator.

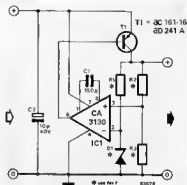

$$R_1 = 0.2 \times R_2 \text{ (k}\Omega\text{)}$$

$$R_2 = (U_{out} - U_{ref}) \times 1 \text{ k}\Omega$$

$$R_3 = U_{ref} \times 1 \text{ k}\Omega$$

in which U_{out} is the required, stabilised output voltage and U_{ref} = U_{D1} which is slightly lower than U_{out} . If, for instance, a stabilised output voltage of 8 V is required, the following values are arrived at: U_{ref} = 6.8 V; R_1 = 220 Ω ; R_2 = 1k2; R_3 = 6k8.

73

electronic switch for audio signals

The complexity of the problems associated with switching audio signals is proportional to the sophistication of the playback system. In this field all roads lead to the mixing desk where the bundles of cables start or finish. The same signal must be sent, for example, to the control amplifier (monitor), the tone correction stages, the special effects stages, an output amplifier, a tape recorder... and so on. In other words there are cables everywhere! So either the cables must frequently be moved from one place to another or some form of switching mechanism is needed. Mixing desks often have mechanical switches for this but these are far from ideal simply because they are not of high enough quality. Electronic switches, on the other hand, provide a very satisfactory solution and are devoid of clicks and

other such undesirables.

The circuit consists basically of two integrated circuit analogue switches controlled by two push buttons. In the rest state the voltage at point C (the control input of switch ES1) is low. When the 'on' button is pushed the voltage rises and reaches the switching threshold of ES1, which then closes. When the pushbutton is released the control input of ES1 remains at almost the same voltage as before because, in closing, the switch completes the circuit which ties its control input to +15 V via R3. The switch is then latched and stays closed.

Pressing the 'off' button causes the control voltage to decrease and ES1 opens. The circuit is then at rest again.

The output of ES1 controls switch

ES2, through which the signal to be switched passes, so switching is simply a matter of pressing the right button.

The control signal provided by ES1 could be used to simultaneously open or close several analogue switches, either carrying the same signal in different directions, or different signals in the same direction. Two of these parallel switches (ES3 and ES4) are shown dotted.

This simple circuit makes no pretensions to being perfect; the problems posed by switching a sinusoidal audio signal during its cycle (rather than when it crosses zero), are not soluble by such a simple circuit, but by the same token it is far better than what is often hidden under the shiny surface of many a 'Hi-Fi' mixing desk!

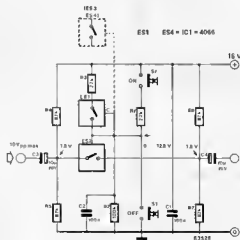

74

Nigel Humphreys

vector control for the Junior Computer

The circuit described in this article makes it possible to read out the necessary vector data from the standard EPROM of the Junior Computer, without having to give up a considerable part of the address range and/or requiring an additional ROM. The vectors for NMI, RES and IRQ are located at the addresses FFFA...FFFF. The complete memory range of F000...FFFF would be 'sacrificed' for 6 bytes if the above vectors were to be read out of the standard EPROM according to the method described in the Junior Computer Book 3. This means a loss of 4 K memory location. With the solution described here, only 16 bytes are reserved to read out these 6 bytes. Obviously, this circuit is only needed if the constructor

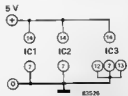
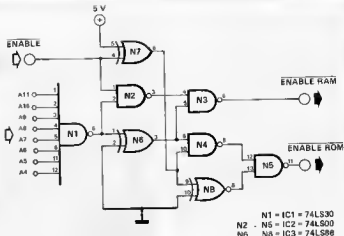

wants to put RAM in the upper memory range of F000...FFFF, for example if the mini EPROM card (Elektor April 1982) is used. The circuit only consists of 8 gates. It generates two separate enable signals out of an 'ordinary' enable signal, for this highest 4 K range. A new ENABLE RAM signal is given at addresses F000...FFFF. However no ENABLE ROM signal is given at addresses FFF0...FFFF,

but an ENABLE ROM signal is sent to the standard EPROM of the Junior Computer.

The complete circuit can be mounted onto the corresponding RAM card because it only consists of three ICs. The old ENABLE line for the range F000...FFFF of the address decoder on the RAM card (which is output F of IC11 on the dynamic RAM card) is connected to the 'supplement/additional' circuit and the eight inputs of N1 are connected to the address lines A4...A11. A new ENABLE RAM signal will therefore go to the RAM card, which means that this line is attached to one of the points V, W, X or Y of the dynamic RAM card. The ENABLE ROM line must be linked to K7 (pin 14a) of the connector. ■

75

four quadrant multiplier

This four quadrant multiplier can be built using just one op-amp and the amplification factor can be preset with a potentiometer.

The input signal, U_1 , is applied to the inverting input of the (741) op-amp via resistor R1. As $R1 = R2$, the signal is amplified by a factor 1. However, U_1 is also applied to the

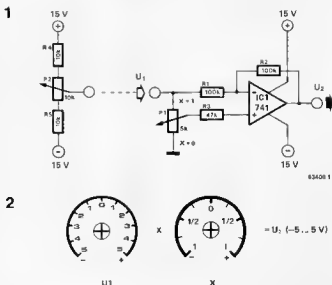

non inverting input of the op-amp via potentiometer P1 and resistor R3, therefore the signal level at the non

inverting input is determined by the position of P1. The resulting total output voltage is given by

$U_2 = (2x - 1)U_1$, where x represents the position of P1. For example, with the wiper of P1 fully clockwise ('up' in the circuit diagram) $x = 1$, in the mid position $x = 0.5$ and fully anti clockwise

$x = 0$. It should be noted that U_1 may be a d.c. or an a.c. signal ($f_{max} = 5 \text{ kHz}$). By adding an extra potentiometer P2, as shown, the circuit can also be used as an 'analogue hand-held multiplier'.

The input level can then be preset with P2 and the multiplication factor with P1. Both potentiometers can be provided with a scale as shown. **M**

76

microprocessor aid

Faultfinding in microprocessor systems is an arduous and time-consuming task. It would be a great help if it were possible to display the information on the data and address bus of the processor. And that is exactly what the circuit described here does: the conversion of data and address into hexadecimal code onto six displays.

The displays are controlled by an IC which combines all the necessary functions: the 9368. This IC accepts a four-bit binary code, converts it into the corresponding hexadecimal number and makes it visible on a seven-segment LED display. A latch 'memory' is also provided and the LED display is controlled directly by the IC. From figure 1 it will be seen that, apart from the six ICs and six displays, nothing further is required. The power requirement

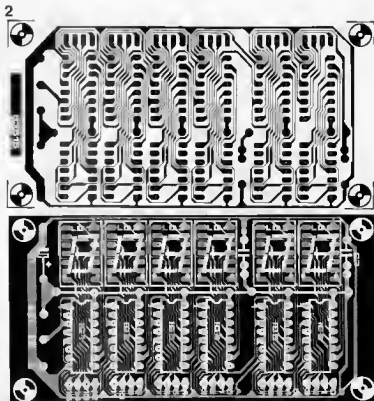

is 5 V at 750 mA. The printed circuit board for the aid is shown in figure 2. After all components have been mounted, the circuit is connected to the microprocessor. This is made easier by the use of an additional 40-pin socket with wire-wrap pins as shown in figure 3. The circuit here is then connected to the 40-pin socket by means of a suitable length of ribbon

Parts list

Capacitors

- C1 = 10 μ , 10 V
- C2, C3 = 100 n

Semiconductors:

- IC1 ... IC6 = 9368 Technomatic
- LD1 ... LD6 = 7760 (CC) LED display

cable. The various connections are made so that the first four displays

1

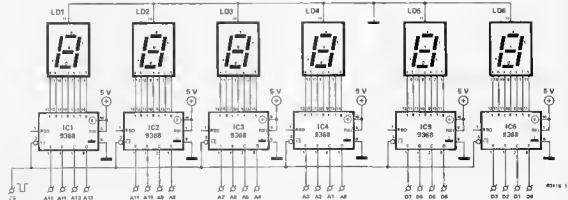

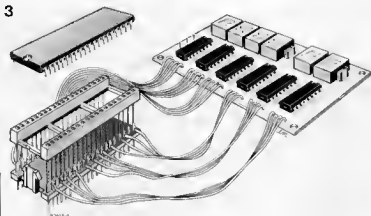

show the address and the last two the data.

If an external power supply is used, the earth of the supply must be connected to the 0 V of the micro-processor board.

There are two methods of using the circuit. The first is single step mode in which case the LE (latch enable) must be taken to 0 V and the display will read the data and address of each step. In the second method, the LE is controlled by the computer itself to enable a specific (and maybe momentary) data and address to be retained. The fact that it is not necessary for the computer to stop is an added advantage.

77
dexterity game

Having reached the end of the tube the ring touches the finish 'line' and activates ES4 which sends the signal produced by the oscillator at N2 to ES1, thus switching from highest to lowest frequency. Every time the ring touches the tube the D1...D5 diode network connected to inverters N3 and N4 drives N5 and N6 through D6. The N5/N6 couple is connected as a power stage and drives a buzzer while the ring touches the tube. The current consumption of such a simple circuit is quite small (≈ 5 mA) so it could be considered as a 'pocket'

game and powered by a battery. The values of resistors R3...R5 is a matter of experimentation as the tone for each stage is a something for each user to decide. The same is true of the switching tone between two stages and at the end of a 'run'.

In electronics, as in everything else, we must be able to laugh, to have fun now and again, and games circuits are always particularly well received in the 'Summer circuits' issue. The principle of electronic manual-dexterity games is well known: the player attempts to pass a metal ring along a length of wire without touching the wire. An alternative version, instead of a wire, uses a metal tube which is open along its length (illustrated in the drawing). In this version of the game the tube is divided into four sections, each of which is more difficult than the last. The sound emitted, when the ring touches the tube, increases stepwise in frequency as the ring is moved closer to the end of the tube. The circuit consists of a few resistors and diodes, two CMOS ICs and, of course, a buzzer. The sound generation circuit is based on N1, a Schmitt trigger inverter, and the oscillating frequency is dependent upon the number of resistors R3...R5 short-circuited or left in series by the analogue switches ES1...ES3. If only R6 (and capacitor C1) is in the feedback loop from the output of N1 to its input, the frequency of the signal is at its maximum. This will occur if the ring touches the final section of the tube.



- N1...N6 = IC1 = 40106
- ES1...ES4 = IC2 = 4066
- D1...D6 = 1N4148

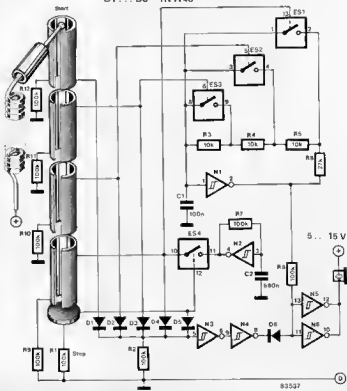

78

40 watt main amplifier

Our December 1982 issue featured the 2 x 140 watt Crescendo; here we describe the circuit for a main amplifier for those with more modest power requirements. A normal amplifier which is, however, not so normal.

The output stage contains two type 2N3055 power transistors: proven, reliable components. At first sight it appears that the output stage is not symmetrical because transistors T15 and T16 are NPN types but a second look will show that it is: the top half consists of NPN 'supertransistor' T11/T13/T15, while the lower half comprises PNP 'supertransistor' T12/T14/T16. These 'supertransistors' are complementary; as their emitters are connected together via R25...R27 and R28...R30, the output stage is symmetrical. The remainder of the amplifier is also constructed symmetrically: a double differential amplifier, T1/T2

end T3/T4, current sources T5 and T6, followed by driver stages T7 and T8. The output power is 40 watts into 8Ω or 60 watts into 4Ω for a distortion not greater than 0.01% over the frequency range 20 Hz...20 kHz. Maximum power at the onset of clipping is 45 watts into 8Ω and 65 watts into 4Ω. The input sensitivity is 800 (850) mV_{eff} for 40 (45) watts into 8Ω and 700 (725) mV_{eff} for 60 (65) watts into 4Ω. The frequency characteristic is within 1 dB from 15 Hz to about 100 kHz. Partly because of the high current amplification of not less than 200,000, the output stage has a low quiescent current (which is not critical) of 25...50 mA. Even with P1 set for minimal resistance, a spectrum analyzer connected to our prototype showed a cross-over distortion of a very small magnitude. The quiescent current is set by means of P1, with a universal meter (dc-mV range) connected between the emitter of T15 and the collector of T16, that is across the series-

connected resistor chain R25...R30. A voltage of 33 mV corresponds to a current of 50 mA. There is no printed circuit board available for this project, but it can be constructed using Vero board. It is advisable to arrange the layout as much as possible in line with the circuit diagram. A common heat-sink of 1.5...2°C/W is required for T15 and T16, not forgetting the mica washers! T13 and T14 should each have a separate heat-sink of about 12°C/W. Although the output stage, as far as quiescent current is concerned, is virtually unaffected by temperature, T9 and T11, as well as T10 and T12, may be thermally coupled, that is, they can be glued together by their flat vertical surfaces. L1 is constructed by winding 2 x 10 turns of 0.8...1 mm dia. enamelled copperwire around resistor R7. The power supply is quite normal. Current consumption amounts to 1.0 (1.06) A for 40 (45) watts into 8Ω and 1.75 (1.81) A for 60 (65) watts into 4Ω.

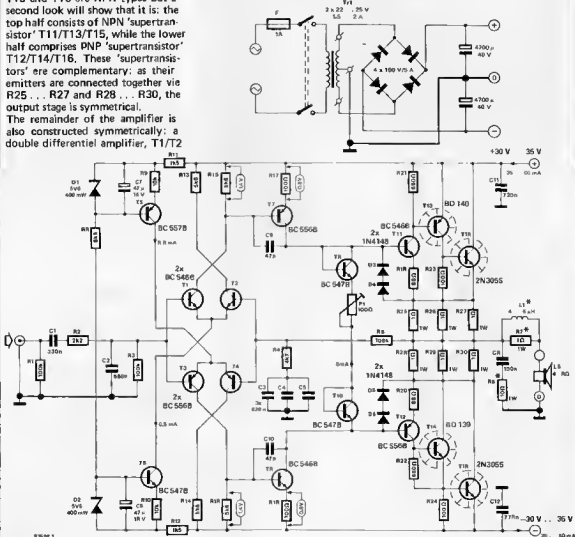

81

distance meter for thunderstorms

The clouds in the sky are dark, giving an ominous warning of the thunderstorm that is on its way. Sure enough, the first flash of lightning is seen; it would be interesting to know how far away the thunderstorm is.

The circuit described here is intended to provide the answer to that question.

Light (including lightning) travels at a speed of 300,000 m/s. Sound, in this case thunder, travels in air at an average speed of 333 m/s, depending on the ambient temperature. This is the reason why the thunder is usually heard a few seconds after the lightning flash is seen. The thunder needs about three seconds longer to travel one kilometre than does the lightning; this is the same as 0.3 seconds per 100 metres.

The circuit puts this theoretical knowledge into practice. The 555 timer IC operates as an astable multivibrator with a frequency of 3.33 Hz; the period is 0.3 s. This is exactly the time differential between the propagation speeds of the lightning flash and the thunder. As soon as the flash is seen, the distance meter is started by briefly pressing

pushbutton S2. Counters IC2 and IC3, which are connected in series, are given a reset signal which resets them to zero. The output signal of IC1 is applied to the clock input of the first counter (IC2) and is then processed by the latter. LED D1 lights after 0.3 s. Each subsequent clock pulse activates the next higher output after 0.3 s. The counting operation is interrupted by pressing pushbutton S1, as soon as the thunder is heard.

The distance of the thunderstorm from the user's location is indicated by one or two of LEDs D1 ... D18. Counter IC2, counts the distance from 100 m to 900 m. If the thunderstorm is further than that, counter IC3 handles the kilometres. If, for example, only LED D5 lights, the thunderstorm is at a distance of 500 m; if LEDs D16 and D3 light up, the distance is 7300 m (maximum distance = 10 km).

The maximum current drawn by the circuit does not exceed 30 mA; a 9 V battery is therefore sufficient to power the circuit.

A digital watch with chronograph function is used to align the circuit. P1 is adjusted so that the last LED D18 lights up 27 seconds after S2 has been released (the stopwatch must be started simultaneously!). Further refinements could include an LDR that will allow the lightning to automatically start the counter, and a microphone to stop it. However, the LDR would be useful only at night and the problems associated with catching distant thunder with a microphone... Perhaps it would be better after all to do what we do... put your head under the pillow and forget the whole thing!

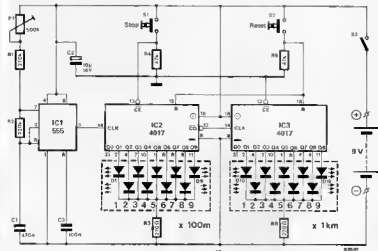

82

common base mixer

Mixing of audio signals is normally effected by means of a so-called virtual-earth mixer, in which the various input signals are applied to the virtual earth, that is, the inverting input of an op-amp, via a series of resistors. The mixer described here

uses a different approach.

The circuit is designed on the common base principle in which the input voltages are transformed into alternating currents which, when added together, constitute the collector a.c. component. The emitter of a common base configuration is low impedance and acts as virtual earth, so that crosstalk between the various input signals is virtually impossible. The output signal is taken from the collector of T1. The amplification of the circuit is equal to $R_6 \div R_1$ where R_1 is the input resistance (= one of the resistors R1 ... R5). A current source, consisting of T2 and T3, has been provided in the emitter circuit of T1. This current source is high impedance for alternating voltages so that it does not affect the signals at the emitter of T1. The base voltage of T1 is set by resistors R7 and R8. Capacitor C1 ensures that the

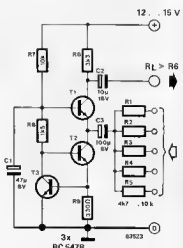

base of T1 is decoupled effectively. The number of inputs can be extended as required.

83

drill speed controller

This simple circuit is of interest because it enables drill speed to be controlled irrespective of the load on the drill. The design makes use of the fact that as the load increases the back EMF of the drill falls and thus the current increases.

It is clear, looking at the circuit diagram, that this circuit is not at all complicated, and the same is true of its operation. During the positive half-cycles of the mains C2 is charged up through R1 and D1, until the voltage across this capacitor is equal to the 'zener voltage' of the circuit at T1. The circuit based on T1 is an adjustable zener in which the zener voltage is defined by the setting of P1. In fact the voltage between collector and emitter is defined by

the ratio between resistors R3 and R2 + P1. The voltage drop across R3 is always equal to the base-emitter voltage of T1 (0.6 V) so it follows that the zener voltage is equal to $\frac{P1 + R2 + R3}{R3} \times 0.6 \text{ V}$. The motor is

not connected in the usual place at the beginning of the circuit, but instead it is immediately after Thy 1. The firing time of Thy 1 is thus defined by the difference between the zener voltage and the back EMF of the motor. If the motor becomes more heavily loaded, the thyristor will fire sooner.

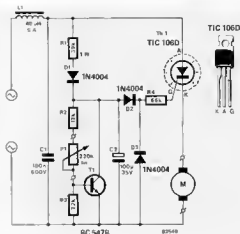

Because a thyristor is used the circuit can only control 180° of the supply cycle; so with this circuit it is not possible to vary the drill speed from 0 to 100%, but such a controller is usually only used in low speed applications. A disadvantage of this circuit is that the motor 'stutters' a bit when it is not under any load but this effect disappears when there is a load on the drill.

Inductor L1 and capacitor C1 are used to filter out high frequency effects caused by phase-chopping. The thyristor must be mounted on a heat sink to ensure effective cooling.

84

S.P.T.S.

single pole toggle switch

As can be seen elsewhere in this issue, a press on/press off function (toggle) from a single pole push button can be achieved quite easily. In this case the circuit is slightly more sophisticated and uses an op-amp to provide the toggle function. Switch bounce, (where the contacts quite literally bounce and provide a number of pulses instead of one) the ever present problem with all mechanical switches, is removed in this circuit. Even though an op-amp is involved, the circuit is still very simple. The gain (amplification) of the op-amp is very high which means that its output can easily be high (+U_B or logic '1')

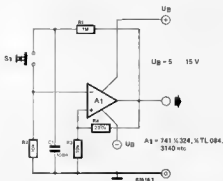

or low (-U_B or logic '0'). A small portion of the output voltage level (for real fanatics about 1/23) is fed back to the non-inverting input of the op-amp. Pressing push button S1 will connect capacitor C1 to the inverting input of the op-amp. If the output was low, the op-amp will immediately change state and C1 will begin to charge via R1. However, if S1 is held the capacitor will only charge to a value of U_B × R₂ / (R₁ + R₂) which works out to about 0.01 U_B. When S1 is released the capacitor will continue to charge right up to U_B. Now that S1 is open C1 is no longer connected to the op-amp and its

output information is retained. If S1 is then closed once more, the logic '1' across the fully charged capacitor will appear at the inverting input of the op-amp. The op-amp will again change state to provide a logic '0' at its output and the capacitor will discharge. We are back where we started! It must be remembered that when an op-amp is used with an asymmetrical supply, the junction of R2/R3 must not be connected to earth but to a point midway between the positive and negative supply level (½U_B). A potential divider consisting of a pair of resistors will be sufficient for this purpose.

85

simple D/A converter

Special ICs are available to achieve an analogue output from a computer. A digital to analogue converter using these beasts can be simple but expensive. However, a simple circuit can also be constructed from standard components. The circuit described is simple in conception, no special components (not even high stability resistors) are used and it provides two outputs: one pulse width and one analogue.

The operation of the converter can be seen from the block schematic diagram in figure 1. An 8-bit data word from the computer determines the level of the analogue output voltage, and this data (0...255) is stored in a latch. An 8-bit counter continuously counts from 0 to 2⁸ (256). The output data from the latch and those from the counter are compared by a comparator. The A > B output of the comparator will be logic 1 during the time it takes for the counter to run from 0 to the number in the latch. From that point on (that is from the number in the latch to 2⁸), it will be logic 0. This output therefore delivers a pulse-width modulated signal, of which the pulse-width is determined by the data the computer supplies to the latch. The available signal can be converted to an analogue voltage by integration and for this only a resistor and capacitor are required.

The circuit of the D/A converter is

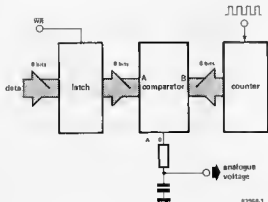

given in figure 2 in which the latch (IC1), comparator (IC2 and IC3) and the counter (IC4) are immediately evident. Other stages are a clock oscillator (N1, N2 and N3) and a buffer for the analogue output (IC5). The integrator (R3 and C2) is preceded by two CMOS gates the supply of which can be derived from a reference voltage.

To start reading of the data, an enable pulse must be given at pin 11 of IC1. The oscillator can be switched on and off by the input at f; if this input is open, the oscillator will do just that! It is possible

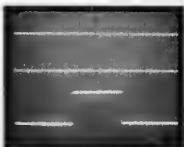

to connect a second, external oscillator to this input, in which case, the clock frequency will be that of the

2

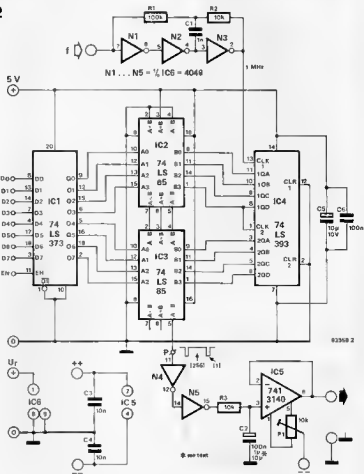

Parts List

- Resistors**
 R1 = 100 k
 R2, R3 = 10 k
 P1 = 10 k preset potentiometer

- Capacitors**
 C1 = 1 n
 C2 = see text
 C3, C4 = 10 n
 C5 = 100 n
 C6 = 10 μ/10 V

- Semiconductors**
 IC1 = 74LS373
 IC2, IC3 = 74LS85
 IC4 = 74LS393
 IC5 = 741, 3140
 IC6 = 4049

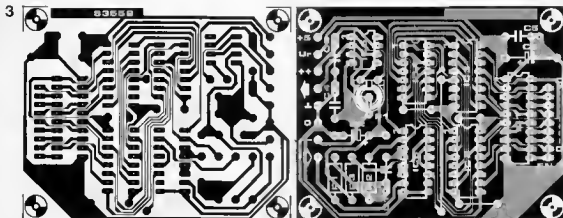

external oscillator. With the component values shown, the clock oscillator frequency will be about 300 kHz. This results in a pulse width modulated signal at output P with a frequency of (1/256 of the clock frequency) a little higher than 1 kHz. The clock can go up to 10 MHz. If lower frequencies are desired the value of the integrator capacitor C2 must be increased. IC1...IC4 are supplied from a single 5 V line at a current consumption in the order of 50 mA. The

inverters in IC6 are supplied from a reference voltage U_r . This voltage must be about 5 V and determines the stability and the maximum level of the analogue output signal. Buffer IC5 needs a symmetrical supply of $\pm 12 \text{ V} \dots \pm 15 \text{ V}$. Preset potentiometer P1 is included for adjustment of the off-set of the op-amp. The pulse-width signal can be used directly or via an amplifier to control the speed of d.c. motors (which react well to pulse control). This

signal can be taken from either pin 11 of N4 or pin 15 of N5. If the analogue output is not used, R3, C2...C4, P1 and IC5 can be omitted.

The simple digital to analogue converter can be constructed on the layout for the printed circuit board shown in figure 3.

The photograph is that of the output signal of the comparator (lower trace) at a clock frequency of 100 kHz and input data corresponding to number 15.

86

synchronous, constant-amplitude sawtooth generator

This circuit was designed because we needed a sawtooth waveform with a well defined constant amplitude for applications in pulse-width modulation control systems.

The circuit here is a generator that produces a sawtooth signal which can be synchronized with an input pulse. The circuit can therefore be considered as a control system which is comparable with an analogue subroutine. The average output signal level of op-amp A1 is compared with a reference voltage by comparator A2. If necessary, the two

levels are equalized by means of T1 and T2. The time-constant of the control system is formed by resistor R4 and capacitor C3. If the time-constant is made too small, the rising edge of the sawtooth will tend to become sinusoidal and the linearity of the signal will suffer. With the values shown, the frequency range lies between 100 Hz and 5 KHz, which can be extended upwards by the

use of an op-amp with a higher performance. The value of capacitor C1 will then have to be modified accordingly.

The amplitude of the output signal can be calculated from the formula: $U_{out} = R_6 / (R_5 + R_6) \times 2U_b$. The circuit has been designed for a supply voltage, U_b , of 12 V; the current consumption will be less than 10 mA.

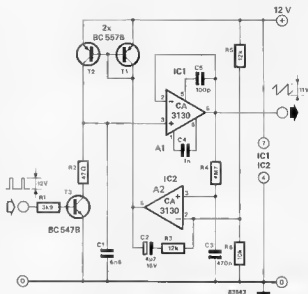

87

preset the hard(ware) way

Since the inspired 'eureka!' of one R. Moog while pondering the concept of voltage controlled sound synthesis modules, electronic music making has virtually stood still. Peremptory though it may seem this statement is none the less true and the same can be said of other 'up to date' electronic musical instruments.

In fact there is only one novelty of note and that is the advent of 'musical microprocessors', and these are already commonplace in modern synthesisers. Their task is not really to supply music, rather to make up for the deficiencies suffered by many musicians who play from 'memory' and cling blindly to 'programming'. Programming and memorising certainly give undeniable benefits which simply were not possible before. But not everybody is willing to pay the (high) price and many may prefer a completely different solution, so it is worthwhile considering a wired, discrete, inexpensive alternative. What we propose here is the basis of a

system which can be expanded at will.

A main switch allows a selection to be made between ordinary manual mode (with the original potentiometers acting as usual), and programming mode. In this latter case the normal potentiometers are disabled; a multi-way switch (S2) switches, in turn, batteries of programming presets, each delivering the exact voltage needed to obtain

a specific sound.

All the control lines are connected by means of a system of diodes which prevent any interaction between the control signals which are inactive and those which are active.

In order for this circuit to operate, the original wiring must be modified and, of course, care must be taken in rewiring, but this is a small price to pay for what could be the ultimate solution!

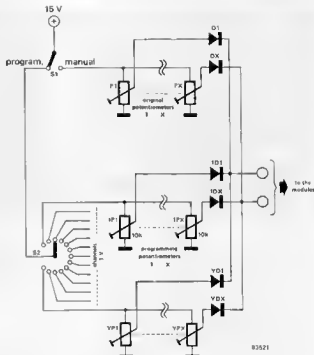

81521

88

variable zener

One of the problems encountered in developing circuits is the selection of correct values for various components. Often trial-and-error is used to find the most suitable value for a particular circuit. There is, however, one major problem with this method of selecting values; most people who build electronic circuits as a hobby do not have vast quantities of components to cover all the various

values which might be needed. And, of course, there is always Murphy's law to consider: you always have every value of component possible — except the one that you need. So, having been 'bitten' (not literally) once again by Murphy, we came up with a design for a 'zener diode' with variable zener voltage. Compared to 'normal' zener diodes, R_1 is somewhat higher (20 . . . 50 Ω), the maximum load lower and the temperature coefficient less ideal (about $-2 \text{ mV}/^\circ\text{C}/0.6 \text{ V}$). The circuit is, however, quite straightforward and U_{zener} can be varied over a wide range (3 . . . 25 V) which is, after all the whole idea.

As soon as the voltage at the base of T1 is greater than 0.6 V this transistor will conduct. Consequently T2 conducts and the voltage cannot rise any more, just as in a zener diode. The ratio between $P1/R1$ and $R2$ defines the zener voltage of the circuit. To set the zener voltage the circuit must

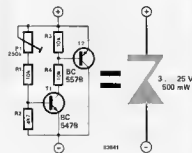

12881

be connected via a 10 k resistor to a supply, and then potentiometer P1 should be adjusted until the desired zener voltage is reached. If the circuit is used to replace a zener in an existing set-up the extra 10 k resistor is not needed, of course. The maximum permitted current through this variable zener is 100 mA. Transistor T2 can dissipate a maximum of 100 mW.

91

H. Fischer

6809 DRAM controller

This circuit of a Random Access Memory controller is a real treat for owners of a 6809. It enables at least 128 k bytes of dynamic RAM to be addressed and even then it has some spare capacity.

The controller cannot be used for chips other than the 6809 as it makes use of a special feature of that particular processor. The memory refresh is produced by timing signals from the microprocessor E and O. An OR function with these two signals is performed by gates N2, N3 and N10, and the timing diagram is shown in figure 3. The circuit of figure 1 shows only two of the eight memory ICs (4164); the corresponding signals must, of course, be fed to each of the

eight memories of a 64 k block (see figure 2). A buffer for the data bus is not envisaged; if this is desired, take care that its operating speed is sufficient, otherwise it could upset the operation of the controller. By 'ANDing' the E and O signals, the CAS signal for both 64 k stacks is produced. The CAS1 select signal for the upper 64 k stack is produced by 'NANDing' CAS and the 1Y output of IC5; that for the lower 64 k (CAS2) stack by 'NANDing' CAS and output 2Y of IC6. The software should ensure that during the row address time suitable signals (A0, A1, A2, A14 and A15) for driving IC6 and IC7 are present on

3

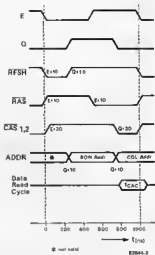

2

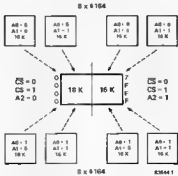

the address bus. It is almost impossible to show this correlation clearly, but the matter should be much more obvious if you imagine IC7 as being replaced by the four bistables which make it up. A final note: IC6 produces the MSB (address 15) at its 3Y output when strobed by the signal on address bus line A15.

1

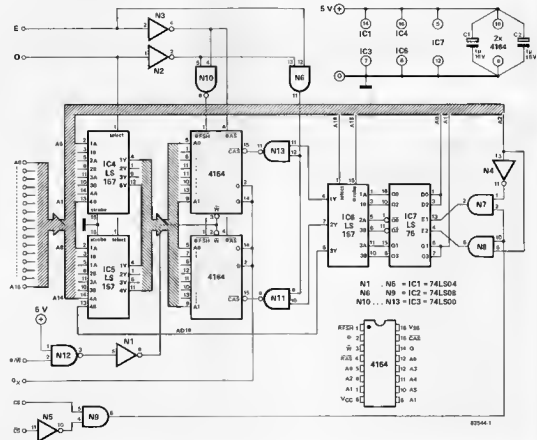

- N1 . N5 = IC1 = 74LS04
- N6 . N9 = IC2 = 74LS08
- N10 . . . N13 = IC3 = 74LS00

92

acoustic 'flag' for the RS232 interface

In the course of their work programmers rarely use their sense of hearing. Why not use these inactive ears? Serial communication between a computer end its peripherals (notably the VDU) is in the form of pulse trains which make up the givan transmissions. In the case of the Junior Computer and the elekterminal, for instance, the pulse width is determined by the trans-

mission rate of 1200 baud; or $833 \mu s$... which is of course within the audible frequency range! This fact gave rise to the idea of using these pulse trains as acoustic flags, thus allowing the programmer to concentrate on his screen, keyboard and especially his manuscripts, while entering data into memory. Similarly, while cleaning the memory (at the end of some particular type of research, for example) the user need no longer keep looking at the screen until the required output appears; a string of $\$FF$ (or any other constant signal) gives an audibla indication as long es the same signal (which could be programma instructions, for example) continues. You only heve to listen. The actual circuit is very simple: it consists of a small amplifier which drives a miniature loudspeaker. The few components required are mounted on a printed circuit board which has a 31 pin male connector (or solder tags). This mates with the 31 socket female connector on the main card of the Junior Com-

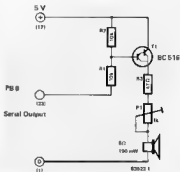

puter. Apart from the two supply lines we only have to make a connection to PB0, the series output of the RS 232 interface. The logic level present at this pin is inverted with respect to the actual logic level output from the RS 232 interface; consequently in the inactive state PB0 has a high logic level: thus the acoustic flag will ba on stand-by during data transfer via the interface. Apart from the use outlined here, this little circuit can also be used as a complete amplifier for other purposes.

93

simple PA system

A vary nice power amplifier delivering 10 W into 2Ω (two 4Ω loudspeakers in parallel) can be built using the TDA 2003 IC and a few passive components. The circuit diagram shows that a fully operational circuit need not be big and complicated. The signal input is via capacitor C1 to pin 1 of the IC. There is a feedback loop between pin 4 (the output) and pin 2 (the feedback input). The amplificationfactor is defined by the relationship between resistors R1 and R2 and in this case, the amplification is about 100 times. Resistor R4 and capacitor C7 are included to ensure that the amplifier remains stable at higher frequencies. The loudspeaker is connected to the output via electrolytic capacitor C4.

The RC network of R3/C5 acts as a component of the output load and compensates for the rising impedance of the loudspeaker at high frequency. The power supply is connected to pins 3 and 5 and maximum supply voltage is 18 V. Higher supply voltages will not necessarily damage the IC but will mean that the output d.c. voltage drops to such a level that the IC can no longer be driven. The IC also includes short-circuit, overload and thermal protection. To maintain stability it is rec-

commended that separate wires are used to connect the 0 V of the printed circuit board and the loudspeaker independently to the main earthing point on the chassis. After construction is completed the current consumption of the circuit should be checked. It should be about 50 mA, and the value of the d.c. voltage at the output should be about half the value of the supply voltage. The output power is 10 W into 2Ω , 6 W into 4Ω , and 3 W into 8Ω .

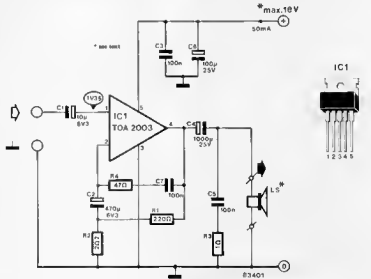

94

C. Bejeux

5 V logic tester

The full title for the description of this circuit should be '3 state 5 V logic tester', which at least hints at the fact that this logic tester is something out of the ordinary. And indeed it is, for not only does it differentiate between the two normal logic levels (high and low) but also it indicates when the signal under test is neither of these, be it a negative voltage, more than 5 V or even an alternating voltage. Similarly it recognises unpolarised TTL or LS circuit inputs.

And that is not all... this circuit also enables the logic level indication to be made audible, so there is no need to concentrate on anything other than the circuit under test.

To do all this the circuit uses an LM 3914, which is an IC that can sense analogue voltage levels and can directly drive 10 LEDs to provide a linear 10 step display.

The IC, among other things, has its own adjustable reference source that controls the internal 10 step divider chain. The reference level

(at pin 6) is set in the circuit here to 10 V thereby providing 1 V between each 'step' in the dividing chain. The upper half of the drawing contains the circuit for the 10 step divider and display. The reference level is adjusted by P2. The circuit illustrated in the lower half is that of the audio indicator, a useful accessory to the logic tester. The various uses of the tester will be understood by the indications given by the display.

LED D2 lit: in this case the 'Z' output is active 'low' (set to ground), to indicate 'high impedance'; there is no voltage at the B input and the input (pin 5) of the LM 3914 is held at slightly less than 2 V by means of R5, P1 and T1.

LED D3 lit: point A acts as a reference point in this case and is tied to the ground of the circuit under test, (which may be different from that of the tester), and point B is taken to the same potential as point A, pin 18 goes to logic low and output '0' is active, indicating 'low logic level'. This particular arrangement of A as a reference point also prevents the power supply of the tester from being affected by the logic levels of the circuit under test.

LED D4 lit: when the potential difference between A and B is between 1 and 2 V LED '7' lights

to signify a logic 'not sure'.

LED D5 lit: if the voltage at point B is between 2 and 5 V the '1' LED will be lit to indicate that there is a 'high logic level' present.

LED D6 lit: if there is a negative voltage between A and B, T1 conducts, followed by T2, resistor R6 is shunted. Immediately the voltage at pin 6 drops and LED 'D' lights, signalling a 'defect'. Similarly this LED lights if the potential between A and B is more than 5 V.

The audible indication circuit consists of the four NAND gates of a 4093 and a 555 timer, and these two are all that is needed for a simple but usable device. The acoustic signals are as follows:

- D2 lit: 'high impedance': silence.
- D3 lit: 'low logic level': short tones.
- D4 or D6 lit: 'fault': continuous tone.
- D5 lit: 'high logic level': long tones.

The prototypes worked very well and we found that current consumption is about 37 mA without the audible indication circuit, or about 50 mA with. One point to note is that precision resistors must be used because of the accuracy required for the 2 and 10 V references, and similarly care should be taken to select a good quality voltage regulator.

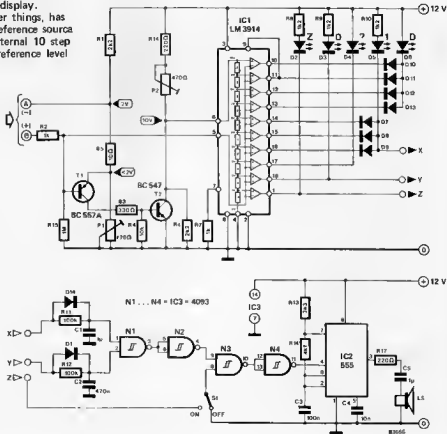

95

microphone amplifier with preset tone control

The active parts of the circuit (amplifiers A1 and A2) shown in figure 1 are contained in IC1.

A1 operates as a non-inverting amplifier and the microphone input is applied to pin 1 via coupling capacitor C1. The amplification factor of this stage is determined by the ratio of resistor R5 to the parallel combination of R1 ... R4.

With R1 switched in, the amplification factor is about 225, with R3 switched in about 60, and with S1 in the centre position about 14. As the effective input sensitivity can be altered by S1, it can be matched to different input levels of microphones.

The output of A1 is applied to a tone control stage, A2. The ratio R13/R12 determines the amplification (about 18 dB) of this stage. The effect of R11 and C6 is, in principle, the same as that of R2 and C2: a smaller value of C6 increases the lower cut-off frequency. The RC network between A1 and A2 is the real tone control. Potentiometer P1 sets the bass level and P2

the treble level. Use is made of the characteristic of capacitors behaving as frequency-dependent resistances for ac voltages.

The output signal of the amplifier is available for connection to the main amplifier via C9 and potentiometer P3.

This microphone amplifier has not only been tested in the Elektor laboratories but also by the designer during searching on-stage tests. A printed circuit board for this low noise amplifier is available. It is very narrow to enable it to be used as an input module in a mixer.

Parts list

Resistors

- R1 = 470 Ω
- R2 = 10 k
- R3 = 2k2
- R4 = 27 k
- R5 = 100 k
- R6 = 10 k
- R7 = 10 k
- R8 = 3k9
- R9 = 3k9
- R10 = 12 k
- R11 = 3k3
- R12 = 270 k
- R13 = 2M2
- R14 = 1 k

- P1 = 100 k lin. preset
- P2 = 500 k lin. preset
- P3 = 10 k log. preset

Capacitors

- C1 = 100 n
- C2 = 10 μ/35 V
- C3 = 1 μ/35 V
- C4 = 47 n
- C5 = 4n7
- C6 = 2n2
- C7 = 100 n
- C8 = 1 μ/35 V
- C9 = 10 μ/35 V
- C10 = 100 n
- C11 = 100 p

Semiconductors

- IC1 = LM 387

Miscellaneous

- 1 switch, miniature, single pole change-over, centre off
- 1 microphone socket (mono)

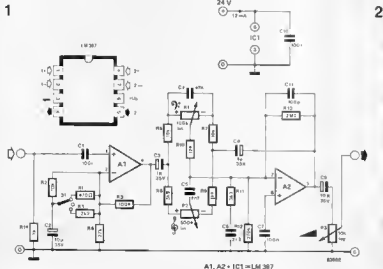

A1, A2 = IC1 = LM 387

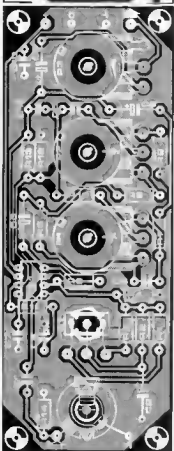
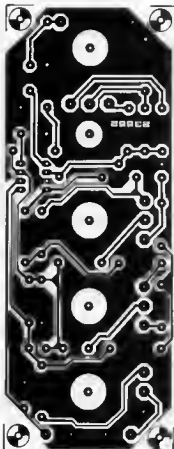

96

current source for photodiodes

There are many circuits available today which use modulated light signals to transmit information. Generally, the actual receiver consists of one or more photodiodes. In such applications it is important that the dynamic range of the photodiode is sufficient. However, increasing the dynamic range can cause the sensitivity of the diode to decrease. Another disadvantage is that photodiodes are sensitive to changes in ambient light conditions. The circuit described here increases the dynamic range of the photodiode without affecting its amplification.

It also filters out the effects of slow variations in light intensity so that the problems with ambient light are greatly reduced.

As the diagram shows, the circuit is very simple. When light falls on D1 this diode produces a photocurrent relative to the intensity of the light. If the current is small, transistor T1 just conducts. When the light intensity (and thus the photocurrent) increases, the current through T1 also increases and this shorts excess current to ground. With rapid fluctuations in the light intensity falling on D1, T1 presents a high impedance (because C1 does not have time to charge). The input signal is then output directly at X. This means in

effect that the dynamic range of the diode has been increased without reducing the amplification. The signal at point Y, even though it is not directly proportional to the light intensity, can be used to examine the changes in the average light intensity falling on D1.

In virtually all applications it is important that when the light is frequency modulated at 50 Hz (such as house lights) this must not be seen as a modulated signal. To ensure this, C1 must be at least 1.5 μF . With this value of capacitor the change-over point from high-pass to low-pass is about 50 Hz. If, as shown in our diagram, C1 has a value of 10 μF the change-over point is about 7 Hz. \blacksquare

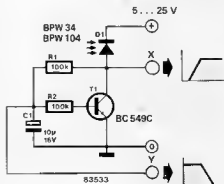

97

faultfinder for ASCII keyboard

To be able to check the connections to an unknown ASCII keyboard, you want to know first of all where the supply voltage is connected. This can quite simply be done by removing the cover and tracing a pair of the wider tracks to the ICs. Next, the strobe connection has to be found. After the supply voltage has been connected, pressing one of the keys must produce a short (strobe) pulse at one of the output pins. If an oscilloscope is used to find this pulse, it will be seen at once whether it's positive or negative. Once these preliminary checks have been carried out, the faultfinder can be used. Connect the outputs of the keyboard

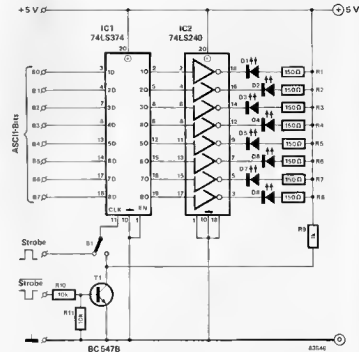

to the faultfinder. Set the strobe input to positive or negative with switch S1. A positive strobe is connected directly to S1; a negative strobe is first inverted by transistor

T1 as shown in the circuit. When one of the keys is pressed, a strobe pulse is produced which triggers the eight-stage bistable IC1. The signals present on the data lines

are stored by the bistables and the resulting outputs are applied to IC2, which comprises eight inverting driver stages. If one of the bistable outputs is logic 1, the output of the corresponding driver is 0. Consequently the corresponding LED lights. If the input to one of the driver stages is logic 0, its output is 1 and

therefore virtually of the same level as that at the anode of the respective LED which thus remains off. Now all that's needed is an ASCII table and the various connections are soon sorted out. If you don't have such a table, you'll find one on page 6-59 of our June 1983 issue.

A final important note: in the case

of keyboards which have not only a parallel but also a serial output, it is possible that on pressing one of the keys a series of pulses is produced of which the level lies at ± 12 V. If you're therefore not sure whether the keyboard under test has only a parallel output, check this before connecting the faultfinder to it. **M**

98

μ Processor fault finder

When fault finding in a micro-processor system it is not always possible to work in single-step mode, as the processor would then have to stop completely. Not all processors have a wait-input; the Z80 (which is the system we used to evaluate this circuit) has such an input, but with this we get the problem that the

refresh of any dynamic RAMs used is lost if the processor is stopped. With the fault finder described here, and the ' μ Processor aid' published elsewhere in this issue, both addresses and data can be looked at without the processor having to be stopped for any length of time. Operation is as follows. After the circuit sends a short reset pulse to the processor the program is executed. This RESET pulse is supplied by monostable multivibrator (MMV) IC1a; pulse duration is about 2 μ s (the pulse has to be short or the data in the dynamic RAMs might be corrupted). At the same time the second MMV, consisting of IC1b, is triggered. The duration of the pulse supplied by IC1b can be adjusted with the ten turn potentiometer P1. This pulse is combined with the Memory Request (MREQ), Read (RD), and Write (WR) signals of the computer system so that a latch enable (LE) pulse is present at the

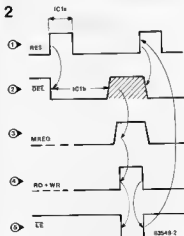

output of N3 after the MMV time of IC1b has elapsed. This LE pulse is sent to the μ Processor aid which then reads and holds the data and address present at that moment. The pulse also goes to the input of IC1a so that when this LE stops another RESET pulse is automatically sent to the processor.

In this way it is possible, simply by turning P1, to look at all the memory cycles one after another. This system gives a reliable read out of programs that are not more than a few decades of bytes long. However, the time delay is not stable enough for the system to be usable with bigger programs.

This circuit uses the RD, WR and MREQ signals so that during a read or write operation the information content is read into the μ Processor aid. If only RD and MREQ were used, then only read instructions could be saved for examination. Using WR and MREQ only write instructions are 'latched' into the μ Processor aid, and using RD and MREQ only opcode fetches; other combinations are also possible, of course. RD and/or WR must still be used as addresses and data are only valid when these signals are active. If processors other than the Z80 are to be used then this circuit will have to be adapted to use the available signals. **M**

1

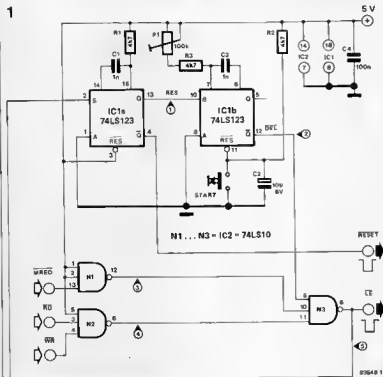

99

thermal indicator for heat-sinks

The temperature of a heat-sink can be measured with a wet finger: if it sizzles, the temperature is too high. The circuit in figure 1 is an alternative method of checking that does not cause blisters: a thermal traffic light not unlike the audio traffic light featured in our March 1983 issue. A green 'safe' LED lights as long as the temperature of the heat-sink does not exceed 50° Centigrade, an orange 'caution' LED for temperatures of 50° ... 75° Centigrade and a red 'danger' LED for temperatures above 75° Centigrade.

The circuit is simplicity itself, two special zener diodes, D1 and D2, are connected in series to ensure an accurate zener voltage of 5.96 V at 25° Centigrade. The zener voltage will rise by 20 mV for each degree Centigrade rise in temperature. The voltage level corresponding to the temperature of the heat-sink is

2

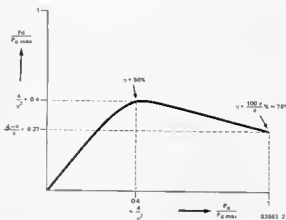

compared with two reference voltages by IC1 and IC2. When the temperature reaches 50° Centigrade the output of IC2 goes high so T3 conducts and causes D4 to light and at the same time D5 is extinguished by T4. At or above 75° Centigrade the output of IC1 is high and T2 and T3 then conduct to make D3 light and D4 extinguish.

Under normal conditions, that is, considering a heat-sink of sufficient cooling area, a temperature of 75° Centigrade will never be reached. Figure 2 shows the $P_d/P_{d(max)}$ relation between the power dissipation of a class B amplifier and its effective power output $P_o/P_{o(max)}$ under normal conditions. The drive signal is a sine wave. The effect of the quiescent current on the dissipation has been ignored. It is seen

compared with two reference voltages by IC1 and IC2. When the temperature reaches 50° Centigrade the output of IC2 goes high so T3 conducts and causes D4 to light and at the same time D5 is extinguished by T4. At or above 75° Centigrade the output of IC1 is high and T2 and T3 then conduct to make D3 light and D4 extinguish.

Parts List

- Resistors:
 R1 = 22 k
 R2 = 5k6
 R3,R12 = 820 Ω
 R4 = 220 Ω
 R5 = 180 Ω
 R6 = 470 Ω
 R7 = 4k7
 R8,R9,R10,R11 = 15 k

Semiconductors

- D1,D2 = LM335 (National Semiconductor)
 D3 = LED red 5 mm
 D4 = LED orange 5 mm
 D5 = LED green 5 mm
 T1,T2,T3,T4 = BC 547B
 IC1,IC2 = 3140

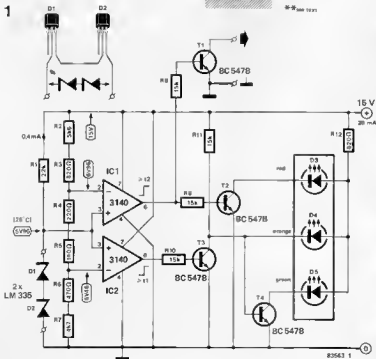
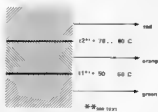

3

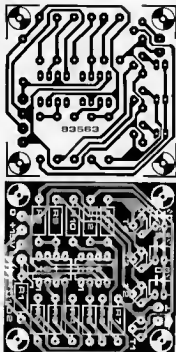

that the maximum temperature does not occur at maximum but at 40 per cent output. By comparison, the dissipation in a class A amplifier is highest in its quiescent mode and lowest at full output. Under abnormal conditions the heat-sink can get very hot. If the output is shorted, for instance, P_O is nil, but the alternating output current is far from zero and the totally internally dissipated power is converted into heat. Assuming that the extremely high temperature of the heat-sink is caused by a very low load resistance, T1, which conducts at a temperature

of 75° Centigrade and higher, is used to remove the low load from the amplifier output. If the collector of T1 is connected to the base of T5 in the switch-on and d.c. protection circuits (featured in our January issue in 'Accessories for the Crescendo Power Amplifier') the loudspeaker relay controlled by T5 will open. If it is required to monitor both channels of a stereo amplifier such as the Crescendo, the thermal indicator circuit can be duplicated or expanded. To expand the circuit diodes D3, D4, D5 and resistor R12 remain as shown, while the LEDs are controlled by parallel connected tran-

sistors T4 and T4', T3 and T3' and T2 and T2'. In that case the higher of the two heat-sink temperatures determines which LED will light.

It is fairly simple to vary the temperatures corresponding to the orange and red, if so required. The reference voltage, U_{ref} , of a comparator can be derived from the temperature, t , according to the following formula

$$U_{ref} = \frac{5960 + 20(t - 25)}{1000} V$$

It is possible to set the two reference voltages very accurately by means of voltage divider R2...R7.

100

R. Storm

high and low tester

This is not our first high and low tester, but the present circuit offers something new: a seven-segment display which shows 'H' or 'L' and at the same time a small loudspeaker emits a corresponding tone. And all that at very reasonable cost. When the supply is switched on, the decimal point of the display lights and indicates that the unit is ready for use. If this is not the case, or an

2

Input & Display	$U_b/T2 = U_{in}/N1$	$U_b/T1 = U_{in}/N2$	N1 out	N2 out
non-defined	$U_b > U_t$	$U_b < U_t$	0	1
H	$U_b > U_t$	$U_b > U_t$	0	0
L	$U_b < U_t$	$U_b < U_t$	1	1

$U_b = U_{emitter}$
 $U_t = \text{trigger-level}$

undefined signal is applied to the input, the display, apart from the decimal point, remains dark and the loudspeaker remains silent. If the input signal is logic 0, the display shows 'L' and the loudspeaker emits a low note. When the input signal is logic 1, the display shows 'H' and the loudspeaker emits a note which is an octave higher than the 'low' tone. Operation of the circuit can be seen from the circuit diagram in figure 1 and the truth table in figure 2. When the input signal is 1, transistor T1 conducts taking the input of gate N2 above the trigger threshold and

the trigger output goes to logic 0. Transistor T2 (PNP!) is cut off, the input of gate N1 is also above the trigger threshold and this trigger output is therefore also logic 0. Both switching transistors T3 and T4 are off and a current flows through the corresponding segments (b, c, e, f, g), diodes D4 and D5 and R7.

When the input signal is logic 0, T1 is cut off and T2 conducts. The voltage at the inputs of gates N1 and N2 are below the trigger threshold and both outputs are logic 1, switching on transistors T3 and T4; the emitter voltage of T4 rises and cuts off diodes D4 and D5. This causes a current to flow through segments d, e and f, diodes D2 and D3, resistor R6 and transistor T3.

With non-defined inputs (between 0.8...2.15 V) and an open circuit input, both input transistors are cut off. The output of N1 is then logic 0 and that of N2 is logic 1: no current can therefore flow through any of the segments.

As regards the drive for the two oscillators, suffice it to say that during low inputs N3 is driven by the output of N1 and during high inputs N4 is driven directly by T1.

If required, the loudspeaker can be switched on by means of S1. The switch can, of course, be omitted if the audio tone is always required. If you have an ear for music, R10 and R12 may be replaced by a 220 Ω resistor and a 250 Ω preset potentiometer so that the tone can be adjusted to your particular liking.

1

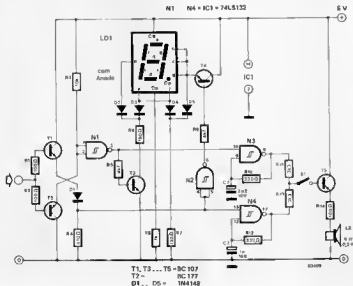

101

capacitive switch

Take a square wave signal with a given frequency and integrate it. This gives a stable continuous average voltage. By changing the existing frequency of the signal the average

integrated value remains the same but, at the instant when the frequency is changed, a positive or negative voltage peak will appear due to the momentary change in the average waveform of the signal. This is the principle upon which our switch is based.

The 555 or 7555 timers will oscillate in a stable manner. However, if we add an external capacitive sensor it becomes possible to vary the oscillation frequency.

In this circuit the square wave is integrated by the tripla RC network, while IC2, used as a comparator (with a variable reference value), uses the changes in the integrated voltage to alternately make and break the relay. Thus when you move close to C the relay makes; if you remain stationary the relay breaks. It may seem a bit basic but

it is a valid idea and it is worth looking at it in greater detail. To obtain better results you could take the signal after integration and differentiate between negative pulses (the frequency decreases as the value of C increases: when the sensor is approached) and positive pulses (the frequency increases again if the sensor is no longer affected) and compare them. Without this refinement the size of the sensitive plate must be such that the frequency of oscillation be at least several kHz. Failing this the operation of the circuit would often be disrupted by false detections. Coarse and fine adjustment is provided, using P1 and P2, to reduce the risk of incorrect switching. Note: The numbers in parentheses are the pins if an LM311 is used in place of the CA3130. ■

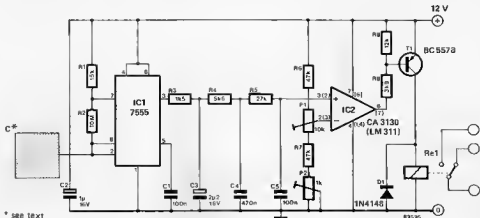

* see text

102

simple power supply regulator

The cost of high grade, regulated power supplies has dropped with the advent of modern ICs. For many applications the requirements are not that stringent and a simple, discretely constructed regulator as described here will suffice. With values as shown, the output

Table 1

U_i (V)	R_L (Ω)	U_o (V)
15	∞	12.00
	100	11.95
	22	11.72
17	∞	12.02
	100	11.97
	22	11.78
20	∞	12.06
	100	11.86
	22	11.50

Correlation between input and output voltage and load resistance

voltage is 12 V and the output current is limited to 0.5 A. For applications not requiring current limiting the circuit can supply up to 1 A. The current limiting components can then be left out. The relation between input voltage, load resistance and regulated output voltage is shown in table 1. This table can therefore be used to determine whether the regulation for

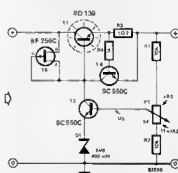

a particular application is sufficient. The 'heart' of the regulator, high-power low-frequency transistor T1, must be fitted onto an adequate heatsink. FET T3 operates as a current source with an output maximum of 11... 18 mA: this limits the base current of T1, of course, but the alternative would have been a very low value resistor; this would have resulted in large

power losses under low load conditions. To ensure correct operation of T3, the input voltage must be at least 3 V higher than the output voltage; for optimum regulation, a 5 V difference is recommended. The base circuit of T2 is driven by voltage divider R1, P1 and R2. Potentiometer P2 is set such that T2 'taps' some of the current of T3; the

smaller this current, the higher the base current of T1 and therefore the output voltage. This raises the voltage across the voltage divider, and consequently the base voltage of T2; T2 then takes some more current from T3: this reduces the base current of T1 and again the output voltage. In practice, an equilibrium is, of course, soon reached.

Transistor T4, in conjunction with resistors R3 and R4, forms a simple current limiter with the limit being determined by the values of R3 and R4. This stage also 'taps' some of the current from T3. If current limiting is not required, T4, R3 and R4 can be omitted. The emitter of T1 is then connected directly to the positive output terminal.

103 universal AFC

This AFC is suitable for frequencies up to 100 MHz and for use in frequency generators, waveform generators and all sorts of receiver.

The amplitude of the signal to be controlled is first amplified in two transistor stages, T1 and T2, and then applied to the D input of bistable FF1. The clock input of this multivibrator is connected to the Q8 output of IC1 which is a 14-step counter and crystal-controlled oscillator. The frequency of this oscillator is 32.768 kHz, so that a square wave of frequency 64 Hz becomes available at output Q8 (pin 13). This is used to clock FF1 and the input signal is therefore sampled 64 times per second. Flip-flop FF2 is fed from output Q9 (pin 15) of IC1 to provide an output of 16 Hz at its Q output. The trailing edges of the sampled signal and the leading edges of the 16 Hz signal are summed by C4, C5, D1, R7 and R8 and applied to the inverting input of op-amp IC3.

The non-inverting input of the op-amp (and the junction of D1 and D2) is held at half the supply voltage via R9, R10 and C6. IC3 integrates the difference between the output signals of FF1 and FF2. The output signal of IC3 is taken through a low-pass filter (R12, C9) and may be used for fine adjustment of the oscillator frequency (for instance, with a varicap). With the sampling and reference frequencies used, the fine adjustment is variable over a range of ± 16 Hz. The separation between the two ranges is always 64 Hz. The AFC adjusts the oscillator frequency, therefore, always to the nearest

multiple of 64 Hz. Once the oscillator is adjusted, its frequency stability is better than 1 Hz. An indicator, formed by T3...T8, is also connected to the output of IC3. T3 and T4 are connected as a current source, while LED D3 provides the reference voltage. The outputs of the current sources are applied to two comparators, T5/T6 and T7/T8. One two-colour LED is connected to each of the com-

parators. The output voltage of IC3 is compared with half the supply voltage (to which T6 and T8 are connected) by T5 and T7. If the output voltage of IC3 is lower than half the supply voltage (that is, the oscillator frequency is too high), the red section of LED D4 and the green section of LED D5 will light; when the oscillator frequency is too low, the green section of D4 and the red section of D5 will light. When the output voltage of IC3 is exactly equal to half the supply voltage, and therefore the oscillator frequency is right, both LEDs will glow orange/yellow. If the colours of the LEDs are the same tint, the AFC is at dead centre. This is a very precise method of indication.

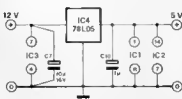
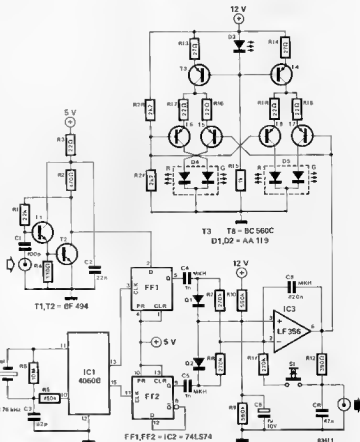

104

key bleep

There are many situations where an audible indication for a button pressed would be very useful. Two particular cases are: a morse key, where it is otherwise impossible to know that the key has been operated, and an ASCII keyboard. This circuit is based on a 7555 timer IC (the CMOS version of the well known 555) which is connected as an astable multivibrator (AMV). Its output is a square wave at a frequency of about 700 Hz and is used to drive a small buzzer. The circuit will be prevented from oscillating if pin 4 of the IC is taken to 0 V, in other words, a short between points A and B in the circuit diagram.

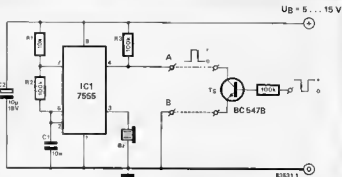

As mentioned, the key bleep is ideal for use as a key push indicator with the ASCII keyboard. In this case a tone will be produced each time the key is pressed making it unnecessary to continually look at the screen to verify correct operation. Don't worry, only one key bleep circuit is needed, not one for each

key of the keyboard! The circuit can be controlled by the strobe pulse which can, of course, be either a logic '1' or a logic '0'. If it is a '1' the strobe can be connected directly to point A. If on the other hand, it is a '0' then the transistor stage TS will have to be connected between points A and B. The strobe output is then fed directly to the base of transistor TS. If the circuit is to be used with a morse key, the transistor stage TM is required. The emitter and collector of the transistor are connected to points A and B and the key is placed between its base and 0 V.

105

180 watt DC/AC converter

This is a portable converter and is intended for use with a 12 V lead-acid battery. Whether it's in the car, boat, caravan or mobile home, this converter provides a mobile 220 V a.c. supply suitable for powering small electrical appliances, such as lights, soldering irons or electrical tools. The circuit requires only six transistors, a mains transformer and some capacitors and resistors. An astable multivibrator (AMV), consisting of transistors T1 and T2, provides a square-wave at a frequency of about 50 Hz. As T1 and T2 conduct alternately, the output stages also operate in 'push-pull'. When T1 conducts, a current also flows through T3; this switches on T5 and this transistor connects

one half of the secondary winding of mains transformer Tr across the 12-volt battery. If T2 conducts, transistor T6 switches the other half of the mains transformer across the battery. If RCA 40411 transistors are used in the output stages, the current through the secondary winding can be as high as 10 A, giving a possible power output of 180 watts. If 2N3055 transistors are used, the power output will be about 90 watts. As the output transistors are driven into saturation, they should be mounted on very large (100 mm high fins) heat-sinks. If a toroidal mains transformer is used, the converter can be constructed as a

very compact unit. The advantages of a simple construction and high efficiency are offset by the disadvantage of a square-wave output voltage which, in the absence of a regulator, is load-dependent: at low loads the output voltage may be well over 220 VAC. This presents no problems for small electrical appliances, but drills with electronic speed control or light dimmers may not work effectively as they are designed for sine-wave operation only. It is definitely not advisable to try to operate colour television sets, video recorders or HiFi equipment from this converter.

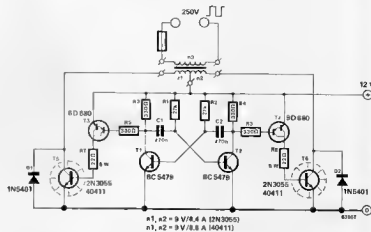

PC board pages

Apart from words of praise for our printed circuit boards, we receive many letters from readers inquiring into the possibility of making, that is, etching, their own boards. It is, of course, true that producing negative or positive film from the track layouts published in Elektor is no easy task. We decided, therefore, to seek a solution to our readers' quests with the proviso that this would not increase the cost of the magazine. We think we have found a satisfactory one . . . The following pages contain the mirror images of the track layout of a number of printed circuit boards. If you now wish to etch your own board, go to your local arts shop or stationers and buy a can of transparent spray. This spray makes paper transparent, particularly to ultra-violet light. You also need positive photo-sensitive board material. This can either be bought or,

using photo copying lacquer, home made by applying a film to normal board material. The photo sensitive (track) side of the board must be thoroughly wetted with the transparent spray. Then lay the layout cut from the relevant page of the magazine onto the wet board. Remove any air bubbles by carefully 'ironing' the cut-out with some tissue paper. The whole can now be exposed to ultra-violet light. Covering with a glass plate is not necessary as the spray ensures that the paper sticks to the board. Do not delay the exposure too long because when the spray dries the paper no longer sticks. During long exposure times, the paper can be held in place with a glass plate. Do bear in mind, however, that normal plate glass (but not crystal or plexiglass) absorbs some of the ultra-violet light so that the exposure time has to be increased

somewhat.

The exposure time is dependent upon the UV lamp used, the distance of the lamp from the board and the photo sensitive board. Using a 300 W UV lamp at a distance of about 40 cm from the board and using a plexiglass sheet, an exposure time of 4 . . . 8 minutes should be sufficient.

After exposure remove the layout sheet (which can be used again) and rinse the board thoroughly under running water. After development of the photo sensitive film in sodium lye (about 9 grammes of etching sodium to one litre of water), the board can be etched in ferric chloride (500 grammes of Fe_3Cl_2 to one litre of water). Rinse the board (and your hands!) thoroughly. Remove the photo sensitive film from the copper tracks with wire wool and drill the holes.

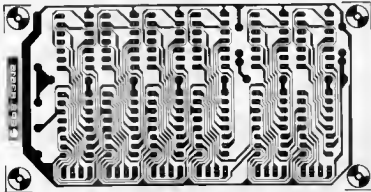
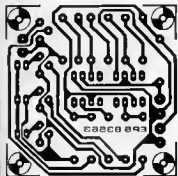
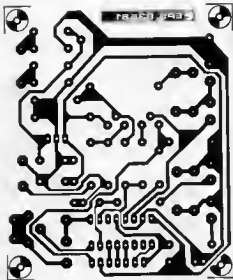
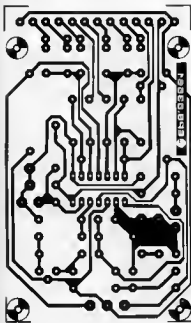

service

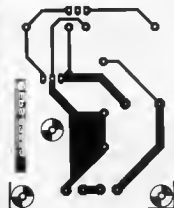
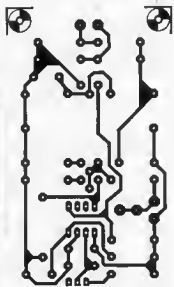
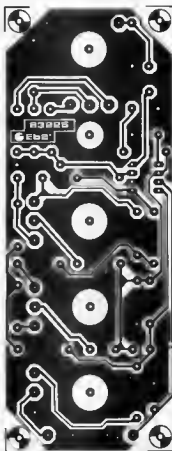
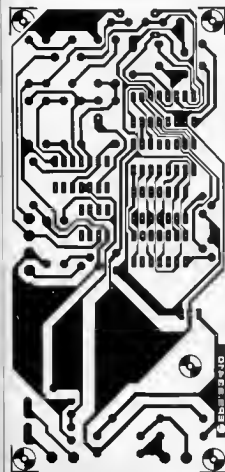
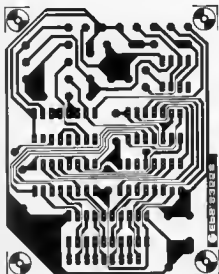
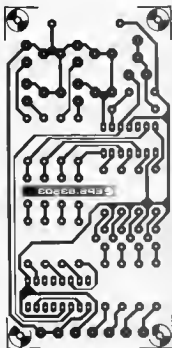
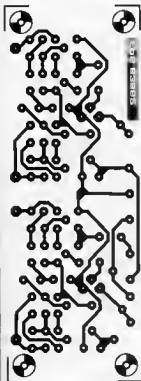

The Texas Instruments Electronic Library

Words from the wise for beginners to buffs.

Semiconductor Publications

- Optoelectronics Data Book**
Ref. LCC 440.
Softbound 408 pages. **£4.00**
- Optoelectronics Theory and Practice**, 1st edition 1976.
Ref. OTP
Casebound 434 pages. **£6.00**
- Linear Control Circuits**
1980 edition. Ref. LCC 478L.
Softbound 416 pages. **£4.00**
- Voltage Regulators**
1977 edition. Ref. LCC 4350.
Softbound 200 pages. **£4.50**
- MOS Memory**
1982 edition. Ref. LCC 706L.
Softbound 293 pages. **£3.95**
- The Bipolar Microcomputer Components Data Book**
3rd edition. Ref. LC 583L.
Softbound 560 pages. **£4.50**
- Interface Circuits**
2nd edition 1981. Ref. LCC 592L.
Softbound 750 pages. **£7.00**
- *TTL Sixth European Edition 1983**
Volume 1. Ref. TTLDB 1.
Softbound 1120 pages. **£9.00**
- *TTL Sixth European Edition 1983**
Volume 2. Ref. TTLDB 2.
Softbound 1016 pages. **£8.00**
- The Bifet Design Manual 1982**
Ref. BDM 2.
Softbound 124 pages. **£3.95**
- Fundamentals of Microcomputer Design**
1982 edition. Ref. MPB 30A.
Softbound 584 pages. **£9.00**
- 9900 Family Data Book**
1st edition. Ref. FDB.
Softbound 770 pages. **£10.00**
- The Power Semiconductor Data Book**
2nd edition 1983. Ref. PDB.
Softbound 890 pages. **£9.00**
- Software Development Handbook**
2nd edition. Ref. SDIL.
Softbound 434 pages. **£12.90**

The TI Electronic Library was specially developed and written to give you an in-depth knowledge of today's world of electronics.

Each book (and there are over 30 on offer) is comprehensive, yet easy to understand. As informative for the electronics buff as for someone who's simply interested in what's going on today.

Together this library will give you the most complete range of titles available. Take advantage of our range and choose the book, or books you want from the titles below.

You'll find whole new worlds of advanced technology unfolding before you.

Pocket Guides

- TTL 1st European Edition 1981**
Ref. PGV1.
Softbound 336 pages. **£3.50**
- Linear & Interface**
Ref. PGV2.
Softbound 256 pages. **£2.50**

Basic Electricity Series

- Basic AC Circuits** Ref. LCW 8168.
Casebound 560 pages. **£8.50**
- Basic Electricity and DC Circuits**
Ref. LCW 816B.
Casebound 924 pages. **£9.75**

Home Computer

- 99/4A. Beginners Basic**
1981 edition. Ref. LCB 4180.
Softbound 244 pages. **£6.20**

*NEW TITLES THIS YEAR How to order

Fill in the coupon or if someone else has already used it, simply:

1. List reference numbers and quantities required.
2. Calculate total order value. Add £1.50 for postage and packing.
3. Send the list, plus your cheque payable to: Texas Instruments Ltd., PO Box 50, Market Harborough, Leicestershire. Allow 30 days for delivery.

Technical Publications Catalogue

Tick the box in the coupon if you would like a free copy of our detailed guide to all publications listed above.



Understanding Series

- *Understanding Electronic Control of Energy Systems**
1st edition. Ref. LCB 664Z.
Softbound 272 pages. **£3.95**
- *Understanding Electronic Security Systems**
1st edition. Ref. LCB 720L.
Softbound 128 pages. **£1.95**
- *Understanding Telephone Electronics**
1st edition. Ref. LCB 714L.
Softbound 288 pages. **£3.95**
- Understanding Solid-State Electronics**
3rd edition. Ref. LCC 336L.
Softbound 282 pages. **£3.95**
- Understanding Digital Electronics**
1st edition. Ref. LCB 331L.
Softbound 260 pages. **£3.95**
- Understanding Microprocessors**
1st edition. Ref. LCB 4023.
Softbound 288 pages. **£3.95**
- Understanding Computer Science**
1st edition. Ref. LCB 547L.
Softbound 278 pages. **£3.95**
- Understanding Communications Systems**
1st edition. Ref. LCB 452L.
Softbound 282 pages. **£3.95**
- Understanding Calculator Math.**
1st edition. Ref. LCB 332L.
Softbound 230 pages. **£3.95**
- Understanding Optronics**
1st edition. Ref. LCB 547Z.
Softbound 270 pages. **£3.95**
- Understanding Automotive Electronics**
1st edition. Ref. LCB 577L.
Softbound 288 pages. **£3.95**



TEXAS INSTRUMENTS
Creating useful products and services for you

To: Texas Instruments Ltd., PO Box 50, Market Harborough, Leics.

Please send me the following publications:

Technical Publications Catalogue

REFERENCE No.	QTY
1.	
2.	
3.	
4.	
5.	

REFERENCE No.	QTY
6.	
7.	
8.	
9.	
10.	

I enclose a cheque for £.....

Name.....

Company (if any).....

Address.....

Send now for an application form — then buy it with MAPCARD.

MAPCARD gives you real spending power — up to 24 times your monthly payments — instantly!

Maplin News

MAP

MAPLIN magazine / January 1983

MAP003
M 10078
Every Day Now 75

Sole UK Agents for Heathkit

NOW THE world-famous Heathkit range of superb electronic kits is available from Maplin — the newly appointed exclusive UK distributor. Kits range from a simple clock for beginners to a unique Robot (see pic) with which you can learn about robotics.

There is a range of training courses covering electronics and computing topics, many containing constructional projects. For full details, pick up a copy of the latest Maplin magazine or write for a free copy of our Heathkit catalogue. **Order As XH62S.**



GREAT PROJECTS FROM E&MM



OUR NEW book "Best of E&M Projects Vol. 1" brings together 21 fascinating and novel projects from E&MM's first year.

Projects include Harmony Generator, Guitar Tuner, Hexadrum, Synthesizer, Auto Swell, Partyline, Car Aerial Booster, MOS-FET Amp and other musical, hi-fi and car projects. **ORDER AS XH61R PRICE £1**

Computer Shopping Arrives

AS FROM June 1st you can place orders directly with our computer from your personal computer. The computer shopping revolution has arrived! To communicate, you'll need a modem (our RS232 compatible modem kit is LW99H price £39.95) and an interface (our ZX81 interface LK08J price £24.95 is available already with many more for most popular micros coming soon).

Just dial us up on 0702 552941 and you'll be able to interrogate our stock file then place your order, type in your credit card number and a few minutes after you hang up your order will print out in our warehouse ready for packing. And all without saying a word.

Try out the future way of shopping now! You'll see immediately what stock we've got available and you'll discover how easy it is to ensure your order is exactly right. And you'll see precisely what the current price is for each item and what total amount will be charged to your credit card. It all helps to make buying easier. So give us a ring now!

Maplin's Fantastic Projects

FULL DETAILS in our project books. Price 70p each.

In Book 1 (XA01B) 120W rms MOSFET Combo-Amplifier • Universal Timer with 18 program times and 4 outputs • Temperature Gauge • Six Vero Projects.

In Book 2 (XA02C) Home Security System • Train Controller for 14 trains on one circuit • Stopwatch with multiple modes • Miles-per-Gallon Meter.

In Book 3 (XA03D) ZX81 Keyboard with electronics • Stereo 25W MOSFET Amplifier • Doppler Radar Intruder Detector • Remote Control for Train Controller.

In Book 4 (XA04F) Telephone Exchange for 16 extensions • Frequency Counter 10Hz to



600MHz • Ultrasonic Intruder Detector • I/O Port for ZX81 • Car Burglar Alarm • Remote Control for 75W Stereo Amp.

In Book 5 (XA05F) Modem to European standard • 100W 240V AC Inverter • Sounds Generator for ZX81 • Central Heating

Controller • Panic Button for Home Security System • Model Train Projects • Timer for External Sounding.

In Book 6 (XA06G) Speech Synthesizer for ZX81 & VIC 20 • Module to Bridge two of our MOSFET Amps to make a 350W Amp • ZX81 Sound on your TV • Scratch Filter • Damp Meter • Four Simple Projects.

In Book 7 (XA07H) Modem Interface for ZX81/VIC20 • Digital Fingerprint Timer/Controller • DXers Audio Processor • Sweep Oscillator • CMOS Crystal Calibrator

25W Stereo MOSFET Amplifier



- Over 26W/channel into 8Ω at 1kHz both channels driven.
- Frequency response 20Hz to 40kHz ± 1dB.
- Low distortion, low noise and high reliability power MOSFET output stage.
- Extremely easy to build. Almost everything fits on main pcb, cutting interwiring to just 7

wires (plus toroidal transformer and mains lead terminations).

- Complete kit contains everything you need including pre-drilled and printed chassis and wooden cabinet.

Full details in Projects Book 3 Price 70p (XA03D). Complete kit only £55.20 incl VAT and carriage (LW71N).

MATINEE ORGAN

EASY-TO-BUILD, superb specification. Comparable with organs selling for up to £1000.

Full construction details in our book (XH55K). Price £2.50. Complete kits available. Electronics (XY91Y) £299.95* Cabinet (XY93B) 599.50* Demo cassette (XX43W) £1.99



Maplin's New 1983 Catalogue

Over 390 pages packed with data and pictures and all completely revised and including over 1000 new items

On sale in all branches of WH SMITH Price £1.25



POST THIS COUPON NOW!

Please send me a copy of your 1983 catalogue, I enclose £1.50 (inc. P&P). If I am not completely satisfied I may return the catalogue to you and have my money refunded. If you live outside the UK send £1.90 or 10 International Reply Coupons.

Name

Address

Post Code

E78/83

MAPLIN ELECTRONIC SUPPLIES LIMITED, P.O. Box 3, Rayleigh, Essex S86 8J.R. Telephone: Sales (0782) 551911 General (0782) 554155.

Shops at 159 King St., Hammersmith, London W6. Tel: 01-748 0926. 284 London Rd., Westcliff-on-Sea, Essex. Tel: (0782) 554000. Lynton Square, Perry Barr, Birmingham. Tel: (021) 356 7292.

Shops closed Mondays. All prices include VAT & carriage. Please add 50p handling charge to orders under £5 total value.