

elektor

up-to-date electronics for lab and leisure

D 71683

97

May 1983

85 p.

IR 123 p. (incl. VAT)
\$2.75

**μ P keyboard,
serial and parallel ASCII out**

IR remote control



self-locking morse decoder
for 6502 or Z80

wattmeter

contents



selektor	5-19
wattmeter	5-22
This circuit will be of interest to anyone whose wallet feels decidedly light after paying the electricity bill. No... it cannot be used to make money, but it can help you to control your electricity usage and thus save money.	
ASCII keyboard	5-26
Keyboard projects are always popular and this is an advanced design incorporating many features not normally found in this sort of project. It includes: a separate hexadecimal keyboard, extra function keys, the complete ASCII set, the possibility of using other codes, auto-repeat, shift-lock, capital-lock and RS 232C compatibility. It is, in fact, comparable to many professional keyboards used by computer manufacturers.	
Prelude p.s.	5-33
Those of you who have been following the Prelude project will now have quite a few, hopefully complete, printed circuit boards. This article gives a few final tips and some details which have not yet been mentioned. Also included are the technical specifications of the Prelude.	
multitester	5-36
(E. Osterwick)	
A simple circuit with a multitude of uses. Its small size makes it particularly useful, especially as it can be used as a logic tester for TTL levels, a voltage supply checker, a clock pulse detector and because it has an acoustic indication, all you have to do is listen.	
maestro (part 1)	5-38
A remote control unit similar to that used for television sets. In this case, however, it is used to control the whole Prelude system, adjusting volume, balance and tone, switching all the ancillary equipment on and off and selecting any input desired. All this and much more, without moving from the comfort of your armchair.	
what is power?	5-47
Our wattmeter can help tell you how much power is being used. This article gives some insight into the 'whys and wherefores' of power consumption.	
parallel-serial keyboard converter	5-50
Intended for use with our ASCII keyboard this parallel-serial converter allows the keyboard to be used with any computer which has serial input, with particular reference to the RS 232C.	
morse converter	5-52
(R. Unterrichter)	
Morse "translation" is a skill which many people would like to have but it is often not really worth the effort. In fact it is much easier to "teach" a computer (in this case with the 6502 processor) to read morse, which is just what we have done.	
78L voltage regulators ... and 79L	5-59
A brief description of these very useful components and hints on how to use them.	
morse decoding with the Z80A	5-60
(P. von Berg)	
Our second morse decoding program, this time with particular application to the Elektor Z80A card and using the Elekterminal and a CW signal forming circuit.	
market	5-62
switchboard	5-67
EPS service	5-80
advertisers index	5-82

*Immer da
für Sie*

You can't beat The System.

The Experimentor System™ — a quicker transition from imagination through experimentation to realization.



Experimentor solderless breadboard



Experimentor Scratchboard™ workpads



Experimentor Matchboard™ pre-drilled PCBs

When you have a circuit idea that you want to make happen, we have a system to make it happen quicker and easier than ever before. The Experimentor System.

You already know how big a help our Experimentor solderless breadboards can be. Now we've taken our good idea two steps further.

We've added Experimentor Scratchboard workpads, with our breadboard hole-and-connection pattern printed in light blue ink. To let you sketch up a layout you already have working so you can reproduce it later.

With Experimentor Matchboard you can go from breadboard to the finished product nonstop! We've matched our breadboard pattern again, this time on a printed circuit board, finished and ready to build on. All for about £1.50.

There's even a letter-and-number index for each hole, so you can move from breadboard (where they're moulded) to Scratchboard™ (where they're printed) to Matchboard™ (where they're silkscreened onto the component side) and always know where you are.

When you want to save time and energy, you can't beat The Experimentor System.

- | | | | |
|---|---|---|--|
| 1. EXP 300PC , which includes one item
A Matchboard pre-drilled PCB
£1.50 | 2. EXP-302 which includes three items
Three 50-sheet Scratchboard
workpads
£1.75 | 3. EXP 303 which includes three items
Two Matchboards and an EXP 300
solderless breadboard
£8.00 | 4. EXP-304 which includes four items
Two Matchboards, an EXP 300
breadboard and a Scratchboard
workpad
£9.40 |
|---|---|---|--|

GLOBAL SPECIALTIES CORPORATION



G.S.C. (UK) Limited, Dept. 2W
Unit 1, Shire Hall Industrial Estate,
Saffron Walden, Essex, CB11 3AQ.
Telephone: Saffron Walden (0799) 21682
Telex: 617477

GLOBAL SPECIALTIES CORPORATION DEPT. 2W

Unit 1, Shire Hall Industrial Estate, Saffron Walden, Essex

Name _____

Address _____

Incl. P&P and 15% VAT

1 EXP 300PC Only Reqt **£2.59** 2 EXP 302 Only Reqt **£2.88** FREE Catalogue tick box

3 EXP 303 Only Reqt **£10.35** 4 EXP 304 Only Reqt **£11.96** I enclose cheque PO for

£ _____

Please your order with Access, Barclaycard or American Express

Card No. _____ Expiry date _____

Goods despatched within 48 hrs



The MIGHTY MIDGETS
S&R B SOLDERING
IRONS AND ACCESSORIES

TYPE	18watt	5.46	35p
Model D	50watt		
temp controlled		14.20	35p
STAND for above		4.99	1.00
Model H	70watt	13.23	1.10
Model H	150watt	20.42	1.10
Solder low melt		94p	20p

From your Local Dealer or Direct from Manufacturer's

S&R BREWSTER LIMITED
86-88 UNION ST. PLYMOUTH PL1 3HG
0752-665011 TRADE ENQUIRIES WELCOME

PLEASE QUOTE YOUR NUMBER WHEN ORDERING

BIG NEWS

from

EMOS

VAST STOCKS OF COMPONENTS
AT RIDICULOUSLY LOW PRICES

MAIL ORDER

we offer the best component prices
In the business, and no order is
too small to receive our first class
attention.

COMPONENT WAREHOUSE

we have a huge warehouse full of
components, test equipment — in fact
virtually everything you will ever need.
Come and have a browse around.
Open Mon. to Sat. — 9am to 4pm.
You will easily find us opposite the
John O'Gaunt Hotel on the A45.

SEND A LARGE S.A.E. FOR OUR FREE
COMPREHENSIVE CATALOGUE

EMOS DEPT 5F
HIGH MARCH,
DAVENTRY

MODULES FOR SECURITY & DETECTION

INTRUDER ALARM CONTROL UNIT
CA 1250

The exciting new module offers all the possible features likely to be required when building an intruder alarm system. Whether used with only 1 or 2 magnetic switches or in conjunction with several ultrasonic alarm modules or infra-red units, a highly effective system can be constructed at a fraction of the cost of comparable ready-made units. Supplied with a fully adjustable Date Sheet that makes installation straightforward, the module is fully tested and guaranteed.

Available in kit form £19.98 plus VAT

- Built-in electronic siren drives 2 loud speakers
- Provides exit and entrance delay together with hold alarm time
- Battery backup with trickle charging facility
- Operates with magnetic switches, ultrasonic or I.R. units
- Auxiliary tamper and panic facility
- Strobe/led output voltage
- 2 operating modes: full alarm/anti-tamper and panic facility
- Secure connections for ease of installation
- Separate relay contacts for switching external loads
- Test loop facility

Only £19.98 + VAT

ULTRASONIC ALARM MODULE

US 4012

Fully built & tested

Adjustable range
from 5ft. to 25ft.

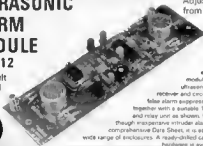

A really effective fully built module containing both ultrasonic transmitter and receiver and circuitry for generating false alarm suppression. This module, together with a suitable 12V power supply and relay unit as shown, forms an effective though inexpensive intruder alarm. Supplied with comprehensive Date Sheet, it is easily mounted in a wide range of enclosures. A ready-to-kit case and necessary hardware is available from right.

Only £19.98 + VAT

DIGITAL VOLTMETER MODULE DVM 314
3 digit. Fully built & tested



Only £19.98 + VAT

INFRA-RED SYSTEM

IR 1470

Fully built & tested

- Range up to 50
- 12V operation
- Supplied with full instructions
- Easily installed

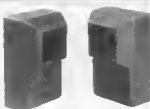

Now available, a really effective infra-red system built to the high standards demanded by the security industry and yet offered at a low price. The system consists of a transmitter and receiver which provide an invisible beam over distances from 1-50m or more. When the beam is interrupted, an alarm is arranged as the receiver unit. The use of a modulated beam combined with the infra-red line prevents interference from artificial or sunlight, whilst LED indicators ensure easy alignment of the beam. Both units are housed in attractive black moulded enclosures which are easily mounted. Supplied with full instructions, the unit is ideal for use in conjunction with the Control Unit CA 1250 or as an independent unit.

Power Supply & Relay Units PS 4012

£4.25 + VAT

Provides a stabilised 12V output and relay with 2A contacts. The unit is designed to operate one or two of the ultrasonic units. Fully built and tested.

Siren Module SL 157

£2.95 + VAT

Produces a loud and penetrating siren using tone operating from 9-15V. Capable of driving 2 off 8 ohm speakers to GND at 110db at 2M. Contains an alarm facility for use with alarm clocks or other break to activate curtilage.

Full VAT & 80p post and packing to all orders.
Shop hours 9.00 - 8.30 p.m.
(Wed. 9.00 - 1.00 p.m.)
Units on demonstration - orders welcome. S.A.E. with all enquiries.



Telephone orders welcome

Hardware Kit HW 4012

£4.25 + VAT

A suitable ready-to-fit case with the various mounting points, mains switch socket and nuts and bolts. Designed to house the ultrasonic alarm module together with its power supply. Size 193mm x 120mm x 45mm.

★ ACCESSORIES ★

3-position Key Switch for use with CA 1250 supplied with 2 keys £7.43
Magnetic switch (with magnet) £1.17
5 Horn speaker for use with CA 1250 and SL 157 £4.95

RISCOMP LIMITED

Dept. EKS,
21 Duika Street,
Princes Risborough, Bucks.

Princes Risborough (064 44) 8328

Please allow 7 days for delivery

B.K. ELECTRONICS

SPECIAL OFFER

DIGITAL CAPACITANCE METER
 LCD DIGITAL MULTITESTER
 MINIATURE AUTORANGING D.M.M.



DM 2350/C

KD615

DM 6013

INCLUSIVE OF
 POST & PACKING
 AND VAT.

DM6013 DIGITAL CAPACITANCE METER

£52.75

High accuracy measurement of capacitance over a wide range of values. Fast sample time, easy to read LCD display. Rugged construction — easy operation.

Display	3 1/2 digit LCD x 13 mm to 1999
Ranges	B ranges, full scale values 200pF to 2000µF
Sample time	0.5 second
Measurement capability	0.1pF to 2000µF
Accuracy	0.5% full scale ± 1 digit

Features	Zero adjustment, over load protection, side switches for single-handed operation
Accessories	Pair test leads with alligator clips, spare fuse
Power	1 x PP3 battery (not supplied)
Calibration	By internal adjustment
Dims.	175 x 80 x 35 mm

KD615 LCD DIGITAL MULTITESTER

£39.99

Multifunction 3 1/2-digit test including transistor tester and 10A d.c. range. Over-range, low battery and polarity indication. Full fuse overload protection. Supplied complete with carrying case, test leads, battery and instruction manual.

d.c. Volts	0.2 - 2 - 20 - 200 - 1000V ± 0.8% Impedance 10M
d.c. Amps	0.2mA - 2mA - 20mA - 200mA ± 1.2%, 10A ± 2%
a.c. Volts	200 - 750V ± 1.2% - Impedance 5M

Resistance	200 ohms - 2k - 20k - 200k - 2M - 20M ohms ± 1%
Transistor check.	hFE 0 - 1000 PNP or NPN; I _{BE} 10µA, V _{CE} 2.8V.
Dims.	196 x 93 x 42mm

DM2350/C MINIATURE AUTORANGING D.M.M.

£52.00

Super compact autoranging digital multimeter featuring continuity buzzer and large (10mm) clear 3 1/2-digit display. Full fuse overload protection. Carrying case, leads, battery, spare fuse and instruction manual supplied.

d.c. Amps	0 - 200mA ± 1.2%; 20A with shunt (included)
d.c. Volts	0.2 - 2 - 20 - 200 - 1000V ± 0.8% Impedance 10M
a.c. Amps	0 - 200mA ± 1.4%, 20A with shunt (included)

a.c. Volts	2 - 20 - 200 - 600V ± 1.0% Impedance 10M
Resistance	200 ohms - 2k - 20k - 200k ± 0.8% 2M ohms ± 2%
Dims.	130 x 65 x 20mm

B.K. ELECTRONICS Dept. EK

UNIT 5, COMET WAY, SOUTHEAST ESSEX, SS2 6TR.

★ SAE for current lists. ★ Official orders welcome ★ All prices include VAT

please phone 0702 527572



hFE
 TEST
 10A
 RANGE

AUTO
 RANGING
 POCKET
 SIZE

Selektor

Electrical language of fish

Man has known about electric fish at least since the ancient Egyptians decorated the walls of tombs with fishing scenes that depicted the formidable electric catfish of the Nile. But millions of people in central Africa eat large numbers of another type of 'weekly-electric' fish, which use their discharges to communicate with each other and find their way about in complete darkness.

Electrolocation

Weakly-electric fish produce electric organ discharges (EODs) of only two to three volts continuously throughout their lives.

Each discharge, emitted by a special electric organ in the fish's tail, sets up an instantaneous electric field in the surrounding water. Objects in the near vicinity distort this field in a

predictable way, thereby informing the fish of their size, conductivity and relative movement. Thousands of electro-receptors constantly monitor the pattern of current flow around the fish.

The receptors form conductive pores in the otherwise highly resistive skin of the fish so that current generated by the electric organ tends to leave the fish by those routes, returning along curved paths to re-enter the fish at its tail. The sensory cells at the base of the electroreceptors encode the current intensity directly into nerve impulses, which show the greatest modulation in the area of skin closest to the nearby object. This local modulation has been likened to projecting an electric image of the object on the surface of the skin.

Continued study revealed several different types of electroreceptor. So-called ampullary receptors monitor the surroundings for low-frequency

electrical signals generated by the swimming muscles of non-electric fish and insect larvae, providing information about predators and prey. The sensitivity of such receptors is so great that navigation by measuring induced electric currents as the fish swims through the Earth's magnetic field has been shown to be possible.

Ampullary receptors cannot, however, respond to the high-frequency content of electric fish signals. They are used only in a passive way and it seems that it is others, known as tuberous receptors, which are designed for the job of active electrolocation.

If tuberous receptors code the fish's own electric field, it seems likely that they should at least be useful for detecting the EODs of other electric fish.

A rich variety of messages, regarding species, age, size and sex of electric neighbours can be communicated

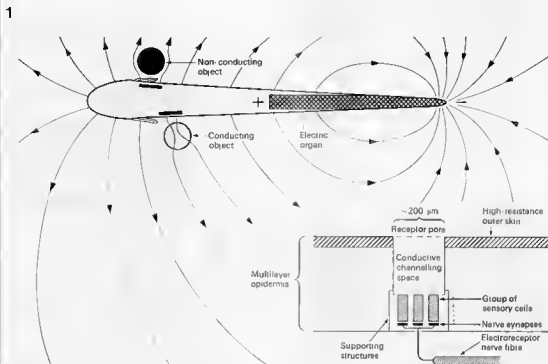

Figure 1. Simplified section through a typical electric fish. The electric organ in the fish's tail produces a low-voltage discharge which sets up a current flow through the fish and surrounding water. Lines indicate the current flow out through the low-resistance electroreceptor pores, concentrated at the head end, and in at the tip of the tail. Objects of lower or higher conductivity than the water distort the field lines in a predictable way, altering voltages across the skin in the adjacent regions, shown by bars. The inset shows the basic structure of an electroreceptor. A pore in the high-resistance outer layer of the skin channels current to the sensory cells which translate the variations in the electric field into nerve impulses.



Figure 2. Electrical discharges of some of the more common African Mormyrid fish. At the left is the only 'wave' species on the African continent *Gymnarchus niloticus*, the subject of Lisman's classic experiments in which electrolocation was first demonstrated. The other, mormyrid, pulse-type fish serve to highlight the striking differences in waveforms between species. As with the gymnotoid pulse fish, the intervals between pulses are all highly variable and they overlap; in some species, discharge rates as low as 1 Hz occur. Head positivity is shown upwards.

electrically, as are signals of threat, submission and readiness to mate.

Electrocommunication

Two groups of weakly electric fish can be broadly classified into 'pulse' and 'wave' species. Pulse species generate brief EODs separated by relatively long and variable intervals. By contrast, wave species produce pulses separated by very short intervals, approximately equal to the pulse width itself. Wave fish also hold their EOD frequency amazingly constant, with variations of less than 0.1 per cent.

Species differences

Within the pulse end wave classes there are also quite clear characteristics that are specific to the EOD of every species. The waveform is fixed by the anatomical arrangement of the electrocytes, or generating cells of the fish's electric organ. Variations in the innervation and physico-chemical make-up of the electrocytes alter the pulse waveform recorded outside the fish. The diversity of the EODs of sympatric species of electric fish (that is, those sharing a common habitat) is quite astounding. Of the 30 or more mormyrid EODs which have been recorded we find variations in the number, duration, polarity and relative amplitude of the pulse components. The most impressive differences are in the duration of the EOD, which had a range of 50 μ s to 10 ms. Although the ranges of intervals between pulses are species-specific, there is considerable overlap and it

seems that the form of the EOD alone is ample for species identification and is a vital block to interbreeding, thereby keeping the species genetically pure.

Sex and age differences

It has been found that the waveform varies even between individual fish. Each has its own, discrete EOD, as characteristic as a fingerprint. Furthermore, the variation falls into two distinct classes corresponding to the sex of the individual. This obviously has important implications for electric communication and suggests that the difference in waveforms between the sexes plays a part in attracting a mate. Is information about the age of the fish contained in the EOD? It has been discovered that the larval EOD is quite different from that of the adult. It is of the opposite polarity and 20 times as long as the EOD of adult fish. The first pulses appear between eight and ten days from hatching and the larval EOD continuous for the first 40 days of life, after which it is replaced by the normal adult EOD. As well as signals identifying species, sex and age, more complex information can be sent electrically. It is not coded by altering the pulse shape (which is fixed for individual fish) but by modulating the pulse repetition frequency. The effectiveness of certain pulse sequences as suspected signals can be assessed by playing back the patterns, using a model fish. Messages of threat are coded in all species by sudden increases in frequency. Mormyrids, for example, normally discharging at around

10 Hz, sometimes produce sharp frequency increases of up to 100 to 120 Hz for a short time. Such signals are often seen when a fish receives the playback of an intruder fish. A typical response to a threat signal is to stop discharging altogether. Submissive fish turn off their EODs for a short time such as half a second; in extreme cases, for example, where the fish has been injured, the electrical silence may last as long as 30 minutes. This signal is highly effective and a dominant fish rarely continues attacking an electrically silent partner. Its effectiveness is probably partly due to the fact that turning off the EOD renders the fish more or less undetectable: it is as though it were hiding electrically. Silent fish generally remain very still, probably to avoid detection; moreover, because they are then electrically blind and unable to electrolocate, they are afraid of crashing into things! One big problem with this dual-function electrosensory system is that there are many instances in which electric communication is either incompatible with or else upsets the efficiency of the electrolocation system. Turning off the EOD is obviously incompatible with active electrolocation; but just listening to other electric fish can cause difficulties. At worst, the electrosensory system may be completely jammed if another electric fish is discharging synchronously nearby. This is seen most clearly in wave species where another fish with an identical EOD frequency severely upsets electrolocation. The fish have a built-in jamming avoidance response, or JAR, specially

3

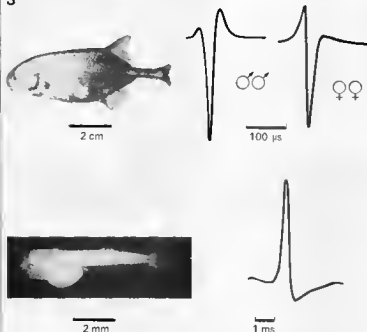

Figure 3. Top: Adult male mormyrid, *Pollimyrus isidori*, with (right) typical male and female discharges. Bottom: Eight-day old fry of *P. isidori* with its larval pulse recorded only a few hours after the first discharge. The waveform lasts a lot longer than that of the adult, and its polarity is reversed.



Figure 4. *Gymnnotus carapo* reacting aggressively towards a plastic dipole model playing back simulated 'burst' thrust signals. The fish is attacking the electrical 'head' of the otherwise symmetrical model. Reversing the polarity of the playback causes the fish to direct its attack to the opposite end. This experiment demonstrates that *G. carapo* can determine the orientation of another fish solely on the basis of electrical cues.

to avoid this problem. When a fish is confronted by another fish with a similar EOD frequency, it simply shifts its discharge rate away from that of the intruder. The JAR is triggered at quite a distance, long before the discharge of an approaching fish becomes intense enough to affect electrolocation. Interference from other species is not a problem because EODs from other species are filtered

out at a peripheral stage.

JARs in pulse fish involve sudden jumps in discharge frequency as attempts are made to avoid impending coincidence of discharges. Another trick is to lock on to a neighbour's EOD and discharge at a short fixed delay, rather than an echo, thereby completely avoiding any possibility of simultaneous discharge.

Mormyrid pulse species appear to be exquisitely well-designed to solve interference problems. Firstly, the tuberous receptors are of two types. The *Mormyromasts* respond only to the fish's own EOD. The *Knollenorgan* functions solely in electric communication and, because of its high sensitivity, is well suited to detect distant fish of that species, and is tuned to the species-specific EOD.

The Mormyrid has solved the jamming problem by time-sharing the two functions of the electro-sensory system, rejecting communication signals during electrolocation and attending carefully to them during the relatively long interval between pulses.

Dr. G.W.M. Westby,
Spectrum 181.

Stereo TV sound

BBC finds dual FM system workable, but digital system might be better

Towards the end of 1982 the BBC conducted over-air tests to establish whether a two-carrier sound-with-television system can be compatible with normal UHF reception. These tests took place out of normal service hours and were observed by staff from the BBC, ITV and receiver manufacturers in the area served by the Crystal Palace transmitter. A total of 414 questionnaires was completed, and the analysis of these is now complete.

The system tested is a variant on that used for stereo TV sound in Germany, in which the additional sound signal is carried on a second FM carrier set at around 7 dB below the main sound carrier and separated by some 300 kHz from it. The results confirmed the expectation that cross-talk from the second sound signal into the first is not a problem, and that patterning caused by beats between the sound carriers can be kept to a tolerable level if the amplitude of the main sound carrier is reduced a little. They also showed, however, that buzz-on-sound can be a problem with existing receivers, regardless of the level of the second carrier, and that this buzz problem is increased by turning the main sound carrier down. Buzz is to some extent receiver-dependent, but the main factors affecting it are multipath propagation, which can cause the received sound-to-vision carrier ratio to vary by ± 5 dB or more, and the spectral content of the picture. All in all it appears that a system of this type might give a largely satisfactory service, but investigations are continuing into alternative possibilities. Stereo TV sound will be available from 1986 via DBS in digital form, and broadcasts of this sort might precede terrestrial two-channel sound with television. It is thus important to establish whether a digital sound package could satisfactorily be received from terrestrial transmitters as perhaps a better alternative to a second FM carrier. Preliminary assessments indicate that the digital option could give a better compromise between compatibility and ruggedness. A thorough examination of the digital system has therefore begun, and this will call for further over-air tests in due course.

BBC Engineering Information
Department.

1867 SJ

How much current is drawn by a dimmed light-bulb? Does the extractor fan actually 'consume' the rated power specified by the manufacturer? What output power can I expect from my home-made windpowered generator? Or even: What is the power consumption of my super hi-fi FET power output stage? All these questions, and more, can be answered simply, using an electronic wattmeter.

watt-meter

measuring
electric power
the electronic
way!

If the wattmeter is expanded to a kilowatt-hour meter by adding a suitable extension circuit (this will probably appear in the June issue), the user will also be able to answer the following questions:

How much can I save by placing the refrigerator in a cool room and what is its average consumption per week? What contribution to energy saving is made by insulating the electric boiler? What is the cost of a 'machine wash' at 90°, compared with one at 60°?

The wattmeter can be used simply and safely as an intermediate socket between the load and the mains socket. The terms 'power', 'energy', 'r.m.s. voltage and current' are explained in a separate article in this issue.

Block diagram

The operation of the electronic wattmeter is best explained on the basis of the block diagram in figure 1. The (average) power is equal to the mean product of the instantaneous voltage across load X and the instantaneous current through it. The alternating

mains voltage $u(t)$ is brought to the proper level by an input stage (A1) and fed to the input of a four-quadrant multiplier. A voltage is developed due to the load-current $i(t)$ flowing through a shunt resistor (R_{sh}). This voltage is fed via a second input stage (A2) to the other input of the multiplier. The multiplier forms the product of the alternating voltage and current and supplies a current as a measure of the instantaneous power $p(t)$. A moving coil meter takes the average of the current and indicates the average power.

Why do we use a four-quadrant multiplier and not, for example, a two-quadrant multiplier? This requires some explanation: during multiplication of alternating voltages and currents four different situations can be encountered: instantaneous voltage and instantaneous current are simultaneously positive (quadrant I); the instantaneous voltage is negative and the current is also negative (quadrant III); the voltage is negative and the current is positive (quadrant II) and vice versa (quadrant IV). Figure 2 shows these possible situations.

If the instantaneous power is positive (I and III), power is being consumed. If the power is negative (II and IV), the load returns power to the mains on account of its capacitive or inductive characteristics.

This can also be expressed as follows: if the average power (product of the mean values over one period of mains voltage) is positive, we are dealing with a load. The multiplier supplies a positive output current and the

Figure 1. Simple block diagram of the wattmeter. The voltage drop across load X and the current through it are applied to a four-quadrant multiplier via two input stages. The multiplier forms the product of the alternating voltage and current, and drives the meter which indicates the average power.

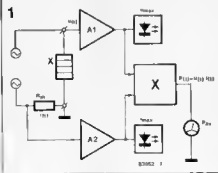

4

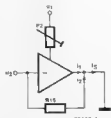

Figure 4. Equivalent circuit diagram of an OTA configured as a four-quadrant multiplier.

$$i_3 = i_1 + i_2$$

$$i_3 = -(S + S_0) \times u_2$$

$$+ \frac{u_2}{R_{15}}$$

$$S_0 = \text{slope at } u_1 = 0$$

$$S = k \times u_1 \quad (k = \text{constant})$$

$$i_3 = -(k \times u_1 + S_0)$$

$$\times u_2 + \frac{u_2}{R_{15}}$$

$$= -k \times u_1 \times u_2$$

$$-S_0 \times u_2 + \frac{u_2}{R_{15}}$$

If P2 is adjusted so

$$\text{that } S_0 = 1/R_{15};$$

$$i_3 = -k \times u_1 \times u_2$$

$$- \frac{u_2}{R_{15}} + \frac{u_2}{R_{15}}$$

$$= -k \times u_1 \times u_2$$

Important note

Excessive load currents can damage the shunt resistor R4. The power dissipated in this resistor is:

$$P_R = R_4 \cdot I_{rms}^2$$

The load current can be estimated before connecting the meter:

$$I_{rms} = \frac{P_{load}}{U_{rms} \cos \varphi}$$

The value given (0G47, 5 W) should be safe for loads up to 350 W (mains-powered). For higher loads, the value of R4 must be decreased

The amplification factor of the input stages can be set to 1 or 10. For a factor of 1, the terminals at A and B should be jumpered; otherwise the amplification factor will be 10. The choice of amplification factor depends on the load voltage and current. If desired, switches can be used for selecting the amplification factor, instead of actually connecting wires at A and B. This is a convenient method to use as then it is easy to change the amplification factor if the meter deflection is too low or if the multiplier is overdriven. To minimise power dissipation in R4, A2 should be allowed to operate at maximum gain (omit jumper B).

The output signals of A1 and A2 are fed to the four-quadrant multiplier A5. OTA 13600, which we met in the April 1982 issue, is used here. Readers interested in the operation of this IC can consult that issue. The OTA amplifies the differential voltage applied to its inputs (pins 13 and 14) and supplies a current at its output (pin 12). The amplification factor is quoted in mA/V and is referred to as 'slope'. This slope is relatively linear and varies as a function of the (control) current flowing in at pin 16. Thus the OTA multiplies two variables and provides a current as the product. In this case, one variable is the voltage derived from the mains and converted to control current by P2 and R16, and the second variable is the voltage which results from the load current

through R4.

The situation is clarified by figure 4. The OTA is represented as an amplifier with slope S. The voltage derived from the mains is designated u_1 and the voltage derived from the load current is designated u_2 . The slope S of the inverting OTA is adjusted with P2. This circuit produces current i_3 which flows to chassis earth (or virtual earth, to be precise). This current, in turn, is proportional to the product of u_1 and u_2 . This means that if one of the two factors is zero, no output current will flow because zero multiplied by another value is zero. If the OTA has no u_2 input signal, this condition is met so there is no gain and therefore no current. The slope is adjusted with P2, so that i_3 plus i_2 is equal to zero when u_1 is zero. According to the rule of nodes, i_3 is then also zero. If neither voltage is zero, an output current i_3 , proportional to the product of u_1 and u_2 , is produced as a result of the linear characteristic of the OTA. The four-quadrant multiplier is followed by a stage with a virtual earth input. We refer to this as a 'virtual earth', because the non-inverting input is connected to earth and the voltage difference between non-inverting and inverting inputs of operational amplifiers is assumed to be zero. Integrating network R28/C11 forms the mean value of the alternating output current of A5 and drives meter M1 via D5 or T1.

In the description of the block diagram, we said that the meter takes the average of the alternating current. Network C11/R28 would therefore seem to be superfluous. In fact, the meter does not take the average of the current but of the torque, i.e. the force which moves its coil. The VCO circuit (with A6 and A4) is provided to allow expansion to a kilowatt hour meter; since, however, this circuit can only process an average current, we have to include network R28/C11.

For use as a wattmeter (without VCO extension) a centre-zero moving-coil meter can

5

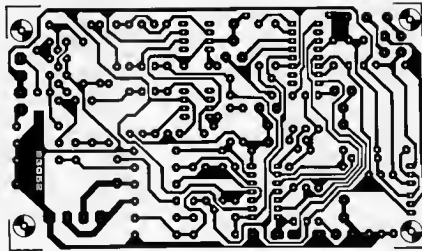

Figure 5. Track pattern and component layout of the printed circuit board for the wattmeter. Since the chassis earth will be connected to the mains during measurement, the p.c.b. must be installed in a well-insulated case.

indicate both positive (absorbed) and negative (delivered) power. Since the VCO circuit can only process positive currents, the wattmeter expanded to a kilowatt-hour meter will also only be capable of indicating positive power readings. In order to measure the power of a generator, the input of the wattmeter is connected to the generator. Two LEDs are contained in the circuitry of A7 and A8 to indicate overdriving. These circuits operate as fullwave rectifiers. Positive voltages are applied via D6 (D6') and negative voltages via the inverting input of the operational amplifier and D7 (D7') to transistor stage T2/T3 (T2'/T3'). If the signal level filtered by C8 (C8') is sufficiently high LED D8 (D8') lights to indicate that the wattmeter is being overdriven.

Construction and alignment

Once the components have been fitted to the printed circuit board (figure 5), the active part of the extension circuit (A4 and A6) is also complete because A4 and A6 are already contained in IC1 and IC2. The passive components of the VCO circuit (C1, R19, R20, R21 and P4) can be omitted for the time being. Voltage divider R1/R2/R3 is designed for a mains voltage of 220 V. It may be necessary to select another value for R4, to suit the load current. The power rating for the resistor is calculated as follows: $P_r = R4 I_{rms}^2$.

Since one of the mains voltage lines is connected to the circuit negative supply, the printed circuit board must be installed in an insulated plastic case. If the wattmeter is to be expanded to a kilowatt-hour counter, a larger case and a bigger transformer will be needed.

Three 2-core mains cables are inserted into the case: one with a plug for connecting the power supply of the circuit, a second one with a plug as the 'test cable' and a third one with socket as the output of the circuit. If it is only desired to measure the power drawn by a mains-powered load, the voltage

for the power supply can be obtained directly from the wattmeter input. There is therefore no need for a special mains cable (see photograph).

Please take note of the following warning before beginning alignment:

Do not touch any component when the circuit is connected to mains. Use a well-insulated screwdriver to adjust the preset potentiometers.

Insert jumpers A and B or close the corresponding switches (if used). Connect pin 5 of A1 to chassis earth and pin 3 of A2 to the positive pole of a 1.5 V battery (negative pole to earth). Switch on the mains voltage. Adjust P3 to its extreme anti-clockwise position (most sensitive setting), and adjust P2 so that the meter indicates zero. Switch the mains off again. Disconnect pin 5 of A1 from earth; remove the battery and connect the mains voltage to the input of the wattmeter. Switch on the power supply and adjust P1 so that the meter indicates zero. Repeat this procedure (first adjusting P2, then P1) several times so that the presets are set to an optimum.

Now remove jumper B or open the relevant switch. Connect a 60 W bulb to the output of the wattmeter and adjust P3 to its extreme clockwise position (least sensitive position). Plug the 'test cable' into a mains power socket. Switch on the mains and adjust P3 so that the meter reads exactly 0.6 mA (≈ 60 W). As a further check, this adjustment can be made with other bulbs. With high-grade bulbs the power indicated will agree with the rating printed on them. A more precise method is to measure the voltage across the bulb and the current through it. Multiply these values to obtain the power, then set this figure on the meter. After alignment of the wattmeter, the power can be read off in divisions of 10 W per 0.1 mA. If voltages lower than mains are to be measured frequently, the sensitivity of the wattmeter can be increased by a factor of 10 by removing jumper A. **M**

wattmeter
elektor may 1983

Parts list

Resistors
(all 1/8 W, except R4):
R1, R2, R22, R22' =
R23, R23' = 100 k
R3 = 3k3
R4 = 0.47 Ω /5 W
R5, R7, R9, R11 = 18 k
R6, R10, R24, R24' = 2k2
R8, R12 = 1k8
R13, R15, R20 = 10 k
R14 = 4k7
R16, R18 = 6k8
R17 = 820 Ω
R19 = 22 k
R21, R27, R27' = 1 k
R25, R25' = 47 k
R26, R26' = 15 k
R28 = 22 k
P1, P3 = 1 k preset
P2 = 50 k preset
P4 = 500 Ω preset

Capacitors:
C1 = 16 n
C2, C3 = 220 μ /25 V
C4, C5, C8, C8' = 10 μ /16 V
C6, C7, C9, C10 = 100 n
C11 = 10 μ /63 V

Semiconductors:
B1 = bridge rectifier
B40C800
D1... D6, D8',
D7, D7' = 1N4148
D8, D8' = red LED
T1 = BC557B
T2, T2', T3, T3' = BC547
IC1 = TL084
IC2 = 13600 or 13700
IC3 = 78L12
IC4 = 79L12
IC5, IC5' = 741

Miscellaneous:
Tr1 = mains transformer
2 x 15 V/0.2 A sec.
(1 A for expansion)
F1 = fuse, 0.2 A slow
M1 = 1 mA moving-coil
meter
4-way terminal block
(p.c.b. type)
Plastic case
2 or 3 mains cables

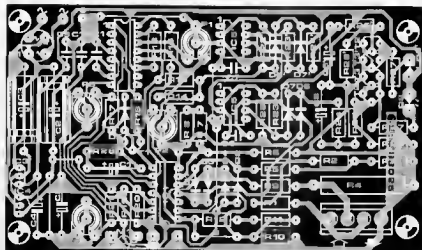

Our first ASCII keyboard was published in November 1978 (Elektor No. 43) and proved to be extremely popular. However, times change and the field of electronics and computers has taken several steps forward. It was therefore considered that it was time for a new design that was a little more sophisticated than the old one.

- separate hexadecimal keyboard
- extra function keys
- complete ASCII set
- other codes possible
- auto-repeat
- shift-lock
- capital-lock
- RS 232C compatible

ASCII-keyboard

... complete
with hexpad

As its name implies an alphanumeric keyboard includes both alphabetic characters and decimal characters (numbers), as well as all the punctuation marks. In order that the computer and the terminal can 'converse' they must obviously speak the same language; to do this several codes have been devised which give a specific binary word to each alphanumeric character. The best known and most widely used format is the American Standard Code for Information Interchange, usually abbreviated to ASCII. This is an 8-bit code which uses the most significant bit (MSB) as a parity bit for error detection. The remaining 7 binary digits provide 128 different combinations, so even when all decimal, alphabetic (upper and lower case) and punctuation marks are coded we still have a few codes left for control functions. Table 1 shows the complete set of ASCII characters, including command functions. This table also shows that there is a logical connection between specific groups of characters; so for example bit 5 is logic '1' for lower case and logic '0'

for upper case. Table 2 lists various abbreviations used and their meanings.

Keyboard circuit

Even though it is theoretically possible to have a keyboard with one key for each of the 128 functions, this could be rather confusing. To sidestep this difficulty every key is normally given a double (or triple) function and, in the same manner as scientific calculators, a shift key is added to the keyboard to select which particular function associated with a key is required. When a key is pressed the corresponding ASCII code word is formed by a coding IC. This simply consists of a ROM containing all the ASCII codes, and is addressed by the keyboard via two counter circuits whose outputs form a matrix. The RC network connected between pins 2, 3 and 40 of the decoder/encoder IC determines the frequency at which the matrix is scanned (in fact, the counter clock frequency). One of the counters delivers its

table 1

Character	Binary Bit 7 to Bit 0	Hexadecimal ASCII	Character	Binary Bit 7 to Bit 0	Hexadecimal ASCII	Character	Binary Bit 7 to Bit 0	Hexadecimal ASCII	Character	Binary Bit 7 to Bit 0	Hexadecimal ASCII
NUL	00000000	00	@	01000000	40	SP	10100000	20		11100000	60
SOH	00000001	01	A	01000001	41	!	10100001	21	a	01100001	01
STX	00000010	02	B	01000010	42	"	10100010	22	b	01100010	02
ETX	00000011	03	C	01000011	43	#	10100011	23	c	01100011	03
EOT	00000100	04	D	01000100	44	\$	10100100	24	d	01100100	04
ENQ	00000101	05	E	01000101	45	%	10100101	25	e	01100101	05
ACK	00000110	06	F	01000110	46	&	10100110	26	f	01100110	06
BEL	00000111	07	G	01000111	47	'	10100111	27	g	01100111	07
BS	00001000	08	H	01001000	48	(10101000	28	h	01101000	08
HT	00001001	09	I	01001001	49)	10101001	29	i	01101001	09
LF	00001010	0A	J	01001010	4A	*	10101010	2A	!	01101010	0A
VT	00001011	0B	K	01001011	4B	+	10101011	2B	"	01101011	0B
FF	00001100	0C	L	01001100	4C	,	10101100	2C	!	01101100	0C
CR	00001101	0D	M	01001101	4D	-	10101101	2D	m	01101101	0D
SO	00001110	0E	N	01001110	4E	.	10101110	2E	n	01101110	0E
SI	00001111	0F	O	01001111	4F	/	10101111	2F	o	01101111	0F
DLE	00010000	10	P	01010000	50	0	10110000	30	p	01110000	70
DC1	00010001	11	Q	01010001	51	1	10110001	31	q	01110001	71
DC2	00010010	12	R	01010010	52	2	10110010	32	r	01110010	72
DC3	00010011	13	S	01010011	53	3	10110011	33	s	01110011	73
DC4	00010100	14	T	01010100	54	4	10110100	34	t	01110100	74
NAK	00010101	15	U	01010101	55	5	10110101	35	u	01110101	75
SYN	00010110	16	V	01010110	56	6	10110110	36	v	01110110	76
ETB	00010111	17	W	01010111	57	7	10110111	37	w	01110111	77
CAN	00011000	18	X	01011000	58	8	10111000	38	x	01111000	78
EM	00011001	19	Y	01011001	59	9	10111001	39	y	01111001	79
SUB	00011010	1A	Z	01011010	5A	-	10111010	3A	z	01111010	7A
ESC	00011011	1B	[01011011	5B	-	10111011	3B	[01111011	7B
FS	00011100	1C	\	01011100	5C	<	10111100	3C	\	11111000	7C
GS	00011101	1D]	01011101	5D	>	10111101	3D]	11111001	7D
RS	00011110	1E	A	01011110	5E	>	10111110	3E	-	11111010	7E
US	00011111	1F	-	01011111	5F	?	10111111	3F	DEL	11111011	7F

table 2

NUL	- null, or all zeros
SOH	- start of heading
STX	- start of text
ETX	- end of text
EOT	- end of transmission
ENO	- enquiry
ACK	- acknowledge
BEL	- bell
BS	- backspace
HT	- horizontal tabulation
LF	- line feed
VT	- vertical tabulation
FF	- form feed
CR	- carriage return
SO	- shift out
SI	- shift in
DLE	- data link escape
DC1	- device control 1
DC2	- device control 2
DC3	- device control 3
DC4	- device control 4
NAK	- negative acknowledge
SYN	- synchronous idle
ETB	- end of transmission block
CAN	- cancel
EM	- end of medium
SUB	- substitute
ESC	- escape
FS	- file separator
GS	- group separator
RS	- record separator
US	- unit separator
SP	- space
DEL	- delete

table 3

C: control
S: shift
N: normal

	y0	y1	y2	y3	y4	y5	y6	y7	y8	y9	y10
NUL											
SOH											
STX											
ETX											
EOT											
ENO											
ACK											
BEL											
DC1											
DLE											
DC2											
DC3											
DC4											
NAK											
SYN											
ETB											
CAN											
EM											
SUB											
ESC											
FS											
GS											
RS											
US											
SP											
DEL											

table 4

(FORM FEED)	CTRL + L	=	FF	=	home cursor + page clear
(LINE FEED)	CTRL + J	=	LF	=	LF + cursor ↓
(HORIZONTAL TAB)	CTRL + I	=	HT	=	cursor →
(VERTICAL TAB)	CTRL + K	=	VT	=	cursor ↑
(CARRIAGE RETURN)	CTRL + M	=	CR	=	CR + erasure to end of line
(BACK SPACE)	CTRL + H	=	BS	=	cursor ←
(ESCAPE)	CTRL + [=	ESC	=	scroll up
(FILE SEPARATOR)	CTRL + %	=	FS	=	home cursor

table 5

DATA	STROBE	connections
normal	pos:	c, f, h
invert	pos:	d, e, h
normal	neg:	c, f, g
invert	neg:	d, e, g
even parity:		a
odd parity:		b

board is the possibility of locating the keys wherever you like on the keyboard, thanks to the option of code conversion shown in part of Figure 1. The ASCII information provided by the keyboard converter is applied as an address to an EPROM (2716). The EPROM is programmed such that a given input (in the form of an address) corresponds to a particular code which appears as data at the EPROM output. The ribbon cable from the computer or terminal connects to the data lines of the EPROM through a 14-way DIL pin head.

The EPROM can be divided into sections by means of connections at m, n, o, p, so in one 2716 we can have 16 different combinations of 128 characters. If only the normal QWERTY keyboard with no code conversion functions is required then the EPROM should be omitted and the address inputs connected directly to the corresponding data outputs.

A parallel/serial conversion to provide RS 232 compatibility is a very interesting possibility with this keyboard. It is discussed in greater detail elsewhere in this issue.

Figure 2. The location of the alphanumeric keys is determined, in principle, by the keyboard encoder. Figure 2a shows the normal QWERTY configuration which can be changed at will by including a code-conversion EPROM in the output of the encoder. The hexadecimal keys (Figure 2b) are placed at the same nodes in the matrix as their counterparts are on the big keyboard.

2a

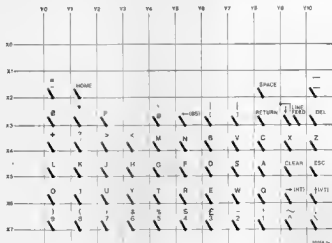

b

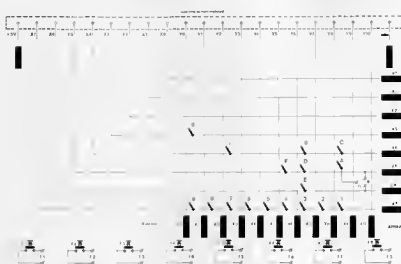

Table 1. The complete ASCII code in binary (7-bit) and hexadecimal (00...7F) forms.

Table 2. The CONTROL (CTRL) key combined with certain other keys allows special functions (see also Table 3).

Table 3. A number of keys in the keyboard provide special functions when used in conjunction with the SHIFT (upper case) or CTRL keys.

Table 4. Some functions that are used frequently are provided by an independent-key.

Table 5. The active logic levels of the data signal-strobe and parity are user-programmable.

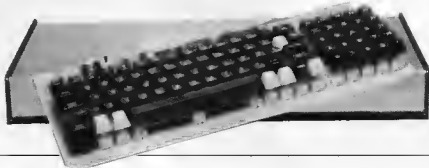



For the standard keyboard layout, the EPROM (IC4) can be replaced by a set of jumpers mounted on a DIL socket.

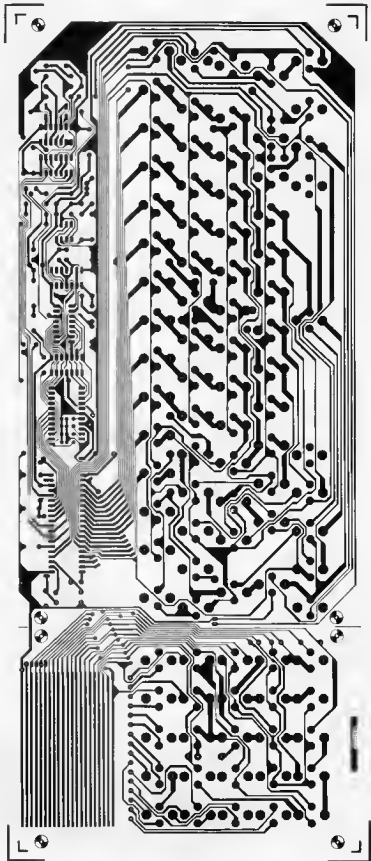

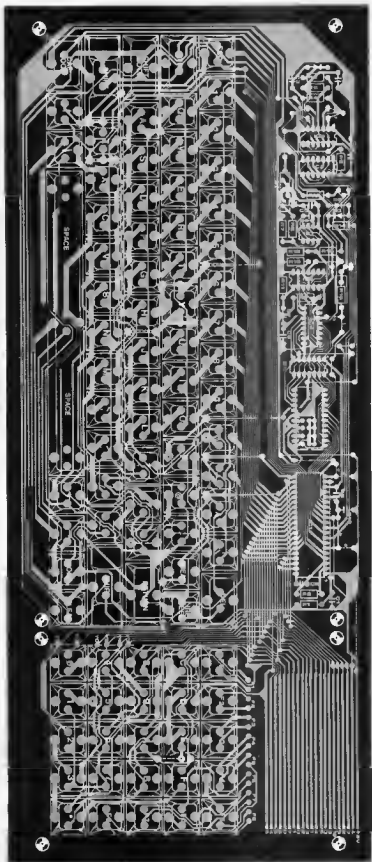

Some jumpers are shown dotted on the component layout of figure 4. These jumpers do not apply to the U.K. keyboard. Some countries use different keyboard layouts, so for example a link marked fr applies only for the keyboard used in France.

Parts list

Resistors.

R1 = 680 k
R2,R3 = 100 k
R4 = 4M7
R5 = 2M2
R6 = 10 k

Capacitors:

C1 = 4n7
C2 = 56 p
C3,C9,C10 = 100 n
C4 = 47 n . . . 150 n
C11 = 1 μ /16 V

Semiconductors

D1 = DUS
IC1 = AY-5-2376 (from
General Instruments)
IC2 = 4011
IC3 = 4093
IC4 = 2716

Miscellaneous

14-way DIL ribbon cable
connector
Set of FUTABA keys and
caps for the ASCII key-
board



Figure 3. This shows the actual mounting positions of the keys in the keyboard.



Figure 5. When the keys are mounted in the manner shown here, the result will be a 'terraced' keyboard, inclined at about 15°, which puts the keys right under your finger.

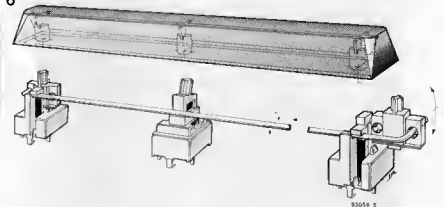
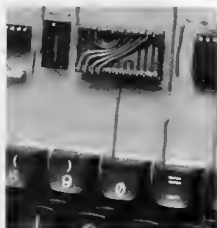

Figure 6. Positioning the space bar is a little more involved than the other keys caps but will pose no problem if this drawing is used.

Construction

Before starting construction you should look at Figure 5, which clearly shows that the inclination of the keys and that of the caps are different. This gives a 'terraced' keyboard with an inclination of about 15° to the horizontal. The positioning of the space key is illustrated in Figure 6. Don't solder in the keys right from the start. Better just to solder one pin, which makes moving them easier later on. Supply voltages to the keyboard are carried via the ribbon cable used for data transfer between the keyboard and the terminal or computer. Note also that the SHIFT-LOCK and CAP-

LOCK keys have two stable positions and should not be confused with the other keys. The wiring for the 8 function keys is left to the initiative of the user according to his needs, the printed circuit board design enables each of these keys to be connected to any point in the keyboard matrix. Finally, regarding the choice of a case for the keyboard, bear in mind that the printed circuit board will be inclined at 15° so the case should accommodate this. The case size will be governed by the dimensions of the printed circuit board in Figure 4. The BOT 880G from West Hyde is an example of a suitable case.

Readers who decided to construct the Prelude preamplifier from the earlier series of articles will by now have a total of ten printed circuit boards hopefully in the throes of 'final assembly'. It is a fairly complex undertaking and, although everything should work perfectly, there may be one or two questions that could arise. It is intended in this summary to cover the problem areas where confusion may occur and also to put forward a few ideas on the use of the completed Prelude.

Prelude p.s.

pro's and
con's
of the Prelude

It may be of interest to know that the complete Prelude consists of 10 printed circuit boards, 14 ICs, 106 transistors, 11 diodes, 262 resistors, 26 potentiometers, 149 capacitors and 13 switches. Undoubtedly of more interest however, is what can be achieved when all these components are united into one big circuit called the "Prelude".

Probably the first question that will be asked is "how does it all perform?". Rest your mind on this because there should be no reason why any Prelude (constructed on Elektron printed circuit boards) should not meet the specifications given in Table 1. These are reasonably conservative figures and it is likely that your Prelude will improve on this performance, if it has been constructed carefully. It has been suggested by those in the know that Rome wasn't built in a day and we firmly suggest the same for the Prelude. Poor workmanship and over-eager assembly is a quick way to degrade the performance.

Not only must the Prelude be constructed correctly, it must also be used properly in order to achieve the best results.

The case for presets

The Prelude departs from conventional preamplifier design in one major aspect,

and that is the positioning of the volume control in the circuit. Contrary to the normally accepted ideas, the volume level control is situated at the output of the preamplifier. Initially this may seem a little odd but it does have one significant advantage. Any noise that may be generated in the preamplifier stages will be attenuated together with the volume level at the output of the preamp. This of course would not be the case with a volume control at the front of the preamp. A good idea but where is the snag we bear you say and, of course, there always is a snag. With no means of limiting the input levels the risk of over-driving the preamplifier into 'clipping' could be very high. We would then be trading a reduced noise level for increased distortion - not what we had in mind at all!

The gain of the line amplifier is approximately $\times 20$ (the fixed attenuation of the balance control in midposition is 6 dB, so that the total line amplification is about 10 times). The maximum line amplifier output voltage of approximately 26 V_{pp} corresponds to a maximum input level of approximately 1.3 V_{pp}, or approximately 460 mV_{rms}. The output voltage of the tone control amplifier can be higher than the output voltage of the tone control; how

Technical specifications of the Prelude

Table 1.	
Nominal output voltage:	1 V _{rms} (max. 4.6 V _{rms})
Output impedance:	< 400 Ω
Harmonic distortion:	< 0.015% (1 V from 20 Hz ... 20 kHz) (also holds good for headphone output; class A range)
Frequency range:	6 Hz ... 60 kHz ⁺⁰ dB
RIAA deviation:	< 0.5 dB (20 Hz ... 20 kHz)
Input sensitivity/impedance:	
MC:	0.1 mV _{rms} /100 Ω
MM1, MM2:	2 mV _{rms} /120 k//10 p (impedance programmable)
other inputs:	100 V _{rms} /45 k (when using Interlude 30 k)
Tone control:	
Low (400 Hz):	± 12 dB at 50 Hz
Low (800 Hz):	± 12 dB at 100 Hz
High (2 kHz):	± 12 dB at 10 kHz
High (4 kHz):	± 12 dB at 20 kHz
Signal/noise ratio (unweighted):	
MC:	> 60 dB
MM1, MM2:	> 80 dB
other inputs:	> 95 dB
Muting:	-20 dB
Balance control:	+6 dB ... -∞ dB
Cross-talk:	
MC, MM1, MM2:	-60 dB (20 Hz ... 20 kHz)
other inputs:	-60 dB (with input buffers, 20 Hz ... 20 kHz) -45 dB (without buffers, 20 Hz ... 20 kHz)

Missing Link

In the circuit of the tone control (April issue, page 4-53, figure 1), R16 and R16' are shown as 6k8. This should be 1k. The parts list was correct.

much depends on the position of the high and low control. In other words, the tone control stage is also sensitive to being overdriven.

The answer to the problem is to use presets for a number of the inputs. The phono inputs are not provided with presets because there is a more elegant way to set the phono input amplification (if required at all). In this case the gain is set by selecting the value of R7 and R7' of the magnetic cartridge preamp up to a maximum of 390 Ω . However the presets are a necessary evil and it would be better to get rid of them completely if at all possible. This is easy with a modern receiver, say, that is equipped with a built in, low impedance AF output level control. Bear in mind also that a 250 k Ω preset can be replaced by a voltage divider consisting of two resistors as long as the input voltage level is known. A total resistance value of 5 to 10 times the (normally low) output impedance of the corresponding audio voltage source is quite sufficient and will even help to reduce crosstalk and noise level.

Under all circumstances make sure that the input level of the tone control amplifier (tone control switched 'on') or line amplifier (tone control switched 'off') does not exceed 100...150 V_{rms}; this corresponds to 1...1.5 V_{rms} at the output of the Prelude, which is more than enough to drive any output amplifier.

One minor advantage of presets is that they can also be used to limit the output level; handy if you object to your house being turned into a disco in your absence!

The assets of low impedance!

In spite of the large number of switches and potentiometers and the rather long track runs in some cases, the cross-talk between the channels is surprisingly low. It is not helped by the 'bus board' concept with inputs and outputs on the same 'plug in boards' facing each other. However, the cross-talk level is still much better than the DIN standard minimum requirement which is 30 dB in the frequency range of 250 Hz...10 kHz. This is generally an acceptable level but it can be improved by the use of the buffer stage in Figure 1. This circuit was originally intended for use at the tape and auxiliary outputs but it can also be used to replace the 250 k presets. A point to note: it is a waste of time inserting a buffer for the phono inputs due to the fact that the output of the MM amplifier is low impedance anyway (cross-talk attenuation is at least 60 dB). But why buffers? The answer is simple: buffers ensure that the inputs to the tone control and line amplifiers are low impedance. This is desirable because the lower the impedance the lower is the cross-talk since the interaction between the channels is mainly capacitive.

The wiring of mode-switch S11 must be changed if a buffer is connected in series with one or more inputs. Figure 2 (a and b) show how this should be done. During the 'mono' mode the resistors R_y and R_y' see to it that one buffer is not loaded by the low

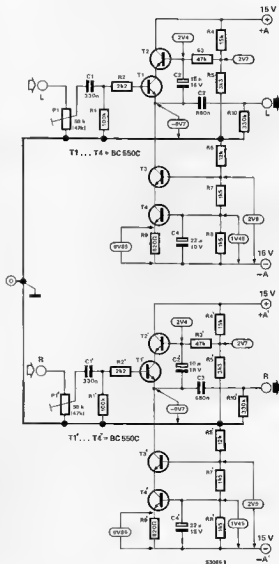

output impedance of the other buffer. These resistors are switched off during 'stereo' and 'reverse-stereo' operation, otherwise they could be the cause of a still higher line impedance.

Construction

There are some points of note regarding construction:

1. The wiring data for a number of switches situated on the bus board (see Merch issue) are not always clear. That is why this particular section of the component side of the bus board is repeated here (see Figure 3). After wiring S3 and S11 use an ohm-meter to check that they are switching properly.
2. The bus board contains 3 wire links which cross the connection board (see Figure 3). Connect these (insulated) wire links to the copper side of the bus board,

Figure 1. The circuit illustrated here can be used as buffer for the 100 mV inputs of the Prelude and as output buffer for the tape recording and auxiliary outputs. The actual emitter follower consists of a 'super transistor', formed by the cascode T1 and T2. Capacitor C2 ensures that the base of T2 follows the emitter voltage of T1, which is very favourable for its modulation 'behaviour'. The supply for the emitter follower is provided by a current source, which is also connected as cascode (T3 and T4); this increases the (already high) linearity of the emitter follower considerably.

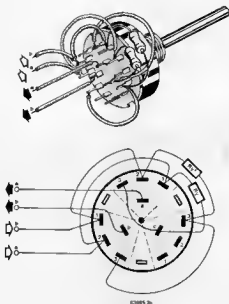
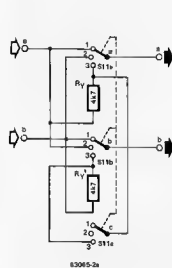

Figure 2. The circuit diagram (a) and the wiring (b) of mode-switch S11 must be changed when using one or more input buffers of Figure 1.

after the connection board has been mounted. Don't forget the wire link that is half hidden by S3.

3. The case can be earthed either at a point somewhere around the supply or at the ground of the MM inputs. One point will produce less hum than the other. Earth the case at one point only and make sure the switches and potentiometer shafts on the bus board and especially the socket for the headphone are electrically insulated from the metal front panel.

4. As far as the case itself is concerned, it is best to use a 19 inch type. It's no problem whatsoever if the housing is 5 cm deeper than the length of the printed circuit boards; in fact some of the connection

plugs, situated at the rear, will then be better protected against possible damage.

5. The supply transformer of the Prelude can be mounted at the right side of the housing, just behind the signalling board. Especially if you want the MC amplifier built-in it is recommended that a small ring core transformer is used. First of all its stray field is less than for ordinary transformers, and secondly, this type of transformer is much smaller. The supply transformer can be enclosed in a metal housing, as long as it gets adequate ventilation, so that it does not run hot.

6. A final note repeated from our March issue. Don't forget to mount Cx and Cx' onto the line amplifier board!

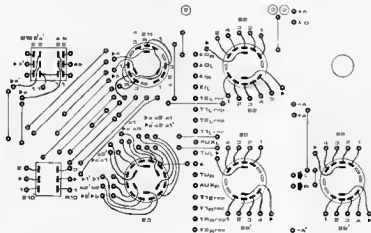
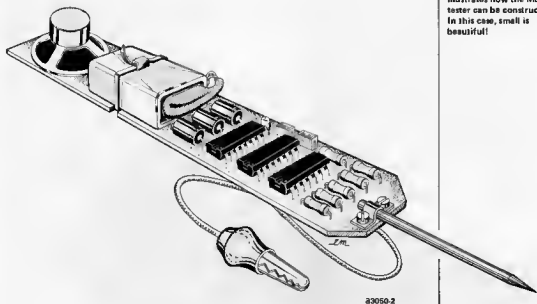

Figure 3. A section of the component side of the bus board illustrating the wiring of some of the switches.

PS.

If there is sufficient interest, we will include a p.c. board design for the buffer circuit (figure 1) in the coming July/August issue.

Figure 2. This drawing illustrates how the Multitester can be constructed. In this case, small is beautiful!



high and low tones at the frequency of the detected signal. These four unambiguous acoustic indications provide a quick and easy method of simple fault tracing.

The circuit diagram

The simplicity of the Multitester is clearly illustrated in the circuit diagram of figure 1. Two oscillators, gates N2 and N3, and the counter IC3 form the basis of the circuit. The detector probe is connected to the junction of R2 and R3. If the probe touches a point in the circuit under test that is at 0 V resistor R3 will be short circuited. This will cause the voltage level at the junction of resistors R1 and R2 to fall. The output of gate N1 will rise to logic '1' to activate the oscillator formed by gate N2. If the probe is taken to +5 V the oscillator formed by N3 will be switched on.

The existence of high frequency pulse signals at the probe will not affect either of the two oscillators but they will reach the counter (IC3) via C3. By frequency dividing the pulse train the counter will convert the high frequencies into audible tones. The dividing factor of IC3 can be selected by deriving the output from pin 13 (divide by 128), pin 14 (divide by 512) or pin 15 (divide by 1024). Although it is not shown in figure 1, it is of course possible to select these outputs by means of a rotary switch. The frequency of the oscillators N2 and N3 are determined by the values chosen for the time constants set by C1/R4 and C2/R5. Obviously, changing the value of any of

these components will alter the frequency of the oscillator should it be considered necessary. Bear in mind that to make it easier to distinguish between the high and low tones it is advisable to keep the frequencies as far apart as possible.

The outputs of buffers N4...N9 are connected in parallel and fed to the miniature loudspeaker. The three electrolytic capacitors C4, C5 and C6 are included to protect against d.c. voltage levels appearing across the speaker (it would not appreciate this at all!). Do not forget to tie down the inputs to the unused gate N10.

The power supply

If necessary, the Multitester can derive its power supply directly from the circuit being tested. However, this is far from ideal and it would be better to make it fully independent and provide it with its own power source. This presents no problem at all. Since the supply required must be +5 V a voltage regulator will be needed even if batteries are used. The 78L05 voltage regulator IC will be adequate for the purpose. There is a slight disadvantage with the use of the regulator. Without it the circuit has a quiescent current consumption of only 0.3 mA but this rises to 2.4 mA when a regulator is used.

The completed circuit together with a miniature speaker can be mounted in any convenient case — with the accent on 'small'. The easier it is to handle, the more useful it will be!

In the April article we said that the Interlude can be controlled remotely. The remote control unit necessary is described here. We call it 'Maestro'. Without leaving his armchair the music lover can listen to music played just as he likes it, and the Maestro takes care of the 'conducting'. Volume, balance, treble, bass, input selection, power on/off to other equipment, and even a tape recorder are all controlled. All the functions of the receiver are clearly shown using various LEDs and two 7-segment displays.

Topical note:

To prevent confusion arising between our Maestro and that of another well known manufacturer, ours does not have any wheels... and anyway, we thought of the name first. So there!

(part 1)



armchair
conducting

to their centre positions, and the volume control to a preset level. The mute button will turn the volume down to zero - a very useful asset when answering the telephone or front doorbell! The volume can be returned to its previous level by the volume-reset button. It is also possible to control three 240 V supplies enabling the power to the amplifier, tuner or tape recorder to be switched on or off. A further seven keys are included for the remote control of a tape recorder.

The seven accessory outputs of the receiver will go to a logic '1' when the associated key is pressed. With an interface (between these outputs and the tape recorder) the relays of the recorder can be directly controlled. Finally there are two more keys with which the receiver of the remote control can be switched to 'stand-by' and 'on' again. In the stand-by mode almost all the LEDs and the displays are switched off, but the digital section of the circuit is still powered so that the levels of volume, balance, tone controls and the selected output are still shown. The stand-by and power LEDs remain on. The output connections for external equipment

Maestro

A remote control unit must always consist of two parts: a transmitter and a receiver. The transmitter is usually no more than a number of keys and a transmitting section which sends the infra-red signals to the receiver. At the receiver the signals are picked up and converted to usable control signals.

For the Interlude eight control channels in all are needed: four variable (or analogue) channels for volume, balance, treble and bass, and four logic channels for the input selection circuit. The level of each analogue signal is shown on a two-digit display as some value between 0 and 99. With the logic signals, a choice can be made between phono, tape, tuner and auxiliary. These are the basic functions of the remote control.

There are also a whole lot of extras included in our design. There is a preset button which will set the balance, treble and bass controls

(power 1, 2 and 3) also remain on so that it is still possible to use the equipment while the remote control is on stand-by.

The transmitter

The transmitter circuit diagram in figure 1 uses the Plessey SL490 in a similar circuit to the 16 channel remote control that was published in Elektor 90 (October 1982 page 10-40). This IC contains the coding logic for the keypad and the complete transmitter circuit. Its output is passed to the infra-red power stage (consisting of transistors T1 and T2) in the form of a 'Pulse Position Modulated' (PPM) signal.

The keyboard can have up to 32 push buttons and the position of each in the matrix determines its coding (in EDCBA format) and therefore its function. On reaching the IC the code is converted into a

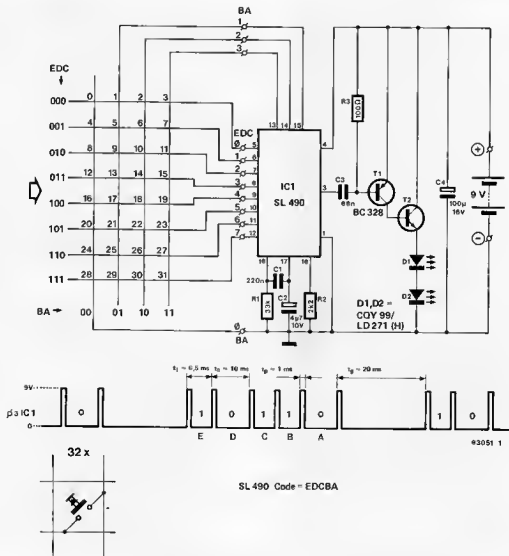

series of six narrow pulses which are passed onto the output stage. The coded information is contained in the pulse intervals; a short interval represents a logic '1' and a longer interval a logic '0'. The current consumption of the infra-red LEDs during transmission of the pulses is very high, in the order of about 8 amps, and therefore the buffer capacitor C4 is required. The IC also contains its own internal 'power-down' switch which ensures that the IC is only switched on for the time that a key is pressed. The quiescent current in the power-down mode is only a few microamps and therefore a separate supply on/off switch is not needed.

The receiver

The basic receiver section of the circuit diagram of figure 2 is the SL 480 (IC1), again from Plessey. It contains a series of

three amplifiers which convert the received signal into a usable waveform for further processing. The receiver diode (D1) current is controlled by the current source and combined low pass filter formed by transistor T1. This makes the diode less sensitive to interference from ambient light and other sources of low frequency signals such as incandescent lights and fluorescent tubes.

The PPM output signal of the SL 480 is fed to two decoder ICs, IC2 and IC14. These are the ML 926 and ML 927 from Plessey and, together with the SL 480 and SL 490, form a complete set of infra-red remote control ICs from this manufacturer. The decoder ICs, IC2 and IC14, return the PPM signal to the original EDCBA code that originated in the transmitter. The code of table 1 is divided into two parts that are dealt with separately by IC2 and IC14. The first part, codes 00001... 01111 (E = 0),

Figure 1. The circuit for the transmitter is very simple. A Plessey IC takes care of almost all the electronics, from coding right through to transmitting. A small power stage, consisting of T1 and T2, drives the Infra-Red LEDs.

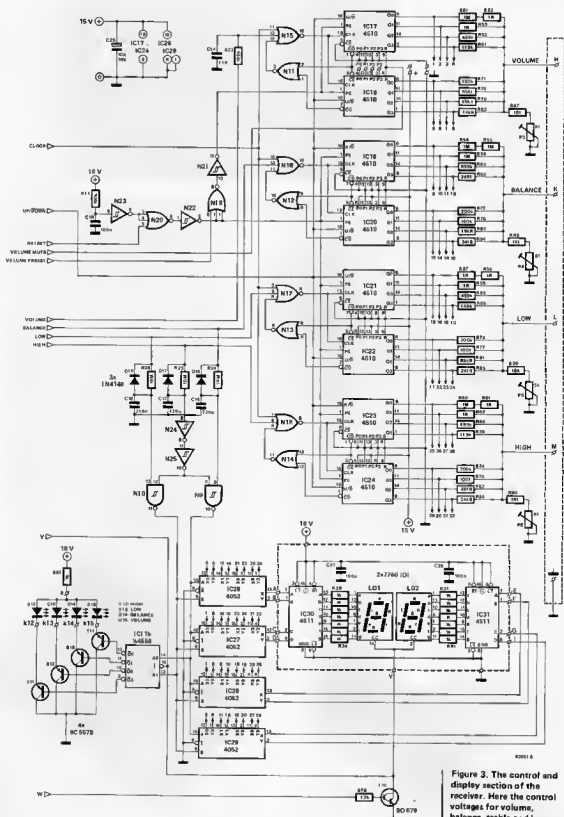
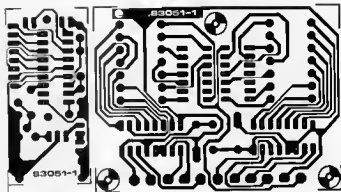

Figure 3. The control and display section of the receiver. Here the control voltages for volume, balance, treble and bass are formed and the relevant value is displayed for a chosen function.



Parts list Transmitter

Resistors:

R1 = 33 k
R2 = 2k2
R3 = 100 Ω

Capacitors:

C1 = 220 n
C2 = 4 μ 7/10 V
C3 = 68 n
C4 = 100 μ /16 V

Semiconductors:

T1 = BC32B
T2 = 8D433, BD 435,
BD 437
D1, D2 = CQY 99,
LD 271(H)
IC1 = SL490

Miscellaneous:

30 push buttons (see text)
Reflectors for transmission
diodes
Battery-clip with
9 V battery

Parts list Display board

Resistors:

R28 ... R41 = 1 k

Capacitors

C26, C27 = 100 n

Semiconductors:

LD1, LD2 = 7760(D)
IC30, IC31 = 4511

is decoded by IC2 while the second part, 10001...11111 (E = 1), is decoded by IC14. Codes 00000 and 10000 are not decoded and for this reason key positions 0 and 16 on the transmitter cannot be used. The functions decoded by IC14 are stand-by, on/off, tape recorder control and relay control for the external mains powered equipment. The oscillator frequencies of the decoder ICs can be tuned to the fixed transmitter frequency by the preset potentiometers P1 and P2.

The output codes of IC2 are passed to IC11 and IC12. With no key pressed at the transmitter, the Q0 output of IC12a will be at logic '1'. In this condition the oscillator formed by the circuit round N8 will be running at the fairly low frequency of a few Hz (determined by R20 and C13). This is the clock signal for the D/A converters IC17...IC23.

When a transmitter key is pressed for any function in the upper part of table 1 the Q0 output of IC12a will go to logic '0'. Now the output of N4 will change state and, after a few seconds (determined by the values of

R20 and C13), transistor T2 will switch on. This puts resistor R19 in parallel with R20 and causes the oscillator frequency to increase. When the key is released Q0 goes to logic '1', the output of N4 goes low and capacitor C12 is discharged via D2 and R21. Transistor T2 now switches off and the oscillator returns to its lower frequency. The sequence, then, in brief. A key for volume, balance, treble or bass is pressed. The counter display begins counting (up or down depending on the key pressed) slowly at first and then speeding up after a few seconds. As soon as the key is released the counter stops. This is an elegant method of achieving both a fine resolution and large adjustments in a short time. This, of course, only applies to the analogue controls mentioned.

We move on now to the digital controls of this section. These are the input selection controls for the Interlude and appear at the output of IC13 (D1...D4). This IC is a 4 bit latch and it is able to retain data at its outputs when the information at its inputs has ceased to exist. The latch control is

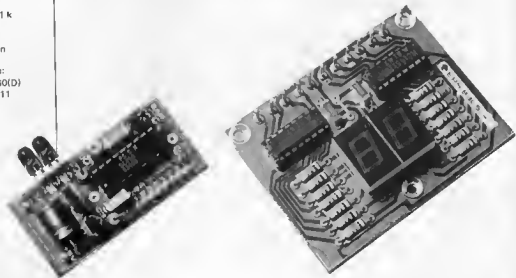

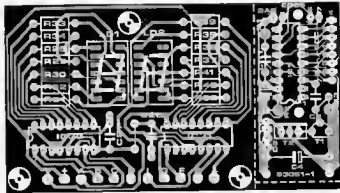

Figure 4. 'Two for the price of one!' Here we show the printed circuit board layouts for the transmitter and display sections. It may prove useful to separate the two before starting to build them!

carried out by the OR gate N6 which clocks the new information into IC13 when a pulse appears at any of the outputs of IC12b. A visible indication of the selected input is provided by LEDs D4... D7 via transistors T3... T6.

The remaining control functions of table 1 (the lower half) are decoded by IC14, a 4 to 16 line decoder. This has a very similar function to that of IC13 but has 16 lines out instead of just 4. Here the latch control is carried out by gate N7. Outputs Q1... Q7 are used for the control of the cassette or tape recorder. Q8 to Q15 are fed directly to the inputs of IC16 which contains four R/S flipflops. The outputs of this IC will remain in the state dictated by the associated keys. The Q1, Q2 and Q3 outputs of IC16 are used to control the three relays Rel1... Rel3 which in turn switch power to the external mains powered equipment. The LEDs D9 to D11 provide an indication of the condition of the relays. Output Q0 of IC16 is the stand-by switching line for the receiver and its condition is indicated by LED D8.

Of all the outputs discussed, one remains unmentioned so far: the Q0 output of IC15! This is unused and there is a very good reason for it, but we will leave that for you to puzzle over!

That concludes the description of the receiver and decoder section of the circuit diagram. We can now move on to cover the analogue controls and the seven segment LED displays shown in the circuit diagram of figure 3.

The analogue control outputs

The length of time for which the keys concerned with volume, tone and balance are held down must be converted into a number of pulses and stored in memory. To do this we use the clock oscillator (N8) and a number of presettable BCD up-down counters. For each of the functions there are two counters connected in series. This is necessary as a count of 100 is needed and each counter refuses to count beyond 10! Taking the controls in order they are: ICs 17 and 18 for volume, ICs 19 and 20 for balance, ICs

Table 1

SL 490 code	EDCBA	dec.	function	
	00000	0	not used	
	00001	1	preset volume, balance, treble, bass volume mute	
	00010	2	volume preset	
	00011	3	volume preset	
	00100	4	input D1 on (phono)	
	00101	5	input D2 on (tuner)	
	00110	6	input D3 on (aux.)	
	00111	7	input D4 on (tape)	
ML 926	01000	8	volume down	
	01001	9	volume up	
	01010	10	balance left	
	01011	11	balance right	
	01100	12	bass down	
	01101	13	bass up	
	01110	14	treble down	
	01111	15	treble up	
		10000	16	not used
		10001	17	Q1 on
		10010	18	Q2 on
		10011	19	Q3 on
		10100	20	Q4 on
		10101	21	Q5 on
		10110	22	Q6 on
	10111	23	Q7 on	
ML 927	11000	24	remote control on	
	11001	25	remote control stand-by	
	11010	26	power 1 on	
	11011	27	power 1 off	
	11100	28	power 2 on	
	11101	29	power 2 off	
	11110	30	power 3 on	
	11111	31	power 3 off	

21 and 22 for bass and, finally, IC23 and IC24 for treble.

A key pressed for one of these functions causes the counter associated with that function to begin counting the clock pulses from the oscillator N8. Depending on whether the key has an up or down function, the clock pulses will be added or subtracted

Table 1. Transmission codes and the associated functions. This also shows which codes are decoded by the ML 926 and which by the ML 927.

5

a

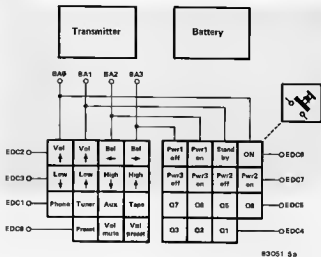

Possible functions:

- Volume ↑ and ↓
- Balance ← and →
- Treble ↑ and ↓
- Bass ↑ and ↓
- Volume mute
- Volume preset
- Preset
- Phono
- Tuner
- Tape
- Aux
- Power 1 on/off
- Power 2 on/off
- Power 3 on/off
- On
- Stand by
- Q1, Q2, Q3, Q4, Q5, Q6, Q7

b

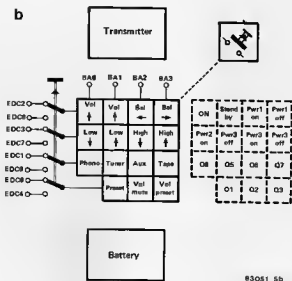

c

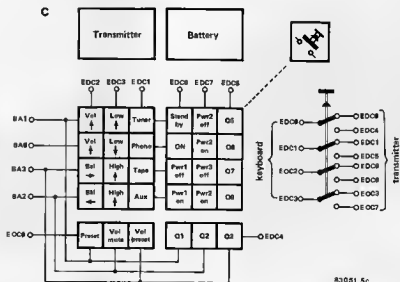

Figure 5. Some design examples of possible keyboards.

from the initial figure. This is determined by the logic level at the A output of IC2 which finds its way to each of the counters. The range of the counters is between 0 and 99. This is to say that the count cannot jump to 99 when 0 is reached. This is achieved by gating out the clock signal when both counters of a function give a carry-out signal (CO). This operation is performed by gates N11...N18.

The contents of the counters is converted to an analogue signal by means of a set of precision resistors at the outputs. For example, the D/A converter for the counter IC17 and IC18 consists of R51...R53, R63, R67, R71, R75, R79 and R83. The logic signals of the eight Q outputs are summed by the resistors. The maximum level of the output signal is determined by a resistor in series with a potentiometer, in the example we are using this is R87 and P3. The four outputs then, H, K, L and M, are control voltage levels that are variable in 100 steps from zero to a maximum.

When power is first applied to the circuit a preset command is given by the small network consisting of R23, C15 and N23. The same command, given by the transmitter, ultimately arrives at the Q1 output of IC12a. The preset command provides a preset enable signal to the counters which then go to a preset level. In this case of the balance, treble and bass this will be the centre value of 50 on the display, determined by the logic levels present at the P0...P3 inputs to the counter ICs.

The preset level for the volume control however, can be programmed by tying the P0...P3 inputs to either ground or +5 V. Each input represents a decade in BCD code therefore, if P0 is connected to +5 V and the rest of the inputs to ground, the preset level will be 10. Connecting only P1 to +5 V will give a level of 20, P2 is 40 and P3 is 80. Other combinations are also possible up to a maximum of 90. For example, if P1 and P2 are taken to +5 V and P0 and P3 are grounded, the preset level will be 60. In any event, none of these inputs must be left floating. The volume will always go to the preset level when the unit is powered up or the preset key is operated.

The volume level can also be set to zero by means of the 'mute' key on the transmitter. This signal eventually arrives at the reset inputs of IC17 and IC18. It is returned to the preset level at the command via the Q3 output of IC12a and N19 and N21.

The display

The contents of each counter can be indicated by means of the two seven-segment displays. These will indicate a number between 0 and 99 to represent the control voltage for the volume, balance, treble or bass. The outputs of each pair of counters are connected to the inputs of a pair of 4 into 1 multiplexers IC26...IC29. Each of these ICs contains two multiplexers. Their outputs are passed to IC30 and IC31 which have the grand title of 'BCD to 7-segment latch-decoder-drivers'. These two ICs drive and control the two common-cathode displays LD1 and LD2. Their cathodes are

taken down to earth via the Darlington transistor T15. When the remote control system is switched to stand-by, the displays are turned off by this transistor. It also switches off LEDs D4...D7, D12...D15 via the 'V' connection points shown in the circuit diagram.

The multiplexers are controlled by the circuit containing the gates N9 and N10. The displays will indicate the volume level until one of the keys for balance or tone control is operated. When this occurs, one of the Q1...Q3 outputs of IC11a will be taken low and the corresponding capacitor, C16...C18, will discharge rapidly through its associated diode (D16, D17 or D18). Thus, via the gates N9 and N10, the associated multiplexer will be driven by the relevant counter to display the level of the function of the key that was operated. On releasing the key, the capacitors will charge relatively slowly through a 10M resistor (R24...R26) and eventually the display will revert back to indicating the volume level.

To summarise briefly:

The display normally indicates volume level until one of the keys for balance, treble or bass is operated. The corresponding level indication is then displayed for the period of time that the key is held, reverting back to volume level a few seconds after the key is released. Four LEDs controlled by IC11b, via transistors T11...T14, show what output level is being displayed.

The entire system is powered by a single 15 V regulator IC25.

That completes the description of the circuit diagram. It will be obvious that if all the functions are desired, then all the components shown must be used.

Construction of the transmitter

As can be seen from the printed circuit board layout in figure 4, the transmitter can be made quite small. Do not be confused by the printed circuit for the display board which is shown in the same figure. It was decided not to produce a printed circuit for the keyboard in order to allow an open choice to use any key switches that may be available. It also allows a choice on the size of the case used for the transmitter.

Three suggestions for design ideas for the keyboard layout are given in figure 5. The basic criteria behind these designs has been

maestro (part 1)
elektor may 1983

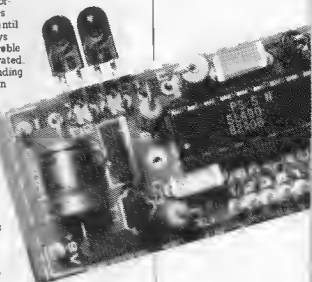

6

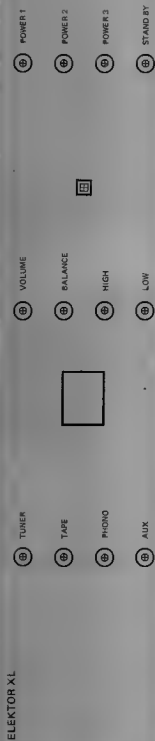

Figure 6. This is an illustration of the Maestro front panel. The width is kept the same as the Prelude front panel so that the two can be positioned one on top of the other.

to keep the essential control functions to the left and the 'extras' (which relate to IC14) to the right. A 30 key transmitter is shown in figure 5a. The printed circuit board and battery can be mounted in front of the keyboard. Another possibility is the design of figure 5b using 15 keys and an additional 'function select' key. Pressing this key and one of the function keys will result in selecting the 'second' function. This method still provides the possibility of 30 functions. A third option is given in figure 5c where 30 normal function keys or 15 double function keys (and a 'function select' key) can be used.

An idea may be to use a calculator keyboard, after all, it is possible to buy a calculator cheap enough for the keyboard alone!

Constructing the receiver

The receiver printed circuit board is double sided with plated through holes and is slightly smaller than Eurocard size (113 x 255 mm). The board layout will be published in the next issue. However, knowing the board size enables a suitable case to be built. The display section containing the two displays, IC30, IC31 and the associated components, is mounted on the printed circuit board shown in figure 4. The case need not be unnecessarily large. If it is to be used with the Prelude it would be aesthetically better if both cases were of the same type. The design for the front panel that is available for the Maestro is shown in figure 6 to the same scale as that for the Prelude. Do not forget to allow sufficient room for the transformer.

The front panel, available through the Elektor readers service, is manufactured from flexible plastic sheet and is self-adhesive. It is obviously necessary to complete all drilling and cutting (for the display window and LED mounting holes) and to fit the printed circuit boards, by means of counter-sink screws, before fitting the front panel. To prevent errors, it will probably be as well to wait until the last possible moment to fit the front panel. Remember, Murphy's Law will strike at the slightest opportunity!

'Here endeth the first lesson . . .', or, in this case, the first part of the Maestro. The second instalment, together with the promised printed circuit board layout, will be published in the next issue of Elektor. In the meantime, you could get in some practice with the transmitter . . . !

'Watts' have got something to do with power, watt-seconds with energy and kilowatt-hours affect our wallets!

The arithmetic is as follows: measured 'watts' multiplied by hours of operation equals watt-hours. This is then divided by 1000 and the result is kilowatt-hours (or units of electricity on our electricity bill). When this figure is multiplied by the unit price the result is the cost to the consumer. This issue also contains an article on a wattmeter for those readers interested in measuring kilowatt-hours.

In this article we shall discuss the difference between energy and power, the meaning of r.m.s. value, and the reason why multimeters are not usually suitable for measuring non-sinusoidal voltages.

what is power?

a brief study
of the theory

If a current I flows through an electrical conductor of resistance R during time t , the energy W released in this conductor is proportional to the value of the resistance, time and the square of the current. ($W = I^2 R t$ or $W = U I t$). This statement (or one with very similar wording) was made by the English physicist Joule as a result of his observations involving electrical energy.

In his honour, the unit used for electrical energy is the joule ($1 J = 1 Ws$). When calculating electricity consumption we use the unit 'kilowatt-hour' (kWh) in order to keep the figures lower ($1 kWh = 3,600,000 Ws$). But this has no effect on the price we have to pay for the electricity! The phrase 'energy consumption' has become established in everyday usage, but in fact energy *cannot* be consumed. It can, of course, be converted to another form (according to Einstein it can even be converted to mass and vice versa). It is not lost. This conversion of energy into another form over a particular time is known as power. Power is therefore energy (conversion) per unit of time.

($P = W/t$ or $P = UI$)
Power can be calculated quite simply: when a direct current flows through a resistance, we multiply the voltage by the current. Since the voltage is constant in this case, the current is also constant. The power has the same value at any moment of time. This situation is shown in figure 1 in the form of three characteristics. The d.c. voltage is switched on at time t_0 (a). A current now flows through the resistance (b). If the two characteristics are multiplied (point by point) the result is the power as a function of time (c). With a voltage of 24 V and a current of 2 A, the power is 48 W (watts). Since both the voltage and the current are constant, the values of power at time t_1 and time t_0 are also constant. The power line is therefore flat as a function of time (c). By calculating the power rating of a load, we obtain the 'consumed' electrical energy as the product of power and on-time. The cross-hatched area in figure 1c represents the electrical energy which is converted to heat by the resistance, from the time it was turned on until time t_1 . This area is the product of voltage, current and time, and therefore represents energy. Thus a kilowatt-

hour meter for d.c. current simply consists of a voltmeter, an ammeter and a clock! Unfortunately, this simple formula cannot be used to calculate a.c. power. The mains supplies an alternating voltage, and therefore an alternating current: it is relatively sinusoidal at a frequency of 50 Hz. The first problem is to express mathematically the values of voltage and current varying over time. This is further complicated by a situation in which the alternating current does not flow through a resistance but through a coil (with an inductance) or capacitor (with a capacitance). In these cases the alternating current is not in phase with the voltage. The puzzling result of this is that a 'positive' current flows whilst a 'negative' voltage is applied. Some loads even draw a non-sinusoidal current although a sinusoidal voltage is applied! Furthermore, there are cases in which only a part of the mains voltage is applied to the load - as with triac control systems (light dimmers), for example. In this way, curious current forms are produced in loads which are not purely resistances.

The simplest task is to determine the a.c. power drawn by a resistance. Figure 2a shows the periodically varying mains voltage. The amplitudes vary sinusoidally. If this voltage is applied to a resistive or 'constant' load (a heating filament, for example), the current which flows is also sinusoidal (figure 2b). If the voltage and current values at a particular time are multiplied, the power at that moment of time is known. This procedure is followed point by point over time: figure 2c shows the result. To be able to express this power in a simple value, we must determine the average power in a period T . The average power in the other periods is the same.

Let us refresh our memories by taking another look at the definition of energy: power multiplied by time. The power is therefore the energy per period T . But the energy is none other than the cross-hatched area in figure 2c (see also figure 1c). If the period is subdivided into an infinite number of times Δt , both the voltage and current are constant in this short time. The energy can therefore be calculated as though a direct current were flowing in time Δt .

Figure 1. The values of direct voltage (a) and direct current (b) are constant at any moment of time. The product of these two values is a constant power (c). The cross-hatched area represents the energy (power multiplied by time) which is converted to heat in a resistance, during the time t_0 to t_1 .

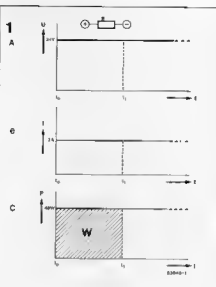

D.C. energy: $W = Pt$
A.C. energy: $w = pt$
 $\Delta w = ui \Delta t$

When added, all these instantaneous values of energy Δw result in the total electrical energy applied to the resistance in time t . If this value is divided by T , the final result is the average power P .

This addition is performed with integral calculus, but there is a simpler method in practice. For this purpose the root-mean-square (r.m.s.) value was introduced and defined as follows: The r.m.s. value of an alternating current produces the same heat (= energy) in an ohmic resistance as would be produced by a direct current of the same value. Expressed more simply: the r.m.s. alternating current has the same effect as the direct current. If the r.m.s. value of the alternating current is known, the power is obtained by multiplying I_{rms}^2 by R .

$$P = I_{rms}^2 R$$

$$P = U_{rms}^2 / R$$

$$P = I_{rms} U_{rms}$$

Unfortunately we need integral calculus to calculate the r.m.s. value of a current and of a voltage. For sinusoidal voltages and currents, however, there is a simpler relationship between peak value and r.m.s. value. For example, the peak value of mains voltage is 338 V. The r.m.s. value is obtained by multiplying 338 V by 0.71 = 240 V: a familiar figure!

$$U_{rms} = \frac{U_p}{\sqrt{2}} \approx 0.71 u_p$$

$$I_{rms} = \frac{i_p}{\sqrt{2}} \approx 0.71 i_p$$

Most multimeters are designed so that the r.m.s. value of a sinusoidal current and sinusoidal voltage can be read off using the alternating current and voltage ranges. No calculation is therefore needed.

However, many loads do not behave like pure resistances but like coils or capacitors. A phase shift between voltage and current takes place on them. The current leads the voltage or lags behind it. Figure 3 shows an example of alternating voltage applied to an inductive load. In this case the current lags behind the voltage by time $t_1 - t_0$. The angle φ is used to indicate the phase shift. The a.c. power in figure 3c is formed in the same way as previously: i.e. the values are multiplied point by point. Strangely enough, we also obtain 'negative energy' in this case (marked in black). This current is returned to the mains by the coil. This energy is not 'consumed' and must therefore be subtracted from the 'positive, consumed' energy in the energy calculation. The explanation is as follows: in addition to drawing useful energy, the coil also draws energy in order to develop a magnetic field. When this field decays, the 'field energy' flows back into the mains. Since it does not affect the 'consumption' it is referred to as reactive energy and reactive power (as opposed to active power). By multiplying the r.m.s. values of current

Figure 2. If a sinusoidal voltage (a) is applied to a resistance, a sinusoidal current (b) is drawn. The power curve (c) can be drawn after determining the 'instantaneous' power for short durations of time Δt over the period T . The average power can be calculated exactly by integral calculus.

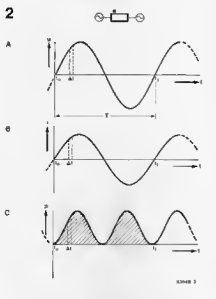
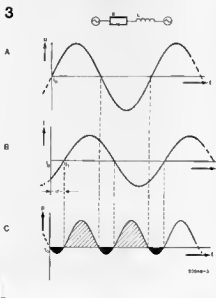

Figure 3. With an inductive load (represented here by the equivalent circuit $R + L$) the current (b) lags behind the voltage (a). The result is 'negative power' (marked in black). The difference between the black areas and the cross-hatched areas is the energy which is converted to heat in the resistance.



and voltage, the result is the apparent power S (unit = VA).

$$\text{Apparent power: } S = U_{\text{rms}} I_{\text{rms}}$$

$$\text{Active power: } P = U_{\text{rms}} I_{\text{rms}} \cos \varphi$$

The active power P is obtained by multiplying the apparent power by $\cos \varphi$. The $\cos \varphi$ value at rated load is specified on the rating plates of many electrical appliances, so that the active power can be calculated quite simply. The consumer is only charged for this active power on the electricity bill. For this reason, electromechanical kilowatt-hour meters are designed so that they multiply the active power by the time.

The $\cos \varphi$ value of a load is between 0 and 1. Zero signifies a purely inductive or capacitive load, because $\cos 90^\circ = 0$. The phase shift between voltage and current is therefore 90° . Thus the active power is $P = U_{\text{rms}} I_{\text{rms}} \times 0 = 0$. No energy is 'consumed'; the kilowatt-hour meter is stationary although a current, i.e. the reactive current is flowing.

Of course, the electricity generating board is not prepared to give away electric power for nothing. For this reason, it specifies a minimum $\cos \varphi$ value for large or industrial consumers.

If the resistive content of an inductive or capacitive load increases, the $\cos \varphi$ value rises also. With a purely resistive load the current and voltage are in phase.

The $\cos \varphi$ value is 1 in this case, because $\cos 0^\circ = 1$.

Unusual current and voltage forms are produced in a TRIAC control system (see figure 4). The formula for calculating the r.m.s. value from the peak value of a sinusoidal voltage or current does not apply here. However, the average power can be calculated quite easily if the so-called firing angle α is known. But even formulae are of little use if the current cannot be described mathematically. For example, the type of motor employed in vacuum cleaners and power drills produces such an unusual current form that the active power consumption can only be determined by measurement.

A meter that is capable of measuring the active power (in watts) irrespective of the type of load, must therefore be able to evaluate widely different voltage and current forms. In principle, the meter continuously determines the instantaneous power from the product of instantaneous voltage and current, and indicates the mean value of this 'calculation'. In the electromechanical wattmeter (see figure 5), the 'instantaneous product' of current and voltage is formed by an electrodynamic measuring system consisting of a high-resistance 'voltage coil' $L_v + R$ and a low-resistance 'current coil' L_i . The pointer is mounted on the voltage coil which rotates within the stationary current coil. The voltage coil is connected in parallel with load X , and the current coil in series with it. As a result of the magnetic field in the current coil, a force which exerts a torque acts on the voltage coil (or, to be more precise, on the magnetic field of the coil). This torque is proportional to the product of instantaneous voltage and instantaneous current (= instantaneous power). The measuring system has considerable inertia, so that rapid variations in measured variables are not registered. The average figure is therefore obtained from the instantaneous values and the meter indicates the average power. The meter only provides a reliable indication when the current through the voltage coil is in phase with the voltage across the load. For this reason, compensation by means of a capacitor across R is usually necessary (drawn with dashed lines in figure 5). However, this compensation is only valid for one frequency. Non-sinusoidal current forms produced by the load contain many harmonics at multiples of the fundamental frequency (e.g. 50 Hz). The compensation therefore does not apply to these frequencies and the reading for non-sinusoidal signals are less accurate.

The problem can be solved electronically. Elsewhere in this issue there is an article describing an electronic wattmeter for home construction. This allows the power consumption of all electrical loads in the home to be measured. The meter can be expanded to a kilowatt-hour meter by edging an extension circuit (to be published later). The cost of running the kitchen refrigerator, for example, can then be established quite simply. ■

4

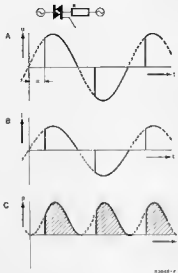

Figure 4. In a TRIAC control system the voltage is partly blocked (a), resulting in a non-sinusoidal current (b). The average power can only be calculated with complex mathematical methods (c).

5

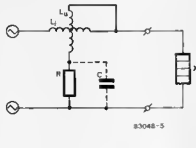

Figure 5. Circuit diagram of an electrodynamic wattmeter. The pointer is mounted on the 'voltage coil' $L_v + R$ which rotates within the 'current coil' L_i . Meter deflection is proportional to the average product of current and voltage.

parallel-serial keyboard converter

As we have already said in the article on constructing the ASCII keyboard, there is another option for the computer hobbyist who wants more. This option allows serial ASCII in both RS 232C and TTL form. Provision for this has already been made on the printed circuit for the keyboard.

This parallel to serial converter makes the keyboard RS 232C-compatible (with a connection at k the serial output is at TTL-level, with a connection at l it is at RS 232C-level). Thus the keyboard can be connected to any computer with serial input.

Parallel-to-serial

The positive strobe-pulse from the keyboard triggers FF1 (IC5). A '0' level at pin 6 of this flipflop acts as a 'load' signal for pin 1 of IC6. The information output from the EPROM (IC4) is then loaded into IC6. In IC6 the parallel-serial conversion takes place when a squarewave is applied to pin 2.

The frequency (read: baudrate) is determined by the circuitry surrounding IC7. The frequency is set with potentiometer P1; it can be checked with a digital frequency meter connected to pin 3 of the 555. If desired, the range (at present up to about 400 Hz) can be changed by making C5 smaller. Because the baudrate is equal to the number of bits per second (thus making the baudrate directly proportional to frequency) this adjustment is a very simple task.

The (clock-) output of the timer is also connected to the clock-input of flipflop 2. The latter receives the bits from IC6 to its data input. The serial signal appears at pin 5 of this flipflop, and the output is

Figure 1. This diagram shows that, with a very small number of components, this extra 'trick' of parallel-to-serial conversion can be achieved.

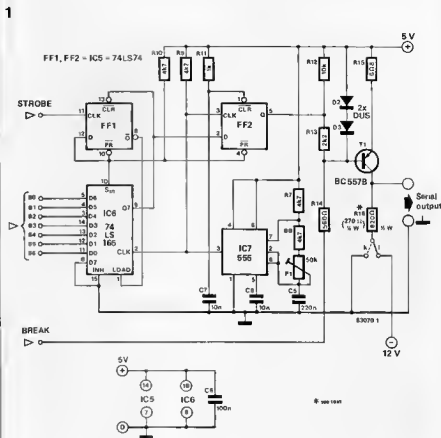

subsequently sent to T1. Also connected to pin 1 of IC5 is another RC combination acting as a 'power-on reset' for FF2. This flipflop ensures that the start bit is always the same width as the other bits in the signal.

The parallel-serial conversion starts, as we have already said, with the aid of FF1. The positive edge of the strobe signal from the keyboard loads the shift register through the action of FF1. The load pulse is extremely short, due to the feedback from Q7 (IC6) to the clear-input of FF1. This makes very high demands on the quality of the strobe signal (any spurious spikes or 'bounce' can cause problems), and must be taken into account as regards applying this converter to other keyboards.

The output of the circuit delivers a serial signal with one start bit, seven data bits, and a stop-bit-value between two characters. Since the clock signal is always present, the circuit actually keeps sending stop bits until the next character appears. In practice this is only noticeable if the baudrate is comparable to printing speed.

Finally, connections j and i make it possible to tie the break-key either to '0' or '1'. Very little needs to be said about construction. Figure 4 shows how the constituent parts are mounted. If no code-conversion is desired some wire links must be included (see p.c. board design).

2



85070-2

- | | |
|------------------------------------|-------------------------------|
| 1. Protective Ground | 16. Not Used |
| 2. Transmitted Data | 17. Received Bit Clock |
| 3. Received Data | 18. Not used |
| 4. Request to Send | 19. Not used |
| 5. Clear to Send | 20. Data Terminal Ready |
| 6. Data Set Ready | 21. Not Used |
| 7. Signal Ground | 22. Ring Indicator |
| 8. Data Carrier Detect | 23. Data Signal Rate Selector |
| 9. . . . 14 Not Used | 24. Transmitted Bit Clock |
| 15. Transmitted Bit Clock Internal | 25. Not Used |

3

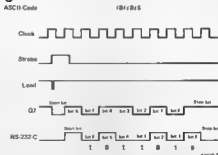

parallel-serial keyboard converter
elektor may 1983

Figure 2. Connections for RS232C standard.

Figure 3. This timing diagram (for ASCII character 1011010) shows the relationship between the various signals.

4

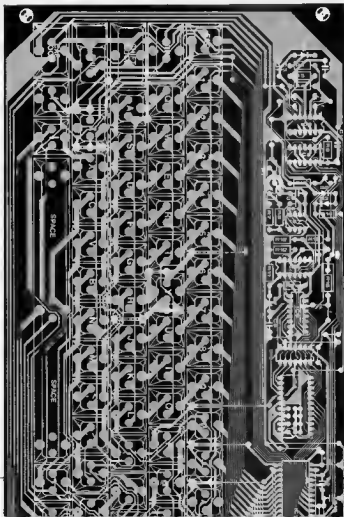

Figure 4. Part of the keyboard circuit, including locations of the various components.

Parts list

Resistors:

- R7, R8, R9, R10 = 4k7
- R11 = 1 k
- R12 = 10 k
- R13 = 2k2
- R14 = 560 Ω
- R15 = 6 Ω
- R16 = 820 Ω 1/2 W (270 Ω 1/2 W for connection K, TTL level).
- P1 = 50 k potentiometer (10-turn pot, if possible)

Capacitors:

- C5 = 220 n
- C6, C7 = 10 n
- C8 = 100 n

Semiconductors.

- D2, D3 = DUS
- T1 = 8C 557B
- IC5 = 74LS74
- IC6 = 74LS165
- IC7 = 555

connections

- i = break "0"
- j = break "1"
- k = TTL level
- l = RS232C-level

Many radio amateurs and shortwave listeners are very interested in receiving Morse transmissions. However, the problem is understanding Morse signals, a skill that can only be learned with experience. The alternative is to own a Junior Computer. Using a small circuit and a program, the Junior can learn to read Morse!

Morse converter

With a Morse
decoder program
from R. Unterrick

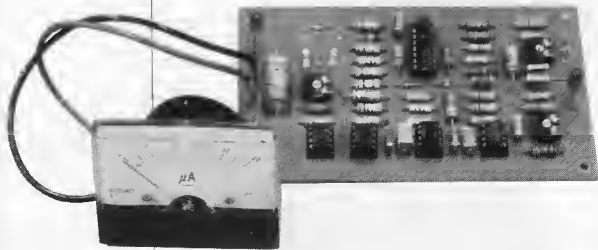

copying
Morse with
the computer

Who can read Morse nowadays? Radio amateurs with the full (HF) licence have passed a Morse test. But this skill that was once learned with considerable effort is often forgotten, and is hardly sufficient in practice anyway. A large number of people are unable to read Morse but are interested in copying these signals. A Morse decoder gives them access to the world of dots and dashes.

This type of Morse decoder converts Morse signals to normal characters. In principle, any microcomputer can be provided with a small hardware interface and a Morse decoder program, allowing it to be used for this purpose.

This article describes a universal Morse interface and a powerful decoder program for the Junior Computer.

Decoding Morse signals

As most people know, a Morse signal consists of dots and dashes. However, the intervals between the dots and dashes are also important. Since the individual characters consist of a different number of dots and dashes, the intervals of different lengths

indicate the end of a character and the end of a word.

Within a Morse character, the intervals between dots and dashes are shorter than twice the duration of a dot. Between two letters in a word the interval is longer than two, but shorter than four dots, and between two words the interval is longer than four dots.

The problem in decoding Morse is that exact timing is almost never encountered; the durations of dots and dashes can vary as well as the intervals; the ratio between these times can vary as well as the speed at which the characters are sent. There are no absolute values, and everything is relative. As an intelligent being, however, the human is able to cope with this situation as long as there is some difference between the durations of dots, dashes and intervals. This is considerably more difficult for a computer. On the other hand, it is easier to teach the computer Morse than to learn it oneself. The many interfering signals received with the desired Morse signal on shortwave present another handicap for the computer. These can be atmospheric interference, radio

interference, interfering carriers, beating with stations on adjacent frequencies, noise and the like. A skilled Morse operator can 'copy' very weak Morse signals which are almost buried in the noise level.

Clearly, a computer Morse decoder cannot compete with these outstanding human capabilities. Nevertheless, the computer is an excellent aid for shortwave listeners, allowing most stations to be decoded. Only very weak stations or those sending extremely poor Morse will be incorrectly copied by the computer.

The Morse audio signals emitted by a receiver cannot be used by the computer. It requires an interface which converts the Morse tones to a square-wave signal which the computer can understand, and which simultaneously suppresses interference. The computer must first measure the pulse and interval durations of this square-wave signal; then, using relatively simple software routines, it must decide whether it is receiving a dash, a dot, a short, medium length or long interval. Once the individual elements have been detected, there is no difficulty in grouping the received dots and dashes in binary-coded characters and then converting them to ASCII code. Figure 1 is a block diagram showing the structure of the microprocessor Morse decoder. A printer can be connected to the computer instead of a video interface with monitor.

The Morse interface

In principle, the function of this circuit is that of an audio-tone decoder: if a 1 kHz tone is applied to the input, a logic 1 is present at the output. If there is no signal the output goes to logic 0. An interrupted 1 kHz tone (Morse signal) results in a square-wave signal at the output, whose pulse

length corresponds to the duration of the tone.

Using the beat frequency oscillator (BFO) of the shortwave receiver, the frequency of the Morse tones can be set to exactly 1 kHz. Since the Morse interface only responds to this frequency, interfering signals of a different frequency are considerably suppressed. However, the selectivity of the tone decoder is not sufficient for pulse-type interference which exhibits a wide frequency spectrum. For example, an interfering pulse appearing in a Morse signal interval could be incorrectly detected as a dot. For this reason, the circuit of the Morse interface also contains an integrator which ensures that only pulses of a certain minimum length result in a logic 1 at the output of the tone decoder. Most short interfering pulses are thus eliminated. Figure 2 explains the method of operation of the Morse interface with simplified signal diagrams.

The circuit is shown in figure 3 and the printed circuit board in figure 4.

The interface is connected to the tape

micro converter
elektor may 1983

Figure 1. Block diagram of a Morse decoder using a microcomputer. The important elements are a hardware interface and decoder software.

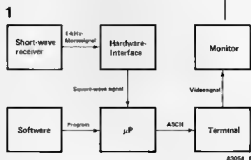

2

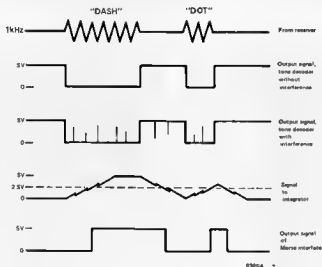

Figure 2. Simplified signal diagram for the Morse interface. A tone decoder forms a square-wave signal from the different lengths of the Morse signals. By integrating this signal with the following threshold switch (trigger), short interfering pulses are suppressed.

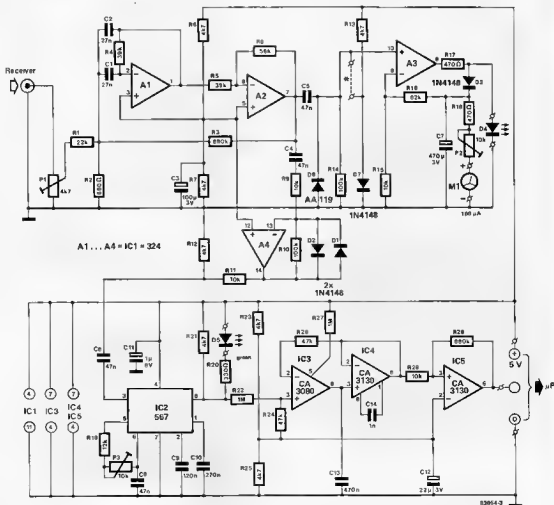

Figure 3. The Morse interface identifies the Morse tones by means of tone decoder chip IC2. A relatively involved level indication facilitates tuning of the receiver for good Morse reception.

recorder output of the receiver. A preset potentiometer at the input of the interface is used for matching the levels. A1 and A2 form an active 1 kHz filter. This is followed by amplifier A4 which has an amplification factor of 10. Diodes D1 and D2 in the feedback loop of the amplifier ensure that the output signal is limited to approximately 600 mV peak to peak value. After some attenuation at the output of A4 (R11/R12) the signal is fed via C6 to the input of the 567 tone decoder (IC2). The output of IC2, pin 8, goes to logic 0 as soon as a 1 kHz tone is applied. The green LED D5 then lights. However, the tone decoder also responds to short interfering pulses with a 0 at its output. These pulses are eliminated by the following circuit consisting of IC3 ... IC5. A CA 3080 OTA (IC3) is configured as an integrator whose time constant is determined by the control current flowing via R27 into pin 5 and by capacitor C13. This integrator decelerates the voltage change from 0 to 1 and vice versa (see

figure 2). The next operational amplifier, IC4, serves as a voltage follower in order not to load C13. IC5 is configured as a comparator with a threshold of 2.5 V. At input voltages above this value, the output (pin 6) is a logic 1. If the voltage is lower than this figure, the output presents a logic 0. The filtered 1 kHz signal is also fed to A3, which amplifies only the positive half of the signal-waveform, and is therefore simply an 'active rectifier'. The purpose of the exercise is to drive the moving-coil meter M1 (100 μ A full scale deflection) to indicate the signal strength. Diode D7 is only required for aligning the meter; it delivers a reference voltage of 0.6 V when the jumper (drawn in dashes) is soldered in. D4, the red LED, indicates overdriving.

Aligning the Morse interface

The first step is to align the meter: insert the jumper (et D3/D7) and adjust P2 for full

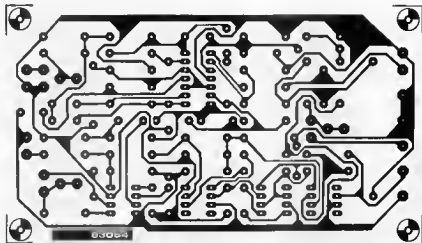
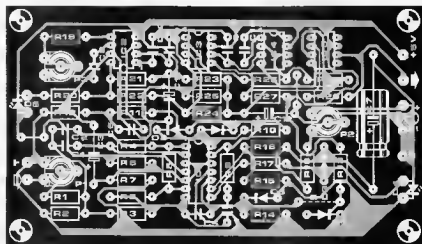

Figure 4. The printed circuit board for constructing the Morse interface; this is connected between the receiver and the computer.



scale deflection. Then remove the jumper. The receiver can now be connected. Set P1 approximately to its mid-point, and tune the receiver to maximum reading on meter M1. Remember to switch on the BFO of the receiver beforehand! In the event of over-driving, reduce the sensitivity with P1. The tone decoder can now be aligned. Adjust P3 so that the green LED (D5) flashes at the rate of the Morse signal. The 'lock range' that can be set by adjusting P3 is relatively high. When properly adjusted, P3 should be in the middle of this lock range.

Morse decoder software

This is a program for the Junior Computer. The software contained in a 2716 EPROM is suitable for the Junior Computer with interface card extension and for the DOS Junior.

The Morse interface is connected at PB7 (6532) of the Junior Computer. For demon-

strations and practising, a Morse key can also be connected at PB7 with the debounce circuit shown in figure 5.

After the start of the program, the program name 'Morse decoder' is printed out. The computer first compares the received Morse characters with each other until it detects a difference in length of at least 50 ms. Signals of a duration of less than 80 ms (interference) are ignored. As soon as the relevant time difference of more than 50 ms is detected, the Morse signals received are decoded, the first dash to be encountered serves as a time reference. With each received dash this reference is corrected, so that the decoder immediately and automatically follows any changes in sending speed.

The Morse decoder prints 64 characters per line, automatically followed by a carriage return (CR) and line feed (LF) instruction to the printer or video interface. In general, the program uses the following criteria for detecting Morse characters:

- Minimum difference between dot and

Parts list

Resistors:

- R1 = 22 k
- R2 = 680 Ω
- R3, R29 = 680 k
- R4, R5 = 39 k
- R6, R7, R12, R13, R21, R23, R25 = 4k7
- R8 = 56 k
- R9, R11, R15, R28 = 10 k
- R10, R14 = 100 k
- R16 = 82 k
- R17, R18 = 470 Ω
- R19 = 12 k
- R20 = 330 Ω
- R22, R27 = 1 M
- R24, R26 = 47 k
- P1 = 4k7 preset
- P2, P3 = 10 k preset

Capacitors:

- C1, C2 = 27 n
- C3 = 100 μ /3 V
- C4, C5, C6, C8 = 47 n
- C7 = 470 μ /3 V
- C9 = 120 n
- C10 = 270 n
- C11 = 1 μ /6 V
- C12 = 22 μ /3 V
- C13 = 470 n
- C14 = 1 n

Semiconductors:

- D1, D2, D3, D7 = 1N4148
- D4 = LED red
- D5 = LED green
- D6 = AA 119
- IC1 = LM 324
- IC2 = LM 567
- IC3 = CA 3080
- IC4/IC5 = CA 3130

Miscellaneous:

- M1, moving coil meter, 100 μ A

5

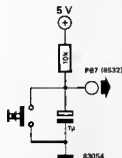
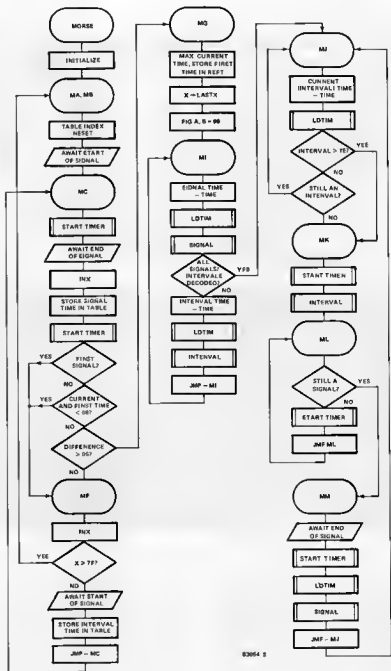

Figure 5. For practice and demonstrations a Morse key can be connected to PB7 of the Junior Computer via this debounce circuit.

6



dash lengths at program start

- Minimum interval for spaces
- Minimum interval for a new character (letter)
- Minimum length of a dash
- Number of characters per line

If the Morse decoder should go out of lock without relocking automatically, the program can be restarted with the NMI key. The program structure is shown in detail in the flowchart of figure 6. For reasons of space, it is not possible to provide a full

listing here; we shall therefore briefly discuss the most important sections. After establishing an initial reference time REFT, the computer is in the loop starting at label MJ. Between labels MJ and MK it awaits a Morse signal, but not longer than 18 reference time units; otherwise the last character to be received at the end of the transmission would not be decoded. This 'emergency exit' necessitates the loop under label ML, which stops the processor until the start of a new character.

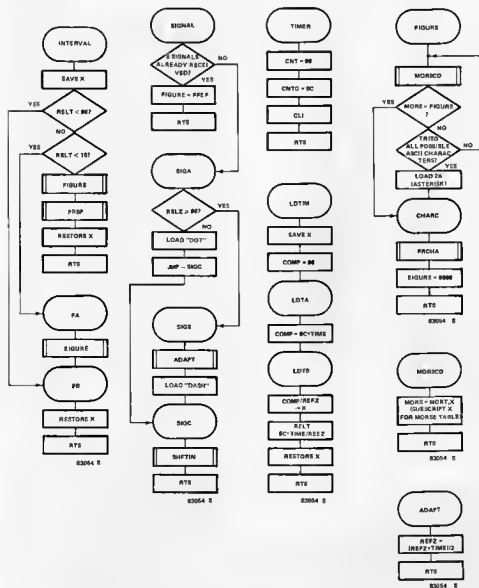

Figure 6. Flowchart of the Morse decoder with which the Junior Computer reliably converts Morse signals to plain language.

Subroutine LDTIM standardizes the time located in TIME to that in REFT: $RELT = \text{\$OC TIME} / \text{REFT}$. Factor OC is used to keep rounding-off errors low with this division. Subroutine FIGURE compares the Morse character located in FIG A,B with the Morse code of ASCII characters $\text{\$22-\$5A}$. In the event of agreement (identification of a Morse character) the corresponding ASCII character is printed; unidentifiable Morse characters (such as mistakes in sending) are output as an asterisk (*). The error signal

(8 dots) of the Morse alphabet is assigned the ASCII character 23 (#). Subroutine SHFTIN shifts a recognized dot or dash into the cells of FIG A and FIG B. As can be seen in figure 7, 00 is a space, 01 is a dot, 10 is a dash and 11 is an error.

Instructions for using the program

The program requires a memory range of 4000 to 7FFF (RAM). A (dynamic) 16 k RAM card on the Junior bus is sufficient.

78L voltage regulators and 79L

Table 1

 $I_{max} = 100 \text{ mA}$

U_{out}	type	U_{tr} (RMS)		C1
		min.	max.	
5 V	78L05	6.4 V	9.6 V	1000 μ /16 V
6 V	78L06	7.3 V	10.3 V	1000 μ /16 V
8 V	78L08	9.6 V	12.0 V	470 μ /25 V
10 V	78L10	11.0 V	13.4 V	470 μ /25 V
12 V	78L12	13.1 V	15.2 V	330 μ /25 V
15 V	78L15	15.2 V	17.3 V	330 μ /25 V
18 V	78L18	17.5 V	19.5 V	330 μ /35 V
24 V	78L24	21.9 V	23.7 V	330 μ /35 V

Parts list

Capacitors:

C1 = see text and table

C2 = 330 n

C3 = 10 n

Semiconductors:

IC = 78LXX

(see text and table)

B = 40 V/800 mA

bridge rectifier

Low-power IC voltage regulators of the 78L series offer the advantages of good regulation, current limiting/short circuit protection at 100 mA and thermal shutdown in the event of excessive power dissipation. In fact virtually the only way in which these regulators can be damaged is by incorrect polarity or by an excessive input voltage. Regulators in the 78L series up to the 8 V type will withstand input voltages up to about 35 V, whilst the 24 V type will withstand 40 V. Normally, of course, the regulators would not be operated with such a large input-output differential as this would lead to excessive power dissipation. A choice of 8 output voltages is offered in the 78L series of regulators, as shown in table 1. The full type number also carries a letter suffix (not shown in table 1) to denote the output voltage tolerance and package type. The AC suffix denotes a voltage tolerance of $\pm 5\%$, whilst the C suffix denotes a tolerance of $\pm 10\%$. The letter H denotes a metal can package, whilst the letter Z denotes a plastic package. Thus a 78L05ACZ would be a 5 V regulator with a 5% tolerance in a plastic package. All the regulators in the 78L series will deliver a maximum current of 100 mA provided the input-output voltage differential does not exceed 7 V, otherwise excessive power dissipation will result and the thermal shutdown will operate. This occurs at a dissipation of about 700 mW; however, the metal-can version may dissipate 1.4 W if fitted with a heatsink.

A regulator circuit using the 78L ICs is shown in figure 1, together with the layout of a suitable printed circuit board. The output voltage at a current up to 100 mA are given in table 1, together with suitable values for the reservoir

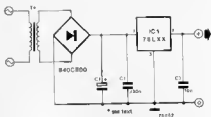

LM78L05ACH	LM78L05CH	LM78L05CZ	LM78L05ACZ
LM78L06ACH	LM78L06CH	LM78L06CZ	LM78L06ACZ
LM78L08ACH	LM78L08CH	LM78L08CZ	LM78L08ACZ
LM78L10ACH	LM78L10CH	LM78L10CZ	LM78L10ACZ
LM78L12ACH	LM78L12CH	LM78L12CZ	LM78L12ACZ
LM78L15ACH	LM78L15CH	LM78L15CZ	LM78L15ACZ
LM78L18ACH	LM78L18CH	LM78L18CZ	LM78L18ACZ
LM78L24ACH	LM78L24CH	LM78L24CZ	LM78L24ACZ

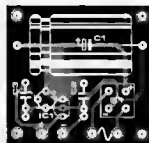
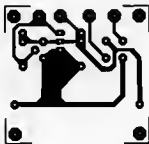

capacitor, C1. The capacitance/voltage product of these capacitors is chosen so that any one of them will fit the printed circuit board without difficulty.

A similar range of regulators exists for negative voltages: the 79L series. Even though the pinning is different, the same basic p.c. board layout can be used. The regulator is mounted 'backwards' in the plastic position; '+' then becomes the negative output, and the positive end of C1 is supply common.

including a program
by P. von Berg
(ON6XK)

morse decoding with the Z80A

using the
Elektor Z80A
card, the
Elekterminal
and a
CW signal
forming
circuit

Spoken language is a code made up of sounds and it describes reality. Written language is a graphical coding of spoken language . . . and morse is an audible coding of written language. Not to mention written morse which is a graphical coding of an audible code . . . and so on. In short this is a mental feat which is left more and more to machines.

We already have the necessary machines; now all we need is the software to drive them. That is what we have here, designed specifically for the Elektor Z80A CPU card.

In this issue we are presenting two CW decoding programs; one for the Junior Computer and other 6502 systems, and the other, described here, for Z80A systems. We will refer to the other article for information on the nature of a morse signal, the difficulties posed by its automatic decoding, and consequently the requirements for the program to decode the

numeric signal which has been converted from analogue. The interface, between receiver and microprocessor, needed for this conversion is the same for the 6502 and the Z80A; it is described in the article on software for the Junior Computer. The circuit description, construction and calibration will not be repeated here, since they are independent of the software used.

1

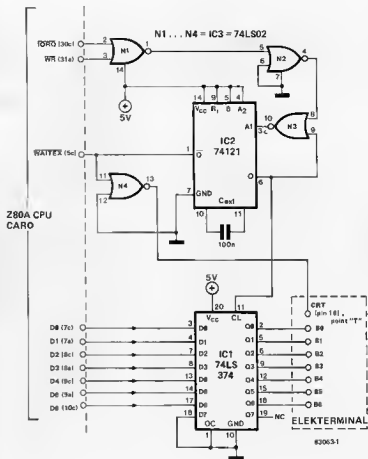

Figure 1. This circuit is the interface between the Z80A CPU card and a display terminal such as the Elekterminal. The numbers in parentheses are for the Z80A card connector. The Elekterminal connections have an alphabetic notation clearly marked on the printed circuit published in December 1978 (Elektor nr. 44, page 12-23).

HEXDUMP: D000, D252

```

8 1 2 3 4 5 6 7 8 9 A B C D E F
00: 31 50 08 C3 BA 08 08 08 C5 21 1F 01 0E 32 70 E0
01: 01 C1 C8 3E 21 D3 08 C9 08 08 08 08 08 08 08 08
02: 08 CB C9 78 08 2E 3E F7 10 69 D9 C3 08 08 08 08
03: C0 00 00 00 00 00 00 00 00 CD 08 08 31 58 08 14 D9
04: 21 A7 06 28 CB 54 28 F0 D9 F8 7D 07 92 30 32 D9
05: CB 03 E7 D9 7A 07 94 30 03 6A 18 1C 7C 07 92 18
06: 14 08 08 08 08 08 08 08 08 08 08 08 08 08 08 08
07: 08 08 08 08 08 08 08 08 08 08 08 08 08 08 08 08
08: 07 D9 C8 23 E7 D9 18 CB 50 3E C7 32 08 08 14 28
09: 4E F3 D9 21 A7 06 28 CB 54 28 00 00 F0 18 E7 CD
0A: AA 30 58 D9 C9 49 28 63 18 63 7A 07 91 30 03 5A
0B: 08 08 10 96 79 07 92 30 01 59 4A C9 78 07 92 30 E8 78
0C: 07 07 92 30 1A CD AA 08 50 09 CB 49 28 04 CB 09
0D: 18 09 CF 28 02 18 04 24 7E 03 08 CB C1 18 CD 08
0E: CB 49 28 04 CB 09 18 09 CF 28 02 18 04 24 7E D3
0F: 08 3E 28 D3 08 D9 16 04 D9 CB 41 28 05 CB 01 51
10: 18 14 14 3E 04 92 20 03 D9 50 D9 1E 0E D9 AF 47
11: D9 47 3E C9 32 08 08 D9 ED 56 F0 0A 0F 57 76 F9
12: 08 EA F4 FC E2 F6 E8 F8 E7 F5 14 F8 FA F7 E6 ED
13: F2 F9 FD F1 E1 F3 E9 E8 08 CF C7 C3 C1 C8 D8
14: 08 CD DE 95 03 08 0C 9E A1 D2 01 05 CA E3 09 EE
15: D6 08 08 08 08 08 08 08 08 08 08 08 08 08 08 08
16: 08 08 08 08 08 08 08 08 08 08 08 08 08 08 08 08
17: 08 08 08 08 08 08 08 08 08 08 08 08 08 08 08 08
18: 08 08 08 08 08 08 08 08 08 08 08 08 08 08 08 08
19: 08 08 08 08 08 08 08 08 08 08 08 08 08 08 08 08
20: 08 08 08 08 08 08 08 08 08 08 08 08 08 08 08 08
21: 08 08 08 08 08 08 08 08 08 08 08 08 08 08 08 08
22: 08 08 08 08 08 08 08 08 08 08 08 08 08 08 08 08
23: 51 52 53 54 55 56 57 58 59 5A 30 31 32 33 34 35
24: 36 37 38 39 2E 2C 3A 3F 27 2D 2F 2D 2D 55 41
25: 4F 40 FF

```

morse decoding with
the Z80A
elektor may 1983

Table 1. This program is stored in the EPROM on the Z80A CPU card when the letter is used for morse decoding. The text gives several important notes referring to program modification or relocation.

Software for the Z80

The program works by incrementing an 8 bit binary word at 250 Hz (it counts from 0 to 256). For this the Z80A clock must run at 4.43 MHz. A different clock frequency may be used by changing the program at addresses \$0041 and \$0042 and also \$0094 and \$0095, so that the D register is incremented at 250 Hz in spite of the modified clock frequency. (Incrementing is carried out in \$003E and \$006E).

Telegraphy can be decoded for speeds varying from 5 to 50 words per minute (75 words with automatic control). If we raise the frequency at which the D register is incremented, we can make the operating rate greater: for example from 12 to 120 words/minute - note the factor of 1/10 which is constant. The CW is input to the data receiver, and is modified to form the equivalent of a TTL numerical signal (see the interface circuit in the article on Junior Computer software). The TTL signal (high logic level in the rest state!) is applied directly to the Z80 CPU, via its interrupt input (pin 16).

Memory area \$0000...\$0850 must be RAM. The program is designed for the Z80A card published in May 1982 (Elektor no. 85, page 5-28), consisting of CPU, a 2716 EPROM, and at least two 2114s. This card does not include the input/output functions, so we have designed a small interface which should be placed between the CPU bus and the Elektor terminal (or any other display terminal).

Latching the ASCII data

Three inexpensive integrated circuits are needed to adapt the Elektor terminal to the Z80A card (and vice versa). In figure 1, an 8-bit latch (IC1) joins the Z80A data bus

(D0...D6) to the display driver of the terminal (B0...B6). The latch is driven by a monostable (IC2) whose calibrated pulse of 10 ms is triggered by the combination of the \overline{IORQ} and \overline{WR} signals of the CPU while the ASCII data is preset on the bus; moreover the Q output of the same monostable (74121) inhibits the Z80 during data transfer, and signals the arrival of a new character on the display driver bus (via pin 16, the point marked "T" on the circuit of the Elektor terminal). Thus the Z80A tunes its speed to that of the terminal.

The software side

As they are divided into two groups, the Z80 can only work on 6 registers at a time. The groups are interchangeable at any time using the instruction EXX \$D9. The functions associated with the registers are listed in the margin.

In its present form the program starts at \$0000 and finishes at \$0150, not forgetting, of course, the ASCII data at \$0220...\$0251. Relocating it would require extensive modification: the absolute jumps would have to be changed. Furthermore, the subroutines at \$0008, \$0020 and \$0030 are called by RST instructions. If located elsewhere, these routines would have to be called by a more usual instruction (CALL). Such a modification to the jumps requires a complete restructuring of the program.

Applying the CW signal to the interrupt input of the CPU makes for a shorter program (there is no need to program an input/output circuit), but it requires the use solely of memory locations \$0038 and its immediate successors (this is the principle of mode 1 interrupts). Any other interrupt method requires the use of a PIO. ■

- B: always 00
- C: only bits 0 and 1 used; bit 0 set to "1"
- D: if the word contains more than one letter, bit 1 set to "1" if the word consists of more than 8 dots or dashes
- D: desynchronisation control
- E: code formation
- H and L: general use (timing and memory management)
- B': always 00
- C': measure of last spacing
- D': measure of incrementation time
- E': reference spacing
- H': measure of rest tone (dot or dash)
- L': reference tone

market

Membrane keypads

Velleman announce the introduction of a new range of membrane keypads available with 12 keys (type KB12) or 16 keys (type KB16). Both versions are offered with standard legend or with blank keys to enable customer to print their own legend. These multi-layer keyboards are manufactured by Velleman using high quality materials with the top layer being polycarbonate film which resists scratching, dust and water.

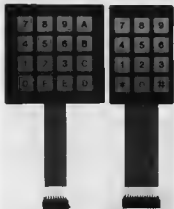

Termination is by insulated flat cable and a suitable PCB connector with 2.54 mm (0.1 inch) spacing is supplied. Ratings are 24 V max and 25 mA max. A data sheet with full technical specifications is available upon request. Velleman will also manufacture special keyboards to customers own design.

Velleman (UK) Limited,
P.O. Box 30,
St Leonards-on-Sea,
East Sussex, TN37 7NL,
Telephone: 0424 753246

(2647 M)

Sound with Sinclair

BI-PAK has now introduced a sound generator for use with all Sinclair computers. Designated ZON X the unit is self-contained in a black plastic case with a loudspeaker and manual volume control. No power supply or batteries are required



to power the unit — it simply plugs into the rear of the Sinclair Computer.

The new unit offers a wide range of sound effects. These are obtained using the three-channel-plus-noise sound chip and is designed so that the pitches and volumes of the three channels and overall attack/decay envelope can be controlled by simple basic statements. This means that Pianos, Organs, Bells, Helicopters, Lasers, Explosions etc., can be simulated and added to existing programmes.

For use with the Sinclair Spectrum Computer there is a further plug-in adaptor for the ZON X which houses a crystal and other electronic devices needed to give unlimited sound facilities.

ZON X for use with ZX81 and Sinclair Timex 1000: £25.95. ZON X plus special adaptor for Sinclair Spectrum: £32.75. Spectrum adaptor only: £6.80. All above prices include V.A.T., and postage.

BI-PAK Semiconductor,
P.O. Box 6,
Ware,
Hertfordshire SG12 9AG
Telephone: 0520 3442/3182

(2635 M)

Cased transformers

ILP announced the availability of 15 VA transformers — all fully encased in ABS plastic shells with easy fixing by an M4 bush at the base.

Test runs have proved the demand for both the lower VA rating and the encased toroid.



This facility will be extended throughout the year to cover transformers up to 120 VA.

ILP Electronics Ltd.,
Graham Bell House,
Roper Close,
Canterbury,
Kent CT2 7EP
Telephone: 0227 54778

(2643 M)

Dynamic displays

Regisbrook have added another new line to their range of display systems. They can now offer TEXT-LITE promotional displays with an optional five years service guarantee.

TEXT-LITE displays are designed to continuously display messages of up to 450 words. The package includes a sixteen-



segment display board 82 mm long, each segment being a 4 x 5.5 mm matrix of 35 light emitting diodes. The bright red LED's provide continuous scrolling across or up the screen. Messages can also be halted, flashed and jumped into the display, while a non-volatile memory contains the text when the power is switched off.

With the display comes a 47 key programming board on a detachable ribbon cable. The keyboard provides a full alphanumeric set, extensive punctuation (including foreign symbols) and editing facilities, while specially defined keys allow the user to program special screen effects, such as vertical scrolling and modifications to the display speeds.

TEXT-LITE displays are particularly appropriate for shops, offices and exhibitions, although their 12 volt consumption permits them to be used in cars, boats and carevans.

Regisbrook Limited,
Studio House,
215 Kings Road,
Reading RG1 4LS,
Berkshire.
Telephone: 0734 665955

(2648 M)

New test clip sizes

Saffron Walden, Essex AP Products brings to market two new sizes of IC Test Clips, 48 & 64 pin clips for troubleshooting Very Large Scale Integration chips TC-48 fits chips with .5" to .6" row-to-row spacing. TC-64 fits chips with .9" spacing.

They are manufactured with nail head pins that keep probe hooks from slipping off ends or with long, headless, test lead pins for connection to AP Jumper Cable assemblies. All Test Clips are available

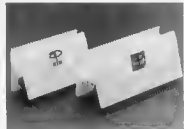

with either Alloy 770 or gold-plated contacts. They are constructed of engineering-grade thermoplastic moulded around contact pins and feature a long-lasting steel pin and hinge design.

AP Products Ltd.,
P.O. Box 19,
Saffron Walden,
Essex
Telephone: 0799 22036

(2640 M)

Telephone keypads

Ambit's KEA series miniature telephone keypads are examples from the broad range offered by ALPS, with minimum life expectancies ranging from 100,000 operations to over 20 million.

These low cost keypads are available with a cross reference that lists each ALPS type against the corresponding dialer IC, including GI, MOSTEK, AMI, Intersil, Motorola, National etc.



Ambit is stocking a selection based on popular types, although any keypad configuration can be supplied to customer order.

Ambit International,
200 North Service Road,
Brentwood,
Essex CM14 4SG.

(2642 M)

Illuminated pushbutton switches

A second range of small sized, illuminated pushbutton switches and matching indicators is now available from N.S.F. Specifically designed for 3amp applications they are marginally larger in size than the Series KB but, at 17.8 mm square and with a body depth of 21.5 mm, Series LB are still smaller than those currently available.

Features include . . .

- Compact illuminating area for bright and positive visual properties.
- Choice of illumination source.
- New 'spot-light' button variant.
- Snap-action mechanism.
- Easy installation.
- Epoxy sealed terminations.

Single end double pole, double throw models are available with momentary or push-push actuation. Rated at 3 A 125 or 250 V ac (resistive), contact resistance is 50 milliohms maximum at 0.1 A 2.4 V dc, insulation resistance is 200 megohms minimum at 500 V dc, and a mechanical life of 1 million operations (momentary) or 200,000 for push-push models

The square shaped actuators and in-

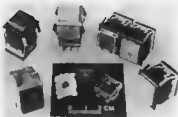

dicators combined with a choice of illumination sources, incandescent lamps and LEDs — 1 element and 4 elements, provide a very wide choice of colour coding. Of special interest is the 'spot illumination', design of actuator. This comprises a small window in the coloured button through which LED illumination (red, yellow or green) provides a visual information.

Snap-in mounting is into a panel cut-out of 16.2 mm square
End terminals are of silver plated brass.

N.S.F. Limited,
Keghley,
West Yorkshire BD21 5EF
Telephone: 0535.61144

(2636 M)

DMM transistor and diode tester

With the increase in demand for convenient low cost component testing, House of Instruments are introducing the MIC 3300A into their range of digital multimeters.

Similar in style and appearance to the already successful MIC 6000Z the new 3300A offers the user excellent Transistor hFE measurement facilities for both NPN and PNP devices. With a hFE range of 0 to 1000 this 3½ digit LCD Multimeter directly indicates the hFE value of the device under test, with approximately 10 microamp of base current and 2.8 V of V_{bc}. Overload protection is 1000 V DC and 750 V r.m.s. A.C.. Diode test facil-



ties give a maximum o/c 3.2 V and 0.2 mA test current.

Other functions include. AC and DC volts, DC current to 10 amps and resistance to 20 M ohms — Auto zero, polarity and low battery indication — 800 hours battery life from a single 9 V cell — Measures 170 x 91 x 40 mm and weighs 320 grams. Included are test leads, handbook and 1 year guarantee. Just ask.

Quiswood Limited,
30 Lancaster Road,
St. Albans,
Hertfordshire AL1 4ET.
Telephone: 0799.24922.

(2644 M)

Wow and flutter meter

A new Wow and Flutter Meter, model WM 1 A from Bang and Olufsen, has a high stability crystal-controlled 3.15 kHz oscillator for very accurate measurements. Available from David Bisset Ltd., it is for use by sound recording and broadcasting studios and by suppliers of audio products.

The meter features a wide choice of filters and detector characteristics. It is capable of servicing and testing high quality sound recording and playback equipment, studio sound equipment, tape recorders, video recorders and turn-tables. For professional equipment, it measures wow and flutter down to $\pm 0.003\%$

Drift, i.e. speed deviations, are measured from $\pm 0.03\%$ to $\pm 20\%$ on the driftmeter relative to a reference 3.15 kHz crystal-controlled signal.



Wow, i.e. very low frequency changes from 0.2 Hz to 10 Hz, flutter from 10 Hz to 300 Hz, or wow plus flutter from 0.2 Hz to 300 Hz can all be measured linearly or weighted.

The unit includes a frequency spectrum analyser which makes it possible to determine which wow and flutter frequencies are dominant. Thus it is possible to predict which rotating components — idlers, belt-drive, motor, bearings, etc. — should be repaired or replaced.

David Bisset Limited,
52 Luton Lane,
Redbourn,
Hertfordshire AL3 7PY.
Telephone: 058285.2637.

(2651 M)

market

ALPS DIP Switches

Ambit has introduced the entire range of new Alps dual-in-line switches to its current industrial stock range. This includes tape sealed, open and covered types with versions from 2 to 10 ways.

The switches are constructed using Alps' insert molding processes, thereby preventing flux ingress during soldering — and the contact is notable for both gold plating and a 2 point contact system for improved resistance to mechanical shock.

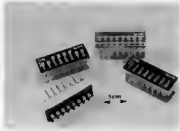

These switches are also a good deal narrower (7.6 mm at the widest point) than many DIL switches, enabling close stacking and complete compatibility with IC packages.

Ambit International,
200 North Service Road,
Brimwood,
Essex CM14 4SG.

(2652 M)

Miniature electrical power tools

Minicraft has introduced a new range in the U.K. including five different portable electric drills, each with the electric motor encased in a tough Polyamid plastic housing. Features of the range include a spindle lock button which grips the spindle when tightening the chuck so wrenches are not required, an on-off button, an eyelid hinged built into the motor body, and a long coil cord.

The motor spindle of the top of the range drill (Buffalo) has two miniature ball bearings for full power, cool running and a

long life. Used with a transformer, the drill has a 9-16 volt capacity (DC), between 20 and 100 watts, a 17,000 RPM maximum and a torque of 14 N/cm (2 amp).

In addition to the drills, a miniature orbital sander is also available along with a drill press, lathe, router attachment, a jig saw and a miniature table saw. All use the durable Minicraft motors. In the accessories line there is a complete range of drills, grinders, buffers, polishers, cutters and saws available.

At the top of the line is a 50 piece home workshop kit complete with drill, sander, and jig saw along with an adaptor for oil transformers, 36 accessories for cutting, drilling, polishing, sanding, grinding, de-rusting, routing, and engraving, plus 10 pieces of sandpaper for the orbital sander. There are five drills in the range selling from £12.50 to £26.95, with the router attachment selling at £7.95 and the jig saw at £22.95, the lathe attachment at £25.95, the drill press at £21.75, and the miniature table saw at £32.95. The home workshop kit in a tough plastic carrying case retails at £83.95.

Nathan Shestapol Ltd,
1 Grangeway,
Kilburn,
London NW5 2BW.
Telephone: 01-328 3128

(2639 M)

Low cost thermal printer

The O111 consists of an industry standard PU1800 20 column thermal mechanism mounted on an interface board. The microprocessor based board controls all timing and drive requirements of the printer and accepts ASCII encoded data in parallel and serial form. There is a Centronics compatible parallel input, RS232C, 20 mA current loop and TTL serial inputs.

Software commands include expanded size, programmable line feed and backspace. Two supply voltages of 19 V dc and 5 V dc are required. The system is easily installed as only four mounting screws are required.

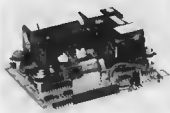

Different modes can be set using a DIL switch. Normal or inverted printing is selectable hence panel mounting is easily accommodated. In RS232C serial mode baud settings from 110 to 4800 are selectable together with 7 or 8 bits/character and parity options. The 20 mA section operates from 110 to 600 Baud.

The D111 prints at 2 character lines/second on standard size 60 mm wide thermal paper and occupies only 140 mm (W) x 110 mm (D) x 50 mm (H).

DED,
47 Station Road,
Lydd,
Kent TN29 9ED
Telephone: 0679.20636

(2650 M)

Soldering kit

Litesold have recently introduced a complete soldering/de-soldering kit for the electronics hobbyist. The kit is centred around a high efficiency 18 watt mains iron, constructed to latest electrical



standards, and fitted with a 3.2 mm copper bit. There are also two alternative bits of 1.6 and 2.4 mm included. Also provided are a reel of 3 metres of 18 s.w.g. flux-coated solder, stainless steel tweezers, three double ended soldering aids and a reel of de-soldering braid.

The new SK18 kit provides all that is required for soldering and de-soldering on almost any electronics project, and is ideal for beginner or expert. The kit comes in a clear PVC wallet, and is available direct from Litesold at a very special mail order price of £14.55 inclusive of postage and VAT.

Light Soldering Developments Limited,
97/99, Gloucester Road,
Croydon,
Surrey CR0 2DN,
Telephone: 01.689.0574

(2638 M)

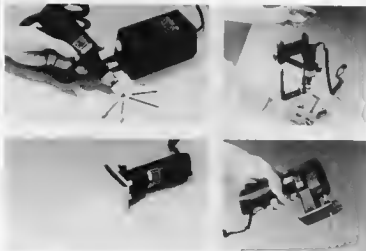

Beat the price increase...

SUBSCRIBE TO ELEKTOR

now!

**SPECIAL OFFER - get 17 issues,
PLUS binder,
FOR ONLY £13.50***

June '83 to December '84 issues incl.

*Price includes P&P in the U.K. only.

Subscribers abroad please add £ 1.50 for seairmail post, or £ 18.75 for airmail

DON'T FORGET - THIS OFFER INCLUDES OUR BUMPER 'SUMMER CIRCUITS' ISSUES FOR '83 AND '84

The cassette style binder will help to keep your copies of Elektor clean and in order, even though you refer to them time and time again. The chamfered corner of the cassette allows instant recognition of each month's issue without the need to thumb through pages of previous months' issues. Because no wires or fastenings are used copies can be easily removed and replaced and each cassette will hold one year's volume of Elektor.



the Elektor binder FREE with this offer

Complete the coupon below and post, with your remittance, to Elektor Publishers Ltd., 10 Longport, Canterbury, Kent CT1 1PE, Telephone (0227) 54439.

I would like to subscribe to Elektor from June '83 to December '84

I enclose my cheque/Postal Order, made payable to Elektor Publishers Ltd., for £ (include P&P/Overseas)

I authorise you to debit my ACCESS account with the amount of £ ACCESS no

Signed

NAME

ADDRESS



elektor BUYERS GUIDE

ETESON ELECTRONICS

E.E.

WE STOCK

A WIDE RANGE OF COMPONENTS
CASES & MULTIMETERS
VERO PRODUCTS
BARANI BOOKS
SOLDERING IRONS, TOOLS
& MUCH MUCH MORE

158 Lower Green Poulton-le-Fylde BLACKPOOL Tel. 885107

Electronic Component Specialists

WATFORD ELECTRONICS

34/35 CARDIFF ROAD, WATFORD, HERTS, ENGLAND
MAIL ORDER, CALLERS WELCOME
Tel. Watford (0923) 40589, Telex: 8966095

ELEKTOR PROJECTS - we stock most of the parts.

BI-PAK

P.O. BOX 6, WARE, HERTS.
SHOP AT 3 BALDOCK STREET, WARE, HERTS.
TEL. (0920) 3182
ACCESS & BARCLAYCARD ACCEPTED.

ELECTRONIC WORLD LIMERICK

Parnell Street Limerick
Republic of Ireland
Tel. 061-4 1233

FRANK MOZER LTD.

Specialists in all Electronic, Television
and Radio Component Parts

5 Angel Corner Parade
Edmonton, N.18

Telephone:
01-807 2784



ACE MAILTRONIX LTD.,
3A, COMMERCIAL STREET,
BATLEY, WEST YORKS, WF17 5HJ
PHONE 0924-441129
TELEX. 51458 COMHUG G for CHABLE

Suppliers of a wide range of electronic components to professional and amateur users
Trade/Retail counter open 9.5-30 weekdays and to 1pm Saturdays
Catalogues available Retail 30p Industrial Free

please mention Elektor when ordering goods or requesting information

THE FIRST ELECTRONIC COMIC-BOOK

RESI & TRANSI BANISH THE

MYSTERIES

OF ELECTRONICS

Excitement, entertainment, circuits.
Complete with printed circuit board
and Resimeter.

Further adventures and circuits
coming soon -
starring Resi & Transi, of course!

Elektor Publishers Ltd., Elektor House,
10 Longport, Canterbury CT1 1PE,
Kent, U.K.
Tel.: Canterbury (0227) 54430.
Telex: 965504
Office hours
8.30 12.30 and 13.30 - 16.30.



EPS-SERVICE

E94 FEBRUARY 1983			
audio/video modulator	83190	4 05	8 —
base projects	83010	2 —	4 —
universal modem	83011	7 50	15 —
Prelude			
headphone amplifier	83022-7	5 10	10 25
power supply	83022-8	4 85	9 25
connection board	83022-9	7 45	15 —
main beam dimmer	83028	1 85	3 75

E95 MARCH 1983			
64 K memory card	83014	7 45	15 —
Prelude			
bat board	83022-1	12 10	24 —
line amplifier	83022-6	5 —	10 —
audio test light	83022-10	2 20	4 50
digital luxmeter	83037	2 10	4 —

E96 APRIL 1983			
programmable deskroom timer	82048	5 20	10 50
low power digital timer moment	82175	2 85	8 —
Prelude			
MC preamplifier	83022-2	5 08	10 —
MM preamplifier	83022-3	6 20	12 50
Interscud remote control preamp	83022-4	4 05	8 25
tone control	83022-5	4 80	9 50
7-day timer/controller	83041	8 40	10 76

NEW

E97 MAY 1983			
Messico	83051-1	2 55	5 —
Watt meter	83052	3 55	7 —
music converter	84064	3 15	6 25
ASCII keyboard	83058	20 50	41 —

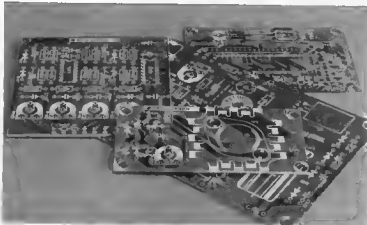

front panels

simple function			
generator (E33, F39)	9453-F	3 15	6 25
Elektor Art 3 (E85)	82014-F	2 80	5 25
precision power supply (E92)	82178-F	2 35	4 75
Prelude (E94, F96)	83022-F	2 15	4 50
7-day timer/controller	83041-F	12 45	25 —

NEW

Messico	83051-F	4 65	8 25
---------	---------	------	------

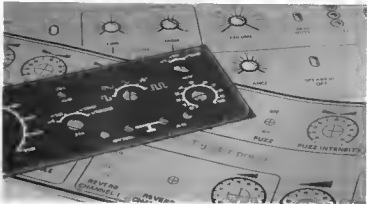

software

available with µP programs

µP TV games 15 programs (jackpot, reverse amazon, code breaker, etc.)	ESS 007	5 25	10 50
µP TV games 15 programs (invaders, Tithing, maze adventure, memory, poison, nim, etc.)	ESS 009	6 55	13 —
µP TV games 15 programs (airi, flippers, helicopter, polo, basketball, hangman etc.)	ESS 010	8 55	13 —



ORDERING INFORMATION

Payment must be in advance.

- For UK and all countries except the USA, payment, incl. £ 0.50 postage and packing direct to Elektor Publishers Ltd., or via bank transfer to The Midland Bank Ltd., Canterbury, A/C no. 11014587, sorting code 40-16-11.
- For the USA only: please make your cheques/money order payable to Elektor Publishers Ltd., Band of America, c/o Fils No. 1504, 1000 W. Temple, Los Angeles, Cal. 90074, A/C no. 12350-04207. Prices include post & packing, surface mail. If air mail, please add \$ 1.50.

Cheap Imitations?



Microdottron

is an alternative to AUTOMATIC TEST EQUIPMENT which can be very expensive. MICRODOCTRON is perfectly adequate for diagnosing faults in microprocessor boards or computers in the REPAIR SHOP or on the PRODUCTION LINE. Reports are PRINTED on the integral thermal printer. Tests supported are CHECKSUM, RAMTEST, WAIT, READ, WRITE, I/O READ, I/O WRITE, DUMP IN HEX, DUMP IN ASCII, TEST DATA LINES (line shorts between data, address and clock), SEARCH (for two specified bytes), MAP (maps a memory map of ROM, RAM, I/O and EMPTY SPACE). Supports both multiplexed and non-multiplexed address/data. Standard software will also DISASSEMBLE in 280 mnemonics - other disassemblers cut extra. Programs in board testing can be written in MINUTES and - reloaded for MONTHS even if the power is switched off (CMOS RAM is backed-up with rechargeable battery). Capacity up to 15 different programs of 12 zeros each. Included are two PROM CONFIGURATION CARDS (On 280, other microcontrollers), PROMS with 24 each cable and 40-pin DIL chip - and POWER SUPPLY. Extras available are 6502 disassembler software... £35, 6800 disassembler software... £25. Thermal paper £3.00 box of 10. Chipover PROMS (only needed if µP is soldered-in)... £35. Spare cards... £6.50.

£295



The Menta 280 Development System

uses the MOST POWERFUL LANGUAGE OF ALL - direct ASSEMBLER MNEMONICS. MENTA has VISUAL AIDS to program development which the big systems lack: a TV display of PROGRAM, REGISTERS and STACK, single-step operation (watch the cursor move from instruction to instruction, see the register-contents change, observe stack operations, etc.). BUGS can be fixed immediately without reassembling. Full speed operation is supported too - with or without BREAKPOINTS. Designed originally for the SChnee. Control to teach microprocessing, MENTA is a complete CONTROLLER in its own right. Like any other 280 system, with practical, commercial applications in ROBOTICS. Features include CASSETTE INTERFACE, ASSEMBLER/EDITOR, serial DISASSEMBLER (now included as standard), 24 bits of I/O - also TV FLYLEAD, POWER SUPPLY and COMPREHENSIVE MANUAL with SOURCE-CODE LISTING.

£99

Goodies from Dataman

Olivetti Typewriter Interfaces

for ET121 and ET221 machines which permit the typewriter to be used as a DAISY WHEEL PRINTER for computers implementing the RS232, IEEE 488 (PET) or CENTRONICS PARALLEL buses, almost all computers in fact. Great for word processing and letter-writing! Same price, fitting time free if requested (you pay carriage on typewriter if we fit). £195.00

Thandar Logic Analyser Enhancements

THE THANDAR TA2080 LOGIC-ANALYSER was NOT designed by DATAMAN - BUT WE CAN ENHANCE IT. We use SOFTY for ROM-EMULATION, following the program-flow on the TA2080 screen. We modified our TA2080 to make it more useful, adding an RS232 OUTPUT TO PRINTER - also 280 and 6802 DISASSEMBLER. Now we can follow program operation in MNEMONICS on-screen and print TIMING or STATE DIAGRAMS and DISASSEMBLED CODE. Cost of this RETROFIT kit (12K of program ROM socket for RS232 interface board, instruction sheet) is, if fitted by us and purchased with a TA2080 £195.00. If purchased as a kit without TA2080 £295.00

Softy I with PSU

Yes, we still have a few and revised 3 rail EPROM PROGRAMMERS around, as seen in Kensington Science Museum. If you are still using 2708's get yourself this fine old classic at a bargain price (telephone for stock, please). £95.00

Ultra-Violet Eprom Erasers from £33.00



Softy Eprom Programmer/Emulator

SOFTY has functions equal to at least 10 equipment which sells for over £500. SOFTY EMULATES AND PROGRAMS 2716, 2516, 2732, 2532 EPROMS. (The type is selected by a personality switch. SOFTY will copy any of these EPROMS to any other.) SOFTY has a HEX KEYPAD, a full CASSETTE INTERFACE, a MEMORY MAP TV DISPLAY with powerful editing - such as INSERT, DELETE, SHIFT-BLOCK and many other facilities - too many to list here. RS232 SERIAL and CENTRONICS PARALLEL routines for INPUT and OUTPUT are standard. The price includes TV FLYLEAD, POWER SUPPLY and ROM EMULATOR CABLE WITH 24 PIN DIL PLUG. SOFTY is used as a DEVELOPMENT SYSTEM for STAND-ALONE or as a ROM PROGRAMMER.

£169

All our own work!
Dataman

LOMBARDO HOUSE,
CORNWALL ROAD,
DORCHESTER, DORSET OT1 1RX.
Telephone: Dorchester (0305) 68066
Telex A18442 DATAMAN

Dataman Designs

Prices quoted normally exclude VAT unless otherwise stated. Prices include best value standard goods in UK. Delivery: Next Day, all other goods VAT should be added at current rates.

SPEECH SYNTHESISER FOR ZX81 and VIC20

THE MAPLIN TALK-BACK

Now your computer can talk!

- ★ Allophone (extended phoneme) system gives unlimited vocabulary.
- ★ Can be used with unexpanded VIC20 or ZX81 — does not require large areas of memory.
- ★ In VIC20 version, speech output is direct to TV speaker with no additional amplification needed.
- ★ Allows speech to be easily included in programs.

Complete kit only £24.95.

Order As LK00A (VIC20 Talk-Back).

LK01B (ZX81 Talk-Back).

Full construction details in Maplin Projects Book 6.
Price 70p. Order As XA06G (Maplin Mag Vol. 2 No. 6).

KEYBOARD WITH ELECTRONICS FOR ZX81



- Full size, full travel keyboard that's simple to add to your ZX81 (no soldering in ZX81).
 - Complete with electronics to make "Shift Lock".
 - Function and "Graphics 2" single key selections.
 - Powered (with adaptor supplied) from ZX81's own standard power supply.
- Full details in Project Book 3 (XA03D) Price 60p
Complete kit (incl. case) £19.95 Order As LW72P
Case £4.95 Order As XG17T
Ready built-in case £29.95 Order As XG22Y

OTHER KITS FOR ZX81

- 3 Channel Sounds Generator (Details in Book 5)
Order As LW98E Price £10.95
- ZX81 Sound On Your TV Set (Details in Book 6)
Order As LK02C Price £19.95
- ZX81 I/O Port gives two bi-directional 8 bit ports (Details in Book 4)
Order As LW78H Price £9.25
- ZX81 Expandboard will accept 16K RAM and 3 other plug-in modules
PCB Order As G808J Price £2.32
Edge Connectors 14 needed
Order As RK350 Price £2.39

HOME SECURITY SYSTEM

- Six independent channels - 2 or 4 wire operation. External horn. High degree of protection and long term reliability.
- Full details in Project Book 2 (XA02C) Price 60p



MATINEE ORGAN

Easy-to-build superb specification. Comparable with organs selling for up to £1000. Full construction details in our book (XK455K). Price £7.50. Complete kits available: Electronics (XY91Y) £299.95; Cabinet (XY93B) £99.50; Demo cassette (DX43W) £1.99



25W STEREO MOSFET AMPLIFIER



- Over 26W/channel into 8Ω at 1kHz both channels driven
 - Frequency response 20Hz to 40kHz ±1dB
 - Low distortion, low noise and high reliability power MOSFET output stage
 - Extremely easy to build. Almost everything fits on main pcb, cutting interwiring to just 7 wires (plus toroidal transformer and mains lead terminations)
 - Complete kit contains everything you need including pre-drilled and printed chassis and wooden cabinet.
- Full details in Project Book 3. Price 60p (XA03D)
Complete kit only £88.20 incl. VAT and carriage (LW71N)

BUY IT WITH MAPCARD

Send now for an application form — then buy it with MAPCARD. MAPCARD gives you real spending power — up to 24 times your monthly payments instantly.



All prices include VAT & carriage. Please add 50p handling charge to orders under £5 total value.



MAPLIN'S FANTASTIC PROJECTS

Full details in our project books. Issues 1 to 5 60p each. Issue 6 70p.

In Book 1 (XA01B) 120W rms MOSFET Combo-Amplifier • Universal Timer with 18 program times and 4 outputs • Temperature Gauge • Six Vero Projects

In Book 2 (XA02C) Home Security System • Train Controller for 14 trains on one circuit • Stopwatch with multiple modes • Miles-per-Gallon Meter

In Book 3 (XA03D) ZX81 Keyboard with electronics • Stereo 25W MOSFET Amplifier • Doppler Radar Intruder Detector • Remote Control for Train Controller

In Book 4 (XA04E) Telephone Exchange for 16 extensions • Frequency Counter 10Hz to 500MHz • Ultrasonic Intruder Detector • I/O Port for ZX81 • Car Burglar Alarm • Remote Control for 25W Stereo Amp

In Book 5 (XA05F) Modem to European standard • 100W 240V AC Inverter • Sounds Generator for ZX81 • Central Heating Controller • Panic Button for Home Security System • Model Train Projects • Timer for External Sounder

In Book 6 (XA06G) Speech Synthesiser for ZX81 & VIC 20 - Module to Bridge two of our MOSFET Amps to make a 350 W Amp - ZX81 Sound on your TV - Scream Filter - Damp Meter

MAPLIN'S NEW 1983 CATALOGUE

Over 350 pages packed with data and pictures and all completely revised and including over 1000 new items. On sale in all branches of WHSMITH. Price £1.26



Post this coupon now!

Please send me a copy of your 1983 catalogue. I enclose £1.50 (inc. p&p). If I am not completely satisfied I may return the catalogue to you and have my money refunded if you live outside the UK send £1.90 or 10 International Reply Coupons.

Name _____

Address _____

E583

MAPLIN

MAPLIN ELECTRONIC SUPPLIES LTD.
P.O. Box 3, Rayleigh, Essex S56 8LR
Telephone: Sales (0702) 552911 General (0702) 554155

Shops at: Note: Shops closed Mondays
159 King St., Manchester, London W9. Telephone: 01-746 0928
284 Linden Rd., Westcliff-on-Sea, Essex. Telephone: (0702) 554000
Lynton Square, Perry Barr, Birmingham. Telephone: (021) 356 7232