

elektor

up-to-date electronics for lab and leisure

D 71683

94

February 1983

75 p.

IR 112p. (incl. VAT)
\$ 2.50

headlamp
cross-fader

no-blow fuse

μ P telelink

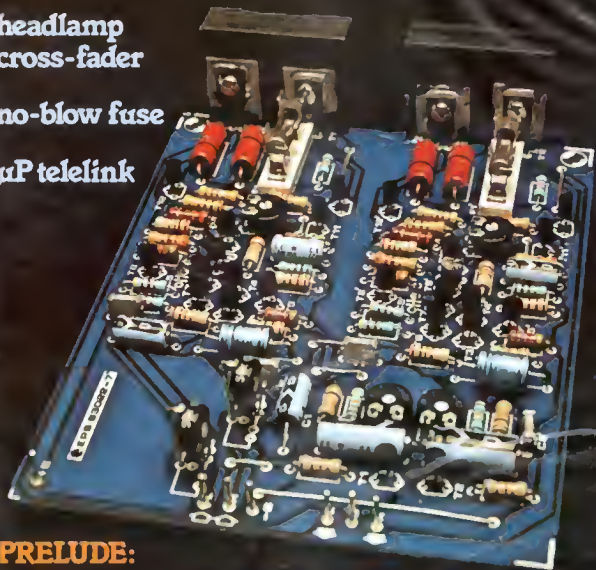

PRELUDE:

**the XL control pre-amplifier with facilities:
class-A headphone amp * bus board based *
remote control option * etc**

selektor	2-16
Prelude part 1	2-18
The preamplifier of the Elektor XL system, A completely modular design allowing the constructor to configure it according to the facilities required. The Prelude handles, controls, and distributes varying signal sources, and it is also suitable for equipping with a cordless remote control.	
VAM — video/audio modulator	2-27
The growth in the number of video enthusiasts has kept pace with that of computer 'freaks'. The colour modulator presented here is driven from the RGB output of a personal computer, thereby keeping everyone happy.	
main beam dimmer	2-32
Every motorist has been dazzled by oncoming vehicles that fail to dip their headlights, and the results can be dangerous. The culprit also has a problem. If he suddenly dips his lights then his sight is affected by the new situation. An electronic solution has now been found: dimming/dipping in stages with the main beam dimmer.	
Prelude class A headphone amplifier	2-34
In keeping with the XL system this article introduces an amplifier which delivers in class A a useful 160 mW per channel into 8 Ω . It can be used separately or with any other control amplifier even though it was originally intended as a part of the XL Prelude.	
fuse protector	2-39
Where circuit breakers are utilised in place of mains fuses, it is quite common for a variety of high powered appliances, when switched on, to cause them to trip. One way to get over this problem is by using a fuse protector.	
acoustic telephone modem	2-42
A circuit designed to send and receive digital information via normal telephone lines. It enables the interconnection of two computers (or terminals) even though they are physically separated by large distances. The modem is compatible with an RS 232 interface and is acoustically coupled requiring no modification to your existing telephone receiver.	
double dice	2-51
Here we go; a non talking double dice, which, if nothing else, is self explanatory. It is not totally dumb however, showing the score on LED displays as either a single or a double dice.	
chips for digital audio part II	2-54
In last month's article the source such as the compact disc was discussed in great detail. This time we discuss the distinct possibility that 'Hi-Fi' systems of the future will look more like microcomputers, and rather than talking about signal-to-noise ratio, we will mention software and so on.	
applicator	2-58
A good look at programmable universal filters with switched capacitors.	
market	2-60
switchboard	2-63
EPS service	2-72
advertisers index	2-74



Over the next few months, we will be dedicating quite a few pages to the description of 'Prelude'. Several of the modules used in this preamplifier are useful circuits in their own right: this month's headphone amplifier is an example.

MARKETED BY

precious[®]

ELECTRONICS CORPORATION

HEAD OFFICE BRANCH
 1 CHURCH LANE, 8 ATHERTON ST., MOUNT ROAD
 DE BONDERRAY MARC, NAURUVA, SINGAPORE
 BOMBAY 400017 PHONE 342718
 PHONE 394733 FAX 342718

Handwritten signatures:

[Signature]

[Signature]

electronize

ELECTRONIC IGNITION KITS OR READY BUILT

IS YOUR CAR AS GOOD AS IT COULD BE ?



- ★ Is it **EASY TO START** in the cold and the damp? Total Energy Discharge will give the most powerful spark and maintain full output even with a near flat battery
- ★ Is it **ECONOMICAL** or does it "go off" between services as the ignition performance deteriorates? Total Energy Discharge gives much more output and maintains it from service to service.
- ★ Has it **PEAK PERFORMANCE** or is it flat at high and low revs, where the ignition output is marginal? Total Energy Discharge gives a more powerful spark from idle to the engines max. (even with 8 cylinders).
- ★ Is the **PERFORMANCE SMOOTH** The more powerful spark of Total Energy Discharge eliminates the 'near misses' whilst an electronic filter smooths out the effects of contact bounce etc.
- ★ Go the **PLUGS and POINTS** always need changing to bring the engine back to its best. Total Energy Discharge eliminates contact arcing and erosion by removing the heavy electrical load. The timing stays "spot on" and the contact condition doesn't affect the performance either. Larger plug gaps can be used, even wet or badly fouled plugs can be fired with this system.

Most **NEW CARS** already have **ELECTRONIC IGNITION**. Update **YOUR CAR** with the most powerful system on the market - 3½ times more spark power than inductive systems - 3½ times the spark power of ordinary capacitive systems, 3 times the spark duration.

Total Energy Discharge also features:
EASY FITTING, STANDARD/ELECTRONIC CHANGE-OVER SWITCH, LEO STATIC TIMING LIGHT, LOW RADIO INTERFERENCE, CORRECT SPARK POLARITY and DESIGNED IN RELIABILITY.

- ★ **IN KIT FORM** it provides a top performance system at less than half the price of competing ready built units. The kit includes pre-drilled fibreglass PCB, pre-wound and varnished ferrite transformer, high quality 2uF discharge capacitor, case, easy to follow instructions, solder and everything needed to build and fit to your car. All you need is a soldering iron and a few basic tools.

FITS ALL NEGATIVE EARTH VEHICLES

6 or 12 volt, with or without ballast

OPERATES ALL VOLTAGE IMPULSE TACHOMETERS - (Older current impulse types need an adaptor).

STANDARD CAR KIT £15.90
Assembled and Tested £26.70

PLUS
P. & P.
£1 (U.K.)

TWIN OUTPUT KIT £24.55
For Motor Cycles and Cars with twin ignition systems
Assembled and Tested £36.45

Prices
include
VAT



ELECTRONIZE DESIGN

Dept. J • Magnusc EK • Wilnecote
Tamworth • B77 5BY
tel: 0827 281000

The basic function of a spark ignition system is often lost among claims for longer "burn times" and other marketing fantasies. It is only necessary to consider that, even in a small engine, the burning fuel releases over 5000 times the energy of the spark, to realise that the spark is only a trigger for the combustion. Once the fuel is ignited the spark is insignificant and has no effect on the rate of combustion. The essential function of the spark is to start that combustion as quickly as possible and that requires a high power spark.

The traditional capacitive discharge system has the high power spark but, due to its very short spark duration and consequential low spark energy, is incompatible with the weak air/fuel mixtures used in modern cars. Because of this most manufacturers have abandoned capacitive discharge in favour of the cheaper inductive system with its low power but very long duration spark which guarantees that sooner or later the fuel will ignite. However, a spark lasting 2000uS at 2000 rev/min. spans 24 degrees and 'lister' could mean the actual fuel ignition point is retarded by this amount.

The solution is a very high power, medium duration, spark generated by the **TOTAL ENERGY DISCHARGE** system. This gives ignition of the weakest mixtures with the minimum of timing delay and variation for a smooth efficient engine.

- ★ **SUPER POWER DISCHARGE CIRCUIT** A brand new technique prevents energy being reflected back to the storage capacitor, giving 3½ times the spark energy and 3 times the spark duration of ordinary C.O. systems, generating a spark powerful enough to cause rapid ignition of even the weakest fuel mixtures without the ignition delay associated with lower power "long burn" inductive systems
- ★ **HIGH EFFICIENCY INVERTER** A high power, regulated inverter provides a 370 volt energy source - powerful enough to store twice the energy of other designs and regulated to provide sufficient output even with a battery down to 4 volts.
- ★ **PRECISION SPARK TIMING CIRCUIT** The circuit removes all unwanted signals caused by contact volt drop, contact shuffie, contact bounce, and external transients which, in many designs, can cause timing errors or damaging un-timed sparks. Only at the correct and precise contact opening is a spark produced. Contact wear is almost eliminated by reducing the contact breaker current to a low level - just sufficient to keep the contacts clean

TYPICAL SPECIFICATION

	Total Energy Discharge	Ordinary Capacitive Discharge
SPARK POWER (Peak)	140W	90W
SPARK ENERGY	36mJ	10mJ
STORED ENERGY	135mJ	65mJ
SPARK DURATION	500uS	160uS
OUTPUT VOLTAGE (Load 50pF, equivalent to clean plugs)	38kV	26kV
OUTPUT VOLTAGE (Load 50pF + 500k, equivalent to dirty plugs)	26kV	17kV
VOLTAGE RISE TIME TO 20kV (Load 50pF)	25uS	30uS

TOTAL ENERGY DISCHARGE should not be confused with low power inductive systems or hybrid so called reactive systems

301 circuits

The book follows the theme, and is a continuation of our popular and very successful 300 circuits publication. It is composed of 301 assorted circuits ranging from the simple to the more complex designs described and explained in straightforward language. An ideal basis for constructional projects and a comprehensive source of ideas for anyone interested in electronics. In a nutshell something to please everybody.

price £ 4.25 incl. p&p
overseas surface mail
price £ 4.50

Please use the Order Card in this issue

Elektor
Publishers Ltd.



MULLARD SPEAKER KITS

A MURPHY'S DESIGN 40 WATT 0 M S 8 OHM SPEAKER SYSTEM RECENTLY DEVELOPED BY MULLARD'S SPECIALIST TEAM IN BELGIUM. It comprises a Mullard 8" Woofer with foam surround and aluminium voice coil. Mounted 37 high power, same reactance 4 K E bulk and sealed crossover, based on Mullard circuit combining low loss components, glass fibre board and recessed inductor terminals. Recommended cabinet size 240 x 218 x 445 mm. A superb sound at a relatively low cost. Complete with instructions. Price £14 90 £10 90 per kit

New 5" 30 watt new version of above here built Recommended cabinet size 180 x 155 x 295 mm. Price £13 90 £10 90 per kit per kit

STEREO CASSETTE TAPE DECK MODULE

Comprising of a top panel and basic chassis unit, coupled to a record/play base printed board assembly. Supplied as one complete unit for horizontal installation into cabinet or console of your choice. These units are brand new, totally built and tested.

Features: Three digit tape counter. Auto stop. Six phono type levers, record, repeat, fast forward, play stop and fast. Automatic record level control. Main inputs plus secondary inputs for stereo microphones. Input Sensitivity 100mV to 2V. Input Impedance 10K. Output level 400mV to both left and right hand channels. Output Impedance 10K. Signal to noise ratio 45dB. Noise and Hiss 0.1%. Power Supply requirements 18V DC at 300mA. Connectors: The left and right hand stereo inputs and outputs are via individual screened leads all terminated with phono plugs (phono sockets provided). Dimensions: Top panel 5 1/2" x 11 1/2" x 115mm. Chassis depth under top panel 2 1/2". Supplied complete with record dials, gram and connecting diagram. Attractive black and silver finish.

Price £26 70 - £2 50 postage and packing. Supplementary parts for 18V DC power supply transformer, bridge rectifier and smoothing capacitor. £3 90



1000 MONO DISCO MIXER
A superb fully built and tested mono mix amp with stagger power supply. 4 active 2 horizontal tonearms controlled. Also for tape deck and 400Watts with stereo main in with individual level controls. Two sets of active tone controls (bass and treble) for MC, MC and MC. Master volume control. Monitor output with select switch and volume control.
Outputs: Main 750 mV and Monitor 500 mV into 8 ohm. Supply 220-230V AC 20-90Hz. Size 221 x 51 x 21. Price £28 95 £2 90 P&P

BK ELECTRONICS
Prompt Deliveries
VAT inclusive prices
Audio Equipment
Test Equipment
by Thandar and Leader

1K.WATT SLIDE DIMMER

- Controls feeds up to 1KW
- Compact size
- 4 x 13 x 2 1/2"
- Easy slip on using through panel cabinet cut out
- Full wave control using B.M.T. diac
- Insulated plastic case
- Conforms to BS800
- Suitable for both resistance and inductive loads

Innumerable applications in industry, the home and discos theatres etc.
Price £11.70 each + 50p P&P 1Any quantity

BSR P256 TURNTABLE

- P256 invertible chassis
- 5 shaped tone arm
- Bell driver
- Aluminium pulley
- Price set cableless motor balance
- Alu skate base divertor
- Damped carrying laves
- 240 volt AC motor (18V)
- Full auto temp. supported
- Consistency manual arm

This deck has a completely manual arm and is designed primarily for disco and studio use where all the advantages of a manual arm are required.
Price £28 50 £2 50 P&P

KEYBOARDS



MEMBRANE KEYBOARDS
Manufactured from 5 tough poly capsules line mounted on 1000 piece fibre printed circuit board assembly incorporating silver plated contacts.
18 way rugged keyboard Standard keyboard printing 0.15" x 0.15" Alpha Numeric Keyboard 101 size 95 key non enclosed keyboard with the standard numeric keypad functions in 5 Query any Matrix layout size 1.6 pin DIL socket. Size 350mm x 100mm. Price £5 99 £3 99

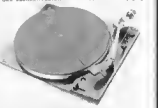

100 WATT R.M.S. AND 300 WATT R.M.S. MODULES

Power Amplifier Modules with integral toroidal transformer power supply and heat sink. Designed as one complete built and tested unit. Can be fitted in minutes. An IED VU meter or oscilloscope as an optional extra.

SPECIFICATION
Max Output Power: 110 watts @ 8 Ω S. 100W (100) 300 watts @ 8 Ω S. 300W (300)
Levels: 0dBm and short circuit proof. S 15 ohms
Frequency Response: 20Hz to 25kHz ± 3dB
Sensitivity for Max. Output: 100mV for 100W (100) 1V for 300W (300)
THD: Less than 0.1%
Simply 240V 50Hz.
Size: 100W 100 260 x 115 x 72mm
300W 300 480 x 153 x 60mm
Price: 100W £11 00 £3 00 P&P £2 00 P&P
300W £30 00 £8 00 each £2 00 P&P
VU Meter £8 00 each £ 50 P&P

NEW RANGE DUALITY POWER LOUD SPEAKERS (15, 12 and 8")

These speakers are an ideal for both hi fi and also applications. Both the 12 and 15 units have heavy duty die cast chassis and aluminium centre domes. All dynamic units have white speaker cones and are fitted with attractive cast aluminium grilles. Small hi fi speakers are available in 8, 12 and 15 sizes.

15 100 watt R.M.S. impedance 8 ohms. 20 to 20,000 Hz. Frequency Response to 20KHz. Sensitivity 97dB. Price £32 each £3 00 Packing and Carriage each

12 100 watt R.M.S. Impedance 8 ohms. 50 Hz. Frequency Response to 20KHz. Sensitivity 96dB. Price £23 70 each £3 00 Packing and Carriage each

8 50 watt R.M.S. impedance 8 ohms. 20 to 20,000 Hz. Frequency Response to 20KHz. Sensitivity 92dB. Also available with black matt. Impedance 16 ohms. Price £18 50 each. P & P £1 25 each

PIEZO ELECTRIC TWEETERS MOTOROLA

Join the Piezo revolution. The low dynamic mass low voice coil of a Piezo tweeter produces an employed 1/2 instant response with a lower distortion level than ordinary dynamic tweeters. As a crossover is not required these units can be added to existing speaker systems of up to 100 watts (more if 2 put in series). FREE EXPLANATORY LEAFLETS SUPPLIED WITH EACH TWEETER

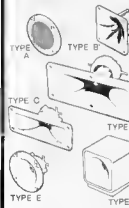

- TYPE A (KSN2006A) 3"** 100 watt 16 ohm 20 to 20,000 Hz. Frequency Response to 20KHz. Sensitivity 92dB. Price £3 48 each
- TYPE B (KSN1005A) 3"** 50 watt 16 ohm 20 to 20,000 Hz. Frequency Response to 20KHz. Sensitivity 92dB. Price £3 48 each
- TYPE C (KSN8016A) 2"** 50 watt 16 ohm 20 to 20,000 Hz. Frequency Response to 20KHz. Sensitivity 92dB. Price £3 48 each
- TYPE D (KSN1025A) 2"** 50 watt 16 ohm 20 to 20,000 Hz. Frequency Response to 20KHz. Sensitivity 92dB. Price £3 48 each
- TYPE E (KSN1036A) 3 1/2"** horn tweeter with 200Watts max. power. Suitable for hi fi stereo systems etc. Price £4 26 each
- TYPE F (KSN1052A) 2"** closed version of Type E. 100 watt standing surface tweeter. Perfect add on tweeter for conventional loudspeaker systems. Price £10 75 each. U.K. post has for SAE for Piezo leaflets

POWER AMPLIFIER MODULES

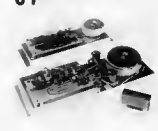

Matching 3-way loudspeakers and crossovers

Build a quality 50watt R.M.S. system. Build a quality 600W R.M.S. system.

- ★ 10" Woofer 35Hz-4.5KHz
- ★ 3" Tweeter 2.5KHz-19KHz
- ★ 5" Mid Range 600Hz-8KHz
- ★ 3-way crossover 60dB/oct. 1.3 and 6KHz
- Recommended Cab-size 26" x 13" x 13"
- Price £220 per kit (£2 50 postage and pack)

12 80 watt R.M.S. Loudspeakers

A superb general purpose twin cone loudspeaker. 50 watt impedance 2 aluminium voice coil. Rolled surface. Response frequency 25Hz frequency response to 12.5KHz. Sensitivity 95dB. Impedance 8 ohms. Attractive blue cone with aluminium centre dome. Price £12 98 each + £3 00 P&P



B.K. ELECTRONICS

37 Whitehouse Meadows, Eastwood, Leigh-on-Sea, Essex SS9 5TY

★ SAE for current lists ★ Official prices welcome ★ All prices include VAT ★ Mail order only ★ All items packed where applicable in special energy absorbing PU foam. Callers welcome by prior appointment. please phone 0702 527572

selektor

Talking to computers

by Brian Pay, National Physical Laboratory, London

Speech is the quickest and most natural form of human communication. So, the best way of improving our interface with computers and other machines, to get the utmost from the microcomputer power now available to us, is to develop systems that recognise natural, continuous speech without need for special enunciation or unnatural pauses between words. Through research at the UK National Physical Laboratory, we may expect to see such systems appear within the next few years.

For more than 50 years scientists have been fascinated by the idea of getting a machine to understand speech. We may assume that the interest was, at first, mostly academic, because no application of such a device was seriously considered. We can also certainly say that the technology available to the pioneers was very primitive by today's standards. So, when the word computer entered our vocabulary, nobody thought it would be useful to speak to one. After all, computers were gigantic pieces of electronic machinery, some as big as 10 double-decker buses, with scarcely more power than a programmable pocket calculator that we can now buy for a little less than £100.

But the technology moved very rapidly: computers became smaller, more powerful and more sophisticated. More important, their cost fell to the point where we are now able to design equipment to do tasks that are very complex indeed and to behave almost as if they were intelligent. With computer power spreading across disciplines and professions as diverse as medicine, aviation, banking, insurance, engineering, police work, education and so on, it has become more and more important to improve communication between man and computer.

We could see this need arising in the late 1950s and the early 1960s, with the introduction of so-called high-level programming languages that

were nevertheless simple to use and the development of machines to recognise the type-written word. A decade later there was a surge in research into speech recognition. Today, the general belief is that it will have to be as commonplace to talk to a computer as it is to make a telephone call if we are to get the best from the microcomputer power now at our finger-tips. The problem is no longer academic; the rewards for success will be high.

Flow of words

Why then, with all the research that has been done, has the problem not been solved? To answer this question it is probably best to reason 'from the top down'. Let us consider a task that seems quite trivial but is really extraordinarily difficult, such as simply dictating a letter to a speech-driven typewriter. If I were to say to you 'Catalogue four feet long', you would think it nonsense. But imagine, if you will, that you are a tree-feller being instructed by foreman; you would probably hear me say 'Cut a log four feet long'. The acoustic difference between the two phrases is so small that we must rely on other clues. In this case our environment, to discern the correct meaning.

If I were to say 'There were six . . . ' you might decide, at that instant, that I have just said the word six. But if I continue ' . . . teen . . . ' you change your first decision to the other word sixteen. If I continue a little further with ' . . . agers ' the whole phrase becomes 'There were six teenagers' and you realise that your first guess, the word six, was correct.

Yet another example is a news item on the radio: 'The Government is considering attacks on merchant shipping'. This might well have been true in 1940; but was not the news-reader really saying 'The Government is considering a tax on merchant shipping'?

From these examples we can make fundamental observations. First, there is no correlation between pronunciation and the way words are spelt. Second, spoken words flow into each other, whereas in written language there are convenient spaces between them. Third, we cannot extract meaning from a message without using a great many clues: in one case, our environment; in the next, subject matter or context and, in yet another case, the state of international affairs. Fourth, and most important, every legitimate word in our language is likely to appear as a 'rogue'. In the examples

already given, the legitimate words (catalogue, sixteen and attacks) were all rogues; our language, and most other languages, are littered with them.

In general, this attribute of the language does not confuse us too much (indeed, comedians capitalise on it). This is because we have a wide knowledge of our world. On the other hand, a computer's awareness may be as restricted as that of a rabbit which spends the whole of its life in the same hutch, with a basic experience no more than that of an infant.

Specific task

So it would seem our secretaries are not yet redundant. But is it possible to make any useful advance? Well, when we identify the problems we can set about eliminating them by placing constraints on either the user or the machine. The obvious one is to restrict the computer to one specific task, such as explicit collection of data, which may have to do with, for example, temperature readings, contour data in map reading, and so on. The job may be to acquire information from a data bank, perhaps covering warehouse stocks, social security records, train or aircraft time-tables and movements; or it may cover heuristic applications, in which problems are tackled by trial and error, of the sort often found in banking, insurance, police work and medicine. Alternatively, the application may be in the control of a system where, as often as not, the operator's hands are already fully occupied: one such example is control of an aircraft. None of these applications depends upon the direct use of speech, but in general they all depend upon the supply of certain special knowledge or expertise. If we are to improve the interface by introducing speech, the operator must be free to speak in a way that is entirely natural. It would be disadvantageous and, perhaps, dangerous to apply constraints to the user, and we have to bear in mind that even highly-trained operators who are called upon to speak clearly, such as air traffic controllers, find it difficult to maintain a rigid verbal discipline. Many people, quite unconsciously, tend to prefix their words and phrases with 'ers' and 'ums' and we all prefer to run words into each other rather than pause distinctly between them. A good example is the way we pronounce numerals: try saying your telephone number with a well-defined pause between each digit.

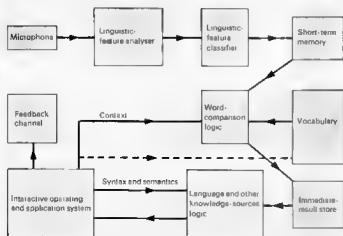

Block diagram of the NPL speech-recognition system. Its heart is the block at the lower left, the only module that needs to be chosen according to the application. It issues directives to the rest of the system, digests incoming information and controls the information fed to the user via the feedback channel. It needs to be completely 'aware' of what is important, and how important, in the specific application. The linguistic feature analyser extracts from the speech only the important content, disregarding irrelevant characteristics such as whether the voice is male or female, or whether the speaker has a head cold. The signal is then classified into linguistic features which are stored in the short-term memory (STM). A word-comparison logic module compares features in the STM with words in the vocabulary and stores possible and probable results in the intermediate-result store; this logic is controlled by the application system, which decides which words need to be compared, thereby removing a large amount of ambiguity. Fundamental language rules (for example, how words can flow together) are applied to the signal from the intermediate-result store by the next module, which also applies rules explicitly to do with the application (supplied by the application system); the processed information is finally fed back to the system. The context channel fixes which words in the vocabulary module are relevant: for example, in 'what day of the week is it?' the context has determined that only the names of days matter. Syntax information governs the form the operator is expected to use and leaves the system aware only of the base syntax: for example, 'shut door' is the artificial syntax of, say, 'please shut the door'. Semantics information relates directly to meaning within the application: '429 degrees' is, for example, meaningless as a compass bearing, and 'a person with grey hair and balding' cannot be 'sixteen'. (People use may clues to apply semantics). The application system is, of course, the computer itself.

Speech algorithms

To aggravate the problem, it is by no means certain that all the users of a system would realise that there were constraints imposed and, if so, precisely what they were. This makes for a very low integrity of interface. It is to this aspect of the speech recognition problem that we have directed most effort. So, while other researchers have applied constraints to the user in various degrees, we have been firmly of the opinion that constraints other than natural ones always create other problems. Having adopted that approach, we have built up many years of experience and we are now able to use speech naturally by employing what we call continuous speech algorithms. This term may perhaps be too simple a description, for the design of the algorithms, which are prescribed steps in computer processing

of the input data, takes into account a great deal of information about the way the language is constructed and how it is spoken. One important thing that has to be taken into account is the enormous amount of acoustic data that we emit whenever we speak, so we have to know how the language is constructed if we are to eliminate all those data that are not essential. It means that we have to know the language's phonetic decoding rules and those that govern the way it is ordered. Obviously, the sounds we make depend on our vocal mechanism. Because we all have similar mechanisms, the basic amount of data we produce is independent of whatever our native language might be. We call the sounds we make 'linguistic features' and they become encoded into the language we speak. Once we can capture and identify them, the

subsequent part of the speech recognition process is, of course, peculiar to that language. Written language and their alphabets are interesting, too, in the context of our problem. Both the Cyrillic alphabet, used by certain Slav people and by the Russians, and the so-called English Initial Teaching Alphabet (ITA) contain about 40 symbols and are phonetic, each symbol being known as a phoneme and representing a spoken sound. The definition of a phoneme is 'a unit of significant sound in a given language', but a more precise definition would be 'a unit of sound, within a word, that would, if replaced or removed, change the meaning of the word.'

Context

It is a remarkable coincidence that all languages use about 40 phonemes; there is no obvious reason why. Nevertheless, the foregoing definitions show that the phoneme is a symbol of information that cannot be independent of the language. In other words, no phoneme can be defined without stating the language to which it belongs. As with words, which are obviously language-dependent, there is no convenient way of telling where one phoneme ends and the next one begins in natural, flowing speech. Speech has, indeed, more in common with handwriting than with printed text, for the printed words have clear spaces between them. But in handwriting, individual characters are often difficult, and even impossible, to identify when its companions on both sides are covered from view. Indeed, handwriting and speech are fully understood only because we bring other clues into play, the most important being that of context. It appears that language evolves through certain contextual rules by which we need articulate fully only those words or parts of words that carry the more important information. For example, you would understand someone to say 'Please shut the door' even if the word 'the' were not said at all. It is quite usual for there to be only a slight acoustic disturbance between 'shut' and 'door'. Nevertheless, we may expect to see speech-recognition systems appear, within the next few years, which will respond to our talking to them in a completely natural way. When that comes about, we shall be a great deal nearer to the ideal, 'friendly' computer interface.

It is impossible to design a perfect preamplifier — one that will suit everyone's taste. But there's no harm in trying! For our XL system, we felt that the best was just good enough. We didn't skimp on components, and we included almost every feature we could think of. At the same time, all the 'features' are optional: if you don't want them, leave them out! Furthermore, anyone who feels the urge to re-design some section or other should welcome the modular concept that is used throughout.

Prelude

(Part 1)

the
preamplifier
of the Elektor
XL system

Our basic concept for the XL system was to achieve the highest possible quality for home construction, without expensive test equipment. With respect to quality, it should be noted that most of the modules in the XL system contain considerably more components than is usually the case in projects for home construction. The Prelude is no exception. However, one should not be discouraged by the large number of components; construction is facilitated by a detailed description and modular design. Furthermore, the circuit is designed so that Prelude can be configured according to one's personal desires. Any sections considered to be superfluous can be omitted.

Since the Prelude preamplifier is a fairly involved project for home construction, we have had to subdivide the entire description into several chapters. In this issue we will begin with the description of the entire circuit using a block diagram, with the power supply, the connecting board and the headphone amplifier. The latter will be assigned an article of its own, because it is also very suitable for applications in or with other preamplifiers.

The modules

It is logical to begin with a description of the entire circuit of the Prelude and its operations in general. Clearly, the most important task for a preamplifier is to provide sufficient signal amplification without distortion. Furthermore, the user must have the facility to select various signal sources and match their levels. This particularly applies to pick-ups. In the hi-fi world in recent years there has been a growing trend to omit everything that is not absolutely necessary. The argument is that unnecessary equipment can only contribute to distortion and/or noise. Without challenging this statement, it is nevertheless true to say that there are also hi-fi enthusiasts who expect their preamplifiers to be suitable for various tape units, to provide wide tone adjustments, and so on. There are no objections to this approach, as long as the quality is not impaired and all "extras" in the signal path can be bypassed. This is the case with the Prelude. It will meet practically all requirements. In constructing this preamplifier, modules that are considered to be necessary can be incorporated

Figure 1. The block diagram of the Prelude preamplifier shows the operational blocks of the completed unit. The "bare minimum" is the MM preamplifier, high-level ("line") amplifier and the power supply.

1

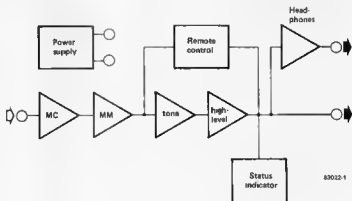

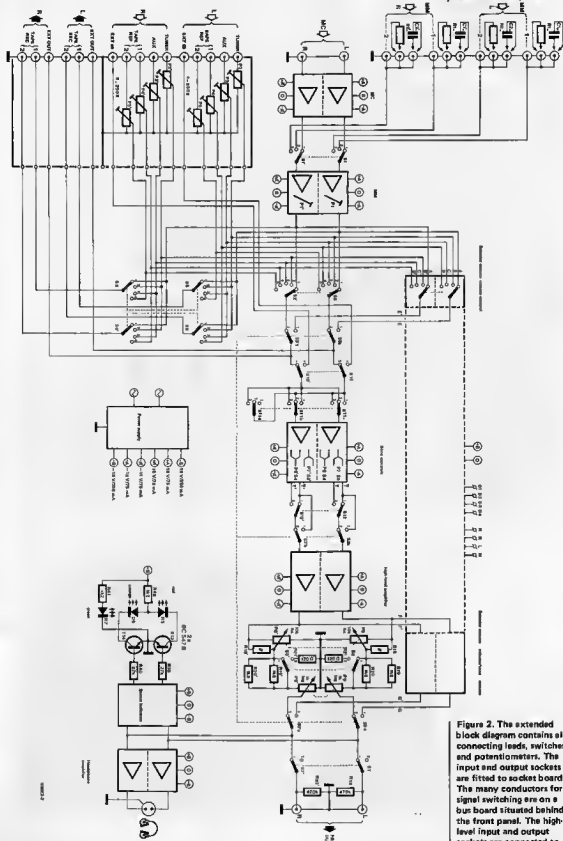

Figure 2. The extended block diagram contains all connecting leads, switches and potentiometers. The input and output sockets are fitted to socket boards. The many conductors for signal switching are on a bus board situated behind the front panel. The high-level input and output sockets are connected to the bus board by means of a special connecting board.

and the others can be omitted. It is therefore just as possible to construct a basic preamplifier. In its fully expanded version, Prelude is even equipped with remote control. It should be noted, however, that in this case the term hi-fi can only be applied with reservations. This is the price that must be paid, even today, for operating convenience.

Figure 1 is a greatly simplified block diagram of the entire Prelude. The diagram clearly shows which blocks are essential for signal processing and which ones can be considered as "extras". In general, the circuit is based on a tone control facility and a high-level "line" amplifier, supplemented by an MM end/or MC amplifier, as required. Of course, the tone control circuit can also be omitted. The remote control facility, status indicator and headphone amplifier do not affect signal processing and can be added if desired. The power supply is of course essential.

Power supply. The power supply for the Prelude must provide the operating voltages for the different stages of the circuit; these must be stable, free from noise and ripple and must be symmetrical.

MC preamplifier. This type of amplifier is required if the record player pick-up is of the moving coil type. An MC pick-up only provides a very low voltage (approximately 100...200 μ V). The MC preamplifier amplifies this signal to the level required by the MM (moving magnet) amplifier which follows. This is a symmetrical amplifier with outstanding audio characteristics and low noise. Its amplification can be matched to appropriate pick-ups.

MM (or MD) preamplifier. This amplifier is required for MM and for MC pick-ups (see above). The necessary RIAA equalisation is obtained with an active filter for the low frequencies and a passive version for

the high frequencies. This circuit principle offers some advantages in comparison with conventional MM preamplifiers, and it is often used in top quality equipment.

Tone control facility. This has an adequate but not excessive range of adjustment with selectable cutoff frequencies for treble and bass, providing a wide range of possibilities of affecting the tone. This entire block can be bypassed if desired.

High-level (line) amplifier. This amplifier has the task of providing linear amplification. It contains the balance and volume controls.

Headphone amplifier. This is a must for intensive and private listening pleasure. The unit delivers adequate power for headphones with an impedance of 8...600 Ω . It is also a true class A amplifier.

Status indicator. This circuit provides a visual indication of the signal levels at the outputs of the preamplifier. Three LEDs are used to indicate the ON-condition of the Prelude, presence of an output signal and overdriving of the power amplifier (or if a preselected level is exceeded).

Remote control. This is an extra for hi-fi buffs who appreciate such convenience and enjoy operating their equipment from the comfort of an armchair. This is, of course, a cordless remote-control circuit and is accommodated in a handy control box. The receiver is situated in the preamplifier housing, where it executes the control and switching functions. The remote control circuit can be used to control volume, balance, treble and bass, and to select one out of four input signals. It is also possible to switch other equipment on and off. If the remote control facility is switched off, the full quality of the preamplifier is once again available.

The description has only covered the most significant points. Further details can be

Figure 3. The complete Prelude. The bus board accommodates all switches and potentiometers and, in conjunction with the front panel, forms a kind of basic board. The individual modules (amplifiers, connections, power supply, status indicator) are mounted on the bus board at a right angle and electrically connected to it using short lengths of wire.

3

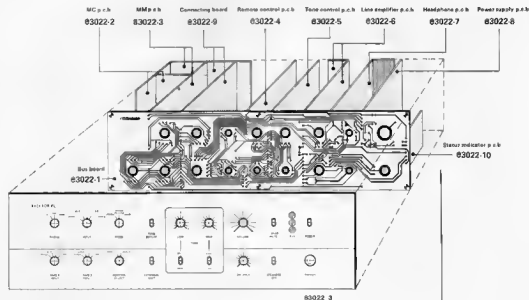

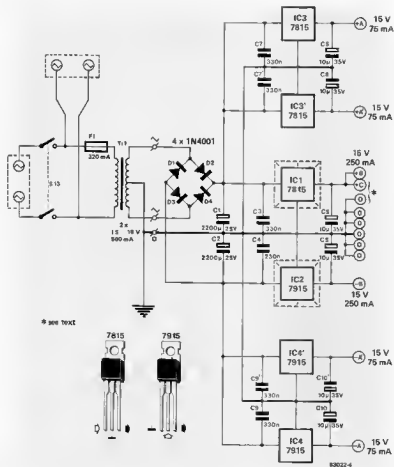
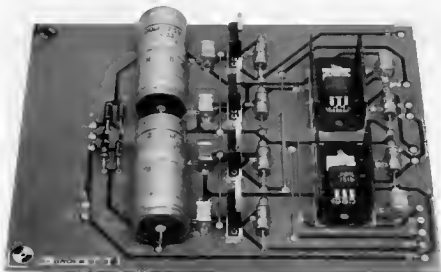

Figure 4. The power supply circuit of the Prelude. In order to provide the greatest possible rejection of crosstalk between the left and right channels, each channel is provided with its own power supply. There is also a "power" circuit for the headphone amplifier, status indicator and remote control.



The advantage of IC voltage regulators is obvious: how else could you mount three complete symmetrical power supplies on a single p.c. board? Note the small heatsinks for IC1 and IC2.

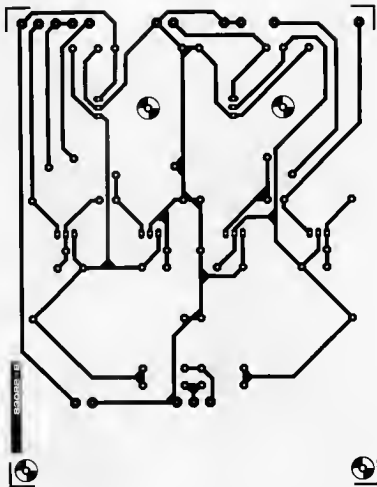

Figure 5. Track pattern and component layout for the power supply printed circuit board. IC1 and IC2 are fitted with small heat sinks. Outputs A and B should be connected to the corresponding terminals on the bus board.

found in the construction information. We would like to point out that all the amplifiers (MM, tone, line and headphone) are of the discrete operational amplifier type. This is a high-quality circuit principle which is particularly reliable for home construction.

Since the entire circuit diagram of the Prelude would fill three or four pages of the magazine, we are providing a more convenient compromise in figure 2. The blocks from figure 1 were incorporated in this diagram. The many switches and connecting leads are particularly noticeable, and we shall refer to these again in the construction details for the Prelude. First, however, here are some comments on this extended block diagram.

Connected in parallel with the MM input sockets are other sockets which are intended to accept "adapter plugs". These plugs contain a resistor or a capacitor which, when combined with the impedance of the pick-up, form a suitable input impedance for the MM preamplifier. Switch S1 is used to select MC, MM1 or MM2. Since the signals applied to this switch are of a very low level, it is situated in the

immediate vicinity of the input sockets on the rear panel of the preamplifier housing. The MM preamplifier is followed by the input-signal selector switch S2. A preset potentiometer is connected in series with each input, allowing the levels of the various signal sources to be adjusted to each other at this point. Two outputs are provided for tape recordings: TAPE REC 1 and TAPE REC 2. The various signal sources can be switched independently to each of these two outputs, by means of S8 and S9. S3 switches the remote control on and off. S10 serves for "patching in" an external device, such as an equaliser. S11 is for selecting mono or stereo. The "tone adjustment" hlock can be switched off with S12. The volume control P9 and balance control P8 are located after the high-level amplifier. Also situated at this point is switch S6 for attenuation of the output signal by 20 dB (MUTE). S7 allows the output signal to be disconnected from the power amplifier, to allow listening with headphones only.

The circuit in practice
Point-to-point wiring in a preamplifier

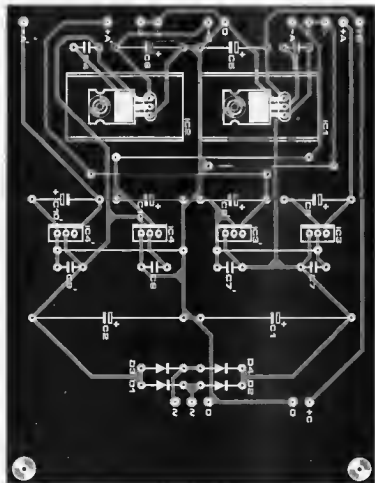

**Parts list
 for figure 5**

Capacitors:
 C1,C2 = 2200 μ /25 V
 C3,C4,C7,C7',
 C9,C9' = 330 n
 C5,C6,C8,C8',
 C10,C10' = 10 μ /35 V

Semiconductors:
 D1 ... D4 = 1N4001
 IC1,JC3,JC3' = 7815
 IC2,IC4,IC4' = 7915

Miscellaneous:
 Tr1 = mains transformer
 2x15 ... 18 V/0,5 A sec.
 2 heatsinks for
 IC1 and IC2 (SK 13)
 S13 = double-pole
 mains switch

containing this number of switches and potentiometers would tend to encourage faulty connections. For this reason we have developed a bus board whose tracks represent almost all the connecting leads shown in figure 2. This bus board also serves as a mounting board for all the switches and potentiometers. The preamplifier is constructed in modular fashion. This means that each block in figure 2 is constructed on a separate printed circuit board. The different modules are connected with the bus board.

Figure 3 clearly shows the assembly of the different printed circuit boards for the Prelude. A special connecting board provides the connections between the input sockets at the rear and the bus board behind the front panel. As with the connecting board, some of the module boards are fitted with smaller boards to accept the corresponding sockets. As can be seen, every effort has been made to reduce the amount of wiring.

This modular design makes it possible, for example, to omit the MC board, the remote control board, the headphone board or the status indicator board. In this case, it is

6

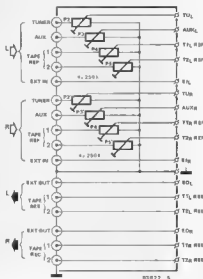

Figure 6. The "circuit" of the connecting board merely consists of 8 preset potentiometers and 16 input and output sockets. The leads are wired from the bus board behind the front panel to the sockets at the rear.

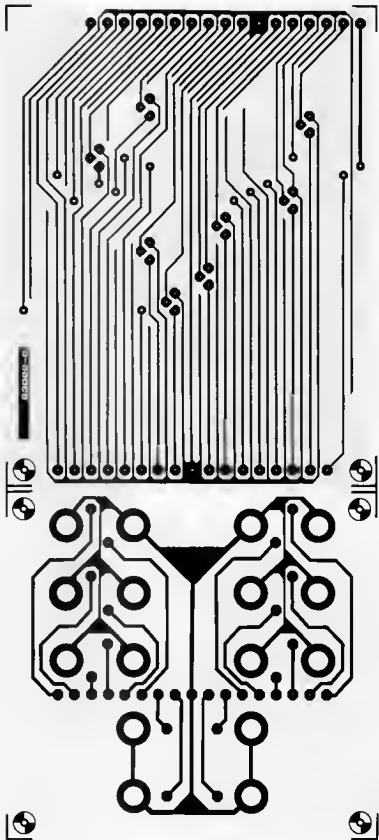
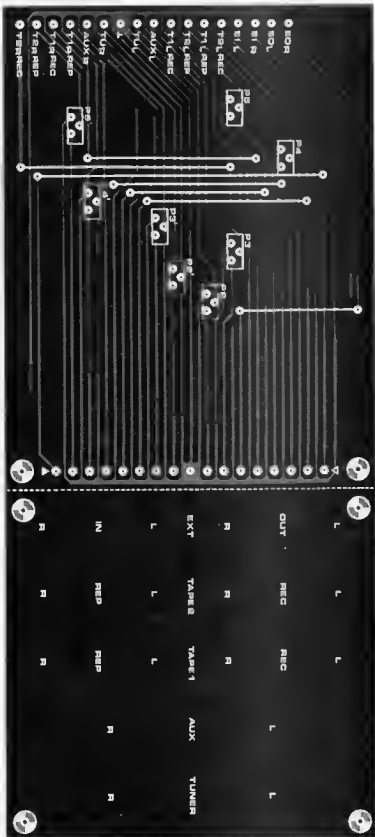

Figure 7. Track pattern and component layout of the connecting board. This consists of two parts which must be separated: the socket board and the actual connecting board with the preset potentiometers. Interconnect the terminals with the same designations.



Note that it is advisable to use vertical mounting preset potentiometers.

Parts list
 for figure 7

Resistors
 P2 . . . P5, P2' . . . P5' =
 220 k preset
 potentiometer

Miscellaneous:
 16 Cinch sockets with
 screw mounting (metal)

One good photo explains more than a thousand words, when it comes to such a complicated mechanical construction as this connecting board!

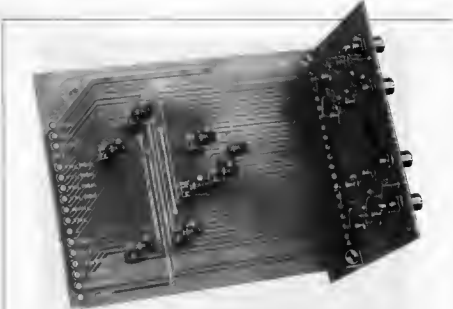

merely necessary to insert a few wire links into the bus board.
Figure 3 also shows that a total of 10 boards are needed for the full circuitry. This is a fairly involved project and the description has therefore been distributed over several articles in Elektor. This month we will be dealing with the power supply, the connecting board and headphone board. This article contains the descriptions and track patterns for the power supply and connecting boards. The headphone amplifier will be covered by a separate article.

Power supply

Figure 4 shows the circuit diagram of the power supply. Six integrated voltage regulators ensure stability of the d.c. voltages required. In fact only two voltages are needed: +15 V and -15 V. It is good design practice, however, to separate light loads from heavy loads. For this reason, the headphone amplifier, remote control and status indicator are powered by IC1 and IC2. These lines are marked +B and -B. Since the headphone amplifier draws considerable current in class A operation, IC1 and IC2 must be fitted with heatsinks.

All stages involved in signal processing (MC, MM, tone and line) have two separate stabilising circuits, one for the left channel and one for the right channel. IC3 and IC4 supply the symmetrical operating voltage for the left channel and IC3' and IC4' are assigned to the right channel. Capacitors are wired in the vicinity of the regulator ICs to suppress possible interference at that stage. The other components, mains switch S13, mains transformer, bridge rectifier and electrolytic capacitors C1 and C2 require no special commentary.

The circuit is constructed on the board shown in figure 5. IC1 and IC2 are fitted with heatsinks. Once the circuit has been constructed and inspected, the power supply can be tested. Connect the transformer and measure the voltages at points +A, +A', +B (these are +15 V) and -A, -A', -B (these are -15 V), against ground. Perform a load

test using 68 Ω /5 W resistors for + and - B and 220 Ω /1 W resistors for $\pm A$ and $\pm A'$. This printed circuit board can now be put to one side and components can be fitted to the connecting board.

Connecting board

The connecting board contains all paths between the bus board and the inputs and recording outputs. Also fitted to this board are the preset potentiometers (except for those for MM). Figure 6 shows the "circuit" of the connecting board: it consists of a number of tracks and a few preset potentiometers. Of course, these preset potentiometers can be replaced by wire links or a potential divider consisting of two resistors. The advantage is a reduction in noise.

The printed circuit board in figure 7 consists of two parts: the actual connecting board and a board to which the sockets are fitted. It must be separated into these two parts, and the 16 sockets and 8 preset potentiometers must then be installed. Once the phono sockets have been fitted to the socket board, the solder lugs can be connected to the corresponding terminals on the board with short lengths of wire. The preset potentiometers must be of the vertical type. Once the completed board has been installed in a housing, they must be accessible from above or below to allow adjustments to be made. When purchasing them, therefore, one should ensure that the preset potentiometers can be adjusted from both sides. Incidentally, they should be positioned in such a way that the signal level increases when the wiper is rotated anti-clockwise, viewed from above. The terminals of the socket board and of the actual connecting board are connected according to the proper designations, using short lengths of wire.

There is not much that can be tested here; a visual inspection should be sufficient. Finally, the finished construction can be put to one side and we can turn our attention to the headphone amplifier, described elsewhere in this issue.

Next month:

- bus board
- front panel
- line amplifier
- signal indicator

Recently, the growth in the number of video hobbyists has kept pace with that of computer 'freaks'. For this reason, we would like to devote more articles to the field of video in future. The colour modulator presented here will also be of interest to computer fans; it is driven from the RGB output of a personal computer, thus enabling the domestic TV set to reproduce the pictures and 'home-composed' audio.

VAM —
video/audio modulator
elektor february 1983

VAM- video/audio modulator

colour
pictures and
sound from
your personal
computer

First of all, let us answer the question: What is a video modulator? This could be described as a kind of miniature TV transmitter which processes a video signal in such a way that it is suitable for application to the aerial input of a conventional TV set. It is an essential element in a TV games computer, for example, or a test pattern generator. It is also required by a Videotext decoder or TV terminal for a personal computer. Several video modulators have already been published in Elektor. However, the last design dates back to the October 1978 issue and is not suitable for colour applications. Moreover, it cannot be used for audio and the sound must be applied to a separate amplifier. This means that the sound section of the TV set remains silent, which is a pity. It is not an elegant solution from the technical point of view.

These various factors prompted the design of a new circuit which is suitable for modulating both video and sound. The circuit is of such universal design that it can be used for a wide number of applications.

Design

The intention is for the user of the VAM to be able to convert the RGB signal generated by this bobby computer, test pattern generator or other source into a video signal of his choice. This was a basic requirement of the VAM in the development stage. The circuit was to be equipped with digital R(ed), G(reen), B(lue) inputs, a separate audio input, and a video output. After some reflection, the 'Teletext Decoder published in the November 1981 issue was

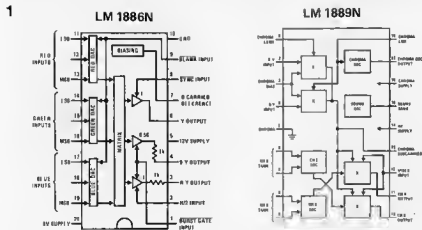

Figure 1. The two most important components for the VAM miniature colour TV transmitter: LM 1886N (video matrix and O/A converter) and LM 1889N (video modulator).

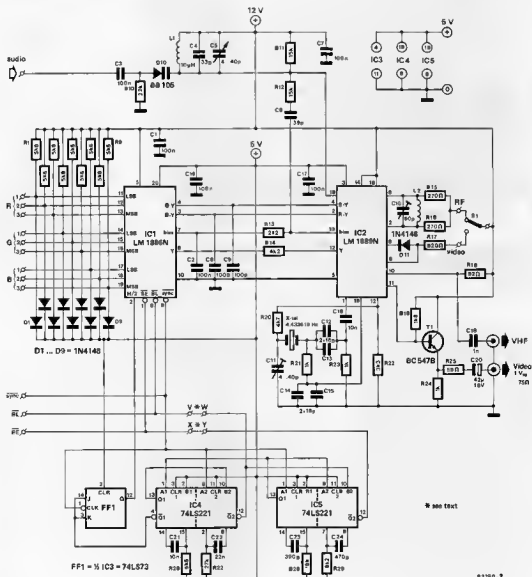

Figure 2. Circuit of the VAM — video/audio modulator. RGB end audio signals in, VHF or video signal out.

chosen as a suitable basis for our design. After minor modifications and a somewhat different arrangement, we achieved our objective — the VAM.

The circuit chiefly consists of two special ICs whose internal block diagram is shown in figure 1. The LM1889N is the heart of the circuit. This IC contains a complete colour modulator which is capable of 'composing' a colour video signal from a brightness (luminance) signal Y (at pin 13) and the R-Y and B-Y signals. The LM1889N also contains an oscillator for generating the sound carrier. This sound carrier is mixed with the video signal via pin 12.

The LM1886N integrated circuit serves as a converter. In addition to a matrix for generating the Y, R-Y and B-Y signals required by the LM1889N, this IC has inputs for colour modulation according to the PAL system. Three digital inputs are provided per colour (Red, Green and Blue), corresponding to 9-bit colour data; this is adequate for all possible applications.

The circuit

Figure 2 shows the combination of the two ICs into a 'miniature colour-TV power encoder'.

The different inputs can be seen on the left of the figure. The most important ones are the 9 RGB inputs, sync input and audio input. The VHF and video outputs are on the right of the figure. They can be optionally selected by means of S1. The LM 1886 N and LM 1889 N are designated here as IC1 and IC2 respectively and interconnected via lines B-Y, R-Y, bias and Y. ICs 3, 4 and 5 are needed to be able to obtain the burst-anable (burst) and H/2 (for the PAL switch) signals required for generating a PAL video signal. Additionally, a blanking pulse (BL) is generated with these ICs; this suppresses the picture information during vertical synchronisation.

However, the pulse is only required when no external BL signal is available. We shall examine this in more detail later.

The audio modulator in the upper part of figure 2 is a simple circuit. A resonant circuit (L1, C4, C5) at the intercarrier frequency (6 MHz) is frequency modulated by means of varicap diode D10. The audio signal serves as modulation signal. Since the circuit mentioned is a part of the oscillator contained in IC2, the sound is also modulated in this way. Input sensitivity of the audio modulator is approximately 1 V_{rms}.

We shall now consider the signals in more detail.

RGB

Three inputs are provided for each of the red, green and blue signals. Eight levels can therefore be realised per colour, resulting in a total of $2^3 = 512$ different colour shades. The coding for the most common colours is listed in table 1.

For simple applications the three R, G and B inputs can be interconnected, so that only one input is available per colour. One pull-up resistor (R1, R4, R7) and one limiting diode (D1, D4, D7) is utilised per group of three in this case. The selection is thus restricted to six colours plus black and white. This may not appear to be much, but it is satisfactory in most cases, e.g. for microcomputers with digital RGB outputs.

Such microcomputers often supply an NTSC colour signal which is of little use in the UK and continental Europe. However, the VAM can be directly utilised as an 'adapter' between these computers and the

aerial or video input of a PAL colour television set. In these cases problems are sometimes encountered with the vertical synchronisation (60 Hz for NTSC). In general, however, the TV set can easily be readjusted.

One more comment: if the RGB inputs are driven by TTL, the pull-up resistors and limiting diodes can be omitted.

Sync

The sync signal must be applied to the circuit without fail. For this reason it is also provided by every video signal source. Pulses (logic zero) which can be directly used as a sync signal are those with a width of about 4 μ s and a repetition frequency of 15625 Hz (64 μ s). Additionally, the pulse train must contain an interval of approximately 500 μ s (7.5 x 64 μ s, to be precise) every 20 ms for purposes of vertical synchronisation. During the interval, the synchronisation signals deliver a substitute signal which is inverted with respect to the original sync signal and which has twice the frequency. This doubled frequency is used in the VAM to suppress the burst pulse. We shall examine the BE (burst enable) signal later. Incidentally, a combined (horizontal plus vertical) sync signal is not always available. In this case the horizontal (HS) and vertical (VS) components must be combined into a sync signal. Figure 3 shows a simple circuit: an AND gate (3a) or two tri-state buffers (3b) form the desired sync signal from the HS and VS.

BL = blanking

The BL signal is not absolutely necessary. Its purpose is to suppress the input signals at the RGB inputs. In most cases this suppression already takes place in the computer or test pattern generator, thus making an external blanking signal superfluous. If necessary, the VAM can provide an external although 'primitive' rasterblanking signal. This will be discussed in the description of the BE signal.

When applying a BL signal, care should be taken to ensure that it is active during the logic zero periods.

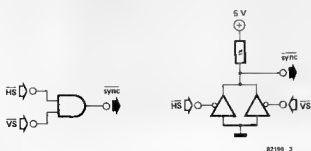

Figure 3. If only a horizontal and a vertical sync signal are available, the two can be combined in this way.

BE = burst enable

The sync signal is immediately followed by a short pulse (approximately 9 periods), to synchronise the TV set with the colour demodulator. The task of the BE signal is to establish the instant at which this pulse is emitted. To prevent the TV set from 'flipping out' during the raster-sync (vertical-sync) pulses, the BE signal is suppressed during this period.

On the one hand, the PAL flip-flop IC3 is prevented from reacting to the double sync-frequency by means of IC4 (Q1 - see figure 2); FF1 continues to follow the same rate. On the other hand, a blanking signal of approximately 600 μ s in duration is

generated as soon as IC4 signals this double frequency (when a new sync pulse appears within 40 μ s). This signal can serve for raster blanking via wire link V-W, instead of an external BL signal. However, this blanking signal is mainly required to suppress the BE pulse.

Here are two more points. Firstly, it should be noted that when the VAM is used as a monochrome modulator the oscillator connected to pins 1, 17 and 18 of IC2 becomes superfluous. In this case the BE signal is not required either, because it is normally employed to modulate the phase of this oscillator together with the RGB signals (converted to R-Y and B-Y). The second

VAM -
video/audio modulator
efaktor february 1983

Parts list

Resistors:

R1...R9 = 6k Ω
R10 = 22 k
R11, R12 = 15 k
R13 = 2k2
R14, R20 = 4k7
R15, R16 = 270 Ω
R17 = 820 Ω
R18 = 82 Ω
R19 = 1k8
R21, R23, R24 = 1 k
R22 = 3k3
R25 = 68 Ω
R26 = 6k8
R27 = 27 k
R28 = 18 k
R29 = 8k2

Capacitors:

C1...C3, C7, C17, C19 =
100 n
C4 = 33 p
C5, C11 = 4...40 p
trimmer
C6 = 39 p
C8, C9 = 100 p
C10 = 10...60 p
trimmer
C12...C15 = 18 p
C16, C21 = 10 n
C18 = 1 n
C20 = 47 μ F/18 V
C22 = 27 n
C23 = 390 p
C24 = 470 p

Semiconductors:

D1...D9, D11 = 1N4148
D10 = 88 105 (varicap-
diode)
T1 = 8C 5478
IC1 = LM 1886 N (National
Semiconductor)
IC2 = LM 1889 N (National
Semiconductor)
IC3 = 74LS73
IC4, IC5 = 74LS221

Miscellaneous:

L1 = 10 μ H
L2 = 8 turns enamelled
copper (0.8 mm ϕ)
on 6 mm former
S1 = changeover switch
Xtal = 4,433619 MHz
crystal

4

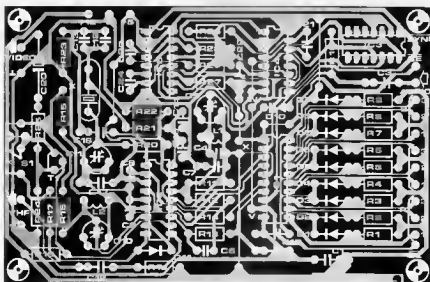
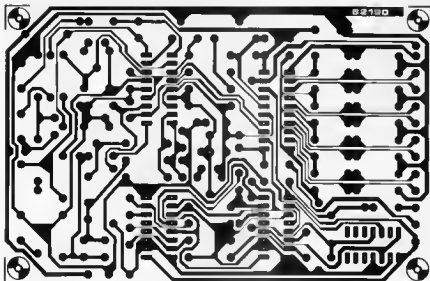

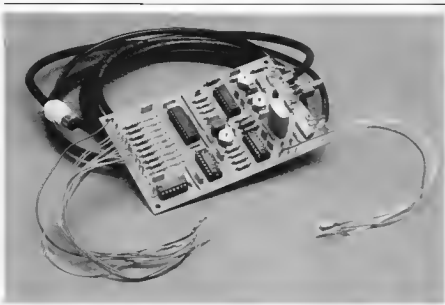

point, which may seem obvious, is that the BE signal can also be applied externally. In this case, X-Y remains open circuit.

Practice

Construction of the VAM should present no problems using the printed circuit board shown in figure 4. All inputs are arranged at one edge of the p.c.b. Located at the other edge are the VHF and video outputs and the terminals for switch S1, which is used to select one of the two outputs. The supply voltage terminals are at one of the longer edges of the p.c.b..

Two different supply voltages are required: +12 V and +5 V. The 12 V rail must be capable of supplying approximately 60 mA and the 5 V rail approximately 10 mA. Since no other special demands are made on the power supply for the VAM, it is possible to use the teletext power supply from the February 1982 issue, for example.

When fitting the components to the p.c.b. it should be noted that a total of six wire links must be installed. Two of these wire links are alternatives: if an external BE signal is applied, wire link V-W is omitted. If an external BE signal is applied, link X-Y is omitted.

Alignment

Alignment is fairly simple. It is merely necessary to adjust three trimmer capacitors: C5, C10 and C11. The oscillator circuit of the audio modulator is tuned to precisely 6 MHz by means of C5. This is easier than one might think. In practice the trimmer is set to minimum audible noise and maximum level.

C11 is used for fine adjustment of the colour carrier frequency. The range of adjustment is relatively narrow, because this is a crystal-controlled frequency. The colour TV set will display a good picture within a particular capacitance range of C11. The trimmer should therefore be set to the midpoint of this range.

		INPUT CODE					
		RED		GREEN		BLUE	
		M	L	M	L	M	L
	Colour	M	L	M	L	M	L
	Black	000	000	000	000	000	000
	Dark Grey	010	010	010	010	010	010
	Light Grey	101	101	101	101	101	101
	White	111	111	111	111	111	111
Primary	Red	111	000	000	000	000	000
	Green	000	000	111	000	000	000
	Blue	000	000	000	111	000	111
Complementary	Cyan	000	111	111	111	000	000
	Magenta	111	000	000	111	111	000
	Yellow	111	111	000	000	111	111
	Brown	011	011	000	000	000	000
	Orange	111	100	000	000	000	000
	Flesh tone	111	110	101	101	101	101
	Pink	111	110	110	110	110	110
	Sky Blue	101	101	101	111	111	111

This compact unit converts digital colour and tone signals into a clean 'composite video' signal. If desired, a UHF modulator can be added, so that the signal can be applied to an aerial input.

Table 1. Coding for the most common colours.

Last but not least, C10. The main purpose of this trimmer is to allow adjustment of the VHF output frequency. If switch S1 is set to the 'RF' position, the output signal can be tuned to VHF channels 2, 3 and 4. Fine adjustment can be made using the appropriate potentiometer in the TV set. Readers fortunate enough to have a TV set with a video input should connect it to the corresponding output of the VAM. Picture quality will probably be somewhat better. It is also possible to obtain video via a channel in the UHF band. This necessitates a modulator, however, to which the video signal of the VAM is then applied. A suitable modulator, for example, is the VHF/UHF modulator described in the October 1978 issue.

Every motorist is occasionally dazzled by oncoming vehicles that fail to dip their headlights, and the results can be dangerous. But the culprit has his problems too. If he suddenly dips his headlights he will see as little as the driver who is dazzled. It would be better if his eyes could adjust to the new situation more gradually. Even this problem has an electronic solution: dimming/dipping in stages with the main beam dimmer.

main beam dimmer

headlight
dimmer/dipper

How does this main beam dimmer operate? Figure 1 clarifies the situation. Until the instant of dipping (t_0) the full battery voltage is applied to the two headlight bulbs. When the dipswitch is actuated the bulb voltage drops by about 4 V, clearly indicating that the main beam has been removed. The bulb voltage then continues to drop, so that headlight brightness decreases. Finally, t_{max} is reached - the instant at which the main beam is fully switched off - and only the dipped headlights are active.

Circuit

Fortunately, the apparently complicated response illustrated in figure 1 can be duplicated with fairly simple electronics. Figure 2 shows the circuit of the main beam dimmer. This dimmer/dipper can be compared to a power supply with series-pass stabilisation. However, the 'regulation' between t_0 and t_{max} takes place considerably more slowly.

At time t_0 , the relay contact for the main beam is opened. At this instant, capacitor C1 is discharged. Thus the voltage across it is approximately 0 V. A low current flows via the emitter-base diodes of T2 and T3,

and via D3. Stage T1/T2/T3 performs like a zener powerdiode so that a voltage of about 4.2 V is present across the pass transistor T1. At this instant, therefore, the bulb voltage is approximately 9 V (at a battery voltage of 13.2 V).

On account of the relatively constant voltage over the emitter-base junctions of T2 and T3 and over zener diode D3, a constant charging current for electrolytic capacitor C1 now flows via P1. With P1 set to its midpoint the current is approximately 190 μ A. The voltage over C1 rises at a rate of 4 V/s. Once it reaches 7.5 V (voltage over the emitter-base junction of T4 and over zener diode D4), T4 conducts and capacitor C1 charges very rapidly up to the maximum voltage. The pass transistor then turns off completely so that the current for the main beam bulbs ceases to flow. A minimum voltage rise, i.e. a 'dimming time', of 2 V/s can be adjusted with P1.

Diodes D1 and D2 ensure that capacitors C1 and C2 can discharge immediately after the headlight flasher is actuated or the main beam is switched on, thus making the circuit operational again.

An important point to note is that on some

Figure 1. The response of the main beam dimmer is that of dimming/dipping in stages. Time $t_0 \dots t_{max}$ can be varied. At t_0 , the dip switch is operated. The dipped headlights come on immediately, at full brightness, and the main beam is dimmed quite noticeably. Then the main beam is dimmed down further, during a set period, after which it is cut off entirely.

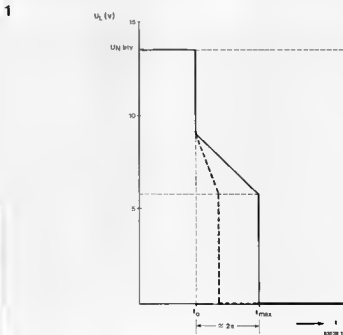

cars the ignition lock is also the main switch, as shown in figure 2. When the ignition is switched off there is no voltage at point A. If the engine is started, then of course the effect shown in figure 1 is encountered. But we just have to live with this situation! The current flowing at this instant could result in a much more unpleasant effect. In laboratory trials the 2N3055 survived all attempts to destroy it. However, those readers with any doubts should substitute a 2N3771 or 2N3772 for the 2N3055.

Construction and installation

Construction is made simple by the printed circuit board of figure 3. Transistor T1 is fitted to the p.c.b. together with the finger-type heatsink. Use serrated washers between the nuts and the copper surface to ensure good electrical contact.

The two leads are made from vehicle-type wiring and appropriate lugs or spade terminals are fitted to their ends. The other two ends are soldered directly to the p.c.b.. Grommets are fitted to the through-holes for the two leads and it may be necessary to seal them. The assembly is then installed in a case (whether waterproof or not will depend on the mounting location) and fitted at a suitable point - preferably near the fusebox.

The relay contact for the main beam switch now be located and the two leads A and B connected according to figure 2 (do not reverse them!). The main beam dimmer can be disabled with switch S1.

All that remains is a functional check. The unit should operate in accordance with figure 1. A functional check using the headlight flasher should also be made.

2

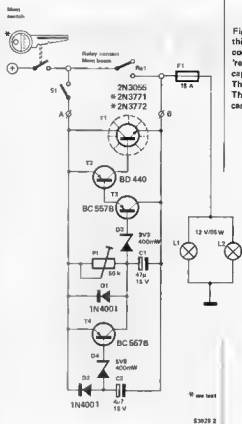

main beam dimmer
elektor february 1983

Figure 2. The circuit for this complicated response consists of a series-pass 'regulator' (T1) and two capacitor charging circuits. The result? See figure 1. The main beam dimmer can be disabled with S1.

3

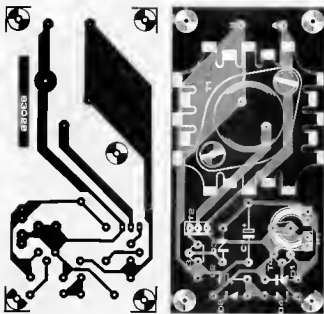

Figure 3. Track pattern and component layout of the printed circuit board for the main beam dimmer. T1 is fitted with a finger-type heatsink.

Parts list

Resistor:
P1 = 50 k preset

Capacitors:
C1 = 47 μ F/16 V
C2 = 4 μ F/16 V

Semiconductors:
D1, D2 = 1N4001
D3 = zener diode
3V3/0.4 W
D4 = zener diode
6V8/0.4 W
T1 = 2N3055
T2 = BD 440
T3, T4 = BC 557B

Miscellaneous:
Finger-type heatsink for T1
45 mm x 45 mm x 25 mm
(e.g. FK 201)

Prelude: class A headphone amplifier

One of the easiest ways to achieve privacy from everyone around you is to listen to music through a pair of headphones. There are cheaper methods such as 'yoga', but the latter cannot be termed as easy. Obviously the first criterion to satisfy is to have a good quality pair of headphones. There are many on the market which deliver the same standard of reproduction as the top quality expensive speakers without the same price label. Even so, unless they are used with a 'high-end' type headphone amplifier the whole exercise would be futile. In keeping with the XL audio system this article introduces such an amplifier, which delivers in class A a useful 160 mW per channel into 8Ω . It can be used separately, or with any other control amplifier even though it was originally intended as an integral part of the XL Prelude.

mini-power
amplifier
for private
listening

In the normal course of events there are two practical ways of driving a pair of headphones. The first is to use resistors positioned at the output of the power amplifier. This procedure was described in the 'accessories for the Crescendo power amplifier' article in last month's issue. The main disadvantages are that it may be physically inconvenient, depending on the positioning of the power amplifier itself and because of the use of resistors the damping factor is low resulting in poor bass response.

The second is to construct a totally separate amplifier. This is by far the best solution and because only a small output power is required, excellent quality can be achieved with a class A type amplifier. The normal problems of heat dissipation (as with large class A amplifiers) are

not encountered, simply because of the low output power. Apart from the overall quality of the resulting reproduction a class A type has the unrivaled advantage of not having any crossover distortion what so ever!

The headphone amplifier introduced here was originally designed for the 'Prelude' pre-amplifier, so the printed circuit board is fully compatible with the rest of the 'Prelude' end XL system. However as it is self contained it can be used independently, only needing a separate power supply ($\pm 15 \text{ V}/250 \text{ mA}$), or with any other control amplifier.

The circuit

Figure 1 shows the circuit diagram of the stereo version. The first thing to strike the eye is the fact that there are quite a few transistors used throughout. Unfortunately it is unavoidable, especially when considering the high standard aimed at.

It is rather pointless to describe both channels as one is identical to the other, so we will restrict ourselves to the left side. All the components belonging to the right channel are denoted with a single inverted comma (R').

Op-amp configurations and techniques are applied using discrete components. This ensures a good and stable operation, with simple construction. As a matter of interest the same techniques are implemented in every part of the Prelude.

Preset P1 acts as a preset volume control for the channel (P2 for the right one). In effect it means that the balance is adjusted using these two potentiometers. The input signal reaches the base of transistor T3 via capacitor C1. T3 together with T4 form a differential amplifier. The direct current flowing through this stage is supplied by a current source constructed around T5.



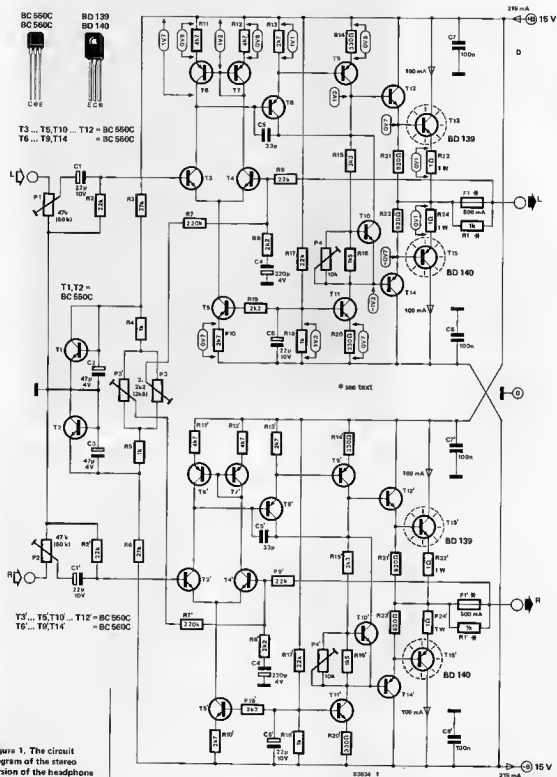

Figure 1. The circuit diagram of the stereo version of the headphone amplifier. The important aspect is the fact that it uses two class A output stages.

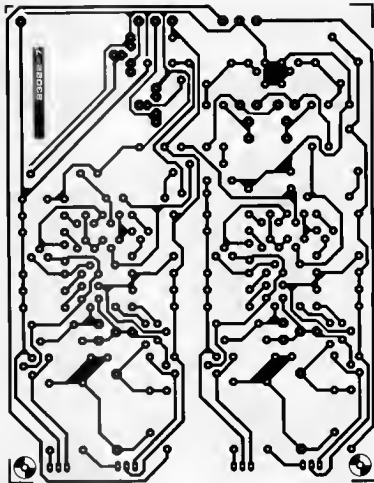

Figure 2. The printed circuit board for the amplifier. No provision has been made for mounting the power supply.

The collectors of T3 and T4 feed into a current mirror composed of T6 and T7. Any mismatch existing between T6 and T7 is compensated for by the resistors R11 and R12.

Anyone wishing to know more about current mirrors should consult the April 1982 issue of Elektor which dealt, in depth, with the theory and application.

A current mirror does exactly what its name suggests, in that the current on one side is reflected by the other. Under quiescent conditions, the current flowing through T6 is equal to the current through T7. Should the current drawn by T7 drop, then T6 will automatically draw the same current as T7. The use of a current mirror in this way results in a differential amplifier which exhibits better characteristics, such as: linearity, gain, output swing and so on. The signal present at the collector of T3 is now greatly amplified by the darlington configuration T8 and T9. In the collector line of this pair is another current source T11. The high gain of T8 and T9 is because of the high collector impedance achieved with the help of the current source. The output stage consists of the drivers T12/T14 and the power transistors T13/T15. The quiescent current is determined by T10. Basically P4 sets the collector/emitter voltage of T10 which in turn determines the voltage

level across the base of T12 and T14. The quiescent current level is purposely set high (100 mA) so that the amplifier operates in class A until the output power exceeds 160 mW (into 8 Ω). The amount of feedback is controlled by R8 and R9. It may seem strange that R9 is positioned after the fuse, but, rest assured that this is a good way of getting rid of any bad characteristics of the fuse. Method in our madness, so to speak! To ensure the feedback loop is not broken should the fuse blow a 1 k resistor (R1) is placed in parallel with the fuse. The d.c. offset is looked after by T1 and T2 (used as diodes). They make sure the voltage across the capacitors C2/C3 and the series resistors R4, P3', P3 and R5 is always ± 0.6 V.

With the aid of P3 the d.c. voltage at the output is set to 0 V. In practice this is accomplished by supplying T4 with more or less base current. Bear in mind any substantial d.c. voltage present at the output is likely to destroy the headphones. At the very least, it is liable to give rise to noticeable distortion.

Any symmetrical power supply can be used providing it delivers a minimum of 250 mA at ± 15 V. It should be short circuit protected to ensure a maximum current consumption of 1 A. The best solution is to

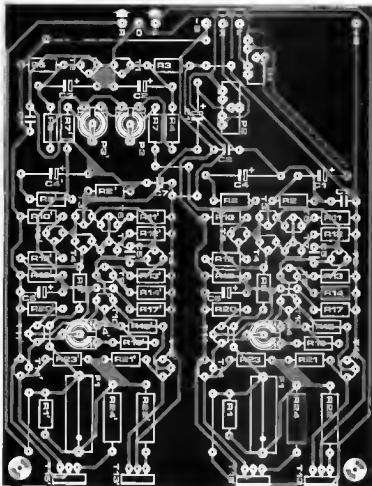

Prelude class A headphone amplifier
 elektor february 1983

Parts list

Resistors:

- R1, R1', R4, R5, R18, R18' = 1 k
 - R2, R2', R9, R9', R17, R17' = 22 k
 - R3, R6 = 27 k
 - R7, R7' = 220 k
 - R8, R8', R19, R19' = 2k2
 - R10, R10', R13, R13' = 2k7
 - R11, R11', R12, R12' = 4k7
 - R14, R14', R20, R20' = 330 Ω
 - R15, R15' = 3k3
 - R16, R16' = 1k5
 - R21, R21', R23, R23' = 820 Ω
 - R22, R22', R24, R24' = 1 Ω /1 W
 - P1, P2 = 50 k (47 k)
- vertical preset
 P3, P3' = 2k5 (2k2) preset
 P4, P4' = 10 k preset

Capacitors:

- C1, C1', C6, C6' = 22 μ /10 V
- C2, C3 = 47 μ /4 V
- C4, C4' = 220 μ /4 V
- C5, C5' = 33 p
- C7, C7', C8, C8' = 100 n

Semiconductors:

- T1 ... T5, T3', T4', T5', T10, T10', T11, T11', T12, T12' = BC 550C
- T6 ... T9, T6' ... T9', T14, T14' = BC 560C

Miscellaneous:

- F1, F1' = 500 mA, fuses with board mounting holders
- Heatinks for T1 ... T4

use one of the modern voltage regulators, which are easily available.

Construction

The printed circuit board is illustrated in figure 2. We strongly suggest the use of top quality components, especially when considering the semiconductors. The better the parts the better the final result. Resistors R1, R1' and fuses F1, F1' are for current level protection (protecting equipment connected to the output). They do not protect the actual amplifier in any way, as the fuses react too slowly. They can be removed if desired and wire links put in their place.

The output transistors T13, T15, T13' and T15' need cooling. Separate heat sinks can be mounted, or one large one for all four. Keep in mind in the latter case each transistor has to be electrically isolated from the others. Obviously the rear of a suitable case can come in handy for this purpose, especially if building the complete Prelude. These constructional aspects have been taken into account for the overall design of the Prelude pre-amplifier.

We must re-emphasise the power supply must be stabilised, short-circuit proof, and current limited to a maximum of 1 A. The Prelude power supply as described in the pre-amplifier article elsewhere in this issue

conforms to these parameters. The 7815 or 7915 voltage regulators were found to be ideal when constructing a completely separate supply.

Calibration

Start with the wipers of P3' and P3 in the mid position, and P4', P4 fully to the left (anticlockwise). Now set a multimeter to the 500 mV d.c. range and connect it to the emitters of T13 and T15. Turn P4 clockwise until you have a reading of 200 mV. Give the circuit time to 'settle' as the output transistors take a little time to warm-up, and repeat the procedure until a stable 200 mV reading is achieved. The same procedure is required for the other channel.

The meter should now be set to the lowest possible d.c. voltage range. Connect it to the output, and adjust P3 until the meter registers a 0 V reading. Once again repeat for the other channel.

Points to consider

By now you will have noticed the large number of transistors used especially of the BC550C variety. Taking this into consideration, it must be possible to find matched pairs for T3, T4, T3' and T4', thereby improving the already fine specifications of this amplifier. (In fact, if an ideal match is

Specifications

Output power in class A:
 160 mW into 8 Ω
 600 mW into 30 Ω
 120 mW into 600 Ω
 Harmonic distortion:
 0.01% at a nominal
 20 ... 20 000 Hz
 Frequency response:
 6 Hz ... 100 kHz \pm 0 dB
 Signal-to noise ratio:
 better than 90 dB
 (1 mW into 8 Ω)
 Damping factor:
 > 80 (20 ... 20 000 Hz
 into 8 Ω)
 Input sensitivity:
 8 mV for 1 mW into 8 Ω

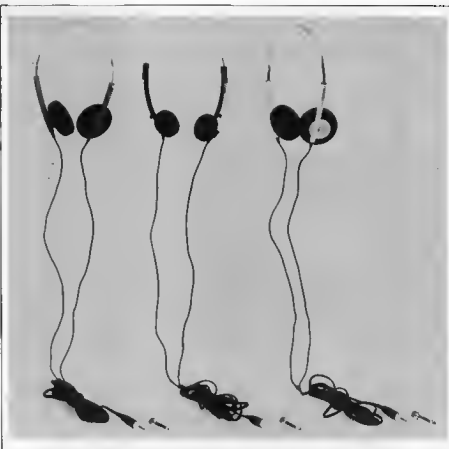

3

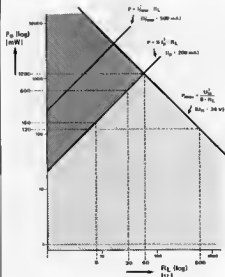

found, it will be possible to omit the complete d.c. compensation stage: T1, T2, C2, C3, R3 ... R7, R7!). The easiest method to adopt is to mount transistor sockets for T3 and T4 and just find the right ones by a process of elimination.

At the beginning of the article we mentioned the amplifier operates in class A only until a certain output power level is reached. In practice this point really depends on the impedance of the headphones used. The prototype was tested with quite a few different versions and it was found that nearly any headphone set can be used without exceeding the class A limits.

Figure 3 shows the output power relative to the headphone impedance and further more the limits between class A and B operation. The normal limits are set to 160 mW into 8 Ω and 120 mW into 600 Ω . With a low impedance such as 8 Ω more power is available but obviously only by going into a class B operation. The efficiency of headphone drivers is such (90 to 110 dB for 1 mW input), it is unlikely that you will ever enter the class B range.

However, should you really want it, figure 3 illustrates that even more power is available. If the fuses are replaced by wire links, nearly 10 W can be delivered into 8 Ω !

Figure 3. The diagram shows the limits between class A and class B operation, relative to the headphone impedance.

soft start for
high-current
equipment

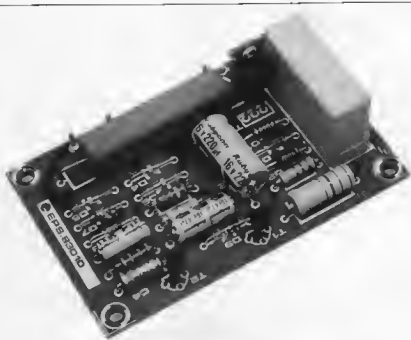

fuse protector

Where circuit breakers are utilised in place of mains fuses, it is quite common for a variety of electrical apparatus, such as amplifiers, halogen movie lights, power saws, etc., to cause the circuit breakers to trip when the apparatus is switched on. Even fuses have been known to blow unexpectedly. The fuse protector is situated electrically between the circuit breaker and the load, acting as an intermediate stage.

The rating of the new power amplifier is '350 VA max.'.

Thus the maximum power consumption of the amplifier is 350 watts. Since the circuit breaker is rated at 16 A, why does it trip each time the amplifier is switched on?

The paradox seems to contradict Ohm's Law; when connected to the 220 V mains, our amplifier with its 350 watt rating should not draw more than 1.6 A – a tenth of the value required to trip the circuit breaker. Something is wrong: is it our arithmetic, the circuit breaker or the ratings indicated on the amplifier?

Initial current surge

Incandescent bulbs have a so-called cold resistance. This means that the filament material exhibits a positive temperature characteristic. The resistance of a bulb filament at room temperature is only a fraction of that at its operating temperature, about one seventh of the normal resistance. Clearly, it only takes a 500 W lamp to trip the circuit breaker.

The problem is also associated with a particular type of electric motor which is used

in domestic apparatus and power tools. This is the series motor, in which the field and armature windings are wired in series. When this motor is switched on (or if it is stalled whilst running) it draws far more current than under normal loading. Adequate self-induction for a sufficiently high impedance is only encountered at sufficient speed. For this reason, circuit breakers will only allow motors rated at less than 1 kVA to be switched on.

The mains transformer in the example of our power amplifier presents something more of a puzzle. Not only does the power formula no longer seem to apply ($P/V = I$) but the characteristics of a coil and a capacitor appear to have swapped places.

Transformer behaviour

When a mains transformer is switched on, the mains voltage is applied to the primary winding. The latter usually exhibits considerable inductance, and one would think that this would be sufficient to prevent an initial current surge.

H. Dominik

That would be quite true if one were only dealing with an ideal coil. However, the primary winding of a transformer has characteristics that are far from ideal: it has an iron core; and a small one at that! Furthermore, the electrolytics in the power supply are discharged.

This means that a mains transformer should not be switched on at the instant of zero crossing of the mains voltage, but should be switched on at a voltage maximum.

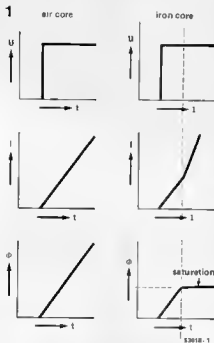

Figure 1. Current and magnetic field when a voltage is applied, showing comparison between air-core coil and coil with iron core. Both coils have the same inductance and the same ohmic resistance. In the case of the coil with an iron core, a steep rise in current is apparent after core saturation.



Figure 2. Mains voltage and current of a transformer when switched on at a voltage maximum.



Figure 3. Mains voltage and current of a transformer when switched on at the instant of zero crossing. Once the magnetic field has reached the saturation limit of the core, a current peak is produced.

Figure 2 shows the situation when a transformer is switched on at a voltage maximum. It can be seen that the voltage is only present in one direction for 5 ms. Only during this time can the magnetic field build up in the primary winding; it therefore does not become great enough for the core to be saturated. In subsequent periods in which the voltage is present in one direction for 10 ms, a magnetic field is induced which opposes this voltage and which must first decay. The core therefore cannot reach saturation. The magnetic field and the current lag the voltage nicely by 90°.

Figure 3 illustrates the situation when the transformer is switched on at the instant of zero crossing. In this case a voltage (a positive voltage in figure 3) is present at the primary winding for twice the duration, i.e. 10 ms. But when it is switched on, the transformer has not yet built up a magnetic field which must first decay.

The result is inevitable: the magnetic field created becomes even greater, until the iron core is finally saturated. Since the saturated core can no longer contribute to the inductance of the primary winding, the voltage applied is only opposed by the impedance consisting of the ohmic resistance of the winding and its inductance as a air coil. Since this impedance is very low compared to that with the unsaturated iron core, the result is the current peak shown in figure 3. This current peak can reach values of more than 10-times the value of the normal peak current.

Let us return to our claim that the core of a mains transformer is too small. Of course, this statement only applies to the instant of switching on. If each transformer were dimensioned to prevent initial current surges, the core would have to be more than 50% bigger. The transformer would then be correspondingly heavier and more expensive; this would not be in anyone's interest.

At any rate, one thing is sure: the initial current surge does not harm the transformer. The ideal methods of overcoming these problems are; for the lamps to be switched on at the zero crossing point of the mains supply, transformers at the maximum voltage point, and for motors to be manually rotated before switching on.

With the 'fuse protector' circuit an electronic solution is found. The circuit conducts the mains to the load via a series resistor. The series resistor limits any initial current surges to values that are harmless to the circuit breaker and the circuit.

After the first two seconds, lamps have warmed up sufficiently, motors have developed enough speed and transformers have developed an adequate 'opposing magnetic field' so that the circuit breaker is unaffected when the full mains voltage is applied.

The circuit

As already mentioned, the circuit is connected between the mains and the load. It draws its current via capacitor C3 and limiting resistor R4. The continuous current flowing is 22.5 mA. However, the load is almost

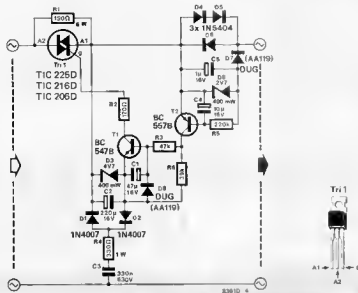

fuse protector
elektor february 1983

Figure 4. The complete circuit diagram of the Fuse Protector.

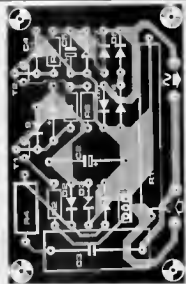
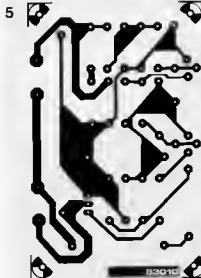

Figure 5. Track pattern and component overlay of the printed circuit board for the Fuse Protector. Input end output are at the same edge of the p.c.b. and must not be inter-changed!

Partelist

Resistors:

R1 = 150 Ω/9 W
R2 = 120 Ω
R3 = 47 k
R4 = 330 Ω/1 W
R5 = 220 k
R6 = 39 k

Capacitors

C1 = 47 μ/16 V
C2 = 220 μ/16 V
C3 = 330 n/630 V
C4 = 10 μ/16 V
C5 = 1 μ/16 V

Semiconductors.

D1, D2 = 1N4001 ..
.. 1N4007
D3 = 4V7/400 mW zener diode
D4 .. D6 = 1N5401 ..
.. 1N5407
D7 = DUG (AA 119, see text)
D8 = 2V7/0.4 W zener diode
T1 = BC 547 B
T2 = BC 557 B
Tri 1 = TIC 206D (4 A),
TIC 216D (6 A),
TIC 225D (8 A)

Miscellaneous:

Plastic case
Power socket

purely capacitive, so that only about 170 mW are accountable on the electricity bill! From this current flow, D1, D2, D3 and C2 produce a stabilised supply voltage of 4.7 V.

If no apparatus is switched on, there is no voltage drop across diodes D4... D6. The result is: T2 is turned off, T1 is turned off and Tri1 is not provided with triggering current and is therefore also turned off. When the apparatus is switched on, its starting current flows via R1 which limits it, thus preventing the type of surge discussed.

Simultaneously, however, this current flow results in a voltage across D4... D6 which is rectified by D7 (germanium) and smoothed by C5. T2 then begins to conduct after a delay caused by R5 and C4. The result is that T1 is activated after a delay brought about by C1 and R3 and the triac is finally triggered. After these delays, the mains voltage is fully applied to the apparatus.

Application, installation, modification

The fuse protector can be simply utilised as an outboard unit. There is no need to modify the apparatus in question. It is practical to install the printed circuit board with its components and a power socket in a well insulated housing, which can then be employed as a universal soft-start unit.

The connected load must not exceed 660 VA. This somewhat restrictive limit is governed by the ratings of diodes D4... D6. Diodes with higher ratings can be utilised but are not always easy to procure. A connected load of 1.3 kVA, for example, requires 6 A diodes and a type 216 TICD triac (with heatsink).

When using triacs other than the ones specified, their triggering characteristics must be taken into account; an equivalent triac must trigger reliably at 10 mA.

The modem described here is a circuit that is designed to send and receive digital information via the normal telephone lines. It enables the interconnection of two computers (or a terminal and a computer) even though they are physically separated by a large distance. The circuit provides a minimum data transfer rate of 600 Baud. The modem is compatible with an RS 232 interface and is acoustically coupled with the telephone receiver handset. A safety circuit is also incorporated to prevent the modem from switching to transmit during data reception.

acoustic telephone modem

data transfer
via telephone
lines

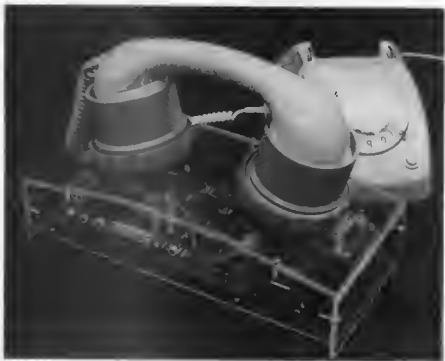

J.J.M. Habets and
C.A. Truijens

The term 'modem' is a contraction of the two words modulator and demodulator. At one end of the data transmission line (for us that usually means a telephone line) the digital information is transmitted in a modulated form and then demodulated at the other end to restore the original data.

The principle is illustrated in figure 1. Two matched modems are required to make a single data transmission line, one for each telephone. Each modem is able to transmit and receive (but not at the same time we hope!). If one modem is in the transmit mode, the modem at the other end of the line must obviously be switched to receive. The only existing limitation is that data traffic is possible in only one direction at a time.

Since it is not possible to connect any circuit directly to the telephone lines (a prospect that makes British Telecom go

weak at the knees), we must resort to an acoustic coupler. This is not the awful disadvantage that may at first be presumed. The connection to the computer, or any peripheral, is by means of an RS 232 interface.

The modulation method used with the modem is that of frequency shift keying (FSK). This means that the digital information is translated into frequencies for transmission. In this case, frequencies of 1200 and 2200 Hz have been chosen - a logic '1' being represented by 1200 Hz and a logic '0' by 2200 Hz. FSK is ideal for this application since it is simple and relatively free from interference.

Modem basics

The principle of the circuit of the modem is illustrated in the block diagram of figure 2.



Figure 1. The use of a modem is illustrated in this drawing. Each modem can act as either a transmitter or as a receiver.

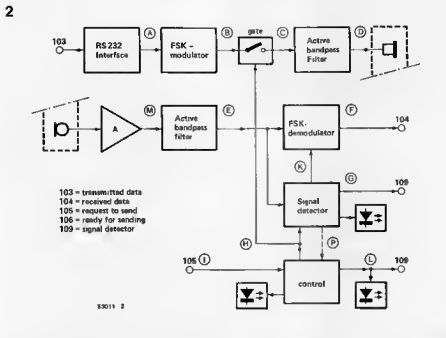

Figure 2. The separate stages of each modem are shown in this block diagram. The transmit section is at the top with the receive section in the centre and the control section at the bottom.

In the transmitting section the incoming digital data is passed via an RS 232 interface to the FSK modulator where the logic levels are converted into 1200 or 2200 Hz bursts. The output of the modulator is then fed via the gate to a bandpass filter that will pass the two FSK signals but will reject any higher harmonics. The acoustic coupling to the telephone handset for the transmit section is carried out by means of a small speaker, placed in close proximity to the microphone insert.

The acoustic coupling for the receive section of the modem is, as expected, a microphone placed over the earpiece of the handset. Again, a bandpass filter is employed to remove unwanted signals above the two FSK frequencies. The FSK demodulator then processes the information and restores the original data.

The two other blocks shown in the diagram, 'signal detector' and 'control', regulate the traffic flow in the modem. If a 'request to send' is made by the equipment connected to the modem, the control stage ensures that the signal detector has released the transmitter. If such is the case then, after a brief interval, the gate is activated enabling the output of the modem receive section. At the same time it gives a 'ready for sending' signal to the connected equipment so that transmission of the data can commence.

The signal detector checks to see if data is being received. As long as one of the two

FSK signals is detected on the line the control block is prevented from switching in the modulator circuit. This effectively prevents transmission by the modem while data is being received.

The modem circuit diagram

The layout of the circuit diagram of the modem shown in figure 3 closely follows that of the block diagram. The upper section is the modulator, the centre section the demodulator while the signal detector and the control sections are to be found to the right and the left respectively of the lower part of the diagram.

The transmitted data arrives at the upper left-hand corner of the drawing at terminal 103. This terminal numbering is related to CCITT recommendation V24. If S1 is in position Q-R, T-M the requirements of this recommendation and that of the virtually identical EIA RS 232 standards are met. The RS 232 interface consists of components T1, D1, R1 and R3. With an RS 232 interface a logic '0' is represented by a voltage level of between +5 and +15 V and a logic '1' by a level between -5 and -15 V. When a logic '1' present at terminal 103 transistor T1 will conduct to bring point A of the circuit down to about -10 V. With logic '0' at the input, point A will rise to 12 V. Diode D1 ensures that the base-emitter voltage of T1 does not exceed 0.6 V. With the levels thus

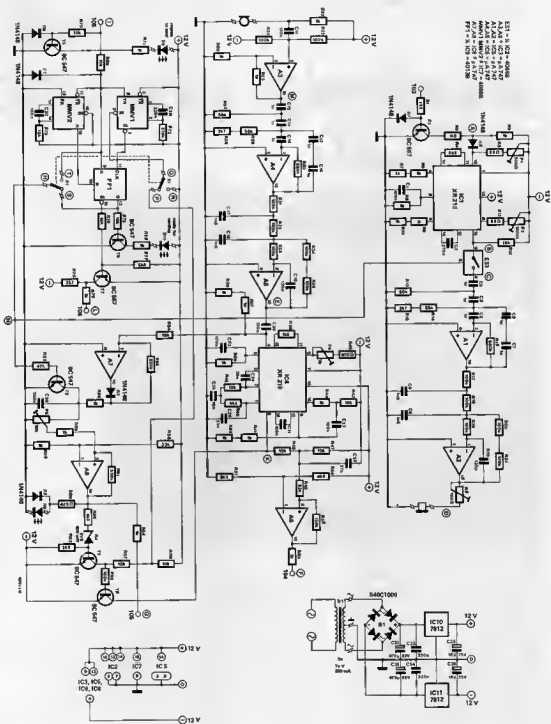

Figure 3. The layout of the circuit diagram here closely follows that of the block diagram in figure 2.

obtained at point A the FSK modulator — constructed with an XR 210 — can be driven. The IC is a phase-locked loop specifically designed for data communication applications, particularly FSK. Dimensioning of the components around the IC is such that a frequency of 2200 Hz is present on pin 15 with a voltage of -12 V on pin 10. With a voltage of -11 V or less (in this case about -10.5 V) on pin 10, pin 15 supplies a frequency of 1200 Hz. This means that the FSK modulator produces frequencies of 2200 Hz with a '0' and 1200 Hz with a '1' at input 103. The modulator is followed by the gate with which the connection between the modulator and the succeeding filter can be interrupted by the control section.

The active filter comprises a series circuit formed by third order high- and low-pass Butterworth filters. The crossover point of the high-pass filter is 1200 Hz and that of the low-pass filter 2200 Hz. The whole forms a bandpass filter accepting the two FSK frequencies only and attenuating the higher harmonics in the modulator output signal. The frequency characteristic of the bandpass filter is shown in figure 4. The output from the second filter section (A2) drives directly a small telephone receiver loudspeaker. The volume level can be adjusted within certain limits by P3.

The demodulator begins with a telephone receiver microphone capsule followed by the buffer/amplifier A3. Since the capsule contains a carbon microphone, it is connected to the positive supply voltage via resistor R22. A bandpass filter configured around A4 and A5 follows the amplifier, its function being to filter out interference caused by switching noise and cross-talk on the telephone line. The demodulator is also rendered less susceptible to environmental noises and vibrations caused by shocks on the modem housing. The filter construction is identical to that in the modulator part (around A1 and A2); the crossover points are also the same.

The FSK demodulator includes a second XR 210 (IC4); the demodulated signal is available on pin 8. R47, R48 and C27 again form a low-pass filter for this output, its purpose being to filter out small interfering impulses which may occur in the demodulator output signal. Finally, the Schmitt-trigger built up with A6 produces a well-defined digital signal with fast edges. The 'received data' can be fed to the connected computer or peripheral equipment via output 104. The output from A6 switches between + and -12 V so that RS 232 levels are directly available.

The signal detector comprises the section around A7, A8, T2, T3 and T4. The signal originating in the filter of the receiving stage is first limited while transistor T2 which follows switches off the limited signal when transmitting; in that case the detector is switched out. The limited signal passes via potentiometer P5 to a Schmitt-trigger with a switching hysteresis of about 150 mV (A8). The output from A8 supplies the detection signal (connection 109; data carrier detect) for the connected equipment (+12 V); A8 provides an RS 232-compatible



signal. If the circuit detects an incoming signal this is indicated by LED D6 (data carrier detect) lighting up. The signal detector can, by means of T3, short-circuit the demodulator output if transmitting. The control circuit (the section around MMV1, MMV2 and FF1) regulates the exchange of traffic. If the interconnected equipment wishes to transmit it will present a 'request to send' signal (+12 V) at input 105; transistor T5 then causes LED D9 to light. In the position of S1 shown in the drawing, MMV1 will be triggered by the leading edge of the signal at input 105 (provided the signal detector doesn't detect a received signal; in which case MMV1 is blocked by T3 and nothing happens further). Following the MMV time of 45 ms its Q output becomes '1' again. The logic level at the D input of FF1 (the +12 V present at input 105) is at that moment transferred to the Q output of the flip-flop (Q thus becomes 0), with the result that LED D10 lights up (ready for sending), ES1 is activated and the signal detector blocked via T2. Output 106 supplies a 'ready for sending' signal (+12 V) to the connected equipment. Transmission

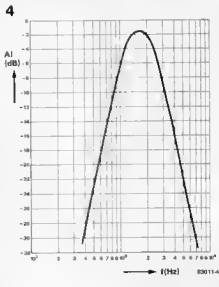

Figure 4. The frequency characteristics of the bandpass filters used in both the transmit and receive stages. The slopes are 18 dB/octave.

of the digital information can then commence. The computer or peripheral equipment must maintain the 'request to send' input at +12 V throughout the entire transmission period. After transmission, input 105 must be set at a voltage of between 0 to -12 V, with which MMV2 is triggered. This then resets FF1 so that the modulator is deactivated and the receiving section released by means of the signal detector. If S1 is set to the other position (through-connections Q-P and H-S) the modem satisfies the guidelines of CCITT recommendation V24. In that case the automatic blocking facility which inhibits switching to transmit while receiving, is out of action. If a 'request to send' is then presented, the modulator section is directly activated. Information transmission can actually begin when the connected equipment has received a 'ready for sending' signal from the modem. In other words after the 45 ms delay time produced by MMV1. During the 45 ms, echo's caused by a signal on the telephone line are given time to decay. Figure 5 is a timing diagram of the different signals from the control section, intended to clarify its functioning. When building the modem as described later, it is not essential to include switch S1. If the intention is to use the modem in one manner only, two links on the printed circuit board will suffice. Lastly, two integrated voltage regulators IC10 and IC11 stabilise the + and -12 V circuit voltage supplies.

Zero and One with RS 232/V24

In the course of this article we have mentioned that all the modem connections are V24/RS 232-compatible. Further explanation is necessary since the V24/RS 232/level interface definitions might appear somewhat confusing to someone not at home in this field.

A V24/RS 232 interface operates with positive and negative voltages, the negative voltage lying between -5 and -25 V and the positive between +5 and +25 V. The interface functions with negative logic, that is to say a binary '1' corresponds with a negative voltage and a '0' with a positive voltage. With a V24/RS 232 interface one talks actually about zeros and ones on the data lines (in the modem these are terminals 103 and 104). On the control lines one speaks of 'on' and 'out' states, where 'on' corresponds with a positive voltage and 'out' with a negative (or no) voltage. We know it sounds confusing, but this has been done to avoid faults. If namely an input control line is open or short-circuited, then it is interpreted as being 'out'. With data lines an open data input is interpreted as a line on which nothing has changed. In this way the whole is 'fail safe'.

The construction

The entire circuit can be assembled on the printed circuit board shown in figure 6. It will be apparent that, for a complete system, two printed circuit boards are necessary, one at each end of the telephone line. The completed circuit board is mounted, together

Table 1

To computer or terminal

pin	signal	pcb/CCITT
1	protective ground	
2	transmitted data	TMD 103
3	received data	RCD 104
4	request to send	RTS 105
5	ready for sending	RFS 106
6	data set ready	DSR 107
7	signal ground	gnd
8	data carrier detect	DCD 109
20	data terminal ready	DTR 108

acoustic telephone modem
elektor february 1983

Table 1. The wiring plan for the D connector.

Table 2

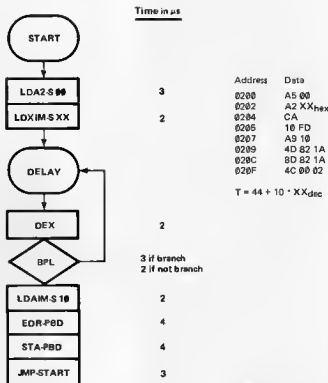

Table 2. This program enables the Junior Computer to be used when calibrating the modem.

with the transformer, in a case that is large enough to rest a telephone handset on. Performance of the system as a whole can depend to a large extent on the 'quality' of the audio coupling. For this reason it is important that the distance between the handset microphone and earpiece and the modem loudspeaker and microphone are kept as close together as possible. It is also necessary to keep out external noise as much as possible. One method would be to fit two short lengths of tubing (plastic drainpipe?) into the top of the case in such a way that the handset just fits in when it is laid on top of

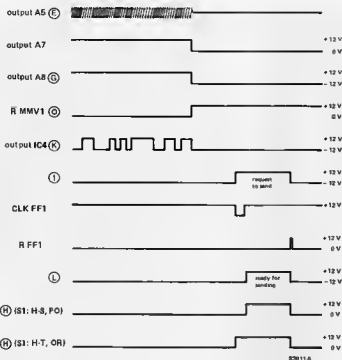

Figure 5. This waveform timing chart shows the different signals for the control section. The two waveforms for point H depend on the position of switch S1.

the case. The modem loudspeaker and microphone can then be mounted in the ends of the tubing. A ring of foam rubber (or draft excluder) glued around the lower end of the tube will complete the seal.

A surplus handset can supply the microphone and loudspeaker for the modem if this option is open. However, a higher quality microphone insert and loudspeaker would probably give better results. It is also possible to use a dynamic rather than a carbon microphone. In this case the amplification factor of A3 must be adjusted by increasing the value of resistor R25 to, for example, 100 k. Since a dynamic microphone does not need a dc voltage resistor R22 can be omitted.

LEDs D6, D9 and D10 are mounted on the front panel together with switch S1 and a 25 pole D connector for the V24/RS 232 interface. Table 1 shows the wiring for the D connector.

Calibration

For initial calibration, terminal 105 on the printed circuit board is connected to +12 V. This will activate the modulator and produce a tone from the loudspeaker. LEDs D9 and D10 should also light. Terminal 103 is then connected to -12 V and the modulator will now produce a frequency of 1200 Hz. The frequency on pin 15 of IC1 is aligned exactly to 1200 Hz by P2 with the aid of a frequency meter. Terminal 103 is then connected to +12 V and the frequency on pin 15 adjusted to 2200 Hz with P1. These adjustments must be repeated a few times until

the frequencies remain constant (due to the variation in temperature of the IC and the influence of P1 and P2. If a frequency meter is not available it is still possible to make accurate adjustments by using a computer. Almost every computer contains a crystal-controlled clock generator and since the number of clock periods needed by the CPU for carrying out a specific instruction is known, it is possible to write a short program to produce a square wave with an accurately defined frequency. Table 2 gives a suitable program for the Junior Computer. With the help of the formula the required periodic time is first calculated for the number XX_{dec} . The resulting number is then converted into a hexadecimal cipher XX_{hex} , this being assigned to address 0203 in the program. The registered number determines how often a program loop must be made. For frequencies of 1200 Hz XX_{hex} is \$4F\$, for 2200 Hz \$29 and for 1700 Hz (needed later) XX_{hex} is \$37. In order to obtain the 1700 Hz as accurate as possible, the first instruction (A5 00) is omitted. All other instructions are then moved up two address places. The program starts on address 0200. The square wave is available at point PB4 of the computer.

With the aid of the frequency produced by the computer and the small circuit of figure 7 the modulator can then be aligned without a frequency meter. Point 1 of the circuit is connected to the computer output that supplies the 'reference frequency' - PB4 with the Junior - and point 2 is connected to pin 15 of IC1. A telephone earpiece or small

Parts list

Resistors:

- R1, R73 = 15 k
- R2 = 1k8
- R3, R6 . . . , R10, R22, R25,
R26, R37 . . . , R39, R41,
R42, R44, R53, R56, R59,
R60, R64, R71, R74,
R79 = 1 k
- R4, R63 = 2k2
- R5, R11 = 22 Ω
- R12, R43 = 18 k
- R13, R14, R27, R28 = 56 k
- R15, R29, R78 = 2k7
- R16, R30 = 680 k
- R17 . . . , R21, R23, R24,
R31 . . . , R35,
R68 = 100 k
- R36 = 1k5
- R40 = 470 Ω
- R45, R47, R48, R54, R66,
R87, R69, R70, R75,
R76 = 10 k
- R46, R50, R62 = 4k7
- R49, R58 = 33 k
- R51 = 3k3
- R52 = 150 k
- R55, R61 = 330 k
- R57 = 47 k
- R85 = 820 Ω
- R72 = 270 k
- R77 = 5k6
- P1 P2 = 500 Ω 10 turns
potentiometer
- P3 = 100 Ω preset
potentiometer
- P4 = 1 k preset
potentiometer
- P5 = 10 k preset
potentiometer

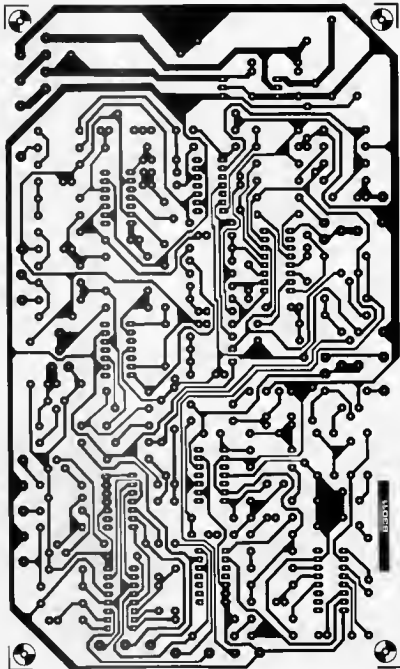

amplifier with loudspeaker is connected to the potentiometer wiper. Output 103 is now connected to -12 V, the 1200 Hz program started and we can listen to what the loudspeaker produces. Three different frequencies are audible: the 1200 Hz from the computer, the modulator frequency and the difference between these two frequencies. The 50 k potentiometer is adjusted so that the difference frequency can be heard as clearly as possible. P2 is then rotated until the volume of the difference frequency is as low as possible. The modulator frequency

is then virtually equal to the 'reference frequency'. The same procedure is then repeated with connection 103 at $+12$ V and the computer program for 2200 Hz; adjustment takes place with P1. Point 105 is then disconnected from $+12$ V. For adjusting the demodulator a frequency meter is connected to pin 15 of IC4; P4 is then turned so that the frequency at this point is exactly 1700 Hz. The computer can again be used here with the program for 1700 Hz (see table 2). This frequency again passes to point 1 of the auxiliary circuit and

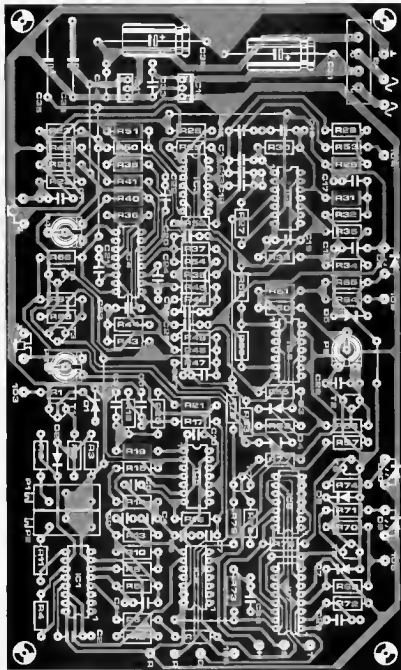

Capacitors:

- C1,C22 = 470 n MKT
- C2 = 270 n MKT
- C3 ... C7 = 1 n ceramic
- C8,C17 = 1n8 MKT
- C9,C18 = 1n5 MKT
- C10,C19 = 120 p ceramic
- C11,C23, C30 = 100 n MKT
- C12 ... C16 = 1 n MKT
- C20 = 120 n MKT
- C21 = 150 n MKT
- C24 = 39 n MKT
- C25 = 10 n MKT
- C26 = 22 n MKT
- C27 = 27 n MKT
- C28 = 220 n MKT
- C29,C33, C34 = 330 n MKT
- C31,C32 = 470 µ/25 V
- C35,C36 = 10 µ/25 V

Semiconductors:

- D1 ... D3,D5,D7, D8 = 1N4148
- D4 = zener 6V8/400 mW
- D6,D9,D10 = LED red
- T1,T7 = BC557
- T2 ... T6 = BC547
- IC1,IC4 = XR210
- IC2 = 40668
- IC3,IC5,IC8,IC9 = 747
- IC7 = 40988
- IC9 = 40138
- IC10 = 7812
- IC11 = 7912
- B1 = B40C1000

Miscellaneous:

- Tr1 = transformer
 2 x 15 V/250 mA
- 1 loudspeaker capsule
- 1 microphone capsule
 from telephone receiver

point 2 is connected to pin 15 of IC4. P4 is then aligned to a minimum difference frequency.

For adjusting the signal detector a tone must be supplied to the microphone. For this purpose another modem can be utilised whose loudspeaker is coupled to the microphone of the other modem. Terminal 105 of the 'transmitting' modem is connected to +12 V. If only one modem is available the loudspeaker can be temporarily removed from its normal position and rested on the microphone. Terminal 105 is then connected

to -12 V and IC2 temporarily removed from its base. Pins 8 and 9 in the vacant base are then bridged with a wire link. P5 must then be adjusted so that LED D6 lights when the spacing between the loudspeaker and the microphone is such that 1 V is measured across P5. If the loudspeaker is removed the LED must extinguish. The loudspeaker volume can be varied slightly with P6, however this adjustment is not critical. The alignment of P5 needs to be checked again in practice since incorrect adjustment of the signal detector can result in the transmit

section being released and the data output short circuited, while in reality data is being received.

The modem in use

This modem is primarily intended for communication between two personal computers so that programs can be exchanged by telephone. In that case the automatic blocking possibility is not absolutely necessary, so that the position of S1 is immaterial. This switch can thus be left out as we have already seen. For personal use not all the printed circuit board terminals are necessary. Terminals 103 (for transmission of data) and 104 (for data reception) are, in principle, sufficient. It is important moreover, that terminal 105 be used in the correct manner. If data is to be received a voltage of -12 V (or zero) must be at this point; for transmission pin 105 must be at a voltage of +12 V. If this is not the case the modem will not switch over from receive to transmit. It is possible to let the computer give these signals but it can, of course, be done manually by means of a switch, where terminal 105 can be connected to +12 V or -12 V according to choice.

On giving a 'request to send' signal it is necessary to reflect that terminal 106 will give a 'ready for sending' signal only after 45 ms; the computer can thus commence transmitting after the 45 ms. Furthermore it is necessary to ensure that nothing more is received (terminal 109 must be 'out') otherwise the demodulator will be switched off while data is still coming in.

The modem described here is intended for half duplex use so that signals can be received and sent, however not simultaneously. It is possible to adapt the modem for duplex use, simply by removing transistor T2. The frequencies must also then be chosen for duplex traffic. The relevant calculations are given at the end of the article. The minimum speed at which data can be sent and received is 600 Baud. Higher speeds are possible depending on adjustment accuracy, up to a maximum of 1200 Baud.

The quality of the telephone connection is very important. A reasonable 1200 Baud connection is possible for local use, although completely faultless transfer of large quantities of data can not be expected. On longer distance telephone connections or via small exchanges it is better to choose slower speeds. Interference on the telephone lines is prevented from reaching the demodulator by the filters as far as possible, but a noisy telephone line definitely produces faulty bits. Above all computers with a simple receiving routine will have this problem. The reliability increases as the Baud rate is lowered. A transmission speed of 600 Baud or less is thus preferable. Before transmitting data the telephone connection should be checked for sound quality. A weak connection or noise invariably entails breaking the connection and trying again. It is infinitely better to dial a few times more rather than have a data block full of faults; the latter certainly costs much more time!

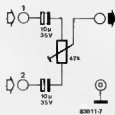

Figure 7. The small auxiliary circuit shown here is necessary only if the aid of a computer is enlisted for calibration purposes.

Modifications for alternative frequencies

For different applications it may be necessary to alter the FSK frequencies; this is quite possible by changing some of the component values. For the modulator (IC1) the following FSK frequencies are valid:

(e) for the lowest frequency:

$$f_l = \frac{220}{C2} \cdot \left(1 + \frac{0.1}{R11 + P2}\right)$$

(b) for the highest frequency:

$$f_h = f_l \cdot \left(1 + \frac{0.3}{R5 + P1}\right)$$

(c) The filters must also be modified:

$$R13 = R27 = \frac{0.06484}{f_l \cdot C}$$

$$(d) R14 + R15 = R28 + R29 = \frac{0.07547}{f_l \cdot C}$$

$$(e) R16 = R30 = \frac{0.8239}{f_l \cdot C}$$

$$(f) \text{ Where } C = C3 = C4 = C5 = C6 = C7 = C12 = C13 = C14 = C15 = C16.$$

$$(g) C8 = C17 = \frac{0.3908}{f_h \cdot R}$$

$$(h) C9 = C18 = \frac{0.3356}{f_h \cdot R}$$

$$(i) C10 = C19 = \frac{0.03073}{f_h \cdot R}$$

$$(j) \text{ Where } R = R17 = R18 = R19 = R20 = R21 = R31 = R32 = R33 = R34 = R35.$$

(k) With the demodulator the VCO of IC4 is adjusted such that the VCO on pin 15 supplies a frequency that lies between the FSK frequencies if the VCO is free-running (no input signal). This frequency is determined by the values of C21, R40 and P4:

$$f_{\text{middle}} = \frac{f_l + f_h}{2} = \frac{220}{C21} \cdot \left(1 + \frac{0.1}{R40 + P4}\right)$$

(l) In view of the fact that large tolerances occur with the PLL ICs it can happen that with a precalculated value a specific frequency cannot be set with the associated potentiometer. In such cases the values of the frequency determining capacitors (C2 with IC1 and C21 with IC4) must be modified.

more spots before the eyes

double dice



After the 'Talking Dice' published in the November issue it could be considered that we have just about gone as far as we can go with respect to electronic dice. But no, we now have the 'non-talking double dice' which, if nothing else, is self explanatory! It is not totally dumb however, the score is shown on an LED display as either a single or a double dice, that is, a maximum count of six or twelve. It can even show when a double has been thrown!

The Talking Dice published recently created quite a lot of interest and a great many readers suddenly found themselves 'into' electronic dice. Paradoxically however, the next request was for a 'silent' dice! The reasons for this are not entirely clear but anyway, here we go!

It was considered that the dice must be easy to read but the use of LEDs in the pattern of a dice was 'old hat'. This only leaves seven segment displays but that is not such a bad idea. The following points were also considered to be essential.

- The circuit must be able to operate as a single or a double dice.
- It should be easy to use and always accurate.
- The dice must of course be completely random and not prone to 'favourable' repeats.
- Indication of a double would be a distinct advantage.

1

	A	1	2	3	4	5	6
B	1	2	3	4	5	6	7
	2	3	4	5	6	7	8
	3	4	5	6	7	8	9
	4	5	6	7	8	9	10
	5	6	7	8	9	10	11
	6	7	8	9	10	11	12

83009 1

Figure 1. This table illustrates the total number of combinations possible with two dice.

2

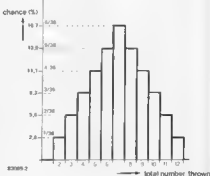

83009 2

Figure 2. A histogram of the probability factor in percentages of any combination actually occurring.

The possible number of 'thrown' combinations of two dice comes to a total of 36 as shown in figure 1. However, the possibility of some numbers occurring more frequently exists. For example, double 1 (snakes eyes to the poker players) is far more difficult to find than say, a seven. Double 1 will only occur as 1 + 1 whereas 7 can arrive as 1 + 6, 6 + 1, 2 + 5, 5 + 2, 3 + 4

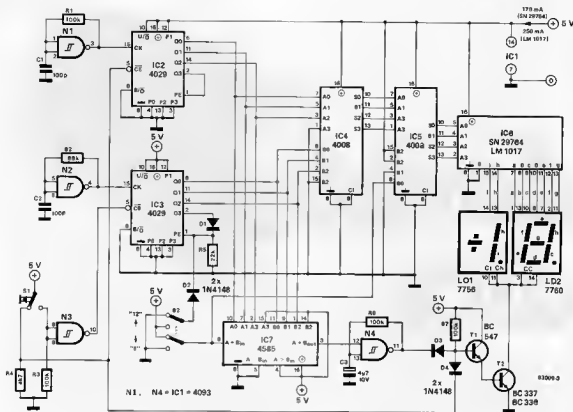

Figure 3. The complete circuit diagram of the double dice. The two part numbers for IC6 are explained in the text.

and 4 + 3. When the possibilities of 'random occurrences' is expressed as a percentage it will be found that double 1 is only a 2.8% probability against a 16.7% probability factor for number 7. This is illustrated in figure 2 (forgetting the higher orders of Murphy's Law).

On now to the circuit diagram which is shown in figure 3. The clock oscillator formed by gate N1 and the counter IC2 are the basis for dice 1 while dice 2 consists of oscillator N2 and its counter, IC3. Switch S1 triggers the counter or 'roll' the dice. The frequency of the clock generators is not at all critical apart from the fact that they must be different, guaranteed by the different values for R1 and R2. The actual frequency will be somewhere between 50 and 200 Hz. It would at first sight seem logical for the counters to count from 1 to 6 but they do in fact count from 2 to 7. This peculiarity makes things a little simpler and is accomplished by programming the P0...P3 inputs of the counters. In effect, when the count reaches 7 the Q3 output will go high and reset the counter. The P1 programming input is held at logic 1 while the others, P0, P2 and P3, are at logic 0 to result in a program code of 0010 which is BCD for 2 - but you already knew that! So, the counter counts between 2 and 7 but only when the CE (count enable) input is at logic 0, helped along by switch S1 and N3.

When counting, the outputs of the counters are as shown in figure 4. The top waveform (CK) is the output of the clock oscillator N1 or N2. During the time that S1 is operated the base of transistor T1 is held low causing the display to be switched off by T2. This effectively prevents any possibility of 'manipulating' the roll of the dice. So why is N3 there you may ask. A good question and it does have a purpose that is not immediately apparent. At the instant that the contact of S1 leaves its normally closed position counter IC2 will start to count. There then follows a finite time before counter IC3 gets under way due to the delay before the other contact is made in the switch and the propagation delay (the time taken for the output to react to the input) of gate N3. This ensures a completely 'cheat free' roll since not only do the two dice run at different frequencies but also start and stop at different times. Our learned reader will now confidently suggest that the same time delay will occur when the switch is released therefore cancelling the difference out! But it won't and we leave it to you to figure out why not. All very cunning really! A good point at which to move on to the other switch, S2, whose purpose, as suggested in the circuit diagram, differentiates between a one or two dice operation,

that is, a maximum count of six or twelve. The outputs of both counters is fed to IC4 which, since it is a 4 bit adder, logically (?) adds them together. The output of IC4 is still not ready to display yet because we arranged the counters to count between 2 and 7! It seemed like a good idea at the time but it would not be Monopoly to have a set of dice (even if they were electronic) that came up with numbers like 13 and 14. Very trendy but we have to do something about it. In fact, it's IC5 that does something about it. The outputs of IC4 are fed to the A inputs of IC5 which then carries out some rather quick calculations with the 12 (1100) or 13 (1101) programmed on the B inputs and comes up with the answers shown in tables 1 and 2. This explains the link between switch S2 and the B0 input of IC5, it selects either 1100 or 1101. We are still not entirely out of the wood because, as the tables show, IC6 must still add 1 to the output of IC5 before the correct number can be displayed. However, it does get there in the end!

IC7 rejoices in the grand title of 4 bit magnitude comparator but it could almost be called a 'double detector' since that is its function in life in this circuit. It simply looks at the two sets of inputs, A0...A3 and B0...B3, and produces an output when they are equal. This is called A = B output, of course, and when it goes high the oscillator formed by N4, R6 and C3 will

4

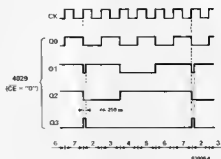

double dice
elektor february 1983

Figure 4. The waveforms for the Q outputs of the 4049 counters. The top pulse 1µsec (CK) is the output of the clock oscillators, N1 or N2.

Table 1

single dice

number thrown	output IC2	output IC3	output IC4	output IC5 (+12)	display
1	2	2	4	0	1
2	3	2	5	1	2
3	4	2	6	2	3
4	5	2	7	3	4
5	6	2	8	4	5
6	7	2	9	5	6

5

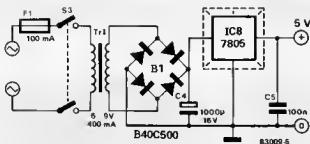

Figure 5. The power supply shown here will be more than adequate for the double dice. Remember to provide the regulator with a heatsink.

switch the display on and off with a little help from transistors T1 and T2. A flashing display therefore signifies that a double has been thrown. All very swish but it would be most unseemly if it were to happen when only one dice is thrown. The paradox is prevented by switch S2 which takes the A = B input low when in the single dice, or '6' position. This effectively puts a black hood over IC7 and prevents it from 'seeing double'!

The power supply for the circuit consists of the usual 7805 regulator, probably the most useful IC ever invented. Only one other item worthy of note is left. The SN 29764 is pin compatible with the LM 1017, the only difference being current consumption. This is 170 mA for the former and 250 mA for the latter. It might be advisable to look for the SN 29764 since it is a little easier to find — especially from Anglia Components. ■

Table 2

double dice

number thrown	output IC4	output IC5 (+13)	display
2	4	1	2
3	5	2	3
4	6	3	4
5	7	4	5
6	8	5	6
7	9	6	7
8	10	7	8
9	11	8	9
10	12	9	10
11	13	10	11
12	14	11	12

Last month's article concerning digital audio dealt with signal sources such as the compact disc. With the advent of digital pre-amp and control-amp IC's, the next stage can aptly be renamed the 'digital audio processor'. From this statement it is clear that 'Hi-Fi' systems of the future will look more like micro-computers and rather than discuss gain and feedback we will talk about time, software and so on.

Astonishingly, digital audio IC's were originally developed for television. ITT was the first company to manufacture these, introducing their digital T.V. chassis concept called 'Digit 2000'. The AF section including the power amplifier is digitised. In fact the complete audio processing stage including the stereo decoder (for stereo T.V. sound) consists of two chips! The digital to analogue converter is the MAA 2300 and the signal processor the MAA 2400. The main thought in mind which prompted the research was to bring down the production costs, with the obvious price advantages to the consumer. Using the chips already developed for the compact disc would not have helped as they were very expensive, and anyway the production cost priorities are not the same as in the 'Hi-Fi' field. Or at least the thinking is relatively

different. These two new chips are extremely versatile and can be used in many aspects of the audio field. They can be termed as the first born in the new family of digital audio processors.

Figure 1 shows the block diagram of the MAA 2300. The two analogue input signals are not digitised here by a 'real' binary encoding A/D converter, but by 1-bit quantizers in sigma-delta modulators (pulse density modulators). These emit a 1-bit data stream with a maximum rate of 4 MHz (4 Mbit/s); the digital filter which follows turns them into data words of 16 bits in length and a rate of 35 kHz. This method has already been well-proven with analogue-to-digital converters for the telecommunication's field (coders for the digital telephone). Steep-slope filters at the input (to limit the signal bandwidth) can be

digital audio
in the T.V. set

chips for digital audio

part II

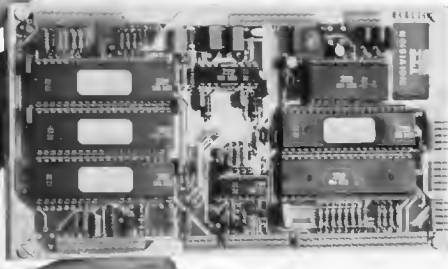
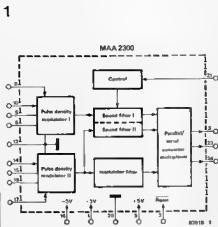

Figure 1. Block diagram of the MAA 2300 audio A/D converter from Intermetal. It is designed for converting two audio channels and delivers serial 16-bit data words at its output, with a word rate of 35 kHz per channel. The signal-to-noise ratio is comparable to that of a conventional 13-bit A/D converter.



2

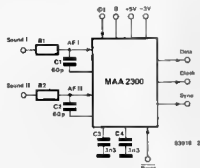

Figure 2. Application circuit of the MAA 2300. Input filters are not usually required on account of the high sampling rate of the pulse density modulators.

3

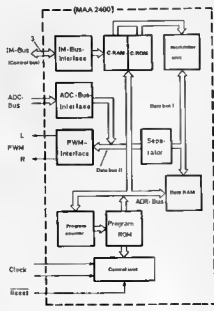

Figure 3. Block diagram of the MAA 2400 digital two-channel audio processor. The hardware structure is reminiscent of that of single-chip micro-computers.

dispensed with, thanks to the very high sampling rate of the sigma-delta modulators. The signal-to-noise ratio achieved by this analogue-to-digital converter approximately corresponds to that of a conventional 13-bit A/D converter.

The MAA 2300 also contains digital identifier filters which filter out the amplitude-modulated identifier from the sound signal of channel II. In the case of the stereo TV sound method introduced by a TV network in West Germany, these identifier signals are inaudibly superposed on the channel II sound signal and indicate whether the station being received is transmitting mono, stereo or two-channel sound. The identifier signal is also reduced digitally to a low bit rate.

Three signals are present at the output of the A/D converter: the data which are transmitted serially and which cyclically contain sound I (16 bits), sound II (16 bits) and identifier (10 + 1 bit), the 4 MHz clock signal and a 32 kHz synchronizing signal as the shift clock rate at which the data are transmitted synchronously. Figure 2 shows the application circuit of the A/D converter. Present at the inputs are: Sound I and sound II which, when free from DC, are connected via resistors for level adjustment, $\phi 1$ a clock input for the clock signal from a 17.7 MHz clock generator (IC type MEA 2600) and, finally, a reset input.

The MAA 2300 is also suitable for normal stereo applications; in that case the identifier data are superfluous.

The MAA 2400 digital audio processor is designed for processing the audio and identifier data provided by the MAA 2300. As far as we are aware, this chip is the first digital audio processor in one IC. The IC executes a large number of digital processes at high speed; a detailed description would extend beyond the scope of this article. Basically, however, this IC resembles a 1-chip microcomputer which contains special interface and peripheral modules. The block diagram in figure 3 shows the hardware structure of the chip. It would be difficult to guess that this is an audio chip. The processing functions are specified in the program ROM by software. The IC can be very rapidly converted to different functions during production, by changing the program mask. With the ROM program supplied by ITT for TV applications, the user also has the facility for modifying basic functions via a serial bus input. The functions of the standard ROM are shown in figure 4, which also represents the hardware interfaces in addition to the software blocks. This time it is quite easy to guess that the device is an audio chip.

The following functions could just as easily be found in the block diagram of an analogue audio-frequency IC: matrix decoding, de-emphasis, linear volume adjustment, loudness adjustment, treble and bass adjustment, balance adjustment, stereo bass width adjustment, pseudo-stereo circuit. These are all familiar features, in spite of the fact that they are all incorporated in one special single-chip microprocessor. An innovation, however, is that this chip does

4

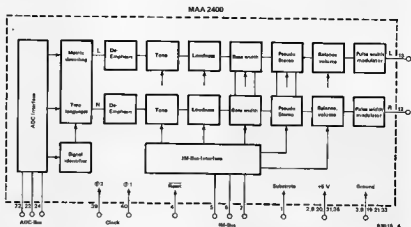
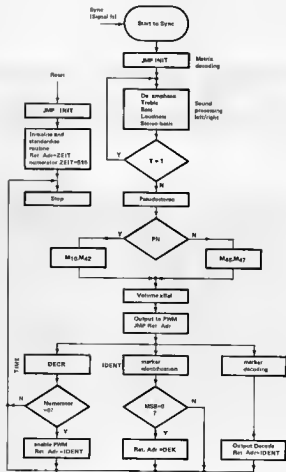

Figure 4. The functions of the audio processor are apparent in this block diagram, which contains the software blocks and hardware interfaces (marked *).

5a



83018 - 5a

Figure 5a. The flowchart shows the program structure of the audio processor.

5b



chips for digital audio (part 2) *elektor* february 1983

Figure 5b. Program timing: only 28 μ s are available for each run consisting of several hundred operations.

6a

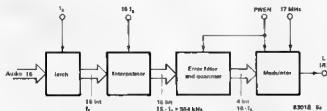

Figure 6a. Block diagram of one of the two PWM interfaces at the output of the audio processor.

6b



Figure 6. Pulse-width modulated output signal of the digital audio processor. This allows switching output stages to be driven, as well as conventional analogue amplifiers after lowpass filtering (integration).

not present digital or analogue audio signals at its outputs, but pulse-width-modulated signals. Instead of the usual D/A converters, digital/PWM converters are used here to allow direct driving of switching output stages. By means of simple lowpass filtering (integration) of the PWM signals, analogue outputs are also obtained for driving conventional amplifiers. The arithmetic operations for implementation of these functions are obviously complex. Most of the functions are implemented by digital filtering. One simple filtering function, for example, requires three multiplications and one addition of three addends. The basic operations for filter systems are 'multiplication + adding/subtracting'. For a simple highpass filter, three such basic operations must be executed together with the corresponding data transfer, within a sampling period of 28 μ s. When being processed in the MAA 2400, the digital audio signals are subjected to about 100 such operations, so that each individual basic operation must take place in less than 280 ns. The program ROM must deliver commands at extremely high speed: at intervals of 56 ns.

The flowchart in figure 5a shows the program of the MAA 2400. After activation, the processor is initialized by a reset. Then comes a 'stop'. A program run starts with the sampling clock signal (sync) from the MAA 2300 A/D converter. Branching to various routines takes place at the end of the main program. A time loop is processed

after the system start. In normal operation the IDENT routine looks for valid identifier data which are then evaluated in the identifier decoding routine in the next program run. The timing diagram of figure 5b shows the timing of the program run. Only 28 μ s are available for one program run, i.e. 32,000 runs per second allowing a maximum of 4 million data bits to be processed.

Figure 6 shows the block diagram of one of the two identical PWM interfaces. The processed audio information of the channel is presented in 16-bit words with a sampling frequency of 35 kHz. The input latch is followed by an interpolator (for intermediate values) which increases the sampling number by a factor of 32. After this oversampling with a factor of 32, the 16-bit samples arrive from the interpolator at a sampling frequency of 554 kHz. A drastic process takes place at this stage: of the 16-bit words, only four bits are left over and are converted to a 554 kHz PWM signal by the modulator. The remaining, truncated 12 bits per sample are not discarded but fed back for correction. With the Philips D/A converter this is known as noise shaping; this process serves the same purpose here. The next step is another outstanding achievement in the digital audio technique: These 4-bit words, which are all that remain of the 16 bits at the output, are corrected to such an extent that a signal-to-noise ratio of 75 dB is claimed by Intermatell over the audio frequency range.

applicator

R5620 . . . a programmable universal filter with switched capacitors

As their name implies, switched capacitor filters (SCFs) make use of switched capacitors as adjustable components, instead of variable resistors. This technique allows filter circuits to be completely integrated, with the filter parameters remaining extensively variable. The special feature is that SCFs require almost no external components. The centre frequency (f_c), for example has a fixed relationship with the clock frequency (f_t). Varying f_t results in an automatic variation of f_c . Particular, fixed frequency ratios between filters can therefore be achieved with ease and precision, by inserting flip-flops and similar digital circuits into the clock frequency line.

We shall not go into more theory at this stage; those readers interested in obtaining further details can consult the literature referred to in this article.

1

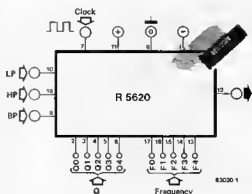

Programmable and universal

If the R5620 were only an improved version of its predecessors, we would not have devoted an Applicator to it. However, this IC exhibits a number of characteristics which make it one of the more outstanding innovations. When comparing the device to the predecessor types from Reticon, one notices that the new IC has no fixed filter type, special application, filter Q or filter characteristic. Even the versatile MF 10 from National Semiconductor cannot compete with features such as programmable Q and centre frequency, as well as the fact that no additional components are required for most applications. Its name is certainly justifiable: PUSCAF = Programmable Universal Switched Capacitor Active Filter.

Other attractions are: the low current consumption, it can be directly and digitally controlled (computers) and, last but not least, it is relatively inexpensive and is available to the hobbyist.

Internal circuits

As shown in figure 1, the IC has three inputs. LP is the input for the lowpass function, HP is that for the highpass function, and BP is used for the bandpass response. Two filters are integrated into the IC itself: a second-order (12 dB/octave) lowpass filter and a highpass filter. The third terminal (BP) is a combination of both filters; hence the bandpass response.

Table I

Technical specifications

Supply voltage	
minimum: ± 4 V	
maximum: ± 11 V	
Clock trigger voltage	
minimum: 0.8 . . . 2 V	
maximum: as per the supply voltage	
Trigger pulse width	
minimum: 200 ns	
maximum: $1/f_t - 200$ ns	
Clock frequency	
minimum: 10 Hz	
maximum: 1.25 MHz	
Centre frequency	
minimum: 0.05 Hz	
maximum: 25 kHz	
Supply current: 4.5 mA	
Output voltage	
minimum: ± 7 V	
Output current	
maximum: 4 mA	
Noise (Q = 1)	
typical: 270 μ V	
Dynamic range (Q = 1)	
typical: 94 dB	
Dynamic range (Q = 40)	
typical: 84 dB	
Insertion gain: 1	
Capacitive output load	
50 p max.	
Dynamic output impedance	
10 Ω	
Input impedance	
1 M/20 p	
THD @ 1 kHz:	
typical 0.2%	

Table II RS5620 Q, F₀ Programming Table

Q	CODE Q ₄ . . . Q ₀	F ₀ /F ₀	CODE F ₀₄ . . . F ₀₀
.57	00000	200.0	00000
.85	00001	191.3	00001
.71	00010	182.9	00010
.79	00011	174.9	00011
.87	00100	187.2	00100
.95	00101	159.9	00101
1.05	00110	152.8	00110
1.2	00111	146.2	00111
1.35	01000	139.8	01000
1.65	01001	133.7	01001
1.95	01010	127.9	01010
2.2	01011	122.3	01011
2.5	01100	118.9	01100
3.0	01101	111.8	01101
3.5	01110	106.9	01110
4.25	01111	102.3	01111
5.0	10000	97.8	10000
5.8	10001	93.5	10001
7.2	10010	89.4	10010
8.7	10011	85.5	10011
10.7	10100	81.8	10100
11.5	10101	78.2	10101
13.0	10110	74.8	10110
15.0	10111	71.5	10111
17.5	11000	68.4	11000
19.0	11001	65.4	11001
23.0	11010	62.5	11010
28.0	11011	59.8	11011
35.0	11100	57.2	11100
40.0	11101	54.8	11101
80.0	11110	52.3	11110
150.0	11111	50.0	11111

* These values are maximum. Minimum values are greater than $\frac{1}{2}$ Q. All other Q have a tolerance of $\pm 10\%$ and typically are within a few percent.

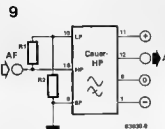
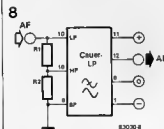
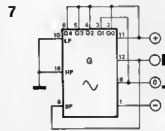
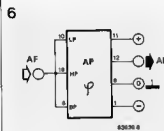
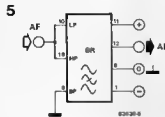
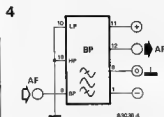
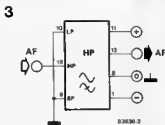
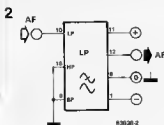

Frequency f_0 is the frequency which would be valid without resistors. Thus with one single IC it is possible to obtain eight different types of filter, merely by programming the device; 'programming' in this context means choosing the input configuration.

2-times 5 bit

So that a filter based on the R 5620 will have a defined centre frequency, a clock signal must be applied to it. Here we encounter another special feature of this IC: at a given clock frequency, f_0 can be varied by applying 5-bit data.

The centre frequency of the sinewave generator, for example, can be shifted by two octaves simply by applying digital data: this is known as 'digital sweeping'. The resolution of this sweep is $32(2^5)$ steps and logarithmic instead of linear. With a clock frequency of 1 MHz, therefore, a filter is obtained with an f_0 of 5 kHz... 20 kHz; this is also precise because of the digital method without a preset potentiometer.

The same applies to the filter Q. This can also be set digitally in 32 logarithmic steps from 0.57 to 150. The tolerance of the set Q over the range 0.71... 23 is less than 10%.

Table 2 shows which data must be applied to the Q and F inputs in order to obtain the desired Q and frequency. A '0' is a voltage of < 0.8 V and a '1' is a voltage of > 2 V. The Q and F inputs are both TTL and CMOS compatible, thus making the device ideally suited to microcomputer control. For fixed applications, however, DIL switches can be utilised or simple wire links.

Application

The device is suitable for almost any audio-frequency applications. It exhibits good dynamic response, noise and distortion performance (table 1).

One application could be as an active crossover network for loudspeakers, allowing precise matching to the room without soldering and modifications. Or as a digitally adjustable sinewave generator with constant output amplitude; or as an automatic notch filter to prevent feedback in PA systems; or...

But these are by no means all the possibilities. Other types of filter can be "produced", depending on which inputs are driven by the AF signal and which are grounded. Thus it is possible to configure the device as a band-rejection (notch) filter (BR) and as an all-pass (AP) filter (phase shifter). With the BP input at the output one even obtains a (programmable) sinewave oscillator (G). Figure 2 to 7 show how the three inputs must be wired in order to obtain one of the six functions. When the device is configured according to figure 7 (sinewave oscillator) the Q is permanently set to 40. The transfer response of the filter

can be varied by two additional resistors. Figures 8 and 9 show a Causer lowpass and highpass filter respectively. Since Causer filters are part of the group of 'music filters', this variant will be of interest in spite of the need for two external resistors. These resistors affect the centre frequency as well as the transfer response. The new centre frequency f_c of the Causer filter is calculated with the following formulae:

$$LP: f_c = f_0 \sqrt{\frac{R1 + R2}{R2}}$$

$$HP: f_c = f_0 \sqrt{\frac{R2}{R1 + R2}}$$

market

Kikusui DMM

Kikusui have introduced a 3½ digit mains powered digital multimeter to the British market. The Kikusui Model 1502 is for use in laboratory and production test and is available from the UK distributor, Telonic Berkeley. 1502 functions are AC and DC voltage, AC and DC current and resistance, and input circuits are protected against overvoltage and overcurrent. Maximum display value of 1999 is on LED's, with display of the selected function as well as automatic polarity indication.

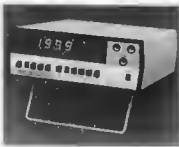

The 1502 has high sensitivity with 100 μ V resolution on voltage ranges, 0.1 μ A on current ranges, and 0.1 Ω on resistance ranges. An 'GLD' facility is included, providing for a less than 0.5 V maximum open terminal voltage when wanted. The double integration system is used and an automatic zero function dispenses with the need for zero adjustment. The instrument's basic accuracy is 0.1% and it is priced at £120 plus VAT.

Telonic Berkeley UK,
2 Castle Hill Terrace,
Maidenhead, Berkshire.
Telephone: 0628.73933.

(2513 M)

Logic probes and pulsers

OK's PRB-1 Digital Logic Probe detects pulses as short as 10 nsec, has a frequency response of better than 50 MHz and an automatic pulse stretching to 50 nsec but is competitively priced at £33.24. It is compatible with RTL, DTL, HTL, TTL, MDS, CMOS and microprocessor logic families and also features 120 Kohm impedance, power lead reversal protection and over-voltage protection to 200 V (+V -V). Supply voltage range is 4-15 V but a PA-1 adaptor can be supplied for use with voltages from 15-25 V. The PLS-1

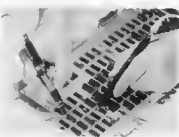

pocket-sized, multi-mode, high-current pulse generator will superimpose a dynamic pulse train (20 pps) or a single pulse onto the circuit mode under test, without having to unsolder pins or cut printed circuit traces, even when these nodes are being clamped by digital outputs. It can source or sink sufficient current to force saturated output transistors in digital circuits into the opposite logic state. Signal injection is by push-button, and when the button is depressed a single high-going pulse of 2 μ sec wide is delivered to the circuit node under test. Pulse polarity is automatic, high nodes are pulsed low and low nodes are pulsed high, and holding the button down delivers a series of pulses at 20 pps to the circuit under test. PLS-1 is ideally suited for use in conjunction with the PRB-1 probe and costs £43.13.

OK Machine & Tool (UK) Ltd.,
Dutton Lane,
Eastleigh,
Hants. S05 4AA.
Telephone: 0703.610944.

(2520 M)

Compact digital panel meter

Measuring 60 x 38 mm overall with a maximum depth of just 16 mm, these new OEM-2 digital meters offer OEMs considerable potential in the design of the next generation of compact handheld portable instruments such as digital thermometers, pH meters, moisture meters,



pressure indications, resistance meters and multimeters.

Featuring a 3½ digit (\pm 1999) LCD display with large 0.5 in. (13 mm) high digits, these meters are easy to read in most ambient light conditions including direct sunlight. For applications requiring readings to be taken under all conditions, even dim lighting or in the dark, the OEM-2L version is available which incorporates a long life filament type lamp.

Designed for a 9 V battery supply, the OEM-2 has a basic input sensitivity of \pm 200 mV with a resolution of 100 μ V. Supply current is just 1 mA (excluding lamp) and a low battery state indicator shows when the voltage drops to 7.2 V, at which point typically 20% of the battery life remains.

An in-built 7106 type analogue-to-digital converter provides the true differential input and auto zero operation together with automatic input polarity detection and display. Overall accuracy is claimed to be better than 0.15% of reading \pm 1 count. Operating temperature range is 0 to +50°C with a typical coefficient of 80 ppm per °C.

Anders Electronics Limited,
48-56 Bayham Place,
London NW1 0EU.
Telephone: 01.387.9092

(2563 M)

World's smallest video camera

A colour video camera, compatible with all video deck systems and weighing only 690 grams (including cable), is



to be launched in to U.K. under the Konica brand by the Japanese company, Konishiroku. This revolutionary camera, the Konica Color VC, overturns conventional notions of the size and weight requirements for portable video cameras.

An important element in the camera is its energy saving design - power consumption being 10 to 20 per cent less than conventional portable video cameras. This is a decisive factor in extending total recording time. The camera, which has a 10-30 mm zoom lens and an optional electronic viewfinder, will be available with a black or silver body, and is to be launched in the U.K. in the Spring of 1983.

Alastair Sedgwick,
Carl Byott & Associates Ltd.,
17a West Halkin Street,
London SW1X 8JL.
Telephone: 01.235.9292.

(2516 M)

New cabinet range

This Cabinet forms part of Amtron UK Ltd's range of 25 plastic and metal cabinets of varying dimensions. This particular model is constructed from shock-proof materials with front and rear panels of brushed aluminium, making it suitable for both industrial and laboratory electronics as well as for the home user. Built-in rails can be used to insert printed circuit boards vertically, horizontally or parallel to the front panel, but separate rails are also supplied for customer mounting. In addition, the kits for these cabinets contain vibration damping rubber feet and self tapping screws. The cabinet is available in three sizes:

*Amtron UK Ltd.,
7, Hughenden Road,
Hastings,
East Sussex.
Telephone: 0424 436004.*

(2519 M)

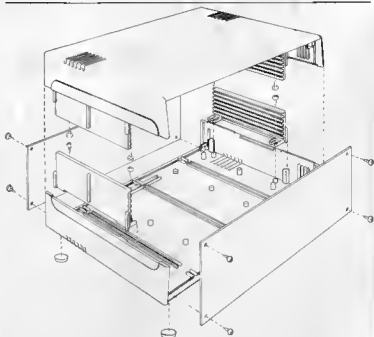

5 1/4" disc drives

Rohan Computing is pleased to announce an addition to the Qume Track range of 5 1/4" drives: the model 592, which is a 96 track per inch, one megabyte capacity, double sided mini floppy drive.



The independently fluted trigimbal head mechanism gives superior data reliability and significantly longer media life. The media life is further extended by the electronically dampened head load solenoid fitted to the drive, which far exceeds the recommendation for industry standard tap test. A band stopper head position mechanism gives 3 milliseconds track to track time, and a direct drive brushless DC motor dispenses with pulleys and belts offering a significantly longer drive motor life.

The main performance figures of the drives are 3 milliseconds track to track access time; 15 milliseconds settling time and 50 milliseconds head lower time with an average latency of a 100 milliseconds. Continuous power requirements are typically 10 watts or less offering very low heat dissipation. Additional features on the drive are an easy open and close bezel with an antirunch door lock.

*Rohan Computing Ltd.,
52 Coventry Street,
Southam,
Warwickshire CV33 0EP.
Telephone: Southam 02681.4045.*

(2523 M)

MODEL	OUTSIDE DIMENSIONS					
	WIDTH		HEIGHT		DEPTH	
	INCH	mm	INCH	mm	INCH	mm
00/3001.00	7,54	191,4	1,81	46	6,89	175
00/3001.02	7,54	191,4	2,36	60	6,89	175
00/3001.04	7,54	191,4	2,9	74	6,89	175

Inexpensive 0-10 amp meter

An inexpensive 0-10 amp (close tolerance) moving coil meter for bench use has been introduced by Semiconductor Supplies for use where it can be used in preference to more expensive equipment such as Avometers in experiments or on test rigs. Priced at £5,25 plus VAT with reductions for quantities, this equipment is ideal for use in schools.

The specification includes mirror-scale and a sturdy plastics case on four rubber feet. Red and black terminal posts take banana plugs, spade terminals or bare wire ends. Heavy duty test leads are supplied. Size 110 x 110 x 90 mm (height, width, depth).

*Semiconductor Supplies International
Limited,
Dawson House,
128/130 Carshalton Road,
Sutton,
Surrey SM1 4RS
Telephone: 01.643.1126*

(2564 M)

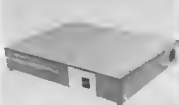

full A3 size sheet of paper or draughting film and is made of 5 mm thick opal white Perspex fitted to give a flush top to the box with no sharp corners to cause operator discomfort.

Constructed in solid Mahogany, the smooth polished frame is mounted on a 9 mm plywood base and four heavy duty rubber feet to permit desktop use without risk of slipping or scratching. Illumination is provided by four fluorescent tubes which are controlled by dual chokes and starter circuits; overall power consumption is approximately 60 watts.

*Electronic Assistance Limited,
Unit 1,
Brynberth Industrial Estate,
Rhyader,
Powys, LD6 5EN.
Telephone: 0597.810711*

(2561 M)

PCB lightbox

Designed for the professional drawing office, the ECx2 Artwork Lightbox is correctly sized for the production of 2:1 PCB artwork to Eurocard dimensions 100 x 220 mm. The viewing panel is large enough to provide backlight for a

The magazine with a different approach to micro's.



Electronics and Computing looks at a computer as the beginning of something interesting rather than an end in itself.

We thought that using a micro to drive something other than a TV screen could open up fascinating possibilities.

A few simple circuits, used as building blocks, can stretch your computer, your imagination and your fun, a long way.

Combine a few switching circuits with some motor

drive controls and a real time clock facility—driven by your micro, and you could build a robot to bring you tea in bed. Or the world's most impressive automated model railway.

That's what Electronics and Computing is all about—giving you ideas for new applications, and giving you the software to expand your micro.

Project by project we show you how to add another dimension to your computer.

Attached to the cover of the February issue are 10 free circuit cards to get you started.

And inside is enough information to build your own hi-res graphics computer.

All you need is a hot soldering iron and a cool 75p.

WHERE ELECTRONICS AND COMPUTING INTERFACE.

AT YOUR NEWSAGENTS FROM JAN 15TH.

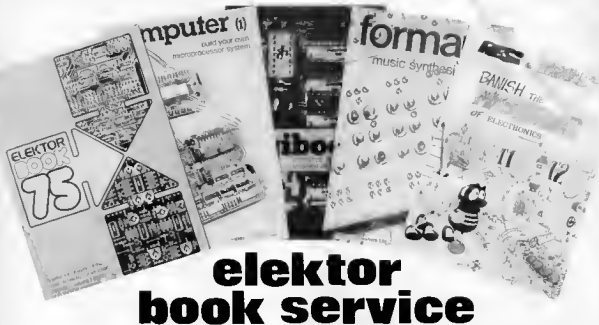

elektor book service

FORMANT

Complete constructional details of the Elektor Formant Synthesiser — comes with a FREE cassette of sounds that the Formant is capable of producing together with advice on how to achieve them.
Price — UK £5.25 Overseas £5.50

SC/COMPUTER (1)

Describes how to build and operate your own microprocessor system — the first book of a series — further books will show how the system may be extended to meet various requirements.
Price — UK £4.45 Overseas £4.70

SC/COMPUTER (2)

The second book in series. An updated version of the monitor program (EiBug II) is introduced together with a number of expansion possibilities. By adding the Elektterminal to the system described in Book 1 the microcomputer becomes even more versatile.
Price — UK £4.75 Overseas £5.00

BOOK 75

A selection of some of the most interesting and popular construction projects that were originally published in Elektor issue 1 to 8.
Price — UK £4.25 Overseas £4.50

TV GAMES COMPUTER

This book, provides a different — and, in many ways, easier — approach to microprocessors. The TV games computer is dedicated to one specific task, as the name suggests. This provides an almost unique opportunity to have fun while learning!
Price — UK £5.50 Overseas £5.75

JUNIOR COMPUTER BOOK 1

For anyone wishing to become familiar with microcomputers, this book gives the opportunity to build and program a personal computer at a very reasonable cost.
Price — UK £5.00 Overseas £5.25

JUNIOR COMPUTER BOOK 2

Follows in a logical continuation of Book 1, and contains a detailed appraisal of the software. Three major programming tools, the monitor, an assembler and an editor, are discussed together with practical proposals for input and peripherals.
Price — UK £5.25 Overseas £5.50

JUNIOR COMPUTER BOOK 3

The next, transforming the basic, single-board Junior Computer into a complete personal computer system.
Price — UK £5.25 Overseas £5.50

BOOK 4 £5.25/£5.50

300 CIRCUITS

For the home constructor — 300 projects ranging from the basic to the very sophisticated.
Price — UK £4.25 Overseas £4.50

DIGIBOOK

Provides a simple step-by-step introduction to the basic theory and application of digital electronics and gives clear explanations of the fundamentals of digital circuitry, backed up by experiments designed to reinforce this newly acquired knowledge. Supplied with an experimenter's PCB.
Price — UK £5.50 Overseas £5.75

When ordering please use the Elektor Reader's Order Card in this issue (the above prices include p. & p.)

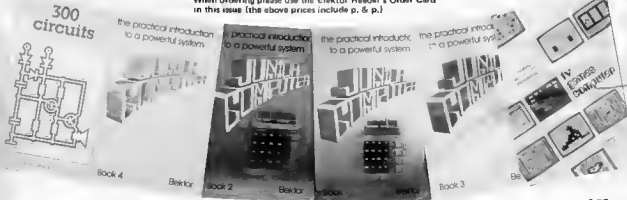



THE NEW MAPLIN CATALOGUE FOR 1983

BRINGS YOU
RIGHT UP-
TO-DATE IN
ELECTRONICS
& COMPUTING

Nearly 400 pages of all the most useful components and a whole big new section devoted to home computers and personal software. As always the catalogue keeps you up-to-date with the latest technology — even our ordinary miniature resistors are now superb quality 1% tolerance metal film, yet they're still only 2p each. As well as our usual quality products at low prices, now we're offering quantity discounts too. So pick up a copy of our catalogue now — it's the biggest and the best!

ON SALE IN ALL
BRANCHES OF WHSMITH
FROM 18th NOVEMBER 1982
PRICE £1.25

Send now for an application form — then buy it with MAPCARD. MAPCARD gives you real spending power — up to 24 times your monthly payments, instantly.



Post this coupon now for your copy of our 1983 catalogue, price £1.25 + 25p p&h. If you live outside the UK send £1.90 or 10 International Reply Coupons I enclose £1.50.

Name

Address

.....

.....

£7/83

MAPLIN

ELECTRONIC SUPPLIES LTD

P O Box 3, Rayleigh, Essex SS6 8LR
Telephone: Southend (0702) 552911/554155

Shops at
159-161 King Street, Hammersmith, London W6 Tel: (01) 748 0926
Lynon Square, Perry Barr, Birmingham Telephone: (021) 356 7292
284 Landon Road, Westcliff-on-Sea, Essex Tel: (0702) 554000
All shops closed Mondays