

elektor

up-to-date electronics for lab and leisure

D 71663

89

September 1982

65p.

IR 85p. (incl. VAT)

CAN \$2.25

Surinder Singh

Rugby
timekeeper

dark-room
computer

gas alarm

house
telephone

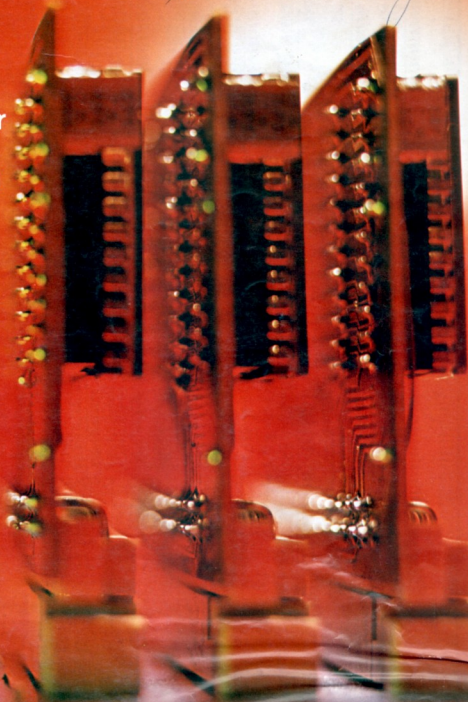

selektor	9-12
gas detector	9-16
Most people underestimate the damage that can be caused if a gas leak remains undetected for a lengthy period of time. This gas sensor can raise the alarm very quickly. It can also be used to trace a leak, should one occur.	
rapid loading games	9-20
The major source of irritation to TV games owners is the time it takes to locate a program on tape and load it. We found a solution to that problem: using some further hardware, games can be stored in EPROM. A simple program can transfer any desired game to the RAM within seconds!	
the Elektor connection	9-27
F. Richter As the old saying goes, 'it's simple, when you know how'. Most of the really good ideas and inventions over the last century have been simple and so it is with the solution to an old problem outlined in this article. A low cost electronic connection between the main Junior Computer boards and the interface!	
inductive sensor	9-28
Anyone wishing to measure something will often require some kind of converter. This article introduces a distance meter which uses the principle of induction.	
darkroom computer part 1	9-30
The darkroom computer described here is based on the 6502 and is capable of dealing with virtually everything in the darkroom as far as measurement and control is concerned. It is an exposure timer, a dual process timer, temperature meter, photometer and contrast meter.	
applicator	9-42
A full description with applications for the versatile MF10.	
home telephone system	9-46
Home telephone systems are fast growing in popularity with the availability of telephone sets at a reasonable cost on the surplus market. The design described here is a self-contained system and does not require a telephone exchange.	
synthesised sound animation	9-52
Sound animation or to put it in another way: the changing, delaying or phase shifting of any periodic waveform, enhances any final result, sometimes quite dramatically. This article introduces an effective solution which, although being relatively inexpensive, produces a rich ensemble type sound.	
missing link	9-53
time receiver for the Rugby MSF	9-54
This circuit was designed as an addition to the '6502 housekeeper' published in the May 1982 edition. The two together provide an extremely accurate time clock controlled by (60 kHz) transmissions from the Rugby MSF transmitter that provide good reception throughout the U.K.	
three phase tester	9-60
When connecting three phase motors to the power source, confusion can arise if the cable markings are incorrect, illegible or non-existent. How do you deal with this problem? The simple answer lies in the circuit described here.	
market	9-63
advertisers' index	9-74

contents

COMPUTERS

Suzanne Long

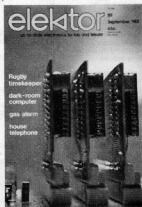

As μ P systems grow, they tend to develop plug-in extensions. The 'rapid loader for TV games', portrayed on this month's cover, consists of three plug-in boards on a basic board that plugs in to an extension board of the original computer!



TECHNOMATIC LTD.

MAIL ORDER TO: 17 BURNLEY ROAD, LONDON NW10
Tel. 01-452 1500/450 6597 TLX. 922800

Retail Shops : NW London : 15, BURNLEY ROAD NW 10
(2 mins. from Dollis Hill Tube Station)
Ample parking space

West End : 305, EDGWARE ROAD W2
(opposite Edgware Rd. Tube Station)

YOUR ONE STOP SHOP FOR PERSONAL COMPUTERS, ACCESSORIES, SOFTWARE & COMPONENT REQUIREMENTS

ACORN ATOM



BUILT 8K + 2K £135 EXPANDED £175

8K + 5K + COLOUR CARD £170
(£3 / unit P & P)

ATOM PSU £7 + 0.70p P & P

3A 5V REGULATED PSU £26 £2 P & P

4K F.P. ROM £19.50 1K RAM £1.90 TOOL BOX ROM £25.00

WORD PACK ROM £26.00

FULL RANGE OF ATOMSOFIT IN STOCK

ATOM FORTH £10.00
MANUAL £6.00

ATOM LISP £15.00
MANUAL £6.00

ATOM CALC £34.00

ATOM BASIC UPGRADE TO BBC (20K ROM + 2K RAM) £44.00

NEW 2K MONITOR ROM to allow direct machine code programming £17.00

ATOM DISC PACK : 5 1/4" Drive with PSU, DOS ROM, Utilities disc, Connector cable and Manual £299 + £6 carriage.



BBC MICRO
OFFICIAL DEALER

Model B £399

inc. VAT
carr./unit £6.00

Upgrade kit

Model A → B

£60

16K memory
upgrade £21.60

Full range of
connectors available

Send for our
Software list.

NEC PC8023BE-C

- * 80 Col. 100CPS
- * Bi-directional
- * Logic seeking



£340

- * Forward & Reverse Line Feed + £9 carr.
- * Hi-Res and Block graphics
- * Int'l. & Greek char. set

PRINTERS EPSON MX80 F/T3

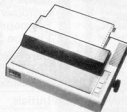

* 80 Cols 80 CPS

* Bi-directional

* Logic seeking

* Hi-res. graphics

£330 + £6 Carr.

SEIKOSHA GP100A



* 80 cols 30 CPS

* Std. & Dble. width char.

* Up to 10" paper

* Full graphics

* Self testing

£175

+ £6 Carr.

SOFTY II

EPROM PROGRAMMER

Software development tool for developing programs, debugging and verification. The program on Softy buffer can be used directly into a host Computer or burnt into most +5V EPROMS. Powerful editing facilities.

Softy II C/W PSU, TV Lead £169

UV ERASERS

A range of erasers to suit all requirements. All erasers fitted with Mains On/Off switch and indicator. Built in safety interlocks prevent accidental exposure to UV rays.
UV16 £47.50 + £1.50 p&p (6 Eprom tray)
UV17 with timer £60 + £1.50 p&p
(6 Eprom tray)
UV140 £61.50 + £2 p&p (14 Eprom tray)
UV141 with timer £78 + £2 p&p
(14 Eprom tray)

MONITORS

12" BMC Green Screen
18 MHz B/Width £99 + £6 carr.
14" BMC Colour Monitor
RGB Input £240 + £6 carr.
Computer Grade SANYO
Cassette Recorder £24.50
C-12 Computer Cassettes 50p

ZX81 ACCESSORIES

ONE PIECE 47 KEY KEYBOARD - FULLY ASSEMBLED AND TESTED. NO ADDITIONAL SOLDERING REQUIRED £33 + £1 P&P
ANODIZED METAL CASE TO HOUSE OUR KEYBOARD + ZX81 PCB £13 £ + £1 P&P

OS HIGH RESOLUTION GRAPHICS BOARD

6K RAM on board. Resident Software provides fast high res. facilities which include mixed text and graphics. £69.50 + £1 P&P

OS SOUND BOARD
£21.50

CHARACTER GENERATOR BOARD

with Demo Cassette
£21.50 + £1 P&P

USER PORT

B CH INPUT and 8 CH OUTPUT PORTS
Kit £11.50 Built £14.95

SEE OUR INSIDE FRONT COVER PAGE ADVERTISEMENT FOR COMPONENT PRICES



Please add 40p p&p to all orders except where it is specified. Add 15% VAT to total order value.
For Export p&p will be charged as cost. Telephone orders (min. £5) can be placed using Access or Barclaycard
ORDERS FROM GOVERNMENT & EDUCATIONAL ESTABLISHMENT WELCOME



THE MULTI-PURPOSE TIMER HAS ARRIVED

Now you can run your central heating, lighting, hi-fi system and lots more with just one programme timer. Your selection is designed to control four mains outputs independently, switching on and off at pre-set times over a 7 day cycle, e.g. to control your central heating (including different settings for weekends), just connect it to your system programme and set it and forget it—the clock will do the rest.

FEATURES INCLUDE:

- 0.5 LED 12 hour display.
- Day of week, am/pm and output status indicators.
- 4 zero voltage switched mains outputs.
- 5000mAh mains operation.
- Battery backup allows stored programmes and continues time keeping during power failures. (Battery not supplied).
- Display blanking during power failure to conserve battery power.
- 18 programme time sets.
- "Postful" "Everyday" function enabling output to switch every day but use only one time set.
- Useful "sleep" function—turns on output for one hour.
- Direct switch control enabling output to be turned on immediately or after a specified time interval.
- 20 function keypad for programme entry.
- Programme verification at the touch of a button.

(Kit includes all components, PCB, assembly and programming instructions).

NOW ONLY £29 WITH SO MANY EXTRA FEATURES OPTIONAL BLACK PLASTIC CASE READY DRILLED £2.50

3-NOTE DOOR CHIME

Based on the SAB8000 IC the kit is supplied with all components, including loudspeaker, printed circuit board, a pre-drilled box (86 x 71 x 30mm) and full instructions. Requires only a 9V 5V battery and push-switch to complete. AN IDEAL PROJECT FOR BEGINNERS. Order as XK102. **£5.00**

For a detailed booklet on remote control — send us 30p + SAE today.

"OPEN-SESAME"

The XK103 is a general purpose infra-red transmitter/receiver with one momentary (normally open) relay contact and two latched transmitter output. Designed primarily for controlling motorised garage doors and two auxiliary outputs for drive-garage lights at a range of up to 40 ft. The unit also has numerous applications in the home for switching lights, TV, closing curtains, etc. Ideal for aged or disabled persons. The kit comprises a mains powered receiver, a four button transmitter, complete with pre-drilled box, requires a 9V battery and one opto-isolated relay contact switch kit for interfacing the receiver to mains appliances. As with all our kits, full instructions are supplied.

Only £23.75

Extra Solid State Switch Kits (XK104) and transmitters (XK105) can be supplied.

XK104 £2.40 XK105 £10.50

REMOTE CONTROL KITS

- MK6 SIMPLE INFRA RED TRANSMITTER**
Plastic housed infra-red source complete with hand-held plastic box. Requires a 9V battery. **£4.20**
- MK7 INFRA RED RECEIVER**
Single channel, range approx. 20ft. Mains powered with a triac output to switch loads up to 500W **£12.50**
- MK8 CODED INFRA RED TRANSMITTER**
Based on the 54850, the kit includes all components to make a coded transmitter and only requires a 9V (PP3) battery and keyboard. 8 x 2 x 1.3oms **£5.90**
- MK16 16-WAY REMOTE**
For use with MK2 and MK18 to generate 16 different codes for decoding by the ML528 or ML526 receiver (MK12) kit. **£5.40**
- MK11 10-Channel + 3 Analogue ch/B Receiver**
Based on MS1522 decoder IC. Functions include on/standby output, toggle, control of volume, tone and lamp blinding. Includes its own mains supply. **£12.90**
- MK12 16-CHANNEL IR RECEIVER**
For use with MK11 with 16 on/off outputs, which with further interface circuitry, such as relays or triacs, will switch up to 16 items of equipment on or off remotely. Latched or momentary outputs — please specify when ordering. Includes its own mains supply. **£11.95**
- MK15 11-WAY KEYBOARD** For use with MK6, MK18 and MK11 kits. **£4.95**
- MK16 Mains Powered IR Transmitter**
Mains powered for continuous operation — single channel, for applications such as burglar alarms, automatic door openers, etc. Range approx. 6 ft. **£2.50**
- MK17 12V d.c. IR RECEIVER**
Use with MK2 or MK16. Relay output with DP 3 Amp change-over contacts, may be used as latched, momentary or "break beam" receiver. Operates from 6-13V d.c. **£5.50**
- MK18 HIGH POWER IR TRANSMITTER**
Similar to MK6 but with range of approx. 60ft. **£3.20**
- Auxiliary Kits :** MK2 Solid State Relay. Opto-isolated with zero voltage switching. No triac supplied. **£2.80**
- MK19 DUAL LATCHED SOLID STATE RELAY**
Comprises 2 x solid state relays and 1 switch for use with momentary version of the MK12. 2 output triacs required (not supplied). **£4.50**

FREE SHORT FORM CATALOGUE — send SAE (6" x 9"). We also stock Vero, Books, Resistors, Capacitors, Semi-Conductors etc.

FAST SERVICE · TOP QUALITY · LOW LOW PRICES

No circuit is complete without a call to —

ELECTRONICS Dept. EK

11 Boston Road London W7 3SJ

HOME LIGHTING KITS

These kits contain all necessary components and full instructions and are designed to replace a standard wall switch and control up to 300w of lighting.

- TDR300 Remote Control** **£14.30**
- MK6 Transmitter for above** **£4.20**
- TD300K Touchdimmer** **£7.00**
- TDEK Extension kit for 2-way switching for TD300K** **£2.00**
- LD300K Rotary Controlled Dimmer** **£3.50**



MINI KITS

MK1 TEMPERATURE CONTROLLER THERMOSTAT

Uses LM318 IC to sense temperature (NTC type) and triac to switch heater. 10W. **£4.00**

MK2 Solid State Relay Ideal for switching motors, lights, heaters, etc. from logic. Opto-isolated with voltage switching. Supplied without triac. **£2.80**

MK3 MOUNT DISPLAY Displays an analogue voltage on a linear 10 element LED display as a bar or single dot. Used for thermometers, level indicators, etc. May be stacked to obtain 20 to 100 element displays. Requires 5-20V supply. **£4.80**

MK4 PROPORTIONAL TEMPERATURE CONTROLLER Based on the 5241 zero voltage switch, this kit may be used to form a "burn" fire power controller, enabling the temperature of an enclosure to be maintained to within 0.1°C. **£5.88**

MK5 MAINS TIMER This kit will switch a mains load on or off for a preset time from 20 mins. to 95 hrs. Longer or shorter periods may be realised by minor component changes. Max. load 10W. **£4.50**

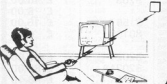

THE HOME CONTROL CENTRE

This New Remote Control Kit enables you to control up to 16 different appliances anywhere in the house from coded pulses into the mains wiring which are received by receiver modules connected to the same mains. Receivers are addressed by the same mains keyboard, followed by means of a 16-way rotary switch and by an on or off command. Since a miller also includes a computer interface so you can control your favourite micro to switch lights, heating, electric blanket, make your coffee in the OF THE POSSIBILITIES. The KIT includes all PCBs and components for one transmitter and two receivers plus a pre-drilled box for the transmitter.

Order as XK112

£42.00

ALL PRICES EXCLUDE VAT

We use the SOFTY 2 EPROM programmer in stock at £169

THE KEY TO YOUR SECURITY IS IN OUR LOCK

If the thought of car thieves, house breakers or people tampering with your electrical and electronic equipment upsets you, we have just the kit for you. Our ELECTRONIC LOCK KIT includes 10-way keyboard — a special IC which provides a 750mA output to drive a solenoid or relay (not supplied) when four keys are depressed in the correct sequence. This gives over 5,000 possible combinations! The required 1.500V (pre-wired) may be easily changed by means of a small plug and socket. A "SAFE" function is also available enabling the open code to be stored (especially useful in a car when it is left in a garage) for servicing as the open code need not be disclosed. Size: 7x5x3 cms. Power Consumption is 40uA at 10V to 15V d.c.

At only **£10.50 + VAT**, it will make a smaller hole in your pocket than a bunch of keys!

Electric Lock Mechanism **£13.50**
Suitable for use with existing door locks and above electronic lock kit.

24 HOUR CLOCK/APPLIANCE TIMER KIT

- Switches any appliance up to 14W on and off at preset times once per day. Kit contains: AY5-1230 IC, 0.5" LED display, mains supply, display drivers, switches, LEDs, track, PCBs and full instructions.
- CT100K Basic Kit **£14.80**
CT1000K with white box (56/131 x 71mm) (Ready Built) **£17.40**
..... **£22.50**

Add 50p postage & packing +15% VAT to total.

Overseas Customers: Add £1.50 (Europe), £4.00 (elsewhere) for p.p. Send S.A.E. for further STOCK DETAILS. Goods by return subject to availability.

OPEN 9am to 5pm (Mon to Fri) 10am to 4pm (Sat)

CLOCK TOWER

EXURBIOUR ROAD

CAR PARK

ACCESS BY BANKCARD

TEL. 01-567 8910 ORDERS 01-579 9794

ENQUIRIES 01-579 9794

21-579 2842 TECHNICAL AT 11.30-1.30

selektor selektor

a new resolution for X-rays

In recent years the use of microfocus X-ray equipment has become established in the aerospace, steel, nuclear and electrical industries for checking the integrity of components and revealing minute, incipient flaws. Now, real-time imaging on television screens, using microfocus sources, is emerging as a high-resolution technique and its value has already been demonstrated in exposing small cracks and microporosity in castings and welds.

Since the early days of X-ray radiography, workers have strived to improve the resolution of the radiographic system. The first recorded application of microradiography in materials studies was in the late 1890s when Heycock and Neville produced images that showed the fine structural detail of alloys composed of two metals. Prior to this, shortly after his discovery of X-rays, Röntgen had himself produced magnified radiographs of biological specimens.

In medical radiography, the quest for higher resolution has been, and still is, hampered by the biological effect of X-rays, which means that the X-radiation to the patient has to be kept to as small a dose as practicable. Involuntary movements of the patient during exposure also introduces unacceptable blur with all but the shortest of exposures. To work within these constraints, conventional medical radiography usually uses extremely fast film-screen combinations; but these are themselves grainy and therefore inherently lacking in sharpness. Nevertheless, workers such as Buckland-Wright of Guy's Hospital Medical School

in London are using direct, high-resolution X-ray techniques with microfocus X-ray equipment to examine the hands and feet of patients and to investigate pathological *in-vivo* specimens; they report that they have observed radiological information that was hitherto unobtainable.

In industrial radiography, the constraints imposed by the health and by the movement of the patient do not apply. Moreover, in general, industrial radiographs are produced on fine-grained film with longer exposure times, so they are usually able to resolve finer detail.

Exposure and Projection

In the technique of microradiography, a thin specimen is placed in contact with an ultra-fine-grained film or photographic plate and exposed in a film cassette using a normal X-ray tube. The image is enlarged by optical techniques.

Resolution is limited by the graininess of the film, background fogging caused by photoelectrons and scattered X-rays from the irradiated specimen, and any aberrations introduced by the optical system. All these can largely be overcome by using an extremely small X-ray source, of the order of a few tens of micrometres in size, and projecting the image, thereby producing a primary X-ray enlargement by beam divergence which is virtually free of what is called geometric 'unsharpness'. This reduces any degradation of the image through optical enlargements of the film grain and completely obviates imperfections caused by particles of dust, which often mar radiographs that have been optically enlarged.

The great improvement in resolution through enlargement is not the only important advantage of using a microfocus source and projection; perhaps equally significant is the way it improves the contrast of the radiographic image. This comes about because making the separation bigger between specimen and film (or detector) reduces

the relative intensity of unwanted, non-image-forming radiation that reaches the film.

Radiographic contrast C can be written as:

$$C = \frac{0.43 (\mu_1 - \mu_2) G \cdot I_D}{I_S + I_D}$$

Where μ_1 and μ_2 are the linear attenuation coefficients of the matrix and embedded 'features', G is the gradient of film or detector (density change for a given step in exposure); I_S is the intensity of scattered or non-image-forming radiation (noise) reaching the detector, and I_D is the intensity of attenuated radiation emanating directly from the focal spot (image-forming signal).

So, any reduction in I_S improves the contrast, and the mere act of making the space between the specimen and the film bigger (up to between one and two metres) significantly reduces the noise level I_S and thereby noticeably improves the contrast in the radiographic image. One disadvantage when using the projection technique is that the field size, that is, the area of the specimen in the effective beam, is smaller, which restricts the amount of specimen coverage on each film. However, the contrast is further improved by this reduction; because the intensity of scattered radiation I_S is proportional to the volume of irradiated sample, the scattered radiation I_S is proportional to the volume of irradiated sample, the giving an image which is cleaner and therefore has better contrast.

Focal Spots

X-rays are generated by accelerating electrons from a heated filament to hit a tungsten anode (target). When the electrons are decelerated by the target atoms they give off energy in the form of a continuous spectrum of X-rays; the minimum wavelength of the radiation depends on the maximum accelerating voltage.

Some focusing of the electrons normally occurs in the conventional X-ray tube,

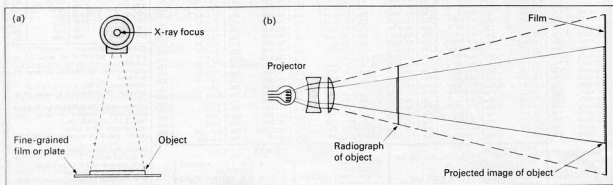

Producing a microradiograph with conventional X-ray equipment. A thin specimen is placed in contact with an ultra-fine-grained film or photographic plate (a) and exposed in a film cassette using a normal X-ray tube. The image is then enlarged (b) by optical techniques.

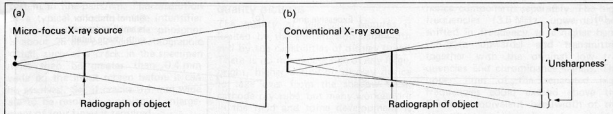

Comparison of the sharpness of images projected by microfocal and conventional X-ray equipment.

the design of which is a compromise between the area of the 'focal spot' at the target and the flow of electrons striking it. For radiology, a range of focal spots from 0.5 mm to 4 mm diameter is generally used both in medicine and industry. The two-way dependency between the area of the focal spot and the electron-current density is constrained by the melting temperature of tungsten; nevertheless, as the focal spot is made smaller, a greater power loading into it, expressed in watts/mm^2 , becomes possible and the source is said to be more 'brilliant'.

To achieve high resolution and enlarged radiological images it is necessary for the focal spot to be of the order of a few tens of micrometres in diameter and it is desirable that it should dissipate as much power as possible, to allow short exposures for film techniques and ample real-time image brightness for direct-viewing systems.

During the past 30 years a range of microfocal X-ray equipment has emerged which is suitable for medical, biological and many engineering applications. One early practical design was developed and demonstrated by Cosslett and Nixon of the Cavendish Laboratories at Cambridge in the early 1950s, and later manufactured. The Harwell E12 X-ray unit is derived from a series of X-ray units with small foci based on designs by Ely (now Honorary Fellow at Reading University) who has contributed greatly to the development of such specialized equipment and to the increase in the application of microfocus X-ray technology generally.

The Harwell E12 can operate at up to 100 kV and has a focal spot of roughly $15 \mu\text{m}$ diameter. When used as a radiographic source it enables an extremely finely detailed array of X-ray information to be recorded on film or other devices. The X-ray unit comprises a continuously-pumped vacuum chamber, with a demountable electron gun and target assembly. Filament changes and other maintenance can be carried out without difficulty. The electron beam is obtained from a heated tungsten filament which is maintained at -45 kV negative potential; the beam is focused electrostatically onto the cylindrical tungsten target (set at $+45 \text{ kV}$).

The filament itself is made from 0.1 mm diameter wire bent into a sharp hairpin

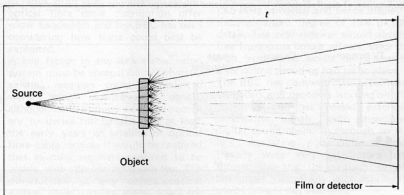

When the projection distance (t) is long, it reduces the amount of scattered radiation that reaches the film, thereby improving the radiographic contrast.

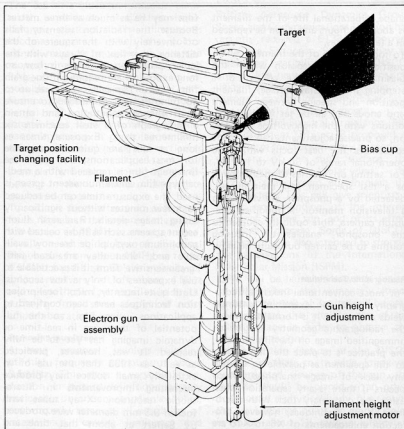

Cut-away diagram of an X-ray unit tube-head, showing internal features.

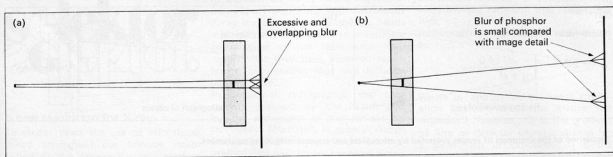

Comparison of detail resolution for conventional fluoroscopy with that when a microfocus projection technique is used.

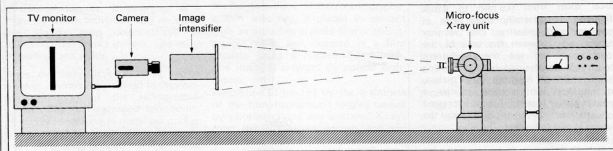

Typical direct-viewing X-ray system incorporating a particulate phosphor, which converts X-ray photons to electrons of similar spatial distribution. A high voltage accelerates the electrons to a smaller, output phosphor, where the image formed can be viewed directly using an optical device or a television camera.

shape. Operational life of the filament is about 60 hours and it can be replaced in a few minutes.

To focus, the tip of the filament can be positioned with precision within the biasing cup under the control of a stepping motor. Bias voltage, filament position and spacing between filament and anode can all be set for best conditions with the high voltage switched on, so precise adjustments can be made to achieve the best focus within the operational range of 30 kV to 100 kV. For setting up, a series of meshes serve as a test specimen and their images, detected by a phosphor, are viewed on a television monitor. A modified television camera, fibre-optically coupled to the phosphor, enables the focusing routine to be carried out quite quickly.

Radiographic Techniques

For most conventional industrial radiography, used for examining castings, welds and so on, it is normal to arrange the radiographic geometry to give an unmagnified image on the film. Indeed, the practice is to place the film as near to the specimen as possible to obviate any lack of image sharpness, which occurs if there is any separation when using the customary foci. With micro-focal X-ray techniques, however, projection enlargements of X5 to X10 are common and enlargements up to as much as X25 are sometimes used.

To obtain a X25 enlargement the distance from the source of radiation to

film may be as much as three metres. Because the radiation intensity falls off inversely with the square of the distance, the flux of X-rays with the larger projection distances is low, so long exposures are required if fine-grain film is used. Typically, exposures up to 40 minutes may be needed to ensure good enough penetration and obtain a radiograph of a steel specimen six millimetres thick. Exposure times as long as this are quite unacceptable for most applications, but when the fine-grain film is replaced with a medical-type film and a fluorescent screen is used, the exposure time can be reduced to a few minutes without significantly losing image details. Rare-earth fluorescent screens such as those coated with gadolinium oxysulphide are now available and, when they are used with 'green-sensitive' films, it is practicable to use exposures of only a few seconds. Until quite recently, micro-focal-projection techniques have been confined to applications using film, so the full potential of their use in real-time or dynamic imaging has yet to be fully realized. It was, however, predicted as early as 1938 that the use of an extremely small source may produce interesting improvements in fluoroscopic resolution. X-ray tubes with foci of 0.3 mm diameter were produced by Seifert at about that time and they were used in conjunction with binocular image intensifiers in the early 1950s for medical engineering applications. But the combination never

achieved the resolution to match the fine-grained-film, contact X-radiographic techniques that were, and still are, practised in industry.

Lack of Resolution

There are many positive advantages for striving towards direct imaging systems, including lower costs through eliminating film, the ability dynamically to view the specimen from varying aspects, and data that are more readily adaptable to automation and to computerized systems. Using a microfocus X-ray unit, a great improvement in image resolution can be made by projecting the radiographic image virtually devoid of geometric blurring. Analogous to the use of fast film, fluorescent screens combined with the projection techniques allow fast image-intensifier systems to be used. The improvement in contrast found with film techniques also holds good when a real-time detector system is used.

A typical direct-viewing X-ray system usually incorporates a particulate phosphor which converts X-ray photons to electrons. With a spatial distribution similar to the intensity distribution in the X-ray image, the electrons are accelerated by high voltage to a smaller, output phosphor. The image on the output phosphor can be viewed directly with an optical device or with a television camera and displayed on a monitor.

It is convenient to express the resolu-

ution of a television image-intensifier system in line-pairs/cm. The resolution of a typical, modern image intensifier with a fast caesium iodide phosphor is about 25 line-pairs/cm. Radiographic detail, such as a crack in the specimen must then be greater than 0.4 mm wide on the input screen before it can be resolved. So, if cracks 0.1 mm wide are to be resolved, a projected enlargement of four times is required.

Engineering Applications

Over the past few years, since suitable microfocus X-ray equipment has been available, projection radiography has established itself as a valuable technique in the UK in the aerospace, steel, nuclear and electrical instrumentation and generating industries. The technique is now being applied routinely to small weldments, aero-engine investment castings including turbine blades, small intricate assemblies, micro-electrical components, plastic high-tension electrical terminations, composite materials and ceramics.

Application of real-time imaging with microfocus X-ray sources is only just emerging as a technique but already its value has been demonstrated in the examination of aluminium castings and welds for porosity, the study of crack growth in composite materials and the dynamic study of diffusion processes in certain metals.

Developments

No doubt there is a need to produce high-resolution radiological images that can examine larger thicknesses of material than can be accommodated with the present X-ray units, even though radiographs of up to 25 mm of steel, with X8 projected enlargements, have been obtained using 'cold-film' techniques. For real-time imaging with an image intensifier, about 6 mm of steel is the thickest that can be dealt with. Good results have been obtained in real time on aluminium alloy samples up to 20 mm thick, with a better sensitivity than is usual with many fine-grained film techniques.

A marriage between microfocus X-ray equipment and computerized image processing techniques will probably extend the thickness range and may improve the image resolution.

With such developments, direct imaging using microfocus X-ray equipment is likely to become more widely applied, both as a research tool and as a means of checking the integrity of mass-produced components. 0733/1

BBC moves towards better TV quality pictures

The quality of television pictures is limited by the transmission bandwidth and by the capabilities of display tubes. There is no immediate sign of any large, bright, higher definition display device to take over from the shadow mask cathode ray tube, but many workers are in the field and some development is expected during the next few years.

Assuming that a better display becomes available there are possibilities for matching wider bandwidth transmissions. Both satellite broadcasting and optical fibre cable distribution offer wider bandwidth and the BBC has been considering how these could best be exploited.

A key factor in any new transmission system must be compatibility, whereby existing receivers could continue to work with new-standard signals, although new receivers would be necessary to derive full benefit. For at least the early years of satellite or optical fibre cable services it would be required that existing receivers continue to be usable, with appropriate converters. The introduction of any non-compatible system could require many years for international agreement and new receiver development and hence seriously delay the establishment of satellite broadcasting.

The 5.5 MHz video transmission bandwidth is adequate for 625-line monochrome pictures. The limitations become apparent when the colour signals must be squeezed in with the monochrome. Ingenious though the PAL coding system may be, it is impossible to avoid some mutual interference between monochrome (luminance) and colour components. These interferences show themselves as luminance appearing in chrominance channels (cross colour) giving rise to flashes of false colour on striped suits for example; and chrominance signals appearing in the luminance channel give spurious dot patterns.

To reduce these effects to acceptable levels, signals in the region of the colour sub-carrier (4.43 MHz) are attenuated, usually resulting in loss of all signal frequencies from about 4 MHz up to the 5.5 MHz band limit. So the majority of colour receivers roll off about 4 MHz and show little fine detail whilst still suffering from some degree of cross colour aberrations.

Removing interference

A new proposal involves filtering off high frequency components above 3.5 MHz. This gives a very slight reduction in picture definition, scarcely noticeable on present-day display-tubes, but virtually removes all possibility of interference between luminance and chrominance components so that cross colour effects disappear.

In a wider-bandwidth satellite or optical fibre channel there is room to transmit

the filtered off high frequency luminance components separately. The high frequencies (3.5 MHz upwards) are shifted in frequency to a higher band (98 MHz upwards) and transmitted together with the original low frequencies and chrominance signals. The upper limit of the separated high frequencies could extend above the 5.5 MHz equivalent bandwidth of the present transmission channel.

A new receiver, specially designed for this wide bandwidth transmission system, would shift the transmitted high frequencies back to their original values (3.5 MHz upwards) and hence display a much-enhanced degree of fine picture detail. The new receiver would also be free from cross colour effects, since the high frequencies would be re-inserted after colour decoding had taken place. The BBC has demonstrated experimental coders and decoders working on this principle and has passed extended bandwidth signals, with associated digital sound channels, through an RF link simulating a satellite channel. Results were very satisfactory and showed also that the proposed system is entirely compatible with continuing use of present-day receivers.

(78 S)

British Aerospace interested in DISCO

British Aerospace Dynamics Group Space and Communications Division has recently received a £133,000 contract from the European Space Agency to conduct a Feasibility Study of DISCO, one of five new space science projects being studied before selection as Europe's next major Scientific Satellite. The work will take seven months.

DISCO (Dual-Spectral Irradiance and Solar Constant Orbiter) is proposed as a long-term solar observatory to monitor variations of the sun's surface, the heliosphere and the "solar wind" - the particles that stream out through the solar system. This will give scientists a better understanding of the internal workings of the sun, and of its effect on earth's climate. Some of DISCO's instruments are also intended to support the observations of the International Solar Polar Mission (ISPM).

ISPM will be launched towards Jupiter in 1986 where the immensely strong gravitational pull of Jupiter will be used to accelerate the satellite out of the ecliptic plane in order to observe the sun's polar regions.

An interesting feature of the DISCO project is that, to provide long-term uninterrupted viewing of the sun, the satellite would be placed in an orbit, not around a physical body, but around the L₁ Lagrange point, an empty point in space about 1½ million kilometers from earth towards the sun, where the gravitational fields of the earth and sun balance.

(807 S)

Pure air is a rare commodity these days, especially in urban areas. It is, therefore hardly surprising that the average city nose has become insensitive to pollution. After all, generations have inhaled a mixture composed of exhaust fumes, sewage smells, and industrial chimney smoke. The result of all this is that a change in the course of evolution has taken place, practically destroying (in a lot of us), our ability to sniff out gas leaks, and household fires. It is important to detect these possible catastrophes in their early stage when they can be effectively and economically dealt with. And just think about the large amounts of odourising agent

which without too much difficulty can be incorporated into home built detection circuits.

As opposed to using radioactive elements this sensor is in the form of an NPC resistor. In other words, a resistor which has a 'negative pollution coefficient'. This is a highly technical term used to hide a very simple principle. The higher the concentration of undesired gas or compound in the air, the lower the resistance of the sensor. The addition of a comparator and display circuit creates a reasonably sensitive electronic nose.

There are two main types of NPC sensors which are suitable for the circuit described, the 812 and 813. The only difference between them is that the 812 is highly sensitive to carbon monoxide, ammonia, alcohol and benzine, making it ideal for smoke/fire detection and breathalysers, whereas the 813 is better at recognising propane, butane and methane, which is just right for finding gas leaks. The choice is left to the constructor.

The circuit

Readers will be pleasantly surprised by the electronics in figure 1, or rather by the lack of them. As can be seen very few components are required.

To the left of the circuit diagram, a standard 5V stabilised power supply is shown. As the gas detector consumes rather a lot of current, simply connecting an ordinary dry battery won't do. Further on in this article the use of lead/acid batteries is described and discussed, but, to be quite honest, the circuit should be mains powered.

Resistor R1, potentiometer P1 are connected in series with the gas sensor GS1. This network constitutes a voltage divider, the operation of which is related to the amount of pollution in the air. To put it in more down to earth terminology: the stronger the pong, the higher the voltage applied to the positive input of the comparator IC2. The reference voltage is applied to the negative input of IC2 and is determined by P2.

Assuming that the circuit is adjusted in a relatively clean environment to start with, the voltage at the negative input of IC2 (reference) will be initially higher than at the positive input. When the sensor detects something out of the ordinary this situation should reverse itself. The voltage applied to the positive input will now be higher. As a result transistor T1 will be turned on (conduct) causing the LED D7 to light and the relay Re1 to be switched on. Obviously the relay can be used to activate any kind of alarm system chosen, such as tweetters, bells or of course a ventilator. Looking at the circuit it may seem at first sight, that one of the two potentiometers is superfluous. This is not really the case, because it is a good idea to use P1 to determine the operating range of the sensor, with the

24 hour protection
against gas leaks

gas detector

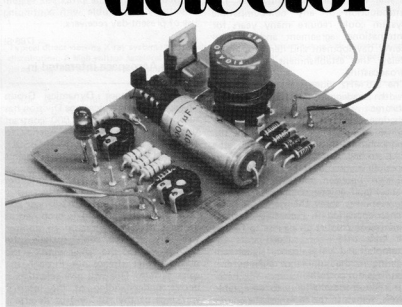

Gas is a very widely used commodity in today's energy. Most people underestimate the danger of a gas leak and the damage that can be caused if it remains undetected for a lengthy period of time. This gas sensor can raise the alarm very quickly. It can also be used to trace a leak should one occur.

that the gas board mixes with natural gas (without smell) every day at great expense to us! Waste of time perhaps?

Efficient and sophisticated detection equipment although being easily available is rather expensive. So, instead of paying a high price for equipment which makes your nose completely redundant, it would be nice to have a useful, cheap, but not so accurate device to augment the human one. Let's face it two noses are bound to be better than one, and although some busybodies try hard they still find it impossible to poke their nose in two places at once.

The Figaro Engineering Company (no not from Seville) from Japan have come up with a low priced gas-sensor

1

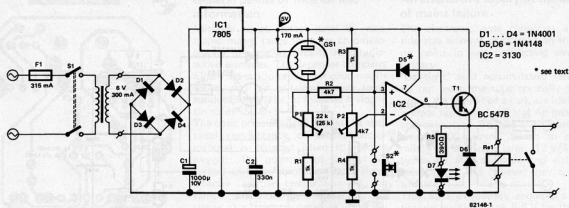
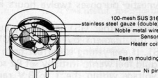
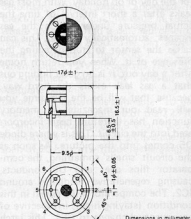
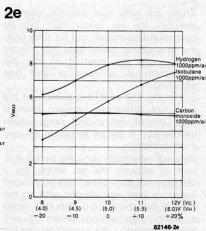
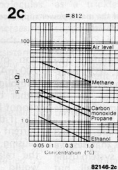
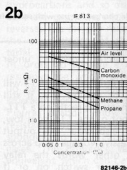
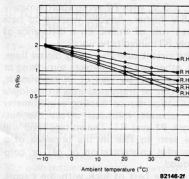
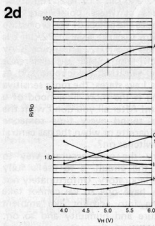
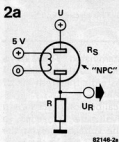

Figure 1. The circuit diagram for the gas sensor. All the components are mounted on the printed circuit board with the exception of the transformer and the relay.



TGS #812
Pins numbered 1 and 3 are connected internally.
Pins numbered 4 and 6 are connected internally.

Figure 2. The parameters and specifications of the FIGARO gas sensors type 812 and 813.

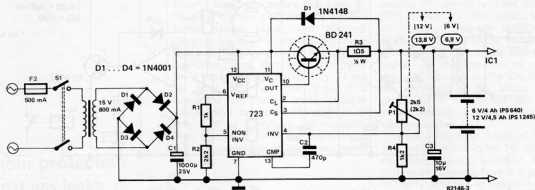

Figure 3. The circuit diagram of the mains power supply and trickle charger for use with sealed lead acid accumulators. This circuit is not mounted on the printed circuit board.

reference voltage and therefore the sensitivity being set by P2. IC2's operation is basically independent of the 'absolute' levels at either of its inputs because it has a common mode range.

Components D5 and S2 are marked with an asterisk for reasons that deserve an explanation. Any alarm system using bells and LEDs is all very well, but they are only effective as long as there is someone to hear or see them. That is certainly not the case when you are out for the day or on holiday. With most gas leaks after a short interval of time the actual pressure under which the gas escapes, automatically drops. This can cause the sensor to stop detecting the presence of it. When you return home after a day out, it is no good finding out that a gas leak exists the hard way, because that will be the last time you will read our magazine! A memory function has therefore been incorporated into the circuit. This is where diode D5 comes into the picture. As soon as the circuit 'smells' something, the comparator flips over and D5 conducts, causing regenerative feedback around IC2. The comparator will remain in this condition (staying high), irrespective of any eventual change to GS1. This latch function is maintained until the reset switch S2 is depressed.

Putting the electronic nose together

Figure 4 shows the printed circuit board of the circuit. No provision for mounting the relay onto it was made, because we know from experience that most of you have your own ideas as to the type and size to use. Keep in mind that the current level required by the relay should not be more than transistor T1 can handle. It should be below 100 mA. This will also keep the total consump-

tion of the circuit down to under 200 mA.

Although the emitter voltage of T1 will either be 0 V or around 4 V, it still cannot be connected directly to a TTL. For if the output of the TTL goes low, current would also enter this output causing an excessive voltage drop across the relay. In other words the relay would either never switch on or if already on it would certainly drop out.

There are only two possible ways of inserting the gas sensor GS1 into its corresponding socket, and for once both are correct. It really does not matter which way it's inserted as the pin assignment is symmetrical and non polarised.

Either the 812 or 813 is suitable as the only real difference between them is their overall operational range which incidentally is set by adjusting the two potentiometers.

Before finally calibrating the circuit it is best to operate the gas sensor for a certain amount of time. This may sound ludicrous (can you do one without the other?), but the point is, that GS1 needs a warming-up period before it will behave correctly. We suggest leaving the circuit switched on, permanently, for a period of two to three days. This time frame depends on the accuracy required by the user. In practice, for most domestic purposes twelve hours is sufficient.

Check whether GS1 is drawing current for the filament by touching IC1 and GS1. If everything is correct both these should feel warm. Initially set P2 so that a voltage within the 1 to 3 V range is measured at the junction of P1 and R2. After the warming-up period the circuit can be calibrated precisely, obviously in a clean environment if at all possible. Anyone with a private jet should fly the circuit to Lapland, where the air is still

relatively uncontaminated. Those of us who are prepared to settle for less will have to make do with the fresh air of the workshop.

In order for the calibration procedure to be successful a voltmeter is needed, so as to measure the voltage levels at the junction of P1 and R2 and at the junction of P2 and pin 2 of IC2. The absolute values at these points are not important as the object of the procedure is to ensure that the level at P2/pin 2 is higher than at P1/R2. The point is by how much? The smaller the difference the more sensitive the circuit and as Murphy's Law states; the more sensitive something is the more likelihood of a false alarm! After all you don't want the alarm to sound every time someone lights a cigarette or when the gas central heating switches on?

In theory the only accurate way to calibrate the circuit is to use a fully equipped laboratory. Unfortunately not all of us have one so we cannot take everything into account like ambient temperature and humidity and so on. By a process of elimination we found the prototype worked well when P1 was set to give a reading of between 1...3 V, with P2 set to approximately 0.5 V higher. Anyone wishing to base their rule of thumb on a difference of only 50 millivolts will be warned!

The circuit operates along digital lines. In other words, it detects something or it does not. By way of an experiment, this can be translated into an analogue indication by connecting a multimeter or separate voltmeter across the network P1 and R1. The voltage level will be seen to rise in the presence of a harmful concentration of gas or compound.

And the best of luck with the circuit, keeping in mind that it is not going to tell you when your son has been smoking in the outside loo again.

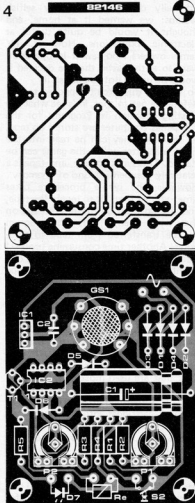

Figure 4. The printed circuit board for the gas detector circuit.

Parts list

Resistors:

- R1, R3, R4 = 1 k
 R2 = 4k7
 R5 = 390 Ω
 P1 = 22 k (25 k) preset
 P2 = 4k7 (5 k) preset

Capacitors:

- C1 = 1000 μ /10 V
 C2 = 330 n

Semiconductors:

- D1, D2, D3, D4 = 1N4001
 D5 (see text), D6 = 1N4148
 D7 = LED
 T1 = BC 547B
 IC1 = 7805
 IC2 = 3130

Miscellaneous:

- GS1 = Figaro gas sensor,
 type 812 (orange) or 813 (black)
 (see text), with socket (Watford
 Electronics)
 Tr1 = 6 V/300 mA transformer
 F1 = 315 mA fuse
 S1 = dp mains switch
 S2 = push-button make contact (see text)
 Re1 = 5 V/300 . . . 650 Ω ;
 relay; make contact (not on pcb)

General points of interest and information

Methods which detect gases by electronic means range from gas chromatography to complex circuits using radioactive elements. The Japanese company Figaro set out to prove that good results could also be obtained using semiconductor material, in this case N doped tin oxide (SnO_2).

The basic principle used, is that the electrical conductance of semiconductor material is reduced when it absorbs oxygen. The quantity of oxygen absorbed and the absorption rate relates directly to the temperature of the sensor. Therefore by maintaining the sensor at a fixed temperature in normal air, its resistance should remain constant. This gives the reference value R_s . When the sensor comes into contact with gases such as carbon monoxide, hydrocarbons and so on, the molecules of these gases are also absorbed. This reverses the oxygen reaction, increasing the conductance of the sensor's material, thereby decreasing its resistance. In order to achieve a reasonably fast response the whole process is speeded up by heating the sensor's surface by several hundred degrees celsius.

Figures b and c show the decrease in resistance of the 812 and 813 corresponding to their exposure to certain gases. The reference value R_s has an equivalent which can be determined by using the formula shown in figure 2a. In this case U is the constant supply voltage, U_r being the voltage measured at the junction of the sensor and resistor R . The sensitivity and performance of the sensors is greatly affected by the voltage drop across the filament (figure d), the supply voltage (figure e), the temperature and relative humidity of the environment, (figure f). The graphs shown in figures d to f are only meant for information and general interest. This is because very few home constructors are going to have a fully equipped laboratory at their disposal, which is needed in order to calibrate the sensor accurately.

The operation of the sensor is based on lengthy absorption processes. Consequently, it takes quite a time to react to changes in environmental conditions and to different gas concentrations. If the sensor has not been in use for a while (however short), the whole warming-up and calibration procedure must be repeated.

A few useful specifications

	812	813
filament resistance	38 \pm 3 Ω	30 \pm 3 Ω
sensor resistance	1 . . . 10 k	5 . . . 15 k
R_s (1000 ppm) (isobutane)	15 mW max.	(methane) 15 mW max.
sensor dissipation	24 V max.	24 V max.
sensor voltage	650 mW	830 mW
filament dissipation	5 V \pm 0.2 V	5 V \pm 0.2 V
filament voltage	2 minutes	2 minutes
warming-up period	orange	black
colour		

An alternative supply in the event of mains failure

The electronic nose consumes a considerable amount of current, so there is no point in just connecting any old battery.

'Gas-tight' lead accumulators (and we do not mean the type normally found under the bonnet of a car), are ideal. An average type rated at 6 V/4 Ah measures approximately 66 x 33 x 127 mm and weighs 700 grammes, which to put it mildly is not very large. 12 V/4.5 Ah types are also available and although being larger and heavier, they are still suitable.

This kind of battery requires a continuous trickle charge. 6.9 V for the 6 V type and 13.8 V for the 12 V one. The circuit shown in figure 3, uses a 723 voltage regulator and can be used for independently charging the battery, or as a trickle charger/stabiliser for an alarm system switching on the battery supply in the event of a mains failure. The 723 is also useful as a stabiliser should you wish to power the gas detector by battery only. In this case every component to the left of IC1 shown in figure 1, should be omitted.

The choice of whether a 6 V or 12 V battery is used is left to the constructor, but we suggest that a 6 V one is better, but then IC1 has to be substituted for an LM2930 from National. This National IC has the advantage that the difference between input and output voltage need only be 0.6 V making it very efficient (low dissipation).

Constructors should refer to the Car Stabiliser article which appeared in Elektor's summer circuits issue in 1980, where they will find a detailed description of the LM2930. The pin assignment is identical to the 7805.

When using a 12 V battery the 7805 can be retained, with the proviso of adequate cooling.

Before any battery is connected to the circuit the output voltage of the 723 IC should be adjusted to 6.9 V or 13.8 V. The battery should have an average life span of 20 hours (without recharging).

rapid loading games

Nowadays, people tend to hate anything that seems to be a waste of time. To TV games computer owners, a major source of irritation is the time it takes to locate a program on tape and load it. The whole procedure can take as long as two or three minutes! Terrible. Two or three seconds would be infinitely better.

Faced with this problem ourselves (yes, and irritated!) we started looking for a solution — and found one. Using some further hardware, games can be stored in EPROM; a simple program can transfer any desired game to the RAM area within seconds. This is a major improvement, as you can imagine!

for the TV games
computer

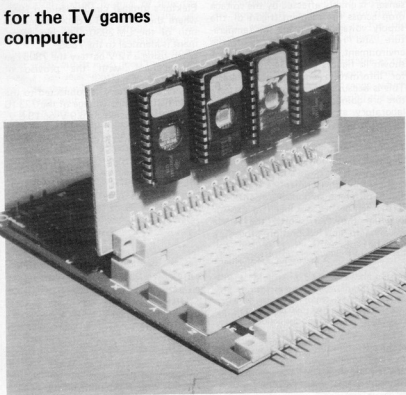

To be quite honest, this circuit was originally designed for purely selfish reasons: we wanted it at home, and thought it would be quite useful at electronic exhibitions. However, TV games owners who saw it in operation were so enthusiastic that we decided it would be unfair not to publish it!

So what is this circuit supposed to do? Before we get to that, let's see what the existing situation is. Programs for the TV games computer are stored on tape. As required, they can be read into the RAM area after which the game can be started. This works nicely, and tape is a relatively inexpensive kind of 'memory'. However, the whole procedure takes time: you've first got to locate the tape, and the position of the desired file on that tape. Then, finally, the program can be transferred from tape to computer. Another time-consuming process! Furthermore, it is not as reliable as one might wish. Interference pulses, tape drop-outs and other 'nasties' can cause the computer to reject the incoming data. A second or third try may be required before the program will load properly. Fortunately, this does not happen often — but even so, when it does happen it is infuriating!

For 'popular' games or programs — the ones that are used most! — it would be nice to have a reliable rapid-loading facility. Something that is as quick as plugging cartridges into a 'commercial' machine (but, preferably, not quite so expensive . . .) An obvious solution is to use EPROMs. However, there is one problem: many programs for the TV games computer will only run if they are stored in RAM. So what do you do? Store them in EPROM, and transfer them to RAM when you want to run them!

The basic idea

The TV games computer (even the extended version), uses only a small section of the available address space. The 2650 can handle memory from 0000 to 7FFF, but we are only using the addresses to 1FFF. All higher memory area can be used for storing programs in EPROM.

To make this system work, we need three things: some hardware for address decoding, a set of EPROMs to cover the higher address range, and a little program to transfer the desired data from EPROM to RAM area.

Basically, the upper address range (24K) is sufficient for five or ten programs. This may well be more than enough, but we preferred to make double sure.

The basic address-decoding hardware is mounted on one p.c. board, and the EPROMs are mounted (in groups of four) on plug-in extension boards. This does tend to get complicated, since the basic board is designed for plugging into the extension board for the TV games computer . . . In other words: the

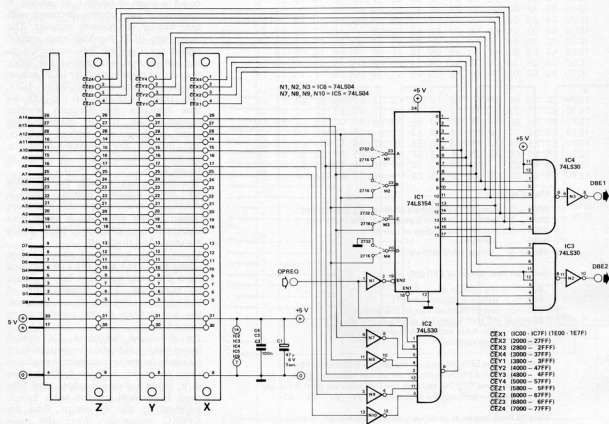

Figure 1. The basic 'rapid loader' extension board contains little more than two address decoders.

EPROM boards are plugged into a board that is plugged into the extension board that is connected to the basic TV games computer. Confusing? Yes, for now. Easy to do? Yes, definitely!

Before going into this further, we must apologise: we are going to add to the confusion! The three plug-in extension boards each contain four EPROMs, making a total of twelve. Using 'normal' 2716s, this would seem to fill the available 24K address space. However, one EPROM must contain the program-transfer routine. Therefore, we are one EPROM short, and the last 2K is left unused. If this is deemed unacceptable, we have a solution to offer: the extension boards will also accept 2732s. Six of these will cover the total area! Plus one for the transfer routine, of course. However, the boards will only cater for one type (as determined by one wire link on each plug-in board and four links on the basic board) and 2716s cannot be mixed with 2732s.

The details

As mentioned earlier, programs for the TV games computer will only run correctly if they are loaded into RAM,

in the 'normal' address area. This means that they can be stored in EPROM, at higher addresses, but not run 'up there'. Before running a program, it must be copied into the RAM area: furthermore, it is useful if the program counter (PC) is set correctly at the same time. This transfer is accomplished by means of a short auxiliary routine; to avoid problems, this routine is stored from 1C00 to 1C7F and from 1E00 to 1E7F - two unused areas, until now. This program is also stored in EPROM, on one of the plug-in boards. Note that this *must* be the first board (connector X) and the first position! The 'hex dump' is given in table 1.

The procedure for loading a new game is as follows: Enter 'PC = 1C00'. When the '+' key is operated, the computer will request a 'file number'; as soon as this is entered (again followed by a '+') the desired file will be located and transferred to RAM (provided the corresponding EPROMs are plugged in, of course!). Then the program counter will be set to the correct start address; hitting the '+' key will start the game. And that's all: rapid (a few seconds) and easy.

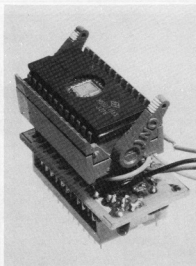

A few more points require explanation, unfortunately. Lets start with an easy one!

The hardware

This part is easy for two reasons: a) it

Table 1

1C00	76	60	75	08	06	24	3F	06	02	3F	1E	00	1A	7B	CC	08
1C10	95	3F	02	0E	3B	F4	9A	7C	06	08	20	CE	48	00	5A	7B
1C20	04	20	CC	08	00	0E	E8	00	9A	05	05	FF	20	F8	0E	C3
1C30	86	02	0E	E8	00	C1	0E	A8	00	EB	D4	18	17	77	09	84
1C40	00	3B	04	18	1C	1B	5B	C2	45	07	85	00	75	08	08	D3
1C50	44	F8	81	17	CC	08	05	3B	6F	CC	08	04	A6	02	1F	1E
1C60	1E	04	19	CC	08	96	04	11	0D	08	03	18	09	2D	08	02
1C70	20	84	01	51	9A	7B	CC	08	97	3F	02	0E	1F	1C	00	FF
1E00	20	CC	08	9F	77	02	12	9A	7D	3F	00	55	3F	01	81	F5
1E10	40	18	73	01	1A	02	05	0F	45	1F	0D	61	22	17	0E	E8
1E20	00	9A	06	44	7F	CC	08	03	20	68	81	CC	08	02	E8	F6
1E30	98	02	74	40	05	FA	0E	A8	00	C0	C0	C0	C0	C0	C0	CD
1E40	67	A6	D9	72	0F	08	00	86	01	98	04	87	01	CB	F6	0E
1E50	E8	00	CC	88	A4	3F	03	9F	EE	08	05	98	6A	EF	08	04
1E60	98	65	09	E1	02	B4	40	1C	3D	06	04	3F	02	E3	0E	00
1E70	08	A2	0D	08	A3	3F	05	29	04	0D	CC	08	9A	1F	00	38

Use of scratch:

- 0800, —1: basic EPROM address (indexed R2 in program)
- 0802, —3: section indicators (cumulative) and check bits
- 0804, —5: last EPROM address of current section
- 0895 : file number
- 08A4, —5: current RAM address

Required data format in EPROM:

- .000 : file number (0...F)
- .001 : section indicator (note 1)
- .002, —3: last EPROM address of this section
- .004, —5: PC start address of program
- .006, —7: first RAM address for this section
- .008... : program data

Note 1: for one EPROM section, the section indicator is 80;
for two EPROM sections, the section indicators are 01 — 81;
for three EPROM sections, the indicators are 01 — 02 — 83;
for four sections, the indicators are 01 — 02 — 04 — 87.

Note 2: Programs must be densely packed in EPROM. In other words, there should be no unused bytes between the 'last EPROM address of this section' and the file number for the following program.

Table 1. This routine transfers programs from EPROM back to RAM, as required. When using 2732s, it is advisable to store 450F at address 1C48, and 44F0 at 1C50.

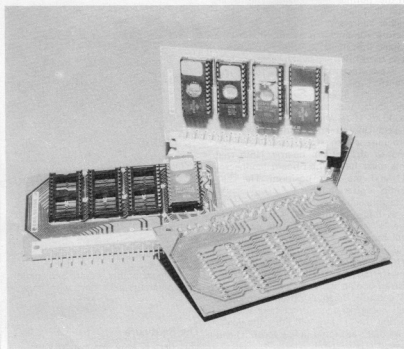

is relatively unimportant, and *b* it is easy!

The circuit for the basic extension board is given in figure 1. In essence, it consists of two address decoders with two further (combined) outputs. The main chip (IC1) provides 'chip enable' signals for the EPROMs, according to the address that is output by the 2650; the second address decoder (IC2) selects the two address ranges (1C00...1C7F and 1E00...1E7F) for the EPROM that contains the program transfer routine. Two further multiple-input gates combine the various outputs, and provide the necessary feedback to the extension board, as shown in figure 3.

The plug-in boards with the EPROMs are even simpler: witness figure 2. Address, data and chip-enable inputs are passed to the EPROMs. A single wire link determines whether 2716s or 2732s are used. And that's all!

Figure 3, as mentioned above, shows where the DBE1 and DBE2 connections from the basic extension board should be connected. This entails a bit of scratching on the p.c. board, to break the connections to the corresponding pins of this IC.

On the same 'extended TV games' board, four additional connections must be made to the first connector position; these are shown in figure 4. While we're at it, figure 5 shows a copper track that must be broken on the same board, adjacent to this connector. And the OPREQ connection from the main board is shown in figure 6. The new boards are shown in figures 7 (basic board) and 8 (EPROM plug-in board). What does all this accomplish? In a nutshell:

- the basic extension board (that is to carry the EPROM plug-in boards) is connected to the 'Interton' position on the 'extended TV games' board. This provides the bulk of the necessary signals.
- the OPREQ signal from the 2650 is connected to the new hardware.
- pins 11 and 12 of N23 on the 'TV games extension board' are disconnected from positive supply, and connected to the DBE1 and DBE2 signals. This ensures that the Data-Bus buffer is Enabled when transferring data from the new EPROMs.
- finally, the 'missing' address lines (A14, A13 and A12) are also applied to the 'Interton' connector — at pins 26, 27 and 28. Address line A11 is also required, and this entails disconnecting it from supply common.

The software

There are three points that can be considered, when discussing software: 'How to use it' (very important!), 'What it does' (interesting) and 'How it does it' (of limited interest, for enthusiasts only). In this article, we only intend to deal with the first two of these points.

There are actually three programs involved (tables 1...3). Taking it from the top: table 1 gives the 'hex dump' of the routine that transfers programs from EPROM into the RAM area, when you want to run a stored program. The 'instructions for use' are simple: start the program at PC = 1C00. Then enter the file number of the desired game; after a few seconds, 'PC = ...' will appear. Operating the '+' key will start the program. If a program was stored in more than one EPROM (more on this later), an error indication will be given if one EPROM was not plugged in: 'FIL = X-N', where X is the file number, and N is the number of the missing section. An 'L' in this position indicates that the last section was omitted, or that the file number was not used at all.

In essence, this routine is little more than a 'block transfer' with a few refinements. It scans the memory area, from 2000 on, looking for the requested file number. If it hits 'FF' (or any negative number, for that matter) in a file number position, it assumes that the remainder of that EPROM is unused and jumps to the next one. This does mean that EPROMs must be densely packed: a new program *must* follow its predecessor without leaving any unused gaps! The position of the EPROM(s) in the upper address range is unimportant: they can be plugged in anywhere. The 'RAM scratch' assignment and 'data format in EPROM' are summarised below table 1.

One important point should be noted. When using 2732's for program storage, it is advisable to store 450F at address 1C48 and 44F0 at 1C50.

Given a program that will transfer data from EPROM to RAM, the next question is: how did the data get into EPROM in the first place? Easy! It was transferred from RAM to EPROM, by means of the program given in table 2! This routine is a variation on the one given in chapter 21 of the TV games computer book. It uses the plug-in EPROM programmer, as described in the book - in fact, programming can be simplified considerably by using several programmers in consecutive EPROM sockets.

As before, 'instructions for use' come first. The EPROM with this program is inserted in the same position as the previous one, since it uses the same address range (1C00...1C7F and 1E00...1E7F). This is the only unused address range on the same 'page' as a RAM area, so there is no other solution! The program is started, as before, at 1C00. Based on the data that is located from 1BD0 on (details are included below table 2), it will first display the next EPROM range that it intends to program. If this meets the programmers approval, he can operate the WCAS key. Normally speaking, the EPROM will then be programmed. Possible errors are indicated: if the

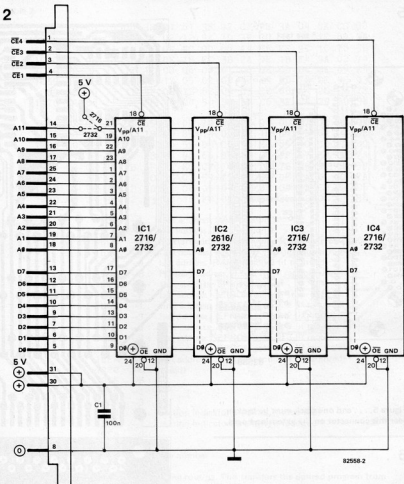

Figure 2. The plug-in modules are even simpler: they consist of nothing more than EPROMs!

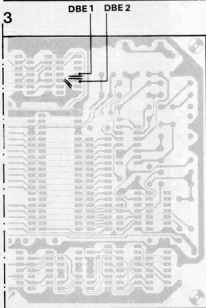

Figure 3. The DBE1 and DBE2 signals are connected to pins 11 and 12 of IC27 on the existing TV games extension board.

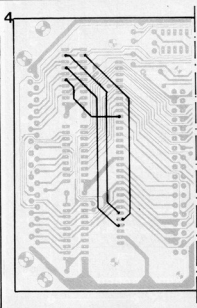
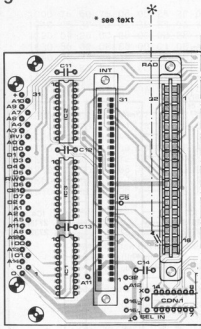

Figure 4. Four new connections must be made to the 'Interten' connector on the existing extension board...

5



82558-5

Figure 5. . . and one track must be broken, near this connector on the extension board.

6

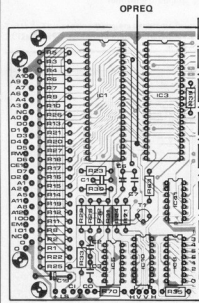

82558-6

Figure 6. The OPREQ signal is available at this point on the basic TV games board.

7

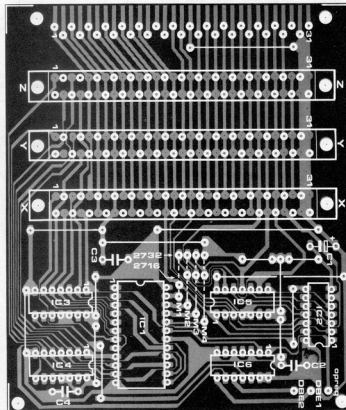
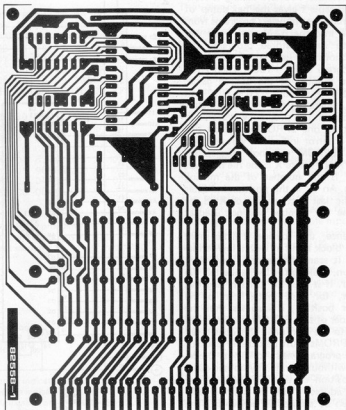

Figure 7. The basic 'rapid loader' extension board. Note that four wire links determine the choice of EPROM (2716 or 2732)!

In order to load a program, one must first know the 'begin' and 'end' address. This information is rarely available, and simply storing the whole range (00C0 to 0FFF, say) is rather wasteful. One solution is to shorten the program on a trial-and-error basis: successively storing shorter sections on tape, and then testing to see whether they still contain sufficient data.

As far as the programs on ESS tapes are concerned, the new ones will include this information; for the existing tapes it is listed below. Note that a few programs use two RAM sections!

ESS 007

File	Beg	End	(Beg 2	End 2)
1	0900	0FCE		
2	0900	0FFF		
3	0900	0E97		
4	08C0	0FFF		
5	08C0	0E84		
6	0900	0DFF		
7	08D0	0E77		
8	08C0	0FFF		
9	0900	0FFF		
A	0900	0AF9		
B	0900	0BCA		
C	0900	0FFF		
D	08C0	08F6	1F80	1FAD
E	08C0	0FFF		
F	0900	0F8E		

ESS 009

File	Beg	End		
1	08C0	0FFF		
2	08C0	0F8F		
3	08C0	0FFF	1F58	1FAC
4	0900	0FFF		
5	08C0	1210		
6	08C0	19B7		
7	08C0	0FFF		
8	08C0	0FFF		
9	08C0	0FFF	1F58	1FAD
A	0900	0FFF		
B	08C0	0FFF		
C	08E8	0C93	(PC = 0932!)	
D	08C0	0DEE		
E	0900	0FFF		
F	08C0	0FFF		

Parts list for figure 7

C1 = 47 μ 6V3 (tant)
 C2...C4 = 100 n
 IC1 = 74LS154
 IC2, IC3, IC4 = 74LS30
 IC5 = 74LS04
 3 connectors = 31-pole female,
 DIN-41617

Parts list for figure 8

C1 = 100 n
 IC1...IC4 = 2716 or 2732
 (see text)
 1 connector = 31-pole male,
 DIN-41617

Table 2

1C00	76	60	75	08	3F	01	61	3F	02	CF	3B	3A	04	8A	CC	08
1C10	94	3F	02	0E	77	02	12	9A	7D	3F	00	55	0C	1E	89	9A
1C20	75	08	FA	1A	7C	04	4C	0D	88	A4	E5	FF	9C	1C	78	3B
1C30	25	98	72	3B	11	0E	1B	FC	3B	2A	0E	1B	F4	9A	02	74
1C40	40	3B	21	1F	1E	00	06	04	07	08	0E	5B	DC	6E	68	A4
1C50	3F	03	53	5B	75	17	05	02	0D	48	A4	ED	7B	DE	9C	03
1C60	9F	59	75	17	3B	02	1E	6E	05	03	CE	88	A4	20	F8	7E
1C70	EE	88	A4	14	F9	74	04	5D	CC	1F	C6	3F	04	2B	9B	38

1E00	07	06	0F	5E	65	C1	0D	7B	D0	C2	98	0D	E7	03	98	09
1E10	0C	1B	DB	CC	1B	D5	0E	1B	DA	3F	1C	64	5B	64	0E	9B
1E20	D0	05	02	77	09	0D	5B	D0	CC	7B	EC	84	00	CD	7B	D0
1E30	59	73	75	08	3B	E4	98	66	B4	40	98	2F	07	F4	0F	7A
1E40	FC	CF	7A	FB	0F	7A	EC	CF	7A	E8	DB	72	05	02	0D	5B
1E50	EC	ED	7B	D2	9C	1C	07	59	75	07	FA	0F	7A	DC	CF	7A
1E60	D6	DB	78	1B	F0	01	00	05	04	0F	0E	04	2A	CC	1F	C6
1E70	06	24	3F	02	E3	0D	1B	FC	08	94	3F	02	0E	9B	38	

Required data:

1BD0	-1	: first address, RAM section 1
1BD2	-3	: last address, RAM section 1
1BD4	-5	: PC start address, if only one RAM section; else 00--
1BD6	-7	: first address, RAM section 2 (if required)
1BD8	-9	: last address, RAM section 2 (if required)
1BDA	-B	: PC start address, if two RAM sections used
1BDC	-D	: first address, EPROM section 1
1BDE	-F	: last address, EPROM section 1
1BE0	-1	: first address, EPROM section 2 (if required)
1BE2	-3	: last address, EPROM section 2 (if required)
1BE4	-5	: first address, EPROM section 3 (if required)
1BE6	-7	: last address, EPROM section 3 (if required)
1BE8	-9	: first address, EPROM section 4 (if required)
1BEA	-B	: last address, EPROM section 4 (if required)
1BEC	-D	: (used)
1BEE	-F	: -
1BF0	-1	: -
1BF2	-3	: -
1BF4	-5	: section indicator 1 (and 2, if required)
1BF6	-7	: section indicators 3 and 4, if required
1BF8	-9	: -
1BFA	-B	: -
1BFC		: file number
1BFD...F		: -

Table 2. The actual EPROM programming routine. This transfers the desired program from RAM to EPROM, as determined by the data from 1BD0 on.

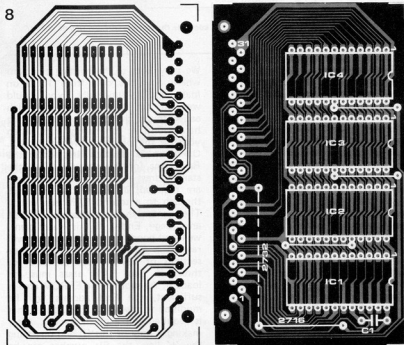

Figure 8. The EPROM plug-in board. The position of one wire link is determined by the choice of EPROM type.

Table 3	2000	1B	02	21	FF	76	60	75	18	07	04	3F	21	03	04	AC	C8
	2010	AC	04	01	C8	AA	04	04	C8	A8	04	FF	C8	A6	06	18	3F
	2020	21	31	06	1C	3B	FA	3F	21	D5	C9	06	20	3B	F1	08	
	2030	94	98	16	B4	40	98	12	74	40	1B	62	08	A2	08	7E	1B
	2040	FD	1B	FE	1B	FF	1B	04	08	84	07	0A	05	06	3F	21	05
	2050	04	AC	C8	F3	07	0B	CB	EB	1B	09	B4	40	1C	20	CC	76
	2060	40	07	14	77	09	05	02	20	8D	0C	C4	CD	E1	D3	0D	E0
	2070	C6	CD	E0	C4	59	71	08	C7	DD	C8	C4	E4	20	1C	21	EC
	2080	BF	21	8D	07	0B	C2	09	B8	60	1A	03	61	98	68	77	09
	2090	0B	B0	0F	E1	49	08	05	45	81	CF	E0	C8	C1	0F	C1	A9
	20A0	CF	E0	45	82	CF	E0	C8	77	01	A5	01	A4	00	75	08	C2
	20B0	CF	E1	49	01	CF	A1	49	87	04	CB	87	1F	20	5A	1B	FD
	20C0	1B	F3	1B	FF	1B	EE	1B	EC	1B	D2	1B	FC	3F	05	29	04
	20D0	2A	C8	AA	04	C0	C8	A8	3F	21	56	04	80	06	24	3F	21
	20E0	51	08	9E	C8	E5	08	D7	50	50	C3	05	80	01	63	E3	18
	20F0	03	C3	D1	01	CE	A0	C0	1C	1C	00	1B	71	C0	1F	C6	1B
	2100	FB	08	95	05	04	77	10	3F	02	CF	75	10	0F	41	1A	CD
	2110	C1	18	59	78	3F	02	0E	17	08	90	15	0A	AA	E6	0E	14
	2120	15	00	AA	E6	AA	00	10	00	8A	17	8A	15	0E	14	0E	0A
	2130	BC	20	3B	1D	0A	8F	05	FE	0D	E1	47	CE	A1	49	D9	78
	2140	CA	83	DA	00	17	1B	FF	07	A4	1B	D0	08	A7	08	9F	1B
	2150	FB	C8	FC	3F	06	02	77	02	20	C8	F0	08	F0	44	7F	C8
	2160	EC	12	9A	7D	3F	00	55	3F	01	81	F5	40	18	73	01	9A
	2170	70	45	17	0D	E1	92	9A	05	E4	E0	14	1B	5E	09	D0	1A
	2180	07	C8	91	3F	05	2F	1B	53	D1	1A	50	C8	89	3F	02	E0
	2190	1B	49	01	22	08	A1	08	95	06	18	3F	21	31	06	1C	3B
	21A0	FA	0A	A6	DA	00	07	06	3B	2E	77	09	09	A0	A5	07	C9
	21B0	9C	A4	00	C8	9A	75	08	06	24	07	08	60	1A	03	61	98
	21C0	16	08	86	A4	04	C8	82	1B	4F	1B	FF	1B	FE	1B	F1	1B
	21D0	F0	1B	CE	1B	F2	0B	F4	05	02	77	09	0E	C1	49	AE	E1
	21E0	D1	CF	C0	C6	F9	75	CB	83	75	09	17	00	07	0F	05	05
	21F0	3F	02	D9	3F	21	0C	07	17	05	08	3F	21	05	1F	20	00

Table 3. This calculation routine greatly simplifies the job of loading all the necessary data from 1BD0 on!

9

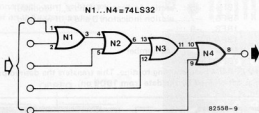

Figure 9. A five-input NOR gate can be used to combine the various OPACK signals, if four EPROM programmers are available.

EPROM section is not 'empty', the first programmed (EPROM) address, with its data, are displayed on a red screen; if programming fails at some address, this is displayed on a purple screen. If all goes well, however, this (section of the) program will be stored correctly: file number, section indicator, last EPROM address for this section, PC start address for the program, first RAM address for this section and program data — all as shown below table 1. If further program sections are required (as described later), the next section to be stored will now appear on the display. If the next EPROM is inserted, on a programmer board, WCAS can be operated again. Alternatively, the current data from 1BD0...1BFF can be stored (operate Reset to return to monitor!); switch off, not forgetting the 25 V supply (!), and plug in the correct units; switch on and reload the program and the data from 1BD0 on; restart at 1C00. When the last section of program is stored, the file number will be displayed on a green screen.

We now come to the burning question: where does the data from 1BD0 on materialise? Admittedly, you could work it out yourself. But it's much easier to let the computer do all the hard work! It can hardly miss, when you use the program given in table 3. Operation is simple. First, enter the RAM area for the program. Then the start address — unless two RAM areas are required, in which case '+' steps through to a second RAM area entry. Then enter the next vacant EPROM area (Beg=, End=). If this is sufficient, well and good; if not, the program will request a further section. Up to four sections of EPROM can be used (or three, if two RAM areas must be loaded). As soon as the EPROM area is sufficient, the End address will be modified to the actual End address that is required (on a green screen). After making a note of this (!) and operating the '+' key, the file number can be entered (00...0F). The program then branches to 1C00, which is just right if the EPROM with program 2 is installed!

In conclusion

This useful extension for the TV games computer consists of quite a few bits and pieces of hardware and software. A brief summary may prove helpful:

- The basic extension board (figures 1 and 7) is plugged into the Intertcon position on the TV games extension board. Two further connections are made to the extension board (DBE1 and DBE2, see figure 3), four connections are made on that board (figure 4) and one copper track is broken (figure 5).
- The OPREQ connection is taken from the main TV games computer board, as shown in figure 6.
- Up to three EPROM plug-in boards (figures 2 and 8) can be inserted in the basic extension board.
- One or more (up to four) plug-in EPROM programmers are built, as described in chapter 21 of the TV games computer book. Connections to the main board of the TV games computer are also described there; it should be noted, however, that a multiple-input OR gate must be used to combine the various OPACK signals, if more than one EPROM programmer is connected. A suitable circuit is shown in figure 9.
- The calculation routine (table 3) is stored from address 2000...21FF. In other words: the second EPROM position on the first plug-in board. The EPROM programming routine (table 2) is located in the first EPROM on this board: addresses 1C00...1C7F and 1E00...1E7F. (Note that these EPROMs can be programmed by means of the plug-in programmer! A suitable routine is given in the book, as table 48; however, the instruction at 191C must be deleted — C0, C0 — to program the EPROM from 2000 on.)
- Programs can now be stored in EPROM. First enter the RAM and EPROM addresses, using the calculation routine as described earlier; then initiate the actual programming by means of the WCAS key.
- When programming is completed, replace the first EPROM on the first plug-in board: this position should now contain the transfer routine given in table 1. It will transfer a program from EPROM to RAM, as soon as the file number is entered. Note that the programmed EPROMs can be mounted in any position on any of the plug-in boards: the transfer routine will locate all relevant sections without difficulty. One final note, for those who hate 'wasting' EPROM area. The routines given in tables 1 and 2 must be located in those address ranges, as mentioned earlier, and the remaining space in these two EPROMs must unfortunately be left unused. However, the program given in table 3 is initiated in such a way that the area from 2200 on can be used for storing games programs! That EPROM, therefore, can be used to the full.

the Elektor connection

a link between the Junior and interface board

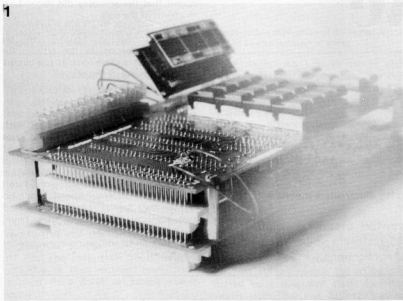
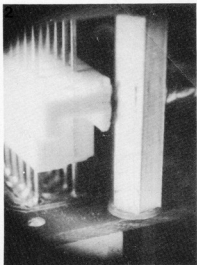

As the old saying goes, 'it's simple, when you know how', most of the really good ideas and inventions over the last century have been simple and so it is with the solution to an old problem outlined in this article. The idea is so straightforward that all our design staff were astonished! A low cost electronic connection between the main J.C. boards and the interface!

Once more an active and resourceful reader has come up with a relatively brilliant idea!

F. Richter

Despite all the solutions presented by our design staff in the May 1981 issue, and in the Junior Book 3, problems still existed.

The main disadvantages of the original system were:

- Too costly.
- Relocation of the interface board presented problems.
- The bus board for the interface was a relatively long distance away from the main construction.
- The way the bus board was designed could easily lead to short circuits.

Without doubt the solution presented by our reader gets over most if not all these problems.

Figure 1 clearly illustrates how it is done. Female connectors with wrap-around pins are used. One multiway connector also serves as the physical foundations of the sandwich type construction.

First of all a connector is mounted onto the interface board and obviously soldered into place. The wrap-around pins protruding from the copper side are then plugged into a second multiway connector, which in turn has been mounted onto the main base board.

Could it be simpler?

The distance between the boards should not be less than 1.5 cm otherwise some of the components will snag the construction. The tallest components to watch out for are switches S1 and S2. And please remember that the quartz crystal must be remounted at 90 degrees to the vertical (flat), over IC6.

When screwing the 'sandwich' together some of the plastic surrounds of the connectors (at each end), may get in the way of the spacers. This problem can be solved very easily by sawing off a small piece of the connector (see figure 2).

By the way, we certainly don't have any objection against receiving more of these ingenious ideas from our readers. Get your thinking caps on!

Most readers will remember the old principle of induction, forced upon us by enthusiastic teachers in our school days. No? Never mind we had to look it up as well!

The universally accepted principle is that when a current flows through a conductor, a magnetic field is created around it. Winding the wire (conductor) into a coil will mean that the magnetic field of each individual winding is added to the relatively homogeneous field at the core of the completed coil. The result is that a type of electro-magnet is created which has a negative and a positive end or pole, very similar to a permanent magnet. On we go with the physics lecture!

The coil's inductivity can be calculated by using the formula:

$$L = \mu_0 \cdot \mu_r \cdot N^2 \cdot D/l.$$

So, besides the number of windings N

and the geometric dimensions (D/l), the inductivity (L) is also dependent on the relative permeability (μ_r). What we mean by this is best explained by the fact that an iron rod which fills the inner space of the coil completely (no air gap), gives the maximum possible induction. When compared with a coil without a rod the induction is approximately 6000 times greater! This maximum value will never be realised with this circuit simply because we do not push the rod all the way. We will explain this later on in the article.

As most of you have already guessed, the principle of the inductive sensor is based upon the fact that the inductivity of the coil will vary according to the space taken up by the rod.

By using this principle we can now make physical distance proportional to an electrical signal. Couldn't be simpler, well, maybe! Some of you may be surprised to learn that the prototype was accurate to ± 0.01 mm over a distance of a few centimeters, even though we found that the accuracy did depend on the form of the coil.

How to combine the sensor to the circuit as shown in figure 7 will be explained later on in the article. We thought that a close look at the circuit would be better at this stage.

inductive sensor

have coil will travel

Anyone wishing to measure something by electronics means will often require some kind of converter.

This article introduces a distance meter which uses the principle of induction. The result is an easy to build, relatively simple to calibrate, measuring circuit, with a wide range of applications.

The circuit

A Wien bridge oscillator together with an amplitude stabiliser (A1) produces a sine wave signal with a frequency of approximately 13 kHz. This signal is in turn fed to a Wheatstone bridge via a power stage mainly consisting of T1 and T2. The Wheatstone bridge is made up by the two partial resistors of P1 and two identical coils, one of them being the coil of the sensor. The formula to use, in order to achieve a balanced bridge, is

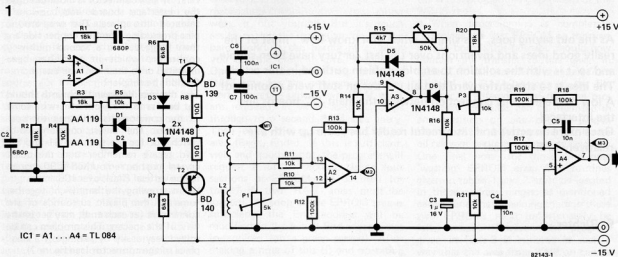

Figure 1. The circuit diagram of the sensor, showing the points at which the voltage are to be measured for correct calibration. A DVM or analogue voltmeter is all that is required to complete the instrument.

2

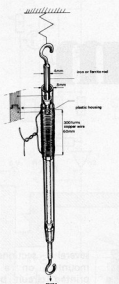

Figure 2. The coil for the prototype used is a ballpoint pen plastic housing as the coil former with a 4 mm iron rod inserted into it.

$$X_{L1}/X_{L2} = R_{pa}/R_{pb}$$

In the circuit, the A.C. voltage levels of the differential amplifier inputs are identical. Consequently, the A.C. voltage level at its output will be approximately 0 V.

As already explained the inductivity of the coil changes with the position of the iron or ferrite rod. By moving the rod, the bridge will become unbalanced and the input voltages of the differential amplifier will no longer be identical. The result of all this is that pushing the rod further into the coil will result in a higher A.C. voltage level at the output of A2. The output of the differential amplifier is then rectified ready to be applied to a DVM or analogue voltmeter.

The coil

The circuit just described is suitable for any type of coil. However, tests with the prototype have shown that a coil identical to the one shown in figure 2, produced the best results. Therefore, for simplicity's sake we have based all our calculations and calibration procedures on this type.

The coil consists of a plastic housing of approximately 8 mm. We actually used the case of an ordinary ballpoint pen. Three hundred turns of 0.2...0.3 mm enamelled copper wire are wound on to the housing over a length of 6 cm. Keep in mind that fewer windings would increase the load on the power stage of the circuit (T1/T2). Two identical coils have to be made (L1 and L2). As long as the coils are made along the lines specified you will find that the induction of each coil will have a value of 95 μ H. One of these coils can serve as the dis-

3

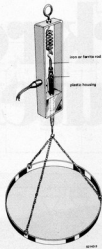

Figure 3. One application of the sensor as used in an electronic set of scales.

tance meter. An iron or ferrite rod, which must be longer than the coil housing has to be inserted into it. The prototype used is an iron rod 13 cm long and 4 mm in diameter.

Obviously different coils can be constructed for other purposes, but, as the applications are many, we have left that to the reader's discretion. An example of an electronic scale or, we should say a pair of scales is shown in figure 3.

Calibration

In order to calibrate the circuit correctly an induction curve has to be drawn as shown in figure 4.

First of all the circuit has to be calibrated in a quiescent state. In other words with the rod fully extracted. Check that the oscillator is operating correctly (giving a 13 kHz sine wave), by measuring the A.C. voltage at point M1 as shown in the circuit. If everything is correct then the voltmeter should read approximately 1 V_{rms}. The next step is to connect the voltmeter to point M2 on the circuit. P1 should be adjusted until there is a minimum output from the differential amplifier A2. The prototype gave a reading of approximately 0.074 V_{rms}. A DVM or analogue voltmeter set to the D.C. range is connected to the output of the circuit (M3).

Before going further, just like the famous professor, who had a biological problem to solve. We need pencil and paper to work it all out, plus a ruler. Push the rod in one mm at a time taking a note of the voltage reading at the output. From the results a graph should be drawn (see figure 4). You will notice from the graph that the relationship between the movement of the rod and

4

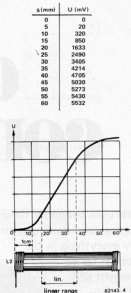

Figure 4. The relationship between the movement of the rod and the voltage drawn as a graph. A necessary requirement for correct calibration.

the voltage level at the output is only linear over a specific range. Armed with all these data the sensor can now be calibrated precisely.

Push the rod into the coil until the start of the linear range and take a note of the voltage reading at the output. Now push the rod a further 1 cm exactly, and adjust P2 to give a reading precisely 1 V higher. Finally return the rod once again to the start of the linear range and set P3 to give a reading of 0 V. This completes the calibration procedures as the aim is to achieve a linear relationship of 1 V per cm.

Applications

The circuit described is meant as a starting point for different designs. It serves as the basic ground work needed before the constructor can go on to design sophisticated measuring instruments. In other words we found it to be a good teaching aid. Obviously some applications come immediately to mind. These are, the scales as shown in figure 3, for the measurements of thicknesses, level indicators and even in the study of earthquakes. A more down to earth application is for measuring the depth of tread on a tyre, and so on and so forth.

When designing a particular measuring instrument using the principles outlined in this article, there is one fact that must be taken into account at all times. You must ensure that the magnetic field of the coil does not saturate the iron rod! Apart from that, obviously any change in the specification of the coil will require appropriate changes in the component values, but, the basic principles will always remain the same. ■

darkroom computer

The darkroom computer described here is capable of dealing with virtually everything in the darkroom as far as measurement and control is concerned. It is an exposure

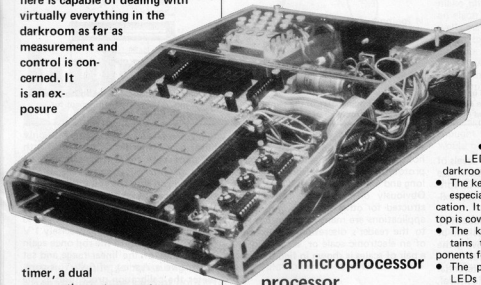

timer, a dual process timer, temperature meter, photometer and contrast meter.

The darkroom computer is based on the well-known 6502 microprocessor and a capacitive keyboard designed specifically for this application. Construction is relatively easy while overall cost is far less than the equivalent commercial systems.

PART 1

a microprocessor processor

The timing of publication of this article is no accident and was planned for the photographic enthusiasts among our readers who look forward to developing the results of their summer photographic sessions round about September. The darkroom computer was designed to take the guesswork out of the darkroom.

The microcomputer used is the 6502 and the system will cater for black and white processing as well as colour. For black and white processing, the computer functions as an exposure timer or process timer (for paper and film development), photometer, contrast meter and a temperature meter. For colour processing it is equipped with a second process timer with ten pre-settable time periods. However, it is not a colour analyser, since this would not only make the circuit far more complex, but mechanical construction would present difficulties. A detailed description of the uses of the darkroom processor are contained in the chapter headed 'Instructions for use'.

The darkroom processor is divided into

several sections, each mounted on a separate printed circuit board and there are a total of seven boards in all:

- The processor board. A small 6502 system that forms the heart of the circuit.
- The display board. Obviously LED-displays are necessary for the darkroom.
- The keyboard. A capacitive keyboard especially designed for this application. It can be lit from behind and the top is covered with a protecting layer.
- The keyboard interface board contains the necessary electronic components for the capacitive keyboard.
- The process timer board. The 25 LEDs are used as the timing indicator.
- The photometer board, with which the light and contrast can be measured.
- The temperature meter board. For accurate temperature measurements of the several baths.

The project is fairly complex and for this reason it was decided to divide it into two separate articles. In this issue we will give a description of the computer itself together with its display and special keyboard. Instructions for use are also included. A closer look at the accessories; the process timer, the light meter and temperature meter will follow in the next article.

The microprocessor circuit

Regular readers may see from figure 1 that the microprocessor circuit is virtually identical to that of the '6502 housekeeper' that was published in the May 1982 issue. In fact the same printed circuit board is used. For a detailed description of the circuit we refer readers to this article as it will be covered only briefly here.

As can be seen from figure 1, the circuit consists of three main ICs. The 6502 microprocessor itself is IC1. This is

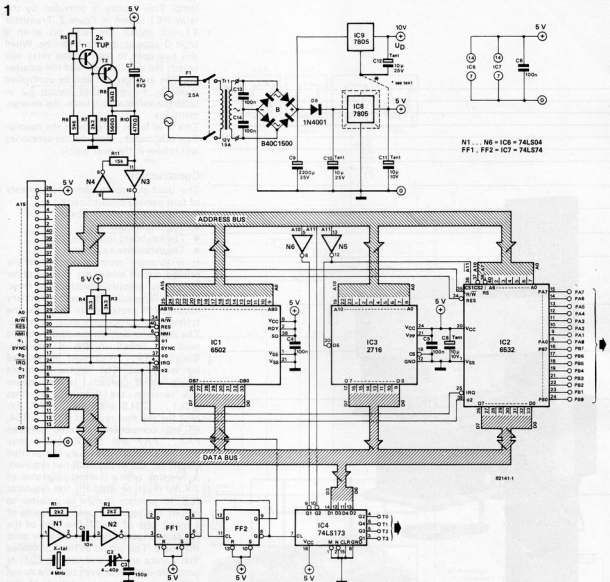
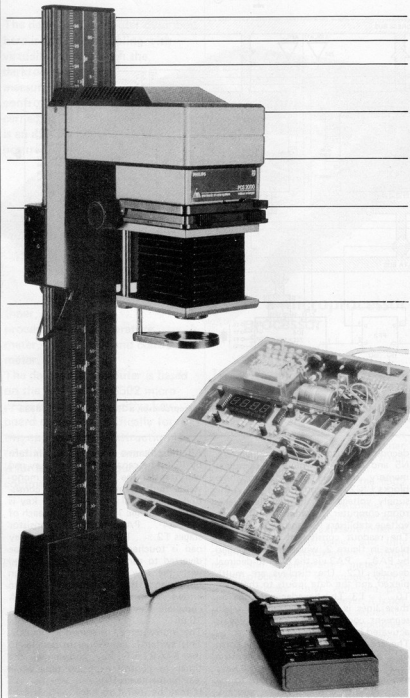

Figure 1. The circuit diagram of the microprocessor section. The system mainly consists of a 6502 microprocessor, a 2716 EPROM and a 6532 RIOT (which contains a RAM, I/O lines and a timer).

followed by the 2716 EPROM IC3, which contains the necessary software. The third major 'box' in the circuit, IC2, consists of a 6532. This IC is the interface between the computer and the outside world. It contains 16 I/Q lines and takes care of the keyboard, display, process timer and the light and temperature meters. The 6532 also contains a timer which is used for the two process timers and the enlarger. The 128 byte RAM in the 6532 is used to store the temporary data and the process and alarm times given by the keyboard. The 1MHz clock signal required by the processor is supplied by a 4MHz crystal oscillator and a divider-by-four, consisting of FF1 and FF2. The circuit around T1, T2 and N3 and N4 provides a reset signal when the power supply is initially switched on. The address

decoding consists only of two inverters, N5 and N6, with which the complete memory range is divided into three blocks (IC2, IC3 and IC4). Finally, the supply voltage for the complete darkroom computer is produced by the two voltage stabilisers IC8 and IC9. The readout consists of the four displays in figure 2, which are multiplied by PA0...PA3 via the BCD-to-decimal decoder IC2. The displays are multiplexed and the data inputs to them are T0...T3. The hexadecimal code on these lines is converted into the seven segment code by IC1. Each display is activated for about 25 ms. The capacitive keyboard is in the form of a printed circuit board. It consists of 20 keys, arranged in 5 rows of 4 keys and each key pad only needs to be touched with a finger tip to operate.

All the columns are pulled low in turn by IC2. The capacitance of the key pad will transfer the pulse to the 4 monostable multivibrators (MMV's) consisting of gates N1...N8. If no key is touched, a logic 1 will appear on each of the PA4...PA7 lines, via the transistor stages T2...T5. However, when a key pad is touched, the scan pulse will be diverted to earth. The MMV associated with the row will not receive a scan pulse and the microprocessor then knows which key has been touched. A complete keyboard scan takes about 10 ms. The footswitch S1 is shown in figure 2. This switch is connected in parallel to the START/ST. key and allows the timer to control exposure time while leaving the hands free. It may be useful to have the safe light



operate in conjunction with the enlarger lamp. This facility is provided by the relay RE1 shown in figure 2. Transistor T1 will switch the relay on when a logic 0 appears on the PB5 line. When this line goes to logic 1, the relay will switch the safe light off and the enlarger on. The enlarger can also be controlled manually by means of switch S2 in order to refocus or change the enlargement size.

This is as far as we go with the description this month, more on the accessories will follow in the next article.

Construction

The basic darkroom computer consists of four printed circuit boards:

- The microprocessor board.
- The display board.
- The keyboard interface.
- The capacitive keyboard.

It is strongly recommended that the printed circuit boards are used in order to greatly simplify construction. However, it is possible to use an ordinary keyboard if preferred. In this case the following modifications must be made: The A/B wire link on the display board must be linked in the B position. Resistors R9 . . . R13 must be replaced by wire links. The normal keyboard (using 'make' contacts) is then mounted between the junctions of lines COL1 . . . COL5 and PA4 . . . PA7. Except for the four resistors R31 . . . R34, all the components situated between PA4 . . . PA7 and the keyboard may now be omitted. Obviously the printed circuit for the keyboard is not required. A heatsink with a thermal resistance of 7°C/W must be used for the regulator IC8. In practice it may be possible to mount the regulator onto the inside of a metal case (if used). The pins of the regulator must be soldered directly onto the board. This would be ideal, provided that a mica washer and heat conductive paste are used. It is even possible to cut off the power supply section of the printed circuit board and mount it elsewhere, if that happens to be more convenient. In any event, ensure that the case is well ventilated or IC8 will get hot under the collar. There is a minor modification to the board with respect to IC9 (the second regulator). The track between the common terminals (centre lead) of this regulator and the earth plane at the edge of the board (the wide track) must be cut. The section of track left, connecting the common terminal of IC9 and the negative end of C12, must now be linked with a short length of wire to the +5 V output of IC8. This modification must be made because the board was designed for the 6502 'house-keeper' which needed two 5 V rails. Here we need +5 V and +10 V. If a 7810 can be found it can be soldered directly into the board in the position for IC9 without the need for any modifications, but they are very thin on the ground. No heatsink is required for IC9. Do not forget to check that the

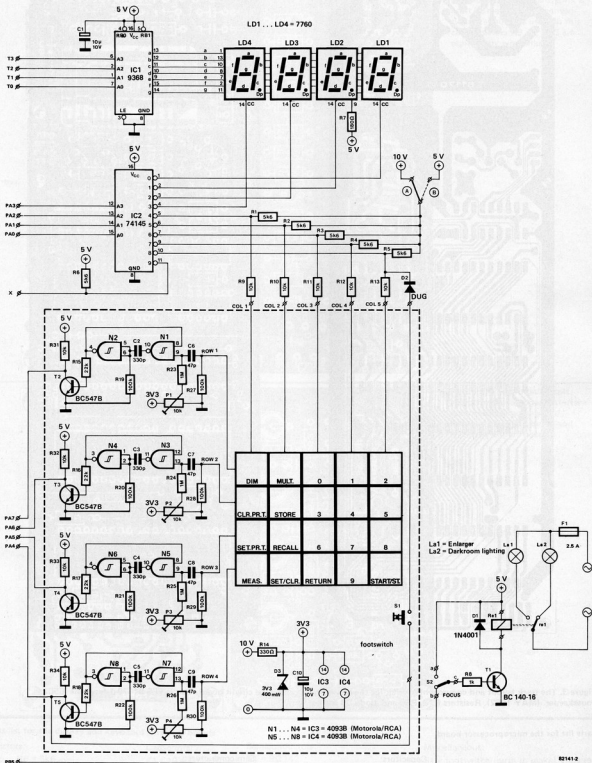

Figure 2. The circuit diagram of the display and keyboard. It is a capacitive keyboard which requires only a light touch to operate.

3

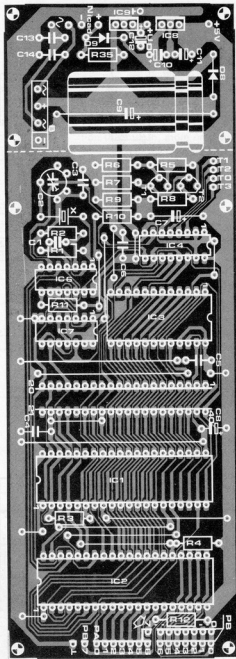
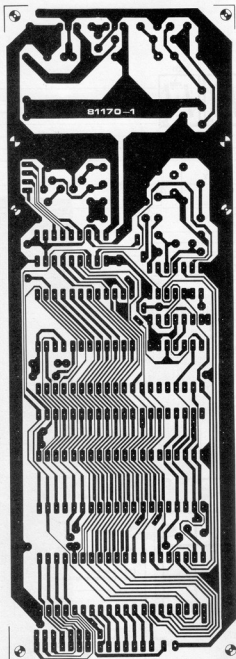

Figure 3. The track layout and component overlay for the microprocessor printed circuit board. This is EPS 81170-1 from the '6502 housekeeper' (MAY 1982). Resistors R12, R35 and diode D9 are not required.

Parts list for the microprocessor board

Resistors:

R1,R2,R7 = 2k2
 R3,R4 = 3k3
 R5 = 1 k
 R6 = 5k6
 R8 = 56 Ω
 R9 = 560 Ω
 R10 = 470 Ω
 R11 = 15 k

Capacitors:

C1 = 10 n ceramic
 C2 = 4 . . . 40 p trimmer
 C3 = 150 p
 C4,C5,C6,C13,C14 = 100 n
 C7 = 47 μ/6,3 V
 C8,C11 = 10 μ/10 V Tantalum
 C9 = 2200 μ/25 V
 C10,C12 = 10 μ/25 V Tantalum

Semiconductors:

T1,T2 = TUP
 IC1 = 6502
 IC2 = 6532
 IC3 = 2716
 IC4 = 74LS173
 IC6 = 74LS04
 IC7 = 74LS74
 IC8 = 7805

IC9 = 7805 (or 7810)
 D8 = 1N4001
 B = B40C1500 bridge

Miscellaneous:

Tr = 12 V/1.5 A transformer
 X = 4 MHz crystal
 heat sink for IC8 (7°C/W or better)

4

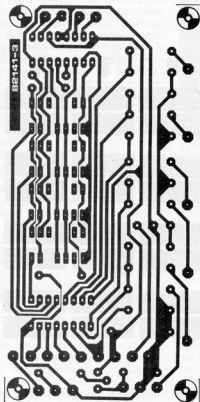

Figure 4. The display board. Wire link A must be fitted when using the capacitive keyboard. Link B must be made when a conventional keyboard is used. In this case, resistors R9 ... R13 are replaced by wire links.

5

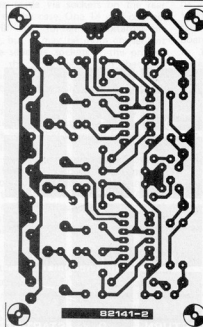

Figure 5. The printed circuit board for the keyboard interface. A footswitch can be wired between S1 of this board and S1 of the display board.

Parts list for the display and keyboard interface boards

Resistors:	Capacitors:	Semiconductors:	Miscellaneous:
R1 ... R6 = 5k6	C1, C10 = 10 μ /10 V	T1 = BC 142	S1 = footswitch (push to make)
R7 = 180 Ω	C2 ... C5 = 330 p	T2 ... T5 = BC 547B	S2 = changeover switch
R8 = 1 k	C6 ... C9 = 47 p	D1 = 1N4001	F1 = 2.5 A fast fuse
R9 ... R13, R31 ... R34 = 10 k		D2 = DUG	Re = relay with changeover contacts 5 V (max.) 100 mA
R14 = 330 Ω		D3 = zener diode 3V3/400 mW	
R15 ... R18 = 22 k		IC1 = 9368	
R19 ... R22, R27 ... R30 = 100 k		IC2 = 74145	
R23 ... R26 = 1 M		IC3, IC4 = 4093B (RCA or Motorola)	
P1 ... P4 = 10 k presets		LD1 ... LD4 = 7760	

power supply functions correctly before inserting any expensive ICs into their sockets. It is also a good idea at this stage to check for any short circuits on the printed circuit board.

A 1 MHz symmetrical square wave must appear at pin 8 of IC7. A multimeter together with the test circuit of figure 7 can be used to measure this clock frequency. The meter must indicate 0 V on both the Q and \bar{Q} outputs when a square wave is present. Of course it is also possible to use a frequency meter if one is at hand, in which case the frequency can be set accurately with C2.

Check that the output of N3 (pins 9 and 10 of IC6) goes high after switching the power on. The code AA (10101010) must now be put on the data bus by means of the small test circuit in figure 7b. The circled numbers refer to the board connector pins (between IC1 and IC3). Now IC1 can be fitted into its socket (ensure that the power is off when doing so). The connector must now have symmetrical square wave signals at the following points: Pin 29 A0 250 kHz, A1 125 kHz, A2 62.5 kHz and so on down to a frequency of 7.6 Hz at A 15.

Pin 14 of the connector (R/ \bar{W}) must be logic 1. If a fault exists it must be verified at first that AA really is present on the data bus (by means of a multimeter). The easiest method of checking all the frequencies is with the aid of an oscilloscope. However, the circuit in figure 7c together with a multimeter can also do the job. The circuit is connected to a pair of adjacent address lines (A15 and A14; A13 and A12; ... A1 and A0). The meter will indicate either 0 V or 5 V if all is well. Any other value will indicate either a short circuit or an open circuit on one or other of the two lines. If everything is in order, AA can be removed from the data lines. Remember to take IC1 out of its socket before using the soldering iron on the board.

The above tests should ensure that the printed circuit board assembly has been completed correctly. All the ICs may now be fitted into their sockets.

Only one point needs particular attention on the display board. This is the wire link A mentioned earlier on in this text when an ordinary switch type keyboard is to be used. As stated, the link must be in position B in this case.

The connections between the keyboard and the other boards must be kept as short as possible whatever type of keyboard is used. The capacitive keyboard itself needs some attention before being wired in. It is manufactured from printed circuit board material with a red colour on the underside. However, in contrast to a normal printed circuit board the top is covered in a thin layer of hard plastic to prevent damage and oxidation of the key pads. On the underside the row contacts are already interconnected

6

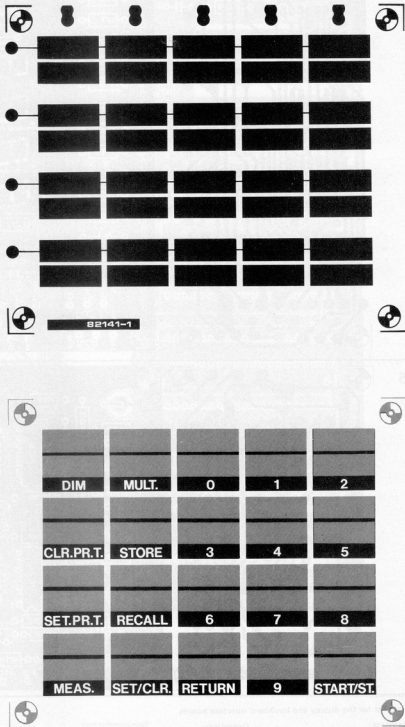

Figure 6. The keyboard. The front is covered by a protective layer. As explained in the text, it can be illuminated from behind.

during manufacture. The same is not true of the column contacts. These connections must be made carefully using thin enamelled copper wire. Bearing in mind that the keyboard is capacitive and therefore good operation is only guaranteed when the wire links are as near identical as possible. The photograph illustrates the completed keyboard and can be used as a guide. The footswitch is connected between S1 on the display board and S1 on the keyboard.

The finished printed circuit boards can now be mounted in a case and wired as shown in figure 8. The drawing also illustrates how the display board and the keyboard interface must be placed in relation to the keyboard if optimum results are to be achieved. It is important that the leads between these three boards are kept very short. Allow a space of at least 3 cms behind the keyboard for the illumination. More of this in a minute! Normally the keyboard will not require screening but if the keyboard is not mounted parallel to the front panel of the case it may be necessary. In this case a sheet of thin aluminium will have to be placed behind the board and earthed. It may be preferable to complete the wiring and check the operation first in order to see if screening is required. All connections to the outside world can be made via sockets on the rear panel of the case. One 14 way connector will cater for all the external circuits, but it may be more convenient to use separate sockets if the process timer, the light meter and the temperature meter are not all required. Two sockets for the enlarger and the safe lights will be necessary and these should be positioned as far away from the keyboard as possible. This also applies to all 220 V wiring for obvious reasons.

When using an enlarger with a halogen lamp (together with a transformer) it is recommended that a filter network, consisting of 100 Ω and 100n/400 V in series, is wired between the relay and the enlarger. This will keep interference to a minimum.

The keyboard illumination

It is obviously very necessary that the keyboard is made visible for it to be used with any great success in the darkroom, and we went to great pains to make this possible.

Four or six 6 V/50 mA miniature bulbs can be uniformly distributed behind the keyboard. These can be mounted in miniature sockets fitted into a sheet of white (or red) plastic or perspex placed underneath the keyboard. Sides can then be glued to form a box to prevent any stray lights from escaping. While the box must remain 'light tight' it must definitely not be air tight, since these bulbs can generate a surprising amount of heat.

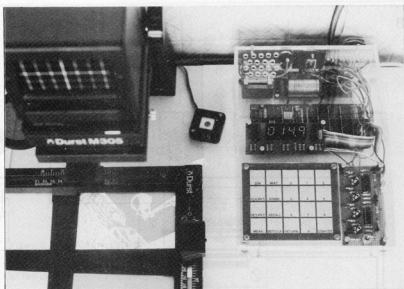

The lamps can be fed with an un stabilised d.c. voltage and their brightness can be adjusted by means of series resistors. These will need to be of a fairly high voltage. The lighting system can be made even more attractive if the lamps together with the displays could be dimmed to cope with the changing conditions. The circuit in figure 9 will provide this facility. It can be constructed on a small piece of Veroboard. The output must be connected to pin 1 of IC2 on the display board. The value of R4 must be reduced to 10 Ω if 6 lamps are being used instead of 4. The maximum brightness can be set by P4. The supply voltage for

the lamps and the dimming circuit is derived across C9. Before inserting the bulbs into their sockets ensure that their supply is set to 6 V by P1. This is important since the voltage level across C9 is about 18 V. Transistor T3 of the dimmer circuit must be provided with a heat sink.

Practical tests

When construction and wiring are completed (for this section) it will be possible to check that all the operations are correct. Before going any further the darkroom computer will only operate correctly if the EPROM, IC3, contains the correct program. The listing of this

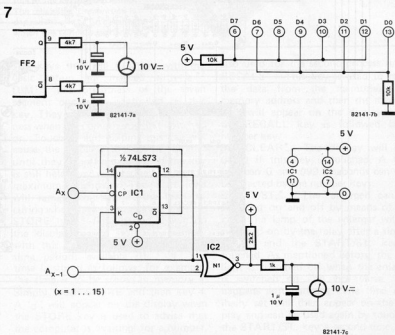

Figure 7. The processor board can be tested without a scope, by using the three auxiliary circuits shown here together with a multimeter.

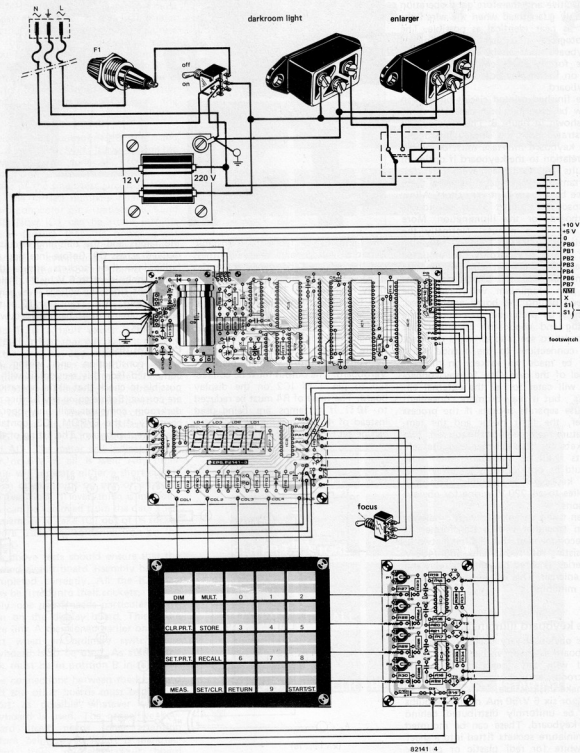

Figure 8. The interconnections between the printed circuit boards is shown here. The relationship between the keyboard interface, display board and the keyboard itself must be followed in order to keep the wiring between these boards as short as possible.

program is shown in the accompanying table 1.

The links PA5, PA6 and PA7 between the processor board and the keyboard interface must be disconnected. Check that presets P1...P4 are set to zero, before the power supply is switched on. The display should now read 000.0. This brings us to the calibration procedure of the keyboard printed circuit board. For this purpose potentiometer P4 must be turned anti-clockwise very slowly, while intermittently touching the MEAS key. At a certain point the sign 'd' will appear on the display. When this occurs do not rotate P4 any further. When touching the RETURN key, 000.0 must appear again on the display. The display must show 000.9 when touching the keys SET/CLR and 9 respectively. When touching the START/ST. key the relay must be activated and switched off again after 0.9 seconds. If one of the keys does not operate correctly, P4 must be rotated slightly further and the procedure described above repeated until all keys react equally well.

The darkroom computer must then be switched off and PA5 reconnected. Switch the computer on again and turn P3 until key SET.PR.T. reacts correctly, 'd' appears on the display. Repeat this procedure with links PA6 and PA7 and the potentiometers P2 and P1. Before doing this it is best to take a look at the instructions for use in order to become familiar with the functions of the various keys. This helps to avoid mistakes. For example, the START/ST. key will not react at all if it has been touched after the MULT. key. Only keys 0...9 and RETURN react after MULT. has been touched.

Ready for use

Adjustment of the four potentiometers completes the construction and calibration procedure of the basic darkroom computer. It can already be used in this form in the darkroom. However, not all functions will be operational of course.

To reach this aim, the constructor must add the three circuits being published in the next article. Anyway, the darkroom computer can already be used as exposure timer, as memory to store the various times and as a process timer with ten different times at its disposal. Last, but not least, it also works as continuous brightness control for the displays!

Instructions for use of the darkroom computer

This chapter deals with the operation of the darkroom computer. Since it describes the function of each key it may be an advantage to have the computer at hand, so that the theory can be 'converted' into practice right away. The instructions for use deal with the complete computer system and include the circuits that will be published later.

9

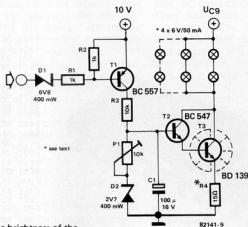

Figure 9. The brightness of the keyboard lighting can be varied continuously with the addition of this circuit.

10

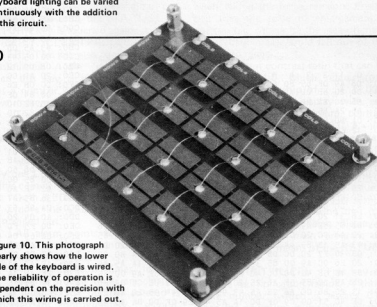

Figure 10. This photograph clearly shows how the lower side of the keyboard is wired. The reliability of operation is dependent on the precision with which this wiring is carried out.

The keys that will function with the basic set-up are marked with a *:
 DIM*: The brightness of the seven segment display is controlled by this key. They will be at maximum brightness when the computer is first switched on. Touching and holding this key will cause the displays to become dimmer until they go off altogether. If the key is still held they will gradually return to maximum brightness. The light level will remain constant at the level occurring when the key is released.
 STORE*: The time period shown on the display can be stored in memory with this key. There are ten different time periods available (0...9). The time is stored as follows; for example, the time is to be stored in memory 4. Simply touch STORE and then key 4. A 'd' will appear on the display when the STORE key is used to advise that the computer is 'waiting' for a number. When a number is entered it will appear for one second on the display. The number is stored when the display blanks. The ten memories available are

also used for the second process timer.
 RECALL*: This key is used to recall the data from the memories. The memory address and then the memory data will appear on the display when the RECALL key is followed by a number key.
 SET/CLEAR*: The display will read 000.0 if this key is touched. A time between 0 and 999.9 seconds can now be selected by the number keys.
 START/ST.*: The enlarger can be switched on and off by means of this key. The lamp of the enlarger will be switched on by the relay after a time is fed in and the START/ST. key is touched. As mentioned before, the safe light is switched off when the enlarger is switched on and vice versa. This happens automatically. The time originally set will then appear on the display and can be used again by touching the START/ST. key a second time. The enlarger can be switched off at any time by this key. The START/ST. key is also used to start and stop the second process timer (see SET.PR.T. 2).

RETURN*: This key is used to return from a certain function to the main program, in order to select another function. It can be used when a key has been touched by accident, which applies to the CLR.PRT.; SET.PRT.; MEAS; STORE; RECALL and MULT. The 'old' data appears on the display again after the RETURN key is used (except for the RECALL key).

0...9*: These keys are used to read in a certain time and to choose a particular function with keys that have more than one function.

SET.PR.T. (SET PROCESS TIMER): The three functions of this key set the process and alarm times. A 'd' will be displayed (indicating that a decimal key must be used now) after this key has been touched. The following choices are:

-0: The time can now be entered. The time shown on the display remains there for 3 seconds after the last key was touched and then disappears, indicating that it has been stored.

-1: It can now be determined at which LED of the timing indicator the alarm must sound, as follows: After the command SET.PR.T.-1 has been given, the code 02 will appear on the display. The number on the display is increased by 1 per second until number 25 is reached. This will be followed by a return to the 'old' data (02) on the display. The number displayed indicates the number of a certain LED. For example, it is required to sound the alarm at the 6th LED. Any key touched when the number 06 is shown will add an 'A' to the display. This indicates that the alarm will go off at this LED number. The alarm can be set 15 times in this way. After the 25 numbers have been scanned, the timer returns to the main program. Giving the command SET.PR.T.-1 again causes all alarm numbers (with the 'A') to appear on the display again. It is now too late to make any changes. To be able to do that alarm registers must be cleared again.

-2*: This key initialises the programming of the second process timer. This timer can store a maximum of 10 different time periods ranging from 0.1 to 99.9 minutes. Three of the four displays show the first time period in minutes. The fourth (left) display becomes dim and flashes very quickly. This indicates the memory location in which the number shown on the other displays is stored (0...9). The time period will be stored in this memory address when the STORE key is touched. The number of the next memory location will then be displayed and the same procedure can be repeated. As stated before, this can be done 10 times. The following must be carried out if less than 10 process times are used, when the last required time is stored (for example, the third), the command 00.0 must be entered. The first time period will then re-appear on

the display when the STORE key is used. The second process timer can now be started by operating the START/ST. key. The left display will behave 'normally' again. Now the countdown for one process time begins. When 00.1 appears on the display, the buzzer announces that the last 6 seconds (of that particular time) have been reached. At the end of the period the buzzer produces one long tone and the countdown for the next process time begins. The first time period re-appears on the display and the left display starts to flash again, after the last process time has passed. It is now possible to either start again (START/ST.), change the process time or return to the main program (using the RETURN key). The process timer can be stopped whenever required. In this event the timer jumps back to the first process time and remains there until the START/ST. or RETURN key is touched again.

CLR.PR.T. (CLEAR PROCESS TIMER): This key also combines several possibilities. Again 'd' is displayed when this key is touched to indicate that a number key must be used next. Now, there are several possible options:

-0: The LED that is furthest to the right on the process timer is now cleared.

-1: If lit, the second LED goes out when touching this number. If only one LED is lit, nothing will happen at this command.

-2: Both LEDs will go out. Furthermore the LED running period is then wiped out.

-3: All alarm points for the process timer are cleared, in other words, all alarms are silenced.

-4*: All ten process times for the second process timer are cleared. In all 4 cases, the number entered is displayed for approximately 1 second, after which the computer returns to the main program.

MEAS. (MEASURE): All measuring functions are controlled by this key. The three possibilities are:

-0: Light measurement. The enlarger is switched on as soon as the '0' key has been touched. The '0' remains visible on the display for a moment before it disappears. The display is blank for two seconds while the computer measures the amount of light that falls on the light sensor. This value is converted into an exposure time and the result appears on the display. The enlarger then switches off. The calculation made by the computer is based on the brightness of the enlarger lamp (the more light falling on the sensor, the shorter the exposure time) and the multiplication factor that can be added by means of the MULT. key. We will come back to that later on. An incorrect (light) value will be indicated on the display by EEE.E.

-1: Contrast measurement. The relationship between the lightest and darkest spot on a negative. First

place the light meter on the lightest part of the negative being projected. Then touch the keys MEAS. and 1 respectively. The display will blank for 2 seconds after which 'd' will appear (the enlarger remains on). The meter is then placed on the darkest area of the negative and key 1 is touched. After 2 seconds, the left display will indicate a C and the others a number relating to the contrast. The contrast ratio is indicated in light values; This is the logarithm to the base 2 of the ratio between the lightest and darkest spot. The value obtained in this way can help in choosing the right kind of paper for a certain negative (the bigger the contrast ratio, the softer the paper will need to be).

The enlarger lens should not be fully open, but be on, for example f5.6, when taking the measurements. Ensure also that the scale of enlargement is not too big, otherwise the measurement of the dark areas would fall out of the measuring range.

The minimum contrast ratio that can be measured is 1.0, which relates to a light/dark relationship of 2:1. C 00.0 will appear on the display with any lower ratio. The maximum contrast that can be measured is 12.0, a value that is only very, very rarely reached!

-2: Temperature measurement. About 1 second after the '2' key has been touched, the temperature will be indicated on the display. This value is accurate to within 0.1°C. The display flashes very weakly showing that it is temperature that is being displayed. Returning to the main program can only be done by means of the RETURN key.

MULT. (MULTIPLIER): This key enters the multiplication factor. A three-figure number (which is always 0.10 when the computer is initially switched on) appears on the display after this key has been used. A number entered will now appear on the display.

The multiplication factor is used in the light measurement (see MEAS.-0), the exposure time internally measured by the computer is multiplied by this factor and the final result is displayed. The multiplication factor depends on the type of paper being used and sometimes on the scale of enlargement. More details will follow in the darkroom computer part 2.

Again the constructor can only return to the main program by using the RETURN key.

There are still two 'ordinary' switches that need to be described.

START PR.T. (START PROCESS TIMER): This switch is situated on the process timer containing the 25 LEDs. The first LED starts to 'run' when this switch is used. Operating the switch once again causes the second LED to run as well.

FOCUS*: The enlarger can be switched on and off by means of this switch.

applikator

a full description with applications for the very versatile MF 10 by National

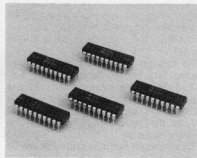

The MF 10 is a dual switched capacitor filter in the forefront of today's electronics. In every sense of the word it is a component for the eighties. A complete AF filter network in one single IC, which at last gets rid of the old problems of trying to integrate capacitors in bulky and sometimes unreliable filter circuits. We have already described the actual technique employed by this IC in the October 1980 issue of Elektor, so this article is aimed at really getting to grips with its uses. Readers who refer to the old issue will see that the MF 10 constitutes an interesting example of a concrete application of a relatively new technique. Nearly all the components required for a comprehensive filtering system are integrated onto a single chip. Fortunately National Semiconductors have not integrated every component possible, and therefore the IC still needs a few external resistors. I say fortunately because the use of external components is an advantage as it allows greater versatility. As a result the manufacturer describes no less than 9 applications!

The MF 10 comes in a 20 pin dual-in-line plastic package. Two general purpose CMOS active filter components are also included, which incidentally can be used separately, if required. This automatically means that the IC should be handled carefully especially when considering static loads.

The block diagram of the system is depicted in figure 1. Each building block making up the IC, together with an external clock and a few resistors can produce various 2nd (12 dB/octave rise time) order functions. Each block has 3 output pins. One of these can be applied to create either an allpass, high pass or a notch function. The remaining 2 outputs can be used as lowpass and bandpass filters. The really interesting part about all this is that it performs all these functions simultaneously.

The centre frequency of the lowpass and bandpass 2nd order functions can either be directly dependant on the clock frequency, or on both the clock frequency and external resistor ratios. The centre frequency of the notch and allpass filters is directly dependant upon the clock frequency, while the highpass centre frequency is determined by both the resistor values and the clock.

High and lowpass 2nd order functions can be

realised with only half an IC. By connecting both halves 4th order filters (24 dB/octave) can be realised.

Obviously filters having an even higher steepness can be constructed by cascading a number of MF 10s. Any of the classical filter networks (such as Butterworth, Bessel, Cauer and Chebyshev) can be formed.

Features

Besides the worthwhile qualities already mentioned, the MF 10 is extraordinary in as much as the clock to centre frequency ratio is accurate to $\pm 0.6\%$. This kind of accuracy, which incidentally remains the same irrespective of the number of times you duplicate the circuit, can never be realised by conventional filters using OTAs. The accuracy of these filters really is useful, especially when considering them for use with microprocessors, for automatic testing and measuring equipment, and intelligent meters.

The stability of the filter cutoff frequency is directly proportional to the stability of the clock frequency. The highest input frequency is 30 kHz with the highest clock value at 1 MHz with around 1.5 MHz being typical. So far so good! At first sight it may appear that the high price of the MF 10 is rather prohibitive. But, when considering the possibilities available as against the price and applications possible with a double OTA, then there is no question that the MF 10 is good value for money. Another feature of this IC which deserves a special mention is that the output contains a 'typical' clock signal (clock feedthrough) of 10 mV. This is mainly due to the crosstalk characteristics (around 50 dB).

Table 1 gives the essential data information of the MF10BN and MF10CN versions. The C type is the cheaper of the two.

Modes of operation

First of all we advise the reading of table 1 in order to get acquainted with the IC. In any case we assure you that by doing so the rest of the article will be far easier to follow and read.

And don't worry, by the time we have finished with this 'narrative' there will be very little that you won't know about this IC and how to use it!

Out of the nine applications offered by the manufacturer we decided to have a real close look at three.

- Figure 2 shows a mode of operation ideally suited to the actual specifications as laid down in the data sheet.
- Figure 3 illustrates the most straightforward version.
- Last but not least, figure 4, which illustrates a standard state variable filter network.

We deliberately picked these three applications as they represent a good cross-section of the nine, giving you a good grounding to go further. A detailed look at all nine was thought to be unnecessary, and in some cases, a kind of 'can't see the wood for the trees' situation.

Each figure also shows the formulae necessary to work out the component values dependant on the parameters needed. Table two (11) gives a definition of the terms used with the different characteristic values optically represented by the diagrams showing the bandpass curves.

1

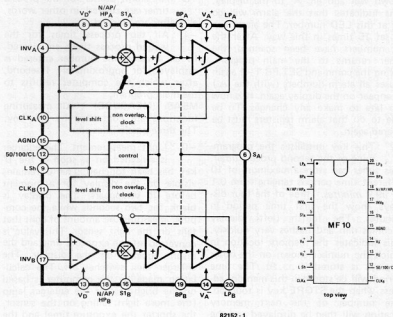

Figure 1. Block diagram of the integrated dual filter MF 10. The IC contains two separated, independent, universal filter building blocks, with which all 2nd order functions can be realised. The filter cutoff frequencies depend on the frequency of an external clock signal applied to the two integrators (with connected capacitors).

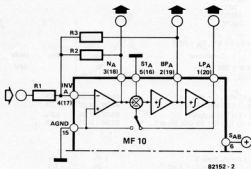

Figure 2. One half of the MF 10 as a 2nd order filter with notch, band and lowpass outputs. With the values shown the circuit performs as per the data sheet.

Figure 2 shows a 2nd order inverting filter with bandpass, lowpass and notch functions. Pay particular attention to the formula shown for the circuit dynamics, (H_{OLP}). These expressions are very important as they determine the swing at each output as a function of the desired Q factor of the 2nd order function. In other words the output voltage level is a function of the Q factor selected. When considering high Q factors, inadequate attenuation of the input results in overthrust distortion (clipping, overdriving the IC circuits).

Figure 3 depicts a similar filter based on the same principles, the only difference being that it is non-inverting. This configuration is the most straightforward 2nd order function possible, with the MF 10. Only two resistors are required to set the Q, and therefore the gain. Even so, the circuit does contain an

inverting and non-inverting bandpass output, as well as a lowpass one. Ideal for lowpass 2nd order (or higher) filters. The remarkable feature of this circuit is its very useful low input impedance, mainly due to the fact that S1 is used as the input (see connection description).

The state variable filter is demonstrated in figure 4. This has a bandpass, highpass and lowpass output. A notch function can be realised quite easily by an additional external opamp. This extra opamp is used as an adder, which sums up the low and highpass signals. Obviously anyone not wishing to have a notch function can forget about R1, R9, R4 and of course the opamp.

Quite surprisingly, in contrast to the other two applications, in contrast to the other two applications, pin 16 of the IC (in this case), is connected to the negative supply voltage!

$$f_0 = \frac{f_{CLK}}{100} \text{ or } \frac{f_{CLK}}{50}$$

$$f_{notch} = f_0$$

$$H_{OLP} = \frac{R_2}{R_1}$$

$$H_{OBP} = \frac{R_3}{R_1}$$

$$H_{ON1} = \frac{R_2}{R_1}$$

$$Q = \frac{R_3}{R_2}$$

$$H_{OLP} = \frac{H_{OBP}}{Q}$$

$$H_{OLPmax} = Q \cdot H_{OLP} \text{ (for high Q)}$$

All applications involving the use of the MF 10 have one problem in common. The possibility of D.C. offset voltages at the output.

The switched capacitor integrators of the MF 10 have a higher equivalent input offset than a typical R.C. integrator of a discrete active filter. The input offsets of the CMOS opamps although being very small also add to the overall offset. However, for most applications it does not present a real problem, as a double capacitor at the output of the IC should eliminate the D.C. values. The only disadvantage of excessive D.C. offsets is that the modulation range will be restricted. Too high an input level (voltage) should be avoided at all times, otherwise there is a risk of overdriving the IC. The gain of each filter stage differs, obviously depending on the mode of operation. The result is that the stage with the highest gain will 'clip' first, and in turn will effect a negative influence on the other filters.

For the mode of operation as shown in figure 4, a word of caution is necessary. By allowing small R2/R4 ratios and a high Q factor, the lowpass output will exhibit a couple of volts of D.C. offset, and therefore an offset adjustment will have to be made. Should this be the case then we suggest that the method shown in figure 5 be used to trim the offset.

In practice

As they say in electronic circles or is it in the kitchen, the proof of the pudding is in the eating and for once with this IC we can have our cake and eat it!

The first example we look at is the construction of a 4th order Butterworth filter (24 dB/octave) with a cutoff frequency of 2 kHz and a bandpass gain factor of 1. This is easily realised by cascading two 2nd order functions. In other words by using both halves of the MF 10 and ensuring the correct corresponding values for F₀ and the Q. The next stage is to look up the Q factors required in a coefficient table. That's exactly what we did and found out that a Butterworth filter has Q₁ as 0.54

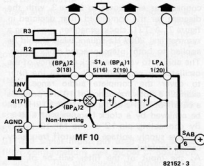

$$f_0 = \frac{f_{CLK}}{100} \text{ or } \frac{f_{CLK}}{50}$$

$$Q = \frac{R_3}{R_2}$$

$$H_{OBP1} = \frac{R_3}{R_2}$$

$$H_{OBP2} = 1$$

$$H_{OLP} = 1$$

$$H_{OLPmax} = Q \cdot H_{OLP} \text{ (for high Q)}$$

$$H_{OBP1} = Q \text{ (Maximum)}$$

Figure 3. The other half of the MF 10 as a non inverting 2nd order filter with band and lowpass outputs.

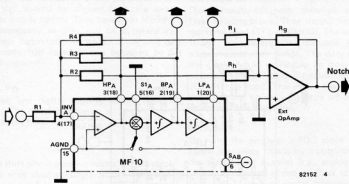

$$f_0 = \frac{f_{CLK}}{100} \sqrt{\frac{R_2}{R_4}} = \frac{f_{CLK}}{50} \sqrt{\frac{R_2}{R_4}}$$

$$Q = \sqrt{\frac{R_2}{R_4} \cdot \frac{R_3}{R_2}}$$

$$H_{OBP} = \frac{R_2}{R_1}$$

$$H_{OBP} = \frac{R_3}{R_1}$$

$$H_{OLP} = \frac{R_4}{R_1}$$

$$\text{Notch: } f_0 = \frac{f_{CLK}}{100} \sqrt{\frac{R_6}{R_1}} \text{ or } \frac{f_{CLK}}{50} \sqrt{\frac{R_6}{R_1}}$$

$$H_{ON1} = \frac{R_3}{R_1} \times H_{OLP}$$

$$H_{ON2} = \frac{R_2}{R_6} \times H_{OBP}$$

Figure 4. One half of the MF 10 used as a 2nd order universal filter with high, band, lowpass and notch outputs. An additional opamp is required for the 'notch' function. In this circuit pin 6 must be connected to U_B.

and Q_2 as 1.31.

From the several different ways of constructing an MF 10 lowpass filter we chose the simplest, as shown in figure 3. Once the Q factors have been decided upon, it is an easy matter to determine the resistor values.

Given the fact that $Q = \frac{R_3}{R_2} = 0.54$ and the

smallest resistor value should be 5k, a 10k resistor for R_3 and an 18k for R_2 will suffice. For the second 'half' filter using the same formula we find that we can use an 10k resistor for R_3 and an 13k one for R_2 . Obviously it may not be possible to find a

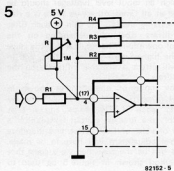

Figure 5. The application shown in figure 4 may need an offset adjustment by means of an additional 1M Ω trimming potentiometer.

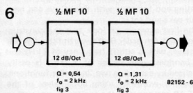

Figure 6. Block diagram of a 4th order Butterworth lowpass filter (24 dB/octave).

7

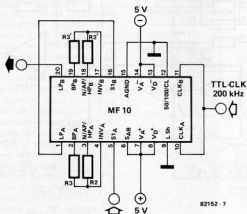

Figure 7. Circuit diagram of the Butterworth filter. This filter is constructed as per the circuit shown in figure 3. It only requires two external resistors per filter stage. The 2 kHz cutoff frequency is realised by applying a clock frequency of 200 kHz.

Table 1

Absolute maximum values:

Supply voltage	7 V
Power dissipation	500 mW
Operating temperature range	0 ... 70°C
Highest storage temperature	150°C
Soldering temperature (10 seconds)	300°C

Characteristics (Complete Filter) $V_S = \pm 5$ V, $T_A = 25^\circ\text{C}$

Parameter	Conditions	Min	Typ	Max	Units
Frequency Range	$f_0 \times Q < 200$ kHz	20	30		
clock to Center Frequency Ratio, f_{CLK}/f_0					
MF10BN	Pin 12 High, $Q = 10$	49.94 \pm 0.2%		\pm 0.6%	
MF10CN	$f_0 \times Q < 50$ kHz, Mode 1	49.94 \pm 0.2%		\pm 1.5%	
MF10BN	Pin 12 at Mid Supplies	99.35 \pm 0.2%		\pm 0.6%	
MF10CN	$Q = 10$, $f_0 \times Q < 50$ kHz, Mode 1	99.35 \pm 0.2%		\pm 1.5%	
Q Accuracy (Q Deviation from an Ideal Continuous Filter)					
MF10BN	Pin 12 High, Mode 1		\pm 2%	\pm 4%	
MF10CN	$f_0 \times Q < 100$ kHz, $f_0 < 5$ kHz		\pm 2%	\pm 6%	
MF10BN	Pin 12 at Mid Supplies		\pm 2%	\pm 3%	
MF10CN	$f_0 \times Q < 100$ kHz, $f_0 < 5$ kHz, Mode 1		\pm 2%	\pm 6%	
f_0 Temperature Coefficient	Pin 12 High (1-50:1) Pin 12 Mid Supplies (~100:1) $f_0 \times Q < 100$ kHz, Mode 1 External Clock Temperature Independent		\pm 10		ppm/ $^\circ\text{C}$ ppm/ $^\circ\text{C}$
Q Temperature Coefficient	$f_0 \times Q < 100$ kHz, Q Setting Resistors Temperature Independent		\pm 500		ppm/ $^\circ\text{C}$
DC Low Pass Gain Accuracy	Mode 1, $R_1 = R_2 = 10$ k			\pm 2	%
Crosstalk			50		dB
Clock Feedthrough			1		mV
Maximum Clock Frequency		1	1.5		MHz
Power Supply Current			8	10	mA

Electrical Characteristics (Internal Op Amp) $T_A = 25^\circ\text{C}$

Parameter	Conditions	Min	Typ	Max	Units
Supply Voltage		\pm 4	\pm 5		V
Voltage Swing (Pins 1, 2, 9, 20)	$V_S = \pm 5$ V, $R_L = 5$ k	\pm 3.8	\pm 4		V
MF10BN		\pm 3.2	\pm 3.7		V
Voltage Swing (Pins 3 and 18)	$V_S = \pm 5$ V, $R_L = 3.5$ k	\pm 3.8	\pm 4		V
MF10CN		\pm 3.2	b3.7		V
Output Short Circuit Current Source	$V_S = \pm 5$ V		3		mA
Sink			1.5		mA
Opamp Gain BW Product			2.5		MHz
Opamp Slew Rate			7		V/ μs

13 k resistor, so just connect a 12k and 1 k in series.

The filter is now nearly complete. The other connections are shown in figure 3, with the diagram for the completed filter depicted in figure 7. A TTL clock generator supplying a symmetrical 200 kHz square wave should be applied to both inter-connected clock inputs. The ability to vary the clock frequency of the oscillator or generator will enable the filter to cover the complete audio range. For example a clock frequency of 10 kHz provides a cutoff of 50 Hz and a cutoff of 10 kHz can be achieved by a clock frequency of 1 MHz. By connecting pin 12 of the MF 10 to the positive supply voltage any cutoff frequency can be doubled.

As the input of the filter will be of low impedance, an additional amplification stage using a dual fed opamp preceding the filter is advisable. And don't forget to use a double capacitor at the output in order to get rid of the D.C. offsets! The value of this capacitor will depend on the input impedance of the circuit to which the filter signal is fed. For an impedance of 10k or more we suggest a value of 1 μF .

Literature:

National Semiconductors MF 10.
Universal Monolithic Dual Switched Capacitor Filter. Data sheet XH/227, December 1981.

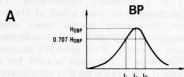

$$Q = \frac{f_0}{f_H - f_L} = \frac{f_0}{\sqrt{1/40} - \sqrt{1/40}}$$

$$f_L = f_0 \left(\frac{-1}{2Q} + \sqrt{\left(\frac{1}{2Q}\right)^2 + 1} \right)$$

$$f_H = f_0 \left(\frac{1}{2Q} + \sqrt{\left(\frac{1}{2Q}\right)^2 + 1} \right)$$

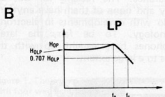

$$f_c = f_0 \times \sqrt{\left(1 - \frac{1}{2Q^2}\right) + \sqrt{\left(1 - \frac{1}{2Q^2}\right)^2 + 1}}$$

$$f_p = f_0 \sqrt{1 - \frac{1}{2Q^2}}$$

$$H_{OP} = H_{OLP} \times \frac{1}{\frac{1}{Q} \sqrt{1 - \frac{1}{4Q^2}}}$$

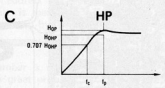

$$f_c = f_0 \times \left[\sqrt{\left(1 - \frac{1}{2Q^2}\right) + \sqrt{\left(1 - \frac{1}{2Q^2}\right)^2 + 1}} \right]^{-1}$$

$$f_p = f_0 \times \sqrt{1 - \frac{1}{2Q^2}}$$

$$H_{OP} = H_{OHP} \times \frac{1}{\frac{1}{Q} \sqrt{1 - \frac{1}{4Q^2}}}$$

82152 9

Definition of terms

- f_{CLK}**: the switched capacitor filter external clock frequency.
- f_O**: center of frequency of the second order function complex pole pair. f_O is measured at the bandpass output of each ½ MF 10, and it is the frequency of the bandpass peak occurrence (figure A).
- Q**: quality factor of the 2nd order function complex pole pair. Q is also measured at the bandpass output of each ½ MF 10 and it is the ratio of f_O over the -3 dB bandwidth of the 2nd order bandpass filter, figure A. The value of Q is not measured at the filter, but its value relates to the possible amplitude peaking at the above outputs.
- H_{OBP}**: the gain in (V/V) of the bandpass output at f = f_O.
- H_{OLP}**: the gain in (V/V) of the lowpass output of each ½ MF 10 at f → 0 Hz, figure B.
- H_{OHP}**: the gain in (V/V) of the highpass output of each ½ MF 10 as f → f_{CLK}/2, figure C.
- Q_Z**: the quality factor of the 2nd order function complex zero pair, if any. (Q_Z is a parameter used when an allpass output is sought and unlike Q it cannot be directly measured).
- f_Z**: the center frequency of the 2nd order function complex zero pair, if any. If f_Z is different from f_O, and if the Q_Z is quite high it can be observed as a notch frequency at the allpass output.
- f_{notch}**: the notch frequency observed at the notch output(s) of the MF 10.
- H_{ON1}**: the notch output gain as f → 0 Hz.
- H_{ON2}**: the notch output gain as f → f_{CLK}/2.

Pin description

LP, BP, N/AP/HP

These are the lowpass, bandpass, notch or allpass or highpass outputs of each 2nd order section. The LP and BP outputs can sink typically 1 mA and source 3 mA. The N/AP/HP output can typically sink and source 1.5 mA and 3 mA, respectively.

INV

This is the inverting input of the summing opamp of each filter. The pin has static discharge protection.

S1

S1 is a signal input pin used in the allpass filter configurations (see modes of operation 4 and 5). The pin should be driven with a source impedance of less than 1 k.

S_{A/B}

It activates a switch connecting one of the inputs of the filter's 2nd summer either to analog ground (S_{A/B} low to V_A⁻) or to the lowpass output of the circuit (S_{A/B} high to V_A⁺). This allows flexibility in the various modes of operation of the IC. S_{A/B} is protected against static discharge.

V_A⁺, V_D⁺

Analog positive supply and digital positive supply. These pins are internally connected

through the IC substrate and therefore V_A⁺ and V_D⁺ should be derived from the same power supply source. They have been brought out separately so they can be bypassed by separate capacitors, if desired. They can be externally tied together and bypassed by a single capacitor.

V_A⁻, V_D⁻

Analog and digital negative supply respectively. The same comments as for V_A⁺ and V_D⁺ apply here.

L Sh

Level shift pin; it accommodates various clock levels with dual or single supply operation. With dual ± 5 V supplies, the MF 10 can be driven with CMOS clock levels (± 5 V) and the L Sh pin should be tied either to the system ground or to the negative supply pin. If the same supplies as above are used but T²L clock levels, derived from 0 V to 5 V supply, are only available, the L Sh pin should be tied to the system ground. For single supply operation (0 V and 10 V) the V_D⁻, V_A⁻ pins should be connected to the system ground, the AGND pin should be biased at 5 V and the L Sh pin should also be tied to the system ground. This will accommodate both CMOS and T²L clock levels.

CLK (A or B)

Clock inputs for each switched capacitor filter building block. They should both be of the same level (T²L or CMOS). The level shift (L Sh) pin description discusses how to accommodate their levels. The duty cycle of the clock should preferably be close to 50% especially when clock frequencies above 200 kHz are used. This allows the maximum time for the opamps to settle which yields optimum filter operation.

50/100/CL

By tying the pin high a 50:1 clock to filter center frequency operation is obtained. Tying the pin at mid supplies (i.e., analog ground with dual supplies) allows the filter to operate at a 100:1 clock to center frequency ratio. When the pin is tied low, a simple current limiting circuitry is triggered to limit the overall supply current down to about 2.5 mA. The filtering action is then aborted.

AGND

Analog ground pin; it should be connected to the system ground for dual supply operation or biased at mid supply for single supply operation. The positive inputs of the filter opamps are connected to the AGND pin so 'clean' ground is mandatory. The AGND pin is protected against static discharge.

a home telephone system

up to nine extensions without an exchange

Home telephone systems are fast growing in popularity with the availability of telephone sets at a reasonable cost on the surplus market. Even many small businesses are catching on to the fact that a do-it-yourself intercom system is far cheaper than a professional installation. A further advantage is the ease with which the system can be modified to cater for changing conditions.

The design described here is a self-contained system and does not

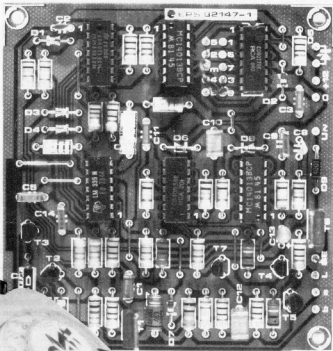

require a telephone exchange. Each telephone set requires a small printed circuit board and interconnections are made via a four-way cable.

The telephone is a familiar and accepted part of our everyday life. For the vast majority of users it forms the basis of their livelihood, while for many others it is a necessary convenience. The telephone is so much a fact of life that not too many people, even many electronic engineers, fully understand how it works. It is generally assumed that since it has been around for so long, it can't really be that complicated. Not true, the average telephone set is a hybrid concoction of electro-mechanical bits and pieces, all held together with 3BA nuts and bolts. After all, it did originate in the era of valves and internally does present a somewhat dated appearance. The reasons for this are many and none of them have anything to do with developments in electronic technology. To be fair, the latest telephones have caught up with the times to a large extent.

Our home telephone system here does not profess to break any boundaries of technology, but it is very much in keeping with what our readers expect an electronic system to be. In fact, no 'high technology' components are used, they are all very much of the 'common or garden' variety — and easily obtainable!

It must be stated here and now that this project is for a self contained intercom system for use in any desired manner — but it must not be used with the British Telecom network. When that saga is sorted out we can do something about it, but until then — no tampering with the 'company lines'!

What are the basic requirements for a telephone system using the available sets? The first problem that arises is

1

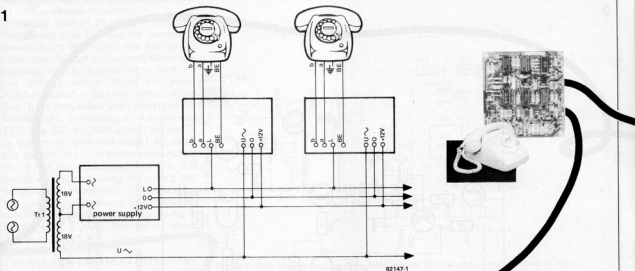

Figure 1. The wiring of the installation. All interconnections between the extensions are made with four way cable.

that the circuit must carry out a part of the task that is usually performed by the exchange in the national telephone network. Obviously it must be possible to address the extension you require. This is performed by a pulse train produced by the dial mechanism when a

number is dialled. Fortunately, this is no great problem since, of course, the telephone set already has this facility built in. However, we have to make sure that the dial pulse train corresponds to the number of that particular extension. If the answer happens to be 'yes' - then the bell must ring. In the event that somebody answers, - that is, the television is switched off - then the handsets of the two extensions must be interconnected. It should also be impossible for others to 'listen in' to the conversation. It all adds up to a fair amount of complications that must be ironed out before the network can be called fully operational.

No switchboard!

The Elektor telephone system meets all the requirements expected of a home (or small business) intercom plus a few added features. While the number of extensions is limited to nine, it should be quite enough for the majority of users. This number would probably even be sufficient for private functions, such as exhibitions, fetes and the like.

The main requisite of a private network of this type is that it should not need a master 'switchboard' or exchange. An advantage of this is that installation is very much simpler. Instead of the 'star' network (all extensions are wired directly to the master), the extensions are simply interconnected by means of a four-way cable as shown in figure 1. This removes the necessity of those

mega-way cables that our B.T. friends are so fond of. The cable carries the following:

- The ringing line (UU)
- The power supply line (+12 V)
- The ground line (0)
- The speech line (L)

The power consumption for the whole network is very low and the single power supply is quite sufficient. Wiring between individual extensions is made simple by the connections provided on the printed circuit board.

Features of the system

The number of each extension (1 . . . 9) is determined by means of a wire link

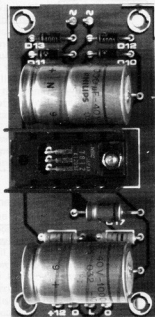

on the printed circuit board of that extension. When a specific number is dialled, it will cause the bell of that extension to ring and an intermittent tone will be put on the L line. A LED will light on all the other extensions to indicate that the line is busy. The interconnection between the two receivers is made as soon as the handset of the extension called is lifted. It is not possible for any other extension to 'listen in' to the conversation. The connection is broken when both receivers are replaced.

In spite of having said that any conversation remains private (no other extension can listen in) we can, if required, invite a third party to join by means of a little 'glitch' in the system. Supposing the extension being talked to was number 3 and it was considered that the topic of conversation might be enjoyed by extension 7 also. To obtain number 7 (without losing number 3) simply dial the difference between the two numbers, in this case $7 - 3 = 4$. Both extensions, 3 and 7, will now be in circuit. Similarly, when talking to extension 3 and extension 8 is required to join, the number to dial is 5. A 6 is dialled for extension 9 and 8 is dialled for extension 1 and so on.

As if this was not enough, it is possible for any number of parties to join in. In this case the number to dial will be the difference between the number of the last extension to join and that of the potential newcomer. This has all the overtones of impending chaos (especially if junior discovers it), but the facility is there.

The inside story

The circuit diagram in figure 2 is fairly complicated but construction is helped over this problem by the use of the printed circuit board. The complete

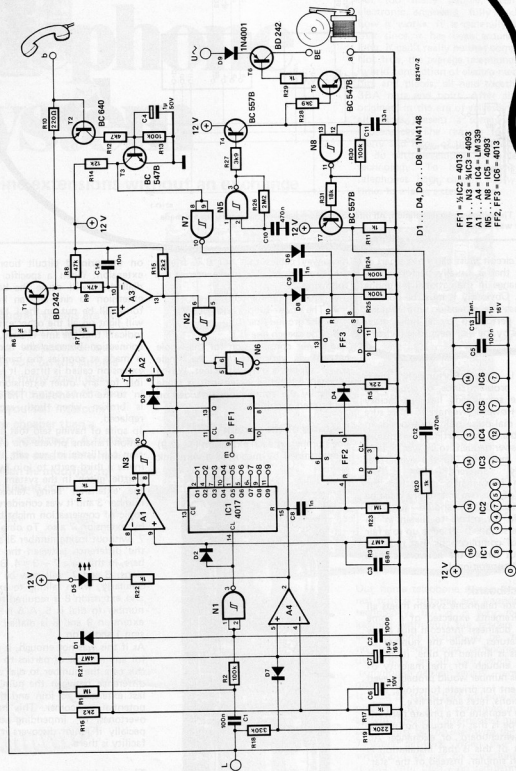

D1 ... D4, D6 ... D8 = 1N4148
 821472

FF1 = 1/2 IC2 = 4013
 N1 ... N3 = IC3 = 4093
 LM 339
 N5 ... N8 = IC5 = 4093
 FF2, FF3 = IC6 = 4013

Figure 2. The circuit diagram for each telephone set.

circuit is fitted into the telephone set of each extension required.

A voltage level of 25 to 30 V exists on the speech line (L) but no current is drawn from this until the handset is lifted and the dial is operated. When this happens, line 'b' is switched to earth via the dialling switch (once for every number dialled - plus one extra). When line 'b' is first taken low, pin 10 of A3 follows suit. The output of A3 then sets FF2 (via N2 and N6) which causes T1 to switch on with the aid of A2. Now the speech line L is directly connected to 'b' of the telephone, and the dial pulses will be sent along the speech line to all other extensions. The pulses on the speech line produced by the dialling mechanism are approximately 40 ms in length with a pulse interval of about 60 ms.

The first pulse received by all the extensions will reset the counter IC1, FF1 and FF2. The following pulses are then counted by IC1. Comparator A1, together with D2, R3 and C3, forms a retriggerable monostable which will provide a clock pulse to FF1 0.2 seconds after the last dialling pulse arrives. At the required extension the linked output (between one output of IC1, Q1...Q9, to m) will be high thus setting FF1. The Q output of this flip-flop will now go high and connect the speech line (L) to the handset by means of A2 and T1. At the same time, the Q output of FF3 (now high) will start the oscillator around N5 and ring the bell via T4...T6. When the handset is lifted, FF1 is reset and the bell stops ringing. The person at the extension is now connected to the caller.

All other extensions are disconnected. The Q output of FF1 will be low with the result that T1 will be switched off. LED D5 will be lit, denoting that the line is busy.

If the handset of the telephone being called is not lifted (there is a good programme on television), FF3 will be reset and the bell will stop ringing.

Power supply

Power consumption of the whole telephone system will be very low and the power supply shown in figure 3 will be quite sufficient. The supply must fulfil three requirements. The 12 V is used to supply the power for all electronics and the 7812 regulator IC takes care of this easily. The U line provides the power for ringing the bells and is provided for by the two 18 V secondary windings of the transformer in series.

The purpose of the L line may not be quite as obvious. As many readers may know, the microphone inserts in the handsets are carbon granule capsules and these require a voltage across them to allow them to function.

All the four output lines of the power supply; 0, 12 V, L and U are connected to the printed circuit boards of all the extensions.

3

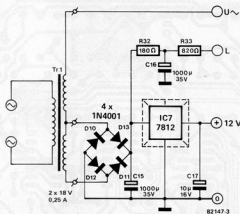

Figure 3. This power supply will be sufficient for the complete network of up to nine telephones. A heatsink is required for IC1.

The printed circuit boards

The track patterns and layouts of the printed circuit boards for the extension circuits and power supply are shown in figures 4 and 5. It is strongly recommended that printed circuit boards are used, since one complete circuit of figure 2 is required for each extension telephone set. As previously mentioned, only one power supply is required for the whole system.

The extension board is small enough to be mounted in a small box under or near to the telephone of each extension or even in the telephone itself. However, this will depend on the telephone, since not all of them have enough internal free space to accommodate the extra board. The 'line busy' LED must obviously be mounted so that it is visible to the user.

Two points to note regarding the printed circuit board. It will be seen in figure 4 that there are a row of points on the board, marked 1...9 and m. A link connected between m and one of the numbers will give that extension that particular number (link m to 6 = extension 6). It should be remembered to provide the regulator IC7 on the power supply with a heatsink, especially important if a lot of extensions are being considered.

The wiring

The interconnections between the telephone sets are made by means of a four way cable and, if figure 1 is followed, will create no problems. Bear in mind that the U connection will not be found on the power supply board. This line carries the bell ringing voltage and must be connected in the power supply directly to one end of the 18 V secondary winding of the mains transformer as shown in figure 1.

Parts list for figures 2 and 4

Resistors:

- R1, R23 = 1 M
- R2, R13, R24, R25, R30 = 100 k
- R3, R21 = 4M7
- R4, R6, R7, R11, R17, R20, R22, R29 = 1 k
- R5 = 22 k
- R8, R9 = 47 k
- R10 = 220 Ω
- R12 = 4k7
- R14 = 12 k
- R15, R16 = 2k2
- R18 = 330 k
- R19 = 220 k
- R26 = 2M2
- R27, R28 = 3k9
- R31 = 18 k

Capacitors:

- C1, C5 = 100 n
- C2 = 100 p
- C3 = 68 n
- C4 = 1 µ/50 V
- C6 = 1 µ/16 V
- C7 = 1 µ/5/16 V
- C8, C9 = 1 n
- C10, C12 = 470 n
- C11 = 33 n
- C13 = 1 µ/16 V Tantalum
- C14 = 10 n

Semiconductors:

- T1, T6 = BD 242
- T2 = BC 640
- T3, T5 = BC 547B
- T4, T7 = BC 557B
- D1...D4, D6, D7, D8 = 1N4148
- D5 = LED
- D9 = 1N4001
- IC1 = 4017
- IC2, IC6 = 4013
- IC3, IC5 = 4093
- IC4 = LM 339

4a

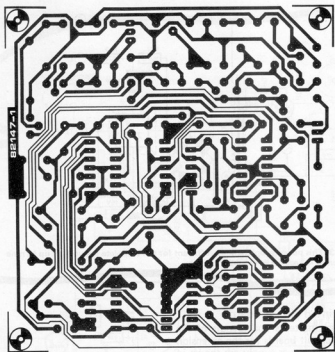

5a

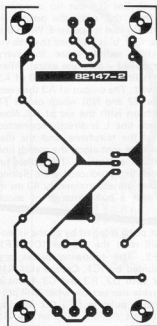

4b

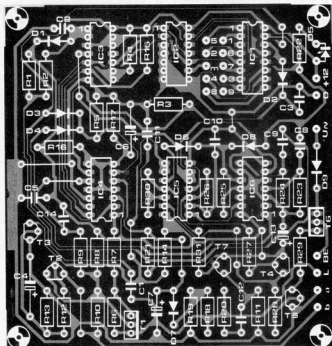

5b

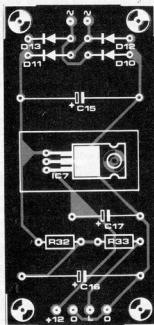

Figure 4. The printed circuit board for figure 2. One is required for each telephone. All external connections are made on one edge of the board.

Figure 5. The printed circuit board for the power supply. Only one is required.

Parts list power supply figures 3 and 5

Resistors:

R32 = 180 Ω
R33 = 820 Ω

Capacitors:

C15, C16 = 1000 μ /35 V
C17 = 10 μ /16 V

Semiconductors:

D10 . . . D13 = 1N4001
IC7 = 7812

Miscellaneous:

Tr1 = transformer 2 x 18 V/250 mA
heat sink for IC7

How to connect the telephone set itself will probably be the most popular question. Here is where the major difficulty may present itself due to the fact that the telephone sets that are available on the surplus market may

have originated anywhere. However, it is relatively safe to assume that most, if not all, telephone networks will have been based on the G.P.O. system. Having said that, we must advise readers that this is an area where Murphy's law is most active. It is strongly hoped that the four rather nice telephones you have just picked up at the right price were not designed solely for use as replacements for the unique Klutterbang exchange that existed in the middle of the Burmian jungle in 1934!

Whatever sets you may have found, figure 6 should help. Coupled to this, our spies in B.T. (planted in 1953 for just such an occasion) have sent us the following information. In most ex-G.P.O. telephones, the BE line (in figure 6) will be labelled connection 16. The 'a' connection will be 9 and the 'b' will be 19. The circuit in figure 6a is what you can expect to find in the average telephone set, but our system here requires the circuit of figure 6b. Our agent informs us from the inscrutable B.T. that the simple removal of a wire strap between connections 17 and 18 will be all that is necessary for the change to be made. But we don't believe a word of that, do we? So... we invented a simple test procedure to find the truth of the matter.

Use one of the 18 V transformer windings as a test voltage and connect a 100 μ /35 V electrolytic capacitor in series with one lead, for self-preservation and protection against any damage to the telephone. Connect this test voltage across any two terminals on the telephone set (normally only 3 or 4 in use... hopefully). If the bell rings you have the bell connection, 'a' and BE. If the result is a loud hum in the earpiece, then the 'test voltage' is connected across 'a' and 'b'.

Hand up those readers who got it right first time...! Who believes in Murphy's law now?

Final remarks

A few pointers are included here to provide readers with a 'ring of confidence' in the final stages.

The reference levels of the comparators A1...A4 are set at a level of 3.75 V. This is verified if LED D5 lights as soon as one handset is lifted (A4 operating correctly). If this is not the case then the value of R17 can be modified. It may also be necessary to change the value of R18 if the LED still does not behave correctly.

The bell may be caused to switch off inadvertently by the current sensor T1 although this is unlikely as the majority of telephones have a power consump-

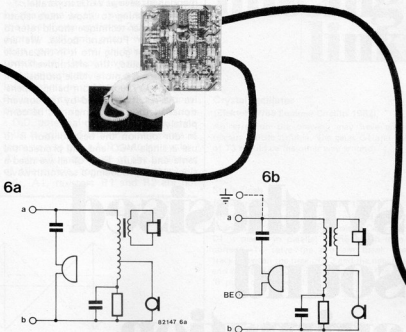

Figure 6. The first drawing shows the circuit that is expected to be found in the normal telephone set. Drawing 6b is the circuit required for the home telephone system. Notes on the changes are in the text.

tion of about 20 to 25 mA.

The voltage level at pin 10 of A3 must become practically 0 V when the handset is lifted in order to connect the telephone to the speech line.

It is also possible to use a two wire interconnection between the telephones if a small power supply is provided in each set. This will supply each telephone with its own power for the speech line. This may be very useful for some installations.

The discerning reader may miss the realism of crossed lines and wrong numbers but a steady diet of B.T. each day should help!

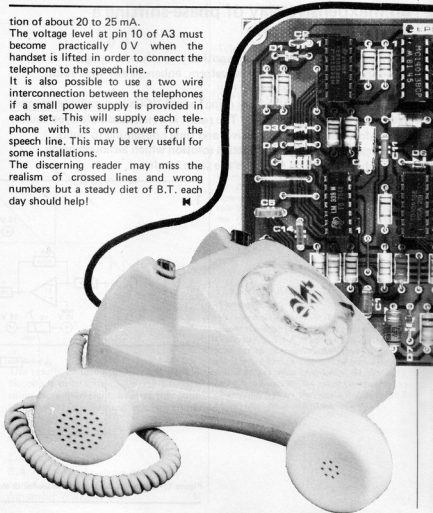

The recognised method used by synthesiser builders is, the one already mentioned; several VCOs in parallel.

Readers wishing to know more about this particular technique should refer to the Elektor Formant books. We are certainly not going into it in this article simply because, the alternative introduced here, is a more viable proposition. And, anyway, apart from being expensive the results achieved by the conventional method can sometimes be completely unpredictable.

In our opinion the best solution is to use a single VCO and still produce the same end result. First of all we need a single VCO producing a sawtooth wave-

form. The animation circuit is based upon an algebraic phase shift of this waveform. The input to the circuit is the sawtooth signal from the VCO, while the output is a sawtooth that is shifted in time from the original by an amount depending on the control voltage. Thus the shift is already under voltage control. If a number of these units (typically eight), are used in parallel, a rich animated bright sound results. As a matter of interest A1 in figure 1, can be used to provide the inverted sawtooth signal for all the phase shift circuits used. This means that all the additional circuits will not require A1, saving components!

Figure 1 illustrates one way of achieving the necessary shift. The circuit has three main stages:

- An inverter A1.
- An adder or summing up stage A2.
- A comparator and rectifier A3 and D1.

The reference voltage level (U_R) will have a direct influence on the time shift of the output compared to the input. Figure 2 clearly indicates this.

Figure 2c illustrates the result of adding the following constituents:

- A pulse form positive signal which has an amplitude, equal to the peak-to-peak value of the sawtooth.
- a negative going edge which corresponds to the positive edge of the sawtooth, that is as far as the time factor is concerned.
- The sawtooth voltages depicted as the dotted signal line shown in figure 2a.

Turn figure 2c upside down and add the D.C. voltage value to the result as shown in figure 2c. The final result is a time/phase shifted sawtooth as depicted by the solid black lines in figure 2a. The phase shift basically equals the pulse width of the signal illustrated in figure 2b.

synthesised sound animation

an inexpensive way of phase-shifting a sawtooth waveform

Sound animation or to put it in another way: the changing, delaying or phase shifting of any periodic waveform, enhances any final result, sometimes quite dramatically.

One way of achieving this is by using several VCOs in parallel, each one having a tiny tuning deviation. The result is a rich ensemble type sound, but, unfortunately it is expensive, and time consuming to build.

This article introduces an effective solution which although being relatively inexpensive produces the same results.

1

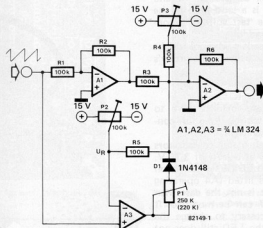

Figure 1. The circuit diagram of the sawtooth shifter.

In practice it is not the voltage but the currents which are added (see figure 1). The dotted lines in figure 2a, correlate to the current passing through R3. Assuming P1 has been correctly calibrated, the current passing through P1 and D1 is depicted by the shape and value of the curve in figure 2b. There are two further additional D.C. factors represented by the currents through R5 and R4. All of this is necessary in order to ensure that the shifted sawtooth swings around the 0V potential, just like the input signal.

Looking at figure 1, you will notice that the circuit contains three presets, so don't expect to carry out the calibration procedure in just a few minutes.

0.10V higher than the negative supply voltage of the LM 324 (typically -15V). The output signal of A2 should be the same as the inverted version of the one shown in figure 2c, which incidentally will only occur when P1 has been correctly set. In this case P1 is turned until the positive going edges of the sawtooth are no longer interrupted by any short positive or negative 'jumps'. P3 is used to add sufficient D.C. components in order for the output to have a D.C. potential of 0V. The phase/time shift is adjusted with P2. The range is from zero to one a full sawtooth cycle. As already mentioned at the beginning of the article, for each additional circuit, A1, resistors R1 and R2 are not

2a

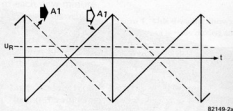

2b

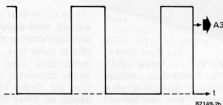

2c

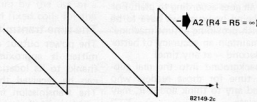

Figure 2. The function of the shifter visualised.

Calibration

A two channel oscilloscope is an absolute must. Constructors without one will have to beg, steal, or borrow one, because it is practically impossible to do without it.

First check whether the output of A1 is an inverted sawtooth, when compared with the input. Now check that the output of A3 is a signal similar in shape to the one shown in figure 2b. The lowest point of the trough should be around

required.

The results of using up to eight parallel circuits is outstanding. We don't suggest using more than eight, as after this point the law of diminishing returns comes into effect.

Literature:

B.A. Hutchins, *Analogue circuits for sound animation*, JAES November 1981.

missing link

Crystal oscillator

(Elektor 87/88 Summer Circuits 1982)

An error on the drawing may have given readers a little trouble. The gates G1 and G2 of T3 should be the other way around.

Slave flash

(Elektor 87/88 Summer Circuits 1982)

An error occurred on the printed circuit board (EPS 82549) for this project. Capacitor C1 is placed in parallel to R6 which is incorrect. To solve the problem break the track between the base of T3 and the negative end of C1. Now just link this end of C1 to the '0' point on the board.

Output unit and keysoft for the Polyformant

(Elektor 87/88 Summer Circuits 1982)

In a 10 channel version the values of R7 and R8 must be increased to 1k5.

Teletext decoder

(Elektor 80 December 1981)

Capacitor C49 on the printed circuit board is not shown in the drawing of figure 9. The C49 in the drawing is in fact C48. Values are as shown in the parts list.

RAM/EPROM card for the Z80

(Elektor 85 May 1982)

When the RAM/EPROM card is modified for Z80 systems, it is then not protected against programming errors. To overcome this 2C of IC7 is linked not to earth, but to the RD line. Incidentally, gate N3 is drawn in figure 3 as a NAND. It is, of course, an AND gate.

The Elektor Artist

(Elektor 85 May 1982)

An incorrect wiring in figure 5 may have caused some problems to the constructors.

Obviously, point A of socket Ba1 must not be soldered to connection Ba4, but to Ba1 on the printed circuit board. The connections 1 and B of Ba1 must be linked to S1. Similarly, point A of socket Ba4 must be attached to connection Ba4 on the board. Points 1 and B of Ba4 must be linked to S4.

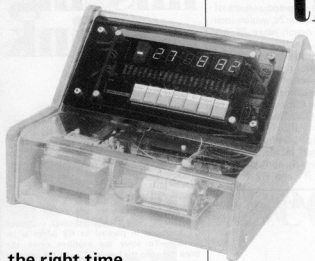

the right time all the time . . .

This circuit was designed as an addition to the '6502 housekeeper' published in the May 1982 edition. The two together provide an extremely accurate time clock controlled by transmissions from the Rugby MSF transmitter. The timing is derived from a caesium atomic clock that boasts an accuracy of 2×10^{-3} . The receiver circuit described in this article is designed to operate from the 60 kHz transmissions (VLF) from Rugby that provide good reception throughout the U.K.

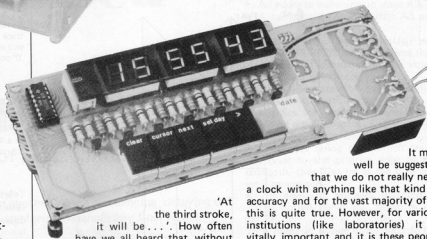

'At the third stroke, it will be . . .'. How often have we all heard that, without realising that our entire life style is ruled by time — a concept that we haven't got a hold on, yet! We at Elektor are working on it though. Our dual made time machine will be published last month, if all goes according to plan. For the time being however, we have to be content with providing a 'time machine' that can maintain an accuracy of better than one second — at any time!

A little background into the real substance of time for those readers who haven't had any to think about it, may be appropriate. The second became the standard unit of time in 1968. In that year the second was defined by the Conférence Générale des Poids et de Mesures as being 9,192,631,770 periods of the radiation that corresponds to the transition between two hyperfine levels of the ground state of the atom caesium 133! A suitable ground definition — coming from the Poids et de Mesures — but roughly speaking it means that (give or take a transition or two) there are about sixty to every minute!

Anyway, the facts of the matter stand that you do not have to write away for your box of caesium atoms (complete with hyperfine levels), the circuits here can provide you with an accuracy to within 9,192,631,770 of all those things right in your own house.

It may well be suggested that we do not really need a clock with anything like that kind of accuracy and for the vast majority of us this is quite true. However, for various institutions (like laboratories) it is vitally important and it is these people that the Rugby MSF transmissions are aimed at. Since the service exists (and for nothing) why don't we make use of it? The fact that it is highly accurate is almost beside the point for us.

The time transmitter

The power output of the Rugby transmitter is approximately 50 kW and, thanks to its location, its transmissions can be received throughout the land. The transmission frequency is 60 kHz which is itself derived from the atomic standard at the National Physical Laboratory. The deviation of the atomic clock is less than 2×10^{-3} over a period of 100 days, so except for the phase shifts that are typical of long wave transmissions, the carrier wave is exceptionally stable.

The Elektor clock is equipped with its own time base, in case the MSF transmission fails or is lost. Very short intervals, due to interference, will probably not be noticed as the clock continuously compares the indicated time with the signal transmitted from Rugby.

The time signal

The MSF carrier wave is modulated by reducing the amplitude to 25% at the beginning of each second, with the

exception of the 59th second. This 'mark' is missing altogether to denote the impending arrival of each new minute.

The time code

The complete time clock, including the exact time and full date (day of the week, month and year) is transmitted before each approaching minute. The second 'markers' are used to transmit the data in BCD format. The second marker itself consists of a break in the carrier with the timing for the second being accurate at the beginning of this break. Each second marker also doubles as the data for one bit of the transmitted information. A carrier break, if 100 ms long, indicates a logic '0' while a break of 200 ms is a logic '1'. This is illustrated in figure 1.

The first 16 seconds of each new minute are used to correct discrepancies which occur between the international atomic time scale (used by Rugby MSF) and the universal time scale that relates to the rotation of the earth as a reference source.

As mentioned, the time code information is transmitted during the minute prior to that data becoming accurate. The drawing in figure 2 shows what data bit arrives when in the minute cycle.

The time signal receiver

The drawing of figure 3 shows the block diagram of the receiver section. It was designed with three main parameters in mind:

- high sensitivity
- narrow band width
- no 'problem' coils

High sensitivity is achieved by the use of an active aerial together with a low noise preamp and a bandpass filter to keep the bandwidth narrow. Calibration is kept to a minimum by the use of a crystal oscillator and fixed coils for the

1

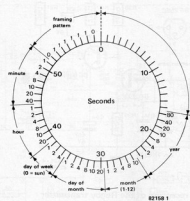

Figure 1. This drawing shows when the specific data arrives during each minute.

2

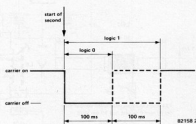

Figure 2. The MSF time information is transmitted by modulating the carrier as shown here.

bandpass filter. It was decided that a superhet design presented the best possibility of meeting all the required parameters.

The receiver circuit is based on the TCA 440 IC. This contains an RF preamp, a balanced mixer, a separate internal oscillator and an internal IF amplifier. Furthermore, all characteristics of the TCA 440 are virtually independent of the supply voltage due to an internal stabiliser.

The preamp and the triple IF stage require a feedback input from the automatic gain control. This AGC is obtained by rectifying and filtering the IF output signal and feeding it back via pin 9. The AGC is passed to the preamp via an emitter follower in the control amplifier and an external link between pin 3 and 10.

The MSF output at pin 7 is rectified and filtered before being passed to a Schmitt trigger. The 'clean' MSF signal then appears at TTL level at the 'DATA' output. The Schmitt trigger also switches an LED on and off at one second (effectively) intervals.

The circuit for the time receiver is a combination of figure 4 and 5. The active aerial circuit is that of figure 4. The aerial itself consists of a coil (L8) wound on a ferrite rod. With the addition of C43, this forms a tuned circuit that is resonant of 60 kHz. The coil can be moved on the ferrite rod if any tuning is necessary. The FET T5 and its associated components forms an amplifier with a gain of 20.

The aerial circuit is connected to the main receiver circuit by means of a screened cable. Power supply decoupling is provided by R1, C1 and C4, while R4

3

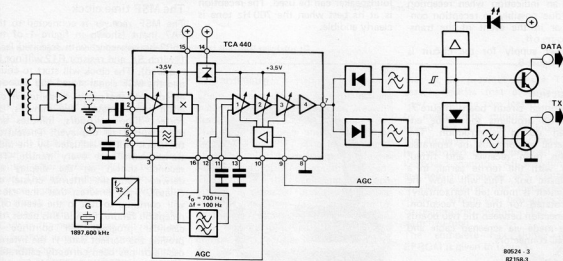

Figure 3. The receiver is based on the TCA 440 IC as shown in this block diagram. The input from the active aerial circuit is fed into pin 1 and the MSF data appears at pin 7.

4

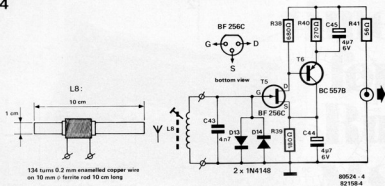

Figure 4. This active aerial circuit will provide good reception of the Rugby transmitter throughout the country.

ensures that the RF signal is not short circuited by the supply.

In the circuit of figure 5, a bandpass filter network with a centre frequency of 700 Hz and a bandwidth of 100 Hz, is connected between pins 12 and 16 of IC1. It would be easy to make the bandwidth narrower, but then calibration would be necessary and that is something that we want to avoid if possible. IC2 divides the crystal oscillator output by 32 to provide a frequency of 59.3 kHz. This is fed to pin 4 of IC1 and is mixed internally with the carrier frequency of 60 kHz to provide a centre frequency of 60 kHz (60,000 Hz - 59,300 Hz = 700 Hz). This appears at pin 7 and is then filtered and amplified. The AGC voltage is obtained by rectifying the 700 Hz output by D3. The MSF signal reaches the DATA output via D4 and the Schmitt trigger formed by IC4. The output is tailored to TTL level by means of D7 and T3. The LED is flashed at the data frequency by means of T4.

If required, the TX output (via T5) will provide an indication when reception is lost, due possibly to reception conditions or in the event of the transmitter going off.

The power supply for the circuit is shown in figure 6.

Construction

If the printed circuit board (figure 7) is used no problems should be encountered during construction. The active aerial section must be separated from the main receiver and fitted, together with the ferrite aerial, in a small plastic box. This will allow the aerial (which is mounted horizontally) to be rotated for the best reception. The connection between the two boards must be made via screened cable and small BNC connectors.

Calibration

The need for calibration has been reduced wherever possible in the circuit, but there are a few areas where it is

necessary. Connect the aerial circuit and power supply to the receiver. After checking the supply voltage turn the preset R25...R27 to their mid. position.

Guesswork will have to be applied to the trimmer (C29) but 'about right' will be close enough. An oscilloscope must now be connected to test point TP2 in order to check the amplitude of the 700 Hz signal. Adjust the amplitude for a maximum by moving the coil L1 on the ferrite rod. C29 can now be adjusted to improve the amplitude still further. The oscillator frequency can be set precisely if a frequency counter is available. In practice, the setting of C29 is not that critical and the mid. position will be fine.

If an oscilloscope is not at hand the calibration can be carried out with the aid of a multimeter switched to the 500 μ A range. This is connected to test point TP1 and the above adjustments are made for a maximum reading on the meter. At the very least, a crystal earphone or small AF amplifier with a loudspeaker can be used. The reception is at its best when the 700 Hz tone is clearly audible.

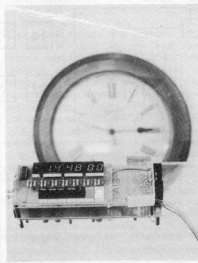

The rectified MSF signal appears at TP3 and an oscilloscope connected to this point can be used to examine the waveform.

The remaining calibration required concerns R25 and R27 in the Schmitt trigger circuit. Set R27 to its mid. position and rotate R25 until LED D8 flashes. R27 can be treated as the 'course' adjustment and R25 as the 'fine'!

It will be clear that the output of the receiver cannot be connected to any simple digital circuit that drives some display. Some sophisticated hardware is required before we can tell the time.

MSF + 6502 housekeeper

It was stated in the summary that the MSF receiver was intended for use with the 6502 housekeeper published in the May 1982 issue of Elektor. The combination of the two circuits will provide a clock that will remain very accurate. Furthermore, this clock has the added facility of four switched outputs that can be programmed over the period of a week.

Very briefly the 6502 housekeeper is a microprocessor-based circuit that is able to accept the MSF output of the receiver section and decode it, in order to provide a visual display of the time.

It will be remembered that the MSF information is transmitted throughout the period of each minute and therefore a simple decoder will not be enough. The incoming data will have to be put into memory and processed to arrive at the display at precisely the correct time. The 6502 microprocessor was chosen for this task and for a complete and detailed description of the housekeeper we refer the reader to the May issue, since, if the construction of the complete clock is contemplated, this article will be required.

The MSF time clock

The MSF receiver is connected to the PA7 input (shown in figure 1 of the 6502 housekeeper) with screened lead. (Switch SA and resistor R12 will not be required). The clock will start to count and the MSF signal stored and decoded as soon as the power is switched on. After approximately two minutes, the correct time in hours, minutes and seconds will be displayed. Thereafter, the clock will be adjusted by the MSF transmission once every minute. The seconds shown on the display are derived from the internal crystal oscillator. This ensures that the clock will continue to run in the event of a reception failure. Should this occur, the calendar program will continue to provide the correct date. If the internal oscillator has been correctly calibrated, the error will not exceed half a second per day if reception is lost for a long period of time. This is, hopefully, unlikely to happen.

5

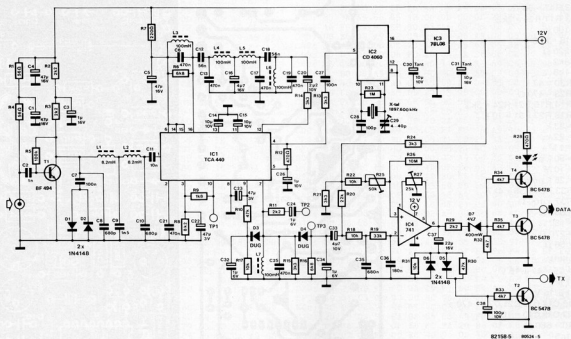

Figure 5. The circuit diagram of the receiver. It consists of the TCA 440, a bandpass filter (between pins 12 and 16), a crystal oscillator and divider (IC2) and a Schmitt trigger (IC4). TP1, TP2 and TP3 are the test points for calibration.

6

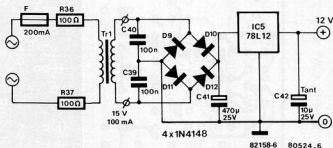

Figure 6. The power supply for the receiver consists of the usual regulator IC.

The data will be displayed for as long as the 'date' key is held. The days of the week are indicated by seven LEDs. One LED is also used to indicate good reception of the Rugby MSF signal. This LED will flash if reception fails for any reason. It will cease to flash two full minutes after reception has been restored. This will indicate that the clock is once again synchronised with the MSF signal.

It is worthwhile remembering that the NiCads in the housekeeper will maintain the internal time if the mains supply fails. The time will of course automatically be corrected when the power supply returns. The only noticeable difference will be the display becoming considerably dimmer.

The software

There are easier things to explain than a complete program. However, we will describe what it actually accomplishes. The MSF time code enters the housekeeper via line PA7. The logic '1' and '0' are decoded from the pulse lengths and the data obtained are then stored. Furthermore, the beginning of each minute is detected and the processor 'bears in mind' how many pulses are to be received in one minute's time. The data is only used when the correct number of pulses has been received and the parity check of the input data is correct. If an error occurs, the processor will automatically start counting and decoding afresh. The data that arrives during the minute will be compared to

that of the previous minute. The processor decides that everything is all right when the two lots of data differ by exactly one minute. The data received last will then be indicated on the displays. The display multiplexing is controlled by the program as is the keyboard scanning. All switching times are held in memory and continuously checked against the displayed information. When the two coincide, the corresponding output (T0...T3) is switched high.

The complete hex dump for the EPROM is given in table 1.

The ASCII data outputs

The PB0...PB6 output of the 6502 housekeeper will now provide the MSF

Parts list

Resistors:

R1, R3, R41 = 56 Ω
 R2, R3, R11, R29 = 2k2
 R5 = 100 k
 R6, R16 = 6k8
 R7 = 220 Ω
 R8 = 8k2
 R9 = 1k8
 R10, R30 = 47 k
 R12, R28 = 470 Ω
 R13, R14, R15, R21, R24 = 3k3
 R17, R18, R22, R31 = 10 k
 R19 = 33 k
 R20 = 22 k
 R23 = 1 M
 R25 = 50 k preset
 R26 = 10 M
 R27 = 25 k preset
 R32, R33, R34, R35 = 4k7
 R36, R37 = 100 Ω
 R38 = 680 Ω
 R39 = 180 Ω
 R40 = 270 Ω
 R41 = 56 Ω

Capacitors:

C1, C4, C5 = 47 μ /16 V
 C2 = 1 n
 C3 = 1 μ /16 V
 C6, C13, C17, C19, C21, C25 = 470 n
 C7, C27, C39, C40 = 100 n
 C8, C10 = 680 p
 C9 = 1n5
 C11 = 10 n
 C12, C18 = 56 n
 C14, C15 = 10 μ /10 V
 C16 = 4 μ 7/16 V
 C20 = 2 μ 2/10 V
 C22, C23 = 47 μ /3 V
 C24, C32, C34 = 1 μ /6 V
 C26 = 1 μ /10 V
 C28 = 100 p
 C29 = 4 . . . 40 p trimming capacitor
 C30 = 10 μ /10 V tantalum
 C31 = 10 μ /16 V tantalum
 C33 = 4 μ 7/10 V
 C35 = 680 n
 C36 = 180 n
 C37 = 22 μ /16 V
 C38 = 100 μ /10 V
 C41 = 470 μ /25 V
 C42 = 10 μ /25 V tantalum
 C43 = 4n7
 C44, C45 = 4 μ 7/6 V

Coils:

L1, L2 = 8,2 mH
 L3 . . . L7 = 100 mH
 L8 = see text

Semiconductors:

D1, D2, D5, D6, D13, D14 = 1N4148
 D3, D4 = DUG
 D7 = 4V7/0,4 W zener
 D8 = LED
 D9 . . . D12 = 1N4001
 T1 = 8F 494
 T2, T3, T4 = BC 547B
 T5 = 8F 256C
 T6 = BC 557B
 IC1 = TCA 440
 IC2 = CD 4060
 IC3 = 78L08
 IC4 = 741
 IC5 = 78L12

Miscellaneous:

X-tal = 1897,600 kHz crystal
 Tr1 = transformer 15 V/100 mA
 S1 = double pole mains switch
 F = fuse 200 mA

7

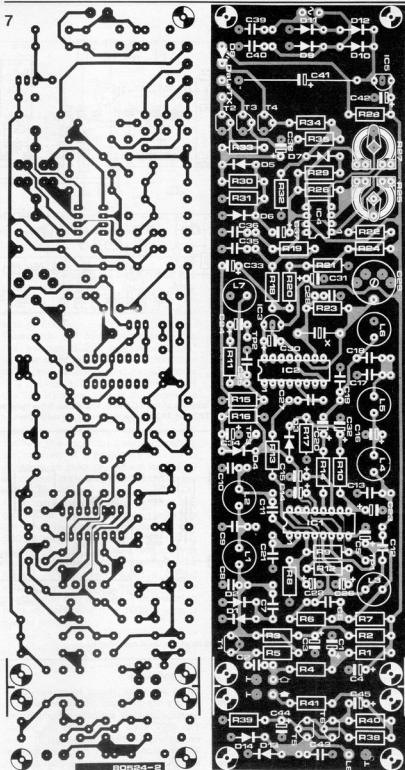
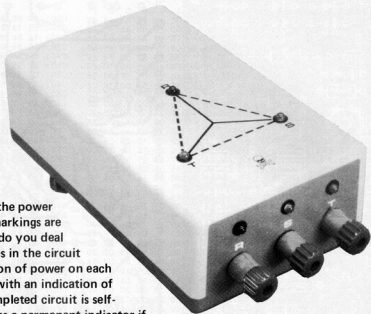

Figure 7. The printed circuit board for the complete receiver. The active aerial section must be separated from the main receiver before assembly can be started. The electrolytic capacitors are mounted vertically.

time in ASCII code. All data (time and date) is read out once per second for a period of approximately 600 μ s. This period can be identified by the fact that only two of the PB4 . . . PB6 lines (either PB4 and PB5 or PB5 and PB6) will be at logic '1' simultaneously. At

any other time (during the display routine) only one of them will be at logic '1'. Table 2 shows when the data outputs take place. The time sequence and the letters shown in figure 8 correspond to the table.

three phase tester



When connecting three phase motors to the power source, confusion can arise if the cable markings are incorrect, illegible or non-existent. How do you deal with this problem? The simple answer lies in the circuit described here, where an optical indication of power on each of the three phases is provided together with an indication of the direction of motor rotation. The completed circuit is self-powered and compact and can be fitted as a permanent indicator if desired.

Those of our readers who are familiar with three phase mains power supplies will no doubt be fully aware of the confusion that can arise if, for one reason or another, the supply cables lose their identification. The problem is increased by the fact that either the motor being connected will not run at all (in which case the fault will invariably be blamed on the motor), or the motor will run the reverse direction. The latter case brings with it the attendant possibility of damage to equipment being driven. This is as good a case as any for building a phase detector.

The circuit derives its power from the three phase supply under test and therefore requires no batteries or power supply. Three LEDs will indicate that power actually exists on the cables of the three phase supply, when connected. The output of the circuit consists of three further LEDs arranged in the form of a triangle. These are a 'running light' display and show the direction of rotation of the motor when it is connected to the three phase supply in a similar manner.

The circuit

As has already been mentioned, the circuit derives its power from the three phase supply. This results in a very unfamiliar power supply in the circuit diagram of figure 1 and readers will be forgiven for not having spotted it immediately. It basically consists of capacitors C1 . . . C3, diodes D1, D4 and D7 and the reservoir capacitor, C7. The resistors R1 . . . R3 are included to limit the initial capacitor charging current. The diodes form a

electronic rotating field direction indicator

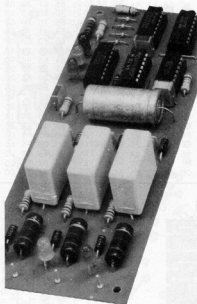

three phase half-wave rectifier which provides a d.c. voltage across C7. This voltage level is then stabilised to 10 V by the zener diode D10.

The LEDs D3, D6 and D9 are the indicators that check the three phase connections. If one phase is connected incorrectly or power does not exist on

that phase then the corresponding LED will not light. Furthermore, if a connection is made to the neutral line instead of a phase, the LED will light at about half its normal brightness. These checks take care of the incoming supply. The remainder of the circuit provides the rotation indicator for a three phase motor. The phases of a three phase supply (normally indicated by the colours red, yellow and green) provide sine wave voltages with a frequency of 50 Hz that are phase shifted apart by 120°. The voltage is 220 V with respect to the neutral line.

Phase detection is essential for the circuit to be able to display the direction of rotation. In the case of the red phase (the top one in the circuit diagram) this is carried out by C4, D11, D12 and R7. These components together provide a pulse output at point 1 in the circuit that corresponds to a particular point in the sine wave of that phase input. It follows then that points 1, 2 and 3 in the circuit are relative to the phase angles of the three phases.

One other parameter essential to the circuit is of course the pulse sequence from the three phases. This is 'decoded' by means of the flip-flops FF1 and FF2 and the two gates N3 and N4. The R phase (red LED) is used as a reference. Rotation of the field will be clockwise

Direction detection

How the logic circuit for direction detection makes sense of the pulse sequence of the three phases is quite straightforward, if we start with an input from the red phase (input R). A pulse at point 1 will set flip-flop FF1.

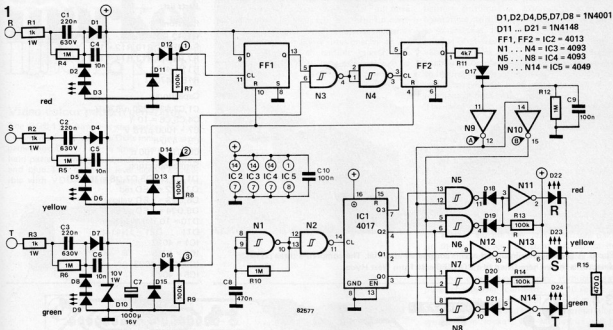
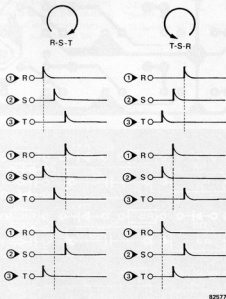

Figure 1. The circuit diagram of the three phase tester. Three of the LEDs provide an indication that power exists on the three phases. The remaining three LEDs form a running light display to indicate the direction of rotation of the motor.

Its Q output will now be logic 1 (high) which enables gate N3. With clockwise rotation a pulse from point 2 will now follow and this will be passed by N3 to the clock input of FF2 via N4. The Q output of this flip-flop will now also be at logic 1. The final pulse to arrive in this chain of events will be that of phase T (green) at point 3 and, when it occurs, this will reset both flip-flops. Since this all happens at 50 times a second it is not a lot of good to us as it stands. The simple answer would be to have a LED that lights when rotation is clockwise and this is exactly what we can have at point B in the circuit. The train of logic 1 pulses from the Q output of FF2 is 'stored' by capacitor C9 to provide a constant 'high' at the output of the inverter N10. A LED at this point would light to indicate that direction of rotation is clockwise. That takes care of the clockwise indicator but what about anti-clockwise? Figure 2 tells us that, in this case, phase is phase R is followed by phase S and then T. It will be anti-clockwise if phase R is followed by T and then S. This is clearly illustrated in figure 2.

2



82577

Figure 2. This illustrates the six possible combinations of phase sequence with respect to points 1, 2 and 3 in the circuit diagram.

Running lights

We were tempted to call the rotation indicator display a Progression of R must be followed by T and S in that order. This means that the pulse at point 3 will be continually resetting FF1 before the S phase pulse at point 2 can reach the input of gate N3, with the result that FF2 will never be set. Its Q output will therefore remain low. A LED at point A will now be lit to advise the world that the direction of rotation

is anti-clockwise! This is all very fine for a simple yes/no indication, but the silicon chip must be capable of better things!

Horizontal Illuminated Lights In Sequence (PHILIS?) but the LEDs are formed in a triangle. This led us to Progressive Illuminated Lights Equally Sequenced which is something else to sit down and think about...! So running lights it is, with one LED at each corner of a triangle to give a very clear indi-

cation of motor rotation. The basis of this section of the circuit is the CMOS decade decoder IC1, together with the clock oscillator formed by the gates N1 and N2. Two outputs of the decoder are fed to the N5 ... N8, which are in turn controlled by the yes/no signals at point A and B. If A is high the lights run in an anticlockwise direction round the triangle and if B is high in a clockwise direction. It will be obvious that since N9 and N10 are inverters, A and B can

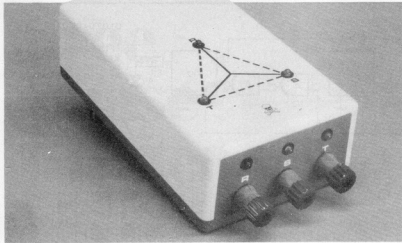

Photo. A good quality insulated case is considered essential. The completed three phase detector is shown here fitted in a BOC 450 case from West Hyde.

Parts list:

Resistors:

R1, R2, R3 = 1 k
 R4, R5, R6, R10, R12 = 1 M
 R7, R8, R9, R13, R14 = 100 k
 R11 = 4k7
 R15 = 470 Ω

Capacitors:

C1, C2, C3 = 220 n/630 V
 C4, C5, C6 = 10 n
 C7 = 1000 μ /16 V
 C8 = 470 n
 C9, C10 = 100 n

Semiconductors:

D1, D2, D4, D5, D7, D8 = 1N4001
 D3, D22 = LED red
 D6, D23 = LED yellow
 D9, D24 = LED green
 D10 = 10 V/1 W zener
 D11 ... D21 = 1N4148
 IC1 = 4017
 IC2 = 4013
 IC3, IC4 = 4093
 IC5 = 4049

3,4

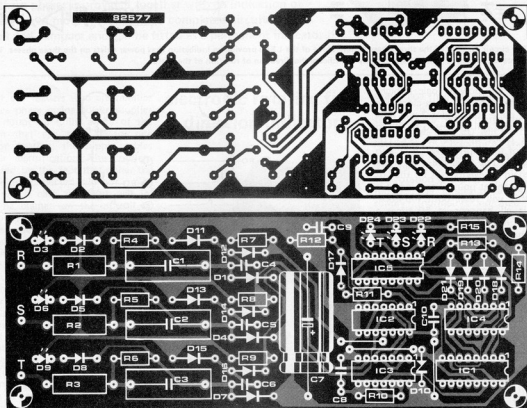

Figure 3 and 4. All the necessary components are mounted on the printed circuit board. The component layout of the printed circuit board.

never be at the same logic level...a fairly convenient state of affairs! LED D23 is controlled directly by the Q1 output of IC1 without interference from either of the A and B signals. Being the centre LED at all times, it does not need to concern itself about direction!

Construction

A point to note regarding the three LEDs D22 ... D24. Care must be taken when wiring these as one placed in the

wrong position will play havoc and provide a 100% incorrect display! While not wishing to go on at great length about the safety aspect of a project of this nature, it must be borne in mind that any three phase supply carries a totally unhealthy respect for human feelings and may be backed up by far larger fuses than are normally found in the domestic tranquility of the home! Be reminded, a 150 amp fuse will make a lot of pretty colours with

your screwdriver before you can say 999! The completed circuit must be housed in a good quality plastic or resin based case with three, preferably locking type, sockets for connecting the inputs from the phases. The LEDs can be positioned anywhere on the case that is convenient provided that they can be easily read. It is strongly advised that all testing of the circuit should be carried out with the printed circuit board mounted in the case. **M**

market

Video colour pattern generator

The RGB-11 is aimed at the market for both commercial and hobby VDU's including video games and CCTV. It is a small compact hand held pattern generator and delivers red, green and blue TTL or lower level signals compatible with VDU or video games requirements.



The unit has 8 basic patterns available which are: colour-bars - red, blue, green and white rasters - grey scale - cross hatch and vertical lines. The internal rechargeable battery gives approximately 4 hours use from an overnight charge or can be used continuously via a mains adaptor. This unique hand held unit comes complete with rechargeable battery, connecting cable, adaptor/rechargeable and carrying case. It is fully guaranteed for 12 months and costs £120 (exc. VAT).

House of Instruments Ltd.,
Clifton Chambers,
62 High Street,
Saffron Walden,
Essex CB10 1EE.
Telephone: 0799.24922

(2447 M)

Audible digital multimeter

This hand held instrument, the MIC-6000Z digital multimeter, is designed for both field and laboratory use and features one rotary switch to select both function and range at the same time. It requires only two input terminals to measure both AC and DC voltage, current and resistance with a third terminal for high current measurement. Operation of the unit is easier than a traditional analogue multimeter.

The 3½ digit LCD features large 0.5 inch easy to read numerals with automatic decimal point, over-range and polarity indication. 800 hours of operation are achieved from a standard 9V battery while the battery condition is continuously monitored and a warning displayed during the last 20% of life. Line operation is possible using a 9V AC to DC adaptor.

Measurement functions include AC and DC voltages to 1000V with a basic DC accuracy of 0.5%, AC and DC current to 10A, resistance to 20Mohms, diode and switched

audible continuity check. All functions are fully protected against overload. Full scale resistance test voltages will not turn on components, allowing "in-situ" resistance measurements and quick continuity checks to be detected easily by an audible buzzer. The instrument uses a dual slope integrating A to D converter giving fast recovery from over-range.

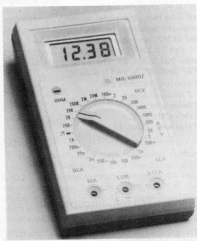

This DMM weighs only 330 grams including battery and is carefully designed to give long and reliable performance for all applications. Priced at £46.00 complete with free battery, test leads, spare fuses and instruction manual, the MIC-6000Z is fully guaranteed for one year.

House of Instruments Ltd.,
Clifton Chambers,
62 High Street,
Saffron Walden,
Essex CB10 1EE.
Telephone: 0799.24922

(2441 M)

Time switch

A new micro-electronic time control switch which can be programmed for up to 168

different switchings a week is available from Sauter Automation Limited. Called the Memotime, this time control switch is as easy to operate as a pocket calculator and is so reliable that Sauter is offering a special 10 year free service arrangement. The Memotime enables a complex series of timing commands to be programmed through a single unit which would previously have required a range of mechanical time switches.

The Memotime has 24 memory addresses which allow 168 switching times to be set with a minimum interval between switchings of only one minute. A running reserve also ensures that it will continue to operate for up to 48 hours following any power disruption. Accurate to within one second, the Memotime has 12 pockets calculator-like buttons with which programmes can be set in detail. Instructions on how to operate these are also printed on a plastic drawer which slots into the casing of the device for quick reference. To further aid the user, an illuminated panel on the face shows a constant read-out of the day of the week, hours and minutes as well as the on or off switching status. The Memotime has a switching capacity, through single pole changeover contacts, of 10 Amps at 250V. It can be either wall or panel mounted and is supplied with a separate terminal block with plug-in socket. The Memotime will be available from September 1, at a list price of £66 (plus VAT).

Sauter Automation Ltd.,
165 Bath Road,
Slough,
Berkshire.
Telephone: 0753.39221

(2450 M)

market

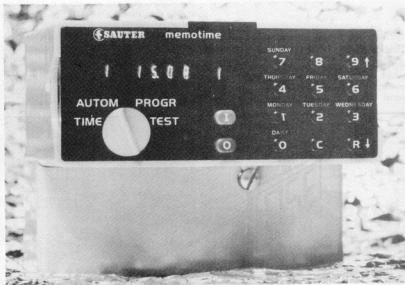

market

Half height floppy disc drive

The FD-55E and FD-55F are half height drives which give 0.5 Megabyte and 1 Megabyte storage capacity respectively. The two devices satisfy single sided and double sided requirements and the track to track access time is reduced to less than 3 ms. Recording density is 96 TPI and FM or MFM recording methods can be employed. 2 Mbytes of information can be stored in the space previously needed to store 1 Mbyte. Side by side, two drives can be neatly packaged beneath a 9 inch monitor or above a standard QWERTY keyboard, taking up only 41.3 mm in height. The compact drives are ideally suited for use in intelligent terminals or as back-up for 5¼" Winchester drives.

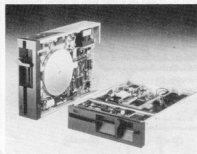

A direct drive DC brushless motor is used which can be run continuously. The head load mechanism is solenoid operated and an optional contact mechanism (without the solenoid) can be specified.

Tekdata Electronics,
Unit 1,
Federation Road,
Burslem,
Stoke-on-Trent ST6 4HY.
Telephone: 0782.813631

(2445 M)

Backlighting for LCDs

An electroluminescent backlighting panel, which is highly reliable and bright is now available from Electronic Hobbies Ltd. The panel has a thin profile permitting high

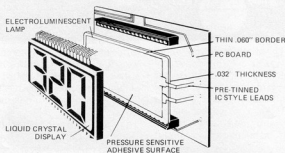

density packaging, low power consumption, and is easily mounted with a pressure sensitive adhesive front surface. It has a cold light source eliminating any heat problems and eliminating the need for sockets and bulbs. Diffusers and reflectors provide uniform lighting across the entire lamp surface. Backlighting is green, working voltages are in the range 41 V to 130 V, and it will operate at frequencies of up to 600 Hz.

With IC style tinned leads spaced nominally at 5.08 mm, the panel is easily compatible with printed circuit boards. Overall dimensions are as follows — package size 22.9 x 53.1 mm, lit size 19.3 x 47 mm, length 30.2 mm and lit area 907.1 mm sq. The panel costs £6 (plus P&P at £0.45 & VAT).

Electronic Hobbies Ltd.,
17 Roxwell Road,
Chelmsford,
Essex CM1 2LY.
Telephone: 0245.62149

(2449 M)

Single trace oscilloscope with built-in component tester

The capabilities of the type 3030 single trace oscilloscopes are extended beyond the range of a normal scope with the inclusion of a built-in component tester; active and passive components, including diodes, transistors and FETs can be tested in and out of circuit, test results are displayed instantly on the CRT. Thus the 3030 has increased use as a test and trouble shooting instrument.

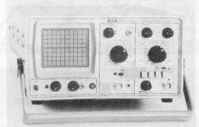

With front panel controls clearly marked and related functions and controls colour linked, the 3030 is designed to achieve the optimum styling size. Having a 15 MHz bandwidth and deflection coefficients from 5 mV to 20 V/div, it is ideal for investigating low level circuits and allows the onscreen measurement of high levels. Vertical performance is fully complemented by a wide range time base with 18 sweep speeds plus a variable, covering the range 200 ns to 200 ms/div.

With two trigger modes, automatic and level,

the 3030 will lock to any repetitive waveform and display a bright base line at all sweep speeds in the absence of an input signal in the auto mode. The level mode features reliable triggering for complex signals. Giving 50 percent more display area than normally found for this price range and performance bracket, it has an 8 x 10 div rectangular CRT, with bright high definition display. It also has a 200 mV calibration signal.

With the incorporation of a component tester, this scope would be an ideal test and measuring instrument for the hobbyist. Priced at £ 145 (plus P&P at £ 12.00 and VAT).

Electronic Hobbies Ltd.,
17 Roxwell Road,
Chelmsford,
Essex CM1 2LY,
Telephone: 0245-62149

(2344 M)

Solar cells

The SB-250 series solar cells from Solartron can be arranged in series or parallel and have many uses, including charging NiCad batteries, button cells and stacks. (On a sunny day, light energy in the UK, can be in excess of 500 W/m²). Features of these cells include high efficiency and unlimited life. They have a low iron, high transmission glass protective surface with cells in silicone rubber pottant. The base plate is anodised aluminium.

The SB-250-2 has an output voltage of 2 V with output current of 550 mA and an open circuit voltage of 2.5 V, the SB-250-8A has an output voltage of 8 V with output current of 95 mA and an open circuit voltage of 11.0 V.

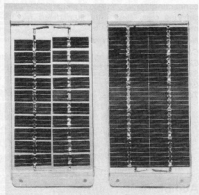

All current values are nominal at 2800° K and 25° C at 100 mW/m² Tungsten. Weight is just 150 gms, dimensions are 150 x 85 x 5 mm.

Solartron Ltd,
Haywood Way,
Ivyhouse Lane,
Hastings,
Sussex.
Telephone: 0424.442160

(2440 M)

market

market

Lithium batteries

A new range of high quality lithium batteries from SANYO said to be today's most advanced, are now available from Stotron. The lithium battery features include high voltage and high energy density. They have an extremely long shelf life and are absolutely safe,

units for leisure activities.

The auto units are made of a special material for safety. The portable units are housed in tough A.B.S. plastic for durability and, the C-Box for the home uses separate stackable units so that you can design your own cassette storage system to fit into shelves, cupboards, drawers or anywhere you need cassettes to hand.

*Fischer C-Box,
Fischer House,
25 Newtown Road,
Marlow,
Bucks.*

Telephone: 06284.72882

(2438 M)

The new shadowmasks are the product of recent advances in precision optical exposure and etching technology. To get the best from the ultra-fine shadowmasks, NEC have improved convergence performance, resulting not only in higher resolution, but also in a smoother display and better picture quality. As a result, horizontal resolution is improved from previous levels of around 700 pixels to more than 1100 pixels, i.e. a phosphor dot pitch of 0.206 mm.

*Impectron Ltd.,
Foundry Lane,
Horsham,
W. Sussex RH13 5PX.
Telephone: 0403.50111*

(2448 M)

Ultra-high resolution TV tubes

A new type of ultra high resolution colour cathode ray tube, capable of displaying up to 6500 alpha numeric characters on a 14-inch screen has been introduced in the UK by Impectron Ltd. Developed in Japan by NEC, the type 370MKB22 tube has been designed with office automation, data processing and word processing systems in mind.

Secret of the new tube is the use of a 0.2 mm pitch shadowmask, compared with 0.3 mm pitch shadowmasks currently used for the finest display applications and 0.6 mm pitch for the tubes used in domestic TV appli-

Tough tuboxes

ZAERIX Electronics Ltd. have recently introduced a new range of multi-purpose boxes that combine the advantages of simplicity and cost effective design with those of extreme robustness and good aesthetic qualities. The base comprises an extremely rigid, natural coloured, anodised aluminium 70 mm wide by 40 mm deep U-section extrusion, manufactured in 6 lengths of between 70 mm and 220 mm into which slide 1.5 mm thick PVC coated covers having integral end pieces.



having no corrosive electrolyte and unpressurised cells. They also have a wide temperature operating range. Button and cylindrical styles are available.

*Stotron Ltd.,
Haywood Way,
Ivyhouse Lane,
Hastings,
Sussex.*

Telephone: 0424.442160

(2444 M)

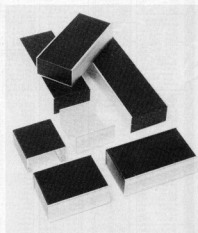
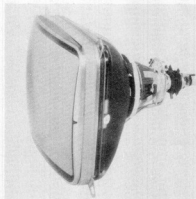

Cassette Storage System

Like all great ideas C-Box is simple, a spring loaded drawer delivers your cassette at the touch of a button. When closed the drawer keeps your cassette dust free and splined hubs prevent the cassette from unwinding. Designed around this unique idea are cassette storage systems for the car, the home and portable

Utilising 4 self-tapping screws for securing base and cover, these new tough but elegant TUBOXES are ideally suited to hand-held equipment applications such as walkie-talkies and in-field test gear.

*Zaerix Electronics,
Electronic House,
Cray Avenue,
St. Mary Cray,
Orpington,
Kent BR5 3QT.
Telephone: 0689.27099*

(2446 M)



market

FROM CASSETTE TO VIDEO AND BACK

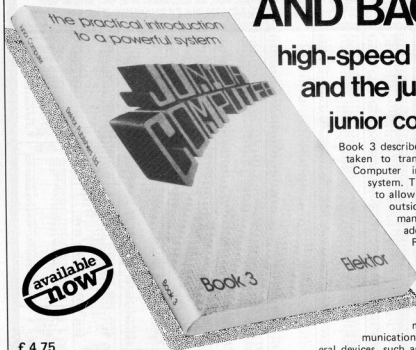

£ 4.75
ISBN 0905705 09 2

high-speed data transfer and the junior-computer junior computer book 3

Book 3 describes a number of steps that need to be taken to transform the single-board, basic Junior Computer into a complete personal computer system. This involves adding an interface board to allow the machine to communicate with the outside world (its operator) in 'adult' manner. The interface board provides additional I/O, a cassette interface, an RS 232 interface and an internal connection with the buffered bus board.

The hardware extensions complete the physical development of the computer and the sophisticated software in Book 4 enables the machine to fully utilise its additional memory capacity by extending its communication skills. As a result, a number of peripheral devices, such as a printer or a video terminal can be 'hooked up' to the computer.

Every week, millions of advertisements appear in the press, in print, on posters or in the cinema.

Most of them comply with the rules contained in the British Code of Advertising Practice and are legal, decent, honest and truthful.

But if you find one that, in your opinion, is wrong in some way, please write to us at the address below. (Complaints about TV and radio should be sent to the Independent Broadcasting Authority).

We'd like you to help us keep advertising up to standard.

The Advertising Standards Authority. ✓
If an advertisement is wrong, we're here to put it right.

ASA Ltd., Brook House, Torrington Place,
London WC1E 7HN.

Please mention

elektor

when ordering goods or
requesting information
from advertisers.

elektor

Photocopies of articles can be obtained from out of print back issues of Elektor.

Send details of the name of the article required and the number of the back issue concerned, your name and address plus 50 p per cost of article and 20 p for postage and packing.

copy service

TV GAMES COMPUTER BOOK

an exciting
introduction to
microprocessors

The first acquaintance with microprocessors can be rather frightening. You are not only confronted with a large and complex circuit, but also with a new language: 'bytes', 'CPU', 'RAM', 'peripherals' and so on. Worse still, the finished article is a miniature computer and so you have to think up some sufficiently challenging things for it to do! This book provides a different - and, in many ways, easier - approach.

The TV games computer is dedicated to one specific task: putting an interesting picture on a TV screen, and modifying it as required in the course of a game. Right from the outset, therefore, we know what the system is intended to do. Having built the unit, 'programs' can be run in from a tape: adventure games, brain teasers, invasion from outer space, car racing, jackpot and so on. This, in itself, makes it interesting to build and use the TV games computer.

There is more, however. When the urge to develop your own games becomes irresistible, this will prove surprisingly easy! This book describes all the components parts of the system, in progressively greater detail. It also contains hints on how to write programs, with several 'general-purpose routines' that can be included in games as required. This information, combined with 'hands-on experience' on the actual unit, will provide a relatively painless introduction into the fascinating world of microprocessors!



£ 5.00 - Overseas £ 5.25
ISBN 0-905705-08-4

for your copies of Elektor

THE ELEKTOR CASSETTE BINDER

This cassette style binder will help to keep your copies of Elektor clean and in order, even though you refer to them time and time again. The chamfered corner of the cassette allows instant recognition of each month's issue without the need to thumb through pages of previous months' issues. Because no wires or fasteners are used copies can be easily removed and replaced and each cassette will hold one year's volume of Elektor. Their smart appearance will look good on any laboratory shelf.

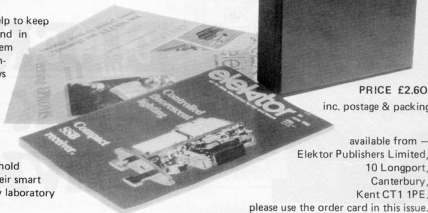

PRICE £2.60
inc. postage & packing

available from -
Elektor Publishers Limited,
10 Longport,
Canterbury,
Kent CT1 1PE.

please use the order card in this issue.

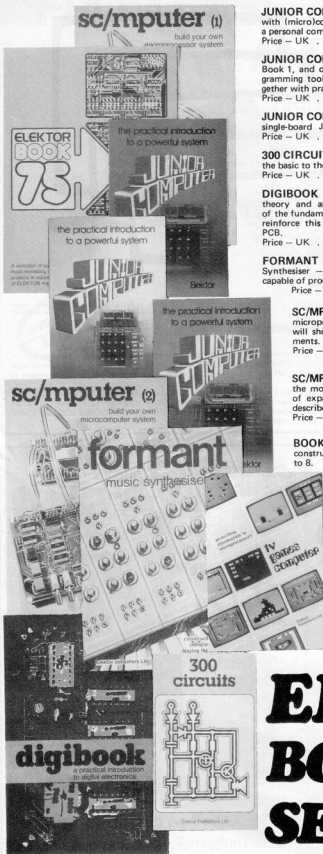

JUNIOR COMPUTER BOOK 1 — for anyone wishing to become familiar with (micro)computers, this book gives the opportunity to build and program a personal computer at a very reasonable cost.
 Price — UK £ 4.50 Overseas £ 4.75

JUNIOR COMPUTER BOOK 2 — follows in a logical continuation of Book 1, and contains a detailed appraisal of the software. Three major programming tools, the monitor, an assembler and an editor, are discussed together with practical proposals for input and peripherals.
 Price — UK £ 4.75 Overseas £ 5.00

JUNIOR COMPUTER BOOK 3 — the next, transforming the basic, single-board Junior Computer into a complete personal computer system.
 Price — UK £ 4.75 Overseas £ 5.00

300 CIRCUITS for the home constructor — 300 projects ranging from the basic to the very sophisticated.
 Price — UK £ 3.75 Overseas £ 4.00

DIGIBOOK — provides a simple step-by-step introduction to the basic theory and application of digital electronics and gives clear explanations of the fundamentals of digital circuitry, backed up by experiments designed to reinforce this newly acquired knowledge. Supplied with an experimenter's PCB.
 Price — UK £ 5.00 Overseas £ 5.25

FORMANT — complete constructional details of the Elektor Formant Synthesiser — comes with a FREE cassette of sounds that the Formant is capable of producing together with advice on how to achieve them.
 Price — UK £ 4.75 Overseas £ 5.00

SC/MPUTER (1) — describes how to build and operate your own microprocessor system — the first book of a series — further books will show how the system may be extended to meet various requirements.
 Price — UK £ 3.95 Overseas £ 4.20

SC/MPUTER (2) — the second book in series. An updated version of the monitor program (Elbug II) is introduced together with a number of expansion possibilities. By adding the Elektorterminal to the system described in Book 1 the microcomputer becomes even more versatile.
 Price — UK £ 4.25 Overseas £ 4.50

BOOK 75 — a selection of some of the most interesting and popular construction projects that were originally published in Elektor issues 1 to 8.
 Price — UK £ 3.75 Overseas £ 4.00

BOOK 75 — a selection of some of the most interesting and popular construction projects that were originally published in Elektor issues 1 to 8.
 Price — UK £ 3.75 Overseas £ 4.00

TV GAMES COMPUTER — this book provides a different — and, in many ways, easier — approach to microprocessors. The TV games computer is dedicated to one specific task, as the name suggests. This provides an almost unique opportunity to have fun while learning!
 Price — UK £ 5.00 Overseas £ 5.25

When ordering please use the Elektor Reader's Order Card in this issue (the above prices include p. & p.)

ELEKTOR BOOK SERVICE

Make it with MAPLIN



KEYBOARD KIT WITH ELECTRONICS FOR ZX81

- A full size, full travel 43-key keyboard that's simple to add to your ZX81 (no soldering in ZX81).
- Complete with the electronics to make "Shift Lock", "Function" and "Graphics 2" single key selections making entry far easier.
- Powered from ZX81's own standard power supply - with special adaptor supplied.
- Two-colour print for key caps.
- Amazing low price.

Full details in our projects book. Price 60p. Order As XA030.
Complete kit for only £19.95 incl. VAT and carriage. Order As LW72P.



25W STEREO MOSFET AMPLIFIER

A superb new amplifier at a remarkably low price.



- Over 25W per channel into 8Ω at 1kHz both channels driven.
- Frequency response 20Hz to 40kHz ±1dB.
- Low distortion, low noise and high reliability power MOSFET output stage.
- Extremely easy to build. Almost everything fits on main pcb, cutting interwiring to just 7 wires (plus toroidal transformer and mains lead terminations).
- Complete kit contains everything you need including pre-drilled and printed chassis and wooden cabinet.

Full details in our projects book. Price 60p. Order As XA030
Complete kit for only £49.95 incl. VAT and carriage. Order As LW71N

MAPLIN'S FANTASTIC PROJECTS

Full details in our project books only 60p each.

- In Book 1 (XA018)** 120W rms MOSFET Combo-Amplifier - Universal Timer with 18 program times and 4 outputs - Temperature Gauge - Six Vero Projects
- In Book 2 (XA02C)** Home Security System - Train Controller for 14 trains on one circuit - Stopwatch with multiple modes - Miles per-Gallon Meter
- In Book 3 (XA03D)** ZX81 Keyboard with electronics - Stereo 25W MOSFET Amplifier - Doppler Radar Intruder Detector - Remote Control for Train Controller
- In Book 4 (XA04E)** Telephone Exchange expandable up to 32 extensions - Ultrasonic Intruder Detector - Frequency Counter 10Hz to 650MHz - Remote Control for 25W Stereo Amplifier

*Projects for book 4 were in an advanced state at the time of writing, but contents may change prior to publication (due 14th Aug 1982).

MORE GREAT KITS FROM MAPLIN

- Matinée Organ (see box above)
- Spectrum Synthesiser. Full details in book XH56L. Price £1.00
- 3800 Synthesiser } Full details in book XF11M. Price £2.00
- 5600S Synthesiser }
- 150W Power Amp Kit LW32K. Price £17.95*
- 75W MOSFET Power Amp Kit LW51F. Price £11.49*
- 50W Power Amp Kit LW35D. Price £14.95*
- 15W Power Amp Kit YD43W. Price £8.45*
- 8W Power Amp Kit LW36P. Price £4.45*

*Construction details with kit. (Power supply not included - details with kit).

MAPLIN ELECTRONIC SUPPLIES LTD.

All mail to:
P.O. Box 3, Rayleigh, Essex SS6 8LR
Tel: Sales (0702) 552911 General (0702) 554155
Shops at:
159 King St., Hammersmith, London W6. Tel: 01-748 0926
284 London Rd., Westcliff-on-Sea, Essex. Tel: (0702) 554000
Lynton Square, Perry Barr, Birmingham. Tel: (021) 356 7292
Note: Shops closed Mondays

MATINÉE ORGAN

Easy-to-build, superb specification. Comparable with organs selling for up to £1,000. Full construction details in our book. Price £2.50. Order As XH65K.
Complete kits available:
Electronics - £299.95.
Cabinet - £95.50 (carriage extra).
Demo cassette price £1.99. Order As XX43W.



HOME SECURITY SYSTEM

Six independent channels - 2 or 4 wire operation. External horn. High degree of protection and long term reliability. Full details in our projects book. Price 60p. Order As XA02C.

Maplin launches MAPCARD

A new way of buying from Maplin!

Now Maplin have their own credit card. You could have one too!

APPLY NOW!

Write to our Rayleigh address for details or pick up a leaflet in our shops.



NEW SHOP IN BIRMINGHAM

Visit our brand new shop in Birmingham for our complete range of electronic components and computers.

Come and see us at Lynton Square, Perry Barr, Birmingham, just off the junction of the Outer Ring Road, A4040 and Birchfield Road A341. Tel: 021-356-7292. Excellent free parking.

Opening Tuesday 24th August, 1982



Don't miss out - get a copy of our catalogue now! Over 140,000 copies sold already!

On sale now in all branches of WHSMITH price £1.
320 big pages packed with data and pictures of over 5,500 items.



Post this coupon now!

Please send me a copy of your 320 page catalogue. I enclose £1.25 (inc. 25p p/ply). If I am not completely satisfied I may return the catalogue to you and have my money refunded.

If you live outside the U.K. send £1.68 or 12 International Reply Coupons.

Name

Address