

# elektor

up-to-date electronics for lab and leisure

D 71663

86

June 1982

65p.

IR 66p (incl VAT)

CAN \$ 2,25

**Controlled  
fluorescent  
lighting**

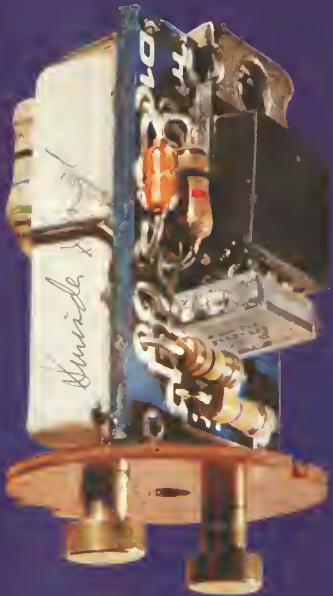

**Compact  
SSB  
receiver.**

elektor .....	6-12
<b>the principles behind an SSB receiver</b> .....	6-13
This article provides the uninitiated with a crash course in transceiver technology in general.	
<b>compact shortwave SSB receiver</b> .....	6-16
A single side band (SSB) is normally associated with high cost and complexity. This does not always have to be the case! The use of 'direct conversion' techniques results in a compact low cost SSB receiver with excellent performance.	
<b>electronic starter for fluorescent lights</b> .....	6-22
Speed up the ignition of fluorescent light tubes by installing an electronic starter! The tube strikes almost immediately, without any flickering.	
<b>measuring AC waveform</b> .....	6-24
(K. Fierra) An insight into measuring techniques needed for fault finding in AC circuits.	
<b>mobile aeriels</b> .....	6-27
Although some CB enthusiasts no longer have to be on the run, many still prefer to use a mobile rig. The article describes how a single aerial can serve both car radio and transceiver purposes.	
<b>electronic dog whistle</b> .....	6-30
In order to keep the dog lovers of the community happy, here is our first dog circuit!	
<b>talking clock</b> .....	6-32
Using the UAA 1003 the 6502 housekeeper published in last month's issue will well and truly tell the time.	
<b>the 'Poly bus'</b> .....	6-36
Constructors who intend to make a complete polyphonic synthesiser, will be confronted with a complex wiring problem. A bus board has been designed, helping to keep the amount of wiring to the bare minimum.	
<b>fluorescent light dimmer</b> .....	6-42
Usually fluorescent lights are not compatible with existing dimmer circuits. This article explains how to modify fluorescent lights, so that they can be dimmed, and describes a circuit able to fully control them.	
<b>car alarm</b> .....	6-47
An active insurance policy which is also a deterrent to would-be thieves!	
<b>from the 6502 to the 6809</b> .....	6-50
The 6809 CPU manufactured by Motorola supersedes 6502. The beauty of this chip is that it can be implanted into existing 6502 systems.	
<b>introducing DMOS power FETs</b> .....	6-52
New power FETs seem to be christened almost every day. Despite all their different names, they all have a great deal in common. This article takes a look at power FETs in general, paying special attention to the fast-switching DMOS branch of the family.	
<b>solid state relay</b> .....	6-57
Electronic relays have quite a lot of advantages over their conventional electro-mechanical counterparts. The solid state relay won't spark or wear out as quickly and perhaps more importantly, it can be built easily at home!	
<b>missing link</b> .....	6-62
<b>market</b> .....	6-62

# contents

## CONTENTS

**EDITOR:**  
P. Holmes

**UK EDITORIAL STAFF**  
T Day E. Rogens

**TECHNICAL EDITORIAL STAFF**  
J. Berendrecht  
G.H.K. Dam  
E. Krampelsauer  
G. Nachbar  
A. Nachtmann  
K.S.M. Walraven



*Suminder Singh*



# selektor selektor

## Look, no hands!

For the first time in its 88-year history London's Tower Bridge was raised by remote control today — using an ordinary telephone some seven miles away. It was done using a unique interface unit and microcomputer which together form a device called an Information Transfer Module (ITM), a new technology developed by the Brighton-based company ITT Business Systems. The ITM integrates and extends the functions of business communications products such as telephones, telexes, VDUs and word processors. The telephone used was connected through the public telephone network to an ITM at Tower Bridge. The ITM converted the signal and passed it via an actuator to move a lever which raised the bridge. The lever is usually moved by hand.

(785 S)

## Direct broadcasting by satellite

Following the Home Secretary's announcement in the House of Commons on the go-ahead for direct broadcasting by satellite, British Aerospace, Marconi and British Telecom declared their intention of forming a joint company, United Satellites, to provide Britain's first national broadcasting and telecommunications satellite system. The project could be operating by the end of 1985. As Halley's comet is due to reappear the same time, the satellite system may well be called Halley 1.

Two satellites will go into orbit: one for broadcasting purposes and the other in case of temporary system failure. A third satellite on the ground would replace a satellite that failed altogether. Two TV channels will be transmitted, one of which will be paid for by viewers' subscriptions. The signals will be broadcast in coded form and only those who buy a decoder will be able to receive the transmissions. In addition, the satellite will serve to improve telecommunications.

United Satellites have already investigated potential markets, and also the technical and operational means to meet broadcasting and telecommunications requirements on both a short and a long

term basis. The company's preliminary work has already involved liaison with Government departments and with the broadcasting industry. Further to this, British Telecom have advised on the development of national and international satellite telecommunications services from the mid-1980s.

The next phase will call for further discussions with the broadcasting organisations to define technical requirements and the terms on which satellite capacity will be able to be offered for direct broadcasting television services. The requirements for satellite telecommunications services will also be specified in agreement with British Telecom.

The Halley 1 project will not only be the first British national system for direct broadcasts by satellite, but it will also promote British satellite systems and services on an extensive scale throughout the world.

[767 S]

## Four-year old computer relegated to Science Museum

Computer developments are progressing at such an alarming rate these days that they are virtually impossible to keep up with. It is disconcerting, to say the least, when brand new systems, each in itself a remarkable feat of engineering and technology, are superseded by better, faster machines almost before they are given a chance to prove their worth. The amount of money involved is mind-boggling.

Just recently an IBM System 370/148 computer, which originally cost nearly a quarter of a million pounds, was relegated to the London Science Museum! Its former owner, Gulf Oil Corporation, acquired the computer in 1978 (a century ago in computer terms) for its Copenhagen Accounting Centre, where it was used to administrate the Gulf credit card scheme for the whole of Scandinavia. It has now been replaced by a computer which operates at three times the speed and has a four times larger memory capacity.

The Science Museum is planning to add the computer to their collection of historic computer hardware and is hoping to eventually have it in running order... Where will it all end??

(784 S)



# selektor selektor







a direct conversion  
circuit achieving  
'superhet' quality

# compact shortwave SSB receiver

A single side band (SSB) is normally associated with high cost and complexity. This does not always have to be the case! With direct conversion, the RF signal is converted directly into AF without producing an intermediate frequency (IF). The use of such a technique results in a compact low cost SSB receiver with excellent performance. The cost of construction bears no relation to its quality! While not being exactly simple, we are sure that this project will bring the world of 20 metres into your home, without the expense associated with commercially available equipment.

Communication receivers are invariably extremely complex and expensive, but in some cases these facts alone, surprisingly, do not guarantee good performance. When compared to a number of commercial receivers, the Elektor SSB performed rather well, and actually beat some of them 'hands down'!

The article 'The principles behind an SSB receiver', elsewhere in this issue, may suggest that building an SSB requires quite a lot of skill and knowledge. The simplified block diagram published in the theoretical article depicted an average receiver which is in fact very difficult to build. However the circuit diagram of commercial communications equipment will probably put you off completely.

The use of complex superhet type circuits is not the only way to design an SSB. A more straightforward approach is to use 'direct conversion'. This principle allows much simpler receivers to be built that still achieve a high performance.

The main difference between a direct conversion receiver and a superhet is the fact that the first type does not produce an intermediate frequency (IF). Like the superhet, its input and oscillator are mixed, but inasmuch as the

oscillator frequency is equal to the input signal their sum and differential products supplied by the mixer are restricted to audio frequency information. The audio frequency (AF) part of the receiver (section LPF — low pass filter) filters the signal in order to obtain good selectivity.

The oscillator also functions as a Beat Frequency Oscillator (BFO). It has the same frequency as the input signal. From the constructional point of view, the oscillator is one of the difficult parts of the circuit, since a high standard in stability is essential.

The main advantage of a direct conversion receiver over a superhet design are:

- Straightforward and compact construction.
- Easy to align and control.
- Because the oscillator and input signal frequencies are identical, problems relating to image frequencies are eliminated. Only the harmonics and sub-harmonics of the oscillator frequency could cause some trouble, but the superhet has the same problem anyway!
- Low cost, due to its straightforward approach to construction and design.

The filtering necessary for good selectivity is applied in the AF stage saving on cost around. An RF filter for the same bandwidth as the AF one used in this design (−8 dB at 3 kHz . . . −60 dB at 5.5 kHz) would cost at least forty pounds!

The direct conversion receiver does not naturally suffer from some disadvantages:

- It is susceptible to audio image frequency interference, thereby receiving both side bands instead of one.
- The operational range is slightly less than that of a superhet because the mixer stage could work as an AM detector, if the specified input signal strength is exceeded.

## Versatility

The receiver described is suitable for the 20 metre amateur band ranging from 14.00 to 14.35 MHz. This frequency range was chosen because it is used frequently and therefore the most interesting bandwidth to listen to. For quite some time now, we have been under the influence of sunspot activity which makes it possible for the 20 metre band to be in use 24 hours a day. So starting off with the 20 metre band is a good way for constructors to get value for money.

With the addition of converters, the receiver is an ideal starting point from which to build a multiwave band communications receiver. This is partly thanks to its tuning (approximately 0.5 MHz). All the amateur bands with the exception of the 28 . . . 29.7 MHz band can be received easily by using a single converter for each band.

## The circuit

A block diagram of the receiver in its final form is shown in figure 2.















Standard fluorescent light tubes, or to give them their scientific name 'low pressure gas discharge tubes', are not as straightforward as they seem. The normal opaque-looking tubes are in fact made of clear glass with an internal coating of fluorescent powder, and filled with mercury vapour (and a little argon). The vapour is under an extremely low pressure (about 0.00001 absolute atmospheric ata.).

By ionising the vapour under the influence of a powerful electrical field, a gas discharge (discharge of electrons) occurs. When an electric discharge passes through the mercury vapour a small quantity of visible light and a large amount of invisible ultra-violet light is generated.

As already mentioned, the internal surface of the glass tube is coated in a thin layer of fluorescent powder. This converts the ultra-violet (short wave) radiation into visible (long wave) light

with a continuous spectrum. The kind and colour of the light produced from discharge sources depends on the choice of powder. This is one reason why tubes are available in various colours and shades. A detailed look at this aspect can be found in the article on the fluorescent tube dimmer published elsewhere in this issue.

A little argon (an inert gas) is added to the mercury vapour as a kind of catalyst, helping in the lighting-up or striking process. The start or strike voltage level required for the tube to ignite depends on the temperature of the gas. The lower the voltage the higher the temperature of the gas has to be. For this reason, filaments are mounted at either end of the tube. They pre-heat (pre-ionisation) the gas to promote ignition. Once the gas has started to discharge (tube lights), the glowing discharge (staying alight) can be maintained by a relatively low voltage. As

strike a light!

# electronic starter for fluorescent lights

When fluorescent light tubes are switched on they tend to light up in a rather hesitant manner and the flickering effect is often irritating. Manufacturers have produced special, 'rapid starting' types, but these are more expensive and this makes them less popular. However even standard fluorescent tubes can be speeded up by means of the electronic starter described here. The tube strikes almost immediately — an amazing effect, when you see it for the first time!



a matter of interest, exceeding the glow discharge voltage by a large amount will cause a progressive reduction in the internal resistance of the tube. As the resistance decreases, the current flowing through the gas increases (current density), making some form of current limitation necessary.

A choke, which dissipates very little power in the form of heat, is used as an induction coil together with a starter to produce a high ignition voltage. The choke also tends to suppress RF interference caused by the gas discharge inside the tube (avoiding

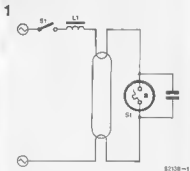

Figure 1. A fluorescent light source consists of a choke (ballast), a mechanical starter and a fluorescent tube.

mains borne interference).

The starter not only serves to generate an induction voltage, but also switches the current through the filaments. The most common type of starter includes a helium filled lamp containing a bimetal (thermal) electrode. This is shown in figure 2. The switch contacts are open when the device is quiescent. If the mains switch (S1) is closed, the entire mains voltage will be applied to the starter. This is enough to fire the helium lamp. The design structure of the starter only allows a low current (about 0.1 A) to flow.

The heat produced by the gas discharge causes the bimetal switch to close. As a result, a high current passes through the filaments which pre-heat the gas for a while. When the bimetal switch closes the helium lamp is internally short-circuited and so goes out. After a while, the temperature inside the lamp will drop to such a low level that the bimetal switch will open. In resisting this abrupt current cut-off, the choke generates a momentary high voltage by self-induction and feeds this to both ends of the tube. Consequently, the fluorescent tube will light. When this happens, the voltage across the starter contacts is equal to the glow discharge voltage of the tube. This is too low to restrike the small helium 'lamp' in the starter again. Since the bimetal switch remains open, the starter will be inactive when the tube is lit. A capacitor is connected in parallel to the starter to suppress any RF interference in the fluorescent tube. Unfortunately, the tube will not remain lit after the initial strike operation. More often than not, the temperature inside the tube will not be high enough to maintain the gas discharge straight away. The current could also be practically zero when the bimetal switch is opened, in which case insufficient induction voltage is available.

The tube will have to be struck several times for it to remain lit. As mechanical starters are rather slow, a visible delay occurs between every start session. This explains why the tube flashes on and off for a while after it is turned 'on'. To

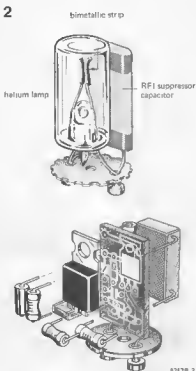

Figure 2. Mechanical starters commonly contain a helium lamp including a bimetal switch. A capacitor is connected in parallel to the starter to suppress any RF interference caused by the gas discharge inside the fluorescent tube.

Parts List

Resistors:

- R1 = 470 k
- R2 = 100 k
- R3 = 1 k
- R4 = 56 Ω

Capacitors:

- C1 = 15 n (see text)
- C2 = 100 n/630 V

Semiconductors:

- D1 = ER 900 diac
- Th1 = TIC 106D thyristor

avoid such flickering, we will have to make sure that the tube is sufficiently pre-heated and that the strike operations take place in quick succession. This is exactly what the electronic starter does.

The circuit

Figure 3 shows the circuit diagram of the electronic starter. When dealing with its operation, let us assume that switch S1 is closed and that the voltage at the anode (with respect to the cathode) of the thyristor is positive. As long as the tube is not lit, the voltage across the electronic starter contacts is equal to the mains voltage. When the voltage level in capacitor C1, charged by way of the divider R1/R2, reaches the break-down level of the diac (about 30 V), the thyristor will conduct and C1 will discharge. A relatively high current will now flow through the filaments, and the choke. As a result, a magnetic field is created inside the choke. When the mains voltage assumes a negative polarity, the positive current will continue to flow through the choke, but only for a while. With the dying magnetic field the current drops to zero. At this point the thyristor will switch off and the maximum voltage (approximately) of the negative half cycle of the mains will appear across C2/R4. Together, L1 and C2 form a resonant circuit and this will now cause the capacitor to rapidly charge and discharge to approximately double the mains voltage. This high voltage level will readily ignite the tube. When the following positive half cycle of the mains supply arrives, the thyristor will once again turn on and repeat the procedure. The whole process is repeated at a rate of 50 times per second. After several cycles the tube will be sufficiently hot to remain lit and so the voltage across the starter contacts will drop to the 'glow discharge' level. This is much too low for the diac and therefore the thyristor to conduct. Consequently the electronic starter will remain in a quiescent state.

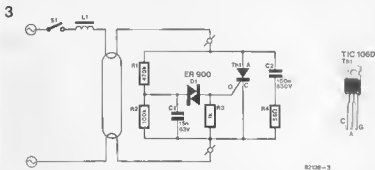

Figure 3. Only eight components are involved in the electronic starter circuit. The circuit allows a series of 'strikes' to be produced in quick succession, thereby preventing in the tube from flickering in a visible, and often irritating, manner.



Figure 4. The printed circuit board and the component overlay for the electronic starter circuit. The mounted board is compact enough to fit inside the case of the 'old', mechanical starter. For safety reasons, a metal case should not be used.

## Building the circuit

Although the theoretical aspects behind the electronic starter require a detailed explanation, the construction is simple and straightforward. Constructors will be pleasantly surprised by the format of the circuit and printed circuit board. Only eight components are involved! Figure 4 shows the printed circuit board for the circuit. It is compact enough to fit inside the plastic (not aluminium!) case of a conventional starter, which saves having to modify the fluorescent tube holders in any way.

Make sure that the connection wires of the thyristor are not in contact with the metal heat sink. If necessary, glue the thyristor to the board with a touch of epoxy resin. Resistor R4 and capacitor C2 must be mounted on the copper side of the printed circuit board. The heading photograph shows the finished product from two different angles. As mentioned earlier, we do not recommend the use of a metal starter. The photograph shows the finished product from two different angles. As mentioned earlier, we do not recommend the use of a metal starter case for safety reasons.

Open the starter case with care. Remove the 'helium' lamp and the capacitor from the contact pins. Do not cut the connection wires of the capacitor too short, as they can be used to solder the printed circuit board to the contact pins. Assemble the starter carefully and insert it in a fluorescent tube holder. The circuit is designed for fluorescent lamps in the 20...65 W range. In the event of a 20 W tube not igniting right away, lower the value of C1 to 10 nF. The value of this capacitor really depends on the type of fluorescent tube used. Incidentally, the same applies to C2. If fluorescent tube power ratings below 20 W are selected, it may be necessary to try out different capacitor values. K

Please note that this circuit is patented by Philips (Mullard) no. 122 3733.



# measuring AC waveforms

... no problem when you know how

When testing a circuit it is often very difficult to know exactly what to measure. With a digital multimeter measuring DC voltages is quite straightforward. But what about AC voltages? The constructor then has to decide what to measure; peak, average or rms (root-mean-square) values. This depends on which of the three alternatives gives a reliable indication of whether the circuit is working properly or not. Then again, which one is actually being displayed by the meter?

K. Fiëtta

Testing and measuring electronic equipment can lead to a variety of problems. Before endeavouring to come up with any solutions, let us examine a few examples of the type of situation that is likely to arise. Figure 1 shows three different ways in which to evaluate an AC waveform. The peak amplitude  $U_{pp}$  corresponds to 100% of the amplitude in either the positive or the negative half of the waveform. The root-mean-square value  $U_{rms}$  is about 71% of the amplitude and the average value  $\bar{U}$  is only about 64% of the peak value. These percentages may seem rather strange, but that is because electronics is subject to the general laws of physics rather than any arithmetical correlation.

The mathematical relationships between the three possible values for sine-wave voltages can be expressed as follows:

$$U_{rms} = \frac{U_{pp}}{\sqrt{2}} = \frac{\pi}{2.2} \bar{U}$$

The basic formulae can be varied in form to provide the appropriate values. It is not our intention to delve into the physical features of test and measurement equipment here. It is enough to know that a moving coil meter (that is one without a permanent magnet) indicates the arithmetical mean of an AC waveform and that a moving iron meter displays a root-mean-square value. To find out the principles behind this, it is advisable to refer to the subject in a good electronics book. A digital voltmeter may also be used to measure AC voltages, but only if a rectifier is connected in the input circuit.

That brings us to the problems mentioned earlier, for both moving coil meters and DVMs require a rectifier. Although multimeters very often incorporate an average responsive and a peak responsive rectifier to measure the average and peak values, respectively, the scale of the actual meter is calibrated to the rms values of a sine wave. This fact should be remembered when measuring other waveforms or results could become very confusing. One thing is clear: rectifiers play an important part in meters and it is a good idea to find out why before going any further.

It should be noted that although a moving iron meter is suitable for

measuring the rms value of AC voltages, it is only used in heavy current engineering because of its low internal impedance.

## Rectifiers

Figure 2a illustrates a peak response rectifier. Resistor R2 represents the high impedance input of a sensitive moving coil meter, a DC measurement amplifier or a DVM. Provided the R2/R1 parameter is met, the voltage levels of figure 2b can be expected to appear across capacitor C1. The capacitor will be charged to the  $U_{pp}$  level on the rising edge of the positive half cycle. When the voltage drops, the capacitor can only be discharged very slowly by way of R2. The leakage is compensated for during the following positive half cycle. As a result, the DC voltage  $U$  is produced; this is the actual measurement voltage. Where  $U_{rms} = 10\text{ V}$ ,  $U = 10\text{ V} \cdot \sqrt{2} = 14.1\text{ V}$ . As this method is mainly used to measure the rms value of sine wave voltages, the meter scale indicates 10 V which corresponds to the rms value when a DC voltage of 14.1 V is applied.

The peak response rectifier behaves extremely well in the case of non sine wave signals (waveforms other than sine waves). The peak values are of course also indicated accurately. However, errors will occur in the reading when the sine wave is degraded by spurious signals or other interference. Then the 'true' rms voltage value cannot possibly be deduced from the reading. Discrepancies of a more serious nature arise if AC voltages are produced with different half-cycle peak values and which are then mixed with a DC voltage. Peak meters are frequently used in audio to measure signal strength for recording levels.

Figure 3 shows an average response rectifier. The current flowing through the meter is always in proportion to the actual value of the signal under test. Due to the mechanical characteristics of the meter, the values are integrated and the result displayed is the average. As was already seen in figure 1, the average value of a sine wave signal is only 10% below the rms value. Again, the meter scale is calibrated for rms values.

An average response rectifier responds fairly precisely to a square wave signal. At a duty cycle of 50% the instrument indicates 11% in excess of the true value. Now of course readers will point out the fact that when the duty cycle of a square wave signal is 1:1, the peak, average and rms values should all be the same... so why does the meter miss the mark by 11%? Answer: because the scale has been calibrated to provide the rms values of sine wave signals.

Note that average response meters are universal in that they provide fairly accurate rms readings even when the sine wave signals are distorted (up to 10% harmonics). A good example of this is the VU meter which monitors

1

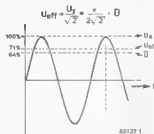

Figure 1. How the peak  $U_{pp}$ , root-mean-square  $U_{rms}$  and average  $U$  values of a sine wave signal are interrelated.

2a

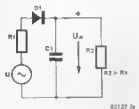

Figure 2a. In principle, a peak response rectifier consists of a diode and a capacitor. Resistor R2 must be much greater in value than R1!

2b

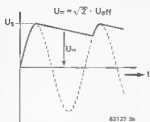

Figure 2b. The capacitor is charged during the positive half cycle and keeps its charge even when the voltage is no longer applied.

signal modulation in tape decks and cassette recorders.

## Measuring rms values

The rms of an AC voltage is defined as: The level of AC voltage required to produce the same amount of heat from a specific resistance as an equivalent DC voltage over a predetermined time interval, irrespective of the waveform.

The relationship between the rms and peak values of a sine wave signal with respect to power is illustrated in figure 4. All the values in the 'u' curve are squared, so that the values in the new curve, 'u<sup>2</sup>', are positive. Since power  $P = U^2/R$ , the root of the mean of the square is obtained as follows:

$$U_{pp}^2/2 = U_{rms}^2$$

3

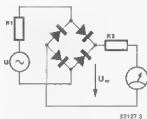

Figure 3. An average response rectifier basically consists of a diode bridge. The mechanical characteristics of the moving coil instrument integrate the applied voltage.

4

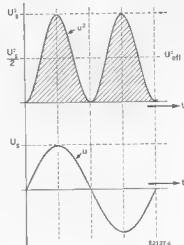

Figure 4. This graph helps to establish the relationship between  $U_{rms}^2$  and  $U_{pp}^2$ . The result is:  $U_{rms} = U_{pp}/\sqrt{2}$ .

This confirms the assumption made earlier that  $U_{rms} = U_{pp}/\sqrt{2}$  (for sine wave voltages). The relationships could also be illustrated by means of complicated and highly aesthetic integrals, but that would only confuse the issue — and the constructor!

The question is, how to obtain the real/rms value on a scale, irrespective of the waveform of the input signal? A moving iron instrument is not suitable here, as its internal losses are high. In other words, a comparatively large amount of power has to be fed to it before it will even start to indicate anything. As hobbyists are not in the habit of working with anything in the order of kV, kW, kVA or kA, they can forget about the moving iron meter for a while. The mathematical method for measuring rms values (for which special ICs are



5

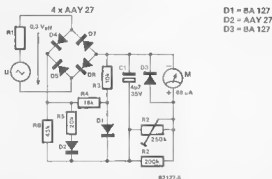

Figure 5. A quasi rms response rectifier. The diode/resistor network 'shapes' the behaviour of the rectifier so that the meter shows the rms value.

6

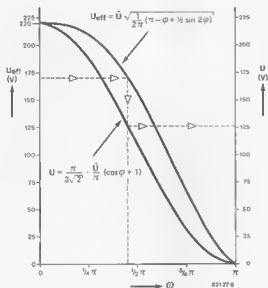

Figure 6. A graph to obtain the correct reading for a corresponding voltage value in a circuit that involves a change in the phase cutoff angle (such as dimmer controls).

available nowadays) is very complicated. First the signal is squared. An RC network acts as an integrator, an 'average shaper', so to speak. Finally, a rooter circuit extracts the root of the average value, providing the rms value of the signal at the output. In practice, this method uses a slightly different approach. In order to obtain as wide a dynamic range as possible, the squared signal is divided by the output signal at the input. The 'rooter' at the output is then omitted. The division is logarithmic to allow small signal levels to be detected as well. In all honesty, the whole process is rather complicated and takes

hours to explain, so let's forget about it for now!

An alternative method is based on the physical principle behind the rms definition: a resistor wire is heated and the amount of heat is measured using a thermocouple. Obviously these very low voltages are rather difficult to measure. Diagnosis: this method is totally unsuitable for amateurs. Therapy: none!

#### Quasi rms measurement

A compromise is reached between economy and practicality by measuring the quasi rms. There is no point in over-

doing the economy aspect by merely substituting the average response rectifier in figure 3 for an integrator in the form of an RC network. Instead, it is preferable to set slightly higher parameters. Figure 5 shows a quasi rms rectifier, which naturally has nothing to do with the accurate measurement procedures used in maths and physics. The behaviour of a 'real' rectifier (its curve) is imitated so effectively by the diode/resistor network D1/D2/R3...R6 that the deviation of the reading remains within the tolerance range permitted for rms measurement equipment. This type of circuit is particularly suitable for measuring distortion and for calculating power levels. Rms meters can also be used for other purposes as well, as we will now see.

#### Measuring voltages in static converter circuits

Fortunately, it is possible to carry out rms measurements without using the 'quasi' method. For, as it was mentioned at the beginning of this article, the reading may be multiplied by a correction factor to obtain the correct rms value. For this type of rectifier used in the meter must be known. In most cases, an average response rectifier will be involved and the scale will already be calibrated to read rms, in other words, it was multiplied previously by a factor of 1.11. This figure only holds good for sine waves.

The relationships between peak, average and rms values have already been dealt with. However, where voltages in static converter circuits are concerned, the change in waveform will cause considerable errors to occur. This is because the phase cutoff angle is not taken into account. This is how the rms value is related to the phase angle:

$$U_{rms} = U_{pp} \sqrt{\frac{1}{2\pi} (\pi - \varphi + 1/2 \sin 2\varphi)}$$

The formula for calculating the average value looks a little more straightforward. By multiplying it by the correction factor mentioned above, the actual reading will be:

$$U = \frac{\pi}{2\sqrt{2}} \cdot \frac{U_{pp}}{\pi} (\cos \varphi + 1).$$

The two formulae may be plotted in relation to the phase angle as curves in a graph. The graph helps the constructor calculate the reading required for a certain rms value. If for instance, the voltage in a dimmer circuit is to be measured and its value should be 170 V<sub>rms</sub>, the phase angle in the  $U_{rms}$  curve will be 81°. At this value the vertical axis intersects the U curve at 126 V. If this is what the meter displays, the true rms will be 170 V. ■

Source:

G. Zapf, *The behaviour of measurement devices when measuring non sine wave voltages*, Grundig TI.

One of the biggest problems faced by breakers is which aerial system to choose, so that their transceiver will operate efficiently. This is a universal problem encountered by the whole spectrum of radio communication system users (HAMS, etc.). It is a fact of life that an aerial is probably the most vital part of any system. No matter what the quality or power rating, a transceiver will be made impotent by a badly designed or maladjusted aerial. Further restrictions are imposed on the designers when an aerial has to be mounted upon a vehicle. Unfortunately, because of practical and safety considerations the normal highly efficient static

# mobile aerials

Although 'some' CB enthusiasts no longer have to be on the run many will still prefer to use a mobile installation in the car. This article describes how a single aerial can serve both the car radio and a CB transceiver operating within the legal 27 MHz 'FM' band. It also discusses the various merits of different 'possible' aerial designs.

systems are totally unsuitable. A mobile aerial has to be compact and fairly short if only to comply with the existing laws. Many readers are probably wondering why the majority of VHF/UHF aerials are vertical rods of various descriptions. The main reasons for using vertical as opposed to horizontal polarisation are as follows.

- They are simple and unobtrusive and easily mounted onto vehicles;
- single element antennas give all-round coverage (omnidirectional) irrespective of the direction which the car is facing;
- it is an accepted standard for mobiles working within the UK.

Readers should not worry about the term 'ground-plane' aerial. Basically any rod (or whip) aerial becomes one of these if it is mounted on the metal roof of a car.

Before delving too deeply into the problems surrounding the use of ordinary telescopic car aerials, it is a good idea to look at the 'possible' types usable for 27 MHz. The simplest and most commonly used mobile aerial is the  $\frac{1}{4}\lambda$ . For a standard  $\frac{1}{4}\lambda$  aerial to have a resonance frequency of 27 MHz, it would have to be approximately 2.7 metres long. Stick that on a car and see what happens to the driver when confronted by the local bobby! The only alternative is to physically shorten the rod, and 'electrically' lengthen it in order to retain the 27 MHz resonance. This is achieved by adding a 'loaded coil' (to the shortened rod). In other words: cut it down to a size (length) that can be mounted on a car, and then add a

coil to 'make it long again'.

Three different types of loaded coil mobile antennas are possible. Figure 1a shows the BLC (Base Loaded Coil) and figure 1b the CLC (Centre Loaded Coil) type. Both these designs are compact and reasonably short. Even though the rod is approximately 1 metre in length, the induction of the coil enables the entire unit to have a resonance of 27 MHz. The current distribution along each aerial is shown on the right-hand side of figure 1. These diagrams give a general picture of the way the aerials behave.

As a general rule, the longer the aerial and the greater the current passing along it, the more radiation it produces. As a matter of interest, the CLC type has a better performance than the BLC, because the length of rod carrying a maximum level of current is greater than the BLC. By far the simplest to build is the BLC (figure 1a). This type is also easily and cheaply available professionally built.

Readers are reminded that the BLC is the only 27 MHz CB mobile aerial that can be used legally on British roads. The use of any other type, as described in this article, should be confined to drive ways, private roads, and when on holiday abroad (check each country's

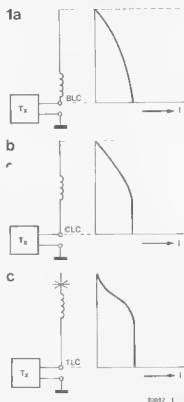

Figure 1. Three different ways in which to electrically lengthen a rod aerial with the aid of a loaded coil. The graphs plot the level of current passing along the aerial in each example. Note that only the BLC is legal in the UK.

regulations first). The BLC principle can also be utilised when modifying a standard car aerial for CB and the modification circuit is described later on in the article.

A CLC is rather impractical from a constructional point of view. A normal rod aerial has to be cut into two equal lengths, the coil being fitted between the two halves. The result would probably be rather unstable.

Figure 1c shows a TLC (Top Loaded Coil) aerial. This type can be easily built and has the best overall performance. In order to maintain equal resonance, a capacitive load has been included in the form of a 'capacitive hat'. The 'hat' may be either a metal lid or a couple of metal spokes. The TLC has two advantages over the BLC and CLC types: the length carrying the maximum current is greater (see the graph in figure 1c) and due to the careful construction of the 'hat' the inductance of the coil is reduced considerably. This results in more radiation (yield) and less 'mismatch' losses, leading to a better performance. There are various ways in which to build a TLC 'hat'. Figure 2 shows one method. A coil is wound around a piece of PVC 'conduit', one end of which is connected to one vertically and four horizontally mounted 'spokes'. The other end is obviously attached to the aerial. The 'spokes' may be knitting needles (the old-fashioned metal type) or bicycle spokes that are cut to size. The coil has a total diameter of 19 mm and consists of 24 turns of 1 mm  $\phi$  enamelled copper wire. The wire must be wound very tightly, without leaving spaces. The

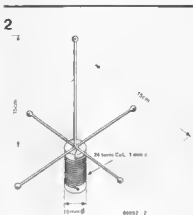

Figure 2. Using a home-built 'mount', a car aerial can be converted into the shortened  $\frac{1}{4}\lambda$  rod for 27 MHz as shown in figure 1c.

other end of the coil is linked to the top of the rod aerial with the aid of a terminal block. The coil can be made waterproof by means of a plastic coating spray or an epoxy resin. This is highly recommended, as most car aerials have to withstand all kinds of weather. In any case, the coil will be considerably damaged, if any water manages to trickle in. Note that the TLC mount causes no interference to the FM wave band. Therefore there is no need to remove it when using the car radio. Before explaining the modification circuitry a short note on the use of shortened car aerials. These normally

have a length of  $\frac{1}{4}\lambda$  for the FM wave band (about 70 cm). Although this is far too short, the addition of a loaded coil together with a modification circuit as shown in figure 3 will make it resonate at 27 MHz.

### One aerial, two radios . . .

Whether the mobile aerial is a home-built or a bought 27 MHz type, problems are bound to arise once the aerial is used for both the car radio and the CB transceiver. It would be dangerous, to say the least, to simply connect the transmitter output of the transceiver to the input of the car radio . . . and hope for the best. Few car radios will appreciate, or even survive, this kind of treatment.

In order to avoid damaging the car radio, a filter system has to be installed. The simplest solution would be to connect an effective high-pass filter (which would eliminate any signals below 80 MHz) in series with the car radio aerial input. The FM wave band (87 . . . 108 MHz) can then be received without any interference on the car radio, while simultaneously transmitting on CB. Unfortunately, this kind of filter also 'cuts out' any long and short wave signals that the aerial picks up.

For this reason a different approach was looked for. Figure 3a shows the complete filter circuit as it would be mounted on a printed circuit board. The filter is made up of two separate sections, the lower section of which (L6 . . . L8, C4 . . . C6) contains an aerial modification network for the 27 MHz transceiver. This enables the transceiver to be used at full power (4 W) despite the

3a

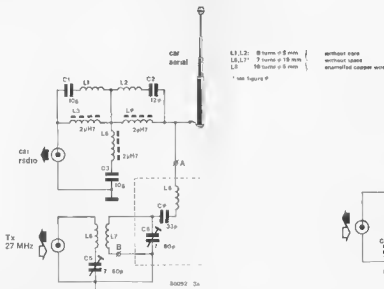

b

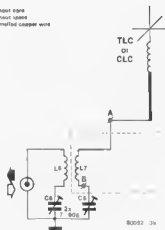

Figure 3. Circuit diagram for the transmission filter which enables a car radio and a 27 MHz transceiver to be used simultaneously with only one aerial. If the aerial were a CLC or TLC type, the lower section of the diagram would have to be replaced by the modification network shown in figure 3b.

shortened aerial modification. Using the trimmer capacitors C5 and C6, the set may be adjusted to a minimum VSWR. Readers should note that the circuit shown in figure 3a is designed for a BLC type using a normal car aerial, in which L8 acts as the loading coil. If either a CLC or a TLC is used, L8 (and C4) may be omitted. The modification network will then resemble the circuit in figure 3b.

The filter designed to protect the car radio against high-risk 27 MHz transmitter signals is shown at the top of figure 3a. As can be seen, it isn't a high-pass but a highly selective filter. It consists of a band-stop filter (L3...L5, C1...C3) for the 24...30 MHz frequencies and a by-pass filter for the FM wave-band. The resonant circuits L1, L2/C1, C2 are included in the by-pass filter and are tuned to approximately 95 MHz.

The filter circuit is quite effective. Frequencies within the band-stop range are suppressed by around 60 dB. Therefore, using the authorised CB transmission power of 4 W, not more than 0.5  $\mu$ W interference reaches the aerial input of the car radio. A very satisfactory state of affairs.

### Construction

Some of the coils used are not available ready-made, so readers will have to

4

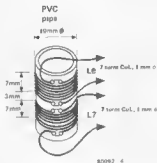

Figure 4. Coils L6 and L7 can be wound, one beside the other, around a piece of PVC conduit.

make them themselves. However they are not difficult to wind, as there aren't any taps or secondary windings. Three of the eight coils required (L3...L5) are in fact easily obtainable chokes. Details concerning the construction of the other five are provided in figure 3. L6 and L7 can best be wound around a piece of PVC conduit in the manner indicated in figure 4.

For ease of construction, a printed circuit board has been designed for the circuit and is shown in figure 5. Once the coils are made, the filter can be built in a matter of minutes. Although this cannot be seen in figure 5, the board is in fact double-sided. There is a wire link, as opposed to a copper track, connecting the lower side of L7 to earth. This allows the modification circuit needed for a CLC or TLC aerial to be constructed (as shown in figure 3b) without the need for any drastic changes to the printed circuit board. C6 is soldered in the position of the wire link (becoming C7) and therefore no longer acts as a trimmer capacitor for L7. By shorting out C4 and L8 with wire links, the circuit will resemble the one in figure 3b. An important point to note is that the dotted lines as shown in figure 3 have a specific purpose. The optimum operation of the circuit is only guaranteed when the 'radiating' section of the aerial modification network is screened from the band-stop filter. This is done by mounting a metal partition on the board, in the position denoted by the dotted line.

Finally, the link between the printed circuit board and the aerial should be as short as possible to prevent unnecessary dissipation. If possible, the printed circuit board should be mounted just below the car aerial. **M**

5

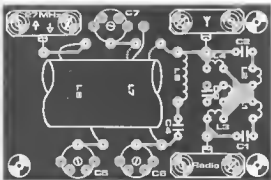
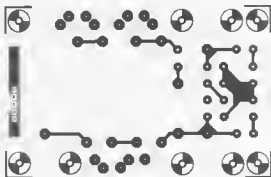

Figure 5. The (double-sided) printed circuit board is designed for the circuit in figure 3a, but also caters for the modification network shown in figure 3b.

### Perts List:

#### Capacitors:

- C1, C3 = 10 p ceramic disc
- C2 = 12 p ceramic disc
- C4 = 33 p ceramic disc
- C5...C7 = 7...80 p trimmers

#### Coils:

- L1, L2, L6...L8 = d-i-y  
(details shown in figures 3 and 4)
- L2, L4, L5 = 2.7  $\mu$ H chokes

Figure 4. 7 turns of enamelled copper wire, 1 mm diameter

Some time ago a particular type of tweeter came onto the market accompanied by an enormous amount of publicity such as 'over 300 W' and 'without a crossover network', etc. The 'Hallelujah Chorus' of the advertising fraternity was convinced that it would take the world by storm. The piezo tweeter did not in fact receive the universal acclaim expected and as result they are still relatively cheap and easily available.

The article is certainly not going to argue the pros and cons of this tweeter, let's just say, that for certain applications it is ideal.

### Doggy ears

Have you ever wondered why your dog pricks up its ears from time to time when no apparent audible sound is present? As most readers will know dogs are able to perceive audio frequencies outside the human hearing spectrum. This is for both ends of the scale. Considering a frequency of 20 kHz, the average person will not hear it at all (there are exceptions) irrespective of the volume level. On the other hand, animals and in particular dogs, are sensitive to these tones and will react instantly; unless they are asleep or just lazy. Anyway whistles producing such frequencies are useful, allowing dogs to be called from great distances without waking up the whole neighbourhood. Mind you, even using one will not guarantee that fact because dogs are not the only ones able to hear it! Canaries, young children and some adults are likely to hear it as well! There is also the probability that all the dogs in the neighbourhood will respond and land on your doorstep.

# electronic dog whistle

## high quality ultra-sonic dog call

Most if not all the circuits published in electronic magazines have always catered for other hobbies. During the last few years Elektor has designed numerous circuits for photographers, musicians, movie makers, model railway enthusiasts and so on. But, 'where oh where' are the circuits for the dog owners of this country? After all there are millions of people who are proud of 'man's best friend'.

In order to keep this section of the community happy, we hereby publish our first dog biscu . . . sorry, circuit, and we assure everyone that electronics is not going to the dogs.

### The Piezo tweeter horn

The main difference between normal dynamic horns and the piezo is its construction. The latter has a membrane driven by a small plate of piezo ceramic material. The result is a horn with a very small dynamic mass. Incidentally the same principles are employed in certain ceramic cartridges and most commonly in cigarette lighters.

The impedance of a piezo tweeter resembles that of a capacitor (see figure 1), rather than that of a resistor (normal dynamic type). Consequently this type of tweeter has a very high efficiency, in other words a good input to output sound pressure level (dBs) relationship. Therefore it can be driven by a battery powered circuit and made to reproduce very high frequencies.

Just right for the dog circuit!

### The circuit

The high frequency tone required can be derived by driving the piezo tweeter with the circuit as illustrated in figure 2. A square wave instead of a sine wave is applied in order to keep battery consumption as low as possible.

The tone is produced by means of N1 . . . N3, R1 and C2, which constitute an astable multivibrator. Due to the fact that the Piezo horn forms a capacitive load, the wave forms of the signal will have high peaks. That is why the Schmitt trigger inverters N1 . . . N3 and N4 . . . N6 (all 6 inverters are present in the 40106 IC) have been connected in parallel and supplied with an output stage, consisting of T1/T2 and T3/T4 respectively. N4 . . . N6 invert the signal coming from N1 . . . N3. In this way a 'power oscillator' is constructed. When fed by a 9 V battery, this 'power oscillator' supplies an a.c. voltage having an amplitude of 15 V<sub>pp</sub> and a frequency of approximately 21 kHz. Could not be better for our needs!

### Sound pressure

Figure 3 shows the frequency response of the Piezo tweeter. In this case we are mainly interested in the 20 kHz range and fortunately enough the horn reaches its maximum efficiency at this frequency. This curve was recorded with a controlled voltage of 4 V<sub>rms</sub> and a microphone held at a distance of 457 mm from the horn. The Elektor dog whistle supplies a voltage of 15 V<sub>pp</sub>. The rms value of this voltage is approximately 6.5 V, because we are dealing with a square wave voltage having a slightly unsymmetrical duty cycle. Using

1

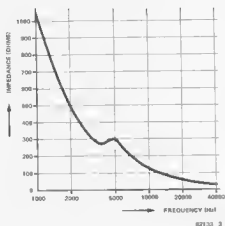

Figure 1. The impedance curve of the Piezo horn.

2

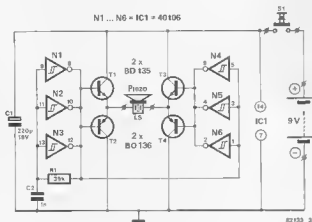

Figure 2. The circuit diagram of the electronic dog whistle. A CMOS IC, containing 6 inverters, is used as a power oscillator.

3

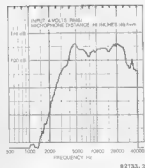

Figure 3. The frequency response of the Piezo tweeter. The loudspeaker reaches its maximum volume level at 20 kHz.

4

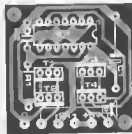
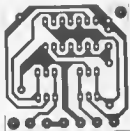

Figure 4. The copper track pattern and component overlay of the printed circuit board for the electronic dog whistle.

this value (6.5  $V_{rms}$ ) and extending the microphone distance to 1 metre, will result in a sound pressure of 101 dB!! Quite a lot for 20 kHz!

**Be Warned**

Care should be taken when using the whistle. Even though the user may not be able to hear it, remember 101 dBs are being produced which is going to give somebody or other a headache. 20 kHz at high volume should not be aimed at any human or animal in close proximity. It's similar to sitting in front of the speakers of 1000 W disco system for a few hours. Keep in mind that the long term side effects of all this are not known, but to be on the safe side (like smoking) it's better to accept the possibility that it could 'damage your health'. Finally, to play it safe we suggest you equip your dog and yourself with ear protectors and then try it. Have fun!

**Parts list**

Resistors:  
R1 = 39 k

Capacitors:  
C1 = 220  $\mu$ /16 V  
C2 = 1 n

Semiconductors  
T1, T3 = BD 135, BD 137, BD 139  
T2, T4 = BD 136, BD 138, BD 140  
IC1 = 40106

Miscellaneous:  
Piezo tweeter KSN 1001A, KSN 1005A (Motorola)  
S1 = pushbutton  
Battery: 9 V transistor battery

In a very short time every electrical appliance will be talking to you: the washing machine, vacuum cleaner, cooker and probably, the kitchen sink. This 'desirable feature' (?) is already evident in the new generation of digital clocks that are fast beginning to appear. A clock that actually tells the time is not such a bad idea after all, especially for the visually handicapped. The UAA 1003 from ITT has been designed specifically to form the basis of a talking clock. It incorporates a complete speech generator designed specifically to 'tell the time'. Furthermore, it can be connected directly to

### The speech generator

The UAA 1003 is a speech generator IC in a 40-pin package. The IC is shown in the form of a block diagram in figure 1. Digital techniques are used to store and process the required phonemes. By using data and redundancy reduction methods, it was possible to store a vocabulary of about 20 words and integrate the necessary control, decoder and D/A converter circuits, all on a single chip.

Every word generated by the speech IC contains a number of step-shaped pulses, each one having a fixed pulse duration of 10 ms. Every pulse is made of up to 128 different amplitudes which can each assume 16 values. This corresponds to 4-bit amplitude modulation. Different word segments are linked up according to the digital control signals that are applied.

The IC is currently available in two languages, English and German.

Let's examine the 'insides' of the IC as shown in the block diagram in figure 1. When the speech generator is 'switched on' via either of the two start inputs, the intermediate input data is read in. The decoder ROM and the control circuit establish the word order according to the data entered and then address the corresponding word parameters, after which the address logic fetches the speech segments from the speech ROM. The output digital code is processed inside a data regenerator before being sent to a D/A converter which delivers the actual speech signal.

The speech generator IC has a special feature in that it receives its time data from the clock's seven segment connections. However, the data inputs of the IC will only function provided the circuit is connected to a digital clock with common cathode displays that are not multiplexed.

Not all the segment connections are needed to decode the time. Segment connections c and d serve to decode the hour tens, a, b, e, f and g the hours, d, e and f the minute tens and finally,

# talking clock

give the 6502 housekeeper the gift of the gab!

More and more 'chattering chips' are appearing on the market. In December 1981 Elektor introduced the Talking Board with its extensive vocabulary. But, as this article points out, computers are not the only ones to talk. Even digital clocks can now be 'conversed with' thanks to the UAA 1003 from ITT, a single chip speech generator. Once the IC and a few other components have been added to the 6502 housekeeper described last month, the clock will well and truly be able to 'tell' the time!

the seven segment outputs of any (existing) digital clock.

Last month, Elektor published a versatile clock of its own, the 6502 housekeeper, and so it seemed a good idea to draw up a circuit for it using the UAA 1003. After leaving the 'operating table', the clock will be able to express the time both in digits and words.

As mentioned earlier, the speech circuit can be connected to 'ordinary' digital clocks, with the proviso, that their displays are of the CC (common cathode) type.

1

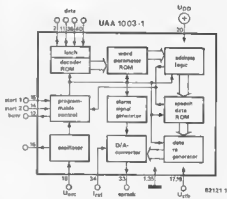

Figure 1. Block diagram of the UAA 1003. Phonemes are stored and processed in a digital manner.

2

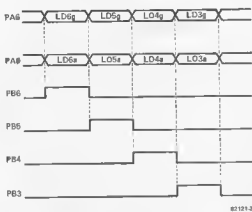

Figure 2. These signals for the display control in the 6502 housekeeper are also used to control the talking clock.

3

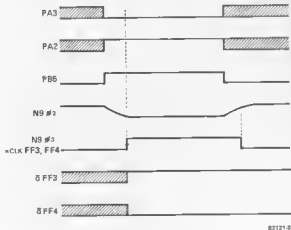

Figure 3. The signal waveforms. The PB signal can be seen to be delayed, as a result of which the clock signal for the flipflops does not arrive until the data is already available at the inputs. (In the example illustrated here there is a  $\bar{Q}$  at LD6).

a, b, e, f, and g the minutes. The data inputs of the IC have an internal pull-down resistor, enabling them to be connected directly to the segment outputs of the clock.

The pin assignment is as follows. There are two start inputs, pins 14 and 15. When the IC generates a positive pulse at pin 14 the time is announced in the manner described above. If this is produced at pin 15, however, the time is preceded by an alarm signal that lasts about one second. The "busy" output (pin 12) is a kind of open collector output and has a low impedance while the time is being output. It may be used to control any external devices that are hooked up to the clock.

A DC voltage is applied at pin 18 so as to calibrate the oscillator frequency of the IC. The set frequency is available

at pin 16 (a kind of open collector output too) for measurement purposes.

An external reference current must be applied to pin 34. The amount of current determines the level of the output signal. The speech output (pin 33) again produces an output current, as a result of which a resistor will also have to be connected to it in order to provide an output voltage.

Pins 17 and 19 constitute the stand-by power supply connections. They allow the IC to be connected to a stand-by supply whenever it is not used to indicate the time. This comes in handy if the circuit is battery-powered, for instance, but there is no need to go into that here.

Pins 20, 1 and 35 are the "normal" power supply connections and the remaining IC pins are all data inputs.

## Adapting the circuit to the 6502 housekeeper

As readers will remember, the 6502 housekeeper is more than just a clock. It can be used for timing all sorts of processes in the home, darkroom, workshop, etc. In short, a device well worth endowing with the power of speech! One minor problem has to be dealt with first: the displays on the housekeeper are multiplexed and, remember, that is precisely what the UAA 1003 does *not* cater for. Don't worry, this can be remedied by adding a couple of ICs, by way of an interface, to the circuit.

Figure 2 shows the various signals that control the displays in the 6502 housekeeper. The display segments are driven by PA0...PA6 and lines PB3...PB6 make sure that the four required displays are multiplexed. Using a set of D flipflops, the segment data belonging to the various displays must now be stored to allow all the signal information to be applied to the speech IC simultaneously. To ensure that the right information enters the right flipflops, the PB signals are used to read in the data on the PA lines. This means that the flipflops corresponding to the segments in display 6 must receive a clock pulse from line PB6, and so on.

If we take a closer look at the waveform on PB6, as shown in figure 3, the rising edge of the signal can be seen to appear virtually at the same time as the data on PA0...PA6 (for LD6). The rising edge on PB6 must be slightly delayed, initially to make absolutely sure that the correct signals are read into the flipflops. This is taken care of by the R1/C1 delay network included in the circuit diagram in figure 4. A similar delay technique is also employed on the other PB lines.

The flipflops (IC2...IC6) are situated to the left of figure 4. The seven segment data required by the UAA 1003 is permanently available at the outputs of the flipflops (as if the clock were a non-multiplexed type, after all). Theoretically, therefore, the flipflop outputs could be linked directly to the data inputs of the speech IC, were it not for another slight snag... The data on the PA lines is inverted with respect to the segment information. Fortunately, this can easily be remedied by connecting the  $\bar{Q}$  outputs of the flipflops to the data inputs instead of the Q outputs.

That just about covers all there is to say about the circuit diagram. We've already dealt with the UAA, so that only leaves the output amplifier, an LM386 in this case. A bandpass filter consisting of R10, C5, R11, C6, C7 and P2 is included between IC1 and IC10. Potentiometer P2 acts as the volume control.

Finally, the stabilised 5V voltage is provided by a 7805 chip, IC11. The whole circuit consumes about 150 mA current. P1 effects the only calibration needed for the circuit. This adjusts the



internal clock frequency of the speech IC. The adjustment may either be carried out by ear (until the voice sounds human!) or by measuring the frequency at pin 16 of the IC. This should be about 25.6 kHz.

### Connecting up the circuit

The circuit shown in figure 4 can be connected to the 6502 housekeeper without any difficulty. Lines PA0...PA6 and PB3...PB6 belonging to the talking clock board are simply linked to the corresponding connections on the main board of the 6502 housekeeper. The power supply may be connected up right after the bridge rectifier on the housekeeper power supply board. The ALARM input may be linked to one of the T0...T3 switch outputs. Whenever the corresponding output goes high, a short alarm signal will be emitted, after which the time is announced. Usually, of course, pushbutton S1 is depressed to make the clock 'speak', but then the time indication will not be preceded by an alarm signal.

### What about other digital clocks?

Other digital clock can be made to talk too, but this does call for a little more time, effort and components. The simplest solution is to connect the circuit to a non-multiplexed clock with

common cathode displays, as this, after all, is what the UAA1003 was designed for. In that case, components IC2...IC9, R1...R4 and C1...C4 may be omitted. The input of IC1 (points A, B...P) are connected directly to the corresponding display segments in the clock. Segment c pertaining to the hour tens display is therefore linked to point P, segment d to point N, and so on.

The logic levels of the digital clock pins from which the required signals are derived must meet the following parameters:

- $0V < U_L < 0.3V$  (segment 'off')
- $1.5V < U_H < 5V$  (segment 'on')

The 'low' level is usually correct due to the pull-up resistors at the inputs of the UAA 1003. The 'high' level should not be a problem either, as the operating voltage of a display segment is at least 1.6 V.

Making clocks with multiplexed displays talk is a different matter. Since in this case all the components must be mounted on the board (to store intermediate multiplexed data), the segment connections must be linked to inputs PA0...PA6 and PB3...PB6 in the normal manner. Note that the inputs respond to TTL levels here ( $0V < U_L < 0.8V$  and  $2V < U_H < 5V$ ). In the case of some inputs (such as PA5, for instance), a logic zero level at the

### Parts list

#### Resistors.

- R1...R4 = 560  $\Omega$
- R5 = 22 k
- R6 = 470 k
- R7 = 1 M
- R8,R9,R13 = 10 k
- R10 = 680  $\Omega$
- R11 = 1 k
- R12 = 10  $\Omega$
- P1,P2 = 10 k preset

#### Capacitors.

- C1...C4,C10,C12 = 100 n
- C5 = 150 n
- C6 = 33 n
- C7 = 56 n
- C8 = 47 n
- C9 = 220  $\mu$ /10 V
- C11 = 330 n
- C13,C14 = 10  $\mu$ /10 V

#### Semiconductors

- T1 = 8C 857
- IC1 = UAA 1003-3 (English)
- IC2...IC4 = 74LS175
- IC5,IC6 = 74LS74
- IC7,IC8 = 74LS00
- IC9 = 74LS132
- IC10 = LM 386
- IC11 = 7805

#### Miscellaneous.

- LS = 8  $\Omega$ /0.5 W loudspeaker
- S1 = pushbutton switch

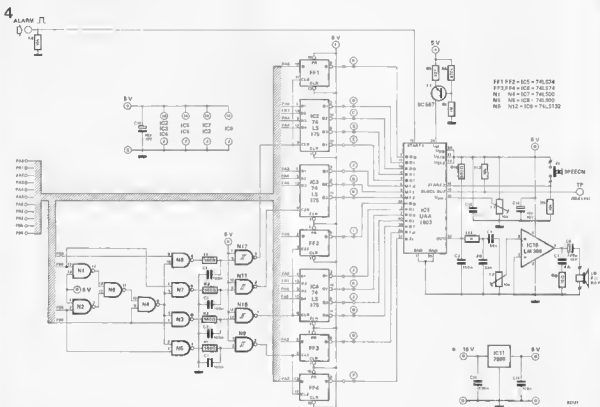

Figure 4. The circuit diagram of the talking clock. The flipflops to the left are required in connection with the multiplexed display control of the 6502 housekeeper.

5

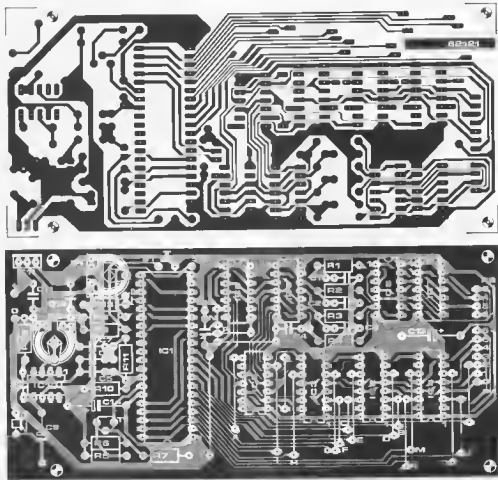

Figure 5. The printed circuit board and component overlay for the talking clock.

6

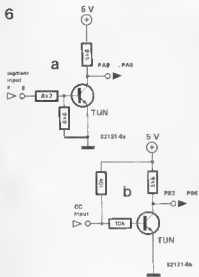

Figure 6. The interface circuits shown here have to be connected to the inputs, if the talking clock is to be combined with an ordinary clock having multiplexed CC displays. The PA and PB interfaces are depicted in figures 6a and 6b, respectively.

input will cause 1.2 mA (= 3 x LS TTL load) to be drawn from it. The segment control of such clocks does not usually meet these parameters. For this reason, an additional small interface will have to be connected to every input of the talking clock board.

The wire links to the clock will then be as follows:

PA0 - segment a

PA1 - segment b

⋮

⋮

⋮

⋮

⋮

⋮

⋮

⋮

⋮

⋮

⋮

⋮

⋮

⋮

⋮

⋮

⋮

⋮

⋮

⋮

inputs. Again, this circuit matches the logic levels and inverts the signals. Normally speaking, the common cathodes are driven by a transistor. The transistor conducts when its control signal is high. Thus, the principle for the PB lines and the buffer/inverters connected after them is the same as for the cathodes in the 6502 housekeeper. Every PB interface input has to be connected to the collector (and there to the CC of the display) of the 'CC' transistor just described.

The input sensitivity of the PA interface is:

$$0 \text{ V} < U_1 < 1 \text{ V}$$

$$1.5 \text{ V} < U_2$$

and that of the PB interface is:

$$0 \text{ V} < U_1 < 0.6 \text{ V}$$

$$0.6 \text{ V} < U_2 \text{ (open input)}$$

We are sorry to have to disappoint owners of digital clocks with common anode displays: this is the only type of clock which is not compatible with the talking clock board. Never mind, they will still be able to see what time it is. . .

Designing a proper layout for the bus board was anything but easy. Unlike computer circuits, almost every connection of the three printed circuit boards (VCO, etc.) requires a line to the 'outside world'. Figure 1 shows the circuit diagram of the bus board and its inputs. Particular attention must be paid to the VCO board, because the numbers shown do not correspond to those indicated on the printed circuit board. This irregularity was brought into line after the other boards were numbered.

Figure 1 shows the new numbers which are printed on the bus board. In order to cross-refer to the old (original) connection numbers (on the VCO) table 1 should be used.

Let's look at the connections of the bus board from top to bottom to see exactly

what their individual functions are (figure 2)!

All the printed circuit boards have the same supply voltage connection points (14...16). For this purpose, three tracks run the full length of the bus board. They lead to the connection points 40, 36 and 38 of board 1 (VCO) to 18, 20 and 22 of board 2 (DUAL-AOSR) and to 6, 18 and 26 of the last board (VCA-VCF).

The connections can be found very easily in two ways:

- look at the number shown on the printed circuit boards;
- mount the analogue boards on the bus board. Now turn the bus board so that the copper side is facing you and the component side of the analogue modules are towards the left. The con-

# the 'poly bus'

this bus will save you a lot of time . . .

Constructors who intend to make a complete polyphonic synthesiser with the polyphonic keyboard by using the printed circuit boards described in previous articles will be confronted with a complex problem: wiring up the connections between up to 30 printed circuit boards! This will tax the patience of even the expert. For this reason a bus board has been designed to contain three analogue modules (VCO, DUAL-ADSR, VCA-VCF) at a time, helping to keep the amount of wiring to the bare necessities and avoid any errors. Also included in the article are a few suggestions for the construction of the complete synthesiser.

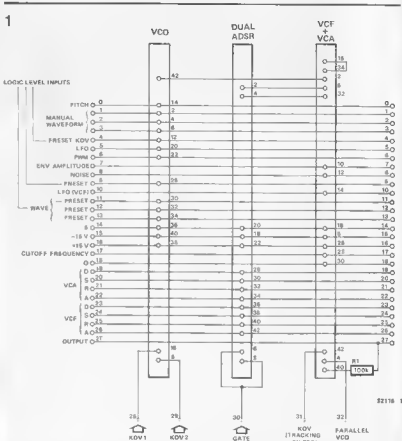

Figure 1. The circuit diagram of the bus board. The numbers shown on the three analogue modules indicate the order of connections for the 21-pin multiway connector. The new connections for the VCO can be found by numbering the pins (even numbers) as indicated in table 1. These inputs and outputs are described in detail in the text.

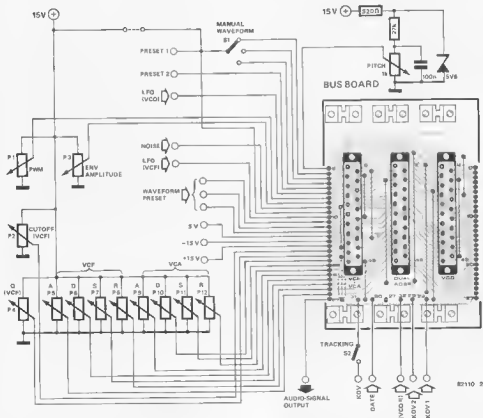

Figure 2. Only a single bus board must be connected to the controls on the front panel via connections 1...27. The other bus boards are interconnected by means of wire links. Connections 28...32 must be separately linked for each individual channel.

Table 1. Connections of the VCO multipoint connector.

Old: December 1981	New: bus board
34	2
32	4
30	6
10	8
2	10
20	12
36	14
14	16
18	18
22	20
22	22
42	24
6	26
16	28
28	30
26	32
24	34
6	36
2	38
4	40
8	42

connections are numbered with even numbers (connector pin multiplied by 2), beginning from the top.

The circuit at the left side of figure 2 only has to be constructed once. All the other bus boards can be connected together by means of 27 wire links. Each channel receives specific information via connections 28...32. These are the control voltages and corresponding gate pulses supplied by the polyphonic keyboard.

#### Connection 0

The tuneshift board connected to the input unit makes it possible to change the pitch of the polyphonic synthesiser one semitone at a time, in either direction.

An infinite variation of the VCO frequency to simulate other instruments cannot be realised by the processor, due to the digitalisation of the KOV. For this task an adjustable DC voltage must be fed to the VCOs of all channels

(pitch control). A 1 k $\Omega$  potentiometer, which is connected to the positive supply voltage via a series resistor, serves to shift all VCOs simultaneously by approximately one full tone.

A simple solution for mounting the zener diode, capacitor and series resistor is to solder them directly to the tags of the potentiometer. It is advisable to cover them with a 'tube' of insulation sleeving to prevent the possibility of 'shorts'.

#### Changes to the VCO board

The 'pitch' voltage mentioned earlier is fed to input 36 (new number: 14) of the VCO board via bus line 0. (This input is indicated as number 44 in the circuit diagram.) Those constructors who do not wish to make use of the switching facility between parallel and separate operation of the VCOs must fit 4 wire links to the socket of IC7 (1, 2/3, 4/8, 9/10, 11). In this case the track between pin 9 of IC7 and P5 will have to be

broken and pin 9 reconnected to the track that leads to pin 15 of IC1. Pins 8, 9 and 10, 11 must be interconnected, irrespective of whether parallel or separate operation is preferred.

Before coming to the switching facilities of the KOV it is advisable to mount wire links in order to short out all the switches in IC7. A wire link is also

needed between pins 8 and 9 for the following reasons:

In the monophonic synthesiser the voltages at the tune potentiometer and the range stage switch reach the VCO control input via the KOV switch. Without these voltages the VCO frequency would be below 1 Hz at a control voltage of 0 V (from the D/A converter of the key-

board). However, as some readers may know, a suitable tone for musical purposes is only produced at a control voltage of approximately 5 V. Therefore a voltage of 5 V must be fed to range input 13 via a wire link to point 13 (output of A1). In this case, IC6 will not be used. But, pins 2 and 3 of this IC must be linked together.

## 3

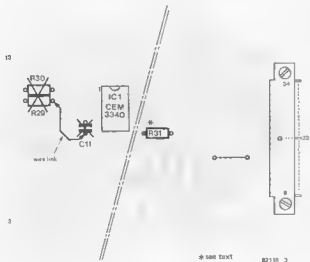

Figure 3. A wire link must be inserted and several components replaced in order to allow the pulse width of the squarewave VCO signal to be varied. Remove C11, R29 and R30 and insert a wire link as shown here. The value of R31 becomes 33 k $\Omega$ .

## 4

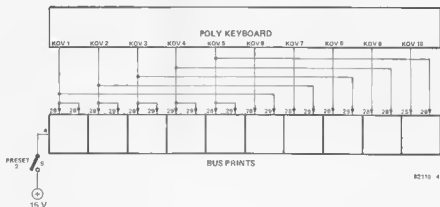

Figure 4. It is possible to connect two channels to one control output, thanks to the switch 'preset 2'. This means that only 5 keys can be played simultaneously (in the 1D channel version). Two channels having the same frequency will then be heard when depressing one key, which gives the well-known beat effect.

#### Calibration of the VCOs

After all wire links required have been inserted we can start with the calibration procedure. The following measures will simplify the procedure considerably:

- Remove P11 The VCO of a polyphonic synthesiser must be extremely stable. Despite the fact that P1 is a potentiometer the voltage range covered by one turn is too wide and therefore not stable enough for polyphonic purposes. So, out it goes!
- Presets P5 and P6 are replaced by a low tolerance precision resistor (metal film), because the polyphonic keyboard supplies exactly 1 V per octave. The critical adjustments of P5 and P6 during calibration are therefore dispensed with.
- Now P9 must be set so that an increase in control voltage (1 V) will double the frequency of the VCO.
- Despite the identical control voltages, not all of the VCOs will oscillate at the same frequency, due to component tolerances. As a result, some compensation for variations in the control voltages supplied to each VCO is required. This can be as much as 300 mV and a D/A converter circuit has been designed for this purpose. Due to lack of space in this issue this circuit will be described at a later date.

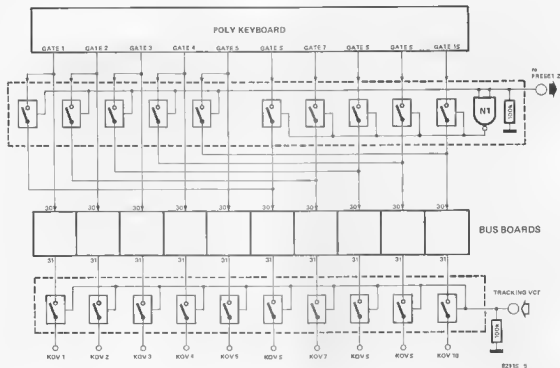

Figure 5. The gate pulses must be routed to perform the triggering, as shown here. This circuit must be constructed on a piece of Veroboard since there are no switches present on the analogue boards to take care of this task. The well known 4066 ICs are used as switches for this purpose. The 'tracking' inputs of all bus boards (connection 31) can also be simultaneously controlled by means of CMOS switches. The wiring of the ICs should not cause any problems. The positive supply voltage of the CMOS switches and the gate must be connected to pin 14 of each IC and pin 7 must be connected to ground.

#### Connections 1, 2, 3, 9, 11, 12 and 13

A logic level at 'preset 1' (+15 V or 0 V) determines whether the waveform of the VCO can be set by the front panel switch (S1) or by information stored in the preset memory. Without the preset facility, the input indicated as 'preset 1' must be connected to +15 V. This voltage is fed to inputs 1, 2 and 3 by S1.

A glance at the VCO circuit diagram (Elektor, December 1981 issue) shows that these inputs are connected to the control inputs of the waveform generator switch ICB. Pin 9 of the bus board leads to the inputs of N4. It should be noted that gate N4 is incorrectly drawn in figure 1 (December) as a NAND when it is in fact a NOR gate (4001). A 4011 can be used without difficulty because N1, N2 and N4 function purely as inverters, N3 is not needed. The logic '1' at N4 switches off IC9 so that information coming from the preset memory (pins 2, 4, 8, 9) will not affect the circuit. Connections 11...13 of the bus board, which lead to pins 2, 4 and 8 of IC9, do not have to be connected yet!

Figure 4 published in Elektor December 1981 clearly indicates that three ad-

ditional wire links are required. The three soldering points next to IC8, nos 36, 38 and 40, must be connected to the three soldering points in the top right-hand corner. Although it is not the ideal approach, it certainly is much cheaper than a double-sided board. All other connections shown in this figure are irrelevant.

#### Input: preset 2

The VCO board contains an electronic switch for selecting two different control voltages: KOV 1 and KOV 2. The logic level at input 4 of the bus board determines which of the two voltages controls the VCO frequency (KOV 1 via connection 28 and KOV 2 via 29). The KOV must be fed to connection 28, if input 4 is not connected.

#### Inputs 5 and 10: LFO

An LFO signal at input 5 modulates the frequency of all the VCOs. Input 10 is connected to all the VCFs: an LFO signal changes the cutoff frequency of all the filters.

#### Input 8: Noise

A noise signal connected to this input is

filtered by each of the VCFs, thus producing chords.

#### Connection 31: Tracking filter

This connection must be fed to the KOV of the corresponding channel, during the tracking mode, using a single-pole switch. With several channels a central switching system using CMOS ICs is recommended. One possibility is shown in figure 5. This procedure is also followed when connecting the VCOs in parallel.

#### Connection 32: VCO II

We are dealing with the well known and often described beat effect that occurs when at least 2 VCOs oscillate at (almost) the same frequency. In the polyphonic synthesiser this effect can only be produced with 2 VCOs or more per signal. Due to the fact that the bus board can only contain one VCO at a time, a solution was sought. As a matter of fact, two alternatives were found: The economical version. It is possible to connect the second half of all channels to the control voltages of the first half, thanks to the input 'preset KOV'. The number of keys that can then be ad-

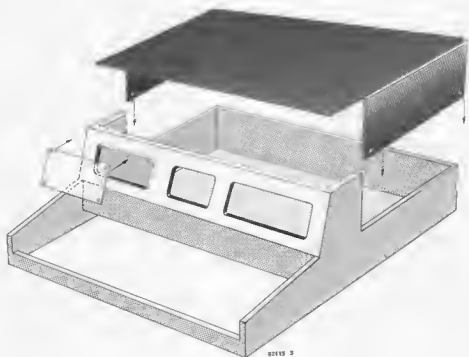

Figure 6. A suggestion for constructing the cabinet for the Polyformant is illustrated here. Readers may wish to base their design on other equipment already in their possession. The cabinet must be fairly strong as it may well be asked to take quite a few knocks in use.

pressed simultaneously is reduced by 50% (figure 4).

The expensive version: Each channel receives an additional VCO which is not mounted on the bus board and its signal output must be attached to bus connection 32.

#### Connection 27: audio signal output

Thanks to the resistors R1 (100 k $\Omega$ ) on the bus boards it is possible to connect the audio signal output directly to the inverting input of the opamp mixing stage.

#### The remaining connections

All other bus connections must be linked to the 12 potentiometers on the front panel as indicated in figure 2. Their functions were already described in previous articles.

#### Further changes to the analogue boards

The external connection for the pulse width modulation (PWM) of the VCO is now via pin 22 on the connector of the VCO board (with the modifications as shown in figure 3).

#### VCF/VCA board

The signal inputs for the VCOs lead from the multiway connector (points 2

and 4) to the opposite side of the board (connections 1 and 3). As both potentiometers meant for the volume control may be left out, wire links must be soldered between 1/7 and 3/9.

#### Wire links in the CMOS IC sockets

1. VCO: see the changes in the previous sections.
2. VCA:VCF: Except for the two CMOS switches, all ICs must be mounted in their proper places. This calls for some minor changes to the wire links that already exist in the sockets:
  - IC3 socket: 1-2 and 10-11 instead of 8-9, 3-4.
  - IC4 socket: 1-2 instead of 3-4.
3. ADSR: 3-4 and 10-11 for all CMOS IC sockets.

#### Gate triggering

The small circuit shown in figure 5 is for gate triggering and can be constructed on a piece of Veroboard. This circuit allows a choice to be made between a fixed VCF frequency (tracking) and a VCF frequency controlled by the KOW.

#### General calibration

We cannot give an absolutely definite pitch indication, as this is, as mentioned earlier, a matter of taste. Constructors

who wish to tune their instrument according to the official standards can find precise frequency indications in the corresponding technical literature.

#### Frequency drift

What with ten VCOs working independently, some readers may wonder what the frequency stability is like. As every pianist knows, the slightest shift in pitch will make his/her instrument sound awful. Unfortunately the same is true of all other polyphonic instruments. According to manufacturers, such problems cannot arise where VCOs are concerned. To be on the safe side, Elektor's designers tested them and came to the same conclusion. Nevertheless, the instrument must still be protected against large temperature fluctuations and a stable voltage supply helps avoid problems of this kind.

#### The power supply

Due to the large number of printed circuit boards the power supply must be able to deliver quite a lot of current. Remember that each analogue channel requires a current of approximately 190 mA (positive and negative supply).

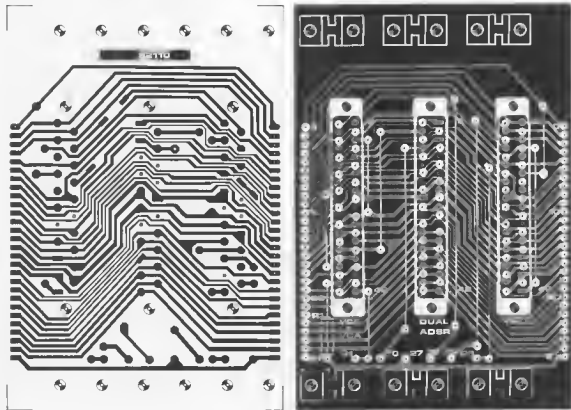

Figure 7. The track pattern and component overlay of the bus board.

Table 2

All changes of the VCO board when used for the polyphonic synthesiser.

Additional wire links and changes

1. Socket IC7: 3, 4/10, 11/1, 2/8, 9 (If no KOV switching is desired)
2. Socket IC6: 2, 3
3. Connect soldering point 36 (next to IC6) to pin 2 of the multiway connector (new indication)  
Connect soldering point 38 to pin 4  
Connect soldering point 40 to pin 6
4. Link connection 13 to connection 15
5. Remove C11, R29 and R30. Mount a wire link as shown in figure 3. Replace R31 by a resistor having a value of 33 k.
6. Remove P11
7. Replace P5 and P6 by a metal film precision 100 k resistor!
8. With KOV switching  
Socket IC7: Wire links between 8, 9 and 10, 11.  
Interrupt copper track from pin 9 to P5!  
Make a wire link from pin 9 to pin 2.  
Mount IC7!

#### Parts list

Resistor:  
R31 see text

Miscellaneous:  
three 2t pin multiway connectors  
six card supports  
for the printed circuit boards

These components are only sufficient for one complete bus board.

#### Practical hints for construction and wiring

The interconnection wiring of the polyphonic synthesiser has been reduced considerably by the use of the bus boards. Obviously, due to the large number of switches and potentiometers on the front panel, it has not been possible to eliminate all the connection wires completely.

We strongly recommend the use of card supports on the bus boards. They go a

long way in helping avoid damage to the boards and connectors when fitting and removing cards and they are not that expensive.

The construction of a strong wooden housing is not too difficult. However, please remember that a wooden cabinet is bound to make the synthesiser rather heavy to carry around. It will also need a fairly substantial stand. One possible design for a suitable case is illustrated in figure 6. But readers are welcome to use their own ideas.

The bus boards can best be mounted with aluminium brackets, which in turn can be attached to the keyboard assembly.

#### Hints for calibrating the analogue boards

It is rather difficult to reach the presets during calibration once the boards have been inserted into the bus boards. It is therefore advisable to use an extension cable consisting of a 21-way ribbon cable together with a plug and socket. This will enable the board to be calibrated with ease.

This is not the end of the story. A further article will be appearing, covering the output unit, in the next issue of Elektor - if all goes well! M



Before taking a closer look at the dimmer described here, there is one misconception we wish to do away with right from the start: dimmers are not necessarily economical energy consumers! On the contrary, an awful lot of electricity is wasted by keeping a high-power light bulb permanently dimmed. Although dimmed light bulbs consume less mains energy, their efficiency - their light to power consumption ratio - does not compare favourably with their full power performance. In short, it is much more economical to replace a dimmed bulb by a lower rated type. To give an example, a 100 W bulb dimmed down to 40 W provides less light than a fully lit 40 W bulb. Dimmed light has to be paid for dearly and that is why it is often considered to be a luxury.

electronic control of up to three tubes

# fluorescent dimmer

Electronic light dimmers are a welcome asset to the living-room. They enable lamps to be adjusted to suit everyone's individual requirements. Unfortunately, the circuits currently available are usually suitable for fluorescent tubes, or rather more correctly, fluorescent tubes cannot accommodate dimmers. This article explains how to modify fluorescent lights so that they can be dimmed, after all. In addition, a circuit is described which can be controlled by means of a time switch and even allows the lights to fade on and off very gently if desired. The circuit is ideal in aquaria, reptile tanks and aviaries, as it successfully imitates the rising and setting sun and makes the animals forget that they are indoors . . .

But sometimes it is worthwhile to spend a little extra, for dimmers do have great advantages. It is ideal to be able to adjust the lights for every occasion, such as reading, watching television, or spending a quiet evening with friends, etc., without having to change the bulbs all the time! Think of the huge collection of lamps you would have to have! Unfortunately, dimming fluorescent light tubes is even less economically viable. It isn't so much the actual dimming process that causes energy to be lost, but the necessity to heat the tube, for reasons we will come back to later.

Far be it from us to discourage constructors, however, for in spite of the snags mentioned earlier, a dimmed lamp is bound to save more energy in the long run than an excessively bright one. Furthermore, dimmers are ideal in reptile tanks and bird cages, as 'jumpy' animals tend to feel more at home in surroundings where the day/night and night/day transitions are as gradual and as natural as possible. This can be simulated by installing a dimmer in the animal's habitat.

Aquarium owners will be pleased to know that the fluorescent tubes usually preferred to filament lamps can now also be controlled by means of the dimmer circuit described here.

The printed circuit board for the dimmer has been designed with the possibility of a number of different versions to suit various applications:

- an ordinary filament lamp dimmer in which a set brightness is adjusted within a variable range by a preset.
- a gradual on/off filament lamp dimmer that can be operated either manually or by means of a time switch. The user is free to select the control time and the variable brightness range.
- as in a. or b. but now for fluorescent tubes.

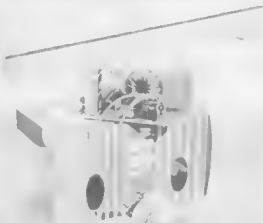

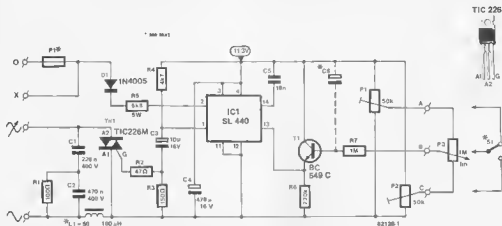

Figure 1. The dimmer control is designed around the SL 440 IC which is a phase angle controller from Plessey. Presets P1 and P2 adjust the control range limits.

**The dimmer circuit**

Figure 1 shows the circuit diagram of the dimmer. Normally speaking, an RC network would be used in combination with a diac to control the triac (Tri1). Here however, an IC specifically designed for the purpose, the SL 440 from Plessey, has been included to control the phase cut-off angle. The IC has the advantage that it enables the phase to be controlled during practically the entire half cycle of the mains voltage. This means that the power can be adjusted from roughly zero to the maximum level.

Figure 2 illustrates what is meant by the phase cut-off angle. If the triac receives a gate pulse (curve a) from the IC at each zero-crossing point of the mains voltage, the load will be under the full brunt of the mains voltage (curve b).

But if, for instance, the gate pulses are applied two milliseconds after the zero-crossing points (curve c), the load will be at about 95% of full power (curve d). By phase shifting the gate pulses even further away from the zero-crossing points (curve e) reduces power to the load even further (curve f) in this case, to about half power. Varying the phase cut-off angle in this manner allows the power to the load to be controlled from full to zero.

As mentioned earlier, the gate pulses are provided by the SL 440 IC. Among other things, the IC incorporates a DC stabiliser, a zero-crossing detector, a pulse generator with a variable delay, and an amplifier. The mains voltage is rectified internally by the DC stabiliser and capacitor C4 is used to smooth the internal supply. The zero-crossing detec-

tor detects the mains zero-crossing point and triggers the pulse generator. This is in fact a monoflop with a variable time. At the end of the preset period (0...10 ms = mains half cycle) the monoflop generates a pulse. The pulses are boosted by the output amplifier and are output at pin 1 of the IC. In the network around C3 and R2/R3 the pulses are converted into negative gate pulses having a pulse width of about 50 μs and a current of about 100 mA.

The phase cutting angle is controlled by potentiometer P3 (via emitter follower T1) to provide a voltage roughly between 1.8 V and 8.5 V at pin 13 of IC1. (Switch S1 and capacitor C6 will be considered later on.) P1 and P2 are included to preset the control range.

Rather a lot of radio frequency interference (RFI) is created when the triac receives a gate pulse and starts to conduct. For this reason, a filter network must be included around the triac and this consists of L1, C1, C2 and R1. The LC network avoids RFI by preventing the load current from rising too quickly. As filament lamps have a tendency to cause short circuits in other equipment when they fail, fuse F1 has been connected in series with the mains supply. It also serves to protect the triac against excessive currents.

**Dimming filament lamps**

Filament lamps may be connected directly to the dimmer via the connections shown in figure 3. The current through a cold lamp filament may be 10...25 times higher than the normal rate, so the fuse (F1 in figure 1) must be able to handle this. A practical guideline is to reckon with 2 or 3 times the nominal current rating of the lamp (= watts divided by the mains voltage, times 2 or 3). A total lamp power of,

2

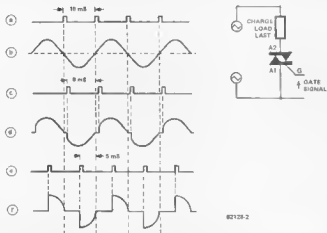

Figure 2. The timing of the gate pulse to the triac (a, c or e) will dictate the amount of power available to the load (b, d or f).

3

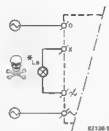

Figure 3. How to connect filament lamps to the dimmer.

say, 100 W requires a 1 A slow blow fuse.

A voltmeter with a measurement range of at least 220 V (AC) is needed when setting the control range. With the wiper of P3 turned towards connection point A adjust P1 until the voltage across the lamp(s) is at its minimum level. Turn P3 back the other way and the meter will now indicate a much higher voltage. Then adjust P2 until the voltage reaches its maximum level. The meter will indicate just about the full mains voltage.

When using P3 to control the brightness of the lamp, a 'dead space' will be apparent. This is because the voltage across filament lamps needs to reach a certain level before they are able to light. P1 gets rid of the 'dead space'. To remove the 'dead space' set P3 to its minimum position (wiper towards point A) and then adjust P1 until the lamp is barely lit. There is one drawback to this: the lamp will always draw current from the mains, in other words, there is always a voltage across it. Keep this in mind when changing the bulbs!

Constructors are, of course, free to choose other light control ranges (such as 30% . . . 80% of the maximum lamp brightness) according to their needs.

The total filament lamp power should be at least 40 W for the dimmer to work properly. If the triac is not cooled, the maximum power may be around 200 W. Provided the triac is sufficiently cooled, filament lamps of up to 1500 W total power may be controlled (see the article on the 'solid state relay' elsewhere in this issue). Remember that the choke L1 must be matched to the load. In the case of a 1000 W load, for instance, the choke must be able to handle 1000 W: 220 V = roughly 5 A.

### Dimming fluorescent lamps

Fluorescent lamps cannot simply be connected to a dimmer, because they have to be pre-heated by the filaments and 'fired' at a high strike voltage. Once the tube lights, the gas discharge maintains it at the right temperature. If a tube were to be dimmed in the manner described above, insufficient heat would be produced and, beyond a certain limit, the light would go out. Thus, the

fluorescent tube will have to be modified. (For further information on fluorescent lighting, read the 'fluorescent tube starter' article elsewhere in this issue.)

One type of fluorescent tube is available that will start without a high voltage. These are known as self-starting fluorescent tubes and are provided with a conductive strip along the outside, one end of which is connected to a filament via a high impedance resistor (see figure 4). When the fluorescent tube is switched on, the full mains voltage is applied between the disconnected end of the conductive strip and the filament.

The gas between them will ionise very rapidly because of the powerful electrical field (= voltage per distance). The conductive strip makes sure that the ion cloud is quickly distributed over the full length of the tube. As a result, a gas discharge is produced and the tube lights. The greater the current heating the filaments of the tube, the easier it will strike. Provided the filaments are sufficiently heated, the tube may even light at extremely low voltages, in which case the tube can be dimmed. In principle, an ordinary fluorescent tube can also be dimmed, provided it is sufficiently pre-heated. However, it won't work as

4

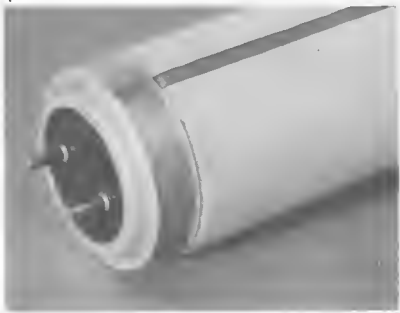

Figure 4. A self-starting fluorescent tube with a conductive strip on the outside, one end of which is connected to the filament via a high-impedance resistor. Self-starting tubes can be fired at lower voltages, provided they are sufficiently pre-heated by the filament.

5

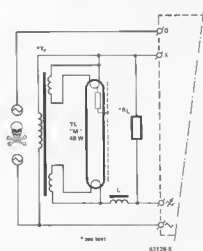

Figure 5. How to connect a (self-starting) fluorescent tube to the dimmer. The tube is continuously heated with the aid of a transformer (Tr), which enables the tube to be dimmed to very low voltage levels. An impedance load ( $R_L$ ) is required for the dimmer to work properly.

well as a self-starting type. The latest, thin tubes will be even more difficult to dim. It is best to stick with self-starting fluorescent tubes. Even though they are slightly more expensive than their counterparts.

A method will have to be found to pre-heat fluorescent tubes so that they can be dimmed. Figure 5 shows how this can be done with a transformer. The transformer needs to have two separate 3.7V/0.62 A secondary windings. Philips manufactures special filament transformers for this purpose (see table 1) which can be built into the starter case of an existing fluorescent tube holder.

Alternatively, an ordinary transformer with two separate 4 V (6 V max.)/0.8 A windings is also suitable. If necessary, two 3...5 V/1 A bell transformers may be used.

Let's take another look at the circuit diagram in figure 5. L is a normal fluorescent choke. The magnetic field that is periodically created in the choke must be able to be broken down quickly, as otherwise the triac in the dimmer will carry on conducting for too long. This is taken care of by the resistor  $R_L$ . The lower the value of  $R_L$ , the faster the magnetic field is broken down and the wider the control range of the dimmer.

If the range is exceeded, the fluorescent tube will start to flicker. This should be remedied very quickly, as a harmful, asymmetrical AC current (in other words a DC component) will start to flow through the choke. P1 and P2 (see figure 1) keep the range within safe limits. Adjust P2 so that the tube will light at full power without flickering.

Although selecting a low value for  $R_L$  will provide a wider control range, it does mean more energy is lost. As a compromise, it is best to select a value of 4k7/15W for a 40 W fluorescent tube. In the case of a higher tube rating, or when multiple tubes are to be con-

trolled,  $R_L$  should be lowered in value and increased in power rating (for 80 W fluorescent power,  $R_L = 2 \text{ k}\Omega/30 \text{ W}$ ). It will be found that an ordinary filament lamp will serve the purpose rather well. A 40 W bulb will be sufficient for two or three self-starting 40 W fluorescent tubes. Figure 6 shows how two fluorescent tubes can be connected to a single dimmer circuit.

The transformer needs to have three windings. Two tube filaments may be connected in parallel on one of the windings. Of course, the winding must be able to handle the current for both (see table 1). It is equally feasible to use two transformers with two separate windings each or to use three transformers with a single winding each.

As in the case of filament lamps, the load, when fluorescent tubes are dimmed, must be at least 40 W (power inside tube +  $R_L$ ). Using an uncooled triac the dimmer can cope with (a load of) up to 200 W. If the triac is cooled, however, the dimmer can handle 1500 W.

Self-starting 40 W types fluorescent tubes are the easiest to get hold of. They are 120 cm long but if this is too long to fit inside your aquarium use an ordinary fluorescent lamp. As mentioned earlier, they don't quite come up to scratch, but a prototype was tested in the lab and found to give acceptable results.

### Dimming filament or fluorescent lamps on and off

In gradual on/off dimmers, preset P3 is replaced by a toggle switch or a two-way relay contact in a time switch (see figure 1, connection points A...C). The result is a two-way dimmer. The brightness may be preset in both switch positions by P1 and P2. By adding capacitor C6 to the circuit, the voltage

at pin 13 of IC1 will gradually change in level while the capacitor is charged or discharged, gradually increasing or decreasing the brightness. This allows the light to fade on and off in a more natural manner.

In combination with filament lamps and, if necessary, a time switch, the on/off dimmer is an ideal light controller in aviaries. The slowly on-coming darkness gives the birds plenty of time to 'get ready for bed'. In this particular application filament lamps have an advantage over fluorescent tubes in that they dissipate a considerable amount of heat, which birds certainly appreciate during the cold winter months. A gradual on/off dimmer could also be installed in children's bedrooms, for children who to be woken up suddenly by a bright light.

Aquarium owners will have plenty of uses for the circuit. Although fish are noted for their cold-bloodedness, they almost jump out of their skins when it suddenly gets dark. They probably think they have been swallowed by a ferocious predator in broad daylight! Funny enough, they don't mind the light being turned on so much. Thus, the gradual on/off dimmer can greatly contribute to domestic bliss both in and out of the water.

The dimming range needs to be calibrated with P1 and P2 before capacitor C6 is mounted. Once this has been set, the capacitor may be added to the circuit. Be sure to break the mains connections beforehand! Due to the leakage current, the capacitor should have an operational voltage of 40 V. As far as the capacitance is concerned, every  $\mu\text{F}$  induces a delay period of about 5 seconds. But as the capacitance to delay ratio depends on the setting of P1 and P2, try a value of, say, 4.7  $\mu\text{F}$  to start with and modify this, if necessary. After power-up wait until C6 is charged up to the

6

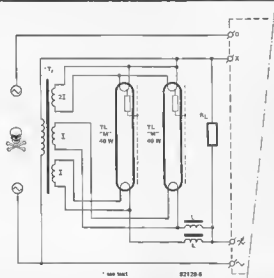

Figure 6. How to connect two [self-starting] fluorescent tubes to a single dimmer control.

Table 1.

Philips manufacture special components for dimming (self-starting) fluorescent tubes' PMP 42T/05 transformer, part no 9131990491, has separate 2 x 3.7 V/0.62 A and 1 x 3.7 V/1.25 A secondary windings BTP 40L06L chokes, part no. 9130335403, suitable for 1 x 40 W fluorescent tube dim holders

TMX 100-140 DIM for 1 x 40 W tube  
TMX 100-240 DIM for 2 x 40 W tube  
TMW 060-140 DIM for 1 x 40 W tube (waterproof, rustproof, suitable for aquaria). The holders contain one or two chokes and a single filament transformer, type PMP42T/05

self-starting tubes: 40 W is the most common type and is available in warm white (nos. 29, 82, 83) bright white (nos. 33, 84) and in cold white (no. 54). The 80 series provides the best colour quality (not such a strain on the eyes) and suit botanical requirement, in other words, they're good for plants.

20 W and 65 W self-starting tubes and types with a built-in reflector are also available.

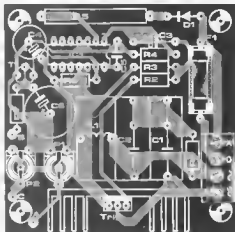
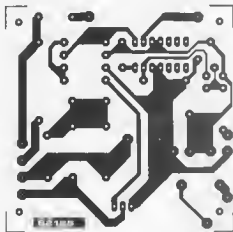

Figure 7. The track pattern and component overlay of the dimmer control printed circuit board.

#### Parts list

##### Resistors\*

R1 = 100  $\Omega$   
 R2 = 47  $\Omega$   
 R3 = 150  $\Omega$   
 R4 = 4k7  
 R5 = 6k8/5 W  
 R6 = 220 k  
 R7 = 1 M  
 Pt,P2 = 50 k preset  
 P3 = 1 M (linear (see text))

##### Capacitors\*

C1 = 220 n/400 V  
 C2 = 470 n/400 V  
 C3 = 10  $\mu$ /16 V  
 C4 = 470  $\mu$ /16 V

C5 = 18 n  
 C6 = see text

##### Semiconductors

T1 = 8C549C  
 IC1 = SL440 (Plessey)  
 Dt = tN4005, tN4004

Tri t = TIC 226M or TIC 226D triac

##### Miscellaneous:

Lt = 50 ... 100  $\mu$ H (toroidal) choke  
 see text  
 S1 = toggle or relay contact  
 see text  
 F1 = fuse (see text)  
 fuse holder for pcb

quiescent voltage level before checking the delay time. A very high value (more than 1000  $\mu$ F) may lead to an excessive leakage current and cause problems.

#### Practical points

Construction of the printed circuit board will present no problem. However, if a socket is used for IC1 it is important to ensure that C4 is discharged each time before fitting the IC. In practice the unit can be mounted virtually anywhere that is convenient, including an existing switch box. In the latter case it must be noted that the dimmer control will not be compatible with normal house wiring and extra cable runs will have to be fitted. A total of 4 wires plus earth must run between the switch box and the light fitting. Further to this, a mains supply is also required. An alternative is to fit the entire electronics into the light fitting, if at all possible. This method requires only three wires to the switch control unit.

It is not possible to advise exactly what modifications are required, as 'standard electrical wiring practices' may well not prevail, especially if yours is an older property. Enough to say that if you are at all unfamiliar with the electrical 'arrangements' in your house, it may well be advisable to invite your friendly electrician in for an evening and gently steer him towards the subject. ■



Electronics are finding their way into the car more and more these days. This is not confined to the up-market models either. The application of the majority of electronic circuits in the car are related to energy and cost saving. This normally takes the form of electronic ignition and timing systems of varying complexity. Another obvious application of electronics is the protection against theft of the vehicle.

As well as protecting the car, the alarm system described here also provides protection for accessories such as radio, cassette deck and CB rig. In many cases it is not the car itself that is stolen, but its contents!

# car alarm

## an active insurance policy

Although cars are insured against theft, most motorists will agree that it is preferable not to make use of the policy. The major advantages of the circuit described in this article are automatic resetting and protection against false alarms, which is not only a good thing for the owner, but also for the neighbourhood.

### Alarm systems

Alarm systems will always be a matter for discussion. This is especially true when deciding which type of system to apply and how extensive the coverage needs to be, since as far as electronics is concerned, the complexity could be infinite.

Commercially available systems usually come in one of three guises. The basis of a very popular alarm system is a type of 'tilt switch' which is used to activate the alarm. Effectively, this consists of one or more switches which are sensitive to any slight movement of the vehicle. This makes it almost impossible for a would-be thief to touch the car without activating the alarm. However, the major disadvantage of this system is that the alarm cannot differentiate between various kinds of vibration. They tend to be triggered by passing vehicles, strong wind and pedestrians who inadvertently touch the car.

Far more sophisticated alarm systems are based on ultrasonic or infra-red principles. These do not react to the movement of the vehicle, but they certainly provide excellent protection for the interior of the vehicle. However, installation and setting up require a fair amount of time and effort. The system must be designed to cater for fluctuations in temperature (which can be large inside a vehicle) and prevent false triggering by the movement of insects inside the vehicle. The latter holds particularly true for ultrasonic based systems.

The third and simplest type of alarm is triggered by courtesy light door switches. This is a good compromise between cost and efficiency. With the help of some electronic circuitry the construction of a reliable alarm installation should not prove to be too difficult. The following circuit is based on this principle.

### Operation of the system

The simpler the circuit, the more reliable it is likely to be, and so this type of circuit is the basis for the vast majority of car alarm systems. How does it work? When leaving the car the system will be arming, either automatically or by a switch that is hidden somewhere inside the car (underneath the dashboard, for instance). A lamp on the dashboard (which can be either a LED or a commercially available 12V indicator) will light for approximately 1 minute showing that the alarm is activated. During this time period the occupants of the car must leave it and close the doors. The alarm will remain silent while the car doors are being opened and closed. The alarm will be primed 6 seconds after the light goes out.

If a door is now opened, the alarm will sound after a 6 second delay. It will continue to sound for a period of 1 minute, by which time your average thief will be attempting to fade discretely into the background. A useful advantage of this circuit is its reset facility. This is fully automatic ensuring that any further attempts will have the same result.

On returning to the vehicle, the rightful owner would simply turn off the alarm by means of the hidden switch during the 6 second delay. (This should be practised as any fumbling would cause a certain amount of embarrassment...)

### CMOS ICs in the car

There are a number of reasons why CMOS ICs are suitable for use in the car. The most important is their wide supply voltage range (between 3 and 15 volts), eliminating the need for voltage regulators. With a supply voltage of 12V, a noise immunity margin of better than 5V can be reached - a figure that is far superior to any other logic family. Another advantage, of course, is their extremely low current consumption. The quiescent current of CMOS devices can be considerably less than the normal self-discharge rate of the car battery. The only real disadvantage of using CMOS ICs is the problem associated with handling. This however, ceases to exist once the IC is mounted on a printed circuit board.

### The circuit

Figure 1 shows the complete circuit diagram of the car alarm. The system is

1

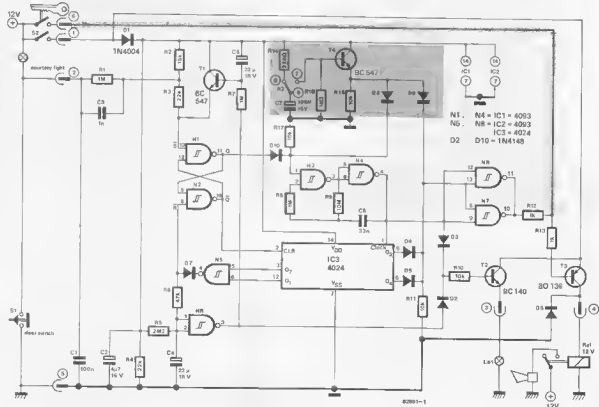

Figure 1. The circuit diagram of the car theft alarm. The shaded areas shown in the drawing are optional, as explained in the text. A standard car horn relay should be used for Re1.

activated by means of the hidden switch S2 which, when closed, supplies power to the circuit via diode D1.

Initially, the flipflop consisting of gates N1 and N2, will be reset. This is ensured by the time constant of capacitor C4 and resistor R5 which holds the pin 8 input of N2 low for a period of time. The initial state of the outputs of the flipflop will therefore be low and high for the Q and  $\bar{Q}$  outputs respectively. The Q output is used to control the N3/N4 oscillator which will be switched off with a logic '0' at pin 1 of N3. The 'high' output of  $\bar{Q}$  is fed to the clear input (pin 2) of IC3. The contents of this seven stage ripple counter will now be cleared and ready for action.

For the C4/R5 time period, the output of N6 will be high, switching on the lamp La1 via T2. This gives a visual indication that the alarm is primed. During this time period, opening the door will have no influence on the circuit because the trigger input of the flipflop is 'latched' high by the output

of N6 via T1. The circuit will remain in this condition until C4 charges via R5. With the values shown in the circuit diagram this will be about one minute, by which time the trigger threshold of N6 will be reached. Its output going to logic '0' will have two results: Transistor T2 will switch the indicator lamp off and C5 will begin to charge via R7. After about 6 seconds (the time constant of C5/R7) T1 will release the set input at pin 13 of N1. The flipflop will not alter its state yet, it will require the operation of the door switch to do this. The alarm circuit is now fully 'active'.

An entrance to the car by an uninvited guest will result in the set input of the flipflop being taken low. Things really start to happen now. The high appearing at the Q output starts the N3/N4 clock oscillator running at the same time as the 'clear' is removed from IC1 by  $\bar{Q}$ . The counter outputs at pins 9 and 6 are 'summed' together with the clock signal. The resultant outputs of gates N7 and N8 will operate the relay (via T3)

12 times in 6 seconds. After a short interval the cycle is repeated, three times in total. The indicator lamp on the dashboard will also light in sympathy. This method of sounding the horn is for two reasons. Firstly it is quite 'energy conscious' and secondly, the horn will sound different from normal, and therefore, hopefully, easily recognisable by the car owner.

At the 64th clock pulse at pin 1 of IC3, about the same time that the would-be thief is attempting to merge with the nearest crowd, the Q1 and Q7 outputs will coincide with a logic 1 output. Gate N5 will now provide a reset pulse for the flipflop. This will stop the horn from sounding but it will not disable the alarm circuit. It will simply wait with infinite patience for the next customer.

#### Additional protection

The shaded areas in the circuit are 'optional extras', that is, the circuit will also

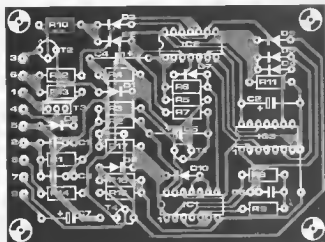
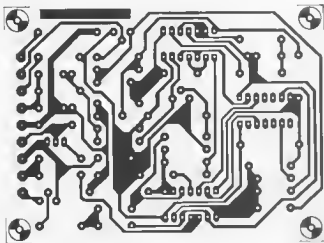

Figure 2. A suggested track pattern and component overlay for readers who wish to make a printed circuit board.

#### Parts list

##### Resistors:

R1, R7, R8 = 1 M  
 R2 = 15 k  
 R3, R4 = 22 k  
 R5 = 2M2  
 R6 = 47 k  
 R9 = 10 M  
 R10, R11, R15, R17 = 10 k  
 R12, R13 = 1 k  
 R14 = 220  $\Omega$   
 R16 = 1M2

##### Capacitors

C1 = 100 n MKS  
 C2 = 4 $\mu$ 7/16 V  
 C3 = 1 n MKM

C4, C5 = 22  $\mu$ /16 V tant  
 C6 = 33 n MKS  
 C7 = 100  $\mu$ /16 V

##### Semiconductors:

D1 = 1N4004  
 D2 = D10 = 1N4148  
 T1, T4 = BC 547B  
 T2 = BC 140  
 T3 = 80 136  
 IC1, IC2 = 4093  
 IC3 = 4024

##### Miscellaneous:

S2 = ignition switch  
 S3 = 2-way double pole switch  
 Re1 = 12 volt relay  
 La1 = 12 V/50 ... 100 mA light bulb or  
 LED with 1 k resistor in series

function correctly if they are not included. The components around S3 and T4 form an anti-sabotage circuit. The experienced car thief will attempt to open the bonnet of the car first in an effort to disable any electronic protection circuit fitted. With the circuit here things do not get off to a good start for him. Switch S3 is operated by the bonnet which, when opened, makes the connection between terminals 9 and 7. The charge on C7 will now switch T4 on and sound the horn immediately for about 20 seconds (until C7 discharges). Our unwelcome friend will be wise if he drops the bonnet and moves on. This will make S3 bridge the contacts 8 and 9 to allow C7 to recharge via R4. In a few seconds the alarm will again be fully active.

The second option is a connection to the ignition switch, shown in the circuit diagram at point 6 (top left-hand corner). This ensures that the alarm is always disabled when the ignition is switched on.

#### Construction and installation

The circuit can be constructed on a piece of Veroboard and fitted in a small plastic box. Small is the operative word here because the completed circuit must be hidden and this will be easier if its size is kept to a minimum. The relay for the horn should be a standard car headlamp or horn relay. It will also be less apparent that it is an addition under the bonnet. The object of the exercise is to make the whole installation as unobtrusive as possible in order to escape the attention of the more experienced thief. For instance, use black cable for all wiring under the bonnet and keep it out of sight as far as possible. Do not fit the relay near the horn. It is strongly advisable to cover the horn connections with a few layers of tape so that a disconnection here is as difficult as possible. Remember, the greatest enemy of the car thief is time and the longer we can delay him the better chance there is of him giving up and moving on to an easier victim. **M**



Following the latest trend in high-speed systems, Motorola has developed a microprocessor that has an internal 16-bit structure. One of the reasons why the 6809 is known as a 'Super 6502' is that its registers have the same names as those in the 6502. The features of the two systems are in fact very similar, except that the Motorola chip is much faster and more powerful. The differences in structure are shown in figure 1.

# from the 6502 to the 6809

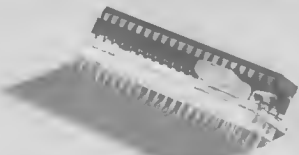

## a new 'super' 6502! The 6809.

As always in the ever advancing world of electronics a popular and worthwhile microprocessor, has been superseded once again by a chip with a greatly improved performance: the 6809 CPU, manufactured by Motorola.

The beauty of the 6809 is that it can be implanted into existing 6502 systems without any difficulty, thereby creating a new 'super' 6502. With just a few minor hardware modifications, constructors will then have at their disposal a much faster, more powerful computer with new fascinating programming facilities.

As can be seen, the 6809 contains an additional B-bit accumulator and a variable 'direct page register'. The 6502 CPU, on the other hand only had a single page zero. The 6809 also makes 256 direct pages available. The 6809 has a further advantage in that its two accumulators, A and B, may be combined into a 16-bit D accumulator. The instruction set will look familiar to 6502 operators. Very little has in fact been altered in the mnemonics and addressing modes.

The branch commands are particularly effective. The processor can branch within the  $-16 \dots +15$ ,  $-128 \dots +127$ , or  $-32768 \dots +32767$  address ranges. New instructions, such as BRA (branch always) and BSR (branch to subroutine),

allow programs to be stored in any area of memory, without having to rely on absolute addresses and without having to alter a single byte. Such programs are known as 'relocatable' routines. The system introduces a new addressing mode, the 'program counter relative' mode. This is extremely powerful, and enables any memory location to be addressed (at a certain moment) that corresponds to the contents of the program counter.

As the saying goes, "What you gain on the swings, you lose on the roundabout" and the same applies here, for 6502 fans will have to give up one of their favourite addressing modes, the indirect indexed mode (as in LDA (POINT), Y, for instance). Unfortunately, indirect addressing modes cannot be indexed on the 6809. However, as we have already seen, plenty of other valuable facilities are available instead.

The indexed addressing takes a slightly different form. The opcode consists of a single byte and is followed by a 'post byte', which may contain a 5-bit displacement. The next byte or byte pair either represents an 8-bit or a 16-bit displacement in two's complement. The effective address is calculated by adding up the index and the displacement:  $\text{index (contents of X, Y, S, U, A, B or C registers)} + \text{displacement} = \text{effective address}$ .

If a displacement is made within the  $-16 \dots +15$  range an instruction in the index addressing mode will only contain two bytes: the opcode and the post byte.

Although there is no actual indirect indexed addressing mode, memory may also be accessed indirectly in the indexed addressing mode. What happens is that the pointer (the sum of the index and the displacement) indicates the memory location in which the ADH of the effective address is stored. The ADL is stored in the following memory location: In the 6809 CPU, the ADH and ADL are always located in that order, after the operation word. But, as readers will remember, this was the other way around in the 6502 (ADL, ADH). An indirect facility is extremely useful, as it enables arrays and symbol tables to be drawn up in high-level programming languages.

The accumulators may also be used as index registers. This means not only can they be incremented and decremented, but they can also be employed during operations in arithmetic or binary (Boolean algebra). In other words, the index can be calculated. This is known as the accumulator indexed mode. The 6809 CPU contains two stack pointers, S and U, and is therefore already one up on the 6502. S is a 16-bit stack pointer with the same function as that of the 6502. Return addresses from sub-routines and from machine registers are automatically stored on the S stack. It is also used to execute interrupts.

As its name suggests, the user stack

Register	6809	6502
X-Register	16 Bit	8 Bit
Y-Register	16 Bit	8 Bit
Stack Pointer	16 Bit	9 Bit
Accu A	8 Bit	8 Bit
Direct Page Reg	variable	fixed: Page zero
Status Register	8 Bit	7 Bit
Program Counter	16 Bit	16 Bit

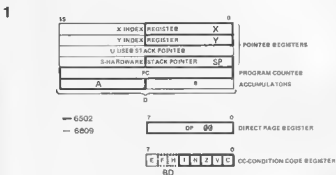

Figure 1. A comparison of memory organisation in the 6809 and the 6502.

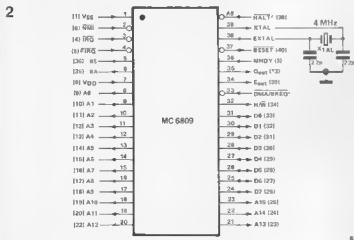

Figure 2. Pin assignment of the 6809 CPU. The pin numbers in brackets correspond to the 6502.

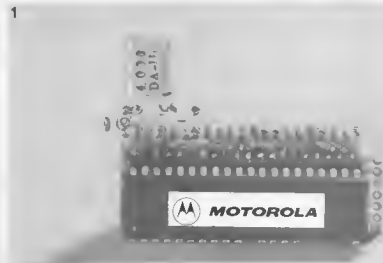

Photo 1. How to construct the piggy-back board for the 6502 socket. The new CPU board is mounted on a 40-pin DIL connector.

pointer (U pointer) is purely at the disposal of the programmer. It is also 16 bits wide and mainly used as an input buffer and loop pointer during text editing.

When the 6809 and 6502 systems were compared at the beginning of the article, both were seen to have a fairly similar programming structure. Even the addressing modes are almost identical, the only difference being that the 6809 CPU provides a more 'powerful' instruction set and is faster than the 6502. All in all, it really is worthwhile to update the 6502 system and convert it into a 6809. What makes it even more tempting is the fact that:

- only the hardware needs to be slightly modified;
- more software is available for the 6809 CPU than for the 6502;
- BASIC, FORTRAN, PASCAL and a cross assembler (for all commercial processor types) are all provided on diskette for the 6809 system. Cross assembly may be 'bi-directional' such as, say, from the 6809 to the Z80, or vice versa;
- and there is one standard floppy disc control format for all 6809 systems, whereas various formats exist for the 6502.

But it is time to answer the question of how can a 6502 system be converted into a 6809 computer? First of all, mount the 6809 CPU together with a 4 MHz quartz crystal and two capacitors on a piece of Veroboard and mount the unit on a 40-pin DIL connector. Now simply substitute the 6502 for the 6809. The pin assignment is shown in figure 2. This piggy-back construction is illustrated in the photograph.

#### The conversion procedure:

- Remove the 6502 CPU from its socket.
- Insert the 6809 piggy-back board in the now empty socket.
- Replace the 6502 operating system (stored in ROMs or EPROMs) by the 6809 version. Use may be made of the ASSIST 09 monitor program, for instance, published in the Programming Manual mentioned below.

A text editor, a linker/loader and a disc operating system (DOS) are also available for the 6809, which means that the Junior Computer (in combination with a floppy disc system, of course) can now be 'taught' to run in FORTRAN and PASCAL. In the end, the machine will be completely polyglott!

#### Background literature:

MC 6809-MC 6809E; 8-bit Micro-processor Programming Manual; M6809 PM (AD); 1.3.1981; Motorola (including ASSIST 09) Macro Assemblers Reference Manual; 6800, 6801, 6805, 6809; M68 MASR (D); Motorola.

# introducing DMOS power FETs

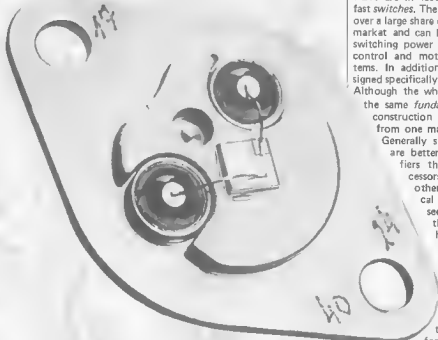

New power FETs seem to be christened almost every day: VFETs, HEXFETs, DMOS, TMOS and SIPMOS, to mention but a few. Despite their different names, they all have a great deal in common, as far as their characteristics, structure and applications are concerned. This article takes a look at power FETs in general, paying special attention to the fast-switching DMOS branch of the family.

The term VFET will sound familiar to most readers, although few are likely to have actually seen one 'in the flesh'. Not that they are much to look at, but it does go to show that VFETs have as yet failed to attract the amount of popularity they deserve. Way back in 1976 (see the *Elektron* April issue of that year) VFETs were billed to be the (almost) ideal output transistors for (audio) amplifiers. Due to their high price and poor availability, however, they never quite made it into the limelight. But then, this is just one of those vicious circles, for components don't drop in price and become easy to obtain until they are already popular. . .

About a year ago, a new branch was welcomed to the VFET family: the DMOS series. Basically, they are very similar in operation to VFETs, but their structure is slightly different and their switching times are much faster. DMOS FETs are in fact mainly promoted as fast switches. They are predicted to take over a large share of the power transistor market and can be used in converters, switching power supplies and in relay control and motor speed control systems. In addition, some types are designed specifically for RF purposes.

Although the whole DMOS family has the same *fundamental* structure, the construction of the gate may vary from one manufacture to another.

Generally speaking, VMOS FETs are better suited as RF amplifiers than their DMOS successors. The latter, on the other hand, are more vertical in structure (as will be seen later on) and are therefore capable of handling higher voltage levels.

Before we go any further, let's take a look at the main characteristics of the VFET family as a whole and disregard their individual traits for the moment. First of

all, we need to find out how FETs differ from their well-known bipolar counterparts. (Anyone with a special interest in this field might like to read the data books referred to at the end of this article.) To put it in a nutshell, FETs cost less than bipolar types, switch faster (in a few nanoseconds), afford higher input impedances with low drive parameters and have widely extended the range of circuit possibilities.

At the time of going to press, the new DMOS transistors were still very difficult to get hold of in the retail trade and those that were to be had were far from cheap. Nevertheless, we have every reason to believe that this situation will change within the not too distant future.

## FETs

Even 'ordinary' MOSFETs are not used

all that often, so it might be a good idea to recap on some of their features. Normally, MOSFETs have a high input impedance and a fairly average mediocre gain. They are suitable for use at high frequencies (up into the gigahertz range), but can only handle low power. Consequently, they are mainly used in receivers. Their basic operation is shown in the form of a block diagram in figure 1.

The source and the drain are both bonded with an n zone within a p substrate. Thus, as in ordinary transistors, a npn structure is involved. This may be represented as two diodes connected back-to-back, as a result of which no current is allowed to flow from drain to source.

When the gate is made positive, electrons collect in the p material bordering the gate (electrons are negatively charged particles and are drawn by the positive gate). The p material around the gate now contains an excess number of electrons and has therefore become an n region. A channel is thus formed between source and drain consisting entirely of n doped material. Furthermore, since conduction can take place, current can now flow. The higher the voltage across the gate, the wider the channel and the lower the resistance between source and drain.

Figure 2 shows a VFET in cross-section. Again, a p region separates the source and drain, both of which are bonded with n regions.

The principle is the same as in figure 1: when the gate is made positive, a conductive channel is formed in the p region, allowing a current to flow between drain and source.

That covers the basic operation of a VFET. The 'V', by the way, stands for vertical (the direction in which the current passes through the substrate) and has nothing to do with the V-shaped groove in the substrate.

The reason why a VFET can handle high power better than an ordinary FET is purely due to its format and not to any great technological achievement. The cost of semiconductors is largely determined by the size of the chip. An ordinary, planar power FET would have to be relatively large in order to cope with the same amount of power. The area occupied by the drain connection has been economised on in the VFET and the drain is now situated underneath the chip. Furthermore, the channels are formed by means of diffusion, enabling the VFET to operate at much lower tolerance levels. The result is a much smaller chip incorporating a few thousand FETs in parallel, (as can be seen in Photo 1). Thus, it is not a question of a single VFET being able to take on an army of amps, but a whole host of them hold the fort!

DMOS FETs will seem quite straightforward in comparison. Here the gate is completely surrounded by an insulating layer of silicon dioxide ( $\text{SiO}_2$ ) and the

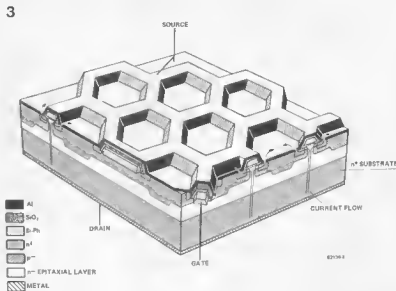
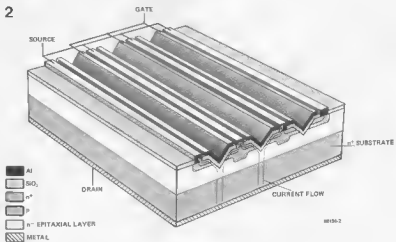
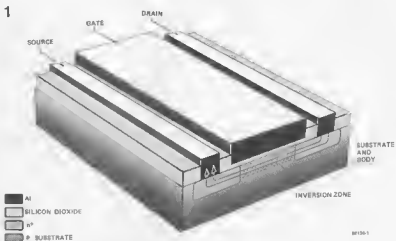

Figures 1, 2 and 3. Block diagrams showing an 'ordinary' FET, a VMOS FET and a DMOS FET, respectively. While the FET is not conducting it functions as a cutoff diode. When it conducts the diode effect gradually disappears until only a slight on-resistance is left, (when the transistor is fully drained).

source occupies the whole upper surface. As opposed to the VFET, where the gate is embedded, the gate in the DFET juts out slightly forming a little 'bump'. In photo 1 the gate is in the shape of a square, but other patterns, such as hexagonal (HEXFETs, etc) are also possible, according to the preferences of each particular manufacturer.

So much for the structure of DFETs. It should be noted that some types specifically designed for audio or RF applications do not follow this rule.

The DMOS structure just described has a disadvantage in that the gate combines a certain amount of internal resistance with a rather large capacitance (several *nano*-farads). When driven with a signal in the MHz range, the gate may well get so hot under the collar that the whole FET will go up in smoke! This is where VFETs are at an advantage, for their gate can be made of aluminium, which considerably reduces the internal resistance. This is also the reason why DFETs are advertised as *switches* rather than RF components.

But what you lose on the roundabout, you gain on the swings, and DFETs are able to deal with relatively high voltages. Great field intensity is produced at the bottom of the V shaped groove in VFETs and the various etching and diffusion processes down there are very difficult to control. Fortunately, these snags do not exist in planar DMOS FETs and the latter also have a higher breakdown threshold.

#### DFETs: do they come up to scratch?

For one thing, DFETs dissipate about the same amount of power as a transistor in a similar package. Then there are types that can withstand up to 1000 V and others that can switch up to 25 A. As in bipolar transistors, the maximum current level may even be higher than that — for *brief* periods!

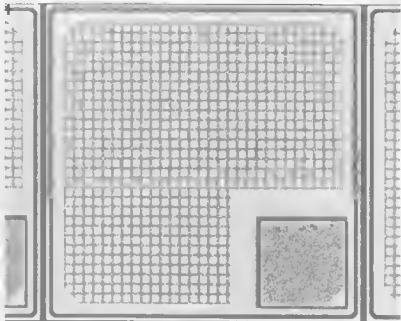

Photo 1. A DFET consists of a large number of FETs that are connected in parallel. The square in the top left hand corner represents the gate, whereas the rest of the upper surface is taken up by the source (the whole top surface is plated through).

Constructors are recommended to go by the  $R_{ds(on)}$  (= maximum on-resistance) rather than rely on the current ratings provided by the manufacturer. The lower the  $R_{ds(on)}$  the more current the FET can handle. Be sure not to exceed the maximum dissipation rate!

The gain of a FET is expressed in terms of its slope and is a couple of amps per volt, the threshold voltage being one or two volts. An example of the current voltage ratio is given in figure 4.

Since a MOSFET is involved, no power is required to drive the gate, as there is

no current flow. Thus, the power gain of DFETs is ideal: it is infinite! Unfortunately, this feature does not have any practical advantages. A fair amount of power is certainly needed during the switching process, as the gate capacitance of several nanofarads has to be transferred. If the capacitance transfer takes too long, in other words, if the gate is fed a slowly changing voltage, the FET will be unable to switch as fast as usual. Although the whole FET family is noted for its remarkably rapid switching capabilities (they switch cur-

4

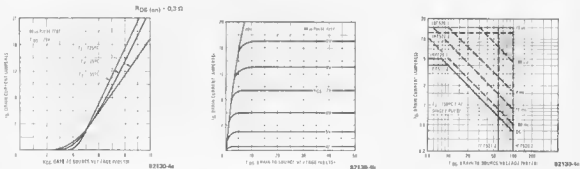

Figure 4. These graphs show the characteristics of a FET. Similar curves apply to other members of the power transistor family.

rent in about twenty nanoseconds), this speed can only be reached provided the gate voltage is a perfect square wave. In practice, the gate voltage looks far from symmetrical, as can be seen from the (slightly exaggerated) example given in the second photograph). The top trace shows a symmetrical square wave driving a CMOS 4049 inverter. The output of the 4049 is connected directly to the gate of a DMOSFET (in this case a BUZ10). The signal edges leave a lot to be desired and tend to form 'kinks' half-way down the curve. The bottom trace represents current passing through the FET.

Clearly, it takes the CMOS inverter quite a while to alter the gate voltage, for the gate capacitance can only be transferred with a couple of milliamps. As the 4049 is designed as a TTL buffer, it enables more current to flow to ground than to the positive connection. Not surprisingly, the falling edge is much steeper than the rising edge.

But why is the strange kink formed in both edges and why is it more pronounced in the slower, rising edge? Well, the gate/drain capacitance is mainly responsible for this. Figure 5 shows a simplified equivalent circuit diagram which valve lowers will immediately recognise as the 'Miller' effect.

The rising voltage across the gate causes the drain voltage to drop. The signal alteration is passed on to the gate by way of the gate/drain capacitance and, as a result, the gate voltage will only be able to rise very slowly. This situation continues until the drain voltage cannot drop any further. The effect is clearly visible in Photo 1, where the gate voltage is relatively constant while the drain voltage alters. In addition, there is almost always a certain amount of inductance in the source connection and this enhances the effect by making the source slightly negative. At a higher supply voltage, the gate/drain capaci-



Photo 2. When a power FET is driven from CMOS, considerable delays are caused because the driver cannot produce enough current for a rapid gate capacitive transfer. From top to bottom: The CMOS buffer control, the waveform at the gate of the FET and the current passing through the FET.



Photo 3. Better switching times are obtained by driving power FETs from a TTL open collector buffer. The gate control voltage can best be selected at twice the level of the drive voltage. This will produce fairly even edges in the drain current. A higher voltage allows the power, required to drive the gate, rise quickly (with the square of the voltage) and does not cut down the time.



Photo 4. The gate voltage during the switching process. It is very difficult to predict the exact time delay, because the related gate capacitances are dependent on the (intermediate) drain voltage levels. The same thing applies to the driving power requirements, which is why some manufacturers provide graphs showing the gate voltage waveform at different drain voltage levels.

tance transfer will obviously take longer.

In short, the actual switching time is mainly determined by the circuit driving the gate. The time achieved depends on the drain source voltage (the higher this is, the longer the process takes), on the gate capacitances (which in turn depend on the FET used) and on the driver circuit (regulated by the user).

Photo 3 shows a FET driven from TTL, which is a lot faster. High speed switching does, however, entail one or two difficulties. If a current of a couple of amps is flowing through the FET and is interrupted in a matter of nanoseconds, appallingly little self induction is needed in the drain network to cause a considerable peak voltage ('spikes'). The peak voltage must be added to the supply voltage and should the sum exceed the drain source voltage rating of the FET, the transistor will 'kick the bucket' at once. The solution is to construct the circuit carefully and connect a freewheeling diode to the power supply. Alternatively, a zener diode may be connected in parallel to the FET. It is not really advisable to use an RC network, as a slowly decaying oscillation can rarely be avoided and, in the event of an ill-chosen RC time, it could make matters far worse!

'Spikes' in the drain voltage also affect the gate voltage by way of the drain/gate capacitance. If the gate is driven at a high on-resistance, the maximum gate/source voltage may easily be exceeded — and the constructor will end up having to buy a new FET. Either drive the gate with a low on-resistance and/or connect a zener diode between the gate and source.

Readers will have gathered from the above that this type of power FET does not incorporate an internal protective diode (zener diode). This is not necessary, because of the relatively high gate capacitance, as a result of which 'spikes' can only be caused by an inordinate amount of static charge. The lack of diodes has the advantage that the constructor can drive the gate without any compunction. Negative voltages in particular will no longer present any problems (provided they are not too large). All in all, due care must be taken with regard to static charges when handling DMOSFETs!

## Paralleling DFETs

Normally speaking, DFETs can quite easily be connected in parallel, because the semiconductor material provides greater resistance at rising temperatures. The  $R_{DS(on)}$  will then increase. This ensures that the hottest transistor will automatically consume less current and therefore dissipate less heat. Figure 4a shows what effect this has on the graph: the maximum current is lower at a high temperature. But the opposite is true of current levels below 2A.

## 5

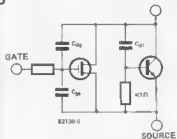

Figure 5. An equivalent, simplified circuit diagram for a DFET. The drain/source capacitance is of particular significance when driving the transistor. A transistor is connected in parallel to the FET and acts as a diode by way of the  $1\Omega$  resistor and the base/collector junction) in the case of negative drain voltages. The diode can handle the same amount of current as the DFET, although it is of course much slower.

So far, so good. Should FETs with mismatched  $V_{GS}$  characteristics be connected in parallel, the FET with the minimum gate voltage will be driven 'on' first and will temporarily have to do all the work. A second problem may involve oscillation at extremely high frequencies (above 100 MHz). The constructor should keep this in mind and try to match the  $V_{GS}$  levels of the FETs to within about 5% of each other. To be on the safe side, include a couple of low value resistors in each gate connection. Two birds are killed with one stone: the oscillation is suppressed and the drive potential is better distributed.

### Cooling

DFETs are available in the same packages as bipolar transistors. They are easy to mount on a heatsink (whether they are insulated or not).

Cooling is absolutely vital where FETs are involved. When we discussed how to connect two DFETs in parallel, we

mentioned the fact that the  $R_{D(s)}$  has a positive temperature coefficient and that this was an advantage in that particular instance. Unfortunately, this behaviour certainly does not benefit dissipation, for the hotter the FET and the greater its resistance, the higher the dissipation. The result is a vicious circle: the temperature rises even further! This may lead to regenerative feedback and inevitable death of the expensive DFET. Such detrimental effects are avoided by keeping the temperature as low as possible. By cooling the transistor, the saturation voltage risk is kept to a minimum and any overheating is prevented. The best rule-of-thumb is simply to use a 50% larger heatsink than normal.

6

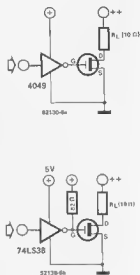

Figure 6. Provided the switching speed parameters are not set too high, DMOS FETs can be driven in a very straightforward manner. In figure 6a the DFET is driven directly from a CMOS gate with a supply voltage of about 10 V. In figure 6b the DFET is driven from TTL with an open collector output. In most cases, the pull up resistor will have to be fed with a higher voltage than the 5 V TTL supply.

### Background literature

The 'HEXFET Data Book' from International Rectifier makes an excellent read.

The Siliconix 'VMOS Power FETs Design Catalogue' also provides plenty of information.

Then there's IIT's book on 'VMOS transistors, their features and applications'.

Other titles include: 'Hitachi Power MOSFETs' by Hitachi and 'SIPMOS Power Transistor' by Siemens.

M



# solid state relays

## the modern method of switching mains

Electronic relays have quite a lot of advantages over their conventional electro/mechanical counterparts; they don't spark, wear out as quickly, cause less or interference, and they require a control current of only a few milliamps. Even so, compact solid state relays are extremely rful. The ability to handle up to 8 A is not at all unusual,

Solid state relays perform in exactly the same manner as conventional mechanical relays, but, as their title would suggest, contain no moving parts. However their design is a little more critical if long term reliability is to be achieved. The solid state relay (SSR) to be described here can be used in complete safety as the control circuit is totally isolated from the load. Moreover the control voltage can be varied over a wide range which is more than can be said of its mechanical counterpart.

### The pros and cons

It can be considered that the conventional relay provides a near perfect solution to its job, after all, it has been with us for a long time. So why do we need to employ solid state devices?

In principle both types have more in common than just the term relay.

Both require relatively low control current, which need bear no comparison to the switching load. Both also 'electrically' isolate the control current from the load. This aspect is clearly illustrated in figure 2.

Here the similarity ends, for the conventional type uses mechanical switch contacts to switch the load current. The contacts are mechanically activated by an electromagnet controlled by a low current source. The electronic relay, on the other hand uses a triac or thyristor to switch the load. In this case isolation is achieved by the use of an opto coupler.

The use of electronic relays certainly removes many of the main drawbacks

associated with the conventional type: Arcing, contact bounce, and wear are the downfall of the mechanical relay (MR) and cause no end of problems to designers. Unfortunately the SSR does create new ones! It cannot stand the same degree of overload that a MR can. We also have internal losses to the load voltage to contend with in critical conditions. A drop of 1 or 2 volts to the load voltage is possible, when the switch is 'closed', but this is generally not too inconvenient. However, the inability to handle even small overloads is a very important factor, which must be kept in mind at all times. This is due to the fact that the triacs or thyristors, used in the SSR, will not withstand an excessively high voltage across it. Further to this an excessively rapid increase in the load voltage will also cause the semiconductor to break down. Another consideration is that triacs cease to conduct if the load current falls below a specific value, the 'holding current'.

### Zero-crossing points

Now we come to real and unquestionable advantages of the SSR over the MR. Where mains voltages are concerned it is kinder for motors, light bulbs and other equipment to be switched on at a time when the AC waveform is actually at zero. This is termed (logically enough!) the zero-crossing point.

Readers will be aware, for example, that the filament resistance of an ordinary light bulb is low when cold (or switched off) and rapidly increases when the lamp is switched on. If this occurs when the mains waveform is at a peak (maximum voltage) it follows that a surge current results across the lamp filament. If this happens consistently, as it often can, the life of the filament will be significantly shortened.

It will now be apparent why switching on at the zero-crossing is so important. This is totally impossible with our old friend the mechanical relay.

One minor disadvantage with the SSR described in this article is that the supply is never totally isolated from the equipment. This is because a semiconductor is used instead of an actual mechanical switch. A small leakage current through the thyristor/triac and surrounding circuits will always occur. It is so small however, that it can be discounted in most applications. A comparison between the SSR and the MR relays is given in table 1, but it must be emphasised that this is very generalised and does not take into account, particular uses where one type of relay may be far superior for a specific purpose.

### Isolation

An inherent characteristic of the mechanical relay is the complete isolation between the control voltage and the load voltage. The same degree of iso-





1a

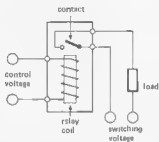

Figure 1a. The basic construction of a mechanical and a solid state relay.

lation with a SSR needs much thought, if it is to be reliable and still able to cope with a wide control voltage range. The smaller drawing in figure 1 illustrates diagrammatically how isolation is achieved in the MR. No electrical contacts exists between its coil and contacts.

In the SSR, an opto coupler provides the separation between control and load voltages.

### The Elektor SSR

Working from left to right we first have the input and control circuit D5, T2 and the transmitting side of the opto coupler (IC1). Next is the 'receiver' part of IC1, the zero-crossing delay switch (T1) and what can be termed the 'ignition' circuit made up of thyristor Th1 and the diode bridge D1...D4. Finally the brawn; triac Tri1, switching the load on and off.

To drive the control circuit a DC voltage of 3...32 V is applied to the input. The FET (field effective transistor) T2 serves as a current source for the LED within the opto coupler. A typical source current is about 5 mA, which of course will remain constant irrespective of the input voltage.

The value and therefore tolerance of the FET will determine the source current. Anything between 3 and 7 mA is sufficient. Diode D5 protects the opto coupler by ensuring the correct polarity of the control voltage.

When current flows through the LED, the photo transistor (receiver of IC1) conducts, thus cutting off T1. This in turn triggers the gate of thyristor Th1 by way of R5. When Th1 conducts, it applies a gate current, via the diode bridge, to the triac to enable it to switch on. Now only the forward voltage of the triac (about 2 V) is present in the relay circuit. The relay is pulled in!

The other important condition to be met in order for the triac to remain 'switched on', is that the load current should not be less than the hold current (approximately 60 mA).

So far, it may seem that the triac switches on immediately the relay is

1b

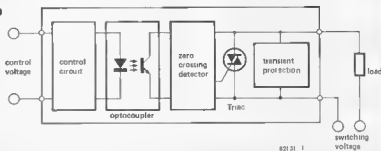

Figure 1b. The circuit diagram of the solid state relay. The actual switching is performed by the triac which is situated at the output. The drive by means of T1 and the thyristor makes sure that the relay is switched on at a zero-crossing. The opto coupler takes care of the isolation of the control circuit from the load circuit.

2

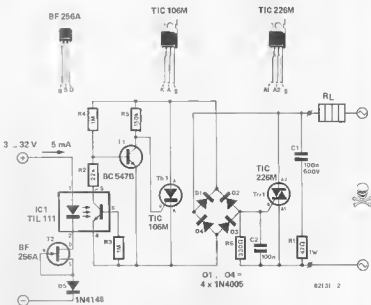

Figure 2. The circuit of the solid-state relay.

Table 1

Comparison between mechanical (MR) and solid state relay (SSR).

	SSR	MR
vibration and shock stability	excellent	poor
temperature stability	excellent	good
logic compatibility	yes	yes
multiway contact	no	yes
change-over switching	no	yes
isolation	excellent	excellent
service life	excellent	good
size	good	good
overload capacity (switching current)	poor	good
arcing	nil	yes
quietness of operation	excellent	poor
switching stability	good	good
leakage current when off	negligible	none
bistable types (NC/NO)	no	yes
drop load voltage	negligible	none
driving capacity	good	excellent
contact bounce	none	yes
protection against overloaded	good	none

triggered. The zero-crossing detection is in fact rather subtle and is all to do with the voltage divider R4/R2. Their values and therefore, relationship to each other ensures the opto coupler cuts off T1 when the AC voltage, rectified by the diode bridge, is below 30V and not before!

30V is pretty close to the zero-crossing of the AC voltage, and remember the triac can only switch on the load when T1 is cut-off. Above 30V, even with a conducting photo transistor, the base/emitter voltage of T1 will exceed 0.6V because of R4 and R2. T1 therefore continues to conduct, preventing both T1 and Tr11 from being activated or driven.

In order to switch off the relay, obviously the control current to the opto coupler (LED) has to be terminated, allowing T1 to conduct continuously. The triac will, however, continue to remain 'on' even without a gate current, as long as the load current is high enough (above 60mA). But upon the next AC zero-crossing the load current will drop below this level switching itself off automatically, and remaining off until the next time the relay is triggered.

The other components ensure the safety and stability of the circuit.

Resistor R3 ensures the photo transistor does not conduct until the LED is illuminated.

Capacitor C2 connected to the gate of Tr11 prevents the triac from switching on as a result of mains borne interference.

The RC network R1 and C1 acts as a transient protection, also for the triac. As already mentioned an excessively rapid increase in the load voltage is enough to destroy the triac. This manifests itself as noise and 'spikes' in the AC waveform. C1 serves to smooth out these 'spikes' and so that C1 in itself

### 3a

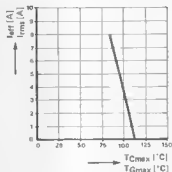

82131 3a

Figure 3a. Relationship between the tolerated case temperature and the load current of the triac. The load capacity reduces considerably when the temperature of 85°C is exceeded.

does not become a danger to the triac, R1 limits its charging capacity.

### Cooling and capacity

Most domestic solid state devices, such as light dimmers, contain 400V rated components. The thyristors, triacs and diodes are often TIC 106D, TIC 226D and 1N4004 types. Although for normal applications these will suffice the safety margin, is rather low, especially considering that peak voltages of 320V may have to be handled from time to time. Professional and small industrial types tend to have heavier duty components and use 600V rated items. Obviously the choice is up to you, but, as the difference in price is only marginal it is better to use the higher rated components if you can. As shown quite

### 3b

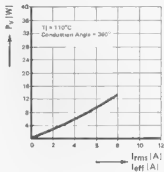

82131 3b

Figure 3b. The power dissipation of the triac related to the load current. Essential for choosing the correct heat sink.

explicitly in the circuit diagram we strongly recommend the use of the 600V types TIC 106M, TIC 226M and 1N4005.

Using the values indicated for R1 and C1, the relay will cope with a switching load of up to 1kW. If a higher load is envisaged, then C1 should be changed for a capacitor of between 22  $\mu$ F ... 1  $\mu$ F (depending on the load), with a 250V AC or 600V DC voltage rating stability.

Switching domestic fluorescent light tubes requires something out of the ordinary, due to the self-inductance of the choke used in the starter. In this case R1 needs to be 10k, in order to increase the transient damping.

The actual load capacity of the SSR is also dependent on the cooling of the triac. With good cooling (not exceeding a temperature of 85°C), the maximum current can be as high as 8A, achieving a power handling of 1.8kW. Without the use of any heat sink whatsoever, current is 1A, which is still very good as it gives you 225W to play with.

For full power a heat sink with a thermal resistance of 4°C/W or less, is required. The triac should be mounted onto it using heat conductive paste. As a matter of interest a 15°C/W type allows a load of 3A (650W).

Constructors should not find any difficulty in working out the exact heat sink requirements for any particular load to be applied, for figure 3a indicates the maximum tolerated case temperature of the triac for the corresponding load currents. First subtract the highest possible environmental temperature (say 30°C or 86°F) from the maximum temperature shown in the graph for the load current required. Then divide the result by the dissipation value corresponding to the maximum load as found from figure 3b.

In order that you get the maths right here is an example.

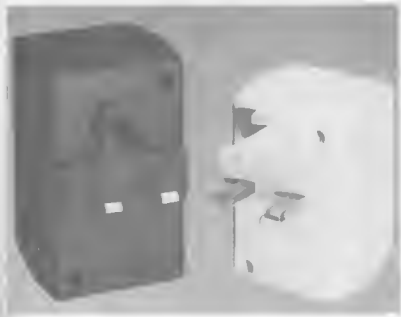

4

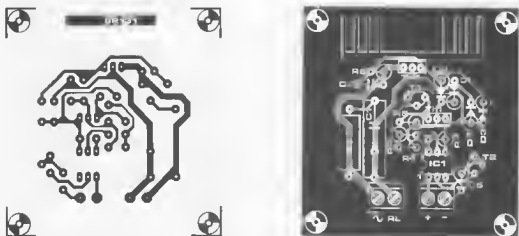

Figure 4. The copper track pattern and component layout of the printed circuit board. It has been designed for mounting into a plastic housing and its size can be reduced, if desired.

With a maximum load of 1 kW, and a nominal mains voltage the current is 4.4 A.

This results in a  $T_C$  maximum of 95°C (see figure 3a), and a dissipation of 7 W (see figure 3b).

Allowing for an environmental temperature of 30°C, the thermal resistance needed for the heat sink is calculated by using the following formula.

$$\frac{95^{\circ}\text{C} - 30^{\circ}\text{C}}{7\text{ W}} = \frac{65^{\circ}\text{C}}{7\text{ W}} = 9.3^{\circ}\text{C/W.}$$

Table 2 shows the specifications of the SSR. Attention should be paid to the minimum load and leakage (maximum reversed) current values. 60 mA minimum load or holding current, basically means, that equipment consuming less than 15 W cannot be controlled accurately. The maximum reversed current or leakage of 10 mA should not present any problems in most cases, although it is enough to cause a glow in vary low rated light bulbs.

### Construction

Figure 4 shows the printed circuit board layout. The size actually allows you to cut it to any shape, within reason, required. By reducing the overall width of the board it will fit quite nicely into mains power supply case type PSC 100 or PSC 200 as supplied by West Hyde Developments Ltd. of Aylesbury.

Care should be taken to isolate the printed circuit board as parts of it are carrying the full mains voltage. Make sure that any test leads and terminals are well insulated. Mount the heat sink somewhere unobtrusive, remember it is also conducting the mains! Just be vary very careful!

A careless approach may prove fatal,

### Parts list

#### Resistors:

R1 = 47  $\Omega$ /1 W (see text)  
R2 = 22 k  
R3, R4 = 1 M  
R5 = 150 k  
R6 = 330  $\Omega$

#### Capacitors:

C1 = 100 n/600 V (400 V, see text)  
C2 = 100 n

#### Semiconductors:

T1 = BC 547B  
T2 = BF 256A  
D1 ... D4 = 1N4005 (1N4004, see text)  
D5 = 1N4148  
IC1 = TIL 111  
Tri1 = TIC 226M (TIC 226D, see text)  
Th1 = TIC 106M (TIC 106D, see text)

#### Miscellaneous:

heat sink, according to load (see text)



Photo 1: The control signal



Photo 2: The voltage at the load

Table 2

### Technical data

#### A. circuit

nominal voltage	240 V <sub>rms</sub>
maximum off-state voltage	
TIC 106D, TIC 226D, 1N4004	400 V
TIC 106M, TIC 226M, 1N4005	600 V
critical rise of off-state voltage	500 V/ $\mu$ s
maximum load current	8 A
( $T_C$ , Tri1 < 85°C)	
maximum load current	1 A
Tri not cooled	
peak current max. 20 ms	70 A
(1 mains cycle)	
peak current max. 10 ms	80 A
(1/2 mains cycle)	
minimum load current	60 mA
(hold current)	
maximum reverse current	10 mA
(R1 = 47 $\Omega$ , C1 = 100 n)	
zero-crossing connection	
voltage	
maximum	$\pm$ 30 V
maximum forward voltage	1.6 V

#### B. control circuit

control DC voltage	3 ... 32 V
control current	3 ... 7 mA
	typ. 5 mA
rise time	max. 1 half-wave (10 ms)
fall time	max. 1 half-wave (10 ms)

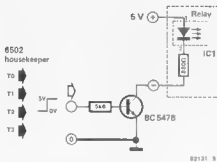

Figure 5. Circuit to connect the solid state relay to the DCF computer time-switch. In this way the circuit can be connected to all TTL outputs.

and that certainly won't help you or us. Although we are negotiating, there are still distribution problems to be solved before you can receive a 'heavenly' copy of Elektor.

The printed circuit board contains 4 connections; two for the control input and two for the load. Use insulated terminals mounted onto the board rather than soldering pins as this will eliminate the possibilities of arcing, short circuits and so on. Keeping the soldered joints as small as possible is also going to help, especially when mounting the opto coupler, otherwise what's the point

in isolating the control voltage from the load.

#### A variety of applications

The SSR can obviously be used wherever an MR would be used. There are so many applications that we are certainly not going to itemise them all. Irrespective of the application you will find the following hints useful.

If the relay is going to be used as a simple light switch, then the opto coupler becomes superfluous, as a small mains switch or miniature toggle is

sufficient. Mind you the switch will have to have a minimum rating of 250 V 0.5 A. In this case IC1, D5, T2 and R3 are not needed. A single pole switch connected to the track connection points for pins 4 and 5 of IC1 is all that is required.

This SSR is ideal for the 6502 housekeeper (Elektor May 1982). The digital circuit of the housekeeper can be used to trigger a number of SSRs.

The current source is then omitted (T2 and D5), as we are dealing with only one kind of control logic, 5 V. The opto coupler is driven directly via a resistor which is substituted for D5. By means of a wire link the drain and source track points for T2 are also connected. The value of the coupling resistor is proportional to the input current (between 3...5 mA). With a 5 V control voltage a 680  $\Omega$  resistor is sufficient.

#### Final remarks

When dealing with any project associated with the mains supply great care should be taken at all times.

Make sure the outer case does not touch any of the components. Should you be using a metal case then the usual precautions such as earthing and so on apply. The load supply line must include a fuse.

#### Literature:

'Switching mains-powered equipment'  
Elektor May 1979, p. 5-13

#### Walter Brünner:

'Elektronisches Lastrelais (ELR)'  
Siemens Components 18 (1980),  
Book 2, from p. 69 onwards

#### Horst Schierl:

'Solid-State-Relais, ein voll-elektronisches kontaktloses Relais mit galvanischer Trennung', part 1 and 2,  
Siemens Bauteile Report 15 (1977),  
Book 5, p. 163 and book 6,  
from p. 198 onwards

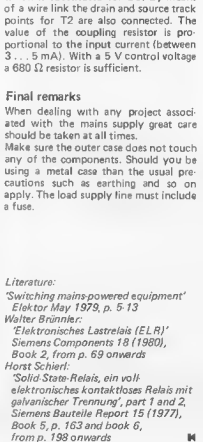



# market

## 40 channel emergency CB

Tandy Corporation have recently announced the launch of the new realistic TRC-1004 emergency mobile 40-channel walkie-talkie (catalogue no. 21-9113) to their range of CB equipment.



compartment. One of the greatest advantages over fixed mobile CB units is its versatility — the TRC-1004 can be swapped from vehicle to vehicle (making it ideal for the two car family) in seconds — or set up anywhere where a 12 V power source is available.

### Features include

- 40 channel operation
- Plug-in magnetic-base antenna (for use on any metal surface).
- 12 V DC car adapter (plugs into cigarette lighter holder).
- Hi/Low RF output power switch.
- Built-in microphone with push-to-talk button.
- Travel case (for portability and easy storage) The ring also has wrist strap.
- LED channel indicator.
- External antenna socket.
- Negative ground operations.
- Built-in automatic noise limiting circuit.

Tandy Corporation (branch UK),

Tamewey Tower,  
Bridge Street,  
Walsall,  
West Midlands WS1 1LA.

(2343 M)



The TRC-1004, (which meets all prevailing Home Office specifications), can be kept in the boot to provide rapid communication in an emergency, and security and peace of mind whenever you're on the road! It is very simple to set up and use — just connect the supplied magnetic-mount antenna and plug the power lead into the cigarette lighter socket of the car. You are then ready to report accidents, ask for assistance, find out about traffic conditions, or any other communications you need. When not in use it can be stored under a seat, or in the glove

## Larger enclosure

OK have added a larger case to their PacTec range. The CLH series, with handle, measures 12.5 in (W) x 11.63 in (D) (318 x 296 mm) and is available in heights from 4.5 in to 5.76 in (115-146 mm) increments. It can be used for oscilloscopes, medical instruments, indicator systems, computer interface devices, recorders, amplifiers, and a host of other applications, and is moulded from heavy-weight ABS.

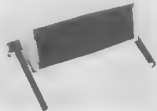

The PacTec system is extremely flexible, allowing a designer to specify an enclosure from a standard size unit and then specify low cost options and accessories, thus saving up to one-half of a comparable metal enclosure.

Using special systems of integral mounting bosses, PC card guides, mounting rails, accessories, and other hardware, the CLH offers unlimited flexibility for creating the exact enclosure required. It has a sturdy, positive

setting turning handle which doubles as a convenient tilt stand.

Four standard colours are available, blue, tan, black and gray, but custom colours and combinations may be specified. In addition to internal hardware modifications, externally the CLH enclosure can be custom designed with inexpensive ABS die-cast front and rear panels, special bezels, custom trim, EMI/RFI shielding, shoulder straps and many other options.

The enclosure is also available in kit form, including top and bottom covers; side panels; front and rear panels which can be drilled, cut, punched, or silk screened; card guides; mounting rails; and an assortment of hardware.

OK Machine & Tool (UK) Ltd.,  
Dutton Lane.

Eastleigh,  
Hants SO5 4AA,  
Telephone. 0703-510944

## RS 232C/V24 linetesters

Amplicon Electronics Limited now have a range of linetesters which provide access to all 25 conductors of the EIA RS 232C or CCITT V24 interface between data modems and data terminals or computers. 25 light emitting diodes monitor the status at the source of the primary signals.



(2347 M)

Powered from the RS 232C or V24 source the range consists of two models. The LTV 241 uses bipolar LEDs which monitor the positive signals in red and negative signals in green. 25 miniature switches allow the interface conductors to be individually interrupted and 25 test sockets on each side are provided to allow cross patching and monitoring of signals.

Measuring 120 x 80 x 17 mm (4.7 x 3 x 0.7"), the linetesters which are for use when interfacing or debugging RS 232C systems are supplied complete with patch leads, instructions and a black protective pouch. The LTV 240 is priced at £129 and the LTV 241 bipolar version at £159.

Amplicon Electronics Limited,  
Richmond Road, Brighton,  
East Sussex BN2 3RL,  
Telephone: 0273-608331

(2346 M)



# market

# market

## Hectaphone power supply

Hectaphone power supply is a completely new concept in both design and construction. The outer casing of the supply has been used for housing the power supply end to meet with heatsink requirements. The case is fitted with guides at a pitch which will enable it to slide into a eurocard rack.



The range of power supplies use toroidal transformers which means that internal power losses have been dramatically reduced. This results in a lower temperature rise which increases the reliability of the supply and of surrounding equipment. Power MOSFETs are used as the series pass element. These are able to operate at a substantially lower head room than the power transistor usually used. This reduces losses significantly, especially for higher current rating. Both the AC input and DC output are fused. There is an LED DC presence indicator.

*Highams Electronic Communications Ltd.,  
96, Cobham Road,  
Wimbarn,  
Dorset.  
Telephone: 0202-893514*

(2297 M)

## Lightweight 25 MHz bandwidth miniscope

The new Ballantine 1024A mini oscilloscope, available from PPM Limited, has been de-

signed to suit the needs of the field engineer, and light weight and small size have been achieved without reduction in instrument performance. The 1024A's specification is equal to laboratory bench scopes two or three times larger and heavier; it is shock and weather proof and will operate in harsh environments. The 1024A weighs 2.1 kilos and measures 87 mm x 203 mm x 220 mm. The Ballantine 1024A provides a 25 MHz bandwidth in each of its two vertical input channels. The wide 25 MHz frequency response extends 1024A use to fast signals, and the instrument has a passive delay line, so that the leading edge of fast rise pulses can be displayed when using internal triggering.

The scopes are reliable and run with less than a 9°C hot-spot rise in ambients from 0° to 50°C. The containing cases are dust, splash, and EMI proof. The shock and vibration resistant CRT and solid internal construction of the 1024A make it dependable in demanding field conditions.

The Ballantine Model 1024A mini oscilloscope provides 5 mV per division to 2 V per division vertical deflection sensitivity in 9 calibrated range steps in two channels. Frequency response is from DC to 25 MHz at the 3 dB point. There is also X-Y operation with equal amplifiers.

Time base speeds are from 1 microsecond per division to 0.5 seconds per division in a 1-2-5-10 sequence, expandable by an X10 magnifier to 100 nanoseconds per division. The internal trigger sensitivity is 0.35 division from DC to 5 MHz, increasing to 2 divisions at 25 MHz. Three coupling modes, dc, ac, and ac fast can be selected on both internal and external triggers. The CRT display area is 8 x 10 divisions, each division equals 0.5 cm, and the 1 KV accelerating voltage gives a bright, high resolution easy-to-read trace.

*PPM,  
Hermitage Road,  
St. Johns,  
Woking,  
Surrey GU21 1TZ.  
Telephone: 04867-80111*

(2293 M)

## Mini enclosure with battery compartment

OK's PacTec HP series enclosures are now available with a battery compartment for standard 9V batteries. Called the HP-BAT-9V the enclosure has a removable battery 'hatch' in its back panel, together with the

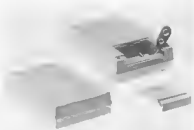

battery clip and lead, and, as with other enclosures in the range, the front panel can be inexpensively 'customised' to individual specifications. Measuring 1.12 in (h) x 3.60 in (w) x 5.75 in (d), the case is constructed of ABS material, providing durability, excellent impact resistance and an attractive textured appearance, and is ideal for housing all hand-held instruments.

Four standard colours are offered, gray, tan, black and blue, but special custom colours are also available. Other options include belt-clips, shoulder straps, wrist straps, construction of UL-listed flame retarding material and EMI/RFI shielding.

*OK Machine & Tool (UK) Ltd,  
Dutton Lane,  
Eastleigh,  
Hants SO5 4AA.  
Telephone: 0703-610944*

(2287 M)

## DIL switches

Eng Components is to launch a major new range of dual in-line switches. These are fully sealed, have colour-coded actuators and hinged, transparent, dust covers. The range comprises 24 switches in a variety of switching configurations. All switches in the new range are designed to meet BS9565 and exceed MIL-S-83504. Switching ratings are 30 V 250 mA 7.5 VA max. (non switching 240 V a.c. 2 A), with initial contact resistance typically 18 mΩ.



Top and base sealed dual in-line switches in the SpectraDIL 023 series will be on the market soon. The efficient top and base sealing allows flow soldering and solvent cleaning without affecting switch performance. Single throw, ganged and changeover styles are included.

*Eng Industrial Corporation Ltd.,  
Luton Road,  
Dunstable,  
Bedfordshire LU5 4LJ,  
England.  
Telephone: 0582-62241*

(2288 M)



# market

## New digital multimeter

A new hand-held digital multimeter, designed for applications in the computer and telecommunications testing and servicing markets, has been announced by SEI. Introduced to meet market demand for a highly portable multimeter, SEI's pocket sized meter incorporates two important new design features. The input terminals are at the top, enabling the operator to 'probe' the circuit under test, whilst holding the instrument in one hand. The 3½ digit LCD display is at the base, and is sloped for easier reading. Both these design features, combined with ergonomic placing of switches, are intended to make SEI's new 'personalised' multimeter more flexible in everyday usage. The meter is fully protected against short duration transients and will withstand 250 V RMS into any input, on any range, indefinitely.

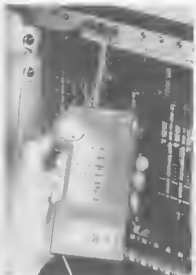

SEI's new digital multimeter covers a resistance range of 0 to 20 MV, with diode test facility, and a voltage range 0 to 1 KV (max) dc and 0 to 750 V RMS (max) ac. Current range is 0 to 2 A, both ac and dc, which is protected by a single 2 A fuse. The meter, which is powered by a PP3 battery, comes complete with carrying case and probes.

Salford Electrical Instruments Limited,  
Barton Lane,  
Eccles,  
Manchester M30 0HL,  
Telephone: 061-789 5081

(2338 M)

## Templates for pcb design

A new range of electronic layout templates for printed circuit board design has recently been introduced by LINEX of Denmark, and

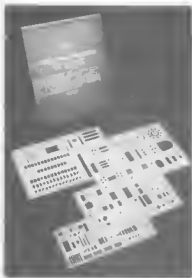

are of interest to both amateur and professional users who are involved in the design or production of printed circuit boards. The templates are available in scales of 1:1 (one template), 2:1 (set of 2) and 4:1 (set of 4) and they contain the most commonly used figures for printed circuit layouts, circuit views and component views. Component outlines include potentiometers, diodes, resistors, capacitors, dual in line, transistors, edge connectors etc., etc.

All component dimensions and terminals are given in millimetres and in tenths of inches, and dimensions are provided with mm and 0.1" divisions in the respective scales. All the templates in the series are produced with ink bosses so that they can be used for tracing with technical pens.

A comprehensive leaflet illustrating the templates is also available and this leaflet suggests methods and instructions on how best to use the templates.

Pelltech Ltd.,  
Station Lane,  
Witney,  
Oxon OX8 6YS,  
England.  
Telephone Witney 72130/72014 (STD 0993)

(2349 M)

## Video monitors

Thandar Electronics have recently announced the introduction of a complete range of professional video monitors. Each monitor is supplied fully operational in chassis format with a choice of black and white or green phosphor tubes with the option of standard or nonglare screens.



The range of monitors are primarily aimed at the DEM test and measurement, computer and video markets although they are ideally suited to many other areas.

Designated the TV2, TV5, TV9 and TV12 each type is very competitively priced with price breaks for both the single and multiple user.

Thandar Electronics Ltd.,  
London Road,  
St. Ives,  
Huntingdon,  
Cambs.  
Telephones: 0480-64646

(2339 M)

## Cassette recorder for personal computers

The ECR81 Enhanced Certified Recorder has been designed specifically as a storage medium for personal computer systems and incorporates a number of features which are lacking in machines designed for the audio market which have hitherto been used with such systems. The circuitry includes a signal enhancement board with signal shaping for peak performance.



One of the problems with personal computer systems is that of achieving low cost program storage. The difficulty with using ordinary portable recorders is that the level of the output signals from most microcomputers is very low which leads to errors or loss of signal on playing back the tape. Also, tape stretching may occur with ordinary recorders and this can cause computer clock pulses to miss a list of information.

The ECR81 is fitted with a long life head matched to TDK's high bias "Super Avilyn" cassette tapes. Output level is preset in the factory thus eliminating the need for 'volume control' adjustment. A 'write protect' micro-switch is fitted to protect accidental tape erasures. Controls include fast forward and re-wind tape search.

Manolith Electronics Co. Ltd.,  
5-7 Church Street,  
Creekside,  
Somerset.  
Telephone - 0460-74321

(2292 M)

# market



## Tracker CAR COMPUTER



"One of the easiest, most comprehensive and most useful of these car computers that we have ever come across."  
Practical Motorist

The Tracker Car Computer was designed to exceed the specifications of all others, both for number of functions and accuracy.

It provides three classes of information:

**Driving information** — 7 functions including miles per gallon (or litres per 100 kilometres) used, fuel used.

**Journey information** — 11 functions such as how far to go, ETA, how far you can go on the last litre. How fast you need to drive to meet an arrival time.

**Car performance information** — measure acceleration (eg 0 to 60), standing quarter miles, braking tests and much more using the unique 'programmed' mode. Check which types of driving are particularly uneconomic, dynamically tune your car for optimum performance and economy.

The Tracker also incorporates an ignition cut-out as an optional extra. Set the lock and the engine will not restart until a three digit combustion is quashed.

The unit is housed in a custom designed box with high quality printed panels having an overall size of 165 x 50 x 80 mm deep, and can be fitted above or below the dashboard. The display is liquid crystal for clarity in all lighting conditions. The box includes all sensors, wiring, etc and is available for all cars except those fitted with diesel or fuel injection engines.

Tracker price £88.50. Kit of parts £78.50. Ignition cut-out £7.75.

Prices include VAT but allow £1.00 post & package.  
Send SAE for list of separately available parts. Goods by return of post.

### PIMAC SYSTEMS LTD

20 Bloomfield Road, Moseley, Birmingham B13 9BY

Tel. 021-449 0384

## Fotolak POSITIVE LIGHT SENSITIVE AEROSOL LACQUER

Enables YOU to produce perfect printed circuits in minutes. Method: Spray cleaned board with lacquer. When dry, place positive master of required circuit on now sensitized board. Expose to daylight, develop and etch. Any number of exact copies can be made from one master. Widely used in industry for prototype work.

FOTOLAK	£3.00	Fine coated 1/16"	Fibre glass board	£1.50
Develop	30	204mm x 114mm		£3.00
Fabric Chloride	50	204mm x 228mm		£5.00
		456mm x 228mm		£9.00
		457mm x 305mm		£9.00

Plain Copper clad Fibre glass	Single sided	Double sided
Approx. 2.00mm thick. See fit	£2.00	
Approx. 1.00mm thick. See fit	£1.50	£1.75
China Acrylic Sheet for making master		1.25

G.F. MILWARD ELECTRONIC COMPONENTS LTD.  
P.O. BOX 19, CASTLE DRIVE, PRAA SANOS,  
PENZANCE, CORNWALL. Tel. 073 676 2329

# SOLD OUT

## elektor Up-to-date electronics for lab and leisure

If you experienced difficulty in obtaining this magazine take this form along to your newsagent and ask him to reserve a copy for you each month.

To the newsagent:

If you experienced difficulty in fulfilling our customers order, contact our distributors: Seymour Press, 334 Brixton Road, London SW9 7AG.

Surname

Initials

Street/Ave./Blvd.

Town

County/Province/State

Post code/Zip/Area code

Country

# elektor

Photocopies of articles can be obtained from out of print back issues of Elektor.

Send details of the name of the article required and the number of the back issue concerned, your name and address plus 50p per cost of article and 20p for postage and packing.

## copy service

# TV GAMES COMPUTER BOOK

an exciting  
introduction to  
microprocessors

The first acquaintance with microprocessors can be rather frightening. You are not only confronted with a large and complex circuit, but also with a new language: 'bytes', 'CPU', 'RAM', 'peripherals' and so on. Worse still, the finished article is a miniature computer and so you have to think up some sufficiently challenging things for it to do! This book provides a different — end, in many ways, easier — approach.

The TV games computer is dedicated to one specific task: putting an interesting picture on a TV screen, and modifying it as required in the course of a game. Right from the outset, therefore, we know what the system is intended to do. Having built the unit, 'programs' can be run in from a tape: adventure games, brain teasers, invasion from outer space, car racing, jackpot and so on. This, in itself, makes it interesting to build and use the TV games computer.

There is more, however. When the urge to develop your own games becomes irresistible, this will prove surprisingly easy! This book describes all the components parts of the system, in progressively greater detail. It also contains hints on how to write programs, with several 'general purpose routines' that can be included in games as required. This information, combined with 'hands-on experience' on the actual unit, will provide a relatively painless introduction into the fascinating world of microprocessors!



£ 5.00 — Overseas £ 5.25  
ISBN 0-905705-08-4

# ANTEX PRO-SOLDERING

**TCRUS** soldering station with modular changeable bits, detachable hook, very tough handle with an exhaust mounted on plug  
R.S.P. £4.50 plus V.A.T. or R.S.P. £5.30 plus V.A.T. touch plug

**CB** - 17 watt soldering iron, 5 push-on interchangeable bits, detachable hook, very tough handle with an exhaust mounted on plug  
R.S.P. £4.50 plus V.A.T. or R.S.P. £5.30 plus V.A.T. touch plug

**CBK** The new range with the big orange PCB grip handle, Antex iron.  
R.S.P. £1.70 plus V.A.T.

**MLK** The soldering iron for use on a 12 volt car battery. Ideal with 2 battery clips and extra long cable (4 yds. 15 ft.)  
R.S.P. £5.30 plus V.A.T.

**XBSE** - 85 watt general purpose soldering iron, cast handle, detachable head, 3 inter-changeable bit sizes. With or without, metal-on-plus.  
R.S.P. £4.50 plus V.A.T. or R.S.P. £5.30 plus V.A.T. touch plug

**CB40** Antex miniature soldering iron, 7 interchangeable push-on bit sizes, 0.25mm tip size  
R.S.P. £4.50 plus V.A.T.

**ANTEX**

Antex (Electronics) Limited,  
Mayflower House, Plymouth, Devon  
Telephone: (0752) 657377  
Telex 45296

Name \_\_\_\_\_  
Address \_\_\_\_\_  
E602

Step-by-step fully illustrated assembly and fitting instructions are included together with circuit descriptions. Highest quality components are used throughout.

# Sparkrite

## BRANDLEADING ELECTRONICS

### NOW AVAILABLE IN KIT FORM

#### SX1000 Electronic Ignition

- Inductive Discharge
- Extended coil energy storage circuit
- Contact breaker driven
- Three position changeover switch
- Over 65 components to assemble
- Patented clip-to-coil fitting
- Fits all 12v neg earth vehicles



#### SX2000 Electronic Ignition

- The brandleading system on the market today
- Unique Reactive Discharge
- Combined Inductive and Capacitive Discharge
- Contact breaker driven
- Three position changeover switch
- Over 130 components to assemble
- Patented clip-to-coil fitting
- Fits all 12v neg earth vehicles



#### MAGIDICE Electronic Dice

- Not an auto item but great fun for the family
- Total random selection
- Triggered by waving of hand over dice
- Bleeps and flashes during a 4 second tumble sequence
- Throw displayed for 10 seconds
- Auto display of last throw 1 second in 5
- Muting and Off switch on base
- Hours of continuous use from PP7 battery
- Over 100 components to assemble



#### TX2002 Electronic Ignition

- The ultimate system
- Switchable contactless
- Three position switch with Auxiliary back-up inductive circuit
- Reactive Discharge Combined capacitive and inductive
- Extended coil energy storage circuit
- Magnetic contactless distributor trigger head
- Distributor triggerhead adaptors included
- Can also be triggered by existing contact breakers
- Die cast waterproof case with clip-to-coil fitting
- Fits majority of 4 and 6 cylinder 1.2v neg earth vehicles
- Over 150 components to assemble

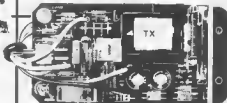

#### VOYAGER Car Drive Computer

- A most sophisticated accessory
- Utilises a single chip mask programmed microprocessor incorporating a unique programme designed by EDA Sparkrite Ltd
- Allford's 12 functions centred on Fuel, Speed, Distance and Time
- Visual and Audible alarms warning of Excess Speed, Frost/Ice, Lights-left-on
- Facility to operate LOG and TRIP functions independently or synchronously
- Large 10mm high 400ft-L fluorescent display with auto intensity
- Unique speed and fuel transducers giving a programmed accuracy of + or - 1%
- Large LOG & TRIP memories: 2,000 miles, 180 gallons, 100 hours
- Full Imperial and Metric calibrations
- Over 300 components to assemble
- A real challenge for the electronics enthusiasts!



#### AT-80 Electronic Car Security System

- Arms doors, boot, bonnet and hat security loop to protect log/spot lamps, radio/tape, CB equipment
- Programmable personal code entry system
- Armed and disarmed from outside vehicle using a special magnetic key fob against a windscreen sensor pad adhered to the inside of the screen
- Fits all 12v neg earth vehicles
- Over 250 components to assemble

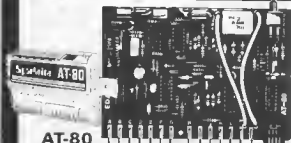

All EDA SPARKRITE products and designs are fully covered by one or more World Patents

EDA SPARKRITE LIMITED 82 Bath Street, Walsall, West Midlands, WS1 3DE England Tel (0922) 614791

	SELF ASSEMBLY KIT	READY BUILT UNITS
SX 1000	£12.95	£25.90
SX 2000	£19.95	£39.90
TX 2002	£29.95	£59.90
AT 80	£29.95	£59.90
VOYAGER	£59.95	£119.90
MAGIDICE	£9.95	£19.90

Please allow 28 days for delivery

NAME \_\_\_\_\_

ADDRESS \_\_\_\_\_

E682

I ENCLOSE CHEQUE(S)/POSTAL ORDERS FOR

£ \_\_\_\_\_ KIT REF \_\_\_\_\_

CHEQUE NO \_\_\_\_\_

24 hr Answerphone

PHONE YOUR ORDER WITH ACCESS; BARCLAYCARD

SEND ONLY SAE IF BROCHURE IS REQUIRED

PRICES INC VAT, POSTAGE & PACKING

BRANDLEADING BRITISH ELECTRONICS

CUT OUT THE COUPON NOW!

**sc/mputer (1)**... your own  
processor system**ELEKTOR  
BOOK  
75**the practical introduction  
to a powerful systemthe practical introduction  
to a powerful system**sc/mputer (2)****formant**

music synthesis

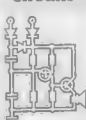
**300  
circuits****digibook**

**JUNIOR COMPUTER BOOK 1** — for anyone wishing to become familiar with microcomputers, this book gives the opportunity to build and program a personal computer at a very reasonable cost.  
Price — UK ..... £ 4.50 Overseas ..... £ 4.75

**JUNIOR COMPUTER BOOK 2** — follows in a logical continuation of Book 1, and contains a detailed appraisal of the softwares. Three major programming tools, the monitor, an assembler and an editor, are discussed together with practical proposals for input and peripherals.  
Price — UK ..... £ 4.75 Overseas ..... £ 5.00

**JUNIOR COMPUTER BOOK 3** — the next, transforming the basic, single-board Junior Computer into a complete personal computer system.  
Price — UK ..... £ 4.75 Overseas ..... £ 5.00

**300 CIRCUITS** for the home constructor — 300 projects ranging from the basic to the very sophisticated.  
Price — UK ..... £ 3.75 Overseas ..... £ 4.00

**DIGIBOOK** — provides a simple step-by-step introduction to the basic theory and application of digital electronics and gives clear explanations of the fundamentals of digital circuitry, backed up by experiments designed to reinforce this newly acquired knowledge. Supplied with an experimenter's PCB.  
Price — UK ..... £ 5.00 Overseas ..... £ 5.25

**FORMANT** — complete constructional details of the Elektor Formant Synthesizer — comes with a FREE cassette of sounds that the Formant is capable of producing together with advice on how to achieve them.  
Price — UK ..... £ 4.75 Overseas ..... £ 5.00

**SC/MPUTER (1)** — describes how to build and operate your own microprocessor system — the first book of a series — further books will show how the system may be extended to meet various requirements.  
Price — UK ..... £ 3.95 Overseas ..... £ 4.20

**SC/MPUTER (2)** — the second book in series. An updated version of the monitor program (Elbug II) is introduced together with a number of expansion possibilities. By adding the Elektor terminal to the system described in Book 1 the microcomputer becomes even more versatile.  
Price — UK ..... £ 4.25 Overseas ..... £ 4.50

**BOOK 75** — a selection of some of the most interesting and popular construction projects that were originally published in Elektor issues 1 to 8.  
Price — UK ..... £ 3.75 Overseas ..... £ 4.00

**BOOK 75** — a selection of some of the most interesting and popular construction projects that were originally published in Elektor issues 1 to 8.  
Price — UK ..... £ 3.75 Overseas ..... £ 4.00

**TV GAMES COMPUTER** — this book provides a different — and, in many ways, easier — approach to microprocessors. The TV games computer is dedicated to one specific task, as the name suggests. This provides an almost unique opportunity to have fun while learning!  
Price — UK ..... £ 5.00 Overseas ..... £ 5.25

When ordering please use the Elektor Reader's Order Card in this issue (the above prices include p. & p.)

# ELEKTOR BOOK SERVICE

AND CO-STARRING : **Cappy** the capable capacitor

COMING SOON

**RESI &  
TRANSI**

IN  
ELEKTROTECHNICOLOR

**Transi**, the (not very) active component

**Resi**, the irresistible resistor



**Ledy**, the brilliant show-off and many, many others !!

The first electronic comic-book  
**RESI & TRANSI**  
**BANISH THE MYSTERIES OF ELECTRONICS !**

Excitement, entertainment, circuits. Complete with printed circuit board and Resimeter

Further adventures and circuits  
coming soon - starring Resi & Transi  
of course!

**- from Elektor**

Elektor Publishers Ltd., Elektor House, 10 Longport, Canterbury CT1 1PE, Kent, U.K.  
Tel.: Canterbury (0227) 54430. Telex: 965504. Office hours: 8.30 - 12.30 and 13.30 - 16.30.

**STARRING :**

# Make it with MAPLIN



## KEYBOARD WITH ELECTRONICS FOR ZX81

- A full size, full travel 43 key keyboard that's simple to add to your ZX81 (no soldering in ZX81).
- Complete with the electronics to make "Shift Lock", "Function" and "Graphics 2" single key selections making entry far easier.
- Powered from ZX81's own standard power supply - with special adapter supplied.
- Two-colour print for key caps.
- Amazing low price.

Full details in our projects book. Price 60p.

Order As XA03D

Complete kit for only **£19.95** incl. VAT and carriage

Order As LW72P

## 25W STEREO MOSFET AMPLIFIER



A superb new amplifier at a remarkably low price.

- Over 25W per channel into 8Ω at 1kHz both channels driven.
- Frequency response 20Hz to 40kHz  $\pm$  1dB
- Low distortion, low noise and high reliability power MOSFET output stage
- Extremely easy to build. Almost everything fits on one pcb, cutting the wiring to just 7 wires (plus toroidal transformer and mains lead terminations)
- Complete kit contains everything you need including pre drilled and printed chassis and wooden cabinet

Full details in our projects book. Price 60p.

Order As XA03D

Complete kit for only **£49.95** incl. VAT and carriage

Order As LW71N

## MATINEE ORGAN

Easy to build, superb specification. Comparable with organs selling for up to £1000. Full construction details in our book. Price £2.50.

Order As JH55K.

Complete kits available

Electronics - **£299.95**

Cabinet - **£99.50** (carriage extra)

Demo cassette price **£1.99**. Order As XA33W



## HOME SECURITY SYSTEM



Six independent channels - 2 on 4 wire operation. External horn. High degree of protection and long term reliability. Full details in our projects book.

Price 60p

Order As XA02C

## MILES PER GALLON METER

Digital display shows you how economical your driving is as you go along.

Complete kits available

Full details in our projects book

Price 60p

Order As XA02C



## DIGITAL MULTI-TRAIN CONTROLLER

Control up to 14 trains individually on the same track with any four simultaneously! Low cost kits available. Full details in our projects book. Price 60p. Order As XA02C.



Don't miss out - get a copy of our catalogue now! Over 140,000 copies sold already!

On sale now in all branches of WHSMITH price 1

320 big pages packed with details and pictures of over 5,500 items



### Post this coupon now!

Please send me a copy of your 320 page catalogue (I enclose £1.25 inc. 25p p.p.s.) If I am not completely satisfied I may return the catalogue to you and have my money refunded.

If you live outside the U.K. send £1.68 or 12 International Reply Coupons.

E682

Name \_\_\_\_\_

Address \_\_\_\_\_

# MAPLIN

ELECTRONIC  
SUPPLIES LTD.

All mail to

P.O. Box 3, Rayleigh, Essex SS6 8LR  
Tel Sales (0782) 562911 General (07021) 854155

Shops at

159 King St., Hammersmith, London W6. Tel 01-748 0926  
284 London Rd., Westcliff on Sea, Essex. Tel (07021) 954000  
Note: Shops closed Mondays