

elektor

up-to-date electronics for lab and leisure

83

March 1982

65p.

IR 85p. (incl. VAT)

Sunder Singh

**LEDs are
going
BLUE!**

**wind sound
generator:
a storm
on board!**

**automatic
squelch**



erasing EPROMS

selektor	3-13
Express train to nowhere.	
high com monitor extension	3-14
Very few additional components are required to extend the High Com and provide multiple head tape systems with a monitor facility.	
wind sound generator	3-16
H. Pietzko Anyone requiring a windlike sound, such as amateur photographers during a film or slide show, can make good use of this electronic wind sound generator.	
adding the finishing touches to the NEW Elektor synthesiser ...	3-18
The final article on the basic version of the NEW Elektor synthesiser describes the control and output module (COM) and a simple power supply.	
automatic squelch	3-26
Besides the straightforward construction and calibration involved here, the automatic squelch has a major advantage: You do not need to be an expert to install it into the audio section of a receiver.	
DNR printed circuit board	3-28
Last month we promised a practical noise reduction system - and here it is. The circuit literally makes noise go 'off the air'.	
lead acid battery charger	3-32
The circuit presented in this article not only charges lead acid batteries, but also acts as a power supply. It is polarity-protected and includes current and voltage limiting. It also provides charge control and a polarity indicator. In other words, the battery charger is practically foolproof!	
blue LEDs	3-36
During the past three years, the physical properties of SiC (silicon carbide) have been the subject of an enlightening study. This article describes this semiconductor material and shows how blue-emitting SiC diodes can be manufactured.	
missing link	3-41
AD/DA conversion	3-42
T. Schaerer Analogue to digital conversion technology has advanced to the degree at which electronics enthusiasts can afford to experiment with digital circuits, such as the one described in this article.	
dissipation limiter	3-47
The circuit illustrated here provides a safeguard for the 2N3055, a sort of life insurance.	
EPROM eraser	3-50
Since Elektor has paid a good deal of attention to EPROM programmers lately, it is high time a suitable EPROM eraser was considered. The ultraviolet method described here is both efficient and fairly cheap.	
polyphonic synthesiser	3-51
The advantages of computer controlled polyphonic keyboards are discussed in this article, which at the same time paves the way for the printed circuit boards and the constructional details to be published in due course.	
market	3-54

contents

COMPUTERS

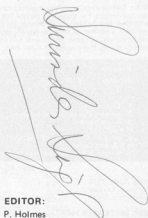

EDITOR:
P. Holmes

UK EDITORIAL STAFF
T. Day E. Rogans
P. Williams

TECHNICAL EDITORIAL STAFF
J. Barendrecht
G.H.K. Dam
E. Krempelsauer
G. Nachbar
A. Nachtmann
K.S.M. Walraven

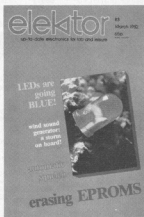

(Cover photo: F.M. Habla)



selektor

Express train to nowhere stores electrical energy

Experts throughout the world agree that the future for energy would look much smoother — and renewable energy sources would look more tempting — if the basic problems of bulk energy storage could be solved. Even in existing centralised energy utilities, and particularly electricity grids, the ability to store energy at times of low demand for use during periods of peak consumption would have immediate and substantial benefits.

Generating equipment of whatever kind could be operated at its optimum load at all times and the ironing out of the peaks and troughs from the demand curve would mean very large reductions in capital and operating expenditure. In most European countries and the United States of America the possible savings approach 40%, although 25% might prove more realistic.

Troughs in demand

An advance of this kind would require storage systems that operate on the basis of electrical input and electrical output, and with a capacity commensurate with that of utility power station production — perhaps in the range of 500...1000 megawatt hours. The system would also have to operate at high efficiency over a storage period of 12 to 36 hours, to take into account daily and weekend demand troughs, and be capable of being constructed close to the power station for which it was to serve as the store.

In areas where suitably large lakes can be created by building dams, water can be used in pumped storage systems with a storage time-base that is virtually unlimited. However, overall efficiency is not particularly high because of losses in the pumping process, and in any case pumped storage, like the storage of energy in the form of high pressure air underground caverns, is feasible in only a few localities.

During the past couple of decades a number of engineers and scientists throughout the world have attempted to find a solution to the problem, and many proposals have involved the use of flywheels of one kind or another. This is because, in broad principle, the flywheel is an excellent storage system, capable of being driven up to great speeds by high efficiency motors which can also serve as very efficient generators to take the stored kinetic energy out again.

But conventional flywheels on a central spindle have basic design problems which become increasingly prohibitive

as the scale — and hence the potential storage capacity — is increased. The ideal flywheel would have all its mass at the outer rim, which is the point of highest velocity. But the larger the mass at the rim and the higher the velocity, then the higher the structural stresses between the spindle and the rim and the greater the proportion of mass of structural material that has to be introduced into the low velocity area.

Exotic and expensive

Even with the most exotic and expensive materials, a store of 200 megawatt hours is approaching the practical limits. Smaller stores exist and have operated well for many years — Professor Oliphant's homopolar motor-generator in Australia is a famous example — but these are not at utility scale. However, two British scientists, Dr F. M. Russell of the Rutherford and Appleton Laboratories and Dr S. H. Chew, who worked until recently at the University of Malaya but is now at Oxford University, have come up with a genuinely revolutionary idea for, in effect, they have turned the flywheel inside out.

According to Dr Russell, when the problem is thought through, it becomes obvious that you have to do away with the central spindle and all the engineering difficulties it entrains. So they decided to design a flywheel with all the mass in the rim and the bearings outside. The result looks highly promising. Their basic idea, which already has the interest of engineering and construction companies in Britain and is being evaluated in considerable design detail, is deceptively simple. In effect it involves the construction of a high speed underground railway with a single 'train' occupying the full length of a circular track. Taking a diameter of 1000 metres as a design criterion — for this fits comfortably within or just around large power station sites — the scientists have examined the problems and hence the required technology for a 500 megawatt hour store.

The technology is available

This was described in detail at the recent Second International Conference on Energy Storage at Brighton, England, and the specification contains several surprises. The first, and perhaps the most important, is that almost all the required technology is already available because it has been developed in several national programmes for high speed trains. The tunnelling technology, developed both for urban subways and other transport requirements, and in a high precision form for large 'atom smashing' accelerators — such as the 27 kilometre diameter electron-positron collision ring soon to be built in Geneva — is also at the required level.

Even more encouraging are the first cautious, broad assessments of cost. They suggest that the underground train storage system should not be very

different from that of pumped storage systems. Fears that rolling friction losses and losses caused by air resistance in the tunnel would prove serious were shown to be unfounded as the study progressed.

The system emerged as a train, carrying a mass of dense material — the heavy rock excavated during tunnelling could provide the bulk of the mass — driven by 24 motor-generators and borne by tracks taking both vertical and horizontal loads. As the detailed engineering evaluation was pushed forward the basic principles were clarified but remained unchanged. The required storage capacity could be attained at train velocities only about twice those becoming common in high speed rail systems. The 'reference' design has a maximum linear speed of 300 metres/second, a design efficiency substantially greater than that of pumped storage over a period of 24 hours, and the capability of being built anywhere since the sub-surface geology is sufficiently strong to accept the transfer of large inertial, centrifugal and gravitational forces. The 'switching time' of the system — that is from store to energy output of 200 megawatts, is assessed at 3 milliseconds, which is adequate for the most sensitive grid control systems now envisaged.

Wheel and track wear

But detailed study of the reference design has also revealed problems, and the most serious involves 'bearing' — that is wheel and track — wear. One of the design requirements is that the storage system should have a virtually maintenance free life comparable to or greater than that of the power station with which it would be associated. That means 30 years or more, and to achieve that lifespan the loads transmitted to the tracks would have to be reduced by 'an order of magnitude or a little more', according to Dr Russell.

The inventors claim that the technology already exists for the provision of this kind of magnetic load reduction but prefer not to talk about it yet. The system they have in mind would be 'advanced' in the sense of concept, yet very robust. Costs are uncertain at this stage, but there is no reason to believe that they would be outrageous. Industry is interested and it seems quite feasible that the expense will still be within striking distance of the costs of pumped storage.

Anthony Tucker,
Science Editor for 'The Guardian',
London.

(74 S)

selektor

high com monitor extension

... for multiple head tape recorders

We have been asked by a number of readers whether it is possible to extend the High Com circuit so that it can be used in conjunction with the monitor facility found on multiple head tape recorders. Initially, this came as rather a surprise, since the High Com system was designed for 'normal' cassette decks. Nevertheless, it is possible to extend the system so that the monitor facility can be fully utilised.

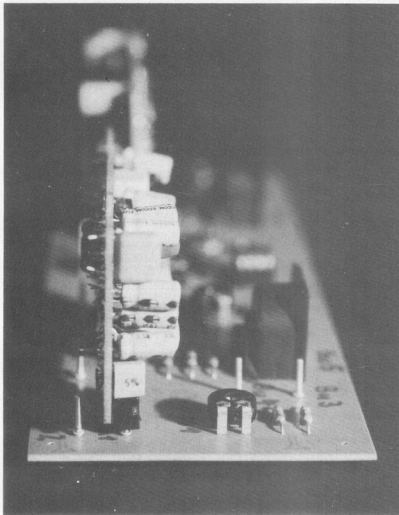

Many readers may not have yet had the opportunity to construct the noise reduction circuit published in the March 1981 issue of *Elektor*, if not... now's your chance! Others may wish to extend the 'old' circuit. In either instance the *Elektor* High Com system will have to be available in its original form to start with. However, before we continue, let's make a study of some of the background details so that we 'know what we are doing'.

Tape recorder technology

Reel-to-reel tape recorders and cassette decks can be placed into two main categories: those with monitor facility and those without. In principle, three heads are required: an erase head to 'wipe' the tape clean; a record head to transfer the relevant signal to the tape; and a playback head to retranslate the recorded information into an electrical signal.

For reasons of economy, the record and playback heads are very often combined into a single unit. It should be noted, however, that a record/playback head cannot record any kind of signal and play it back (monitor) at the same time. Recordings can only be monitored if separate record and playback heads are available.

Supposing, for instance, that a noise reduction system was connected between the signal source and the record head, and the playback head was used to monitor the recording. Then the same noise reduction system would have to be connected between the playback amplifier and final output medium. Since the High Com system can only be operated in the 'record' or 'playback' mode, separate record and playback channels will have to be added, in other words, two noise reduction systems! The extra expense can, of course, be avoided by simply playing back the companded signal, but this will not guarantee high quality reproduction.

The monitor

Fortunately, very few additional components are required to extend the High Com system. Firstly, two more modules will have to be added: one for the right-hand channel and one for the left-hand channel. Since the recording channel constitutes the most complicated circuit, it is included on the existing board. The majority of the playback channel, on the other hand, consists basically of the High Com module. To work out the best method of constructing the monitor section, let's take another look at the circuit diagrams in figures 6 and 7 of the original article published in the March 1981 issue of *Elektor*.

One solution, for readers with plenty of time and money, is to build the complete device twice and record through one and monitor with the other. However,

1

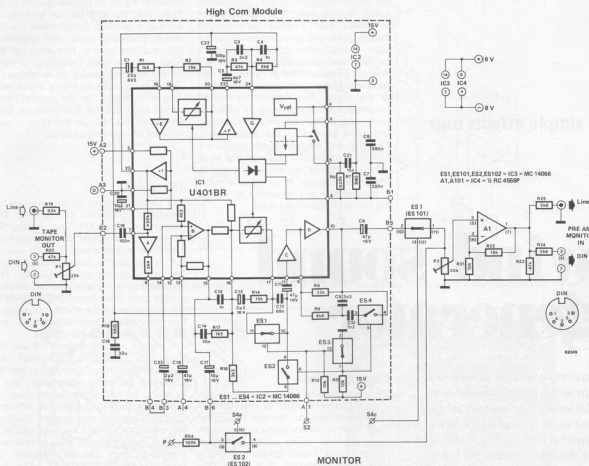

Figure 1. The circuit diagram of the High Com 'monitor' extension. Only the left-hand channel is shown, the values for the right-hand channel are indicated in parentheses. It is very similar to the playback section of the original High Com system published in the March 1981 issue of Elektor.

there are cheaper and less time-consuming methods, which will be discussed here.

The circuit diagram of the prototype is shown in figure 1. The playback channel consists of the High Com module, the input and output interfaces and the electronic switches. For the monitor channel, the interfaces and the electronic switches can be omitted if desired, in which case the tape unit will be in the High Com mode permanently. This option is recommended as it enables any differences in level to be equalised from the start.

Construction

For those readers who have not yet built the original Elektor High Com system, full constructional details will be found in the March 1981 issue of Elektor. As far as the monitor extension is concerned, two extra High Com modules are required together with the components listed in table 1. These components are the same as those used in the original playback system and

Table 1.

Parts list for figure 1

Resistors:

R19, R119 = 82 k
 R20, R120, R23, R123 = 47 k
 R21, R121 = 10 k
 R22, R122 = 15 k
 R24, R124, R25, R125 = 5k6
 R54, R154 = 100 k
 P1, P101, P2, P102 = 25 k preset

Semiconductors:

IC3 = MC 14066, CD 4066
 IC4 = RC 4558P

all other components are included on the High Com modules.

should be mounted on a suitably sized piece of Veroboard according to the circuit diagram in figure 1. Solder pins should be provided for each of the connection points, the ones used to mount the High Com modules should be 1.3 mm in diameter. Of course, an extra main board could also be used and

the superfluous components omitted, but this may prove to be rather expensive. The Veroboard should be the same width as the main board. This ensures that there is plenty of room for the two modules, which can be mounted at right angles to those on the main board. This allows the various connections to the main board to be situated along one of the sides of the extension board, while all the external connections can be situated along the opposite side.

The extension board should be positioned so that the two sets of connections marked; 'S4a', '+15 V', '-8 V', '+8 V', 'ground', 'S4c', 'S2' and 'P' are exactly opposite the outputs on the main board. As a result, the interconnections can be kept as short as possible. As far as calibrating the circuit is concerned, the same procedure as that described in the March 1981 issue of Elektor should be followed.

References: Noise reduction, Elektor February 1981, page 2-04. The High Com noise reduction system, Elektor March 1981, page 3-06. ■

a simple effects unit

The sound of the wind is very similar to the major headache of HiFi enthusiasts, noise. Nevertheless, it is not sufficient to utilise just a noise generator to imitate gusts and gales, especially as the main characteristic of the latter is to produce considerable volume within a limited frequency range, although the complete audio spectrum is represented in the signal. The increase in volume accompanied by a howling or whistling tone is caused by diverting, compressing and then expanding the actual wind. The slightest alteration will produce a different sound. Of course, the same principle applies to wind instruments where the 'column' of air inside a 'tube' is compressed and expanded to obtain the various notes of the scale.

wind sound generator

Generating wind at professional film and television studios is a relatively simple matter: all they have to do is press a button and a powerful fan supplies anything in the way of simulated sea breezes to gale force winds. In the home, such effects are much harder to create, and usually result in the perpetrator being thoroughly winded . . .

Anyone requiring a windlike sound, such as amateur photographers during a film or slide show, can now make use of this portable electronic wind sound generator. A few components, a battery and an amplifier are all that are required to produce effects ranging from a gentle breeze to a Caribbean hurricane. Just the thing for livening up a dull party!

The circuit

The circuit diagram of the wind sound generator is shown in figure 2. The germanium diode D1 and resistor R1 constitute the actual noise generator. The noise signal is amplified by opamp A1 to produce a noise level of about 150 mV_{pp} at the output (pin 1). The amplified noise signal is then fed through a high pass filter consisting of resistor R4 and capacitor C4 and then through a low pass filter comprising R6/C5 and R7/C6 to reduce the bandwidth.

The circuit around opamps A2 and A3 forms the 'variable inductance' for the bandpass filter. Inductors can be 'imitated' by using a capacitor and a gyrator, as has often been done in Elektor circuits in the past. A different approach involves two opamps. Resistor R8, capacitor C8 and the 'coil' (A2/A3) form a tuned circuit with a resonant frequency that can be adjusted by means of potentiometer P1. The impedance between the non-inverting input of A2 and ground is:

$$Z = j\omega \cdot (P1 + R9) \cdot T$$

Thus, the inductance will be:

$$L = (P1 + R9) \cdot T$$

where $T = R10 \cdot C9 = (P2 + P3) \cdot C10$. The inductance of the 'coil' and therefore the centre frequency of the bandpass filter can be adjusted by means of potentiometer P1. The Q of the filter can be regulated by means of P2 and P3. As a result, the wind force is established by the former and the volume of its whistling tone is established by the latter.

Opamp A2 also acts as a buffer stage and provides a low impedance output for the wind signal. The amplitude at this output will only be about 1.4 mV,

Electronic wind

We are not going to discuss electronic wind instruments here, as the majority of music synthesisers are able to imitate them. Rather, we are going to discuss an effective wind sound generator which uses a reverse biased germanium diode as a 'noise generator'. The block diagram of the unit is given in figure 1.

If only a small current is allowed to pass through the diode the current will not remain stable. At room temperature (about 300° Kelvin), which is a very high temperature for diodes, the electrons in a crystalline structure move about in a totally random manner. They do not become immobile until the temperature drops to 0° Kelvin, the absolute zero level. This (normally undesirable) effect, which manifests itself in the form of audible broadband noise, is eminently suitable for this particular application. After being amplified by a large amount, the noise signal can be further 'processed'.

The most straightforward method is to use a bandpass filter which greatly

1

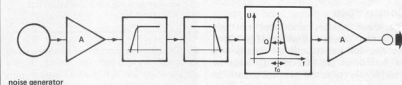

noise generator

82086 - 1

Figure 1. The block diagram of the wind sound generator.

2

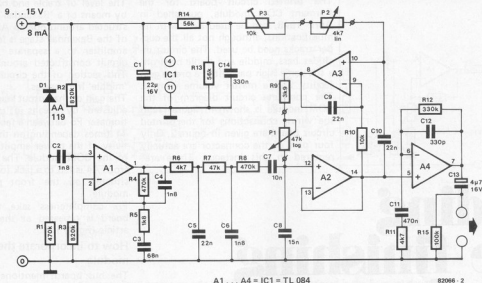

A1...A4 = IC1 = TL 084

82066-2

Figure 2. The circuit diagram of the wind sound generator. The 'noise diode', D1, and four opamps (contained in a single package) are the only active components.

3

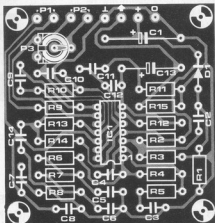
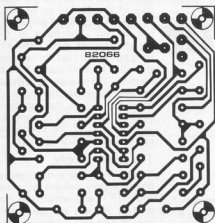

Figure 3. The printed circuit board and component overlay for the wind sound generator.

Part List

Resistors:

R1, R4, R8 = 470 k
 R2, R3 = 820 k
 R5 = 1 k Ω
 R6, R11 = 4k7
 R7 = 47 k
 R9 = 3k9
 R10 = 10 k
 R12 = 330 k
 R13, R14 = 56 k

R15 = 100 k

P1 = 47 k logarithmic
 P2 = 4k7 linear
 P3 = 10 k preset

Capacitors:

C1 = 22 μ F/16 V
 C2, C4, C6 = 1n8
 C3 = 68 n
 C5, C9, C10 = 22 n
 C7 = 10 n
 C8 = 15 n

C11 = 470 n
 C12 = 330 p
 C13 = 4 μ F/16 V
 C14 = 330 n

Semiconductors:

D1 = AA 119
 IC1 = TL 084 or LM 324

Miscellaneous:

9 V battery or 9 V power supply (see text)

therefore the signal needs to be amplified somewhat. This is accomplished by means of opamp A4, the final amplitude of the wind signal being in the order of 100 mV.

Construction, calibration and operation

Although the circuit has very few components, the performance is quite surprising. All the components (apart from the potentiometers) can be

mounted on the printed circuit board shown in figure 3.

Since the current consumption of the circuit is a mere 8 mA, it can be battery powered. A separate small power supply could also be used provided the supply voltage is adequately smoothed. A number of suitable circuits have been published in Elektor over the years. Calibration simply involves the adjustment of preset potentiometer P3. With P1 and P2 set to their minimum and maximum resistances, respectively, P3 is turned (starting from its minimum

resistance value) until the bandpass filter is just about to change frequency. In other words, the amplifier and loudspeaker should not emit the slightest breeze!

It may be advisable to connect the wind sound generator to a mixer prior to the audio amplifier. This would enable the unit to be operated with maximum efficiency during slide and/or film shows etc. The device is, of course, also suitable as a sound effects generator, in which case it can be connected directly to the line input of the audio amplifier. \blacksquare

The printed circuit board for the Formant COM module, published in April 1978, can be used here with no modifications, although not all the copper tracks need be used. The circuit includes bass, middle and treble controls, a sub-sonic high pass filter, a preset gain facility and a master volume control. The complete circuit diagram of the COM module is shown in figure 1 and the wiring connections for the printed circuit board are given in figure 2. Only four pins of the connector are actually required in this instance. These are:

The level of treble and bass is adjusted by means of a 'Baxandall' network constructed around opamp A2. The output of the Baxandall stage is fed via a buffer amplifier to a separate 'pre-emphasis' circuit constructed around opamp A3. This section of the circuit controls the 'middle' frequencies.

The gain of the output stage, A4, can be adjusted by means of preset potentiometer P5 between a factor of 1.8 and 11 times depending on the input sensitivity of the power amplifier connected to the COM module. The output signal from A4 is fed to a jack (or DIN-socket situated on the front panel of the module.

For completeness' sake, the 'old' p.c. board is repeated at the end of this article (figure 10).

How to incorporate the COM module

The bus boards mentioned in the previous articles on the NEW Elektor synthesiser have to be slightly modified in order to accommodate the COM module. As can be seen from figure 3, the pins of the 21-way connector soldered to the COM printed circuit board will not fit into the holes of the corresponding socket, if the latter is mounted on a bus board that has been inserted in the slide-in unit using the 'standard' method. The pins are positioned exactly half-way between the holes. The solution is to turn the bus board 180° before insertion and to remove the first and last pins of the connector with a pair of suitable cutting pliers.

The power supply

The NEW Elektor synthesiser requires a power supply capable of producing + and -15 V and which will maintain a load of 200 mA per rail. Furthermore, the polyphonic extension to be described later requires a +5 V supply. A suitable circuit is given in figure 5 (and a p.c. board layout in figure 11). Obviously, the components for the +5 V supply need not be mounted yet (IC3 with its heatsink, C7 and C8).

Although it is not strictly necessary, it is a wise precaution to mount the voltage regulators (IC1, IC2 and IC3) on small heatsinks. After all, it is better to be safe than sorry!

How to connect the power supply

For safety reasons, it is not recommended to mount the power supply transformer directly on the printed circuit board. Having a copper track bear the brunt of 240 volts is rather risky to say the least. The transformer should be mounted on a piece of aluminium, about the size of a eurocard, which will also act as a 'screen' from the rest of the circuit — provided the aluminium is grounded.

The power supply and transformer can be wired directly to the connector. A robust, mechanical connection can best be made using long screws and spacers, as indicated in figure 6.

adding the finishing touches to the NEW Elektor synthesiser

the COM module, the power supply and a few constructional hints

The final article on the basic version of the NEW Elektor synthesiser describes the control and output module (COM). This was originally designed for the Formant synthesiser and was fully described in the April 1978 edition of Elektor (page 4-33). It includes a preamplifier with bass, middle, treble and volume controls.

The power supply for the synthesiser is very simple and consists of virtually only two voltage regulator ICs.

ground; the positive 15 V supply rail; the negative 15 V supply rail; and a signal input, which is connected to the output of a VCA. The tandem potentiometer P1a/P1b prevents the remainder of the circuit from being over-modulated and at the same time ensures that the desired signal is not 'drowned' by noise from the circuitry shown between P1a and P1b.

Depending on the settings of the various synthesiser controls, a brief low frequency signal produced when a key is depressed could cause damage to the loudspeakers. Such detrimental tones are suppressed by means of the low pass filter connected in front of the tone control network. The filter has a cut-off frequency of about 20 Hz and is similar to the rumble filters found in stereo equipment.

1

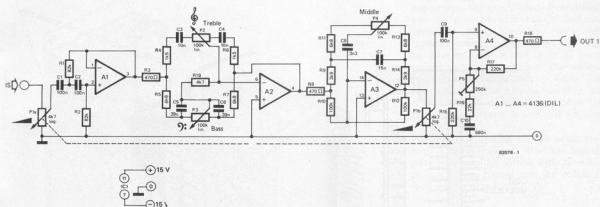

Figure 1. The circuit diagram of the control and output module (COM) is identical to that used in the Formant design.

Two LEDs on the front panel (connected to the + and -15 V supplies) allow the user to ascertain at a glance whether the power supply unit is working correctly.

Constructional hints

Figure 7 shows all the basic connections for the various synthesiser modules. The boards are linked to the power supply

via three supply voltage rails. The signal paths are indicated as thick, black lines.

The output signals from the two VCOs and the LFO are first fed to the mixer input of the VCF, then to the VCA and finally to the COM unit. The gate pulse from the Formant keyboard also controls the vibrato section of the LFO/NOISE module, but not the two envelope generators.

The LFO signal can be used to fre-

quency modulate the VCOs, the VCF or all the modules simultaneously. The ADSR outputs are linked to the control inputs of the VCF and VCA. The KOV inputs of the two VCOs are linked to each other and also to the KOV output of the Formant keyboard (see the article on the VCO published in the December 1981 issue of Elektor, page 12-39).

The various modules can all be accommodated in a 'card frame'. Suitable

2

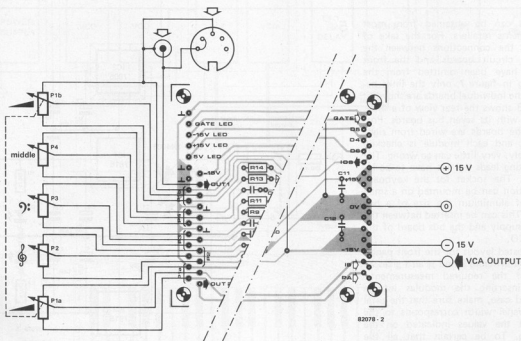
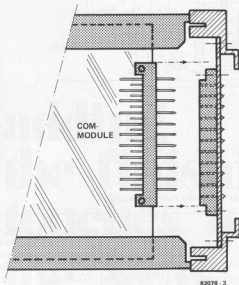
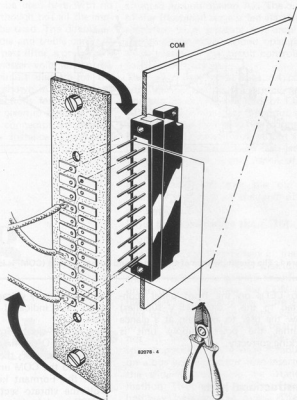

Figure 2. The wiring details of the COM unit.

3



4



Figures 3. and 4. The connector on the COM board does not line up with that on the bus board. For this reason the bus board must be turned 180° degrees before being installed.

systems can be obtained from most components retailers. For the sake of clarity, the connections between the printed circuit boards and the front panels have been omitted from the drawing in figure 7, only the links between the individual boards are shown.

Figure 8 shows the rear view of a slide-in case with its seven bus boards. Provided the boards are wired from right to left, and each module is checked separately, very little can go wrong. The connecting leads do not have to be insulated. The socket for the keyboard connection can be mounted on a small piece of aluminium the size of a bus board. This can be inserted between the power supply and the bus board of the first VCO.

A suggested layout for the front panels is shown in figure 9 and it also gives an idea of the required measurements. When inserting the modules into a standard case, make sure that the total front panel width corresponds to the sum of the values indicated on the drawing. To be certain that all the potentiometers fit on the various front panels, miniature types with a spindle diameter of 4 mm should be used. Of course, many readers will wish to design their own cases and front panels, in

5

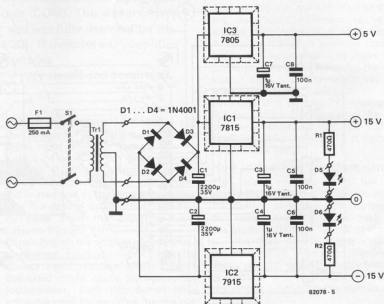

Figure 5. The circuit diagram of a suitable power supply for the Elektor synthesiser.

6

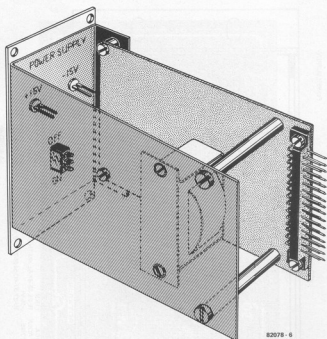

Figure 6. For safety reasons, the transformer is best mounted on a separate piece of aluminium.

7

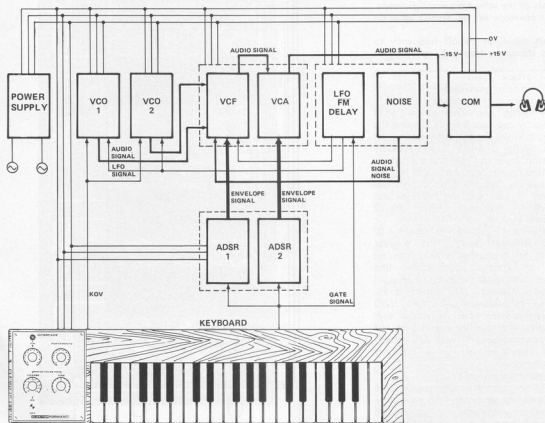

Figure 7. How the various modules of the synthesiser are interconnected.

which case we would be interested to hear about the results.

As far as legends on the front panels are concerned, the (pre-drilled) front panels can be marked with rub-on lettering (available from stationers and electronics retailers). The panels can then be covered with a thin layer of transparent adhesive foil and the various holes cut out with a sharp knife. The foil should be slightly larger than the front panel in question, so that it can be wrapped around it and will not peel off easily.

Alternatively, the panels can be sprayed with a suitable laquer after the legends have been applied. With a little time and patience, the panels can be made to look very professional.

Principal settings for the synthesiser

Now that the NEW Elektor synthesiser has been completed, it is time to try out a few sounds. Admittedly, the choice of modules is rather limited compared to the Formant, but then the whole point of the new system was to make it easier to produce synthesiser music on stage, which meant reducing the vast array of knobs and buttons used in the Formant

system to an absolute minimum. The remaining 28 controls still offer plenty of musical possibilities. The following settings can be combined as desired:

- with or without glissando
- one or two VCOs
- in the case of two VCOs:
 - both with the same frequency
 - with an octave between them
 - with a fifth, a fourth or a third between them
- filter with envelope control
 - percussive sounds: attack/decay curves, attack time = 0
 - wah-wah and brass instruments: attack time not equal to 0, ADSR curve
- filter without envelope control
- tracking filter
- VCA envelope: this must be tuned to the VCF envelope. A short VCF attack and decay time will not go into effect, for instance, if the VCA attack time is long. The VCA plays an important role, whenever the filter is not modulated by way of the envelope generator and the cut-off frequency is somewhere in the audio range (see point 5).
- additional mixing of LFO and noise

A few examples:
(The names given below to the various sound effects are purely fictional and do not claim to be official terms.)

- Spherical sound: two sawtooth signals of the same frequency/glissando. Filter envelope set on zero/Q value on zero.

Adjust the filter cut-off frequency to allow the entire frequency spectrum to pass/
VCA: attack: zero

- sustain: maximum
release: 1.2 seconds

- By using two symmetrical VCO squarewave signals while keeping the other modules in the same setting, an effect similar to that in 'Lucky Man' by Emerson, Lake and Palmer is created.

- Disco sound: VCO setting as in 1/no glissando. Set the filter cut-off frequency to zero and the envelope amplitude to maximum. Adjust the Q factor to zero.

Filter envelope: attack = 0, sustain = 0.
Using different decay times, a great variety of percussive effects can be produced, some of which sound like the staccato accompaniment often used in disco numbers. The effect is enhanced by separating the two VCO frequencies by a fifth. Remember that melodies with parallel intervals do not always combine well with accompaniment chords played on a different instrument.

- 'Sound the trumpet':

VCOs: sawtooth or squarewave, same frequency or a third, fifth or octave interval between them.

Filter settings as in point 3.

Filter envelope: attack time not equal to zero, sustain equal to 100%, release very brief, but not zero.

- Woodwind instruments:

8

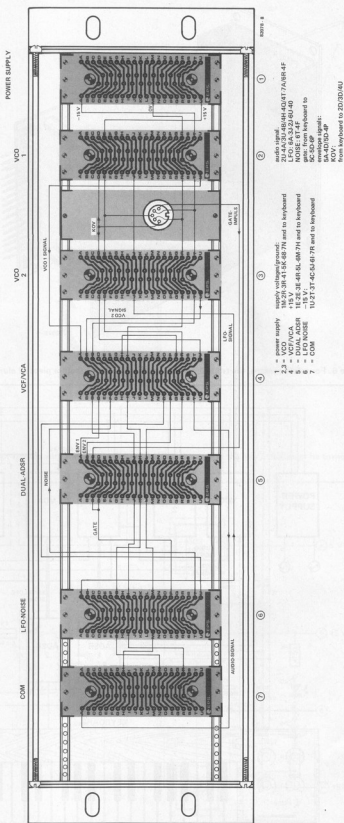
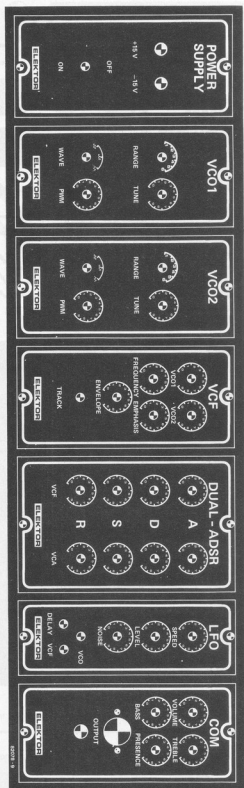

Figure 8. Rear view of the completed synthesiser.



COM 1 8

A single VCO with a squarewave signal.

Filter envelope: see point 4.

Filter envelope amplitude: low.

Try out different cut-off frequencies!

6. Sinewave sound:

VCO with triangle signal.

Switch on tracking filter operation and set the cut-off frequency to match the VCO frequency.

Filter envelope = 0

VCA: see point 1.

We will not go into all the possible sound effects that the synthesiser is capable of producing, as this would fill several issues! In any case, it is much more fun to experiment and find out for oneself. After a certain amount of practice readers should be able to discover all sorts of novel and interesting combinations and settings. This obviously involves a little more than aimlessly twiddling the knobs. The tones obtained using this method are likely to be cacophonous, if anything. Thus, a systematic approach and fine tuning are an absolute must when operating the synthesiser.

This completes the series on the basic version of the NEW Elektor synthesiser. The forthcoming sequel will describe how to construct a polyphonic keyboard and how to connect it to the existing modules.

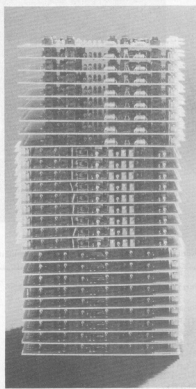

Figure 9. A suggested front panel layout for the various modules.

10

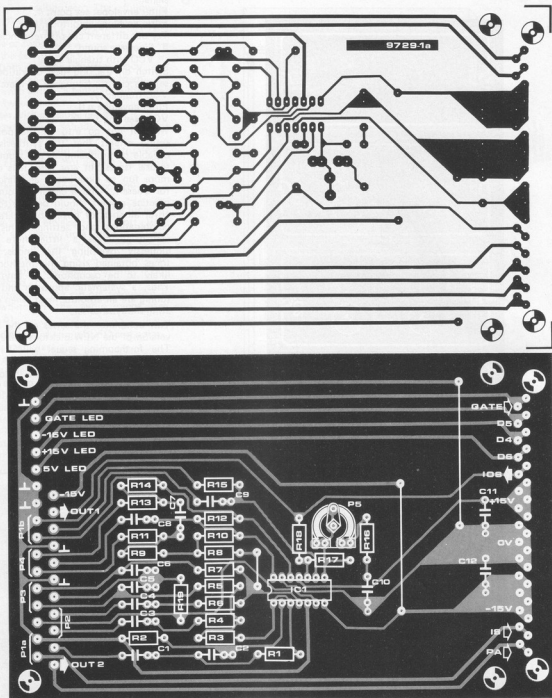

Figure 10. Copper track pattern and component overlay of the COM module.

Parts list for the COM module

Resistors:

R1, R2 = 82 k
 R3, R8, R18 = 470 Ω
 R4, R6 = 1k5
 R5, R7, R11, R13 = 6k8
 R9, R14 = 3k9
 R10, R12 = 100 k
 R15, R17 = 220 k

R16 = 22 k

R19 = 4k7

potentiometers:

P1a, P1b = 4k7 log. ganged pot.
 P2, P3, P4 = 100 k lin.
 P5 = 220 . . . 270 k preset

Capacitors:

C1, C2, C9 = 100 n

C3, C4 = 10 n

C5, C6 = 39 n

C7 = 15 n

C8 = 3n3

C10, C11, C12 = 680 n

Semiconductors:

IC1 = 4136 (DIL package) EXAR,
 Fairchild, Raytheon or
 Texas

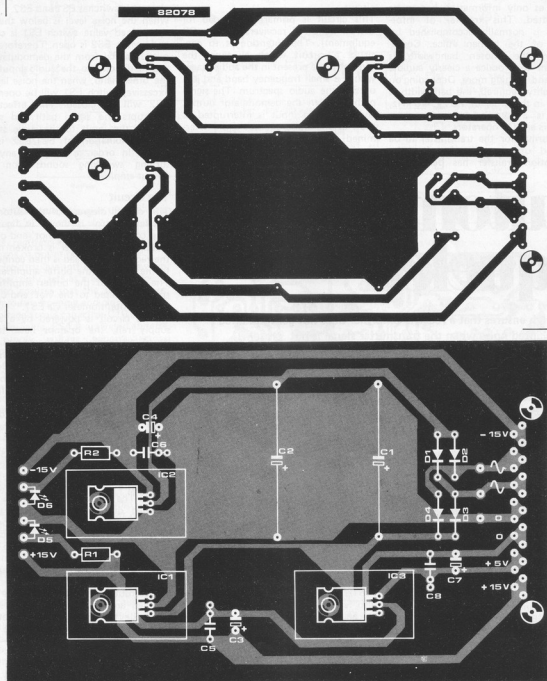

Figure 11. Copper track pattern and component overlay of the power supply.

Parts list for the power supply

Resistors:

R1, R2 = 470 Ω

Capacitors:

C1, C2 = 2200 μ /35 VC3, C4, C7* = 1 μ /16 V tantalum

C5, C6, C8* = 100 n

Semiconductors:

IC1 = 7815

IC2 = 7915

IC3 = 7805

D1 ... D4 = 1N4001

D5, D6 = LED

Miscellaneous:

Tr = 2 x 18 V/500 mA (centre tap)
transformer

S1 = dp toggle switch

F1 = 250 mA slow fuse

21-pin connector

heat sinks for IC1 ... IC3

* not required for monophonic version
without preset facility

The audio bandwidth in communications equipment is almost always relatively narrow, which is quite sufficient as only information has to be transmitted. This transfer of information is normally accomplished by means of the human voice. Consequently, the chosen bandwidth is sufficient to produce a clearly audible sound and nothing more. Depending on the quality required, the bandwidth is usually in the order of 1.5...4.5 kHz, which is a familiar value for radio amateurs and CB operators.

It is normal for the transmitter to be switched off, immediately after the information transfer has been com-

munications equipment. This will be our starting point, since we are going to describe a fully automatic noise squelch circuit.

This circuit is primarily intended for narrow band FM receivers (such as CB equipment). The intention is to construct a circuit which examines the level of noise present in the audio stages within a small frequency band and just outside the audio spectrum. The signal path between the demodulator output and the audio input is interrupted as soon as the noise exceeds a pre-determined level. Consequently, the loudspeaker will fall silent until an actual transmission is received.

rectifier stage determines whether or not the electronic switch, ES4, is open or closed. The latter in turn controls electronic switches ES1 and ES2.

When the noise level is below the pre-determined value switch ES1 is closed and switch ES2 is open. Therefore, the output signal from the demodulator is passed directly to the audio input. On the other hand, when the noise level is excessive, switch ES1 will be open and ES2 will be closed. This effectively interrupts the signal path and short-circuits the input to the audio stages. The combination of ES1/ES2 is included in order to eliminate any disturbing switching sounds from the output amplifier.

automatic squelch

A squelch ensures that a receiver amplifier does not get inundated by unwanted noise when the transmitter signal is not present. Such a device is essential for communications equipment, since the transmitter is switched off between transmissions. If the receiver does not possess a squelch circuit, the noise literally bursts out of the loudspeaker during these breaks.

Besides the straightforward construction and calibration, a major advantage of the automatic squelch circuit described here is the fact that you do not have to be an expert to install it into the audio section of the receiver.

pleted. The noise which builds up during the breaks can be suppressed with the aid of a squelch circuit.

Basically, there are three different types of squelch systems: carrier squelch; noise squelch; and signal-to-noise squelch. The carrier squelch circuit derives its information from the presence or absence of the transmitted carrier wave. It is evident that this system cannot be used with single sideband (SSB) or double sideband (DSB) transmissions as the carrier wave is suppressed. The noise squelch circuit checks whether or not the transmitter is active by examining the amount of noise present outside the audio pass band, since a strong noise signal is produced when no transmitter signal is present. The last system is the signal/noise squelch circuit which determines the relationship of the detected signal to the amount of noise present continuously. The audio signal is not passed on to the amplifier stages if the ratio of signal/noise drops below a certain level. The major drawback of this system is that it is a rather extensive and complicated circuit, compared to the other systems.

At the beginning of this article we mentioned the bandwidth of communi-

Block diagram

The block diagram of the automatic squelch control circuit is illustrated in figure 1. The output signal from the demodulator is fed to a buffer amplifier, A1. The output of this buffer is then fed back to the volume control (the audio input) via an electronic switch (ES1). However, the buffer output is also fed through a bandpass filter (A2) to an amplifier (A3) and a rectifier stage (A4). The DC output of the

The circuit

The circuit diagram of the automatic squelch control is shown in figure 2. The connection to the 'hot' end of the volume potentiometer is broken inside the receiver. This lead is then connected to the input of the buffer amplifier A1. The output of the buffer amplifier is then connected to the 'hot' end of the volume potentiometer via ES1.

As the circuit is powered by a single supply rail, the opamps have to be biased 'artificially'. This is accomplished by the potential divider R3/R4, resistor R1 and preset potentiometer P2. Consequently, the non-inverting inputs of A1 and A2 receive approximately half the supply voltage.

The output of A1 is also fed to the input of opamp A2, which forms the bandpass filter, via capacitor C4 and preset potentiometer P2. The LC tuned circuit connected between the inverting input and the output of A2 determines the centre frequency of the bandpass filter. The centre frequency can be changed quite easily, by altering the value of the inductor, L1, and/or the capacitor, C5. With the values indicated, the centre frequency is around 5 kHz. The signal level fed to the input of the bandpass filter can be set by means of P2.

On its route to the rectifier stage constructed around A4, the output signal from the bandpass filter is amplified considerably by opamp A3. The gain

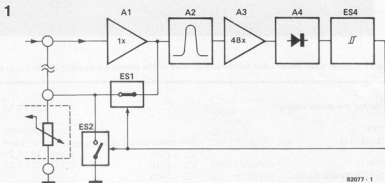

Figure 1. The block diagram of the automatic squelch control.

2

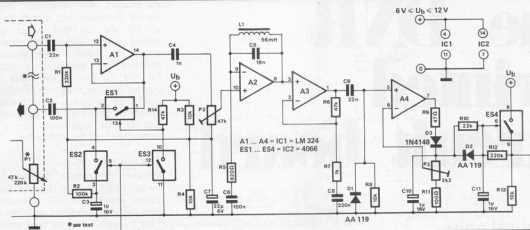

Figure 2. The circuit diagram of the automatic squelch control.

of the rectifier stage can be adjusted by means of preset potentiometer P3. The circuitry around electronic switch ES4 not only acts as a Schmitt trigger, but also ensures that the switch is not continuously opening and closing. When the voltage across capacitor C10 exceeds a certain value, ES4 is activated and the full supply voltage appears across resistor R13. The combination D2, R10, R12 and C11 slows down the switch when this voltage changes value, thereby preventing short noise pulses from influencing the circuit. The junction of ES4 and R13 is connected to ES2 and ES3. The combination ES3 and R14 functions as an inverter and drives ES1. Thus, the circuit shown in the block diagram is realised. Switch ES1 will be closed and ES2 will be open when only a little noise is detected, therefore the output of buffer amplifier A1 is fed to the input of the receiver audio stages. On the other hand, when a lot of noise is present, ES1 will open and ES2 will close. Consequently, the loudspeaker will remain silent.

3

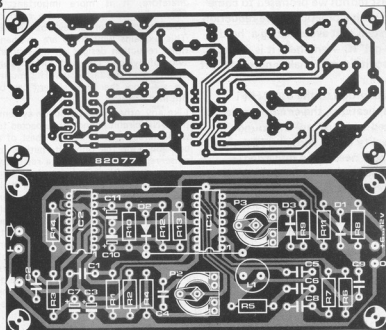

Figure 3. The printed circuit board and component overlay for the automatic squelch control.

Parts list

P2 = 47 k preset
P3 = 2k2 preset

Resistors:

R1, R12 = 220 k
R2 = 100 k
R3, R4, R8, R13 = 10 k
R5 = 820 Ω
R6, R14 = 47 k
R7 = 1 k
R9 = 47 Ω
R10 = 22 k
R11 = 100 Ω

Capacitors:
C1, C9 = 22 n
C2, C6 = 100 n
C3, C10, C11 = 1 μ/16 V
C4 = 1 n
C5 = 18 n
C7 = 22 μ/6 V
C8 = 220 n

Semiconductors:
D1, D2 = AA 119
D3 = 1N4148
IC1 = LM 324
IC2 = 4066

Miscellaneous:
L1 = coil 56 mH

which the squelch circuit is activated) is set by means of P3. The setting of P2, although sounding complicated, is really quite simple. An incorrect setting of P2 means that the circuit switches on and off continuously. In which case P2 should be adjusted until the circuit reacts as it should.

The automatic squelch control could be used in a number of applications such as CB transceivers, the MW receiver (Elektor March 1981) and the induction loop paging system (Elektor January 1982) when used as a 'babyphone' or intercom.

the DNR printed circuit board

a practical noise reduction system

Last month we promised to come up with a practical noise reduction system that avoids using a 'hard-to-get' IC — and here it is. The circuit literally makes noise go 'off the air'.

In addition to the usual HiFi applications, the circuit can be used to 'brush up' the sound quality of old records. They no longer need to be discarded because of the grating noise that made listening to favourites of years gone by almost unbearable. The same goes for FM radio: remote stations will sound much clearer once noise is eliminated.

Noise is a universal problem, whether on television, radio, records or cassettes. It is even more irritating than distortion, especially in cases where the trebles are reproduced as piercing notes. As a rule, therefore, it is more important to accomplish a signal to noise ratio of 70 dB than a distortion level of -70 dB. This explains why there are so many noise reduction designs on the market, two of which, CX and DNR, were described in the last issue. This month we see how the DNR system can be put into practice.

Like any other noise reduction system, the DNR circuit cannot be expected to work miracles. It makes the 'best of a bad job', for the only alternatives to noise reduction are to use a relatively noise-free signal source together with high quality equipment having a high signal-to-noise ratio. Let's face it, even high quality tuners using rotational, multi-unit aerials and professional tape recorders are not totally noise free. But, at least they do reduce noise to an acceptable level. It is when the use of less-than-top quality cassette recorders and gramophone records is contemplated that noise reduction systems really can make an impressive improvement to the overall signal-to-noise ratio.

As readers will remember, the DNR circuit described last month contained an IC, the LM1894, which unfortunately is very difficult to obtain. The circuit in figure 1 gets around that problem by providing a substitute for the IC, but at the same time it creates another snag: the circuit is not nearly as compact. Nevertheless, the board has been kept to a reasonable size and can be connected into a stereo system without any difficulty.

The circuit

Most of the circuit in figure 1 looks similar to a LM 1894 National Semiconductor application. IC1, a double OTA with darlington buffers, is in the centre.

Two low-pass filters are built around the IC and have a turnover frequency that is dependent on the control current through pins 1 and 6. The greater the current flow, the higher the turnover frequency. The filter configuration is slightly different from the version shown in figure 5 in the February article. This time, the negative input of the OTAs (virtual ground) is driven instead of the positive input. The current source controlled capacitors C3 and C4 replace the active integrator. A capacitor voltage buffered by darlington transistors constitutes the output voltage of the DNR circuit and this is reverse fed back to the negative input of the double OTA by way of R13 and R14.

By way of a series resistor (R9 . . . R12), both OTA inputs are provided with a current which serves to improve the linearity of the input stage. After all, the OTA is simply a differential stage with a collector current that is equal to half the control current I_{ABC} . Differential stages tend to get overdriven rather easily, which is why the OTA input is often derived after a considerable voltage division. As a matter of fact this is not necessary in this particular application, as the OTA used here is not the type to be overdriven. The circuit diagram for the dynamic noise filter substitute is very straightforward indeed: it includes an RC filter with a resistor between its input and output and a capacitor between its output and ground. The dynamic constituent of the filter is provided by the variable RC time — in other words, the adjustable turnover frequency. The further the signal is filtered, the higher the voltage across resistor R. In figure 1 this will be seen to correspond to the current passing through C3 and C4, respectively. I_{ABC} determines the maximum current level. The filter attains its optimum performance when the turnover frequency is at a minimum (at around 800 Hz). This occurs when there is plenty of noise, but no other input signal to speak of. As soon as this happens, the I_{ABC} (as will be apparent later) and, therefore the modulation, increases. Thus, the OTA operation is based on an increasing bandwidth to

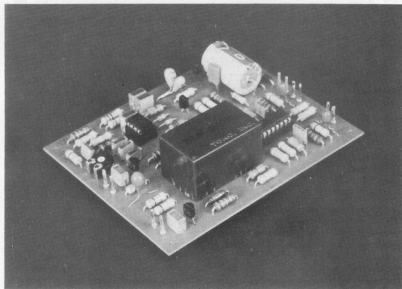

1

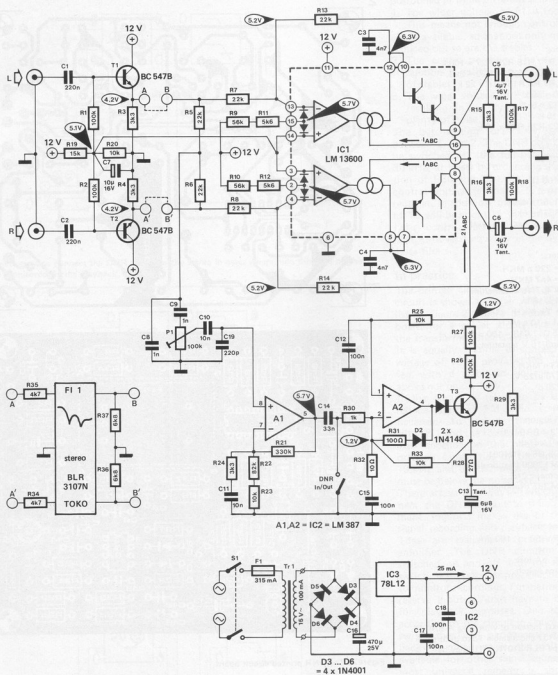

82080-1

Figure 1. The DNR circuit diagram.

rising modulation ratio.

Now to get back to the DNR circuit inputs. The emitter followers, T1 and T2, buffer the left-hand and the right-hand input signals, and for a very good reason. For not only does this provide the circuit with an input impedance of around 100 k, but the signals have to be buffered if the stereo pilot tone filter is to be added (between A and B and A' and B'). The filter must be driven from a source impedance of 4k7 and be terminated with the same value

(R34 . . . R37). The filter may be necessary to make sure the pilot tone residues (19 kHz and 38 kHz) are below the noise level. What is at stake here is the effect of the pilot tone residues on the control loop, rather than on the output signal. Now that we're on the subject, let's take a look at the control loop.

Resistors R5 and R6 add up the left and right channel input signals. The capacitors, C8 and C19, serve to attenuate frequencies above 16 kHz. The wiper position of P1 exerts a considerable in-

fluence on the gain factor of the control loop. The latter determines the extent to which the L + R signal affects the turnover frequency of the two noise filters with the aid of the control current I_{ABC}. The circuit around A1 amplifies the control signal. Its gain factor is frequency-dependent. At very low frequencies, the gain of A1 is 4½; at frequencies above 6 kHz this rises to 100. The time constant formed by R24 and C11 corresponds to a turnover frequency of around 6 kHz. A1 is followed

Parts List for figures 1 and 2

2

Resistors:

R1, R2, R17, R18, R26, R27 = 100 k
 R3, R4, R15, R16, R24, R29 = 3k3
 R5, R6, R7, R8, R13, R14 = 22 k
 R9, R10 = 56 k
 R11, R12 = 5k6
 R19 = 15 k
 R20, R23, R25, R33 = 10 k
 R21 = 330 k
 R22 = 82 k
 R28 = 27 Ω
 R30 = 1 k
 R31 = 100 Ω
 R32 = 10 Ω
 R34*, R35* = 4k7
 R36*, R37* = 6k8
 P1 = 100 k preset (see text)

Capacitors:

C1, C2 = 220 n MKH
 C3, C4 = 4n7 MKH
 C5, C6 = 4 μ 7/16 V tantalum
 C7 = 10 μ /16 V
 C8, C9 = 1 n MKH
 C10, C11 = 10 n MKH
 C12, C15, C17, C18 = 100 n MKH
 C13 = 6 μ 8/16 V tantalum
 (or 4 μ 7/2 μ 2)
 C14 = 33 n MKH
 C16 = 470 μ /25 V
 C19 = 220 p

Semiconductors:

T1, T2, T3 = BC547B
 D1, D2 = 1N4148
 D3, D4, D5, D6 = 1N4001
 IC1 = LM13600 (National),
 Technomatic Ltd.
 IC2 = LM387 (National)
 IC3 = 78L12

Miscellaneous:

Tr1 = 15 V/50 ... 100 mA
 transformer
 F1 = 315 mA fuse
 S1 = mains switch

Note:

* (see text) Instead of wire links A-B/A'-B',
 R34 ... R37 and a single Toko pilot tone
 filter, type BLR 3107N (F11) may be
 connected.

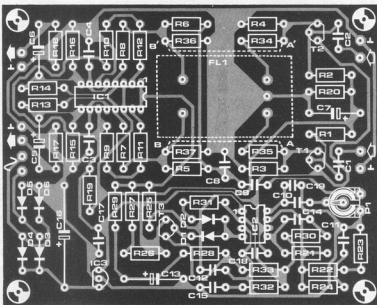
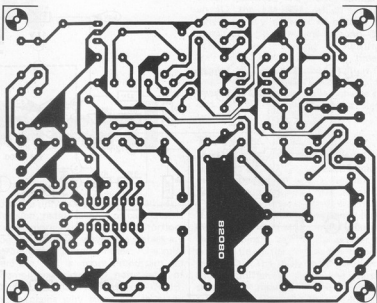

Figure 2. The DNR printed circuit board.

by the negative peak rectifier around A2. The storage capacitor C13 is charged from T3 by way of R28, provided the output voltage of A2 is sufficiently positive with respect to the voltage across C13 to make D1 conduct. As soon as this happens, the gain of A2 — in other words, the ratio of the emitter voltage of T3 to the output voltage of A1 — will be determined by the ratio of R33 to R30 and C14 connected in series. Again, operation is based on frequency-dependent behaviour. The control loop has the frequency characteristics of a high-pass filter featuring a turnover frequency of

6 kHz and a filter slope of 12 dB per octave. The reason for this parameter was explained in the February issue. By connecting R31 and D2 in series, the output of A2 is prevented from becoming too low when D1 no longer conducts. R32 and C15 are also connected in series, which is necessary to limit the open loop gain of A2 during the periods that D2 conducts, whereas D1 does not. This is essential, since A2 (one half of the LM387) is compensated for a greater closed loop gain than while D2 conducts.

The OTA control current $2|I_{BC}|$ is determined by the voltage across C13

and R29. The greater the voltage across C13, the greater the control current and therefore the turnover frequency of the dynamic filters. The voltage across C13 in turn depends on the level of the control signal; in other words, on the extent to which frequencies above 6 kHz are represented in the control signal. That covers the function of the control loop. A slight current I_{ABC} passes through resistors R26 and R27. This is partly used to adjust the DC level of A2 (by way of R25). Something should be said about P1. This adjusts the gain of the control loop. The lower the wiper position of P1, the

3

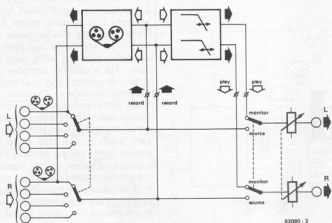

Figure 3. How to connect the DNR circuit to the stereo in cases where recordings do not have to be monitored during playback.

4

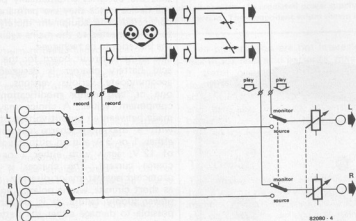

Figure 4. Here the DNR circuit is connected permanently and exclusively to the playback module in the cassette deck.

5

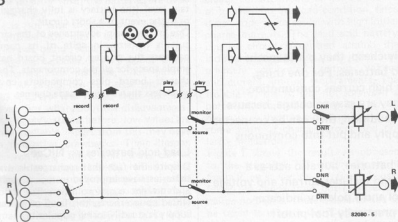

Figure 5. The most universal solution: the DNR can be switched off both for all types of signal sources and to allow recordings to be monitored.

greater the noise reduction. P1 can be positioned in three different settings:

1. The wiper voltage of P1 is too low. This means not enough control voltage is available, so that not only noise is reduced but so are the trebles.
2. The centre position. The noise reduction is satisfactory without loss of trebles.
3. The wiper voltage of P1 is too high, resulting in plenty of trebles and plenty of noise.

The best setting for P1 is half-way between 1. and 2. The DNR control can be switched off (the full bandwidth of 30 kHz, at least) by grounding the junction of R30 and C14. As a result, the control voltage is unable to reach the rectifier. In addition, the emitter voltage of T3 will be about 11 V, causing a high IABC control current and therefore a high turnover frequency in the dynamic noise filters.

In practice

The printed circuit board for the DNR circuit is shown together with the parts list in figure 2. There is room on the board for a power supply, apart from the transformer, mains switch and fuse. It is equally feasible to connect a DC voltage of 15 V, provided the circuit is fed with a stabilised voltage neither above nor below 12 V.

If the circuit is (also) to be used to reduce noise on FM radio, it may be necessary to include the pilot tone filter F11 and the resistors R34... R37. This depends on the pilot tone suppression capabilities of the tuner. The 19 kHz and 38 kHz pilot tone residues must be below the noise level.

There are various ways in which to connect the DNR circuit to stereo equipment. Figure 3 makes use of the tape signal recording and playback facilities. These are available in practically any amplifier. The DNR circuit can be switched on and off with the monitor switch. It is no longer possible, however, to monitor recordings. Furthermore, the reserve inputs ('Aux') have to be used for playback purposes. One solution, according to the circuit in figure 3, is to switch the DNR permanently to playback. In other words, the unit is not available for other signal sources. The most universal remedy is shown in figure 5, but this involves modifying the amplifier.

The Elektor DNR prototype was tested thoroughly. All sorts of signal sources with various levels of noise were connected up. On the whole, the results were satisfactory. The setting of P1 (noise reduction without loss of trebles) proved to be rather dependent on the signal source. It might be a good idea to substitute the preset for an ordinary potentiometer, but then again this depends on what the circuit is used for. At excessive noise levels during breaks in the music, audible fluctuations occurred in the noise volume. Again, this depends on the programme material. ■

lead acid battery charger

safe and easy to use



Although NiCad batteries are relatively cheap, they by no means eliminate hermetically sealed lead acid batteries. For one thing, it is more economical to use them for high current consumption applications. As opposed to NiCads they are easy to charge, because they have a specific charge density. In addition, they can be connected in parallel to the load and a power supply and put into continuous operation.

The circuit not only charges lead acid batteries, but also acts as a power supply. It is polarity-protected and includes current and voltage limiting. It also provides charge control and a polarity indicator. In other words, the battery charger is practically fool-proof!

Compact lead acid storage batteries, like the well-known 'Dryfit' from Sonnenschein and YUASA from Japan are very popular with model hobbyists. Very often the smaller types (6 V and 12 V; 1.1 Ah) fit in equipment that is normally supplied with baby or mono cells, for example, portable TV sets, video recorders and battery-powered cassette recorders. In such instances these batteries are a cost-saving alternative to non-rechargeable batteries. Compared to the NiCad batteries they are very easy to recharge since they can remain inside the equipment. The power supply/charger is simply connected to the power supply socket of the device. It then takes over from the mains power supply while simultaneously recharging the batteries. As soon as the batteries are fully charged, they are topped up with a small 'stand-by' current. The charger may remain connected to the device for an unlimited period of time.

The moment the mains plug is pulled out, the batteries automatically power the device, since they are permanently connected. The equipment merely has to be connected to the mains again for the batteries to be recharged.

The printed circuit board for the lead acid battery charger is designed to accommodate various versions, with one or two minor modifications in component values. A choice may be made between an output voltage of 6 V with a maximum charge current of either 1 or 3 A and an output voltage of 12 V, again with either 1 or 3 A charge current. The charger is well protected against major disasters, such as short circuits, wrong polarity and/or power supply failure. It is almost impossible to damage either the batteries or the charger.

To make things easier, a LED is provided which lights up when the battery is connected the wrong way round. A second LED illuminates when the charge current starts to flow and goes out when this drops below a certain level (the battery is fully charged) or in the event of a short circuit.

One of the main advantages of the circuit is its size. In spite of its compactness the printed circuit board has ample space for all the components. The charger board plus components cost much less than a ready-made charger.

Lead acid batteries vs. NiCads

Despite the fact that rechargeable dry batteries have improved in recent years and do not cause pollution like their NiCad counterparts, this form of power supply is steadily losing popularity.

One of the main reasons for this is that dry lead acid batteries start to be available from a nominal capacitance of 1 Ah, NiCads on the other hand can be acquired at much lower values. The

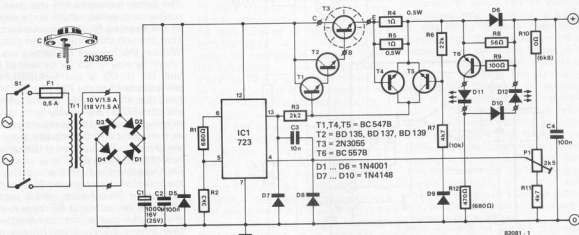

Figure 1. The lead battery charger circuit. Basically, it consists of a regulated power supply including limiting, polarity protection and LEDs to indicate the polarity of the battery and the output current. The component values shown in brackets refer to the 12 V circuit.

minimum nominal capacitance of 1 Ah roughly corresponds to a single cell (the 'round cell' by General Electric), whereas Sonnenschein offers series that can be substituted for 4 or 6 baby or single cells.

Compared to NiCads, lead acid batteries have the following advantages:

- The cell voltage is 66% higher, since it has a nominal value of 2 V.
- It is very straightforward to control with the aid of a specific 'full' charge voltage.
- They react better to both high and low temperatures.
- They present a very low discharge. In fact they still rate 50% of their nominal capacitance after 16 months' quiescence at 20°C.
- There is no danger of damage and loss of capacitance caused by changing the polarity when the batteries are over-charged.
- It is not wise to store over-discharged batteries for more than four weeks without being recharged. Their current carrying capacity is very good. Drift batteries, for instance, that have a 1.1 Ah rating, can be loaded with up to 40 A. Very few NiCad types can beat that. But what about the disadvantages? As already stated before, low values are not available. Apart from this they have a few other drawbacks. Their lifespan is relatively short and they cannot always be charged rapidly. NiCad manufacturers claim their batteries provide 500 times the nominal capacitance; whereas Sonnenschein types can only manage a factor of 200 and up to 1000 charging cycles in the case of partial discharge. This may sound a lot less, but in practice such batteries enable model enthusiasts to run a boat for several years.

Even readers who are not interested in leak-proof lead acid batteries, may find a useful occupation for the charger described here. The circuit will act as an efficient 6 V or 12 V power supply and can also be used to charge car batteries.

The circuit

The circuit charges sealed lead acid batteries in a very straightforward manner. Readers merely have to keep an eye on the charge voltage and make sure this does not exceed 2.3 V per cell, to prevent an overcharge. Contrary to NiCad batteries, the initial charge state (partial discharge) is totally irrelevant. As a power supply therefore, the circuit is fully stabilised. In addition, the charge current should be limited too, so as to avoid an overload condition, since it can cope quite easily with high initial charge currents. The lead acid battery charger circuit is centred around the indispensable 723 IC. This meets the precisely calibrated output voltage and current limiting requirements. The trouble is, the IC will not survive if a battery is connected with the wrong polarity, so that the circuit must include some form of charge current and polarity indication.

Figure 1 shows the result. As opposed to the standard 723 circuit shown in figure 2, the version in figure 1 uses fewer pin connections but more external components. These measures had to be taken to protect the IC against negative voltages in the event of an incorrectly connected battery. Obviously, the fewer pins there are to protect, the easier it is to shield the IC. The 723 now merely acts as a reference voltage source

and transistors T1... T5 constitute the opamp, the output stage and the current limiter.

The voltage divider R1,R2 divides the nominal reference voltage of 7.15 V at pin 6 down to 6 V at pin 5. This enables an output voltage of 6.9 V to be implemented for the 6 V circuit. Pin 5 is the non-inverting input of the opamp inside the 723. The output voltage is fed back by way of the voltage divider R10,P1 and R11 to the inverting input of the opamp (pin 4). Capacitor C3 serves to prevent oscillation and is connected between pin 4 and the output of the opamp at pin 13.

Diodes D7 and D8 protect the circuit against polarity confusion by limiting the negative voltage to 0.7 V. The darlington output stage consists of T1... T3 and provides the necessary current amplification. T3, a 2N3055, is well equipped to cope with the amount of dissipation expected due to the difference in voltage level between the non-calibrated voltage at the charge capacitor C1 and the output voltage (and current).

T4 limits the output current. As soon as the voltage at the 'current sensor resistors', R4 and R5, drops to about 0.6 V, T4 starts to conduct and draws base drive current from T1. This stops the output current from rising any further.

T5 is connected in parallel to T4. Normally speaking, T5 does not conduct since its base voltage does not get a chance to become more positive than that at the emitter. This situation will only alter if a battery is connected with the wrong polarity. D9 will now be forward biased, enabling the transistor to be supplied with base drive current by way of R7. The transistor starts to

current to rise above 10 mA, if necessary. LED D11 is lit, provided a charge current flows through the circuit, the battery polarity is correct and no short circuit is produced at the output.

1 A operation

The circuit can be constructed for either 6 V or 12 V. The component values required for the 12 V version are indicated in brackets in the circuit diagram and the parts list. Apart from the transformer and the electrolytic capacitor only three resistors (R7, R10 and R12) have to be modified, if the 12 V version is chosen.

Where 6 V batteries have to be charged, the output voltage is adjusted with P1 to 6.9 V (± 0.1 V) when the circuit is quiescent. This can be done with a multimeter. In the case of 12 V batteries, the quiescent voltage of the charger must be adjusted to 13.8 V (± 0.1 V). Transistor T3 must always be cooled. In 1 A applications, however, the heat sink can be relatively small and can even be omitted if the transistor is mounted on the back of a metal case.

3 A operation

The above also applies to 6 V/3 A and 12 V/3 A circuits, only now the transformer, capacitor C2, diodes D1...D6, R4 and R5 must be modified to cope with the higher output current. The new values are indicated in the parts list. In the 3 A output current circuits, cooling transistor T3 is a little more critical. At an output voltage of 6 V, a heat sink of 2°C per Watt will guarantee enough heat dissipation even if a short circuit condition lasts for a relatively long time. At 12 V the transistors have to dissipate a considerable amount of power. In the case of a short circuit, T3 has to get rid of some 50 Watt. Provided the short circuit does not last longer than a few minutes, a heat sink may be used with a heat resistance of 1.5°C per Watt. If the circuit is to be short proof for longer periods, however, it is advisable to distribute the output power between two transistors, as shown in figure 3.

Charging car batteries

The 3 A version is particularly suitable for charging car batteries. About 36 Ah can be charged during the night. Using

the indicated output voltages of either 6.9 V or 13.8 V, starter batteries can be recharged to about 75% of their nominal capacitance. Generally, this should be enough to revive a dead battery. Furthermore, the battery can be connected for an unlimited length of time at these voltage levels. Readers who intend to use the charger for this purpose only should set the output voltage at a higher value to be on the safe side. If 2.4 V is provided per cell, the battery will reach 80% of its nominal value and 2.65 V will bring it up to 100%. Once the battery is fully charged, topping it up any further will damage it in the long run. If the battery is to be charged overnight, an output voltage of either 8 V or 16 V will be perfectly safe, but do not forget to disconnect the charger in the morning!

With regard to R4 and R5, they may be replaced by a single resistor that has half the value but double the load capacity, such as $0.47\ \Omega/\text{W}$ for 1 A, for instance. The LEDs may be any colour, since it makes no difference to the circuit. In the prototype the charge control LED (D11) was green and the polarity indicator (D12) was red.

4

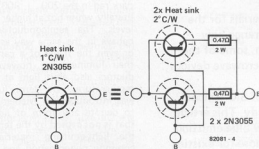

Figure 4. This drawing shows how transistor T3 may be replaced by two transistors connected in series. Another solution is to mount T3 without a mica washer and to apply heat conductive paste to a heat sink having a heat resistance of less than $1^{\circ}\text{C}/\text{W}$.

5

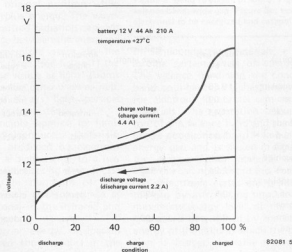
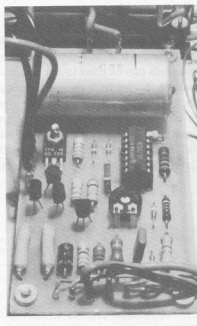

Figure 5. Terminal voltage of a 12 V car battery during the charge and discharge process. The output voltage must be set at about 16 V to ensure the car battery is fully charged.



Silicon carbide is by no means a 'new' semiconductor material, even though it has come into vogue only fairly recently. In fact it is one of the oldest materials, its electroluminescence being reported by Round as early as 1907 (Round was working with SiC crystals at that time). As far as its semiconductor properties are concerned, SiC is similar to silicon, but there are several essential differences. SiC has a non-axial crystal structure, a large unit cell and a large band gap, meaning that the physical phenomena observed are extremely complicated to interpret. Unlike other large-gap semiconductors, SiC can easily be doped both p- and n-type, although involved techniques have to be developed to deal with its extreme hardness and chemical inertness. For this reason the amount of research that has

been carried out to date is rather limited. Furthermore, scientists have as yet failed to come up with a practical method for processing single-crystal silicon carbide, which is essential if the semiconductor material is to be implemented in electronics. Consequently, semiconductors were initially made of germanium and later silicon, using increasingly advanced technology. It is only now, when the sky seems to be the limit as far as silicon applications are concerned, that less common semiconductor materials, such as gallium, arsenic and silicon carbide, are being rediscovered. This is because there are a few areas in electronics to which they are particularly suited. Gallium, for instance, is ideal in LEDs and RF semiconductors. Now that silicon carbide has been found to emit blue light, the 'file' dating back to 1907 has at last been reopened. But before we examine the properties of SiC in detail, let us find out how semiconductors emit light in general.

blue LEDs

silicon carbide may provide the answer

Large-gap semiconductors are potentially useful materials for the manufacture of light-emitting diodes. Their spectral range now includes the blue and ultra-violet regions. In addition, some of the materials can be used to manufacture high-power microwave devices and sensors for high-temperature operation.

During the past three years, the physical properties of SiC (silicon carbide) have been the subject of an enlightening study. This article describes this semiconductor material and shows how blue-emitting SiC diodes can be produced by methods similar to those for existing GaAs (gallium arsenide) or GaP (gallium phosphide) devices.

Semiconductor light

Any semiconductor will emit light at a certain temperature. The material goes dark red in the 700 . . . 900°C range and literally white hot at higher temperature levels. The semiconductor will then behave in the same way as a light bulb or even the flame of a candle. Due to their luminescence, however, semiconductors also emit light at much lower temperatures. The term 'luminescence' was introduced by Wiedemann in 1889 to denote any form of light emission that is not caused by the temperature of the light-emitting material. It is a common phenomenon and can be seen in fluorescent TV screens, etc.

Table 1.

material	band gap eV	emission wave length nm	emission range	recombination type
germanium	0.66	—	—	indirect
silicon	1.09	—	—	indirect
gallium arsenide	1.43	910	infrared	direct
gallium arsenide phosphide	1.91	650	red	direct
gallium phosphide	2.24	560	green	indirect
silicon carbide	2.5	490	blue	indirect
gallium nitride	3.1	400	violet	indirect

Table 1. The band-energy gap and radiated wavelengths of various semiconductor materials.

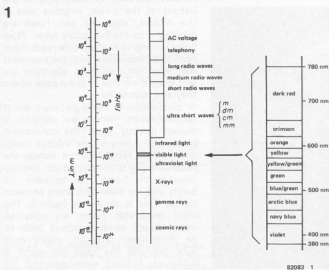

Figure 1. Visible light is part of the electromagnetic spectrum and ranges from the 380 (violet) to the 780 nm (dark red) wavelength.

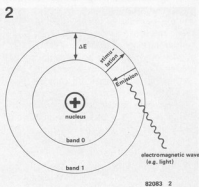

Figure 2. The light emission principle, as represented in Bohr's atomic model. Stimulated (energized) electrons are launched into a higher (further away from the nucleus) more energetic band. During light emission, the electrons return from the outer band to one on the inside. The difference in energy between the two bands is radiated as light.

Light emissions are based on the following principle. When an atom is supplied with energy, it is stimulated and absorbs the energy. An atom can only be energized very briefly before returning to its stable ground state. The absorbed energy is then released as electromagnetic radiation which assumes the form of visible light when it coincides with a certain wavelength.

Bohr's atomic model as illustrated in figure 2, can be used to visualise this process: atoms move in a fixed orbit around the nucleus, rather like planets around the sun. Energy in the form of a high-speed electron is propelled in from the exterior and collides with one of the electrons belonging to an atom. This absorbs the incoming energy and is launched into a higher, more powerful orbit. The whole process lasts a very short time, after which the electron returns to its original position while releasing its surplus energy. The wavelength of the emitted radiation depends on the difference between the energized and the non-energized state. In the 380...750 nm range (see figure 1) the radiation will be visible as light. Atoms can be stimulated in other ways as well, with the aid of X-rays, light, particle radiation, or heat, for instance.

The same principle applies to luminescence in semiconductor materials. Again, light is produced by electrons returning from a high energy to a low energy state while releasing their excess energy, usually in the form of heat (phonon vibration), but sometimes as radiation (photons) in the infrared and visible light range.

The charge carrier energy dissipation process described above occurs in the polarised pn junction of a diode that is forward biased. To understand this process, let us make a short 'excursion' into semiconductor technology.

3

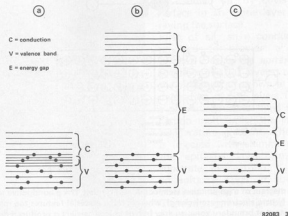

Figure 3. Band structure in solids. Figure 3a: the conduction band, no gap. Figure 3b: the valence band, wide gap. Figure 3c: semiconductor, narrow gap. This enables electrons (valence electrons) to be energized and catapulted from the valence band to the conduction band.

In semiconductor materials, electrons assume certain levels of energy only. The valence band and the conduction band both have the highest energy levels for electrons in normal semiconductor materials. The separation between the top of the valence band and the bottom of the conduction band is known as the energy gap and is shown in figure 3. If the semiconductor material is pure, electrons can not exist in this 'forbidden' gap. Electronic states are produced in the gap by introducing impurities. The maximum energy level of the emitted photons is determined by the band gap energy of the solid in which the pn junction is formed. Suitable materials for LED devices are GaAs, GaP and SiC. Thus, blue light having a wavelength of 380...440 nm in the short wave region of the emission spectrum can

only be derived from semiconductor materials that have a corresponding band gap. This is why gallium junctions, for instance, cannot emit blue light.

Table 1 provides a survey of various semiconductor materials and lists them according to their band gap, wavelength (if available) and radiation range.

Semiconductor photo diodes

Figure 4 shows the structure of a semiconductor photo diode. It consists of n doped and p doped semiconductor material. The area between the p zone and the n zone is called the boundary layer or junction, in which the illuminating recombination occurs. The doping material in the p zone contains atoms which all have one valence electron less than semiconductor material.

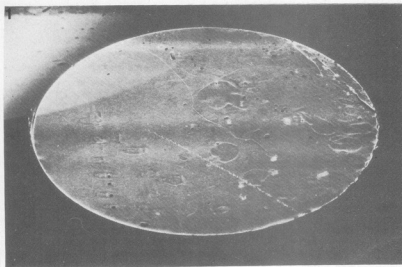

Photo 1. X-ray of a silicon carbide wafer which can be used in spite of the irregularities shown.

4

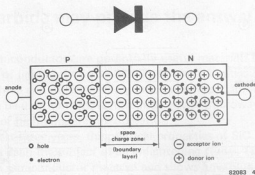

Figure 4. Block diagram of a pn junction (semiconductor diode). The p conductive material contains 'holes' (where electrons are lacking), whereas the n material features too many electrons. In the contact or boundary zone, an area free of charge carriers is produced due to recombination. Holes 'swallow' electrons, so that both holes and electrons disappear from the conduction band. Charge carriers are unable to cross this barrier until a forward voltage is connected that exceeds the threshold value.

As a result, the 'acceptor' ions remove the valence electrons from the semiconductor atoms, leaving a series of 'holes'! The electrons represent mobile positive charge carriers and are called p semiconductors. The exact opposite happens in n semiconductors, where the doping material contains one valence electron more than semiconductor material. Since the electron is superfluous, it is released as a free electron by the doping material or 'donor'. When the junction is not provided with a voltage, the holes and electrons in this region exchange their charges. As a result, a narrow strip on both sides of the boundary layer is totally deprived of mobile charge carriers. At the same time, the positively charged donor ions in the n zone and the negatively charged acceptor ions in the p zone remain within the region and build up a space charge. By applying a voltage in the

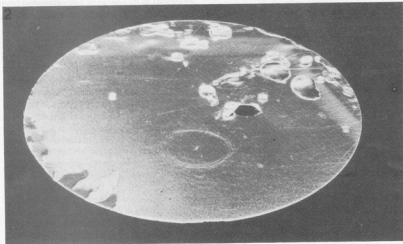

Photo 2. X-ray of a badly damaged silicon carbide wafer.

forward direction (positive pole of the battery at the p side, negative pole at the n side), electrons and holes are injected into the boundary layer. Now holes belonging to the p side reach the n zone and 'recombine' with the abundant free electrons. Similarly, electrons are sent from the n side to the p zone where they also recombine.

A distinction is made between direct recombination (where an electron is moved directly from the conduction band into a hole in the valence band) and indirect recombination (where the recombination is not carried out directly between the bands, but between the bands and the transition levels between them). This is shown in figure 5. The most favourable ratios are obtained using 'direct' semiconductors (able to be recombined directly), which emit light provided the band gap width is sufficient. Indirect semiconductors are also able to emit light at a certain band gap width. This can be controlled by injecting foreign atoms, 'iso-electronic centres'. GaP LEDs, for instance, are doped with nitrogen to make them emit green light. Injecting zinc oxide, on the other hand, causes them to emit red light.

Silicon carbide for blue LEDs

As can be seen from Table 1, silicon carbide constitutes an indirect type of semiconductor with a large band gap. This allows visible radiation to occur within a wide colour range, so that even blue light may be produced. Various colours are obtained at different transition levels. As opposed to GaN (gallium nitride) and Zn (S,Se) junctions, SiC can be p and n doped without any difficulty. The trouble is, SiC junctions have a low luminescence performance. Once a suitable iso-electronic recombination centre has been found, the luminescence will be improved. SiC

5

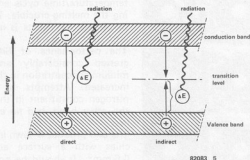

Figure 5. Recombination of electrons and holes. Once a forward voltage is connected, electrons and holes are injected into the barrier zone and reach the other side. Holes and electrons recombine, that is, the electrons leave the conduction band and fill the vacancies (holes) in the valence band. The difference in energy is radiated in the form of an electromagnetic wave which illuminates the LED.

3

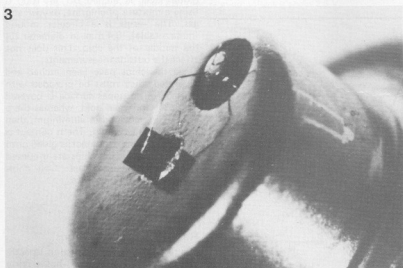

Photo 3. An LED chip mounted in a TO-18 case.

6

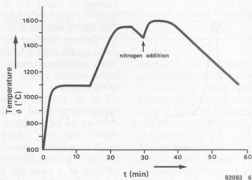

Figure 6. Cross-section of an SiC LED chip.

involves technological problems as well due to the high temperature requirements for the epitaxial and gas etching processes. Once these problems have been solved, SiC single crystal wafers will be able to be produced on a large scale. At present, relatively small wafers, about 15 mm in diameter, are available. Research in this field is being carried out in the United States, Japan, West Germany and Russia.

Pn junctions are usually fabricated according to the epitaxial method. Interesting results have been obtained in Japan by Matsunami and in West Germany by Von Münch and Kürzinger.

Fabricating blue LEDs

SiC crystal chips constitute the raw material. Only two methods (Acheson and Lely) exist to manufacture a fairly low yield of SiC chips. Not only do the crystals have to be ground and polished, but each one has to be inspected carefully to see whether it is suitable. Since the crystals are made of sand containing aluminium, the wafer material is p conductive by nature. Crystal impurities are 'shown up' by covering the chip surface in an oxide layer and then X-raying the surface.

First of all, an n conductive layer is required to provide a pn junction (diode). During the epitaxial process, a p conductive SiC layer grows on top of the substrate as shown in figure 6. The deposition of SiC layers takes place in a graphite crucible filled with a silicon carbon melt under the influence of a temperature gradient. The silicon melt is injected with aluminium to p dope the epitaxial layer growing on the substrate. In the 1600...1700°C range an epitaxial layer of about 30 μm is obtained after roughly 35 minutes. Then nitrogen is injected to provide an n doped layer. The result is a pn junction. The process is illustrated by the graph in figure 7.

7

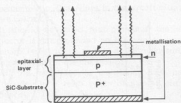

Figure 7. The temperature curve in the epitaxial process, during which a p doped and then an n doped (with the addition of nitrogen) layer is produced on a silicon carbide wafer.

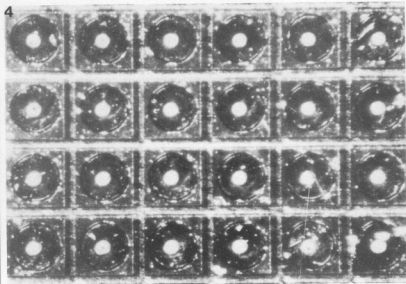

Photo 4. Close-up of LEDs on a silicon carbide wafer. Each square has a circular mesa etched surface with an n doped layer at its centre.

8

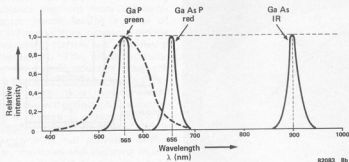
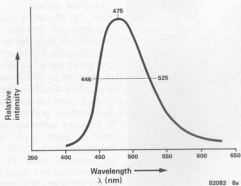

Figure 8. Figure 8a shows the emission spectrum of a blue silicon carbide LED. Figure 8b represents the spectra of various other types of LEDs. The sensitivity curve of the human eye is shown as a dotted line.

Initially, the production yield was only 30%, but this could be increased to more than 70% by introducing a new temperature/time cycle and by improving the melting crucible. The remaining percentage of rejects is mainly due to imperfect substrates.

The performance of SiC chips progressed considerably once the aluminium concentration in the p layer was increased. Attempts to modify the nitrogen constituent in the n layer, on the other hand, had no effect whatsoever.

The end product is sawn into individual chips with a surface area of $0.6 \times 0.6 \text{ mm}^2$. It should be noted that this type of chip ages very quickly. Sawing the material damages the edges of the chip, causing the light to appear greenish in colour. This may be avoided by mesa etching the material before it is sawn into chips. First of all, an oxide pattern is mounted through photo illumination, after which the chip surface that is not protected by an oxide layer is etched off at 1000°C using a mixture of chlorine, oxygen and gas. The result is a circular mound (mesa = table), 0.4 mm in diameter, in the middle of the chip. This does not affect the outside measurements.

Once the chips have been etched and separated, they must be provided with contacts. The upper surface is covered in nickel and then gold, whereas the p side is first covered in aluminium, then titanium and finally gold. The n contact is bonded and the p contact is glued onto a carrier. Lastly, the chips are mounted and cast into a package. Cast chips afford better luminescence.

Results and specifications

Figure 8 shows the emission spectra of various LED types. SiC has a fairly wide emission spectrum, since an indirect form of recombination radiation is involved with a maximum level at 475 nm, which roughly corresponds to 'arctic blue'. The LEDs have a forward voltage of about 2.5 V, as can be seen from the graph in figure 9.

The ageing process is illustrated in figure 10. During the first thirty minutes, the chips go through a 'warming-up' period. Their efficiency drops to 70% of the initial value, after which it remains fairly constant.

All in all, the SiC processing method is highly complicated, so that the chips are unlikely to be produced on a large scale within the near future. There is one small consolation, however... The chip industry is interested in using silicon carbide as a basis for RF power semiconductors. Once significant advances have been made in this area, therefore, and a suitable growth process for large silicon carbide single-crystals has been found, blue LEDs will also be available. They will be manufactured as a by-

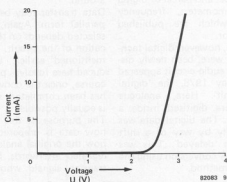

Figure 9. The voltage curve of a blue LED. The 'warm-up' voltage is about 2.5 V.

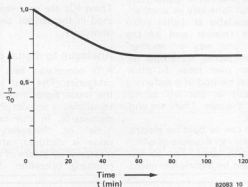

Figure 10. The ageing process in blue LEDs. After about 30 minutes, the performance remains at a constant level. This is 70% of the initial value.

product of power FET technology. And then electronic enthusiasts may look forward to using blue LEDs in their circuits . . .

Sources:

Günther Ziegler, Siemens AG, Research Laboratories, Erlangen and Munich, W. Germany: 'Blue light-emitting diodes using silicon carbide', BMFT research bulletin T81-010
 E. Pettenpaul, W. von Münch and G. Ziegler: 'Silicon carbide devices,' Institute of Physics, Conf. Ser. No. 53
 Alan Chappell, Volmar Härtel: 'Optoelectronics: Theory and Practice,' Texas Instruments Ltd., Manton Lane, Bedford.
 Stan Gage, Dave Evans, Mark Hodapp and Hans Sorensen: 'Optoelectronics Applications Manual', Mc Graw-Hill Book Company.

missing link

EPROM programmer (E 81)

For the 2732 to be programmed according to the software table, the circuit has to be modified as shown in the drawing. (The alterations do not affect the programming of the 2716). As can be seen, the wire link immediately above IC3 is removed. One of the disconnected points (linked to pin 18 of the EPROM) is connected to pin 6 of IC12. The other is connected to pin 5 of IC12. Next, S1c is wired in the manner shown: it therefore becomes a three-way switch. As far as IC12 is concerned, N12 . . . N16 = IC12 = 74LS86.

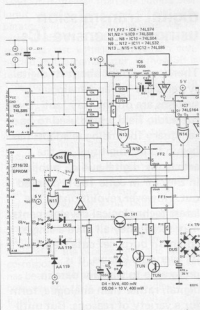

In the parts list R5 and R6 are indicated as 220 k Ω , but should be 120 k and 270 k respectively. The values in the circuit diagram are correct.

It should be noted that pin 4c of the connector is not grounded on the printed circuit board (= 4a, 16 a,c and 32 a), so make sure it is grounded on the bus board!

All the modifications mentioned have been included in a fresh batch of printed circuit boards.

The listing on page 1-30 contains an error. Line 0540 should read: 0540: 0217 D0 EA.

Admittedly, most readers will be familiar with A/D and D/A conversion processes that are the heart of any digital transmission system. For such conversions are part and parcel of digital voltmeters, thermometers, frequency counters, etc. which are published regularly in *Elektor*.

In the audio field, however, digital technology has, as it were, been newly discovered. A digital audio circuit appeared in *Elektor* in May 1978, the 'digital reverberation unit'. Here, analogue input signals were digitised inside a 'delta modulator'. The digital data was transmitted serially by way of a shift register and thus 'delayed'. This was followed by a D/A conversion using the delta modulation method.

processor system. For whatever purpose the circuit is used, the transfer channel must always be modified to the system's requirements, rather than the other way around.

Data transfer may be either in serial or parallel form. Again, which method is selected depends on the particular application of the circuit. Like the examples mentioned earlier, the system introduced here involves parallel transfer. Of course, once the conversion in question has been completed, serial data transfer is equally possible.

The purpose of this article is to show how data is prepared for transfer and how the original analogue signals can be regained afterwards. Since we wish to transfer signals whose logic state is

A/D and D/A conversion

digital transmission using inexpensive ICs

There's no doubt about it: digital systems are 'in' and analogue systems are on the way 'out'. Even the audio field which used to be a sanctuary for analogue adepts has begun to be 'digitised', as the article on 'digital audio', published in *Elektor* in June 1981, pointed out. However revolutionary the latest technological developments may seem, they all have a single, common purpose: data transfer. As everyone knows, it is preferable to transfer data in digital, rather than analogue, form for a variety of reasons. But until quite recently, the technology required just wasn't economically viable.

Meanwhile chip production has made such terrific progress that even amateur electronics enthusiasts can afford to experiment with digital circuits, such as the one described in this article.

T. Schaerer

Digital data transfer

In principle, data transmission always follows a set procedure: information is sent from a data source (the transmitter) to a data sink (the receiver) through a specific transfer channel. Basically, what happens is that data is transmitted into the channel in *digital form* and is passed on 'one way or another', so that it is available as digital information at the receiver end of the channel. The 'one way or another' leaves the user plenty of scope for realising his/her own ideas. In other words, the actual method of transferring the data is more or less left to the imagination of the user. There are endless possibilities.

A delay system can be built for electro-acoustic purposes (an example of which will be dealt with later). The transfer channel may even be a complete micro-

continually changing, the actual A/D conversion is rather slow and will be elaborated upon later. (The D/A conversion, on the other hand is almost immediate.) The conversions can be achieved very easily thanks to two readily available, low-cost ICs, the ZN 426 and the ZN 427 from Ferranti. These ICs are very versatile and can be used in the various circuits referred to previously.

Analogue-to-digital conversion

A/D conversion falls into two main categories. The first initially converts the input signal into another analogue signal that is proportional to it and then digitises it. In this case the analogue 'time' or 'frequency' instantaneous value is digitised, after which it is measured by means of a straightforward counting operation. Such a system

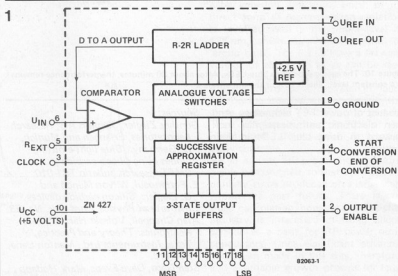

Figure 1. The internal structure of the ZN 427 A/D converter.

2

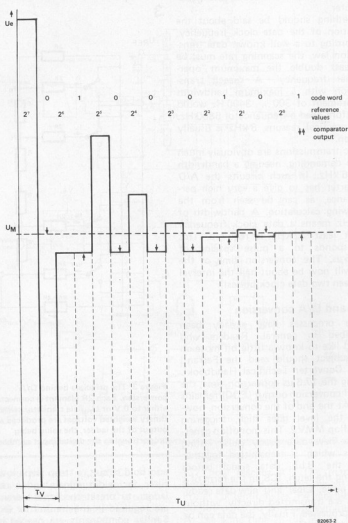

Figure 2. The operation of a successive approximation A/D converter is illustrated by this graph.

would contain a single slope, a dual slope and a voltage/frequency converter. It constitutes a straightforward means of reaching a high degree of accuracy. The conversion time is around 1...100 ms, which is rather slow. The converters are very sophisticated integrated circuits and are available with dual coded parallel outputs, parallel BCD outputs, BCD multiplex outputs, parallel seven-segment outputs or seven-segment multiplex outputs. Generally speaking, they are used in digital displays.

In the second category the amplitude of the input signal is directly compared to a certain parameter. Converters that use counting, successive approximation and direct methods all belong to this second category.

The fastest type of A/D conversion is achieved by the 'direct' method. The scale is divided into such minute steps that whenever one of these corresponds to the amplitude of the input signal, either a logic 1 or a logic 0 is obtained.

This has the advantage that it reduces the conversion time to as little as 85 ns (1).

To find out what the successive approximation method entails, let us examine the ZN 427 IC used in this circuit. Figure 1 shows the internal structure of the IC in the form of a block diagram. Where successive approximation is concerned, the scale is not divided into equal steps, but into binary steps. This requires a reference voltage (U_{ref}) and a resistor ladder network (R-2R ladder) to produce the binary graduated reference voltages. The analogue input signal is compared to each binary coded voltage in turn, starting with the level corresponding to the most significant bit. If the analogue voltage is greater the MSB remains set to a '1', otherwise it is reset to '0'. The next bit is then tested in the same way, and so on until the least significant bit is reached. The final binary code is passed through the 3-state buffers to provide the digital output data. The section in figure 1

marked 'successive approximation register' contains a ring counter which controls the analogue voltage switches and the 3-state output buffers. The required clock signal is provided by an external source. The command to start the conversion (START CONVERSION) must, of course, also be produced externally. When the conversion is complete, the END OF CONVERSION output will go high and will remain high until the next START CONVERSION pulse.

The conversion procedure is as follows: The START CONVERSION command resets the successive approximation register at the beginning of each measurement. Then a voltage level of exactly half the reference voltage (U_{ref}), which corresponds to the most significant bit of the D/A converter inside the ZN 427, is fed to the comparator. If this level is less than the comparator input voltage, V_{in} , the comparator output will go high and the MSB will remain set. If, on the other hand, it is greater than the comparator input voltage, the output of the comparator will go low and the MSB will be reset. If the MSB remains set the corresponding test voltage will remain connected to the comparator, if the MSB is reset, the voltage will be disconnected.

The following test signal to be fed to the comparator will be exactly half the level of the previous one and will correspond to the next significant bit of the D/A output. Again, the two comparator voltages are compared and the result 'remembered' by setting or resetting the particular data bit. And so on down the chain until the least significant bit is reached. If any of the comparisons result in a bit being set, the next reference voltage is added to the previous one(s). This is illustrated in the conversion graph given in figure 2. At the end of the process, after the voltage corresponding to the least significant bit has been tested, the number of 'positive' comparisons (bits set) will indicate the binary value of the input voltage. The conversion time, T_U , is totally independent of the input voltage and will be equal to $N \times T_V$ where an N bit converter is used. The time T_V corresponds to the period of the clock frequency.

Digital-to-analogue conversion

D/A conversion occurs in the ZN 427 IC mentioned earlier with regard to obtaining the (binary) reference voltages from U_{ref} . The principle behind the conversion is illustrated in the block diagram in figure 3. Every junction in the $P_0 \dots P_{N-1}$ range has two paths leading to 0V by way of a total resistance of $2R$. The component currents derived from each branch flow through the load resistor R_A and produce a voltage U_A . This can be calculated as follows:

$$U_A = \frac{2}{3} \cdot U_N \cdot \frac{Z}{N}$$

where Z represents the value being con-

verted and N the number of binary stages.

The block diagram in figure 4 shows the internal structure of the ZN 426 D/A converter IC. This 8 bit converter contains a resistor ladder network consisting of eight stages. The conversion time is $2 \mu\text{s}$.

The digital transmission circuit

Figure 5 shows the data transmission circuit which includes the ZN 427 A/D converter and the ZN 426 D/A converter. These ICs are widely available, relatively inexpensive and are particularly suitable for use in audio applications. Since the typical conversion time of the A/D converter is $15 \mu\text{s}$ (clock frequency = 600 kHz), a sample and hold circuit is not necessary here. If, however, input signals have to be 'frozen' for a certain period of time, the circuit in figure 8 can be added. For the full details concerning the operation of the circuit and the ICs, readers are referred to the data sheets mentioned in the list at the end of this article.

Upon examining the timing of the A/D conversion, as described in the data sheet, it can be seen that the 'start conversion' pulse has to be generated at specific minimum intervals following the positive and negative going edges of the clock signal. This is solved in the circuit in figure 5 by means of 'pulse processing logic'. This can even deal with system clock and data clock frequencies that are asynchronous with respect to each other. How this works is explained in the following paragraph and illustrated in the pulse diagram in figure 6.

Pulse processing logic

The clock frequency of the host microprocessor system can be used for the system clock. The pulse diagrams in figure 6 relate to a clock frequency of 6.144 MHz used in certain microprocessors. A system clock of 2.048 MHz is exactly one third of that frequency. The maximum system clock in the A/D converter is 900 kHz . The system clock signal is divided by 4 with the aid of FF1...FF3 in the two-phase clock circuit. As a result, two 512 kHz signals that are 90° out of phase with each other are produced at the Q outputs of FF1 and FF3. Signal '2' controls the clock input of the A/D converter. The conversion time will therefore be $17.6 \mu\text{s}$.

When the data clock enable input is high, the pulses at the data clock input will initially be stored in FF4. Upon the positive-going edge of clock signal '3', the data clock pulse will be inverted when it reaches the system clock input of the A/D converter. After this the monoflop MMV2 resets the flipflops FF4 and FF5. Now the next start conversion pulse may be transmitted. Thus, the data clock pulse will always be synchronous to the system clock frequency and at the same time the conversion

meets the parameters set by the manufacturer.

Something should be said about the selection of the data clock frequency. According to a well known data transmission law, the scanning rate must be at least double the maximum 'operational frequency'. A speech transmission with a maximum bandwidth requirement of $300 \dots 3400 \text{ Hz}$ would therefore need a frequency of 6800 Hz . For practical reasons, 8 kHz is usually chosen.

MUSIC transmissions are obviously much more demanding, needing a bandwidth of 16 kHz . In such circuits the A/D converter has to give a very high performance, as can be seen from the following calculation. A bandwidth of 16 kHz means a data clock frequency of at least 32 kHz is required. This corresponds to a pulse spacing of $31.25 \mu\text{s}$. The conversion time of the ICs will now be about half the interval between two data clock pulses!

A/D and D/A conversion

These processes have already been described in general. Readers who would like to know a little bit more on the subject should read the Ferranti 'Data Converter Technical Handbook'. During the $17.6 \mu\text{s}$ conversion time, the end of conversion output (EOC) remains low. At the end of the conversion, however, the level goes high, triggering monoflop MMV2. This monoflop generates a new data ready pulse lasting 300 ns which is transmitted together with the 8 bit data signal before reaching the latch, IC8, in the form of a clock pulse. 'Clear' and 'new data ready' pulses are transmitted directly, without being processed. Finally, the data can be converted by IC7.

The analogue interface

We already mentioned the fact that a sample and hold circuit can be used as an analogue interface, if necessary. Which external components are required to prepare analogue input signals for conversion? In addition to the sample

3

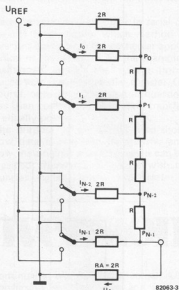

Figure 3. The principle behind D/A conversion. Each $2R$ element is connected either to 0 V or U_{REF} via transistor switches. Binary weighted voltages are produced at the output of the ladder, the value being proportional to the digital input number.

and hold circuit, a steep slope low pass filter for audio signals and a resistor ladder to preset the input parameters are required in the transmitter section. Similar components are needed in the receiver section to preset the output parameters and to filter audio signals. Preset potentiometers P1 and P2 (in figure 5) are calibrated so that symmetrical input signals having an amplitude of $\pm 5 \text{ V}$ (equivalent to $3.53 \text{ V}_{\text{RMS}}$) can be processed. This value corresponds to 'full scale deflection' ($\pm \text{IS}$). This is done by linking the data outputs of IC6

4

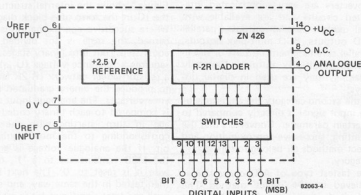

Figure 4. The internal structure of the ZN 426 D/A converter.

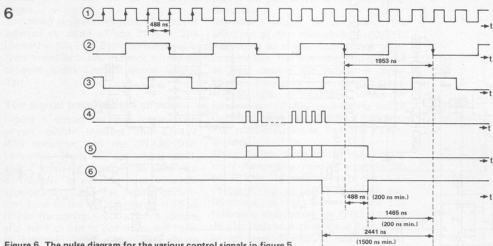

Figure 6. The pulse diagram for the various control signals in figure 5.

62063-6

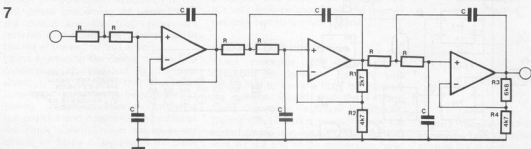

Figure 7. This 6th order low pass filter can be used to attenuate frequencies outside the audio band.

p. 6-34). Here again the circuit was placed directly in front of an A/D converter, type ZN 427. During the period that IC6 requires to carry out an A/D conversion, the EOC output is low. This 'freezes' the input signal. The input voltage for the converter remains at a constant level. This circuit is only needed, if the input signal alters during the conversion period by more than 1 LSB.

The IC consists of an amplifier with a current source output and can be switched on and off by means of a control signal at pin 5. The 330 pF 'hold' capacitor stores the amplifier output signal. In other words, the gain can be adjusted by providing a control current at pin 5. The FET acts as a buffer with a very high input impedance to prevent the capacitor from discharging during the storage time. The FET output is linked to the inverting input of the amplifier by way of the 2k2 resistor. This makes sure that the output voltage of the circuit is the exact image of the input circuit during the sample phase of the amplifier.

How to use the circuit

For speech communication systems to be clearly intelligible in large rooms, the speech signal often needs to be delayed on its route to the loudspeakers. Supposing the orator is situated some 30 metres away from the loudspeaker,

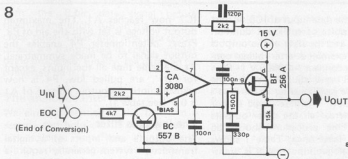

Figure 8. A simple sample-and-hold circuit which can be used if a slower clock rate than that shown in figure 5 is required.

62063-8

which is in the vicinity of the audience. The signal must then be delayed by 0.1 seconds to give the listeners the impression that the sound is coming from a source directly in front of them. Although such delay devices are widely available, commercial units are extremely expensive, home-made versions are much more economic. Random access memory (RAM) ICs can be bought at very low prices and so can address counter ICs. A few of these combined with the circuit provided here and the result is a complete speech communication system. If necessary, the delay time can be adjusted by means of programmable counters.

Of course, there are plenty of other uses for the circuit. It can be included in a

digital storage 'scope', it can serve as a value processing system using a micro-processor, etc. For anyone who enjoys experimenting, the sky is the limit as far as application possibilities are concerned.

Sources:

Data sheets: ZN 426 and ZN 427

Ferranti Electronics Ltd,
Oldham, U.K.

Data Converter Technical Handbook,
Ferranti Electronics Ltd,
Oldham, U.K.

Tafel, H.J.: 'Introduction to digital data processing',

Carl Hanser Verlag, Munich.

'Storage 'scope', Elektor 74
(June 1981, p. 6-34).

help power transistors
to keep their cool

dissipation limiter

Occasionally, even a 2N3055 is unable to cope with the stress it is put under. Some designs which prevent the power transistor from being damaged under extreme conditions are rather complicated and expensive. This article intends to prove that this need not be the case. Let us take the design of a normal, straightforward battery charger using a 2N3055 as the series transistor. During normal operation, this transistor has to cope with 5 V across it while it is supplying a current of 5 A, which amounts to a reasonable 25 W. What happens though when the output is short-circuited? The voltage across the series transistor rises to at least 12 V; 5 A multiplied by 12 V give us 60 W, which will eventually destroy the transistor. It becomes even worse when the battery is connected the wrong way round. As can be seen from this example, some form of protection is really necessary.

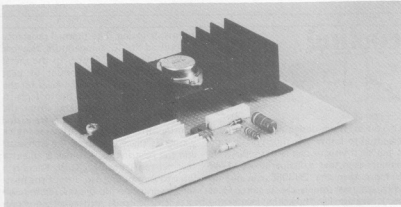

Having to protect a power transistor such as the 2N3055 may seem like a pointless task. However, there are some instances where even these mighty work-horses can be blown up! The circuit described in this article provides a safeguard for these devices; a better life insurance is hardly possible.

Of course, it would be ideal if such a protection circuit were able to calculate the dissipated power by multiplying the voltage across the transistor by the current through it. However, it is sad, but true, that in electronics multiplying is a process that is neither easy nor fast. The circuit described here is a kind of compromise, since it uses a straightforward addition circuit instead of a multiplier. As soon as the sum of the voltage and the current exceeds a preset value, the base drive to the output transistor is reduced. However, this circuit does have one major disadvantage; the maximum available output voltages and currents are lower with a protected transistor than those with an unprotected one. Supposing the power output is limited to 40 W (2 A at

20 V). Figure 2 shows that the resultant curve crosses the voltage axis at 40 V, which is the highest voltage level that the 2N3055 can withstand. The same holds true for the current; the current axis is crossed at 4 A, therefore, as a result of the protection circuit, larger currents are impossible.

It is therefore essential to consider in advance whether or not protection is an appropriate solution to this problem. It may be better to use more than one output transistor, as this enables a larger power dissipation. We will come back to this later.

It is important to remember that the dynamic qualities of the protected power transistor are completely different. For this reason, it is advisable not to protect the output transistors of audio equipment.

Circuit diagram

As indicated in figure 1, two additional transistors are required to protect the 2N3055 from any disasters. Transistor T2 does not actually protect anything, but it does enable the base current at point 'b' to be 50 times lower than

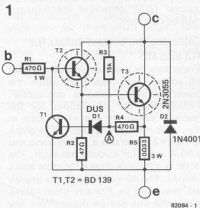

Figure 1. The circuit diagram of the protected power transistor. The voltage and current levels are kept within limits and are determined by the values of R3 and R5.

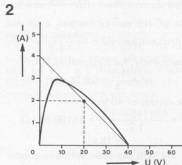

Figure 2. The thick line shows the real current/voltage characteristic of the protected output transistor. The thin one indicates the 40 W limit.

transistor characteristics

normal. This is a comforting thought, since a smaller base current enables a straightforward drive.

The current passing through the power transistor provides a voltage across resistor R5. If this voltage is about 1.2 V, diode D1 and transistor T1 start to conduct. Consequently, the base current flows away via T1, so that the current through the output transistor cannot increase. Resistors R3 and R4 act as a potential divider which monitors the voltage across the power transistor. If the voltage at point A reaches 1.2 V, T1 will again prevent T3 from conducting too much and exceeding its maximum dissipation. Therefore, the 2N3055 is protected against both excessive voltages and currents.

Between these two extremes, the voltage at point A in the circuit is determined by the sum of the voltage across R5 (caused by the current through it) and the voltage across R4 (from the potential divider). The limiter comes into operation when the sum of these two exceeds 1.2 V. As mentioned previously, the 2N3055 will not work if too high a voltage level is present, which depends on the values of R3 and R4. Moreover, the voltage must not exceed 60 V, otherwise the transistor will be damaged.

Selecting the correct values for R3 and R5

These two resistors determine the level of voltage and current at which the power transistor remains operational. Fortunately, the calculations for the required values are not as difficult as they may seem at first sight. The graph in figure 3 illustrates a 117 W curve and a 40 W curve for a power transistor. The latter is a suitable choice for most applications. The 40 V/4 A line is the one we are interested in. For any other values, a straight line can be drawn from any point on the curve to intersect the voltage and current axes. The relevant values can be altered by adjusting the slope of the line, but the 40 W curve must not be crossed. The value of R5 can be derived directly from the required current level: $R5 = \frac{1.2}{I}$ and the value of R3 can be derived from the required voltage: $R3 = \frac{R4 \cdot (V - 1.2)}{1.2}$.

Consequently, for a current of 4 A:

$$R5 = \frac{1.2}{4} = 0.3 \Omega \text{ and}$$

for a voltage of 40 V:

$$R3 = \frac{470(40 - 1.2)}{1.2} = 15196.667 \Omega$$

$$\approx 15 \text{ k}\Omega$$

The 2N3055 can cope with any combination of voltage and current values provided they lie underneath the curve. It is wise to bear in mind that the circuit will not pass a great deal of current at voltages lower than 1 V, as the 'turn-on' voltage of the transistor has to be overcome first.

While discussing the safety of a power transistor it is useful to know where the problems are, in other words, why does the transistor break down? There are two possibilities: an excessively high voltage level and overheating. It is evident that the transistor will break down when the voltage is too high, it is put under too much pressure.

The second cause is slightly more complex. Not only can the actual transistor (the silicon chip) get overheated when the current level is too high, but also the internal connections can get so hot that they start to melt. Although in this instance the transistor itself may remain more or less undamaged, it will not work any longer since it has become 'insulated'.

In most cases the transistor will break down because of excessive dissipation (power which is converted into heat) in the chip, so that the structure will be irreparably damaged. The dissipation in the transistor can be calculated quite easily by multiplying the voltage across the transistor by the current through it. Manufacturers always indicate a maxi-

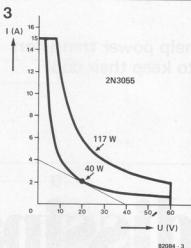

Figure 3. This graph shows the theoretical 117 W dissipation limit of the 2N3055 and the more realistic 40 W curve. The straight line indicates the permissible power range when the protection circuit is used.

cooling

Of course, when designing a circuit, it is essential to know how much dissipation a power transistor can endure. We have already seen that a dissipation of 117 W is more than the 2N3055 can put up with, so how much can it take? Heat is generated by the chip inside the

transistor casing. The thermal resistance (expressed in °C temperature rise per watt of dissipated power) of the metal case determines the amount of heat conducted away. The data sheet for the 2N3055 shows that its thermal resistance is 1.5°C/W, calculated from the chip to the outside of the transistor housing. In the majority of cases a mica washer is placed between the transistor and the heatsink, which means an extra thermal resistance of 1°C/W. There is a limit to the cooling capacity of the heatsink, as indicated in figure 5. Despite an excellent heatsink and correct construc-

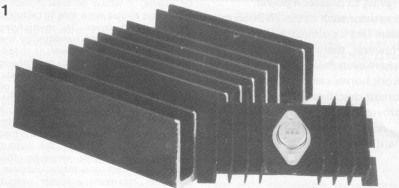

Photo 1. Two examples of heatsink profiles. The commonly used SK 03 is on the right and the larger SK 53 on the left.

mum value. This is the maximum theoretical value that can only be obtained with 'super-cooling'. For instance, the theoretical maximum dissipation of the 2N3055 is 117 W, but in practice this figure can never be reached.

A 117 W curve is shown in figure 3. Above this curve the transistor will always be destroyed, below it the life of the transistor depends on the quality of the cooling mechanisms. Normally, the curves indicated by manufacturers will be different from that in figure 3. A typical example is given in figure 4; both axes are logarithmic, therefore the graph itself is a straight line. Within this area there is another prohibited spot, which is indicated by the shaded part of figure 4. In this region it will take the transistor quite some time to break down. This phenomenon is called 'second breakdown': due to impurities in the transistor, so called 'hot spots' will occur. These hot spots will conduct better than the rest of the transistor due to the negative temperature coefficient of the chip. Therefore, there will be a considerable current increase in these hot spots, so that they get hotter and hotter until the critical temperature of 200°C is exceeded. Then the transistor is bound to 'die'. The effects described up to now hold true for continuous operation. However, the limit of 117 W can be exceeded for

4

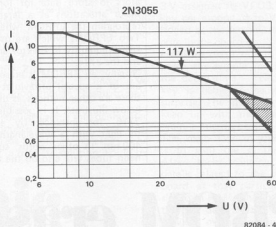

Figure 4. The same graph as for figure 3, but in this case the voltage and current axes are logarithmic. The shaded section indicates the 'second breakdown' area. The topmost curve shows that the transistor will survive short 'bursts' of very high power dissipation.

a short period, as the chip takes a certain amount of time to get hot. This is illustrated by the top curve in figure 4. This line indicates dissipation values of up to 700 W! It is imperative

that conditions indicated by this curve never last for more than 50 μ s. The transistor can only withstand this high power if this procedure is not repeated too often.

5

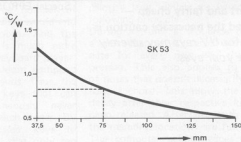
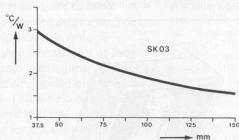

Figure 5. These two graphs indicate the thermal resistance of a commonly used (SK 03) and a large area (SK 53) heatsink. Note that the relationship between the thermal resistance (vertical axis) and the length (horizontal axis) is not linear.

tion, the overall thermal resistance will be at least $1.5 + 1 + 0.5 = 3^{\circ}\text{C}/\text{W}$.

If the maximum operating temperature of the transistor is 150°C and the environmental temperature is 25°C, the tolerated temperature difference will be 125°C. As mentioned above, the thermal resistance is 3°C/W, so the maximum permitted dissipation will be $\frac{125}{3} = 41.7 \text{ W}$. The moral of this tale is: even a 'super-heatsink' cannot work miracles.

It would be better to solve the problem by using several transistors instead of just one. Adding one more transistor to the heatsink mentioned previously provides a vast improvement. Now each transistor occupies half of the heatsink

6

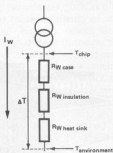

82084-6

(having a length of 75 mm). The thermal resistance per transistor is then $1.5 + 1 + 0.65 = 3.15^{\circ}\text{C}/\text{W}$. The maximum permitted power dissipation will then be 39.7×2 (transistors) = almost 80 W! The only drawback of this method is the (slight) extra cost. ■

EPROMs (Erasable Programmable Read Only Memories) are erased with the aid of ultraviolet light. This enables operators to store data for long periods, make alterations at a later date and reprogram the EPROM, when required. Two EPROMs which are used particularly frequently in Elektor are the 2708 and the 2716.

Usually, an EPROM is erased with the aid of a special ultraviolet lamp, but there are other methods, as the examples below illustrate. It is possible to erase a 2716, for instance, by exposing it to light with a wavelength less than 400 nm. In other words, sunlight and neon tubes will also do the trick. Tests

this purpose, but since hobbyists do not need to use them very often, they just aren't worth the money. Special bulbs are also effective. The TUV 6 W from Philips only costs a few pounds and has exactly the right wavelength. The bulb is usually employed for sterilisation purposes to kill bacteria, etc. The bulb is rather elongated and has an Edison screw.

WARNING: Never look at the lamp while it is burning, the light could permanently damage your eyes. Excessive exposure to UV radiation can also cause skin burns. To avoid such mishaps, it is essential to house the lamp inside a light-proof case. Make sure the case is not too small either, as the bulb gets very hot. Figure 1 gives an idea of what the case should look like. The bulb fitting is mounted inside the lid and a reflector is placed above the bulb. The rest of the case will accommodate the EPROMs that are to be erased. To ensure absolute safety, mount a microswitch in the case. This prevents the bulb from lighting unless the case is completely closed.

Before the EPROMs are inserted under the UV bulb they are mounted on a piece of conductive rubber. Up to four EPROMs can be erased simultaneously. Provided there is a space of about 1 cm between the bulb and the EPROMs, 30 minutes should be plenty of time for most types. During laboratory tests at Elektor, however, the TMS 2516 from Texas Instruments was found to be an exception. It took at least 2 hours to wipe it clean!

EPROM eraser

EPROMs are ideal memory devices, for not only do they store data in a relatively permanent manner, but they can be erased and reprogrammed, whenever necessary. Since Elektor has paid a good deal of attention to EPROM programmers lately, it is high time a suitable EPROM eraser was considered. The ultraviolet method described here is both efficient and fairly cheap — provided the necessary caution is taken, for UV rays may severely damage your eyes.

have shown that a 2716 will, on average, be erased after about three years' continuous exposure to neon light. Leaving it in the sun will wipe it clean within a week! For this reason it is advisable to cover the 'window' of the EPROM with a label to be absolutely sure the data remains intact for a long time. The best way to erase 2708, 2716, 2732 and most other EPROMs is to subject them to UV light having a wavelength of 253.7 nm and an intensity of 12 mW per cm². This will ensure complete erasure within 15 . . . 20 minutes. Special EPROM erasers are available for

1

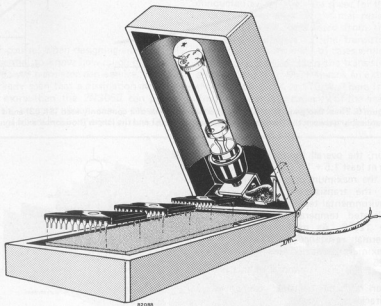

Figure 1. An idea for an EPROM eraser unit. The microswitch makes sure the bulb will only light once the case is closed. This is a safety measure in view of the harmful UV rays.

Why use a microprocessor?

Isn't the use of a microprocessor in this case a little like using a sledge hammer to crack a nut?, one may ask. After all, the FORMANT managed very well without. Like it or not, electronic music is becoming invaded by 'digitology'. Quite apart from anything else, the cost of the Z80, the microprocessor used in this project, is under five pounds, a good enough reason to give it serious thought!

In this particular case, a microcomputer was introduced because it was considered to be absolutely necessary. For one thing, a discrete solution would be

with 3 V. If the second key is released, VCO1 will continue to be fed with 1 V, whereas VCO2 is now supplied with the 3 V assigned to VCO3. As a result, the key corresponding to VCO3 is acknowledged as the second, rather than third, note in the chord.

Problems occur due to the gate trigger pulse, the sample and hold circuit and the decay time - releasing the second key is liable to cause a cacophonous surprise. The instrument simply cannot keep up with the changes without a brain, a microprocessor.

The main task of the microprocessor is to scan the synthesiser keyboard. After each scanning procedure, the details related to the state of the keyboard at that particular moment are stored in RAM. The computer compares the new data to that derived from the previous matrix configuration and then decides which keys were released and which ones have now been depressed. Whenever a key is released, the GATE signal at the control output becomes logic 0. However since the pitch code at the output remains unchanged, the note is able to decay at the right pitch.

If more than ten keys are depressed simultaneously, the computer must be able to pick out the ten initial notes. If a new key is depressed during the decay time of the ten notes, the processor determines which note should be interrupted and substituted for the new note. How this is done is extremely complicated, involving various time priority laws, which are based on the following principle:

During a 'run', a sequence of notes, a new channel is stored with voltage data for every new key that is depressed. This also applies to a string of notes that doesn't necessarily have to form a chord. This allows the notes to decay after their respective keys have been released. After the tenth note, all the memory locations are full of data. The computer acknowledges the note that was the first to be produced during the series and replaces the corresponding VCO data in its memory location by information referring to the new note, the 'eleventh' in the series.

There is one exception to this rule. If the same key is depressed and released repeatedly (as in staccato playing, for instance) the control voltage and the gate signal must always be fed to the same VCO. Otherwise, an additional VCO 'voice' having the same frequency would be heard. The Z80 software has taken this problem into account and avoids such interference.

Another reason for using a microprocessor is that it offers a tremendous amount of flexibility and allows the synthesiser to be constructed in stages, which is preferable nowadays with most hobbyists managing on a very tight budget. Unlike discrete circuits, where it's 'all or nothing', the facilities of a microcomputer can be extended simply

polyphonic synthesiser

... with a computer controlled keyboard

Faced with a wide selection of polyphonic keyboard kits, synthesiser enthusiasts have a hard time finding the right one, since most of them seem to have considerable disadvantages. After examining various systems thoroughly (the subject of long and heated discussions), Elektor's design staff decided on computer control. This article compares it to others and at the same time paves the way for the printed circuit boards and the constructional details which will be published in due course.

vastly complicated and take up an awful lot of space. To find out why let us recap briefly on the last article in the monophonic series.

On a conventional polyphonic synthesiser keyboard every key requires a VCO along with the associated VCFs, VCAs and envelope generators. From now on we will refer to such units as 'channels'. A complete keyboard would therefore require a large number of channels and the synthesiser would end up filling an entire room. And the expense! The answer is much more straightforward, for a keyboard player, however brilliant, is seldom equipped with more than two hands. Thus, the maximum number of keys that can be depressed simultaneously never exceeds ten, one for each finger. By connecting the depressed keys to individual VCOs means that only ten synthesiser channels are needed to provide a sophisticated polyphonic instrument and that is where the microprocessor comes in. It is an ideal means of storing parameters, such as pitch, and allows the musician plenty of scope for developing his/her own ideas and programming these into the machine.

Synthesiser systems without microprocessor control have one main disadvantage: the only way in which they can find out which key was depressed is by means of keyboard multiplexing. In the case of a three-note chord, all the key contacts have to be scanned in turn. The control voltage of the first key that is acknowledged to be depressed is fed to the first VCO, that of the next key is fed to the second VCO, etc. As figure 1 shows, the control voltages at the VCOs shift while the instrument is being played. Supposing three keys are depressed and VCO1 receives 1 V, VCO2 is supplied with 2 V and VCO3

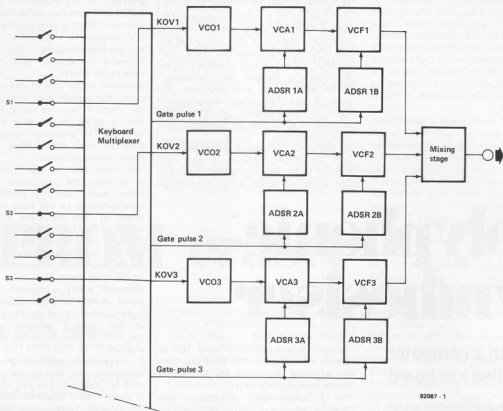

Figure 1. Any keys that are pressed are connected to a free synthesiser channel in order of pitch. When S2 (keyboard key) is released (see text) VCO2 assumes the control voltage produced by S3. This type of keyboard control is known as multiplexing.

by adding more memory cards to its bus system. It has the added advantage that EPROMs can be reprogrammed whenever required. Changing discrete circuits is almost impossible and costs a lot of time and money.

The brain behind the polyphonic keyboard

As mentioned earlier, the microprocessor used here is a Z80A. Its tasks fall into two main categories. Initially it 'collects' all the data from the key contacts and preset controls on the front panel. It then processes the data and assigns specific voltage values to the synthesiser modules under its control. Each of the connected synthesiser channels is provided with a 'pitch' and gate pulse. This is where the computer proves its flexibility, for readers who do not wish to spend too much all at once, can begin with two synthesiser channels and extend them gradually up to a total of ten. A select switch informs the processor how many channels are preset. The control voltage levels and the GATE pulse are in the form of a digital code, which are then 'translated' into the corresponding voltage values by the A/D-D/A interface board. The two range switches on the front panel of the synthesiser adjust the setting of each channel within a range of three octaves (12 semitones

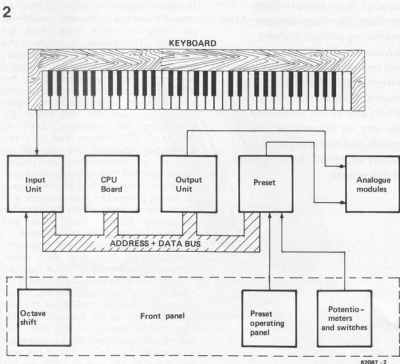

Figure 2. Block diagram of the keyboard/preset controller. This consists of a CPU card, an I/O device and the preset control logic.

and 2 octaves).

The second major task of the microprocessor involves controlling the presets. This enables a certain pitch or sound to be selected 'at the drop of a hat' with the aid of a single switch and saves fumbling around in the dark for the right lever, switch, etc. The operator has 64 preset (preprogrammed) sounds and an additional 64 memory locations to store personal tone compositions.

The hardware

The following section provides a detailed description of the hardware. This mainly consists of a debouncing circuit for the key contacts, a CPU board, an I/O circuit and various ICs which control the presets. The complete system is shown in the form of a block diagram in figure 2.

The preset unit

Figure 3 shows the keyboard and display matrix used to adjust the settings. The control unit includes the following facilities:

1. A keyboard containing keys 0...9, 'RAM' and 'CLR' (CLEAR) serves to select a certain sound. Each sound has its own program number and this is indicated on a two-digit 'SELECT' display.
2. A 'PANEL-PRESET' mode switch together with its LED which converts the pitch as stored in memory into the setting obtained by adjusting the controls on the front panel.

3. The 'STORE' key reads the sound adjusted by the pots on the front panel and stores it in EPROM. The storage procedure can only be performed provided the 'STORE ENABLE' switch at the back of the synthesiser is in the correct position when STORE is depressed. If so, the 'STORE ENABLED' LED on the front panel will light. This facility was included with a view to protecting musicians against involuntary acts of 'sabotage' by inquisitive friends and relatives who couldn't resist 'twiddling the knobs'... and prevents preset sounds from being accidentally overwritten. Discovering an erased synthesiser memory just before a concert is enough to cause a musician more sweat than the actual performance! Not that the audience is likely to notice any difference, where certain groups are concerned.

4. A significant feature of the preset circuit is its three channel sound stand-by circuit consisting of three ENTER keys and their corresponding displays and the PLAY 1...3 keys. Depressing the ENTER key causes the program number of a particular sound to be shown on the display. The settings shown on the three displays can be altered in a split second simply by pressing one of the three PLAY keys and operating the PANEL switch. The PLAY keys cannot be depressed simultaneously. After the 'PANEL' switch has been pressed (indicated by the LED on this switch), operating the

'STORE' key will transfer the current settings of the keyboard into the program number indicated by the 'SELECT' keyboard display. The selection can be any number between 1 and 64. It is also possible to select either the pre-programmed sound or a 'real time' sound, also numbered 1 to 64, by operating the RAM key on the keyboard. The latter is indicated by the presence of the decimal point on the display. The CLEAR key erases the SELECT display. Special software measures prevent an incorrect program number, such as 75 for instance, from being entered.

It should be mentioned that the total data for one particular sound may comprise 28 different analogue voltages ranging from 0 to +10V and 32 data bits relating to the switch positions for the waveforms, etc. This may seem a bit of a luxury at this stage, but it might as well be included now, as it doesn't add much to the construction costs and will be needed later on anyway.

One or two things to bear in mind

The next article in the series on the polyphonic synthesiser will provide printed circuit boards and constructional details. Readers should take various facts into account before 'diving in at the deep end'. The components can be fairly expensive and ideally, an understanding of analogue and digital circuits is desired. However, enthusiasm makes up for a lot and the printed circuit boards simplify the problems to a large extent.

The design staff decided against mounting a complete synthesiser on a single printed circuit board for the following reasons:

The printed circuit boards should be universal and suit the requirements of both monophonic and polyphonic synthesisers, leaving the choice up to the reader. The monophonic version must be able to accommodate a variety of combinations in the same manner as the FORMANT. The model based on the CURTIS ICs, as described in Elektor, is just one possibility. Anyone who has already built the FORMANT probably has personal ideas for a synthesiser using CURTIS ICs. At any rate, readers should decide beforehand whether they prefer a monophonic or a polyphonic synthesiser. It should be noted that the monophonic system published in Elektor cannot be elaborated into a polyphonic instrument in its present mechanical form. This does not apply to the CMOS switches, however, which are already available on the printed circuit board. These enable the preset facilities to be extended without the need for the complex microprocessor control unit designed for the polyphonic keyboard, but then, of course, no sounds can be stored. In any case, the preset unit can only be constructed if the keyboard controller is provided.

3

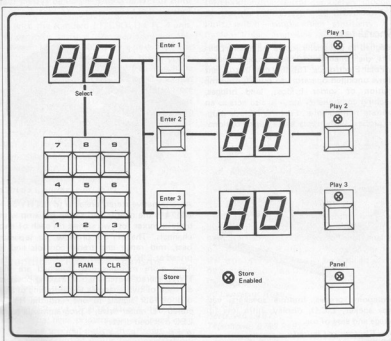

Figure 3. The operating panel for scanning and storing preset sounds. Its main features are the keyboard and displays. The program number shown in the top left-hand display may be temporarily stored in one of the right-hand displays to enable programs to be changed rapidly. This facility is ideal during live performances on stage.

market

WORLD

Mini TIL switch

Erg components has launched the smallest ever double changeover, ganged, triple-in-line switch: the SCS1G-023. The smallest switch of its type in the world, the Erg SCS1G-023 is both top and base sealed. Top sealing is achieved with a special, heat-resistant, transparent, polyester tape. Switching action is break-before-make. Features include: suit-

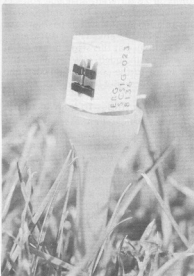

ability for both very low and high levels of switching — from 1 μ V to 100 V, 1 μ A to 1 A up to 10 VA; contact resistance repeatability \pm 1 milliohm; contacts are gold-plated for reliability and employ a patented wiping action.

*Erg Components,
Luton Road,
Dunstable,
Bedfordshire LU5 4LJ.
Telephone 0582.62241*

(2248 M)

Long display

The new LCM 1012 liquid crystal display from Siemens takes the form of an 80-character display with an active visible area 24.4 mm high and 320 mm in length. Such a high number of characters enables the text of a complete typewritten line containing, as a rule, 60-70 strokes to be represented. It is primarily for such applications that this "record length" LCD has been designed. The keyed-in text can be checked for possible errors before they are put to paper. The low current draw of the liquid crystals also permits applications in mobile equipment, for instance in portable data collection units or in terminals.

Each of the 80 characters consist of 35 lines arranged one above the other; each of these lines is divided further into five dots along its length which can be activated individually. The dots are 0.56 x 0.60 mm in size and are spaced 0.10 mm from each other. This provides the active visible area of 24.4 mm by

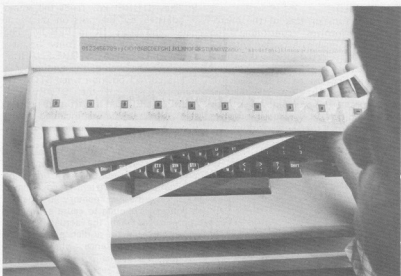

320 mm. Of the 35 lines, 16 may be shifted up or down, allowing super- and sub-scripting and under- and over-scoring, in dark characters on a light background.

The actual LCD is accommodated, together with its drive electronics and internal lighting, in a rugged frame measuring 400 x 40 mm with a maximum installation depth of 21 mm. The display is controlled by ten SM804 K driver devices. By means of a potentiometer the user can adjust the contrast of the display characters to suit his operating position.

*Siemens House,
Windmill Road,
Sunbury-on-Thames,
Middlesex TW16 7HS.
Telephone: 09327.85691, Ext. 250.*

(2242 M)

'Short' tester

Designed to physically locate p.c.b. short circuits, the Toneohm 550 has just been released by Polar Electronics. This low cost instrument allows unskilled operators to quickly find the position of solder bridges, land bridges, touching components etc — it also acts as an accurate milliohmeter. Features include plug-in probes with replaceable tips, optional



needlepoint probes, internal speakers, ear-piece socket, L.C.D. display, ultra low tip voltage and ease of use.

*Polar Electronics Limited,
P.O. Box 97,
Lowlands Industrial Estate,
St. Sampsons,
Guernsey.
Telephone: 0481.48129*

(2244 M)

Stereo audio modules

ILP Electronics of Canterbury have added four new stereo audio modules to their range. These bring the total ILP range to almost 50 different modules.

First of the new encapsulated units is the HY 74 stereo mixer, which is priced at £11.45 excluding VAT. This unit provides sophisticated mixing facilities — five signals into one on each of the two channels — and can be used with an appropriate ILP power supply, an ILP pre-amp such as the ILP HY 66 stereo pre-amp, an MOS or bipolar power amplifier and appropriate controls to create a hi-fi amplifier of very high quality at minimum cost. Virtually all ILP audio modules are cross-compatible: DIY hi-fi addicts and disco/music amplification enthusiasts can combine the units to create almost any audio system they fancy.



An alternative stereo pre-amp to the HY 66 + HY 74 is the new HY 75 stereo pre-amp with built-in mixer for two signals on each of two channels. The HY 75 provides for separate bass, mid range and treble controls and is priced at £10.75 excluding VAT.

Two more modules just launched are the HY 76 stereo switch matrix, making possible on each of two channels the switching of any one of four signals to one, and the HY 77 stereo VU meter drive, a programmable gain/LED overload driver.

*ILP Electronics Limited,
Graham Bell,
Roper Close,
Canterbury,
Kent CT2 7EP.
Telephone: 0227.54778*

(2240 M)

market

Soldering iron with digital temperature measurement

LITESOLD'S advanced ETC-4C Soldering System incorporates a DVM circuit and digital display of the soldering iron temperature. The display circuit is driven by the output from the thermocouple temperature sensor, located inside the element shaft of the soldering iron, where it reads the temperature at the front of the externally mounted bit. The sensor output is also used to operate the transistorised temperature control circuit, which feeds the DC power supply to the soldering iron. The digital temperature read-out and the bit temperature are thus locked together and the display provides a continuous indication of the actual operating conditions at the soldering bit, including any small variations which may occur in use, or major changes which may be due to malfunction of the control circuit or soldering iron, before damage to the work can occur.



As with the standard LITESOLD ETC-4 unit, temperature settings are steplessly variable between 180° and 400°C by a potentiometer knob on the control unit, and the temperature control circuit is entirely free of spiking and RFI generation. The 22 volt DC-operated iron is also earthed and completely free from hum and static. Temperature control is typically within ±2°C and the outstanding heating/recovery performance is demonstrated by the fast heat-up time of 20°C to 400°C in less than 60 seconds.

Light Soldering Developments Limited,
Spencer Place,
97/99, Gloucester Road,
Croydon, Surrey, CR0 2DN.
Telephone: 01 689 0574

(2273 M)

Graphics printer mechanisms

Two new impact needle printer mechanisms are being offered by Roxburgh Printers. Based on the same design as the highly popular DP-822 and DP-824, 21 and 40 column units. The new printers are equipped with 1/12" line spacing, optical 'head reset' sensor and a motor control circuit, features necessary for achieving the highest possible accuracy when printing graphics. Both friction and sprocket drive versions are available for the 21 and 40 column types. There is also a choice of 12 or 24 V DC voltage operation for the 40 column unit. Type numbers are: DP-822G

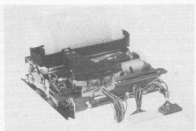

for the 21 column and, DP-824G for the 40 column.

Roxburgh Printers Ltd.,
22, Winchelsea Road,
Rye,
East Sussex TN31 7BR.
Telephone: 079 733777

(2271 M)

70 MHz 4 channel oscilloscope

House of Instruments announce the new CS 2070 Oscilloscope from Trio, utilising the latest in oscilloscope technology and innovation to solve the fast, complex signal analysis problems encountered with such equipment as VTR's, Compact Discs, DAD and Audio, as well as other difficult waveform applications. This compact 70 MHz oscilloscope has a 4 channel 8 trace display capability and is packed with a variety of features such as: alternate delayed sweep, 1 mV/cm sensitivity all the way to 70 MHz and delayed intensified sweep, features born of Trio's 100 MHz oscilloscope technology. All of this high performance is displayed on a large bright 12 kV CRT with Auto-focus.

Other excellent features include: Holdoff for synchronisation of unstable signals - Maximum sweep speed of 5 ns/cm - Delayed sweep intensity control completely independent of the main sweep - 20 MHz bandwidth limit switch - simple high sensitivity X-Y mode - Video frame synchronisation is linked to the base for automatic switching - 500 microV/cm sensitivity in the Cascade mode - Single sweep and TTL intensity modulation.



(2266 M)

Ergonomic electronics switching has been implemented using LED pushbuttons with a back up memory provided for the panel set up. If the unit is turned off, or power lost, the front panel set up can be recalled simply by switching on the CS 2070.

Quiswood Ltd.,
30 Lancaster Road,
St. Albans,
Herts. AL1 4ET.
Telephone: 0799 24922

Bench power supplies

The new Kikusui PAB Series DC bench power supplies from Telsonic Berkeley UK Limited

offer many practical features and a wide range of output options at very competitive prices. There are 22 models in the range, with outputs from 8 V 2.5 A to 350 V 0.2 A. Output voltage may be varied continuously from 0 V by the use of the two variable resistors giving coarse and fine adjustment or, in some models, a 10-turn potentiometer. Continuous control of current is also available from 10% to 100% of rated value, so the units may be operated in the constant voltage or constant current mode. Voltage and current are displayed simultaneously on separate meters. Overload protection is by constant current transfer.

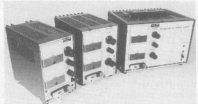

Multiple units may be used in series to obtain a higher output voltage and two of the same model may be connected in parallel to double the available current. In parallel operation a simple link between the units enables both to be controlled from one unit. Up to 5 units may be mounted in a standard 19in rack.

Telsonic Berkeley UK Limited,
2, Castle Hill Terrace,
Maidenhead,
Berkshire.
Telephone: 0628 73933

(2269 M)

Stripper with drive

The CF Wire Stripper is a low voltage electrically operated hand tool designed for the stripping of insulation from enamelled wires used in the manufacture of coils, motors, transformers etc. and incorporates a DC motor to provide more efficient operation.

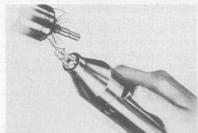

The stripper automatically adjusts for wire sizes between 11 swg and 33 swg by the use of three stripping blades which are centrifugally operated by counter balanced weights. This automatic adjustment of the tool makes it ideal for applications where a number of different wire sizes are encountered on a single component. All cutting blades are manufactured from tungsten carbide and are easily replaced. The Model CF is suitable for production use but may also be employed for low volume runs and research in development applications.

Eraser International Limited,
Unit M,
Portway Industrial Estate,
Andover, Hants SP10 3LU.
Telephone: 0264 51347/8

(2265 M)

market

Low-Power Z80

Zilog have just introduced a new version of their successful and well proven Z80 8-bit microprocessor which consumes only 10% of the power of the standard Z80. Known as the Z80L, the new processor is available for operation at clock rates of 1 MHz, 1.5 MHz, or 2.5 MHz as identified by the suffix L1, L2 or L3 respectively.

Power consumption for the Z80L family is 75 mW, compared with 500 to 750 mW for the standard part, and is therefore ideally suited for use in hand-held or portable battery powered products. By the same token, the low power consumption allows battery backup to be implemented easily in systems where the data being processed is of a critical nature or where the application relies on continuous processing.

Another important feature of the Z80L is its full pin and software compatibility with the Z80 allowing it to be used in existing circuit boards without the need for expensive circuit re-design. In addition, the new device is fully supported by Z80 development systems and in-circuit emulators allowing products based on the Z80L to be developed, tested and debugged quickly, thus reaching the market place in the shortest possible time.

The Z80L can be used with the complete range of Z80 8-bit peripheral devices currently offered by Zilog. In the near future a new range of low-power peripherals will be announced including versions of the PIO (parallel input/output), SIO (serial input/output), CTC (counter/timer circuit) and DART (dual asynchronous receiver/transmitter). These devices will consume about 10% of the power of currently available products at prices substantially lower than CMOS equivalents. The Z80L family employ a single +5 V power supply and operate over the temperature range 0 to 70°C. They are available in either ceramic or plastic packages.

*Industrial Products Division,
Zilog (UK) Limited,
Babbage House,
King Street,
Maidenhead,
Berks SL6 1DU.
Telephone: 0628 36131*

(2272 M)

Miniature power relay

A miniature power relay is announced by Londex Limited, as a further extension to

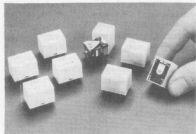

their range of space-saving pcb-mounted relays. Named the 'Quarz', this new relay stands less than 16 mm from the board when mounted; it is 22 mm long, and 16 mm wide and weighs ten grams. There are five basic types in the range, rated at voltages from 6 to 48 VDC, with coil resistance from 100 to 4500 ohms. Each of the five types is also available as a sealed version. The switching capacity is 125 V AC or 30 V DC, 3 A (resistive load), or 250 V AC, 1 A. Operating time is approximately 6 ms, with a release time of approximately 2 ms. The relays' dielectric strength is 1500 V AC (50/60 Hz) one minute, contact to coil; 750 V AC (50/60 Hz) one minute, contact to contact. Life expectancy is five million operations (mechanical), with more than one hundred thousand electrical operations at switching capacity.

*Londex Limited,
Oakfield Road,
London SE20 8EW.
Telephone: 01659 2424*

(2267 M)

Transient waveform analyser

SE Labs (EMI) Limited has launched a micro-processor-based transient waveform analyser, which has a standard 16K memory per channel. The 4-channel SE 2550 is the first of a new generation of intelligent transient recorders and it is also the first to offer a combined integral display. All parameters are set up via the keyboard and menu pages. The main unit comprises a 19" cabinet containing the power supplies, cooling fan, video display screen, keyboard, timebase controller, control logic and 4-channel modules. There is also an IEEE 488 interface for data input/output and remote control of the unit, optional anti-aliasing filters, and an optional RS 232 interface card. The SE 2550 offers analogue input and both analogue and digital output. Two other models are available: the SE 2560, similar to the SE 2550 but with eight channels, and the low cost, 2-channel SE 2520.

Features include: up to 10 timebases independently selectable, simple keyboard entry, 4-trace display, up to 6 individual sets of instrument parameter settings stored in non-volatile memory, versatile triggering facilities and 4-channel configurations (8 in the SE 2560). The SE 2550 offers an optional 32K memory per channel, in place of the standard 16K. The 4-trace display is contained within a 5" monitor, allowing the complete contents of each channel to be viewed across the screen. Alternatively, the user can select a portion of the waveform for expansion in terms of timebase and amplitude. On-screen measurements can be calculated and displayed, due to the provision of a cursor which allows individual memory locations to be identified. Seven major display modes are available: from individual channels or the summation and subtraction of any two channels, to the subtraction of any data block in the memory with any other data block in the total memory.

Among the unique features of the SE 2550 is the comprehensive triggering facility: each amplifier can be programmed to trigger the unit in response to a combination of settings. Also unique is the pre-trigger mode, which allows the user to select 10 discrete timebases across the 16K memory (or optional 32K) per channel.

A primary function of the SE 2550 is to record and reproduce transient waveforms



automatically, without external programming. A timer menu page stores a transient and outputs it to a computer store. The memory contents can be plotted onto an XY plotter or a hard copy printer via the IEEE 488 interface, in addition to the more usual method of photographing the display screen with Polaroid film. A 'select' page lists the various menus available to completely set up the instrument, while a real-time clock enables the time to be retained in the digital store when a transient is recorded. The use of a non-volatile memory allows the instrument to be programmed in the laboratory before being utilised on-site without further operator intervention.

*SE Labs (EMI) Limited,
Spur Road,
Feltham, Middlesex, TW14 0TD.
Telephone: 01 890 1477*

(2270 M)

Micro miniature DIL thumbwheel switches

This range of micro miniature digital thumbwheel switches are used in conjunction with end plates and optional spacers which are all rigidly clipped together to form stable switch assemblies. The switch housings, spacers and end plates are a matt black with contrasting highly legible non-dazzle white display digits. Switch assemblies of from 1 to 10 units can be accommodated, with dual-in-line terminal spacings and a common bar if required.

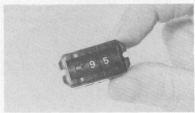

They are of an extremely compact design and are suitable for use in computers, vending machines, automatic control equipment, measuring and testing units, communications equipment together with very many other general applications for numerical, volume or time control and computation. They have a DC resistance load switching capacity of 28 V 50 mA, with continuous current ratings of 100 μ A to 10 mA. Mechanical and electrical life is 100,000 steps minimum and they have an operating temperature band of -20° to +80°C. Contact resistance is 250 M Ω ohm maximum and insulation resistance 100 M Ω ohm minimum at 250 V DC.

*P. Caro & Associates Ltd.,
2347 Coventry Road,
Sheldon,
Birmingham B26 3LS.
Telephone: 021 742 1328*

(2268 M)

ELEKTOR BOOK SERVICE



JUNIOR COMPUTER BOOK 1 — for anyone wishing to become familiar with (micro)computers, this book gives the opportunity to build and program a personal computer at a very reasonable cost.

Price — UK £ 4.50 Overseas £ 4.75

JUNIOR COMPUTER BOOK 2 — follows in a logical continuation of Book 1, and contains a detailed appraisal of the software. Three major programming tools, the monitor, an assembler and an editor, are discussed together with practical proposals for input output and peripherals.

Price — UK £ 4.75 Overseas £ 5.00

JUNIOR COMPUTER BOOK 3 — the next step, transforming the basic, single-board Junior Computer into a complete personal computer system.

Price — UK £ 4.75 Overseas £ 5.00

300 CIRCUITS for the home constructor — 300 projects ranging from the basic to the very sophisticated.

Price — UK £ 3.75 Overseas £ 4.00

DIGIBOOK — provides a simple step-by-step introduction to the basic theory and application of digital electronics and gives clear explanations of the fundamentals of digital circuitry, backed up by experiments designed to reinforce this newly acquired knowledge. Supplied with an experimenter's PCB.

Price — UK £ 5.00 Overseas £ 5.25

FORMANT — complete constructional details of the Elektor Formant Synthesiser — comes with a FREE cassette of sounds that the Formant is capable of producing together with advice on how to achieve them.

Price — UK £ 4.75 Overseas £ 5.00

SC/MPUITER (1) — describes how to build and operate your own microprocessor system — the first book of a series — further books will show how the system may be extended to meet various requirements.

Price — UK £ 3.95 Overseas £ 4.20

SC/MPUITER (2) — the second book in the series. An updated version of the monitor program (Elbug II) is introduced together with a number of expansion possibilities. By adding the Elekterminal to the system described in Book 1 the microcomputer becomes even more versatile.

Price — UK £ 4.25 Overseas £ 4.50

BOOK 75 — a selection of some of the most interesting and popular construction projects that were originally published in Elektor issues 1 to 8.

Price — UK £ 3.75 Overseas £ 4.00

TV GAMES COMPUTER — this book provides a different — and, in many ways, easier — approach to microprocessors. The TV games computer is dedicated to one specific task, as the name suggests. This provides an almost unique opportunity to have fun while learning!

Price — UK £ 5.00 Overseas £ 5.25

When ordering please use the Elektor Readers' Order Card in this issue (the above prices include p. & p.)

Sinclair ZX81 Personal Comp

the heart of a system

that grows with you.

1980 saw a genuine breakthrough – the Sinclair ZX80, world's first complete personal computer for under £100. Not surprisingly, over 50,000 were sold.

In March 1981, the Sinclair lead increased dramatically. For just £69.95 the Sinclair ZX81 offers even more advanced facilities at an even lower price. Initially, even we were surprised by the demand – over 50,000 in the first 3 months!

Today, the Sinclair ZX81 is the heart of a computer system. You can add 16-times more memory with the ZX RAM pack. The ZX Printer offers an unbeatable combination of performance and price. And the ZX Software library is growing every day.

Lower price: higher capability

With the ZX81, it's still very simple to teach yourself computing, but the ZX81 packs even greater working capability than the ZX80.

It uses the same micro-processor, but incorporates a new, more powerful 8K BASIC ROM – the 'trained intelligence' of the computer. This chip works in decimals, handles logs and trig, allows you to plot graphs, and builds up animated displays.

And the ZX81 incorporates other operation refinements – the facility to load and save named programs on cassette, for example, and to drive the new ZX Printer.



New BASIC manual

Every ZX81 comes with a comprehensive, specially-written manual – a complete course in BASIC programming, from first principles to complex programs.

Kit: £49.⁹⁵

Higher specification, lower price – how's it done?

Quite simply, by design. The ZX80 reduced the chips in a working computer from 40 or so, to 21. The ZX81 reduces the 21 to 4!

The secret lies in a totally new master chip. Designed by Sinclair and custom-built in Britain, this unique chip replaces 18 chips from the ZX80!

New, improved specification

● Z80A micro-processor – new faster version of the famous Z80 chip, widely recognised as the best ever made.

- Unique 'one-touch' key word entry: the ZX81 eliminates a great deal of tiresome typing. Key words (RUN, LIST, PRINT, etc.) have their own single-key entry.
- Unique syntax-check and report codes identify programming errors immediately.
- Full range of mathematical and scientific functions accurate to eight decimal places.
- Graph-drawing and animated-display facilities.
- Multi-dimensional string and numerical arrays.
- Up to 26 FOR/NEXT loops.
- Randomise function – useful for games as well as serious applications.
- Cassette LOAD and SAVE with named programs.
- 1K-byte RAM expandable to 16K bytes with Sinclair RAM pack.
- Able to drive the new Sinclair printer.
- Advanced 4-chip design: micro-processor, ROM, RAM, plus master chip – unique, custom-built chip replacing 18 ZX80 chips.



Built: £69.⁹⁵

Kit or built – it's up to you!

You'll be surprised how easy the ZX81 kit is to build: just four chips to assemble (plus, of course the other discrete components) – a few hours' work with a fine-tipped soldering iron. And you may already have a suitable mains adaptor – 600 mA at 9 V DC nominal unregulated (supplied with built version).

Kit and built versions come complete with all leads to connect to your TV (colour or black and white) and cassette recorder.



uter-



16K-byte RAM pack for massive add-on memory.

Designed as a complete module to fit your Sinclair ZX80 or ZX81, the RAM pack simply plugs into the existing expansion port at the rear of the computer to multiply your data/program storage by 16!

Use it for long and complex programs or as a personal database. Yet it costs as little as half the price of competitive additional memory.

With the RAM pack, you can also run some of the more sophisticated ZX Software - the Business & Household management systems for example.

Available now - the ZX Printer for only £49.95

Designed exclusively for use with the ZX81 (and ZX80 with 8K BASIC ROM), the printer offers full alphanumeric and highly sophisticated graphics.

A special feature is COPY, which prints out exactly what is on the whole TV screen without the need for further instructions.

At last you can have a hard copy of your program listings - particularly

useful when writing or editing programs.

And of course you can print out your results for permanent records or sending to a friend.

Printing speed is 50 characters per second, with 32 characters per line and 9 lines per vertical inch.

The ZX Printer connects to the rear of your computer - using a stackable connector so you can plug in a RAM pack as well. A roll of paper (65 ft long x 4 in wide) is supplied, along with full instructions.

How to order your ZX81

BY PHONE - Access, Barclaycard or Trustcard holders can call 01-200 0200 for personal attention 24 hours a day, every day.

BY FREEPOST - use the no-stamp-needed coupon below. You can pay

by cheque, postal order, Access, Barclaycard or Trustcard.

EITHER WAY - please allow up to 28 days for delivery. And there's a 14-day money-back option. We want you to be satisfied beyond doubt - and we have no doubt that you will be.

To: Sinclair Research Ltd, FREEPOST, Camberley, Surrey, GU15 3BR.

Qty	Item	Code	Item price £	Total £
	Sinclair ZX81 Personal Computer kit(s). Price includes ZX81 BASIC manual, excludes mains adaptor.	12	49.95	
	Ready-assembled Sinclair ZX81 Personal Computer(s). Price includes ZX81 BASIC manual and mains adaptor.	11	69.95	
	Mains Adaptor(s) (600 mA at 9 V DC nominal unregulated).	10	8.95	
	16K-BYTE RAM pack.	18	49.95	
	Sinclair ZX Printer.	27	49.95	
	8K BASIC ROM to fit ZX80.	17	19.95	
	Post and Packing			2.95

Please tick if you require a VAT receipt

TOTAL £

*I enclose a cheque/postal order payable to Sinclair Research Ltd, for £

*Please charge to my Access/Barclaycard/Trustcard account no.

*Please delete/complete as applicable.

Please print.

Name: Mr/Mrs/Miss

Address:

FREEPOST - no stamp needed. Offer applies to UK only.

ELK 03

sinclair ZX81

6 Kings Parade, Cambridge, Cambs., CB2 1SN.
Tel: (0276) 66104 & 21262.

Step-by-step fully illustrated assembly and fitting instructions are included together with circuit descriptions. Highest quality components are used throughout.

Sparkrite

BRANDLEADING ELECTRONICS

NOW AVAILABLE IN KIT FORM

SX1000

Electronic Ignition

- Inductive Discharge
- Extended coil energy storage circuit
- Contact breaker driven
- Three position changeover switch
- Over 65 components to assemble
- Patented clip-to-coil fitting
- Fits all 12v neg. earth vehicles

SX2000

Electronic Ignition

- The brandleading system on the market today
- Unique Reactive Discharge
- Combined Inductive and Capacitive Discharge
- Contact breaker driven
- Three position changeover switch
- Over 130 components to assemble
- Patented clip-to-coil fitting
- Fits all 12v neg. earth vehicles

MAGIDICE

Electronic Dice

- Not an auto item but great fun for the family
- Total random selection
- Triggered by waving of hand over dice
- Bleeps and flashes during a 4 second tumble sequence
- Throw displayed for 10 seconds
- Auto display of last throw 1 second in 5
- Muting and Off switch on base
- Hours of continuous use from PP7 battery
- Over 100 components to assemble

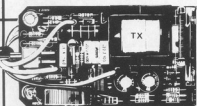

TX2002

Electronic Ignition

- The ultimate system
- Switchable contactless
- Three position switch with Auxiliary back-up inductive circuit
- Reactive Discharge
- Combined capacitive and inductive
- Extended coil energy storage circuit
- Magnetic contactless distributor triggerhead
- Distributor triggerhead adaptors included
- Can also be triggered by existing contact breakers
- Die cast waterproof case with clip-to-coil fitting
- Fits majority of 4 and 6 cylinder 12v neg. earth vehicles
- Over 150 components to assemble

VOYAGER Car Drive Computer

- A most sophisticated accessory
- Utilises a single chip mask programmed microprocessor incorporating a unique programme designed by EDA Sparkrite Ltd.
- Affords 12 functions centred on Fuel, Speed, Distance and Time
- Visual and Audible alarms warning of Excess Speed, Frost/Ice, Lights-left-on
- Facility to operate LOG and TRIP functions independently or synchronously
- Large 10mm high 400ft-L fluorescent display with auto intensity
- Unique speed and fuel transducers giving a programmed accuracy of + or - 1%
- Large LOG & TRIP memories 2,000 miles, 180 gallons, 100 hours
- Full Imperial and Metric calibrations
- Over 300 components to assemble
- A real challenge for the electronics enthusiasts!



AT-80

Electronic Car Security System

- Arms doors, boot, bonnet and has security loop to protect fog/spot lamps, radio/tape, CB equipment
- Programmable personal code entry system
- Armed and disarmed from outside vehicle using a special magnetic key fob against a windshield sensor pad adhered to the inside of the screen
- Fits all 12V neg earth vehicles
- Over 250 components to assemble

All EDA-SPARKRITE products and designs are fully covered by one or more World Patents

EDA SPARKRITE LIMITED 82 Bath Street, Walsall, West Midlands, WS1 3DE England. Tel: (0922) 614791

Please allow 28 days for delivery

E382

NAME _____

ADDRESS _____

I ENCLOSE CHEQUE(S)/POSTAL ORDERS FOR

£ _____ KIT REF _____

CHEQUE NO _____

24hr. Answerphone

PHONE YOUR ORDER WITH ACCESS/BARCLAYCARD

SEND ONLY SAE IF BROCHURE IS REQUIRED

	SELF ASSEMBLY KIT	READY BUILT UNITS
SX 1000	£12.95	£25.90
SX 2000	£19.95	£39.90
TX 2002	£29.95	£59.90
AT. 80	£29.95	£59.90
VOYAGER	£59.95	£119.90
MAGIDICE	£9.95	£19.90

PRICES INC. VAT. POSTAGE & PACKING

BRANDLEADING BRITISH ELECTRONICS

CUT OUT THE COUPON NOW!

AND CO-STARRING : **Cappy** the capable capacitor

COMING SOON

**RESI &
TRANSI**

IN
ELEKTROTECHNICOLOR

Transi, the (not very) active component

Resi, the irresistible resistor

STARRING :

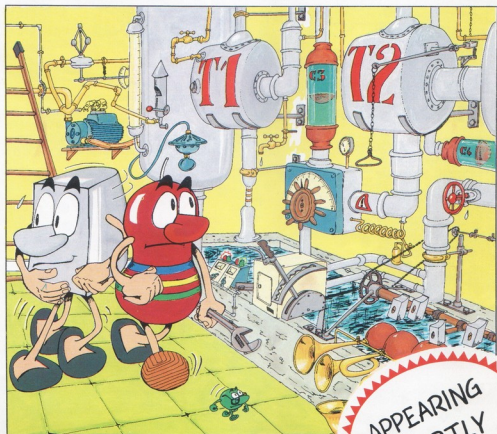

APPEARING
SHORTLY

The first electronic comic-book

RESI & TRANSI

BANISH THE MYSTERIES OF ELECTRONICS !

Excitement, entertainment, circuits. Complete with printed circuit board and Resimeter.

Further adventures and circuits
coming soon - starring Resi & Transi,
of course!

- from **Elektor**

Elektor Publishers Ltd., Elektor House, 10 Longport, Canterbury CT1 1PE, Kent, U.K.
Tel.: Canterbury (0227) 54430. Telex: 965504. Office hours: 8.30 - 12.30 and 13.30 - 16.30.

Ledy, the brilliant show-off and many, many others !!

MAPLIN make it easy...

in
SOUTHEND
284 London Road
Westcliff-on-Sea
Essex
Tel: (0702) 554000
(Closed Mondays)



in
HAMMERSMITH
159-161 King Street
Hammersmith
London W6
Tel: 01-748 0926
(Closed Mondays)



For personal service visit one of our stores.

Our new store at Hammersmith is conveniently situated near the end of the M4 and the North and South Circular Roads.

There is excellent street parking on meters a few steps away and Hammersmith Underground Station is nearby. Call in and see us soon.



in our
CATALOGUE

320 big pages packed with data and pictures of over 5,500 items

Over 100,000 copies sold already!

Don't miss out on your copy.

On sale now in all branches
WH Smith price £1.

In case of difficulty check the coupon below.

by
MAIL ORDER
A fast service
you can rely on

- * Same day service on in-stock lines
- * Very large percentage of our stock lines in stock
- * All prices include VAT
- * Large range of all the most useful components
- * First class reply paid envelope with every order
- * Quality components—no rejects—no re-marks
- * Competitive prices
- * Your money is safe with a reputable company

On price, service, stock, quality and security it makes sense now more than ever to make **maplin** your first choice for components every time!

make it easy... with **MAPLIN**

The
Maplin Matinée

Amazing value for only £239.95 plus £39.50 for cabinet if required (carriage extra)

Easy to build, superb specification. Comparable with organs selling for up to £1,000. Send for our new book giving full construction details, order as XH55K price £ 2.50 inclusive.



MAPLIN ELECTRONIC SUPPLIES LTD.

All mail to: P.O. Box 3, Rayleigh, Essex SS6 8LR. Tel: Southend (0702) 554155 Sales: (0702) 552911

Post this coupon now.

E 382

Please send me a copy of your 320 page catalogue. I enclose £1.25 (incl. 25p p&p). If I am not completely satisfied I may return the catalogue to you and have my money refunded. If you live outside the U.K. send £1.68 or 12 International Reply Coupons.

Name _____

Address _____
