

elektor

up-to-date electronics for lab and leisure

80
December 1981
U.K. 65p.

**talking
board**
give your μ p
a voice !



**combination
lock**
a novel approach

IPROM
a battery RAM !



electronics in focus - competition results! 12-01

selektor 12-02

talking board 12-04
 The speech synthesiser featured in this article consists of a single board that can provide a microprocessor system with a vocabulary of several hundred words. We hope that the first words it utters are not - 'take me to your leader' ...

EPROM 12-15
 This article describes a 'plug in' instantly programmable read only memory which will fit in a standard 2716 EPROM socket

capacitance meter module 12-18
 This add-on module converts a normal frequency counter into an instrument capable of accurately measuring capacitor values.

NiCad battery monitor (W.O. Roth) 12-21
 A simple but highly effective method of keeping NiCads permanently 'topped up' is described in this article.

lap counter/timer (A. Schwall) 12-22
 This project provides a slot racing track with electronic timing and lap counting facilities bringing it into line with all the well known racing circuits throughout the world.

cumulative index 1981 12-26

coming soon ... perhaps! 12-28

teletext decoder part 3 12-29
 The final article of the Teletext decoder series contains the receiver and the video control board. No modification is required to the TV set with these additions.

combination lock (R. de Boer) 12-37
 A combination lock that used only one rotary control and yet features an infinite number of possible 'combinations'.

the new Elektor synthesiser 12-39
 This, the third article in the series, begins practical construction with the voltage controlled oscillator. The design and performance of the synthesiser depend to a large extent on this module.

flashing lights 12-45
 These lights can be fitted to an inexpensive toy car to provide an effect very similar to the warning lights seen on ambulances, fire engines and police cars.

market 12-46

advertisers index UK 24

contents

COMPONENTS

EDITOR:

P. Holmes

UK EDITORIAL STAFF

T. Day E Rogans
 P. Williams

TECHNICAL EDITORIAL STAFF

J. Barendrecht
 G.H.K. Oarn
 E. Krempelsauer
 G. Nachbar
 A. Nachtmann
 K.S.M. Walraven



Wunderlicht



THE ELEKTOR TALKING BOARD

The complete kit
of parts for the
Talking Board
is available
now

£76.00

including VAT

The kit for the Talking Board has been produced for the project described in this issue of Elektor.



Features of the Talking Board include:
single board construction
expandable vocabulary
low power consumption
self contained memory

TMS 5100

CrestWay
ELECTRONICS

WOODHILL LANE,
SHAMLEY GREEN,
near GUILDFORD,
SURREY.

Telephone 0483 893236

electronics in focus... ... competition results!

We have come to expect a flood of entries for an Elektor competition — not surprising, with close on a million readers! — and 'Electronics in focus' is no exception. What did come as a very pleasant surprise is the high quality and extreme diversity of the photo's and slides. Single components and complete circuit boards from all angles; close-ups of integrated circuit 'chips', all kinds of photographic and lighting tricks and effects. Some themes proved highly popular: 'components among the flowers' and 'electronics in space', to name just two. The deflection coils for TV picture tubes also turned up at regular intervals. All entries were judged on the following points:

- initial 'impact' of the photo;
- how clearly does it relate to electronics in general (components or assemblies clearly visible? functional in the photo? etc.);
- technical aspects: lighting, focus, etc.;
- finally, and mainly to distinguish between almost equally good entries: how 'pure' are the electronics in the photo? A good picture (with high impact etc.) of a few resistors scored marginally higher than an equally 'good' picture of a little man built from a few resistors.

Admittedly, we were sorely tempted to add a few further points, like 'how suitable is the entry for printing?' and even 'how easy is it to unpack?' . . . But we disregarded these factors, since they were not specified in the original competition rules.

Finally, after a lot of soul-searching and long evaluation and comparison sessions — burning the midnight candle at both ends, so to speak — our jury came up with the list of prize-winners shown here. Numbers 1 . . . 28 are given in order of merit; 29 . . . 78 are in alphabetical order.

The next step, obviously, is to publish the prize-winning entries. However, this takes some further organizing: among other things, we must now obtain the original negatives for several of the photo's. If all goes according to plan, we hope to present the winners (in colour!) in the coming February issue.

Meanwhile, our congratulations to all prize-winners! The results were astonishingly good. We would like to add that the overall standard of the entries was better than expected — it seems that electronics and photography are hobbies that fit together rather well.

First prize of £ 200:

1. P. Gottschalk, Gutenbergstraße 14, 3014 Laatzen 1, Germany.

Second prize of £ 100:

2. S. Vernimb, Graumannsweg 46, 2000 Hamburg 76, Germany.

Third prize of £ 50:

3. D. Campe, Schaubeke 52, 9160 Hamme, Belgium.

These readers each receive £ 20:

4. J.W. van Boordt (Holland)
5. D. Reetz (Germany)
6. A. Kwint (Holland)
7. C. Bösch (Switzerland)
8. S. Vernimb (Germany)
9. P. Ekholm (Sweden)
10. K.D. Krömer (Germany)
11. R.M. Smert (England)
12. F. Kolling (Germany)

13. G. Gorzawski (Germany)
14. D.R. Newell (England)
15. A. Hogeveen (Holland)
16. G. Combe (France)
17. D. Campe (Belgium)
18. J. van den Boom (Holland)
19. A. Kwint (Holland)
20. H. Kottke (Germany)
21. H.J. Figge (Germany)

22. K. Langbehn (Germany)
23. S. Vernimb (Germany)
24. K.D. Krömer (Germany)
25. P. Ekholm (Sweden)
26. R.M. Smart (England)
27. P. Sardonis-Heysse (Belgium)
28. F. Chanet (Belgium)

These readers will each receive a free subscription for 1982.

- P. Baas (Holland)
G. Bauer (Germany)
P.J. Beuprez (France)
K. Becker (Germany)
K. van der Bent (Holland)
F.M. Berden (Holland)
B. Bois (France)
H.J. Brede (Germany)
A. Chaxel (France)
J. Drescher (Germany)
B. Duranteau (France)
J.P. Dzido (France)
J. Erker (Germany)
H. Feller (Germany)
F. Fleer (Germany)
S. Fischer (Germany)
S. Folliot (Belgium)

- M. Gerlach (Germany)
D. Guillermin (France)
B. Haugrund (Germany)
M. Held (Germany)
A.C. van Hoboken (Holland)
F. Jacquot (France)
M.G. Jekel (Holland)
C. Kohlpaintuer (Germany)
V. Kulhanck (Germany)
H. van Laarhoven (Holland)
J. Laetkainen (Finland)
C. Labrut (France)
G. Landen (Germany)
W. Lehrke (Germany)
M. Levy (France)
W. Majdic (Germany)
Q. Peeters (Belgium)

- R. Perry (England)
E. Peters (Germany)
M. Przewloha (Germany)
N. Reneberg (Germany)
A. Russel (Holland)
H. Schöllhorn (Germany)
R. Slomski (Germany)
H. Sölter (Germany)
R. Thormann (Austria)
J.F. Tinot (France)
V. Ulle (Germany)
L. Veldkamp (Germany)
J.A. Walton (England)
H.M.F.J. de Wijs (Holland)
F. Zwinger (Germany)
S. Zywiets (Germany)

selektor

Solar-hydrogen plants

Since the oil-crisis of 1973 the energy problem has become an important issue in our western society. From that point on people started to occupy themselves more intensively with this problem. Energy was saved as much as possible and research into new, not fossil, energy sources such as sun, wind and water energy was intensified. These forms of so-called renewable energy can be used to generate electricity, warmth and labour (pumping-engines). Since the oil

and gas prices are increasing all over the world, these alternative energy sources are becoming more and more important.

During a recently held conference concerning photo-voltaic energy (generating electricity from the sun) Reinhard Dahlberg, a leading researcher of AEG-Telefunken, unfolded a plan to cover the world's energy demand up to the year 2040. If Dahlberg's plan is approved, AEG-Telefunken will start the construction of two experimental plants, each having a capacity of 10 MW. These solar-hydrogen plants will convert sunlight into electricity, with which water can be separated into its two components: hydrogen and oxygen by means of electrolysis. Dahlberg is convinced that thousands of solar power stations can be put into use within a few decades. Here we have a closer look at the two processes involved, namely solar

electricity and hydrogen (as energy storage).

Solar cells

The first silicon solar cell used to convert solar energy into electricity was demonstrated by assistants of the Bell Telephone Laboratory in 1954. This type of cell consists of a wafer of n-doped silicon covered by a p-conducting material. Consequently a p/n-boundary layer comes into being. When the cell is exposed to light an absorbed photon produces two 'holes' in the silicon, which creates a surplus electron. The liberated electrons can't pass the p/n junction because it functions as a barrier. However, they will pass via the metal contacts of an external ring with which the p and n layer are connected. Consequently a voltage of approximately 0.5 V is generated between both electrodes of the solar cell.

In the beginning the efficiency of solar cells was very low (about 5%), but due to the improved manufacturing techniques it could be raised to 10%. Since fossil fuels were very cheap before 1973 to solar cells were mainly used in astronautics. The electricity supply of most satellites is supplied by solar generators. The cost for this application was about £ 85 per watt, but due to the increasing oil prices solar cells suddenly became economical. Nowadays solar electricity costs about £ 10 per watt. It could be used to generate electricity on vessels, islands or for water pumps in warm, isolated areas. Experts expect the solar cell to become a competitor for the conventional energy sources.

Hydrogen

As stated before, Dahlberg's plan not only discusses solar energy but also hydrogen as energy storage. Neither electricity nor hydrogen are an energy source, they are just a way to distribute energy. The use of hydrogen has some considerable advantages. Its transport is easier than that of electricity and it is easier to store in large quantities. It could replace natural gas in every application. Last but not least, hydrogen can generate electricity by means of so-called fuel cells. Cars could run on hydrogen! However, the major problem is that the fuel tank becomes a high explosive bomb, when exposed to oxygen.

Hydrogen can be obtained in several ways. When heated enough (3000°C) water can be divided into its two components: hydrogen and oxygen. Hydrogen can also be derived by electrolysis.

It can be transported in three different ways:

- as gas by pipe-lines
- as liquid under pressure in containers and tankers
- as a solid by combining it with other elements, which evokes the so-called hydrides.

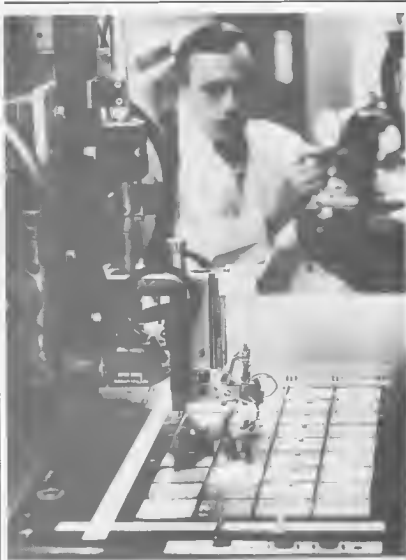


Photo 1. AEG-Telefunken was the first firm to develop a fully automatic method of manufacturing solar cell units. This photograph shows an automatic welder, which is only a small part of the complete process.

Solar-hydrogen plants

Dahlberg's suggestion combines the advantages of solar electricity and hydrogen. This suggestion was given a lot of consideration before it was introduced. According to his plan, gigantic solar power stations should provide enough electricity to produce hydrogen by electrolysis. As well as the production of hydrogen, the solar calls would supply electricity to a factory making solar cells. Consequently such a 'hydrogen plant' would consist of a solar power station, a hydrogen electrolysis installation and a production unit for solar power stations. In this way a hydrogen plant would eventually produce enough material to 'give birth' to a second plant. A production-unit for a solar power station would contain:

- a glass-works (for coating the solar-calls)
- a factory to produce silicon which can be used to make solar-cells
- a factory to convert silicon into solar-calls and to combine these single cells into panels
- a factory to combine panels and dynamos into solar power stations.

After building one solar-hydrogen plant enough material would be obtained to build an identical plant in a few years time. According to Dahlberg these enormous plants could be situated in 7 deserts: in Africa, Australia and North and South America. In the year 2040 the plants would cover an area of about 2,000,000 km². The hydrogen could be transported to the 'civilised' world via pipe-lines or as hydrides.

Dahlberg divided his plan into three phases: 1979-1989 (first phase); 1990-2000 (second phase); 2001-2040 (third phase). During the first phase the main concern is to build a factory for the production of solar cells, using conventional energy sources. Dahlberg told his audience that AEG-Telefunken is negotiating with several firms in Japan, Europe and the United States in order to form an international consortium. Its task will be to build a factory for producing solar cells having a total capacity of 1.5 Gigawatt in 1989.

In the second phase (1984) AEG would start the construction of two prototype plants having a capacity of 1 Gigawatt each and covering an area of 10 square kilometres. They should start production at the beginning of the nineties. They will provide hydrogen and solar calls.

If the initial plants appear to be successful, 10 plant families with 10 plants each will be built between 1990 and 2000. They will cover an area of 200 square kilometres. The generators for the first family (family A) will be supplied by the factories of the international consortium. Thereupon AEG will begin the construction of families B and C in 1996. These factories will be built from parts supplied by the consortium factories. By then the members of family A will reach the last stage of

2



Photo 2. Ships in particular can profit from the possibilities of solar energy.

their self-replication towards the end of the century. During the last stage of Dahlberg's plan all members of families B and C will be completed towards 2005. Together with family A they will supply the parts required for families D, E, F, G, H, I, J.

Ambitious but practicable

The greatest investments will have to be made in the period between 2000 and 2040, due to the fact that the number of plants is raised to a square. By the year 2005 the plants will only be used to produce hydrogen. The main solar cell production will take place in the second generation. The third and fourth generation of family A will start production in 2020 and 2030 respectively. The fourth generation of the families B and C will be completed in 2035. The 10 families, producing 10,000 copies during a period of 50 years, will provide the world with 100,000 plants. Their total production will be equivalent to 15 billion tons of oil (15,000,000,000,000), which is four times the world energy consumption.

The whole operation will cost about 14 billion pounds (£ 14,000,000,000). Dahlberg admits this amount to be a 'little' steep, but he points out that the same amount of money will be needed for oil as fuel in the conventional power stations during the next 20 years. Until 1989 'only' £ 6,000,000,000 will be needed. The largest investments have to be made towards the end. Dahlberg admits that his plan is ambitious. However, he sees no reason why his plan shouldn't give considerable thought. After all, hydrogen as an energy source fulfils all the conditions to become the fuel of the future. It can match

other energy sources. There is no shortage of raw materials when hydrogen is produced by means of solar energy. Dahlberg's plan makes it possible to produce enough hydrogen to replace the fossil fuels before they are exhausted.

3

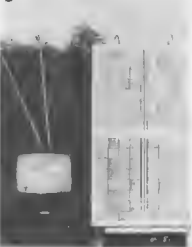


Photo 3. The advantages of solar energy are evident in sunny third world countries.

selektor
selektor

In an earlier article ('Chattering chips', *Elektor* September 1981), several speech synthesis systems were discussed. For various reasons, the Texas Instruments 'Voice State Speech' system seemed the best bet — certainly for microprocessor enthusiasts. In the first place, it can produce an output that is something like a human voice coming over a telephone line: not hi-fi, admittedly, but good enough to notice traces of an American accent coming through! Furthermore, the coding system used is fairly 'logical', which means that it is quite feasible to work out codes for new words — without having to resort to a huge computer.

talking board

a solid-state voice

In the early days of science fiction, robots could walk and talk like human beings. Later on, as authors learned of the possibilities and limitations of computers, it became more realistic to reserve the power of speech for huge, 'space-ship filling' electronic brains. Now, in this project, we can proceed to science fact: a single board that can provide a vocabulary of several hundred words for a microprocessor system!

Having decided to use the Texas Instruments system, the next step is to make a choice between the two versions: the older TMS 5100, intended for talking games and the like, or the new TMS 5200 that is intended for use in microprocessor systems. Surprisingly enough, we decided to use the 5100, for two good reasons: there is a much larger vocabulary available for this chip, as well as a good circuit in the TI application note! With only a few further modifications and additions, this system can be interfaced to almost any microprocessor system.

The basic principle of the actual speech synthesis process will be discussed later. For the moment, the only important thing to know is that a serial bit stream must be fed into the 'VSP' (Voice Synthesis Processor) in order to make it talk. For the word 'help', say, a total of 534 bits are required: just less than 67 bytes. Since this is a fairly short word, it will be obvious that a considerable memory range is required for a total vocabulary of several hundred words. To avoid wasting memory range in the 'host' microprocessor system, the 'speech memory' is included on the speech board — complete with a local address counter and associated control circuits.

The block diagram of the 'talking board' is given in figure 1. The lower half of this diagram shows the memory and control circuits. Initially, the first address for a given word must be loaded into the address buffer/counter. Since 16-bit addressing is used, the first address is loaded in two bytes (8 bit): first the low byte is placed on the data bus and LDA 1 is toggled briefly, after which the high byte is loaded by pulsing LDA 0. The 'bit counter' is reset when LDA 1 is toggled.

Once the first address is loaded, the unit can be given the 'talk' command. Each I/O clock pulse from the VSP increments the bit counter, causing the 'parallel-to-serial bit stream converter'

to select the next bit in the selected speech memory byte. The same I/O pulse clocks each bit in turn into a flip-flop, which passes the bit stream to the speech processor. When the bit counter has scanned all eight bits, it increments the address buffer/counter to select the next memory byte.

As illustrated in the block diagram, the connection between the bit stream converter and the following flip-flop can be interrupted, and both sides brought out to the 'host' processor. Data from the speech memory can be read into the host's RAM area via the Y output; after modification, to obtain a new word or sentence, it can be fed back in via the D input. Admittedly, this will often require a little interface — but we intend to publish a suitable circuit in the near future.

The upper part of the block diagram shows the word processor proper (the 'VSP'). Two control inputs, C0 and C1, come in at the left. These give the commands 'reset', 'talk' and 'test busy' as shown in table 1. The test busy command refers to the 'busy' output: when enabled, this goes high at the end of a speech sequence.

The VSP chip contains a clock oscillator — among other things, this determines the pitch of the spoken output. To synchronise the external CCLK (control clock) input to this on-chip clock, the two signals are fed through a flip-flop. The result goes back into the PDC (processor data clock) input. The VSP indicates that it needs the next speech data bit by toggling its I/O output; as described earlier, this clocks the next bit into the flip-flop and updates the bit counter. When entering speech data from external RAM, the I/O output must be used for correct synchronisation. Finally, the two differential speech outputs are passed through a low-pass filter and power amplifier to the loudspeaker.

Timing

Obviously, the various control signals must be applied to the board in the correct sequence. This is illustrated in figure 2. After power-up, the circuit

Table 1

C0, C1:

Command	C0	C1
reset	1	1
talk	0	1
test busy	0	0
(invalid)	1	0

Busy When enabled, goes high at end of word
CCLK Control clock for word processor
LD0, LD1 Enable input of low address byte and high address byte, respectively, on DE 07
I/O, OY Control lines for external speech memory

Table 1. The three commands which are initiated via the control inputs C0 and C1.

1

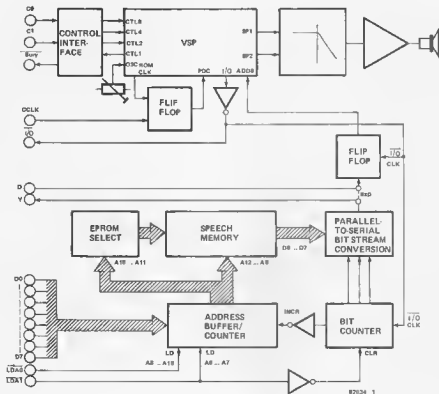


Figure 1. The block diagram of the talking board.

2

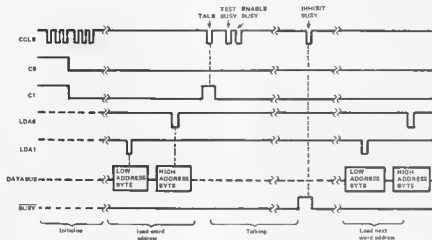


Figure 2. The various control signals must be applied to the talking board in the correct order.

must be initialised. This is done by applying a logic 1 level to C0 and C1 (corresponding to 'reset') and toggling the CCLK input three times; then, C0 and C1 are set to logic 0 (test busy) and CCLK is toggled a further three times.

The unit is now 'ready to go'.

To output a word, the low address byte is put onto the data bus and LDA 1 is pulled low briefly; then the high address byte is loaded from the data bus by toggling LDA 0. C1 is now set to logic 1

(C0 remains low), corresponding to the 'talk' command, and the CCLK input is toggled. This initiates the speech output. Meanwhile, C1 is returned to logic 0 and the CCLK input is toggled twice. This enables the 'busy' output, so that

Table 2

	min	max
T_S	0	—
T_{DOWN}	$T = 6,25 \mu s$	—
T_{UP}	$T = 8,25 \mu s$	—
T_H	$1\frac{1}{2}T = 10,9 \mu s$	—
T_W	20 ns	—
T_{HO}	0	—
$T_{I/O}$	$1\frac{1}{2}T = 7,8 \mu s$	$8,1 \mu s$

$$T = T_{ROMCLK} = 6,25 \mu s$$

Table 2. The timing requirements for the various control signals.

it will go high at the end of the word. At that point, a further CCLK pulse will reset the VSP in readiness for the next word.

All control signals must meet the timing requirements shown in figure 3 and table 2. Figure 3a corresponds to the initialisation procedure; the main point here is that the CCLK pulses must be sufficiently long for guaranteed synchronisation with the VSPs

'ROMCLK' oscillator. This means that both T_{DOWN} and T_{UP} must be at least $6.25 \mu s$, in most practical applications. Figure 3b shows the situation for 'talking'. The T_W period, for loading the lower and upper address bytes, must be long enough for the address buffer/counter to latch: 20 ns or more. The shaded portions on the $C0/C1$ lines and data bus indicate that the logic levels are unimportant at that time.

The circuit

The general layout of the circuit diagram (figure 4) corresponds to that of the block diagram given in figure 1. Starting at the top, for a change: $T1 \dots T3$ convert the $C0/C1$ inputs into the actual control signals required by the processor, and N2 buffers the Busy output. P1 sets the frequency of the on-chip oscillator; the correct setting corresponds to 160 kHz at pin 3 of IC1. No frequency counter is required, however: the output signal should sound like a normal male voice — not Donald Duck or 'Infra-Iwan-Rebroff'!

Normally, the mid-position of P1 should be fairly accurate. Note that this adjustment does effect the minimum length of the CCLK pulses — the $6.25 \mu s$ mentioned above corresponds to 160 kHz!

The CCLK input is synchronised to the ROMCLK output at pin 3 by means of FF1; via T4, this signal goes back to the PDC input of the VSP, IC1. The other flip-flop and T5 are used to clock the bit stream into the ADD8 of IC1, under the control of the I/O output. In between these two, the speech outputs (SPK1 and SPK2) are passed to the low-pass filter (A1 and A2) and the power amplifier (A3, T6 ... T9). The output level is set by means of P2.

The lower section of the circuit is the memory with its associated control circuits. IC4 ... IC7 are the address buffer/counter. When the parallel load inputs (pin 11) are pulled low, via LDA0 or LDA1, the byte on the data bus is transferred to the corresponding pair of ICs. The outputs from these ICs drive the address inputs of IC12 ... IC19 (the actual EPROMs) and the EPROM selector, IC9.

3

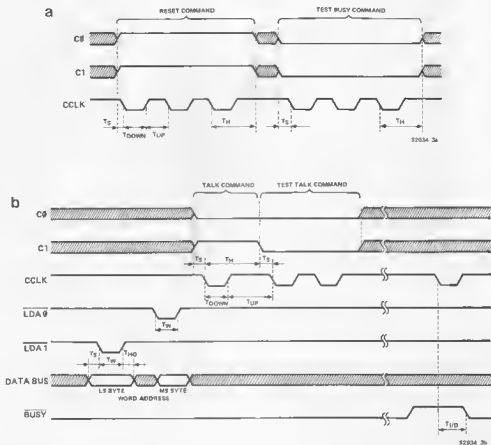


Figure 3. The control signals must meet certain timing requirements. Figure 3a shows the duration of the signals during the initialisation procedure while figure 3b illustrates the situation when the board is 'talking'.

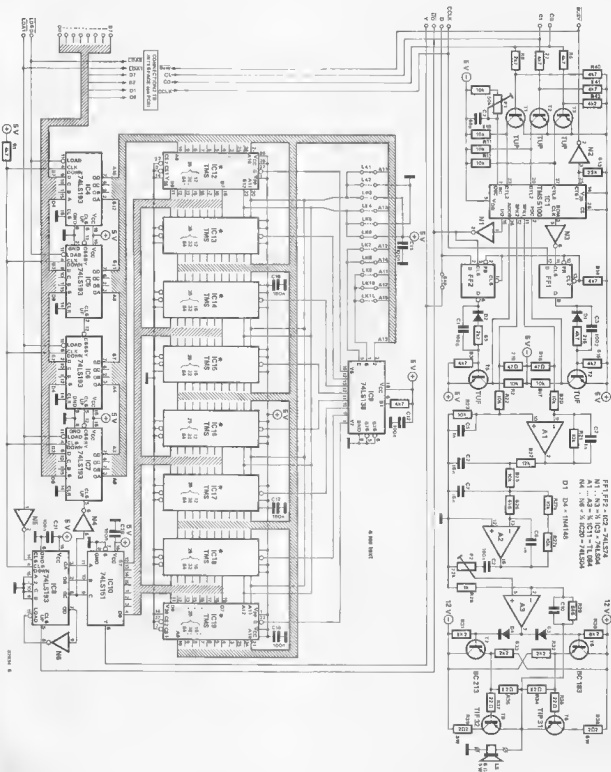


Figure 4. The complete circuit diagram of the talking board. The layout corresponds quite closely to that of the block diagram.

Table 3

	E	R	P	K1	K2	K3	K4	K5	K6	K7	K8	K9	K10	FRAME TYPE	
	0000													SILENCE	
H E L	0100	0	00000	10011	01110	1001	0111							SILENCE	
	0111	1	00000											UV	
	1101	0	10010	10000	10100	1000	0110	0111	1000	1010	100	101	010	UV — REPEAT	
	1101	1	10011											V	
	1110	1	10011											V — REPEAT	
	1101	0	10100	01101	01111	1010	1010		1001	0111	1000	100	101	101	V
	1101	0	10100	01110	01011	1000	1100		1101	1000	0100	100	011	101	V
	1101	0	10011	10001	01010	0110	1001		1111	1011	0101	010	000	110	V
	1011	1	11010												V — REPEAT
	1010	0	10010	01101	00111	1000	1100		1111	0111	0010	001	010	110	V
	1001	1	10001												V — REPEAT
	1001	1	01110												V — REPEAT
1000	1	01101												V — REPEAT	
0010	0	01110	00101	00101	1101	1001		1110	0101	0111	001	011	011	V	
0000														SILENCE	
0000														SILENCE	
0000														SILENCE	
P	0111	0	00000	10100	01011	1011	1000							UV	
	0111	0	00000	10001	01011	1011	0110							UV	
	0101	1	00000											UV — REPEAT	
	0011	0	00000	10011	00111	1010	0110							UV	
	0010	0	00000	10010	00101	1011	0101							UV	
	0000													SILENCE	
1111													STOP CODE		

V = VOICED
UV = UNVOICED
E = ENERGY
R = REPEAT
P = PITCH
K1...K10 = FILTER PARAMETERS

Table 3 This sequence of digital code words will make the Texas Instruments chip shout for help!

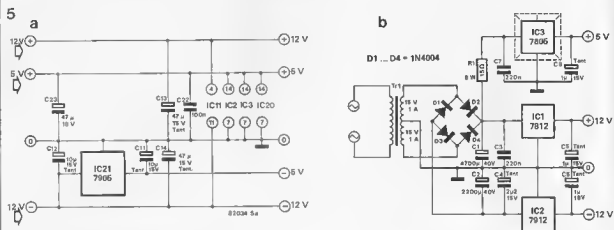


Figure 5. The power supply for the talking board can be derived from that of the host computer [figure 5a]. Alternatively, a separate power supply can be constructed quite simply (figure 5b).

The confusing array of wire links are included so that different types of EPROM can be used. For 2716s, links 2, 6, 7 and 9 should be used; the EPROMs are then addressed in the following sequence: IC12, IC13, IC16, IC17, IC14, IC15, IC18, IC19—corresponding to the address range from 0000 to 3FFF in 2 kbyte chunks. For 2732s, as

in the Talking Board kit, links 1, 6, 8 and 10 should be mounted, as shown. The EPROMs are now selected in sequence, from IC12 to IC19, to cover the address range from 0000 to 7FFF. Finally, links 1, 4, 8 and 11 are provided for 2764s; these cover the complete address range from 0000 to FFFF in the following sequence: IC12, IC14,

IC16, IC18, IC13, IC15, IC17, IC19. It should be noted that the board layout and pinning is given for 2764s; the other types are slightly shorter, as indicated by dotted lines on the board. This means that pin 1 of a 2716 or 2732 is inserted in the pin 3 position, and so on down.

Finally, the lower right-hand corner of

Table 4.	ADDRESS (HEX)	WORD	ADDRESS (HEX)	WORD	ADDRESS (HEX)	WORD
EPROM 1						
0000	AGAIN	060A	HOW	0D6C	R	
004B	DOWN	0724	IN	00A8	C	
0084	HELLO	0760	IS	0DEC	D	
0000	MESSAGE	079C	IT	0E36	E	
0138	MISTAKE	0784	ME	0E60	F	
019B	NAME	0800	MUCH	0E94	G	
01CE	NEAR	082A	MY	0EC4	H	
0222	PLEASE	0856	NO	0EFE	I	
0262	PUT	0890	NOT	0F34	J	
026C	REPEAT	08CA	NOW	0F80	K	
02CC	RIGHT	0906	OF			
0324	THANK	0948	ON			
036E	UP	0970	OR			
0388	WANT	099A	OUT			
03CE	'S	09D8	THE (E)			
03EA	ALL	0A08	THE			
041A	AN	0A44	THERE			
0446	AND	0A78	THIS			
0484	ANY	0A9E	USE			
0484	ARE	0AF8	WHAT			
0400	AT	0B20	WHEN			
04F2	CAN	0B6C	WHERE			
0522	DID	0B84	WILL			
0568	DO	0C06	WITH			
05A0	DOES	0C5A	WOULD			
05FC	FOR	0C94	YES			
0634	FROM	0CC8	YOU			
0662	GOT	0CF8	YOUR			
069C	HAVE	0D2E	A			
EPROM 2						
0000	L	0732	FOURTEEN			
004C	M	0774	FIFTEEN			
008A	N	0800	SIXTEEN			
00C2	O	0864	SEVENTEEN			
00EA	P	08C2	EIGHTEEN			
0114	Q	08FC	NINETEEN			
014C	R	0952	TWENTY			
0178	S	0986	THIRTY			
01A0	T	09B6	FORTY			
01F0	U	09EC	FIFTY			
021E	V	0A46	SIXTY			
0250	W	0A7E	SEVENTY			
0298	X	0AC4	EIGHTY			
02BE	Y	0AF0	NINETY			
0300	ZEO	0B58	HUNOREO			
0346	ZERO	08C2	THOUSAND			
03A4	ONE	0C3E	EQUAL			
03F6	TWO	0C94	NUMBER			
0430	THREE	0D04	PERCENT			
0474	FOUR	0C54	AMPS			
04C2	FIVE	0C84	DEGREES			
0510	SIX	0DF4	FARAD			
054E	SEVEN	0E22	FREQUENCY			
05A4	EIGHT	0ECE	HENRY			
05D4	NINE	0F18	HERTZ			
061E	TEN	0F66	HOURS			
0652	ELEVEN					
069A	TWELVE					
06F6	THIRTEEN					
EPROM 3						
0000	MEGA	09DE	GOOD BYE			
005E	MICRO	0A36	DATE			
00D2	MILLI	0A6A	LEFT			
010A	MINUS	0A98	CHANGE			
0172	OHMS	0ADE	DIRECTION			
01C6	PLUS	0B5C	ENTER			
01FA	POINT	0B88	FAST			
023C	POWER	0C00	SLOW			
0282	SECONDS	0C48	GO			
02EA	TEMPERATURE	0C9C	STOP			
0362	TIME	0CEA	HIGH			
03AC	READY	0D46	LOW			
00F0	SWITCH	0D9A	MOVE			
043E	CONTROL	0E10	RANGE			
04A2	WARNING	0E7E	EXIT			
04EC	DFF	0E9E	CARDS			
0530	CHECK	0F10	ATTACK			
0568	BUTTON	0F4C	DESTROY			
0586	TELEPHONE					
0908	BUSY					
0556	INVALID					
0768	MONDAY					
08D0	TUESDAY					
0872	WEDNESDAY					
0802	THURSDAY					
0802	FRIDAY					
0838	SATURDAY					
0994	SUNDAY					

Table 4. The vocabulary of the talking board is contained in EPROM. Note that the first digit in the word address must correspond to the position of the EPROM. If these are mounted in sequence in the IC12...IC14 position, the first address in EPROM 2 will be 1000; EPROM 3 then starts at 2000.

figure 4. IC8 is the bit counter: the incoming $\overline{170}$ (clock) signal is divided by 8, to select the eight bits in each byte in sequence. Actually, IC8 is a 4-bit counter, but the fourth bit (QD) is fed back to the 'load' input so that 0000 is loaded as soon as it goes high. The three lower bits, QA...QC, control the data multiplexer (IC10) that selects the correct bit from the memory output byte. After each group of eight bits has been scanned, a pulse is fed from IC8, via N4, to the count input of IC7. This causes the address counter to increment to the following address.

Power supply

Very little needs to be said on this subject. The main board contains a sufficient number of smoothing capacitors, as shown in figure 5a, and an IC that derives the -5 V supply from the incoming -12 V rail.

The board therefore requires an adequately smoothed $+12$ V/ ± 5 V/0 V/ -12 V input. This can be provided by the 'host' microprocessor, or derived from an additional supply circuit as shown in figure 5b. The 5 V supply must be capable of delivering 300 mA. The quiescent current consumption of the ± 12 V supply is 50 mA, but this will increase at high audio output levels.

How it talks

Having dealt with the basic hardware, it is time to take a closer look at the software — in particular, how a given word is coded. Basically, the processor is an electronic analog of the human speech tract. In plain language, it simulates the lungs ('energy'), the vocal cords ('pitch') and the shape of mouth and lips ('filters'); when the vocal cords are not resonating ('unvoiced' sounds, like S and F) a noise generator is used instead of a tone generator. All this information, for a given word, is contained in a succession of digital bits.

A practical example will help to make this clear. Table 3 gives the complete code for the word 'help'. The first group of bits is 0000: silence. Then, 0100 sets the initial energy; the repeat bit is zero (we'll come to this later) and the 'pitch' is 0000 — corresponding to 'unvoiced'. For unvoiced sounds, the next 18 bits set four filter parameters as shown. The next line starts with a higher 'energy' setting (0111), followed by the repeat bit at logic high: unmodified filter settings. The pitch remains 0000, for unvoiced. Since the filter settings remain unchanged, we can proceed to the next line. A higher energy is defined, no repeat, and a non-zero pitch: 10010, defining the desired tone generator frequency. For voiced sounds, more precise filtering is required. This results in a total of 39 bits to determine the settings of all ten filters. Fortunately, the filter settings can remain unaltered for the next two lines (repeat bit one), although

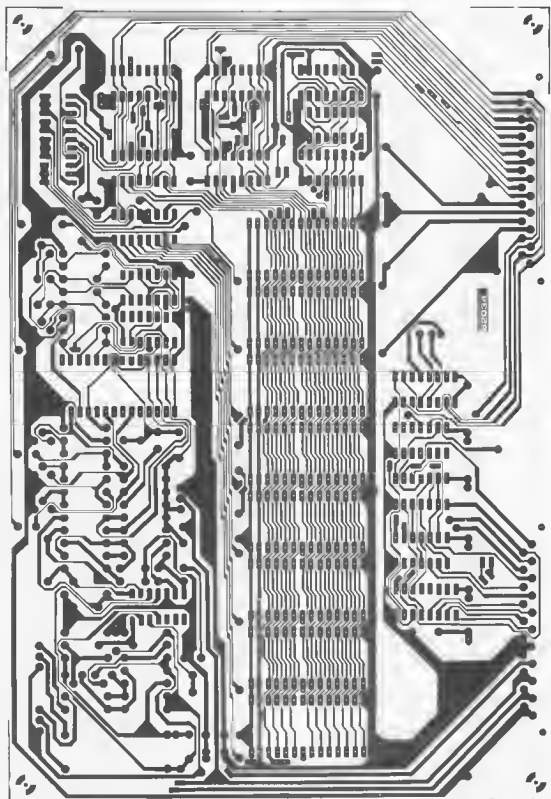


Figura 6. The talking printed circuit board.

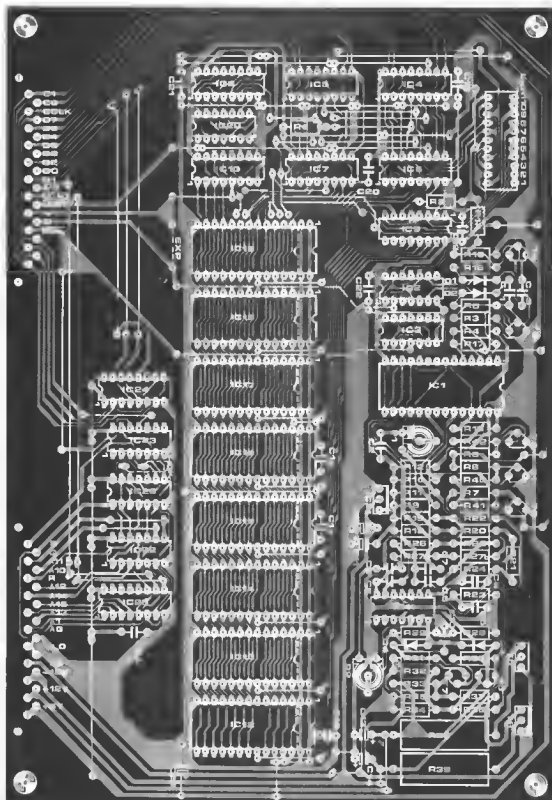


Figure 7. The component layout for the talking board.

Parts list:

Resistors.

R1 . . . R3, R5 . . . R8, R14 . . . R15,
R40 . . . R42 = 4k7
R4, R9 . . . R12, R17, R20 . . . R23, R25,
R27a, R27b = 10 k
R13 = 22 k
R18, R19 = 47 Ω
R24 = 12 k
R26, R29 = 6k8
R28 = 1 k
R30, R31 = 8k2
R32, R33 = 2k2
R34, R35 = 82 k
R36, R37 = 22 Ω
R38, R39 = 2 Ω /2/3 W
P1 = 50 k preset potentiometer
P2 = 22 k preset potentiometer

Capacitors:

C1, C3 = 100 p
C2 = 88 p
C4, C5, C8 = 1 n
C6, C7 = 10 n
C9, C15 . . . C22 = 100 n
C10 = 2n2
C11, C12 = 10 μ /16 V tantalum
C13, C14 = 47 μ /16 V tantalum
C23 = 47 μ /10 V

Semiconductors

D1 . . . D4 = 1N4148
T1 . . . T5 = TUP
T8 = 8C 183
T7 = 8C 213
T8 = TIP 31
T9 = TIP 32
IC1 = TMS 5100
IC2 = 74LS74
IC3, IC20 = 74LS04
IC4 IC8 + 74LS193
IC9 = 74LS138
IC10 = 74LS151
IC11 = TL 084
IC12 . . . IC19 = TMS 2532*
IC21 = 7905

* see BX1
A complete kit of parts is available from
Crestway Electronics.

Parts list for the power supply (figure 5b)
not included in the kit.

Resistors.

R1 = 15 Ω /5 W

Capacitors:

C1 = 4700 μ /40 V
C2 = 2200 μ /40 V
C3, C7 = 220 n
C4 = 2 μ /2/16 V tantalum
C5, C6, C8 = 1 μ /18 V tantalum

Semiconductors:

D1 . . . D4 = 1N4004
IC1 = 7812
IC2 = 7912
IC3 = 7805

Miscellaneous

Tr1 = 2 x 15 V/1 A mains transformer
Heatsink for IC3

Parts list for the interface (figure 8) not
included in the kit:

Capacitors:

C26 = 100 n

Semiconductors:

IC22 = 74LS02
IC23, IC24 = 74LS175
IC25 = 74LS138
IC26 = 74LS00

8

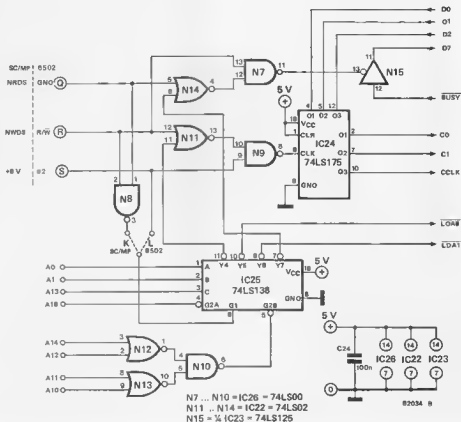


Figure 8. If there are no I/O lines available in the host computer, this simple interface will be required.

9

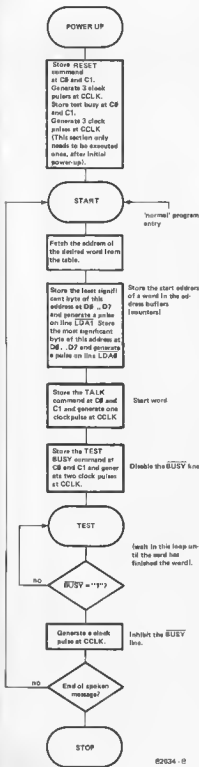


Figure 9. This flow chart explains steps required for the system to produce a speech output.

the energy and pitch increase slightly. And so it goes on.

The basic principle is fairly clear. When scanning a given word (with the intention to turn it into some other word?) the following rules apply

- If the first four bits on a line are zero, forget them: they specify 'silence'.
- Otherwise, look at the next (repeat) bit: if it is logic 0, filter parameters will be specified; otherwise, the next five 'pitch' bits will complete the line.
- If the 'pitch' bits are 00000, an unvoiced sound is specified: the following 18 bits determine the filter parameters. For voiced sounds (pitch \neq 00000), the following 39 bits determine the filter parameters.
- When the first four bits in a line are 1111, this signifies the end of the word.

Given this information, it is quite feasible to decode any given word. More importantly, it is possible to 'construct' new words by modifying existing codes. We had a crack at assembling the word 'Elektor', and the result was quite acceptable! A basic vocabulary is a great help, of course, and this is supplied in EPROMs with the kit. The words are listed, with the corresponding first addresses, in table 4.

Construction and operation

The printed circuit board and component layout are shown in figures 6 and 7. Construction is started by mounting all the wire links (including EXP) with the exception of link L or K which will be discussed later in the text. Note that TB and T9 could do with a little heatsink if high output levels are required. As well as the basic circuit, room has been provided on the board for a general purpose microprocessor interface (IC22... IC26 and C24). Connection can be made via a 21 way DIN 41617 male socket with 90° solder pins.

In principle, the board can be driven from any microprocessor system — provided 14 I/O lines are available. These are the 14 lines at the left of figure 4. Lines D, I/O and Y are not used initially. If necessary, they can be used for reading the code in and out. In some instances further interfacing may be required and a suitable circuit is shown in figure B. It should be noted that, although this circuit can be mounted on the board, the components are not included in the basic 'Talking board' kit. Connection is carried out via the lines to the left of figure 8 which are linked to the corresponding microprocessor lines. In addition, lines D0... D7 must be connected to the data bus in the microprocessor. Connections to the remaining lines at the left of figure 4 are obviously not then required.

Address decoding is rather rudimentary; the circuit shown utilises the complete address block from 2000 to 23FF for

only four addresses. Obviously, the address range can be moved or reduced by swapping lines and/or adding further address decoders. Basically, only four addresses are required:

- data for C0, C1 and CCLK: in this circuit, address 2000 is used. Bit 0,1 = C0, C1; bit 2 = CCLK.
- LDA 1 command: address 2002. (Data = lower address byte).
- LDA 0 command: address 2001. (Data = higher address byte).
- Busy output: address 2003, bit 7 (MSB).

The G1 input to IC25 can be set according to the microprocessor system used. For the Junior Computer, it must be linked to 02 (link L); for the SC/MP it is derived from a combination of NRDS and NWDS (link K). In general, it indicates when the address and data are valid.

Given a suitable interface, it is a fairly simple matter to produce a 'speech' output. The basic flow chart is given in figure 9. After power-up, the first step is to initialise the word processor. This is accomplished by loading the data 07-03-07-03-07-03-07, alternately, to address 2000. This corresponds to a logic 1 for C0 and C1, while CCLK is toggled three times. Note that the CCLK pulse (bit 2 in this sequence) must remain low or high for at least 6.25 μ s, which may involve adding a delay in this routine. The next step in the initialisation procedure consists of alternately loading '00' and '04' into address 2000 — again, three times in all.

This brings us to 'start': the point at which an actual speech output is initiated. First, the lower address byte for the desired word is transferred to address 2002 (this automatically initiates the necessary [LDA 1] pulse!); then, the higher address byte is transferred to address 2001. Now the 'Talk' command can be given (02-06 to address 2000). Finally, the data sequence '00-04-00-04' is applied to address 2000, in a 6.25 μ s rhythm as before. This corresponds to applying the test busy command and toggling the CCLK input twice.

A test loop is now run, waiting for the 'busy' output (the MSB at address 2003) to go high. When this occurs, a further '00-04' sequence is loaded to address 2000 to inhibit the 'busy' output. If further words are to be voiced, the whole procedure can now be repeated from Start.

As a further illustration, a complete program for the Junior Computer is given in table 5.

Component availability

For this project, we have found a very simple solution to the component availability problem: the 'Talking Board' kits are available from Crestway Electronics (among others). Details are given in an advertisement elsewhere in this issue. It

Table 5.

JUNIOR'S ASSEMBLER	PAGE #:
00:0: 0200	ORG \$0200
00:20: 00:20:	DATE : 29-9-'81
00:40: 00:40:	
00:50: 00:50:	SPEECH SYNTHESISER TMS 5:00
00:60: 00:60:	
00:70: 00:70:	INTERFACE ADDRESSING
00:80: 00:80:	
01:00: 0200	CMND * \$2000 COMMAND ADDRESS
01:10: 0200	LDZERO * \$200. LDA# STROBE ADDRESS
01:20: 0200	LDONE * \$2002 LDA: STROBE ADDRESS
01:30: 0200	BUSY * \$2003 BUSY READ OUT
01:40: 01:40:	
01:50: 01:50:	JUNIOR MONITOR START ADDRESS
01:60: 01:60:	
01:70: 0200	RESET * \$1C1D
01:80: 01:80:	
01:90: 01:90:	SPEECH ADDRESS LOOK UP TABLE
02:00: 02:00:	
02:10: 0200	TABLE * \$0400 LOWER ORDER ADDRESS BYTE FIRST WRD
02:20: 02:20:	\$040. HIGHER " " " " "
02:30: 02:30:	\$0402 LOWER ORDER ADDRESS BYTE SECDND WRD
02:40: 02:40:	\$0403 HIGHER " " " " "
02:50: 02:50:
02:60: 02:60:	\$04FF HIGHER ORDER ADDRESS BYTE LAST WORD
02:70: 02:70:	
02:80: 02:80:	*****
02:90: 02:90:	MAINPROGRAM
03:00: 03:00:	*****
03:10: 03:10:	
03:20: 0200 A9 07	POWUP LDINH \$07
03:30: 0202 8D 00 20	STA CMND SET 'RESET' COMMAND ON C0 AND C1
03:40: 0205 20 45 02	JSR TOGGLE TOGGLE CCLK THREE TIMES
03:50: 0208 20 45 02	JSR TOGGLE
03:60: 020B 20 45 02	JSR TOGGLE
03:70: 020E A9 00	LDINH \$00
03:80: 0210 20 45 02	JSR TOGGLE SET 'TEST BUSY' COMMAND ON C0 AND C1, AND
03:90: 0213 20 45 02	JSR TOGGLE TOGGLE CCLK THREE TIMES
04:00: 0216 20 45 02	JSR TOGGLE
04:10: 04:10:	
04:20: 0219 A2 00	START LDINH \$00 CLEAR X-REGISTER
04:30: 04:30:	
04:40: 021B 8D 00 04	STRT LDAX TABLE LOWER ORDER SPEECH START ADDRESS TO ACCU
04:50: 021E 8D 02 20	STA LDONE SET D0 TO D7 TO THIS BYTE AND STROBE LDA:
04:60: 0221 E8	INX
04:70: 0222 8D 00 04	LDAX TABLE HIGHER ORDER SPEECH START ADDRESS TO ACCU
04:80: 0225 8D 01 20	STA LDZERO SET D0 TO D7 TO THIS BYTE AND STROBE LDA#
04:90: 0228 A9 02	LDINH \$02
05:00: 022A 20 45 02	JSR TOGGLE SET 'TALK' COMMAND DN C0 AND C1, AND
05:10: 05:10:	TOGGLE CCLK ONCE
05:20: 022D A9 00	LDINH \$00
05:30: 022F 20 45 02	JSR TOGGLE SET 'TEST BUSY' COMMAND DN C0 AND C1, AND
05:40: 0232 20 45 02	JSR TOGGLE TOGGLE CCLK TWICE
05:50: 05:50:	
05:60: 05:60:	
	JUNIOR'S ASSEMBLER
	PAGE #2
05:70: 0235 AD 01 20	TEST LDA BUSY READ BUSY LINE
05:80: 0238 10 F8	RPL TEST BUSY LINE NOT HIGH?
05:90: 023A 20 45 02	JSR TOGGLE TOGGLE CCLK ONCE
06:00: 023D E8	INX
06:10: 023E E8 00	CPXIN \$00 COMPARE K WITH THE NUMBER OF WORDS MULTIPLIED
06:20: 06:20:	BY TWO (IN THIS CASE THE NUMBER
06:30: 06:30:	OF WORDS IS FOUR)
06:40: 0240 D0 D9	0NE STRT WRD SEQUENCE NOT COMPLETED?
06:50: 0242 4C 1D 1C	JMP RESET RETURN TO JUNIOR MONITOR
06:60: 06:60:	
06:70: 06:70:	*****
06:80: 06:80:	SUBROUTINE
06:90: 06:90:	*****
07:00: 07:00:	
07:10: 0245 29 03	TOGGLE ANDINH \$03 SET CCLK TO ZERO AND
07:20: 0247 8D 00 20	STA CMND TRANSFER ACCUMULATOR 00 AND 01 TO C0 AND C1 LINE
07:30: 024A 09 04	ORAIN \$04
07:40: 024C EA	NOP DELAY TWO MICRO SECONDS (CCLK 'LOW' TIME MUST
07:50: 07:50:	BE AT LEAST 6.25 MICRO SEC.)
07:60: 024D 8D 00 20	STA CMND SET CCLK TO ONE
07:70: 0250 60	RTS
07:80: 07:80:	
07:90: 07:90:	
08:00: 08:00:	
08:10: 08:10:	
08:20: 08:20:	
08:30: 08:30:	
08:40: 08:40:	
08:50: 08:50:	
09:00: 09:00:	
09:10: 09:10:	
09:20: 09:20:	
09:30: 09:30:	
09:40: 09:40:	
09:50: 09:50:	
10:00: 10:00:	

Table 5. This program provides the Junior Computer with the power of speech!

should be noted that the kit includes the Elektor p.c. board, the speech memory EPROMs and all other components for the basic circuit. It does not include the edge connectors, the loudspeaker or the components for the

add-on interface and the power supply — although these are available separately.

At a later date, if there is sufficient demand, further speech memory EPROMs can be made available. For this

reason, we will welcome any lists of 'desired words'! Meanwhile, it will prove quite feasible to code your own new words and store them in EPROM, with the aid of a little interface that will be published in the near future. M

IPROM

A non-volatile RAM

As every (micro) computer operator will agree, having an area of non-volatile RAM (Random Access Memory) situated somewhere in the system could prove to be very useful. If development work on a particular program has to be halted for any reason, the machine can be turned off without having to transfer the program to cassette or EPROM. When the computer is turned on again, the program will still be stored in memory and work can continue from where it was left off — without having to reload the partly completed program into the computer. All that is required is RAM devices having a very low power consumption in the 'standby mode' and one or two small batteries to power the RAM while the machine is turned off. This article goes one step further by describing the 'plug-in' instantly programmable read only memory (IPROM) module which will fit in a standard (2716) EPROM socket. Once a program is stored in the device it will remain there until the batteries run out (which could be years!) or until it is placed in another EPROM socket (or the same one) and the program changed.

The idea of computer memory having battery back-up is by no means new — mainframe systems have been using this method for quite some time. However, a portable non-volatile RAM is something else! The ability to store program data for a considerable length of time, without having to use cassette tape, floppy disc, etc., will be a real advantage for the majority of home computer

operators. Programs can now be developed on one machine and the IPROM removed and plugged into another machine. Provided the two computers are the same, the program can then be run instantly on the second machine. It would also be possible, of course, to develop programs for a particular computer on a completely different type of machine.

1

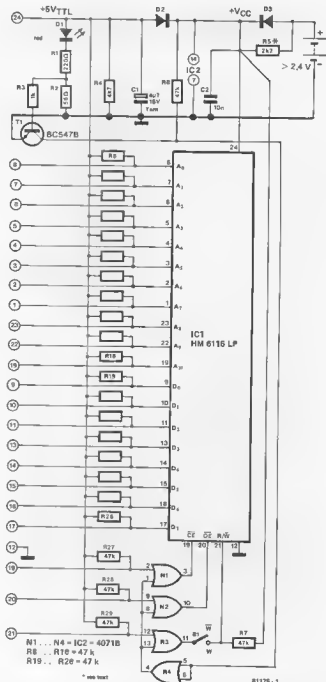


Figure 1. The complete circuit diagram of the IPROM. When the computer power supply is switched off, the batteries take over. The circled numbers refer to the pin numbers of the socket in which the IPROM is installed.

The IPROM can be removed from the 'programming' computer and sent by mail to a second user. Another possibility is for the IPROM to be used as a master EPROM after a particular program has been developed. The IPROM is simply placed in the EPROM socket of the programmer, whereupon the program could be copied into a 'real' 2716 device.

It could be argued that all of the above could be performed using EPROMs. This is very true, but to be able to enter a program into an EPROM an (expensive) EPROM programmer is required. Also, when EPROMs are used, it becomes rather difficult to alter one or two memory locations — usually, the whole contents of the device have to be erased. This is not the case with the

IPROM. A single byte can be altered, if required, as it is simply a matter of writing to RAM.

The IPROM consists of a low power CMOS RAM IC and a couple of (rechargeable) batteries. However, for the device to be able to fit into an EPROM socket, a certain amount of engineering skill is necessary. Also, a great deal of care must be taken during assembly, but

2

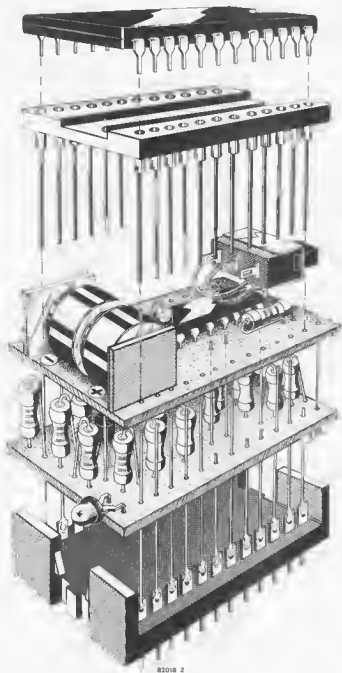


Figure 2. The exploded view of the constructional details. It is essential that care is taken during assembly to avoid malfunction.

Parts list

Resistors:

- R1 = 220 Ω
 - R2 = 56 Ω
 - R3 = 1 k
 - R4 = 4k7
 - R5 = 2k2 (only for NiCad cells)
 - R6 = 47 k
- All resistors are $\frac{1}{8}$ W

Capacitors:

- C1 = 4 μ 7/16 V Tantalum
- C2 = 10 n ceramic

Semiconductors

- D1 = red LED 3 mm
- D2, D3 = DUG
- IC1 = HM 6116 LP
- IC2 = 4071

Miscellaneous:

- S1 = miniature slide switch
 - 24-pin DIL plug
 - 24-pin DIL wire-wrap socket
 - 2x button type batteries or NiCad cells
11.5 x 5 mm
- For example: V675 PX (quicksilver)
V76HS (silver oxide)
20 DK (NiCad)

3

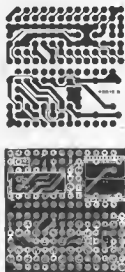


Figure 3. The copper track pattern and component overlay for the two IPROM circuit boards.

provided the instructions and exploded diagram are followed closely, it should not prove too difficult to manufacture your very own IPROM.

The circuit

The complete circuit diagram of the IPROM is illustrated in figure 1. The RAM device used here is the HM 6116LP from Hitachi, which has a capacity of $2k \times 8$ bytes. The internal organisation and the extremely low current consumption in the 'standby mode' make this device eminently suitable for this application. Data can be entered into the IC and read from it in the form of eight bit words. For this reason it can be connected directly to the data bus of virtually every conceivable type of computer system.

Since the current consumption is only a few microamps, a pair of (rechargeable) batteries (button type) can power the IC for months. If rechargeable batteries are used, and the computer is used regularly, there should be no need to change the batteries in the IPROM for years!

Normally, the memory IC would be powered directly from the +5 V line of the computer. In this instance, however, the supply voltage from the computer is fed to the IC via diode D2. LED D1 indicates that this supply voltage is present. The potential divider formed by resistors R1 and R2 determines the moment at which transistor T1 starts to conduct. The base of this transistor is connected to the junction of R1/R2 via resistor R3. The values of all three resistors have been chosen so that the transistor turns on when the supply voltage is greater than 4...4.5 V. Subsequently, T1 pulls the inputs of N4 low thereby permitting the signals at pins 18, 20 and 21 of the device to pass through to the CE, OE and R/W inputs of the memory chip. As an extra security measure, a switch has also been included in series with the R/W line. When this switch is open the contents of the memory can not be altered — they can only be read.

When the computer power supply voltage is removed (the machine turned off), a battery supply is automatically switched on. The RAM is then supplied from two button cells via diode D3. The inputs CE, OE and R/W are now held high via diode D3, resistor R6 and the four gates (N1...N4), since the transistor is no longer conducting. At this moment in time the RAM will be in the standby mode and no information can be written to or read from it. This is just as well, seeing that the computer is turned off! The IPROM can now be removed if required and transported to wherever necessary or stored away in a safe place.

The resistors R8...R29 are not strictly required, but practice has proved that current consumption may

be increased if the address and data lines of the RAM IC have no fixed voltage level. When the resistors are included, all inputs will be tied to ground when the supply voltage is switched off.

The complete IPROM is constructed in such a way that it is pin compatible with a 2716 EPROM. However, there is one exception to this rule, namely pin 21. This is the programming pin of the 2716 and is normally held high when the device is not being programmed. When the IPROM is inserted into an EPROM socket, pin 21 must be connected to the R/W line of the computer — otherwise it will not be possible to enter any data into the IPROM! If the IPROM has already been programmed and is just being used as a ROM, the R/W line need not be connected.

There are several possibilities as far as the battery supply is concerned. The IPROM can be powered by quicksilver oxide, silver oxide or alkaline manganese batteries. Two small NiCad cells 11.5×5 mm) would be ideal. Resistor R5 should not be included unless NiCad batteries are used. Ordinary batteries tend to explode if attempts are made to recharge them!!

Construction

The exploded diagram of the IPROM is shown in figure 2. It is essential that construction is carried out carefully and in the correct order. The components must be soldered to the printed circuit boards first. Thereupon the remainder of the assembly work is

continued from the top downwards. Testing and measuring during the assembly procedure can save a lot of time and trouble afterwards.

The switch (S1) can be glued to the underside of the RAM socket. It is recommended to use a wire-wrap type socket in this application, since these have longer and slightly thicker leads than the normal type. The batteries or NiCads have to fit tightly into their holder. The connections between the printed circuit boards (see figure 3) and the lower part of the IPROM, which is plugged into the EPROM socket, have to be soldered to the upper printed circuit board first (together with the pins of the RAM socket), then to the second printed circuit board and finally to the IC 'plug'. The RAM IC can then be inserted into its socket. To aid construction, an enlarged view of the component overlay for the two IPROM boards is shown in figure 4 (they are separated with the aid of a hacksaw!)

A word of warning: The supply has to be switched off before the EPROM is removed from the socket which is to hold the IPROM. The same applies when the EPROM has to be replaced (otherwise: Amen!). If non-rechargeable batteries are used to power the IPROM, they should be replaced regularly — at least once a year!

4

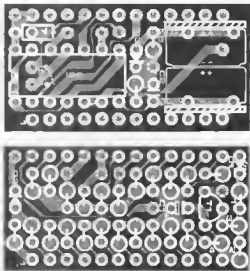


Figure 4. An enlarged view of the IPROM boards. These are separated and mounted one on top of the other. The points corresponding to pins 18, 20, 21 and 24 of the IC sockets are not linked together — all others are. Ten additional links between the boards must be included at the points marked ○.

The block diagram in figure 1 shows the principle of operation of the capacitance meter module. Three separate signals are NAnDED together to produce a usable input signal for the frequency counter. The pulse diagram shows the 'waveforms' present at various parts of the circuit during the actual capacitance/frequency conversion.

The circuit contains a 4 MHz crystal oscillator which is responsible for generating the required clock pulses. Let us

for a capacitor to charge to a specific value to the duration of the gate pulse, the frequency counter can be supplied with a proportionate amount of pulses to give a direct reading of the capacitor value. The actual capacitance-to-frequency converter consists, quite simply, of a monostable multivibrator (monoflop). The time duration of the monoflop is determined by the values of the resistors, R (preset potentiometers), and the capacitor under test,

capacitance meter module

... for frequency counters

Frequency counters are a lot more versatile than the average reader may imagine. With the right input circuitry they can be used to measure all sorts of parameters other than frequency and time. The 'add-on' module described in this article converts a 'normal' frequency counter into an instrument capable of accurately measuring (unknown) capacitor values. The advantages of being able to 'plug in' an unmarked capacitor and instantly read off its correct value are enormous. The module also proves to be very useful when a number of capacitors having the same value need to be found (for example, when constructing precision filter circuits, etc.). The capacitance-to-frequency converter described here is very compact and can easily be fitted inside the majority of existing frequency counters.

assume that the gate pulse from the frequency counter (signal A) lasts for a period of 0.01 seconds. This means that the counter will receive a total of 40,000 pulses every 10 milliseconds. Therefore, with this gate time the figure '40000' would be displayed. By relating the period of time it takes

C_x . Therefore, the length of time that the clock pulses are received by the frequency counter depends on the length of the output pulse from the monostable.

The monostable is triggered by the gate pulse from the counter. In principle therefore, the frequency counter itself

1

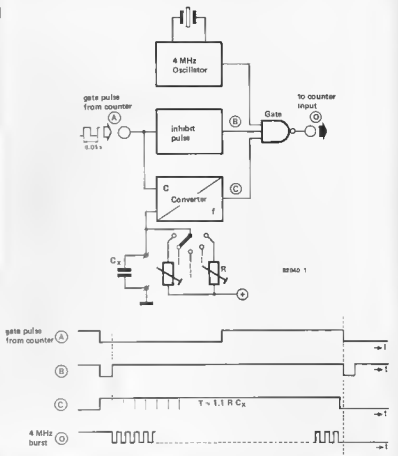


Figure 1. The block diagram and pulse diagram of the capacitance meter module. Signal A represents the gate pulse generated by the frequency counter. Signal B is the inhibit pulse used to eliminate any interfering pulses at the start of the measurement procedure. Signal C is the 'window' for the clock pulses generated by the 4 MHz crystal oscillator.

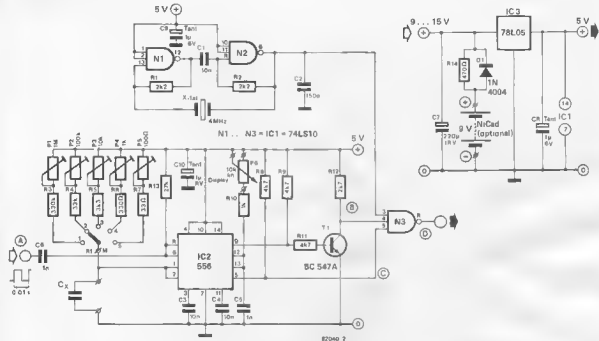


Figure 2. The basic requirements for construction of the capacitance meter module are a dual timer IC and a 4 MHz crystal oscillator.

determines whether the clock pulses are required. For the number of oscillator pulses counted to depend on the duration time of the monoflop, the output of the oscillator and signal C (the output of the monoflop) have to be Nanded together.

By examining the pulse diagram and the block diagram, it can be seen that the counting procedure is not quite as straightforward as that described above. This is because an inhibit pulse (B) is also applied to the NAND gate. Effectively, this signal stops the counter for a certain period of time at the start of the measurement. This prevents any initial 'spiky' pulses, which are produced by the monostable when it is first triggered, from being registered as measurement pulses. The inhibit circuit is also triggered by the frequency counter gate pulse.

However, a measurement error is caused when the B signal is Nanded with the A and C signals. For during the period of the B signal the clock pulses should already be counted (see figure 1). This effect can be remedied by adjusting the trimmer potentiometers (R).

Also shown in the pulse diagram is the actual output signal produced by the capacitance meter module (signal D): the clock pulses are only present for the combined periods of signals B and C. Here again, there is a slight problem, as the duration of the monoflop output signal must not be longer than the gate time.

The capacitance meter module was designed with the hand held frequency counter (described in the November 1981 issue of Elektor) in mind. For this reason the maximum value of capacitor

which can be measured with the basic unit is $400 \mu\text{F}$. However, in principle the module can be used with any frequency counter and capacitance values greater than $400 \mu\text{F}$ can be measured by first dividing the clock frequency by a factor of ten or hundred and by selecting a longer gate time (for example, 1 second).

Circuit diagram

Fortunately, the capacitance meter module can be constructed with very few components. The complete circuit diagram is shown in figure 2. The dual timer IC, IC2 = 555, is connected to form two independent monostable multivibrators. One of them constitutes the capacitance-to-frequency converter together with capacitor C_X and the preset potentiometers P1...P5 and resistors R3...R7. The preset potentiometers also serve to calibrate the circuit. The other half of the timer IC, the second monoflop, constitutes the inhibit circuit. The duration of the inhibit pulse produced by the second monoflop is determined by the values of capacitor C5, resistor R10 and the preset potentiometer P6. The duration of the inhibit pulse can be adjusted within a range of 1...12 μs with the aid of P6. The inhibit pulse is then inverted by transistor T1 before being fed to the NAND gate N3. The output signal of the first monoflop is fed directly to one of the other inputs of N3. The gate pulse produced by the frequency counter triggers both monostables via capacitor C6 and resistor R13.

The 4 MHz crystal oscillator is constructed around gates N1 and N2. The output signal from the oscillator is also

fed to N3. The signal at the output of N3 is the one required by the frequency counter.

Power supply

Just a few words about the power supply: there are two possibilities. One method is to power the module from the frequency counter itself. In this instance the supply voltage can be obtained from across the smoothing capacitor in the power unit of the frequency counter and then stabilised by IC3. This type of regulation is quite sufficient, since the power supply voltage has no effect on the result of the measurement - due to the principle of operation.

On the other hand, the module could be used with a battery powered frequency counter, such as the one described in the November issue of Elektor. In this case it is advisable to provide a separate power supply using either a PP3 type battery or NiCad cells. If the latter option is chosen, the NiCad cells can be 'topped up' via resistor R14.

Construction

The printed circuit board and component overlay for the capacitor meter module are shown in figure 3. Preset potentiometers P1...P5 can be multi-turn types if desired. The connections for the input (gate pulse) and output signals are best made via BNC sockets. The leads connecting capacitor C_X should be as short as possible. By far the best method is to employ press type loudspeaker cable connectors, thereby enabling the capacitor leads to be connected directly, quickly and simply. For

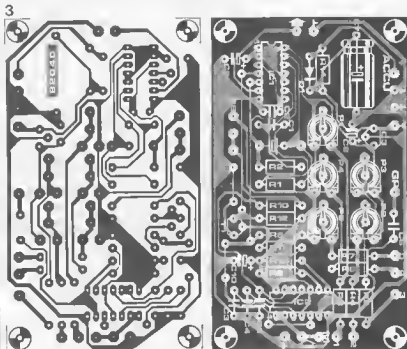


Figure 3. The printed circuit board end and component overlay for the capacitance meter module. The leads to capacitor C_x should be as short as possible.

large (value) capacitors a pair of short leads terminated with "crocodile clips" can be attached to the loudspeaker connectors. In addition, a plug and socket arrangement for the power supply connection is required along with a suitable case.

If the module is to be installed inside a frequency counter, the only connections required to the outside world are for capacitor C_x and potentiometer P6. If the frequency counter used has no provision for a gate pulse output, the reader will have to provide one. It should not prove too difficult to ascertain the whereabouts of the gate pulse from the circuit diagram of the particular counter.

Calibration and use

As in the case of any measuring instrument, the accuracy of the capacitance meter module depends on how well it is calibrated. Although each range needs to be calibrated separately, by actual calibration procedure is very straightforward. It is best to use quality capacitors having a 1% tolerance in order to calibrate the unit correctly. The capacitor is connected to the test sockets, after which the corresponding trimming potentiometer is adjusted until the value indicated on the capacitor appears on the display of the frequency counter. If there are no high tolerance capacitors available, the module can be calibrated by 'empirical means'. This involves measuring at least ten 5% tolerance capacitors having the same value. The

circuit is then calibrated according to the reading which was obtained most often. Obviously, in this instance the capacitors will have to be identical types, that is, all metal foil types or all styroflex types, etc. (The latter are frequently available with tolerances of 2.5%.)

Once the module has been calibrated, the circuit is switched to the highest range and an unidentified capacitor is connected across the terminals. Potentiometer P6 is then adjusted so that the value of the capacitor is indicated

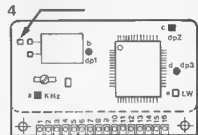


Figure 4. This illustrates the position of the gate pulse output of the FM 777 module.

Table 1

S1 position	range
1	00.100 nF ... 39.999 nF
2	000.10 nF ... 399.99 nF
3	0001.0 nF ... 3999.9 nF
4	01.000 μ F ... 39.999 μ F
5	001.00 μ F ... 399.99 μ F

Table 1. Scale factors for the range switch S1.

Perts list

Resistors

- R1, R2 = 2k2
- R3 = 330 k
- R4 = 33 k
- R5 = 3k3
- R6 = 330 Ω
- R7 = 33 Ω
- R8, R9, R11 = 4k7
- R12 = 2k7
- R13 = 27 k
- R14 = 470 Ω
- P1 = 1 M preset (multiturn)
- P2 = 100 k preset (multiturn)
- P3 = 10 k preset (multiturn)
- P4 = 1 k preset (multiturn)
- P5 = 100 Ω preset (multiturn)
- P6 = 10 k linear

Capacitors:

- C1, C3, C4 = 10 n MKH (metal foil)
- C2 = 150 p ceramic
- C5, C6 = 1 n MKH (metal foil)
- C7 = 220 μ /16 V
- C8 ... C10 = 1 μ /6 V tantalum

Semiconductors.

- IC1 = 74LS10
- IC2 = 555
- IC3 = 78L05
- D1 = 1N4004
- T1 = BC547A

Miscellaneous:

- 4 MHz crystal (HC-18/U)
- 2 press type loudspeaker cable connectors

clearly and without flicker on the frequency counter display. The value indicated then has to be multiplied by the range adjustment factor (see table 1).

As far as measuring the value of electrolytic capacitors is concerned, an extensive article on the subject was published in the September 1980 issue of *Elektronik* (E65, page 9-33: *Electrolytology*). It would be advisable to read this article again, rather than get confused about the contradiction between the value marked on the capacitor and that indicated on the display!

Note also that capacitor values alter with frequency. At a frequency of 100 Hz, as in this particular instance (geta time), the values indicated may well be up to 20% less than would be the case if the measurement frequency was 10 Hz.

When using the capacitance meter module with the hand held frequency counter described in the November issue of *Elektronik*, the latter should be switched to the 4 MHz range. Unfortunately, this means that the decimal point and kHz legends will not be valid. However, if a dual-ganged switch is used for S1, the decimal points can be switched according to the details given in the measurement range table. The gate pulse output of the frequency counter is situated slightly to the left of the crystal when looking at the module from the rear. This is illustrated in figure 4.

W.-D. Roth

NiCad battery monitor

keeps the cells
'topped up'

Now that an increasing number of battery-powered devices are being used in the home, it is much more economical to replace 'ordinary' batteries with NiCad cells. If such cells are to lead a long and healthy life, however, they will have to be correctly recharged from time to time. The question is, when is the right moment to recharge them?

More often than not, no indication is given on the electrical device itself until it isn't until the portable radio, the calculator, etc. stops working that its batteries are discovered to have run out, but then, of course, it is already too late... This article describes a small circuit that constitutes a very straightforward and yet highly effective method of keeping NiCads permanently 'topped up'.

It would seem that batteries are specifically designed to go flat at the most inopportune moment, during an interesting radio programme or when the calculator is absolutely necessary. In either case, the answer is not simply to replace pen light batteries by NiCad cells, as these need recharging too every now and then. The trouble is, very few devices are equipped with some sort of monitor system, so it is very difficult to know when the cells need boosting. To sit back and wait until they run out won't exactly guarantee the cells a long lifespan — which, remember, was the reason why they were bought in the first place!

The author felt it was high time an end was put to this situation and designed a straightforward circuit to monitor the battery voltage. The circuit operates as follows: when the voltage drops below a certain pre-determined value, the current supply to the circuit is cut off to prevent the cells from discharging any further. Even when the battery voltage rises again because no current is being consumed, the cells will remain cut off. As a result, the monitor's own current consumption will be practically nil as well so that the entire circuit will use a minimum of current during normal operation.

The circuit

Looking at the circuit diagram, it can be seen that very few components are involved. The circuit is connected in series with the electrical device's power supply line 'after' the on/off switch as indicated in the drawing in figure 1. The battery voltage may be between 12 and 30 V. Transistors T2 and T3 from a PNP darlington pair, the base of which is

linked to transistor T1 by way of a resistor (R1). When transistor T1 conducts, so will T2 and T3 and everything connected to the supply line will be provided with current. If, on the other hand, T1 stops conducting, T3 will stop too and the cells will no longer supply any current.

The purpose of the circuit is to allow T3 to conduct for the period during which the battery voltage (under load) is higher than 80% of the nominal voltage. This is done by connecting D1, R2, P1 and R3 in series, the junction of P1 and R3 being connected to the base of T1. If the base voltage of T1 drops below 0.6 V this transistor will stop conducting (and so will T3). The values of the zener diode and the resistors are chosen so that the voltage at the base of T1 is greater than 0.6 V when the battery voltage is 0.8 times the size of the nominal voltage. At the same time, the zener diode makes sure that a large share of the change in voltage on the supply line reaches the base of T1. The zener voltage is dependent on the battery voltage and can be calculated as follows:

$$U_z = 0.8 \cdot U_{\text{nominal battery}} - 1.5.$$

D1 may then be the lowest value closest to that result. The zener diode need only be a 400 mW type, as in this particular case the current passing through it will be very low (only about 200 μ A). Otherwise the true zener voltage will drop way below the level indicated and the calculation will no longer apply. Pushbutton S1 plays a very important part in the circuit. If we were to construct the circuit without it, or the batteries for that matter, the circuit would never conduct. When the circuit is initially switched on, current is unable to reach the zener diode and the resistor chain, as a result of which the voltage at the base of T1 will prevent the transistors from switching on. If, however, S1 is pressed briefly, current will be able to reach the resistor divider chain via the zener diode. This will enable transistor T1 to conduct and thus switch on the rest of the circuit. It will be apparent that only a momentary operation of S1 is necessary.

The precise moment at which the circuit switches off can be determined with the aid of the preset potentiometer. First of all, the voltage of a fully charged cell that is under no load is measured with an accurate voltmeter. After this, 80% of the measured voltage is fed to the input of the circuit by means of an accurate power supply. P1 is then adjusted very carefully until the point is reached where T3 stops conducting (don't forget to press S1).

The circuit can produce a maximum current level of 1 A. The current consumption is very low. When the circuit is switched on this will be less than 0.5 mA at 12 V and less than 1 mA at 30 V. In the 'off' state, the amount of current consumed will be negligible. ■

1

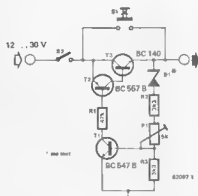


Figure 1. This circuit switches off the load whenever the battery voltage drops below a certain limit.

lap counter/timer

an electronic jury for the mini race track



This project will be welcomed by all members of the slot racing fraternity, young and old alike. It provides the home slot racing track with complete electronic lap counting and timing thus bringing it into line with all the well-known racing circuits throughout the world.

A. Schwall

The circuit supplies the race data for a race track with two cars. Either car has the facilities of a stopwatch and a lap counter at its disposal. The number of laps in the race is set before the race and the stopwatch begins to run when the race is started. Each time a car passes the finish line one lap is subtracted from the counter. When a car completes the required number of laps, the clock will stop, enabling the race time to be read. Furthermore, since the race is over, power to the track is switched off.

Block diagram

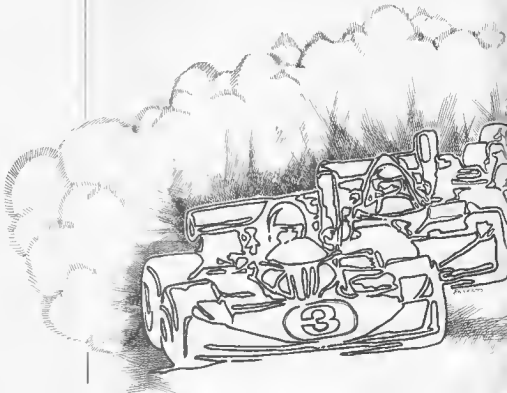
The block diagram of the counter/timer is shown in figure 1. Pressing the 'start' button will set the timer to zero. The clock input has a square wave with a frequency of exactly 1 Hz. This frequency is derived from the 50 Hz mains frequency via a divide-by-50 counter. The timer will run as long as the gate is open, which depends on both lap

counters.

The lap counters are preset to the number of laps in the race at the same time that the timer is reset. Each time a car passes the finish line a count pulse is sent to the related lap counter and at the finish of the race, the lap counter will indicate a zero. The counter output signal will then become logic zero thus stopping the timer and, via a buffer amplifier, operating a relay to break the power supply to the track.

The circuit diagram

The timer in the circuit diagram of figure 2 consists of four decade dividers IC2... IC6. These also contain decoder/drivers for the seven segment displays. The decade counter IC3 is arranged as a divide-by-six. Thus LD1 and LD2 will display seconds and LD3 and LD4 will display minutes. Note that the displays do not have current limiting resistors (except for the resistors R5 and R6).



This isn't necessary since the IC's contain segment drivers. The leading zeroes are suppressed by linking the RB1 and RB0 connections.

The 1 Hz signal is provided by IC1 which becomes a divide-by-50 with the aid of N2 and N3. The 50 Hz signal is derived from the transformer secondary winding. The transistor T1 converts the signal into a square wave.

The lap counters

The 4029 counters are used for the two identical lap counters; IC9 and IC10 for the first and IC13 and IC14 for the second. These counters are presettable and can count both up and down. Presetting is done by the two ten position switches S3 and S4. The binary values reach the inputs of the counters after they have been decoded by a diode matrix. A positive pulse on the 'preset enable' inputs (which is produced by pressing the 'start' button) does the rest. Unlike the timer counters, the 4029 does not have built-in seven segment drivers. Therefore current limiting resistors (R16 . . . R43) must be used with IC11/IC12 and IC15/IC16.

The 'zero' signal in the block diagram of figure 1 is derived from the 'carry out' (CO) signal of the tens counters. This will be zero as soon as the lap counter reaches zero, assuming that the 4029 is set to 'count down'. Both CO signals control gate N1 of the timer via N11 and N12. The timer therefore stops at the instant that the lap counter reaches zero.

The clock pulses for the lap counters come from the finish line of the race track. The passing of a car is detected

1

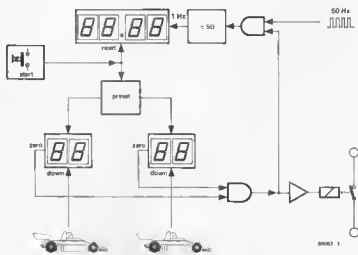


Figure 1. The block diagram of the lap counter. Depressing the start button will reset the timer and preset the lap counters to the required number of laps in the race.

optically by the two photo transistors for each car that are mounted in the track. The presence of two photo transistors ensures that a count pulse will only be passed to the lap counter when the car crosses the finish line in the right direction. A pulse is only given when first T2 and then T3 is covered. This is performed by the circuit around the D type flip-flop FF1. The photo transistors of the left hand track are T2

and T3. Normally the D input as well as the clock input must be high to set the flip-flop. When T2 is covered the D input becomes logic 0 for a moment. However, the reset signal also becomes a logic 1, consequently the flip-flop is reset. Covering T3 then causes a clock pulse and the flip-flop is immediately set again. This results in a short negative pulse at the Q output of FF1, provided that the car passes the finish line in the right direction. This will not occur when the car passes in the opposite direction, since there will be a pulse on the clock input first whereas the D input will still be logic 1.

The count pulse from the Q output of FF1 will only reach the lap counter if FF3 is set. This enables a 'flying start' to the race since the first time that the cars pass the finish line isn't counted, only the time clock starts to run. The race is over when one of the lap counters reaches zero. The output of gate N11 becomes logic 0 and, via gates N12 and N1, this will stop the timer. Moreover the signals from the photo transistors are inhibited and the relay is activated via transistors T6 and T7. The relay connects power to the track when it is 'off' and breaks the connection when it is 'on'. In this way the track can still be used when the lap counter is not operating.

Construction

It is wise to build the lap counter into a type of bridge, similar to that shown in photo 1. This will avoid the risk of trailing wires everywhere. The photo transistors are fitted in or under the

2

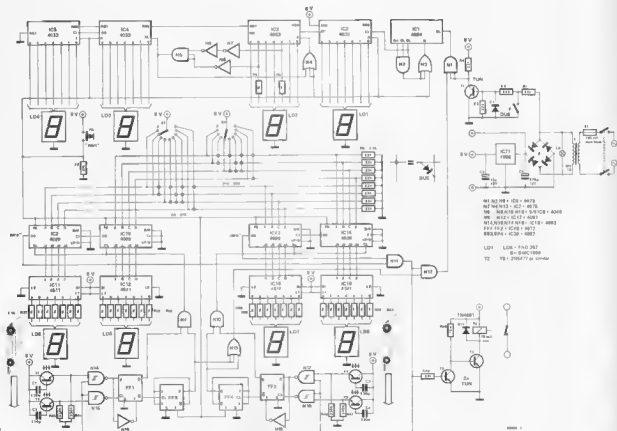


Figure 2. The complete circuit diagram of the lap counter. IC2...IC4 are decade counters with 'built-in' seven-segment decoder drivers.

1



Photo 1. The photograph shows one method of constructing the lap counter.

track surface about 1 centimetre from the current conductors. They should be placed slightly below the surface level so that they are protected from ambient light. Two corresponding photo transistors should be placed about 4 cm apart. The 4 photo transistors are illuminated from above by one 12 V/2.2 W bulb (La in the diagram of figure 2) although two bulbs may be used if it is found to be more convenient. The 220 pF capacitors (C1...C4) are to be soldered directly onto the photo transistors leads.

It is not advisable to put the finishing line on a curve. This may cause the cars to skid and send a pulse to the wrong round counter. Your opponent will be grateful, but you'll never become a world champion then.

we wish all our readers a

**merry
christmas**



**and
a happy
new year!**

cumulative index 1981

Audio

an effective scratch and rumble filter	7-22
audio power meter	2-03
crystal controlled stroboscopa	4-26
"Hi-Fi" pre-amplifier	7-03
LED audio level meter	7-25
loudspeaker peak indicator	7-08
low-noise microphone pre-amplifier (P. de Bra)	7-55
microcompressor	7-92
mini mixer	1-22
raw power	1-18
stereo level controls	7-61
voiced/unvoiced detector (F. Visser)	2-17
High Com noise reduction system	3-06
VOX for P.A. systems	7-28

Car and bicycle

auto reminder (W. Gscheidle)	7-30
auto theft alarm (R. Restetter)	7-18
automatic car aerial control	7-98
caravan connector tester	7-83
choke alarm	5-20
power MOSFETS in the car	7-26
revolution counter	9-07
transistor ignition update	9-48
6 watt stereo amplifier for a car radio	7-06
8 to 12 volt converter	7-74
12 to 8 volt converter	7-76

Disco

disco tips	1-04
disco ceiling lights	1-07
disco lights controller	9-29
EPROM light sequencer	7-59
swinging poster	1-36
simple swinging poster	7-26
silent disco deck switch (K. Kirk)	7-32
big VU meter	1-32

Displays

analogue LED display	9-38
bar graph driver	7-91
constant current LED	7-40
digital tuning indicator	7-23
flashing light	12-45
LED audio level meter	7-25
LED panel meter	10-32
LED voltage monitor	7-70
mains LED	7-82
miser LED	7-15
novel flashing lights	7-53
big VU meter	1-32
universal LED display	10-02

Domestic and hobby

analogue LED display	9-38
automatic soldering iron switch (M.A. Prins)	7-68
camping clock	5-04
CMOS ultrasonic receiver	7-45
combination lock (R. de Boer)	12-37
D/A converter for motor control	7-99
digital barometer	9-12
digital tuning indicator	7-23
dual input channel selector	7-78
economical fridge defroster	10-08
end of tape detector	7-11
high power motor controller	7-86
humidifier (B. Darnton)	7-65
humidity sensor	7-72
hydro alarm	7-68
lap counter/timer (A. Schwall)	12-22
metal detector	11-04
optical indication for the movement detector	7-62
process timer (J. Meyer)	2-10
shutter speed meter	10-04
six hour timer	7-27
speed controller for model boats	7-96
telephony amplifier	11-32
teletext decoder part 1	10-43
teletext decoder part 2	11-38
teletext decoder part 3	12-29
telescope control	11-21
temperature alarm	7-58
temperature recorder	7-10
touch-sensitive 16 channel multiplexer	7-76
water level indicator	6-18
wide range dark room timer	10-40
16 input channel selector	7-79

Fun and games

american billiards (H.J. Weiter)	7-44
electronic gong	7-33
flashing bottle (P. van Valzen)	7-57
"Hi-Fi" Siren	7-54
movement detector	3-30
novel flashing light	7-53
remote control potentiometer (R. Behrens)	7-49
russian roulette (P. Dooley)	7-14
scoreboard	7-02
single IC siren	7-46
solar powered pocket torch	7-43
traffic game	3-39

transistor match-maker	4-04
TV games extended	9-22
3 in 1 pencil holder (W. Gietmann)	7-93

Generators

CMOS pulse generator	7-12
constant pulse width oscillator	7-46
digital sine-wave oscillator	7-38
pulse generator with variable duty cycle	7-47
RF test generator	10-38
sine-wave oscillator	11-34
wave form generator	5-34

HF and CB

active notch or CW filter (H. Platzko)	7-97
crystal oscillator - for low voltage supplies	7-73
forget-me-not transmitter	7-64
forget-me-not receiver	7-64
local oscillator for 2 m transceivers	7-90
low noise parallel resonant oscillator	7-82
low noise 2 metra pre-amp	2-32
medium wave receiver	3-32
RF test generator	10-38
roger bleep	6-42
scrambler	6-06
simple short wave receiver	7-34
solar powered receiver	11-23
transformerless aerial amplifier	7-39
transverter for the 70cm band	6-20
70cm transverter	10-25

Informative articles

bar codes	5-22
chattering chips	9-43
circuits and boards	1-29
digital audio	8-39
disco tips	1-04
noise reduction	2-04
power MOSFETS in the car	7-26
QUAD ESL 63	9-32
reading bar codes	5-43
soldering aluminium	9-48
speak to your computer	11-45
synthesiser IC's	10-18
talk to computers	6-44
to all Elektor readers	8-38

Microprocessors

BASIC calendar (A. Lengenber)	1-40
dynamic RAM power supply	7-89
high-speed cassette interface	10-34
Intalekt	4-10
IPROM	12-15
junior cookbook	4-28
junior's growing up	2-18
Kansas city demodulator	7-41
keyboard encoder (C. Voss)	7-35
lower case and graphics for the Elektor terminal	1-41
map reading by computer	6-29
plug-in EPROM programmer	10-14
protecting dynamic RAMs	7-14
random number generator	7-20
sophisticated software for the Junior Computer	5-36

talk to computers	5-17
talking board	12-04
text display on the Junior Computer	3-36
TV games extended	9-22
using the Junior Computer as a voltmeter	10-11
6 bit keyboard encoder (L. Wittkam)	7-63
text display on the Junior Computer	3-36
the fully fledged Junior Computer	5-08
the Junior reaches maturity	6-10

Miscellaneous

bar graph driver	7-91
constant current LED	7-40
differential switch	7-48
disco lights controller	9-29
EPROM light sequencer	7-59
fast TTL interface	7-60
fuse protector	7-13
high input impedance voltage follower	7-24
humidity sensor	4-19
long period timer	7-51
mains LED	7-82
miser LED	7-15
multichannel tab	3-02
novel clock control	7-52
objektor	7-24
post office letter scales (K. Hense)	7-80
ring counter using timers	7-87
scrambler	6-06
silent disco deck switch (K. Kirk)	7-32
swinging poster	1-38
simple swinging poster	7-26
variable power "resistor"	7-29

Music

crystal tuning fork	7-88
frequency doubler	5-06
high boost	11-12
keyboard encoder (C. Voss)	7-35
mini organ	11-28
new synthesiser	11-14
new synthesiser VCO module	12-39
big VU meter	1-32
VOX for PA systems	7-28
Wagnephon (Dr. Wagner)	2-36

Power supplies

automatic reset	7-69
battery supply timer	7-39
"chopper" front-end for power supplies	7-07
constant current adapter (R. Storn)	7-67
dynamic RAM power supply	7-89
emergency brake for the power supply	2-26
high voltage from 723	2-14
LED voltage monitor	7-70
NiCad battery monitor (W.D. Roth)	12-21
power assisted NiCads	7-18
power failure forecaster	8-02
power stabiliser	7-40
universal LED display	10-02
universal power supply	4-06
variable 2 V ... 60 V power supply	7-50
volt/ammeter for power supplies (P. Gabler)	9-40
voltage regulators in parallel	7-59

Test and measuring equipment

adjustable square-wave edges	7:31
analogue LED display	9:38
audio power meter	2:03
capacitance meter module	12:18
continuity tester	8:00
dB converter	9:20
DFM & DUM	9:02
extended range milli-volt meter	7:56
frequency and phase detector	8:01
input buffers for the logic analyser	7:36
level meter (P. de Bra)	1:27
logic analyser part 1	3:18
logic analyser part 2	4:22
logic analyser part 3	5:26
LCD frequency meter	11:18
LCD panel meter	10:32
LED voltage monitor	7:70
polarity converter	7:09
sound pressure meter	1:14
sound generator	3:22
storage scope	6:34
signal injector-tracer	7:42
six channel A/D converter	7:94
big VU meter	1:32
universal measuring amplifier	7:37
universal digital meter	7:84
variable power resistor	7:29
word recogniser and delayed trigger	7:71
zero voltage indicator	7:17
2½ digit DVM	2:33

Missing links

digital heart-beat monitor (E63/64, No. 101)	2:44
LED audio level meter (E75/76, No. 23)	10:07
protecting dynamic RAMs (E75/76, No. 11)	9:48
scoreboard (E75/76, No. 1)	10:07
TV games extended (E77)	10:07
70cm transverter part 1 (E74)	10:07

cumulative index 1981

coming soon... perhaps

New developments in consumer electronics

In recent years a number of new developments in the L.S.I. integrated circuit field have revolutionised consumer electronics. Described here are some exciting new ideas, even now nearing fruition in the engineering department of Silicon Hollow International Technology Inc. These new lead balloons for the 1981 Christmas season include the Cuckoo Clock chip, Smoke Detector with snooze feature and the digital L.C.D. Sundial with frontlight and melody alarm.

The new nine-pin dual in-line-and-a-bit package outlines of the CUK 100A cuckoo clock chip (figure 1) allows for direct connection of the pendulum without the need for external conditioning circuitry. The audio output (pin 5) drives a piezo-electric transducer to produce an authentic 'cuckoo' sound encoded by Time Domain Linear Predictive Coded Formant Synthesis. The synthesis is based on an actual recording of a cuckoo made by the company's director of research. The high pass filter in the audio output circuit of the chip is necessary to remove a low frequency spurious signal in the cuckoo recording caused by the research director's inordinate love of baked beans. The device will be available in evaluation kit form, including chip, crystal, audio annunciator with beak and printed circuit board.

There are three grades of kit available:

CUK 100 A EV/KIT/S - With dead sparrow

CUK 100 A EV/KIT/P - With dead pigeon

CUK 100 A EV/KIT/C - With dead cuckoo

Silicon Hollow's projected smoke detector with snooze borrows technology from a number of areas. The smoke detector head uses the well known 'coughing canary' system and is supplied complete with sand tray and a one year supply of bird seed. The programming of the snooze timer is taken from the company's successful microwave oven controller, with settings for RARE, MEDIUM RARE, WELL DONE and TOTALLY INCINERATED.

The digital L.C.D. sundial chip uses quadrature Hall Effect sensors to determine magnetic declination and hence latitude. By comparing local Time of day (entered via a calculator keyboard by the user) with G.M.T. (derived from a quartz crystal controlled master clock on the chip), the chip is also able to determine longitude. Knowing these factors, the chip adjusts the angle of the frontlight relative to the display, so that the shadow cast falls on an array of photoreceptors the output of which is digitised to provide the display. Thus the user receives the impression of using an authentic sundial combined with the convenience of digital L.C.D. display.

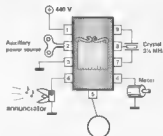


Figure 1. CUK 100A pinout

The decoder section described in part two does have its limitations: no simultaneous reproduction of Teletext information and the television programme; no time indication; no subtitles, etc. The video control board makes all this possible, but as indicated by figure 9, there are still a number of items to be considered. The output of this circuit can once again be connected to the video input (if present) of a television set. The amplitude of the video output signal can be adjusted to a maximum of twice the input level (by means of PB).

part 3

teletext decoder

... that does not require modifications to the TV set

The final article concerning the Elektor Teletext decoder sets out to prove the subheading (at last!). By adding the video control board and the receiver section, both described in this article, a fully independent Teletext decoder can be constructed.

At the same time, the circuit produces a UHF output which makes it possible to supply the Teletext signal directly via the aerial connector. Consequently, it is no longer necessary to work inside the TV set itself, but it is necessary to construct a separate receiver section to produce the required video signal. However, before we continue this discussion any further, we will first provide some more information about the video control board.

The signals involved in the switching are the After Hours Sync (AHS), Blanking (BL), Picture On (PO) and Display Enable (DE). These signals determine whether the television screen (PO) or Teletext picture (DE) becomes visible. A combination of these two 'pictures' is also possible.

The AHS and BL signals serve to avoid erroneous signal combinations by means of a number of wired 'OR' gates. These control four analogue switches that determine which signals are to be fed to

IC24. This IC (LM 1889N) is a complete colour modulator which is able to produce a colour video signal from the luminance signal (Y, pin 13) and the R-Y and B-Y signals. The three signals needed for this purpose are not supplied by the TROM (IC10) in the Teletext decoder, this IC only produces the basic signals R(ed), G(reen) and B(lue), therefore IC20 is used as a converter. Besides a matrix to generate the signals Y, R-Y and B-Y this IC (LM 1886N) contains a number of inputs to provide colour modulation in accordance with the PAL system.

The signals necessary for these inputs are derived from AHS with the aid of IC21...IC23. We are virtually dealing with a pocket size colour TV transmitter having only one drawback; it can only be used with digital signals. The colour possibilities of this design are only partly utilised by the Teletext decoder, since the LM 1886N has three inputs per colour and this results in a total of nine bits for the colour information. In addition to the eight basic Teletext colours (including black and white), this IC is capable of generating a set of eight shades of each colour and a large number of additional combinations as well.

The Y input (from IC10-TROM) and the Video I input are used solely for special functions. Video I is the normal TV programme signal and it is from this that the Teletext information is derived. This original programme signal is fed to IC24 via ES2 (see figure 7) and appears again at the Video II output and the VHF/UHF output. This occurs when the Teletext decoder is switched off from the keyboard. The Y signal can be mixed with the programme signal via ES1. This gives a clearly contrasting reproduction of the Teletext page which is superimposed on the TV picture. The Y signal consists of digital information, the amplitude of which can be adjusted very precisely with the aid of preset potentiometers P3 and P4. During this 'mixing' mode the colour carrier wave from IC24 must be switched off. This is accomplished by means of ES4.

It is now time to discuss the TV sound signal, as this has not been mentioned so far. The LM 1889N IC includes a separate oscillator which is capable of generating a sound carrier wave. For this purpose it must be mixed with the video signal via pin 12 of IC24. In this design the oscillator is not used, since the separation between picture and sound has already taken place inside the TV. A 6 MHz sound carrier wave is also available when the receiver design of figure 11 is used, so a separate oscillator is also superfluous in that instance.

A final remark about the video amplifier IC25. This amplifier is only needed when the amplitude of the Video I signal is greater than 3 V₀₀ and has to be attenuated. Consequently IC25 could well prove to be superfluous and can then be replaced by a simple emitter

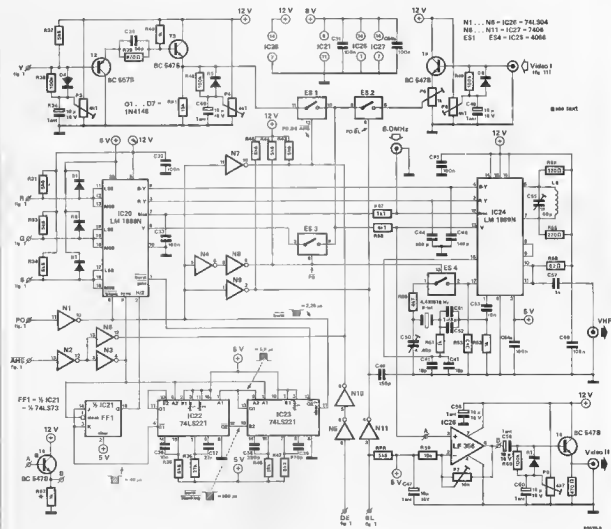


Figure 9. The circuit diagram of the video control board. Most of the switching options are only possible when this printed circuit board is etched.

Teletext video control board

Resistors:

R32 ... R34, R37,
R43 ... R46, R48 = 5k Ω
R35 = 6k Ω
R36 = 27 k Ω
R38, R42, R49, R60 = 100 k Ω
R39, R81 = 470 Ω
R40, R51, R52, R62 = 1 k Ω
R41 = 15 k Ω
R46 = 18 k Ω
R47 = 8k Ω
R50, R56 = 4k7
R53 = 3k3
R54, R55 = 270 Ω
R57 = 2k2
R58 = 82 Ω
R59 = 10 k Ω
P3 ... P5, P8 = 4k7-preset
P6 = 1-k-preset
P7 = 10-k-preset

Capacitors:

C31 ... C33, C43, C54a, b, C56 = 100 n
C34, C40, C47 ... C49,
C58 ... C80 = 10 μ /18 V tantalum
C35 = 56 p
C36, C53 = 10 n
C37 = 27 n
C38 = 390 p
C39 = 470 p
C41, C42, C51, C52 = 18 p
C44, C45 = 100 p
C48 = 150 p
C50 = 4 ... 40-p-trimmer
C55 = 10 ... 60-p-trimmer
C57 = 1 n

Semiconductors:

D1 ... D7 = 1N4148
T2 = BC557B

T3 ... T8 = 8C547B
IC20 = LM 1889N
(National Semiconductor)
IC21 = 74LS73
IC22, IC23 = 74LS221
IC24 = LM 1889N
(National Semiconductor)
IC25 = LF356
IC26 = 74LS04
IC27 = 7406
IC28 = 4066

Miscellaneous:

6 turns of 0.8 mm enam. copper wire,
0.8 mm enam. ϕ 8 mm
crystal = 4.433618 MHz

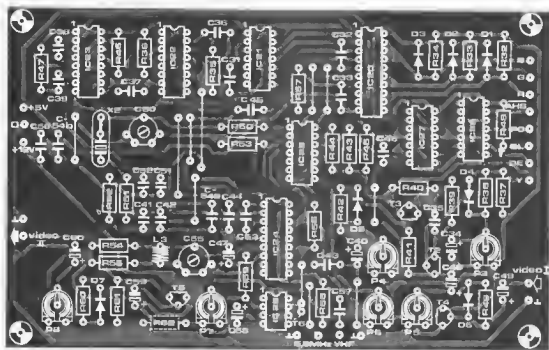
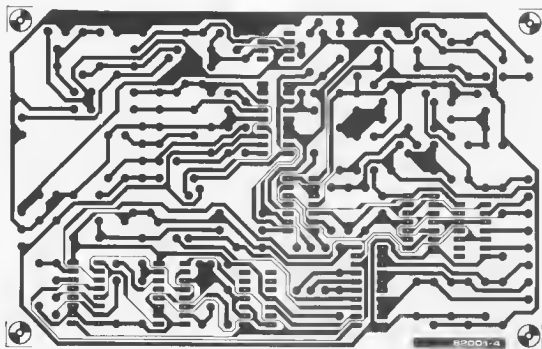


Figure 10. The printed circuit board and component overlay of the video control board. The indicated connection points refer to the corresponding points on the decoder- and receiver boards.

follower installed between the points A and B in the diagram.

Printed circuit board 3

Figure 10 shows the track pattern and the component layout of the video control board. The components required for the 6 MHz sound input and the VHF output are situated as close as possible to IC24. If a video output is not required all the components around IC25 and T5 can be left out. The same applies to the components involved in colour reproduction. Often, during the display of non-moving pictures the colour carrier wave produces a disturbing interference. This problem of course does not occur when black and white are the only colours required, due to the fact that the colour carrier wave becomes redundant in this instance. It is up to the reader to make the final decision. As far as we are concerned it is worth while giving up a little screen quality for a colourful Teletext picture. IC21... IC23 and the surrounding components are involved in the colour generation and therefore they can be left out for black and white reproduction. Also, the colour carrier wave in IC24 must be disabled. To achieve the latter all components connected to the crystal and pin 18 of IC24 must be removed.

The receiver

Integrated circuits play an important part in modern TV technology, and when they are combined with new filter techniques it becomes possible to construct a pocket size TV receiver. The most important new development is the surface acoustic wave filter. Adjustment of the IF amplifier has become superfluous thanks to this filter, which is manufactured with a fixed frequency, so adjustments are not even possible.

The IF amplifier and demodulator are reduced to minimal proportions. As figure 11 illustrates the majority of the electronic parts are concentrated in a single chip, the TDA 2541 (IC30). A usable signal for the Teletext decoder is available at the output of this IC. The only adjustment point is at the demodulator, but this should not present a problem.

The video signal also contains a sound carrier wave which is filtered and amplified, since the programme sound can be of great help when trimming the tuners. An adjustment is not necessary here either due to the use of ceramic filters. The well-known TBA 120T is used as the (sound) IF amplifier, but beware, this is a version specifically made for ceramic filters. The demodulator section of this IC is not used. Instead, the 6 MHz signal is amplified before it is fed to the LM 1889N, so that it can be used in the Teletext decoder.

The demodulator can of course be used when the receiver has to fulfill another function, for example as the front end for video monitor. In that case the

11

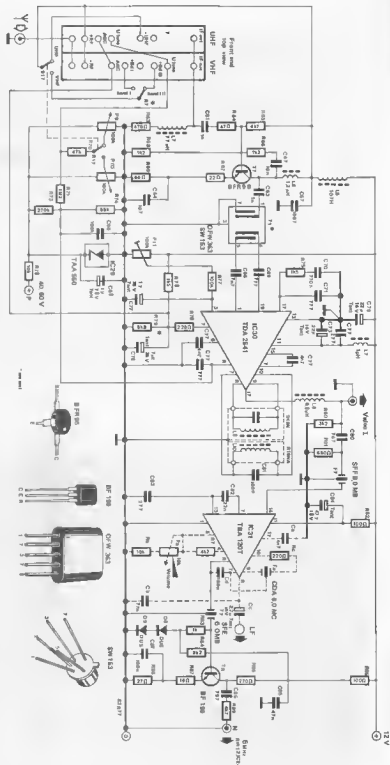


Figure 11. The receiver section for the Teletext decoder. The Teletext decoder comes into being when this receiver is connected with the other circuits which enables Teletext reception without any modifications being made to the TV set.

components inside the dotted area in figure 11 are to be installed and those from F3 onwards are to be left out. The connections to the tuners are shown at the left-hand side of figure 11. The interior of a TV tuner is not very important since the only item of concern is to produce a good signal. Therefore only two blocks illustrating the tuners are shown in the diagram. The parts list mentions a few preferences (they can be soldered directly to the circuit board). A TV tuner is a ready made module and consequently expensive, therefore it seems a good idea to pass on a couple of cost saving remarks. A VHF tuner is not strictly necessary, since the VHF bands are no longer popular and, what is more, the same programmes and certainly the same Teletext information are broadcast on UHF. However, a VHF tuner may be advantageous if continental TV stations can be received in your area.

Many TV manufacturers change the type of tuner used in their sets quite regularly. Consequently, excellent and, above all, cheap TV tuners are to be found on the 'surplus' market. Unfortunately, it is very unlikely that a tuner from this source will fit on the printed circuit board, but this should not be too difficult a problem to overcome.

For a specific tuner to be suitable, it must meet a few technical specifications: supply voltage = 12 V
AGC voltage = +9.2 ... 1.5 V (the stronger the transmitter signal, the lower the AGC voltage)
tuning voltage = 1 ... 28 V
Of course, minor deviations from these values are permitted.

Printed circuit board 4

All of the components for the receiver section, including the tuner(s), can be mounted on the printed circuit board shown in figure 12. Two multi-turn (preset) potentiometers, P9 and P10, are used for tuning the UHF and VHF (if required) bands, respectively. These controls, together with switches S1 and S2 may be mounted a short distance away from the circuit board.

Although not indicated in the circuit diagram, a channel selector circuit can be added and a suitable circuit may be found in the 'Summer circuits' 1981 issue of Elektor.

The tuning voltage is stabilised by IC29. This can be replaced by a zener diode, which is cheaper but less stable. The printed circuit board is designed for either component.

PAL UHF version

For use in the UK a VHF-to-UHF converter must be added. The required frequencies are as follows:

Sound channel: 6.0 MHz;
Colour frequency: 4.43361875 MHz;
Output frequency: 470 ... 500 MHz
(channels 21 ... 25)

The frequency of the VHF output is not critical and need not be adjusted.

A suitable circuit for a VHF-to-UHF converter was published in Elektor 32, December 1977, p. 12.20: the UHF TV modulator. One or two minor modifications are required: R3 is replaced by a 0.56 μ H inductor and R2 end P2 may be omitted. The modified circuit is shown in figure 13, and the printed circuit board and component layout are given in figure 14. As stated in the original article, home production of this printed circuit board is not recommended. It should also be noted that the components are mounted on the same side of the board as the copper track pattern. It is absolutely essential that all component leads should be as short as possible.

One important detail could not be made clear on the component layout: the right-hand end of stripline L2 should be connected to supply common on the board, as shown in figure 13. This is achieved by inserting a piece of wire in the hole underneath the coaxial socket and soldering it to both sides of the printed circuit board. It is strongly recommended to do this before mounting the socket!

The correct way to interconnect the two boards is also shown in figure 13. The upper part of the circuit shows IC24 and the (modified) circuit of the UHF modulator. The connections between the two boards are shown in figure 14. The output of the video board is connected to one input of the modulator board via coaxial cable; the screen of the coax is connected to supply common.

The unit should be mounted inside a screened box. A 75 Ω BNC or TV coaxial socket can be used as the UHF output connector, and it should be mounted directly on the modulator board in the position shown. The ground connection between the circuit and the screened box must be made only at this output socket.

Calibration

Once the entire Teletext decoder has

been built, using all four printed boards, calibration is started as follows. (Readers who intend to build in the decoder 'without the trimmings' can skip this section and the ones following which describe the setting up procedure for the receiver and the video control board).

Initial adjustment

Calibration is started with the initial settings indicated in table 1. With the settings given, either a deformed picture, an off tune TV programme or the letters 'P100' at the upper left of the screen should appear. This is the only requirement for starting the calibration.

The initial adjustment is completed when the (colour) TV, the supply voltages (5 V/600 mA, 12 V/400 mA and 40 ... 60 V/10 mA) and last but not least the TV aerial are connected to the input of the receiver section. The colour TV must of course be connected to the UHF output of the video control board. First of all the signal from the UHF modulator must be tracked by the UHF tuner of the TV.

The alignment procedure in this case is as follows:

- Tune the TV receiver to an unoccupied frequency at the 'low' end of the UHF band, this is near channel 21.
- Set P1 on the modulator board to maximum (fully anti-clockwise).
- Starting from the minimum capacitance setting of C6 on the modulator board, adjust this trimmer slowly until the signal noise disappears or alters very clearly, eventually 'P 100' may become visible on the screen. A precise description of what is expected on the screen is hard to give, due to the fact that nothing has been calibrated yet. Note that the modulator produces a strong carrier, two strong sidebands and several weaker sidebands. Only one of these is the correct signal!
- Adjust C7 on the modulator board for maximum signal strength.
- If necessary, turn back P1 on the modulator board to reduce the signal

Table 1

Calibration point	calibration	initial setting
P1	vert. synchronisation	mid. position
C9	6 MHz oscillator	mid. position
P2	1 MHz oscillator	mid. position
P3	upper threshold Y signal	mid. position
P4	lower threshold Y signal	mid. position
P5	clamp on video input	mid. position
P6	video I amplitude	max = clockwise
P7	amplification factor	min. = anti-clockwise
	IC25 (= 1)	
P8	clamp on video output	mid. position
C50	colour carrier wave	mid. position
C55	VHF tuning	max. capacity
P11	AGC of receiver	min. = anti-clockwise

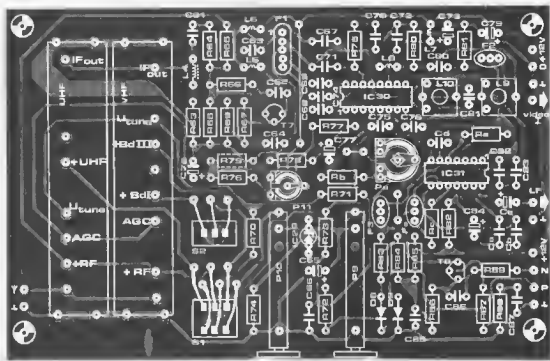
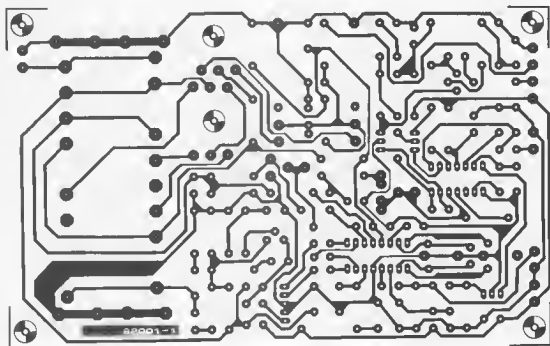


Figure 12. The printed circuit board and component overlay of the receiver. The tuners can be mounted on the printed circuit board, assuming that the recommended types are used.

Teletext receiver

Resistors:

R63 = 470 Ω
 R64 = 47 Ω
 R65, R89 = 4k7
 R66, R68 = 1k2
 R67 = 22 Ω
 R89 = 68 Ω
 R70 = 47 k
 R71 = 1M2
 R72 = 10 k
 R73 = 270 k
 R74 = 68 k
 R75, R76 = 1k5
 R77 = 100 k
 R78 = 220 Ω
 R79 = 8k8
 R80 = 3k3
 R81 = 680 Ω
 R82, R85 = 100 Ω
 R83 = 1 k
 R84 = 2k7
 R86 = 270 Ω
 R87 = 18 Ω
 R88 = 27 Ω
 P9, P10 = 100 k multi turn preset
 P11 = 100 k preset

Capacitors:

C61, C63 = 1 n ceramic
 C62, C64 = 10 n ceramic
 C65, C77 = 1 μ /35 V tantalum
 C66, C67, C87 = 100 n
 C68, C69, C74 . . . C76 = 4n7
 C70 = 470 n
 C71, C72, C82, C83 = 22 n
 C73, C79 = 22 μ /16 V tantalum
 C78 = 2 μ /35 V tantalum
 C80, C86 = 39 p
 C81 = 100 p
 C84 = 47 μ /16 V tantalum
 C85 = 47 n ceramic

Semiconductors:

D8, D9 = DUS
 T7 = BFR 96
 T8 = BF 199
 IC29 = TAA 550 or 33 V/250 mW zener
 IC30 = TDA 2541
 IC31 = TBA 120T

Miscellaneous:

L4 = 4 μ 7
 L5 = 1 μ 2
 L6 = 10 μ H
 L7 = 1 μ H
 L8 = 6 μ 8
 L9 = D10N (TOKO)
 L10 = D10NA (TOKO)
 tuner VHF: AEG-Telefunken
 203 (LO) 371.276893 (M 166)
 UHF: AEG-Telefunken
 204 (LO) 371.278920 (M 187)
 or
 tuner VHF: Mullard V334, V314 or V315
 UHF: Mullard U322, U324
 S1 = DPDT switch
 S2 = SPDT switch
 F1 = surface acoustic wave filter OFW 363
 F2, F3 = ceramic filter SFE 6 M8

Reminders: only mount lettered (Ca etc.) components if an audio output is desirable. If a tuner is not mounted on the printed circuit board a link will have to be fitted between the two widest tracks to take the piece of the tuner housing.

strength.

The receiver section (printed circuit board 4) can be tuned to a TV station as soon as a correct setting is found. Most of the time the strongest transmitter in the neighbourhood can be received, but it will have poor picture quality since the demodulator is not yet calibrated. In the worst case we should already be satisfied with a ghost picture of the test pattern. Now that we have completed this step we can move on to the real calibration.

Receiver board

Since the tuners are already calibrated in the factory, the reader only has to adjust L9 and L10 to achieve maximum picture quality. Calibration must be started with L9 and can be improved by L10 (AFC coil). This adjustment needs to be repeated several times before the circuit is optimally calibrated. A word of warning: be very careful because the cores are fairly fragile. Use only a well fitting plastic trimming tool since the metal of an ordinary screwdriver will influence the circuit, thereby making it

extremely difficult to find the optimal adjustment point.

It is possible that the picture will remain dark in spite of correct adjustment of the demodulator, in which case a humming will be heard from the speaker. This problem can be solved by turning back P5 on the video control board, provided that the video I signal is not too strong.

Altering the AGC setting, with the aid of P11, is only meaningful when the tuners are provided with very strong aerial signals, therefore P11 is not that important and can remain untouched.

After this simple calibration of the receiver, a usable input signal is available for the decoder. However, before we can proceed to calibrate the Teletext decoder the video control board has to be calibrated first.

Video control board

All the video signals are superimposed on a d.c. voltage level of 5 V, due to the fact that the Y signal of IC20 also alternates around this voltage. Of course, 5 V is an agreeable choice in TTL sur-

13

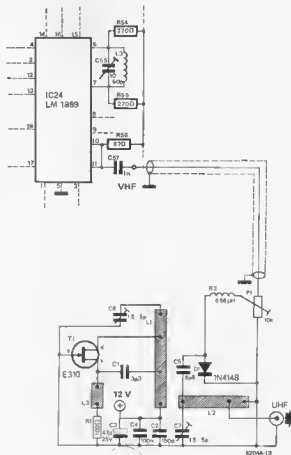


Figure 13. The modified circuit of the VHF-UHF converter.

roundings. Before the actual calibration we first have to measure some fixed voltage levels. The lowest level of the video signal is reached during reception of the sync pulses. In order to set this level the AHS input of the video control board has to be grounded. The voltage level at pin 6 of IC20 should then be about 4.25 V. The measured value must be noted for later use.

The highest level can also be measured at pin 6. The connections to the R, G and B inputs and the AHS signal must be disconnected for this. Now there should be a voltage of about 6.75 V present, therefore the Y signal has a peak-to-peak amplitude of 2.5 V. The amplitude of the video signal from the receiver will be at least 2.6 V with a good aerial signal. This video signal has to be matched to the amplitude and the d.c. voltage level of the Y signal from IC20 by means of P5 and P6. The amplitude levels will be very similar and therefore it will probably be sufficient to adjust P5 in such a way (the Video I signal has to be disconnected) that the wiper of P6 has a d.c. voltage of about 4.25 V (the noted voltage level at pin 6 of IC20).

When the signal from the receiver turns out to be too strong, in other words, when the picture still remains dark after P5 has been re-adjusted, a lower amplitude can be set with P6 and the calibration of P5 must then be repeated. It may be found that P6 can be turned to a certain point, beyond which the reception of a powerful transmitter will cause the test pattern to 'grey'.

After this calibration is completed, and all the connections have been put in their correct place again, it should be possible to switch between Teletext and the normal programme by pushing the TXT-nor and TXT-off keys. The synchronisation of the TV should not be influenced during the switching. The mixing of the Teletext page and the program picture requires adjustment of the amplitude of the Y signal of IC10 with the aid of P3 and P4. The lower threshold is adjusted by P4 when the Teletext signal is switched off (TXT-off). The d.c. voltage at the emitter of T3 should then be 5 V. The upper threshold is adjusted by P3, according to the requirements. In order to do this, the 'mix' key must be depressed, so that the Teletext page becomes superimposed on the test pattern. This Teletext page will probably consist of some incoherent words, letters or just the characters 'P100'. P3 is then adjusted in such a way that the 'white' of the characters can be clearly seen on the picture. After calibration of the decoder this adjustment should be repeated.

This completes the calibration of the video control board, for the time being at least. If a VHF tuner is employed, the unit can be calibrated slightly more accurately (on channel 3) with the aid of capacitor C55. In practice, however,

14

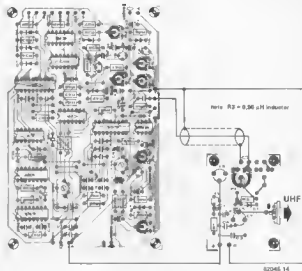


Figure 14. The printed circuit board and component layout for the VHF-UHF converter and the connections required between it and the video control board.

this adjustment will usually prove unnecessary due to the continuous tuning capability of modern channel selectors.

The adjustment of capacitor C50 is only meaningful after the decoder has been calibrated, because clearly differentiated colour information is only available at that time. The frequency of the colour carrier wave is derived from a crystal and therefore the influence of C50 will be very slight. The TV receiver will only reproduce Teletext information in full colour inside a certain capacity range of C50. The trimmer must, therefore, be set in the centre position of this range.

Decoder board

Readers who intend to build the Teletext decoder 'without all the trimmings' come in please! The next passage also refers to you. It is very important for the receiver to be tuned correctly, in other words, that it has a sharp, clear colour picture. After depressing the keys 'reset' and 'mix', the page header, or at least the letters 'P100', should appear on the screen. The core of L2 should then be turned until the time indication becomes visible in the top right-hand corner of the TV screen. This will be indicated very clearly within a limited adjustment range and the correct setting for L2 is in the centre of this range. It is best to press the 'reset' key repeatedly during this last calibration in order to wipe out the nonsense that the decoder displays on the screen. The decoder should now be ready for use.

Note:

The Home Office has recently granted permission for the broadcasting

companies to transmit teletext information on four TV lines instead of two. This means that the access time has now been halved to approximately 12.5 seconds per page.

Directions for use

Since the directions for use were already described in part 2 (November 1981), we will now discuss the meaning of the key legends very briefly.

TXT-off. When this key is pressed the Teletext display disappears.

TXT-nor. This key calls the selected Teletext page onto the screen.

Mix. The Teletext page is superimposed on the normal program picture.

Numeric keys. Page selection is performed with these keys.

RESET. The 'reset' key returns the page number to 100 and simultaneously erases the displayed page.

Timed page. This key allows presetting the moment of display of a previously selected page.

Full page/half page. The 'half page' key selects either the upper or lower half of the page and doubles the character height. The 'full page' key resets the page to its normal proportions.

Reveal. Hidden information. For instance for video games, can be made visible by pressing the 'reveal' key.

HOLD. This key freezes the present page.

Time/B7. Time is displayed for 5 seconds when the keys 'B7' and 'time' are pressed simultaneously.

For detailed information refer to Teletext part 2.

combination lock

A combination lock can be constructed by connecting a number of switches in series with a solenoid or other form of electric door unlocking device. However, this procedure has two main disadvantages: quite a few (costly) switches are required to obtain a reasonably safe lock, if any person forgets to reset the switches after the lock has been opened the complete code remains visible.

To be on the safe side, this design has only one rotary 'switch'. Therefore, only part of the code remains visible. What is more, the number of possible combinations is virtually infinite.

R. de Boer

The block diagram in figure 1 shows that the device consists of two basic sections, namely a window discriminator and a so-called 'voltage generator'. Initially, output '0' of the voltage generator has a high logic level, in contrast to the other nine outputs. By adjusting preset potentiometer P2, any voltage between 0 V ... 12 V can be fed to the first input of the window discriminator via diode D2. The window discriminator then checks to see whether this voltage is the same as that present at the wiper of potentiometer P1 (the code 'switch'). If so, the window discriminator transmits a clock pulse to the voltage generator

The window discriminator is constructed around two opamps (IC2 and IC3) having a high open-loop gain. Therefore, the outputs of these two ICs can only be logic one or logic zero. The voltage at the inverting input of IC3 is approximately 0.6 V less than that at the non-inverting input of IC2. The so-called window voltage depends on the setting of the preset potentiometers P2...P10. The voltage presented to the other input of the window discriminator depends on the setting of potentiometer P1. Both opamp outputs will be high if the inverting input of IC2 and the non-inverting input of IC3 are

when the 'enter' switch, S1, is depressed. This means that the voltage generator will then supply a second (and successive) voltage code(s). By repeating this procedure a total of nine times, output 9 will eventually go high and the relay will be activated: the lock opens.

If the voltage supplied by potentiometer P1 is 'outside the window', the window discriminator will send a reset pulse to the voltage generator when S1 is depressed. The entire circuit is then reset and the procedure will have to be repeated from the beginning.

The circuit

The complete circuit diagram for the combination lock is given in figure 2. The heart of the voltage generator is the well known counter IC, the 4017. Each output of this IC is connected to a preset potentiometer and it is these presets which are used to set up the desired code. The combination voltages are applied to one input of the window discriminator one after the other via diodes D2...D10.

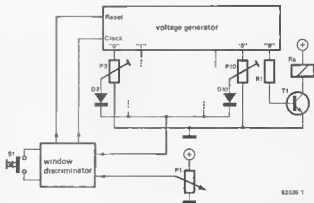
'inside' this window. If not, the output of one of the opamps will be high and the output of the other will be low.

The two output signals from the opamps are NANDed together by N1. This means that when the voltage set by P1 is inside the window voltage, the output of N1 will be low and the output of the inverter, N3, will be high. This enables gate N4 so that when the 'enter' switch, S1, is depressed, a clock pulse is transmitted to the voltage generator, IC1. This causes the next output of IC1 to go high. Correct adjustment of P1 for the voltage supplied by this output, and again depressing S1, will generate another clock pulse.

However, if the voltage code is set incorrectly, the outputs of N1 and N3 will be high and low, or vice versa. In this instance, a pulse will be applied to the reset input of IC1 via gate N2 and the differentiation network C2/R5 when switch S1 is depressed. This means that the whole procedure has to be started from scratch.

If the complete combination has been

1



82036-1

Figure 1. The block diagram of the 'analogue' combination lock. The window comparator compares the voltage on the wiper of P1 with the preset output level from the voltage generator. After selecting the correct code voltage nine times in succession, the lock is opened.

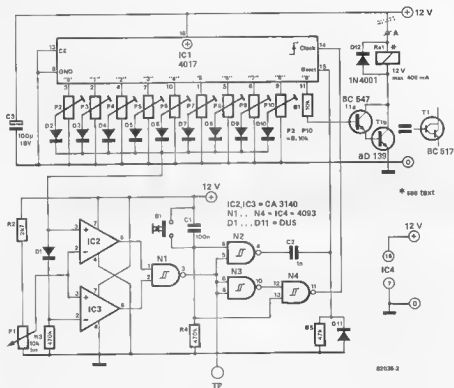


Figure 2. The complete circuit diagram of the combination lock. Preset potentiometers P2... P10 are used to set up a nine digit secret code.

entered correctly, output 9 of IC1 will go high causing transistor T1 to conduct and energise the relay (Re1). Consequently, the lock is now open. If S1 is depressed once more, IC1 will be reset and the lock will be closed.

Components C1 and R4, together with the Schmitt trigger inputs of gates N2 and N4, are responsible for contact bounce suppression. Resistor R2 is included so that the wiper voltage of P1 does not exceed the common mode input voltage of the opamps.

Construction

It is recommended to choose a large type of potentiometer for P1. A scale should be made up with a graduation from 0...9. The digits 0 and 9 should be placed at an angle of 30° from the start and end positions of the scale, respectively. This is necessary so that P1 can be adjusted to give an output voltage which is less than the wiper voltage of the preset in question. The remaining digits are then distributed evenly in the space between these limits. A ten digit scale leads to $10^9 = 1$ billion different combinations! In principle, this figure can be further increased by selecting a finer scale division. However, there is no real point in having more than 15 numbers, as the window

Table:

input (P1)	outputs		
	IC2	IC3	N1
too high	L	H	H
correct	H	H	L
too low	H	L	H

comparator will no longer be able to distinguish between consecutive digits. If a door lock having a drive voltage of 12V is utilised, relay Re1 may be omitted and the door lock may be directly controlled by transistor T1. The current consumption of the door lock should not exceed 400 mA in this instance. The lock may be connected to a different drive voltage level. The connection between point A and positive supply line is then broken (see figure 2). Point A can then be connected to an unregulated d.c. supply up to a maximum of 30V/400 mA. If the door lock is to be driven by a voltage greater than 30V d.c., or with an a.c. voltage relay Re1 will have to be incorporated. The circuit itself must be powered from a stabilised supply. The current con-

sumption of the circuit largely depends on the pull-in current of the relay or door lock used. It is not advisable to power the circuit by batteries, for if and when they run down, the lock will have to be forced open!

If required, an on/off switch can be connected in series with the positive supply line. The voltage generator, IC1, will automatically be reset when the power is switched on.

Calibration

First, select a suitable nine digit code (for example, your date of birth and one other figure). Reset the circuit by depressing S1 (output '0' of IC1 will now be high). Set the pointer of potentiometer P1 to the first digit of the desired code and connect a multimeter to the test point TP (d.c. measurement range > 12V). Adjust P2 until the output of N1 (TP) becomes low. This will be true for a specific range of adjustment. Set P2 in the centre position of this range. Depress S1 (output '1' of IC1 goes high) and adjust the setting of P3 for the second digit of the secret code, and so on, until preset P10 has been adjusted. If the code has to be divulged for any reason, it can be modified quickly by altering the setting of presets P2...P10. M

the NEW Elektor synthesiser

The VCO module

This is the third article in the series relating to the Curtis ICs and the new Elektor synthesiser. Whereas the previous articles were mainly concerned with the 'theory' of the project, we now continue with the practical side of the story.

The voltage controlled oscillator (VCO) is essentially the heart of any synthesiser and the stability of the completed instrument depends to a large extent on the design and performance of this module. For this reason it is important that all the information contained in this article is followed very carefully, especially during the calibration procedure.

A first glance at the circuit diagram in figure 1 will raise some doubts as to how 'simple' this simplified synthesiser really is!

The VCO IC (CEM 3340), already described in the October issue of Elektor, forms the heart of the circuit. Together with six opamps it performs as well as the complete VCO module of the Formant synthesiser. The remaining space is used for the control logic which is necessary for the 'preset' and 'polyphonic' modes of operation. Therefore, it is certainly a simplification in the long run, since all the required components can be mounted on one printed circuit board, thereby saving both time and expense.

The circuit

The first item to consider is the power supply. In contrast to the Formant synthesiser, the VCO described here only requires a symmetrical + and -15 V power supply. The current consumption of the basic version of the instrument (without polyphony) is less than 200 mA per supply line.

The positive supply voltage is fed to pins 11 and 12 of the 723 adjustable voltage regulator, IC2. The (11.05 V) output voltage at pin 10 of this IC is fed to pin 16 of IC1. Besides this positive supply, the CEM 3340 requires two further voltages which are generated by opamps A1 and IC5. These provide output voltages of +5 V and

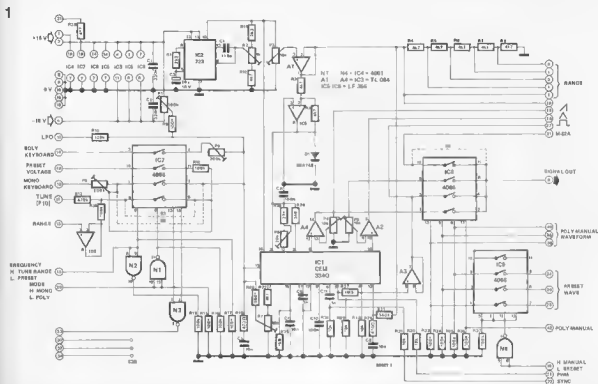


Figure 1. Only a few common ICs and the CEM 3340 are required to construct a precise VCO; the adjustable voltage regulator (723) and 6 opamps. The other ICs are only required when the synthesiser is to be 'programmed' by external stored control voltages.

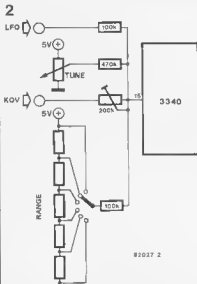


Figure 2. The various control voltages are connected to pin 15 of IC1 via a CMOS analogue switch.

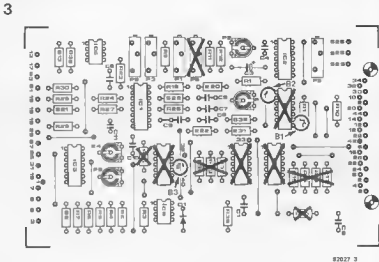


Figure 3. Only the marked components need be mounted on the printed circuit board for the time being.

–5 V respectively. The output voltage of A1 is also used to adjust the frequency range and pitch of the VCO. The output voltage of IC5 provides the negative supply requirement for IC1 and is fed to pins 1 . . . 3 of this IC.

The audio signals (squarewave, sawtooth and triangle) are fed from pins 4, 8 and 10 of IC2 via the buffer stages A2, A3

and A4 and a select switch (S2) before reaching the outside world.

Control voltages

Pin 15 of IC1 is the input for the various control voltages which determine the actual VCO frequency. A bias voltage is applied via a potential divider

network (see figure 2). The values of resistors used determine the volt/octave characteristics of the corresponding control voltage source.

The control logic for the 'preset' and 'polyphonic' modes

Although the three 4066 CMOS switches

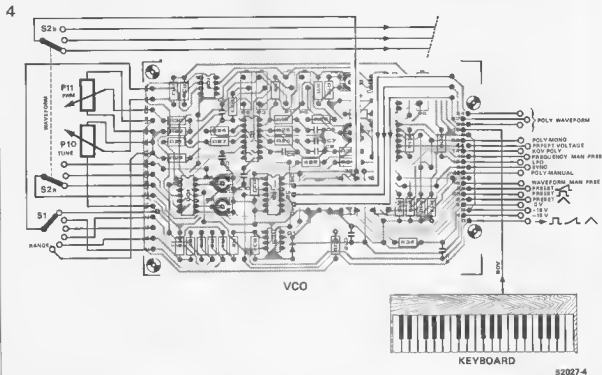


Figure 4. The external wiring of the VCO module.

5

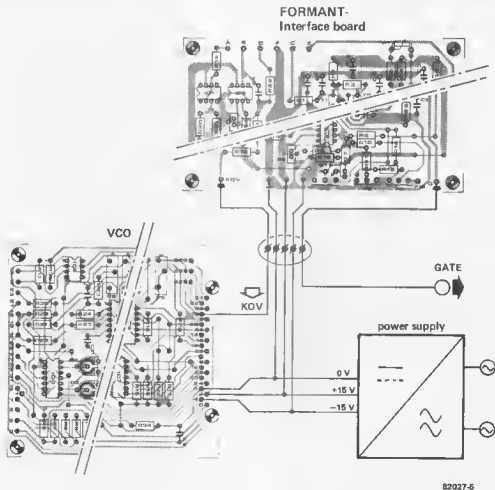


Figure 5. The sample and hold printed circuit board in the Formant keyboard is connected to the VCO module by means of a five-core cable.

and the 4001 are not required for the construction of an 'ordinary' synthesiser, the relevant copper tracks are already on the printed circuit board. Therefore, a future extension will not require the addition of another printed circuit board. Thus, the associated resistors and integrated circuits can be omitted for the time being.

This means that the wire links B1, B2 and B3 should be mounted in the IC socket instead of IC4 and IC7...IC9. Links B1 and B2 supply the VCO with the control voltage from the keyboard, the range switch (S1) and the tune potentiometer P10. Link B3 provides a connection between the wiper of S2 and the output socket (see also figure 3). The wire links must be placed into the following positions:

- link B1; pins B and 9 of IC7
- link B2; pins 1 and 2 of IC7
- link B3; pins 10 and 11 of IC8.

A precise description of the function of the CMOS switches and the inverters will be dealt with in a future article

6

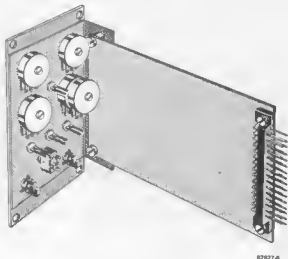


Figure 6. A suggested method of mechanical construction of each module for the synthesizer.

7

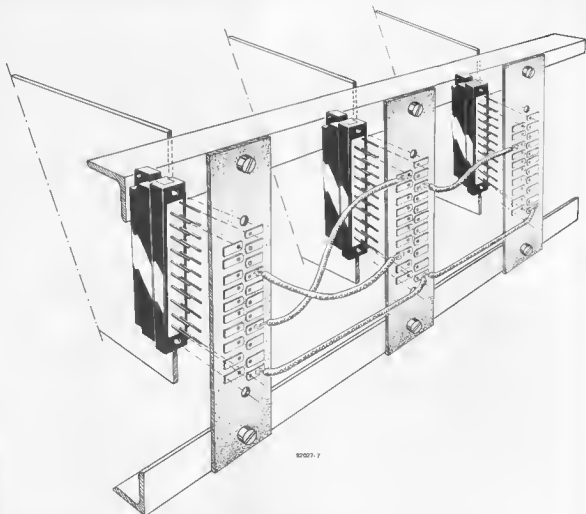


Figure 7. This illustration shows the rear of a card frame and how the connectors of the respective modules are fitted.

table 1

IC2) 723	Pin 4	0 V	[IC removed from socket)
	Pin 5	0 V	
	Pin 6	0 V	
	Pin 7	0 V	
	Pin 10	0 V	
	Pin 11	+15 V	
	Pin 12	+15 V	
IC3 (TL084)	Pin 4	+15 V	
	Pin 11	-15 V	
	Pin 7	+15 V	
IC5,6	Pin 4	-15 V	

table 2

IC1 (3340)	Pin 1	-5 V	[IC removed from socket)
	Pin 2	-5 V	
	Pin 3	-5 V	
	Pin 15	see text	
	Pin 16	+11,05 Volt	
	Pin 5	see text	
	Pin 12	0 V	
	Pin 13	5 V	

which will also discuss the preset and polyphonic modes.

Construction

Figure 4 illustrates the printed circuit board for the VCO module with the connections numbered as shown in the circuit diagram. The Formant keyboard can be used to derive melodies from the VCO module. This keyboard contains a sample and hold stage. It has two power supply inputs, one KOV (keyboard output voltage) output and an output for the gate pulse, the latter is not required for the time being. The wiring between the keyboard and the VCO is shown in figure 5.

The tune and pulse width modulation (PWM) potentiometers as well as both change-over switches for frequency and waveform can be mounted on a small aluminium board for the present. This could be incorporated into a 19" rack (figure 6). A mini bus board allows interconnection between the standard-

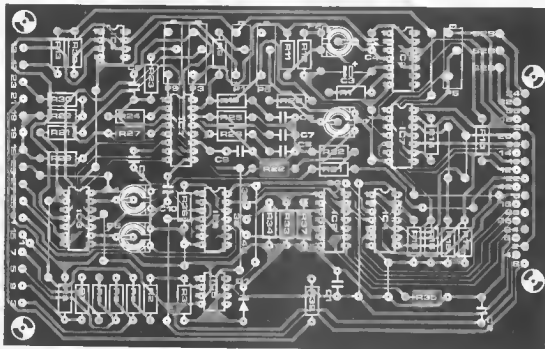
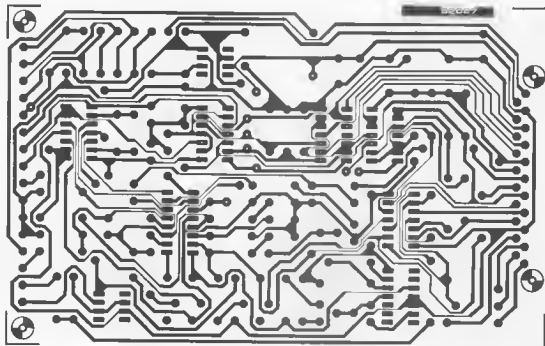


Figure 8. The printed circuit board end component layout for the VCO module. A minor printing error occurred on the component overlay. Connection 36 on the right-hand side should read 44.

ised modules without any problems, however, this may not hold for every card housing (see figure 7).

Operation

The power supply voltage should be connected and checked at the various IC-pins before the ICs are mounted. This avoids the possibility of damage to the expensive ICs if there does happen to be a wiring error or component fault somewhere.

The voltages at the various pins of the IC sockets should then be tested and should correspond to the values given in table 1. If this is the case, you can be sure that the circuit has been constructed correctly.

After disconnecting the supply voltage, IC2 (723) can be placed in its socket. The power supply is then re-connected and the voltage at pin 10 is adjusted to exactly 11.05 V by means of preset potentiometer P2. The voltage at the output of A1 is then adjusted by means of P3 and should be set to exactly 5 V. As opamp IC5 is connected as an inverter, the output of this device will automatically be -5 V. Subsequently, you should check that the voltages of +11.05 V, +5 V and -5 V are present at the corresponding pins of the socket for IC1 (see table 2).

The voltage level at the output of IC6 should change by one volt for each position of the range switch S1. This voltage change can be measured with a digital volt meter (DVM). The voltage at pin 5 of IC1 should be adjustable between 0...4 V with the aid of potentiometer P11 (PWM).

If all the supply voltages for IC1 are correct, this IC can be inserted into its socket. If you are the owner of a variable power supply, it is advisable to increase the supply voltage slowly. The current consumption can then be monitored to ensure that there is no short circuit.

After having taken all the necessary precautions the calibration can be carried out.

Calibration

The curve of the control voltage/frequency characteristic of the VCO is relatively linear. Consequently, the adjustment to the correct voltage level per octave is limited.

A DVM is required to check that the voltages at the output of IC6 are exactly 0, 1, 2, 3 V etc. For an acoustic check of the circuit, the output of the VCO (connection point B on the printed circuit board) should be connected to the input of an audio amplifier. Whereupon the setting of preset potentiometer P9 can be altered very slowly until the VCO frequency changes by an octave for each successive range switch position. Readers who do not possess a frequency counter can use an audio oscillator or a tuning fork. A word of

warning: do not depend entirely on your sense of hearing, as it is not precise. (Even Efektor readers are only human!). The tune potentiometer (P10) can be used to adjust the VCO frequency to give 'zero beat' when an 'auxiliary' sound source (such as a quartz tuning fork) is employed. A clear discord can be heard if the VCO frequency does not alter by exactly one octave.

After a little practice, this adjustment procedure becomes very simple. It is wise to bear in mind that if P9 is altered the frequency of the VCO changes. The latter must then be re-adjusted each time (using the tune potentiometer). A linearity correction in the upper frequency ranges of the VCO can be performed with the aid of preset potentiometer P7. The effect of this preset is very slight; with experimental set-ups the effect was nominal when the wiper of P7 was turned towards ground.

An aural adjustment is very difficult to perform when the keyboard is disconnected, due to the very low VCO frequency. For this purpose P1 should be adjusted so that the lowest octaves can be heard.

Connection of the keyboard

The control voltage output from the keyboard is to be connected to contact 10 (potentiometer P5) of the printed circuit board. This potentiometer is adjusted so that the VCO frequency alters by one octave when two keys having a difference of one octave are pressed one after the other. To be absolutely sure, this procedure should be repeated several times with other keys and different settings of P1 and S1. The final adjustment of P1 is accomplished as follows:

Select the highest octave with the aid of the range switch. Turn the tune potentiometer, which has an adjustment range slightly greater than one octave, to the mid position. Turn off the 'coarse octave' switch on the Formant keyboard and depress the highest key. Using the tuning fork mentioned previously, the VCO frequency is adjusted by means of P1 until the key producing tone A corresponds to the frequency of the tuning fork.

The overall octave position is a matter of taste; P1 can be adjusted so that the highest note on the keyboard is placed just within the threshold of audibility. Whether this is meaningful or not is another question.

The coarse octave switch on the Formant keyboard enables the VCO frequency to be shifted into other ranges.

Setting the signal amplitudes

Once construction of the circuit is complete, the output waveform from the VCO can be selected by the three position switch, S2. The triangular signal will sound lower in volume than a sawtooth waveform of the same ampli-

Parts list

Resistors:

R1, R11 = 2k2
R2...R8 = 4k7 (metal film)
R9, R10, R14...R18, R33...R37 = 100 k
R12, R22, R39 = 4k7
R13 = 470 k
R19, R26 = 470
R20, R21 = 560 k
R23 = 22 k
R24 = 5k6
R25 = 1k8
R27 = 1M5
R28, R29, R31 = 10 k
R30 = 15 k
R38 = 100 k (metal film)
P1 = 100 k multiturn preset
P2 = 1 k preset
P3 = 10 k multiturn preset
P4, P7, P8 = 10 k preset
P5, P6 = 200 k multiturn preset
P9 = 20 k multiturn preset
P10, P11 = 10 k lin potentiometer

Capacitors:

C1, C2 = 330 n
C3 = 10/25 V
C4 = 470 p
C5, C7, C8 = 10 n
C6, C10 = 0.1
C9 = 1 n polystyrene
C11 = 1 n

Semiconductors:

IC1 = CEM 3340
IC2 = 723
IC3 = LM 324 (TL 084)
IC4 = 4001
IC5, IC8 = LM 741
IC7...IC9 = 4068

Miscellaneous:

S1 = 6 pole rotary switch
S2 = dual ganged 3 pole rotary switch

tude; due to the smaller number of harmonics. When adjusting the preset potentiometer P8 and P4 the following items should be borne in mind: P8 has to be adjusted so that the amplitude of the triangular signal reaches a maximum without becoming trepezoidal. Subsequently, P4 should be adjusted so that the audible volume of the sawtooth signal correspond to the volume of the triangular signal. The duty cycle of the squarewave signal can be adjusted between 0 and 100% by means of potentiometer P11. Both edges of the triangle waveform and the leading edge of the sawtooth waveform are extremely linear. The trailing edges of the squarewave and sawtooth waveforms are very steep and can therefore hardly be distinguished on an oscilloscope.

If desired, preset P8 can be mounted on the front panel (as a potentiometer) so that the triangular signal can be made trapezoidal for various 'effects'. ■

Now that the evenings are long and dark and the price of a pint makes you think twice before venturing out of the house, why not save a little money and construct your own Christmas presents? This is an ideal opportunity to indulge in electronics as a hobby for the benefit of the children.

Toy cars are always appreciated and, provided they are not too small, can usually accommodate a small circuit board and a couple of batteries. This particular circuit adds a special touch to the 'common or garden' toy car. As mentioned earlier, the flashing lights are very similar to those found on police cars etc. What is more, the effect is so well simulated that there is no need to include any moving parts.

flashing lights

With Christmas just around the corner, why not 'brighten' the festivities by constructing the flashing lights described here? These lights can be fitted to an inexpensive (plastic?) toy car to provide an effect very similar to the warning lights seen on ambulances, fire engines and police vehicles. When used with the Hi-Fi siren it will, at minimal cost, add new dimensions to a toy, which any child will find fascinating.

Straightforward and to the point

As the circuit diagram in figure 1 shows, it is still possible to design all sorts of amusing and 'fun' circuits with a minimum of components. The antenna unit consists of two identical low frequency oscillator circuits each controlling a small lamp. The principle of operation can be described quite briefly. As both circuits are identical, only one need be described. The oscillator (stable multivibrator) is constructed around the Schmitt trigger N1. Capacitor C1 is connected between the inputs of the gate and ground. The output of N1 is fed back to the input via resistor R1 and potentiometer P1. The capacitor is either charged or discharged by way of these resistors, depending on the logic level at the output of N1. Whenever the voltage across the capacitor reaches one of the trigger levels, the output of the gate 'toggles'. Thus, the multivibrator produces a squarewave output signal, the frequency of which is determined by the relationship between the capaci-

tor value and the total resistance of R1 and P1. The frequency can be altered by adjusting P1.

The RC network C2/R3 connected to the output of N1 acts as a differentiator. Since R3 is connected to the positive supply rail, the network is only sensitive to the negative-going edges of the squarewave signal. These short 'spikes' are then converted to usable pulses by gate N2 to drive the darlington transistor T1. In turn, this transistor switches the lamp connected to its collector on for a short period of time. A resistor (R5) has been included across the emitter and collector of the transistor to ensure that the lamp remains at the correct temperature. This has the advantage that the initial current through the lamp is much less than normal and therefore the lamp will have a much longer life span. To make the lamp light up brightly, a 6 V type can be used with a (recommended) supply voltage of 9 V.

The only difference between the first and second sections of the circuit is the fact that the second one can be 'programmed' to perform in one of three different ways. This is accomplished with the aid of a wire link on the board. By linking points 3 and M, two completely independent flashing lights are obtained. By linking points 2 and M, the lamps light alternately. The frequency can then be adjusted by means of P1. Finally, if points 1 and M are linked, the two lamps will light simultaneously. Again, the frequency is determined by means of P1.

Parts list:

Resistors:

R1, R6 = 47 k
R2, R7 = 10 k
R3, R8 = 470 k
R4, R9 = 22 k
R5, R10 = 470 Ω (see text)
R11 = 100 Ω
P1, P2 = 1 M preset
All resistors 1/8 W

Capacitors:

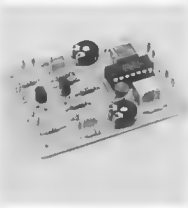
C1, C3 = 820 n
C2, C4 = 100 n
C5 = 10 μ/16 V

Semiconductors

T1, T2 = BC 617
IC1 = 4093

Miscellaneous:

La1, La2 = 6 V, 50 mA bulb



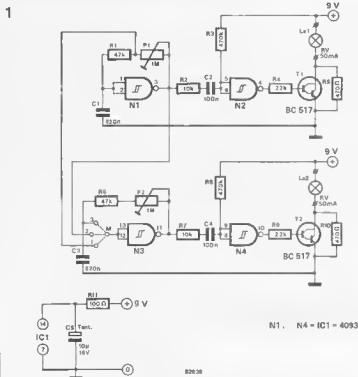


Figure 1. The circuit consists of two identical multivibrators. Depending on the effect required, there are three methods of linking the two circuits.

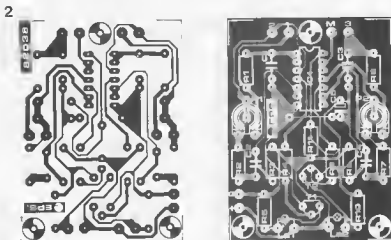


Figure 2. The printed circuit board and component overlay for the flashing lights circuit. The unit is so small that it can be built into a toy car quite easily.

The printed circuit board

The two oscillator circuits can both be mounted on the printed circuit board shown in figure 2. The frequency controls, P1 and P2, can be either normal potentiometers or preset types. Do not forget to make the link between point M and one of the points 1...3. The supply voltage for the circuit can be anything between 3...15 V, but, as mentioned before, a 9 V battery supply (PP3) would be ideal. For optimum performance, the voltage

rating of the lamps should be about 2/3 of the supply voltage, while the current rating should not exceed 400 mA. The values of resistors R5 and R10 should be chosen empirically so that the lamps are just on the verge of lighting. We do not intend to give any details about installing the finished article into the model car. This is very much dependent on the particular model chosen. Usually, all that is required is a couple of holes for the lamps and some simple method of mounting the bits and pieces.

market

Hand held DMM's

Available ex-stock from Electronic Brokers is the new Fluke range of hand held digital multimeters — 8022B, 8021B, 8020B and 8024B.



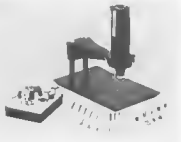
All these new series have a continuity beeper except the 8022B. Accessories include, a protective carrying case, battery eliminator, high voltage probes, high current probes and temperature and RF probes
Electronic Brokers Limited,
61/65 Kings Cross Road,
London WC1X 9LN England,
Telephone: 01-278 3461.

(2191 M)

General purpose drill

OK's lightweight PCB-258 electric drill is suitable for most drilling, grinding and polishing applications, particularly on printed circuit boards.

The drill is powered by a high-speed 220-240 V motor and measures just 175 mm long x 44 mm diameter. Four different collet sizes are supplied to handle 0.4 3.2 mm drills.



Options include tungsten carbide cutter sets, grinding points, cutters, sanding discs, and various drills. Also available, a drill stand with a spring-mounted arm provides excellent stability and can be used with circuit boards up to 280 mm.

OK Machine & Tool (UK) Ltd.,
Dutton Lane,
EASTLEIGH,
Hants SO5 4AA,
Telephone: 0703 610944

(2174 M)

market

Eurosystem card frames

The latest card frame system from OK, the Elrack Eurosystem-D, is the most recent development of a series of compatible Eurosystems. It comprises card frames, instrument cases, plug-in sub-assemblies such as modules and front panels, plus standard circuit boards and connectors. Virtually all mounting requirements for electronic components are met making the system suitable for various applications including data processing, measurement and control, communications, industrial electronics and medical electronics.



Basic frameworks for the card frames and cases are made of aluminium extrusions which can be assembled to a precision fit without the use of jigs. This system has been developed in accordance with international standards, and the appropriate classification together with the extensive range of components are described in the 116 page Elrack catalogue, available from OK.

OK Machine & Tool (UK) Ltd.,
Duxton Lane,
EASTLEIGH,
Hants SO5 4AA,
Telephone: 0703 610944

(2184 M)

Versatile 22" plotter

Available in three intelligence configurations with five different interface capabilities, Houston Instrument's new 22" one pen plotter, the CPS-30, can be interfaced with almost any micro, mini, or maxi computer. The CPS-30 also allows the user to change or upgrade his computer system without having to replace the plotter. Therefore, this unit

can keep in step with growing needs and advancing technology. The CPS-30 also features a speed of 400 IPS, a step size of .005 inches, touch-tube switches fully demagnetized stepper motors designed to provide reliable and quiet 8-vector, and rugged construction for use in adverse conditions. Metric versions are also available.

Houston Instrument,
One Houston Square,
Austin, Texas 78753,
Telephone (512) 837-2820

(2190 M)

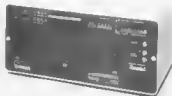
Microprocessor board tester

The T809, a microprocessor board tester from Olivetti Technost, is capable of testing boards containing microprocessors and other LSI devices.

It has the capability to run test programs in real time and utilises the computing power of the microprocessor on the board under test. Where a microprocessor is not present, the T809 will use its internal CPU.

The test program, prepared on a DTS-60 development station, written in the same language as the microprocessor under test, can be put together by choosing from an already available library that includes the test patterns for the most popular microprocessors and LSI devices.

The T809 program for the board under test is resident in EPROM supplied on a removable module. Test modes, such as step-by-step recycling on a test etc, are selected by means of front panel commands. A display allows for the monitoring of the operating instructions and the test results. A standard test fixture plugs into the system's front panel.



A high level of diagnostics is obtained using the fault messages obtained by the fault injection system.

The equipment includes a digital logic probe and current tracer.

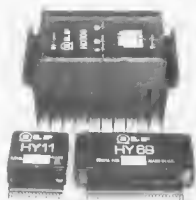
Olivetti Technost,
Chitless Manor Chase,
Haslemere Road,
Liphook,
Hampshire GU30 7AZ,
Tel. (0428) 722844

(2192 M)

Audio modules for Hi-Fi and disco constructors

ILP Electronics of Canterbury, is in the process of launching a range of new modular products for home hi-fi and disco constructors.

The new audio modules are all totally compatible with each other, and home hi-fi enthusiasts can combine them to create almost any audio system. Together, they form



a versatile modular assembly system for constructors of all ages and experience.

A range of heavy duty Bipolar power amps, specially designed to withstand the heavy usage and potential misuse of disco and guitar amplifier work, are available in a choice of three outputs - 60 W, 120 W, or 240 W per channel - each with or without heatsinks. Also recently introduced to the power amp ranges were versions without heatsinks of the 60 W, 120 W and 240 W standard Bipolar power amps, and of the MOSFET power amps of the same outputs.

ILP have also launched a number of modules outside their traditional ILP amplifier/pre-amplifier/power supply area.

The HY7 mono mixer is an encapsulated unit capable of mixing up to eight signals into one. It is intended as a summing amplifier for use when a number of single signals from separate sources have to be mixed. The unit is compact - only 45 mm x 50 mm x 20 mm - and light, weighing just 65 grams, yet delivers excellent performance with minimal distortion and noise.

Similarly, the HY8 module is a stereo mixer with two channels each capable of mixing five signals into one.

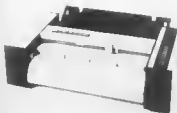
Other new mixer modules are the HY11 mono mixer, which mixes five signals into one and has provision for bass and treble controls, and the HY88 stereo mixer with two channels, each mixing ten signals into one.

Several new pre-amp modules include the HY9 stereo pre-amp, providing two channels for magnetic cartridge or microphone with volume control facility, and the HY69 mono pre-amp with two input channels for magnetic cartridge or microphone with mixing volume, treble and bass control facilities. Top of the pre-amps in the new line-up is undoubtedly the HY71 dual stereo, with four channels for magnetic cartridge or microphone input each with volume control.

Last but not least is the HY67 stereo headphone drive module, which will drive headphones in the range 4 ohm-2 Kohm.

ILP Electronics Limited,
Graham Bell House, Roper Close,
Canterbury, Kent CT2 7EP,
Telephone: (0227) 54778.

(2196 M)



market

market

Light entertainment

Used extensively in the control of lighting for theatres, concert halls, auditoriums, discos etc the RC80 and RC120 Rectilinear Lighting Faders have a working life of greater than 1,000,000 operations.

Designed within a rigid, insulated frame, the resistance and collector tracks, are made from hard-wearing conductive plastic, ensuring long-life and smooth operation plus, very low noise level, good linearity, with almost infinite resolution.



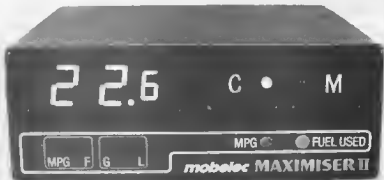
Available with electrical travel of 80 mm (1 W) and 120 mm (2 W) at 10K nominal resistance, both models incorporate specially designed stand-off terminals to allow ease of PCB mounting.

*Cetronic Limited,
Huddesdon Road,
Stanstead Abbots,
Herts,
Herts SG12 8EJ.
Telephone: Ware 0920 871077*

(2107 M)

Duel standard fuel computer

A feature of the new Maximiser II is the ability to measure fuel in gallons or litres and indicate fuel consumption in miles per



gallon. Another feature is the automatic indication of fuel flow in either gallons or litres per hour at speeds below 15 m.p.h., this allows the motorist to keep an eye on excessive fuel consumption caused by leaks, incorrect mixture adjustment or a faulty automatic choke. The Mobelec distance sensor is also unique, it can be fitted to all makes of cars, including those fitted with enclosed drive shafts.

The Mobelec fuel sensor is now suitable for all fuels, including those containing alcohol. Functions of the Maximiser II include miles per gallon or litres per 100 kilometres and a fuel totalling program, including fuel used accuracy of better than $\pm 2\%$ up to 100 gallons or 500 litres.

The instrument can also be set to indicate gallons or litres per hour, making it ideal for marine applications, especially outboard motors, where excessive fuel consumption can be controlled and 'fuel used' can be checked at the push of a button!

*Mobelec Limited,
Oxred Mill,
Oxred,
Surrey.
Telephone: Oxred 7654*

(2109 M)

West Hyde introduces new cases

Quality products from Bople includes a comprehensive range of computer terminal housings (1). These enclosures are injection moulded in foam plastic with interchangeable front mouldings. There are many variations and several custom options on offer. To complete the terminal housing, a range of

'slimline' ABS keyboard housings is available in the same brown and cream colour scheme (5).

The Unicard system (3) constitutes a new concept in enclosure design. This extruded aluminium case with its sloping front panel is totally versatile and is available in two different heights, in lengths of up to four metres. Standard sizes are available for each Eurocard format.

The front Panel Furniture range by Mantor (2) consists of a comprehensive selection of modular PCB-mounting components which can be combined to a high packing density in any configuration. A standard, moulded front panel fits over the assembled group, with no machining being required, allowing the front panel assemblies to be made quickly, easily and to consistently precise standards. Equally extensive, the Opto-electronic range from Mantor (2) provides a series of panel-mounting bezel LEDs which are available in many different sizes, configurations and colours, with convex or concave reflectors.

AKA has just introduced a new Type 02 range of plastic 19" cases (4). This is the first range of plastic housings for 19" equipment built to meet DIN 41494 requirements. These enclosures are as versatile as a card frame and work in exactly the same manner with provision for Eurocards or 112 mm cards and all standard types of edge connector. The top and bottom mouldings allow chip-in ventilated or plain sections to be slotted in at the front or back. Available in an attractive brown and beige finish in a full range of sizes, all models have pop-up feet as an option, and some can be supplied with handles.

*West Hyde Developments Ltd.,
Unit 9, Park Street Industrial Estate,
Aylesbury,
Buckinghamshire, HP20 1ET.
Telephone: Aylesbury (0296) 20447.*

(2130 M)



market

market

CB Radio Antenna

A new British-manufactured CB Radio antenna now available from CB and electrical dealers nationally, is the Ferroline 27. Designed by F.C. Judd, the antenna needs no metallic ground plane, so is ideal for fibreglass bodies such as caravans, boats and motorcycles.



The performance is very impressive for an antenna only 1.5 metres (4' 11") long. The Ferroline 27 is tunable for a 0.5 MHz bandwidth between 27 & 28 MHz, with a VSWR of nominal 1.1 to 1 at selected band centre. The polarisation is vertical and a low angle of radiation encourages the maximum possible range. Impedance is 50 ohms and power handling is up to 25 W. The radiating elements are stainless steel. Inductive units are fully weather protected and factory sealed.

Unit 3-4 Wembley Commercial Centre,
East Lane,
Wembley, Middx. HA9 7XD.
Tel. 908 2726.

(2187 M)

Wirewrap adaptor

The wire-wrap adaptor is the latest oscilloscope probe accessory to be designed and developed by the Greenpar Connectors probe production team at Newmarket. For particular use with edge and multiway connectors, the wire-wrap adaptor makes probing of terminal points on wire-wrap terminations easier and more positive.

The 4 inch 'probe' accessory consists of a flexible adaptor which fits the 88 series probe tips, having at its free end a resilient socket which joins firmly onto a 0.025 inch square wire-wrap post. The adaptor can be used on



posts with centres as small as 0.1 inch and is fully insulated, thus ensuring against shorting out of other terminals
Greenpar Connectors Ltd.,
P.O. Box 15,
Harlow,
Essex CM20 2ER, England.
Telephone: (0279) 27192.

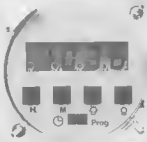
(2182 M)

Time switches with digital display

Time switches with digital display have been announced by Londex Ltd., as an addition to their ranges of 'Timset' and 'Compact' time switches.

The new models, the Timset 21000 series, incorporate electronic programming, and allow two 'on' and two 'off' switching actions in any twenty-four hours.

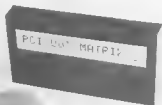
Four pushbuttons and a function selector switch on the instrument's face are designed to give the simplest possible program setting. The digital display, in hours and minutes, confirms the times selected for each of the



(2194 M)

Dot-matrix LCD alphanumeric display

The latest addition to the AMBIT LCD module range is a parallel ASCII driven dot matrix display type DM200. The device comprises 16 characters on a 5 x 7 matrix, with row 8 for use as a cursor.



The display can decode and display 64 ASCII characters (upper case only), with a temperature compensated LCD drive voltage, automatic display refresh (latched display), bus orientated to interface directly to MPUs.

The DM200 has a fully controllable cursor, and powerful display manipulation instructions

32 character right and left rotata, blink display, cursor shift.

The DM200 uses a single 5 V supply, with a maximum operating current of 8 mA, which drops to 4 mA under 'standby' conditions.

Ambit International,
the technology distributor,
200 North Service Road,
Brenwood Essex CM14 4SG,
Tel. (0277) 230909.

(2197 M)

market

market

LE40 soldering iron

Litesold's LE40 Soldering Iron, with in-handle electronic control, now provides the facility for users to adjust the temperature without dismantling.

An access hole is provided in the handle to permit adjustment of the setting potentiometer to vary the bit temperature steplessly from approximately 300°C to 400°C. Irons are normally set at the factory to 370°C, but may also be ordered pre-set to 310°C, 340°C or 400°C



The LE40 can be operated from any 24 volt e.c. 2 A supply, which makes it compatible with many soldering-irons power units. Alternatively, the purpose-made Litesold PU 2450/3 24 volt Power Unit, is also available.

*Light Soldering Developments Limited,
97/99, Gloucester Road,
Craydon, CR0 2DN,
Telephone: 01-589-0574,*

(183 M)

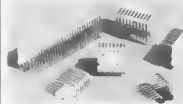
Right angle LED display sockets

A complete series of right angle, pluggable, modular LED display sockets for vertical or horizontal mounting of eight through 40 lead numeric or alpha-numeric LED displays is now available from Dage Eurosem Ltd.

These right angle display sockets, designated the Gentry Series 500 and 501, feature modular construction which enables the user to make any number of digits or alpha-numeric combinations.

Series 500 and 501 sockets feature precision contacts for maximum reliability. Terminals are brass, with tin plating, if desired. The contact body is SE-0 grade thermo-plastic with polarization notches.

To facilitate gang in-line mounting, an alu-



minium mounting bar, with or without mounting ears, to accommodate up to 10 separate display sockets is also available.

The display sockets are available in a variety of contact spacings and configurations to meet specific application needs

*Dage Eurosem,
Rabans Lana,
Aylesbury,
Bucks HP19 3RG,
Telephone: (0296) 32881.*

(218 M)

Rechargeable battery system

The Gould 'Again & Again' rechargeable battery system, offers a low-cost, reusable alternative to expensive alkaline batteries for applications such as electronic toys and games, radios and cassette recorders, photographic flash units, radio-controlled models, and video cameras. The nickel-cadmium battery system includes all the popular battery sizes and a safe, low-cost easy-to-use universal battery charger. One 'Again & Again' rechargeable battery can typically do the job of between 100 and 200 'throwaway' batteries.

An important feature of the Gould system is the low cost of the battery charger and the fact that the charger will take all the batteries in the range including the nine-volt PP-3 type unit. This means that a set of batteries and a charger will typically provide power for up to five years. Current consumption of the charger is very low, so that the cost of each recharge cycle is only a few pence.

The 'Again & Again' system is particularly suited to the modern generation of power-hungry electronic appliances, such as radio-controlled toys, stereo radio/cassette recorders and electronic games, which can involve the replacement of an expensive set of alkaline batteries every two weeks. The Gould charger is universal, so that a family can recharge batteries for many different appliances in a single, simple-to-operate unit.



The Gould batteries offer another important advantage in that they give a steady output throughout their life, unlike conventional batteries which produce a higher voltage when first used, followed by a gradual deterioration. This means that, with the Gould 'Again & Again' system, tape recorders, toys and games will run at constant speeds, and lights will maintain their brightness. The batteries also recover rapidly after discharge, making them ideal for flash units.

The 'Again & Again' batteries are available in AA (HP7), C (HP11), D (HP2) and 9 V (PP3) sizes, and the charger can charge up to four round batteries or two 9 V batteries at a time. The batteries will recharge overnight, and can remain on charge indefinitely without harm, so a consumer can always have fresh

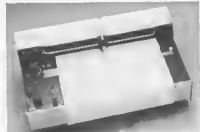
batteries by keeping one set on charge while another is in use.

*Gould Portable Battery Division,
Reynham Road,
Bishop's Stortford,
Hertfordshire CM23 5PF, England,
Telephone: (0279) 55155,*

(218 M)

Low cost chart recorder

The CR450 series of recorders introduced by J.J. Lloyd Instruments Ltd., have been designed to provide sensitive yet relatively simple to operate instruments at competitive prices. To reduce manufacturing costs, the range of optional models offered has been kept to a minimum and instead more popular facilities such as local/remote elastic pen lift and event marker, Z-fold or roll chart paper feeds, are included in the standard specification.



The CR450 series are available with 1 or 2 pens and have 6 calibrated ranges from 1 mV to 100 V F.S.D. with a 5 turn 'span control' to provide intermediate sensitivities between calibrated ranges. The writing speed is greater than 500 mm/s and the d.c. servo drive has infinite resolution and very low dead band. Accuracy on all calibrated ranges is 0.5%. The standard specification includes 11 electronically controlled chart speeds from 0.1 mm/min. to 10 mm/s and the width of chart paper is normally 297 mm. The instrument is handsomely styled with a stainless steel writing table and extruded aluminium trim, and is very compact in size. The chart feed, which is suitable for either roll chart or Z-fold types may be detached, reducing the front to back dimension of the recorder to only 240 mm. This facility will be of particular use to O.E.M. users, who require to build the instrument into a limited space.

*J.J. Lloyd Instruments Ltd.,
Brook Avenue,
Warsash,
Southampton,
SO3 6HP England,
Tel: Locks Heath 4221 (Std. Code 048 95)*

(2179 M)

market

market

Digital run-on counter

IMD Precision Controls has introduced the Omron H7A-4 Digital Run-on Counter capable of storing run on counts during output. The memorized counts are then displayed once output function is completed. The H7A also offers a multiple of functions employing an exclusively designed CMOS LSI for reliable operation at high counting speeds and a long operational life in excess of 50 million operations.



Programming for the three functions via a slide switch allows a choice of output modes — normal, automatic reset and continuous counting during output. Counts can be stored in the battery powered memory for up to one year without the restoration of mains supply. The H7A-4 also provides a 12 VDC supply at 40 mA to drive external sensing devices to provide a complete counting system. Operating from 110/240 VAC, the H7A-4 gives a voltage output and a simultaneous single pole contact output rated at 2A @ 240 VAC variable via a potentiometer between 0.1 sec and 1.0 sec. The integral relay has bifurcated contacts to ensure reliable switching of both high and low voltages.

This compact panel mounted digital counter has a 72 DIN face with a 4 digit LED display that includes count in and end count output indicators. Connection is via screw terminals and the H7A-4 can accept contact or voltage inputs of up to 300 count per second. The H7A-4 is available as a Totalizer (H7A-4TM) or Batch Counter (H7A-4BM).

IMD Precision Controls Ltd.,
349 Edgware Road,
London W2 1BS,
Tel: 01 723 2231/4 and 01 402 7333/6,
Telex: 28514 Cables: Omrontrnls Ldn.

(2175 M)

'Super Beep'

'Super Beep' is Barkway Electronics' new, low-cost, V.H.F. 'mini' radio paging system for a whole host of applications, both permanent and temporary, including offices,



hospitals, factories, hotels, farms, exhibitions and conferences.

Saving time and increasing efficiency, 'Super Beep' is the ideal way of making instant contact with mobile staff and has a range of up to one mile including reception from one building to another.

Available in two sizes with six or 12 light-weight pocket receivers, 'Super Beep' uses a compact, simple to install transmitter/encoder unit supplied complete with antenna, and unlike other systems, does not require any other central equipment.

The receivers, which are leather-like and easily carried in the pocket, on a lapel, or in a handbag, use two mercury batteries lasting 1,000 hours or six months with eight hour daily use.

Barkway Electronics Limited,
Barkway, Royston,
Hertfordshire SG8 8EE,
England,
Telephone: Barkway (STD 0763 84) 666,
Telex: B17651/BARCOM G,
Cables: BARCOM Royston Hertfordshire.

(2193 M)

Citizens Band transceiver

R.F. Technology Ltd. have developed and are commencing production of a Citizens Band (ex-Open Channel) transceiver. This 20 channel set operates on the U.H.F. band at 934 megahertz.

Although more expensive than the corresponding 27 megahertz sets, it has the advan-



tages of reduced interference, greater privacy, superior performance in built-up areas, and very compact aerials.

It is similar in size to a conventional 'C.B.' set, suitable for under dash mounting, and as far as we can tell, unique so far in that the microphone fits on the right hand side for right hand drive cars, unlike foreign designed and built units.

Specification	
Home office	MPT. 1321.
No. of channels	20
Frequency control	P.L.L. synthesiser
Modulation	F.M.
Power	12 V.D.C. neg. ground
Channel spacing	50 KHz
Power output	8 Watts (± 2 dB)
(transmitter attenuator)	-10 dB switch
Receiver audio power output	1.5 Watts
Controls	Channel select Volume on/off Squelch
Connections	Microphone 5 pin Aerial BNC Ext. speaker 3.5 mm jack Fused power lead 1.5 mm

R.F. Technology Ltd.,
Leyton Avenue, Industrial Estate,
Mildenhall, Suffolk, England,
Telephone: (0638) 715053.

(2189 M)

Security cases

Imhol-Becco Standard Products Ltd. has launched a new range of "camera craft" security cases which feature an aluminium frame and facing on rigid wooden panels, combining strength and smart appearance with light weight Lockable toggle catches, robust hinges and riveted corner reinforcements add to the protection offered.



Three sizes of case are supplied complete with carrying straps and shock-absorbent pyramid foam inserts. The foam is easily cut with the knife provided to accommodate equipment of various shapes and sizes. A briefcase version fitted with a PVC lining and document wallet in the lid is also offered.

Imhol Becco Standard Products Ltd.,
Ashley Road,
Uxbridge,
Middlesex UB8 2SQ,
Telephone: Uxbridge (0895) 37123.

(2186 M)

ELEKTOR BOOK SERVICE



JUNIOR COMPUTER BOOK 1 — for anyone wishing to become familiar with (micro)computers, this book gives the opportunity to build and program a personal computer at a very reasonable cost.

Price — UK £4.25 Overseas £4.50

JUNIOR COMPUTER BOOK 2 — follows in a logical continuation of Book 1, and contains a detailed appraisal of the software. Three major programming tools, the monitor, an assembler and an editor, are discussed together with practical proposals for input output and peripherals.

Price — UK £4.75 Overseas £5.00

300 CIRCUITS for the home constructor — 300 projects ranging from the basic to the very sophisticated.

Price — UK £3.75 Overseas £4.00

DIGIBOOK — provides a simple step-by-step introduction to the basic theory and application of digital electronics and gives clear explanations of the fundamentals of digital circuitry, backed up by experiments designed to reinforce this newly acquired knowledge. Supplied with an experimenter's PCB.

Price — UK £5.00 Overseas £5.25

FORMANT — complete constructional details of the Elektor Formant Synthesiser — comes with a FREE cassette of sounds that the Formant is capable of producing together with advice on how to achieve them.

Price — UK £4.75 Overseas £5.00

SC/MPUTER (1) — describes how to build and operate your own microprocessor system — the first book of a series — further books will show how the system may be extended to meet various requirements.

Price — UK £3.95 Overseas £4.20

SC/MPUTER (2) — the second book in the series. An updated version of the monitor program (Elbug II) is introduced together with a number of expansion possibilities. By adding the Elekterminal to the system described in Book 1 the microcomputer becomes even more versatile.

Price — UK £4.25 Overseas £4.50

BOOK 75 — a selection of some of the most interesting and popular construction projects that were originally published in Elektor issues 1 to 8.

Price — UK £3.75 Overseas £4.00

When ordering please use the Elektor Readers' Order Card in this issue (the above prices include p. & p.)

CrestWay

ELECTRONICS

WOODHILL LANE,
SHAMLEY GREEN,
near GUILDFORD,
SURREY.

THE ELEKTOR METAL DETECTOR

Kit no. 82021. An advanced metal detector available for the first time to the home constructor. Professional quality ABS vacuum formed case, complete with 10" ready set up and foamed search head. This kit can be constructed easily in a few hours. High performance specification includes phase locked loop oscillator and discriminator circuitry giving four reject modes with ground effect elimination. For full details and specification see the article in this issue of *Elektron*.

**complete kit now
available**

£89.95
p&p £2.00



CRESTLEK KITS

Ioniser (9823) Negative ion generator	£10.50
Talk Funny (80052) Ring Modulator	£10.00
Sound Effects Unit (81112) Guns, trains, etc.	£ 8.30
Elektornado (9874) 100 W power Amp	£19.50
Top-preamp (80023) Hi-fi preamp	£34.40
Guitar Preamp (77020)	£ 6.50
2½ Digit DVM (81105)	£23.35
AM Receiver (81111) Easy to build	£10.25
Touch Switch (81008) 12 positions	£10.00
200 W Disco Power Amp (81082)	£20.85
TAMP (81141) Mini amplifier	£ 3.75
Pest Pester (80130) Insect repellent	£ 2.35
Aerial Booster (80022)	£ 5.65

LATEST KITS....

TV Games extension (81143)
Disco light controller (81155)
DFM + DVM (81156)
RF test generator (81150)
EPROM programmer (81594)
Frequency counter (82026)
Teletext decoder (82025)
The ELEKTOR MINI ORGAN (82020)
write or phone for details of these kits.

Send cheque or postal order to Crestway Electronics Ltd., write or ring with your Access/Barclaycard account no. (do not send your card). Please add 40p to all U.K. orders for postage and packing. All our prices include VAT.
24 hour answering service on 0483 893236.

Crestway Electronics Ltd.,
Woodhill Lane, Shamley Green,
near Guildford, Surrey.



MAPLIN for ATARI

AUTHORISED DEALER



The World-beating ATARI PERSONAL COMPUTERS

3 consoles available

Atari 400 with 16K RAM (AF36P) £345

Atari 400 with 32K RAM (AF37S) £395

Atari 800 with 16K RAM (AFO2C) £645

(expandable to 48K)

All consoles when connected to a standard UK colour (or black and white) TV set can generate the most amazing graphics you've ever seen.

Look at what you get:

- * Background colour, plotting colour, text colour and border colour settable to any one of 16 colours with 8 levels of luminance! →→→
- * Video display has upper and lower case characters with true descenders, double and quad size text and inverse video.
- * 57-Key keyboard (touch type on Atari 400) and four function keys.
- * Full screen-editing and four way cursor control.
- * 29 keystroke graphics and plottable points up to 320 x 192 (160 x 96 only with 8K RAM).
- * 40 character by 24 line display.
- * Extended graphics control and high speed action using a DMA chip with its own character set.
- * Player missile graphics.
- * Four programmable sound generators can be played individually or together and each has 1785 possible sounds playable at any one of eight volume settings, for game sounds or music.
- * Full software control of pitch, timbre and duration of notes in 4 octave range.
- * Four joystick or paddle ports, sounds output to TV.
- * BASIC cartridge and 10K ROM operating system and full documentation.

MORE HARDWARE

Atari 410 Cassette Recorder (AF28P)	£50
Atari 810 Disk Drive (AF86G)	£345
Atari 822 40 column Thermal Printer (AF04E)	£285
Atari 850 Interface (AF29G)	£135
Joystick Controllers (AC37S)	£13.95
Paddle Controllers (AC29G)	£13.95
16K RAM Memory Module (AF08J)	£65

MUCH MORE FOR ATARI COMING SOON

SOFTWARE

Lots and lots of amazing software for Atari available NOW

- * Word Processor * VISI-CALC
 - * ADVENTURE GAMES * Arcade Games
 - * Trek Games * ASSEMBLER & DISASSEMBLER * FORTH * Teaching
 - * 3D GRAPHICS * Character Set Generator
- SEND S.A.E. NOW FOR OUR LEAFLET (XH52G)

LE STICK

For Atari Computer or Video Game Replaces standard joystick, but much easier to use. Internal motion detectors sense hand movements. Large pushbutton on top of Stick Squeeze Stick to freeze motion. A MUST for SPACE INVADERS, STAR RAIDERS & ASTEROIDS. ONLY £24.95 (AC45Y)



Atari 400 Console



Atari 800 Console

SPECIAL PACKAGE OFFER

Disk based system for £725 with LeStick The Atari 400 Console Special 32K RAM Module Atari 810 Disk Drive Disk Operating System Documentation Interconnecting Leads Everything in "Look at what you get" list. Can any other computer on the market offer all this at anything like this price?

VERSAWRITER

12" x 8" drawing board. Drawing on board is reproduced on TV via Atari with 32K RAM and Disk Drive. Closed areas may be filled in with one of 3 colours. Text may be added in any one of 4 fonts. Paint brush mode: select size of brush and paint away. Air brush mode: shade in your drawing. Colour and density is up to you. Plus many more features. See for price and further details.

MAPLIN

Maplin Electronic Supplies Ltd
P.O. Box 3, Rayleigh, Essex.
Tel. Southend (0702) 552911/554155

Note: Order codes shown in brackets. Prices firm until 14th November, 1981 and include VAT and Postage and Packing. (Errors excluded).

Demonstrations at our shops NOW
See Atari at 284 London Road, Westcliff-on-Sea, Essex
Tel: (0702) 554000 and at
159-161 King St., Hammersmith W6
Tel: 01-748 0926