

elektor

79

November 1981

U.K. 65p.

up-to-date electronics for lab and leisure

Metal detector
sophistication in practice.

**Hand-held
frequency counter**
up to 40 MHz.

Mini organ
with maxi sound.



elektor 11-01

metal detector 11-04
 The metal detector featured in this article is very professional in appearance and operation and performs better than many high-priced commercial detectors. It is both highly stable and sensitive. The construction is very simple since all the obstacles usually associated with this type of project have been removed.

high boost 11-12
 (A.M. Bosschaert)
 The average tone control circuit in an electric guitar usually consists of little more than a capacitor and a potentiometer and can hardly be expected to produce very good results. An active tone control is much more effective and this high boost circuit can either amplify or attenuate the treble within a range of 35 dB.

new synthesiser 11-14
 The success of the Elektor Formant synthesiser led us to the opinion that there is a great interest among our readers in the field of electronic musical instruments, especially synthesisers. The new Elektor synthesiser is of modular construction and can be expanded into a polyphonic instrument with "programming" facilities. This, the first article in the series, explains the basics behind the design.

LCD frequency counter 11-18
 This is the first in a series of projects featuring a frequency counter module with a liquid crystal display. The high performance is out of all proportion to the simplicity of the circuit. Two switched ranges are available, the first up to 4 MHz for use in monitoring frequencies in microcomputers and the second up to a maximum of 35 MHz to cover CB transceivers and general use.

telescope control 11-21
 A camera mounted on a telescope can, with a long enough time exposure, enable the more distant stars to be observed. The circuit in this article enables the telescope to track the star accurately for the period of the exposure.

solar powered receiver 11-23
 The design described in this article is a low cost portable receiver that can be powered with surprisingly few solar cells.

mini organ 11-26
 Thanks to ITT's special organ IC the electronics for the mini organ can easily be built in an afternoon. It uses a full size keyboard and is polyphonic. Its performance is so good that it really must be seen to be believed.

telephone amplifier 11-32
 A pound for a minute seems a lot of money to hear Granny's faint voice ten thousand miles away and then not understand a word she's saying. This telephone amplifier provides a solution and enables the whole family to listen in to the conversation.

sine-wave oscillator 11-34
 (L. Boullart)
 This particular design is not at all complicated as far as construction is concerned and yet it boasts a distortion level of only 0.01%! Its frequency range extends from 10 Hz up to an inaudible 100 kHz.

Teletext decoder part two 11-38
 This article deals with the practical side of the Teletext decoder. Particular attention is paid to the modification of a TV set if the decoder is to be built in; calibration procedures; and, last but not least, the instructions for use.

Speak to your computer 11-45
 The removal of the key pad interface between man and computer has long been the pipedream of every programmer. When using the M 6B00 system it can become reality.

market 11-49

advertisers index UK-22

contents

Surinder Singh

EDITOR:
 P. Holmes

UK EDITORIAL STAFF
 T. Day E. Rogans
 P. Williams

TECHNICAL EDITORIAL STAFF
 J. Barandrecht
 G.H.K. Dam
 E. Krampelsauer
 G. Nachbar
 A. Nachtmann
 K.S.M. Walraven



THE NEW "READY TO GO" SOLDERING IRONS

**WITH
BUILT-IN
FINGER
PROTECTOR/GUIDE
AND FUSED
MAINS PLUG**

A N T E X

Models XS-BP (25 watt) and CS-BP (17 watt) have moulded on safety plugs 'unbreakable' handles and detachable hook cam-finger guide. High class insulation, with ceramic shafts inside stainless steel ones. Negligible leakage. A range of long-life non-rod nickel plated bits, easily interchangeable, slide on or off the shaft which enclose the heating elements for maximum efficiency of heat transfer. R.S.P. XS-BP and CS-BP 240v £5.30 + VAT XS and CS without plug 240, 115, 50, 24 or 12 volt £4.50 + VAT SEE THE NEW ANTEX SOLDERING IRONS AT YOUR LOCAL SUPPLIERS NOW!

ANTEX ELECTRONICS LTD.
Mayflower House, Armada Way, Plymouth, Devon PL1 1JX.
Telephone (0752) 667377 Telex 45296

ANTEX - THE 'HOT TIP' FOR SOLDERING

a very special magazine
for a very special price

Increasingly in demand, amongst
electronics hobbyists and professionals!

£ 6.50

elektor

A 1982 subscription delivered direct to your door for £2.00 less than last year - saving £1.30 on the cover price.
That's what we call a real offer!

Complete the Elektor Readers Subscription and order card, and your cheque/P.O. for £ 6.50.
It's probably the best deal you'll make in 1981

Because of steadily increasing postal charges this offer can only apply to the U.K. Mainland. Subscriptions overseas by post remain the same as last year! Even though the cover price and postage have increased.

We hope you all agree that this is fair to everyone.

P.S. If you live overseas and really can't wait to get your hands on Elektor we will rush you a copy every month by airmail for £ 17.50. Wherever you live don't forget to order your 1982 Binder.

selektor selektor

The electromagnetic spectrum crisis

We have only to listen in on the broadcasting bands at night to notice how some stations appear to be jumbled up on top of one another. Though local ones can be received quite well, there is considerable interference on the distant transmissions, for the region of the electromagnetic spectrum devoted to radio, necessarily very small, is every day becoming more congested. It is, therefore, a finite resource, upon which ever growing demands are made. This problem could be called the electromagnetic spectrum crisis, and in some ways it is more acute than the so-called energy and materials crises which have received so much attention.

To explain the difficulty that the developed world is certain to have to face over the radio spectrum, it is necessary to explain the scientific background. To radiate or receive a radio wave it is necessary to use some kind of aerial structure, or antenna. This structure is necessarily related to the length of the electromagnetic waves: ideally its size should be at least a substantial fraction of the wavelength. If it has to be made smaller, efficiency declines rapidly, and even a powerful transmitter connected to it would produce only a feeble radio signal.

The wavelength is given by dividing the velocity of light by the number of times that the transmitted wave oscillates in a second, that is, its frequency. The velocity of light is approximately 3×10^8 metres per second, so a wave with a frequency of 10 000 cycles per second (hertz) has a length of about 30 km. Obviously, an aerial comparable in size with this would be very unwieldy and suitable only for a very large land installation. Because of this, frequencies below 10 Hz are of little practical use for radio purposes; it is a limit set by a physical law which is likely never to be circumvented.

The upper limit is just as rigid. The main attraction of radio waves for communication is their great penetrating power. They are little absorbed by the atmosphere, so are able to propagate over long distances with only a small loss. Unfortunately this ceases to be true for frequencies of the order of 20 000 million hertz and above. At such frequencies absorption of radio energy by the atmosphere is already considerable and it rises rapidly at higher frequencies.

So we are trapped, for most communication purposes, in this radio

'window'. Obviously, the usable radio spectrum is a natural resource of quite fixed extent. That is one side of the spectrum congestion problem; the other is the width in the electromagnetic spectrum taken up by each radio transmission.

Modulation

All radio transmitters use a technique known as modulation to impress the intelligence to be transmitted on to the radio wave. An unmodulated radio wave simply consists of an oscillation at a particular radio frequency. The only information that it conveys is the fact that it is present. To communicate we must cause it to vary in some way. The simplest thing that we could do would be to keep turning it on and off in the familiar Morse code, the way the earliest transmitters were used for telegraphy. Usually, however, we wish to transmit the human voice or other complex signals, and to do this we must alter the radio wave in accordance with the characteristics of the signal waveform that we wish to convey.

Most existing radio transmitters modulate the carrier wave in one of two ways. They either vary its amplitude in sympathy with the modulating signal, a process called amplitude modulation (AM), or they vary the frequency of the wave, a technique known as frequency modulation (FM).

Although the carrier wave was initially on a fixed, single frequency, as soon as it is modulated energy begins to be radiated at other, additional frequencies. What happens is that two new sources of radio energy appear, called sidebands, which are seen above and below the carrier frequency and each separated from it by an amount just equal to the

modulating frequency. For AM the width of the transmission in the spectrum (we call it the bandwidth) is just equal to twice the modulating frequency. Radio frequency allocation is based on each transmitter radiating in an assigned channel which in practice should be a little wider than its bandwidth.

Spurious Emission

Theoretically, an AM transmitter should radiate nothing else but the carrier and the two sidebands and therefore have a spectrum entirely contained within a bandwidth equal to twice the highest modulation frequency. But in practice AM transmitters are not quite perfect and therefore do radiate some additional energy, which we call spurious emission, generally at other frequencies further removed from the carrier frequency.

In the case of frequency modulation, the effect is to crowd up some of the waves in time and spread others out, but the intensity of the wave remains constant. But the FM wave has a much more complicated spectrum than the AM wave and there are, in theory, an infinite number of separate spectrum lines corresponding to individual frequencies at which energy is radiated.

In this case we might be forgiven for supposing that the bandwidth of an FM wave is infinite. Strictly speaking that is true, but the energy contained in each of the very large number of sidebands from the FM transmission decreases very rapidly with increasing difference in frequency from the carrier, so we can regard the bandwidth as being finite for practical purposes. The mathematics needed to calculate the bandwidth of an FM transmission is complicated and depends in particular on how much the frequency is shifted by the modulation; the shift is called the frequency deviation. Here, too, the total bandwidth occupied can be shown to be a factor multiplied by the modulating frequency, but that factor has a value always greater than two, which it would have been for AM. So FM always has a wider bandwidth than AM.

Television

As far as the modulating frequency is concerned, in the case of human speech it is not necessary to transmit signal frequencies above 3 or 4 kHz, depending on the quality of voice that is required, but for music a good quality transmission should extend to perhaps

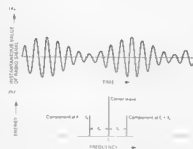

Figure 1. The amplitude of a modulated carrier wave (a) varies at a rate corresponding to the frequency of the modulating signal it carries. This complex wave is the sum of the original carrier wave, shown in (b) with frequency f_c , and two side components at frequencies equal to the sum and difference of the carrier frequency and the modulating frequency, f_m . When the modulating wave itself is complex, as in speech for example, the side components spread out over bands of frequencies on each side of the carrier, each band corresponding to the band of modulating frequencies. They are known as the upper and lower sidebands.

selektor selektor

selektor SELEKTOR

15 kHz of modulating frequency. With AM the minimum bandwidth for a voice transmission might be 6 or 8 kHz and for a high quality music channel at least 30 kHz. Using FM these bandwidths are substantially greater; for example, the present BBC VHF/FM transmissions have a bandwidth of some 200 kHz. Some kinds of signals even demand very much greater bandwidth than this, and the greatest sinner of all is television.

Transmitting a good quality television signal can mean using a signal frequency of up to 4000 or 5000 kHz, depending on the technical details, and for this reason a relatively wide channel is taken up. In open broadcasting FM is never adopted for television; even AM, used in the earliest television broadcasts, gives a transmission of great width in the spectrum. So television is nowadays transmitted on a modified form of AM.

There is an element of redundancy in both the AM and FM transmissions, for they are symmetrical about the carrier frequency and therefore the essential information conveyed by the modulation is represented twice, once above the carrier and once below. This led to the evolution of two closely related alternative forms of modulation, known as single sideband (SSB) and vestigial sideband (VSB). Both are derived from AM. In SSB the carrier and one of the sidebands generated by the amplitude modulation process are totally suppressed and only the other sideband is transmitted. Provided a carrier wave of the correct frequency can be generated at the receiver, all the information needed to reconstruct the original modulated signal is still present in the transmission, because the magnitude of the signal is represented by the sideband amplitude and its original frequency by the difference between the sideband and carrier frequencies. In theory, single sideband transmissions occupy only half the bandwidth of full AM transmissions without the loss of any information.

Vestigial Sideband

SSB is now extensively used in military and commercial point-to-point and mobile radio systems. But for television the alternative, vestigial sideband system (VSB) is preferred, in which the carrier and one complete sideband are left in the transmission but the width of the other sideband is restricted to accommodate only the lower modulating frequencies. This is marginally less

economical in terms of bandwidth, but makes for cheaper design of transmitters and receivers. Obviously, for mass-produced television sets this is a considerable advantage and the small bandwidth penalty is not significant. Using techniques of this kind it is possible to transmit a satisfactory television signal in 6000 kHz or so, but it is still worth remarking that we could have a thousand speech channels for every television channel.

In addition to broadcasting, the radio spectrum is used for radiotelephones, for mobile communications with aircraft, ships and vehicles, for point-to-point transmissions within countries and on the transcontinental scale, too, and for services such as radar and radio navigation which play a vital role in our modern society. Given that the resource is finite, it is clear that there is a limit to the number of users who can simultaneously exploit the economic advantages of radio systems.

Does this matter? After all, the world existed for a long time without radio. Will it be a very serious disadvantage if the growth of radio is shackled by spectrum congestion? It is obvious that although there are some areas where the use of radio might be described as a luxury, there are others where its application is absolutely unavoidable. For example, it is very difficult indeed to imagine airlines running without radio communication, and the policing of our cities could hardly continue if the use of radio were denied. In fact, a feature of the economic development of the whole western world in recent years has been the growing use of radio. All the parameters of economic growth in our society correlate very closely with that growth, and it is difficult to foresee that our economy could continue to develop

if the expansion of radio stopped. In particular, if we face an era in which energy costs are going to rise, the use of vehicles will have to be more efficient, and mobile radio is the most important resource for making this possible.

London's police force is little stronger in numbers than it was in the 1920s, in spite of an enormous growth in population with a corresponding increase in crime and in road users. Senior police officers have no doubt that the ability to go on policing the region effectively depends mainly on the use of radio in cars and of personal radios by individual officers.

Transport

Where public radio paging and car telephone services are available, they are showing steady rates of growth, which means people must think the cost is justified, while private mobile radio is playing a vital part for many companies in enabling them to run their business more efficiently. Studies have shown, for example, that commercial delivery services can make savings of some 20 per cent in fuel and in use of vehicles by introducing radio. Taxis are now largely dependent on it, the growing number of ships in the world are entirely dependent on it and new cheap air fares may be expected to accelerate the already rapid growth of air travel and thereby complicate problems of radio-dependent air traffic control. Already it has been necessary to halve the width of aircraft radio channels to ease congestion.

Then there are areas where the use of radio is just beginning: the UK Transport and Road Research Laboratory has shown that radio can reduce the costs of town and country bus services by 20 per cent and reduce passenger waiting time at stops by 16 per cent.

Safety of life

It is difficult to quantify the economic advantages of any one of these applications; emergency life-saving radio services cannot be costed at all. And there is the social value to consider, for good or ill, of radio and television broadcasting. Clearly the public at large puts a high value on such services.

Inevitably, we must conclude that it is a matter of the utmost importance, for both economic and social reasons, to provide radio services as freely as possible to those who can make good use of them. So we are faced with a very

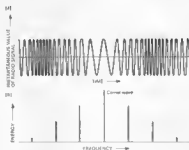

Figure 2. In frequency modulation, the frequency of the carrier wave is varied to impress the modulating intelligence on it, while the amplitude is kept constant. An analysis of the complex modulated wave shows, in theory, an infinite number of separate spectrum lines in addition to the carrier, corresponding to individual frequencies at which energy is radiated. However, the energy they contain falls off fairly rapidly on either side with the increasing separation from the carrier.

selektor SELEKTOR

selektor SELEKTOR

difficult problem of spectrum management. What are the rules for making the best use of our electromagnetic heritage? I believe that they fall into two categories, avoidance of pollution and right organization of use.

We are all familiar with the irritating interference created by electrical machinery. Everybody knows that a good deal can be done to reduce this nuisance by treating the offending equipment and nowadays there are quite stringent laws in many countries about fitting interference suppressors.

A worse pollution hazard probably comes from communications equipment itself, which is capable of interfering with other users and cannot be suppressed easily, for by its very nature a radio transmitter must be able to radiate energy efficiently and is likely to spread spurious radiation where it is not wanted. As the spectrum gets more congested we may expect that the strict regulations about spurious emission made by radio licensing authorities will be tightened further.

Minimum Energy

More fundamentally, all energy transmitted is capable of causing interference, under some circumstances, with other radio users. Often energy from two or three transmitters combine in the receiver to produce a spurious response which destroys the intelligibility of the wanted signal. It is not good enough simply to radiate a very 'clean' signal from the transmitter, for even the energy which forms part of the wanted transmission is itself capable of creating a polluting effect for other users. Another cardinal principle must therefore be that in all cases the energy radiated should be the minimum needed for the job the system is designed to do.

We must recognize that radiating a substantial carrier wave in AM or FM transmission does pollute the spectrum. All the whistling sounds produced by a radio receiver in a congested band are caused by carrier interactions, which are more serious in their effect than interactions between energy from sidebands. Because the carrier wave is of constant amplitude and frequency, and the person receiving a signal knows its frequency in advance, in principle at least it ought never to be necessary to radiate the carrier at all. In practice, it may be costly to generate it accurately enough in the receiver, so it is quite commonplace to simplify the receiving equipment by radiating a substantial but reduced

carrier along with the sidebands. In a typical AM transmitter modulated by speech, on average 90 per cent or more of the radiated power is in the carrier. This means that less than 10 per cent of the radiated power is performing an inescapable communication role and the rest is needlessly generating spectrum pollution, and is retained only to make the receiving equipment cheaper. This may have been justified in an era when the spectrum was relatively uncluttered, but today it should be looked into very closely.

Single-sideband modulation, with a suppressed carrier, is, as we have seen, a perfectly feasible means of transmission, already in widespread use in the short-wave (HF) bands. Not only does it cut the width of the transmitted spectrum by about half, but it avoids emitting radio energy other than the minimum necessary to establish the required communication link. It is therefore our best ally in the fight against spectrum congestion. Recently in the United States the Federal Communication Commission gave wide circulation to a document—the UHF Task Force Report—which strongly supported the extension of SSB into the VHF and UHF bands for land mobile radio. Surely this must be a straw in the wind.

Costs

The disadvantage of SSB is the tighter specification which has to be placed on the equipment, which is thought likely to be considerably more expensive. Against this, present trends in electronics are bringing equipment costs down so rapidly that perhaps the handicap will prove much less than had been imagined.

Probably it is in two-way radio systems rather than broadcasting that SSB will first capture a new empire for itself, and my colleagues and I at the University of Bath have been able, thanks to generous support both from the UK Home Office Directorate of Telecommunications and the Wolfson Foundation, to conduct an investigation into the use of SSB modulation in the land mobile radio service at VHF and UHF. As a result we are convinced that operation in channels only 5 kHz wide is perfectly feasible, as against the 12.5 kHz or 25 kHz channels now used for AM and FM. Because carriers are not transmitted, the total energy radiated is reduced by a factor of about eight when speaking, and to a very low level in between words. To our surprise it appears that the cost of the equipment may be very little more: the saving from the reduced transmitter power rating tends to offset increased costs elsewhere.

If we exploit all possible technical resources, the problem of exhaustion of the electromagnetic resource can be postponed, at least for a generation.

Should we fail to take sensible steps, things could only worsen. The economic toll already is certainly not trivial, and deaths have occurred through the congestion.

Capital Investment

It is, of course, true that spectrum exhaustion is not like exhaustion, say, of hydrocarbon fuels. The spectrum is not used up or worn out by use, and we can always free it again by simply turning off the transmitters or interference sources. Though this is true, it is not a helpful observation. Established patterns of radio use have led to large capital investments which cannot lightly be put to one side. To take an example, radio equipment in the hands of UK police forces is now perhaps worth some £20 million sterling. In theory they could change to an entirely new radio system within days of having new equipment provided for them, but in practice, and quite rightly, only the most compelling reasons would cause this large capital investment to be abandoned. Much the same is true of every other user.

This means, first, that changes will have to be introduced in an evolutionary way, as equipment is inevitably replaced through age and obsolescence, and, second, that because there is this large inertia we must be particularly careful that new systems coming into use do not offend against the needs of spectrum conservation. If any such systems were inadvertently allowed to be installed, the chance of phasing them out again quickly would be small indeed. We should now be directing some of our best engineering talent to spectrum conservation. It would be foolhardy if we were not to insist on the highest attainable technical standards in the design of all our future communication systems that use radio. It is high time that we stopped trying to reassure ourselves that the spectrum congestion problem does not exist or will go away. It is with us now, and it threatens the future of us all. We must learn habits of frugality, and who can not say that if we do so in this field the gift for it may yet spread to others?

*By Professor W. Gosling,
University of Bath.
Spectrum 164.*

[107 5]

selektor SELEKTOR

metal detector

high performance and simple construction

One of the problems that govern the fast growing hobby of treasure hunting is that economical metal detectors are notoriously unstable and suffer from a lack of sensitivity while the good ones are very expensive. The design featured in this article is both highly stable and sensitive and presents no problems in construction. It is professional in appearance and operation and performs better than many high-priced commercial detectors.



One of the projects near the top of our 'most requested projects' list has, for some time, been a metal detector. The reason for the delay in publishing an article on the subject is due to the fact that construction of a good detector (and not one that just detects something) is a very difficult proposition. The very first major problem that rears its head is that of stability since this is dependent on a number of aspects. To achieve a stable circuit design is not easy when cost is taken into consideration. The design and construction of the search head is also a formidable obstruction to obtaining a high performance while still remaining within the capabilities of the average enthusiast.

Furthermore, the search head must be robust and remain stable after the very critical setting-up procedure it requires. In other words, it must not be prone to 'headaches' when knocked. Even the difficulties of waterproofing and resistance to temperature changes are problems enough in themselves if the others are not enough.

What of the circuit itself? There are of course, a number of methods by which metals can be detected with the use of electronics but stability is the governing factor in performance. It is possible to design a circuit using microprocessors and the like that will work wonders but will require a find of gold sovereigns every day for a week to cover its cost.

Overall, the difficulties will appear by now to be unsurmountable and you may well be asking how we managed to do it at all. It took a little time but, rest assured, it has been done and the results have been well worth waiting for. The Elektor metal detector performs very well and is easy to construct due to the fact that the ultimate horror — the search head — does not have to be constructed by the reader. A complete hardware assembly, including the head, is available to readers, ready-made.

How has it all been done? Before reading on to find out, a note of warning. Firstly, reading the article carefully and paying attention to detail during construction are essential to produce a high performance metal detector. Secondly, and not quite so obvious, treasure hunting with any metal detector is much like horse riding, it takes time and practice to become proficient at it. Don't expect it to happen in one day!

Surveying the field

Various methods are used in the design of metal detectors and they all have their various advantages and disadvantages.

RFQ — beat frequency oscillator

These units are cheap, easy to build, but suffer due to the high frequencies used (for economic reasons). They are not very sensitive to metals, suffering badly from instability and ground effect and they do not discriminate between differ-

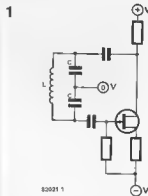

Figure 1. A simplified diagram of a conventional oscillator circuit. No form of compensation is included to allow for changes in the value of capacitor C due to temperature variations.

ent materials. They work on the heterodyne principle of beating two frequencies together and obtaining an audio tone relative to the difference between the two signals. The basic trick is that the oscillator has the search head as its frequency determining component and inducing a metal object into its vicinity will increase or decrease the search frequency so producing a change in audio tone.

TR/IB — transmit-receive/induction-balance

These metal detectors are much better than BFO types as regards general sensitivity but still suffer from stability problems and do not discriminate between metals. This type requires very accurate relative positioning of the coils and can be extremely difficult to set up. Another disadvantage is the fact that a slight knock 'on the head' can cause false signals.

VLF — very low frequency

The most expensive metal detectors are usually of this type. Various circuits will: (a) make the unit sensitive to metals, (b) discriminate between metals and (c) provide ground affect control thus overcoming a lot of shortcomings inherent in cheaper detectors. However, due to the low frequencies used, these types still suffer from instability. The disadvantages are cost (which can be high) and difficulty in setting up the head assembly.

PI — pulse induction

Pulse Induction is used in professional and industrial metal detecting systems. A good design can be extremely costly and construction and calibration is beyond the realms of the average electronics enthusiast.

The Elektor metal detector to be described is a high performance VLF model utilising phase locked loop techniques for stability, good discrimination between metals and elimination of ground effect. It features a better

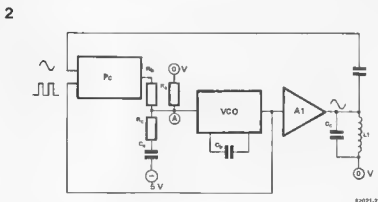

Figure 2. The Elektor metal detector employs a phase locked loop design to provide the basis of a highly stable oscillator with immunity to drift.

detection range than BFO and TR/IB types and does not suffer from instability problems. To achieve all this 'icing on the cake' it will be obvious that the circuit must therefore be more complex. However, a glance at the circuit diagram in figure 4 will show that it is not as complicated as some readers may have expected, and furthermore calibration is extremely simple.

Instability and PLL

As previously mentioned the major disadvantage of cheaper metal detectors is that of instability. In cases of severe instability, the process of detecting metal can be hampered to the degree that it becomes impossible to differentiate between the detector itself being 'off tune' and a 'find'.

Why is the Elektor VLF circuit more stable than others? The simplified circuit diagram in figure 1 is that of the more conventional VLF design. The problem is that the low frequencies used with a VLF design require a large number of turns in the search head coil. This also necessitates that the value of C in the circuit is relatively large. This is the point in the circuit where instability will occur since any capacitor will change value when exposed to heat. If it happens that the capacitor is included in the tuned circuit of an oscillator, it follows that the oscillator frequency will therefore be prone to drift.

In this type of oscillator the drift cannot be compensated for and the problem is further aggravated by the susceptibility of the circuit to voltage fluctuations in the power supply (creating more instability). As if this were not bad enough, the oscillator has a fairly high current-consumption and therefore batteries have a very short life.

To overcome these shortcomings the Elektor phase locked loop design was developed. This effectively compensates for any drift in the oscillator frequency due to changes in the value

of the capacitor. This design is slightly more complex but with the help of figure 2 is fairly easily understood.

The centre frequency of the VCO (Voltage Controlled Oscillator) is initially set by R_a , R_b , R_c and C_a , C_b . This produces a square wave, which is converted into a sine wave by the amplifier A1 and is fed to the search head L1. A proportion of this signal is capacitively coupled back to the input of the phase comparator PC, the output of which is passed to the control input of the VCO via the low pass filter consisting of R_c and C_a . The output of the VCO is also fed back to the other input of the phase comparator. These two feedback loops provide an immunity to drift and form the basis of this highly stable oscillator.

The Elektor metal detector

It has already been stated that the circuit of the metal detector is fairly complex. However, the diagram in figure 3 shows the details of the circuit in block form and it will be understood more easily if each block is treated separately, bearing in mind that each one refers to a section of the main circuit in figure 4.

Since the first block of the diagram, the PLL oscillator, has already been described, we can move on to the phase locked loop discriminator. A discriminator enables the user to reject unwanted materials, for example metal paper foil. This part of the circuit has again been designed with high stability in mind and for this reason a second PLL is used. The adjustment of the phase relationship between the transmit oscillator and the received signal, provides a method of sampling a proportion of the received signal. This provides the phase sensitive detector with its gate input.

The phase sensitive detector 'chops up' the input signal from the receive head and, after filtering, the DC voltage output is used by the meter and audio

circuits.

The auto tune is another special feature of the Elektor metal detector. Briefly the principle is to achieve an offset voltage, by storing it in a capacitor across an FET opamp which is used as a slow/fast integrator. By feeding this voltage level back to the phase sensitive detector we can reset the output voltage of the PSD, in order to zero the meter at the flick of a switch. This means that manual retuning is not necessary when changing modes or altering the sensitivity of the detector.

The meter circuit is straightforward and incorporates a battery status check, as well as indicating the accepted and rejected finds.

The final section of the block diagram is the audio stage, but this does not consist solely of an ordinary amplifier. A gated chopper circuit is also included which takes the search oscillator frequency and divides it down to approximately 270 Hz. This is used to chop the DC voltage output of the PSD before feeding it to the audio output amplifier thus providing an audio tone when metal is received.

This covers the basic building blocks of the metal detector and we can now move on to discuss the finer points of the circuit in detail.

The circuit diagram

The PLL oscillator is formed around IC1 in the circuit diagram shown in figure 4. The frequency is set by the components C3, R12, L1 (the search head), C2 and R10. The value of R10 is chosen to set the VCO initially at mid frequency.

The square wave output of the VCO (pin 4) is coupled via R7 to the search amplifier which is formed by transistors T1...T4. A portion of the sine wave is fed back via C1 and R11 to the signal input of the phase comparator (pin 14) where it is compared to the signal at pins 3 and 4. The resultant output at pin 2 is used to adjust the VCO to its resonant frequency thus forming a stable oscillator.

The VCO output at pin 4 of IC1 is also fed to the input of the phase locked loop discriminator IC2. The configuration of this IC provides a convenient method of adjusting the phase relationship by simply changing the value of a resistor at pin 11. The actual 'resistor' value is selected by S1, P4 and P5 and the resistor networks connected to pin 11 of ES5 and pin B of ES6. The level at pin 11 of IC2 selects either ground effect or reject mode with the aid of the CMOS switches ES5 and ES6.

The phase shifted square wave output of the discriminator IC2 is the gate signal for the phase sensitive detector formed by IC4 and A2. The receive signal from the search head is passed through an impedance converter T12 and then amplified (by a factor of 50) by the opamp A1 before being passed to the phase sensitive detector. It is this signal

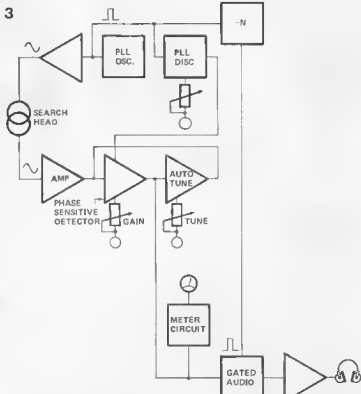

Figure 3. The block diagram of the Elektor metal detector. Each block corresponds to a part of the circuit diagram in figure 4.



Photo 1. The handle and case assembly of the metal detector showing the high standard of the finished project.

that is then chopped and sampled by IC4 and converted to a DC voltage level by opamp A2. The gain of this stage is variable by means of potentiometer P6. The output of A2 is a voltage level that varies in relation to the size and content of any metal object in the proximity of the search head. This signal is now provided with a variable offset by the tune control P7 in order to allow the meter to be zeroed.

Manual tuning can become tedious if it is required after every change of mode and therefore an auto tune is a desirable feature of the circuit. This is carried out by storing a voltage level in C18. This voltage is the sum or difference of the output of A2 and the position of the tune control. A4 together with IC6 form the basis of the auto tune circuit which functions as follows. When the two CMOS switches S3 and S4 close, the output of A4, an opamp with a gain of 4, will be fed directly to the input of IC6 and cause this opamp to act as a fast integrator. Since its output is fed back to the non-inverting input of A2 the original voltage level on the output of this opamp will be restored. Auto tune is brought into operation by flicking the handle switch S3 momentarily. This action will turn on the CMOS switches ES3 and ES4 thus increasing the voltage level on pin 2 of IC6 by a factor of 4.

S3 also serves as the mode change switch when operated in the other

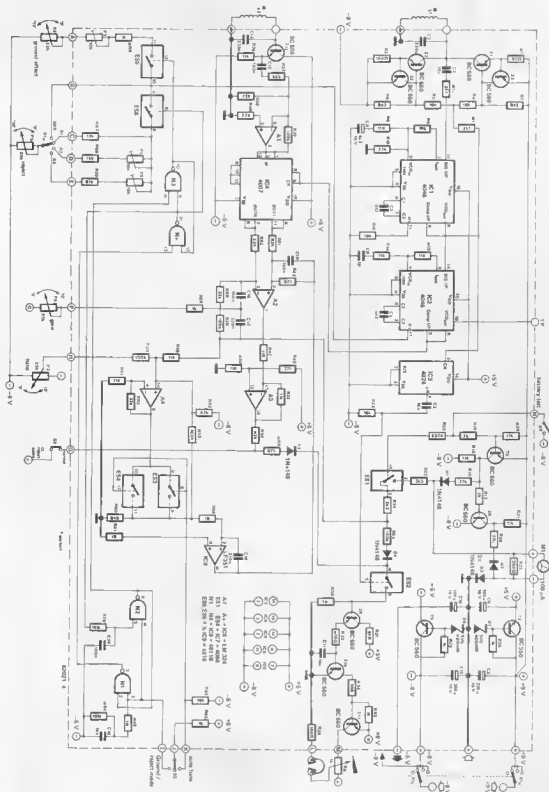

Figure 4. The complete circuit diagram for the metal detector. This drawing can also be used for wiring information for the switches and potentiometers.

direction, changing from ground effect to reject mode or vice versa. It will be apparent then that S3 is effectively a three-way switch. Mode change is achieved by the gates N1...N4 which are configured as a flipflop (although they may not appear to be so in the circuit diagram!). The complementary outputs of the flipflop control the two CMOS switches ES5 and ES6.

Many readers may find this going a little tedious by now, but take heart: we are almost at the end, in fact only the meter and audio sections of the circuit are left. The two functions of the meter are selected by the CMOS switch ES1. This is 'normally closed' and the meter will be connected to the detector circuit. Pressing the battery check switch S4 will open ES1 and at the same time, cause T5 and T6 to conduct. The meter will now be connected across the batteries via R19/D1 and R26/D2.

The remaining part of the circuit is the audio stage. It is slightly unusual but fairly straightforward. The output from the PLL oscillator (IC1) is fed to IC3 where it is divided by 32 to produce a 270 Hz square wave. This is then 'sharpened' by C7 and R27 to provide a control pulse for the CMOS switch ES2. In the normal modes an audio signal will only be heard when the meter moves to the right, indicating the presence of a wanted 'find'. This is when a rising positive voltage appears at the output of A2 and is fed via R25 and D4, through the CMOS switch to the output stage via T8.

It is also possible to use an audible signal for rejected finds. This may not be obvious at first but after some experience with the metal detector this feature will be found to be a useful extra. When S2 is switched off, the output of A3 is allowed to pass, via R55/D5 and again ES2, to the output stage. The audio amplifier consists of transistors T8, T10 and T11 with T10 acting as a level converter.

Construction

Readers will be in no doubt by now that the Elektor metal detector has a very professional appearance and in no way suffers from the usual nuts, volts and tobacco tin look that usually grace home construction projects of this type. The good news is that, yes, your metal detector can look exactly the same as that shown in the photograph here. Even more important, the major problem that prevents construction of a really good metal detector, that of winding and setting the coils in the search head, is completely taken care of. The entire case and hardware assembly, together with the potted, waterproofed and tested search head, has been made available to readers via Crestway Electronics Limited and it can be purchased with or without electronics. The overall design is to fully professional standards and the finished metal detector will out-

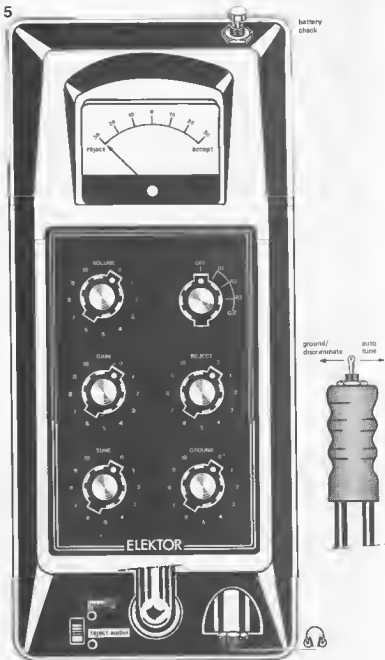

Figure 5. The front panel layout and controls for the metal detector. It is important that the switches and potentiometers are wired correctly. This diagram can be used with the operating instructions.

perform many high quality commercial units.

Should any reader wish to produce his own search head it is just possible although not very practical, since the setting of the coils is extremely critical and their position makes the difference between a very good detector and no detector. However, for those interested the head consists of two 10" coils with 80 turns each of 29 swg enamelled copper wire slightly flattened (to form a D) and overlapped by approximately 1". The critical setting is then found by

trial and error.

The electronics of the metal detector is surprisingly easy to construct. In fact, if the printed circuit board is used, it will present no problems at all. Assembly of the board is carried out in the usual manner after which the point to point wiring is completed, using figure 4 as a guide.

Particular attention should be paid to the wiring of the potentiometers or the direction of the rotation may be incorrect. If one of them does appear to be the wrong way round, exchanging the

wiring at each end of the track (the outside tags) will provide a solution.

The handle switch S3 (ground effect/reject mode and auto tune) is a momentary two-way switch with a biased centre off position. This must be wired correctly to avoid confusion in use. The switch should be fitted so that auto tune is operated when the switch is flicked to the right. The contact that is 'made' in this position (usually the left-hand one) should be the one connected to K on the printed circuit board.

A note on the printed circuit board, there are two points marked -9, these have to be wired together externally. If stereo headphones are used they should be converted to mono by shorting the left and right leads together (not the common lead).

It will be wise to ensure that all connections are correct before connecting the batteries.

Calibration

Any electronic device will only be as good as its calibration and for this reason the setting of the three preset potentiometers P1, P2 and P3 should be carried out with care. Some readers tend to get a little alarmed at this point but we can dispel any worries right away. The metal detector has been specifically designed to allow the calibration to be carried out - with nothing more sophisticated than an ordinary multimeter with reasonably accurate 1 V and 10 V ranges.

Initially all controls must be turned fully clockwise. The unit can now be switched on by turning S1 to the R2 position. The first check is the positive supply rail and this is carried out by connecting the meter (switched to 10 V DC) across C9 - taking note of the polarity. The reading should be between 4.7 V and 5.3 V. The negative supply can be checked across C10, again with attention to polarity, and in this case a reading between -4.7 V and -5.3 V will be fine. If either reading is outside these limits the components in the supply regulators must be checked before going on.

If the supply voltages are correct the meter can now be connected between the test point (TP, pin 10 of IC2) and 0 V (negative lead). With the meter switched to the 1 V range adjust P1 for a reading of 0.65 V. Switch S1 to the R3 position and adjust P2 for a reading of 0.15 V. After flicking the handle switch to select ground effect mode, P3 can be adjusted for a reading of 0.82 V. And that is all - the calibration has been completed!

Operating instructions

1. Switch S1 to the R3 position.
2. Press handle switch S3 to right and hold.
3. Rotate tune control until meter reads zero.
4. Rotate gain control to position 8.
5. Release handle switch.

2

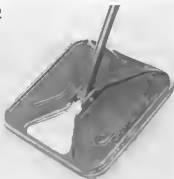

Photo 2. Possibly the most important part of the metal detector, the search head, is supplied as a complete and finished assembly.

6. Adjust volume control to 1/2 way position.
7. Using a gentle sweeping motion sweep the ground in front of you with a left-right-left movement while walking slowly forward. The maximum sweep should be about 18".
8. Practice for a while using this procedure and try to receive signals from all types of metal. Once you are confident in the use of the basic procedures of the machine then move on to the following: using steps 1-6 set up the machine in basic operation mode and carry on with the following steps.
9. Flick handle switch to the left and release.
10. Rotate the reject mode control and check that the mode is correctly selected by a swing on the meter, if not return to step 9 and repeat.
11. Switch S1 to the R2 position and set the reject mode control to 1/2 way.
12. Flick the handle switch to the right (auto tune) momentarily and release.
13. At this point you should be rejecting tinfoil silver paper etc, but accepting coins (cupronickel) bronze, brass, silver and hopefully gold.
14. Rotation of the reject control towards zero will decrease the amount

of rejection, and towards 10 will increase rejection.

15. Practice using the above until you are familiar with the machine, then try the following.

16. The coarse settings of positions R1, R2, R3 on S1 works as follows: R1 will give the maximum rejection of metals.

R2 will give average rejection and is the most used position.

R3 will give a minimum metal rejection, in other words, receives most metals.

17. Ground effect control

On some soil the so-called ground effect may be experienced, due to mineralised soil. The same effect will appear when using the detector on beaches. This phenomenon produces the effect of an almost continual and apparently haphazard series of finds. The indication of ground effect can be verified by a drop in audio output when lifting the search head away from the ground. It must be noted that ground effect is a phenomenon that all metal detectors have to overcome. The Elektor metal detector is able to eliminate this problem when the procedure described here is followed:

18. Depress handle switch to the left momentarily and release.
19. Rotate the ground effect control whereupon the meter should move.
20. Adjusting this control from zero to 10 will increase or decrease the compensation for ground effect and the best setting is when you can lift the head away from the ground, with no change of signal.
21. Gain control, this control sets the sensitivity of the machine and is normally turned up towards position 10 for most of the time. However, if a beach is being searched for coins, which will usually be just on the surface, then turning the gain down will make the detector sensitive to coins on or just below the surface and anything buried deeper will be ignored.
22. Auto tune switch
At any time in use, if changing mode or resetting of the gain, reject and ground controls, then momentarily operation the handle switch to the right will reset the tune position back to zero

3



Photo 3. The distance between the head and the handle is fully adjustable.

Parts list

6

Resistors

R1, R2, R35 = 100 Ω
 R3, R8 = 8k2
 R4, R5, R12, R27 = 16 k
 R7, R11 = 2k7
 R8, R9, R13 . . . R15, R18, R21, R36, R47,
 R48, R50 . . . R52, R67 = 11 k
 R10, R26, R38, R40 . . . R42 = 22 k
 R16, R17 = 2 k
 R19, R49 = 27 k
 R20 = 330 k
 R22 = 390 Ω ✓
 R23 = 3k3
 R24, R37 = 2k2
 R25, R39, R45, R56, R58 = 100 k
 R28, R29, R33, R46, R63, R66 = 1 k
 R30, R69, R61, R65 = 1 M
 R31, R60 = 6k8
 R32 = 470 Ω
 R34 = 5k6
 R43, R44, R53 . . . R55, R57, R89 = 47 k
 R62 = 10 k
 R64, R70 = 10 M
 R68 = 15 k
 P1 . . . P3 = 10 k preset potentiometer
 P4 . . . P7 = 25 k lin. potentiometer
 P8 = 1 k lin. potentiometer

Capacitors:

C1, C7, C11, C19 = 10 n MKM
 C2, C13, C17 = 220 n MKM
 C3, C5 = 4n7 ceramic
 C4 = 4 μ 7/10 V
 C6 = 1 μ MKM
 C8, C12 = 220 μ /10 V
 C9, C10 = 100 μ /10 V
 C14 C16, C20 = 100 n MKM
 C18 = 470 n MKM

Semiconductors:

D1 . . . D5 = 1N4148, 1N914
 D6, D7 = 5V6 400 mW zener diode
 T1, T3, T5, T9, T11 = 2N4126, BC 560
 T2, T4, T6, T7, T8, T10, T12 = 2N4124, BC 550
 IC1, IC2 = 4046
 IC3 = 4024
 IC4 = 4007
 IC5 = LM 324
 IC8 = LF 351, 3140, or equ.
 IC7 = 4066
 IC8 = 4011 B
 IC9 = 4016

Miscellaneous.

S1 = three-pole four-way switch
 S3 = SPDT biased centre off switch
 S4 = single pole push to make switch
 S2 = SPST slide switch } included in complete
 L1, L2 = search head } case-work kit from
 M1 = 100 μ A meter } Crestway Electronics Ltd.
 headphones = 8 Ω
 batteries = 2 x PPG

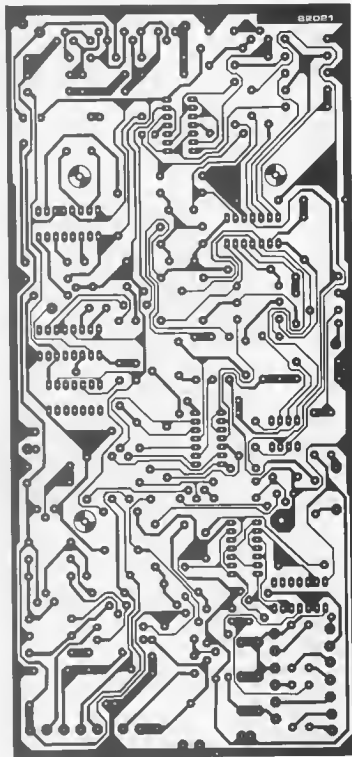
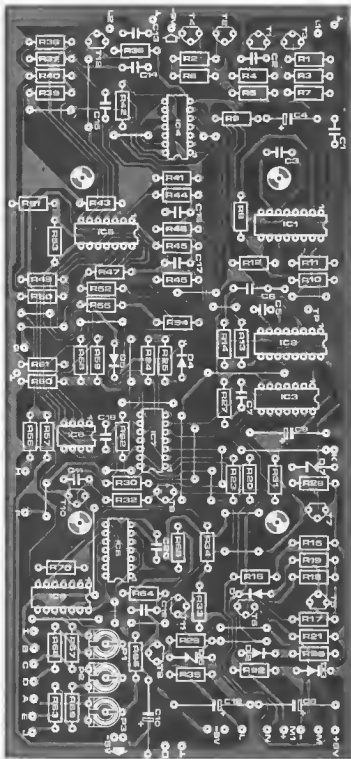

Figure 6. The printed circuit board and components layout for the metal detector. The two points marked 9 are wired together externally.



on the meter, but note: do not hold this switch over while actually searching for metal as the fast integrator circuit will be constantly in use.

23. The slide switch S2, at the left hand rear of the case, is normally in the nearest position to the front panel. This corresponds to an audible indication when the meter moves towards the right. If the switch is in the other position then an audio signal will be present at all times whether the meter is moving towards the right or the left, but a change in tone will be heard as metal is detected. This mode is useful for general searching, since you do not need to look at the meter all of the time.

24. Battery test button

Pushing this will give a meter reading indicating the state of the batteries. The batteries should be replaced when the meter reading falls below 10 on the right hand half of the scale. **M**

Notes for treasure hunters

Successful treasure hunting with any metal detector requires plenty of luck and experience. We are of the opinion that the former is somewhat unreliable but the latter can be gained with practice. After a period of use and time in which to become familiar with the metal detector, you will get to know little tricks like telling the difference between ferrous and non-ferrous materials from indications given by the detector alone. Steel is indicated by a more rapid movement of the meter. It is not really understood why, but bronze tends to give a warbling note in the headphones. Small coins and rings lying on edge in the ground will produce a very sharp on/off signal. It is also useful to know that the larger the size of a buried object, the more area the signal will be on for. We are also reliably informed that gold actually gives a double pulse in the form of an echo.

For consistent results, do not move too fast (neither sweeping nor walking) and keep the head within 1/2 to 1 inch above the ground. This becomes a lot easier with practice. After use always clean the search head with a damp cloth.

Above all, respect other people's property, and request permission before searching an area of land, it is almost always granted. The Elektor metal detector head is perfectly water-proof and can therefore be used in rivers which can prove quite fruitful.

We are given to understand that growing a beard and rising at unhand of hours does bring a measure of success but we have no documentary evidence to prove this. The seasoned treasure hunter can be recognised by this downcast, glazed expression and constant numbling. His hand never leaves the shovel that travels everywhere at his side and he wears headphones in bed!

Treasure hunting can be rewarding, frustrating and damaging to your social life but it will never be boring.

high boost

A.M. Bosschaert

All electric guitars and bass guitars have some sort of tone control, although this is generally very unsophisticated. This high boost circuit can provide a great improvement, for, as its name suggests, the treble can either be boosted or cut by about 35 dB. In addition, the turnover point of the tone control can be set to three different frequencies by means of a single switch.

It is a well-known fact that for some inexplicable reason, electronics has never succeeded in catching up with the quality of electric guitars. The average tone control circuit on an electric guitar usually consists of little more than a capacitor and a potentiometer and can hardly be expected to produce very good results. An active tone control is much more effective and the high boost circuit, for instance, can either amplify or attenuate the treble over a ± 35 dB range. The circuit is compact in size, allowing it to be fitted inside the guitar body, if desired. Its current consumption is low enough for a battery to be used as a power source.

In addition, the tone control is equipped with a turnover point switch. Understandably, not every guitar owner is going to be prepared to cut holes into his/her precious instrument. Taking this into account, the circuit enables both the treble and the turnover point to be selected with a switch that is possibly already fitted to the instrument (as in Stratocaster and Les Paul copies, for instance). This means that the guitar can be provided with a number of practical facilities without having to be disfigured.

Operation

Figure 1 contains the tone control circuit diagram. At the heart of the circuit, IC2 constitutes an active tone control together with R5...R9, P1, C3 and C4. The tone control is preceded by an emitter follower that is built up around T1. This serves as a buffer for the high-impedance guitar pick-up at the circuit's input.

The DC offset of IC2 is determined by the resistors R10 and R11. As a result, half the supply voltage is fed to the IC's non-inverting input. The output of the opamp also determines the bias of T1 via resistors R3 and R4 in the feedback loop. The opamp used is not a common type, but has been selected for this purpose because of its low current consumption.

As mentioned previously, the tone control uses a three-position switch to select one of the three turnover points: 250 Hz, 800 Hz and 2500 Hz. The setting is altered by means of electronic switches which connect R8 and R9 in parallel to P1. The electronic switches, ES1 and ES2, are controlled by the D-type flipflops FF1 and FF2. These are wired so that the count cycle is as follows: 00-01-10-00-01-etc. When the count is 00, no resistor will be connected in parallel to the potentiometer and the turnover point will be at its lowest level (250 Hz). When the count is 01, however, ES1 will switch on, so that R8 will be connected in parallel with P1 and the turnover point will be at 2500 Hz. Then there is the 10 count, where R9 is in parallel to P1 and the turnover point frequency becomes 800 Hz.

Switch S1 controls the FF1 and FF2 counter. This switch is operated with

the aid of P1. A type of monoflop is made using the two other electronic switches in IC3 for the purpose of switch debouncing. Operation is as follows. P1 is usually turned to adjust the treble. If a different turnover point frequency is required, the potentiometer is turned fully anti-clockwise, thereby opening the switch in the pot. The potentiometer is then turned in the opposite direction. Now the treble control can be adjusted as required. After the switch has been operated three times, its initial turnover frequency will be restored.

S1 can also be operated independently from P1. For this S1 must be replaced by a pushbutton type. Depressing the pushbutton will then step through the turnover frequencies.

The current consumption of the circuit is exceedingly low, slightly over 0.5 mA, which means that the circuit may comfortably be powered with a small 9 V battery.

Construction and setting-up

Figure 2 shows the printed circuit board on which all the components are mounted. The board is small enough to be fitted inside a guitar, but it can also be housed in a separate case, which may be preferable for aesthetic reasons.

Most electric guitars have at least two potentiometers: one acts as a volume control and the other as a tone control. All that has to be done therefore is to replace them by two different types. P1 is a potentiometer with a built-in switch. The switch is indicated as S1 in the circuit diagram. The volume control, P2, is a 'normal', logarithmic type.

The potentiometers and switch S1 are now connected up to the printed circuit board and so are the guitar pick-up and the battery. There are two possibilities for switching the power on and off. The first involves using the supply switch S2, which means linking the dotted J connection on the board.

The second alternative is a slightly more elegant solution. The jack socket on the guitar is replaced by a stereo version. When the plug is inserted, a 'short' is caused between the connection for the spare amplifier channel and ground, since the plug is a mono type. By connecting the negative terminal of the battery to the second channel connection of the socket and the circuit earth to that of the socket, the power supply will be switched on automatically when the lead is plugged into the guitar.

If housed in a separate case, the circuit may be provided with a small mains power supply. After all, the circuit barely consumes 1 mA.

How to use the circuit

Readers should know by now how to use the circuit, but just to make things clear: P2 serves to regulate the volume and P1 controls the treble. The turnover point is altered by turning P1 fully anti-clockwise until it 'clicks' end back again. For each 'click' a lower turnover

1

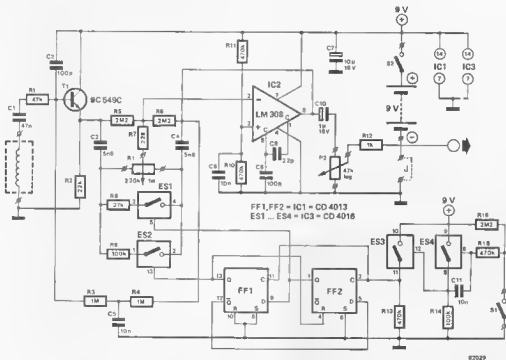

Figure 1. The high boost control circuit for electric guitars. A single switch enables three different turnover points to be selected.

2

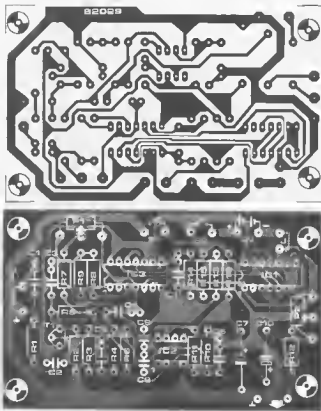

Figure 2. The component overlay and the copper tracking pattern for the high boost printed circuit board.

Parts list

Resistors.

- R1 = 47 k
- R2, R7 = 22 k
- R3, R4 = 1 M
- R5, R6, R16 = 2M2
- R8 = 27 k
- R9, R14 = 100 k
- R10, R11, R13, R15 = 470 k
- R12 = 1 k
- P1 = 220 k linear plus switch
- P2 = 47 k log

Capacitors.

- C1 = 47 n
- C2 = 100 p
- C3, C4 = 5n6
- C5, C6, C11 = 10 n
- C7 = 10 μ /16 V
- C8 = 22 p
- C10 = 1 μ /16 V

Semiconductors:

- T1 = BC 549C
- IC1 = 4013
- IC2 = LM 308
- IC3 = 4016

Miscellaneous.

- S1 = sp switch (on P1)
- S2 = sp switch

point is selected. Three operations are required to return to the original turnover point. The order of selection is high-middle-low. The first change will only be a very subtle alteration to the sound, whereas the lowest turnover frequency will give the greatest change. **M**

For some time our design team have been exploring the possibilities of a successor to the Formant, the Elektor synthesiser. Following the trend in technology, it was felt that a new concept was needed rather than just a refresh of a basic idea.

As regular readers know, the Curtis ICs have just recently made their appearance on this side of the water. These have been specifically designed for synthesizers and are probably the farthest that any company has dared to venture in terms of musical 'chips' so far. No

Throughout the series, readers will be expected to be familiar with the structure and operation of synthesizers in general. However, anyone who is new to this rather complex field can find all the basics in FORMANT Book One.

Why the preset facility?

You only have to analyse the synthetic sounds used in Pop, Rock-and-Roll and Jazz to realize that the number of different presets required is surprisingly few. The audience recognizes the characteristic sound immediately, which is why a lot of rock bands use one particular sound regularly as a kind of 'label'. Furthermore, setting individual modules is extremely time-consuming and, on stage especially, this can be a real nuisance. Things can be simplified by providing a 'manual/preset' switch for all the elements required to produce a complex sound effect: filter frequencies, attack and decay times, VCF resonance factors, the interval between two VCOs or the envelope amplitude, and so on. This is illustrated in figure 2, where inputs 1...4 are for the preset control voltages.

Since only very few variations are regularly used in practice, they can easily be stored as 'programs' and 'called' when needed with the aid of a single switch or a decimal keyboard. If only four situations are required per parameter, say, it is not even necessary to store the exact control voltage values in memory. CMOS analogue switches can be used to select the desired voltages as shown in figure 3a; in effect, this works like the rotary switch shown in figure 3b. The only data that must be stored is the 'setting of the switches'.

Obviously, the possibility of full manual control by means of knobs on the front panel must be maintained as an option — if only for special effects.

The individual boards belonging to the compact model do not need to be modified if the circuit is provided with a preset facility at a later date. The voltages which control the filter frequency, attack times, etc. are fed to the corresponding modules in the compact model by way of the potentiometers on the front panel.

For the preset option, provision must be made to break the connection from the front panel controls, as required, and drive the modules from some fixed (preset) voltage instead. As mentioned above, CMOS switches are the obvious solution. For the VCOs, four different preset voltages can be selected as shown in figure 3. The envelope waveform from an ADSR module can be 'voltage-controlled' by passing it through a VCA (figure 4), and selecting any desired waveshape from the VCO output is only slightly more complicated, as illustrated in figure 5.

As can be seen, eight voltage controlled switches are needed to select the

the new synthesizer

programmable and portable

The success of the Elektor Formant synthesiser led us to the opinion that there is a great interest among our readers in the field of electronic musical instruments, especially synthesizers. The availability of the new Curtis IC described in last month's issue prompted us to embark on an entirely new design.

Since the size of the Formant did not lend itself to portability it was decided that the new synthesiser should be truly portable without any lack in terms of performance. The new synthesiser is of modular construction and can be expanded into a polyphonic instrument with 'programming' facilities. This, the first article in the series, explains the basics behind the design.

further prompting was required to look into the possibilities of utilising these new ICs to form the basis of an entirely new synthesiser.

It was felt that a modern synthesiser should take on a new look together with simpler operation. This is the first article in a series describing a truly portable and fully operational instrument that can be constructed in modular form allowing expansion up to a polyphonic keyboard. Further it was decided that the ability to 'program' different sounds was a facility that could be extremely useful.

In this article we begin by discussing the fundamentals behind the new design. Basically, the concept of the new synthesiser is that of a set of modules which could be combined in various ways leaving the reader free to build four different types of synthesizers using the same basic printed circuit boards. The possibilities are as follows:

1. a simple synthesiser
2. a simple synthesiser including a preset facility
3. a polyphonic synthesiser
4. a polyphonic synthesiser including a preset facility.



1

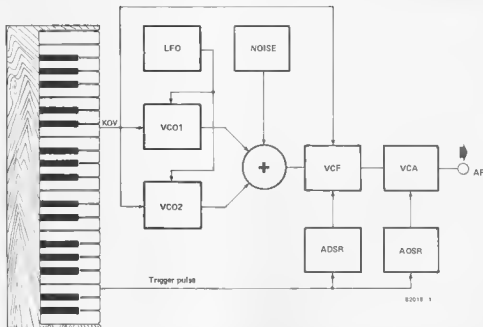

Figure 1. A block diagram of the most straightforward version of the new synthesiser. Two VCOs, a VCF + VCA and two ADSR units are all that is needed for a 'bare-bones' system. With the addition of an LFO, which only produces a triangle signal, and a noise generator, a large number of different sounds can be achieved.

2

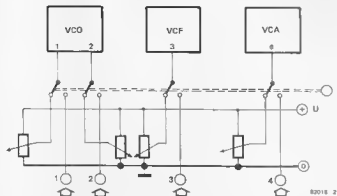

Figure 2. The control inputs 1...4 on the various boards can either be linked to the wipers of the potentiometers on the front panel or to external control voltage inputs.

waveforms (but if a 4066 is used, only 2 ICs are necessary). The principle is fairly straightforward. When the preset/manual switch S2 in figure 5 is in position A, S1' in IC2 will be closed. The waveform can now be selected with S1. Since the analogue switches in IC3 are switched 'off' when the manual/preset switch S2 is in position A, the data at the BCD inputs will have no effect on switches S2'...S4' in IC2. Resistors R6...R10 make sure the switches are held fully 'off' when no voltage is applied to the control inputs. With S2 in position B, however, external data at the BCD inputs of IC3 will select the output waveshape.

As can be seen in figure 5, the octave 'range' switch and the fine tuning

3

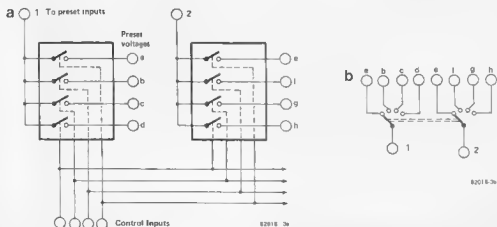

Figure 3. The circuit in figure 3a is little more than an electronic version of the rotary switch shown in figure 3b.

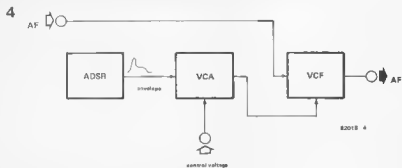

Figure 4. A VCA can be used to control the amplitude of the ADSR signal.

potentiometer are connected to the VCO control input via IC4, in the 'manual' mode. When S2 is switched to 'preset', the pre-programmed control voltage is selected instead.

Driving the preset inputs

Since the synthesiser is made up of individual modules it can be controlled with the aid of external voltages. That's all very well, but how can this be put into practice? As an example, let's assume that sixteen preset voltages are required for any given setting. Corresponding digital information can

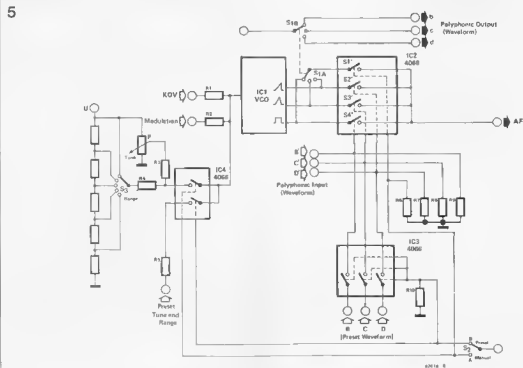

Figure 5. The complete VCO block diagram. The wiring of the CMDS switches gets rather complicated, since provision must be made for switching both the control voltage input and the output wave shape.

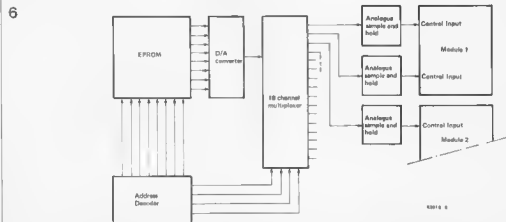

Figure 6. A simplified view of the preset circuit which can be included in an extended version of the synthesiser.

7

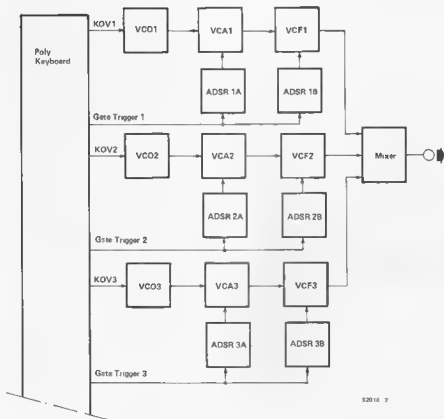

Figure 7. The block diagram of a polyphonic synthesiser. A polyphonic keyboard provides various control voltages (KOV) and gate pulses which each control a complete unit (VCO, VCA, VCF and two envelope generators).

be stored in EPROM, as shown in figure 6. The locations for any given setting can be scanned in rapid succession and passed through a D/A converter and 16-channel (analogue!) multiplexer to sixteen sample-and-hold units. These, in turn, drive the control inputs of the various modules.

8

The polyphonic version

In the polyphonic version (figure 7) the number of basic units required depends on the number of keys that are to be played at the same time. Each key has to be provided with a VCO, a VCF, a VCA and the corresponding envelope generators. All the parameters are controlled centrally either by the knobs and switches on the front panel or by the stored preset information. This means that when the synthesiser is expanded into a polyphonic instrument there is no need to modify the front panel. This has the advantage that the user does not have to buy everything at once; instead, the monophonic unit can be extended by adding other boards. It is important however to have a polyphonic keyboard with separate control voltage outputs.

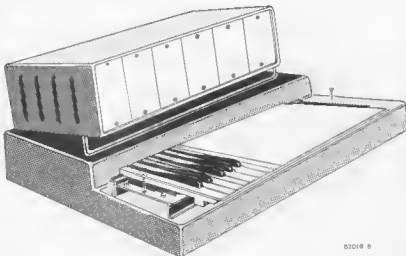

Figure 8. The compact synthesiser version can be housed in a small case and is truly portable. The expanded version will require a second case which is connected to the first by way of a multicore cable. For monophonic purposes the FORMANT keyboard can be used.

LCD frequency counter

professional appearance and performance

This is the first in a series of projects featuring a frequency counter module with a liquid crystal display. The high performance is out of all proportion to the simplicity of the circuit. Two switched ranges are available, the first up to 4 MHz for use in monitoring frequencies in microcomputers and the second up to a maximum of 35 MHz to cover CB transceivers and general use.

The complete counter and printed circuit board are housed in a hand held case that has been specifically designed for a module of this type.

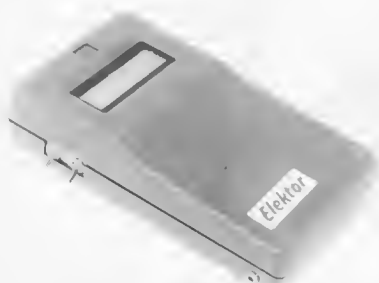

The nice thing about our hobby is that once in a while an electronic device comes along that just begs to be used in one way or another, and not just for the original purpose that it was designed for. Just such a device in the neat little package from Thurlby Electronics, the FM77T. This minor miracle is actually a complete frequency counter module that includes a 4½ digit LCD display, all measuring just 60 x 38 x 10 mm. It incorporates a CMOS LSI chip and a 6.5536 MHz crystal oscillator and the total will measure and display up to 4 MHz with no external components.

As to be expected, we haven't stopped at just a 4 MHz frequency counter in our use of the module. In fact this, the first of the articles featuring this device, incorporates a prescaler enabling a count frequency of up to 35 MHz to be achieved, and it is all mounted in a hand held case. We plan a further counter with a capability of 150 MHz followed by a digital capacitance meter. There are even more projects in the pipeline but they must remain undisclosed at the present time.

The counter module

Since the heart of the counter lies in the FM77T module it is interesting to see just what this package is capable of. Besides being just a 4 MHz counter with a reading rate of 10 per second it can also serve as digital frequency readout for a radio or a tuner. It is possible to select any one of 26 preprogrammed standard JF offset frequencies. The module can then be used to display the received frequency by measuring the frequency of the local oscillator of the receiver.

The 3 decimal points are also selectable together with the kHz, MHz and LW legends at the right hand end of the display. Two other inputs are of importance, both requiring a high level (supply level) to activate. One is a 'hold' input which freezes the display and the other is a 'reset' input which will return the display to zero.

The maximum display is in fact 39999 but the counter will overflow, in which case the correct reading will be the display minus 40000. Thus 5.9 MHz will be displayed as 1.9 MHz. The module will operate on supply voltages between 4.75 V and 7 V with a typical power consumption of a little over 1 mA. A word of warning here, particular care must be taken to prevent incorrect connection of the power supply because this will convert the module to an expensive inmate of the rubbish bin.

The basic frequency counter

The first in the series of projects is a hand held frequency counter having two ranges, 4 MHz and 35 MHz (40 MHz, if you really push it!). The specifications are given in table 1 and they are very good, especially when the total

Table 1

Specification of the frequency counter:	
Frequency range 1:	2 kHz ... 3.999 MHz
Input sensitivity:	30 mV RMS
Frequency range 2:	100 kHz ... 39.999 MHz
Input sensitivity:	80 mV RMS, 100 kHz ... 20 MHz 150 mV RMS, 20 MHz ... 30 MHz 450 mV RMS, 30 MHz ... 35 MHz 900 mV RMS, 35 MHz ... 40 MHz
Maximum input voltage:	50 V RMS
Input impedance:	1 M Ω /10 pF for $U_{in} < 700$ mV
Calibration:	none required
Power supply:	9 V battery or NICAD or external 8 12 V AC power/charging source
Current consumption:	40 mA max.
Automatic decimal point shift:	
Automatic kHz or MHz display:	

1

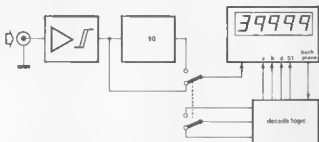

Figure 1. The block diagram of the frequency counter.

2

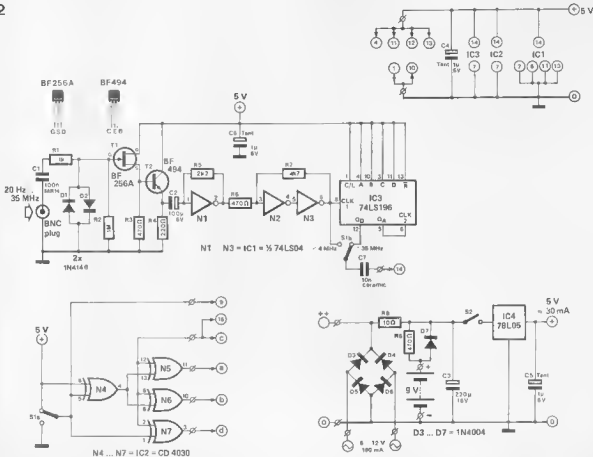

Figure 2. The high performance of the frequency counter is out of proportion to the simple circuit diagram shown here. The numbers in circles relate to connection points on the module in figure 3.

cost of the counter is taken into consideration. Probably the most notable point is that the input level can be anywhere between 30 mV and 50 V without fear of damage occurring.

Block diagram

The simplicity of the counter will be apparent from the block diagram shown in figure 1. The input amplifier is followed by the divide-by-ten prescaler to produce a maximum count of better than 35 MHz. The divider can be bypassed with the aid of a switch to obtain a maximum count of 3999.9 kHz. The automatic decimal point and legend display is controlled by the lower block in the diagram.

The circuit

Only a very few components are required as can be seen from the circuit diagram in figure 2. The two diodes D1 and D2 are to protect the circuit from excessively high input levels (50 V is an absolute maximum). T1 and T2 together form a 'super source follower' or impedance converter and will convert the high (1 M Ω) input impedance to about 220 Ω for the amplifier N1. The amplifier is in fact a TTL inverter but its output will still be analogue for

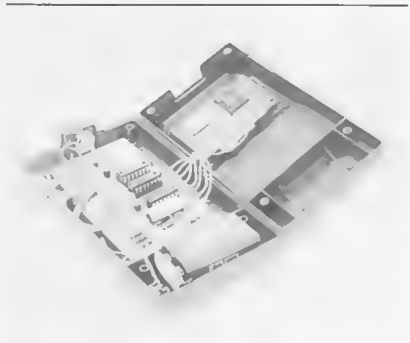

Photo illustration. The counter printed circuit board and module have been designed to fit the Varo 65-2996H case.

4

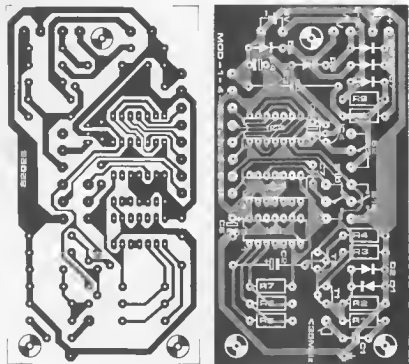

Figure 4. The track pattern and component layout for the printed circuit board of the counter.

small input voltages. At pin 2 it will be between 1.5 V and 1.8 V peak to peak for an input voltage at C1 of 30 mV RMS. The analogue waveform is converted to digital by the pulse shaping circuit formed by N2 and N3. Next in

the chain of events is a divide-by-ten IC3, which can be switched in or out of the circuit depending on the position of S1.

The remaining gates N4...N7 are used purely as a decoding circuit to

3

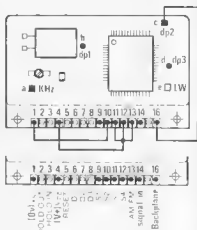

Figure 3. The frequency counter module is illustrated here. The links shown must be made during construction.

Parts list

Resistors

- R1 = 1 k
- R2 = 1 M
- R3, R6, R9 = 470 Ω
- R5 = 2k2
- R7 = 4k7
- R8 = 10 Ω

Capacitors

- C1 = 100 n MKH
- C2 = 100 μ /6 V
- C3 = 220 μ /16 V
- C4 . . . C6 = 1 μ /6 V tantalum
- C7 = 10 μ ceramic

Semiconductors

- T1 = BF 256A (not B or C)
- T2 = BF 494
- IC1 = 74LS04
- IC2 = 4030
- IC3 = 74LS196
- IC4 = 78L05
- D1, D2 = 1N4148
- D3 . . . D7 = 1N4004

Miscellaneous:

- S1 = DPDT miniature switch
- S2 = SPDT miniature switch
- battery = PPS or NICAD equivalent
- Hand held case = 65-2996H from Varo Electronics Limited
- Module = FM77T from Thurby Electronics Limited, Coach Mews, St. Ives, Huntingdon, Cambridgeshire

determine the position of the decimal point and the legend (MHz or kHz) again depending on the position of S1.

The power supply for the counter is slightly more complex since four supply options are possible. A standard 78L05

regulator is used as the maximum current consumption for the entire counter is not more than 30 mA. In the first case, power can be provided by an ordinary PP9 dry battery which will give approximately six hours of continuous operation. Resistor R9 will not be needed. If on the other hand the PP9 is to be replaced with a NICAD, R9 will be required since this provides a path for the NICAD charging current when the counter is supplied with an external 8...12 V AC source. The value of R9 is dependant on the NICAD used and must be calculated to provide a charge current of 20...25 mA when the NICAD is discharged. Resistor R8 acts as a limiting resistor to prevent excessive dissipation in the regulator. The final option is an external DC power source and this will appear in greater detail in a future article.

Construction

Having said all there is to say about the relatively simple circuit we can move on to construction. The case used for this project is the hand held box from Vero, part number 65-2996H. The point to bear in mind is that the interior of the case will become fairly full therefore it would make sense to assemble and connect the component parts of the counter together as far as possible before mounting the whole into the case. Ribbon cable will be ideal but leave enough length to allow assembly, particularly between the module and the printed circuit board. It should be remembered that the case is plastic and is therefore defenceless against a sudden attack by a hot soldering iron.

At this stage it will be as well to double check that all wiring is correct (including the battery connector).

The two switches can be mounted in a small piece of circuit board material that is fixed with super glue to the inside of the lower half of the case. Take care to space them apart enough to allow them to fit side by side. The module can also be fixed in place with two or three drops of super glue. Only a very small amount will be sufficient. The printed circuit board can now be mounted using three very short screws. The BNC socket can be fitted last of all making this connection is the only soldering that needs to be carried out inside the case. The miniature socket for the external AC power source can be mounted at one end of the battery compartment.

Before finally closing the case, ensure that connecting wires can not become trapped between the two halves of the case. If satisfied that all is as it should be a power source can now be connected to check the operation of the counter. There is no calibration required therefore the reading will be correct right from the start. ■

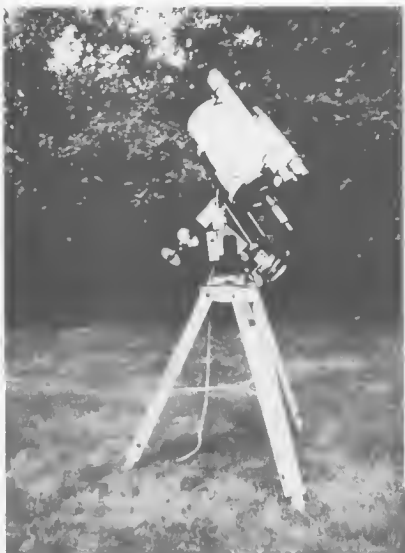

telescope control

seeing distant stars . . .

Stopping the movement of heavenly bodies (on a photographic plate at least) is the purpose of this article. A camera mounted on a telescope can, with a long enough time exposure, enable the more distant stars to be observed. To do this the telescope must be able to track the star accurately for the period of the exposure. Two 24 V synchronous motors are used to enable the telescope to traverse at an accurate speed in either direction.

An important part of astronomy is of course observing stars and other heavenly bodies. Observations can be carried out with the aid of a telescope or even, in some instances, with the naked eye. A vast number of stars still remain unseen however and in order to study them, somehow these (or some of them at least) must be made visible. The method of doing this is to take a photograph of them through a telescope but in order to be any good it must be a time exposure.

Exposure times varying from some minutes or even hours are necessary for the very distant stars to become visible on film and this can cause some problems. During a fairly long exposure the 'position' of the star will change due to the rotation of the earth and the result on the film will not be a dot but a dash.

solar powered receiver



The sky's the limit as far as fuel costs are concerned, like Atlas, we are all finding it increasingly difficult to shoulder the burden. One consolation: when Earth's resources are finally depleted, we will still be able to turn to the Mother of all energy, the sun.

Slowly but surely, solar cells are at last coming down in price, so that one of these days 'sun powered' radios, kitchen equipment, heating systems, etc. are going to be economically viable. Developments in technology have always fascinated hobbyists and scientists alike and readers are invited to participate in an experiment and build a solar powered receiver.

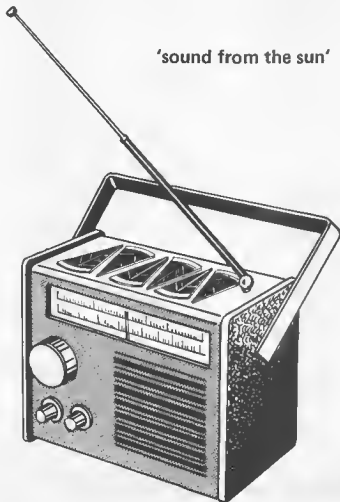

'sound from the sun'

The need to save energy has become a daily part of our lives, not least because of the huge publicity given to it. The media are really going to town and so is the government, what with the advertisement campaigns on television, radio and in the newspapers. The effects are sometimes quite astonishing. The notion 'room temperature', for instance, seems to have dropped to a sub-zero level. People are reluctant to open the curtains in the morning for fear of losing precious warmth.

Contrary to what might be expected, the result is a vicious circle. For now that less energy is being consumed, gas and electricity companies are losing money and are therefore forced to put up their rates. The consumers then react by 'tightening the belt' even further, so that the prices go up again... etc. . . etc.

The fact remains: the world's resources are being exhausted and at an alarming rate. There's only one thing for it, new substitutes will have to be found. One of the main alternatives currently being tried out on a large scale is solar energy. Developments have not yet reached the stage where the 'big' domestic appliances, such as washing machines and central heating systems, can be powered with solar energy, but the 'small' ones can and this also includes radios. The design described here provides a low-cost portable receiver that can be powered with surprisingly few solar cells.

Low power

Solar cells are now readily available in all sorts of shapes and sizes, although the smaller kind tend to be triangular. It is unfortunate that the really effective ones are very expensive. What's more, each cell can only generate about 0.5... 0.6 volts, which must be taken into account when designing a solar powered receiver.

The circuit's current consumption and power supply voltage will therefore both have to be very low.

One design that goes a long way towards meeting these requirements is the medium wave receiver published in March (Elektor 71, p. 3-32). This receiver already has a current consumption low enough for it to be powered with solar energy. Unfortunately, however, the audio amplifier in the circuit requires a rather high supply voltage, which means an awful lot of solar cells would have to be connected in series for it to work!

Let's forget about the audio amplifier for the moment and look at the receiver section. The prospects here are much more favourable. The ZN 414 IC from Ferranti which is at the heart of the receiver fits the bill perfectly. The IC's supply voltage range is between 1.2 and 1.6 volts and only requires 0.3 mA. In other words, two or three tiny solar cells are all that is needed.

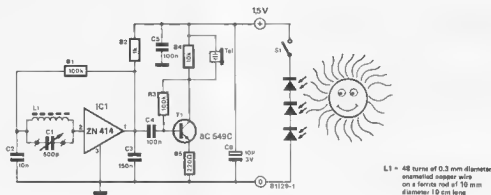

L1 = 48 turns of 0.3 mm diameter enamelled copper wire on a ferrite rod of 10 mm diameter 10 cm long

Figure 1. A solar cell receiver design for beginners. The circuit includes a ZN 414 IC, a single transistor that acts as an audio amplifier and a high impedance crystal ear-phone.

Figure 1 shows a simplified version of the MW receiver which includes an ear-phone. Its current consumption is very low (less than 0.5 mA) and even on an overcast day the circuit provides a reasonable reception using the cheaper kind of solar cells. Provided three cells are used which, when combined together, produce about 1.5...1.6 V, the components may have the values indicated in figure 1. If the output of the cells reaches as high as 0.6 volts each, the third one may be omitted — only then it is advisable to lower the resistance of R2 to 470 Ω. The ear-phons must be high impedance crystal types, as otherwise T1 will be overloaded and the receiver will not function.

As can be seen from figure 1, this MW set needs very few components and yet it leads to a fully 'self-sufficient' radio.

Medium and short wave superhet

Obviously, a set that is run on only two or three solar cells is bound to have a flaw somewhere. You can hardly expect to drive a first-class receiver on a power supply of 1.5 V!

Readers who are prepared to dig a little deeper into their pockets and buy six cells can build a much better design that only requires a supply of 3 volts. The prototype constructed at Elektor did in fact look (and sound!) very promising. The circuit diagram is shown in figure 2. The receiver covers one medium wave band and two short wave bands. The first of the latter extends from 1.7 to 5.1 MHz and includes the popular 'fishermen's' frequency range. The second range is situated between about 5.1 and 15 MHz, and includes the 49 metre band (= at around 6 MHz). The prototype had a sensitivity of about 2 μV.

What kind of receiver is it? Well, basi-

cally, it is an ordinary superheterodyne with a few tricks here and there in the circuit to ensure low power operation with a minimum current consumption. Provided the volume is not turned too high, the whole receiver should not need more than 5 or 6 mA — which could get the circuit mentioned in the Guinness Book of Records!

Now let us take a closer look at figure 2. First of all, the audio amplifier. Regular readers will recognise it to be the 'ulp amp' published in last year's Summer Circuits' issue (circuit no. 55). The amplifier is constructed with ordinary transistors and operates at any supply voltage level between 3 and 12 volts. It will produce about 100 mW maximum power. The design of the output stage, which has no quiescent current adjustment, ensures that current consumption is extremely low (1.5 mA) which makes it eminently suitable for the solar cell power supply.

Now what about the actual receiver section?

The power supply voltage here is stabilised in the circuit around T6...T8. Again, any voltage between 3 and 12 volts may be applied. Transistor T1 amplifies the RF input signal and S2 allows the tuned circuit to be switched from one frequency range to another. The local oscillator is built up around T3 and T4 and can, of course, be switched between the three frequency ranges with the aid of the same switch (S2b). Transistor T2 mixes the oscillator and the input signals, after which the 455 kHz IF signal is filtered by means of a ceramic filter (TokoCFM 2-455 A). The IF signal is then amplified and demodulated inside the ZN 414.

Time to go into a few more details. The RF amplifier T1 is an ordinary amplifier stage which is biased at an unusually low level. There's nothing

extraordinary about the oscillator T3/T4, except that it is not usually included in receivers at this particular spot. The design selected is fairly reliable at the low supply voltage and yet capable of producing a sufficiently powerful oscillator signal. This oscillator has the added advantage that it only requires a single pole switch to select the various frequency ranges. The oscillator coils (L4...L6) do not have taps. The mixing stage T2 and the filters following it are quite straightforward. As for IC1, this was discussed in depth in the article on the MW receiver published in March. Since the IC used, the ZN 414, consumes very little current, there was no need to look for a more economical component. Its automatic gain control, however, has been adapted to suit the more serious nature of the present design. After all, the solar cell receiver needs to be of a much higher quality than its MW counterpart (which, remember, was meant to teach budding electronics enthusiasts how to build their first radiol) and the straightforward version shown in figure 1.

Normally speaking, the AGC's range would only be about 20 dB which is certainly not enough for a good receiver. This is remedied by deriving an additional control voltage from the output of IC1 by way of D1, R44 and R45, as a result of which T5 will be 'cut off', that is to say, it will stop conducting, in the presence of powerful signals. Thanks to this modification the AGC now has a very reasonable range of about 50 dB.

All in all, the circuit is very cost-effective and although it looks rather complicated at first it should be easy enough to build. The only really expensive items are of course the solar cells, but rumour has it that in the near future these too will be available at a much lower cost.

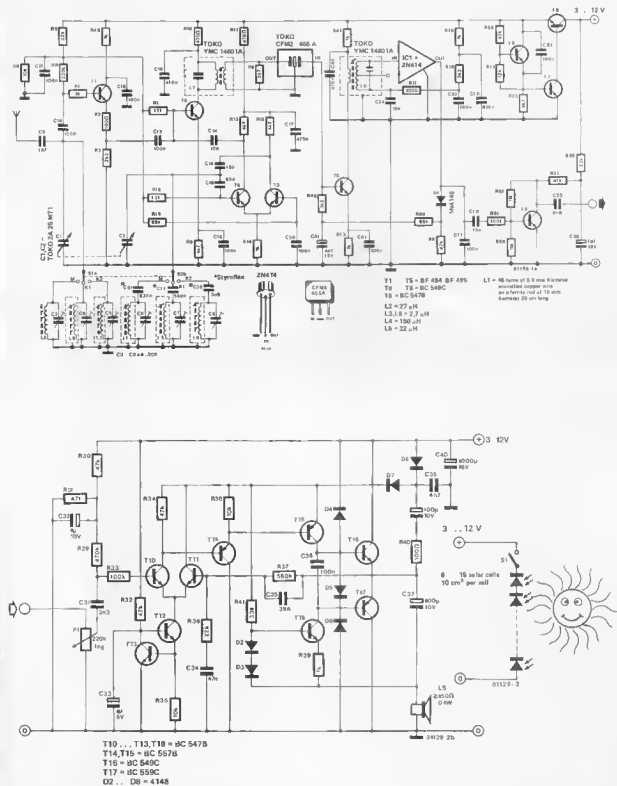

Figure 2. A sophisticated triple wave band receiver which can be powered with solar cells. In spite of the large number of transistors used, current consumption will only be about 5 mA.



the mini organ

musical fun and games
on a single chip

1

Building an electronic organ from scratch can be a tedious and expensive business costing anything over £ 200 and several weeks of hard work. Now for the good news: this particular organ incorporates all the electronics needed on a single compact board and can be built in a matter of hours. Thanks to ITT's special 'organ IC', the mini organ is highly economical and provides a remarkably good performance (that is, as long as the organist isn't 'all thumbs'!). Fun for everyone . . . at the price of a single chip.

ITT recently introduced the highly interesting SAA 1900 IC which, the company claims, is the 'key' to a complete organ. The data sheets, however, are a little ambiguous about the chip's possibilities. On the one hand, they provide a great many fascinating technical specifications, but on the other hand, they modestly christen their brainchild a 'One Chip Toy Organ IC'. This article intends to discover whether the IC is in fact just another 'toy', or whether it can be recommended for serious musical instruments as well. And the best way to find out is, of course, to get hold of such an IC and test it.

As readers can gather from the heading, the test not only proved successful, our designers had so much fun that the IC was up-graded from 'Toy Organ' to 'Mini Organ'!

The SAA 1900

The IC includes a keyboard scanning facility. This scans the 56 single key contacts, 37 of which belong to the 'solo' keyboard and 19 of which constitute the 'accompaniment' manual. It is fully polyphonic with separate outputs for CHORD and BASS. These are controlled by the accompaniment section. In addition, there are two separate voice

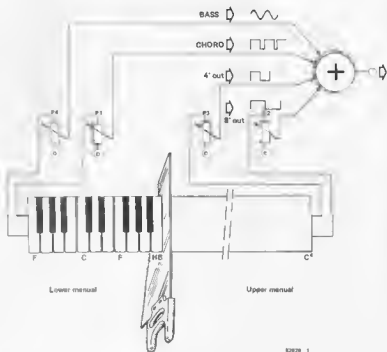

12020 1

Figure 1. The SAA 1900 IC produces four separate LF output signals which are mixed at the output. A signal will only be available at the BASS and CHORD outputs, provided one (or several) of the lower 19 keys is (are) depressed. The "4' out" and "B' out" outputs can only be modulated by the remaining keys. The BASS output is monophonic: only the lowest note of a chord is heard.

pin 11). The Elektor printed circuit board is however designed to cater for the first version, as this is the one most frequently used.

The bass note, which is derived directly from the IC's output is full of harmonics and, with the aid of a low-pass filter consisting of a resistor and a capacitor (R26/C13) connected in front of a summing amplifier (figure 2), its sound is enhanced with the rich resonance that is characteristic of an organ.

The upper manual has two voices. The sound produced by this keyboard is made up of two square wave signals which each have a separate volume control and differ by one octave in frequency. It is a pity ITT did not add a third or even a fourth square wave signal at one octave higher, as this would have given the IC a really professional touch. Actually, it does not really matter, for when the two square wave outputs are mixed, the solo manual produces a very satisfactory sound. Sub-octaves can be produced by divide-by-two's, provided only one key is struck at a time. If several keys are depressed simultaneously, the corresponding signals will be mixed inside the ICs and will appear in a mixed form at pins 21 and 22

The circuit diagram

Using the external components shown in figure 2, the Organ IC can be mounted on a very compact printed circuit board.

3

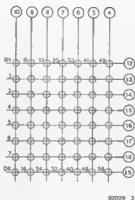

Figure 3. The structure of the keyboard matrix. Only 15 wire connections (to the corresponding 56 pins on the IC) are required for 56 keys to be scanned.

4



Figure 4. Every junction in the matrix shown in figure 3 consists of a diode and a key

5

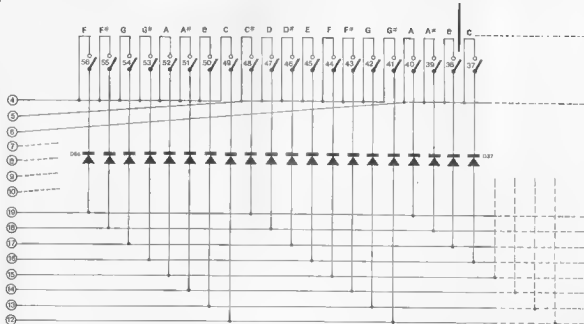

Figure 5. The wire connections for the keyboard: every matrix row contains 8 key contacts, which together lead to connections 4...10 on the printed circuit board. Each contact end a second link with a diode on the corresponding matrix column track. The links are connected to points 12...19.

The IC does not include a clock oscillator so that this will have to be added. The economical 74123 TTL IC serves the purpose admirably

The two transistors T1 and T2 constitute a phase-shift generator. This produces a low-frequency sine wave signal in order to frequency-modulate the oscillator. The result is a slight vibrato, which is exactly what an organ should have.

P6 and P7 adjust the vibrato's amplitude and frequency, respectively. Provided the two potentiometers are both trimmers (as indicated on the board), the vibrato effect can be switched on and off by means of S1. By mounting P6 and P7 on the front panel, the frequency and the amplitude can be regulated continuously. In fact, the amplitude can be turned down to zero, so that S1 may even be omitted here

P5 serves to alter the entire voice range. When the wiper of P5 is set in the mid position, the oscillator frequency should be 500 kHz. This value must be maintained, as the scanner matrix tends to act rather 'strangely' at higher frequencies.

If any component tolerances should prevent P5 from adjusting the frequency into the desired range, the easiest way to alter the frequency is to select two equal capacitor values for C1 and C2. The clock frequency's precision can best be checked with the aid of either an oscilloscope or a frequency counter.

In order to set the organ's range to that of other instruments, P5 may be re-

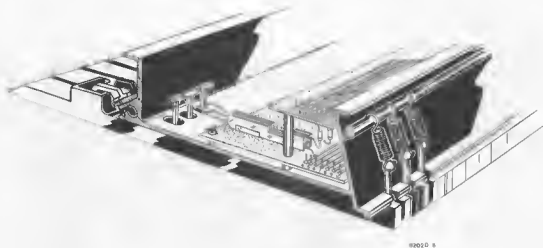

Figure 6. The keyboard's mechanical structure. Pieces of Veroboard are ideal for wiring the keyboard. Together with a plastic cover and the contact blocks, the Veroboard pieces are glued to the keyboard frame.

placed by a potentiometer on the front panel. Pins 2, 21...23 of the SAA 1900 represent the signal outputs which are connected to the output (link F) by way of a mixing stage (P1...P4 and IC3). The latter consists of an inverting opamp in a well-known adder circuit. The bass signal (pin 2) is then sent through a low-pass filter before reaching the input of IC3. Outputs A...E enable the organ to be extended, if necessary, at a later date and are therefore not connected.

The keyboard matrix

The scanner matrix shown in figure 3 is connected to pins 4...10 and 12...19, as indicated in the IC's pin assignment. Each one of the 56 junctions in the matrix is made up with a keyboard contact and a diode (see figure 4). A special control circuit inside IC1 scans every junction 'row by row', one after the other, until the key that was depressed is detected. In other words, instead of 7 x 8, only 7 + 8 contacts are required.

Note: In the matrix shown in figure 3, the lowest note (the first key at the far left of the keyboard) corresponds to contact number 56. This is situated in the lower right-hand corner, not in the upper left-hand corner, of the figure. To make things clearer: contact numbers 56 and 1 are assigned to the lowest and the highest notes, respectively. As long as the contacts are wired in the manner shown in figure 3 and every matrix point is linked in the manner indicated in figure 4, nothing can go wrong.

It is not advisable to construct a matrix on the basis of wire and copper track

junctions and then connect each one to a key. In practice, the simplest way to construct a matrix is shown in figure 5. This enables the 56 diodes to be incorporated on the keyboard as well. The contacts may not be interconnected. It is best to glue each contact block onto a perspex, plastic or pertinax surface. As far as mounting the diodes is concerned, several pieces of Veroboard should be cut into strips and glued behind the contact blocks, with the copper tracking pattern side facing upwards. The 15-wire connection between the keyboard and the printed circuit board is made by using two (7 + 8) pieces of flat cable (see figure 6).

The power supply and the amplifier

The organ circuit requires a total of five different power voltages: +15 V, -5 V, -15 V, -18 V and finally a non-stabilised voltage of about -23.5 V. Two integrated voltage controllers (IC4 and IC5) are already included on the organ printed circuit board. These produce -15 V and -5 V respectively. The remaining voltages (-23.5 V, -18 V and +15 V) have to be connected to the organ board. The need for a suitable power supply is met by the circuit in figure 7. This is in fact a dual power supply and produces +15 V and -18 V

7

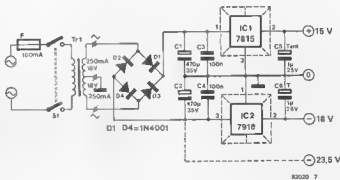

Figure 7. The power supply circuit. The use of a 250 mA transformer enables additional circuits to be powered with up to 150 mA of current as well as the organ board itself. The actual 'organ board' contains the circuit shown in figure 2.

8

Parts list for the board in figure 8

Resistors:

R1, R2 = 2k2
 R3, R5, R14 = 1 k
 R4, R12 = 4k7
 R6, R10 = 470 Ω
 R7 = 33 k
 R8, R9, R13, R31 = 10 k
 R11 = 15 k
 R15 ... R20 = 47 k
 R21 ... R27 = 22 k
 R28 = 680 k
 R29 = 330 k
 R30 = 18 k
 P1 ... P4 = 100 k log.
 P5 = 1 k trimmer
 P6 = 2k2 trimmer
 P7 = 4k7 trimmer
 P8 = 25 k trimmer
 P9, P10 = 5 k trimmer

Capacitors:

C1, C2 = 330 p
 C3, C15 = 100 n
 C4, C5, C6 = 10 μ /16 V
 C7, C8, C9 = 4 μ /16 V
 C10 = 470 μ /6.3 V
 C11 ... C14, C16 = 330 n
 C17 = 1 μ /25 V tantalum

Semiconductors:

T1, T2 = 8C 5478
 IC1 = SAA 1900
 IC2 = 74123
 IC3 = 741
 IC4 = 79L05
 IC5 = 7915

Miscellaneous:

S1 = sp switch
 S2 = sp toggle switch

Keyboard:

1 contact per key, totals 56 keys
 and 56 1N4148 diodes

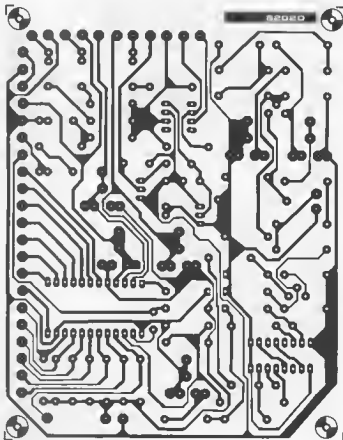

Figure 8. Since all the essential organ functions are already integrated inside the SAA 1900 IC, the printed circuit board is remarkably compact. Outputs A ... E can be used for further extension purposes later on.

9

Parts list for the power supply in figure 9

Capacitors:

C1, C2 = 470 μ /35 V
 C3, C4 = 100 n
 C5, C6 = 1 μ /25 V tantalum

Semiconductors:

D1 ... D4 = 1N4001
 IC1 = 7815
 IC2 = 7918

Miscellaneous:

Tr1 = 2 x 18 V/250 mA mains transformer
 S1 = dp mains switch
 F1 = 100 mA slow fuse



Figure 9. The power supply board for the circuit in figure 7. The wire link situated next to D4 provides the connection for the unbalanced -23.5 V voltage.

with the aid of two voltage regulators. In addition, the required non-stabilised 23.5 V voltage can be derived at the negative pole of the electrolytic capacitor C2. This is done quite easily, since the wire bridge to the right of D4 on the board in figure 9 provides a suitable connection point.

Obviously, the organ's tones, however resonant, will be inaudible without the addition of a miniature amplifier and a loudspeaker. The LF output of the organ (point F) can be connected to any HiFi or PA amplifier. With the aid of P8...P10 the volume at all the IC's outputs (except for the bass signal) can be be adjusted once the board is constructed. Furthermore, the opamp's feedback resistor (R20) can be altered in value to match the signal level to the amplifier. (A higher value will cause the volume to be turned up, whereas a lower one will turn it down.)

The keyboard

A great many keyboards are available at an even greater variety of prices. Since an easy-to-play keyboard involves a considerable amount of precision, both with respect to the keys and to the contact blocks, it is bound to be one of the most expensive items in the instrument. How much it costs to build the organ will therefore depend on the price of the keyboard.

The sound

The prototype produced a remarkably convincing sound, which did away completely with our initial scepticism (evoked by the IC's size!). After hearing the first few notes, it was quite obvious that the organ isn't just another toy, but an "adult" instrument. When it is combined with a monophonic synthesiser, the accompaniment can be played on the organ with the left hand while the right hand plays the melody on the synthesiser keyboard. **M**

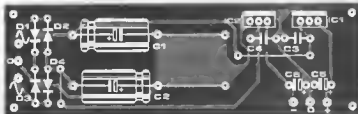
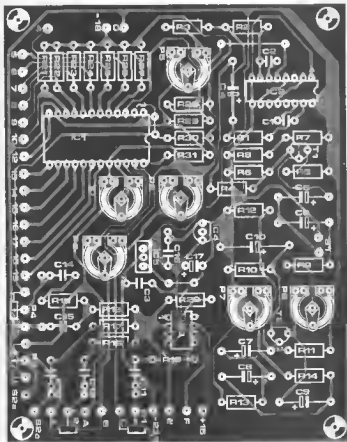
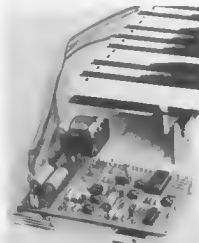

telephone amplifier

makes distant callers loud and clear

'Keeping in touch' is easier said than done, despite the modern telephone networks that stretch to the four corners of the globe. For one thing, a pound for a minute seems a lot of money to hear Granny's faint voice ten thousand miles away and then not understand a word she's saying. Elektor has come up with a solution in the form of an amplifier which, when connected to the telephone, enables the whole family to listen in to the conversation.

Some callers, of course, don't need amplifying, as anyone blessed with an old aunt who bellows hearty greetings down one's ear at eight o'clock on a Sunday morning will agree. Here an attenuator would be more appropriate! But then that is an exception. Distant and sometimes even local lines can be very poor indeed, so that an amplifier is really practical. For instance, when relatives ring up from South Africa, say, or Australia, it would be much more economical if the whole family could listen instead of having to 'queue up' to say a few costly words. What's more, the amplifier drowns any interference caused by crossed lines and thousands of 'clicking' relays, so that the once distant voice sounds as loud and clear as if the person were sitting in the same room.

Now that we know what the amplifier is for, we can study the circuit diagram in figure 1. Looking at the drawing from left to right, the circuit starts with a pick-up coil, the centre contains an amplifier and at the other end there is the loudspeaker. The pick-up coil operates according to magnetic principles: any alteration in the magnetic field that is radiated by wires in the telephone set or in the receiver will be fed to the amplifier. This slightly roundabout system is necessary, since a direct electrical connection to the interior of a telephone is forbidden.

The rest of the circuit diagram in figure 1 comprises very few components. L1 represents the telephone pick-up coil



1

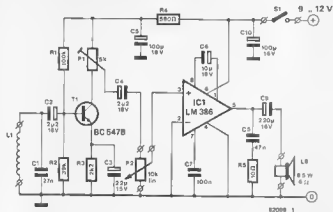

Figure 1. The circuit diagram of the telephone amplifier.

Parts list

C5, C10 = 100 µF/16 V

C6 = 10 µF/16 V

C7 = 100 n

C8 = 47 n

C9 = 220 µF/16 V

Resistors

R1 = 100 k

R2 = 39 k

R3 = 2k2

R4 = 680 Ω

R5 = 10 Ω

P1 = 4k7 (5 k) preset

P2 = 10 k linear

Semiconductors:

T1 = BC 547B

IC1 = LM 386

Capacitors

C1 = 27 n

C2, C4 = 2µ2/16 V

C3 = 22 µF/16 V

Miscellaneous

L1 = telephone pick-up coil

LS = 8 Ω/½ W miniature loudspeaker

S1 = on/off switch

which is specifically designed for this type of application. A very low AC voltage is induced across the coil and this is amplified by transistor T1 and the amplifier IC1 and then fed to the loudspeaker.

There are two ways in which the volume can be adjusted: either by using P1 to set the threshold value or by means of the volume control P2.

A printed circuit board has been designed for the telephone amplifier, the details of which are shown in figure 2. Using a miniature Japanese loudspeaker and a 9V PP11 battery, the whole circuit will easily fit into a plastic case of roughly 120 x 65 x 40 mm. A mains power supply may also be used, provided the supply voltage is very well stabilised, as otherwise there could be some mains hum.

The construction is very straightforward indeed and so we can proceed with the setting-up, which primarily involves L1 and P1. First of all, the best position for the pick-up coil has to be found. Ideally speaking, this is underneath the telephone, but this would mean having to raise the phone a little, since the coil is about 3 centimetres high. Another solution is to fit L1 onto the side of the telephone so that it is close to the amplifier. Readers should decide for themselves what the best practical solution is.

Now for the preset P1. This adjusts the maximum volume. Above a certain level, the sound reaching the amplifier input will be so loud that acoustic feedback ('howl round') will occur. This is a kind of echo that has got out of hand and produces a high-pitched tone. After setting P2 to maximum, P1 is adjusted so that this just does not occur. It would of course be feasible to omit all the components to the right of P2 and use HiFi equipment to reproduce the caller's voice, but then, that is up to the reader.

2

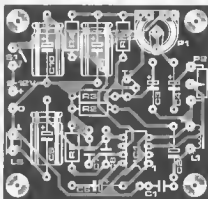
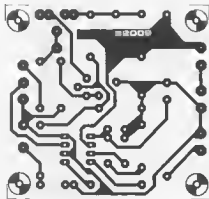

Figure 2. The printed circuit board track pattern and component layout for the telephone amplifier.

sine-wave oscillator

very low distortion

L. Boullart

Nowadays, an entire function generator can be constructed from a few simple ICs. When measuring low-frequency equipment, such as audio amplifiers, it is highly desirable to use a low distortion, reliable sine-wave generator.

This particular design is not at all complicated as far as construction is concerned and yet it boasts a distortion level of only 0,01%! Its frequency range extends from 10 Hz up to an inaudible 100 kHz and is very simple to operate.

Where modern HiFi equipment — especially the home-constructed kind — is concerned, accurate measurements are almost impossible to carry out. Although frequency characteristics and square-wave signals can be checked, there is little that can be done towards measuring the actual distortion level, that is, assuming the unit is properly built and the amplifier is working correctly. Fortunately, most up-to-date designs are so good, that the distortion level will be negligible. In any case, it is hardly worth buying an expensive oscillator with an extremely low distortion factor and a first-class distortion meter to carry out one or two measurements.

An oscillator can be built in a number of different ways, each particular design having certain advantages and disadvantages. For low-frequency measurements, where the frequency needs to be varied, it is best to use a 'Wien bridge oscillator'. This type of circuit provides low distortion and allows the frequency to be changed fairly easily with the aid of a stereo potentiometer or a dual-ganged capacitor. The design described here is quite compact and straightforward, but nevertheless it is eminently suitable for measuring frequency characteristics and distortion levels. In addition, a Schmitt-trigger has been included in the

circuit to provide square-wave output signals.

The oscillator circuit

Although most readers will probably know how an oscillator containing a Wien network works and have reference books in which they can look it up, it might not be a bad idea to go into the matter here.

Figure 1a shows a network of two resistors and two capacitors. This constitutes the frequency-determining section of the Wien oscillator. If the transfer function is calculated as U_1/U_0 , the result will show that there is only one frequency with no phase shift between U_1 and U_0 . This will be at the frequency: $F = 1/(2\pi RC)$. At this frequency the ratio of U_1 to U_0 will be exactly 1:3. If the U_1 voltage is amplified by a factor of three and then fed back to U_0 , as drawn in figure 1b, a perfect oscillator is obtained (since the U_1 and U_0 signals are in phase at that particular frequency). Unfortunately, however, there aren't any opamps available with a manufactured gain of three. As figure 1c shows, this does not matter, as the solution is to connect the RC network between the non-inverting input and the output of an ordinary opamp. A voltage divider (R_1, R_2) is

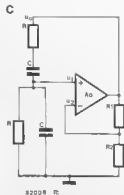
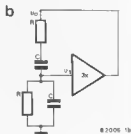
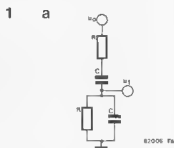

Figure 1. This drawing shows how a Wien bridge can be used to create an oscillator. The voltages U_1 and U_0 will only be in phase for one particular frequency, where U_1 is but $1/3$ of U_0 . By amplifying the voltage U_1 by a factor of three and feeding it back to U_0 , an oscillator can be obtained.

connected to the inverting input of the opamp. The $R1/R2$ ratio is calculated twice, so that the amplification factor will be:

$$A_U = \frac{R1 + R2}{R2} = \frac{2 \cdot R2 + R2}{R2} = 3.$$

There will now be a sinewave signal at the output of the opamp with a frequency based on the formulae provided above. In practice, the amplification factor of three is rather critical, since it is very difficult to maintain both at the opamp side and at the RC network side. If the amplification slightly exceeds a factor of three, the amplifier's output will produce an everincreasing output signal until this is limited by the supply voltage. The opamp will then produce a squarewave. If, on the other hand, the amplification factor drops slightly the oscillator will either stop operating or simply not start in the first place. Then no output signal will be produced at all. Obviously, some sort of control system is needed to adapt the gain so that the circuit oscillates, without affecting the supply voltage. Only then will the output be able to produce a symmetrical sinewave signal.

Usually, such a control system can be set up by choosing a temperature-dependent resistor for either $R1$ or $R2$. When the output voltage increases, the

current passing through the temperature-dependent resistor will also rise, causing its resistance to be altered. As a result, the opamp's amplification will be reduced. If, however, the output voltage drops, less current will pass through the feed-back resistors and so the resistance will change causing the gain to be increased. This method leads to an equilibrium, where the output voltage is constant.

The circuit diagram

Figure 2 shows the circuit diagram for the sinewave oscillator. It looks quite different from the block diagram in figure 1. The opamp here is discrete in structure and consists of transistors $T1 \dots T4$. The input stage is formed by a cascode circuit containing a bipolar transistor ($T1$) and a FET ($T2$). In order to obtain a considerable open loop gain, a Darlington transistor was chosen for $T3$. By means of the current source formed by $T4$, the collector is linked to the negative supply voltage.

The bridge section comprising the resistors and capacitors is connected between the collector of $T3$ and the base of $T1$. Use has been made of a stereo potentiometer with a logarithmic characteristic to regulate the frequency

continuously. Switch $S1$ acts as a range switch and provides other capacitor values. The four positions provide an overall frequency range of 10 Hz ... 100 kHz, which amply serves most audio purposes.

The amplitude is stabilised with the NTC resistor $R19$. The type chosen has a resistance of 1k Ω at 25°C. This produces an output amplitude of about 1.5 VRMS. It is very important to use the right type of NTC here, for if the wrong one is used the distortion level will rise alarmingly. The one used here is housed in a glass package with a maximum power dissipation of 20 mW. The letter is vital, as current passing through the NTC has to heat it.

The output signal is fed to $P3$ by way of $C13$ and preset $P2$ (which presets the maximum output voltage). This output level control is followed by an attenuator which has been drawn separately.

Switching $S2$ connects a Schmitt-trigger in series with the output lead, so that squarewave signals are also available.

The Schmitt-trigger consists of transistors $T5 \dots T7$ and the associated components. As readers can see, the circuit has a standard structure and could have been copied straight out of a text book. However, the square wave signals it produces are of a high enough quality

2

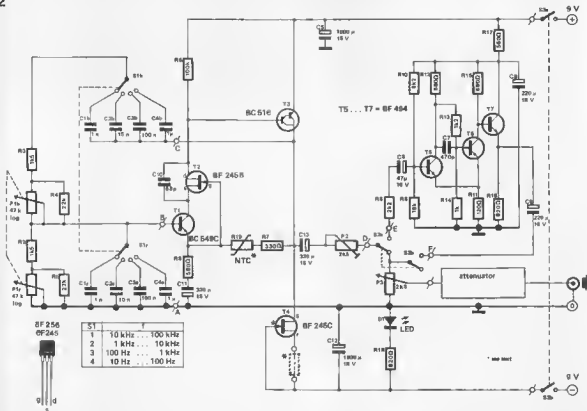
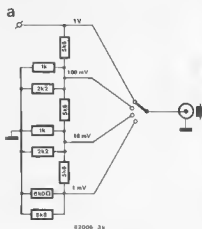

Figure 2. The circuit diagram of the sine-wave oscillator. On the right-hand side a Schmitt-trigger is shown which generates square wave signals. The attenuator is shown in figure 3.

3



b

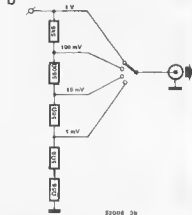

Figure 3. Two different ways in which to build an attenuator. The first version has a constant output impedance of $565\ \Omega$ (except when it is set at 1 V), whereas the second has a variable output impedance. The latter version is much more straightforward.

for odio purposes. The only disadvantage involved in the circuit, is that the mark/space ratio is somewhat dependent on supply voltage, although this is really of minor importance in this particular application.

Figure 3 shows two attenuator circuits. Usually signal generators feature an output impedance of $600\ \Omega$. The same can be done here by using the attenuator in figure 3e. In order to obtain an output impedance of exactly $600\ \Omega$ for every stage, the resistors will have to have rather "odd" values. If, on the other hand, a slightly irregular output impedance is acceptable, the standard values indicated in the circuit diagram will do. The output impedance will be around $565\ \Omega$. It is only at the highest output level that the impedance will be altered between $0 \dots 5\ k$ (depending on

4

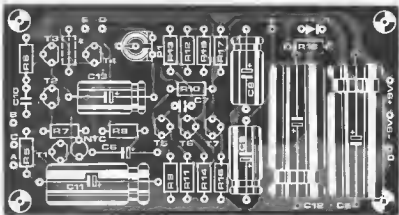
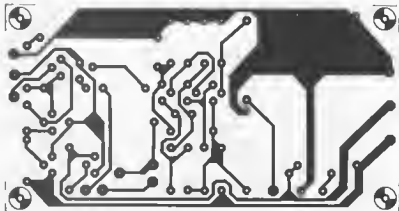

Figure 4. The printed circuit board and the component overlay for the sine wave oscillator circuit. Some of the resistors and capacitors shown in figure 2 are soldered directly to the various potentiometers and switches.

the position of P2 and P3). Provided readers do not require on a standardised output impedance, they can use the attenuator in figure 3b. The output impedance will then of course no longer be constant, but in most cases this does not really matter.

Finally, we still have to mention the LED D1 with its series resistor. This indicates when the oscillator is activated. At the same time, the LED ensures that the circuit's current consumption is equal for both the positive and the negative supply if it is battery-powered. (The current consumption of the LED has been chosen to be the same as that of the Schmitt-trigger circuit.)

Construction and calibration

The easy way out is, of course, to buy

the board end the parts from your local retailer, solder the lot together and Bob's your oscillator. The device will indeed oscillate, but don't be surprised if it turns out to have a considerable distortion factor. Obviously, a little bit more is required. To start with, R5...R7 should be metal foil types having a 1% tolerance. The stereo potentiometer P1 needs to be a good tracking type. Capacitors C1...C4 should also be 1% types, if available. This is not absolutely essential, but it does lead to an accurate scale division for every range. T1 must be a low-noise transistor. Nowadays, various Japanese transistors have an ever lower noise factor than the types mentioned in the parts list. A good example is the 2SC2546, but unfortunately this type is not yet readily available. In addition,

Parts list

Resistors:

R1, R4 = 22 k
 R2, R3 = 1k5
 R5 = 560 Ω
 R6 = 100 k
 R7 = 330 Ω
 R8 = 2k2
 R9 = 18 k
 R10 = 8k2
 R11 = 120 Ω
 R12, R15 = 680 Ω
 R13 = 1k2
 R14 = 1 k
 R16, R18 = 820 Ω
 R17 = 560 Ω
 R19 = NTC 1k5 at 25°C Philips
 type 2322 31152
 P1 = 47 k log stereo
 P2 = 2k5 preset
 P3 = 2k5 potentiometer

Capacitors

C1a, C1b = 1 n
 C2a, C2b = 10 n
 C3a, C3b = 100 n
 C4a, C4b = 1 μ (not an electrolytic type)
 C5, C12 = 1000 μ /16 V
 C6 = 47 μ /16 V
 C7 = 470 p
 C8, C9, C13 = 220 μ /16 V
 C10 = 68 p
 C11 = 330 μ /16 V

Semiconductors.

D1 = LED
 T1 = 8C549C, 8C550C
 T2 = 8F2458, 8F256B
 T3 = 8C516
 T4 = 8F246C
 T5, T6, T7 = 8F434

Miscellaneous

S1 = double pole, 4 position wiper switch
 S2 = double pole toggle switch
 S3 = double pole switch

the voltage at T2 will have to be measured once the circuit has been constructed. This transistor should be a type that has a drain current of 12 μ A at a gate-source voltage of -3 V (we will come back to this later). For this reason, it might be a good idea to place a transistor socket in this position on the board first.

To get back to building the circuit, part of it is not mounted on the board. This includes the frequency-determining network at the circuit input (everything required for connections A...C) and the switch S2 together with potentiometer P3 and the attenuator.

In the input circuit the capacitors are soldered directly to switch S1 and likewise the resistors R1...R4 to the stereo potentiometer. This section is then connected to the board by means

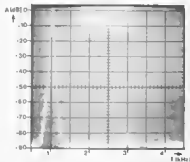

Photo 1. Shown on a spectrum analyser are the oscillator's distortion residues at a frequency of 1 kHz. The first large peak represents the 1 kHz signal. The first even harmonics are at a level of -85 dB with respect to the 1 kHz signal, or rather at 0.006%. The first odd harmonics contribute 0.01% (-80 dB).

of three wires, after the rest of the components have been mounted. Points D...F are then linked to switch S2 and potentiometer P3 is wired. Finally, the resistors belonging to the attenuator are mounted straight onto the switch. Then the supply voltage has to be connected up by way of switch S3.

The power supply may be a straightforward mains type, consisting of a small transformer, a bridge rectifier, one or two electrolytic capacitors and two voltage regulators similar to those published previously in Elektor. Current consumption will be about 23 mA.

Seeing as the current consumption is so low, the circuit may also be battery-powered. Using four 'flat' 4.5 V batteries, the lifespan during intermittent use will be a reliable 100...200 hours. Figure 4 shows the printed circuit board for the sine-wave oscillator. A resistor is indicated by way of a dotted line next to transistor T3. Once the entire circuit has been built, in the manner described above, a multimeter is connected between the two connections of the dotted resistor and the meter is switched to current measurement (DCI). After the supply voltage has been switched on, the current measured should be about 15 mA. If it is any higher than this, a resistor should be connected in series with the meter and have a value that makes the meter indicate 15 mA. Depending on the result, the resistor or, if not required, a wire link, is soldered onto the board.

The voltage is then measured at T2. Initially this is measured between the source and the gate and then the meter is switched to current measurement and connected to the drain. Several transistors of either the 8F2458 or 8F256B type should be experimented with and the one that comes closest to meeting the $V_{GS} = -3V$ and $I_d = 12 \mu A$ require-

ment is soldered onto the board. After this the output voltage can be measured. This is usually around 1.5 V_{RMS} (measured at the junction of R7 and C13). If necessary, the output voltage can be altered slightly by choosing another value for R7. Once this has been done, P2 is adjusted so that the output voltage at the wiper of P3 is exactly 1 V_{RMS} when the latter is turned fully clockwise. The attenuator can then be used to select a lower output voltage, 100 mV, 10 mV or 1 mV, which can also be attenuated with the aid of the potentiometer.

If the squarewave signal observed on an oscilloscope screen looks slightly asymmetrical, the solution is to alter the value of R8. Finally a word of advice: the output amplitude can be kept at a constant level by covering the NTC with a layer of insulating material, such as foam rubber.

Easier said than done...

This circuit is a perfect example of how an affective device can be built without the need for a lot of ICs or other fancy components. All that the enthusiast has to do is think carefully and decide what the circuit is to achieve and then select the best possible components. The result is a compact design with excellent features. That is exactly how the designer created the prototype which has a distortion level of 0.01% at 1 kHz. The designer even maintains that distortion levels as low as 0.0014% at 1 kHz is possible! The frequency range covers 10 Hz...100 kHz within 0.15 dB. These are very satisfactory results by any standards. If such a circuit still is not capable of testing a particular audio amplifier, the amplifier must be of such a high quality that there isn't any point in measuring anything anyway! M

part two

teletext

decoder

... that does not require modifications to the TV set

After the detailed introduction to Teletext given last month, this article deals with the practical side of the project. To keep the whole thing within manageable limits, the circuit description will be as brief as possible. This leaves room to pay closer attention to three important aspects: modifying a TV set if the decoder is to be built in; calibration procedures; and, last but not least, the instructions for use.

This article concerns the Teletext decoder and the circuit-diagram for it is shown in figure 1. This is a repeat of figure 13 in part 1, so many readers may already be familiar with it. The function of the various LSI chips have already been discussed in part one, therefore the operation of this part of circuit should be fairly clear, at least in the main outlines.

The ICs 5 through 9 form the external address counter and page memory (see SAA 5020 of part 1). The remaining part is the control which is clearly separated from the decoder in the circuit-diagram. There are only three connections between the decoder and the command/control section, since IC2 can only be given orders in serial form. This procedure saves IC pins.

Control (handling)

The layout of the command section is again divided into two parts (see figure 2). In fact, the real control is carried out by the keyboard with its encoder consisting of IC17, IC18 and IC19. The remaining ICs (IC11 ... IC16) convert the parallel information of the keyboard, which is available at points C, D, E, F, G and H, into a synchronous serial

2

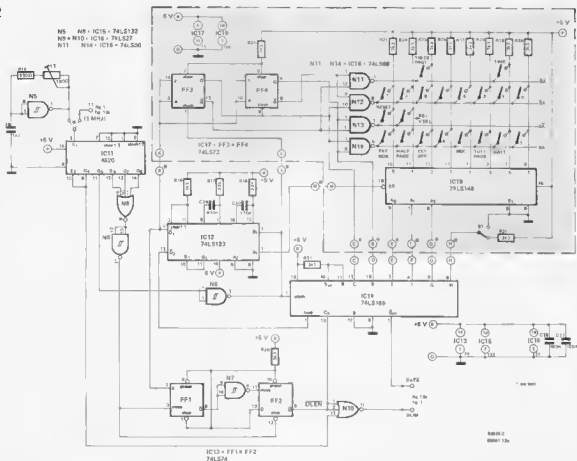

Figure 2. The control section of the decoder. The shaded part of the circuit is placed on a separate printed circuit board.

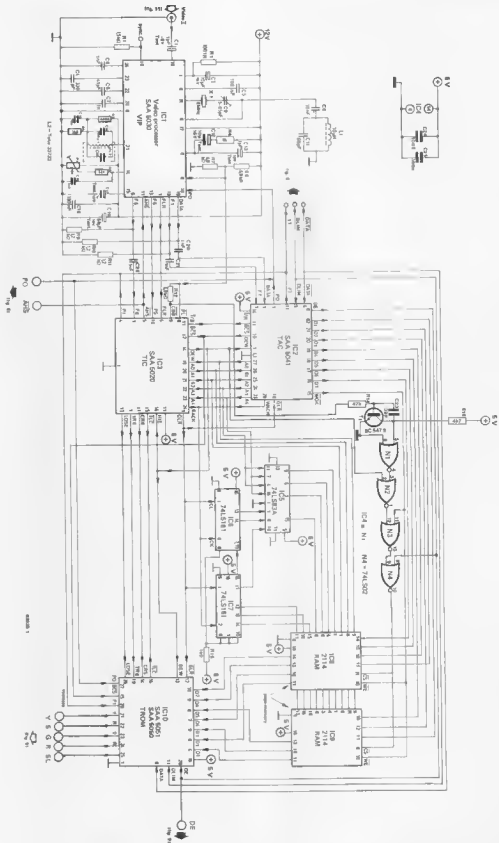

Figure 1. The circuit diagram of the decoder section. Note that this drawing differs slightly from the basic circuit given as figure 13a in part 1.

3

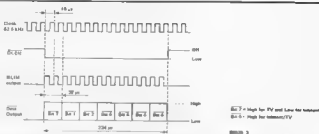

Figure 3. The parallel code of the keyboard output must be converted to serial information. The pulse diagrams in this figure indicate how this conversion is performed.

output. In this context synchronous means that the clock-signal necessary for decoding the serial signal is also transmitted. Figure 3 shows how the keyboard code is supplied serially to IC2 (SAA 5041). The DLIM-signal is derived from a 62.5 kHz clock-signal, which in its turn is produced by dividing a 1 MHz-signal. This can either be derived from the keyboard itself or from IC3 (see figure 1). Figure 1 indicates that the signal from IC3 is derived from the 6 MHz oscillator (crystal controlled)

Parts list Teletext decoder board

Resistors:

R1, R5 = 1k5
 R2 = 100 k
 R3 = 680 Ω
 R4, R15 = 1 k
 R6, R7, R12 = 6k8
 R8 = 33 k
 R9 . . . R11 = 1k2
 R13 = 4k7
 R14 = 47 k
 R16 = 330 Ω
 R17, R18 = 22 k
 R19 . . . R21 = 3k3
 P1 = 10 k-presat
 P2 = 250 Ω -presat

Capacitors.

C1, C13, C17 = 1 μ /16 V Tantalum
 C2, C7 = 1 n
 C3, C12 = 10 μ /16 V Tantalum
 C4 = 330 p
 C5, C18, C24 . . . C27 = 100 n
 C6 = 47 p
 C7, C20 . . . C22 = 1 n
 C8, C10 = 10 n
 C9 = 5 . . . 65-p-Trimmer
 C11 = 68 p
 C14 = 100 p
 C16 = 3n3
 C19 = 68 μ /16 V printed C mounting
 C23 = 39 p
 C28 = 2n2
 C29, C30 = 470 n

Semiconductors

T1 = 8C 547B
 IC1 = SAA 5030 VIP
 IC2 = SAA 5041 TAC
 IC3 = SAA 5020 TIC
 IC4 = 74LS02
 IC5 = 74LS83A
 IC6, IC7 = 74LS161
 IC8, IC9 = 2114 RAM
 IC10 = SAA 5050 TROM
 IC11 = 4520
 IC12 = 74LS123
 IC13 = 74LS74
 IC14 = 74LS165
 IC15 = 74LS132
 IC16 = 74LS27

Miscellaneous

L1 = 10 μ H
 L2 = 33733 (TOKO)

4

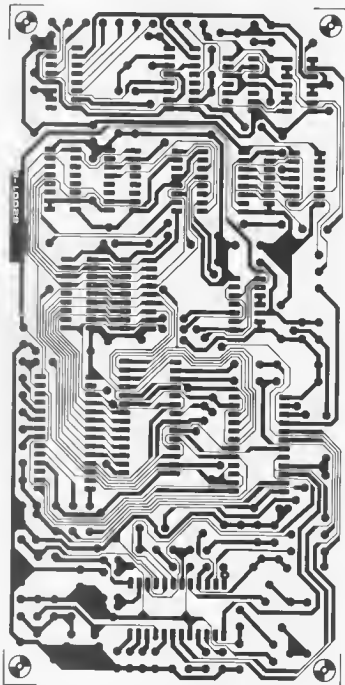

Figure 4. The printed circuit board layout for the Teletext decoder. The indicated connection points must be linked to the corresponding points on the other boards.

of IC1. So using F1 has the advantage that the transmission speed of the command switch (DATA and DLIM) does not have to be trimmed. In order to make testing of the keyboard possible without the aid of the Teletext decoder, the oscillator can be built around N5. The keyboard is only a local control for the Teletext decoder so far. Control over a greater distance using remote control is possible, but a completed design is not available yet, although preparations have been made. The

separation between the keyboard encoder and the parallel series converter has already been carried out on the printed circuit boards. The keyboard code is fed to the parallel series converter via nine connections. In this way a selecting circuit can be added, which makes it possible to choose between local and remote control.

The converter section is combined with the Teletext decoder in order to make it easier to separate the units, as described above. This means that the key-

board printed circuit board only contains IC17, IC18 and IC19, which will simplify the installation of this board in the front of a case. The keyboard may be used at a distance of up to one metre from the decoder board. To avoid problems with interference inherent with longer distances, buffers must be added (at the transmitting as well as the receiving end).

Boards 1 and 2

Figures 1 and 2 give the complete circuit of a Teletext decoder that is suitable for building into a TV set. Figures 4 and 5 show the corresponding printed circuit boards. Only the shaded part of figure 2 is shown on board 2 (figure 5). All the keyboard connections are brought out together in the form of an 11 way ribbon cable between the keyboard and the decoder. With only a few exceptions, the same is true for the connections to the video circuit board (to be described next month).

All boards are 10 cm in width and the length of the decoder board is 20 cm. This enables the keyboard and video circuit boards to be placed beside each other, near the decoder, allowing the connections between them to be kept short.

Modification of the TV set

Although the decoder was not originally intended to be fitted into the TV set we will pass on a few hints for readers who wish to do so.

Only very rarely can the video signal in a TV set be interrupted. Even sets with a video recorder connection socket aren't satisfactory in this case, since they provide an input or output for the video signal but the Teletext decoder needs both possibilities at the same time.

Most TV sets are still produced without a power transformer nowadays, so they may have a live chassis. This problem can be overcome by the use of an isolation transformer (figure 6). It is possible for the transformer to be built into the TV set without too much difficulty but connecting a video input and output is slightly more complicated. It is useless attempting this without a layout diagram of the TV set. Fortunately a diagram is almost always supplied with the set itself, otherwise it may be obtainable from the dealer or a service company.

Figure 7 shows a part of a TV circuit and the modifications necessary for the connection of Teletext or any other video signal. A break must be made between the video demodulator and amplifier. Considering the modular construction of a TV this spot should not be too hard to find. The signal amplitude should be 2-3 V peak-to-peak. In the circuit diagram of a TV set this is usually indicated, as in figure 7, near a sketch of the waveshape at this point.

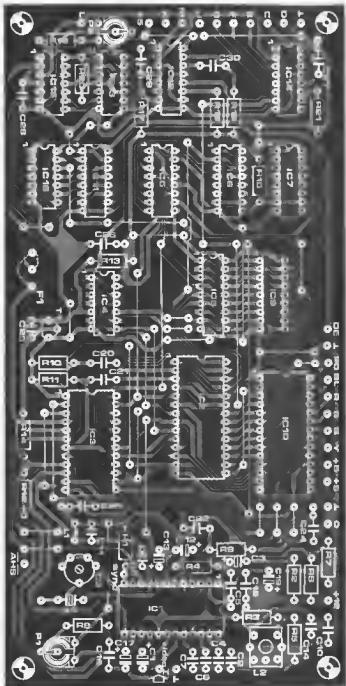

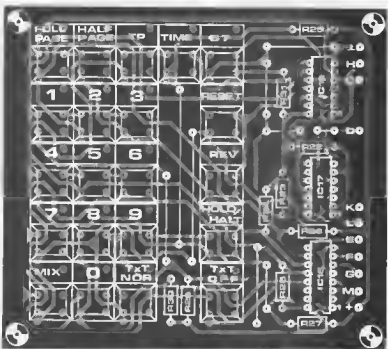
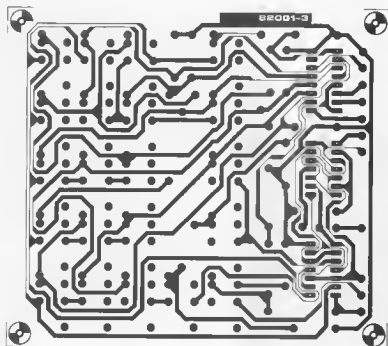

Figure 5. The printed circuit board end component overlay of the keyboard section. Since only the shaded part of figure 2 is placed on this board, it contains just three ICs besides the keys.

Parts list

Teletext decoder keyboard

Resistors

R22 ... R31 = 3k3

Semiconductors

IC17 = 74LS73

IC18 = 74LS148

IC19 = 74LS00

Miscellaneous

21 x digitest switch

(Digitests serve as wire links)

The interruption of the video connection may influence the AGC (Automatic Gain Control) of the tuners. This would lead to much poorer reception quality, or even: no reception at all. Whether the AGC is influenced (situation B of figure 7) or not (situation A) must be checked on the TV circuit diagram. In the unhoped-for event that situation B occurs the AGC must be switched over to a Manual GC (via S_2). The Manual GC control must be adjusted separately for each transmitter, due to the differences in reception. Fortunately, situation B occurs mainly in relatively old black and white TV sets. The video output is easy to connect once the right spot is found. Figure 7 shows how this is done. The DC voltage level, on which the video signal is super imposed, is used to bias the emitter follower T1. Via C3 and R5, the signal can be brought out to a coax (BNC) connector on the back of the TV set, or else a connection can be made directly to the decoder. In the event that the amplitude of the video signal is over 3 V, R4 can be replaced by a trimmer to enable adjustment of the output amplitude.

The video signal must never be greater than 6 V. The supply voltage for T1 must also be derived from somewhere in the TV. Most tuners are connected to 12 V, so a supply can probably be found in that vicinity.

The video input circuit which can be switched by S_2 should return the amplitude of the video signal to the desired value (P3) and super impose the video signal on the required DC voltage component. Adjustment of P2 determines the DC voltage level of the sync pulses via D1 (see figure 7). With the component values given, this level can be set between 0 V and 6 V. If a higher voltage is required a smaller value may be chosen for R2.

These modifications are not only suitable for the Teletext decoder. The design is such that input and output impedance are approximately 75 Ω . Therefore a TV set with this input stage can also serve perfectly well as a video

6

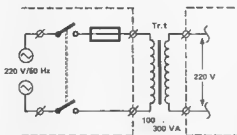

82025-6

Figure 5. The TV set must be isolated from the mains when it is supplied with a video input and output. Generally an isolation transformer can be built in very easily.

7

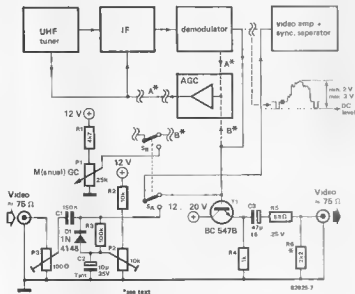

*see text

82025-7

Figure 7. Most TV sets can be modified to provide a video input and output. The block diagram indicates where the video signal must be connected inside the TV. The block diagram of the TV will either look like situation A or B.

8

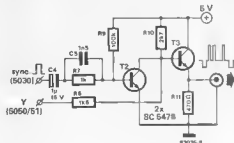

82026-8

Figure 8. The signals from the Teletext decoder must be mixed in this little video combiner, before they can be applied to the video input.

monitor, for example with a video game. In that case a coaxial cable must be used for the signal connection.

Video combiner

Although the TV set is provided with a video input stage, the Teletext decoder signals are not yet fit for this input. The sync signal from SAA 5030 (IC1) and the Y-signal from SAA 5050 must first be combined to achieve this. This is carried out by T2 and T3 (see figure 8). The sync signal at pin 12 of IC1 has a (positive) amplitude of about 0.7 V, so the base of T3 is short-circuited during the sync pulses and the output becomes 0 V.

The Y-signal is supplied by one of the open-drain outputs of IC10. This signal contains the luminance information of the Teletext picture. The proportion of R8 and R10 is chosen in such a way that the combined video signal is modulated up to approximately 60-70% white. Since the complete amplitude is 5 V, P3 (at the video input) will have to reduce the level to 2 to 3 volts. Switching over from Teletext to normal reception is simple: S_A (+S_B) is the selector switch.

With or without frills?

The quickest (and cheapest!) way to Teletext is to build the simple decoder described so far into a modified TV receiver. However, this does severely limit the flexibility of the system.

In the first place, the Teletext picture will not be reproduced in colour. This is not too serious, perhaps, but there is more: the automatic switching facilities of the Teletext system are also lost. Consequently, some useful features like subtitles for the deaf can not be utilised. Furthermore, no time indication can be superimposed on the normal TV picture and, in general, the Teletext information and normal TV picture cannot be displayed simultaneously. The video control board (to be described next month) does add all these facilities - but it is by no means a simple circuit. The output from this unit can be connected to the video input described above.

An even more interesting alternative will also be described. With a little add-on circuit, it is possible to feed the Teletext signal into the aerial input of the TV set. This has the major advantage that it is no longer necessary to dig into the inside of the TV set, provided a separate receiver section is also included to provide the video signal for the Teletext decoder input. This is no real problem either, as we will see. In effect, therefore, the basic unit described so far is suitable for 'standard' Teletext reception, but the 'frills' described next month will convert it into a really interesting project.

This leaves us in a quandary. Readers

who want all the 'frills' cannot put the unit into operation until next month; others, who are prepared to do some prospecting inside their set want the calibration procedures and instructions for use now... To keep both groups happy, we will describe the calibration for the basic unit now, and include the full 'instructions for use' of the final version. The latter include the description of some options that are not available on the basic unit, but this may serve to whet the appetite!

Basic decoder calibration

Initially, P1, P2 and C9 on the decoder board should all be set to the mid-position. In the input/output circuit, P1 and P3 should be set to maximum; P2 sets the DC level, as indicated in the TV circuit diagram. Hopefully, some kind of Teletext picture should now appear - the picture quality is unimportant at this time. Of the potentiometers in figure 7, P2 sets the sync level, P3 adjusts the video level and P1 sets the gain of the front-end according to the strength of the transmitter.

Proceeding now to the decoder board: this calibration is both simple and critical - strange but true! The 6 MHz oscillator is crystal controlled, which means that the control range of C9 is limited (± 4 kHz). This means that the line frequency (15625 Hz) can never be far off. If a frequency counter is available, the oscillator can be set to exactly 6 MHz when no video signal is applied to the input. A suitable test point is line F6 between pin 6 of IC1 and pin 2 of IC3 (see figure 1).

If the vertical synchronisation is incorrect in Teletext mode (leading to a 'jumpy' picture), this can be corrected by readjusting P1.

The most important adjustment in the whole decoder is L2. This coil must be trimmed up until the decoder synchronises properly on the 'clock-run-in' bytes of the Teletext signal. It is very important for the receiver to be tuned in optimally, in other words that it gives a sharp, clear (colour) picture. After pressing the keys 'reset' and 'TXT-nor' the page header or at least the letters 'P100' will appear on the screen. The cora of L2 should be turned until the time indication becomes visible. It will be indicated very clearly within a limited adjustment range and the correct setting for L2 is in the centre of this range. It is best to press the 'reset' key repeatedly during this calibration in order to wipe out the nonsense that the decoder displays on the screen. The decoder should be ready for use now.

Directions for use

TXT-off Fortunately, it is possible to switch off the Teletext decoder. Normally, when the TXT-off-key is operated the TXT picture immediately 'clears the way' for the normal program.

However, when this key is pressed during 'mix-mode' the TXT page remains visible for a few seconds before it disappears. After that the TV program can be watched again.

The keys 'full page, half page and reveal' have no effect on the picture in this mode. All the other keys immediately bring about a change in the picture information.

TXT-nor This key activates the decoder which means that the normal mode is selected. The program picture disappears to 'clear the way' for the selected page (see description of the numeric keys).

Mix The program picture doesn't disappear but the Teletext page is displayed on the normal picture. This function can only be reset by the TXT-nor-key or if necessary cancelled via the TXT-off-key. In the latter case the decoder will always return to the mix function when a following key is pressed. Note that this function is not available on the basic decoder.

Numeric keys Page selection is done by pressing a three digit number, this doesn't necessarily require the 'mix-' or 'TXT-nor'-key to be pressed. The page header is displayed in a rectangle on the (normal) screen as soon as a number key is pressed during the 'mix mode' or when the decoder is switched off. The page header remains visible for a few seconds, disappears and returns again when the selected page is received. The decoder indicates the reception by displaying the page number at the upper left of the screen. Time indication will also be visible for a short time. The page is made visible either by pressing the 'TXT-nor' or 'mix'-key.

RESET Generally the first page (P100) consists of search information, for example several references to a more detailed list of contents, therefore this page will often be consulted in order to find a desired page. The 'reset' key returns the page number register to 100 and wipes out the displayed page at the same time, only the page header remains. The counter visible in this header indicates the number of the page being received at that moment. As soon as page 100 appears on the counter the whole screen is written again.

Timed page A page can be selected at a specified time. In order to accomplish this a page number has to be chosen first and then the 'timed-page'-key has to be pressed. At the upper left of the screen T00.00 will be displayed. The decoder expects the time setting in hours and minutes. At the desired time, the reproduction procedure will operate as described under 'numeric keys'. The 'timed page' function can be cancelled by pressing the same key once more.

Full page/half page The Teletext page consists of rather small letters. In order to improve the readability, it is therefore supplied with the possibility of dividing the page into two pictures. The 'half page'-key selects one half of the

page. Repeated operation of this key displays the upper and lower half of the enlarged page on the screen, in turn. The 'full page' key is operated in order to reset the page to its normal proportions again.

Reveal Some Teletext pages contain a number of hidden information (for example for video games) which can be made visible by the 'reveal' key. However, this information can only be erased by (re-)selecting a page.

Hold Very often the 24 lines of a TXT page are not enough to display all the information about a certain subject, therefore a page can be extended to a number of pages. Turning from one page to another is done automatically with the aid of a control bit that is transmitted together with the page. Each page is displayed for approximately 25 seconds. However, if this is not long enough it can be held by the HOLD-key so that the decoder will not read any more information. Pressing the HOLD-key activates the decoder again. The decoder may also return to the 'mix-mode' in this case (see numeric keys).

Time/B7 Time display is one of the tricks that only expensive TV sets are able to perform. The Teletext decoder enables time to be displayed during a normal program. By pressing the keys 'B7' and 'time' simultaneously, time is displayed in a rectangle at the upper left of the screen for 5 seconds. If only the key 'time' is pressed either the complete page header will be displayed in a black rectangle for 5 seconds or the decoder will return to 'mix-mode' for the same period of time.

Sources

- *The history of CEEFAX*, S.W. Amos (BBC Engineering)
- *Broadcast Teletext Specification* (BBC, IBA, BREMA)
- *Mullard Technical Information No. 72: Multitext*
- *Valvo Technical Information No. 800407: Teletext and Viewdata*
- *Valvo development information No. 67: The integrated Video-IF-Amplifier circuit TDA 2541 for TV receiver*
- *Grundig Technical Information 4/5 '80*
- *Siemens Short Form Catalog 1980: Surface Acoustic Wave Filters LI08[®]*

Human Speech

Before describing the techniques employed in this system it is worth briefly considering the production and form of human speech.

The vocal tract can be seen to consist of a d.c. power supply, square wave oscillator and a resonator. The lungs provide a constant air pressure on the back of the taut vocal folds, or vocal chords, which forces these two flaps of skin to open. The Bernoulli forces set up by the air flow then force the folds shut, and the result is a stream of glottal pulses, which may be approximated to a 150 Hz square wave. This means a fundamental at 150 Hz with exponentially decaying odd harmonics at 450 Hz, 750 Hz etc.

by David Ridyard B. Sc.

speak to your computer

A simple and flexible speech recognition system using an M6800 microprocessor and involving a minimum of external hardware, recognising ten words in less than 1.5 seconds, with better than 90% accuracy. The removal of the key pad interface between man and computer has many advantages and has long been the pipedream of every programmer. By using this M6800 system it can become a reality for every home computer.

The vocal tract itself then acts as a resonator. If it is compared to a perfect closed pipe, 17.5 cm long, resonances would be expected at 500 Hz, 1500 Hz, 2500 Hz and so on. These resonances are known as formants and the form of speech is determined by the position of these formants, which are modulated by the jaw, the tongue, the larynx and the pharynx.

Basic design criteria

Most of the 'word' information is contained in the first three formants, while 'speaker' information is generally contained in the higher formants. Consequently the input signal in this system uses a second order Butterworth filter to band limit the signal to less than 3.8 kHz. This has two advantages. Firstly, it reduces the speed of processing required for analysis and secondly, it means that the response is far less dependant on the speaker's accent.

Work on speech has also shown it is quite intelligible when infinitely clipped, that is to say that zero crossing information is sufficient to characterise a word. This allows us to use a comparator to reduce speech to a single serial bit stream, thus eliminating the need for analogue to digital conversion.

The conventional approach to speech analysis from this point is to perform a Fourier transform, and to look for the positions of formants at various points in the word. However this is clumsy and slow, and so in this system the autocorrelation function has been used:

$$R_X(\tau) = \lim_{T \rightarrow \infty} \frac{1}{2T} \int_{-T}^{+T} x(t)x(t+\tau) dt$$

This lends itself very easily to micro-processor implementation, when the input $x(t)$ is two valued, and '1' represents +1 and '0' represents -1, since multiplication is performed by the EOR instruction.

The value of τ is determined by the Nyquist frequency for a 4 kHz input, as 0.125 ms. The limits of integration were chosen to cover one full cycle of the lowest frequency of interest, in this case 250 Hz, since the 150 Hz fundamental is uniformly present. This is also convenient since the data required for each autocorrelation uses exactly 4 bytes, plus 4 bytes on either side giving a total of twelve bytes. In order to reduce the memory volume per word, only every fourth set of 12 bytes is used. It may be possible to reduce this further by adjusting the constant value in line 124, \$24(36), without reducing accuracy. By taking every sixth set, \$3C(60), a 50% reduction in recognition time would accrue, provided a compatible dictionary is used.

The autocorrelation of the unknown word is compared to the autocorrelation of the words stored in the dictionary, and selection of the answer word is made by the minimum Euclidean distance:

Euclidean distance of answer word = D,

$$D_j = \left[\sum_{K=0}^n |X_k - Y_k| \right]_{\text{MIN}}$$

n = number of bytes stored per autocorrelated word in store

X_k = k th byte of autocorrelated stored word

Y_k = k th byte of autocorrelated spoken word

D_h = distance of h th choice

In order to reduce incorrect decisions a test is done, to see if the second choice word is close to the first choice or not.

$$(D_2 - D_1) \geq A$$

Where A is a constant, specified in line 252.

In its present form, the system outputs 5 ASCII characters for the first choice, and 5 for the second choice. If D_1 differs significantly from D_2 , the words 'I THINK..' appear as a preface to the first choice.

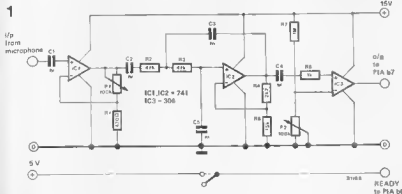

The input routine uses a standard PIA, with the input connected to Bit 7, and the READY line connected to Bit 0.

Filter and comparator design

This circuit consists of three stages, preamp., filter and comparator. The preset P1 could be replaced by a fixed 100k resistance, but best results are achieved by adjusting P1 to give a maximum peak to peak amplitude of 15 V for normal speech. Conversely R7 and P2 could be omitted, and the comparator reference input tied to earth, but best results are achieved by adjusting P2 to make the output bit stream spend roughly equal amounts of time at '1' and '0'. This reduces false triggering by noise.

Using the existing system

The first thing to do is to create a dictionary, by reading in the ten words required. This is done by taking the Speech Recognition Program, and replacing line 135 with a software interrupt.

020F 3F 135: SWI

Words are stored at 2000, 2400, 2800, 2A00 .. 4400 and the required location is determined by the operand of line 29.

After the READY switch has been switched to 5V, the system will wait for the first '1' to appear, and will then sample at 8 kHz, for 0.84 seconds, therefore, the speaker should begin to speak the instant that the READY line is put high, and the READY line should be returned to zero as soon as possible after completion of speech.

The five ASCII characters required for output should then be placed at 23D3, 23D4 ... 23D7 for the word stored at 2000; 27D3 ... 27D7 for the word at 2400 and so on.

When a complete dictionary of ten words has been read in, the original Speech Recognition Program should be reloaded and run, and the word under test spoken, using the READY switch as before.

The output will consist of the first choice answer on the left and the second choice on the right. As a safety precaution, to ensure incorrect answers do not get through, the threshold in line 252 should be set up. In this case, if the answer word does not satisfy the criterion (3), the words 'I THINK ...' will appear on the extreme left. Selection of the precise value of the threshold should be made using Graph 1, bearing in mind, that in order to reduce the number of errors, an increase in the number of no decisions will result: 02 or 03 are usually adequate.

Better results can be achieved using a dictionary consisting of words which have been averaged over several utterances of each word (8 in this case). In order to do this, a word should be read in eight times and stored at 2000, 2800, 3000 ... 5800. The dictionary average program should then be run and the

speech recognition using autovac

	Y	NAM	speech recognition using autovac
0100	2'	DRG	S0100
0100 CF 0004	3	START	LDX E5004
0103 FF F508	4		STX SFS08
0106 86 F508	5	RDY	LOA A SFS08
0108 2A FB	6		ROR SFS08
0108 86 F508	7	ZEND	LOA A SFS08
010E 46	8		ROR A
010F 26 FA	9		ECC ZFAD
0111 CE 0400	10		LDX E50A0
0114 CE 08	11	STORE	LOA B EB
0118 37	12	LOAD	PSH B
0117 F6 F508	13		LOA B SFS08
011A 88	14		ROR B
011B 4B	15		ROR A
011C CE AC	16		LOA B
011E 8A	17	WAIT	DEC B
011F 26 FD	18		RNE WAIT
0121 01	19		NOP
0123 33	20		PUL B
0123 5A	21		DEC B
0124 26 FO	22'		BZF LOAD
0126 AF 00	23		STA A X
0128 08	24		INX
0128 8C DD48	25	CP#	E50D48
012C 26 E8	26	RNE	STORE
0132 86 12	27		LOA A E512
0132 87 0426	28		STA A S0426
0133 CE 1000	29		LDX E51000
0136 FF D406 30		STX	S0406
0139 CF 0A00 31		LDX	E50A00
013C FF 0420 32		STX	S0420
013F CE 0400 33		LDX	E50460
0142 FF 0422 34		STX	S0422
0145 FF 0424 35		STX	S0424
0148 08 0C 36		AUTO	LOA B E50C
014A FE 0420 37		MOVE	LDX S0420
014D AE 00 38			LOA A X
014F 08	39		INX
0150 FF 0420 40		STX	S0420
0153 FF 0422 41		LDX	S0422
0156 A7 00 42		STA	A X
0156 08 43			INX
0158 FF 0422 44		STX	S0422
015C 5A	45		DEC B
015D 26 E8	46		RNE MOVF
015F CE 0500 47		LDX	E50500
0162 FF 0400 48		STX	S0400
0165 FF 0404 49		STX	S0404
0168 CE 04F0 50		LDX	E504F0
0168 FE 0402 51		STX	S0402
016E 08 04 52		LOA B	E4
0170 FE 0402 53	LOOP 1	LDX	S0402
0173 37 54		PSH B	
0174 08 08 55		LOA B	EB
0176 A8 00 56	LOOP 2		X
0178 A7 10 57		STA	A S10_X
017A 08 58			INX
017B 5A 59			DEC B
017C 26 FB 60		BZF	LOOP 2
017E FE 0402 61		LDX	S0402
0181 08 38 62		LOA B	E538
0183 AE 04 63	LOOP 3	LOA A	4_X
0185 AB 10 64		ROR A	S10_X
0187 43 65		COM A	
0188 68 17 66		ROR	S17_X
018A 86 18 67		ROR	S18_X
018C 86 15 68		ROR	S16_X
018F 88 14 69		ROR	S14_X
0190 86 13 70		ROR	S12_X
0192 86 12 71		ROR	S12_X
0194 86 11 72		ROR	S11_X
0198 86 10 73		ROR	S10_X
0198 FF 0402 74		STX	S0402
0198 FE 0400 75		LDX	S0400
019E A7 90 76		STA	A S80_X
01A0 08 77			INX
01A1 08 78			INX
01A2 08 78			INX
01A3 08 80			INX
01A4 FF 0400 81		STX	S0400
01A7 FF 0402 82		LDX	S0402
01AA 5A 83			DEC B
01AB 26 06 84		RNE	LOOP 3
01AD 20 02 85		BRA	I6LE
01AF 20 97 86	AUTO	BRA	AUTO
01B1 08 87	ISLE		INX
01B2 FF 0402 88		STX	S0402
01B5 FE 0404 89		LDX	S0404
01B8 08 90			INX
01B9 FF 0400 91		STX	S0400
01BC FF 0404 92		STX	S0404
01BF 33 93			PUL B
01C0 8A 94			DEC B
01C1 26 AD 95		RNE	LOOP 1
01C3 CE 0580 96		LDX	E50580
01C6 08 38 97		LOA B	E538
01C8 37 98	LOOP 4	PSH B	
01C9 4F 99		CLR A	
01CA 08 100		LOA B	E520
01CC 86 00 101	LOOP 5	ROR	X
01CE 86 01 102		LOA B	1_X
01D0 86 02 103		ROR	2_X
01D2 86 03 104		ROR	3_X
01D4 86 00 105		ADC	A CD
01D6 5A 106			DEC B
01D7 26 F3 107		RNE	LOOP 5

0106 00	108	INX		0206 FF 1802	218	LDX	S1802	
010A 08	109	INX		0209 FF 1808	219	STX	S1808	
010D 08	110	INX		020C 20 1E	230	BRA	SANS	
010C 08	111	INX		020E A5 05	221	RUNLUP	LDA 5,X	compare MSB of 1st choice
010D FF 0408	112	LDX	S0408	020F A1 01	222	CMP A	1,X	
010E FF 0406	113	STX	S0406	0212 27 0A	223	BHI	NAN2	
010F A7 00	114	STA	X	0214 26 18	224	BNE	SANS	
010E 08	118	INX		0218 A4 04	225	LDA	4,X	
010E FF 0408	118	STX	S0405	021B A1 00	226	CMP A	0,X	compare LSB of second choice
010E FF 0408	117	LDX	S0408	021A 22 02	227	BHI	NAN2	
010E 23	118	PUL	B	021C 20 0E	228	BRA	SANS	
010D 8A	119	DEC	B	021E A5 00	229	NAN2	LDA 0,X	substitute new second choice
010E 26 08	120	BNE	LOOP 4	021F A7 04	230	STA	4,X	
010F FF 0408	121	STX	S0408	021F A7 01	231	LDA	1,X	
010F FE 0420	122	LDX	S0420	021F A7 05	232	STX	6,X	
010F 37	123	PUL	B	021F FE 0023	233	LDX	S1802	
010F 2E 24	124	LDA	B ES24	021F FF 180A	234	STX	S180A	
010F 08	125	ALT	INC	021F 33	235	SANB	PUL B	
010A 5A	128	DEC	B	021F 8A	236	DEC	B	
010F 26 FC	127	BNE	ALT	021F 26 08	237	BNE	JUMP	
010F 32	126	PUL	B	0300 8D E0CC	238	JSR	SEDOCC	
01FE FF 0420	129	STX	S0420	0302 20 03	239	BRA	OUT	
0201 PE 0424	130	LDX	S0424	0305 FE 02B3	240	JUMP	JMP	
0204 FF 0422	131	STX	S0422	0308 08 0A	241	OUT	LDA A	line lead
0207 FF 0418	132	LDX	S0408	0310 87 E1D1	242	JSR	SE1D1	
020A 7A 0426	133	DEC	S0428	0310 88 00	243	LDX	A ES0D	carry return
020D 2B AD	134	BNE	AUTC	030F 8D E1D1	244	JSR	SE1D1	
020F CE 2000	138	LDX	ES2000	0312 88 1805	245	LDA	A S1805	load A with MSB of 2nd choice
0212 FF 1A02	139	STX	S1A00	0315 80 1803	246	SUB A	S1802	load MSB of 1st choice
0215 CE 2400	137	LDX	ES2400	0318 8D E0B7	248	JSR	SE0B7	
0218 FF 1A02	138	STX	S1A02	031E 88 5000	249	LDA	A S5000	
0219 CE 2800	139	LDX	ES2800	0321 8D E0B8	250	JSR	SE0B8	
021E FF 1A04	140	STX	S1A04	0324 86 5000	251	LDA	A S5000	
0220 FF 1A06	142	STX	S1A06	0327 81 00	252	CMP A	ES00	compare with threshold
0222 CE 3000	143	LDX	ES2000	0328 24 37	253	BCC	D0	
022A FF 1A08	144	STX	S1A08	0328 88 20	254	LDA	A CS20	output 'I THINK' if bad answer
022D CE 3400	145	LDX	ES3400	032D 8D E1D1	255	JSR	SE1D1	
0230 FF 1A0A	146	STX	S1A0A	0332 86 2E	256	LDA	A ES2E	
0233 CE 3800	147	LDX	ES3800	0332 8D E1D1	257	JSR	SE1D1	
0235 FF 1A0C	148	STX	S1A0C	0335 86 2E	258	LDA	A ES2E	
0239 CE 3C00	149	LDX	ES3C00	0337 8D E1D1	259	JSR	SE1D1	
023C FF 1A0E	150	STX	S1A0E	033A 86 2F	260	LDA	A ES2F	
023F CE 4000	151	LDX	ES4000	033C 8D E1D1	261	JSR	SE1D1	
0242 FF 1A10	152	STX	S1A10	033F 86 49	262	LDA	A ES49	
0245 CE 4400	153	LDX	ES4400	0341 8D E1D1	263	JSR	SE1D1	
0248 FF 1A12	154	STX	S1A12	0344 86 50	264	LDA	A ES50	
0249 CE 1800	155	LDX	ES1800	0348 8D E1D1	265	JSR	SE1D1	
024E FF 1806	156	STX	S1S04	0349 86 74	266	LDA	A ES74	
0251 0G 0A	157	LDA	B ES0A	0348 8D E1D1	267	LDA	A ES0E	
0252 8F 07	156	LDA	A CSFF	034E 86 88	268	JSR	SE1D1	
0255 47 03	158	STX	2,X	0350 8D E1D1	269	JSR	SE1D1	
0257 47 03	160	STA	3,X	0353 86 69	270	LDA	A ES69	
0259 A7 04	161	STA	4,X	0355 8D E1D1	271	JSR	SE1D1	
025B A7 05	162	STA	5,X	0358 86 8E	272	LDA	A ES8E	
025D CE 19FE	163	LDX	ES19FE	035A 8D E1D1	272	JSR	SE1D1	
0260 FF 180A	164	STX	S1000	035D 86 8E	274	LDA	A ES8E	
0263 CE 1000	165	LDX	ES1000	035F 8D E1D1	275	JSR	SE1D1	
0266 FF 1804	166	STX	S1804	0362 FE 1808	276	DK	LDX S1808	
0269 FE 1800	167	LDX	S1800	0365 A6 00	277	LDA	A S00X	output answer word
026E 08	168	INX		0367 8D E1D1	278	JSR	SE1D1	
026D 08	169	INX		036A A6 01	279	LDA	A 1,X	
0268 FF 1800	170	S1800		036C 8D E1D1	280	JSR	SE1D1	
0271 0E 00	171	LDX	X	036F A6 02	281	LDA	A 2,X	
0273 FF 1802	172	STX	S1802	0371 8D E1D1	282	JSR	SE1D1	
0278 27	173	ESH	B	0374 A6 02	283	LDA	A 3,X	
0277 FE 1808	174	LDX	S1806	0378 8D E1D1	284	JSR	SE1D1	
027A 4F	175	LDX	X	0379 A6 04	285	LDA	A 4,X	
0278 A7 00	176	STA	2,X	037B 8D E1D1	286	JSR	SE1D1	
027D A7 01	177	LDA	1,X	037E A6 05	287	LDA	A 5,X	
027F CE 04D3	178	LDX	ES04D3	0380 8D E1D1	288	JSR	SE1D1	
0282 FF 1900	179	STX	S1000	0383 8D E0CC	289	JSR	SE0CC	
0285 FE 1804	180	LDX	S1804	0388 86 28	290	LDA	A CS28	output 2nd choice
0288 A6 00	181	LDA	A X	0388 8D E1D1	281	JSR	SE1D1	
028A 08	182	INX		038E FE 180A	292	LDX	S180A	
028B FF 1804	183	STX	S1804	038E A6 00	293	LDA	A 0,X	
028E FE 1802	184	LDX	S1802	0390 8D E1D1	294	JSR	SE1D1	
0291 A0 00	185	SUB	A	0393 A6 01	295	LDA	A 1,X	
0293 2A 02	186	BFL	PUL	0395 8D E1D1	296	JSR	SE1D1	
0295 4A	187	DEC	A	0398 A6 02	297	LDA	A 2,X	
0295 43	188	COM	A	03A 8D E1D1	298	JSR	SE1D1	
0297 08	189	INX		03B0 A6 03	299	LDA	A 3,X	
0298 FF 1802	180	STX	S1802	03B1 8D E101	300	JSR	SE1D1	
029E FE 1806	191	LDX	S1808	03A2 A6 04	301	LDA	A 4,X	
029E A8 00	182	ADD	A	03A4 8D E1D1	302	JSR	SE1D1	
02A0 A7 00	183	STA	X	03A7 A6 05	303	LDA	A 5,X	
02A2 24 02	194	BCC	NDIVE	03A8 8D E1D1	304	JSR	SE1D1	
02A4 8C 01	195	INC	1,X	03A8 8E 28	305	LDA	A CS28	
02A6 7A 1801	196	DEC	S1801	03A8 8D E1D1	308	JSR	SE1D1	
02A9 26 DA	187	BNE	SUB T	0311 7E 0106	307	JMP	RDY	wait for next word
02AB 7A 1800	188	DEC	S1800	03B4 3F	308	SWI		
02A8 28 D5	199	SUB	T		309	END		
02AE 28 03	200	LDX	A 3,X					
02B0 A8 03	200	LDX	A 3,X					
02B2 A1 01	201	CMP	A 1,X					
02B4 2A 0A	202	BHI	NANS					
02B6 28 28	203	BNE	RUNLUP					
02B8 AC 02	204	LDA	A 2,X					
02BA A1 00	205	CMP	A 0,X					
02BC 22 02	206	BHI	NANS					
02BE 20 1E	207	BRA	RUNLUP					
02C0 A6 02	208	NANS	LDA 2,X					
02C2 A7 04	209	STA	A 4,X					
02C4 A8 03	210	LDA	A 3,X					
02C6 A7 05	211	STA	A 5,X					
02C8 A6 00	212	LDA	A 0,X					
02CA A7 02	213	STX	A 2,X					
02CC A5 01	214	LDA	A 1,X					
02CE A7 02	215	STA	A 3,X					
02D0 FE 1808	216	LDX	S1808					
02D3 FF 180A	217	STX	S180A					
0206 FF 1802	218	LDX	S1802					
0209 FF 1808	219	STX	S1808					
020C 20 1E	230	BRA	SANS					
020E A5 05	221	RUNLUP	LDA 5,X					compare MSB of 1st choice
020F A1 01	222	CMP	A 1,X					
0212 27 0A	223	BHI	NAN2					
0214 26 18	224	BNE	SANS					
0218 A4 04	225	LDA	4,X					
021B A1 00	226	CMP	A 0,X					compare LSB of second choice
021A 22 02	227	BHI	NAN2					
021C 20 0E	228	BRA	SANS					
021E A5 00	229	NAN2	LDA 0,X					substitute new second choice
021F A7 04	230	STA	4,X					
021F A7 01	231	LDA	1,X					
021F A7 05	232	STX	6,X					
021F FE 0023	233	LDX	S1802					
021F FF 180A	234	STX	S180A					
021F 33	235	SANB	PUL B					
021F 8A	236	DEC	B					
021F 26 08	237	BNE	JUMP					
0300 8D E0CC	238	JSR	SEDOCC					
0302 20 03	239	BRA	OUT					
0305 FE 02B3	240	JUMP	JMP					
0308 08 0A	241	OUT	LDA A					line lead
0310 87 E1D1	242	JSR	SE1D1					
0310 88 00	243	LDX	A ES0D					carry return
030F 8D E1D1	244	JSR	SE1D1					
0312 88 1805	245	LDA	A S1805					load A with MSB of 2nd choice
0315 80 1803	246	SUB	A S1802					load MSB of 1st choice
0318 8D E0B7	248	JSR	SE0B7					
031E 88 5000	249	LDA	A S5000					

dictionary average program

0100	11	NAME	dictionary average program	01A8 20 02 69	AVGF	BRA	SKP	long branch instead
0100	2	DRG	\$0100	01AA 20 59 70	SKP*	BRA <td>SKP <td></td> </td>	SKP <td></td>	
0100	3	LDX	\$E1000	01AD 00 00 72		LDA	X	
0103	4	STX	\$1A00	01AF 08 73		INX		
0106	5	LDX	\$E3000	0180 FF 1A0C 74		STX	SLA0C	
0109	6	STX	\$1A02	0183 FE 1A12 75*		LDX	\$1A12	
0109	7	LDX	\$E2800	0186 A7 00 76		GT A	X	
010F	8	STX	\$1A04	0188 0E 77		INX		
0112	9	LDX	\$E3000	018E FF 1A12 78		STX	\$1A12	
0113	10	STX	\$1A05	018C FE 1A0F 78		LDX	\$1A0E	
0118	11	LDX	\$E3800	018F AE 00 80		LDA	X	
0118	12	STX	\$1A08	01C1 08 81		INX		
0118	13	LDX	\$E4000	01C2 FF 1A0E 82		STX	\$1A0E	
0121	14	STX	\$1A0A	01C5 FE 1A12 83		LDX	\$1A12	
0124	15	LDX	\$E4900	01C8 A7 00 84		ST A	X	
0127	16	STX	\$1A0C	01CA 08 85		INX		
012A	17	LDX	\$E5000	01C8 FF 1A12 85		STX	\$1A12	
012D	18	STX	\$1A0E	01CF FE 1A10 87		LDA	\$1A10	
0130	19	LDX	\$E5800	01D1 AE 00 88		LDA	X	
0133	20	STX	\$1A10	01D3 08 89		INX		
0138	21	LDX	\$E1800	01D4 FF 1A10 90		STX	\$1A10	
0139	22	STX	\$1A12	01D7 FE 1A12 91		LDA	\$1A12	
013C	23	STX	\$1A14	01DA A7 00 92		ST A	X	
013F	24	LDX	\$E08A7	01DC 08 93		INX		
0142	25	STX	\$1A16	01DD FF 1A12 94		STX	\$1A12	
0145	26	LDX	\$1A14	01E0 CE 1800 95		LDA	\$E1800	
0148	27	STX	\$1A12	01E3 4F 96		CL R	A	
0148	28	LDX	\$1A02	01E4 AE 00 97		ADD	A	
0148	29	LDA	X	01E8 AE 01 98		ADD	A	1,X
0150	30	INX		01E8 AE 02 98		ADD	A	2,X
0151	31	GT X	\$1A02	01EA AE 03 100		ADD	A	3,X
0154	32	LDX	\$1A12	01E8 AE 04 101		ADD	A	4,X
0157	33	STX	\$1A12	01EE AE 06 102		ADD	A	5,X
0158	34	INX		01F0 AE 06 103		ADD	A	6,X
015A	35	STX	\$1A12	01F2 AE 07 104		ADD	A	7,X
0160	36	LDX	\$1A04	01F4 68 105		RDR	A	
0160	37	LDA	X	01F5 47 106		ASR	A	
0162	38	INX		01F6 47 107		ASR	A	
0183	39	STX	\$1A0A	01F7 CE 1A00 108		LDX	\$E1A00	
0186	40	LDX	\$1A12	01FA A7 00 109		ST A	X	
0189	41	ST A	X	01FC 08 110		INX		
0189	42	INX		01FD FF 1A00 111		STX	\$1A00	
018C	43	STX	\$1A12	0200 7A 1A17 112*		DEC	\$1A17	
018F	44	LDX	\$1A06	0203 2E AE 113		BNE	AVGE	
0192	45	LDA	X	0205 7A 1A16 114		DEC	\$1A16	
0194	46	INX		0208 2E AD 115		BNE	AVGE	
0195	47	STX	\$1A06	020A CF 1000 116		LDX	\$E1000	
0198	48	LDX	\$1A12	020D FF 1A00 117		STX	\$1A00	
0198	49	ST A	X	0210 CD 2000 118		LDX	\$E2000	
019D	50	INX		0213 FF 1A02 116		STX	\$1A02	
019E	51	STX	\$1A12	0216 CE 08A7 120		LDX	\$E08A7	
019F	52	LDX	\$1A06	0219 FF 1900 121		STX	\$1900	
01A4	53	LDA	X	021C FE 1A00 122	MOVE	LDX	\$1A00	
0185	54	INX		021F AE 00 123*		LDA	X	
0187	55	STX	\$1A08	0221 06 124		INX		
018A	56	LDX	\$1A12	0222 FF 1A00 125		STX	\$1A00	
018D	57	ST A	X	0225 FE 1A02 125		LDX	\$1A02	
019F	58	INX		0228 A7 00 127		ST A	X	
0190	59	STX	\$1A12	022A 08 128		INX		
0193	60	LDX	\$1A2A	0228 FF 1A02 129		STX	\$1A02	
0196	61	LDA	X	022E 7A 1901 130		DEC	\$1901	
0169	62	INX		0231 26 E9 131		BNE	MDVE	
0199	63	STX	\$1A0A	0233 7A 1900 132*		DEC	\$1900	
019C	64	LDX	\$1A12	0236 28 E4 133		BNE	MDVE	
019F	65	ST A	X	0238 3F 134		SWI		
01A1	66	INX		023E 08 136		END		
01A2	67	STX	\$1A12					
01A5	68	LDX	\$1A0C					

output address determined by the operand of line 118. Do not forget to add in your five ASCII characters, as before. Doing this ten times is a relatively slow and laborious process, involving a lot of work loading and altering programs from disc or tape but a significant improvement in results is noted, and once a dictionary is completed it can be used indefinitely.

Without using the threshold, but with an averaged dictionary, 90% accuracy should be achieved for all speakers of 02, the errors are reduced to only 4% or less, while the decision rate falls to 81%. Roughly double these errors will occur if an averaged dictionary is not used. Initially a new speaker, not used to timing the switch properly, and over emphasising his speech may achieve less than 70%, but after a few runs through the dictionary he will improve to almost the same standard as the original author of the dictionary.

2

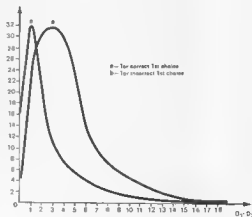

Graph 1: relationship (assumed) frequency of distance between first and second speech elements.

©1123

Unfortunately, almost no success has been achieved in using male speakers and a female author or vice versa, although occasionally a freak set of results can occur, when a female speaks at exactly one octave above the male.

Adapting the existing system

The first variable is the decision threshold, in line 252, which has already been dealt with in some detail.

The next thing the user may wish to do, is to extend the dictionary. The number of words is determined by the operand of line 157. In order to accommodate each extra word, two lines must be inserted between lines 154 and 155, in such a manner as to suitably extend the sequence, which should be obvious from lines 135 to 154; i.e. for the eleventh word:

154.1:	LDX	£\$ 4800
154.2:	STX	£\$ 1A14

The most important alterations which a user may wish to perform, concern the output. The existing system uses the SSB subroutine, which outputs the ASCII character stored in the A accumulator. If this does not exist, a similar routine must be written, and placed at \$E1D1.

The next alteration may be to ask the speaker to 'REPEAT', if the criterion 3 is not satisfied. This is simply done by altering the ASCII characters in lines 254, 256, 258 etc. from 'I THINK' to 'REPEAT'. At the end of this output section a branch back to line 3, should be entered.

The output of the first and second choice relies on the fact that the address of the first ASCII character of the first choice is stored at \$1B08, and the first ASCII character of the second choice is stored at \$1B0A. These addresses could be used as the target addresses for branch instructions, to cause the system to perform whatever function is required.

Using the characters 0 to 7, and the words 'WRITE' and 'STOP', octal programming should only require relatively simple subroutines, as should controlling train sets or remote control of T.V. sets. The latter two applications are particularly good, since an occasional error would not be fatal.

Acknowledgements

The author would like to offer thanks, for the time and equipment lent to him by the University of Durham, Department of Applied Physics and Electronics, especially Dave Isaacs and Dr. Tim Spracklen. ■

market

Secure cordless phone

Known as 'The Handshake', the digital accessing facility from Pace Electronics (UK) eliminates the security risks which have faced manufacturers of cordless phones. 'The Handshake' is a means of providing digital access between the handset and the base station thus offering total security to the phone user. Up to now the major problem of cordless phones has been the ability - albeit inadvertently - to dial out using a neighbour's phone line.



The success of the digital accessing developed by Pace Electronics has been achieved by inserting a security circuit which inhibits the line relay until a decoded train of digits

from 'The Handshake' has been compared with a pre-selected code or number of digits. Upon successful comparison - and only if a successful comparison has been achieved - the line relay is reinstated back into the circuit which then facilitates normal dialling. There are five different Pace models available on the market with operational ranges from the base unit from 100 yards to half a mile.

Pace Electronics (UK),
PO Box 27,
Hevart, Hants, PO9 1QX.
Telephones: (0705) 453333

(2133 M)

Hook-up in an RCA space chamber

Technicians at RCA Astro-Electronics, Princeton, N.J., prepare the RCA Satcom III-R communications satellite for a series of tests in a giant thermal/vacuum chamber. The tests assure that the spacecraft can operate reliably in the vacuum and extreme temperatures of earth orbit. Scheduled for launching in late 1981, the satellite will provide communications for all 50 states. Owned and operated by RCA American Communications Inc., Princeton, RCA Satcom satellites serve the cable TV industry as well as provide commercial and government services.

RCA Astro-Electronics,
Princeton,
NJ, U.S.A.
Telephones: 08540-(609) 448-3400, Ext. 2966

(2136 M)

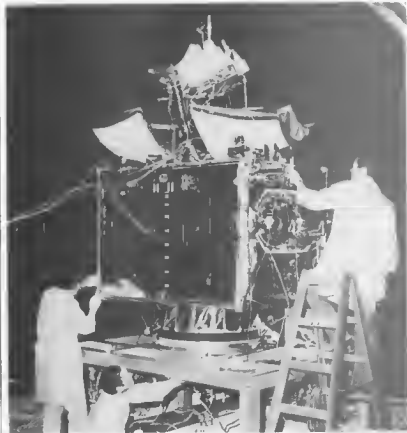

market

Dot matrix LCD module

The AND1811 features 16 alphanumeric characters. Each 5 x 7 dot matrix character is 0.17" high and is capable of displaying the full ASCII character set. Display drivers which store and update the dot information for all 16 characters are included in the dual PC board design. Mounting of the liquid crystal display is accomplished with elastomer connectors and a sturdy, metallic bezel. The entire unit, excluding the attached ribbon cable leads, measures a compact 3.66" (W) x 1.5" (H) x 0.57" (D).

Like all AND liquid crystal dot matrix display modules, the ABO 1811 only requires a single 5 volt DC supply for operation. Additional features include wide 0 to 50°C operating temperature range, low power consumption, and CMOS/TTL compatible interfaces.

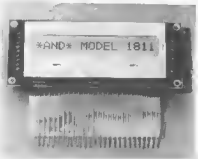

(2108 M)

The display is intended for use in hand-held terminals, microcomputer terminals, phone set message displays, and message displays for measurement, test and analytical instruments, and is available with a red, green, or blue display as well as the standard black.

Semiconductor Specialists (UK) Limited,
Carroll House,
159 High Street,
Weymouth,
West Dorset,
Middlesex UB7 7XB
Telephone: 08954 45522/45415

Computer software test instrument

A new unique test instrument which provides computer and transmission line service engineers with full workshop facilities packages into a neat hand held unit is now available from Haleshore Technical Services Limited of Sheffield.

This new instrument, called the TERMITESTER provides the service engineer with the full on-site test facilities which until now have only been available in a service workshop. Available in two versions it provides all the various types of test signals required to evaluate and 'trouble-shoot' VDU's, printers,

keyboards, communications devices and transmission lines by generating or monitoring RS232 EIA or 20 mA current loop signals.

The TERMITESTER provides all of the following test functions which are switch selected. LED displays signal circuit status. Full ASCII test sequences can be generated repeatedly or on a line-by-line basis. Any single character signal can be generated - a useful coding chart to aid character selection is incorporated into the instrument's protective lid. Monitoring EIA Control signals presented to a terminal by a line or to the line by a terminal. Superimposition of any or all control signals. Internal test and 'transparent' signal evaluation on data lines. 'Echo' keyboard character capability.

When operating on current loop the instrument can be used with either self supplying transmissions or an external current source. Baud speed switch selectable from 100 to 9600 bps for greater versatility.

The TERMITESTER has a robust fold-up lid to protect it when not in use and measures 5in x 8in fit will therefore, fit easily into virtually any service kit. Power is supplied by 'AA' type dry cells, or rechargeable cells with a mains power pack, available as an optional extra.

Haleshore Technical Services Limited,
11, Union Road,
Sheffield, S11 9EF.
Telephone: 0298 5888

(2105 M)

TTL compatible relays

IMO Precision Controls have added the TTL compatible relay, type G2V2, to their range



of OMRON printed circuit board relays, to meet the requirements of the communications and alarm industries.

The G2V2 series have twin bifurcated contacts constructed of gold clad silver palladium and wide switching capacity from 10µA to 2 A.

The low coil resistance of 56 ohms (5 V model) and wide operating voltage of 70-110 per cent make it an ideal interface for communications and alarm applications.

Standard models are available in 5 V DC to 48 V DC operating voltages and sealed versions can also be supplied. The G2V2 relays are ex stock from IMO.

IMO Precision Controls Ltd.,
349 Edgware Road,
London W2 1BS.
Telephone: 01 723 2231

(2102 M)

Neon plasma displays

The Industrial Products Division of Industrial Electronic Engineers, Inc., has introduced a series of neon plasma displays with switch selectable fonts, model numbers 3401-XX-320 and 3401-XX-480. The character fonts are contained in a 2K x 8 EPROM (2715). Up to four fonts can be addressed from a DIP switch. Standard fonts include 64-character English, 64-character European and 96-character English with upper and lower case characters. Characters are formed in a 5 x 7 dot matrix, model 3401-XX-320 has 8 lines of 40 characters and model 3401-XX-480 has

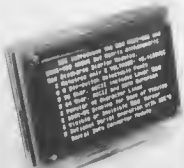

12 lines of 40 characters per line. Data is transferred serially up to 100 bits per second in either 6-bit or 7-bit ASCII. The 3401 series require only two voltages, 5 V DC at 1600 mA and 150 V DC at 185 mA.

IEE,
7740 Lemona Avenue,
Van Nuys,
California, 91405.
Telephone (213) 787-0311, ext. 210

(2110 M)

market

market

Microscopes

A number of very useful pocket sized microscopes are available from Gemdata. They are complete with operating instructions and individually boxed. The unique features of each model are shown below.

The model 3350-C zoom light microscope has its own light source powered by two 1.5 V batteries. There are separate focusing and zoom controls on the microscope and a smart black plastic case is supplied with it. Magnification 30x - 50x.



Model 3350-C
Zoom light microscope
Nickel plated
Magnification 30x - 50x



Model 461-A
Pocket microscope/telescope
Nickel plated
Magnification 8x - 30x



The model 461-A pocket microscope/telescope is a useful dual purpose instrument which can be used either as a microscope or a telescope and it is extremely simple to operate. The unit has an attractive gold anodised finish. Magnification - telescope 8x, microscope 30x.

The model M80 pocket microscope is a very compact unit with an attractive nickel plated finish. Magnification 80x.

Gemdata Limited,
23 Broad Lane,
London N15 4DE

Telephone: 01-508-0447/801 9658

(2131 M)

20 MHz dual trace oscilloscope with delayed sweep

House of Instruments announce another new oscilloscope from Trio. The CS1820 is an elegant solution to the problems of high speed waveform observations at a low cost. Featuring a high resolution display, usable to all four corners of its 140 mm rectangular, post-accelerator type 16KV CRT. A graduated inner face eliminates parallax errors and provides sharp bright pictures of high frequency and fast rising signals.

Trigger delay, for delayed sweep display, the key to observing complex waveforms, first used in the current and very successful CS 1830 is again employed in the CS 1820 to allow observation and analysis of any delayed section of a waveform. In addition, with B



sweep not locked into the delayed sweep function any combination of A and B sweeps may be selected. This system is extremely efficient in the detailed examination of high speed digital or video signals.

The CS 1820 oscilloscope includes 2 mV to 5 V/div sensitivity - 0.2 microsec to 0.5 s/div sweep times plus X5 MAG - a video sync separator for both horizontal and vertical signals, variable hold off for stable observation of complex periodic signals, alternate and chop modes, auto free run triggering, add and subtract modes, high sensitivity X-Y operation, TTL Z modulation and a signal delay line.

Fully guaranteed for 2 years, including pick up and return, the CS 1820 weighs 8.6 kg and measures 260 x 190 x 375 mm. Price £420 (excluding P & D and VAT), 100 MHz X1, X10 switchable probes are available with the oscilloscope at a special price of £ 7 00 each.

House of Instruments,
34/36 High Street,
Safron Walden,
Essex, CB10 1EP
Telephone: (0799) 24922
Telex: 81653

(2137 M)

TRW LSI introduces new 1-micro geometry A/D converter

A new 8-bit A/D Converter Board from TRW LSI Products is now available from MCP Electronics.

Listed as the TDC1025E1C, this latest A/D converter is designed to operate at 75 megasamples/sec and embodies a single chip, 1-micron geometry, triple-diffused (3D) 'flesh' converter mounted on a 100 x 160 mm board and capable of accepting analog input signals with a 20 MHz bandwidth and supplying the corresponding 8-bit digital output.

The CONVERT signal and the 8-bit binary outputs are buffered single ended ECL.

Full scale analog input ranges of 1 to 10 V can be selected using on-board resistors which also select input impedances of 50 to 1 K ohms, and offset adjustments are provided for single or bipolar inputs.



Supply voltages are ± 15 V and -5.2 V with the $+15$ V supplies being used to obtain a regulated -2 V reference -6 V for the 'flash' converter chip and +5 V for the internal buffers. Total power dissipation is about 2 W.

For further details, contact
MCP Electronics Limited,
38 Rosemont Road, Alperton,
Wembley, Middlesex, HA0 4PE.
Telephone: (01) 902 6146.

(2134 M)

New DIN-standard connector

Ultra Electronic Components Limited have introduced the first types in their new range of two-part printed circuit board connectors. Designated the Series 1695, these are totally manufactured in the U.K. to conform to both BS 9525 and DIN 41612 Standards.

The Series consists of two part assemblies moulded in flame retardant end solvent-resistant glass-filled polyester. These incorporate contacts inlaid with gold on the mating surfaces, a technique which reduces costs over fully or selectively plated contacts and results in a particularly cost-effective design.

Two and three row types, with 32 contact cavities per row, are available with 16, 32, 48, 64 or 96 contacts as standard. Gold inlay thicknesses can be specified as 0.5, 1.0, 1.9 or 3.0 μ m, and contact pitch is selectable at either 2.54 mm (0.1") or 5.08 mm (0.2"). The female sockets have twin cantilever contacts for reliability, and pre-mating earthing contacts are available on the male connectors if required.

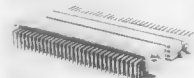

Mechanical endurance (engaging and separating) will exceed 500 operations with 3.0 μ m gold inlaid contacts, and the operating temperature range is -55° to $+125^{\circ}$ C. Contact resistance (after conditioning) is a maximum of 20 milliohms.

Ultra Electronic Components Ltd.,
Fassets Road,
Loudwater, High Wycombe,
Bucks HP10 9UT.
Telephone: 0494-26233

(2135 M)

market

Book 2 in The Junior Computer Series

book 2



Price
£ 4.75
in UK.

Junior Computer Book 2

This, the second in the Junior Computer Book series, follows in a logical continuation of book 1 and is an indispensable aid to users of the Junior Computer.

The book contains a detailed appraisal of the software. Three major programming tools, the monitor, an assembler and an editor are discussed in detail together with practical proposals for input output and peripherals. The complete source listing with relevant comments for all described programs, and the entire contents of the EPROM, are included.

THE JUNIOR COMPUTER BOOK 2 IS AVAILABLE NOW from

Elektor Publishers, 10 Longport, Canterbury, Kent, CT1 1PE.

An order card is enclosed in this issue for your convenience.

Price U.K. £ 4.75, overseas £ 5.00 postage and packing inclusive.

CrestWay

ELECTRONICS

WOODHILL LANE,
SHAMLEY GREEN,
near GUILDFORD,
SURREY.

THE ELEKTOR METAL DETECTOR

Kit no. 82021. An advanced metal detector available for the first time to the home constructor. Professional quality ABS vacuum formed case, complete with 10" ready set up and foamed search head. This kit can be constructed easily in a few hours. High performance specification includes phase locked loop oscillator and discriminator circuitry giving four reject modes with ground effect elimination. For full details and specification see the article in this issue of Elektor.

**complete kit now
available**

£89.95
p&p £2.00



CRESTLEK KITS

Ioniser (9823) Negative Ion generator	£10.50
Talk Funny (80052) Ring Modulator	£10.00
Sound Effects Unit (81112) Guns, trains, etc.	£ 8.30
Elektornado (9874) 100 W power Amp	£19.50
Top-preamp (80023) Hi-fi preamp	£34.40
Guitar Preamp (77020)	£ 6.50
2½ Digit DVM (81105)	£23.35
AM Receiver (81111) Easy to build	£10.25
Touch Switch (81008) 12 positions	£10.00
200 W Disco Power Amp (81082)	£20.85
STAMPING MACHINE	£ 2.00
Pest Pester (80130) Insect repellent	£ 2.35
Aerial Booster (80022)	£ 5.65

LATEST KITS....

TV Games extension (81143)
Disco light controller (81156)
DFM + DVM (81156)
RF test generator (81160)
EPROM programmer (81594)
Frequency counter (82026)
Teletext decoder (82025)
The ELEKTOR MINI ORGAN (82020)
write or phone for details of these kits.

Send cheque or postal order to Crestway Electronics Ltd., write or ring with your Access/Barclaycard account no. (do not send your card). Please add 40p to all U.K. orders for postage and packing. All our prices include VAT.
24 hour answering service on 0483 893236.

Crestway Electronics Ltd.,
Woodhill Lane, Shamley Green,
near Guildford, Surrey.



MAPLIN make it easy...



in **SOUTHEND**
284 London Road
Westcliff-on-Sea
Essex
Tel: (0702) 554000
(Closed Mondays)



in **HAMMERSMITH**
159-161 King Street
Hammersmith
London W6
Tel: 01-748 092
(Closed Mondays)

For personal service visit one of our stores.
Our new store at Hammersmith is conveniently situated near the end of the M4 and the North and South Circular Roads. There is excellent street parking on meters a few steps away at Hammersmith Underground Station is nearby. Call in and see us soon.



in our **CATALOGUE**

320 big pages packed with data and pictures of over 5,500 items

Over 100,000 copies sold already!
Don't miss out on your copy.
On sale now in all branches
WH Smith price £1.

In case of difficulty check the coupon below

by **MAIL ORDER**
A first service you can rely on

- * Same day service on in-stock lines
 - * Very large percentage of our stock lines in stock
 - * All prices include VAT
 - * Large range of all the most useful components
 - * First class reply paid envelope with every order
 - * Quality components—no rejects—no returns
 - * Competitive prices
 - * Your money is safe with a reputable company
- On price, service, stock, quality and security it makes sense now more than ever to make **MAPLIN** your first choice for components every time!

make it easy... with MAPLIN

The **Maplin Matinée**
Amazing value for only £299.95 plus £39.50 for cabinet (if required) (carriage extra)

Easy to build, superb specification. Comparable with organs selling for up to £1,000. Send for our new book giving full construction details, order as XH56K price £ 2.50 inclusive.



Post this coupon now.

E 1181

Please send me a copy of your 320 page catalogue. I enclose £1.25 (incl. 25p p&g) If I am not completely satisfied I may return the catalogue to you and have my money refunded. If you live outside the U.K. send £1.60 or 12 International Reply Coupons

Name _____

Address _____

MAPLIN ELECTRONIC SUPPLIES LTD.

All mail to: P.O. Box 3, Rayleigh, Essex SS6 8LR. Tel: Southend (0702) 554155 Sales: (0702) 552911