

elektor

77

September 1981

U.K. 60p

up-to-date electronics for lab and leisure

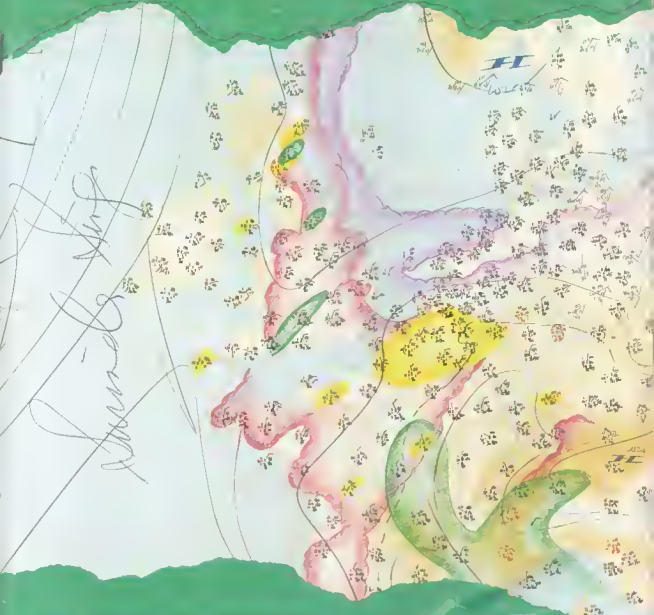

Electronic barometer

the new Quad

chattering
chips?

selektor UK-12

DFM + DVM 9-02
This article combines a digital frequency counter with the 2½ digit DVM published in the February 1981 edition of Elektor. A reasonable degree of accuracy is provided by a crystal timebase.

revolution counter 9-07
Two opto detectors and an up/down counter with a digital display form the basis of this revolution counter. It can be used with any device that uses turning wheels.

digital barometer 9-12
This article features ICs with a difference in a circuit that incorporates both pressure and temperature transducers and indicates the levels measured on a digital display.

dB converter 9-20
The converter described in this article enables the Elektor sweep generator to display frequency response curves on an oscilloscope in levels of dB.

TV games extended 9-22
This extension board for the TV games computer almost triples the available memory space. As an added bonus, two sound effects generators are also included on the board.

disco lights controller 9-29
The controller featured in this article will perform equally well as some of the more expensive systems available.

QUAD ESL 63 9-32
The 3-micron polyester diaphragm uses electronic conduction obtained by doping it with one donor atom to about ten million non-conductive atoms... a new language when related to loudspeakers! The new QUAD electrostatic... in depth.

analogue LED display 9-38
This circuit can be used in voltmeters, revolution counters, humidity meters, thermometers and in fact virtually any meter that requires an analogue indication.

volt/ammeter for power supplies (P. Gabler) 9-40
The circuit published here enables a DVM with an automatic range switch to measure both current and voltage on stabilised power supplies.

chattering chips 9-43
With talking computers, washing machines and telephone exchanges just over the horizon, it is worth taking a look at the principles involved.

transistor ignition update 9-48

soldering aluminium 9-48

missing link 9-48

market 9-49

advertisers index UK-22

contents

CONTENTS

EDITOR:
P. Holmes

UK EDITORIAL STAFF
T. Oay E. Rogans
P. Williams

TECHNICAL EDITORIAL STAFF
J. Barendrecht
G.H.K. Dam
E. Krampelsauer
G. Nachbar
A. Nachtmann
K.S.M. Walraven

elektor 37
September 1981
UK 03



Digital barometer
The new board
capable of
measuring

Sum de Engel



ELEKTOR BOOK SERVICE



JUNIOR COMPUTER BOOK 1 — for anyone wishing to become familiar with (micro)computers, this book gives the opportunity to build and program a personal computer at a very reasonable cost.

Price — UK £4.25 Overseas £4.45

JUNIOR COMPUTER BOOK 2 — follows in a logical continuation of Book 1, and contains a detailed appraisal of the software. Three major programming tools, the monitor, an assembler and an editor, are discussed together with practical proposals for input output and peripherals.

Price — UK £4.75 Overseas £4.95

300 CIRCUITS for the home constructor — 300 projects ranging from the basic to the very sophisticated.

Price — UK £3.50 Overseas £3.70

DIGIBOOK — provides a simple step-by-step introduction to the basic theory and application of digital electronics and gives clear explanations of the fundamentals of digital circuitry, backed up by experiments designed to reinforce this newly acquired knowledge. Supplied with an experimenter's PCB.

Price — UK £5.00 Overseas £5.20

FORMANT — complete constructional details of the Elektor Formant Synthesiser — comes with a FREE cassette of sounds that the Formant is capable of producing together with advice on how to achieve them.

Price — UK £4.50 Overseas £4.70

SC/MPUTHER (1) — describes how to build and operate your own microprocessor system — the first book of a series — further books will show how the system may be extended to meet various requirements.

Price — UK £3.70 Overseas £3.90

SC/MPUTHER (2) — the second book in the series. An updated version of the monitor program (Elbug III) is introduced together with a number of expansion possibilities. By adding the Elekterminal to the system described in Book 1 the microcomputer becomes even more versatile.

Price details on order card.

BOOK 75 — a selection of some of the most interesting and popular construction projects that were originally published in Elektor issues 1 to B.

Price — UK £3.50 Overseas £3.70

When ordering please use the Elektor Readers' Order Card in this issue (the above prices include p. & p.)

SERVICES TO READERS

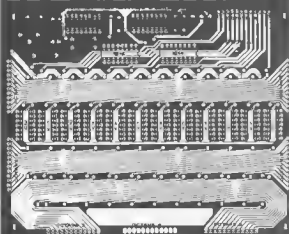

EPS print service

Many Elektor circuits are accompanied by printed circuit designs. Some of these designs, but not all, are also available as ready-etched and pre-drilled boards, which can be ordered from any of our offices. A complete list of the available boards is published under the heading 'EPS print service' in every issue. Delivery time is approximately three weeks.

It should be noted however that only boards which have at some time been published in the EPS list are available, the fact that a design for a board is published in a particular article does not necessarily imply that it can be supplied by Elektor.

Technical queries

Please enclose a stamped, self-addressed envelope, readers outside UK please enclose an IRC instead of stamps.

Letters should be addressed to the department concerned - TOE (Technical Queries). Although we feel that this is an essential service to readers, we regret that certain restrictions are necessary:

1. Questions that are not related to articles published in Elektor cannot be answered
2. Questions concerning the connection of Elektor designs to other units (e.g. existing equipment) cannot normally be answered, owing to a lack of practical experience with those other units. An answer can only be based on a comparison of our design specifications with those of the other equipment.
3. Questions about suppliers for components are usually answered on the basis of advertisements, and readers can usually check these themselves.
4. As far as possible, answers will be on standard reply forms.

We trust that our readers will understand the reasons for these restrictions. On the one hand we feel that all technical queries should be answered as quickly and completely as possible, on the other hand this must not lead to overloading of our technical staff as this could lead to blown fuses and reduced quality in future issues.

Get a great deal from Marshall's

FRANZISONS - JUST SOME OF OUR LARGE RANGE

7N079	28	2N2106	12	2N4903	150	8C142	12	8D111	50
7N131	28	2N2107	12	2N6801	15	8C138	12	8D138	40
7N150	12	2N2108	11	2N6533	28	8C148	28	8D181	16
7N181	18	2N2111	12	2N6810	12	8C168	14	8D182	20
7N182	18	2N2114	100	2N6532	16	8C180	12	8D191	12
7N191	35	2N2118	138	2N6548	15	8C187	12	8D202	70
7N200	208	2N2122	150	2N6810	20	8C188	12	8D204	30
7N205	58	2N2211	186	2N6814	80	8C192	12	8D206	40
7N211	25	2N2122	186	2N6812	80	8C193	18	8D238	30
7N212	22	2N2196	40294	2N6812	50	8C195	11	8D240	40
7N288	24	2N2150	150	40212	50	8C192	11	8D242	42
7N248	45	7N3181	150	40218	80	8C192	18	8D244	50
7N2114	12	2N2194	12	40262	20	8C182	12	8D246	45
7N2884	28	2N2194	12	40268	20	8C138	12	8D248	45
7N2905	28	2N3854A	28	AC121	20	8C184	12	8D248	45
7N2901	28	2N3856A	28	AC128	24	8C206	12	8D251	150
7N2963	32	2N3855	14	AC132	30	8C212	12	8F254	15
7N3054	20	2N3808	15	AC188	30	8C113	12	8F271	20
7N3050	20	2N3867	76	AC188	35	8C214	12	8F281	20
7N3085	25	2N4036	48	AC181	48	8F250	12	8F281	22
7N3293	14	2N4028	13	AF182	45	8C341	12	8F250	21
7N3292	11	2N4028	12	AF108	12	8C338	12	8F250	20
7N3440	50	2N4149	13	AF308	12	8C348	12	7F340	85
7N3441	80	2N4294	15	AF139	12	8C358	12	1N414	55
7N3620	15	2N4298	12	8C108	16	8C358	20	7F116	81
7N3642	15	2N4682	15	8C128C	16	8C261	20	7F131	60
7N3643	15	2N4682	15	8C118	16	8C172	20	7F139	60
7N3702	12	2N4688	180	8C118	18	8D116	25	2F303	16
7N3705	12	2N4691	125	8C138	12	8D116	25	2F303	14

LINEAR INTEGRATED CIRCUITS

LV 2N12	206	5AA 509D	5 11
CP8212	105	5AA 509D	5 11
LV 1201 N	205	5AS 510	146
LV 1214 H	54	5AS 510	146
LV 1221 C	112	5AS 580	854F
LV 301 AH	12	5TF 6800A	4
LV 311 I	150	5TF 6801A	4
LV 380 U4	70	5TF 6821 A	320
LV 381 N	144	5H1 8003 H	240
LV 382	180	5H1 8003 H	180
LV 380 U	95	5H1 8112 U	130
LV 380 U H	25	5H1 8115 H	135
LV 172 C 14	80	5H1 8229 H	125
LV 141 H 14	51	5H1 8176 H	115
LV 1002	44	5H1 8866	140
LV 1303	125	5AA 362	100
LV 1801	204	5AA 521	25
LV 1811	375	5AA 700	245
LV 1872	375	18A 128	26
LV 2014	288	5TA 511 C	270
HP 544 A	156	5TA 818 S	380
NE 556	25	1CA 270 S	215
NE 506	165	TCA 110	285
NE 558	311	TCA 830 S	128
NE 581	108	TDA 1026	240
NE 584	153	TDA 2040	245
NE 510	425	10A 2611	140
5AA 509D	284	10D 811 CP	32
5AA 5011	111	10D 84 CN	120
5AA 5020	323		
5AA 5030	824		

DIGITAL CIRCUITS

CD4000	03 18	CD4096	08 81
CD4001B	02 20	CD4098	02 25
CD4002	02 20	CD4099	02 25
CD4001	02 20	CD4099S	02 25
CD4009	01 16	CD4510	08 90
CD4008	02 20	CD4511	08 90
CD4010	02 20	CD4512	08 90
CD4011B	02 20	CD4514	08 90
CD4012	02 20	CD4520	08 90
CD4013B	02 20	CD4521	08 90
CD4014	02 20	CD4522	08 90
CD4015	02 20	CD4523	08 90
CD4016	02 20	CD4524	08 90
CD4017	02 20	CD4525	08 90
CD4018	02 20	CD4526	08 90
CD4019	02 20	CD4527	08 90
CD4020	02 20	CD4528	08 90
CD4021	02 20	CD4529	08 90
CD4022	02 20	CD4530	08 90
CD4023	02 20	CD4531	08 90
CD4024	02 20	CD4532	08 90
CD4025	02 20	CD4533	08 90
CD4026	02 20	CD4534	08 90
CD4027	02 20	CD4535	08 90
CD4028	02 20	CD4536	08 90
CD4029	02 20	CD4537	08 90
CD4030	02 20	CD4538	08 90
CD4031	02 20	CD4539	08 90
CD4032	02 20	CD4540	08 90
CD4033	02 20	CD4541	08 90
CD4034	02 20	CD4542	08 90
CD4035	02 20	CD4543	08 90
CD4036	02 20	CD4544	08 90
CD4037	02 20	CD4545	08 90
CD4038	02 20	CD4546	08 90
CD4039	02 20	CD4547	08 90
CD4040	02 20	CD4548	08 90
CD4041	02 20	CD4549	08 90
CD4042	02 20	CD4550	08 90
CD4043	02 20	CD4551	08 90
CD4044	02 20	CD4552	08 90
CD4045	02 20	CD4553	08 90
CD4046	02 20	CD4554	08 90
CD4047	02 20	CD4555	08 90
CD4048	02 20	CD4556	08 90
CD4049	02 20	CD4557	08 90
CD4050	02 20	CD4558	08 90
CD4051	02 20	CD4559	08 90
CD4052	02 20	CD4560	08 90
CD4053	02 20	CD4561	08 90
CD4054	02 20	CD4562	08 90
CD4055	02 20	CD4563	08 90
CD4056	02 20	CD4564	08 90
CD4057	02 20	CD4565	08 90
CD4058	02 20	CD4566	08 90
CD4059	02 20	CD4567	08 90
CD4060	02 20	CD4568	08 90
CD4061	02 20	CD4569	08 90
CD4062	02 20	CD4570	08 90
CD4063	02 20	CD4571	08 90
CD4064	02 20	CD4572	08 90
CD4065	02 20	CD4573	08 90
CD4066	02 20	CD4574	08 90
CD4067	02 20	CD4575	08 90
CD4068	02 20	CD4576	08 90
CD4069	02 20	CD4577	08 90
CD4070	02 20	CD4578	08 90
CD4071	02 20	CD4579	08 90
CD4072	02 20	CD4580	08 90
CD4073	02 20	CD4581	08 90
CD4074	02 20	CD4582	08 90
CD4075	02 20	CD4583	08 90
CD4076	02 20	CD4584	08 90
CD4077	02 20	CD4585	08 90
CD4078	02 20	CD4586	08 90
CD4079	02 20	CD4587	08 90
CD4080	02 20	CD4588	08 90
CD4081	02 20	CD4589	08 90
CD4082	02 20	CD4590	08 90
CD4083	02 20	CD4591	08 90
CD4084	02 20	CD4592	08 90
CD4085	02 20	CD4593	08 90
CD4086	02 20	CD4594	08 90
CD4087	02 20	CD4595	08 90
CD4088	02 20	CD4596	08 90
CD4089	02 20	CD4597	08 90
CD4090	02 20	CD4598	08 90
CD4091	02 20	CD4599	08 90
CD4092	02 20	CD4600	08 90
CD4093	02 20	CD4601	08 90
CD4094	02 20	CD4602	08 90
CD4095	02 20	CD4603	08 90
CD4096	02 20	CD4604	08 90
CD4097	02 20	CD4605	08 90
CD4098	02 20	CD4606	08 90
CD4099	02 20	CD4607	08 90
CD4100	02 20	CD4608	08 90
CD4101	02 20	CD4609	08 90
CD4102	02 20	CD4610	08 90
CD4103	02 20	CD4611	08 90
CD4104	02 20	CD4612	08 90
CD4105	02 20	CD4613	08 90
CD4106	02 20	CD4614	08 90
CD4107	02 20	CD4615	08 90
CD4108	02 20	CD4616	08 90
CD4109	02 20	CD4617	08 90
CD4110	02 20	CD4618	08 90
CD4111	02 20	CD4619	08 90
CD4112	02 20	CD4620	08 90
CD4113	02 20	CD4621	08 90
CD4114	02 20	CD4622	08 90
CD4115	02 20	CD4623	08 90
CD4116	02 20	CD4624	08 90
CD4117	02 20	CD4625	08 90
CD4118	02 20	CD4626	08 90
CD4119	02 20	CD4627	08 90
CD4120	02 20	CD4628	08 90
CD4121	02 20	CD4629	08 90
CD4122	02 20	CD4630	08 90
CD4123	02 20	CD4631	08 90
CD4124	02 20	CD4632	08 90
CD4125	02 20	CD4633	08 90
CD4126	02 20	CD4634	08 90
CD4127	02 20	CD4635	08 90
CD4128	02 20	CD4636	08 90
CD4129	02 20	CD4637	08 90
CD4130	02 20	CD4638	08 90
CD4131	02 20	CD4639	08 90
CD4132	02 20	CD4640	08 90
CD4133	02 20	CD4641	08 90
CD4134	02 20	CD4642	08 90
CD4135	02 20	CD4643	08 90
CD4136	02 20	CD4644	08 90
CD4137	02 20	CD4645	08 90
CD4138	02 20	CD4646	08 90
CD4139	02 20	CD4647	08 90
CD4140	02 20	CD4648	08 90
CD4141	02 20	CD4649	08 90
CD4142	02 20	CD4650	08 90
CD4143	02 20	CD4651	08 90
CD4144	02 20	CD4652	08 90
CD4145	02 20	CD4653	08 90
CD4146	02 20	CD4654	08 90
CD4147	02 20	CD4655	08 90
CD4148	02 20	CD4656	08 90
CD4149	02 20	CD4657	08 90
CD4150	02 20	CD4658	08 90
CD4151	02 20	CD4659	08 90
CD4152	02 20	CD4660	08 90
CD4153	02 20	CD4661	08 90
CD4154	02 20	CD4662	08 90
CD4155	02 20	CD4663	08 90
CD4156	02 20	CD4664	08 90
CD4157	02 20	CD4665	08 90
CD4158	02 20	CD4666	08 90
CD4159	02 20	CD4667	08 90
CD4160	02 20	CD4668	08 90
CD4161	02 20	CD4669	08 90
CD4162	02 20	CD4670	08 90
CD416			

Book 2 in The Junior Computer Series

book 2



Price
£ 4.75
in UK.

AVAILABLE
NOW.

Junior Computer Book 2

This, the second in the Junior Computer Book series, follows in a logical continuation of book 1 and is an indispensable aid to users of the Junior Computer.

The book contains a detailed appraisal of the software. Three major programming tools, the monitor, an assembler and an editor are discussed in detail together with practical proposals for input output and peripherals. The complete source listing with relevant comments for all described programs, and the entire contents of the EPROM, are included.

THE JUNIOR COMPUTER BOOK 2 IS AVAILABLE NOW from

Elektor Publishers, 10 Longport, Canterbury, Kent, CT1 1PE.

An order card is enclosed in this issue for your convenience.

Price U.K. £ 4.75, overseas £ 4.95 postage and packing inclusive.

INTRODUCING— from Elektor

sc/mputer (2)

build your own
microcomputer system

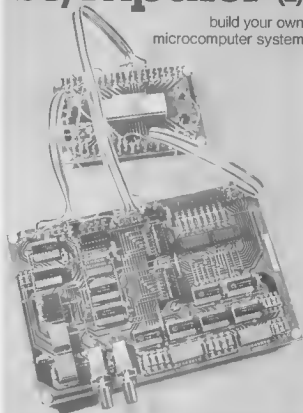

Elektor publishers Ltd

This is the second in a series of books describing the construction and operation of a personal computer system that can be as large or as small as the constructor desires.

An updated version of the monitor program (Elbug II) is introduced together with a number of expansion possibilities. By adding the Elekterminal (ASCII keyboard and video interface) to the system described in Book One the microcomputer becomes even more versatile.

Book Two continues with a description of a BASIC interpreter (NIBL-E) and gives complete details of a basic microcomputer card which can be either incorporated into the system described in Book One or used separately.

The final chapter of the book gives all the information required to enable the Elektor computer to be programmed in the BASIC language.

ORDER YOUR COPY NOW

Price — UK £4.00 inc. postage and packing
Price — Overseas surface mail £4.20 inc. postage and packing

When ordering please use the Order Card in this issue

selektor SELEKTOR

HiFi in the car — possible or not?

How is it, HiFi enthusiasts ask themselves, that HiFi can function in a car where the important HiFi preconditions have not been fulfilled. This is an important question and one worthy of an answer.

HiFi equipment can work if the car is big enough, if the equipment corresponds to HiFi norms and if the background noise is non-existent. However, as most cars are not as big as a living room and do not operate noiselessly, the answer to the question must be, HiFi cannot function in a car. Why is it then that so much money is spent on electronics and amplifiers which distinguish between tuners, cassette decks, equalisers and amplifiers for high quality car music equipment and their "normal" car radio brothers? Is this not perhaps merely half the answer to the question as to whether HiFi is possible in the car? It then seems logical that the other half of the answer is yes and that HiFi is possible in the car. There are two sides to the story. In fact it is not possible but nevertheless an ever-increasing amount of car HiFi equipment is being bought!

HiFi Criteria

In fact the solution to the problem lies in the way in which one looks at the subject. As far as the equipment is concerned, there is no problem in reproducing music of HiFi quality in the car, i.e. the technical prerequisites have been met. However, the interior of a car is blatantly unsuited as a listening area for HiFi reproduction, because it has been constructed in an acoustically unfavourable way and the sound is often drowned out to an unacceptable degree by engine and background noise. To express this in a technical way: noises which are not part of the music must be below the musically desired signal so that they do not interfere with reproduction. In a quiet living room this does not constitute a problem because the background noise is at a level of between 20 and 30 dB and the volume range of HiFi reproduction being above this, at around 50 dB (the range from the lowest to the loudest sound), means that there is a reproduction level of at most around 80 dB. However, even this constitutes a volume level which might bring neighbours to bang on the wall.

In the interior of a car the situation is much more unfavourable. There, the undesired noises, caused by the moving car, are at a level of 75 to 80 dB. If one wanted to listen to music in accordance with HiFi criteria, this would mean an

additional 50 dB and at times in the car this would mean an almost unbearable volume level of over 120 dB, somewhere between a compressed air hammer and a jet engine. Of course, no human being can endure that and for that reason a HiFi compromise must be reached between theory and practice. In addition, every car radio listener is familiar with the relationship between disturbing background music and the musically desired signal. At increased speed one has to turn the radio up in order to maintain the same level of speech and music which can be achieved at lower speeds or at a standstill.

HiFi debit and HiFi credit

The compromise had led to the present possible optimum in high-quality sound reproduction in the car. Since for technical reasons the car makes it impossible to achieve the desired HiFi credit, car radio manufacturers are concentrating all their efforts on providing technical equipment which corresponds to the quality standards set by HiFi. The resulting plus on the "credit side" of the HiFi balance sheet had led to an extraordinary improvement in tone quality in contrast with the "normal" car radio mentioned in the beginning. This is the reason for the growing popularity of high-quality car music equipment conforming to HiFi standards.

All the same, considerable attention must be paid, not only to the technical specifications of receiving sections, cassette recorders, tone control sections and power amplifiers, but also and in particular to loudspeakers. What is the point of having the highest quality frequency response, if the loudspeakers are not able to reproduce this properly?

The right choice and correct installation of loudspeakers is very important owing to the increased difficulties in the interior of a car caused by the partly reflecting and partly absorbing surfaces. Unfortunately, here too there are certain limits. High volume loudspeakers cannot be installed owing to a shortage of space. Therefore special loudspeakers have to be used which are mounted in or under the dashboard, in the doors or on or in the ledge behind the back seat to produce a similar sound quality. This not only presupposes expert installation, it also means that the car HiFi enthusiast has to dig deeper into his pocket. Good loudspeakers are not cheap and one should really only buy first-rate ones.

HiFi music sources

The question as to which HiFi music sources has still to be answered. On the one hand there are the VHF programmes of the broadcasting stations, which in spite of interference from background, engine and reflection noise, often constitute a good source.

On the other hand the music lover can always fall back on cassettes, whether prerecorded or recorded by the individual on his own HiFi equipment. If the relevant criteria are observed and the available technology for car HiFi equipment is used, then this surely is the best way of achieving high-quality music reproduction in the car. In a few years, when the new digital mini-discs can be played in the car music equipment as well, sound reproduction will perhaps be even nearer perfection.

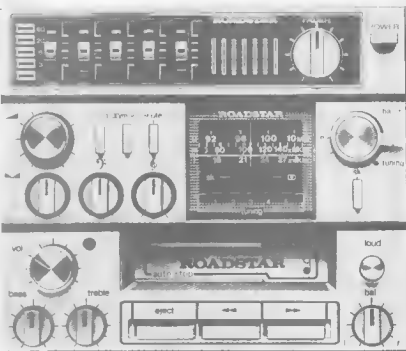

selektor

Choosing the 'right' cassette

Fe-Cr-Me: It's the coating that does it

Thirty years ago, it was a notable achievement in tape recordings to have attained something approaching the of AM radio - 5000 Hz or so. Today, by contrast, a sound quality is demanded from tapes which regards the hi-fi standard of 12,500 Hz as the very lowest limit.

In the past 15 years or so, open-reel tapes have been largely superseded - at least as far as domestic use is concerned - by the handy compact cassette, which now captures about 90 percent of the market. However, the cassettes made at the beginning of the 'tape revolution' are just as impossible to compare with those which music lovers are able to purchase today. Their dimensions remain the same - having been standardised at a very early stage, but their performance has improved tremendously. On the other hand, the purchaser is now confronted with such a wide variety of types and makes that it is wise to get to know a few things about them to be able to make the best choice for any particular requirement.

Here are a few useful tips:

The most important thing about any cassette is the magnetic tape inside it. The original ferrous oxide tape (I) was first joined by the chrome-dioxide tape (II), then came the multi-coated tape (III), in which a ferrous oxide coating is combined with a chrome-dioxide coating, followed by the super chrome-dioxide tape (III), representing a further improvement in quality - and the latest addition is the so-called metal tape (IV). The numbers shown in brackets and reproduced on the cassettes themselves are not indicative of any grade of quality, but are part of an international classification system denoting the bias adjustment recommended for the various tape categories as elaborated by the IEC (International Electronics Committee). Serving on this committee are cassette manufacturers from all the more important producing countries, whose aim is to solve the problems of international interchangeability by means of joint consultations. Now, how do these various tape classes differ?

Ferrous oxide tapes (Fe)

These cassettes can be used with all cassette players/recorders that comply with the DIN Norm.

Chrome-dioxide tapes (Cr)

These are already in the 'hi-fi league', being distinguished by an expanded response and crystal-clear treble reproduction. To exploit their performance to the full, they should be used on cassette recorders with a chrome-dioxide selector switch (marked Cr or CrO₂) or a recorder which switches over automatically.

Multi-coated tapes (FeCr)

These are cassettes of the Hi-Fi class, which combine certain advantages of ferrous oxide with those of chrome-dioxide on one tape. They are designed for universal use on all recorders, and their chief characteristic is a deliberately enhanced brilliance. Optimum performance is obtained on recorders with a special FeCr switch; for Hi-Fi requirements with an extremely wide range of applications.

Super chrome-dioxide tapes (Cr)

With these cassettes, a substantial increase in dynamic range can be obtained in the high register - up to 6 dB at frequencies between 10,000 and 20,000 Hz, a specially important factor in Hi-Fi. At the same time, the extremely low tape hiss, characteristic of chrome-dioxide, is retained.

Metal tapes (Me)

This coating pigment stipulates the use of special erasing and sound heads on the recorders. The tapes can then be even better modulated - by 3-4 dB at 315 Hz and by some 10 dB at 20,000 Hz in comparison with the DIN reference chrome-dioxide tape. These cassettes can be played on conventional recorders, but they cannot be erased and re-recorded.

Faced with this variety of tapes, the logical conclusion would seem to be to go straight for the latest type of cassette: metal tape. In reality, it is not all that simple. First of all, a new recorder is required, because of the need for new heads - and the Hi-Fi enthusiast will not be satisfied with the cheapest. Secondly, metal cassettes are a good deal more expensive than oxide cassettes, and thirdly, although it is quite certain that some technical figures are really better with metal tapes than, for instance, with chrome-dioxide tapes, some of the improvements are only perceptible to instruments, not to the human ear, which, after all, has the last say in the matter. The buyer will continue here to use the tried and true yardstick of price-to-performance relationship, which certainly does not disqualify oxide cassettes. This will also probably be the reason why metal tape cassettes have not managed to seize any sizeable share of the UK market as yet, although they have already been available for two years.

Finally, another point: the striking differences in the prices of cassettes for the user. There are, for instance,

cassettes to be had for very low prices indeed. These cassettes have one great advantage: they are cheap, very cheap! But that's about all. Whether they are good or bad is a matter of pure luck. It can seldom be seen what kind of tape is in the package. Sometimes the buyer will know, sometimes he will have no idea. When he comes to play it, he will often get quite a surprise. Sometimes it's a normal tape, sometimes a computer tape, sometimes it's an unsuitable studio tape cobbled together out of waste material. It may tie itself in knots the first time the reel revolves, or it may wear the head out in no time in the absence of any surface smoothness. Any complaints? Forget it! You can turn the carton round all ways - you won't find the name of any manufacturer.

So anyone who places importance on lastingly clean and good reproduction - full orchestral classical music included - would do well to bear this in mind: choose the right one first time - a quality cassette with a reputable trade mark. It may cost a little more, but it will save a great deal of disappointment.

*Editorial Office,
radio tv press,
Postfach/P.O.B. 19 17 40,
D-1000 Berlin 19,
W. Germany.*

692 S



1991... and Londoners continue the fight against the Martian invaders. That could have been the explanation for this photograph, but the engineers look altogether too happy about the prospect. In fact, it shows one of the four microwave dish aerials erected on the roof of the Abbey Life Building in St Paul's churchyard for transmitting television pictures of the Royal Wedding ceremony to 500 million viewers throughout the world.

British Telecom

(693 S)

As far as test equipment and measurement is concerned, the average electronics constructor has to make do with a collection of bits and pieces that happen to come to hand, usually second or third-hand at that. This is, however, exactly the type of equipment that most enthusiasts are prepared to put up with, for after all, their projects don't usually have to meet very high requirements anyway. The line has to be drawn somewhere for home building to be viable (there is no tax relief on transistors and ICs).

The two items of test equipment

DFM + DVM

digital measurement of frequency and voltage

Any additions to the range of test equipment available to the home constructor are always welcome. This article combines an economical digital frequency counter with the 2½ digit DVM published in the February 1981 edition of Elektor. Absolute accuracy was considered of secondary importance to economy and the use of readily available components, although the circuit does use a crystal controlled timebase.

described in this article constitute a step in the right direction for the home constructor. The 2½ digit DVM published in the February issue provides a reasonable degree of accuracy using fairly common components. The next stage is to combine the DVM with a digital frequency meter that has an acceptable 2 MHz range, a 3½ digit display and a 'real' crystal timebase.

The DFM-plus-DVM consists of two printed circuit boards; the main board and the display. The original display board of the DVM has been retained while the remainder of the DVM circuit is combined with the frequency counter on a new main board. This results in two items of test equipment at very reasonable cost.

The circuit diagram

The complete circuit is drawn in figure 1. The area inside the dotted line represents the display section as used in the DVM. The only changes required are the addition of the extra display and its driver transistor Dp4 and T4, and an increase in the value of R8.

The timebase circuit can be seen at the bottom of the diagram. The crystal controlled oscillator generates a frequency of 3.2768 MHz. This is then divided by a factor of 2¹⁴ by IC3 and then by another 200 by IC4 and IC5a together. The Q4a output of IC5a then produces the clock frequency of precisely 1 Hz. At each negative going clock pulse the differentiators, N1 and N2, originate a latch pulse and then a reset pulse which are passed on to IC1. The width of each of these pulses is about 1 µs which is so short that the error it causes in the reading is negligible. Once every second, therefore, the contents of the counter in IC1 are passed on to the display buffer (latch) and immediately afterwards the counter is reset to start the count once again. It should be noted that display of Dp1 is suppressed whenever a zero exists in this position.

The input signal for the DFM enters the input amplifier via the decoupling capacitor C9 while the combination of R15, D2 and D3 serve to protect the gate of the FET T8 against any excessive input voltage levels. The amplifier stages built around T8 and T9 each amplify the signal by a factor of ten, so that the total amplification of the input amplifier is a factor of 100. The amplified signal is then fed to the Schmitt trigger N4. The DC voltage at the input of this gate can be preset by means of P1 to a level exactly half-way between the positive and negative trigger thresholds of the gate. The DFM input will then be set at its maximum sensitivity.

Three decade counters (divide-by-tens) follow the Schmitt triggers to provide a total of four measurement ranges. The outputs of N4 and the dividers are fed to the range switch S2a which selects one and passes the signal, via S3a (selects either DFM or DVM), to the clock input of IC1.

The S2b wiper of the range switch ensures that the decimal point is

Technical specifications for the DFM + DVM

	DFM	DVM
Number of digits	3½	2½
Range	10 Hz ... 2 MHz	10 mV ... 200 V
Input sensitivity	< 15 mV _{RMS} (f < 1 MHz) < 30 mV _{RMS} (f > 1 MHz)	---
Input impedance	1 MΩ	1 MΩ
Accuracy	± 0.05% (full scale)	± 0.5% (full scale)
Max. input voltage	100 V _{RMS}	200 V

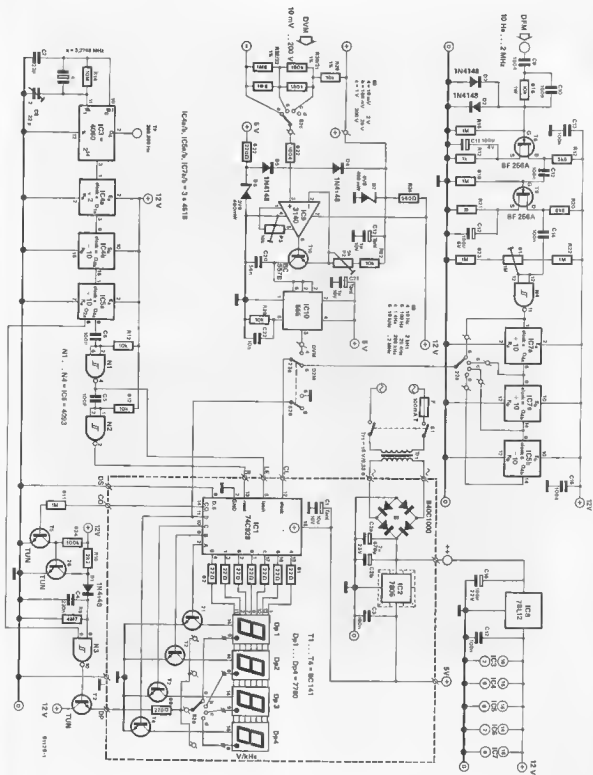

Figure 1. The circuit diagram for the DFM + DVM. A 'real' crystal timebase assures sufficient accuracy.

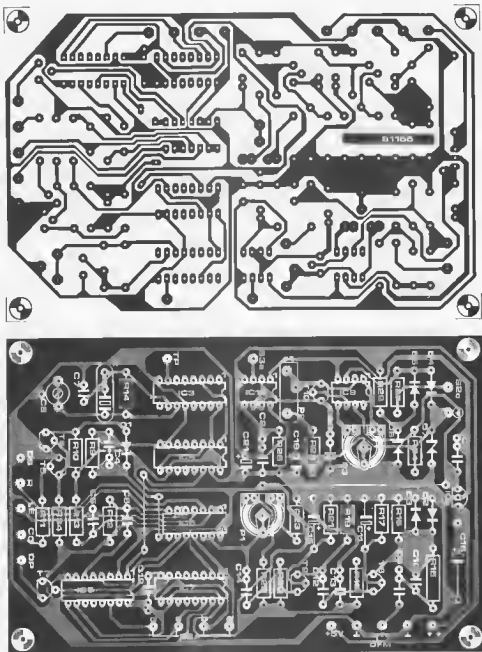

Figure 2. The printed circuit and component overlay of the main board. This includes both the frequency counter and voltmeter sections.

positioned in the correct place. The decimal point also doubles as an over-range indicator. As in the DVM this uses the carry-out output of IC1 which will produce pulses at the rate of one per second when the maximum count (1999) has been exceeded. Since IC1 operates at 5 V, the pulses have to be 'translated' into 12 V and then rectified to provide a logic 1 level for switching N3. A square wave produced by another output

of IC5a in the timebase then becomes the controlling signal (at the other input of N3) that, via T7, causes the decimal point to flash. It will continue to do so until either switch S2 is correctly positioned or the offending input is removed.

A full description of the DVM circuit was published in the February issue. The circuit remains unchanged with the exception of a few modified component

values to accommodate the new timebase. As previously mentioned, switch S3 selects either DVM or DFM. In the DVM position the display Dp4 is switched off as due to the accuracy of the a/d converter, only three figures are needed.

The power supply has been kept simple with two regulators, IC2 and IC8, to produce the 5 and 12 volts required. It will be as well to provide IC2 with a

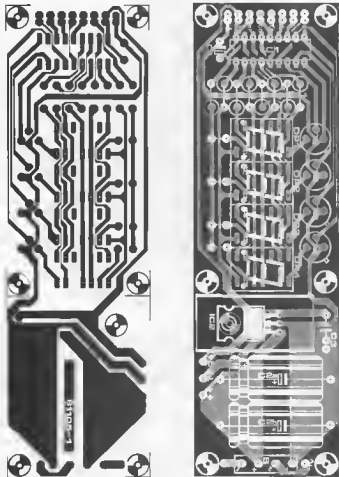

Figure 3. The display board includes the area inside the dotted line shown in figure 1.

substantial heat sink if it is to be kept in one place.

It should be noted that S2 acts as a range switch for both the voltmeter and the frequency counter and will therefore require two scale legends. For instance, switch position (a) will have 10 mV... 2 V and 10 Hz... 2 kHz as its two ranges. One suggestion would be to place a range vertically either side of the control knob. A further set of contacts on S3 could then be used to light a LED above each set of ranges to show which was selected. However, we are sure that readers will have their own ideas.

Construction

The printed circuit board layout and the component overlay for the main board and the display board are shown in figures 2 and 3.

The transformer will have to be a little larger than that required by the original DVM circuit due to the 12 V required. The power supply section of the display board can be assembled in a slightly unorthodox manner to improve the space situation behind a front panel. Figure 4 illustrates the component positions. Capacitors C2a and C2b may be replaced by a single 1000 μ /25 V type and be fitted on the underside of the board as shown. To improve the clearance problem even further, the regulator IC2 and its heat sink may also be fitted under the board but take care not to be confused with the wiring connections. If you're still stuck for space, the bridge rectifier can also be mounted on the track side of the board.

A handy little trick for raising the displays is to place two IC sockets under each display as shown. After assembly of the two boards is complete, the wire connections between the boards can be

Parts list for the main board:

Resistors:

R9 = 4M7
 R10 = 2k2
 R11, R16, R19, R22, R23 = 1 M
 R12, R13, R25, R26 = 10 k
 R14 = 10 M
 R15 = 10 k/1 W
 R17, R21 = 1 k
 R18, R20 = 5k6
 R24 = 560 Ω
 R27, R34 = 100 k
 R28 = 220 Ω
 R29 = 10 k, 1%
 R30, R31 = 180 k, 1%
 R32, R33 = 1M8, 1%
 P1 = 1 M preset
 P2 = 5 k multiterm preset
 P3 = 10 k preset

Capacitors:

C4 = 220 n
 C5, C6, C10 = 100 p
 C7 = 22 p
 C8 = 2... 22 p trimmer
 C9, C12, C13, C14, C17,
 C18 = 100 n
 C11, C15 = 100 μ /4 V
 C16 = 100 μ /25 V
 C19, C21 = 1 μ /10 V tantalum
 C20 = 56 n
 C22 = 10 n

Semiconductors:

T5... T7 = TUN
 T8, T9 = BF 256A
 T10 = BC 557B
 D1... D5 = 1N4148
 D6 = 3V9 zener diode 400 mW
 D7 = 5V8 zener diode 400 mW
 IC3 = 4060
 IC4, IC5, IC7 = 4518
 IC6 = 4093
 IC8 = 78L12
 IC9 = 3140 (DIL)
 IC10 = 555

Miscellaneous:

X = 3.2768 MHz crystal
 Trt = 15 V/0.33 A
 = mains transformer
 F = 100 mA fuse including
 holder
 S1 = double pole mains switch
 S2 = 3 wafer, 4 way
 S3 = dpdt switch

Parts list for the display board:

Resistors:

R1... R7 = 22 Ω
 R8 = 270 Ω

Capacitors:

C1 = 10 μ /10 V tantalum
 C2a, C2b = 470 μ /25 V
 C3 = 100 n

Semiconductors:

Dp1... Dp1 = 7760
 (common cathode)
 B = B40CT000
 T1... T4 = BC 141
 IC1 = 74C928
 IC2 = 7805

Miscellaneous:

heat sink for IC2

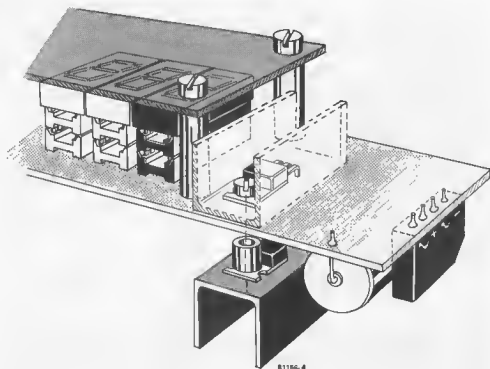

Figure 4. This shows how IC2 and its heat sink can be mounted on the circuit side of the display board. The displays can be raised above the board by placing them on IC sockets.

fitted, DS, R, LE, CD, DP, +5 V, ++ and \perp . Since it is possible that many readers have built the DVM from the original article, the changes in wiring to the present design could become somewhat chaotic. For this reason the following point to point wiring guide has been included.

S2a: e . . . d	to S2a: a . . . d main board
S2a wiper	to S3e:b
S2b: a . . . d	to decimal points on display board
S2b wiper	to display side of R8
S2c: e . . . c	to R29 . . . 33
S2c wiper	to S2c main board
S3a:a	to S3a main board
S3a wiper	to CL main board
S3b:e	to \perp display board
S3b wiper	to pin 11 IC1 display board

The resistors of the DVM input voltage divider (R29 . . . R33) are soldered directly to the switch terminals. The + point marked on the main board next to S2c is first taken to R29 on S2c and from there to the DVM + input socket

on the front panel. The DVM - input socket is connected to the a terminal of S2c. The DFM input and O can now be connected to DFM and \perp respectively on the main board. Readers may prefer to use a BNC socket for the DFM input. Finally, the transformer connections can be made.

Calibration

All that remains (after checking all the wiring again) is the calibration procedure. The timebase is the first section to be adjusted. If an accurate 6 digit frequency counter is available simply adjust C8 so that the frequency at test point TP 204,800 Hz. Otherwise, it is sufficiently accurate to set C8 roughly to the central position.

A frequency of about 1 kHz is then fed to the DFM input. With S2 switched to e and P1 left in the mid position, the amplitude of the input signal is increased until the display indicates the input frequency. The signal amplitude is then decreased until the display just stops

reading. P1 is now readjusted until the reading returns. This procedure is repeated until the input level can no longer be reduced without losing the display altogether (that is, adjustment of P1 is unable to return it). Care is required during this stage of the calibration since it sets the maximum sensitivity of the input amplifier.

To calibrate the DVM section of the circuit the DVM inputs must first be shorted together. Switch S3 must be set to the lowest range (position a) and P3 is turned fully clockwise. Now "back off" P3 until .00 appears on the display. If a reference voltage is not available, connect a DC voltage of about 1 V (a battery!) and adjust P3 while comparing the reading with an accurate meter.

It is as well to remember that all future readings of the equipment in use will depend on the accuracy of the initial calibration.

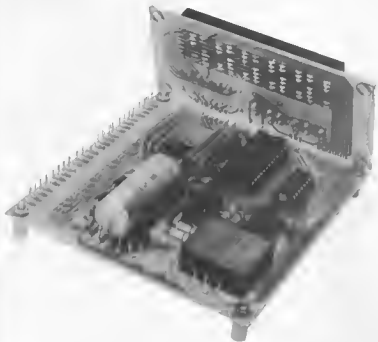

Judging by people's reactions at the electronics fair, this revolution counter can serve a variety of purposes. One favourite 'application' involves trying to "trick" the device into giving a wrong indication by simply turning it backwards and forwards for a time. Readers are assured, however, that that gets to be pretty frustrating pastime after a while, for provided the counter is constructed in the proper manner, it is very difficult to 'lead it up the garden path'. However slowly or quickly you turn it backwards and forwards, it will imperturbably give the correct indication.

Thus, any device that is based on turning wheels and that can be connected by mechanical means to the counter can be checked with it.

The up/down counter

What does the rev counter look like? To start with, the design is surprisingly straightforward. This should put pessimistic readers' minds at rest who always fear the worst and who almost always underestimate their own capabilities.

The simplified block diagram in figure 1 shows that there is really nothing to worry about. All it consists of are two opto detectors, a simple logic circuit, an (integrated) up/down counter and an LED display.

Photo 1 illustrates the small vaned or slotted wheel that is turned by the device of which the revolutions are to be counted. The vanes of the wheel move into the slots of the opto detectors and so periodically interrupt the light beam between the LEDs and the phototransistor. One opto detector is already enough to give a correct pulse count. If two are used, the direction can be indicated ("up" or "down"). In other words the counter counts either up or down, depending on the direction in which the counter wheel is turning. The device counts the number of transitions from light-to-dark and vice versa. After one revolution the display will indicate twice the number of slots in the wheel.

revolution counter

counts both up and down

An up/down counter and two opto detectors with an LED display form a relatively easy to build and highly accurate counter. Since the cost of components is kept to an absolute minimum, the device has infinite possibilities for hobbyists ranging from amateur sound technicians to photographers. Recently, a prototype model was exhibited at an electronics fair in Germany and was found to be surprisingly popular.

1

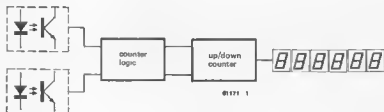

Figure 1. The block diagram of the revolution counter. The direction of rotation and number of turns are detected by two opto detectors. The information is then decoded and passed on to an up/down counter.



Photo 1. The opto detectors are positioned so that the light beam passing from the LED to the photo transistor is broken by the spokes of the turning wheel.

The circuit diagram

The full circuit diagram is shown in figure 2. As you can see very few components are required. This is partly due to the fact that a lot of what is needed is already integrated in the MK 50398N IC. This IC has been used in Elektor before in the 'mini counter' and the '1/2 GHz counter' (June '78) and contains an up/down counter, full display control and a preset facility. The latter is achieved by connecting diodes D1...D24 with the aid of thumb-wheel switches (or wire links) to points DT1...DT6. A certain number can then be programmed which will appear on the six digit LED display after the 'load' switch S2 is pressed.

The control information for the circuit is derived by the opto detectors IC6 and IC7 and the decode logic following them. With the circuit illustrated in figure 3, this takes care of the 'count' and 'up/down' signals. Figure 4 shows how the two sensors have to be mounted. They are moved with respect to each other until there is a phase angle of 90° between the pulse signals produced. This means that when opto detector IC6 is completely covered, IC7 will be in a transition period. The detectors register the light-to-dark transitions, which brings us to the pulse flow chart in figure 5.

Let's look at figure 5a first. The signals which are 90° phase-shifted are shown at the top of the diagram. The up/down information is taken from these with the aid of N12. If the output states of N8 and N9 are equal, the output of N12 will be high, if they aren't equal, it will be low.

Now for the count pulses. These should not reach the counter IC until the up/down information has established whether they should be added to or subtracted from the pulse count. For this reason, the beginning of each pulse

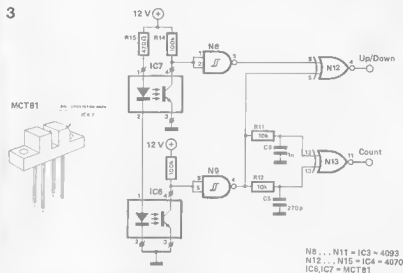

N8...N11 = IC3 = 4093
N12...N15 = IC4 = 4070
IC6, IC7 = MCT81

Figure 3. The information from the opto detectors is decoded by this circuit.

4

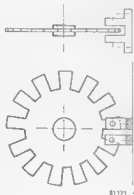

Figure 4. The positioning of the opto detectors is fairly critical. When one is in a dark-to-light transition (IC7) the other should be fully covered (IC6).

is delayed slightly by way of R12/C9. As figure 5a shows, the negative going edge of the counter pulse (output N13) is always just a little late with respect to the edges in the output signals of N8 and N12. The pulse duration is determined by the difference between the RC networks R12/C9 and R11/C8. As soon as C8 is charged, both inputs of N13 will have the same logic level, so that the output will go high again.

Figure 5b, on the other hand, shows what happens when the wheel is turned in the opposite direction. Again, there is a 90° phase shift between N8 and N9, only this time in a different direction. The counter pulses (output N13) therefore do not coincide with the positive but with the negative half periods in

5

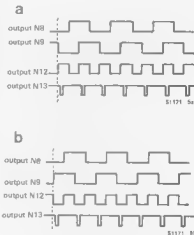

Figure 5. The waveforms of the decoder in figure 3. Illustrations a and b each correspond to a different direction.

the up/down signal produced by N12. In addition, the rev counter is provided with a zero stop. The carry signal produced by IC1 offers this facility, so it might as well be used and the circuit is shown in figure 6. When the display passes from count '999999' to '000000' or vice versa, a pulse is produced at the carry output which operates a relay via flipflop N10/N11. If the system is used in a cassette recorder for instance, the recorder motor can be switched off with a relay. Pressing S3 will reset the device and the cassette recorder can be started again.

Construction

First a few general remarks. Although it is extremely handy that the MK 50398N

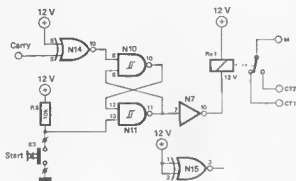

Figure 6. The circuit of the automatic switching facility provided by the 'carry' output of the up/down counter. N15 is an unusual gate.

IC can control an LED display directly, it should be taken into account that this will produce considerably heat. To prevent this from getting the better of the IC, it is advisable to use good quality displays like the type recommended. The segment current is set at 20 mA. This level should not be exceeded; in fact, preferably it should be lower than that, so choose slightly higher values for R1...R7.

The values of resistors R13...R15 may also need modifying. For the detectors IC6 and IC7 to produce clearly defined logic zeros and ones, it is important to make sure that the counter wheel is constructed correctly. Sometimes it may be necessary to try out various resistor values and so empirically establish the correct setting for the two opto detectors. Not more than 50 mA should pass through the detector LEDs!

Figure 7 shows the printed circuit board for the rev counter. This consists of two sections which can be separated if required. This allows the display and switch section to be mounted at right angles to the rest of the circuit, see the illustration in photo 2. Points 1...6, a...g, S1...3, +12 V and ground in both sections should be connected to each other with wire links.

Readers who do not intend to 'pre-program' a certain count, can omit diodes D1...D24 and their associated thumb-wheel switches. This saves quite a bit of money! The relay may also be left out, if it isn't needed. As far as the displays are concerned, the circuit works equally well using only one!

The counter wheel

The wheel may be made of virtually any material: cardboard, wood, metal,

plastic, etc. The wheel in figure 2 was made of Veroboard.

The wheels in both photo 1 and figure 4 were provided with slots rather than holes. However, readers are welcome to drill holes, if they prefer. The best method of making a good wheel is to carefully draw it on paper first and then print a reduced photo of it on copper clad board. Cutting or sawing out the apertures should then be quite straightforward. You can also use a negative end glue it onto a piece of transparent perspex, as this can also be very accurate.

It does not matter how wide the holes or slots are, as long as they are all the same size. The opto detectors' position, however, is rather critical, although not to the extent shown in figure 4, where there only seems to be about half a vane between IC6 and IC7. What must be ensured is that when IC7 is in a state of transition, IC6 is completely covered by a vane — it doesn't matter which one. IC6 may also be mounted at the other side of the wheel, if this simplifies matters. This improves the device's accuracy considerably and there may even be 2½ or 3½ vanes between the detectors. The vanes should not be narrower than that of the light beam between the two halves of the opto detector.

Let's take another look at the opto detectors. These may be bought ready-made or may be home-built. Readers who wish to try their hand at constructing them themselves, need to make sure the photo transistor is well screened from the surrounding light — which is easier said than done. 'Manufactured' opto detectors fall into two categories: 'real' and 'reflective' types. Photo 3 shows both kinds. Elektor's design is based on the first type (there are a few which incorporate two detectors in a single package case!), but the reflective alternative is equally suitable.

This has the advantage that the counter wheel does not have to have slots or holes cut into it. All that has to be done is to draw a black end white chess-board pattern along the edge. This method also has the disadvantage, that it is not as reliable as it is very sensitive to any changes in ambient light.

The type of opto detector used here was the MCT81 from Monsanto. Make sure the opto detector radiates infrared light... this is invisible!

Finally, it should be noted that if the counter is to count 'up' when the wheel turns in a certain direction and it counts 'down' instead, the opto detector connections merely need to be changed round. It's as simple as that... ■

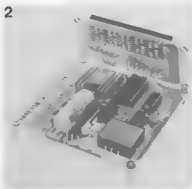

Photo 2. A suggested method of mounting the printed circuit boards is illustrated here.

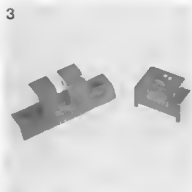

Photo 3. Two common types of opto detector, the reflective type is shown on the right and the slotted, as used in this article, is on the left.

7

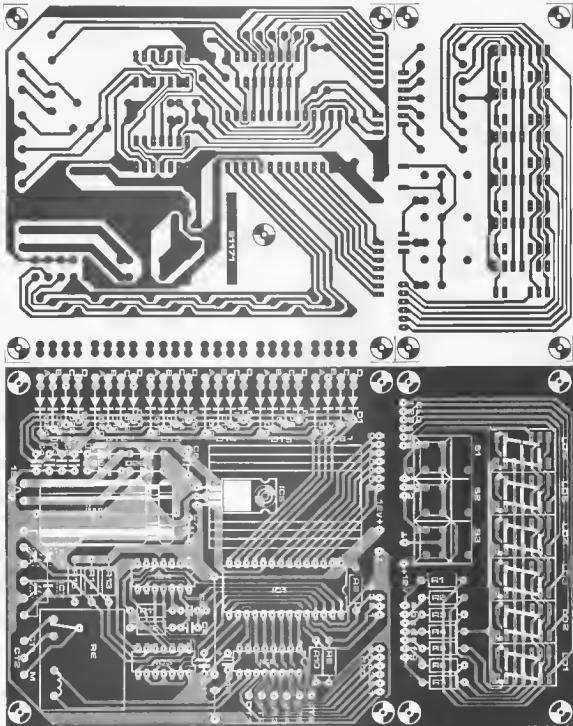

Figure 7. The printed circuit board is divided into two parts. The display section can be separated if desired.

Parts list

Resistors	Capacitors
R1 ... R7 = 270 Ω	C1 ... C4 = 150 p
R8 ... R12 = 10 k	C5 = 1000 μ /25 V
R13, R14 = 100 k	C6, C7 = 100 n
R15 = 470 Ω	C8 = 1 n
	C9 = 270 p
	C10 = 10 μ /16 V tantalum
	C11 = 120 p

Semiconductors

D1 ... D24 = 1N4148
D25 ... D28 = 1N4001
LD1 ... LD6 = 7760
(common cathode)
IC1 = MK 50398
IC2 = ULN 2003, XR 2003
IC3 = 4093
IC4 = 4070

IC5 = 7812
IC6, IC7 = MCT 81

Miscellaneous

S1 ... S3 = digitist switch
S4 = double pole switch
Tr1 = 12 V/500 mA transformer
Re = Siemens E-card relay 12 V
(V23027-A0002-A101)
F1 = 100 mA slow blow fuse

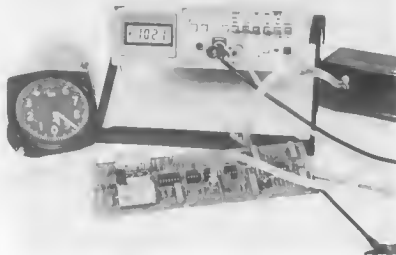

digital barometer

an electronic weather station

However hard we try, there's not much we can do about the weather, except maybe draw up a short-term forecast of the rain showers ahead and repair the roof. Recently, National Semiconductor introduced a set of transducers to lend amateur meteorologists a helping hand when building their own barometer. This article describes a circuit that incorporates both pressure and temperature transducers and indicates the levels measured on a digital display.

Technical specifications

a) The barometer section

measurement range*	0 ... 2068 mb
accuracy	
barometer range:	980 ... 1050 mb ± 2 mb ± 0.25 mb/°C
accuracy in range	0 ... 2068 mb ± 14 mb ± 0.25 mb/°C
output voltage	1 mV/mb
	0 mb = 0 V
in the 980 ... 1050 mb range	980 ... 1050 mV

b) The thermometer section

measurement range (sensor)	-40° ... +100° C
guaranteed operational temperature range (circuit)	0° ... +70° C
output voltage	10 mV/°C
	0° C = 0 V
	± 0.2 ° C
accuracy 0° ... 40° C	
data for both sections*	
current consumption at ± 15 V	30 mA maximum
output current at 9 V output	10 mA maximum

Although the idea to design a barometer for home construction has been around for some time, Elektor has had to put the project 'on ice' until only quite recently, due to a number of problems attached to it. For one thing, the pressure transducers required were so expensive that it was cheaper to buy a ready-made instrument. What is more, any attempt to build the device by less sophisticated means was doomed with failure, as its calibration called for an almost superhumanly steady hand. So it was a nice idea, but it stayed on the 'future projects' shelf to gather dust. However, recently the price of pressure transducers suddenly dropped! Now nothing, not even the difficult calibration procedure, could stand in the barometer's way. And here is the result.

An electronic pressure gauge

As any control engineer will tell you, measuring atmospheric pressure is really a straightforward job. But then that's the point of view of an expert who thinks nothing of converting mechanical values, such as stress and force, into electrical signals with the aid of highly sophisticated extensometers and the like. Anyone who tries to do the same without technical experience and armed only with a home-made inductive transducer is bound to encounter some difficulties. Fortunately, pressure transducers are now widely available on a single silicon chip, so that mechanical precision and RF know-how are no longer essential requirements. The transducers are simply soldered onto a printed circuit board and once 'the chips are down' the rest of the operation can be left to them, for their output voltage gives a direct indication of the pressure value.

The barometer described here is based on two tiny silicon strips separated by a vacuum. According to the amount of pressure exerted, the upper strip bearing four piezo-resistive resistors in the form of a Wheatstone bridge (see figure 1) will start to cave in. The resistors act as extensometers and alter in resistance when the strip bends. As a result, the voltage across the bridge will also change.

Monolithic pressure transducers contain a silicon chip bearing the four bridge resistors and sometimes an additional circuit to ensure temperature compensation. There are also 'hybrid' types which include a complete hybrid IC to look after temperature compensation, amplification and voltage control. Such ICs have the advantage that they are already fully calibrated when they leave the factory, which makes life a lot easier for the constructor. Not surprisingly, this type of luxury considerably affects the price, but since the alternative is to spend hours building a rough and ready calibration circuit, it's a question of choosing the lesser of two evils. Figure 2 provides the block diagram of a hybrid pressure transducer.

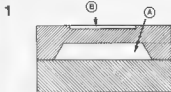

Figure 1. The basic structure of a silicon pressure transducer. The two tiny silicon strips are separated by a vacuum (A). The upper membrane bears four piezoresistive strain gauges which together form a Wheatstone bridge. When air pressure causes the upper membrane to buckle, the bridge becomes unbalanced.

The transducers

The illustration in figure 3 shows the internal structure of the monolithic pressure transducer used in this circuit, the LX 0503 from National Semiconductor. As well as a resistor bridge the device contains a 'transistor diode' to provide temperature compensation. The voltage across this 'diode', between pins 3 and 7, decreases by about 10 mV per degree centigrade. Using the recommended supply voltage of 7.5 V (at pin 3), the voltage level to the bridge at pin 7 will be about 3.5 V and a current of approximately 2 mA will pass through the bridge.

The circuit will be in a state of equilibrium in a vacuum, that is to say, 0 mb (millibar) of pressure. Ideally, the voltage level at both outputs of the bridge (pins 5 and 6) would be equal at around 1.7 V. In practice, however, there is a discrepancy of some 100 mV (offset) between the two outputs.

With a rise in pressure, the bridge loses its balance and pin 6 will become more positive and pin 5 more negative. The pressure-dependent output voltage level is very low, some 29 . . . 116 μ V per mb. The precise value varies according to the type of transducer used.

The internal transistor stage compensates the pressure-dependent voltage in temperature but cannot correct the offset voltage which also appears at the output. The offset voltage changes by between 30 and 120 μ V per degree centigrade and may rise or fall with changes in temperature . . . again, depending on the particular transducer used. Since the offset voltage is as sensitive to temperature as the transducer is to pressure, the offset voltage must have effective temperature compensation. A suitable temperature-dependent voltage is produced at pin 7 of the IC. This output, together with the bridge output at pins 5 and 6 will only supply a few milliamps of current. For readers who are interested, the technical specifications for the transducer are provided in table 1.

Table

Suitable types for IC2 and IC3

IC2, IC3 including C1, C2	excluding C1, C2	description
748, LM 301A	741	standard
LM 108, 208, 308	—	Low Power
LM 108A, 208A, 308A	725, μ A 714	Low Drift

2

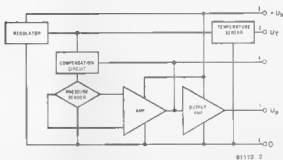

Figure 2. The block diagram of a hybrid pressure converter. In addition to the actual pressure sensor, the hybrid circuit contains the entire, calibrated and temperature compensated test circuit.

3

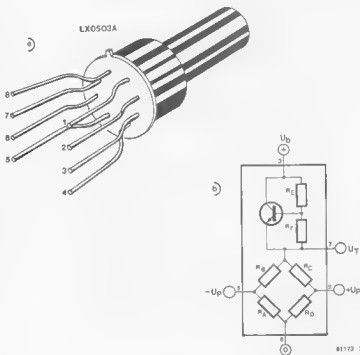

Figure 3. The barometer pressure sensor (LX0503A) viewed from the outside (3a) and from the inside (3b). The sensor produces a temperature-dependent output voltage U_T and the pressure-dependent voltage for the resistor bridge.

Designing the circuit

A few further requirements will have to be met if the transducer output voltages

4

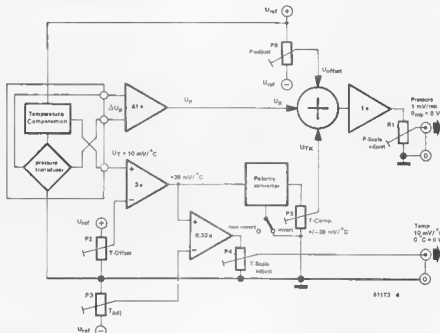

Figure 4. The block diagram of the electronic barometer. It is the task of the circuit to use the sensor outputs for temperature compensation and calibration purposes.

5a

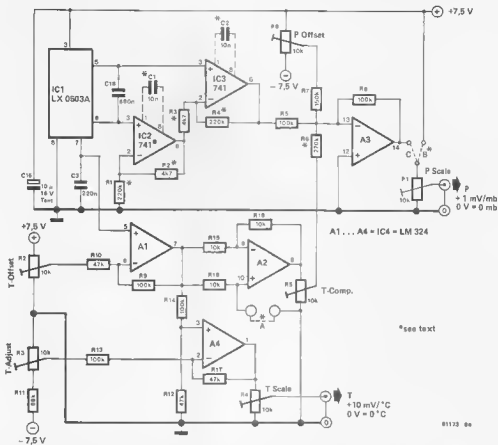

Figure 5. The complete circuit diagram of the barometer and its power supply. All the components shown, with the exception of the transformer, can be mounted on the printed circuit board.

6

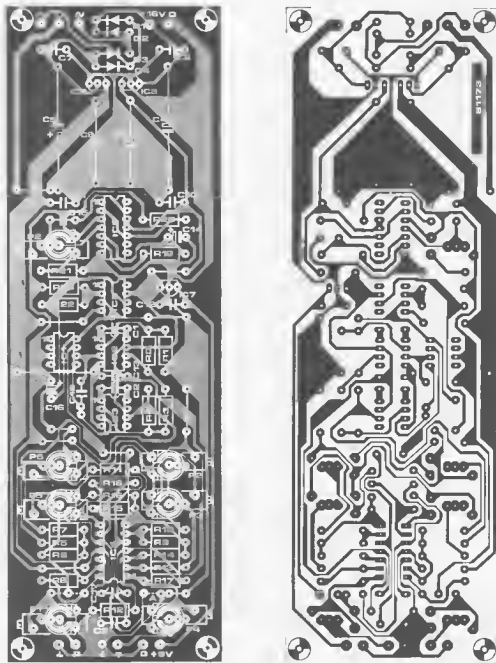

Figure 6. The printed circuit board and the component overlay for the circuit shown in figure 5.

Perts list

Resistors

R1, R4 = 220 k*
 R2, R3 = 4k7*
 R5, R8, R9, R13, R14 = 100 k
 R6 = 270 k*
 R7 = 150 k
 R10, R12, R17 = 47 k
 R11 = 68 k
 R15, R16, R18, R22, R23 = 10 k

R19 = 1k8
 R20 = 10 Ω
 R21 = 3k9
 P1, P2, P3, P4, P5, P6 = 10 k*
 preset potentiometer
 P7 = 1 k preset potentiometer

Capacitors:

C1*, C2*, C15 = 10 n
 C3 = 220 n
 C4, C5 = 1000 μ /35 V
 C6, C7, C10, C11, C12, C13,
 C17 = 100 n
 C8, C9 = 100 μ /25 V
 C14 = 4 μ 7/16 V tantalum
 C16 = 10 μ /10 V tantalum
 C18 = 680 n

Semiconductors:

D1 ... D4 = 1N4001
 IC1 = LX 0503A
 IC2*, IC3*, IC5 = 741
 IC4 = 324
 IC6 = 723
 IC7 = 78L8
 IC8 = 78L15
 IC9 = 79L15

*see text
 Miscellaneous:
 transformer 2 x 18 V/100 mA

needed is the wire link shown in its vicinity, but more about this when we come to the calibration procedure.

To return to the temperature section of the circuit, another opamp, A4, is connected to the output of A1 to prepare the temperature voltage for display on the thermometer. P3 is linked to the negative reference voltage -7.5 V and allows the calibration point to be set, whereas P4 at A4's output sets the scale division for the temperature display at 10 mV per degree centigrade.

Now for the power supply. The opamps are provided with a symmetrical supply voltage of about $\pm 15\text{ V}$. A mains transformer with a centre tap and a bridge rectifier produces a raw DC voltage of $18 \dots 22\text{ V}$ across C4 and C5; the rest is taken care of by two integrated 15 V fixed voltage regulators. Auxiliary circuits such as an LED UAA 170 voltmeter can be powered by way of the 18 V (non-stable) output. Further to this, a 9 V voltage regulator was included in the prototype power supply circuit to power a DVM (digital voltmeter module) and its liquid crystal display.

In addition, the circuit also produces a fairly stable positive voltage of 7.5 V for the pressure transducer and a negative voltage which acts as a reference source when calibrating the offset of the pressure and temperature signal. The positive reference voltage is produced by a voltage regulator IC, the well-known 723 type in standard format, and a 741 opamp takes care of the negative voltage.

Construction

The differential amplifier around IC2 and IC3 must be able to amplify microvolts by a factor of 40. If the instrument is to be used for domestic purposes the opamps may be standard 741 or LM 301A types and R1...R4 may be carbon resistors. Although these components feature greater temperature drift, this can be remedied by careful calibration of P5. In any case, 'room temperature' inside the house should be relatively constant.

If, on the other hand, the temperature measurement must be absolutely stable, metal foil resistors with not more than 1% tolerance are an absolute must. Their values should be: R1, R4 = 200 k , R2, R3 = 5 k . Opamps IC2 and IC3 may be selected with the aid of table 2. There are three different types: standard, low power and low drift. Low power types have the advantage that they distribute temperature evenly very soon after the device is switched on and so help to counteract the slow reaction to temperature changes by the transducer. This enables the total temperature drift of the pressure test circuit to be compensated for with P5.

The printed circuit board in figure 6 is designed to cater for both ordinary preset potentiometers and Cermet

trimmer potentiometers. In practice, however, it is best to use the Cermet type for P1 and P6, P3 and P4 may be ordinary presets, although it stands to reason that multi-turn types are a lot easier to set up. As for P2, P5 and P7, there is no need for these to be special types.

First of all, mount the resistors and capacitors on the board. It is recommended that IC sockets are used for all the ICs. The ICs themselves are not mounted until the circuit has been tested and calibrated. Holes are provided in the board for solder pins and fitting wire links after testing. Wire links A...C (at P4 and P1) are only required during the calibration and it is a good idea to use solder pins here.

Test equipment

The main requirement is a digital multimeter, but if one is not available, use an ordinary multimeter to test and set the supply voltages and a $3\frac{1}{2}$ digit DVM to calibrate the temperature compensation and the pressure and temperature outputs. The latter is needed in any case to display pressure and temperature values. The DVM module does not have to be calibrated with great precision, as it is adjusted along with the pressure and temperature display. Thus, it only needs to be set at 2 V full scale, which can be done with an ordinary multimeter.

When calibrating the pressure display, have a fairly reliable barometer on hand by way of comparison. The ideal solution would be a barometer or an altimeter with a tube connection, for then the meter could be constructed in

the manner shown in the figure and so could measure various values very quickly. Plastic tubes, valves and T connectors, etc. can be obtained at very reasonable cost at the local petshop (they are used in aquariums). The petshop may also be able to supply an electric air pump, although an ordinary bicycle pump will also be suitable. Using the air pump, produce a pressure about $30 \dots 40\text{ mb}$ above the existing level. Then connect the valve to preserve the pressure level and the electronic barometer can be adjusted at leisure. Fitting the valve is a simple operation,

Testing and calibrating the circuit

Follow these instructions carefully and there will be nothing to worry about.

To start with, the transformer is connected to the circuit. Don't forget to connect the centre tap to the ground of the board! Now check the supply voltages: $+15\text{ V}$ at the positive pole of C8, -15 V at the negative pole of C9 and $+9\text{ V}$ at the output. These voltages must not vary by more than 5%.

Next insert IC6 (type 723) and adjust the voltage across C16 to 7.5 V with P7. Now mount IC5 (type 741) and check the output voltage at pin 6, this should be -7.5 V . It is time to fit the pressure transducer IC1. Its pins must be bent slightly to allow it to fit into the DIL holes on the board. Make sure the polarity is correct! The wires should not be too short, as this would cause the IC to be overheated when it is soldered. The pressure opening of the sensor should be sealed with sellotape before it

7

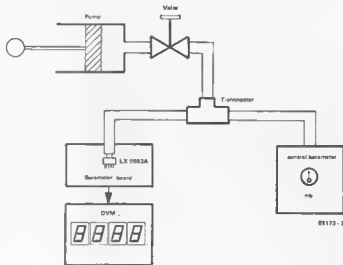

Figure 7. The test equipment required to calibrate the barometer. The air pump allows various pressure levels to be measured and so compare the DVM and barometer displays. By closing the valve, the pressure can be maintained at a constant level for some time in the tube.

8

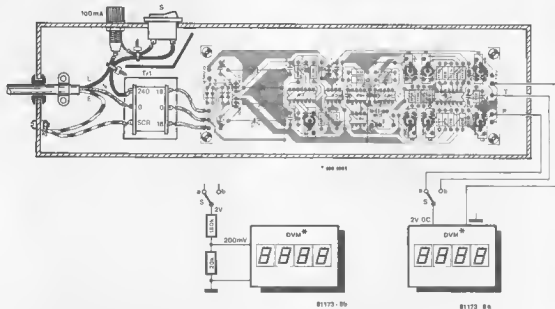

Figure 8. How to wire the digital barometer and a digital voltmeter using a 2 V measurement range. Switch S converts the display from pressure to temperature, and vice versa. Figure 8b shows how the range of a 200 mV DVM can be extended to 2 V.

is soldered to prevent any harmful moisture from entering the IC.

After this, IC2 and IC3 are installed. The voltage at IC3's output (pin 6), which may be negative, is primarily determined by the offset voltage of the sensor. The transducer can now be tested. Depress the tube of the sensor slightly with the tip of your finger and the pressure should increase causing the output voltage of IC3 to rise by several millivolts. Once the last IC (IC4 = type LM 324) is mounted, the actual calibration procedure may begin.

First of all, the output voltage of A2 (pin 8 of IC4) is set at 0 V with P2 (T offset). Then the DVM module or the digital multimeter, whichever is available, is connected to the output of A3 (pin 14 of IC4, wire link C) and the voltage displayed is adjusted to about 1 V with P6 (P offset). P5 (T compensation) is turned fully clockwise so that its wiper will be grounded. Use an electric hairdryer to warm up the transducer and the output voltage will change. The question is now: will it rise or drop? If it drops, the 'A' wire link will have to be fitted; if, on the other hand, it rises, the link may be omitted. Now P5 (temperature compensation) is adjusted until the DVM display does not alter during changes in temperature. The hairdryer method allows P5 to be correctly positioned in no time at all. If the preset range 'runs out', select a smaller value for R6 and a larger one if the range is too wide. The hairdryer method is not particularly suitable for adjusting the compensation finely, as the heat is not evenly distributed throughout the circuit. Give the circuit 'a change of air' and test it under different temperature conditions to be absolutely sure it works properly.

A word about P5. If it is turned fully clockwise, the temperature compensation will be totally ineffective. What is measured at the pressure output is the temperature drift of the transducer. Slowly turn P5 in an anti-clockwise direction and the compensation voltage will be added to the pressure voltage and its polarity will be inverted. As a result the drift of the display will be reduced and when P5 is in the correct position (the compensation voltage is equal to the drift, so that this is cancelled out) the display will not alter. If P5 is turned up too far, the drift will be over-compensated and inverted. Once the right temperature compensation has been found, we may proceed to adjust the scale division factor. Depending on the type of 'control' barometer available, the scale division may be established in two ways.

1. Compare the circuit with another barometer.

Read the air pressure shown on the barometer. Make a note of it and adjust the DVM (DMM) display to the same value with P6. Now wait until the pressure level alters due to a change in weather (by at least 10 mb). Make a note of this new value on the barometer and compare it to that shown on the DVM/DMM. Now a small calculation is called for. By relating the change in pressure to the alteration on the display, the temporary (not yet calibrated) scale division factor of the circuit will constitute a mV/mbar ratio.

Let's take an example:

Supposing the air pressure (barometer) has changed from 1003 mb to 1018 mb, whereas the DVM display has altered from 1003 mV to 1033 mV. Thus, the scale division factor is 30 mV divided by 15 mb, which is 2 mV/mb.

Now assuming you wish to adjust the device to a 1 mV per mb ratio. This is done by reducing the output voltage by means of P1. The division ratio is calculated by dividing the *required* scale division factor (1 mV/mbar) by the factor obtained previously. Thus:

Divider factor D equals 1 mV/mbar divided by 2 mV/mbar, so $D = 0.5$.

$D = 1 \text{ mV/mbar} \div 2 \text{ mV/mbar} = 0.5$

To adjust P1 as accurately as possible to this division factor, P1 is linked to 7.5 V by way of wire link 'B' and the voltage at P1's wiper (P output) is adjusted to 7.5 V x D. In this example ($D = 0.5$) the voltage is set at $7.5 \text{ V} \times 0.5 = 3.75 \text{ V}$. Now remove wire link 'B' and connect P1 to the output of A3 by way of the link 'C' and the scale division factor will be calibrated to 1 mV/mbar.

Once P6 has been adjusted so that the display shows the value of the 'control' barometer, the pressure section of the circuit will have been completely calibrated. The electronic barometer may then be considered ready for use.

2. The pressure meter comparison (using a barometer with a tube connection)

P1 and P6 are calibrated in exactly the same manner as described above, the only difference being that there is no need to wait until the air pressure has changed by more than 10 mb, as different values can be obtained quite simply by pumping air into the system. This method enables various pressure values to be compared to those shown on the pressure meter.

Finally, the thermometer section still has to be calibrated. For this a 'control' thermometer is required and two different environmental temperatures, for example the circuit may be tested indoors at room temperature and then

out of doors or in the garage/cellar, etc. Be sure there is a real difference between these temperatures! The DVM or DMM is linked up to the T output and P4 is adjusted so that the output voltage shows a significant difference of at least $10 \text{ mV}/^\circ\text{C}$ (scale division) between the two temperatures. Then the display is adjusted with P3 (T calibration) to show the same value as that on the 'control' thermometer.

Now the printed circuit board is complete, but that does not mean the device itself is ready for use. Local electronics dealers are bound to have a suitable case the circuit can be built into. Once this has been done, the wire links can be finally fitted. A toggle switch may be fitted to switch the display from pressure to temperature and vice versa. Make sure the case is well ventilated, as an airtight box might lead to errors.

The barometer may be extended into a hygrometer with the addition of the printed circuit board published in the 1981 Summer Circuits' Issue: the 'humidity sensor' (circuit number 77). This circuit can be supplied with the +9 V output produced by the barometer board. The DVM display will then also indicate relative humidity levels.

Figure 8 shows how to wire the digital 'weather station'. If the user wishes to display several values at once, several displays will have to be included, but to add a few more DVMs would be rather costly. A cheaper solution is to use an LED voltmeter scale incorporating the well-known UAA 170 IC. This will allow both temperature and humidity readings to be displayed simultaneously.

A similar idea was published in December 1980 in Elektor in the form of a bath thermometer. Elsewhere in this issue an article describes how to use the bath thermometer circuit as an LED voltmeter. Figure 10 shows the prototype of a weather station using a DVM pressure display and two LED voltmeters to indicate temperature and humidity levels.

What else can the circuit be used for?

Air pressure levels are mostly measured in terms of millibars, but may also be indicated as millimetres of mercury as so many mmHg. One mmHg corresponds to 1.333 mb. If the control barometer used has an mmHg display, the electronic version may be calibrated in terms of mmHg to a scale division factor of $1 \text{ mV}/\text{mmHg}$. This has the advantage that a 3 digit DVM (like the universal digital meter published in Elektor, January 1979) can be used. Since a pressure level of 1050 mb corresponds to 788 mmHg, the range of the meter may cover 1 V (999 mV).

Practically every barometer may be used as an altimeter. Since pressure drops by 1 mb per 8 metres, the barometer display may be calibrated to a scale division of

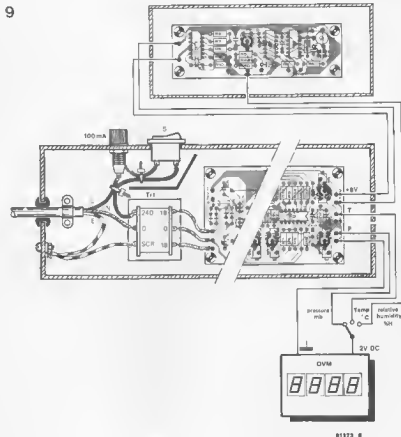

Figure 9. The connections for a digital bar(thermo)hygrometer. The humidity sensor board was published in the 1981 Summer Circuits issue.

10

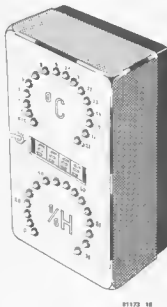

Figure 10. A suggestion for an 'electronic weather station'. The two LED scales indicate temperature and relative humidity levels, whereas the digital display allows all three, pressure, temperature and humidity, values to be shown.

1 mV per 10 metres.

In addition, the circuit may be adapted to transducers in the LX series from National Semiconductor which have different measurement ranges including types which allow liquid pressure to be measured.

Important!

Some digital voltmeter ICs have a negative measurement input which must not be connected to the meter's negative supply voltage (ground). Such meters have a separate power supply. Examples of this are the Intersil types IC1 7106 and 7107. LED DVMs must also have their own power supply due to their relatively high current consumption.

In a forthcoming issue a $3\frac{1}{2}$ digit DVM with an LCD display will be described which can be powered by means of the barometer board.

Data sources:

National Semiconductor: *Monolithic Pressure Transducers LX05XXA, LX06XXD, LX06XXGB Series, DA-FL25M80, August 1980*
National Semiconductor: *Pressure Transducer Handbook.*

The dB converter circuit

The complete circuit of the dB converter will be seen in figure 1 and can be discussed in detail stage by stage.

The input preamplifier employs low noise FETs, T1 and T2. Since the slightest amount of ripple from the power supply at this point will affect the lower threshold in the dynamic range, the supply voltage is filtered by C6 and R10/C5. Diodes D1 and D2 are included to protect the gate of T1 against any overload. Components C1, C2/R4 and C3, C4/R7 constitute filters with a 20 dB per decade (that is 6 dB per octave) slope. These are ideal for use with microphones and for frequencies above 100 Hz.

If, on the other hand, C4 is in the circuit the frequency response will be 1 dB down at 100 Hz. These filters will not be necessary when testing hum-free circuits. This means that the E1 input should be used for microphones if possible. Low frequency noise (rumble) will be filtered out during measurements above 100 Hz. At 100 Hz the error indication will be -2 dB, but will decay rapidly at higher frequencies.

Below 100 Hz amplification will decrease by 40 dB per decade (12 dB per octave). Capacitors C15 and C16 control the response of the meter.

Auxiliary circuits

The two circuits AC1 and AC2 are used

dB converter

a useful addition to the AF sweep generator

The May 1979 edition of Elektor included a design for a sweep generator, which enabled frequency response curves to be displayed on an oscilloscope screen 'at one sweep'. This saves a lot of work when measuring the frequency response of amplifiers or filters. The sweep generator really becomes an invaluable asset when it is combined with a logarithmic rectifier, as the latter 'translates' the frequency response curves into levels of dB. This type of rectifier is known as a dB converter.

This stage is followed by an amplifier, IC1, which is extremely fast due to under-compensation. This ensures that the precision full-wave rectifier receives a low impedance drive. IC1 has a gain of 11 and 100% feedback for DC voltage levels. As a result, its drift is very slight.

Both IC2 and IC3 in the precision rectifier are also under-compensated. Furthermore, there is no feedback around IC2 until either D5 or D6 starts to conduct. This could well cause the circuit to oscillate unless due care is taken during its construction. If faced with this problem avoid increasing the value of C11 and C12 as this may cause a lowering of the upper frequency threshold.

The following stage, around IC4, is a logarithmiser circuit. In the absence of an input signal, resistors R36 and R37 serve to prevent the voltage at pin 6 from reaching +15V and causing an excessive current to pass through diode D7. Capacitor C17 is included to stabilise the output.

The inverter amplifier built around IC5 has a relatively high input impedance and therefore only presents a slight load on the logarithmiser. The inclusion of R44 ensures that the output of the converter is short circuit proof.

The filters

The low frequency threshold of the converter depends, as mentioned earlier, on the high pass filters C1, C2, R4 and C3, C4, R7. When switches S1 and S2 are operated, in other words input E2 and C3 are in circuit, the frequency response drops by 1 dB at 10 Hz.

for calibration purposes only. Setting the output levels of AC1 is simply a case of adjusting the two potentiometers to provide 100 mV with switch S in position 1, and 1 mV in position 2.

Calibration

The main items of equipment required for calibration are an oscilloscope (switched to DC) with a sensitivity of 50 mV per cm, and a 20 k Ω /V multimeter.

All the potentiometers should be set initially in the mid position. Calibration starts at the last stage as this can then be used as a temporary measuring amplifier. Before calibration begins allow the circuit to 'warm up' for at least 5 minutes. The procedure for calibration can then be carried out in the following order.

1a. Separate W7-W8 and ground W8.

Connect the oscilloscope and the multimeter to point A. With the multimeter switched to a suitable current range set the DC compensation by adjusting P7 for a minimum reading on the meter. Switch the meter to its most sensitive range (50 μ A or so) and carefully readjust P7 with greater precision. Then switch the meter to 5 V DC.

1b. Disconnect W8 from ground and reconnect it to the auxiliary circuit AC1 with S in position 1. Now adjust P8 to obtain an output voltage level of -3.33 V at output A.

2 Link W7 and W8 together and separate W5 and W6. Connect AC1 to W6.

(i) With S in position 1, adjust P5 to obtain 0 V at A.

(ii) With S in position 2, adjust P6 to obtain -4 V at A.

1

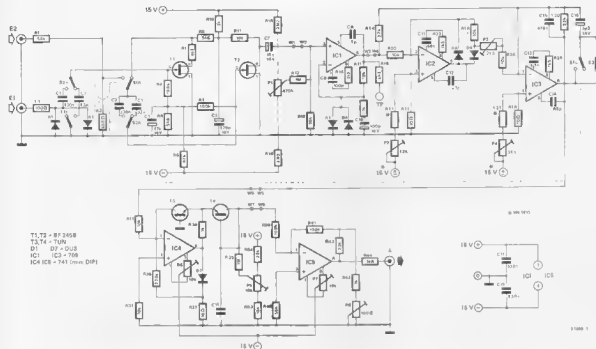

Figure 1. The circuit diagram of the dB converter. This is intended for use with the sweep generator published in the May 1979 issue of Elektor.

2

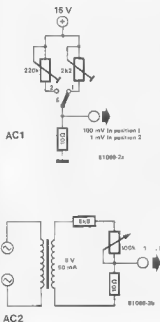

Figure 2. The two auxiliary circuits used during the calibration of the dB converter.

(iii) Repeat (i) and (ii) until no improvements can be made

(iv) Connect W6 to +10V and measure +4 V at A.

3a. Disconnect W6 altogether. Separate W7-W8 and W3-W4. Link W5 and W8 with a short length of wire. Remove C15 and C16 from the circuit. Connect W4 to the auxiliary circuit AC2.

3b. Adjust P2...P4 to achieve a symmetrical full-wave rectified sine wave on the oscilloscope at output A for all voltage levels between 1 and 10 mV. The rectified sine wave will be inverted by IC5 so that its sharp 'spikes' will touch the zero line. Initially, 100 K can be used for R21 and R27. If in doubt, reverse the polarity of P2 and/or P4 that is, either apply +15 V or -15 V! Replace C15 and C16.

4a. Connect W8 to W3 and ground point D of T2.

4b. Set P1 so that the zero line appears on the oscilloscope.

5. Replace the links W1-W2...W7-W8 as drawn on the circuit diagram. Disconnect point D of T2 from ground. The trimmers are now fully calibrated.

6a. Connect the oscilloscope to TP2 and provide an audio frequency signal at the E2 input. Switching S1 and S2 should show a 1.2 amplification factor.

6b. Switch S1 off and ground the E1 input. The zero line should now appear on the screen, slightly noisy (hiss) but without any signal.

6c. Disconnect the E1 input from ground and reconnect it to not more than 10 mV. Check whether the amplification factor is equal to about 960.

The power supply of the existing sweep generator can be used to power this additional circuit.

Technical specifications

frequency range	10 Hz (-1 dB) .. 100 kHz
	[-0.5 dB]
dynamic range	80 dB
response range	-40 dB .. +40 dB
input E1	160 μ V = 0 dB
input E2	130 mV = 0 dB
output A	-4 V .. +4 V,
	short circuit proof
conversion factor	10 dB = 1 V; dB = 0.1 V

The maximum definition on the screen is 0.5 dB = 1 cm where the sensitivity of the oscilloscope is 50 mV/cm (DC).



TV games extended!

another 3K of memory, and sound effects!

The basic TV games computer (Elektor, April 1979) has nearly 2K of program memory. This has proved to be adequate for a lot of interesting games, without the programs getting completely out of hand — bearing Parkinson's Law in mind: 'Computer programs grow until all available memory space is filled'.

However, several of the more dedicated TV games computer fans have reached the point where they can put a greater memory range to good use. Witness the majority of the 30 (!) new games to be released shortly on ESS tapes. For this reason, we feel that it is now time to release an extension board that almost triples the available memory. Also included on the board are two 'Programmable Sound Effects Generators' (PSGs). In this article, we will only give a brief description of 'how it works' and 'how to build it'; fuller details, plus a lot more interesting information about the TV games computer, are contained in a book that will be available in the very near future.

The extension board contains one further interesting feature; provision was made for plugging in games cartridges that are intended for some of the commercial machines!

The extended version

This extension to the TV games computer was designed, quite literally, in response to repeated requests from readers who wanted more 'elbow room'.

The best way to illustrate the new features is by means of a memory map as shown in figure 1. In the basic version, the monitor occupied the first 2K of memory and this was followed by 2K of RAM (1½ K for the user). The address range from 1000 was virtually unused — it only contained a few input/output lines and the PVI. Now, a further 3K RAM is added, from 1000 to 1BFF, and two programmable Sound Generators (PSGs) are located at addresses 1D00 to 1D1F.

The area from 1B00 on gets rather confused, owing in part to a minor error in the original monitor ROM. The Read Cassette address is located at 19BF, instead of 1DBF where it belongs. Since the addresses in this range were not fully decoded, this made no difference at the time. Now, it complicates matters. A facility must be added to

disable the RAM at 199C...199F and 19BC...19BF. This is selected by setting S3 to position 'x' and S5 to position 'B'.

The total 'memory map' from 1B00 on is shown in greater detail in the right-hand half of figure 1. First, the RAM with the two 'input' ranges mentioned above; then a gap; then the sound generators, at 1D00, followed by some input and output ranges (which include cassette read and write). At 1E8E, the keyboard, and, finally, from 1F00 on, the PVI. Readers who feel so inclined can, of course, add other features. A hardware random numbers generator at 1D20? Other custom-designed input/output devices in the 1Dxx range? A commercial-style explosion sound generator at 1E80? They're all possible, under one proviso: they mustn't be used in programs submitted to us for including in the ESS service!

The extension board

A block diagram of the extension circuit is given in figure 2. It is fairly straightforward. To cater for the additional load, the address and data lines from the main board must be buffered. The actual extensions are shown in the lower half of the figure. ROM connectors, for commercial game cartridges; RAM extension; Programmable Sound Generators, with their associated audio outputs. Above these are the control circuits: the address block decoder, with switches for selecting commercial ROM game cartridges as required; the decoder for addresses

1

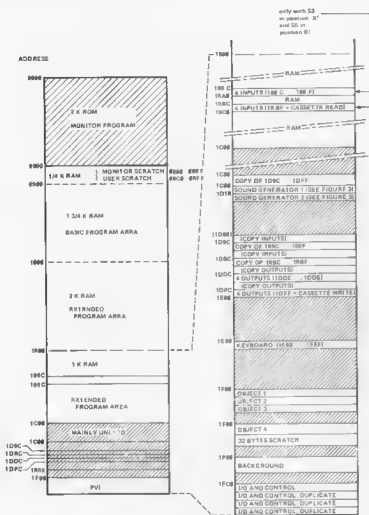

Figure 1. Memory map of the extended TV games computer. The final section, from 1000 to 1FFF, is shown in somewhat greater detail at the right.

2

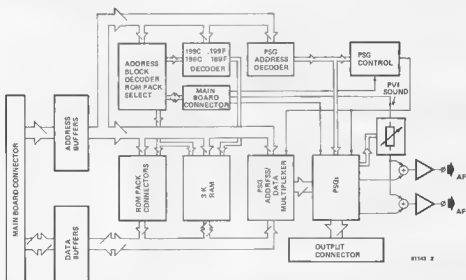

Figure 2. Block diagram of the extension board.

corresponding to the (erroneous) input blocks; the PSG address decoder and control circuit. A further connector to the main board, drawn centrally in the figure, carries a few 'odd' signals like 'clock' and 'PVI audio output'.

The PSGs

The programmable Sound Generators are the most noteworthy part of the extension board. These ICs are quite complicated, as illustrated in the block diagram given in figure 3. Each IC contains 16 registers, corresponding to addresses 1D00...1D0F or 1D10...1D1F, as shown. These registers are controlled by an address/data demultiplexer in the IC - unfortunately, in our case, since it means adding an external address/data multiplexer as shown in figure 2!

The data stored in the registers controls three tone generators, a noise generator and associated mixers; an envelope generator, with associated D/A converter; and two input/output ports. To start with the latter: in the normal case, each input/output port is 8 bits wide, and can be used as bit - independently from the rest of the PSG, provided it is enabled by the corresponding bit in R7. In the application described here, however, they can only be used as outputs. Furthermore, the four least significant bits of port A in PSG 1 (corresponding to address 1D0E) are used for amplitude control of the PVI sound output.

The basic frequency of each tone generator can be set anywhere in the whole audio range - the TV games computer book includes a table for selecting any note in an eight-octave range. The basic noise generator 'frequency' can be determined. The desired outputs can be enabled individually. The output amplitude for each channel

3

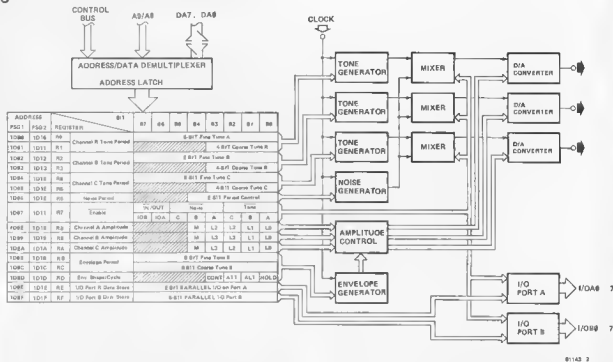

Figure 3. Block diagram of a Programmable Sound Generator IC. The 16 registers control three tone generators, a noise generator, envelope generator, mixers and output ports.

can be set, or else controlled by the 'envelope generator'; in either case, the result is determined by a 4-bit D/A converter, corresponding to 16 amplitude levels.

The envelope generator can be set for single-shot attack or decay effects, like explosions, or periodic amplitude effects like tremolo or machine-gun fire. It should be noted that disabling a tone

or noise generator by means of R7 (address 1D07 or 1D17) is not sufficient to completely 'kill' it. For complete silence the 'amplitude level' of all outputs must be set to zero, by storing 00 in registers R8...RA. This we have discovered after a lot of frustration...

All in all, a phenomenal range of sound effects are available. The original application note gives an 'explosion',

'gun shot', 'European siren', 'laser effect', 'whistling bomb', 'wolf whistle', and 'racing car'. In no time at all, we added a rattling chain and several polyphonic wedding marches. Great fun!

Construction details

The complete circuit is given in figure 4. Virtually the only point worth noting is that it conforms to the block diagram given in figure 2... Some further details are given in the TV game computer book.

For the purposes of this article, we can pass on to the printed circuit board, given in figure 5 — reduced to 70%, for reasons of space — and, more importantly, to the wiring diagram given in figure 6. As can be seen, there are two connection points to the main board: the main 31-pin connector and a 14-pin DIL connector which runs to a 16-pin (!) version in the original IC6 position on the main board. This IC, a 74LS139, is now located on the extension board (IC15). More precise details are given adjacent to figure 6.

Two new audio outputs are provided, one from each PSG; the PV1 sound is mixed into each. Although this offers the possibility of 'stereo' sound effects, we found it easier to combine the whole lot into a single audio output by means of a few 4k7 mixer resistors. Crazy — we offer an option, and don't use it ourselves! However, we must cater for all tastes...



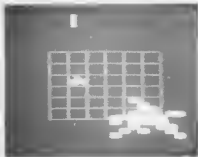

5

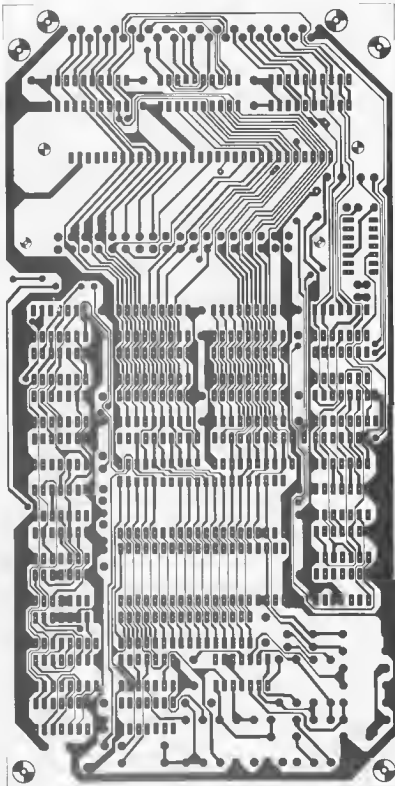

Parts list

Resistors:

R1,R2 = 1k5
 R3 = 82 k
 R4,R14,R21 = 10 k
 R5 = 18 k
 R6 = 39 k
 R7 ... R9, R11 ... R13,
 R18 ... R20 = 4k7
 R10,R17 = 12 k
 R15,R16 = 1 k

Capacitors:

C1,C2 = 22 p
 C3 ... C5 = 220 p
 C6 ... C26 = 100 n

Semiconductors:

IC1,IC2 = 74LS244
 IC3 = 74LS245
 IC4 ... IC9 = 2114
 IC10,IC11 = 74LS241
 IC12,IC13 = AY-3-8910
 IC14 = 4066
 IC15 = 74LS139*
 IC16,IC17 = 74LS30
 IC18 = 74LS161
 IC19 = 74LS138
 IC20 = 74LS74
 IC21 ... IC23 = 74LS32
 IC24,IC26,IC28 = 74LS04
 IC25 = 74LS08
 IC27 = 74LS30
 IC29 = 74LS21
 IC30,IC31 = 74LS00
 IC32 = 74LS20
 IC33 = TL 084

*removed from main board (see IC5)

Switches:

S1,S2,S5 = SPDT
 S3 = SPDT or wire link
 S4 = single pole three-way

Figure 5. The printed circuit board and component layout.

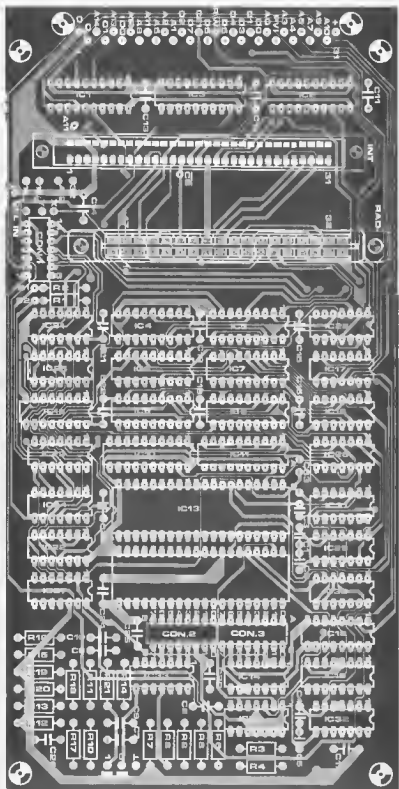

A final word on the power supply. The original version, unfortunately, may sometimes prove rather 'under-powered'. The complete extension board gets quite hot — and heat comes from watts . . . The supply must be capable of delivering nearly 2 A, without getting too hot under the collar. If you made the same mistake that we did — making the original supply too light-weight — some modifications are now in order. The power transistor needs an adequate heat sink, preferably mounted outside the case. Also, it may prove necessary to provide the bridge rectifier with a heatsink. The easiest way to check these components is to touch them with a moist finger. If it sizzles, they're too hot!

A plea to programmers

Now that extended memory is available, some ardent programmers may feel that they would like to submit programs to Elektor for publication. Fine, but before you do we would like to stress some urgent requests. In the first place, please bear in mind that other TV games computer owners may not (yet) have extended memory available. If at all possible, arrange the game so that a basic version will run on a basic computer and the fully enhanced version only becomes operative if extended memory is actually available. The 'Maze adventure' and 'Memory' games on the new ESS tape are examples. In both cases, a branch to 'initialise for extended memory' is included as follows

```

0C1000 LODA, R0
BAFC BSFR, N, 1000

```

If memory extension is not available, the data at 1000 will be FF (negative), so nothing happens; in the extended case, a subroutine at 1000 modifies a few instructions in the basic program to incorporate the program extensions. Owners of a basic version will merely notice that the load routine breaks off at 'AO = 1000'; they can start the program, however, at PC = 0000. The other request concerns the joysticks. Please remember that no two joysticks are alike! A calibration procedure is essential. K

A LITTLE
PRACTICE
DOES
A LOT OF
GOOD
.....

6

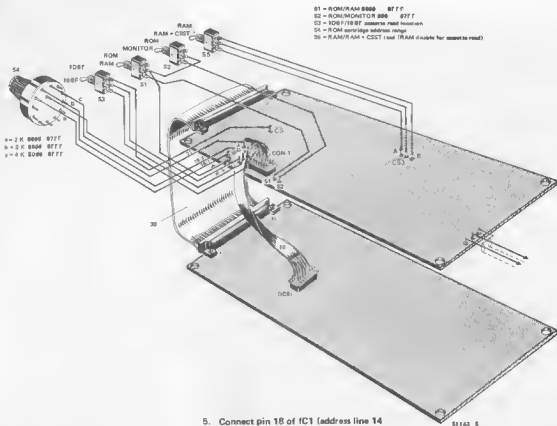

Modifications to the main board:

1. Break the copper track leading to pin 15 of IC3 (address line 12 to PV1), at a point near this IC.
2. Break the copper track leading from pin 5 of the 31-pin connector to pin 6 of IC6 (EXP MEM to LS139), at a point near to the connector.
3. Break the copper track leading to pin 14 of IC6 (address line 6 to LS 139), on the component side of the board near IC6.
4. Remove IC6 (LS 139); it can be re-used as IC15 on the extension board.

5. Connect pin 18 of IC1 (address line 14 from the CPU) to pin 3 of the 31-pin connector.
6. Connect pin 19 of IC1 (address line 13 from the CPU) to pin 5 of the 31-pin connector.
7. Connect pin 15 of IC3 (PV1-SEL from the PV1) to pin 24 of the 31-pin connector.
8. Connect pin 12 of IC4 (CLK from the USG) to pin 6 of the IC6 socket.
9. Connector pin 22 of IC3 (audio out from the PV1) to pin 7 of the IC/ socket.
10. Connect the reset lead (R) to pin 14 of the IC6 socket.

Connections between the boards:

1. The two 31-pin connector are simply wired pin 1 to pin 1, pin 2 to pin 2, etc. Note that pins 4 and 6 are not used.
2. A 16-pin D/I connector is inserted in the IC6 position on the main board and pins 1, 4, 7, 9, 12 and 14 are connected to the same pin numbers on CON 1 on the extension board. Note that the letter is a 14-pin connector, so pin 8 is opposite pin 7 and not adjacent to it!

Figure 5. The wiring to the extension board is not quite as complicated as it looks. The various switches and connectors are clearly shown here, and the necessary operations on the main board are detailed above

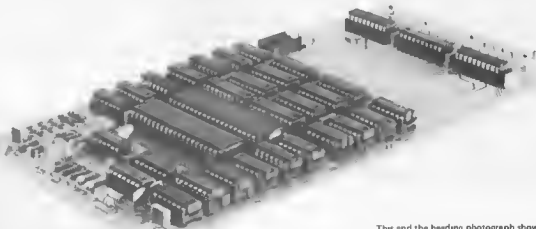

This and the heading photograph show the complete and assembled extension board for the TV games computer.

It would appear to some that the essential ingredients of enjoyment for the younger generation consist mainly of company, noise... and coloured lights, with plenty of each. This is not entirely true, of course, but a disco light system goes a long way towards enabling the junior members of the family to entertain their friends on those nights that ten teenagers manage to sound like fifty.

The main features of the system described here are its safety, and its high performance at relatively low cost. A further advantage lies in the fact that, unlike many designs for disco lights controllers, there are none of those fearful coils to wind. With economy in

terminals. In the latter case, the limiter shown in figure 2 can be placed in series with the input of the controller to reduce the effect of the volume control of the audio system. P2 should be set at minimum resistance.

The important safety aspect of the circuit is that the mains voltage section is separated from the rest of the electronics by means of opto couplers.

The circuit

The input signal amplification is taken care of by opamp A1, seen to the left of the circuit diagram in figure 1. The preset potentiometer P2 is used to adjust the amplification factor of this stage between 1...20. The sensitivity is varied by P1 and is a maximum of 100 mV RMS when both P1 and P2 are turned fully up.

The output of the preamp feeds twin T filters (A2...A4) of the three channels. This form of filter design is easy to construct and maintains good selectivity. At the same time however, these filters do tend to be 'peaky' for this application, in other words, a little too selective at 5 Hz, 1 kHz and 5 kHz. To counter this effect to a certain extent, the three resistors R5, R9 and R13 are included to give some measure of 'attenuation' to the filters.

The filter outputs are rectified and smoothed by diodes D1...D6 and their associated capacitors before being fed to the three comparators A5...A7. The switching thresholds of these are set by potentiometers P2...P5 which can vary the voltage level at the inverting input of each comparator from about 1 V to 8 V. The resistor R20 has been included to prevent any input level from reaching the 12 V of the supply voltage, as this would completely confuse the comparators.

At this stage it should be pointed out that potentiometer P3 controls the high frequency channel, P4 the middle range and P5 the low frequency channel.

With no input signal being fed to the circuit, the comparator outputs will be low. This will cause the LED in the opto couplers to light (via the 1 k resistors R22, R24, R26) thus turning the photo-transistors hard on to hold the thyristor gates down to zero volts. No disco light will be lit yet.

Upon the arrival of an input signal large enough to switch the comparator of any channel (Adam and the Ants and colleagues will ensure that it does!) the opto coupler LED will go out switching the photo-transistor off. The thyristor gate will now be taken high by the 47 k resistor and there will be light... from the bulb of that particular channel.

The reason why thyristors were chosen in preference to triacs is due to the fact that thyristors are far more sensitive. In this circuit for instance, a gate current of only 300 μ A is sufficient to activate the thyristor. Furthermore, the gate control current can be mains powered via a straightforward circuit, without

disco lights controller

It seems that parties are out and disco's are in with the younger set and it goes without saying that the most successful disco's are those that copy the 'real thing' in terms of presentation. This means that a 'light show' is an absolute must. The disco lights controller featured in this article will perform equally well as some of the more expensive systems available, while still remaining reasonably economical in terms of cost and components.

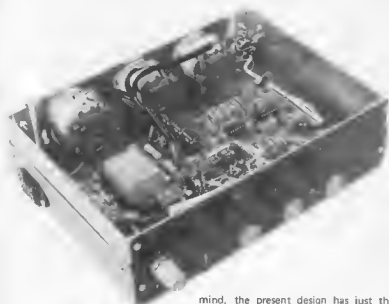

mind, the present design has just the usual three channels, although there is little to prevent the enterprising constructor from expanding this to double the number or even more... simply by building two (or more) complete systems.

For convenience, the signal input can be taken from either the preamp output (preferably the tape output) of the amplifier or direct from the speaker

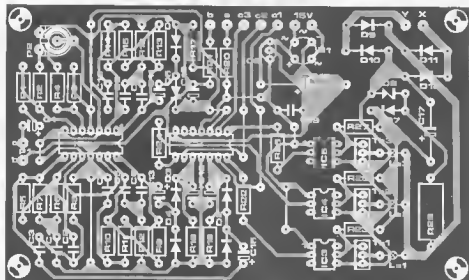
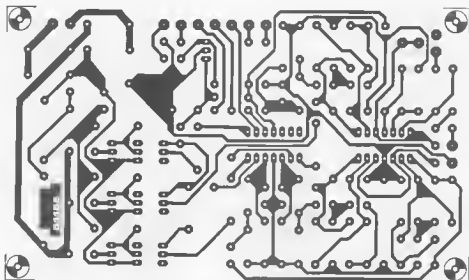

Figure 4. The copper tracking pattern and the component overlay of the printed circuit board. Apart from the transformer, all the components are included.

Parts list

resistors

R1,R2,R17,R18,R19,R23,R25,
R27 = 47 k
R3 = 12 k
R4 = 10 k
R5,R9,R13 = 220 k
R6,R7,R10,R11,R14,R15 = 15 k
R8,R12,R16 = 6k8
R20 = 1k8
R21 = 470 Ω
R22,R24,R26 = 1 k
R28 = 47 k 1 W
P1 = 100 k lin.
P2 = 1 M preset
P3,P4,P5 = 10 k lin.

capacitors:

C1 = 10 μ/18 V*
C2,C3 = 2n2
C4 = 4n7
C5,C6 = 10 n
C7 = 22 n
C8,C9 = 220 n
C10 = 470 n
C11 . . . C16 = 1 μ/16 V*
C17 = 10 μ/16 V
C18 = 100 μ/35 V
C19 = 100 n

semiconductors.

D1 . . . D6 = 1N4148
D7 = 1N4001
D8 = 15 V 400 mW
D9 . . . D12 = 1N5404
IC1,IC2 = LM 324/CA 324
IC3,IC4,IC5 = TIL 111
IC6 = 78L12
Th1,Th2,Th3 = TiC 106D
B1 = B40C500

* = tantalum or electrolytic
mounted vertically

miscellaneous

F1 = 3,15 A fuse
Tr1 = 15 V, 50 mA transformer
S1 = double pole mains switch

An opportunity to examine the circuit diagram and to listen to Peter Walker's new loudspeaker was too good to miss . . .

QUAD ESL 63

It has never been our policy to publish review articles on audio products — and we are not going to start now. This does not mean that we, as critically-eared engineers, do not have our opinions on the standard of engineering demonstrated in any particular product. Therefore when the manufacturer provided us with a copy of the circuit diagram and an opportunity to listen to a Quad ESL 63 we did not put up any resistance . . .

Having said that, we believe that the following article, about the rather intriguing innards of this unusual loudspeaker, will interest many of our readers. After a more general introduction on electrostatic loudspeakers, to set the stage, we shall go into more detail on the ESL 63. Finally we shall discuss the way the ESL 63 behaves as a doublet and how it interfaces with listening rooms.

The electrostatic loudspeaker

An electrostatic loudspeaker is in several ways the counterpart of the ubiquitous moving-coil loudspeaker. Firstly in the strictly theoretical sense: the force

patterned electrodes to be used. (See figure 2.)

One more interesting aspect is that of the damping of the fundamental resonance. In an electrostatic drive unit this is the resonance between the diaphragm compliance (due to the earlier-mentioned restoring force) and the mass of air in the immediate vicinity (plus of course the very small mass of the diaphragm itself). Musically oriented readers may note that this *air-mass-load* ('inertance' in the acoustical scheme of things) is the same mechanism as that requiring end-correction in the tuning of an organ pipe. Electrical damping of this resonance can be achieved by regulating

exerted on an ESL diaphragm is proportional to the applied *voltage* rather than to the *current*, whereas it is the *current flowing in the ESL motional impedance* rather than the *voltage across it* that is proportional to the net diaphragm velocity. Another aspect is that an ESL diaphragm, carrying only a more or less static charge (where else could the name come from?), can be very large in size and yet light — much lighter in fact than the mass of air that it moves. Figure 1 shows a cross-section of a modern electrostatic drive-unit. The diaphragm is a very thin flexible thermoplastic film, stretched tightly to provide a restoring force directed towards the central equilibrium position. It must be possible to charge the diaphragm reliably without the individual charges being able to distribute themselves unevenly during excursions — otherwise the force, which of course acts on the charges would be unevenly distributed as well. This calls for an extremely high surface resistivity. The 3-micron polyester diaphragm in the ESL 63 uses electronic conduction, obtained by doping it with one donor atom to about ten million non-conductive atoms. (This is incidentally something of a technological breakthrough and it was in fact Quad's toughest development problem).

The fixed plates, perforated to allow the passage of air, actually form a parallel-plate capacitor. The AC voltage applied across this capacitor sets up the signal field and the driving force is simply the total charge times this field strength. When the diaphragm moves it will cause a charge-displacement in the plate-circuit and we see that the rate of diaphragm movement (velocity!) must be proportional to the rate of charge-displacement (current). In practice the perforated plates are also of a thermoplastic material, with a conductive layer printed on the outside; this greatly simplifies high-voltage insulation problems and in the ESL 63 also enables

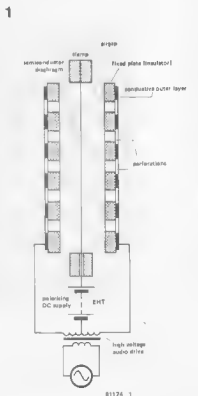

Figure 1. Cross section of a typical electrostatic drive unit with external circuit. The apparent simplicity is misleading.

the motional current (in the moving-coil case, the voltage). In the ESL 63 there is also internal acoustical damping by means of an airflow resistance.

Cabinets

Loudspeaker cabinets as we know them exist mainly to achieve useful bass output from the moving-coil driver, with its

2

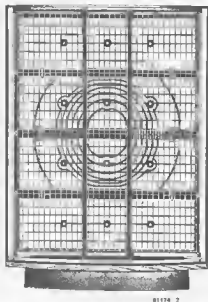

Figure 2. An illustration of one of the ESL 63 fixed plates, showing the separations as dark rings between the various driving sections.

3

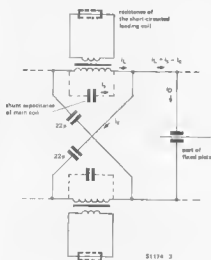

Figure 3. One section of the delay line. If $L_3 > L_4$ the circuit is an all-pass network; with $L_3 = L_4$ it becomes an LC line.

made so large in radiating area that the destructive interference problem is only significant at the very lowest musical frequencies. There it can be overcome by bass-boosting — without distortion — since the drive system itself is linear. (The system must of course be able to make large enough excursions: cubic-metres-per-second of volume-velocity remain cubic-metres-per-second.) *Undesirable* because boxes, by their nature, operate with considerable internal pressures. Such pressures would tend to come straight out through the electrostatic diaphragm.

Delay-line matching

One of the problems with electrostatic drive is the reactive current flowing in the plate-to-plate capacitance at high working frequencies. Peter Walker pointed out, as long ago as 1954, that this problem can be solved by using several loudspeaker sections as the shunt elements in an LC delay-line. British patent number 1228 775, published in 1971, explained how this matching arrangement could be deliberately used to control the radiation pattern of a large-surface electrostatic loudspeaker. In May 1979 an AES paper finally made it clear what was coming. A section of the delay-line used in the ESL 83 is shown in figure 3. It is rather intriguing. With the diagonal capacitors it looks like a first-order all-pass network. It probably is, although at least part of the capacitor-current will null that through the winding stray-capacitance (shown dashed). The apparently-short-circuited secondaries in fact apply damping to the inductors, either to make the all-pass section behave itself on transients or to provide amplitude taper along the line (or both). The delay per section is $24 \mu\text{s}$, which corresponds to a path-length difference in air of just over 8 mm.

The essential point about this method of matching is that the unwanted *acoustical reflection* at the edge of the finite diaphragm will appear as an *electrical reflection* on the line. It can therefore be eliminated by a simple electrical modification to the line.

High voltage audio

The signal voltage applied to the ESL 63 drive system can peak at over ten kilovolts. This is necessary to achieve field-strengths near the ionisation (flash-over) limit, across a total airgap wide enough to permit sufficient diaphragm movement at low working frequencies. Designing an audio transformer to actually do this, over the full frequency range and at low distortion, must have been an interesting exercise...

In fact the ESL 63 has two identical quite hefty transformers, wired with their secondaries in series. Apart from enabling the bulky things to be fitted neatly inside a shallow base, this offers an elegant way of reducing the leakage inductance and stray capacitances that

relatively small diaphragm area. They evolved from typical open-backed radio-set cabinets, when it was realised that destructive interference by the phase-inverted backwave was reducing the net bass pressure in the room. Not counting bass-horns — which are acoustical matching transformers and tend to be enormous — there are two basic ideas:

either absorb the backwave in a closed box, or use it to drive a phase-shifting resonant system that will provide extra bass output (bass-reflex and some 'transmission-line' labyrinth systems). As we see it, two properties of electrostatic drivers make it unnecessary and undesirable to mount them in cabinets. *Unnecessary* because they can easily be

6

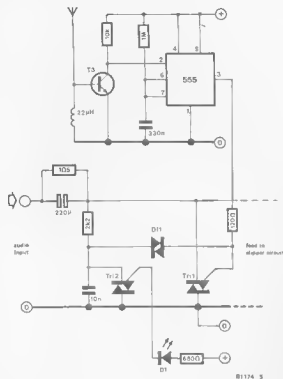

Figure 6. The emergency brake. Normal operation is with triac T3 held on by the power supply. The 555 timer is triggered by ionisation detector Tr3 and then fires T1 to short-circuit the audio input. With power off T1 can be fired via T2 by an excessive input signal.

7

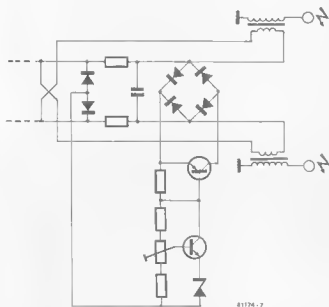

Figure 7. Part of the input circuit showing the soft clipper that reacts to peaks over 40 volts.

about 3 dB below the shutdown level. How this works can be seen in figure 7. The signal is fed to the audio step-up transformers via small series resistors. Tr2 acts in a preset-adjustable voltage-threshold circuit. When the input voltage peaks exceed 40 volts, in either direction of swing, Tr1 will be turned on, drawing extra current through the series resistors. This will cause an audibly non-linear reduction in primary drive voltage.

The clipper circuit could presumably be disabled without affecting the safety-margins in any way. We would in fact have preferred an optical warning device — also driven from a monoflop — instead of a headroom reducing clipper. How about a switchable option?

FRED

The acronym FRED — full range electrostatic doublet — is another Quad original. Let us now try to understand how it works. Peter Walker illustrates his principle of radiating an expanding wavefront from a flat diaphragm, by means of truncated delay-line matching, with figure 8. Others have interpreted this as producing a *virtual* point source about 30 cm behind the loudspeaker as viewed by the listener. The real ESL 63 situation seems to be more complex.

An *acoustical doublet* consists of two equal sources of opposite sign, each small compared to the wavelength and spaced a similarly small distance apart. The net pressure at a distance from the doublet that is large compared to the *spacing* is accurately described by a cosine function (the cosine of the angle between frontaxis and observer direction). This is shown in figure 9. If we've got it right, what Peter Walker has done is to arrange the delay and amplitude shading of the diaphragm drive (with the entire diaphragm behaving as a phased array of *real* sources) to maintain the doublet-like axial lobes throughout essentially the entire working range, even though the array quickly becomes large compared to the wavelength. The radiation patterns of figure 10, showing only a slight sharpening at 8 kHz, illustrate just how well he has succeeded . . .

This is not only a fine loudspeaker: It is a fascinating piece of applied physics.

Listening . . .

Two aspects of the loudspeaker-room interface that can cause trouble in a domestic listening-environment are *early reflections* and *standing waves*. A simple case of an early reflection problem is shown in figure 11. The loudspeaker is standing on a highly reflective floor, so that the listener receives sound along the direct path *and* indirectly off the floor. The reflection will arrive perhaps one or two milliseconds after the direct wave and with rather less intensity. The most effective approach is to imagine that the floor is

8

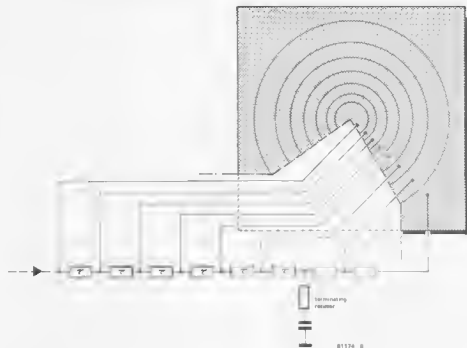

Figure 8. This illustration shows how the ESL 63 radiates a curved wavefront from a flat diaphragm using delay line matching. The delay-line taps are connected to the concentric areas of the drive unit fixed plates.

transparent with the reflection being produced by an *image* of the loudspeaker underneath it. The extra distance travelled by the delayed wave will correspond to one or more half-wavelengths of some musical frequency (usually in the mid-range). The problem is that destructive interference will cause a partial cancellation of the pressure due to the direct wave, resulting in fairly broad response-dips centred on frequencies corresponding to odd numbers of half-wavelengths. The whole-wavelength situation, with the two waves more or less in-phase, will result in broad peaks that are usually even more unpleasant than the dips.

The image-method can be applied to more complex situations provided one uses enough images to account for *all* the troublesome reflections. Note, by way of an example, that a double-bounce reflection would be 'radiated' by an *image of an image*. We believe it was this effect that we ran into on our first hearing of an ESL 63, in a room with a tiled floor. The loudspeaker was well clear of walls — but it 'honked' slightly. The effect disappeared when we either moved the loudspeaker into a carpeted room or else raised it off the floor on a makeshift standard. (An empty milk-bottle crate, actually. Optional extra?)

The carpet presumably attenuated the reflection sufficiently; the effect of the milk-crate is more instructive: refer again to figure 11. We started by noting that the ESL 63 radiates as a doublet,

9

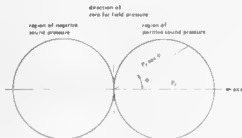
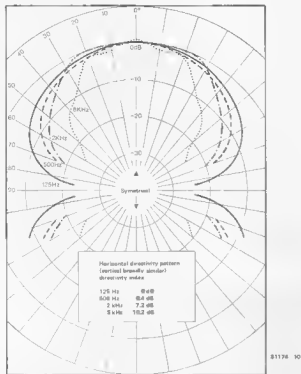

Figure 9. The so-called radiation pattern of a doublet.

with axis horizontal and about 50 cm off the floor. Now fit in the listener, with his ears about 1 metre off the floor and about 3 metres away from the loudspeaker. The vertical angle subtended by the direct listener-path at the loudspeaker is ... etc. etc. This produced the puzzle that the milk-crate operation is ... etc. etc. This produced the puzzle that the milk-crate operation could only have reduced the reflected wave pressure by a couple of decibels. Then it dawned. Moving the image source about 35 cm further below the floor had caused its listener-path to be intercepted by a coffee-table!

A standing wave as a room-interface problem should be distinguished from a standing wave behaving itself as part of the reverberation process. Any standing wave mode is characterised by its *natural frequency* and its degree of *damping*. The problem only appears when a single lightly-damped mode, or a closely-spaced group of such modes, occurs in isolation. Musical tones from an instrument or a loudspeaker, particularly sustained tones, that happen to be near the natural frequency can build up a forced vibration of distressingly high amplitude. After the tone stops the mode will decay more or

10



81176 10

Figure 10. The measured radiation patterns of the ESL 63. Note that the patterns appear flattened in comparison with figure 9 due to the use of a logarithmic amplitude scale.

11

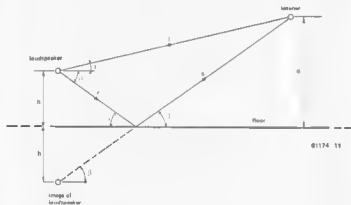

81174 11

Figure 11. An illustration of the image source method applied to the simple case of one reflection off the floor.

less slowly at its natural frequency. Beats can occur if two or more modes are excited together (by the same tone) and then decay independently. The advantage of a doublet in this room interface problem is that its output is in the form of a particle-velocity along the axis. It will therefore only couple to modes that have a significant component of particle-velocity along the axis at the doublet position. This is probably one of the reasons that electrostatic doublets are considered bass-weak, even when like the ESL 63 they are not. The room simply doesn't give the expected (liked?) booming response.

Combating the room-boom problem with a doublet starts by feeding it with a low-level sine-wave (at the 'right' frequency, obviously!) and then moving it - and yourself - around, until the offending mode is identified. Then try to find a position or orientation for the loudspeaker that will sufficiently weaken the unwanted coupling.

To woof or not to woof . . .

Many years ago, when all available loudspeakers had a single nominally full-range cone driver, some innovative soul introduced the concept of the *tweeter*.

The next step was to shift the working range of the main driver downwards in frequency, then call it a *woofer*. Later again came the *squawker* - an epithet that never really stuck - and now we have ultra-widerange systems that add a *supertweeter* and, sometimes, a *sub-woofer*. The separate subwoofer systems that are becoming available should more logically be called *rumbler*s or *thumper*s . . .

The question now is: granted that the ESL 63 delivers its bass output the hard way - into the relatively unfavourable doublet airload - does it need help? Peter Walker says quite emphatically 'no'. For one thing the ESL 63 bass response is more extended and better-controlled than that of its predecessor. For another, its doublet radiation pattern gives a more aperiodic interface to a typical listening room than available auxiliary bass systems do - because they are omnidirectional radiators. On the other hand, people who insist on realistic (?) reproduction of organ pedal - or for that matter heavy trucks and underground trains - may disagree. That of course is up to them . . . (They might of course try listening *right in close* to a doublet. Proximity effect will provide quite an amount of bass boost!)

M



2

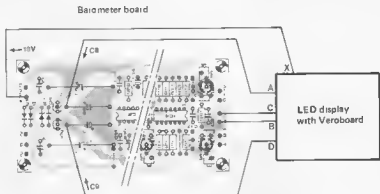

82018 2

Figure 2. How to connect the circuit in figure 1 to the barometer board published elsewhere in this issue. The latter provides a ± 15 V and $+18$ V power supply.

3

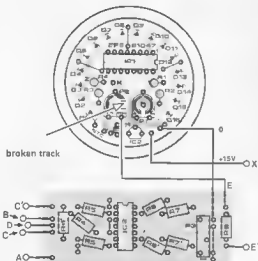

82018 3

Figure 3. How to wire the bath thermometer board to the Veroboard, on which the circuit containing opamps A1 and A2 (figure 1) is built. The two inputs are marked C and C' and the two outputs E and E'. The latter are connected to one display board each. The required break in the track is shown in the copper track pattern of the bath thermometer board.

it can be seen from figure 1, the thermometer circuit has been slightly modified: R4 and the NTC resistor have been removed. The voltage proportional to temperature reaches pin 11 of IC1 from the output of the opamp A2 by way of P2. The two opamps are mounted on a separate piece of Veroboard.

The temperature output which was already present on the barometer board is calibrated to allow the voltage to change by 10 mV when the temperature changes by one degree centigrade, so that this is 0 V at 0°C. This enables temperatures to be read on a DVM. In the case of a temperature indicator consisting of 16 LEDs (16°C display range), the difference between the lowest and the highest temperature level (= 160 mV) will have to be amplified at the input voltage range of the display (5.2 V). Thus, $5.2 \div 0.16 = 32.5$.

A1 will therefore have to amplify the temperature output voltage by that factor at least. Using the indicated values for R4 and R5 this amplification will be about a factor of 39. As a result, P2 can easily set the precise scale division factor. A2 cancels out the inversion of A1 and allows the required display range to be shifted, which without P3 would cover 0...16 degrees. This is a little low for a room thermometer. If, on the other hand, the voltage at the wiper of P3 is 120 mV, the row of LEDs will not start to rise until the temperature is 13 degrees. If the temperature is lower than this, only the first diode will be lit.

From the four opamps inside the LM 324 IC, two amplifiers are left to allow the same circuit to be used again for the humidity sensor. P3 and R8 can be omitted here as humidity in the atmosphere is indicated in 10% steps

between 0 and 100%, so that only the first 10 LEDs are ever required, R5 should only be 47 K in this case, as the output voltage of the humidity sensor is between 0 and 1 V.

Figure 2 shows how the barometer board and a 'case' containing the entire circuit in figure 1 are assembled. The positive and the negative supply voltage for the LM 324 can be derived from the barometer board. For this purpose, a short length of insulated cable is soldered to both the positive pole of C8 and the negative pole of C9, as these are the outputs of the two 78L15 and 79L15 stabilisers.

How to calibrate the temperature display

1. Ground the wiper of P1.
2. Connect 1.3 V to input C.
3. Calibrate P3, so that LED 2 starts to light.
4. Connect 0.27 V to input C.
5. Calibrate P2 until the 16th LED lights.

How to calibrate the humidity display

1. Ground the wiper of P1.
2. Connect 1 V to input C.
3. Calibrate P2 until the 10th LED lights.

Figure 3 shows how the display is wired to the board and how the latter board is constructed: Output E' must be connected to another, similar display. Inputs A...D must be connected to the barometer board in the manner shown in figure 2. Connection C' leads to the humidity sensor's output.

The (bath thermometer) display should be modified as follows:

1. Break the track connection between the wiper and one end of P2 (see indication).
2. Solder a wire (E) to the disconnected end of P2.
3. Remove the NTC resistor and R4 (in other words, do not mount them, if you haven't already done so).

P. Gabler

volt/ammeter for power supplies

plus . . .
an automatic
range switch

This handy circuit enables a DVM to be connected to a stabilised power supply allowing both voltage and current levels to be measured. Furthermore, an automatic range switch is provided and a compensation network to measure the actual output current without increasing the power supply's internal resistance.

Without electricity there is very little you can do in electronics, therefore, a good quality power supply occupies a very important place in any reader's set of priorities. It should have a wide adjustable voltage range providing a current of at least one or two amps. In addition, it would be a considerable advantage if the power supply were to include a built-in meter to display the output voltage and current levels. The ideal meter is a DVM which combines great accuracy with an easy-to-read display.

The idea certainly makes sense. After all, plenty of stable power supplies have appeared in Elektor's pages and so have several digital voltmeters. So the

smallest range a DVM can have is somewhere around 1 or 2 V. Right, now let's get back to the measuring current.

Figure 2 gives a view of the output section in the power supply including the power transistor T and the resistors connected to the output. R1 and R2 constitute the voltage divider for voltage measurement. The regulator maintains the output voltage at a constant level (to the right of R₅ in other words). By measuring the voltage at R₅ — assuming we know the value of R₅ — the current passing through the resistor can be calculated quite easily. The point is, this will not be the 'real' output current of the power supply, because additional current passes through resistors R_a, R_b,

question of combining the two should be a straightforward proposition, surely? But . . . it isn't, in fact, quite of few problems are involved.

The circuit we're about to discuss manages to overcome the various difficulties and provides a successful DVM-and-power supply combination. What's more the meter does not only indicate the voltage and the actual output current, but also switches from one range to another automatically. All that the operator has to do is flick the switch to select either voltage or current measurement.

The basic principle

Figure 1 contains the block diagram for the well-known 'series stabilisation' type of power supply. A differential amplifier compares a reference voltage U_{ref} to a voltage derived from the output by R_a and R_b. The differential amplifier output controls a power transistor T which is connected in series with the power supply line. Usually a current limiter is included which reacts to the voltage drop across a series resistor R₅. More often than not, a bleed resistor R_n is connected across the output to ensure stability at even very small loads.

In order to calculate the output current, measuring the voltage across R₅ ought to be enough, but, unfortunately, this is not very accurate. The reason for this will be explained later. Measuring the output voltage is really an easy job, as it merely involves connecting the DVM to the output terminals. A voltage divider should not be left out here, as the

R₁, R₂ and R_n. One way to avoid this would be to connect another 'R₅' resistor after those mentioned in the positive line and measure the current there. This is inadvisable, however, as this increases the internal resistance of the circuit.

The author has arrived at a very practical solution. As figure 3 shows, the addition of two more resistors, R3 and R4, turns the supply into a bridge circuit. Here R_x replaces R_a, R_b, R₁, R₂ and R_n. If the values of R₃ and R₄ are chosen so that their relationship to each other is equal to that of R₅ to R_x (R₃/R₄ = R₅/R_x) the differential voltage U_d between points A and B of the bridge will be nil, irrespective of the power supply voltage. Once this requirement has been met, the bridge voltage can be used to measure the 'real' output current. This is because the bridge voltage equals the current passing through R₅ minus that passing through R_x. Readers with a flair for maths can check it if they like; we're more interested in the result.

The meter circuit

Now that we know where and how to measure, we can start putting our ideas into practice. The block diagram for the circuit we have in mind is shown in figure 4. The bridge voltage that is required to measure the current is obtained by connecting the junction R3/R4 to amplifier IC1 and by linking the zero line of the meter circuit to junction R₅/R1. The amplification of

IC1 is set so that its output voltage is 1 V when the power supply produces 1 A. Preset R4 is adjusted to balance the bridge with no load on the power supply. In other words, the bridge voltage is 0 V. A diode and a capacitor are connected after the amplifier to produce a peak value measurement.

The output voltage of the power supply is derived from the voltage divider junction R1/R2 and is fed to the inverting input of amplifier IC2 (since the polarity of the voltage at the upper end of R1 is negative with respect to the ground of the meter circuit). IC2 is amplified so that the output voltage is 1 V when the power supply's output voltage is 10 V. This 1 V 'standardisation' (1 V per A and 1 V per 10 V) allows current and voltage levels to be measured without any difficulty when the DVM is adjusted to the 1 V range.

To save having to alter the measuring points any further, an automatic range switch has been added after the amplifiers IC1 and IC2. This has the advantage that the DVM does not have to be readjusted during use.

Figure 4 shows two voltage dividers followed by the comparators K1 and K2. Each comparator activates the voltage divider whenever its input voltage exceeds 1 V.

Finally, there is a single switch allowing the operator to select between voltage and current measurements.

The practical construction

The circuit diagram for the volt/ammeter circuit is shown in figure 5. The dotted area contains the existing stabilised power supply to which the meter circuit is to be connected. R1 and P1 constitute one side of the bridge, P1 being used to regulate the bridge voltage to 0 V when the power supply is under no load. The combination of IC1, D1 and C1 together with associated resistors acts as an amplifier/peak rectifier. P2 adjusts the amplification, so that the voltage at C1 will be 1 V when the power supply provides a 'real' output current of 1 A.

Next follows the voltage divider made up of R6, P3 and R7. The output of comparator A1 will switch when the voltage level at its input exceeds 1 V. This threshold level may be adjusted with P4. When A1 switches, the electronic switch ES4 (which was 'off' up until then), will be activated allowing only one tenth of the measurement voltage to reach the DVM. A1 in turn switches A2, which then operates a relay to display the correct decimal point. Thus, two measurement ranges are available: 1 A and 10 A. The voltage divider can be calibrated for the 10 A range by means of preset P3.

The voltage measurement section is basically the same as that for current measurement, except that the diode and the capacitor used for peak measurements are excluded, as they are not needed: After all, a stabilised power supply ought to be able to produce a

1

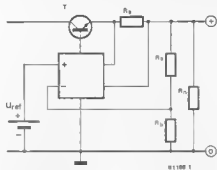

Figure 1. The principle behind the stabilised power supply. A voltage is derived from the output and compared to a reference voltage.

2

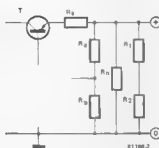

Figure 2. This drawing shows which resistors load the power supply at zero power. R1 and R2 are included to measure voltages.

3

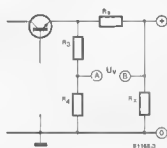

Figure 3. By adding resistors R3 and R4, a bridge circuit is formed.

4

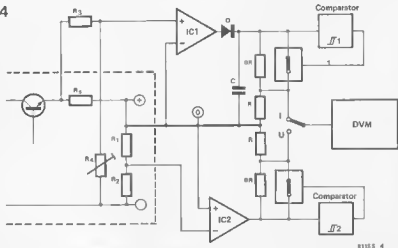

Figure 4. The block diagram for the current measurement circuit including an automatic range switch.

constant voltage! The output voltage measurement is derived via resistor R2. This voltage level is fed to the inverting input of IC2 (since the voltage at R2 is negative with respect to the meter circuit's ground, as was seen earlier). P5 sets the amplification of IC2 so that the output voltage of this IC is 1 V when the power supply output is 10 V. The output of the comparator A3 is set by P7 to switch at 1 V. This will activate ES1 which is placed in series with part

of the voltage divider R13, P6 and R15. P6 serves to calibrate the voltage divider. By means of the relay R_B, A4 selects the correct decimal point in the display. The voltage ranges thus obtained (and indicated) are 10 V and 100 V.

The switches ES2 and ES3 connect either the voltage resulting from the current measurement or that of the voltage measurement through to the input of the DVM. The switch S1 determines which of the two (current or

2

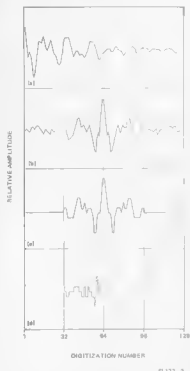

SI 172 2

Figure 2. Orastic data reduction techniques are used in the Digitaltalker system. A 'slice' of the original speech is shown at the top. Phase-angle adjustment converts this to a symmetrical signal (b); after adaptive delta modulation and half-period zeroing, it would look as shown in (c). A digital code, corresponding to the signal shown in (d), is all that is actually stored in memory.

Alternatively, you can make electronic 'lungs', 'vocal cords', 'mouth and nose cavities' and 'lips', and apply fairly complicated control signals to these at a relatively slow rate (once every 25 milliseconds or so). This is how the Texas Instruments 'LPC Solid State Speech' system works.

The Digitaltalker

As shown in figure 1, the basic Digitaltalker system consists of only a few components: the Speech synthesis chip, a 128 Kbit memory (sufficient for about 128 words), a crystal oscillator and filter/amplifier.

The data in the memory is derived from spoken words. These are sampled and converted to digital information, after which several compression techniques are used to reduce the data to a manageable quantity. The first step is to remove redundant (repetitive) information. When several nearly identical periods appear in the total signal, these are replaced by the codes for a single period and a further code indicating how often this must be repeated. On average, this can reduce the total data required to

about one quarter.

A further technique used to 'compress' the volume of data is known as 'adaptive delta modulation'. This is based on the fact that speech waveforms are relatively smooth: sudden level jumps are uncommon. Therefore, the information required to define the difference between two successive samples is less than that required to define the absolute level of any given sample. In plain language: given a particular voltage level at one point on the waveform, you only need to add or subtract a small amount to obtain the next level.

A further step is called 'phase-angle adjustment'. Without going into higher maths and Fourier analysis, it is almost impossible to explain how this works. However, we can attempt to give a basic idea. It is fairly well-known that any complex signal can be described as a mixture of sinewaves, each with different amplitudes and phase angles. Furthermore, human hearing is not very sensitive to phase information. Given these assumptions, it is not such a total surprise to find that the same set of frequencies and amplitudes can produce an almost infinite variety of different waveforms, provided the phase angles can be varied at will. The trick used in this system is to adjust the phase angles to produce a waveform that has mirror symmetry and, furthermore, a low amplitude for at least half of the period. It then becomes possible to reduce the low-amplitude part to zero and mirror the rest, reducing the total data required to one quarter!

The total effect of the latter techniques—phase-angle adjustment, half-period zeroing, adaptive delta modulation and mirroring—is shown in figure 2, for a

small portion of the speech waveform. The original waveform is shown in figure 2a, and the phase-angle adjusted version in figure 2b. Believe it or not, these two signals sound the same! The next step, in figure 2c, shows the effects of adaptive delta modulation and half-period zeroing; finally, figure 2d shows the signal that must be stored in memory (in digital format).

When it comes to reproducing the spoken words, a large degree of flexibility is required. Male or female voice? Loud or soft? And so on... However, the processor chip takes care of all this, on the basis of data stored in ROM by National Semiconductor themselves (according to the customer's specification). So for the purposes of this article—dealing with general principles—we will skip that part.

The Votrax speech synthesiser

The basic Votrax system is even simpler than the Digitaltalker. With only slight over-simplification it can be shown as a single IC! (See figure 3).

A 6-bit input (P0...P5) selects one of the 64 'phonemes' that the SC-01 can produce; furthermore, a 2-bit pitch control input helps to add inflection to the 'speech' output. As shown in table 1, the 'phonemes' are the elementary sounds that can occur in normal speech. Only a very low data rate (approximately 70 bits per second) is required to tell the chip how to tack these phonemes together to produce words.

This system has obvious advantages. The total memory capacity required is minimal, and programming is relatively easy. Furthermore, Votrax maintain a library of phonetically programmed words and they can even supply a

3

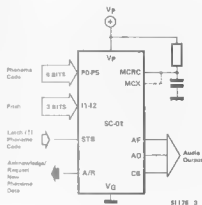

Figure 3. The Votrax system requires little more than a single IC! Control signals are applied to its inputs, at a rate of only 70 bits-per-second, and speech appears at the audio output.

Table 1.

Phoneme Code	Phoneme Symbol	Duration (ms)	Example Word	Phoneme Code	Phoneme Symbol	Duration (ms)	Example Word
00	EH3	59	jeck <u>e</u> t	20	A	185	day
01	EH2	71	en <u>i</u> st	21	AY	65	day
02	EH1	121	heav <u>y</u>	22	Y1	80	yard
03	PA0	47	no sound	23	UH3	47	mission
04	DT	47	b <u>u</u> tter	24	AH	250	mop
05	A2	71	mad <u>e</u>	25	P	103	past
06	A1	103	mad <u>e</u>	26	O	185	cold
07	ZH	90	az <u>u</u> re	27	I	185	pin
08	AH2		h <u>o</u> nest	28	U	185	move
09	I3		in <u>h</u> ibit	29	Y	103	any
0A	I2	80	in <u>h</u> ibit	2A	T	71	top
0B	I1	121	in <u>h</u> ibit	2B	R	90	red
0C	M	103	mat	2C	E	185	meet
0D	N	80	sun	2D	W	80	win
0E	B	71	bag	2E	AE	185	dad
0F	V	71	van	2F	AE1	103	after
10	CH*	71	ch <u>i</u> p	30	AW2	90	salty
11	SH	121	sh <u>o</u> p	31	UH2	71	about
12	Z	71	zoo	32	UH1	103	uncle
13	AW1	146	law <u>f</u> ul	33	UH	185	cup
14	NG	121	th <u>i</u> ng	34	O2	80	for
15	AH1	146	fat <u>h</u> er	35	O1	121	aboard
16	OO1	103	lo <u>o</u> king	36	IU	59	you
17	DO	185	bo <u>o</u> k	37	UI	90	you
18	L	103	l <u>e</u> nd	38	THV	80	the
19	K	80	tr <u>i</u> ck	39	TH	71	thin
1A	J*	47	ju <u>d</u> ge	3A	ER	146	bird
1B	H	71	h <u>e</u> llo	3B	EH	185	get
1C	G	71	g <u>e</u> t	3C	E1	121	be
1D	F	103	f <u>e</u> t	3D	AW	250	cut
1E	D	55	pa <u>i</u> d	3E	PA1	185	no sound
1F	S	90	pa <u>s</u> s	3F	STOP	47	no sound

Table 1. Phoneme chart for the Votrex SC-01.

4

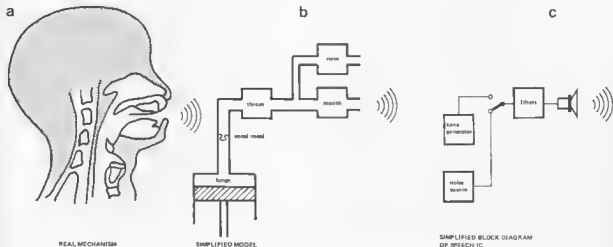

Figure 4. The Texas Instruments system is based on the human speech mechanism, as illustrated here. The lungs and vocal cords are replaced by a noise generator, tone generator and switch; the throat, nose and mouth cavities are simulated by a bank of filters.

Table 2.

	E	R	P	K1	K2	K3	K4	K5	K6	K7	K8	K9	K10	FRAME TYPE	
	0000													SILENCE	
H	0100	0	00000	10011	01110	1001	0111							UV	
	0111	1	00000											UV — REPEAT	
	1101	0	10010	10000	10100	1000	0110	0111	1000	1010	100	101	010	V	
	1101	1	10011											V — REPEAT	
	1110	1	10011											V — REPEAT	
	1101	0	10100	01101	01111	1010	1010	1001	0111	1000	100	101	101	V	
	1101	0	10100	01110	01011	1000	1100	1101	1000	0100	100	011	101	V	
	1101	0	10011	10001	01010	0110	1001	1111	1011	0101	010	000	110	V	
	1011	1	11010												V — REPEAT
	1010	0	10010	01101	00111	1000	1100	1111	0111	0010	001	010	110	V	
	1001	1	10001												V — REPEAT
	1001	1	01110												V — REPEAT
	1000	1	01101												V — REPEAT
	0010	0	01110	00101	00101	1101	1001	1110	1101	0111	001	011	011	V	
	0000														SILENCE
	0000														SILENCE
0000														SILENCE	
P	0111	0	00000	10100	01011	1011	1000							UV	
	0111	0	00000	10001	01011	1011	0110							UV	
	0101	1	00000											UV — REPEAT	
	0011	0	00000	10011	00111	1010	0110							UV	
	0010	0	00000	10010	00101	1011	0101							UV	
	0000													SILENCE	
1111													STOP CODE		

V = VOICED
 UV = UNVOICED
 E = ENERGY
 R = REPEAT
 P = PITCH
 K1...K10 = FILTER PARAMETERS

Table 2. This sequence of digital code words will make the Texas Instruments chip shout for help!

5

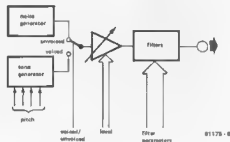

Figure 5. A further block diagram of the TI system.

micro-computer system for automatic conversion of English text into phoneme sequences.

However, there is also a disadvantage: the total capability of the system is determined by the actual phonemes that the chip can produce. This is an extensive list, admittedly, but it is limited — and the same phoneme comes out the same way each time. Even when full use is made of pitch control, and with amplitude control added at the output, the final result always tends to sound artificial.

Texas Instruments Solid State Speech

A prime example of the third approach! As shown in figure 4, the system is closely based on the natural human speech mechanisms. A simplified diagram of 'the real thing' (figure 4b) is very similar to a block diagram of the speech IC (figure 4c).

The more extensive block diagram (figure 5) gives a better idea of the necessary control signals. Starting at the left: the noise generator and tone

generator provide the basic signals for unvoiced and voiced sounds, respectively. In the actual system, four bits control the pitch of the tone generator and a further bit 'operates the switch' for voiced and unvoiced sound. Then the level is set, using a further four bits. Finally, a total of 40 bits set the filter parameters or one bit indicates that the existing parameters can be maintained ('repeat'). An example is given in table 2: the total code sequence for the word 'Help!' As can be seen, a good 500 bits are needed for approximately half a second of speech; this corresponds to something over 1 Kbit/s, which is fairly typical for this system.

To work out those bits, for a given word or phrase, is another matter entirely. However, Texas really uses modern technology to the hilt, for prospective customers! On the European scene, it works like this. A customer either sends in a high-quality tape with the desired texts, or else sends in a word-and-phrase list. The example given by TI is rather unfortunate:

"CLOSE THE . . . DOOR" (!)

The intended meaning of those dots is to distinguish the phrase 'close the' from the word 'door'. Instead of 'door', you can insert other words like 'window', 'blinds' and so on.

6

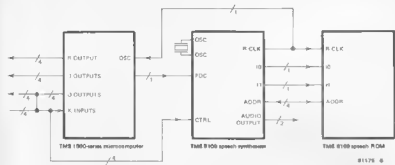

Figure 6. A three-chip self-contained system using the TMS 5100.

7

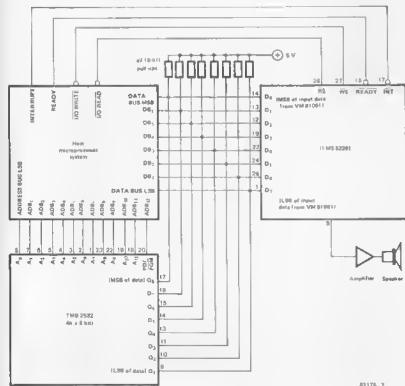

Figure 7. The TMS 5200 is intended for use in an existing microprocessor system.

If a written list is sent in, any desired accent must be clearly specified. The final result will sound like the original human speaker! In fact, this is one of TI's handicaps: they already have an extensive vocabulary on file — 'in

standard TV/radio mid-American accent! No good here ... Given the actual recording (provided by the customer or made by TI), it is converted into a digital code and transmitted by satellite to Houston. At that

end, it is run through a computer that extracts the pitch and voicing information. At the same time, the program computes an optimal set of coefficients for the filters. This is followed by a 'frame repeat analysis', where similar sets of filter control bits are replaced by a single 'repeat' bit.

Then, all this digital information — corresponding to the 'raw' conversion — is transmitted back, via satellite, to Nice. There, the data is auditioned by an expert speech technician (who, in the words of a TI engineer, is 'an extremely multi-lingual young lady'); audible deficiencies are edited by hand. At this point, the customer is called in for final evaluation and, it is hoped, approval.

All right, so you've got your 'speech data' stored in ROM. So how do you use it? According to the application, you can choose between two different 'chattering chips'. The older version (the 5100) was used in the TI 'Speak & Spell' unit; it is intended for talking games, clocks, washing machines and telephone exchanges — in short, any application where it must 'talk' on the basis of simple control signals. The block diagram of a basic three-chip system is given in figure 6. Alternatively there is 'big brother', the 5200, intended for use in conjunction with an existing microprocessor system. This is shown in figure 7.

The link with microprocessors opens an infinite variety of applications. You can store standard words in EPROM, together with a complete set of phonemes — the latter can be used to construct other words, as required. It is even conceivable that you can design a speech-analysis program, so that you can talk into a microphone and use the resulting data in a program. Alternatively, we may be able to supply Texas Instruments' standard library on tape, as part of the Elektor Software Service — pick out the words you want, and burn them into EPROM! This is getting interesting! ... Maybe, in the near future ...

In conclusion

Chattering chips are here — there's no doubt about it. Chattering? We've even heard them produce an absolutely true-to-life 'human' voice! Of the systems proposed at present, Texas Instruments seems the winner — both in price and in capabilities. Price-wise, it wins on points from National — and the programming is easier and, therefore, cheaper and quicker. Quality-wise, it beats Voxtrax — even though the latter is cheaper on memory. And when you're looking for 'the' system for the future, you want something that is both cheap and good.

There are other systems, of course. AMI, General Instruments, Hitachi, Intel, ITT, Matsushita, Philips, TSI ... However, they all use (variations of) the systems described above. Enough is enough! For one article, anyway. ■

transistor ignition update

A year has passed since Elektor published the transistor ignition system in the 'car issue' (April 1980) and yet the project continues to interest and in some cases, judging by the letters we receive, puzzle our readers. This article will try to answer some of the more common queries and provide a few practical, constructional hints. Many readers have sent us their ideas on the subject, for which we are very grateful, as they have proved to be very useful indeed.

The capacitor across the contact breaker

Quite a few questions concern the capacitor across the contact breaker. As the April '80 article stated, this capacitor must be retained even with electronic ignition. Its capacitance, however, may not exceed 0.1 μF . In combination with R1 a higher value will produce an excessive time constant, effectively retarding the ignition timing. One way to solve the problem would be to lower the value of R1, but than the current through the contact breaker will be too high and increase the wear rate. This of course leads to a deterioration in ignition timing — one of the main problems that electronic ignition systems are designed to cure. If the standard capacitor has a value greater than 0.1 μF it is best to try and fit one that is exactly that value. If necessary, a normal low-voltage paper type (at least 60 V) may also be used, since the electronic ignition system does not produce a high induction voltage across the contact breaker. Bear in mind that the capacitor will need to be thoroughly water proofed. The original capacitor is left where it is but unconnected. Should anything go wrong with the electronics, resort to the original capacitor.

Adapting the ignition system to different engines (or vice versa?)

The Elektor transistor ignition was originally designed for 4 cylinder 4 stroke petrol engines with a maximum engine speed of 6000 rpm and an ignition system with a single spark plug per cylinder and a single contact breaker. For this reason the monoflop and the RC time constants in the circuit are based on the ignition frequency of this type of engine.

The ignition frequency depends on the engine speed, the type of engine (2/4 stroke), the number of cylinders and the ignition system (one or more contact breaker sets, spark plugs per cylinder).

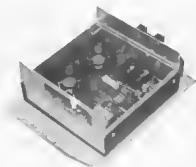

Using the circuit for any other type of engine and/or ignition system than the ones mentioned means having to modify the circuit of the transistor ignition. Not only will the monoflop and RC times be involved here, but also the switching stage. In 6 and 8 cylinder engines and motor cycles, very low impedance spark plugs are sometimes used, for which our transistor ignition is totally unsuitable. Unfortunately, we are unable to modify the circuit to cater for every individual requirement, as many people have requested us to. We can, however, say that the circuit will operate correctly with engines where the firing frequency is up to 12,000 per minute and where the spark plug (including resistors if applicable) have a resistance of at least 1.5 Ω . In other words, the so-called 'super spark plug' is not suitable here.

How to convert from a transistor ignition to a conventional type and vice versa

A number of readers have asked us whether it is possible to use a switch with several contacts or a relay to switch from a transistor ignition to a conventional system and vice versa. This could certainly be done with a switch, but the connections between the switch and the transistor ignition should not exceed 10...20 cm, so in most cases the switch cannot be mounted on the dashboard. On the other hand, a relay would be very unreliable, as any vibration could cause the ignition to become intermittent, which would be highly inconvenient, to say the least.

Turn the engine off before switching from one system to another! Otherwise the switching process might cause an 'artificial' ignition to occur with detrimental results for the engine.

soldering aluminium

H.M. Wolber

Constructors use aluminium a great deal because it is relatively inexpensive and very easy to work with. However, soldering it causes problems, for using an ordinary soldering iron and solder just does not work. The solder does not seem to feel particularly attracted to aluminium. Nonetheless, Mr. Wolber has come up with a solution which allows 'normal' (60/40) solder to be soldered on aluminium.

The problem with aluminium is that it oxidises quickly. In other words, aluminium is always covered in a layer of oxide. As you know, this is a very good insulator and prevents solder from even touching the aluminium. However hard you try to scrape the oxide layer off, oxidation occurs so rapidly that a new layer will appear as soon as the 'old one' is scraped off.

To prevent oxidation, apply grease or oil to the solder point. Then scrape off the layer of oxide with a sharp object underneath the oil. The oil prevents oxygen from reaching the clean aluminium. Now drip hot flux onto the area with a soldering iron, causing the oil to evaporate and the flux to cover the area. The area can now be soldered. To ensure a solid connection make sure plenty of heat is produced by using a soldering iron of at least 100 W. If necessary, the area can be held over a gas flame to remove all traces of oil before soldering.

missing link

Elektor infocard 21

There are two typing errors on the Elektor infocard 21 (Standards 5) in the tone and frequency table referring to musical instruments. The 'B' tone in octave 0 and octave 1 should be 30,8677 and 61,7354 Hz respectively.

Summer Circuits' Issue, circuit no. 11

The second sentence in the third paragraph should read: "This can easily happen if the positive supply is always present before the negative is applied."

market

High performance cassette drive mechanism

Papst Motors Limited have announced a new, very high quality cassette drive mechanism which out-performs many studio reel-to-reel tape transports. Known as the MDD 303, it breaks entirely new ground in that the laminations for the three d.c. motor stators employed in the unit are an integral part of the pressure die-cast chassis. The capstan and two spools are driven directly from the motor shafts, there being no belts, pulleys or other mechanical interfaces to reduce reliability. The cassette drive can be operated either horizontally or vertically at a cassette tape speed of 1.2, 2.38 or 4.75 centimetres per second. For extremely high quality reproduction, tape speeds of 9.5 and 19 centimetres per second are available as an option. However, it is interesting to note that running at 4.75 centimetres per second, the MDD 303 specifications exceed the DIN 45 511/1 requirements for studio tape recorders running at 38 and 76 centimetres per second.

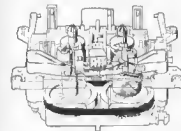

Some of the more significant specifications include a 0.2% maximum deviation from the rated speed, a weighted DIN peak wobble and flutter of $\pm 0.07\%$ and only 35 seconds to fast wind a C60 cassette. The deck runs from 24 V d.c. and consumes 0.65 amps. Operational temperature range is 0 to 50°C with a typical operating life of 5,000 hours. The MDD 303 weighs 1,550 grams and measures only 140 x 95 x 76 mm, which is approximately half the size of any competitive machine.

Three sets of contacts are included within the MDD 303, one to indicate that the cassette is loaded, and two designed for record lock-out applications using the tabs on the back of the cassettes. The latter two can be used for other purposes defined by customers if required. The pinch wheel and record/playback heads are mounted on a swinging arm called a bridge which is controlled by a double wound solenoid. One of the solenoid's coil partially swings the bridge into the operating position by bringing the head in contact with the tape, but not the pinch wheel with the capstan; allowing fast tape search. Tape movement is stopped by electricity, rather than mechanical braking, which provides a positive and carefully controlled halt without placing any additional strain on the tape.

The capstan motor employs a meander disc tachometer which produces a 300 Hz sine wave output when the machine is running at 4.75 centimetres per second to allow very

accurate speed control. The motors include Hall effect sensors to sense drive shaft rotation. This produces three pulses per revolution and can be employed as a tape position counter, end of tape monitor and to actually sense tape motion.

Gordon Hesketh-Jones,
Papst Motors Limited,
Parnell Court,
East Portway,
Andover,
Hants SP 10 3LX5.
Telephone: (0264) 53655

(2063 M)

Short-circuit locator and micro-ohmmeter

The Hy-Trak 100D is a brand new instrument for precisely locating shorts on PCB's. Aural and visual indicators enable the user to probe quickly to the exact fault location, even when the short-circuit is invisible. The instrument provides significant advantages compared with other similar products. It is the first of its kind to use a digital display, giving high accuracy and resolution. It also has comprehensive input protection and a radically new probe design. DC injection is used, enabling probing to be carried out on capacitively loaded circuits. The Hy-Trak 100D doubles as a very accurate Micro-Ohmmeter.

The instrument has five resistance ranges, including the ultra-sensitive 'Hy-Trak' range having a resolution of 100 Micro-ohms. To locate short circuits, two probes are placed on the suspect PCB tracks. Hy-Trak then displays the resistance of any interconnecting path. For resistances less than 60% f.s.d., an on-board oscillator produces a tone which increases in pitch as the probes are moved closer to the fault. When the resistance is within 2% of f.s.d. on any range, the pitch doubles to emphasise fault location. On the 'Hy-Trak' range, short circuits can be pinpointed exactly, even on large voltage planes.

The probes are made of a new material that does not bend or distort under load. Probe tips are an all-in-one design that cannot fall out during use. Long screw threads are used to prevent damage to the probe body. Probes tips have a hyperbolic profile which allows a



probe to be slid along a track at a low angle without damaging its surface, whilst being sharp enough to probe coated boards if required. Plug-in leads facilitate quick probe cable replacement.

As well as testing PCB's, the Hy-Trak 100D is appropriate for a wide range of similar tasks, e.g. as a continuity tester or fault finder for cable assemblies, wire wrapped boards, or wiring looms. It can also be used by skilled personnel as a de-bugging tool for isolating faulty IC's.

Omnitest Limited,
Highcliffe House,
411/413 Lymington Road,
Highcliffe, Christchurch,
Dorset PR 3195.
Telephone: 04252 77731,
Telex: 418449

(2071 M)

7-segment decoder driver

Cosmocond Limited is now marketing a 7-segment decoder driver incorporating input latches and constant current output circuits, for use with common cathode type LED displays rated at a nominal 20 mA at 1.7 V per segment, without the need for current limiting resistors. The 9368 device accepts a 4-bit binary code and produces output drive to the appropriate segments of the 7-segment display.

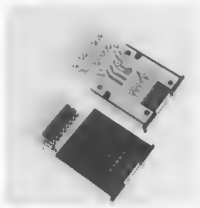

Latches on the four data inputs are controlled by an active LOW latch enable LE. This feature means that data can be routed directly from high speed counters and frequency dividers into the display, without slowing down the system clock or providing intermediate data storage. Another feature of the 9368 is its ability to be driven from an MDS device in multiplex mode without the need for drivers on the data lines, due to the low unit loading on the data input ($\sim 100 \mu\text{A}$ max) when the latch enable is HIGH.

Similarly, the 9368 has provision for automatic blanking of the leading and/or trailing edge zeros in a multidigit decimal number, resulting in an easily readable decimal display conforming to normal writing practice.

Cosmocond Limited,
Eisenor Cross Road,
Waltham Cross,
Herts.
Telephone: Lee Valley 716656

(2062 M)

market

Neons for illuminated push buttons

IMO Electronics have now added a mains operated (neon) to their series of illuminated push button switches and indicators.

The illuminated push button series O1.00 now has the added advantage of a red neon housed in a glass envelope complete with limiting resistor mounted on a TI 3/4 miniature groove base.



The higher brightness of this neon is achieved by incorporating a lens at the end of the glass envelope, therefore focusing the light output in one direction and a special diffuser will prevent the two anode hot spots being prominent and allowing an even overall distribution of light output.

The button colours designed for this red neon are red, orange and yellow.

Available in both 110 VAC and 240 VAC the lamp contacts are fully isolated from switching contacts which are rated at up to 5 amp @ 240 VAC.

IMO Electronics Ltd.,
349 Edgware Road,
London W2 1BS
Telephone: 01 723 9047/8

(2072 M)

DIY speaker range

An entirely new range of speaker components is being introduced by Wharfedale. The kits, named Speakercraft, will enable music and hi-fi enthusiasts to construct their own speakers using proven Wharfedale components from the company's well-established ready-assembled speakers. All the drive units offered under the Speakercraft label can be mounted in various combinations to give a custom-made loudspeaker ideally suited to the personal taste of the listener.

The Speakercraft component range offers a comprehensive selection of treble, midrange and bass drive units as well as a variety of crossover networks. The units offer a high degree of efficiency, above average power handling, excellent appearance, and above all good sound quality at a reasonable cost. Each component comes separately packaged



with construction plans and a Speakercraft booklet which gives all the information necessary, including drawings, for building the speakers. The booklet shows designs for six speakers: the L60, L80, L100, E50, E70 and E90. They roughly approximate to Wharfedale's new Laser series and the high-efficiency, high-power E series.

'Speakercraft',
Wharfedale (Rank Hi-Fi),
Highfield Road,
Idle, near Bradford,
West Yorkshire,
Telephone: 0274 611131

(2064 M)

Digital I.R. meter

Tranchant Electronics Ltd. now have available their new digital (micro-controlled) I.R. meter. The N2700 is part of a new generation of test instruments from Norfolk Industrial Electronics Ltd. and is designed primarily to measure the insulation resistance of capacitors. It can also be used to measure leakage current and has other IR and current measurement applications. The N2200 utilises an auto ranging Pico-ammeter to facilitate the dynamic range of current required.

There are 5 IR ranges and 4 IL ranges. An integral variable DC power supply is incorporated to provide the test voltage. A pre-charge timer function enables the component under test to be charged for a pre-determined time, prior to measuring the IR or leakage current. A pre-settable pass/fail limit may be programmed into the N2700 for both IR and IL. The soak time and indication of parameters is by 3 digit displays: 1) IR/IL 2) Test V 3) SOAK TIME. The IR/IL display indicates the pass/fail limit set, initiated by the keypad. There are 5 Ohmic ranges: 0 to 200 M, 2 G Ω , 20 G Ω , 200 G Ω , 2 T Ω , and 4 leakage



currents: 10.00 mA, 10.00 μ A, 10.00 nA, 10.00 pA. Test voltage is continuously variable in 1 V steps, 2-1000 V DC. Maximum output voltage is 1 KV @ 5 mA max., with short circuit protection. Soak Time is 0-99 seconds.

Tranchant Electronics (u.k.) limited,
Tranchant House,
53 Ormside Way,
Redhill,
Surrey RH1 2LS.
Telephone: Redhill (0737) 69217

(2061 M)

Signal generator

The LSG-16 is a wideband mains operated signal generator with a frequency range of 100 KHz to 100 MHz (300 MHz on harmonic) over six positions. It has internal modulations of 1 KHz or can be modulated externally between 50 Hz and 20 KHz. Crystal oscillator facility is also provided for 1 MHz to 15 MHz. The LSG-16 is housed in an attractive professional case and competitively priced at £55 plus VAT.



Sinclair Electronics Ltd.,
London Road,
St. Ives,
Huntingdon,
Cambs PE 11 4HJ.
Telephone: 0480 64646

(2066 M)

market

Wireless intercom

New from electronics company Eagle International is a 2-channel FM Wireless Intercom, Model TI 250WA can be used conventionally by means of 'call' and 'talk' keys or, by simply depressing the 'auto' key, for complete 'hands-free' communication. Switching from 'receive' to 'transmit' is achieved by built-in voice activated circuitry. For optimum performance the user should be 1 metre from the unit, although it will work up to a distance of 3 metres. LED indicators show



when the unit is in 'transmit' or 'receive' mode. Volume and voice-trigger threshold are adjustable and a channel selector switch allows up to four units to be used in the same vicinity, two on channel 1 and two on channel 2. Transmission is through the mains system thereby eliminating the need for connection leads.

*Eagle International,
Precision Centre,
Heather Park Drive,
Wimby HA0 1SU, Middx.
Telephone: 01-902-8832*

(2057 M)

Audio analyser

A Mk2 version of the Lindos LA1 Audio Analyser has been introduced — a compact all-in-one test set incorporating a low distortion oscillator, a digital frequency meter and a comprehensive measuring section that can check signal levels, frequency response, weighted or unweighted noise, rumble, wow and flutter and distortion. Improvements over the Mk1 include the adoption of BNC sockets as standard, a larger meter scale with 0.1 dB markings, an audio band filter that meets CCIR 468-2 requirements for unweighted noise measurement, and the incorporation of both CCIR and IEC 'A' noise weighting curves as standard.

While the basic LA1 will meet most requirements two other versions are now being offered with the needs of the professional user in mind. The LA1-P includes two extra meter characteristics, true rms and CCIR 468-2 Quasi Peak (for noise measurement). The



LA1-P1 adds Peak Programme Meter characteristics to the list, making it particularly well suited to the needs of local radio stations and others who have to meet the IBA and BBC codes of practice.

All units operate from a single PP9 battery, with a choice of three add-on backs to suit different needs. The MA1 is a simple mains adaptor. The MA2 provides mains or rechargeable operation, audible monitoring, and DIN connectors with channel switching for quick connection to Hi-Fi equipment. The ST1 Studio Interface provides mains operation, audible monitoring, and balanced inputs and outputs with channel switching via four PO Jacks (XLR's optional). It also drives up to +26 dBm into 600 ohms.

*Lindos Electronics,
Sandy Lane,
Bromeswell,
Woodbridge,
Suffolk IP12 2PR,
England,
Telephone: Eyke (03947) 432*

(2059 M)

Mains filter

H & T Components announces the introduction of a compact mains filter unit specifically designed to meet international requirements concerning the suppression of r.f. from, for example, electronic ignition systems. The Series 1179 mains filter unit may be ordered from a variety of standard styles which offer a choice of termination layouts. In this way,



the specific layout may be ordered which meets the individual wiring distribution of the host equipment. The basic filter can be supplied with or without a mains leakage resistor, and has a current rating of 1 A continuous or 3 A peak, at 240 V a.c., 50 Hz. It has been approved by an independent test house, and offers r.f. suppression over the range 150 KHz to 300 MHz.

*H & T Components,
Crowdy's Hill Estate,
Kembrey Street,
Swindon,
Wiltshire SN2 6BN
Telephone: 0793 693681-7*

(2067 M)

Single dot temperature indicators

Thermindex announces a new and improved range of single dot temperature indicators. These self-adhesive dots are 10 mm in diameter and cover the range 38° C to 260° C. Temperatures are shown in both centigrade and Fahrenheit on each dot. They are packed in booklets of 50 dots per booklet priced at £3.50 per booklet, ex VAT. The dots change from silver gray to black upon reaching temperature, the colour change being permanent, thus affording a permanent record of the temperature achieved.

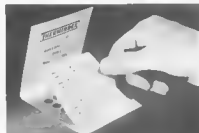

*Thermindex Chemicals and Coatings Ltd.,
P.O. Box 112, Immax House,
Imperial Way,
Watford WD2 4JD,
Telephone: 0923 33477*

(2065 M)

High voltage meter probe

Lightweight, with a built in meter, the LHM-80A from Leader measures up to 40,000 V DC simply and safely. With 20 K Ω per volt input impedance, and an accuracy of $\pm 3\%$, the LHM-80A is an essential tool for TV servicing, and many other applications. Made of high impact polystyrene, the LHM-80A is 385 mm long, weighs 300 g, and costs £16 + VAT.



*Sinclair Electronics Ltd.,
London Road,
St. Ives,
Huntingdon,
Cambs PE17 4HJ,
Telephone: 0480 64646*

(2070 M)

market

market



Hybrid active filters

A range of precision low pass and high pass 4th order active filter modules are now available from Menvar Hybrids Ltd. The modules are trimmed during manufacture and require no external components. Customers can specify the cut-off frequency in the range 50 Hz to 5 kHz and select a Bessel, Butterworth or Chebyshev response approximation. Amplitude and phase response accuracy are better than 0.2 dB and 1.0 degrees respectively.

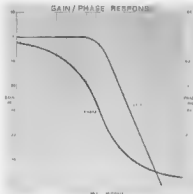

Samples can be supplied within two weeks, there are no tooling charges and quantity prices are from £ 5.30. The modules can be supplied as 16 pin DIL or 8 pin SIL packages. Higher order filters can be supplied.

*Menvar Hybrids Ltd.,
Southam Road,
Banbury,
Oxon OX16 7RX,
Telephone: 0295-56363,
Telex: 837829 MENVI*

(1871 M)

LCR bridge

AIM Cambridge Ltd. have launched a new low cost, automatic, digital LCR bridge priced at £ 495. The LCR Databridge 401 measures inductance, capacitance, resistance and Q,

over eight decade ranges, claiming a basic accuracy of 0.25% of reading. Measurements can be made at either 100 Hz or 1 kHz and either Series or Parallel equivalent circuit values can be displayed on the instrument's four digit display. Designed around a Z80 microprocessor, the LCR Databridge 401 has full auto-ranging facilities, with range lock, and automatically distinguishes between inductors and capacitors, without operator intervention. An internal 2 volt bias supply is provided for use in the measurement of electrolytic capacitors. The LCR Databridge 401 is supplied with an integral 4 terminal test fixture and digital outputs for the option Limit Comparator.

*AIM Cambridge Ltd.,
Burrell Road, Industrial Estate,
St. Ives, Huntingdon,
Cambs.
Telephone: (0480) 65141*

(1995 M)

Exponential voltage to frequency converter

Specially designed for use in applications where the requirement of a wide stable exponential frequency range is of prime importance the Aragon VFO1 encapsulated module also operates in a linear mode with a minimum change of external components.

The operational frequency range lies between 0.1 Hz and 200 kHz with a present maximum of 500 kHz. Accuracy in the linear mode is better than 0.1% central to 6 decades and in the exponential mode better than 0.1% over 5 decades. Power supply requirements are ± 15 volts. The module measures L, 45 x W, 30 x H, 21 mm with 0.040" diameter gold plated pins on a 0.1" grid pattern.

*Turner Electronics Ltd.,
Unit B2, Old Barn Lane,
Kenley,
Surrey, CR2 5AT,
Telephone: 01.663.0821*

(1996 M)

Miniature LCD frequency meter module

The Thurlby FM77T is a complete frequency meter built into a module less than 1/2" deep, and costing under £ 20.

With no additional components the FM77T will directly measure and display frequencies up to 3999.9 kHz. With external pre-scaling, this can be extended to 39.999 MHz or 399.99 MHz.

Stability is better than ± 1 digit over a 10°C to 30°C range and is defined by a built in crystal timebase. The display is a high contrast reflective LCD with 9 mm characters with user selectable decimal points and kHz/MHz legends.

For radio receiver applications, the user can select any one of 23 pre-programmed standard IF offset frequencies, enabling a reception frequency to be displayed by measurement of the Local Oscillator.



The FM77T operates from a single power rail of between 4½ and 7 volts and consumes only 1 mA. Overall size is 2½" x 1½" x ½" and the display is mounted behind a textured bezel.

Price in the U.K is £ 19.95

*Thurlby Electronics Ltd.,
Office Suite 1,
Coach Mews,
The Broadway,
St. Ives,
Huntingdon,
Cambs, PE17 4BN
England.
Telephone: (0480) 63570*

(2056 M)

Miniatura mains switching relays

New AZ692/AZ693 series miniature mains switching p.c.b. mounting relays with 4 kV isolation and 8 mm creep and air gap, have been launched by Zettlar UK Division.

The skilful design of these relays combined with carefully chosen materials gives a relay which, whilst being compact and of sturdy construction, is also inexpensive.

They are available with one changeover, one normally open or one normally closed AgCdO contact set (silver also available), on a standard matrix affording a wide range of compatibility.



Maximum A.C. rating 8 A/380 V

Total epoxy sealing to IP 67 DIN 40 050 is also available on request. AZ692 is similar to AZ693 with the exception that the contact pins of 892 are on a wider 3.5 mm pitch whereas the contact pins on 693 are on a 2.5 mm pitch.

*Zettlar U.K. Division,
Brember Road,
Harrow,
Middlesex HA2 8AS,
Telephone: 01.422.0061*

(1999 M)

market WORLDWIDE

Miniature connector

The Series 1300 miniature snaplock connector has been designed for applications in electrical and electronic equipment in which vibration or intenal movement is commonplace. Both plug and socket halves of the connector are hooded for parsonal protection, and the free plug incorporates twin barbed locks, one on each side of its moulded plastic case. These locks mate with the fixed, flanged socket thus ensuring firm and secure mating. Disconnection is effected by light pressure being placed on the two locking bars



Electrical characteristics of the Series 1300 connector include a current rating, per circuit, of 5 A, operating voltage of 400 V a.c. (maximum), proof voltage of 1.2 KV and contact resistance of 5 milliohms (maximum). The connector shell is moulded in grey Acetal Resin, and contains a moulded phenolic insert with six gold-on-nickel or silver plated brass contacts. The positioning of the contacts is such that mis-mating of the connector is effectively prevented.

*H & T Components,
Crowdy's Hill Estate,
Kembrey Street,
Swindon,
Wiltshire SN2 6BN.
Telephone: 0793 693681 7*

(2073 M)

Morse keyboard sender

The new Datong morse keyboard is intended as a direct replacement for conventional or electronic morse keys. Because hand movements and the need for concentration are reduced compared with conventional keys, sending fatigue is greatly reduced. Also a built-in 16 character buffer memory means that error-free morse of excellent quality can be produced even by a beginner without the need to develop a specialist skill which is of no use in other fields.

The Datong keyboard is the first to use micropower circuitry. This means that no external power cable is needed. Instead, four internal pen cells power the unit for typically 300 hours. Sending effort can be further reduced by storing standard message routines in the four 64-character memories. Programming pauses can be inserted anywhere in

memory allowing reports and call signs etc, to be conveniently included if required. The memory contents remain intact when the keyboard is switched off and even while the batteries are changed.

The exclusive keyboard design combines the benefits of conventional microswitches (1.3 mm travel, light click action) with a dust and water resistant wipe-clean surface. The surface is in fact a tough polycarbonate membrane under-surface-printed in four colours. Other features include built-in sidetone and "keypressed" pip tone; variable weighting; speed ranges 5 to 33 and 20 to 132 words per minute, variable extra delay between letters to ease message editing or to allow use as a morse trainer; auto-repeat from memory for automatic CO calls etc.; an extensive character set includes punctuation, accented letters and procedure signals; "MERGE" key for making non-standard characters.

Model MK is finished in matt black with penel printing in white, brown, and red. Dimensions are 10 1/2" x 6" x 1 1/4" (273 x 150 x 29 mm). The price is £ 140 + VAT (£ 161 total).

*Datong Electronics Limited,
Spence Mills,
Mill Lane,
Bramley,
Leeds LS13 3HE,
Telephone: (0532) 552461.*

(2058 M)

1000 W power supply

A new autoranging power supply with the high performance characteristics and special design features useful in automatic test system applications has been announced by Hewlett-Packard. The HP 6012A gives system designers who need a variety of fixed and programmable power supplies, operating freedom and flexibility in a compact, lightweight and efficient unit. In addition to filling the need for up to 1000 watts of power in the lab, the power supply has special interface and status feedback features for automatic test systems. Typical applications include semiconductor burn-in systems, PC board test systems, and automatic production processes. Option 002 provides a convenient

low-cost means of integration using a 37-pin connector.

The HP 6012A provides maximum output power over a wide and continuous range of voltage and current combinations without having to manually select the proper output range. This feature, unlike conventional CV/CC power supplies which provide maximum output power at only one combination of output voltage and current, makes the 6012A convenient, cost-effective and capable of satisfying many different requirements. For example, an engineer would need a 20 V 50 A supply, a 40 V 30 A supply, and a 60 V 17.6 A supply to cover a range similar to that of the 6012A.

In addition to autoranging, the 6012A has many features which make it a versatile lab supply including mode and status indicators, adjustable overvoltage protection, two 10-turn potentiometers for high resolution control, amplified current monitor terminals, and voltage and current meters. A barrier strip at the back of the supply provides the necessary terminals for current monitoring, remote programming and remote sensing.

Interface option 002 provides various features to the system designer including remote programming, status readback, remote shut down and output bias supplies.

*Enquiries Section,
Hewlett Packard Ltd.,
King Street-Lane,
Wimshurst,
Wokingham,
Berks RG11 5AR,
Telephone: (0734) 784774*

(2060 M)

Hexadecimal push index switches

Designed to satisfy the demand created by microprocessor based equipment, the Cosmoquad 8000 series of 24 mm push index switches has been extended to include a fully hexadecimal version engraved D - B and A to F as standard, and with D - 16 if preferred. The Cosmoquad 8000 series offers a wide choice of output codes including decimal and binary coded decimal - with or without complement. Push mounted from the front, these snap-together switches offer direct visual indication of the last input, eliminating errors associated



with keyboards. The standard case colours are black or grey with large, easy to read engraved white letters on a black wheel. Manufactured in impact resistant Acetal and polycarbonate, the switches have contacts of silver/gold alloy on beryllium copper, offering a switching capability of 1/2 amp and 200 V rms within the limits of 24 watts per switch.

*Cosmoquad Limited,
Eleanor Cross Road,
Waltham Cross,
Herts.
Telephone: Lase Valley 716666.*

(2075 M)

market

New intercom

Barkway Electronics have introduced a new Intercom Unit to complement their micro-computer-controlled POLYDEX System.

The new, ergonomically designed unit, with special key layout conforming to international telecommunications standards, is suitable for desk use or wall-mounting and is available with handset.

The Barkway unit offers considerably advantage over other manufacturers' dual-purpose units which are, at best, a compromise, because the need to make them compact hampers audio output and sound quality capable of a larger unit specifically designed for direct speech.

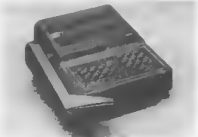

Barkway's experience in supplying many systems throughout the world indicates that no more than 2-3 percent of direct speech customers use handsets or dual-purpose units in the handset mode.

The POLYDEX-System gives a wide range of facilities to direct speech intercom, including: automatically call-back; call transfer; secondary transfer; automatic priority — which enables a caller to cut into an engaged extension; interfacing with a paging system or mobile radio hook-up and a choice of up to 200 stations on 14 channels.

*Barkway Electronics Limited,
Barkway, Royston,
Hertfordshire SG8 8EE,
Telephone: (0763 84) 666*

(2003 M)

Contactless switch

A monolithic integrated Hall effect circuit and a permanent magnet have now been hermetically encapsulated in plastic to form the HKZ101, the new magnetic vane switch from Siemens. The robust construction of the component makes it ideal for use as a contactless breaker in electronic ignition systems in motor vehicles, where it can withstand the most severe operating conditions. The device has a temperature range of -30°C to $+13^{\circ}\text{C}$ and comes in a shockproof case which is resistant to the effects of petrol and oil. The switch is not — as is the case with light barriers — affected by deposits or outside light.

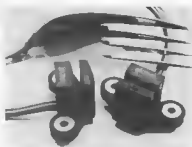

The Hall sensor and the permanent magnet, arranged in a forklike configuration, form an air gap through which a soft iron vane can be pass as a switching medium. The open collector of the Hall amplifier conducts (to a maximum of 40 mA) when the vane is in the air gap. When, however, the vane leaves the air gap, the collector output remains blocked until the vane reappears in the air gap. Because of this static method of operation, there is — unlike with, for example, inductive pick-ups — no lower limit to the working frequency. The output signal shape is independent of working frequency. The new Hall effect magnetic vane switch also features integrated overvoltage protection, which provides the circuit with a reliable safeguard against voltage peaks which occur in the electric of motor vehicles.

The HKZ 101 is also ideally suited for many industrial applications, e.g. as a limit switch, revolution sensor or position sensor for speed measurement and for sampling coding disks. Since the output stage is in the form of an open collector, LEDs or relays can be directly driven; levels can also be matched to supplementary circuits.

*Siemens Limited,
Siemens House,
Windmill Road,
Sunbury-on-Thames,
Middlesex TW16 7HS,
Telephone: (09327) 85691 Ext. 250*

(2006 M)

Versatile LED bar indicators

The Sharp GL Series of LED-based bar-graph indicators from Impetron Ltd. consist of five, seven or twelve LED segments in a choice of colours. There are seventeen different types, all designed for PCB or panel mounting offering a range of colours, sizes and configurations.

There are four basic colours: red, yellow, yellow-green and green, and as well as single colour arrays the user can specify many colour combinations.

Overall dimensions of the five segment versions are $40 \times 8 \times 7$ mm (excluding pins)

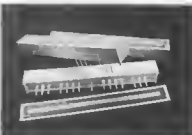

with displayed segment dimensions of 5×2 mm. For the seven segment versions overall dimensions are $42 \times 7 \times 6$ mm, with segments measuring 4.5×2 mm. The twelve segment types measure $58 \times 8 \times 7$ mm, displaying segments of 4×1.5 mm.

Designed to operate on forward voltages of around 2 V, each segment draws a maximum of 20 mA at peak luminous intensity. The indicators can be used as either conventional ON/OFF indicators or to display analogue variables in bars of dots when combined with IC drivers. Applications include display of I/O voltage levels, time variables, temperature, quantity of light and sound volume.

They can also be used as multiple indicators which eliminate problems such as differences in luminance and package size often encountered when using several individual LEDs. Impetron can also supply integrated circuit drivers for all indicators in the Series, allowing high impedance interfacing to most drive circuits.

*Impetron Ltd.,
Foundry Lane,
Horsham,
W. Sussex.
Telephone: 0403-50111*

(2005 M)

Intelligent display module

The DS240 is an intelligent display module comprising a 2-line by 40-character dot-matrix vacuum fluorescent display tube together with all the necessary drive circuitry. The unit is designed for easy incorporation into desktop computers, point of sale terminals, etc. An on-board microprocessor makes system interface a simple matter, two types of parallel interfaces and serial (V24) interface at B different band rates being available as standard.

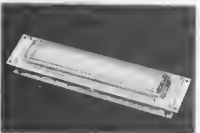

The unit also features a 'self-test' mode to aid system fault tracing. The display is fluorescent blue-green, which may be filtered to blue, green, yellow, pink, etc. (at reduced light output). Characters are generated under software control and therefore custom and special characters are possible. The standard unit produces 96 standard ASCII characters, plus 32 non-standard characters. Characters presented to the unit greater than 9 F (Hex) produce the standard ASCII characters but with underline or blink. Frontal area of the unit has been kept to a minimum to reduce panel space required.

The DS240 measures $10'' \times 2.3'' \times 1.2''$ and costs £346.15 (10 off).

*Delpak Electronics Ltd.,
13 Hazelbury Crescent,
Luton LU1 1DF,
Telephone: 0582 415832*

(2006 M)

MAPLIN make it easy...



in
SOUTHEND
284 London Road
Westcliff-on-Sea
Essex
Tel: (0702) 554000
(Closed Mondays)



in
HAMMERSMITH
159 161 King Street
Hammersmith
London W6
Tel: 01-748 0926
(Closed Mondays)

For personal service visit one of our stores.
Our new store at Hammersmith is conveniently situated near the end of the M4 and the North and South Circular Roads. There is excellent street parking on meters a few steps away and Hammersmith Underground Station is nearby. Call in and see us soon.



in our
CATALOGUE

320 big pages packed with data and pictures of over 5,500 items

Over 100,000 copies sold already!
Don't miss out on your copy

On sale now in all branches
WH Smith price £1.
In case of difficulty check the coupon below



by
MAIL ORDER
A fast service
you can rely on

- * Same day service on in-stock lines
- * Very large percentage of our stock lines in stock
- * All prices include VAT
- * Large range of all the most useful components
- * First class reply paid envelope with every order
- * Quality components—no rejects—no re-marks
- * Competitive prices
- * Your money is safe with a reputable company

On price, service, stock quality and security it makes sense now more than ever to make **MAPLIN** your first choice for components every time!

make it easy... with **MAPLIN**

The
Maplin Matinee
Amazing value for
only £299.95 plus £99.50
(cabinets extra)

Easy to build,
superb specification.
Comparable with organs selling for
up to £1,000. Full construction details
in Electronics & Music Maker commencing
March, 1981 issue. Back numbers available.



MAPLIN ELECTRONIC SUPPLIES LTD.

All mail to: P.O. Box 3, Rayleigh, Essex SS6 8LR. Tel: Southend (0702) 554155 Sales: (0702) 552911

Post this coupon now.

Please send me a copy of your 320 page catalogue. I enclose £1 25 (incl 25p p&p) If I am not completely satisfied I may return the catalogue to you and have my money refunded. If you live outside the UK send £1 68 or 12 International Reply Coupons

Name _____

Address _____

E9/81