

elektor

75,76

July/August 1981

U.K. 120 p

up-to-date electronics for lab and leisure

SUMMER CIRCUITS '81

double issue
over 100
circuits



summer circuits 81

contents
conten
cont
COI

Surinder Singh

| | | | |
|---------------------------------------------------------|------|---------------------------------------------------------------------|-------|
| page one | 7-01 | 56. 'hi-fi' siren | 7-54 |
| 1. scoreboard | 7-02 | 57. low-noise microphone pre-amplifier - P. de Bra | 7-55 |
| 2. 'hi-fi' pre-amplifier | 7-03 | 58. extended range milli-voltmeter | 7-56 |
| 3. 6 watt stereo amplifier for a car radio | 7-06 | 59. flashing bottle - P. van Velzen | 7-57 |
| 4. 'chopper' front-end for power supplies | 7-07 | 60. temperature alarm | 7-58 |
| 5. loudspeaker peak indicator | 7-08 | 61. voltage regulators in parallel | 7-59 |
| 6. polarity converter | 7-09 | 62. EPROM light sequencer | 7-59 |
| 7. temperature recorder | 7-10 | 63. fast TTL interface | 7-60 |
| 8. end of tape detector | 7-11 | 64. stereo level controls | 7-61 |
| 9. CMOS pulse generator | 7-12 | 65. optical indication for the movement detector | 7-62 |
| 10. fuse protector | 7-13 | 66. 6 bit keyboard encoder - L. Witkam | 7-63 |
| 11. protecting dynamic RAM's | 7-14 | 67. forget-me-not transmitter | 7-64 |
| 12. russian roulette - P. Dooley | 7-14 | 68. forget-me-not-receiver | 7-64 |
| 13. miser-LED | 7-15 | 69. humidifier - B. Darnton | 7-65 |
| 14. power-assisted NICADs | 7-16 | 70. automatic soldering iron switch - M.A. Prins | 7-66 |
| 15. zero voltage indicator | 7-17 | 71. constant current adapter - R. Storn | 7-67 |
| 16. auto theft alarm - R. Rastetter | 7-18 | 72. simple ASCII keyboard - from an idea by D. Hul | 7-68 |
| 17. phaser gun - E. Vaughan | 7-19 | 73. hydro alarm | 7-68 |
| 18. random number generator | 7-20 | 74. automatic reset | 7-69 |
| 19. an effective scratch and rumble filter | 7-22 | 75. LED voltage monitor | 7-70 |
| 20. digital tuning indicator | 7-23 | 76. word recogniser and delayed trigger | 7-71 |
| 21. objektor | 7-24 | 77. humidity sensor | 7-72 |
| 22. high input impedance voltage follower | 7-24 | 78. crystal oscillator for low voltage supplies | 7-73 |
| 23. LED audio level meter | 7-25 | 79. 6 to 12 volt converter | 7-74 |
| 24. power MOSFETs in the car | 7-26 | 80. 12 to 6 volt converter | 7-76 |
| 25. simple swinging poster | 7-26 | 81. touch-sensitive 16 channel multiplexer | 7-76 |
| 26. six hour timer | 7-27 | 82. dual input channel selector | 7-78 |
| 27. VOX for PA systems | 7-28 | 83. 16 input channel selector | 7-79 |
| 28. variable power 'resistor' | 7-29 | 84. post office letter scales - K. Hense | 7-80 |
| 29. auto reminder - W. Gscheidle | 7-30 | 85. mains LED | 7-82 |
| 30. adjustable square-wave edges | 7-31 | 86. low noise parallel resonant oscillator | 7-82 |
| 31. silent disco deck switch - K. Kirk | 7-32 | 87. caravan connector tester | 7-83 |
| 32. electronic gong | 7-33 | 88. universal digital meter | 7-84 |
| 33. simple short-wave receiver | 7-34 | 89. high power motor controller | 7-88 |
| 34. keyboard encoder - C. Voss | 7-35 | 90. ring counter using timers | 7-87 |
| 35. input buffers for the logic analyser | 7-38 | 91. crystal tuning fork | 7-88 |
| 36. universal measuring amplifier | 7-37 | 92. dynamic RAM power supply | 7-89 |
| 37. digital sinewave oscillator | 7-38 | 93. local oscillator for 2m transceivers | 7-90 |
| 38. transformerless aerial amplifier | 7-39 | 94. bar graph driver | 7-91 |
| 39. battery supply timer | 7-39 | 95. microcompressor | 7-92 |
| 40. power stabiliser | 7-40 | 96. 3 in 1 pencil holder - W. Gietmann | 7-93 |
| 41. constant current LED | 7-40 | 97. six channel A/D converter | 7-94 |
| 42. Kansas City demodulator | 7-41 | 98. speed controller for model boats | 7-96 |
| 43. signal injector-tracer | 7-42 | 99. active notch or CW filter - H. Pietzko | 7-97 |
| 44. solar power pocket torch | 7-43 | 100. automatic car aerial control | 7-98 |
| 45. american billiards - H.J. Walter | 7-44 | 101. D/A converter for motor control | 7-99 |
| 46. CMOS ultrasonic receiver | 7-45 | 102. continuity tester | 8-00 |
| 47. constant pulse width oscillator | 7-46 | 103. frequency and phase detector | 8-01 |
| 48. single IC siren | 7-46 | 104. power failure forecaster | 8-02 |
| 49. pulse generator with variable duty-cycle | 7-47 | data section | 8-03 |
| 50. differential switch | 7-48 | advertisers index | UK-22 |
| 51. remote control potentiometer - R. Behrens | 7-49 | | |
| 52. variable 2V 60V power supply | 7-50 | | |
| 53. long-period timer | 7-51 | | |
| 54. novel clock control | 7-52 | | |
| 55. novel flashing light | 7-53 | | |

We regret to inform readers that the technical queries telephone service will not be operating during the month of July and August.

Page one!

summer circuits issue . . .

. . . one of the most popular Elektor traditions! Once a year, we do our utmost to produce 'over one hundred' novel, intriguing and original circuits. Furthermore, every year we try to do better than the year before. Not so many application notes using brand-new (and therefore not-so-readily obtainable) components and more truly practical circuits, covering a wider range of topics.

In the ideal case, every circuit should be fully tested in our own lab before it is published. In practice, this is always true for our own designs and for projects that are published with a p.c. board. The remainder (application notes and external contributions) are all studied carefully, tested if possible, and otherwise treated according to our motto: 'When in doubt, cut it out!'

Of course, tradition also dictates that there must be a 'Joke circuit'. In the past, we've had a Fuse Destroyer, a OV Reference and a No-noise Preamp, to name a few. Often, these will also work - in the sense that they do exactly what we specify. This year's version doesn't work. (No, we won't tell you which one it is).

We are often asked where all the circuits come from. Application notes? Yes, a few, with reference given. Readers? Again a few, with author's name included. Preview of (parts of) coming Elektor designs? Very rarely. Our own design, purely for this issue? Yes, usually! So why 'waste' them as one-page articles or less? Because we promise 'over one hundred circuits', that's why! If we gave them all the full description that they merit (or that some magazines would give them . . .), this issue would be a fairly thick book. So we squeeze them in.

One more 'tradition'. Almost, anyway. Over the past few years, we have come to associate the Summer Circuits issue with a competition. Last year we had 'Canned circuits'. This year, various different sources gelled into a new theme: Photography. Most Elektor readers are photographers, and many Elektor covers are based on photographs. So why not let our readers make 'cover' pictures? It's certainly worth a 'shot' . . . The competition details are given separately, but the basic idea is clear: use up the last few frames on that 'holiday' roll on something electronic. You never know: your artistic creation may win the jackpot!

And what of the future? From the September issue on? Who knows . . . We'll do our utmost to 'surprise' you!

electronics in focus

Electronics and photography are two hobbies that often go hand in hand, and so it is hardly surprising that many of our readers are amateur photographers. Furthermore, electronic components or complete circuits on a p.c. board can be very attractive and colourful. An often-heard comment from the 'uninitiated' is: "I don't know what it is, but it looks very pretty!"

Developing this idea a step further, and without implying a negative view of electronics, it seems worth a shot to make it the subject of a competition. To put the whole idea in perspective - and give a clear picture of the wide scope that we have in mind - it is worth looking at Elektor covers over the last few years. They all relate to electronics in one way or another, and they are often based on one or more photo's.

The rules of the competition are few and simple:

- the subject must be related to electronics;
- only colour photo's or slides can be entered, and negatives of prize-winning colour photo's must be made available to Elektor on request;
- the deadline for entries is September 15th, 1981;
- the decision of the judges is final, and it is regretted that no correspondence regarding entries can be entered into;
- all entries become the property of Elektor Publishers Ltd.

Since electronics and photography are both expensive hobbies, we have decided to offer cash prizes. The total 'prize money' is £1000, divided as follows:

First prize: £200

Second prize: £100

Third prize: £50

And 25 runners up will each receive a prize of £20. Furthermore, there will be 50 free Elektor subscriptions for 1982.

All in all, it is well worth taking a new view of your electronic 'junk' and then, having got into the correct frame of mind in the process, slide out of your easy chair, roll out the camera and start shooting! Send your entries to:

Electronics in Focus,
Elektor Publishers Ltd.,
Elektor House,
10 Longport,
Canterbury,
Kent, CT1 1PE



2 hi-fi pre-amplifier

Nowadays, there are quite a number of amplifier modules on the market, which usually contain the complete final output section and all the necessary protection devices. All that is normally required is to mount the module on a heatsink and connect the device up to a suitable power supply. Of course, a preamplifier is needed and this article sets out to describe such a preamplifier.

The entire preamplifier is constructed around a

single IC (the TDA 1054, which is designed for this application). The circuit diagram in figure 1. The first section of the IC contains two transistors which are used to form a magnetic cartridge preamplifier with RIAA compensation. This is the 'standard' straight-through type and is not likely to need further explanation. It is followed by the input selection switch, S2, which connects either the tuner socket or the tape recorder socket to the second half of IC1 in addition to the cartridge preamplifier.

The tone control section is passive so that no problems can arise from too much control. This is

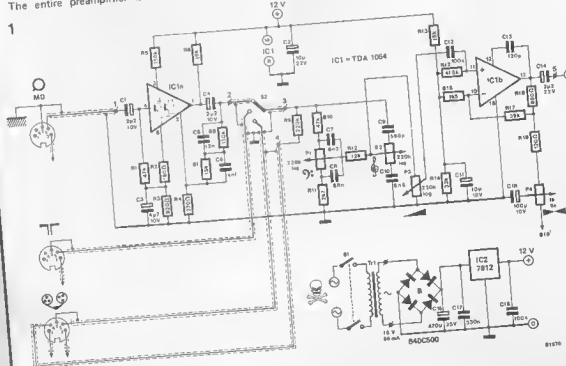

Specifications:

input sensitivity to give 775 mV rms output at a frequency of 1 kHz:

magnetic cartridge — 3 mV
tuner — 220 mV
tape input — 220 mV

input impedance: 50 k Ω

balance control variation: 12 dB

base boost/cut: ± 13 dB (100 Hz)

treble boost/cut: ± 13 dB (10 kHz)

harmonic distortion: < 0.05% (f = 1 kHz at an output level of 775 mV)

frequency response: 20 Hz ... 24 kHz (± 3 dB, tone controls in the midposition)

signal to noise ratio (at 775 mV): > 85 dB

followed by the volume control, P3, after which the signal is boosted by the opamp contained in the second half of IC1. The gain of the opamp is determined by the ratios of resistors R16/R17 as well as R18/R19 + P4.

The required 12 V supply for the preamplifier is provided by an integrated voltage regulator (7812). The asterisks on the component overlay for the printed circuit board (see figure 2) refer to the devices required for the left-hand channel.

(SGS-Ates application note)

Parts list**Resistors:**

R1, R1', R10, R10' = 47 k
R2, R2' = 180 Ω
R3, R3' = 820 Ω
R4, R4' = 270 Ω
R5, R5', R8, R8' = 150 k
R6, R6' = 10 k
R7, R7', R13, R13' = 15 k
R9, R9' = 220 k
R11, R11' = 2k7
R12, R12' = 12 k
R14, R14' = 33 k
R15, R15' = 470 k
R16, R16' = 1k5
R17, R17' = 39 k
R18, R18' = 680 Ω
R19, R19' = 120 Ω
P1, P2, P3 = 220 k LOG stereo potentiometer
P4 = 1 k LIN potentiometer

Capacitors:

C1, C1', C4, C4' = 2 μ 2/10 V
C2, C2' = 10 μ /25 V
C3, C3' = 4 μ 7/10 V
C5, C5' = 15 n
C6, C6' = 4n7
C7, C7', C10, C10' = 8n8
C8, C8' = 68 n
C9, C9' = 680 p
C11, C11' = 10 μ /10 V
C12, C12', C18 = 100 n
C13, C13' = 150 p
C14, C14' = 2 μ 2/25 V
C15 = 100 μ /10 V
C16 = 470 μ /35 V
C17 = 330 n

Semiconductors:

B = 840C500
IC1, IC1' = TDA 1064
IC2 = 7812

Miscellaneous:

Tr1 = 15 V/50 mA transformer
S1 = double-pole mains switch
S2 = three-way double-pole rotary switch

2

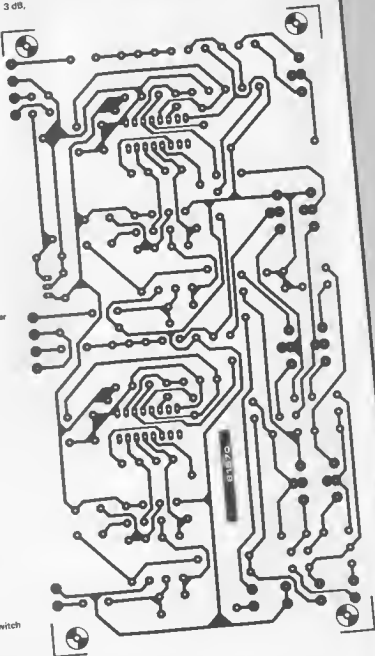

3

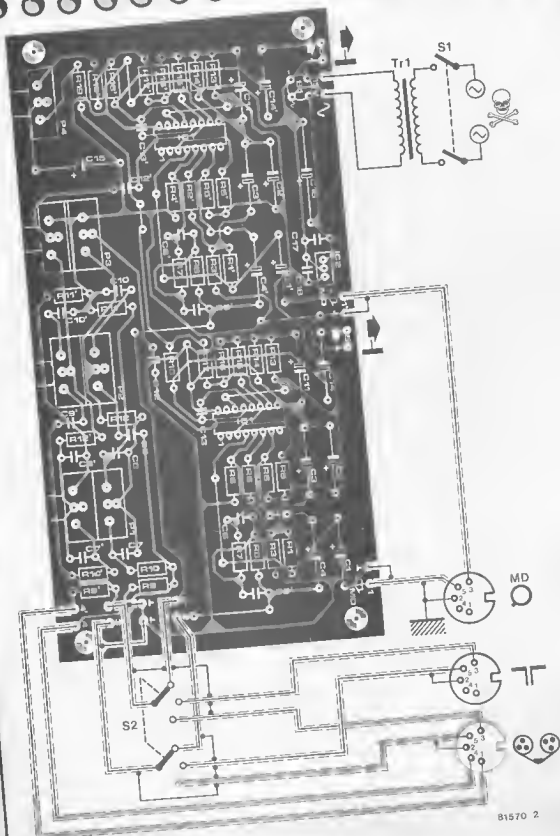

3 6 Watt stereo amplifier for a car radio

The TDA 2004 from SGS-Ates contains two balanced class B power amplifiers. The IC was designed especially for use as an in-car stereo amplifier, and for this reason it is housed in a strong package and protected against all kinds of overload. For example, output short-circuits or disconnection of the loudspeaker, overheating of the chip, peaking of the power supply or even briefly reversing the polarity of the supply connections are unable to destroy the device.

With the component values shown and with a supply voltage of 14.4 V (a fully charged car battery), the stereo amplifier is capable of delivering a power output of at least 6 W, typically 6.5 W with a load impedance (RL) of 4 Ω. It can also handle a load impedance of 2 Ω, in which case the output power is a minimum of 9 W, but typically 10 W. Power outputs of this order are subject to about 10% distortion, however, if lower power outputs are acceptable, 4 W with a load impedance of 4 Ω or 6 W with a load impedance of 2 Ω, distortion is only in the order of 0.3%.

The voltage gain of the left-hand channel is determined by the ratio of R2 to R1, and that of the

right-hand channel by the ratio of R6 to R7. With the values given, this will be 50 dB. Therefore, a signal of about 50 mV is required at the input to give the maximum output. If this input sensitivity is too great, a 50 kΩ stereo potentiometer can be included at the input. The impedance of the non-inverting amplifier input is minimally 100 kΩ.

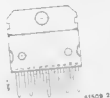

The network consisting of resistor R3 and capacitor C5 (and R5/CB) is included to prevent the amplifier oscillating at high input frequencies. The bandwidth of the circuit is more than adequate for use as a car radio amplifier. The frequency response of the amplifier is 40 Hz to 16 kHz (3 dB points). Obviously, the IC must be kept sufficiently cool. However, the well thought-out design makes it a very simple task to mount the device on an adequate heatsink. The thermal resistance of the heatsink should be at least 4°C/W.

1

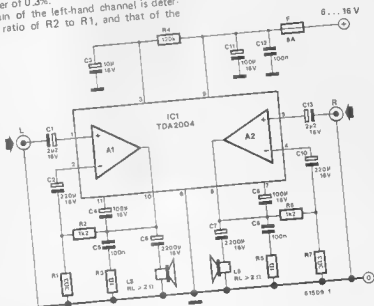

4 'chopper' front-end for power supplies

Power supplies with high output currents, and specifically those with adjustable output voltage, pose a heavy load for the series regulator transistor due to the large amount of power dissipation. This can be reduced by means of a simple additional circuit. Since the dissipation will be reduced, the size of the heatsink for the series transistor can also be made smaller, in fact, the rear of the case will be made smaller, in fact, the rear of the case will quite often be sufficient. Furthermore, it is now possible to use a single transistor instead of the more usual two or three in parallel. All in all, this means that the additional cost of the circuit to be described here could well be offset by the savings on the size of the case, the heatsink and the number of power transistors in the original supply circuit. The additional circuit is connected between the positive side of the bridge rectifier and the series pass transistor. In fact, it has two outputs: one is connected directly to the collector of the (NPN) series transistor and the second is connected to the actual regulator input of the original power supply. The output voltage at the emitter of the series transistor is also fed back in to the extra circuit.

The circuit operates as follows: The 741 opamp is connected as a comparator. It compares the voltage at the emitter of the series pass transistor, which is applied to the non-inverting input, with that of the collector voltage, which is applied to the inverting

input. The 5V6 zener diode keeps the voltage at the inverting input of the opamp 5.6 volts lower than that at the collector. The output of the opamp therefore triggers the thyristor every time the collector/emitter voltage of the series transistor drops below 5.6 volts. The 4700 μF smoothing capacitor is then re-charged briefly.

The regulator circuitry of the power supply which is connected to this unit is powered separately via a diode and its own small smoothing capacitor so that it is always under power and remains independent of the pulsed main supply. The 741 receives its power supply via a very simple voltage stabiliser circuit, so that the IC is protected from too high a supply voltage.

The additional circuit, as given here, can be used in principle with any power supply circuit capable of delivering a maximum output of 25 V. The value of the smoothing capacitor should be 2200 μF per amp, in other words, the value given (4700 μF) is intended for a two amp power supply. The nominal current rating of the thyristor should be at least three times greater than the maximum output current.

For power supplies which have a fixed output voltage, it is possible to reduce the collector/emitter voltage even further. This is determined by the zener diode and the lowest practical value is 3.3 V. To be on the safe side, it may be advisable to include an extra 470 Ω resistor in series with the base of the power transistor.

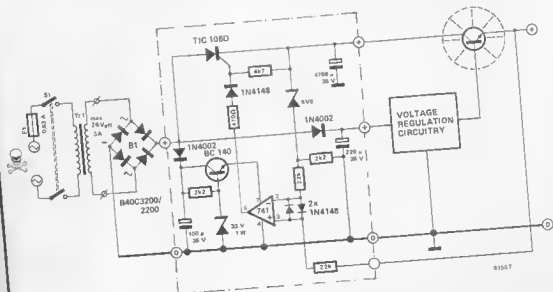

5 loudspeaker peak indicator

Nowadays, any decent loudspeaker unit is, fortunately, pretty resistant to rough treatment. However, problems can arise in the living room when the volume is turned up high enough for clipping to occur. At that point substantial distortion and higher harmonics can be generated. This does not only spoil listening pleasure but it can actually damage the tweeters. A measure of protection can be achieved by the use of a clip or peak indicator, an extra not yet normally included in the majority of audio amplifiers.

The peak indicator described here can be connected directly to the output of the amplifier or even fitted into the speaker since a separate power supply is not required.

The circuit will respond even to very short peaks making it highly suitable for determining when an amplifier is about to peak (in other words, it is not just an overload indicator). The peak power level at which the circuit is expected to respond (that is, the peak voltage) is adjustable between 15 and 125 Watts with an 8 ohm speaker (14...45 V). The circuit will light an LED when the amplifier just delivers its peak power enabling the listener to actually see when things begin to go wrong. If the LED only occasionally lights everything is fine. When the LED begins to light continuously then it is time to turn the volume down a little.

The circuit diagram for the indicator is shown in

Components required:

Resistors:

- R1 = 100 Ω
- R2 = 27 k
- R3 = 5k6
- R4 = 2k7
- R5 = 8k2
- R6 = 39 k
- R7 = 220 Ω
- R8 = 1 M
- R9 = 3k3
- R10 = 27 Ω
- P1 = 100 k adjustable potentiometer

Capacitors:

- C1 = 100 n
- C2 = 220 μ F/50 V

Semiconductors:

- D1 = 1N4004
- D2, D3, D4 = 1N4148
- D5 = LED
- T1, T3, T4 = BC 547B
- T2 = BC 557B

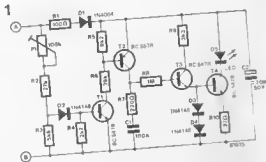
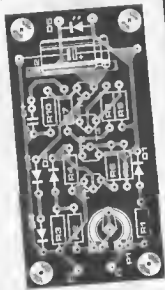
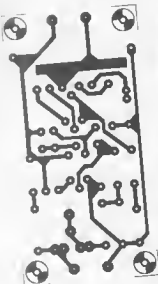

figure 1. Its power supply is derived from capacitor C1 which is charged via R1 and D1 from the speaker output of the amplifier. Half-wave rectification was considered suitable since 'normal' 45 V transistors can be used.

With no signal input all transistors are switched off and therefore current drain from C2 is virtually nil. When the input signal level exceeds a certain value (dependent on the setting of P1), the voltage at the junction of R2 and R3 will reach a point at which T1 will start to conduct. This switches on T2 causing C1 to charge rapidly. Resistor R7 has been included to prevent the maximum permitted collector current of T2 from being exceeded. Both transistors T3 and T4 will now conduct and LED D5 will light. The current through the LED will be maintained at 20 mA by C2, independent of the speaker signal level. When the input voltage then drops below the preset level, T1 and T2 will switch off. However, the LED will remain lit for a few moments longer while C1 discharges via R7 and R8. Construction should not present any problems if the printed circuit board shown in figure 2 is used. It would probably be advisable to use the larger type of LED for maximum 'visibility'. Calibration is

2



carried out in the following manner. If the peak power of the amplifier is known, its peak voltage can be calculated with the formula:

$$V_{\text{peak}} = 2 \times P_{\text{peak}} \times R_{\text{speaker}}$$

Connect the indicator circuit to a stabilised power supply (positive to point A), and set the DC supply level to the calculated value. P1 should then be turned back until the LED just begins to light.

During this operation care should be taken to ensure that the LED does not remain lit for too long because it may cause the dissipation limit of T4 to be exceeded.

Once the clipping level has been set, the circuit may be connected to one of the speaker outputs of the amplifier or, if desired, to one of the speakers. It may be possible to modify the circuit to operate a relay that rings a bell . . . or fires a cannon perhaps? **M**

6 polarity converter

Analogue or digital voltmeters (or both!) are a very important requirement for the electronics laboratory, be it amateur or professional. Therefore, the easier it is to measure voltages, the better. In the case of most analogue meters and some digital ones, it can be something of a nuisance when the probes have to be changed round every time the voltage to be measured assumes the opposite polarity to the one measured previously. Forgetting to do this could result in rather disastrous consequences!

The circuit presented here helps matters considerably, as the output voltage will always be positive irrespective of the polarity of the input voltage. The circuit also has a 'polarity' output which will produce an output of +U_g when the input voltage is positive and -U_g when the voltage to be measured is negative. Provided the circuit is calibrated correctly, the overall accuracy is guaranteed to be better than 0.5% of the maximum input voltage (U_i).

The calibration procedure for the circuit as follows. Resistors R12 and R13 are disconnected from R10 and linked to each other. A level of +1 V is then applied between the junction of R12 and R13 and ground (0 V). The output voltage (A4) is then adjusted to a minimum level by means of preset

potentiometer P3. This is called the common mode rejection ratio (CMRR) preset. The polarity of the 1 V test voltage is then reversed (-1 V). A certain voltage (several millivolts) will now be measured at the output and P3 is adjusted once more to reduce this level to about half.

The above procedure is repeated by alternately reversing the polarity of the test voltage and adjusting P3 until the measured output voltage is the same in both cases (at +1 V and at -1 V). The CMRR will then be set to its maximum level. (The low output voltage is due to the offset of A4 and can not be completely eliminated).

The next step is to connect resistors R12 and R13 as shown in the circuit diagram. The input is then short circuited and the overall offset of the circuit can be reduced to a minimum by means of preset potentiometer P1.

Once this has been accomplished, a known input voltage of, say, +1 V, is applied to the input and the gain of the unit is adjusted by means of P2 so that the output voltage is equal to the input voltage. The circuit will now be correctly calibrated and ready for use.

Last, but by no means least, the circuit should be provided with a stable power supply. This is because fluctuation in supply voltage level would mean having to calibrate the unit all over again.

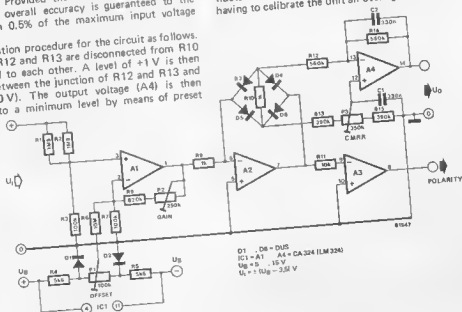

7² temperature recorder

This circuit, together with a certain amount of mechanical ingenuity, makes it possible to construct a relatively inexpensive piece of equipment which can be used to record a temperature curve. An ordinary radio control servo is used to operate the pen. It uses a negative temperature coefficient (NTC) resistor as the sensor. The circuitry around N1, N2, T1 and T2 forms an oscillator whose pulse width is determined by the instantaneous value of the NTC resistor. The resultant signal is fed directly to IC2. This IC (the SN 28654) is specifically designed as a servo amplifier, which is abundantly clear from its specifications:

- an output current of 400 mA with no external transistors
- change of direction is accomplished with a single supply voltage
- the 'dead space' - the degree of input change required before a change in the output occurs - is dependant on the value of C3
- a maximum dissipation of around 800 mW.

The pulse width modulated signal is fed to pin 1 of IC2. The control output for the servo appears at pins 10 and 12 of the IC. Readers who would like to know more about this particular device than we

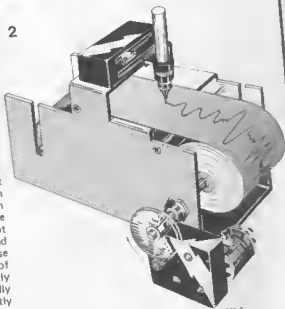

81561 2

have room for here are advised to obtain the data sheet from the manufacturers or from one of their distributors.

The non-linear course of the resistance value constitutes a bit of a problem when using NTC devices as temperature sensors. This can be solved, however, by utilising only a small portion of the temperature characteristic. This is accomplished here by the 'sensitivity' potentiometers P2 and P3 which effectively set the amount of deflection of

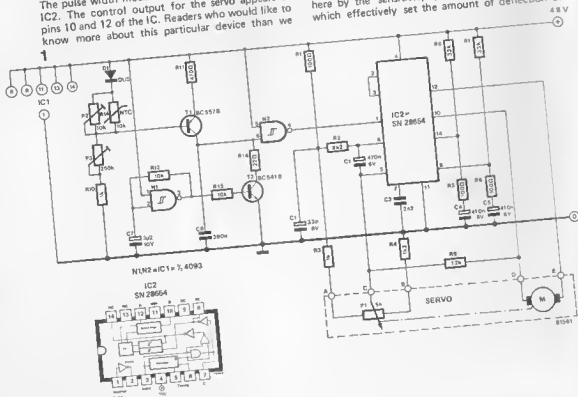

servo per degree of temperature change and the lower limit of the range respectively. This achieves a reasonable degree of accuracy, but of course, we are not trying to construct a piece of laboratory equipment. In reality, the circuit is only intended to record a change in temperature over a period of time rather than measure actual temperatures. The mechanical parts can be constructed quite simply. The servo can be mounted on a clip over the roll of paper. The holder for the recorder pen can be glued or sawed to the arm of the clip. As a holder for the pen, what better than part of an old pair of compasses? This has the advantage that the pen can be easily removed for cleaning or replacement. The

paper can be the type used in printing calculators, but the roll should move at a slow and constant speed when the equipment is in operation. The paper drive can be made with the aid of motors and gears that are normally used by model boat builders, available from any good model shop. Failing this, geared motors, for a variety of voltages, are readily available from surplus stores such as Prooms and J. Bull.

To prevent the NTC resistor from heating up on its own, care should be taken when adjusting P2 and P3 to keep the voltage across the NTC below 0.5 V. If the voltage rises above that value, accuracy will suffer considerably.

8 end of tape detector

This design incorporates a new type of photo-detector which has a large number of applications such as detecting breaks in magnetic tapes. Before the output of the detector reaches the outside world, the signal passes through the following internal stages. The photo-diode is followed by a linear opamp which feeds a Schmitt trigger. In turn, the Schmitt trigger controls a so-called 'totem-pole' output stage. Sensitivity to fluctuations in power supply levels is reduced considerably by the use of the Schmitt trigger. The totempole output enables the user to install several photo-detectors in parallel. Basically, this is how the circuit works: When the light beam is interrupted, the output of the photo-detector goes low and transistor T1 is turned off so

that the relay is deactivated. The normally closed contact of the relay keeps the motor of the tape player running. However, when something goes wrong, the beam from the transmitter (a Ga-As infra-red diode) reaches the receptor so that the output of the device goes high. This turns on transistor T1 which energises the relay thereby interrupting the mains supply to the motor. A dc buzzer has been connected in parallel with the relay to give an audible warning when there is a break or tear in a tape being inspected.

The circuit has numerous applications as long as the object examined has dimensions which fit through the slit of the detector. As mentioned above, one of the most obvious applications is the end, or break, detector in magnetic tapes.

The circuit is completely TTL compatible, so that the power supply can be of the simple asymmetric 5 V type. When the unit is used in conjunction with a tape recorder, it should be kept in mind that the photo-detector should be positioned as closely as possible before the magnetic heads. This is to ensure that if a break occurs, no pieces of tape get wrapped around the heads and drive wheels before the break is detected.

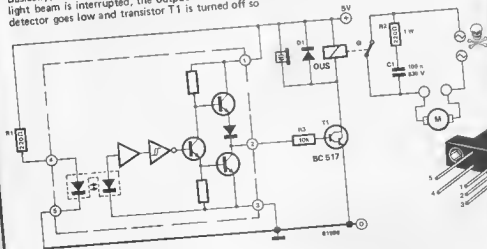

9 CMOS pulse generator

A pulse generator can be extremely useful when designing digital circuits. To make the most of its possibilities it must be as flexible as possible. The clock frequency must be variable over a fairly wide range and of course the pulse width must be variable also. An automatic output level control would be a major advantage. All these and a few other features are combined in the circuit given here.

The use of CMOS ICs throughout has two advantages. In the first place it is possible to power the circuit from batteries. Furthermore, the large supply voltage range afforded by CMOS, from 5 to 15 V, makes it possible to provide the automatic output control mentioned above. This is clear from the fact that if the pulse generator itself is powered from the circuit under test, the supply voltage will equal that of the circuit and the output logic levels must therefore be compatible whether it is CMOS or TTL (out-

put buffers are included). Furthermore, the low current requirement of the generator input results in a very low current drain on the circuit being tested. The description of the circuit begins at the clock generator, IC1. This IC is wired as an astable multivibrator and its frequency is adjustable between 2 Hz and 1 MHz (depending on supply voltage) by potentiometer P1 and switch S1. With S5 closed and S4 in the 'high' position, IC1 will run continuously. With S5 opened an external signal can be used to trigger IC1 via the 'gate in' socket. Switch S4 can then be used to select the required polarity for pins 4 and 5 of IC1 from the external source.

The output signals of the clock generator appear at pins 10 and 11 of IC1. The Q output (pin 10) is passed to the trigger input of IC2. This IC is used as a pulse shaper to provide a narrow sync pulse output for external trigger purposes. The Q output of IC1 is also fed, via S6 (duty cycle 50%) and S8 (signal normal), to the output buffer stage, IC5. ICs 3 and 4 are also wired as triggerable monostable multivibrators. With S6 in the $\neq 50\%$ position and S7 set to delay out, the Q output of IC1 will be passed to the trigger input of IC4. Any required pulse width can now be achieved by the adjustment of both P3 and S3. This provides a variable duty cycle output at pins 10 and 11 of IC4. Depending on the position of switch S8, either the normal or the inverted signal can be passed via the buffer stage to the signal

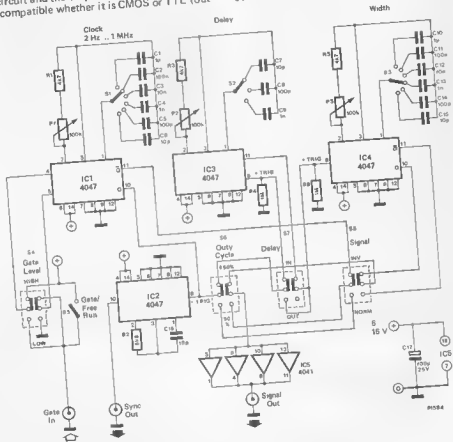

A further modification to the signal can be carried out with IC3 when S7 is switched to the 'delay in' position. IC3 will now be triggered by the clock output signal of IC1 (S6 still in the +50% position). Now, by adjusting P2 and S2, it is possible to delay the output signal from 1.5 μ S to 250 mS with the output reference to the sync out trigger pulse. The pulse width of IC3 is now used to trigger IC4. The pulse width can still be modified as required. It should be noted that the delay circuit does not alter the output signal but varies its timing relative to the sink output. By setting the delay to a suitable value, it is possible to move the leading edge of the output signal but varies its timing relative to the sync output. By setting the delay to a suitable value, it is possible to move the leading edge of the output signal pattern to a more central position on the oscilloscope screen enabling the complete waveform to be studied.

The prototype generator was constructed using Veroboard since very little layout work is required. Virtually all of the wiring concerns the controls on the front panel. All of the range capacitors can be mounted on the switches S1, S2 and S3 if two wafers are used for each switch. Mounting resistors R1, R2 and R3 between the potentiometers and the switches leaves only five components and the five ICs for the board. However, there are quite a few interconnections to be made between the board and the front panel so care should be taken. Ribbon cable may prove to be useful for this purpose. Power for the generator can be derived from the circuit under test or from batteries. If the latter are used, the input and output levels may not be totally compatible.

(RCA application note ICAN 6230)

10 fuse protector

In an earlier Summer Circuits issue of Elektor we published an article entitled 'fuse destroyer', a circuit which was totally effective and worked every time. However, it was rather demanding on replacement parts. The fuse protector described here does not suffer from the same disadvantage and is a practical circuit with a great many applications. In recent times, the requirement for higher power Hi-fi equipment has grown to such an extent that it has now become necessary to protect even the domestic house fuses from being blown too often. The solution is a 'soft start' circuit - a circuit which maintains the initial surge current to within acceptable limits.

Normal domestic fuses are rated at 13 A and many readers may express some surprise if we venture to suggest that the transformer in their equipment could conceivably draw this seemingly excessive amount of current. The short answer is yes, it can and it does! It should be realised that these large transformers can easily withstand powers of up to 1 kW in some cases. The 'turn on' current of the transformer goes into a very low impedance, both in the primary and the secondary winding. Furthermore, the smoothing capacitor on the dc side can be so large that when it is still discharged it can virtually have a zero impedance. Effectively, therefore, the fuse in the primary side of the transformer is presented with a short-circuit and it is not at all surprising that the mains fuse does blow on occasion. The fuse protector alleviates this problem by limiting the surge current via resistor R1. Only after

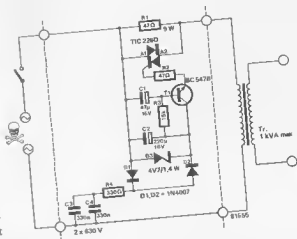

approximately 100 mS (two mains periods) will this resistor be shorted out by the triac. The delayed input voltage is obtained by the drive to the triac gate via transistor T1. The mains voltage is reduced by a capacitive series impedance, C3/C4, to the point that after rectification by diode D2, stabilisation by D3 and smoothing by capacitor C2, a dc voltage of 4.7 V appears across the zener diode. Transistor T1 is then turned on via capacitor C1 and remains on. This in turn drives the gate of the triac causing it to turn on and provide a short across resistor R1. The full primary current will then flow through the triac.

The circuit can be constructed with the triac type TIC 226D (as shown) with transformers with a rating of up to 1 kVA. Larger transformers will obviously require larger triacs. The fuse protector can be used for a variety of applications such as Hi-fi equipment (as mentioned), domestic appliance motors (washing machines etc.) and heavy duty lamps - especially ultra-violet and infra-red types.

11

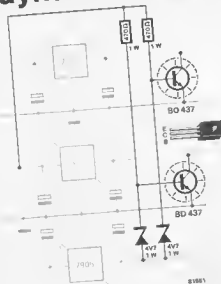
protecting
dynamic RAM's

81581

One of the most useful dynamic RAM's, the 4116, unfortunately needs three supply voltages. Nothing can be done about this, even with the most sophisticated circuit. Although most data sheets imply that these supply voltages may be applied in an arbitrary sequence, this is not necessarily true in all circumstances. We may cynically point out here that even though no sequence is specified, this does not necessarily imply that there is no need to take account of the sequence!

In practice it is happily not as bad as you might think: only when there is a question of overshoot on the supply lines causing the maximum supply voltages to be temporarily exceeded, is it important to ensure that the negative supply is present. The consequence of this is a considerable improvement of voltage regulation!

A second, probably more important, aspect is the requirement that the negative supply voltage should never ever become positive. This can be arranged easily if the positive supply is always present before the negative is applied. A fast Schottky diode between V_{bb} and earth can save a lot of RAM's here. Unfortunately they must be power diodes, and these are neither cheap nor easy to get.

A very effective solution is shown in the diagram. Until the negative voltage is large enough, the positive voltage is simply short-circuited. This, of course, places a considerable demand on the short-circuit capability of the supply.

The circuit must be constructed twice, for the 5 Volt and for the 12 Volt supply.

The BD 437 is a reasonably fast switching transistor with a low threshold voltage. The 7805 and 7812 both draw about one amp, and should therefore be provided with a small heat-sink.

12

P. Dooley

russian roulette

For those readers who have a spirit of adventure, and a sense of humour, we present an interesting little 'game'. The idea is based upon the once popular (?) system of duelling known as Russian roulette where a single bullet is placed in one chamber of a six-gun leaving the other five empty. The cylinder is then spun so that the exact position of the bullet is unknown. The two 'contestants' then take turns to point the pistol at their heads and pull the trigger. Obviously, the winner is the

1

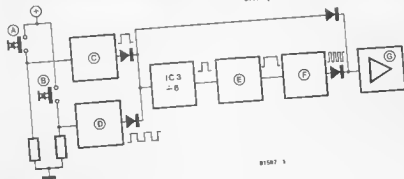

A = Trigger
B = Spin
C = MMV Trigger Pulse
D = MMV Barrel Spin
E = MMV
F = MMV Loss Tone
G = Amplifier

81587 1

person still standing after the loud bang! The game is played exactly as the original, the only difference being a 'raspberry' for the loser instead of a bullet (a lot less messy!).

The circuit works as follows. A monostable multivibrator with a pulse duration of 0.1 seconds is constructed around gates N1 and N2. This effectively debounces the 'trigger' switch, S1, and provides clock pulse for the 'shot' counter, IC3. This pulse is also fed to the audio amplifier, T1, via diodes D1 and D4. Therefore, the counter is incremented every time the trigger is pulled (switch S1 depressed) and an audible 'click' is produced to indicate that a shot was fired. By holding down the 'spin' switch, S2 (a pushbutton with separate make and break contacts), at the start of each game (duel), a train of pulses is fed from the astable multivibrator constructed around N7 and N8 to the (divide-by-six) counter, IC3 via diode D2

Again, these pulses are fed to the amplifier, T1, to produce an audible indication of the spinning of the cylinder. When the switch is released, the counter (and thus the chamber containing the bullet) will be in an unknown position. As each player points the gun to his/her head and fires a shot in turn, the counter is incremented until the output Q6 goes high. This will trigger the monostable multivibrator N3/N4, which in turn will enable the audio oscillator N5/N6. The output of this second astable is fed to the audio amplifier via diode D3. The result is a 100 Hz (dead) tone which lasts for a period of one second. The second half of the spin switch, S2b, disables the tone while the cylinder is being spun.

The power supply voltage for the circuit may be anywhere between 9...12 volts, therefore a 9V battery would be ideal. It should be possible to install the entire circuit into a small toy gun, thereby giving a more 'realistic' effect. If more volume is required, the value of resistor R10 can be reduced (minimum 27 Ω). Obviously, the circuit will then draw slightly more current.

2

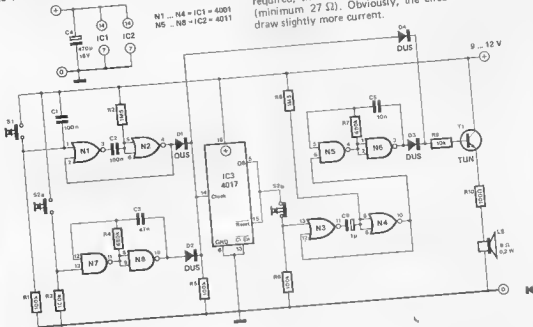

13

miser - LED

The circuit described here allows the amount of energy consumed by LEDs to be reduced to a fraction of the normal value. This is accomplished by

switching the LED on and off at intervals of 0.625 seconds, thereby reducing the average current through the LED to around 200 μ A with a peak value of about 100 mA. This is quite sufficient for normal 'viewing'.

Mainly due to continually more dense integration, electronic circuits are becoming less and less demanding on energy consumption. However, this does not hold true for LEDs which are used for a variety of indicator functions. Most LEDs consume a minimum current of around 20 mA, which in many instances is several times more than that used by the rest of the circuit. This is an especially unsatisfactory situation where the equipment in

question is battery-powered.

The circuit operates as follows: Capacitor C1 is charged via resistor R2. Once the potential across this capacitor is sufficient to overcome the bias presented by (yellow) LEDs D1 and D2, the input of N1 will go high. Consequently the output of N4 will also go high providing a short steep pulse to the base of the Darlington transistor which will then turn on rapidly so that C1 discharges through the LED D3. The current passing through the LED reaches a maximum of 100 mA during the short discharge period. When C1 is fully discharged, the input to N1 goes low. This means that the output of N4 also goes low and the Darlington transistor

will turn off. Capacitor C1 will then start to charge up again and the entire cycle will be repeated. If preferred, several 'ordinary' diodes in series can be used instead of the two yellow LEDs D1 and D2. As the 4011 has a very critical threshold value, it may be necessary to experiment with several different diodes in order to obtain the correct switch-over point. The IC receives its power via resistor R3 which ensures that the current to the IC is restricted to a minimum. The actual physical size of the complete unit is so small that it will cause no problems if it is to be installed into existing equipment.

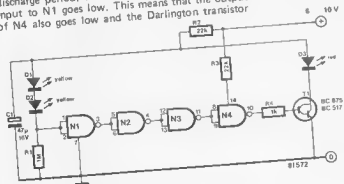

N1, N4 = IC1 = 4011

14 power-assisted NICADs

In many instances where NICAD batteries are used to power immobile equipment it becomes necessary at times to remove the cells for a 'topping up' session. This can of course lead to a certain amount of inconvenience, especially if there is no spare set of NICADs available for replacement. Also, it is not uncommon for NICADs to be used as a 'battery back-up' for mains powered equipment, in which case the NICADs are only used very seldomly when the mains actually fails. There are, however, a number of applications (such as clocks, alarm systems etc.) where the NICAD cells can be used to power the equipment together with a small mains power supply to provide the cells with a 'trickle charge'. The circuitry is then not dependant on the presence of the mains supply and the NICAD cells are given a full time job.

This last application is particularly useful when the size and duration of the load on the batteries can not be accurately predicted (as in the case of alarm

systems — you may or may not be burgled tonight!). However, when designing such a system, certain parameters have to be taken into account: If the load on the batteries is intermittent and fairly heavy, the rated charging current may not be adequate to fully charge the cells. On the other hand, if a high charging current is used the cells may well become damaged if a small load is present for a

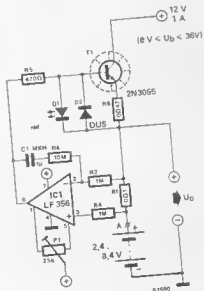

long period of time. These aspects are catered for in the design presented here.

The circuit utilises a resistor to 'measure' the amount of current drawn from the NICAD cells and ensures that they are then charged with exactly the same amount. The value of the measuring resistor, R1, is not at all critical and can be made from a short piece of resistance wire. The potential across R1 is input to an integrator constructed around IC1. This device 'remembers' the amount of current that has been drawn and corrects this by making its output more positive, so that the cells are then charged via transistor T1. When the cells are no longer under load, T1 continues to conduct until the 'memory' (IC1) establishes that all the charge drawn from the cells has been replaced.

Transistor T1 is connected as a current source, the maximum amount of current available being 0.5 divided by 0.47 Ω , in other words, about one ampere. A larger value resistor gives a smaller

current.

To set up the circuit potentiometer P1 should be adjusted so that with no load the current flowing through R1 is one twentieth of the cell capacity. This can be measured by including a (milli)ammeter in series with R1 at point A. This adjustment is very important and must be carried out carefully, therefore a multi-turn potentiometer is ideal. Since therefore a multi-turn potentiometer is ideal. Since therefore a multi-turn potentiometer is ideal. Since therefore a multi-turn potentiometer is ideal. Since therefore a multi-turn potentiometer is ideal.

The output voltage of the trickle charger is 1.2 volts times the number of cells. The charger will not operate with less than two cells or with a supply voltage of less than 8 volts. Also, the supply voltage must be slightly greater than the combined voltage of the NICAD cells. The maximum supply voltage is 36 V. Any desired supply voltage can be chosen within these limits.

15

zero voltage indicator

This zero voltage indicator uses two LED's to show whether the input voltage lies within a specified small voltage range, which is symmetrical about zero. If the voltage is within the range, the LED's flash. If it is outside, one of them lights continuously. Within the specified range there is also an indication of whether the voltage is at the edge of the range, or near the centre (ie near to zero). At the centre of the range the LED's flash regularly, but towards the edges they become irregular.

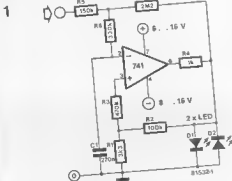

2

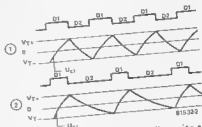

The operation of the circuit is actually quite simple, although it may not at first appear so from the diagram. If you imagine the circuit without some of the components (R3, R4, R5, D1 and D2), you have a normal op-amp oscillator. However, by including the potential divider, R7, R5, we ensure that the voltage fed back to C1 is no longer equal to the supply voltage. (It is also limited by D1 and D2). If R5 is not now connected to earth, but to a DC voltage (the input voltage), the DC level of the feedback voltage will be changed. When this level is so high that the voltage across C1 falls outside the hysteresis loop of the Schmitt trigger, the circuit stops oscillating and one of the LED's lights continuously.

If the input voltage is exactly 0 volts, then the DC level across C1 is zero, and the LED's will flash regularly. However, if the input is not exactly 0 volts, (eg slightly positive), then one LED (D2) will be on slightly longer than the other.

The sensitivity of the circuit is about 50 mV, ie the LED's change from flashing to a continuous light at plus and minus 50 mV. This can be changed readily by altering the value of R7. A higher resistance increases the sensitivity (R7max \approx 3M Ω). You must bear in mind that if R7 is reduced, C1 must be increased.

The source impedance of the voltage which is connected should not be greater than 10 k Ω , otherwise a buffer-emp must be interposed.

16

R. Rastetter

auto theft alarm

Readers who are in the habit of parking their cars close to lampposts at night may presume that the vehicle is considerably safer in a well lit area. However, it could be mentioned that car thieves, as a rule, like to see what they are getting! Further precautions are, therefore, very necessary, or your car could still be found to be gone. Alarm circuits for this purpose must be:

a. reliable; b. easy to operate, and c. failsafe.

After all, if the neighbours have been woken up several times on previous occasions due to false alarms, it may not be easy to maintain good relations with them and they may therefore be less likely to inform yourself or the police when a genuine break-in occurs.

The alarm circuit described here has a number of good features. It uses very little current, it has delayed turn on and delayed alarm, it has repetitive as well as continuous alarm and it will automatically re-arm itself once it has been triggered. All this complexity means that the circuit itself needs to be fairly complex. The actual operation of the unit will become clear as we describe the circuit diagram.

When the alarm circuit is switched on, by means of the (hidden) keyswitch S1, capacitor C1 begins to charge via preset potentiometer P2. This charge time is actually the delay which allows the driver and passengers to leave the car and shut the doors. When the base/emitter voltage of T1 (in series with D1) is sufficient to turn the transistor on, the alarm is activated and is in the 'standby' state. If a door is now opened, the door switch, S2 will make end operate relay Re1. Once the alarm has been triggered, that is, a door has been opened, it can only be switched off by the keyswitch S1.

Now to the next function performed by the circuit. Once the alarm has been armed by means of S1 and a would-be thief opens the door, relay Re1 pulls in and latches on via contacts re1a, which bridge the

door switch S2. If required, the interior (courtesy) light can be made to remain lit by replacing diode D6 with a wire link. A point worthy of note is the fact that no matter how fast the would-be car thief opens and closes the door, the alarm will remain active since the relay has operated.

The other contact of the relay, re1b, enables the charge path for capacitors C2 and C3. At the same time, an indication that the alarm has been triggered is given by LED D5. The charging of capacitor C2 is given by LED D5. The charging of capacitor C2 in via resistor R5 results in the alarm delay time, in other words, the thief still does not know that an alarm is present in the vehicle. This time delay is long enough, about ten seconds, for the driver of the vehicle to enter and disarm the alarm.

Only when C2 is fully charged will the voltage level at pin 2 of N1 become logic '1'. This level is fed through gates N4, N3 and N2 to the relay driver transistor T3. Relay Re2 will therefore be activated and the alarm will sound continuously.

Capacitor C3 will also start to charge at the same time as C2, but this charge time is significantly longer and is adjustable by means of preset potentiometer P3 up to approximately thirty seconds. After this period, pin 8 of N3 will go low, as does the output of N2 and the relay Re2 will drop out again.

The 555 timer, IC2, is connected as a monostable multivibrator and its purpose is to provide the repetitive feature of the alarm circuit. This IC is enabled by relay contacts re1b and is triggered at pin 2 via resistor R13. After the monoflop delay time (adjustable by means of potentiometer P1) has elapsed, transistor T2 is turned on via the output of the 555 at pin 3. Capacitor C1 then discharges through resistor R10 and transistor T1 turns off when the voltage across C1 is reduced to about 1 V. This causes relay Re1 to drop out and capacitors C2 and C3 discharge rapidly via resistors R3 and R6 respectively. At the same time the timer IC is disconnected from the supply. The alarm is now in the original active standby state.

The 4011 (IC1) containing gates N1... N4 also serves another purpose besides that already mentioned. It also functions as a squarewave generator with a frequency of 0.8 Hz. This gives an intermittent alarm signal to the vehicle's horn and/or lights operated by Re2.

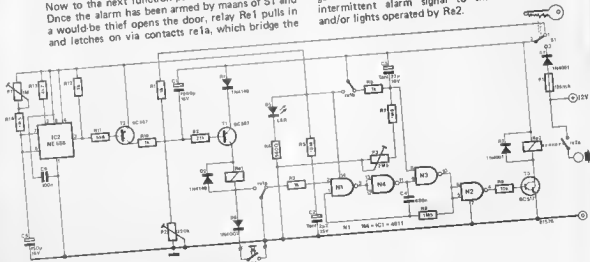

Warning: The horn relay in general use in cars usually has a very low impedance and therefore requires a relatively large amount of current. Transistor T3 must, obviously, be capable of supplying such a current. It may be preferable to incorporate a separate horn for the purposes of the alarm since certain car thieves are aware of the fact

that the ordinary car horn is often used for alarms and therefore promptly disconnect it before opening the car door. It is common sense to conceal the alarm unit and the operating switch as much as is practical for obvious reasons. The current consumption of the circuit is a mere 4 μ A in the standby condition. \blacksquare

E. Vaughan

17 phaser gun

This circuit can be used to produce a sound which can vary from something similar to a machine gun up to a sound that could well find a place in films such as 'Star Wars'. The circuit is derived from the sound effects generator which was published in the March 1981 issue of Elektor. It is shown here drawn in exactly the same way, albeit with minor modifications. The result is that the part numbers may seem rather peculiar as certain items are omitted and some are added. This has the advantage that the circuit can be mounted on the existing printed circuit board (EPS 81112). Components and/or wire links which are shown on the component overlay of that particular board and which are not repeated here are simply omitted. The only major differences are that R4 and R10 of

the original circuit are now replaced with a series connection of R4/P4 and R10/P10 respectively. The potentiometers do not necessarily have to be pre-set as shown in the circuit diagram, it is also possible to use ordinary potentiometers. Resistor R1 in this instance is replaced by a wire link.

After depressing switch S2, the circuit is triggered and the one-shot becomes operative. The duration of the one-shot, and therefore the 'shooting', can be adjusted by means of potentiometer P10. The decay function of the IC (76477) is also used. When the circuit is triggered, a low frequency oscillator starts up, which, in turn, controls a second oscillator with a much higher frequency. This high frequency signal is therefore passed on to the low frequency output to the timing of the first oscillator. Potentiometer P1 is used to set the frequency of the first, low frequency, oscillator. This therefore sets the rate of fire of the machine gun/space weapon. The frequency of the second oscillator is determined by the setting of potentiometer P4, so that the frequency of each 'burst' can be adjusted. By varying these two controls, a whole range of effects can be obtained.

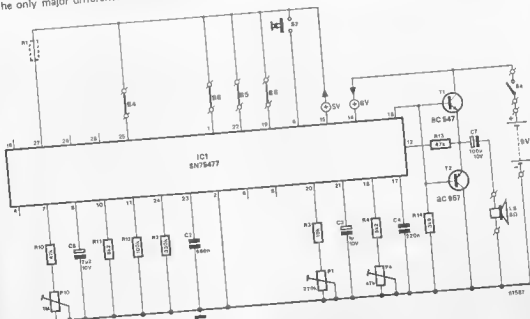

18

random number generator

A random number generator is very often required when developing and running game programs on microprocessor controlled systems. Obviously, it is possible to generate a pseudo-random number with the aid of a short subroutine, but after playing the game several times it becomes apparent that the number is not truly random. For this reason it is far better to have an external random number generator which includes its own oscillator and generator which can be called by the microprocessor at any time. When, in addition, the generated sequence has a reasonably long cycle, it is quite clear that the randomisation closely approaches perfection.

The circuit described here makes use of an 8 bit shift register (IC2). The outputs Q6 and Q7 are fed back to the input of the shift register via EXOR gates N4 and N3, so that the length of the generated cycle is 127 bits. The clock pulses for the shift register are provided by an astable multivibrator consisting of N1, N2, R1, R2 and C1. The frequency of oscillation with the values of the components shown is approximately 20 kHz. Capacitor C3 and resistor R2 are included to reset the shift register when the unit is first switched on.



This is in fact the entire random number generator. Depending on the particular application, this section can be constructed separately and one or more outputs from the shift register can be used to obtain the random number.

Where the generator is to be linked to a microprocessor system, via a parallel input or an addressable buffer, an 8 bit number is, of course, required. This is where the remainder of the circuit comes in. The outputs of the shift register (IC2) are connected to the inputs of the three-state buffer, IC3. The outputs of the buffer are, in turn, connected directly to the data bus of the microcomputer. Care should be taken to ensure that all outputs are in the high impedance condition as long as the processor does not require a random number. In order to detect this, an address decoder consisting of four 4 bit comparators has been

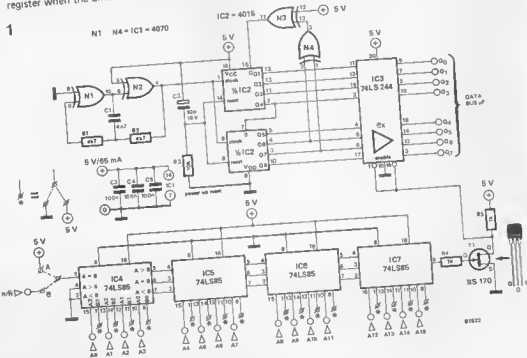

2

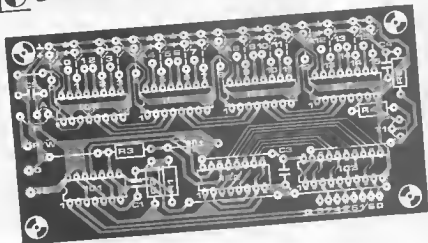
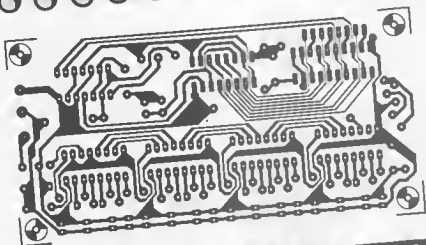

included (IC4...IC7). The four comparators compare the 16 bit address offered by the microprocessor with the address of the random number generator. When the two are the same, the VMOS transistor, T1, turns on which enables the buffer, IC3, and permits the random number to be output on the data bus. A VMOS transistor was selected for this purpose because of its necessarily short turn-on time.

The desired address for the random number generator can be set up on the printed circuit board (see figure 2) by soldering short wire links between the B inputs and the positive supply rail or ground. A connection between B and ground means a logic zero for that particular address line, and a link between B and the positive rail means logic one. If a read/write (R/W) strobe is not available, pin 3 of IC4 should be connected to the positive supply rail. The use of a positive read strobe signal requires a link between the R/W input and pin 3 of IC4, while a negative strobe requires that an inverter be incorporated in series with the strobe signal. The complete circuit requires a 5 V supply voltage and draws a mere 35 mA. This means that in the majority of cases the random number generator can

Parts list

Resistors:

R1, R2 = 4k7
R3 = 10 k
R4, R5 = 1 k

Capacitors

C1 = 4n7
C2 = 10 μ /16 V
C3, C4, C5 = 100 n

Semiconductors.

T1 = BS 170
IC1 = 4070
IC2 = 4015
IC3 = 74LS244
IC4, IC5, IC6, IC7 = 74LS85

be powered from the existing microprocessor supply. Although the printed circuit board has enough room for four address decoders, fewer can be used if desired where incomplete address decoding is considered adequate. Where these ICs are omitted, links should be made between pins 4 and 5, pins 3 and 6, and pins 2 and 7.

19

an effective scratch and rumble filter

Many home-constructed audio amplifiers incorporate scratch and rumble filters, but quite often the roll-off of these filters is so weak their effect is negligible or they affect too large a range of the audio spectrum.

The TDA 1028 is eminently suitable for the construction of a stereo scratch and rumble filter with a roll-off of as much as 18 dB per octave. The IC contains four electronic change-over switches and the wiper of each switch is connected to the input of a non-inverting unity gain opamp. Each electronic switch therefore selects one of two inputs to the opamp and, as they are controlled in pairs, only one external switch is required to insert a filter into each stereo channel.

The first section of the circuit diagram shows the rumble filter. When switch S1 is in position b, both channel inputs are connected, via capacitors C2 and C6, to the inputs of the first two opamps. With switch S1 in this position the circuit will operate normally. However, when S1 is in position a, a third-order low-absorption filter is introduced into

each channel. These consist of capacitors C3, C4 and C5 and resistors R2, R4 and R5 for the left-hand channel and C7, C8, C9 and R8, R9 and R10 for the right-hand channel. The operating frequency of these filters is 79 Hz and their roll-off is as much as 18 dB per octave.

The second part of the circuit diagram depicts the scratch filter. As shown (with switch S2 in position b — the scratch filter switched off) the output signals from the first two opamps are fed, unaltered, to the inputs of the last two opamps. By closing S2 a low-pass filter with an operating frequency of 7 kHz and a roll-off of 18 dB per octave is activated in each channel. The filter components for the left-hand channel are C11, C12, C14, R11, R13 and R14 and those for the right-hand channel are C17, C18, C19, R16, R17 and R18.

The four inputs of the first two opamps require a certain amount of bias. This is accomplished via the potential divider R1/R3 and the bias resistors R5...R8. As there is a certain amount of galvanic coupling between the two sections of the filter, the other inputs do not require any bias voltage. The graph illustrates the frequency characteristics of the circuit for the various settings of switches S1

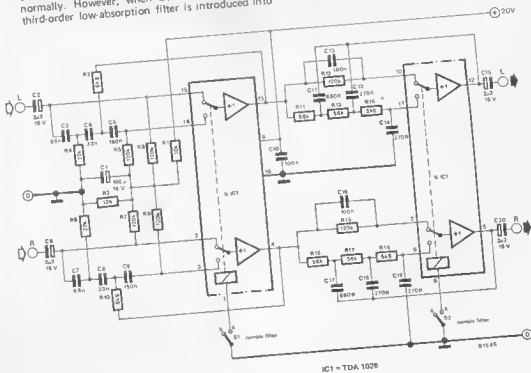
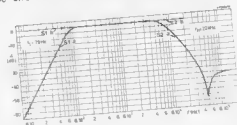

IC1 = TDA 1028

and S2. The specifications for the circuit are fairly good. With a supply voltage of 20 V and an input voltage of 5 V, the harmonic distortion at 1 kHz is less than 0.07% (0.02% at 1 V_{effective}). It should be pointed out that the circuit must be connected to a low impedance source, while the filter outputs

can be connected to a load impedance of 4k7 or greater. The supply voltage can be anywhere between 12...20 V, but at lower supply voltages the maximum input voltage will be reduced.

(Valvo application note)

20

digital tuning indicator

Although the Japanese manufacturer, OKI, is less well known than some others, they are nevertheless important among the Japanese suppliers. One of their important contributions is the development of the electronics for the increasingly popular digital tuning indicators for Hi-fi tuners. These circuits are now integrated onto a single chip.

This is a typical application for the MSM 5526, a monolithic 40-pin CMOS IC which drives directly a 3½ digit LCD. A crystal oscillator with a frequency of 6.5536 MHz is used for timing. As well as the internal clock, this oscillator produces an accurate 50 Hz output signal, and a two-phase signal

to drive the LCD.

A number of different display functions are available. As well as displaying the AM or FM received frequency of a tuner, the IC can be used as a normal frequency meter, or as a pulse counter. The maximum display indication is '2999'. Up to 16 FM and 6 AM frequencies can be preset when the IC is used as a tuning indicator.

The circuit diagram shows that very few components are required other than the MSM 5526. The functions can be selected by S1. The diode matrix provides for the correct setting of the required frequency offset. The signals required to measure AM and FM receiver frequencies are obtained by pick-up coils from the respective oscillators in the AM and FM front ends. They are fed via a transistor stage to the amplifier/prescaler MSL 2318, and from there to the input (pin 38) of the counter IC.

Although the price of this type of IC is slowly becoming more reasonable, they are still not very cheap.

(OKI application)

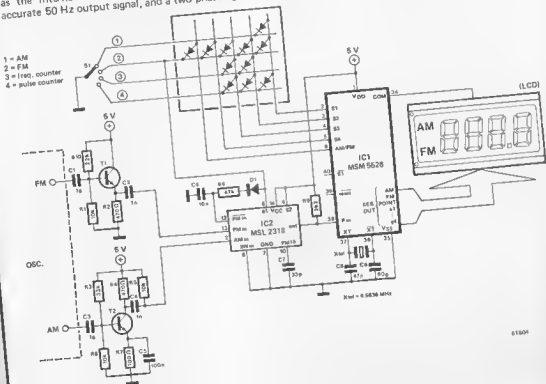

21 objektor

The aim of this circuit is to detect the presence of a conductive object, provided the object is within a certain range. The operation of the circuit is totally independent of the condition of the object (dead, alive, static or moving), as long as it remains within this range. The sensitivity of the circuit can be set remotely, by adjusting the preset potentiometer P1. This is to avoid wearing out shoe leather during the initial (trial and error) alignment procedure — repeatedly walking up and down to obtain the optimum setting for that particular range. A rather innocent application of the circuit is its use as an invisible doorbell sensor, as the sensor could be located inside the house. The most important part of the circuit is the Clapp-oscillator constructed around transistor T1. The capacitor constructed around transistor T1. The capacitor constructed around transistor T1. The capacitor constructed around transistor T1 that should be connected in series with the coil L1 is formed by the sensor plate and the object to be detected. Due to the losses of this capacitor, the

output from the oscillator is rather low, therefore a single amplifier stage (T2) has been added. The Schmitt trigger and monostable functions are performed by transistors T3 and T4. VMOS FETs have been chosen for the sake of simplicity and the fact that less components are required with respect to bipolar devices increases the reliability factor ('what you don't fit don't go wrong!') This does of course mean that the cost of the project will be somewhat higher.

Another application is fluid level measurements in noisy environments. As the sensor does not require physical contact, the fluid could possess aggressive qualities (for instance, fuming sulphuric acid).

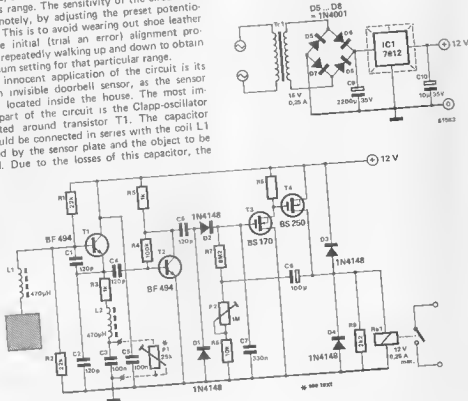

22 high input impedance voltage follower

It is common knowledge that Field Effect Transistors (FETs) feature a very high impedance — well within the Giga-ohm range, in fact. As shown in the circuit diagram, one FET is quite enough to construct a buffer amplifier with an input impedance of 1 GΩ. The circuit is simply an impedance converter (source follower) with a gain of 1 and can be used for a variety of applications, such as a buffer for high impedance (capacitor) microphones, as an oscilloscope probe etc.

One way to obtain the required input impedance is to connect a 1 GΩ resistor between the gate of the

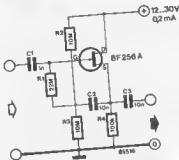

FET and ground. Unfortunately, such high value resistors are not only difficult to obtain, but they are also rather expensive and so a cheaper alternative will have to be found. This particular circuit gets around the problem nicely by utilising capacitor C2 as a form of 'bootstrap'. Theoretically, the input impedance of the circuit should be around 2.2 GΩ, but in practice will never be greater than about 1 GΩ due to leakage currents. The frequency response of the voltage follower extends from 30 Hz to 750 Hz (3 dB points). For correct operation, the load impedance at the output should be at least 100 kΩ.

23

LED audio level meter

A feature of contemporary power amplifiers is an output power level indication consisting of a row of LEDs rather than a mechanical meter. The number of LEDs illuminated in this type of display corresponds to the output level of the amplifier. A 'bar meter' of this type can be added to any power amplifier with the aid of the circuit shown here. The heart of the circuit consists of the LM 3819 IC from National Semiconductors which produces a logarithmic scale and can therefore display low power levels as well. The IC contains an adjustable voltage reference and an accurate ten-step voltage divider. The input buffer drives 10 individual comparators referenced to the precision divider. The power indication at the changeover points (the level at which a particular LED will light) of each individual LED is shown in the circuit diagram. The input signal to the circuit is taken directly from the output of the power amplifier, that is, in parallel to the loudspeaker. It is fed into pin 5 of the IC via capacitor C1 and the divider network R1 and R2. The capacitor may be omitted if the output of the power amplifier already contains a decoupling capacitor for the loudspeaker. The connection at pin 9 of the IC selects either dot or bar mode of operation but most readers will find the bar mode (selected in the circuit diagram) by far the most preferable. Current consumption of the IC is limited by D11 and is about 150 mA with all LEDs lit. Any LEDs can be used but the bar type give a professional appearance.

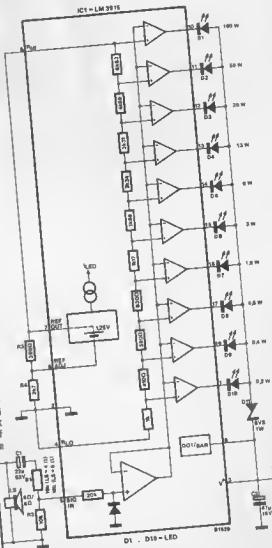

24

power MOSFETs
in the car

Due to the recent breakthrough in power-semiconductor technology it has become relatively simple to construct high power equipment for use in the car. Examples of two possible applications for power MOSFETs are a 50 Watt booster and a 12 V to 24 V converter as shown in figures 1 and 2 respectively.

A booster amplifier intended for use in vehicles should at least meet the following requirements:

1. The output power should be greater than 10 Watts, thereby providing sufficient audio output to overcome the level of ambient background noise (engine, wind etc.).
2. The amplifier needs to be compact without putting any constraints on cooling.
3. Performance must be acceptable even under conditions of large fluctuations in power supply voltage.

1

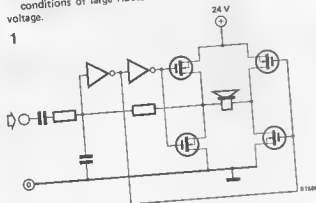

The circuit shown in figure 1 meets these demands quite adequately. It is a bridge version of the self-oscillating PWM amplifier with an output power in the order of 50 Watts.

If such a high power audio amplifier has to be supplied from a 12 V battery, one of the following possibilities may be chosen:

1. The amplifier operates at 12 V in combination with a low impedance load.
2. The amplifier operates at 12 V and a step-up transformer is connected to the output.
3. A voltage converter is used to increase the supply voltage so that the amplifier can deliver the rated output. (The converter may or may not include a transformer).

The advent of the power MOSFET makes the third possibility especially favourable. The simplicity of the design is very apparent from the circuit diagram shown in figure 2. In fact, the entire converter is just a CMOS power astable multivibrator. After rectification and smoothing, the output voltage is added to the battery voltage.

Obviously, the circuit diagrams only reveal the basic principle of operation of the two designs. However, both the 50 Watt booster and the 12 V to 24 V converter are likely to receive further, more extensive treatment in a future issue of Elektor.

2

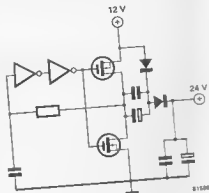
25
simple
swinging poster

The original 'swinging poster' circuit was published in the January 1981 issue of Elektor and is intended to enhance the lighting effects of a disco etc. As the circuit is rather expensive to build and most readers prefer to see the particular visual effects before actually 'forking out' for such a project, a much simpler version has been designed. The majority of this control circuit can be constructed from the components that can be found in the so-called 'junk box'.

Two thyristors and a single CMOS IC are used so that the circuit can be powered directly from the

meins. To avoid any mains interference the circuit is only activated at the zero-crossings of the mains-voltage. The power supply for the circuit is derived from the mains via the series resistor R1 and zener diode D6. The bridge rectifier, D1...D4, has been included as thyristors are used instead of the more usual triacs. The circuit is such that the lamps will light for the full mains period anyway. The heart of the circuit is formed by the oscillator constructed around N4. The frequency of this oscillator can be adjusted by means of potentiometer P1. The 'zero-crossing detector' is formed by transistor T3 and resistors R7...R9. At every zero-crossing of the mains voltage a positive pulse of about 300 microseconds duration will appear at the collector of T3. This pulse is then fed to gates N1 and N2. The output signal from the oscillator is fed to the other input of N2 while the inverted signal is fed to the other input of N1 via N3. The output of N1

will go low for a short period when the mains voltage is somewhere around 0 V and pin 1 of N1 is high. Transistor T2 will then stop conducting and thyristor Th2 will be activated via resistor R3 for one half-cycle of the mains frequency. The same thing will of course happen with thyristor Th1 when pin 13 of N2 is high. The two lamps, La1 and La2, will then flash on end off in turn, in sequence with the oscillator signal. The power rating of the lamps (one red end one green 'flood' type) should not be more than 100 W. The switching poster itself can be ordered from the EPS service (see page UK-04). The circuit can also be used to control normal 'high power' flashing lights without the poster. Note: The complete circuit is connected directly to the mains, so take care!! Potentiometer P1 should have a plastic spindle and the completed unit should be mounted in a plastic box.



- D1 D6 = 1N4004
- T1 T3 = BC147
- Th1 Th2 = TIC 1080
- N1 N4 = IC1 = 4083

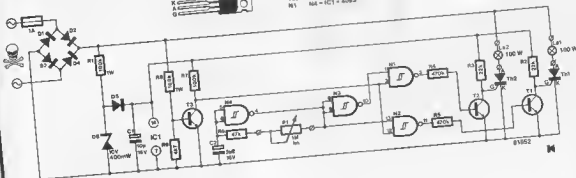

26

K. Siol

six hour timer

This control unit was originally designed to turn off stereo equipment automatically at night, so that music lovers who drift off to sleep in their easy chairs no longer need to worry about the cost of the next electricity bill. As the switching unit controls a relay, the circuit can be used for a multitude of other applications as well.

The heart of the timing circuit is a 4060 CMOS device, which contains an oscillator and a 14 stage divider. The frequency of the oscillator can be adjusted by means of potentiometer P1 so that the output at D13 is approximately one pulse per hour. The duration of this clock pulse will be very short (about 100 ns), as it also resets the entire 4060 IC

via diode D8. The 'once per hour' clock pulse is fed to the second (divide-by-ten) counter, the 4017 IC. One of the outputs of this counter will be high (logic one) at any one moment. As soon as the 4017 is reset, output D0 will go high. After an hour, output D0 will go low and output Q1 will go high, etc. Switch S1 therefore enables the operator to select a time period of from one to six hours. As soon as the selected output goes high, the transistor will stop conducting and the relay will be deactivated (thereby switching off the radio/record player etc.). As the enable input of the 4017 is also connected to the wiper of S1 any subsequent clock pulses will have no effect on the counter. The unit will therefore remain in the 'off' state until the reset button is depressed.

The 4050 CMOS buffer IC and the seven LEDs have been included to give an indication of the number of hours that have actually passed. These components can, of course, be omitted if an elapsed time display is not required. The supply voltage for the circuit is not critical and may be anywhere between 5 and 15 V. The current consumption of the circuit, not including the relay, is in the order of

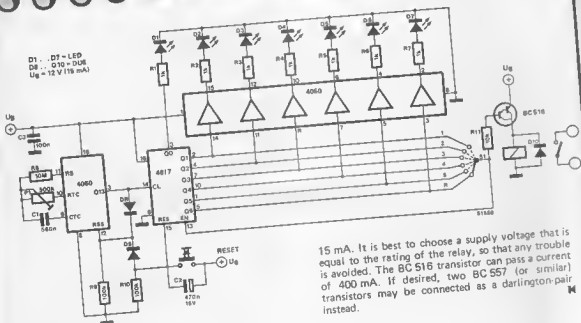

27

VOX for PA systems

An annoying problem with PA systems is their tendency to whistle or 'howl' due to feedback phenomena. There are a number of methods of avoiding the problem, the most obvious being the repositioning of the speakers in relation to the microphone. However, this is not always possible

and the object of this article is to provide an answer for those difficult situations where feedback appears to be 'built in'.

It is well known that lowering the frequency between the microphone and the PA amplifier by about 5 Hz will reduce feedback in many situations when all else seems to fail, but a 'frequency shifter' is an expensive piece of equipment and even then, its effectiveness is not always on a par with its cost. Since feedback requires time to build up, a simple solution to the problem would be to keep the microphone switched off for as long as possible, in fact, right up to the point at which speech begins. In other words, a voice operated switch or VOX.

This design is based on a National IC, the LM 346. This contains four programmable opamps which

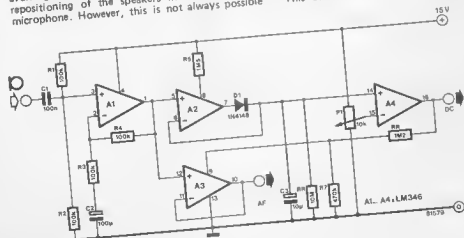

can be used in a variety of applications. Briefly the circuit works as follows: The speech signal from the microphone is amplified by opamp A1 and then fed to two further opamps, A2 and A3. The latter is simply a unity gain buffer for the PA amplifier. Opamp A2, together with diode D1, is used as a rectifier which converts the amplified microphone signal into a positive DC level. Any ripple voltage is smoothed out by capacitor C3. When the voltage across this capacitor is higher than the level set on the inverting input of A4 (with potentiometer P1), the output of the comparator (A4) will go high. This output can be used to control a relay or similar device. This DC level is also fed to the

control pin (9) of opamp A3 via resistor R8. This opamp will only operate while this pin is held high. Therefore, when speech into the microphone ceases, A3 no longer operates and the main power amplifier remains inactive.

A high value resistor (R6) has been included in parallel with C3 to ensure that this capacitor discharges very slowly. This is very important because the signal path to the amplifier must remain open when the speaker pauses for a few moments. As mentioned previously, the output of A4 can be used to control a number of devices via a relay etc. This should find a number of applications especially in discos and the like.

28 variable power 'resistor'

A major difficulty encountered when testing power supplies is the availability (or non-availability) of a suitable load. Usually, the problem is solved by a lash-up of resistors which, although not particularly elegant, will enable tests to be carried out. However, resistors with a power rating of 10 Watts and upwards can be rather expensive and certain values difficult to obtain. Furthermore, this type of load will not be variable. The simple circuit described here can overcome these problems effectively and economically.

A 2N3055 transistor with a variable gain controlled by an independent supply will form an infinitely variable load 'resistor'. This circuit will have a capability of up to 50 Watts if a suitable heat sink is used. The ability to maintain a fixed load current is when the power supply output voltage is varied is an added advantage.

The maximum dissipation of the transistor should be borne in mind. As figure 2 shows, a current of 2.5 A at 20 V is only 50 W but 2.5 A at 50 V is

125 W which may prove to be a little high for the 2N3055.

The base voltage for the transistor can be obtained via a voltage divider across an external power source. If this is not available the circuit shown in figure 3 can be used. In this case, the BD 139 is used as a driver transistor in order to keep the battery supply current drain as low as possible.

The power level can rise fairly steeply with a rising voltage and for this reason some indication of current and voltage levels in the circuit are essential. By using the graph shown in figure 2 it can be easily determined whether the maximum allowable power is being exceeded.

The circuit can also function as a current limiter. This facility will be useful when charging batteries with a constant current. The battery should be placed in the circuit between the ammeter and the collector of the 2N3055. It should be remembered to ensure that the voltage does not rise to a level high enough to cause damage to the plates of the battery.

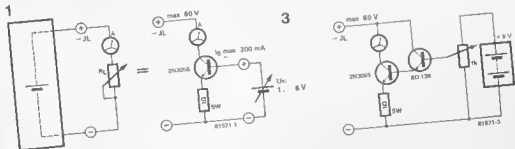
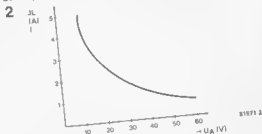

29

W. Gscheidle

auto reminder

The headlights in the majority of motor vehicles are unaffected by the ignition switch. This means that it is possible to leave the headlights turned on after leaving the car. In many instances, this is also true of auxiliary equipment, such as car radios etc., which have been wired directly to the car battery. For the forgetful driver, this can be something of a nuisance when trying to start the car the following morning. This circuit is intended as a warning to the driver that there is still something switched on which is consuming an unacceptable amount of power. The problem can be solved with a bit of logical thinking. After all, what is more obvious than to apply a little digital technology?

At first glance, the circuit looks a lot more complicated than it actually is. It only requires three ICs. The switched supply rails of the equipment to be monitored are connected to diodes D1...D4 (or more if desired), the coil side of the ignition switch is connected to D7 and the battery leads are connected to '+12 V' and '0'.

Let us first see what happens when the ignition switch is turned on and off, but there are no power consuming devices switched on. Effectively, nothing seems to happen! When the ignition switch is turned on, FF1 is reset via capacitor C2, the output of N1 goes low taking the clock input of FF1 low. As this flipflop only reacts to positive-going pulses, the Q output remains low and, via N5, N6 and N3, the Q output of N4 remains low. This means that transistor T1 is turned off and no sound is emitted via the buzzer.

When the ignition switch is turned off, the output of N1 goes high and FF2 will be set via capacitor C3.

The Q output of this flipflop will therefore go high to enable N3. However, although FF1 receives a clock pulse via R3, the information at the data (D) input is low as there are no items of equipment on end so the outputs of FF1 remain as they were. The end result is that the output of N4 remains low and T1 stays off.

Now let us take the case when one or more auxiliary circuits are turned on. When the ignition switch is turned on the end result is the same as that previously described. When the ignition switch is previously described. When the ignition switch is turned off, however, things start to happen! Flipflop FF1 receives a clock pulse via R3 as before. This time, as the data input is high, the Q output will also go high. Capacitor C5 is charged up via resistor R7 and, when sufficiently charged (charge time = $R7 \times C5$), the output of N5 will go low. This signal is differentiated by C4/R3 to provide a further clock pulse for FF1.

During the period that C5 is charging, the driver still has the opportunity to turn off the relative equipment, thus preventing the warning signal from being sounded. If this is the case, the Q output of FF1 will again go low at the second clock pulse and C5 will discharge via R8 and D9. The output of N5 goes low thereby resuming the original condition. If, on the other hand, the driver neglects to switch off certain items, the output of N6 will go high when C5 is charged. This, in turn, takes the other input of N3 high (N3 was enabled when the ignition was turned off as described previously) so that the output of N3 goes low, the output of N4 goes high and transistor T1 turns on to sound the buzzer. At the same time, capacitor C7 charges up via resistor R10 over a period of about ten seconds. After this time the output of N7 goes low. This pulse is differentiated by C6/R11 to provide a reset pulse for FF1 via N8 and D10. Once reset, the Q output of FF1 goes low and the warning is cancelled. It is possible, of course, to interrupt the alarm by switching the ignition back on. The circuit also allows for the possibility of deliberately leaving a particular item (such as sidelights) on without the

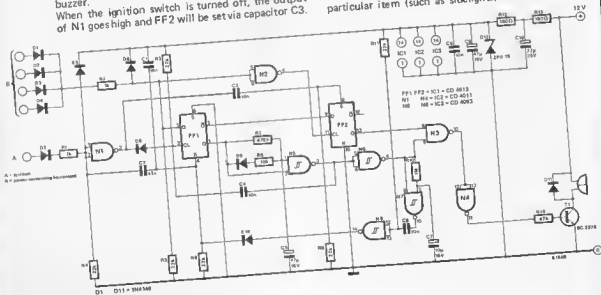

alarm sounding. This is accomplished by first turning off the ignition with the desired piece of equipment switched on. This equipment is then switched off and back on again before the alarm sounds. This means that the output of N2 will go high when the item is switched off, providing a clock pulse for FF2. As the \bar{Q} output of FF1 is low at this time, the D input of FF2 is also low therefore the Q output of FF2 will go low, so that N3 is disabled and transistor T1 is turned off. When the desired item is turned back on, the clock input of FF2 goes low, but the outputs remain the same.

Although FF1 and gates N5... N8 go through their cycle, the alarm will not be operated. It must be admitted that simpler alarm systems do exist. However, this circuit incorporates some interesting ideas and is simple to use. Nevertheless, the device does have one drawback. If, for instance, two items of equipment are left on inadvertently and only one is switched off when the alarm sounds, the unit will not indicate this fact. Care must be taken, therefore, to have a good look round the dashboard when the alarm sounds!

30 adjustable square-wave edges

The ability to delay the leading and trailing edges of a square waveform will find many applications in digital circuits. The diagram in figure 1a shows that only a very few components are required to do this. The circuit makes use of the fact that the output of a Schmitt trigger gate will not change state until the voltage level on the input reaches a certain critical point known as the trigger threshold.

During a rising edge at the input, capacitor C1 is charged via D1 and R1. This increases the time it takes for the voltage level at the input of the gate to reach the trigger threshold point. With a logic 1 at the input to the circuit, the potential across C1 will continue to rise until, for all practical purposes, it reaches the supply voltage level. When the input returns to zero C1 will discharge via D2 and R2, again delaying the time at which the trigger threshold is reached. A clear understanding can be gained from figure 1b which shows the waveforms at various points in the circuit.

It must be remembered that the trigger threshold point of a Schmitt gate is highly dependant on the supply voltage. The following figures are quoted for the RCA 4093.

| U _{DD} | U _T ⁺ | U _T ⁻ |
|-----------------|-----------------------------|-----------------------------|
| 5 | 3.3 | 2.3 |
| 10 | 7 | 5.1 |
| 15 | 9.4 | 7.3 |

The leading edge delay can now be calculated with the equation:

$$\Delta t^+ = -R1 \times C1 \times \ln \left(1 - \frac{U_T^+}{U_{DD} - 0.7} \right)$$

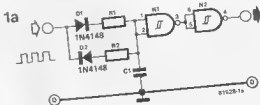

N1, N2 = 1/2 IC1 = 4093

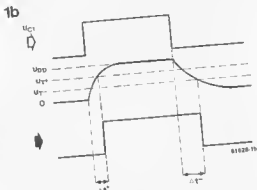

The delay in the trailing edge amounts to:

$$\Delta t^- = -R2 \times C1 \times \ln \left(\frac{U_T^-}{U_{DD} - 0.7} \right)$$

Therefore, the choice of values for R1, R2 and C1 will give any required delay to the leading and trailing edges of the square-wave. However, the maximum delay for either edge should not be more than 80% of the pulse duration. Nothing in this world is perfect and different manufacturers of IC1 quote rather large trigger threshold tolerances. This means that the actual delay times can be quite different from those calculated.

31

silent disco
deck switch

K. Kirk

This circuit is primarily intended to eliminate the distinct 'click' or 'thump' which occurs in many disco systems when the record decks are switched on or off. This unwanted effect is produced by back-emf from the motor, which causes a large 'spike' to cruise around the wiring until it eventually emerges as a thump in the loudspeakers. The level of 'thump' is dependent on the point in the mains cycle at which the deck is switched on or off.

If the deck can be switched on as the mains cycle passes through the zero voltage point and held on for the remainder of the half-cycle, then very little back-emf will be produced as the current passing through the motor as this time will be negligible. No thump will be produced at switch off either as the output device will remain on until the current passing through it has decreased to a very low level. This design uses a zero-crossing detector to switch on a triac twice every mains cycle (on the positive and negative-going half cycles). The circuit is very simple to construct and is relatively inexpensive. The earth line (0 V) is isolated making it safe and 'hum-free' so that it can be controlled remotely, or

indeed, directly from the mixer front panel.

The unit was designed to fit into any disco console and therefore it can derive its power (which only amounts to a few milliamps) from the system transformer. The transformer output voltage needs to be symmetrical about ground and can be anywhere in the region between ± 12 V to ± 24 V. If this is not available then a small separate transformer can be used.

Two anti-phase 50 Hz signals are derived from the transformer output which are then rectified by diodes D1 and D2 to produce a series of negative-going pulses (100 Hz) across resistor R1. These pulses are then shaped by the Schmitt trigger formed by gates N1 and N2 to produce a series of short spikes. These spikes are synchronised to the zero-crossing point of the mains waveform and the width of the spikes can be adjusted by means of the preset potentiometer P1. This can be useful if the triacs used require a higher holding current than normal.

Resistors R3 and R4 hold the inputs of gates N3 and N4 high until such time as the deck switches, S1 or S2, are closed. The negative-going pulses from the Schmitt trigger will then pass through the corresponding NOR gate and will be inverted in the process. This positive-going pulse is then used to trigger the respective programmable unijunction transistor (PUT), which will discharge capacitor C3 (or C4) through the pulse transformer Tr1 (or Tr2) to turn on the triac Tri1 (Tri 2). Resistors R8 and R10 are included to ensure that the PUT turns off cleanly at the end of each pulse. Capacitors C1 and C2 may be required if the power supply used has a high ripple content or to reduce any noise if the deck switches are situated close to a high impedance input (like the preamplifier for instance).

The unit can be made very small and tucked away in any suitable corner of the disco console (away from the power amplifiers). It was found that the pulse transformers produce a relatively high magnetic

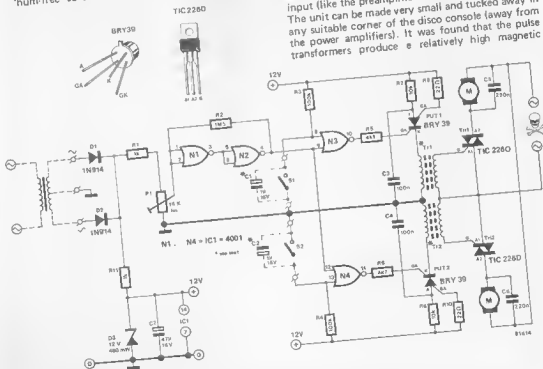

field which may be picked up by the cartridge leads if the unit is placed directly under the turntables. This effect can be minimised by trial and error or screening the unit. In any case, screened leads should be used.

The pulse transformers may be constructed by winding 15 or so turns of 32 SWG for the primary and secondary on a ferrite ring core (FX 300B). The turns ratio and polarity are not critical. Some 'insensitive' triacs may require more turns on the secondary for correct operation, but this again can be found by trial and error. Once the unit is

complete and tested, the transformers should be liberally coated in varnish to reduce 'buzzing'. The only setting-up required is to turn the preset P1 (from ground) until the unit is operating correctly without any clicks being heard. The system may be expanded if required, but the pulse transformers should not be placed too close to each other as operation may be affected by adjacent channels. The unit can also be used for controlling other devices including lights etc. The possibilities are virtually endless (and cheap!).

32 electronic gong

The bipolar integrated circuit type SAB 0600, from Siemens, is yet another sound IC. However, this particular device is different as it is designed to give a harmonic sound, which makes a welcome change from the more common 'beeps', 'whistles' and 'plops'. If and when the SAB 0600 becomes available in the U.K., it will be possible to construct a complete miniature electronic gong with very few external components. The device requires very little current, in fact a small battery is sufficient to power it, which means that the complete unit can be mounted virtually anywhere. This simple circuit is shown in figure 1.

The IC itself consists of a master oscillator whose frequency is determined by the values of the

network R1/C1. This is then internally divided into three further frequencies with fixed harmonic relationships with each other. One of the three frequencies is further divided to form a timebase for the attack/decay envelope. A complex signal, which can best be described as the 'ringing' voltage is derived from four bit digital-to-analogue converters connected to the output of each of the internal frequency dividers.

The IC also contains an audio output amplifier which is capable of driving an eight ohm loudspeaker up to a maximum of 160 mW. The output waveform resembles a squarewave and the upper harmonics in this case are attenuated by edging capacitor C2. It is claimed that the sound quality will be improved if the loudspeaker were mounted in a tubular housing.

An even more interesting affect can be obtained if two gong circuits with slightly different basic frequencies are combined. It is also possible to arrange the two circuits so that they both drive the same speaker. This is illustrated in figure 2. The output signal from the second gong (IC2) is taken from pin 3 via potentiometer P1 and capacitor C5 and fed to pin 8 of IC1. Preset potentiometer P1 can then be used to set the output level while P2 adjusts the frequency of the second gong.

It should be pointed out that long lead lengths to the remote buttons may cause false triggering. This can be avoided by including a resistor in series with switch S1 and a small capacitor between pin 1 and supply common. The low quiescent current consumption of 1 μ A means that a single battery will last for a very reasonable length of time.

1

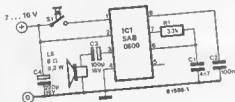

2

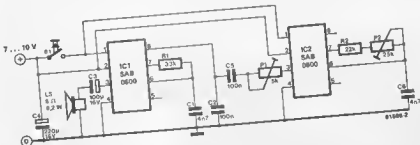

34

C. Voss

digital keyboard

At first sight, this circuit looks rather complicated. It is a keyboard encoder, and it performs the following function: Each of the keys, up to a maximum of 64, are allocated a binary number. This binary number is available in the form of 6 bit parallel data at the Q outputs of IC1 and IC2. The logic level at the Q8 output indicates whether or not one of the keys has been depressed. The outputs Q1...Q6 and Q8 can be connected to a microprocessor system, or alternatively, they can be connected to a digital-to-analogue converter and used to control a music synthesiser. Since the outputs Q1...Q8 remain in the same state after the key is released, there is no need for a sample-and-hold circuit after the D/A converter.

A further advantage of the circuit is that the frequency determining resistors that would normally be present in an analogue keyboard are no longer required. Furthermore, the digital keyboard only requires a single contact per key.

The circuit operation is as follows: Each key is allocated a certain position in an 8 x 8 matrix. This is determined by the crossings of eight output lines from IC3 and eight input lines to IC4. Each of the 84 crossing points are connected to a key contact and when this key is operated a link is made be-

tween the horizontal and vertical lines. A pulse generator formed by N10 and buffered by N9 controls IC3 and IC4 at a frequency of 250 kHz via an eight bit counter IC5 and IC6. This occurs in such a way that each point in the matrix, and therefore the particular key, is enabled row by row and column by column. When all inputs (0...7) of IC4 have been enabled in sequence, the output of IC3 jumps one step further. If a key contact is closed, the Q output of IC4 goes low. The result of this is that the counter position at that time and therefore the 'code' of the depressed key is latched into IC1 and IC2 via N3.

Simultaneously, the Q output of IC4 goes high and is passed to input D8 of IC2. This gives an indication that a key has been operated. To ensure that only one key code is passed onto the output when two or more keys are depressed at the same time, the counters, IC5 and IC6, are reset via N4 whenever a key is depressed. This means that only the lowest value key will be decoded. Gates N6...N8 ensure that the latch and reset pulses do not occur at the same time and also that they have the correct polarity.

The keyboard driver, IC3, has open collector outputs so that when a number of keys are depressed at the same time, no outputs are shorted together. Depending on the particular application of the circuit, complementary outputs are available from Q1...Q6 and Q8 of IC1 and IC2 (not shown in the circuit diagram).

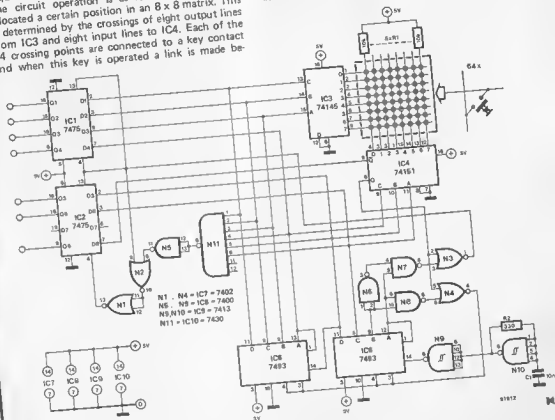

35

input buffers for the logic analyser

The input buffers described here give the logic analyser (Elektors 71, 72 end 73) the following advantages:

- the higher input impedance makes it possible to 'analyse' CMOS circuits.
- the input leads can be lengthened thereby enabling the logic analyser to be operated more easily.

Each buffer consists of a very fast comparator (710) connected as a Schmitt trigger. The hysteresis of such a buffer is determined by the values of the two input resistors ($2 \times 10 \text{ k}\Omega$) and the value of the feedback resistor ($33 \text{ k}\Omega$). Using the given values the hysteresis is around 1 V. If required, this value can be altered. If the value of the feedback resistor is increased, the hysteresis value is reduced. The values of the trigger voltages also depend on the position of switch S1. In position a, the trigger voltages are about 1 V (logic zero) and 2 V (logic 1) corresponding to TTL and 5 V CMOS levels. With the switch set in position b, the values are deter-

Resistors:

R1, R2, R5, R6, R7, R10, R11, R12, R15, R16, R17, R20, R21, R22, R25, R26, R27, R30, R31, R32, R36, R36, R37, R40, R41, R42, R45, R46, R47, R50, R51, R52, R55 = 10 k
R3, R8, R13, R18, R23, R28, R33, R38, R43, R48, R53 = 33 k
R4, R9, R14, R24, R29, R34, R39, R44, R49, R54 = 2k2
R56, R67 = 470 Ω
R58 = 68 Ω
P1 = 500 Ω adjustable

Capacitors:

C1 ... C11 = 10 pF
C12, C13, C14 = 1 μF /16 V tantalum

Semiconductors:

IC1 ... IC11 = μA 7101, LM 710 (8-pin metal can)
D1 = DUS

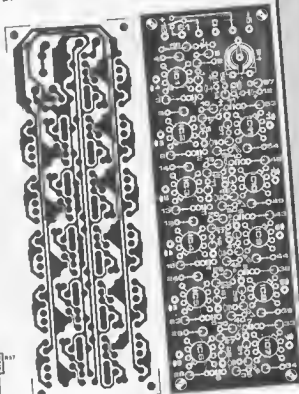
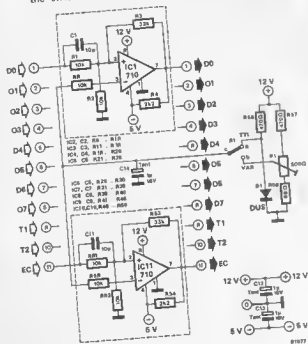

mined by the setting of potentiometer P1. This makes it possible to make measurements in CMOS circuits operating on higher supply voltages (maximum 12 V).

The printed circuit board and component layout for the buffers are shown in figure 2. To keep the board as small as possible, which is necessary in order to mount it close to the input section of the logic analyser, the resistors are mounted vertically.

A length of ribbon cable can be used to connect the buffers to the logic analyser inputs, as described in the articles mentioned above. Ribbon cable can also be used to connect the buffers to the circuit under test. Neither length of ribbon cable, however, should be longer than 40 cm, which means that the total length of the measuring cable, including the

buffers, should be about 80 cm. Finally, a few remarks about the power supply. Current consumption is fairly heavy. The amount drawn from the +12 V supply is approximately 150 mA, while that drawn from the -5 V supply is around 80 mA. If the existing power supply of the logic analyser is to be used to power the buffers,

the voltage regulator ICs will have to be upgraded. In other words, the 78L12 and 7905 regulators will have to be replaced by 7812 and 7905 types respectively. However, note that the pin-outs of the new regulators do not correspond with those of the old ones.

36

universal measuring amplifier

An analogue multimeter is, by now, one of the more 'standard' items of equipment owned by electronics enthusiasts. Even digital multimeters are now becoming quite common. However, it is not uncommon to find that the capabilities of the measuring instruments available are nowhere near as extensive as one would wish. Either the input sensitivity is not high enough (in other words, it can not measure low voltages) or else the input impedance of the instrument is too low. The second disadvantage is the worst, in fact it is often the reason why measurements taken are totally inaccurate. In general, interpretation of incorrect results will lead to incorrect conclusions!

The simple circuit described here, which uses only a few components suffers from none of these disadvantages. The circuit consists of a discrete differential amplifier constructed around transistors T1 and T2. A separate constant current source is connected in series with both emitter leads. The current source for transistors T1 consists of D1, D2, T3 and R6 and that for transistor T2 consists of D1,

D2, T4 and R7. The constant emitter currents make the measuring amplifier independent of supply voltage variations.

The differential amplifier (T1 and T2) is followed by an integrated differential amplifier (the LM 301 by an integrated differential amplifier). This opamp is from National Semiconductor). This opamp is connected to give unity gain. Its output is therefore an analogue measurement signal and can be used directly as such. Two further components, R10 and D3, convert the analogue output to a TTL-compatible signal.

Now that we have described the basic circuit, what can it be used for? Two possibilities have already been mentioned: It can be used as a preamplifier for a normal (analogue) multimeter and it can also be used as a preamplifier for a digital multimeter. Furthermore, the circuit can be used as an AF preamplifier for frequency counters or similar devices. In this case, potentiometer P2 can be used to set the trigger level. Finally, it is also possible to use the circuit as a preamplifier for an inexpensive oscilloscope.

Regardless of the actual application for the circuit, the only main calibration is the same in all cases. This is the 'zero offset' and is adjusted by means of preset potentiometer P1. This potentiometer must be set so that when the inputs are shorted (in other words, when the left-hand sides of R1 and R2 are connected together) the output from the opamp is exactly zero volts. In normal applications, potentiometer P2 adjusts the input sensitivity. With the aid of this potentiometer, it is possible to adjust the gain of the circuit over a wide range; from a gain of 2 to a gain of 130. It may therefore be useful to provide this potentiometer with a calibrated scale.

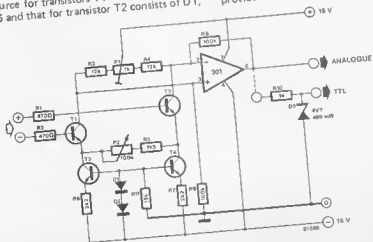

37

digital sinewave oscillator

An assortment of digital sinewave generator circuits have found their way into the pages of *Elektor* magazine over the years, as in last year's Summer Circuits issue for instance. However, the circuit described here requires fewer components than usual and therefore produces a sinewave signal that is perhaps not quite so good qualitywise, but nevertheless serves its purpose very well.

The circuit consists of two sections, each of which could have many useful applications on its own: an oscillator constructed around a pair of EX(clusive) OR gates and a divide-by-three circuit constructed around two ordinary flipflops.

The oscillator is made up from both a non-inverting gate (N1) and an inverting gate (N2). If only inverting gates had been used, at least three would have been required — as a non-inverting gate can be made up from two inverting gates connected in series. Here only two gates are used to construct the familiar (to *Elektor* readers) and reliable 3-gate oscillator.

The circuit works as follows. Let us assume that, initially, the input of N1 (pin 2) is low. This means that the output of N1 will also be low and the output of N2 will be high. Capacitor C1 will then be charged via resistor R2. After a short while, the

input of N1 will go high via R1 and the whole procedure will be reversed. Readers interested in this type of oscillator are referred to the National Semiconductor Application Note No. AN-118, which is included in their current CMOS data book. The divide-by-three section consists of two flipflops which both divide by two, in other words, it would be expected that together they would divide by four. However, another EXOR gate (N3) has been included between the output of FF2 and the input of FF1. This effectively inverts the clock input signal each time the output of FF2 changes polarity. If N3 was not present, the output state of the flipflop would not change until the end of the current clock period. With the addition of N3, the clock signal is inverted and the positive-going edge triggers the flipflop after every half period. Therefore, the dividing factor here is three, not four.

2



81833-2

1

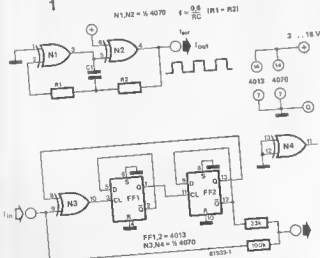

The sinewave signal is generated via a pair of resistors (R3 and R4). When the input to both resistors is low (logic zero) there will be no output voltage. When the input to both resistors is high (logic one) the output voltage will be high. When one input to the resistors is low and the other high the output voltage will be either $\frac{1}{4}$ or $\frac{3}{4}$ of the supply (high) level.

Obviously, this can be proven mathematically. A simpler method to justify it is to examine a single sinewave period diagrammatically. A small rectangle may be drawn in the centre of the sinewave to represent a logic one level. Two further rectangles of the same size can then be drawn to each side of the first. The area inside the sinewave of the last two rectangles will be half that of the first. The digital simulation technique generates a signal with the same areas as the above.

When constructing the circuit it should be noted that CMOS inputs should never be left 'floating'. In other words, pins 12 and 13 of the EXOR chip (N4) should be connected to ground (0 V).

38

transformerless aerial amplifier

The omega-antenna, published in the June 1980 issue of Elektor (page 6-08), fulfilled a popular demand. It's main drawback however, the difficulty to obtain the cores for the broadband transformers, prompted our design staff to come up with a version that does not require these particular components. The 'alternative amplifier for the Ω antenna', described in the previous summer circuits issue, was primarily intended for direction finding purposes in the 100 kHz to 30 MHz range. The compromise, although not mentioned at the time, is the rather high noise figure. It is possible to alter one of the design parameters in order to obtain the best possible compromise between dynamic range and noise figure.

The amplifier shown in the circuit diagram meets this requirement. Although the grounded-base configuration of the BFT66 produces a somewhat higher noise figure than the grounded-emitter

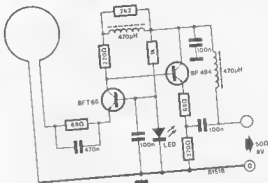

circuit, it can still be considered quite low. The gain of the amplifier is determined by the ratio of the collector and emitter impedances and because of the complex nature of the emitter impedance, which also depends on the loop size, it should be stated that this circuit performs almost as well as the original one.

The circuit does have one snag, however. Due to the absence of a transformer, the tendency for the amplifier to oscillate is increased, mainly because of earth loops. Provided due care and attention are paid to the construction and layout, this should not pose a problem.

39

battery supply timer

A need often arises for battery powered equipment to be switched off after a certain period of time. Although timing circuits are legion, it is not such a simple matter to switch a power supply off after some hours of use. The circuit featured here will do this at the expense of a current drain of only a few nano amps.

A look at the circuit diagram will show that not many components are involved. Switch S1 is the 'on' button and, when pressed, supplies a base drive current to the darlington transistor T1 which will then conduct to supply power to the equipment in use. Transistor T2 will now also switch on to act as a latch across S1 maintaining the base current to T1. Capacitor C1 will now start to charge via R4. When

the voltage across R4 drops to about 1.2 V, T2 will switch off. This in turn will switch off T1 and therefore the supply. The only current now flowing will be the leakage current through both transistors but this will only amount to a few nano amps at most. To all intents and purposes, the battery supply will be switched off.

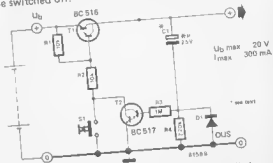

The time period for which the supply will be switched on can be calculated from the rather horrendous formula:

$$t = -22 \cdot 10^4 \cdot C1 \cdot I_n \frac{1.2}{U_B} \text{ s (C1 in Farads)}$$

For those in doubt the 'try it and see' method may take longer but will work just as well. If required, the two darlington transistors can be substituted by discrete transistors.

40

power stabiliser

This power supply circuit consists of a three-pin voltage regulator IC in conjunction with a buffer transistor. This combination is a result of the fact that the 78xx series of voltage regulators are only capable of delivering a current of 1 A. In this design, when the output current exceeds about 200 mA, the buffer transistor takes over the task from the voltage regulator IC thereby allowing currents up to 5 A to be drawn.

The 78xx IC is available for a range of different voltages. By selecting the required regulator in this series, the circuit can be adapted for any voltage, provided of course the transformer output voltage is at least 4 V greater than the required stabilised output voltage.

Where a current of only 1 A (or less) is required, the transistor T1 and resistor R1 can be omitted. If desired, R1 can be retained in the circuit to safe-

guard the regulator IC. It will then function as a so-called 'bleed' resistor. However, in this instance the rating of the resistor should be increased from 0.5 W to 5 W.

The 78xx regulator is protected internally against overheating, but in practice the demand on this protection circuitry is not altogether satisfactory. To obtain a stable design, two measures have been taken in the circuit shown here: The current through the regulator IC can never exceed 300 mA except when there is a short-circuit on the output. The buffer transistor has a more than adequate current rating.

Provided the heatsink used is sufficiently large, both the voltage regulator and the buffer transistor should be able to survive momentary short-circuits, when the peak current may well exceed the maximum output current of 5 A. However, the actual amount of short-circuit current will be limited as the voltage regulator limits the amount of base drive current to transistor T1. Capacitor C1 will smooth out any AC ripple, but its value should be modified to cope with the maximum flow of current. For a current flow of up to 1 A, a value of 1000 μ F should be sufficient, but for a current of 5 A the value should be increased to 4700 μ F.

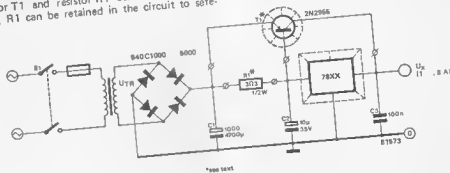

*see text

41

constant current LED

It is normal nowadays to use a LED as a panel indicator whenever possible. However, in keeping with all electronic devices, they do have limitations and their operating parameters can make life difficult at times. For instance, if the supply voltage varies by any great degree the brightness of the LED

will follow suit. Should the voltage level become too high it will result in the LED giving a permanently off indication! The ingenious circuit here can get around these problems quite effectively. The maximum current capability of a LED is nor-

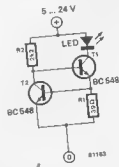

mally about 50 mA but brightness will not significantly increase above 20 mA. This figure is about the optimum economic current level and the purpose of this circuit is to maintain this value irrespective of fluctuations in supply voltage levels. The two transistors, T1 and T2, form a constant current source and will maintain the current level to within the acceptable limits of 15 and 27 mA with variations in voltage level between 5 and 24 V. Operation is relatively straightforward. A rising supply voltage will cause the collector voltage of

T1 to rise. This in turn will increase the base drive current to T2. The subsequent drop in potential at the collector of T2 will reduce the base current to T1 and therefore counteract the rise in current to the LED. The circuit will now be stabilized. The table below gives an indication of the LED current at various supply voltages.

| | |
|--------------|--------------|
| 5 V - 15 mA | 15 V - 22 mA |
| 9 V - 18 mA | 18 V - 24 mA |
| 12 V - 20 mA | 24 V - 27 mA |

42 Kansas City demodulator

The most popular form of FSK (frequency-shift keying) modulator used by computers nowadays is the 'Kansas City Standard' where digital information is transmitted sequentially by means of carrier pulses of constant amplitude and two different frequencies (1200 Hz and 2400 Hz). A logic low level generates a frequency of 1200 Hz whilst 2400 Hz is generated by a logic high level. Obviously, for every modulator there has to be a demodulator.

As can be seen from the circuit diagram, the Kansas City demodulator described here is quite straightforward. Opamp A1 acts as a Schmitt trigger and simply converts the output of the tape recorder into a perfectly symmetrical squarewave signal. Opamp A2 is configured as a 'charge pump' and converts the incoming frequency into a low or high logic level. The output of A2 is fed to a low pass filter, constructed around opamp A3 and the decoded, filtered signal is then fed to a second Schmitt trigger (A4) to 'clean up' the final digital output. Transistor T1 and LED D2 are included to indicate

whether or not the input (FSK) signal is of sufficient amplitude to drive the system. The LM3900 contains four opamps which are slightly unusual in that they react to differences in input currents rather than voltages (this type of device is commonly called a 'Norton amplifier'). This means that the output of the first Schmitt trigger (A1) is zero under no-signal conditions, because the current flowing through the inverting input (via R2) will be greater than that flowing through the non-inverting input (via R3). The charge pump works as follows: When there is no input signal, capacitor C4 is discharged via R8, so that the output of A2 is virtually zero. If at this point a positive-going pulse is received from A1, a brief current pulse will flow into the non-inverting input of A2 via capacitor C3. This means that an identical current must pass through the inverting input for the circuit to remain in equilibrium. This can only be achieved via C4 which is therefore charged a small amount. As a result, the output voltage of A2 will rise whenever a positive-going signal edge is present at the input. Afterwards, capacitor C4 will be discharged via resistor R8 and the more output voltage will drop once more. The more pulses at the input, the higher the output voltage. The circuit around opamp A3 is a conventional low pass filter. The turn-over frequency of the filter depends on the *baud rate* of the incoming signal. At 300 baud the maximum frequency at this point will be 150 Hz therefore the turn-over frequency must be slightly higher. The output of the low pass filter has rather poor

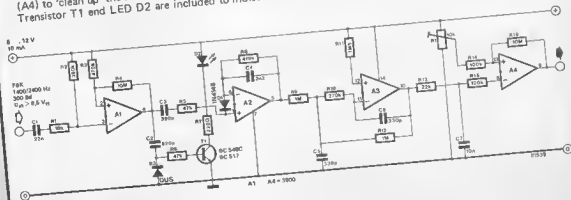

edges and is too low in amplitude to be processed by logic circuitry. For this reason the signal is passed through a second Schmitt trigger constructed around A4. This ensures that the final output pulses are sufficiently fast to drive CMOS ICs. If the phase of the output signal is not correct, the connections to R14 and R15 may be reversed. Current consumption of the circuit is only a few

milliamps and partly depends on the actual supply voltage. Ideally, this should be the same as that of the following logic circuitry. The only adjustment for the demodulator is preset potentiometer P1 which is set so that the duration of logic zero and logic one pulses are the same when the input signal consists of eight cycles of 2400 Hz and four cycles of 1200 Hz.

43

signal injector - tracer

A signal injector must certainly be one of the cheapest and most useful pieces of test equipment in the hobby workshop. The design described here doubles as a signal tracer and features an audio output enabling both eyes to be kept on the work in hand.

The circuit is very simple and consists of three main parts: a signal generator (IC3); a pre-amp (IC2); and a main amplifier. The signal generator, (IC3), is a 555 connected as a 1 kHz oscillator. With S2 in position b, this acts as a simple continuity

tester. Since the test points DP are in series with the oscillator's RC network, the circuit will only oscillate when there is continuity between these DP points. Two test probes connected to the DP points can therefore be used to establish continuity between two points in the circuit under test. The output of the oscillator is fed via P2 to the main amplifier and a tone will be heard from the loudspeaker when there is a short circuit between the probes. Nothing will be heard if the probes are open circuit of course.

With switch S2 in position a, IC3 will oscillate continuously. Its output level is then controlled by P3 and fed directly to probe (B) and into the circuit under test. Capacitor C10 and resistor R13 are included to prevent the oscillator being loaded by the test circuit. Probe (A) is then used to trace the signal through the stages of the test circuit. A resistance or potentiometer will usually attenuate the signal and a transistor will usually amplify it.

In order to detect changes in amplitude, it is im-

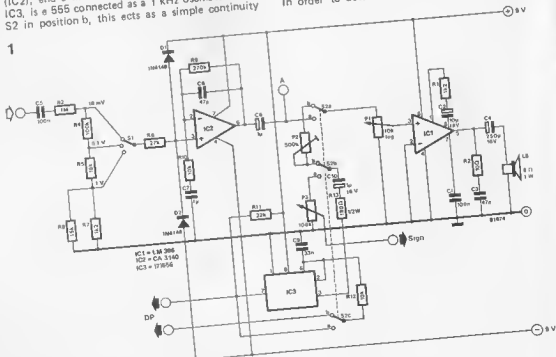

2

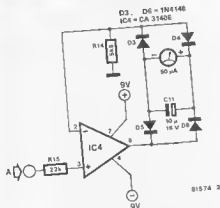

81574 2

portant not to overload the loudspeaker. A simple switched attenuator is therefore included at the input to the pre-amp to provide three different input levels. To avoid loading the circuit under test a high impedance input is ensured by C5 and R3. The probe signal is amplified by IC2 and fed, via C6 and S2a, to P1 which is used to adjust the input level to the pre-amp, IC1. Some readers may prefer a visual output indication and for this purpose a moving coil meter can be used as shown in figure 2.

3

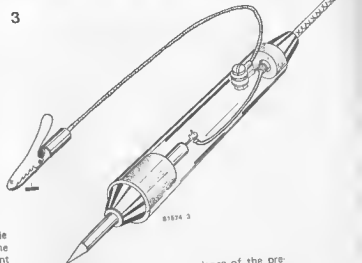

81574 3

Because of the high input impedance of the pre-amp it is necessary to use a screened lead and probe for this input. Failure to do this will result in plenty of noise at the output. A design for an easily constructed probe is shown in figure 3. Normal test leads can be used for the signal output.

44

solar powered pocket torch

Pocket torches are handy things, but they have one great drawback: at the most inconvenient moments their batteries go flat. It is therefore logical to make use of the ever-present energy source, the sun. This design incorporates a Siemens power-LED which can handle a maximum continuous current of 800 mA, and because of its high efficiency it gives as much light as a 5 Watt lightbulb. An ordinary torch bulb can be used as shown in figure 1b, however in some cases, oscillation may occur due to the self-induction of the filament. This can be avoided by simply adding a 100 pF capacitor, C_x. The LED is driven by two S.I.P. MOS-FET's. Their extremely high slope (approximately: 2000 mA/V!) enables them to convert the initial 0.4 V of the solar cells into the 800 mA drive current required for the LED.

The circuit is balanced by means of P1. This potentiometer should be set in such a way that an optimum light yield is obtained, even when scattered clouds are present.

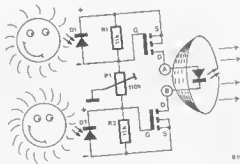

81993

D1 = LD 241, LO 242
 T1 = ZUB 10
 T2 = BUZ 10

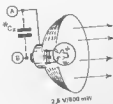

2,8 V/800 mA

45

H.J. Walter
american billiards

The popularity of American Pool continues to increase and this electronic game is played in a similar manner to the original table billiards. However, the billiard balls are symbolically represented here by six LEDs.

The circuit is based on a random generator. When the reset switch is depressed, all the LED's light up, and when the 'hit' button is pushed a number of random occurrences take place so that either one of the LED's goes out or everything stays as it was. One of the LED's going out, means that one of the balls has been pocketed.

The game can be played in two ways. In the first game, each player must pocket all the balls whereby

all the LEDs are extinguished, and the person who can do that with the least number of 'hits' is the winner. In the second variation of the game, the number of players is restricted to only two. One player starts: if the first ball he hits is a red one, then he is obliged to pocket also all the other red ones. The second player then does the same with the green balls. As long as the first player continues to hit his own colour, it remains his turn. Only when he fails to hit a ball or hits one of his opponent's colour, is it the turn of the other player. As soon as three balls of one colour have been pocketed, the player of that colour has won the game. This makes it impossible for the game to end in a draw, and is a good way of deciding the winner of the first type of game that was drawn.

Let us now have a look at the circuit. To start, all six flipflops, FF1... FF6, are set to zero with pushbutton S2 so that all LEDs light up. The multivibrator, constructed with N1 and N2, delivers a clock frequency of about 800 Hz to the Johnson-counter, IC2, of which the outputs deliver '1' in sequence. The gates N5 to N10 are wired as latches

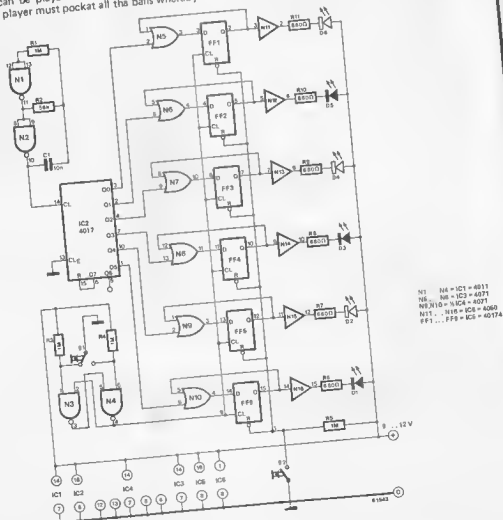

and connect the counter outputs to the D-inputs of the flipflops.

Operating the 'hit' button S1 will supply a pulse to all the flipflops. The counter outputs which are high will then, via the latches, set the flipflops that were not already set, and the relevant LED goes out. The feedback from the D-output of the flipflop to the gate at the D-input forms the latch and sees to it that a 'set' flipflop remains in that position even when further clock pulses arrive. As D6 of the counter leads nowhere, it is possible for even the first shot to be a 'miss'. If so desired, this can be avoided by connecting the reset input of the counter to D6 instead of D7.

The best way of arranging the LEDs is in the form of an isosceles triangle, represented in the circuit diagram by the open diode symbols. The red LEDs are actually placed at the corners of the triangle. The green LEDs (the black ones in the diagram) can then be mounted half-way along the sides of the

triangle in between two red ones. The CMOS 4050 can be replaced by the 4049 which has the same pin arrangement and which contains the six inverting drivers. This causes the state of the six diodes to change so that after reset all LEDs are dark, but 'when a ball is pocketed' the relevant LED lights up.

The two sets of rules for the games described earlier are not the end. There are other possibilities. Dne ball can be designated as the 'black' in snooker, which means that it is the last one to be pocketed. Another variation consists of, prior to 'hitting a ball', deciding which colour it is going to be. No doubt it will be possible to think up further variations, once the circuit and its possibilities have become familiar. When the game is played a lot, it is best to supply the power via a small mains supply or a nicad. The power consumption is 90 mA when all the LEDs are on. When the game is played less frequently it will be sufficient to use two 4.5 V dry cells. M

46 CMOS ultrasonic receiver

Remote control of all sorts of equipment is becoming more and more popular both inside and outside the home. The transmitter can be either a source of light or of sound and the receiver is usually built-in to the equipment which it is intended to control. More often than not, the receiver will only react to the relevant transmitted (coded) control signals and is therefore rather sophisticated. This is not the place to discuss whether infra-red or ultrasonic remote control is more or less suitable for this or that purpose. Rather, this article describes a very simple and inexpensive ultrasonic receiver which can be used for a variety of applications. In addition, it will operate for quite a long time on an ordinary 9 V battery as the current consumption

is very low. This can be useful where it is necessary to isolate the remotely controlled equipment from the mains.

The recommended transducers for the circuit are the SE 04B-25 T/R (25 kHz) or the SE 04B-40 T/R (40 kHz) from Toko. If other transducers are employed, it may be necessary to modify the input stage to the field effect transistor T1. This transistor is used here as a preamplifier for the receiver. The following three inverters (N1...N3) are connected as linear amplifiers and provide a certain amount of filtering for the ultrasonic signal. Penultimately, the signal is rectified and smoothed by diode D1 and capacitor C8 before being fed to the final inverter/buffer N4, which supplies the actual control signal. Depending on the particular application, this output can be used directly (or inverted - there are still two unused inverters inside the 4069 package) to control CMOS switches. Alternatively, it can be used, via a transistor, to activate a relay or solenoid which in turn will switch a piece of equipment on (or off) or open (or close) a lock etc. A suitable transmitter can often be obtained as 'surplus' from mail order firms and, considering their low cost, it is hardly worth constructing one at home.

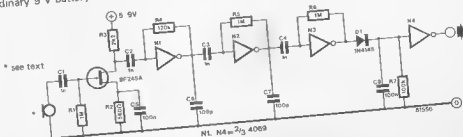

47

constant pulse width oscillator

Switching oscillators on and off can sometimes give rise to problems due to the fact that the first or last (or both) pulses can vary in width from maximum down to almost non-existent. In most cases, it is probably true to say that the very narrow pulse or 'spike' will be the one to cause the problems. It all stems from the fact that the oscillator switch off time is invariably not synchronised with oscillator output.

Figure 1B shows the usual simple gate oscillator that is often found in digital circuits, probably chosen for its simplicity and economy as much as anything. However, it does suffer from the problems mentioned above as can be seen from the waveform illustration in figure 2(B). The variation in pulse width is readily apparent. The last pulse in the second set may prove to be too small for some gates to 'see' while others in the system can. The result could be an extensive 'red herring' chase. An effective solution to the problem is shown in the circuit in figure 1A where the simple gate oscillator is coupled to an RS flipflop. Diode D1 prevents capacitor C1 from charging during the time that the oscillator is switched off. This ensures that the first pulse at the output has the same width as

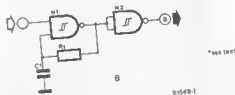
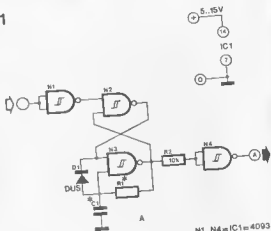

those following. This is illustrated in figure 2(A). The sacrifice of two extra gates may well be worth the benefits that this constant pulse width oscillator can provide.

2

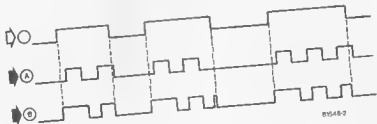
48
single IC siren

Circuits that produce some sort of noise appear to be highly popular with many readers. A possible reason for this is that correct circuit operation is verified audibly and without the need for test equipment, in other words, the circuit does something in a physical sense.

This particular siren is very simple and easy to construct since it is built around a single IC, the LM 389 from National Semiconductors. This IC contains an audio power amplifier, similar to the LM 386,

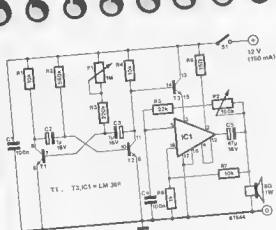

together with three uncommitted NPN transistors. The two transistors T1 and T2 form the basis of an astable multivibrator with a frequency variable between 1 and 7 Hz. The preset P1 is used to adjust this. The amplifier is also configured as a square wave oscillator and its output drives the loudspeaker at frequencies variable between 250 Hz and 1500 Hz. The amplifier, however, is switched on and off by the multivibrator via transistor T3. The result is a pulsed siren like sound. The frequency of the audible tone is adjusted by the preset P2. **M**

49

pulse generator with variable duty-cycle

A single 4093 CMOS IC is eminently suitable for constructing a simple pulse generator. The IC contains four Schmitt-triggers. By adding a resistor, two diodes, a capacitor and a potentiometer, one of the four gates can be used to produce an oscillator with a set frequency and a variable duty-cycle. The pulse duration is determined by the RC time-constant of the network consisting of capacitor C1 and resistors R1 + P1. When the wiper of the potentiometer is in the mid position a perfectly symmetrical square-wave signal is obtained at the output. If, however, the setting of P1 is altered, the capacitor (C1) will take a different time to charge than to discharge. As a result, gate N1 will be triggered either sooner or later on either the positive-going or negative-going edge of the signal depending on the direction in

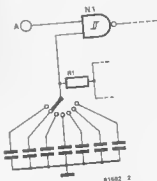
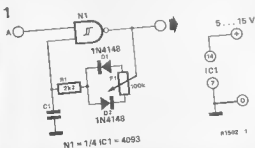

which P1 was rotated. This effectively means that the pulse width varies.

As far as R1 is concerned, this acts as a protective measure in case P1 is turned fully clockwise (minimum resistance). This means that the duty-cycle is not 100% variable, but, after all, a cycle is not 100% variable, but, after all, a 2...98% range should be perfectly acceptable! The frequency of the oscillator is dependent on the value of capacitor C1, since the sum of the RC time-constants is the same for both half-periods. If several different frequencies are required, a multi-throw switch with a corresponding number of capacitors may be included to replace C1 (see figure 2). This enables the pulse duration to be varied in stages.

Using the control input (A) the entire unit can be incorporated in a logic circuit. If the input voltage is logic zero, the output will be logic one; if, however, the input level is logic one, the oscillator will start to operate. If the control input is not required, this may be omitted by either linking the input to the junction of R1/C1 or to the positive rail of the power supply (logic one).

Although the edge of the output pulse is fairly steep already, it can be further improved by connecting one of the other gates in the same IC to the output. The second gate will then act as an inverter. **M**

50

differential switch

There is virtually no doubt that interest in this particular circuit will increase as the price of electricity — and of energy in general — continues to rise. The differential switch is able to measure the difference in temperature between two points and, depending on the temperature difference, it will switch a relay on or off. The relay can then be used, for example, to activate a circulation pump. There are numerous applications for the circuit. It can be used in combination with solar heating panels or solar collectors and it can also be used to control the pump in central heating systems. In the latter case, one sensor is placed in the return pipe while the other is situated in the hot water outlet pipe close to the boiler. As soon as the boiler switches on, a temperature difference is created and the pump also switches on.

The attractive feature of this design is the fact that both the temperature difference and the hysteresis of the unit can both be set independently, so that they do not affect each other. Moreover, the adjustments are virtually linear, therefore the potentiometer settings can be relied on to give consistent results. A LED has been included in the circuit to give an indication of when the relay is actually on.

The temperature sensors are two LM335s (National Semiconductor). This IC can be looked upon as being a zener diode whose voltage increases by 10 mV per °C. Therefore, at room temperature the zener voltage is equal to: $(273 + 20) \times 10 \text{ mV} = 2.93 \text{ V}$.

The temperature transducers incorporate calibration connections, which make it possible to set the output voltage (at 20 °C) to the value mentioned above. In the same way, undesirable differences between the sensors can be corrected. It is also possible to disregard the adjustment input of one of the sensors

(by not connecting it) and to adjust the other sensor to give the same characteristics as the first. This can make construction and setting up considerably simpler.

The principle of operation is as follows: The voltages from the two sensors are directly compared by IC2. When the temperature — and thus the voltage — of Z1 becomes greater than that of Z2, the output of the relay via transistor T2. If potentiometer P1 has not been turned fully up, a higher input voltage is required to operate the comparator and the relay will therefore be activated at a higher temperature difference. There is a potential drop of about 0.6 V across diode D1. Approximately 100 mV of this remains across P1 (the actual voltage drop across P1 can be adjusted by means of P3). The 100 mV corresponds to about 10 °C, so in effect P1 can be adjusted over a range of 10 °C. Sensor Z1 must therefore be 10 °C warmer than Z2 with P1 at the lowest setting in order to activate the relay.

Once the pump has been switched on by the relay, the temperature of the sensor close to the boiler will drop due to the circulation of the water. This could result in the circuit switching itself off almost immediately. Obviously, this situation is undesirable and for this reason potentiometer P2 has been included to adjust the amount of hysteresis by a maximum factor of 5 °C. With P2 set in the centre position the circuit has a hysteresis of 2.5 °C. This means that if P1 has been set to, say, 5 °C, the relay will be activated when the temperature difference reaches 5 °C, but will not turn off until the difference in temperature is 5 °C — 2.5 °C = 2.5 °C.

LED D2 should be a red one with an operating voltage of about 1.3 V. The supply voltage for the circuit is not critical and can deviate by a few volts. The circuit diagram shows a supply voltage of 12 V because relays operating at this voltage are readily available. Transistor T2 is only allowed to dissipate a maximum of 100 mA and for this reason the current rating of the relay should not exceed this value.

The actual temperature at which the circuit operates can be calculated from the voltage across Z1 and Z2, if a thermometer is not available.

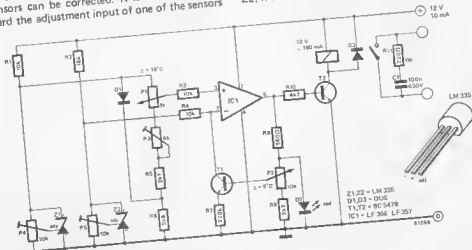

51

R. Behrens

remote control potentiometer

This type of control makes it possible to regulate, for instance, the intensity of a light source or the volume of an amplifier etc. from a number of locations. This function is fulfilled by the circuit described here via two potentiometers which act both as switch and regulator for direct current sources.

What can it be used for? For example, when the telephone rings, and one of these control devices is situated close to the telephone, stereo equipment can be turned down from that location, provided the stereo system incorporates dc controlled ICs such as the TCA 730 or TCA 740. As already mentioned, the circuit can also be connected, via opto-couplers, to a light source and therefore act as a dimmer control. No doubt inventive readers can think of many more applications for the unit.

When the potentiometer setting is altered, an electronic switch will automatically close allowing the dc voltage level on the wiper of the potentiometer to be passed through to the output.

How does it work? The 'hot end' of the two potentiometers (P1 and P2) is kept at about 12 V by means of zener diode D1. As the input range of opamps A1 and A2 is 0 V to 13.5 V, this gives sufficient protection against input overload. When the setting of one of the potentiometers is altered, the potential difference between the inverting input and the non-inverting input of the corresponding opamp, caused by the integration networks R1/C1 or

R2/C2, becomes sufficiently large to make the output of the opamp go high. These output signals serve as control voltages for the electronic switches ES1... ES4 (ES1 and ES2 and resistors R3... R6 form a flipflop). One of the two dc voltages controlled by P1 or P2 is also passed on to the output by way of the buffer A3.

The values of resistors R1 and R2 have deliberately been chosen rather high in order that, with the two potentiometers at their minimum setting, the output of the opamps will be low. Diodes D2 and D3 are included so that the flipflop does not return to its original state during the actual transition. One of the not so good aspects of the circuit should also be mentioned at this stage. This is the fact that when it is necessary to set the previously unadjusted potentiometer to a low dc output, it must first be quickly turned up and then down. This may appear slightly awkward at first, but it will not take long to get the hang of it.

If the connecting leads to the circuit are rather on the long side, it will be necessary to include a 10 μ F 16 V capacitor between the 'hot' ends of the potentiometers and ground.

ES1... ES4 = IC1 = 4068
A1... A3 = IC2 = LM324, CA324
D2... D6 = 1N4148

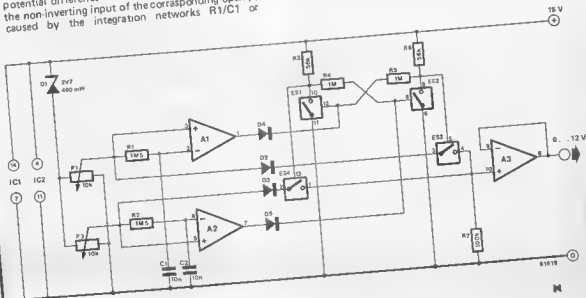

52

variable 2V...60V
power supply

The L146 type integrated circuit from SGS-Ates is pin compatible with and an improved version of the well known 723 regulator IC. The major difference between this new IC and the older type is definitely an advantage. The maximum supply voltage that the 723 will handle is 40 V, while the maximum input voltage to the L146 is 80 V.

With the aid of an external transistor or two it is possible to construct a variable power supply with an output voltage that can be regulated between 2 V and 60 V. In the circuit shown, potentiometer P1 is used to set the current limit to anything between 10 mA and 1 A. Some readers may question the validity of specifying a current output of 10 mA for a power supply. Let us then emphasise the fact that this figure refers to the current limit

Parts list

Resistors:

- R1 = 22 k
R2 = 5k8
R3 = 2k2
R4, R5 = 2Ω/2 W
R6 = 1k5
R7 = 5k6
R8 = 1 Ω/4 W
P1 = 10 k lin
P2 = 22 k lin
P3 = 1 k preset

Capacitors:

- C1 = 2200 μ/100 V
C2 = 10 μ/6 V tantalum
C3 = 10 n
C4 = 100 n/100 V

Semiconductors:

- D1...D4, D6 = 1N4003
D5 = 1N4001
T1, T2 = MJ 3001, TIP 142
IC1 = L146

Miscellaneous

- Tr1 = 50 V/1 A transformer
F1 = 630 mA fuse

value. Potentiometer P2 controls the actual output voltage level within the range stated above. The preset potentiometer P3 is used to set the maximum output voltage of 60 V when P2 is turned fully up (high value end).

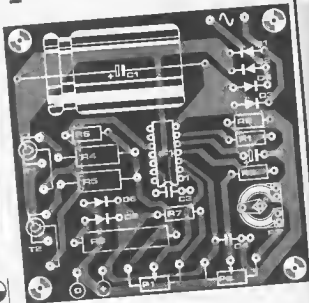
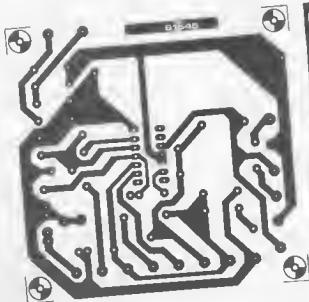
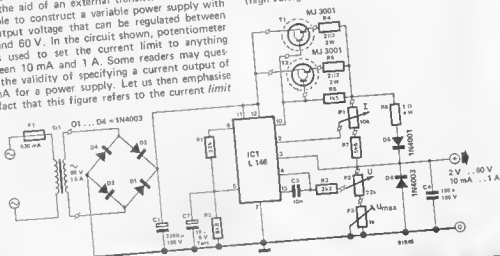

The two series power transistors (connected in parallel) can be replaced by the equivalent TIP 142 instead of the Motorola MJ 3001 Darlingtons if required. Since these transistors are liable to get very hot, a substantial heatsink is required. It should be noted that mica washers *must* be used when mounting these transistors as their emitter is connected to the case.
Disagreeable smells coupled with impaired vision

due to smoke will be the result if the power rating of the resistors used are less than those stated in the parts list. The above comment also applies to the smoothing capacitor C1 and the bridge rectifier diodes D1...D4 since the voltage across C1 can reach up to 78 volts. Because of the internal current limiting of the L146, the power supply is short-circuit proof.

53 long-period timer

This monostable multivibrator can be seen as a long-period alternative for timer circuits which incorporate the well-known 555. It allows the user to obtain on-off periods varying from 20 seconds to about 60 hours.

The design is quite simple. It consists of a start/reset part, a 'slow' oscillator and a series of flipflops. Most of this can be found, ready for use, in IC1. For the internal oscillator of IC1, only a further two and capacitors (C1, C2), two resistors (R1, R2) and potentiometer P1 are needed. The output signals of the counter in the IC can be reached via the Q outputs. Rather curiously, Q10 is not included and a 'Q10' is constructed by the addition of T1 and FF2. The timer is set in motion by the leading edge (positive-going) of the clockpulse to pin 3 of FF1. The Q output (pin 2) then becomes '0', and the

oscillator in IC1 starts. The Q outputs of IC1 will then become 'high' in turn to the timing of the oscillator frequency which is adjustable between 2.5 and 25 seconds by rotating P1. Depending on which one of points A, B, C...K is connected to point X, a logic '1' will be sent to the clear input (pin 4) of FF1 via R5 after a short or very long period. This way, the flipflop is cleared, the Q output becomes '1', and the oscillator stops. The 'timer' will start up again only after a new start pulse reaches pin 3 of FF1.

Due to the very large number of possibilities, there is a formidable choice of periods to choose from. When points A and X are connected, the time set with P1 can be varied to range from 20 sec. to 3.5 min., with connection B-X this range becomes 40 sec. to 7 min., and so on.

The period can be calculated exactly with the help of a simple formula:

$$T = (M - 0.5) \times 25 \cdot 10^{-6} \times (R2 + P1),$$

in which T is the time and M the selected dividing factor. This factor is 2³ for connection A-X, 2⁴ for B-X, 2⁵ for C-X, and so on. For connection K-X, the dividing factor is 2¹⁰ and, substituting this value in the formula, the respectable period of about 60 hours is obtained.

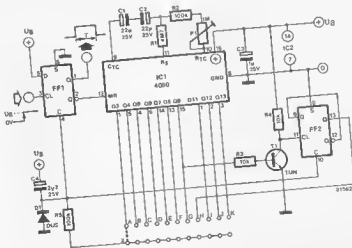

FF1, FF2 = IC2 = 4013
U0 = 5 - 25 V

54

novel clock control

In certain applications it is often necessary to generate a series of clock pulses by using switches etc. For instance, when a digital clock has to be adjusted. More often than not a digital clock has two function buttons. When one is depressed a clock frequency of several Hz is generated enabling the clock to be set to roughly the correct time very quickly. When, on the other hand, the second button is depressed, only one clock pulse is generated so that the clock can be set accurately. Why then two buttons if they both appear to perform what amounts to the same function?

As a matter of fact, there is no real need to have two buttons. The circuit described here fulfils the same task by only using one. Everything now depends on how long the button is depressed for. If the switch is held down for less than half a second, only one clock pulse will be generated. If, however,

it is depressed for longer, a clock frequency of 30 Hz will appear at the output of the circuit.

The circuit works as follows. When switch S1 is open the clock generator constructed around N1 will oscillate at a frequency of 30 Hz. However, since the output of N1 is logic zero, as is also true of pin 13 of N4, the output of the circuit will be constantly high (logic 1). If switch S1 is now depressed the monostable N1 and N2 will be triggered, causing the output of N2 to go low for half a second thereby inhibiting the oscillator N3. The output of N1 will now be high, so that the two inputs of N4 are also high. This means that the output of the circuit (N4) will be low (the first clock pulse). If S1 is still depressed after the time delay of the monostable has elapsed, the output of N1 will remain high, the output of N2 will be high, therefore N3 will now oscillate and the pulse train thus produced will be fed to the output of the circuit. If, on the other hand, S1 had been released before the end of the half second period, pin 13 of N4 would have become logic zero the moment that N3 started to oscillate again. As a result, the output would go high once more.

The waveforms involved are shown in figure 2. The vertical lines in signal A represent the contact bounce caused by switch S1. This contact bounce is suppressed by the RC network R3 and C2.

1

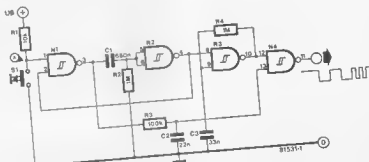

N1 .. N4 = IC1 = 4093
UB = 5 .. 15 V

2



81531-2

55

novel flashing light

As you may have already guessed, this circuit represents no more or less than a method of illuminating a series of LEDs. The diagram shows five LEDs, but this can be extended to a maximum of ten by connecting the reset line (shown connected to output 5) to the next output, or, if ten LEDs are used, by omitting the reset line altogether. Of course, for each extra LED a corresponding output stage consisting of a transistor and a resistor will also have to be added. What can the circuit do? In the simplest configuration, all the LEDs light up in turn. The rate at which this happens is determined by the setting of potentiometer P1. Other sequences can be found by incorporating some clever little 'tricks'. However, the basic configuration can certainly be useful, for example, in the case of a model of a road obstruction where they use those yellow warning flashers which light up one after the other. The illustration at (A) shows how the LEDs can be made to light and remain lit in sequence by simply including a diode between each output stage. The cathode of the diode is connected to the base of T1 and the anode is connected to the emitter of T2. A second diode is connected between the base of T2 and the emitter of T3 and so on. This simple arrangement is quite adequate to produce the desired effect.

LEDs which light up in a 'to-and-fro' fashion can be obtained by connecting the bases of the transistors to the outputs of IC2 in the following manner: The cathode of the first diode is connected to the base of T1 and the anode is connected to pin 3 of the 4017. Two diodes are connected to the base of T2, one goes to pin 2 and the other to pin 6. Similarly, T3 is connected to pins 4 and 5, T4 is connected to pins 7 and 1, and finally T5 is connected to pin 10.

By altering the pin numbering a totally 'random' display sequence can be obtained. Remember that if more outputs are to be used the reset connection must be moved to the next, unused output. The effects can also be combined: all sorts of 'weird and wonderful' sequences can be obtained by placing diodes between the outputs of IC2 and the transistor bases and between the base of one and the emitter of the next.

As it is quite likely that this circuit will be constructed by model builders who may have relatively little electronic experience, a brief explanation of how the circuit works may be advantageous. Opamp IC1 generates squarewave pulses by continuously charging and discharging capacitor C1. If the resistance of potentiometer P1 is increased the charge and discharge time for this capacitor increases and therefore the frequency of the oscillator decreases — this results in the LEDs being lit for longer periods.

The squarewave pulses are fed to a divide-by-ten counter, IC2. The outputs of this counter each go high in turn after every clock pulse. The previous output, which was high, now goes low and the LED connected to it, via the resistor and transistor, will go out, while the next LED in the sequence will come on. Finally, when output five goes high the counter is reset causing a new sequence to be started (LED D1 lights up).

Resistors R5 . . . R9 are responsible for limiting the amount of current through the LEDs. Most LEDs will not withstand currents greater than about 50 mA, therefore it is recommended to restrict the available current and to select the value of the series resistors so that the operating current is less than 30 mA. With a power supply voltage of 5 volts then 30 mA, the current through each LED is about 8 mA. By selecting a lower value resistor the intensity of the LED would be increased.

The power supply voltage for the circuit can be anywhere between 5 and 15 V. If the supply voltage is greater than 8 V, the well known 741 IC can be used for the oscillator. However, this IC does not operate too well at lower voltages, so either the 3130 or the 3140 is recommended.

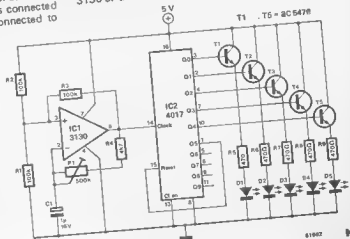
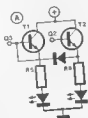

56

'Hi-fi' siren

The title 'siren' above a circuit diagram usually implies a circuit for a two-tone or multi-tone 'horn' which sounds continuously and can be used for an alarm of one sort or another. However, the siren described here is not particularly suitable for that application, but no doubt inventive readers will find a use for it! The Hi-fi siren simulates, as accurately as possible, a passing police patrol car with its siren going full blast.

What happens when a police car approaches? At first the siren is only heard very faintly. The noise increases gradually until at the moment it passes the observer the sound reaches maximum intensity. After this the noise decreases immediately while at the same time the pitch gets lower due to the 'Doppler effect'.

By examining the circuit diagram, we can see how this is accomplished electronically. The oscillators constructed around gates N1 and N2 constitute the actual two-tone siren. Initially, the base voltage of transistor T4, and thus the emitter voltage of T5, is approximately equal to the supply voltage. Therefore, no current passes through the loudspeaker. When the start button, S1, is depressed, the flipflop constructed around N3 and N4 changes state and the potential across capacitor C4 decreases slowly. This causes the emitter voltage of T5 to fall also, so that the current through the speaker will start to build up. This current is in fact switched on and off by T6 and T7 to the timing of the double oscillator

transistors T6 and T7 in the rhythm of the double (N1/N2), which in effect produces the required sound.

The current, and therefore the noise, continues to increase gradually due to the falling voltage across C4. At a certain moment this voltage reaches the negative trigger threshold of N4, so that the flipflop is reset and the output of N4 goes high. At this particular moment the voltage on the emitter of T5 is at a minimum and the noise level is at a maximum. As the output of N4 has now gone low, the frequency of the oscillator constructed around N2 is lowered somewhat, thereby simulating the Doppler effect. Capacitor C4 will then slowly recharge up to the supply voltage level, leading to a gradual lowering of the noise level.

The circuitry around transistors T2 and T3 ensures that the noise level increases very slowly at first, but it will then speed up. This makes the sound more realistic. The resultant effect can be adjusted by means of potentiometer P1 and should be done 'by ear'. To do this, the potentiometer is turned fully clockwise, so that the wiper is at full supply voltage level. The start button is then depressed and the noise produced is listened to. The potentiometer is then turned back a little way and the pushbutton depressed once more. This procedure should be repeated until the siren sounds as realistic as possible.

The printed circuit board for the Hi-fi siren is given in figure 2. The current consumption of the circuit is virtually dependent on the value of resistor R14. This resistor can be reduced in value to a minimum of 27 Ω if a louder siren is required. In that case the current consumption will increase considerably, of course. When R14 has a value of 100 Ω , the total current consumption at maximum noise level is approximately 60 mA ($U_B = 15$ V), while at rest it amounts to only a few mA.

1

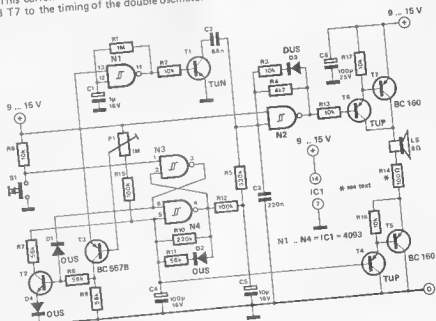

2

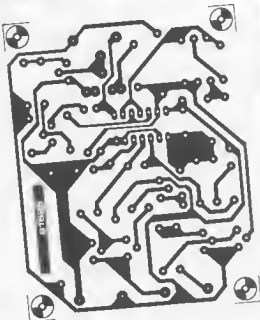

Parts list

Resistors:

R1 = 1 M
 R2, R3, R6, R13, R16, R17 = 10 k
 R4 = 4k7
 R5 = 330 k
 R7, R8, R9, R11 = 56 k

R10 = 220 k
 R12, R15 = 100 k
 R13 = 100 Ω
 P1 = 1 M preset

Capacitors:
 C1 = 1 μ /16 V
 C2 = 88 n MKM

C3 = 220 n MKM
 C4 = 100 μ /16 V
 C5 = 10 μ /16 V
 C6 = 100 μ /25 V

Semiconductors:
 D1... D4 = DUS
 T1, T2 = TUN

T3 = 8C57B
 T4, T6 = TUP
 T5, T7 = 8C 160
 IC1 = 4093

Miscellaneous:
 S1 = pushbutton
 LS = loudspeaker 8 Ω /500 mW

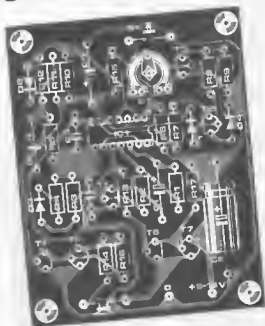

57

low-noise microphone pre-amplifier

P. De Bra

Hi-fi enthusiasts are often faced with the problem of not being able to get near enough to the object they want to record. The only solution in such a case lies in using a very sensitive, low-noise pre-amplifier combined with a good dynamic microphone. The pre-amplifiers in the usual recording equipment are normally not sensitive enough for the purpose, and produce too much noise to ensure good recording quality. It is much better to build a separate low-noise pre-amplifier, that can be inserted in between

the microphone and the recording equipment. Of course, the available microphone will do when recording the roar of a lion. No single pre-amplifier can guarantee a linear amplification of that kind of sound and that of a nightingale at a distance of 100 yards, due to the limits of the input sensitivity. The circuit given here, however, is intended to record the nightingale, but definitely not to record a pop singer who looks as if he is about to swallow his microphone.

Any transistor produces noise, but to combat this as effectively as possible, noise-free types from a good manufacturer should be selected. On top of that, the circuit should make optimum use of the transistor noise characteristic. It will be noticed immediately that the circuit described here contains 5 parallel stages. The noise generated by each stage can be added in the manner of a vector power, that is, as the square root of the sum of the squares of each component. As the noise of each stage is slightly out of phase, the resultant figure will be slightly lower than that of each stage. Mathematically, this reduction can be expressed as \sqrt{n} , so that in this case it is equal to $\sqrt{5}$, in other words, slightly less than 2.3 times. In terms of decibels it can be said that the reduction in noise amounts to

At the lowest measuring voltage of 15 mV the sensitivity is such that there is a full-scale deflection on the 100 μ A meter.

The opamp serves both as measurement amplifier and active rectifier. The level of amplification is determined by the switched resistors R1 to R6. With the Instrument set at a particular sensitivity range, the value of a resistor can be determined simply by dividing the input voltage for a full deflection by 100 μ A. When, for example, at the measuring range of 150 mV, a 200 mV range is expected to be needed, resistor R4 should be changed to a value of 2 k.

Because the bridge rectifier diodes D1 to D4 are located in the feedback loop of the amplifier, there is compensation for the threshold voltage of the diodes, for which reason the mV scale responds in a linear fashion.

The meter is zeroed with the aid of P1 and the input short-circuited, while the measuring range is determined by P2. The latter requires a calibration voltage that can be obtained from a small mains transformer with a secondary voltage of slightly less than 5 V. At this level, the voltage can be measured than 5 V. At this level, the voltage can be measured quite accurately with the aid of the multimeter. The calibration voltage should then be connected to the extended-range milli-voltmeter set at 5 V, and the reading of the 100 μ A instrument is then adjusted, using P2, to the value of the calibration voltage. The

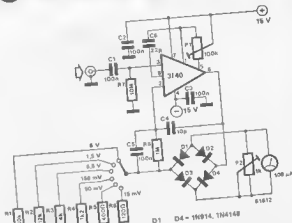

other measuring ranges are then set simultaneously corresponding to the tolerance of the resistors R1 to R6.

When the circuit is used to extend or supplement an existing multimeter, the moving-coil part of the multimeter should be used in the 100 μ A range. The best power supply to use in that case is about 9 V, obtained from two small 9 V dry cells which will last quite a long time as the power consumption is very low.

59

P. van Velzen

flashing bottle

The reason for the publication of this article is, of course, not the circuit, but the shape of the finished product! In this instance the electronic involvement consists of the vintage flashing LED IC from National Semiconductor (the LM3909) and associated components and as such is not very spectacular. However, the way in which it has actually been used is a refreshing change from the usual.

The power source consists of a bottle containing water and a few drops of ferric chloride (printed circuit board etchant). Inserted into the bottle are a carbon rod and a strip of zinc which can be moved up and down. When they are actually immersed in the 'acid' the circuit will be turned on.

The LED is mounted on part of a male connector plug and the components are mounted as shown in the drawing. A loudspeaker adds to the effect. The idea is not altogether new, but it may present an entirely different approach to electronics for many of our readers.

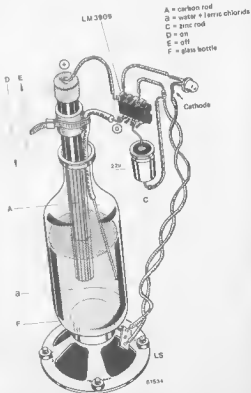

- A = carbon rod
- B = water + ferric chloride
- C = zinc rod
- D = diode
- E = 9V battery
- F = glass bottle

60

temperature alarm

This design allows a simultaneous check of a maximum of four temperatures. The individual detectors are connected to the main control unit by means of a pair of wires. When one of the detectors registers an abnormally high or low temperature, an alarm sounds. The positioning of resistor R10 determines whether the alarm is activated when the registered temperature rises above the preset temperature setting or whether it sounds when it falls below the required temperature.

When R10 is incorporated between the positive supply line and the output of IC3, the alarm will be triggered when the measured temperature exceeds that of the setting of P1. In this situation the output of IC3 falls and the detector starts to draw a current of around 20 mA. This means that the voltage across R1 becomes greater than 0.6 V causing transistor T1 to conduct and the alarm to sound. This occurs because as the temperature rises the resistance of the NTC resistor (R9) decreases taking the inverting input of IC3 higher than the non-inverting input (voltage-wise). This in turn causes the output of the opamp to go low.

If resistor R10 is placed between the output of IC2 and ground, the reverse happens. In this instance, as the temperature drops the resistance of R9 increases taking the inverting input of IC3 more negative than the non-inverting input. Consequently, the output of the opamp will go high and a current of approximately 20 mA will flow through resistor R10. This again causes transistor T1 in the main control unit to conduct and start the alarm oscillator, IC2.

The oscillator generates a tone of about 4 kHz which is then fed to the piezo-electric buzzer (Bz). This relatively high frequency was chosen to suit the resonant frequency of piezo elements and because it is optimal in relation to the aural sensitivity curve.

As mentioned previously, the maximum number of detector circuits that can be used is four. If any more were included the quiescent current would exceed that of the 'alarm current' and the design would not function correctly. In retrospect, the alarm current can not be increased as in that case the output current of the opamp would be exceeded — with detrimental results!

If another form of alarm is required, IC2 and its associated components can be omitted and the transistor can be used to control a relay or other similar device. The sensitivity of the circuit, in other words the temperature at which the device operates, can be adjusted by means of the preset potentiometer P1. It may well be advantageous to use a multi-turn preset so that more accurate settings can be obtained.

Applications for the design include a simple fire alarm, the temperature control of two aquariums (each one requiring a maximum and a minimum detector) and a temperature regulator for central heating installations.

1

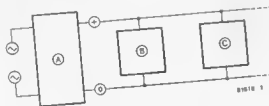

A = CONTROL UNIT
B = DETECTOR 1
C = DETECTOR 2

2

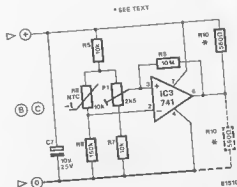
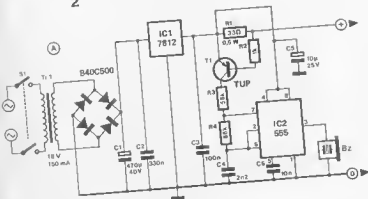

B1510 2

61

voltage regulators in parallel

The well known 78xx series of voltage regulators are designed to produce currents up to 1 amp. In many instances, however, this may be just too low for safety's sake and in this case an elegant solution would be to connect two regulators in parallel. This simple answer suffers from a major drawback (of course). The problem is that one regulator would do all the work while the other would gently tick-over. All is not lost, however, as the circuit here shows. If two ammeters are available they can be connected in the positions shown in the diagram. If

meters are not to hand, two short lengths of resistance wire can be used instead and the voltage drop across them can be measured with a voltmeter. The outputs of each regulator can then be balanced with the aid of the potentiometer P1 with the result that they will both produce the same current. The decoupling capacitors must be mounted as close as physically possible to the regulators, especially C2 and C3.

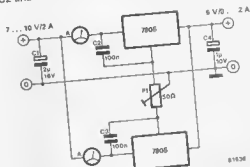

62

EPROM light sequencer

The circuit described here is an eight channel light sequencer. The information for each channel (on or off) is contained in a 2708 type EPROM (these are coming down in price every day!). There are therefore 1024 steps before the 'program' repeats itself. It is possible to program the EPROM yourself if you have access to an EPROM programming device. Otherwise you can use an EPROM which has already been programmed for a computer. This will cause the eight lamps to turn on and off in the

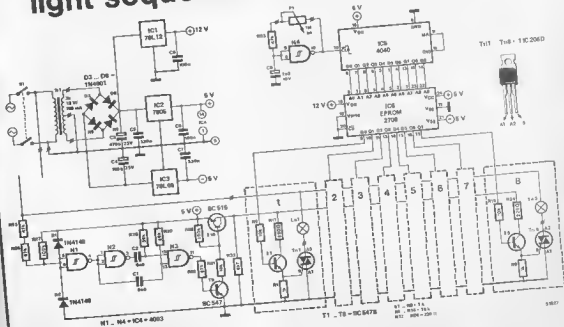

strangest of sequences. A test with the monitor program of the Junior Computer showed this to work very well.

The lamps are switched on or off at the 'zero-crossing' point of the mains waveform in order to avoid interference to TV or radio. The power rating of the lamps should be 200 Watts, but this can be increased to a maximum of 800 Watts if adequate heatsinks are used for the triacs.

As can be seen in the circuit diagram, the unit is controlled by the clock generator formed by N4. The oscillator frequency can be adjusted by means of potentiometer P1. The output of the clock generator drives a binary counter, IC5, which counts up from zero to 1023 in binary. The outputs of IC5 are fed to the address inputs of the EPROM, IC6. The contents of each address location are

therefore read out sequentially. A logic '1' on a data output of the EPROM will turn the corresponding lamp on via the associated driver transistor and triac. When the output is logic zero, the lamp will be extinguished.

The supply voltage for transistors T1...T8 is only present for about 300 μ s at the zero-crossing of the mains voltage. This is accomplished by the circuitry around N1...N3, T9 and T10. Thus if the base of the transistor is also high at this particular moment, the corresponding triac will turn on and will remain on for the remainder of the half-cycle. The supply voltages for the remainder of the circuit are provided by the voltage regulators IC1...IC3.

WARNING: Mains voltages are present throughout the circuit — so BE CAREFUL!

63 fast TTL interface

It is surprising how often TTL ICs are asked to perform a difficult (if not impossible) task. It is, of course, gratifying to know that experimenters have so much confidence in the capabilities of the TTL logic family. But, on the other hand, why drive the devices to extremes when they are not likely to survive? More often than not the output of this type of IC is overloaded, or they are used, mistakenly, to drive CMOS ICs directly. In the latter case, the guaranteed active pull-up TTL output voltage (2.4 V) is lower than the minimum CMOS input voltage required to guarantee switching (3.5 V). Also, the input impedance of CMOS ICs is essentially capacitive, which means that the slew rate of the TTL output signal will suffer at high frequencies. The upper trace in the photograph shows the effect when a TTL output is capacitively loaded (220 pF in this instance). The negative-going edges of the signal are still quite acceptable, as TTL outputs can 'sink' more current than they can 'source'. However, the output current will be reduced at the same rate at which the voltage level increases causing the positive-going edge to level off. As would be expected, CMOS ICs do not react favourably to this type of signal. This is because CMOS ICs will not

switch until the input level has reached approximately half the supply level, unless the manufacturer has taken the appropriate measures to avoid this. As a result, a delay of about 40 ns will be incurred and the poor signal edge at the input is bound to lead to a far optimum edge at the output.

In the case of the lower signal shown, an effort has been made to improve the positive-going edge by including a pull-up resistor between the TTL output and the positive supply voltage. This resistor (220 Ω) will certainly improve the positive-going edge of the signal, but at the expense of the negative-going edge. The ideal solution, therefore, is to incorporate a VFET which will only operate during the positive-going section of the waveform. The middle signal shows that the amplitude will now be the same as the full supply voltage and the positive-going edge reaches its peak very rapidly despite the capacitive load.

Note: the oscilloscope in the photograph was set up as follows:
vertical deflection — 2 V/div.
horizontal deflection — 100 ns/div (in other words, the frequency of the signal on display is 4 MHz/1).

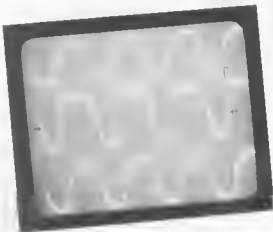
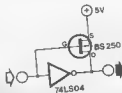

64

stereo level controls

In a normal pre-amplifier, potentiometers are used for volume, balance and tone controls, but, because they carry signal voltages, their connecting wires are prone to noise pick-up. By using the Motorola TCA5500 IC, a miniature stereo control amplifier can be constructed very easily, which does not suffer from these defects, and thus gives reasonable quality. The specifications of the circuit are shown in the table.

From the circuit diagram it can be seen that only passive components are required external to the IC to complete the control system. IC1 contains electronic attenuators, each of which must be controlled by an external voltage. The required voltages are provided by potentiometers, which are connected to a stabilised voltage source. Because these potentiometers only pass dc, they can be located at some distance from the circuit without any problem, and screened leads are not required.

Table

| | |
|---------------------------------------------------------------------------------|----------------|
| Supply voltage (stabilised) | 8 to 18 Volts |
| Supply current | Max 30 mA |
| Input voltage | Typ 25 mV RMS |
| Output voltage | Max 100 mV RMS |
| Output impedance | 100 Ω |
| Input impedance | 100 Ω |
| Output impedance | ± 14 dB |
| Tone control (100 Hz and 10 kHz) | -40 to +3 dB |
| Balance control | -68 to +12 dB |
| Volume control | Min 48 dB |
| Channel separation | |
| Distortion (1 kHz and 100 mV output voltage) | Typ 0,1% |
| Signal to noise ratio (50 Hz to 15 kHz, 12 dB amplification, tone control flat) | Typ 70 dB |

P1 and P2 control base and treble respectively. P3 is the balance control, whose mid-point gives equal amplification in each channel. P4 controls the volume, and at its mid point the amplification is 18 dB.

For optimum performance the input level should be around 25 mV RMS. A higher level can be reduced by using a 100 k Ω stereo pot at the inputs. A lower voltage can be increased by using an extra stage of amplification.

The coupling capacitors on the inputs and outputs can be dispensed with if they are already included in the main or pre-amplifier.

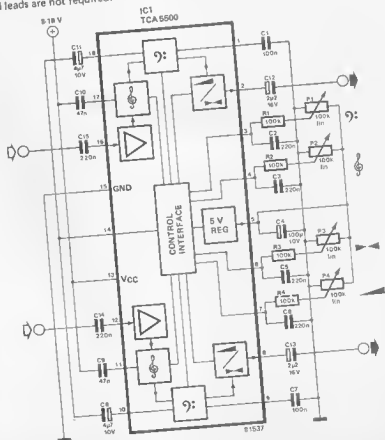

65 ^{1a}

optical indication for the movement detector

This circuit is intended as an extension to the movement detector which was published in the March 1981 issue of Elektor, in the sense that it adds a flashing mains lamp to the original circuit, while keeping the remainder of the circuit isolated from the mains.

Figure 1a gives part of the original circuit as used for controlling a relay. When the detector detects some movement, transistor T3 is turned on via the voltage divider R19/R22. This transistor then activates the relay so that, for instance, a lamp can be illuminated. With the addition of the few components shown in figure 1b, the lamp can be driven by a triac and, at the same time, will operate as a flasher circuit itself. The flasher LED (Siemens type LD 599). A zener diode and the LED of the opto-coupler have been placed in series with the LED. When transistor T3 now turns on, the LED will start to flash. During the time that it is on, a current of approximately 20 mA flows through the LED. This current drops to virtually zero when the LED is off. This means that the LED in the opto-coupler will flash on and off in sympathy.

The zener diode is included to keep the voltage across the LEDs to a safe value. The zener should be a 400 mW type. If a 1 W type is used it may be necessary to include a 4k7 resistor across the flashing LED. By changing the value of the zener diode, the flash rate can be altered.

Switch S is included so that either the original relay or the new flashing lamp can be selected. The opto-coupler is part of the zero-crossing detector shown in figure 1c, which is the actual control medium for the flashing mains lamp. This particular medium of the circuit has been used before and has proved to be very reliable. The thyristor will only pass the gate current to the triac from the mains via

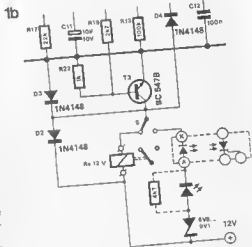
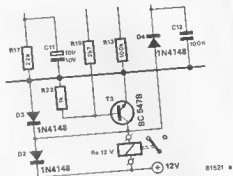

resistor R1 when transistor T1 turns off. The values of the voltage divider network resistors R2 and R3 ensure that the transistor will only be turned off for a very brief period around the zero-crossing point of the mains waveform. This means that the triac can only be fired during this short period, provided, of course, that the LED in the opto-coupler is on at the same time. Obviously, it is possible to drive any other mains driven equipment if desired.

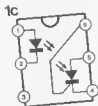
MCS 2400
(Mocnato)

top view

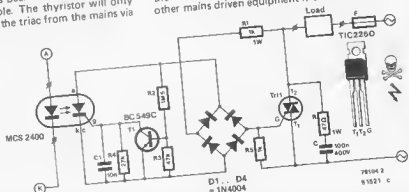
D1... D4
= 1N400478104 2
81521 C

66

L. Witkam

6 bit keyboard encoder

This keyboard encoder is constructed entirely from ordinary, easily obtainable, CMOS ICs. The heart of the circuit consists of two multiplexer/demultiplexer ICs (IC1 and IC2). The first of the 4015s, IC1, functions as the multiplexer, its input being connected to the positive supply voltage via resistor R1. The demultiplexer is formed by IC2. Between the eight outputs of IC1 and the eight inputs of IC2, a total of 64 keys are arranged in a matrix. There is a key connected between each point X and each point Y. In other words, between X0 and Y0, between X0 and Y1, and so on up to X7 and Y7. The control inputs (A, B and C) of IC1 and IC2 are connected to a binary counter, IC3. This counter is driven by the oscillator constructed around N4, so driven that it counts continuously from 0 to 63. This means that the entire matrix is scanned continu-

ously. When a key is depressed, the output of IC2 remains logic zero until the counter reaches the corresponding address for that particular key. At that moment, the high (IC1) input level is passed on to the output of IC2 so that the six latches (IC4 and IC5) receive a clock pulse via gates N2 and N3. The address of the depressed key will then appear on the output lines D0...D5. At the same time, transistor T1 is turned on making the output of N1 go high to provide a keyboard strobe pulse. When the key is released, the output of N1 will remain high for the period of time taken for capacitor C2 to discharge via resistor R3.

The oscillator frequency can be varied between 1 kHz and 1 MHz by altering the value of capacitor C1. The value of C2, however, must be determined by experiment. The discharge time must be such that it is slightly longer than the time taken for 64 clock pulses. This is so that the output of N1 is prevented from going 'up and down like a yo-yo' when a key is held depressed for longer than one scan cycle. The 'key depressed' output functions reliably when the keyboard data is accepted immediately after the leading edge of the pulse, but before the trailing edge. It is therefore recommended to include a monostable multivibrator after the output of N1, thereby shortening the length of the strobe pulse.

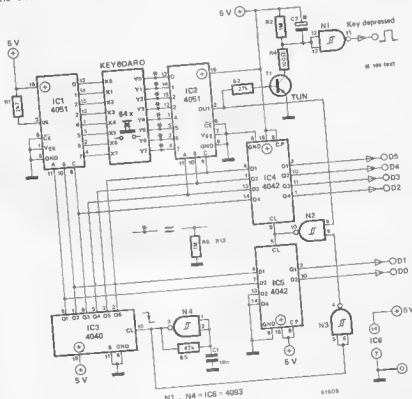

N1, N4 - IC6 - 4093

61008

signal there will be no voltage out of the diode detector and the Schmitt trigger will switch its output polarity thereby enabling the alarm oscillator. The transmitter and receiver alignment procedure is as follows:

1. Connect a DC voltmeter between the inverting input (-) of the Schmitt trigger and ground.
2. Tune the transmitter for a maximum reading on the meter. Initially, the distance between the transmitter and the receiver will have to be fairly small.
3. The trimmer capacitors in the receiver can now be adjusted for a maximum reading on the meter. In order to achieve correct alignment, it is important that the distance between the transmitter and the receiver at this stage is not too small, so as to avoid unwanted coupling effects.

4. The above procedure should be repeated to ensure that optimum alignment is obtained. This is necessary because the transmitter output is frequency-dependent (due to the loop antenna), while the frequency of oscillation is (almost) fixed.
5. The distance at which the alarm is to be triggered is adjusted by means of the preset potentiometer. The aerial is identical to that in the transmitter without the centre tap. It should be noted that, as loop antennas are used, there are bound to be some directional effects. These effects can also be caused by (large) conductive objects in the vicinity of the apparatus acting as reflectors. As a final remark, it should be stated that the absence of good receiver selectivity and/or coding system, limits the number of devices per square yard.

69 humidifier

B. Darton

A 'mist propagation unit' maintains plant cuttings and newly sown seeds in a moist environment until rooting is affected or the seeds have germinated. Generally, the equipment consists of a spray head which is supplied with water via a solenoid valve which is in turn controlled by a relay. Now we come to the electronics. The relay is activated by an 'electric leaf'. When the exposed electrodes of this device become moist, the relay is deactivated and the water valve closes. As soon as the electrodes dry out the solenoid is again opened. In the glasshouse situation it is the electric leaf that causes most of the problems in the traditional unit. The electrodes become coated with carbonates as the tap water evaporates (causing insulation) and any metallic contacts and wires suffer from the effects of electrolysis and become corroded. A new system which is not exposed to the hazards of water, yet which responds to the transpiration requirements of the plant would therefore be

desirable. A study of plant life will reveal that water is lost mainly through the leaf pores which open and close in relation to the amount of sunlight that falls on the leaf. Although temperature, humidity and plant size also affect water loss, sunlight is the controlling factor.

The circuit described here utilises a low frequency light-controlled oscillator (IC1) to provide a train of pulses corresponding to the amount of ambient light. The pulse train is then divided by 10 (IC2) in order to give an accumulative delay before being fed to a variable (1...9) divider (IC3). Although position 1 is suitable for newly taken cuttings, higher positions will give successively drier regimes to be used according to the maturity of the plants. The regime switch (S1) also allows for the excessive influence of other parameters such as temperature. The output from the regime switch is fed to a resistor/capacitor configuration (R5 and C4), which provides a delayed reset pulse for IC3, and to a transistor T1 which in turn triggers the triac Tr1. As the driven output power is not likely to exceed 10 watts the triac does not require a heatsink. The values of the components given have been

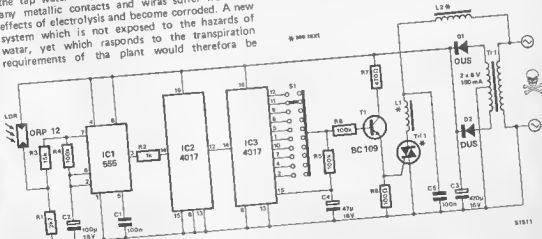

calculated for a mist control unit giving a 10 second spray of water during each (variable) cycle. If the device is to be used as a control unit for 'trickle' or 'drip' installations, a higher régime should be selected and the values of R5 and C4 increased in order to allow for the time required to fill up water pipes etc. The actual values would depend on the pipe pressure and the capacity of the system, bearing in mind that a tomato plant may require anything up to a litre while a cactus could survive on a few drops in any one day. In the diagram, the coil of the solenoid valve is represented by L1, while L2 is a common RF suppression choke. The value of L2 is not critical, but should be able to pass the

required amount of current. Since the circuit is connected directly to the mains, it is essential that the shaft of the régime switch, the on/off switch and the solenoid valve be correctly earthed. The circuit board should be fitted in a waterproof plastic case with the LDR mounted in the lid with epoxy resin. The connecting leads should be fed out through a waterproof connector on the base of the unit.

The circuit lends itself to the experimental watering of pot plants in the home, which is particularly useful in the holiday season, and has the advantage over electrode saturation systems in that drier, more suitable régimes can be selected.

70

M.A. Prins

automatic soldering iron switch

We all know that it is quite easy to forget to turn off the soldering iron. If you then go out of the house with other things on your mind, it is just possible to return to find a heap of smoking rubble. This would be extremely upsetting, especially when this sort of calamity can easily be avoided. The

results are not usually so dramatic, but the least you can expect is a bigger electricity bill. The circuit here will iron the problem out and will repay the effort of making it in a very short time.

The circuit operates as follows. IC1 is an oscillator divided by 2¹³ which generates a time interval of about a quarter of an hour. At the end of this time a LED flashes and a buzzer sounds. Unless S1 is pressed within 50 seconds, the circuit switches itself, and the soldering iron, off. If S1 is pressed, IC1 re-starts the 15 minute period.

Although the prototype circuit behaved satisfactorily, it is just possible that 'spikes' on the mains supply line will cause the relay to pull itself back in. In this case the relay must have an extra contact, to positively switch it off. This then requires a third

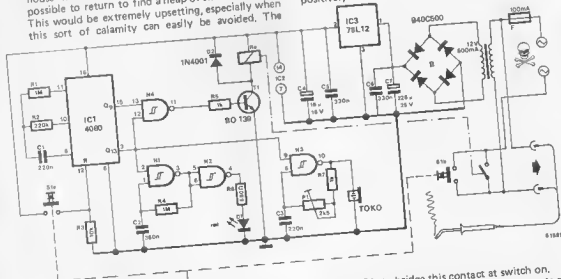

N1...N4 = IC2 = 4093



*see text

pole of S1, to bridge this contact at switch on. The switching can be done using two separate push switches which must be pressed simultaneously. If a relay is available with an operating voltage other than 12 volts, then the circuit can be operated at the relay voltage, by changing the power supply and regulator. The supply voltage must, however, be kept between 3 and 18 volts.

71

R. Storn

constant current adapter

It is quite often the case that the electronics enthusiast requires a constant current source. When such a need does arise, for example for test purposes, it is a piece of equipment that is not usually available. However, it is not necessary to construct an entire constant current source for each application. It is sufficient to have an adapter that can be connected to an existing power supply whenever a constant current source is required. The proposed circuit has another useful application: the asymmetric-to-symmetric power supply converter at the front end of the constant current adapter can be used separately to power an amplifier or similar circuit. Most amateur constructors own a mains power supply with a variable output voltage of up to 30 V

| Table | S1 | I | P1 x |
|-------|----|----------------------------|-------------|
| 1 | | 10 μ A ... 100 μ A | 10 μ A |
| 2 | | 100 μ A ... 1 mA | 100 μ A |
| 3 | | 1 mA ... 10 mA | 1 mA |
| 4 | | 10 mA ... 100 mA | 10 mA |

and a current output of around 200 mA (or greater). This supply can then be used to power the constant current adapter.

The asymmetric-to-symmetric converter consisting of IC1 and transistors T1 and T2 provides an effective output voltage of ± 15 V across the two capacitors C2 and C3. This symmetrical supply can be used separately provided the required output current is no greater than about 50 mA.

Let us now examine the constant current adapter itself in greater detail. The asymmetric-to-symmetric voltage amplifier IC2 is required to power the operational amplifier IC2. This opamp is used as the current source and is controlled by the potential divider consisting of potentiometer P1 and resistors R3 and R4. Potentiometer P1 can be adjusted to give an output voltage of between 1.5 ... 15 V. A constant current will flow through load resistor RL which is dependent on the voltage setting of P1 and on the range selected by switch S1. The circuit is such that, regardless of the actual range, the current through RL is determined by the setting of P1. Transistors T3 and T4 simply form a buffer stage.

The output current of the adapter can be calculated from the formula:

$$I = \frac{0.1 \times U_{p1}}{R10 \text{ or } R11 \text{ or } R12 \text{ or } R13}$$

Potentiometer P1 should be provided with a scale from 1 to 10 so that it is easier to control the desired current. Depending on the setting of the range switch S1, the current can then be deduced with the aid of the multiplication factor given in the table below. Potentiometer P2 should be adjusted initially so that an output current of 10 μ A is obtained when S1 is in position '1' and P1 is set at minimum output.

1

- 1 = asymmetric-to-symmetric voltage converter
- 2 = voltage-controlled current source
- 3 = current range switch

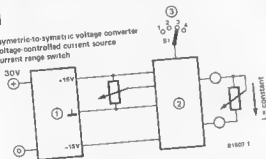

2

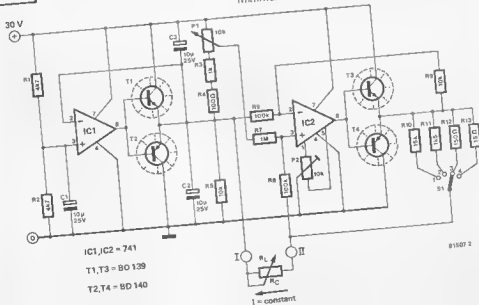

IC1, IC2 = 741

T1, T3 = BD 139

T2, T4 = BD 140

81807 2

72

simple ASCII keyboard

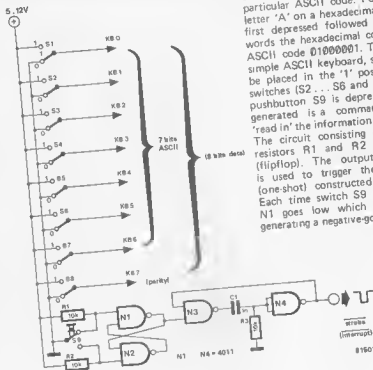

from an idea by D. Hul

Many enthusiasts who would like to possess a video terminal for their (Junior) computer are deterred from constructing one due to the relatively high price of ASCII keyboards. For this reason we present a design for one of the cheapest alternatives for such a keyboard. With the aid of this circuit an 8-bit data output and a key-strobe can be obtained quite simply.

The desired 8-bit information is set up on switches S1...S8 to give the correct configuration for the particular ASCII code. For example, to obtain the letter 'A' on a hexadecimal keyboard, button '4' is first depressed followed by button '1', in other words the hexadecimal code '41'. This sets up the ASCII code 01000001. To obtain this code on the simple ASCII keyboard, switches S1 and S7 should be placed in the '1' position, and the rest of the switches (S2...S6 and S8) in position '0'. Then, pushbutton S9 is depressed. The key-strobe thus generated is a command for the computer to 'read in' the information (data).

The circuit consisting of gates N1 and N2 and resistors R1 and R2 is a bistable multivibrator (flipflop). The output signal from the flipflop is used to trigger the monostable multivibrator constructed around gates N3 and N4. Each time switch S9 is depressed, the output of N1 goes low which triggers the MMV thereby generating a negative-going strobe pulse.

73

hydro-alarm

It is well known that plant growers with a large 'collection' have to work very hard in order to produce successful results. The watering of plants is only one job that has to be done and can become time consuming if large numbers of plants are involved. The same is not true of the 'domestic' plant where on many occasions it may be forgotten and allowed to run dry. The watering of plants can

be aided by electronics, however, and the simple circuit shown here will produce an audible indication when the plant requires topping up.

The two electrodes (A) and (C) in the illustration are placed in the pot and form the 'hydro switch'. When water covers the ends of these probes the output of the 1 kHz oscillator (N1) will be fed to point (C) in the circuit diagram. The AC signal is rectified by diodes D1 and D2 and causes pin 13 of N4 to be taken low. Since this gate forms the basis of another oscillator, a low level on this input will prevent it from doing its job. When the water level drops lower than the end of the (C) probe pin 13 will be pulled high by R9. The N4 oscillator will now produce an output to the buzzer indicating that the plant requires water. The buzzer tone can be varied by adjustment of the 500 k preset. A third electrode (B) is also placed in the pot but ending at a higher level than (A) or (C), in fact it

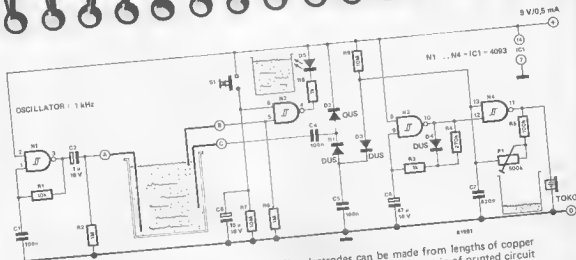

should just reach the maximum water level point. This should give you a clue to its purpose. Switch S1 must be pressed while watering the plant. When the water level in the pot reaches the end of electrode (B), LED D5 will light thus giving a precise visual indication that the plant has sufficient water. To economise on current consumption the LED will only remain lit for some ten seconds after S1 is released. This time can be increased if required by raising the value of C8.

The electrodes can be made from lengths of copper wire or etched as tracks on a strip of printed circuit board. As the current through them will be AC, corrosion will be reduced and they should have a fairly long life.

The supply voltage is not critical and may be anywhere between 5 to 15 volts. However, if it is significantly less than the suggested 9 volts, the cross section of electrode (C) will need to be fairly large to allow for the voltage drop across D1...D3.

74 automatic reset

This circuit is designed to generate a reset pulse whenever the supply voltage is switched on and, in addition, whenever there is any substantial inter-

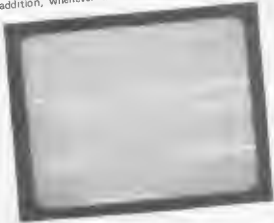

ference 'spikes' on the power supply lines. Most digital circuits (and microprocessor systems in particular) have to be reset for a certain period after the supply voltage is initially switched on. In this instance, an active low reset pulse is generated which will remain logic zero for 30 ms after the supply is switched on. At the end of this duration the supply will be fully on.

The 'automatic reset' works as follows. The section of circuit around transistors T1 and T2 ensures that the voltage across capacitor C1 remains 0V until the supply voltage reaches a level of 4.5V. As soon as the supply voltage reaches this value, the transistors will stop conducting and capacitor C1 will gradually charge up via resistor R5. As a result, the voltage at point A will slowly drop from around 4.5V to 0V, causing the Schmitt trigger formed by N1 and N2 to be triggered and the output RES will go high. In other words, the RES output will most definitely be low for about 30 ms after switch-on until the supply voltage level has attained its correct value (+4.75V for TTL).

As a side-line, the circuit also allows for a reset pulse to be generated if ever the supply voltage should drop below 4.5V for any reason. In certain computer applications this could well be vital, as such an interference spike, however short, could well erase a large section of memory! For this reason a noise generated reset pulse could well be useful, as the computer operator then knows that the program will always be started from 'square one'.

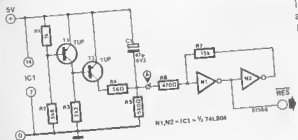

The photograph shows a characteristic form of interference spike and the reset pulse that is generated from it. Finally, it should be noted that the Schmitt trigger need not necessarily be constructed from two inverters and two resistors. In fact, any type of Schmitt trigger will perform adequately here, such as the 74LS132 for instance.

75

LED voltage monitor

A stable power supply is absolutely essential for the correct operation of computers and TTL circuits. A voltage fluctuation of 10% is certainly not tolerable, therefore it is prudent to keep a regular check on the supply voltage level.

Because of their lack of resolution and accuracy it is inadvisable to use analogue panel meters to monitor the power supply voltage. Besides this, a fluttering pointer is hardly the best choice for a warning device. The LED voltage monitor solves all

these problems.

The voltage monitor is set up so that only the range between 4.5 V and 5.5 V is covered. The device used, the LM3914, is very similar to the one used as an 'audio level meter' elsewhere in this issue (the LM3915). There is a slight difference between the two however: The LM3915 has a logarithmic scale whereas the LM3914 has a linear scale. The latter device contains a row of 10 identical 1 k Ω resistors.

The two reference levels, RLD and RHI, of the potential divider network P1, P2 and R4...R6, are set to 4.51/3 = 1.5 V and 5.41/3 = 1.8 V respectively. The '3' is brought into the calculation as the input voltage is also divided by three by resistors R1...R3. The table shows which LEDs will light for the corresponding input voltage once the circuit has been set up correctly.

For a clear warning indication it is best to use red LEDs for D1 and D10 and green ones for the rest. It may also be useful to use a different colour (orange) for D5 and D6 as an indication of the nominal voltage level.

Table

| V _{cc} (V) | | LED |
|---------------------|----------|-----|
| 4.51 | ... 4.80 | O1 |
| 4.61 | ... 4.70 | O2 |
| 4.71 | ... 4.60 | O3 |
| 4.81 | ... 4.90 | O4 |
| 4.91 | ... 5.00 | O5 |
| 5.01 | ... 5.10 | O6 |
| 5.11 | ... 5.20 | O7 |
| 5.21 | ... 5.30 | O8 |
| 5.31 | ... 5.40 | O9 |
| 5.41 | ... 5.50 | O10 |

The power supply for the circuit can be taken from the voltage to be monitored as the current requirement is only 20 mA. Diode D11 is included to protect the circuit against reverse input polarity.

To calibrate the circuit it must be connected to an adjustable regulated power supply. The input voltage is then adjusted until a reading of 5.41 V is obtained on a digital voltmeter. Potentiometer P1 can now be adjusted so that D9 and D10 light up simultaneously. The input voltage is then set to a level of 4.61 V and P2 is adjusted so that D1 and D2 light simultaneously. As the internal resistors have a slight effect on the circuit it is advisable to repeat the calibration procedure to obtain the optimum accuracy. To ensure satisfactory performance of the LED voltage monitor, all resistors must have a tolerance of 5%.

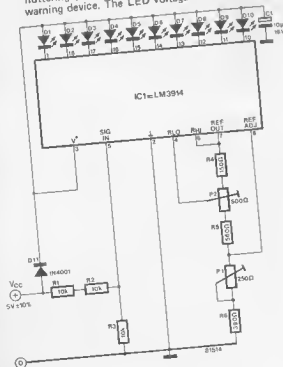

77

humidity sensor

Encouraged by the enormous response to the publication of the humidity sensor in April 1981 issue of *Elektor*, our designers decided to prepare a slightly modified circuit. This also allowed the possibility of altering the power supply slightly so that temperature changes no longer affect the results. This can be realized by using the well-known voltage regulator IC, the 723, which happily combines a very high specification and a low price. Further, its lack of sensitivity to temperature changes is excellent. To obtain an output voltage of 6.5 V, the 723 must be provided with a supply voltage that does not fall below 9 V.

The actual circuit is similar to that published in the April 1981 issue, which also described its operation and calibration. Just as a reminder, we shall include a brief summary here. The Valvo humidity sensor should really be seen as a capacitor, consisting of a separation layer (the dielectric material) covered on both sides by a thin layer of sputimated gold. The gold layer is so thin that the water molecules can penetrate into the separating layer, thus being able to change the capacitance of the dielectric material between the two layers of gold. When the atmospheric humidity rises, the capacitance increases almost proportionally. The circuit which follows the sensor is in reality a capacitance-voltage converter. In the first IC we find two astable multivibrators: N1, N2 and the sensor C1. The other multivibrator consists of N3, N4 and C2...C6 and is used to calibrate the circuit. When calibrated correctly, the

frequency of the two oscillators should be the same. The output of N3 being connected to the input of N2, the two oscillators will spring into action at the same time. With a rise in humidity, the capacitance of C1 increases, and the frequency of N1 and N2 stays drops. This implies that the output of N2 stays 'high' longer than that of N4. The difference in time is detected by IC2 which converts it into an output voltage. To obtain a reliable reading the entire circuit should be calibrated and adjusted in the following manner:

- Check the power supply (6.5 V). It can be adjusted by altering R9/R10.
- Replace the sensor by a 118 pF capacitor, and adjust C4 to obtain the minimum output voltage.
- Connect a 159 pF capacitor instead of the sensor.
- Obtain a full deflection (1 V) by adjusting P1.
- After mounting the sensor (watch for parallel capacitance due to long cables!) C4 is turned until a known humidity is indicated correctly.

In case the reader does not possess capacitors with such unusual values, the circuit can also be calibrated by adjusting to two extreme humidities (a very low and a very high one). For the low one humidity C4 should be adjusted, for the high one turn P1. As these two manipulations affect each other, the entire process should be repeated a number of times.

To generate known humidities, a reliable (borrowed) hygrometer is required. In the April issue of *Elektor* a method, using various salts, was mentioned for obtaining calibration humidities. The output can be read in various ways, for example, in the first place the DVM published in this issue can be used, or, of course, some other digital read-out can be connected, provided that its input impedance is not less than 1 M Ω . If desired, an analogue moving coil meter (50 A, 1 K Ω) can be installed, and must then be connected up in series with a 19.6 K Ω resistor at the common point of P1 and R4 to earth. This

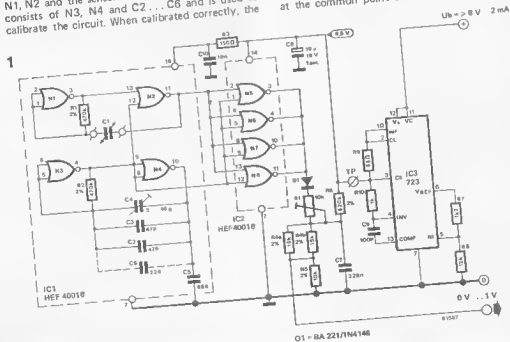

2

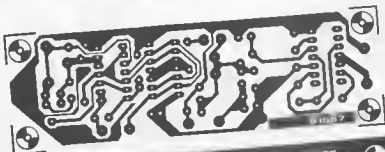

- Resistors:
 R1, R2 = 470 k 2%
 R3 = 150 Ω
 R4a, R4b = 15 k 2%
 R5 = 10 k 2%
 R6 = 820 k 2%
 R7 = 1k2
 R8 = 12 k
 R9 = 68 Ω
 R10 = 1 k
 P1 = 10 k preset

- Capacitors:
 C1 = Humidity sensor (Dorem)
 C2, C3 = 47 p p100
 C4 = 3...40 p trimmer
 C5 = 68 p
 C6 = 22 p p100
 C7 = 220 n
 C8 = 10 μ/16 V tantalum
 C9 = 100 p
 C10 = 10 n

- Semiconductors:
 IC1, IC2 = HEF 4001B
 IC3 = 723
 D1 = BA 221 (1N4148)

peculiar value resistor can be found in the E-48 series, and should have a tolerance of 2%. When including such low-resistance measuring instruments, attention should be given to the fact that only one meter should be connected. When it is desired to include a digital volt meter with an input impedance of less than 1 M, the original R7 should

be modified in such a way that the resistance of the parallel circuit is 18.6 K. It is possible to extend the humidity sensor by the bar-graph, also described in this issue, which makes it possible to obtain a visual display of the measured humidity values.

78 crystal oscillator... ...for low voltage supplies

It is very easy to construct a crystal oscillator using a field effect transistor. This particular circuit operates at relatively low supply voltages, from 1.5 volts upwards, and was tested in the Elektor laboratory with common-or-garden quartz crystals with frequencies ranging from 100 kHz to 10 MHz. The crystal is connected between the drain and gate of the field effect transistor, T1, and operates in the parallel resonance mode. Coil L1 is included to

improve the frequency range. Furthermore, it helps as an additional parallel coil for those crystals which are not particularly suited for this application and which do not feel like oscillating. Capacitor C1 is the series 'padding' capacitor for the crystal. The necessary feedback and the 180° phase shift is provided by the internal input and output capacitances of the FET. The output signal is buffered by transistor T2.

In the laboratory, this circuit was tested with the following range of crystals: 100 kHz, 1 MHz, 4 MHz, 6 MHz, 8 MHz and 10 MHz. The circuit can be used in a variety of applications due to its low supply voltage requirements (1.5 V minimum).

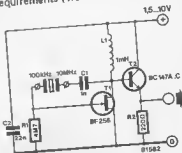

2

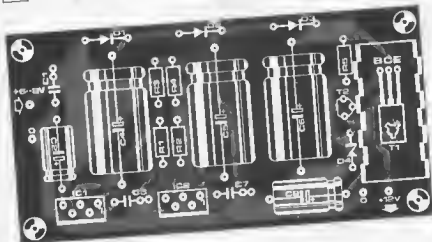
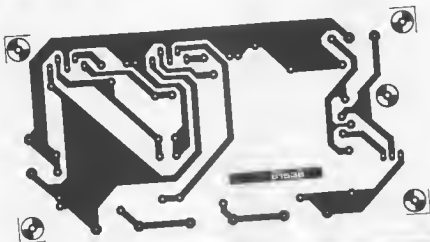
Parts list
Resistors:

R1 = 2M2
 R2 = 390 k
 R3 = 180 Ω
 R4 = 68 Ω
 R5 = 680 Ω

Capacitors:

C1, C3, C7 = 100 n
 C2 = 100 μ /18 V
 C4, C5 = 1000 μ /16 V
 C6 = 1000 μ /25 V
 C8 = 220 μ /16 V

Semiconductors:

T1 = 8D 136/138/140
 T2 = 8C 547B
 D1, D2, D3 = 1N5401/1N4001
 D4 = 15 V/400 mW zener diode
 IC1, IC2 = TDA 2002/TDA 2003

(1N5401) are best suited because less voltage is dropped across them. When 1N4001 types are used, a loss in output voltage of 0.5 V to 1 V should be expected.

If the values of capacitors C4, C5 and C6 are increased to 200 μ F, the maximum output current is raised by about 100 mA. For even higher output currents, two converters can be connected in parallel. In that case, the limiting stage (R5, CB, D4, T1 and T2) is omitted from the second board and a connection made between the two positive electrodes of the two C6s. Transistor T1 can then be one of the following types; BD 236, BD 23B, BD 204, BD 288 or BD 43B. The maximum current that can be obtained by connecting two converters in parallel is nearly doubled to about 1.3 A, therefore stereo or cassette radios can be installed in 6 V cars quite easily.

80

12 V to 6 V converter

After having described how a modern 12 V car radio can be installed in a vehicle with a 6 V system with the aid of a 6 V to 12 V converter, it may be a good idea to look at the other side of the coin — where a lower voltage is required from a 12 volt system. The most common application for this type of converter is when portable cassette recorders are to be used in the car. Many of these require a supply voltage of between 5...8 volts. The simplest and most obvious solution is to use an integrated voltage regulator. Apart from utilising 6 volt types such as the 7806, it is also possible to

use a 5 volt version (7805 or LM 309) and boost its output voltage by including two diodes in the common lead as shown in the circuit diagram. Depending on the type of diodes used, this will produce an output voltage between 6 V and 6.5 V. The maximum output current of the types mentioned is 1 A. It is important to ensure that the regulator is sufficiently cooled by means of a suitable heatsink. Combined radio/cassette players very often require a slightly higher voltage of 7.5 V. In this instance, either the 7808 can be used, or the 7805 with four diodes in series with the common lead.

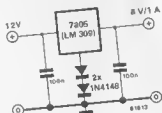

81

touch-sensitive 16 channel multiplexer

Amongst the 'gadgets' which seem to be most popular with amateur electronics enthusiasts, there is one class which appears to stand out from the rest: touch-sensitive controls. These can be found amongst the most simple basic equipment up to the most complex piece of apparatus. Nothing seems to be beyond the realms of touch-sensitive control. This particular application is for controlling the tuning voltage of an FM receiver and is accomplished by multiplexing 16 analogue channels by means of a binary code. Depending on the actual four bit code presented to the input, one of sixteen output channels will be selected. The circuit is divided into two sections; the touch-sensitive binary input and the 16 channel analogue multiplexer. It should be noted that this latter section can be used in conjunction with two other drive circuits which also appear in this issue. Namely, the dual input channel selector and the 16 input channel selector. However, it should also be noted that the operation

of this particular section is only described once — here. In the following articles it simply refers to this one and indicates the points (A, B, C and D) which must be interconnected. According to the digital signal present at these four inputs, one of the 16 analogue input signals is passed to the output (pin 1) of the multiplexer, IC2. This IC is a 4067 CMOS multiplexer/demultiplexer chip. Analogue signals with a voltage of anything between 0 V and 12 V can be applied to each of these sixteen inputs. In this particular instance the voltages are derived from multi-turn potentiometers P1...P16. The output signal from IC2 is available

Parts list

Resistors:

- R1...R8 = 10 M
- R9...R12 = 820
- R13 = 100 k
- R14 = 120 k
- P1...P16 = 100 k lin multi-turn preset potentiometers

Capacitors:

- C1...C4 = 10 p
- C5 = 56 n
- C6...C22 = 100 n

Semiconductors:

- D1...D4 = LED
- T1...T4 = TUN
- IC1 = 4044
- IC2 = 4067
- IC3 = 3140

at point E and can be used as a control signal for all sorts of applications. It should be noted, however, that the input voltage to any one of the sixteen inputs must never exceed that of the supply voltage. If the circuit is required to drive the control voltage of a vari-cap tuner, which may well be the case, it is quite likely that 12 volts is not sufficient since most tuners, both FM and TV, require a higher maximum drive voltage. This problem can be solved quite simply by amplifying the output from IC2 using IC3. This boosts the signal up to a maximum of 24 V. In theory, this may be increased to 30 V if the value of R14 is increased to 150 k.

The noteworthy point of this particular design is that the selection of the channels is made directly, in binary code, by the user. This is accomplished by using four flipflops all contained in a single IC, IC1. Pull-up resistors R1...R8 keep the inputs of the flipflop high as long as none of the touch contacts are activated. Capacitors C1...C4 are included to provide a 'power-on reset'. The logic level at the outputs of the flipflops are indicated by LEDs D1...D4 again, of course, in binary code. The reliability of the flipflops is assured by using

R/S types, which means that they are not affected by brief interference spikes. This also makes the circuit easier to operate. To select a particular channel, the channel number must be known and also how to convert that number into binary by using the touch buttons. As an example, let us assume that channel 5 is to be selected. It is then necessary to introduce the binary code 0101. (It should be noted of course, that the touch buttons should be kept clean). To obtain the code mentioned above, the following buttons would have to be operated: reset A, set B, reset C and set D where set refers to high level and reset refers to low level logic. For this reason, it may be advantageous to mount the four 'set' buttons above the four 'reset' buttons.

This method of 'programming' may appear rather peculiar, but it is quite easy to get the hang of it. Furthermore, it has two advantages: you get to learn the binary code and the circuit is very economic in that only eight buttons and four flipflops are required. What this means can be observed by examining the article which refers to the 16 input controller.

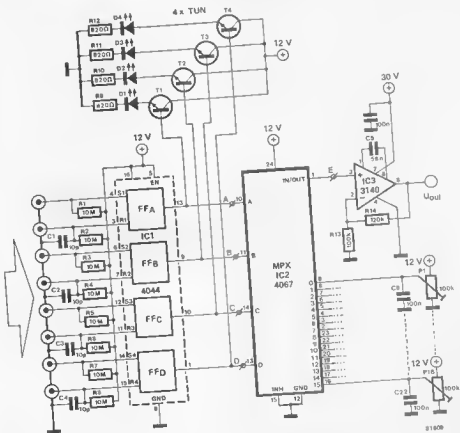

82

dual input channel selector

The circuit described in this article is a different kind of solution to the 16 channel multiplexer described in the previous article. It is not difficult to imagine that binary control is not what all our readers would like, mainly because of its rather unusual mode of operation. With a few additional components it is possible to perform the same function with only two buttons. This makes the unit a lot easier to operate. The only controls in this instance are a touch button to count up and another one to count down through the channels. Furthermore, instead of having a binary display using four LEDs as in the previous case, the actual channel number is indicated on a nine-segment display. This one-and-a-half digit display requires a special type of decoder (the SN 29764).

Let us now examine the circuit itself in greater detail. The clock oscillator formed by N1 and associated components provides a series of pulses for the binary counter IC1. Depending on the logic level at pin 10 of this device, it will be placed in either the 'count up' or 'count down' mode. This logic level is derived from the touch-sensitive inputs via the R/S flipflop formed by N3 and N4. Each time that one or the other touch button is activated,

pin 5 of IC1 is taken low via N2 and transistor T1. This is necessary to enable the counter. Consequently, nothing happens until one of the two touch buttons is actually touched.

The four output lines provide the binary code for the 4067 binary multiplexer, which was mentioned at the start of this article. This binary information is decoded by IC2 into control signals for the 1½ digit display. This is a special type of decoder, which was originally designed for television sets to give a digital display of the channel number. It can control nine segments. The display itself is also a specific type, namely, the MAN 6650 (Monsanto). Obviously, if these devices are difficult to obtain, they can be replaced by a pair of more common decoders and displays. However, it should be noted that the combination of decoder and display mentioned here, give an indication from 1...16 and not 0...15 as might be expected.

Finally, we need to know how to use the circuit. In order to select a particular channel, one or other of the two buttons are operated. This enables the clock input of IC1, which then receives clock pulses from N1 at a rate of two a second. The binary output code is therefore incremented or decremented by one at the same rate depending on which of the buttons was operated. As long as the touch contact is operated the count will continue and the number of the selected channels are indicated in sequence on the display just long enough for them to be seen clearly (approximately 450 mS). As soon as the button is released the state of the counter is 'frozen' and the count input is disabled. The following article will deal with the same sort of thing, but by using a different method again. Namely, a circuit to control the same multiplexer, but this time with no less than sixteen inputs!

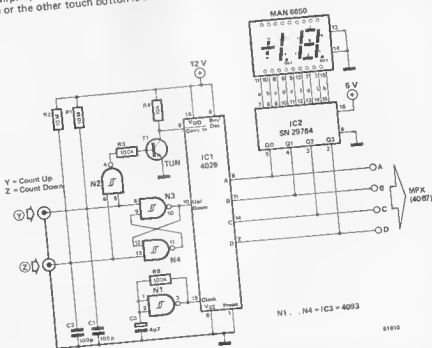

83

16 input channel selector

This is the third method of controlling the sixteen channel multiplexer described in this issue. The first described a binary method of control, while the second described a way of using just two touch-sensitive control inputs. Now, finally, we come to the third and most complex version.

This consists of a demultiplexer input drive with sixteen buttons. In other words, one button for each channel. It provides the easiest possible method of channel selection for the operator. It is quite obvious that it operates in the decimal system, which is the one that most of us poor humanoids know best. Although it is slightly more complex than the others, it requires less components. Therefore, as we can see, comfort pays.

Let us take a brief look at the basic principle of the multiplexer. We have a total of 16 analogue input signals, any one of which can be passed on to the output, amplified, and used to control a varicap tuner or something similar. In the selection circuit described here, the same IC is used as a demultiplexer.

This device is controlled by a binary counter, IC1 (4029), which, in turn, receives its clock pulses from the astable multivibrator constructed around N1. The frequency of oscillation is approximately 500 Hz. At each clock pulse, the binary code at the output of the counter is incremented by one. This means that the demultiplexer inputs are each passed on to the output of IC3 (pin 1) consecutively. The ABCD outputs of the binary counter, IC1, are also fed to the inputs to the four input latch, IC2. This receives its clock input from the monostable multivibrator constructed around gates N2 and N3. When one of the sixteen touch-sensitive inputs are operated, the corresponding demultiplexer input is pulled to supply common. At some moment in time, depending on the count from IC1, the signal from this input of the demultiplexer is passed on to the common output pin, which at that moment also becomes logic zero. This pulse triggers the monostable multivibrator, which in turn enables the latch and the binary data at the input of the latch is transferred to the output. At this moment, therefore, the binary code corresponding to the channel which has been operated is fed to the output.

When the button is released this code is retained in the latch as long as no other buttons are operated. This means, obviously, that it can be used to control the 16 channel multiplexer. No display is shown in this article, but, of course, there is no reason why the display circuitry described in the dual input channel control article can not be used.

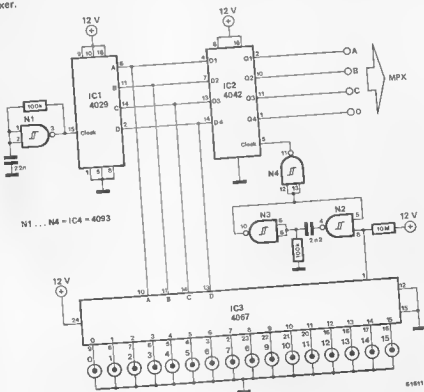

84

K. Hense

post office
letter scales

No doubt, everyone is familiar with the kind of scales to be found on Post Office counters. A letter or small parcel is placed on it and the weight and the required postage can be read off it. There is no reason why this can not be accomplished electronically. Of course, some mechanical ingenuity will be required as the equipment will include some form of scale or balance mechanism. Moreover, the electronic scales should look similar to the mechanical counterpart. If the latter were not the case, nobody would think of putting a letter on to weight it!

Let us first consider the electronic details. The quite

simple circuit is shown in figure 1. It consists of two ICs and a few other components. The 9 volt supply from the battery is stabilised by an integrated voltage regulator, IC1. For this reason, the registered tariffs are reasonably independent of changing voltage supplies (a falling battery voltage). Similar to the mechanical version, the electronic scale will indicate five different rates (see table) by means of LEDs. The relevant LED will light up depending on the weight of the letter placed on the scales. The LEDs are activated by opamps A1...A4, which are connected as comparators. Potentiometers P1...P4 are used to preset the 'target' voltage at the non-inverting inputs of the comparators. The actual inverting inputs of the comparators, which is a measure of the weight of the letter is fed to the inverting inputs via the light dependent resistor (LDR), R3.

Depending on the amount of light radiated by the yellow LED, D7, actually falling on the LDR, a certain voltage will appear at all four inverting inputs of the comparators. When this voltage is identical to, or greater than, that preset at the non-inverting input, the relative opamp output will go low. As the anodes of the LEDs are connected to

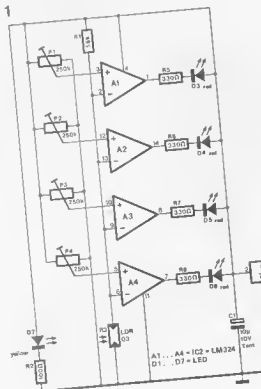

Figure 1. The circuit diagram of the scales. It consists of two integrated circuits and a few extra components. LEDs D3...D6 indicate the various weights and postal charges. The opto-coupler consists of LED D7 and the LDR R3.

Table

| LED | weight in g. | postage | |
|---------|--------------|-------------------------|-----------|
| | | 1st class | 2nd class |
| - | less than 60 | 14p | 11½p |
| D3, D4 | 60...100 | 20p | 15½p |
| D3...D5 | 100...150 | 25p | 19p |
| D3...D6 | 150...200 | 32p | 24p |
| D3...D6 | over 200 | take to the Post Office | |

2

| | |
|----------|---------|
| D3 = 60 | < 100 g |
| D4 = 100 | < 150 g |
| D5 = 150 | < 200 g |
| D6 = 200 | < 250 g |

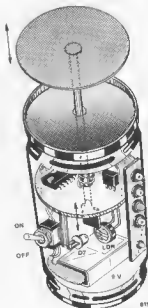

Figure 2. An exploded view of the scales. The tip of the ballpoint pen controls the amount of light that falls on the LDR.

the positive side of the power supply, the corresponding LED will light up.

The mechanical construction of the scales (see figure 2) is reminiscent of the good old 'canned circuits' issue (December 1980). In fact, the best thing to use for this purpose is an old beer or soft drinks can. Actually, two are required. The lid of the first one (with the ring-pull) is removed and discarded. The bottom of the second one is also removed (carefully) as this will be used as the lid for the first one later on, the remainder of this can can also be thrown away. A hole that will just allow a ballpoint pen to pass through it is drilled in the bottom of the undiscarded can (which is, in fact, used upside-down). The ballpoint pen is then attached to the base of the discarded can. Next, the printed circuit board is mounted in the can with sufficiently long bolts and spacers (see figures 2 and 3). The exact location of the printed circuit board should be kept so that the ballpoint pen is positioned as shown in the illustration. Obviously, the pen must be fixed into place before all the bolts are tightened up.

It should now become clear how the LED (D7), the LDR and the point of the pen combine to form the opto-coupler. At this stage it is essential that the LED and/or the LDR be positioned accurately. The ballpoint pen is then cut to size so that it just protrudes through the underside of the printed circuit board. A piece of copper-clad board is then cut to the required dimensions and glued into the end of the ballpoint.

The next operation is to drill holes in the side of the can to accommodate the LEDs, the switch (S1) and the holes whereby the preset potentiometers can be adjusted. It is probably easiest to mount the LEDs together on a small piece of Veroboard. Connections to the main board can then be made via a length of ribbon cable, which, once soldered, can be glued into place. The 9V battery can be stuck to the side of the can with a piece of double-sided sticky tape. Obviously, the positioning of the potentiometer adjustment holes must be determined very accurately. Once everything has been packed in and all the soldering completed, the scales are ready for use.

The table shown above (or similar) should be attached to the outside of the can next to the LEDs, so that the amount of postage required for the particular letter can be read off immediately. Letters over 200 g may just as well be taken round to the Post Office, while anything under 60 g can be sent at the normal rate. The scales are calibrated by adjusting the four trimmer potentiometers with known weights on the scales. LED D3 should light up over 60 g, D4 over 100 g, D5 over 150 g and D6 over 200 g.

Parts list

Resistors:

- R1 = 56 k
- R2 = 100
- R3 = LDR 03
- R4 = 47
- R5 ... R8 = 330
- P1 ... P4 = 250 k preset

Capacitors:

- C1 = 10 μ /10 V tantalum
- C2 = 1 μ /16 V tantalum

Semiconductors:

- D1 = 5V1/400 mW zener diode
- D2 = green LED
- D3 = D6 = red LED
- D7 = yellow LED
- IC1 = 7805
- IC2 = LM 324, CA 324

3

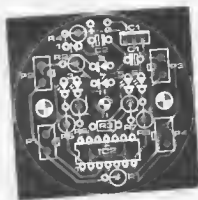
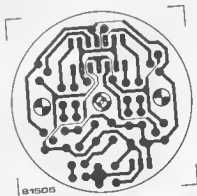

Figure 3. The printed circuit board and component layout for the scales. LED D7, the LDR and the wiring are soldered to the underside of the board.

85

mains LED

The very long life span of LEDs make them eminently suitable for on/off indicators. However, their use on mains voltages has been restricted since a long operating voltage prevents their direct connection with the mains supply in the manner of a neon.

Fortunately, there is a way around this problem, the AC resistance of a capacitor can be used to limit the current. No power is lost in the capacitor at all, since the current passing through the capacitor and the voltage across it are 90° out of phase with respect to each other. This was described in circuit number 19 of the *Elektor Summer Circuits 1979* issue. Unfortunately, that particular circuit did not work very well as the author (and our design staff) did not foresee the problem involved in switching it on! This could have been remedied by including

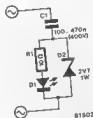

a zener diode in the circuit. Zener diode D2, acting as an ordinary forward-biased diode in this instance, prevents excess voltage levels appearing across the LED during the negative half-cycle of the mains waveform. If the circuit is switched on during the positive half, D2 will prevent the voltage across LED D1 and R1 from rising above 2.7 V. If an ordinary diode were used here, as in the earlier circuit, the LED is likely to go to the big scrap box in the sky. The value of C1 determines the current passing through the LED. When C1 = 100 n the current will be about 4 mA, and about 20 mA if a value of 470 n is chosen.

86

low noise parallel resonant oscillator

It may not be very widely known that overtone oscillators can operate in the parallel resonant mode as well as the series resonant mode. The main advantage of parallel mode overtone resonance is greater stability. Besides this, there is no need to compensate for the parasitic capacity of the crystal (and its holder). The limit imposed on this mode of resonance is set by the parallel impedance. Below a certain value the loop gain will be insufficient to maintain oscillation. In modern receivers and/or converters it is mandatory that the (crystal) oscillator possesses low sideband noise, therefore this aspect is also given some attention.

In the circuit shown, the active element is a low-noise dual FET (virtually any of the available Silicon VHF dual FETs should work correctly). The advantage of using FETs is that the crystal impedance is not loaded. Variations in amplitude are eliminated by the use of the long-tailed pair configuration.

In order to obtain optimum results, the designer/engineer should observe the following guidelines:

1. The output voltage of the tank circuit should not be less than the FET knee voltage.
2. The value of the coupling capacitor to the crystal should be as small as possible in order to avoid spurious oscillation.
3. The output coupling capacitor should be adjusted for maximum output signal.

The optimum noise figure depends on the amount of current passing through the FETs. The value of this current can be obtained from the data sheet of the device used and usually lies between 5 and 15 mA. The value of resistor R1 should be adjusted to obtain the correct current. L1 is 6 turns of 1 mm enamelled copper wire on an Amidon core type T50-12.

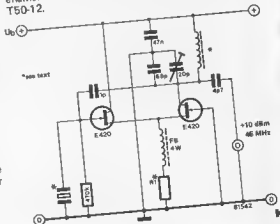

87

caravan connector tester

One of the most important things to be done when coupling a caravan to a car is to check that all the van lights are functioning correctly. Hopefully, everything will work, but occasionally, of course, something falls. The question is, therefore, where does the fault lie, in the caravan or the car electrical system? This tester is intended for checking the car electrical system up to, and including, the caravan connecting socket itself. It then becomes a fairly simple matter to determine exactly where the fault is and repair it in a minimum of time. The tester will give a clear indication of whether all

the connecting pins in the socket operate as and when they should. Simply plug it in the car socket and watch the lamps. The circuit itself is so simple and that it requires no description. However, a word or two about construction would not be amiss. Obviously, for cars with a positive earth system (positive side of the battery connected to chassis) all the LEDs and diodes will have to be turned around. The LEDs etc. can be mounted in a row on the test plug as shown in the illustration.

Some readers may prefer to mount the components in a small box on the end of a fairly long lead so that the indicators, brake lights etc. can be tested from the driving position. The real enthusiast among our readers may even go as far as mounting the LEDs permanently on the instrument panel of the car (wired to the back of the socket!). Or even in the front window of the caravan so that the LEDs are visible in the rear-view mirror.

It is as well to remember that if none of the LEDs light there is quite probably an earth connection fault, which, ideally, should be remedied before any further checks are carried out. This can be proven by connecting the crocodile clip of the extra earth lead to the chassis of the car.

The accompanying table gives the 'international standard' connections together with the cable colour code. Readers who are fortunate enough to own a caravan from late 1980 onwards, will possibly find that 54G is the rear fog warning light supply and that the caravan auxiliary feed is taken via a separate single pin connection moulded into the main socket - yet another 'international standard'. Unfortunately, there could well be other systems but the majority of caravans should be wired as shown (1). Please do not ask us what the wiring numbers mean, we don't know either. We can only assume that they are taken from the 'average car' blueprints which Government departments have referred to since about 1948.

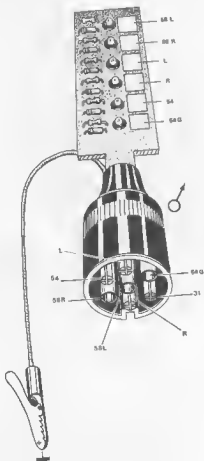

- 58L brown left-hand side, tail end number plate
- 58R black right-hand side and tail
- L yellow left-hand indicators
- R green right-hand indicators
- 31 white earth
- 54 red brake lights
- 54G blue auxiliary power/rear fog warning light

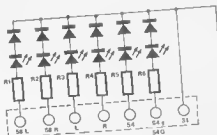

| Ub | R1 | R6 |
|------|-------|----|
| 5 V | 388 Ω | |
| 12 V | 380 Ω | |
| 24 V | 820 Ω | |

88

universal digital meter

This digital meter is a great improvement on the previous design (January 1979) through the inclusion of an input stage containing J-FET opamps. This avoids various problems such as an unstable zero-reading. The J-FET inputs provide a very high input impedance and instead of the normal protection diodes, the circuit contains transistors connected as

diodes. The transistors used have a much lower leakage current (1 nA) than diodes (20 nA). The reason for selecting such an extensive input stage rests on two factors: The common-mode input range of the CA3162 is only $-0.2 \text{ V} \dots +0.2 \text{ V}$ while the 356 opamp has a common-mode range of $-4 \text{ V} \dots +4 \text{ V}$. The second reason is the fact that the input bias current has been reduced considerably: that of the CA3162 is 80 nA while the 356 gets away with a mere 30 pA. The size of the input leakage current in this circuit is determined mainly by the protection transistors T1...T4 which have a typical leakage current of around 1 nA.

The input signal is fed to IC4 via resistor R11. This IC controls the seven-segment driver (IC5) and is responsible for displaying the information once it arrives. The three position switch (S1), situated to the left of IC4 on the circuit diagram, varies the

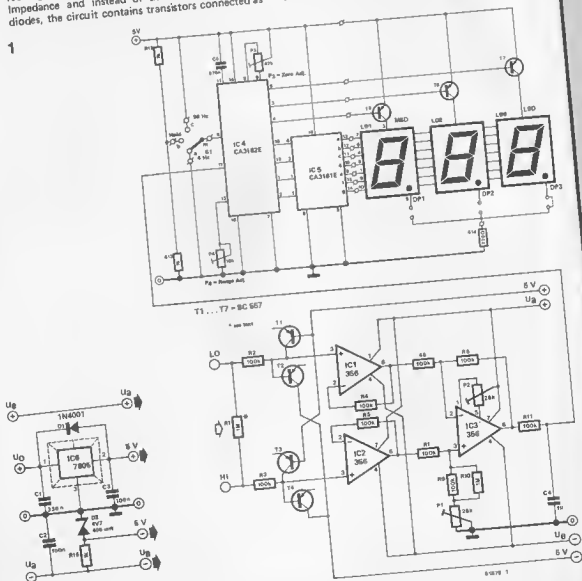

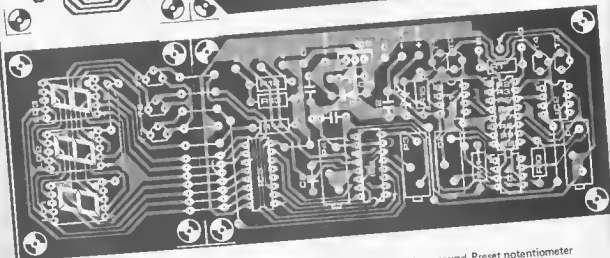
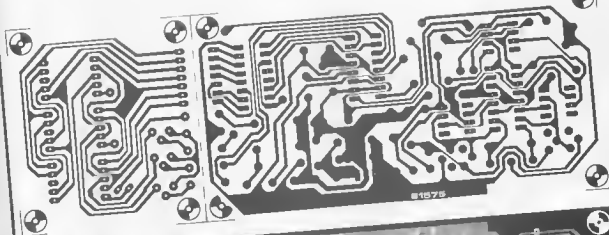
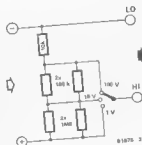
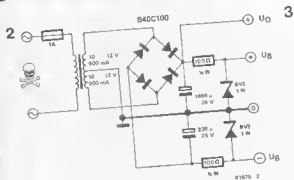

sample-rate of the incoming data. In position (a) a sample is taken every quarter of a second, but in position (b) the display is 'frozen'. To display a rapidly changing input signal, the switch should be placed in position (c) in which case the sample-rate is once every 0.01 seconds and the meter responds very quickly.

Calibration of the universal digital meter is accomplished as follows: Firstly, opamp IC3 is removed and the left-hand side (circuit diagram-wise)

of R11 is connected to ground. Preset potentiometer P3 is then adjusted so that the display reads 000. Opamp IC3 is then re-inserted and the earth connection removed from R11. Now, the two inputs, Hi and Lo, are connected to ground instead and a preset potentiometer P2 is then adjusted to give a reading of 000 on the display. The next thing to do is to connect both the Hi and Lo inputs to a voltage supply of about 3 V and again adjust P1 to bring the display reading back to 000 (common-mode rejection). Finally, an accurate known voltage of, for example, 800 mV is connected to the input, after

Parts list

Resistors:

- R1, R10 = 1 M
 R2 ... R9 = 100 k (see text)
 R11 = 10 k
 R12, R13, R15 = 1 k
 R14 = 220 Ω
 P1, P2 = 25 k
 P3 = 47 k
 P4 = 10 k

Capacitors:

- C1, C3, C4 = 330 n
 C2 = 100 n
 C5 = 270 n

Semiconductors:

- T1... T7 = BC557
 D1 = 1N4001
 D2 = 4V7, 400 mW zener diode
 IC1 ... IC3 = 355
 IC4 = CA 3162E
 IC5 = CA 3161E
 IC6 = 7805
 LD1... LD3 = red FND557
 green FND537
 yellow FND547
 or: TIL 701

which preset P4 is adjusted to give the correct display of 800. During this last operation the Lo input should be connected to ground. The power supply for the circuit is so simple that it hardly needs any description. The zener diode is included to provide transistors T2 and T4 with a slightly negative bias voltage. The power supply circuit is shown in figure 2.

An important feature of the overall design is the fact that the meter can be used in the floating or fixed mode. In the floating mode, the case of the meter (chassis) should be connected to the case of the equipment which is being tested. Also, the common-mode input voltage should, in all instances, lie somewhere between -4.0 V end $+0.4$ V.

In cases where the meter is operated in the fixed mode, the Lo input should be connected to ground. The input impedance of the meter, with resistor R1 in place, is 1 M Ω . If desired, an input divider such as that shown in figure 3 can be incorporated, in which case R1 must be omitted altogether. Resistors R2... R9 are contained in a 16 pin DIL IC package. If this particular device proves difficult to obtain, separate 100 k Ω , 1/8 W resistors with a tolerance of 1% can be used instead of the array. ■

89

high power motor controller

This high power motor regulator features the Ferranti ZN419CN and is capable of controlling electric motors in models with a power consumption of up to 25 A. The IC incorporates a pulse-width modulator which drives the motor via an external output amplifier.

The length of the steering pulse, delivered by the receiver multiplex decoder built into the model, is compared with a reference pulse from the IC. The thus generated differential signal controls the motor via the outputs (pins 5 and 9) and the power stage. When the 'joystick' is in the centre (zero

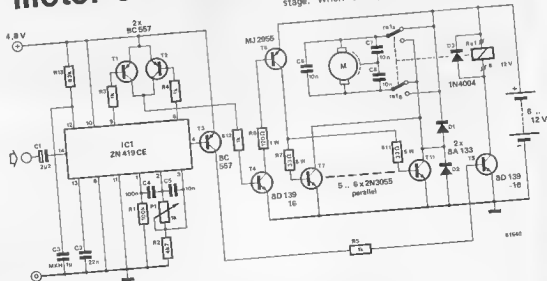

setting), P1 holds the reference signal in a position whereby the motor stops. The rotational direction of the motor is dependent on the signal at pin 4 which, when positive, causes transistors T3 and T5 to be switched off and the motor runs in a forward direction. When pin 4 is low, the two transistors conduct, and the direction of rotation is reversed via the relay. When wiring the motor, attention should be given to ensure correct polarity otherwise the joy-motor could run in the wrong direction. The joy-motor free play movement around the centre position is electronically determined by capacitor C2. Using

components with values as shown in the diagram, this amounts to about 14% (or 7 degrees). Depending on the power consumption of the motor, the final stage can consist of up to 5 or 6 parallel powertransistors (T7 to T11). Because of the relatively high currents, the base (R7...11) resistors should be capable of dissipating at least 5 W. At low rpm's, the power dissipation of the transistors is relatively high so they must be adequately cooled. It is best to use ceramic types for capacitors C6 to C8.

90

ring counter using timers

The 558 quad timer hides four independent timers that are able to generate pulses with a pulsewidth ranging from microseconds to hours. The timers can be arranged in series without the use of coupling capacitors. When the output of the last timer is connected to the input of the first one, there emerges a very simple ring counter.

The advantage of building up a ring counter by using timers is the fact that no clock-oscillator is needed. A resistor (R9) and a diode (D1) have been added which enables the counter to stop or start in response to a control signal. A logic 1 (= supply voltage) on the control signal input will stop the counter working while a logic 0 will start it off. When initially started the output of the first counter

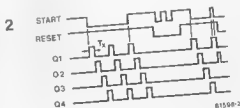

$$T_X = R_X \cdot C_X \quad (X = 1 \dots 4)$$

will become logic 1 (see pulse diagram). After a period determined by R1 and C1 the level at output Q1 returns to logic 0 which triggers the second counter, with logic 1 appearing at output Q2, etc. The logic 1 level therefore skips from output to output. A logic 0 level at the common reset input will set all outputs to logic 0. The RC periods of the timers need not necessarily all be the same; different RC periods give output signals with different pulse widths. The value of the resistors (R1 to R4) which determine the periods should be between 2 k and 100 k. To obtain longer periods, the values of C1 to C4 can be increased.

(Phillips application note)

1

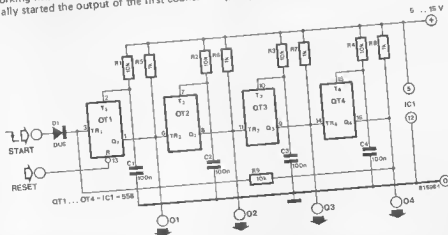

91

crystal tuning fork

The musician, who does not possess 'perfect pitch', will no doubt occasionally have to use a tuning aid such as a tuning fork or an electronic 440 Hz sound generator. Low frequency 440 Hz oscillators are not ideally suited for use as 'electronic tuning forks' because of their inherent instability. For this reason, the crystal controlled oscillator described here may well offer the best solution.

Crystals with a frequency of 27.025 MHz for use in model radio control transmitters, are reasonably inexpensive and readily available. Such a crystal oscillates at a basic frequency of 9.0083 MHz, which when first divided by 5 and then by 12 yields a tone with a frequency of 439.86 Hz. Ideally, a crystal with a frequency of 27.035 MHz, channel 7 of American CB transceivers, would give slightly more accurate results (440.02 Hz), but these are, as yet, not readily available in the UK1.

The division by 2^{12} (= 4096) can be obtained by connecting twelve flipflops in series (IC3... IC5), while the oscillator signal is divided by 5 in IC2. Transistor T2 and the gates in IC1 serve to buffer the oscillator signal from T1, and transistors T3 and T4 allow a direct connection to an 8 Ω loudspeaker. Resistor R6, indicated with an asterisk, regulates the

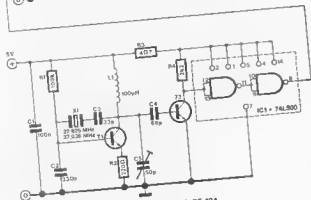
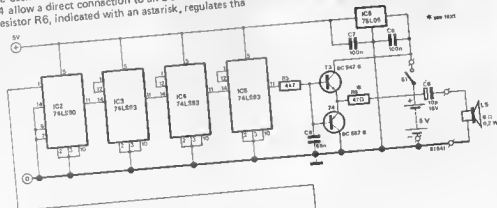
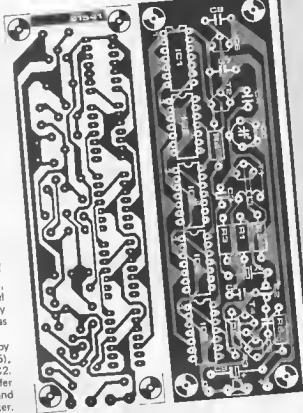

T1...T2 = 8F 199, 8F 199, 8F 494

Parts list

Resistors

- R1 = 100 k
- R2 = 220 Ω
- R3 = 4.7 Ω
- R4 = 2k2
- R5 = 4k7
- R6 = 47 Ω*

Capacitors.

- C1, C7, C8 = 100 n
- C2 = 330 p
- C3 = 33 p
- C4 = 68 p
- C5 = 50 p trimmer
- C6 = 68 n
- C9 = 10 μ/16 V

Semiconductors:

- T1, T2 = BF 198, 8F 199, 8F 494
- T3 = BC 5478
- T4 = BC 5578
- IC1 = 74LS00
- IC2 = 74LS90
- IC3... IC5 = 74LS93
- IC6 = 78L05

Miscellaneous.

- L1 = 100 μH
- X1 = 27.025 MHz crystal (with holder)
- S1 = single-pole switch
- LS = 8/0.2 W loudspeaker

*see text

92

dynamic RAM power supply

It is often a common wish to extend the memory range of a microprocessor system with the aid of economically priced dynamic RAMs. On consideration, the first point to arise is the different supply voltages required by this type of memory device. Generally speaking, dynamic RAMs require supply voltages of +5 V, +12 V and -5 V. Unfortunately, it is not very often that all three supply rails can be found inside the computer concerned. Most microprocessor systems operate on a single 5 volt supply. How, therefore, can the missing supply voltages be obtained easily?

The most obvious solution, of course, is to replace the existing mains transformer by one which has

volume of the resultant tone and can be reduced to a minimum of 22 Ω. The volume can also be increased by raising the battery voltage or by placing the speaker in a box.

If the circuit is to be made part of the Elektor Formant synthesiser, as an extra module, it can be powered from the +15 V rail. Current consumption is somewhere in the region of 40... 50 mA. Readers who possess a sufficiently accurate frequency counter, can try to adjust the oscillator frequency to 9.0112 MHz, using the trimmer capacitor C5. However, this may not be possible as it is slightly 'off frequency' as far as the crystal is concerned. A figure of 9.008332 is more likely. Nevertheless, without adjustment, the circuit will provide a typical tone frequency of 440 Hz with a maximum deviation of ± 0.05 Hz. This remains considerably more precise than most mechanical devices.

three secondary windings and then add the required extra rectifiers and voltage regulators etc. However, this could prove to be rather expensive. A much cheaper solution is suggested by the circuit shown in figure 1.

The principle used is the so-called 'chopper'. The heart of the design is the well known 555 timer IC. It is used here as an astable multivibrator with an output frequency, at pin 3, of approximately 15.5 kHz. The actual frequency can be altered if required and can be calculated from the formula:

$$f = \frac{1.44}{(R1 + 2R2) C1}$$

The squarewave output at pin 3 of the 555 timer drives transistor T1, which in turn controls the current passing through the primary of the transformer. Different output voltages can now be obtained from the secondary windings. Obviously, these signals will still approximate a squarewave and will therefore require rectification, regulation and smoothing in the normal manner. This is accomplished by D1, C3, C4 and IC2 for the +12 volt supply and by D2, C5, C6 and IC3 for the -5 volt supply. Capacitors C4 and C6 should be tantalum types. The transformer can be constructed using a Siemens pot-core type B 65561 - A 250 - A 028 (see figure 2). This has an AL value of 250 nH and an air gap of 0.17 mm.

1

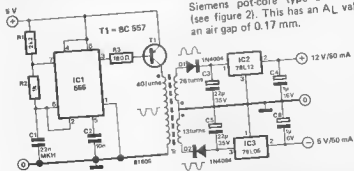

93

local oscillator
filter for
2 m transceivers

One of the most useful improvements that can be made to an existing 2 metre transceiver is to replace the dual-gate MOSFET mixer with a custom double balanced modulator IC. This will result in an improved noise figure and greater dynamic range. However, it is often forgotten that the local oscillator will have to meet more stringent demands on spectral purity (due to its switching action the double balanced modulator is much more prone to 'spuri' than a linear mode MOSFET mixer). At the same time, the output level of the local oscillator must be increased.

In the circuit diagram shown, coils L1... L3 (and

associated capacitors) comprise a symmetrical bandpass filter. As the input and output impedances are both about 50 Ω , there should be no problems with matching. The amplifier following the filter is a grounded dual-gate MOSFET. It has a very low reverse transconductance and a gain of approximately 7 dB. It is a wideband amplifier with a saturation level of around 20 dBm, being adequate for the majority of currently available double balanced modulators.

Provided the circuit is constructed correctly, it should be possible to obtain the following specifications: centre frequency = 134.7 MHz (aligned for region 1)

bandwidth at -1 dB = 5 MHz
bandwidth at -6 dB = 7 MHz
bandwidth at -40 dB = 22 MHz

Construction is quite straightforward, provided a certain amount of care is taken. Pieces of copper-clad board can be used for the screening and the (RF-proof) case. Although the filter is not a helical type, the use of tinned materials should be avoided, as it will increase the filter losses. The rough sketch below the circuit diagram should provide a useful start for construction.

1

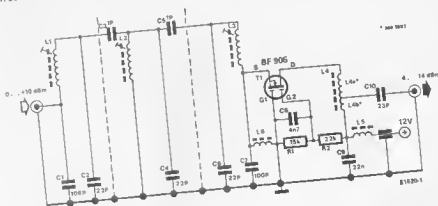

FC = 134.3 MHz
Bw (-1 dB) = 5 MHz
Bw (-6 dB) = 7 MHz
Bw (-40 dB) = 22 MHz

L1... L3 = 301 SN - 0200 (TOKO)
L6... L8 = 4 Turns, ferrite bead

2

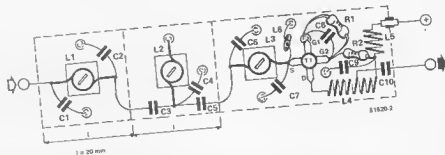

94

bar graph driver

Philips have recently introduced a new integrated circuit which has been specifically designed to control liquid crystal displays. The read-out is in the form of a bar graph, in other words, a number of strips. The attraction of this new IC is that it provides a number of different functions. Any single strip, between 9 and 18 in number, can be selected individually. However, it can also be used to provide a 'thermometer' type scale display. Moreover, in this instance it is also possible to indicate the maximum reading. This can be reset either manually, or automatically after an interval of two seconds (see table).

The two voltage dividers R1/P1 and R2/P2 provide two reference voltages, the maximum input level being set by preset potentiometer P2 and the minimum input level by P1. It is intended that P1 is set within the voltage range of zero up to half the supply voltage, and P2 within the range of 50% ... 100% of the supply level. The input voltage, which must not exceed the extreme limits of the power supply voltage (in either direction), is compared internally to the reference voltages and is displayed on a linear scale. As the reference voltages



are derived directly from the supply voltage, the latter should be reasonably stable and can lie anywhere between 5 ... 15 volts. The input buffer opamp may not always be required. For example, when measuring temperature value, the opamp can be omitted and replaced by a 10 kΩ resistor between pin 25 of the IC and ground, and a 10 kΩ NTC (negative temperature coefficient resistor) between the same pin and the positive supply rail.

In order to use the bar graph display with the humidity sensor (described elsewhere in this issue), the input of the opamp should be connected to the 0 ... 1 V output of the sensor circuit.

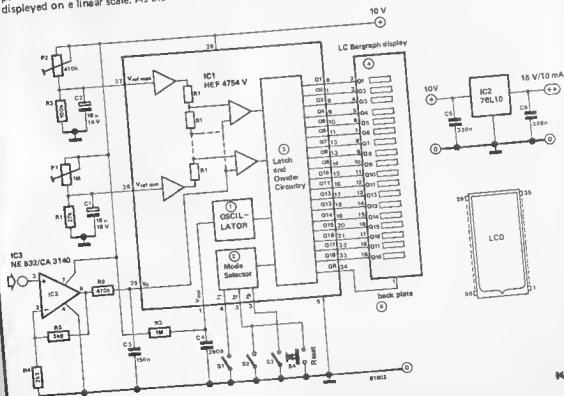

95

2

microcompressor

Dynamic range compressors can be used in any device that requires a constant audio output level. The first example that comes to mind is the automatic record level control in cassette recorders. The compressor can also be employed, however, in such items as amateur radio equipment, discotheques, babyphones and intercom systems to ensure optimum intelligibility and to prevent any damage to amplifiers and loudspeakers. When used in combination with a microphone, compressors give amazingly good results as both quiet and loud speech passages are equally intelligible.

The circuit itself is designed around the TDA 1054 multi-purpose opamp from SGS-Ates. This IC contains four separate elements, each of which performs its own particular task. IC1a is a pre-amplifier which is used to boost the input signal to about $50 \times (1 + R5/R4)$. Opamp IC1b is also used as a preamplifier, but this has a gain of about $400 \times (1 + R11/R10)$. The function of IC1d is to remove any ripple from the supply voltage, while IC1c takes care of the actual automatic level control. A good compressor should compress the entire signal in a linear fashion, in other words, not by simply 'clipping' the top of the waveform. This can be accomplished by making the amount of level reduction dependent on the largest amplitude appearing in the input signal. To do this, the amplitude of the output signal is monitored and when this rises above a certain level, attenuation is introduced.

The attenuator, IC1c, is driven via resistor R13 and capacitor C7 and acts as a variable resistance between the junction of C3/C4 and ground. This

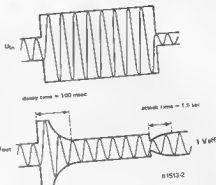

ensures that the input to the output amplifier, IC1b, is sufficiently attenuated when the output level rises above about 1 V rms. Capacitor C7 gives the system delay time which is necessary to ensure that control is adequately fast to follow the envelope of the signal waveform, but not fast enough to respond to the waveform itself. This capacitor therefore determines the attack time of the circuit. The decay time depends on the values of capacitor C6 and resistor R12. This delay time must be much longer in order to maintain a reasonably consistent sound level.

A graphic illustration of how the circuit works is shown in figure 2. The times given are valid for the component values in figure 1. The attack and decay times can be modified according to personal taste by changing the values of C7 and C6 respectively.

The input of the microcompressor is suitable for low signal levels, for instance from microphones. The input impedance is approximately $50 \text{ k}\Omega$. Higher input signal levels can be connected directly to resistor R8, in which case the entire circuit before R8 can be omitted. The supply voltage can be increased to 12 V if desired, but this will mean that the rating of the electrolytic capacitors will have to be increased also.

1

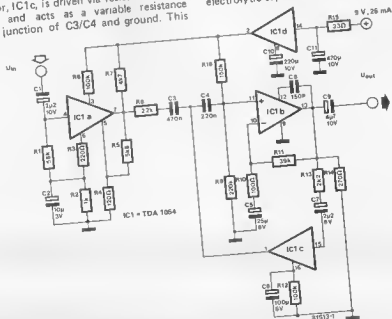

96 ²

W. Gietmann

3 in 1 pencil holder

There are many different types of pen cum pencil cum paperclip etc. holders available nowadays. They come in all shapes, sizes and colours, but the majority of them tend to become rather boring after a while. The circuit described here is intended to remedy this situation by providing two other functions at the same time. These are a telephone timer and extension amplifier.

The circuit diagram of the device is shown in figure 1. The extension amplifier consists of an readily available suction microphone and an integrated audio amplifier (LM 386). The output of this IC can be fed directly to an eight ohm (1 W) loud-speaker.

The timer section consists of a 555 timer IC connected as an astable multivibrator with a frequency of 37 Hz. This signal is then divided by 16384 in IC3 to provide an output pulse every 7½ minutes. This output turns on transistor T1, which in turn drives the piezo-electric buzzer. This section is intended to give you a reminder about last month's high 'phone bill.

Switch S2, in combination with Diode D1, allows the user to select between having the extension amplifier on with or without the timer.

A suggestion for the mechanical details of the pen/pencil holder etc. is given in figure 2. Switch S1 can be a microswitch which starts the timer when the pen is removed from the holder.

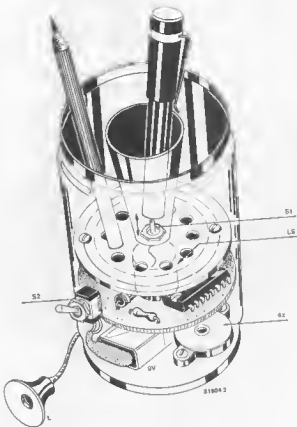

1

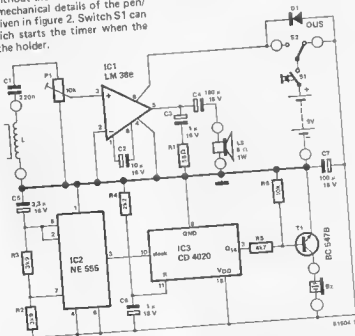

97

S. Traub

six channel
A/D converter

In their simplest form, electronic measuring instruments usually provide an analogue display. In other words, temperature and pressure values, for instance, are expressed as a DC voltage level. Before this information can be further processed, it needs to be translated into a language that a computer can understand. This is accomplished by means of an analogue-to-digital (A/D) converter, which, as its name suggests, converts the analogue signal level into a binary code.

There are numerous types of A/D converters. The principle of operation of the one described here is

to convert the input voltage level to a particular pulse duration (pulse width modulation). During the pulse period, a 'count' routine in the computer program is enabled. Thus the binary result at the end of the pulse duration gives an indication of the voltage level being measured.

The analogue data inputs to IC1 are represented by the symbols I1...I6. Any one of these inputs can be selected by means of the logic levels presented to the select inputs (pins 1, 2 and 16). This information is passed on from the data bus of the microprocessor system via the quad D-type latch, IC2.

Figure 2 shows what happens to the voltage levels at various points during the measurement procedure. The negative-going trigger pulse at pin 3 of IC1, which starts the measurement (see figure 2A), causes capacitor C2 to be charged to the value of the input voltage plus a constant 0.7 V. After the end of the voltage pulse capacitor C1 starts to discharge via a start pulse capacitor C1 to discharge via a reference current 'sink'. The software counter must be started at this time. When the voltage across the capacitor reaches the threshold value of 0.7 V, the logic level at pin 7 will revert to zero. The software

1

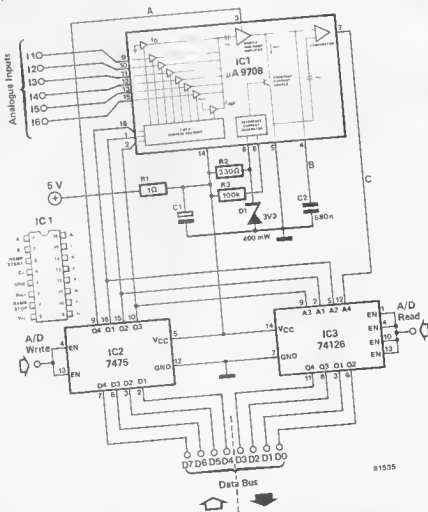

81535

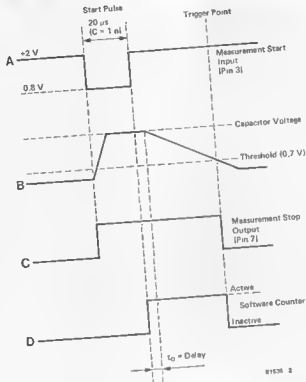

counter must, of course, be stopped at this instant. Figure 2 shows that the time between the end of the trigger pulse and the start of the capacitor discharge curve can not be immediately evaluated. A constant time, t_0 , is contained within this period. Only the discharge time of C2 is a true measure of the level of the input voltage. Since the time period t_0 will still be present at pin 7 even with an input voltage of 0 V, the computer must first check the analogue input I0. This input is connected to 0 V internally. From this the computer will be able to calculate the length of the period t_0 . In other words, the computer must first calculate the binary value which corresponds to this period and then subtract it from the result of an actual measurement later on. To be able to make full use of its memory capacity and the width of the data bus, the computer must contain information about the largest possible voltage which can be measured. This means that the voltage level limits must be defined. For this reason, an internal analogue input I_{ref} is connected to a reference voltage which corresponds to the maximum permissible input voltage. The computer must also examine this input and divide the binary value of the discharge time obtained from this by the highest number that the software counter can reach. The result of this division is a time period which corresponds to the number 1. It is therefore impossible for the value in the counter to 'overflow'.

The data inputs (D0... D7) from the computer are

divided into two sections. Inputs D4... D6 are sufficient for selecting the six external and the two internal analogue channels via the D-type latch IC2. Input D7 controls the start of the measurement procedure via pin 3 of IC1 - this signal also passes through IC2. The remaining connections to the data bus are, in fact, outputs from the tri-state buffer, IC3. This latter IC fulfils the following task: During the enable pulse from the address decoder (A/D Read = logic 1), the output from pin 7 of IC1 is passed on to D3 of the data bus. The analogue address, in binary, which was selected previously appear on lines D0... D2 for control purposes.

IC1 and IC2 are enabled via two different address decoder connections. These can be located at two separate addresses, or, if used in combination with the read/write line, they can be located at the same address. Obviously, the type of program required will be dependent on the particular microprocessor system used. The reference voltage for the converter should be greater than 2 V and should be at least 2 V less than the supply voltage. If the voltage supply to the circuit is to be 5 V or greater, a 3V3 zener diode is required for D1.

The analogue to digital converter can be used in conjunction with a computer to measure various phenomena, provided the input voltage does not rise above the value of the reference voltage. However, if this does occur, the system can be calibrated by means of a voltage divider. If the analogue signal is superimposed on a DC level, an opamp connected as an 'adder' can be used to compensate.

14

98

W. Gscheidle

speed controller
for model boats

Of course, every one who constructs model ships wants his model to be as accurately detailed as possible. That includes obviously a means of infinitely variable speed control of the model, both in forward direction and in reverse. As a rule, however, this often remains a bit of wishful thinking as most basic models do not have this facility. When the model enthusiast wants his ship to steam forwards or in reverse at less than full speed, and wants to have a good degree of control over the speed by means of a 'joy-stick', then the amount of money to be spent on his hobby may be quite considerable. The cost of an electronic speed control will clearly be less when such a circuit is home-built. This is not exceptionally difficult, because servo-driver ICs are easily obtainable.

The circuit is built round the IC SN 28654 of Texas

Instruments. The circuit input is connected directly to the decoder output of a commercially available remote control receiver, and the servo-driver IC1 takes care of preparing the correct pulses. The pulse width generated by the internal monoflop is compared with the input pulse. In that way, a variable width difference is created which controls

the output stage via a Schmitt trigger. The speed control signals at output A (pin 10) and output B (pin 12) are now proportional to the position of the control stick. They also control the direction of movement, i.e. forward or reverse.

When output A is activated, the signal travels via an opto-coupler to the final stage, containing transistors T4 and T5. The power transistor T5 will switch on for a period of time depending on the pulse width and thereby determine the speed of the motor. The flipflop N2/N3 is triggered by the collector of T4 to ensure that (via N4) transistor T6 will remain switched off. The relay will not be activated and directional rotation of the motor will be maintained; the ship will proceed forward.

The final stage, which incorporates T1 to T3, functions in the same way as described above when output B is activated. The speed of the motor is then also controlled by the pulse width via the relevant opto-coupler and transistors T1 to T3, except that the motor does not turn in a forward

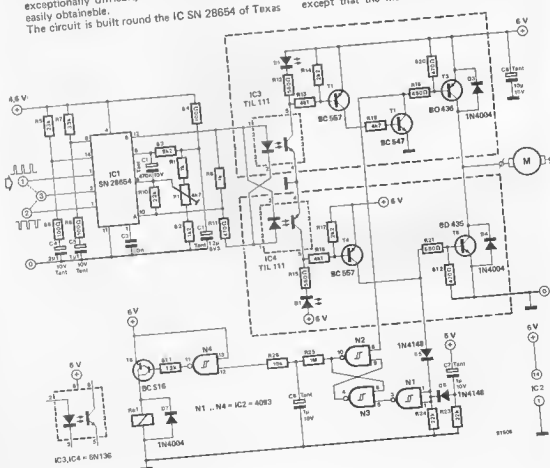

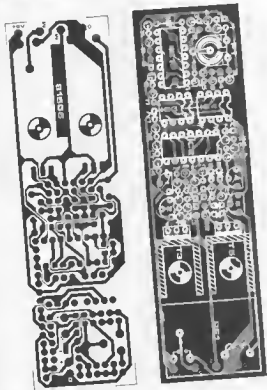

direction, but in reverse. This is done by the pulse at the T2 collector which reverses the flip-flop so that transistor T6 will switch on the relay. This reverses the rotational direction of the motor. At currents greater than 0.5 A the output transistors should be replaced by power Darlington's.

The only adjustment that is necessary is done with trimmer potentiometer P1 as follows: with the control stick in its centre position (neutral), the trimmer P1 should be adjusted until the motor stops.

Parts list

Resistors

- R1, R9 = 1 k
- R2 = 1k2
- R3 = 8k2
- R4, R6, R8 = 100
- R5, R7 = 33 k
- E10, R23, R24, R27 = 22 k
- R11, R20, R22 = 470
- R12, R15 = 580
- R13, R16, R18 = 4k7
- R14, R17 = 2k2
- R19, R21 = 580
- R25 = 1 M
- R26 = 10 k
- P1 = 4k7 preset

Capacitors

- C1 = 22 μ /5V3 tantalum
- C2 = 470 n/10 V tantalum
- C3 = 10 n
- C4, C5 = 2 μ /10 V tantalum
- C6 = 10 μ /10 V tantalum
- C7, C8 = 1 μ /10 V tantalum

Semiconductors:

- IC1 = SN 28654
- IC2 = 4093
- IC3, IC4 = TIL 111
- T1, T4 = BC 557
- T2 = BC 547
- T3 = BD 436
- T5 = BD 435
- T6 = BC 516
- D1, D2 = LED
- D3, D4, D7 = 1N4004
- D5, D6 = 1N4148

Miscellaneous

- Rel = 5 V relay

Finally, the response time is changed by altering the value of C3 and the collector current of T3 and T5 should not be more than 2A. \blacksquare

H. Pietzko

99 active notch or CW filter

In general, the majority of low-cost shortwave receivers have poor selectivity. Usually, reception is accompanied by a number of interfering signals, or more than one transmission is heard at the same time (especially with CW transmissions, which have

a very narrow bandwidth). An add-on extra for the existing inexpensive set could therefore prove very useful, particularly if a (much) more expensive one is not available (or the funds thereof).

The filter described here is an active equivalent for an LC tuned circuit and can be operated in the parallel mode (peaking function) or the series mode (notch function) as can be seen from figure 1. The filter is connected to the audio output of the receiver or, if present, the tape recorder output. The output of the filter is sufficient to drive a pair of headphones directly, provided their impedance is 600 Ω or greater.

The simulated inductor consists of the circuitry around opamps A2 and A3 (see figure 2). A 12 dB per octave filter for the input signal is provided by A1, while A4 acts as an amplifier with an adjustable gain of 2...30 times.



2

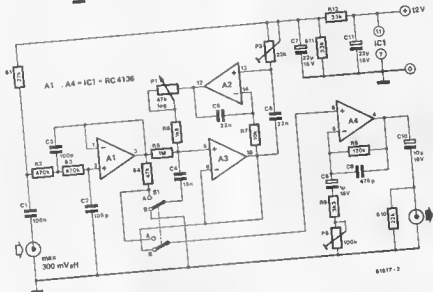

The resonant circuit can be switched between the parallel and series operating modes by means of S1. The filter can be tuned over the range of 300...400 Hz by means of potentiometer P1. With switch S1 in position B, preset potentiometer P3 should be rotated to the position just prior to where the circuit starts oscillating. This calls for a precise alignment and therefore P3 should be a multi-turn type. The gain of the circuit can be adjusted by means of potentiometer P2. This can be

a preset type if a fairly constant level of background noise is to be expected, otherwise a normal (volume control) potentiometer is preferred. When the circuit is actually used, the following points must be remembered:

- 1) the effects of frequency drift will be pronounced
- 2) as the AGC circuit responds to a much wider bandwidth than that of the filter, the recovered signal could show 'alien' pumping action.

100

automatic car aerial control

The circuit entitled 'automatic car aerial' as described in the Summer Circuits 1977 issue of *Elektor* has proved to be very popular. However, some readers were less than fully happy about the circuit because it did have a tendency in some instances to have one slight problem: namely, the two relays used to switch the aerial up and down tended to give a certain amount of contact bounce. It would be far better for this type of automatic system to have a precisely defined time limit for the 'up' and 'down' operations. This is very easy to obtain nowadays with modern integrated 'monoflops'. Two of these monostabla

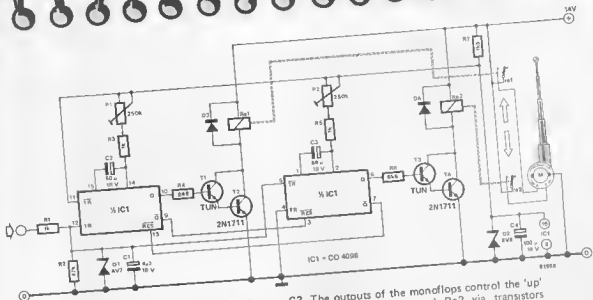

multivibrators are contained in the CD 4098 IC as used here. One monoflop is used to 'run' the aerial up and is triggered by a positive-going pulse at pin 12. The other one requires a negative-going trigger pulse at pin 5 when the aerial is to be run down. The control pulses from the car radio are first 'debounced' by components R1, R2, D1 and C1 to convert it to a clean trigger pulse with an active logic high level of 4.7 V. The pulse duration for the first monoflop is determined by the values of P1, R3 and C2 and that for the second by P2, R5 and

C3. The outputs of the monoflops control the 'up' and 'down' relays Re1 and Re2 via transistors T1...T4. The Q and reset connections are interconnected so that when one is operating the other is disabled, which is just as well as far as the motor is concerned.

The relays are connected directly to the battery supply voltage and the supply for the monoflops is stabilised by means of zener diode D2. The duration of the monoflop pulses is therefore reasonably independent of the battery voltage.

101

D/A converter for motor control

In many instances, it is quite sufficient to control motors with an on/off type action. However, if a more 'linear' control is required, the circuit given here may prove useful. The four bit magnitude comparator (4063) inputs are EX-ORed and fed to a resistive divider chain to provide an output voltage which is proportional to the difference of the comparator input values (with an accuracy of four bits). These values can be derived, for instance, from a binary counter.

The outputs of the comparator ($A > B$, $A = B$, $A < B$) can be used to (indirectly) turn the motor on or off and/or to reverse the polarity of the supply voltage in the case of DC motors. This kind

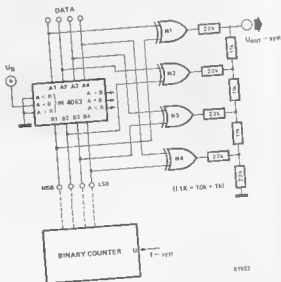

of circuitry can be applied where varicap control is not adequate, such as for remote antenna tuning or phase-noise free VCOs.

102

continuity tester

It is possible that after etching a printed circuit there is a break or short circuit in the copper pattern. The chance of this sort of fault occurring increases as the tracks and the insulation between them become narrower. The methods of manufacture of printed circuits used by the amateur do not always allow very accurate detailing of the copper layout. A detailed inspection of the results is therefore necessary. This can, of course, be done using a normal resistance meter (a multimeter), but this has the disadvantage that you must keep one eye on the meter. An audible indication can make the testing much quicker and easier leaving both eyes free to check suspect tracks with two test probes. The continuity tester gives a tone when there is a connection, and is silent when there is an open circuit.



The circuit diagram (figure 1) shows that the tester is a very simple design consisting only of a two transistor astable multivibrator. When the two test points are connected, the two transistors conduct alternately causing a square wave voltage to appear across the buzzer, at a frequency of a few kHz. The tone produced by the buzzer indicates the connection.

The circuit operates from a supply of only 1.5 V, and draws no more than 1 mA. Because of the small load, even the smallest 1.5 V battery will have a long life.

The continuity tester is built on the printed circuit

board shown in figure 2. This includes space for the buzzer as well. The complete circuit and battery can be fitted into a plastic tube, so that the tester fits easily into the hand.

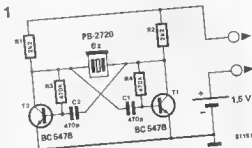

Part list

Resistors:

R1, R2 = 2k
R3, R4 = 470 k

Capacitors:

C1, C2 = 470 p

Semiconductors:

T1, T2 = BC 547B

Miscellaneous:

BZ = buzzer PB-2720 (Toko)
2 test probes
1.5 Volt battery

2





After a printed circuit has been etched, it is wise to test it for breaks before the components are fitted, as otherwise the tester will give misleading indications. A copper track can be tested by placing the test prods at the furthest points of the track. The tone will then indicate a good track. Insulation between two tracks can be checked by putting a test prod on each. A tone indicates a short circuit, which must, naturally be removed. The continuity tester can also be useful for testing the continuity of wiring.

103

frequency and phase detector

2

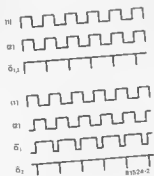

When the frequency range over which the VCO of a phase-locked loop (PLL) must operate exceeds an octave, a multiplier is no longer adequate for use as a phase detector. The circuit must, therefore, also be sensitive to frequency to avoid 'locking' when harmonics of the fundamental lock frequency are present. In many instances the 4046 CMOS PLL IC performs an extremely good job. However, it only has a maximum operating frequency of 500 kHz which can give rise to certain problems.

The circuit shown here has the above mentioned capability and behaves in a similar manner to the phase comparator (pin 13) of the 4046 PLL. The only differences being that the 4046 output is

'tri-state' and this little circuit operates at higher frequencies than the 4046. When the input signals (1) and (2) have the same frequency and phase relationship, the two flipflops are both reset simultaneously. Should the phase shift between the two input signals alter, the reset timing will also change. In this instance, the average voltage at the \bar{Q} output of one of the flipflops will be greater than that at the other. This is clearly illustrated in the timing diagram.

The dc level at the output of the differential amplifier, A1, is used to control the VCO. The actual values of components R1...R4, C1 and C2 depend on the frequency of operation.

1

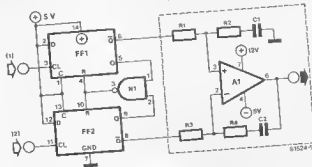

FF1, FF2 = 7411, 574
 N1 = 7411, 5100
 A1 = LF 358

104

power failure forecaster

This circuit can be extremely useful in, amongst other things, microprocessor systems. Should the main power voltage fail, the circuit will provide a logic high level at its output a short time before the supply disappears completely. This time delay, although short, can be sufficient to take emergency measures. For instance, storing the data contained in certain of the internal processor registers into a low-power standby random access memory (battery powered).

In the circuit diagram, above the dotted line, there are two examples of 5 volt power supplies in which

the circuit could be used. Also shown, are the relevant interconnections — this is why there are two sets of points marked X, Y and Z.

The circuit operates as follows: the raw smoothed supply voltage appears at point B and the raw unsmoothed voltage, rectified by diodes D1 and D2 appears at point A. As can be seen from figure 2, the voltage at point A falls below that at point B every 20 ms (at each mains half cycle). At this moment in time transistor T1, and therefore monostable transistor T2, turns on and the monostable multivibrator will be re-triggered. Since the pulse duration of the monoflop is approximately 15 ms, the \bar{Q} output will be low continuously as long as the main supply voltage is applied. However, as soon as the main supply voltage fails, the voltage at point A will become lower than that at point B immediately due to the action of the smoothing capacitor. The MMV is then no longer (re-)triggered and the \bar{Q} output will go high after a maximum of 15 ms. This output pulse can then be used to call an interrupt routine of the type mentioned above.

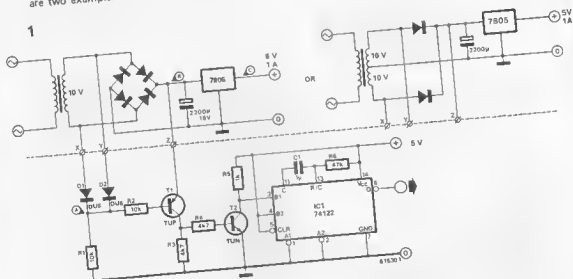

2

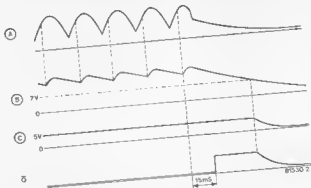

QUADRUPLE 2-INPUT NAND GATE

1400
 2400: open collector outputs
 7400: power driver (fan out = 30)

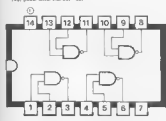

QUADRUPLE 2-INPUT NAND-GATE ALTHOUGH THE LOGIC IS FALSE

1401

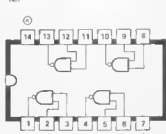

QUADRUPLE 2-INPUT NDR GATE

1402
 1402: power driver (fan out = 30)

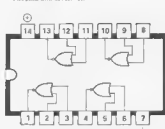

HEX INVERTER

2404
 2404: open collector outputs
 1406: open collector high voltage outputs
 2407: open collector high voltage outputs
 (max. 30 V, fan out = 25)
 (max. 65 V, fan out = 25)

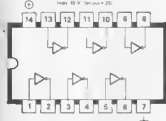

HEX INVERTER WITH A PUSH-PULL CMOS BUFFER

3407
 3407: VOLEDGE OUTPUTS (max. 30 V, fan out = 25)

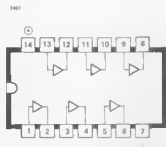

QUADRUPLE 2-INPUT AND GATE

1408
 1408: open collector outputs

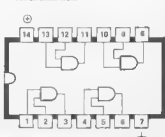

TRIPLE 2-INPUT NDR GATE

2410
 2410: open collector outputs

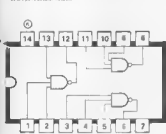

TRIPLE 2-INPUT AND GATE

2411

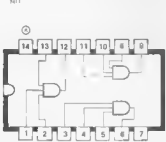

TRIPLE 2-INPUT NAND-OR-INVERTER

2413

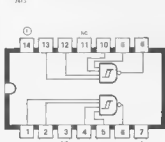

HEX SCHMITT TRIGGER

1414



QUINTUPLE 2-INPUT AND GATE

7420
 7420: power driver (fan out = 30)

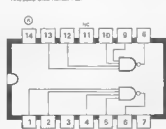

8-INPUT NAND GATE

2430

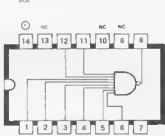

8-TO-24-BIT DECODE AND DRIVER WITH OPEN COLLECTOR OUTPUTS

7448

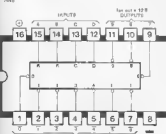

8-TO-24-BIT DECODE AND DRIVER WITH OPEN COLLECTOR OUTPUTS

7449

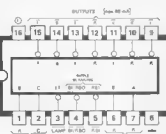

AND GATED JK POSITIVE EDGE TRIGGERED FLIP-FLOP WITH RESET AND CLEAR

7470

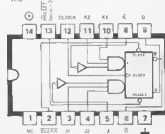

AND GATED J-K MASTER SLAVE FLIP FLOP
WITH PRESET AND CLEAR

7472

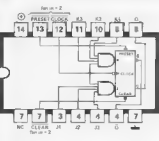

DUAL J-K FLIP FLOP AUTO CLEAR

7473

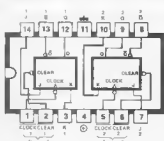
DUAL D-TYPE POSITIVE EDGE TRIGGERED FLIP FLOP
WITH PRESET AND CLEAR

7474

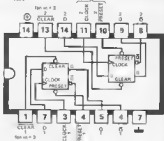

4 BIT BISTABLE LATCH

7475

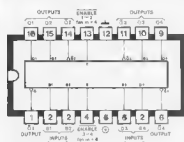
DUAL J-K MASTER SLAVE FLIP FLOP
WITH PRESET AND CLEAR

7476

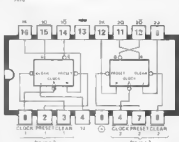

4 BIT COMPARATOR

7486

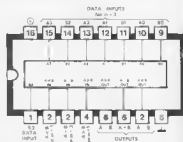

QUADRUPLE 2 INPUT EXCLUSIVE OR GATE

7488

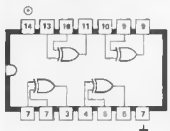

8-BIT READ-WRITE MEMORY WITH 8-BIT COLLECTOR OUTPUTS

7489

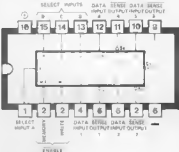

DECADE COUNTER

7490

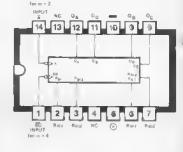

DIVIDE BY TWELVE COUNTER: 7 and 8!

7492

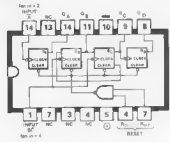

4-BIT BINARY COUNTER

7493

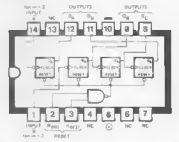

8 BIT PARALLEL IN PARALLEL OUT SHIFT REGISTER

7495

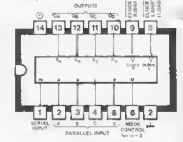

MONOSTABLE MULTIVIBRATOR

75121

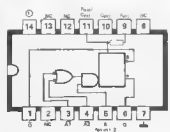

12 TOUCH-SENSITIVE MONOSTABLE MULTIVIBRATOR WITH COLLECTOR

74922

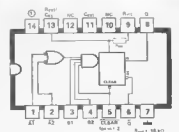

12-STATE TRIGGERABLE MONOSTABLE MULTIVIBRATOR WITH COLLECTOR

74923

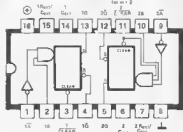

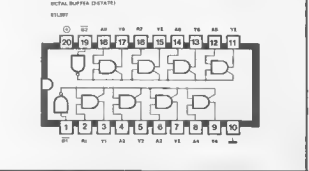
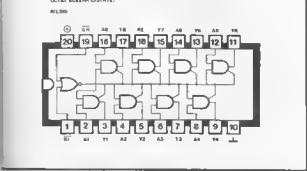
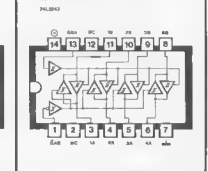
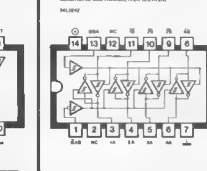
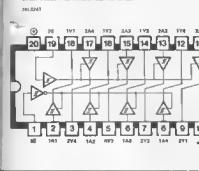
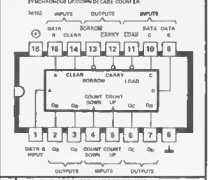
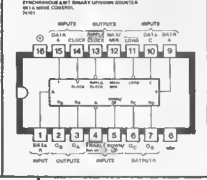
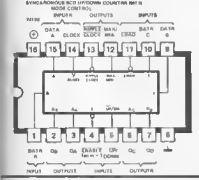
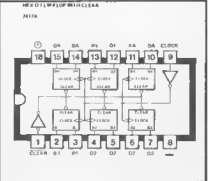
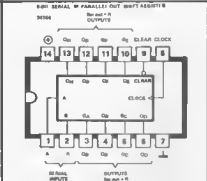
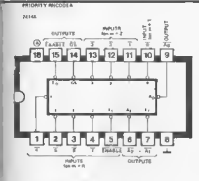
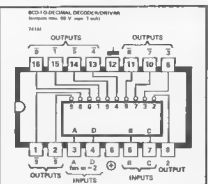
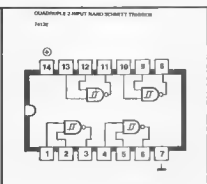
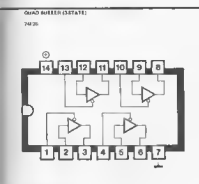

DUAL 5-INPUT NOR-GATE PLUS INVERTER

4089

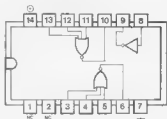

QUADRUPLE 2-INPUT NOR-GATE

4087

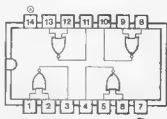

DUAL 4-INPUT NOR-GATE

4088

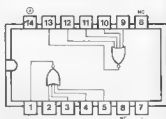

QUADRUPLE 3-INPUT NAND-GATE

40871

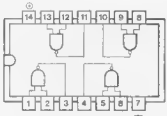

DUAL 6-INPUT NAND-GATE

40872

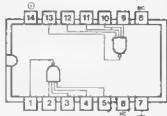

DUAL D FLIP-FLOP

40812

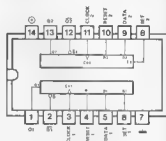

DUAL 4-BIT STATIC BUILT-IN REGISTER

40816

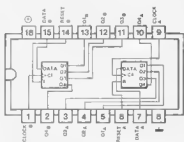

8-BIT 2-TO-1 CARRY-LOOK-AHEAD

40817



SYNCHRONOUS PRESETTABLE DIVIDER / 4-BIT COUNTER

40818

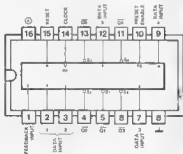

14-BIT 1/16-DIV RUPPLE COUNTER

40820



TRIPLE 3-INPUT NAND-GATE

40873

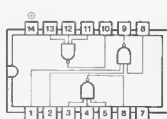

10-STAGE 2/16-DIV RUPPLE COUNTER

40824

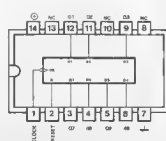

TRIPLE 8 INPUT NOR GATE
4825

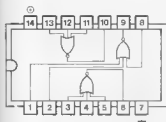

DUAL JK FLIP FLOP
4827

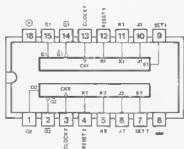

BCD TO DECIMAL DECODER
4828

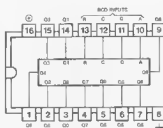

SYNCHRONOUS RESETTABLE BINARY-DECADE UP/DOWN COUNTER
4829

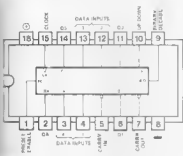

QUADUPLE 4 INPUT LAZARUS OR GATE
4830

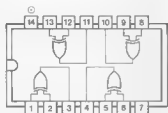

4 BIT PARALLEL IN-PARALLEL OUT SHIFT REGISTER
4835

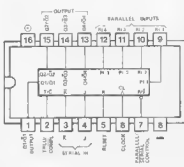

12 BIT BINARY RIFFLE COUNTER
4840

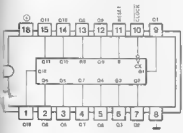

8MSD CLOCKED '10' LATCH
4842

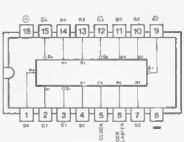

MICROPOWER PLL
4848

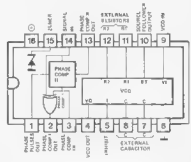

MONOSTABLE/ASTABLE MULTIVIBRATOR
4851

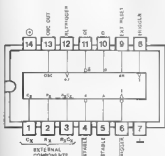

HEX INVERTING BUFFER
4852

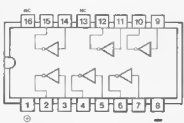

HEX BUFFER
4853

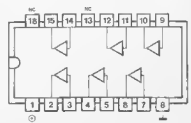

8 CHANNEL ANALOG DATA MULTIPLEXER/MULTIPLIER

4061

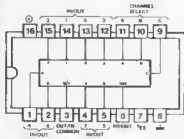

LED DRIVER

4064

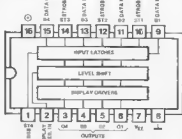

BCD TO 7 SEGMENT DECODER/DRIVER

4066

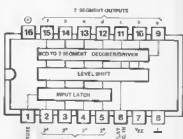

16 BIT BINARY RIFFLE COUNTER 100% OSCILLATOR

4069

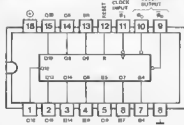

QUAD BILATERAL SWITCH

4068

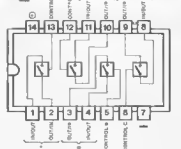

1 INPUT AND/OR GATE

4065

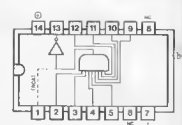

QUADRUPLE 2 INPUT OR GATE

4071

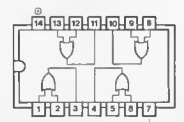

10001 3 INPUT AND GATE

4073

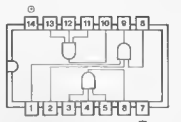

1 INPUT OR/AND GATE

4070

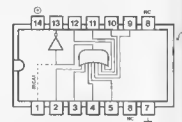

QUADRUPLE 1 INPUT AND GATE

4067

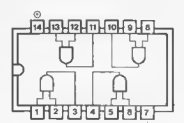

QUADRUPLE 2 INPUT NAND SCHMITT TRIGGER

4063

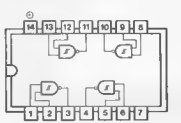

DUAL MONOSTABLE MULTIVIBRATOR

4060

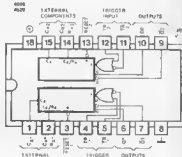

NEX SCHMITT TRIGGER

40106



BCD TO 7 SEGMENT LATCH DECODER/DRIVER

4071

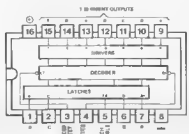

DUAL 4 BIT SYNCHRONOUS UP COUNTERS

4011

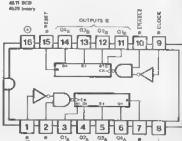

INTRODUCING— from Elektor

sc/mputer (2)

build your own
microcomputer system

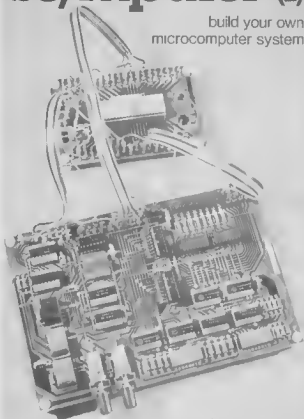

Elektor publishers Ltd

This is the second in a series of books describing the construction and operation of a personal computer system that can be as large or as small as the constructor desires.

An updated version of the monitor program (Elbug II) is introduced together with a number of expansion possibilities. By adding the Elekterminal (ASCII keyboard and video interface) to the system described in Book One the microcomputer becomes even more versatile.

Book Two continues with a description of a BASIC interpreter (NIBL-E) and gives complete details of a basic microcomputer card which can be either incorporated into the system described in Book One or used separately.

The final chapter of the book gives all the information required to enable the Elektor computer to be programmed in the BASIC language.

ORDER YOUR COPY NOW

Price — UK £4.00 inc. postage and packing
 Price — Overseas surface mail £4.20 inc. postage and packing

When ordering please use the Order Card in this issue

ELEKTOR BOOK SERVICE



JUNIOR COMPUTER BOOK 1 — for anyone wishing to become familiar with (micro)computers, this book gives the opportunity to build and program a personal computer at a very reasonable cost.

Price — UK £4.25 Overseas £4.45

JUNIOR COMPUTER BOOK 2 — follows in a logical continuation of Book 1, and contains a detailed appraisal of the software. Three major programming tools, the monitor, an assembler and an editor, are discussed together with practical proposals for input output and peripherals.

Price — UK £4.75 Overseas £4.95

300 CIRCUITS for the home constructor — 300 projects ranging from the basic to the very sophisticated.

Price — UK £3.50 Overseas £3.70

DIGIBOOK — provides a simple step-by-step introduction to the basic theory and application of digital electronics and gives clear explanations of the fundamentals of digital circuitry, backed up by experiments designed to reinforce this newly acquired knowledge. Supplied with an experimenter's PCB.

Price — UK £5.00 Overseas £5.20

FORMANT — complete constructional details of the Elektor Formant Synthesiser — comes with a FREE cassette of sounds that the Formant is capable of producing together with advice on how to achieve them.

Price — UK £4.50 Overseas £4.70

SC/MPUTER (1) — describes how to build and operate your own microprocessor system — the first book of a series — further books will show how the system may be extended to meet various requirements.

Price — UK £3.70 Overseas £3.90

SC/MPUTER (2) — the second book in the series. An updated version of the monitor program (Elbug II) is introduced together with a number of expansion possibilities. By adding the Elekterminal to the system described in Book 1 the microcomputer becomes even more versatile.

Price details on order card.

BOOK 75 — a selection of some of the most interesting and popular construction projects that were originally published in Elektor issues 1 to 8.

Price — UK £3.50 Overseas £3.70

When ordering please use the Elektor Readers' Order Card in this issue (the above prices include p. & p.)

MAPLIN make it easy...



in SOUTHEND
284 London Road
Westcliff-on-Sea
Essex
Tel: (0702) 554000
(Closed Mondays)



in HAMMERSMITH
159-161 King Street
Hammersmith
London W6
Tel: 01-748 0926
(Closed Mondays)

For personal service visit one of our stores
Our new store at Hammersmith is conveniently situated near the end of the M4 and the North and South Circular Roads.
There is excellent street parking on meters a few steps away and Hammersmith Underground Station is nearby. Call in and see us soon



in our CATALOGUE

320 big pages packed with data and pictures of over 5 500 items

Over 100 000 copies sold already!
Don't miss out on your copy.

On sale now in all branches
WH Smith price £1.

In case of difficulty check the coupon below

by MAIL ORDER
A fast service you can rely on

- * Same day service on in-stock lines
- * Very large percentage of our stock lines in stock
- * All prices include VAT
- * Large range of all the most useful components
- * First class reply paid envelope with every order
- * Quality components—no rejects—no re-marks
- * Competitive prices
- * Your money is safe with a reputable company

On price service stock quality and security it makes sense now more than ever to make **MAPLIN** your first choice for components every time!

make it easy...

The **Maplin Matinée**
Amazing value for only £299.95 plus £39.50 for cabinet if required

with **MAPLIN**



Easy to build, superb specification.
Comparable with organs selling for up to £1,000. Full construction details in Electronics & Music Maker commencing March, 1981 issue. Back numbers available

Post this coupon now.

Please send me a copy of your 320 page catalogue. I enclose £1.25 (incl. 75p p&od). If I am not completely satisfied I may return the catalogue to you and have my money refunded. If you live outside the U.K. send £1.68 or 12 International Reply Coupons. **E7-8/81**

Name: _____

Address: _____

MAPLIN ELECTRONIC SUPPLIES LTD.

All mail to: P.O. Box 3, Rayleigh, Essex SS6 8LR. Tel: Southend (0702) 554155 Sales: (0702) 552911