

elektor

up-to-date electronics for lab and leisure

68
December 1980
ISSN 0308-308 X
U.K. 60p
U.S.A. \$2

Swissler King

kaleidoscope
nicad charger
bath thermometer
measuring can
din can



canned
circuits

The new MAPLIN CATALOGUE is out on December 5th

A massive new catalogue from Maplin that's bigger and better than ever before. If you ever buy electronic components this is the one catalogue you must not be without. Over 300 pages, it's a comprehensive guide to electronic components with thousands of photographs and illustrations and page after page of invaluable data. We stock just about every useful component you can think of. In fact, well over 5000 different lines, many of them hard to get from anywhere else. Hundreds and hundreds of fascinating new lines, more data, more pictures and a new layout to help you find things more quickly

MAPLIN

Maplin Electronic Supplies Ltd
All mail to: P.O. Box 3, Wyley, Essex S56 6LR
Telephone: Southend (0702) 554155 Sales (0702) 552911
Shops
159-161 King Street, Hammersmith London W6 Telephone: (01) 748 0926
284 London Road, Westcliff-on-Sea Essex. Telephone: Southend (0702) 554000
Both shops closed Mondays

On sale
in all branches
of W/H Smith
from Dec 5th
price £1

Breadboard 1980

26th to 30th November
Open 10 a.m. to 6 p.m. (and till
8 p.m. Thursday & p.m. Sunday)
Royal Horticultural Halls,
Evertown Street, London
(the St. James's Park Underground)

Visit our huge stand and
see our new 'single-chip' organ,
a new sequencer, composer
and lots more
Don't miss it!!

Post this coupon now for your copy of our 1981
catalogue price £1.

Please send me a copy of your 320 page catalogue.
I enclose £1 (Plus 25p p&p). If I am not completely
satisfied I may return the catalogue to you and have
my money refunded. If you live outside the UK send
£1.68 or 12 International Reply Coupons.

I enclose £1.25

Name _____

Address _____

E1280

selektor	12-01
canned circuits	12-07
bath thermometer (W. Korall)	12-07
xylophone	12-09
can shy (E. Paul)	12-10
midnight raid detector (D. autler)	12-12
NiCad piggy bank (W. Holdinghausen)	12-13
a 'flash in the can' (E. Muller)	12-16
candid comments	12-17
drinks round indicator (H.J. Urban)	12-19
kaleidoscope (J.M. Hainque)	12-20
panoramascop (H. Luhmer)	12-22
locomotive (H. Thiela)	12-24
cumulative index volume 6 1980	12-26
dice shaker (R. Mohunlot)	12-29
canometer (S. Heilmann)	12-30
tilt (P. Grogar)	12-33
marimba can (W. Frose)	12-34
multican (R. de Boer)	12-35
mobile can (R. Wenselburger)	12-38
dincan (L. van Ginderen)	12-39
genie in the can (R. Wenselburger)	12-40
pipng can (A. Kramer)	12-42
simple remote control (F. Knapzrec)	12-44
water can (R. de Boer)	12-46
canine defence (T.N. Stokes)	12-47
garden gnome (W. Holdinghausen)	12-48
market	12-49
advertisers index	UK 22

contents

conten

cont

con

Handwritten signature: S. Heilmann

EDITOR:
W. van der Horst

UK EDITORIAL STAFF
T. Day E. Rogans
P. Williams

TECHNICAL EDITORIAL STAFF
J. Barendrecht
G H K Dam
P. Holmes
E. Krempelauer
G. Nachbar
A. Nachtmann
K S M. Wairaven

elektor 86
Subscription 1980
ISSN 0303-322X
DK 45-12
USA 12



selektor selektor

The development of traffic control systems in Glasgow

The City of Glasgow has seen major developments in traffic control ranging from relatively simple schemes in the early 1930s to sophisticated motorway control schemes in the late 1970s. To meet the challenge of the 1980s, Strathclyde Regional Council has planned a centrally integrated traffic control (CITRAC) system for Glasgow which will further enhance the reputation of the city as a pioneer in traffic control by utilising the most up-to-date technology.

In 1967 Glasgow became the first city in the UK to control traffic on an area basis using a central computer. The scheme is still in operation in the city centre and comprises 90 traffic signal controlled junctions. At the same time urban motorway construction began in Glasgow; this took the form of radial and circumferential motorways and expressways, designed to carry local traffic in addition to providing a city centre by-pass.

The complex network of motorways is epitomised by the Kingston Bridge, a dual five lane carriageway carrying over 110,000 vehicles per day and containing 11 entry and exit ramps within a distance of 0.5 mile. To achieve the highest standards of safety and efficiency the latest technology has been utilised to provide Glasgow with the most sophisticated motorway traffic control and surveillance systems in the UK.

SRc has invested £1.5m in these systems, supplied by two Philips companies - Philips Traffic Systems and Pye Business Communications. The Philips association with Glasgow stems back to the late nineteenth century when Gerard Philips studied in the laboratory of the physicist Thomson, later Lord Kelvin, and supervised the installation of an electric light system.

The integrated motorway control and surveillance system is the first microprocessor-controlled motorway scheme to become operational in the UK. It is the latest step towards the CITRAC system which will eventually link this sophisticated scheme to an enlarged surface street area traffic control system and to a system of diversion routes off the motorway.

The sophisticated signalling system, supplied by Philips Traffic Systems of Mitcham, Surrey, is a key feature in the development of Glasgows CITRAC system. Together with the closed circuit television system supplied by Pye Business Communications of

Cambridge, the signalling system will provide comprehensive control of all traffic activity on the urban motorway network.

The motorway control system comprises 374 signalling units incorporated into 97 overhead gantries. The units can display up to 14 different signals including flashing red and amber lights according to legal requirements; each lane has individual signalling and the system is capable of controlling 800 signs on 200 gantries.

Two Philips PB57 minicomputers, located in the computer centre of the Department of Roads, transmit signals to the microprocessor controlled outstations via party system. The outstations are housed in the gantries, and up to 32 outstations can be attached to a party line which brings considerable savings in copper. Each outstation can control up to eight signal units which comprise 42 V tungsten halogen lamps with fibre optic signs; together with an AC power supply, the lamps will ensure much longer life from individual bulbs.

The system is operated from the central control room at police headquarters in Pitt Street, Glasgow. The operator can view a schematic representation of any section of motorway on a visual display unit, and from its keyboard, messages are sent to the outstations; a scrolling facility enables the operator to scan motorway sections in sequence, and every action taken is logged by a teletype for statistical purposes.

A comprehensive set of ground rules, supplied by the Regional Council's Department of Roads, has been incorporated into the system's software program owing to the complexity of the urban motorway network; these include automatic countdown sequences which ensure that the motorist is advised well in advance of restrictions ahead.

The system has been designed to facilitate ease of maintenance; any fault in a signal unit is illustrated on the VDU in inverse video, and each outstation has a self-diagnostic facility. It is also possible to test all equipment without the motorist being aware; engineers, requiring minimal computer expertise, can analyse the system without interfering with the signal units and can program the system easily to accommodate changes and expansion. The system also enables additional data, for example, information on queues or weather conditions, to be transmitted from any outstation to the operator.

The closed circuit television system, also in operation, comprises 24 Pye 506 CCTV cameras mounted on steel poles with special wind-down facilities for ease of maintenance. Each camera is fitted with a weatherproof housing, a thermostatically controlled heater/demister and screen wipers for protection against the elements.

High quality newicon tubes have been specified for the cameras to counter

the problem of powerful vehicle headlamps and street lighting; and each camera is fitted with 10:1 zoom lens, variable speed pan/tilt facility and automatic iris.

The surveillance system is divided, at present, into three cable networks covering the Monkland motorway, the Ranfew motorway and the Clydesida expressways. The system can be easily extended to accommodate up to six cable networks, and extra cameras can be added where required.

At the base of each pole is a control box with its own built-in microprocessor; power is supplied from a local mains, and the picture signal is fed via the central processor to the motorway control room. The central processor, located in the computer centre of the Regional Council's Department of Roads, is the central element in the functioning of surveillance system.

Up to four cameras on each of the three networks can relay pictures simultaneously to the control room where nine Philips 20" video monitors are controlled by two operators; each operator has a control panel and a desk monitor. The panel enables the operator to select a camera and a monitor to observe an incident on the motorway; coloured pushbuttons and a joystick controller on the panel provide control of camera functions including zoom, pan and tilt.

Pictures from all the cameras in one network can be relayed to a single monitor in automatic sequence; and a digital display on each monitor indicates the location of the camera.

(59t S)

selektor selektor

Optical fibre link in service

Another chapter in Britain's telecommunications history opened in the West Midlands recently with optical fibre equipment being successfully brought into public service in British Telecom's network.

The 9 km link (5.1 miles) between Walsall and Brownhills, capable of carrying 120 telephone calls simultaneously, is the first stage of a new optical fibre cable network for Britain which, when completed at the end of 1982, will be the most comprehensive of its kind in the world. British Telecom, pleased with progress, is shortly to order systems for a further network which will be twice the size of the first.

Five British firms are supplying equipment for the network. BICC and Plessey have provided the Walsall-Brownhills

system with much of the optical cable installation work being done by British Telecom's own engineers. GEC, in conjunction with Telephone Cables Ltd, are currently installing a high capacity link between London and Reading, capable of carrying 1,920 phone calls of which the first section (London-Chiswick), has just been completed. Work by the same companies on the Oxford-Banbury route is approaching completion. STC, who provide both cable and equipment to British Telecom, is supplying a range of systems.

In planning this network, British Telecom expects to achieve several objectives:

- to speed the introduction of optical fibres in Britain, as part of its modernisation programme,
- to ensure that Britain keeps up with world leaders in this technology,
- to obtain expertise in the design, installation and operation of a variety of optical fibre systems, and,
- to give British industry early experience in supplying optical fibres in quantity, with consequent benefit for the industry's export potential.

The new network will eventually use more than 3,500 km (2,200 miles) of fibre — enough to stretch from Land's End to John O'Groats and back, with some over. It is being made up into nearly 450 km (280 miles) of cable which will be installed on 15 routes and equipped with 34 systems in England, Wales and Scotland. These 15 routes, ordered last year, involve more than £6M of investment by British Telecom.

The follow-on order to extend this network will be twice the size of the initial purchase and will require more than 7000 km of fibre.

An optical fibre is a strand of glass as thin as a human hair which guides a beam of laser light, capable of carrying thousands of telephone calls simultaneously. An optical fibre communication system includes electronic equipment to convert the telephone speech, into pulses of light, inject these into the fibre, amplify them as necessary at intervals along the fibres and convert them back to the speech wave at the distant end. Such systems offer significant prospects of economic and technical improvements in running and extending the nation's telecommunication services.

The basic raw material, glass, is cheap and in abundant supply, unlike the important copper used in conventional cables. Optical cables are also more compact than existing types and are immune to crosstalk and electrical interference.

British Telecom is part of the Post Office



Polaroid sonar technology: ultrasonic solutions to engineering problems

Picture a maze of corridors in an office complex, hotel, school building or a series of narrow aisles in a food market or department store. Not particularly adventurous territory for the average person, but potentially dangerous settings for the unsighted who must somehow negotiate obstacles others can see, from furniture and machinery to water fountains and potted trees.

Into our imaginary picture comes a blind student, business executive or shopper using what appears to be a white cane — a device traditionally employed to seek out obstructions that lie in the path of the user. There is a difference, however, in that our subject is using a cane that does not require reaching out, touching or making physical contact in any way.

Impossible? Not if the cane is equipped with a miniature ultrasonic guidance system, instantaneously and continuously measuring the distance from walls and other solid objects, then providing audible signals to establish the location and distance of potential hazards. Although such a device is not yet readily available, it may not be far off.

Polaroid technology now makes it possible for the unsighted to 'hear' their way by means of an ultrasonic echo-ranging system originally developed and currently used to focus Polaroid SX-70 autofocus cameras. In operation, the user activates the battery-powered system which then emits a continuous series of inaudible, high frequency 'chirps' — sound waves that travel from the electrostatic transducer or solid objects and back to the transducer. With the addition of a small speech synthesiser, distances can be 'announced' by the touchless cane.

Experimental models of the 'touchless' cane have already been successfully tested by various organisations for the blind.

The remarkable precision of the ultrasonic rangefinding system that can make split-second measurements, even in the dark, and the simplicity of integrating the electronics into various systems, opens the door to a host of exciting, new applications.

Since Polaroid introduced its SX-70 sonar focusing cameras in 1978, there has been a flurry of interest in non-photographic uses for the unique ultrasonic technology. Spanning a spectrum of business, medical, scientific and transportation needs, the highly sophisticated system, developed to

instantaneously and accurately focus camera optics for crisp, brilliant instant pictures, offers new solutions to old problems.

How it works

The sonar echo-ranging system is comprised of several key elements — an electrostatic transducer, crystal oscillator clock, digital circuit and counter; analogue circuit comprised of a transformer, amplifier and filters, and a power or readout section. The transducer, which acts much like a telephone receiver, converts electrical energy into sound and sound back into electrical energy.

The transducer emits an inaudible sound — a highfrequency 'chirp' lasting only 1/1000 second — and radiates the sound towards the target or in the general direction being investigated. Each chirp consists of four ultrasonic frequencies: 60 kHz, 53 kHz and 50 kHz. The returning signals are accurately measured and travel time is converted to distance to focus a camera lens, turn machinery on or off, provide audible or metered signals or perform any number of functions.

Aviation aids

Aviation is a promising area for application of the echo-ranging system. At present, there is nothing available to a pilot that can provide accurate altitude readings below 20 metres. Commercial passenger aircraft and small private planes are finding that exact readings can aid smooth landings, especially in poor weather conditions, help flying low over water, or assist pilot training.

The international press recently hailed the achievement of Bryan Allen when he broke the world's record for the longest human-powered flight by pedalling the Gossamer Albatross across the English Channel. Not publicised, however, was the critical need to keep the craft at a precise distance above the Channel's choppy waves. This was accomplished by using a custom-built altimeter incorporating Polaroid's ultrasonic echo ranging system to provide altitude readings at a rate of five times per second.

Helicopters, the workhorse of military and civilian airborne missions, can benefit in low altitude hover and touchdown situations. Lowering a heavy load into a limited access area or other high risk environment may be extremely difficult and dangerous for a pilot concerned with surrounding objects or unfamiliar terrain. Imagine the advantages of a continuous series of precise distance readings while manoeuvring and touching-down on a moving aircraft carrier, particularly with critical cargo aboard.

The simplicity of the Polaroid sonar system, its moderate cost and high reliability make it possible to equip large or small aircraft with multiple transducers, enabling the pilot to know

selektor SELEKTOR

precise distances at crucial locations of the aircraft.

Obviously, there are a great many aviation-related applications for echo-ranging systems, safety devices for baggage loading, precision sensing systems for mid-air refuelling, controls for spacecraft docking, and safety mechanisms for parachutists to indicate the last, critical phase of any jump - knowing how far away the ground is.

Vehicle control and safety

The uses of instantaneous distance readings are equally limitless for ground vehicles. The high incidence of accidents involving trucks and forklifts in factories and warehouses or on construction sites illustrates that an automated ranging system can reduce danger to workers, vehicles and valuable cargo. The driver who cannot see clearly in all directions or who is occupied with mechanical functions as well as controlling the vehicle, can be alerted by an audible signal when the truck, crane, earth-mover or harvesting machine nears an obstacle. In fact, the vehicle could be programmed to stop automatically when a minimum safety distance is reached.

Echo-ranging safety can be used for placing loads in visually inaccessible areas, backing trailer trucks up to loading docks, coupling a string of railroad cars, operating vehicles in obstructed or congested areas and safeguarding fragile or dangerous cargo.

For years, automotive engineers, have speculated on the day when passenger cars will be equipped with safety devices to sense the distance from obstacles in their path - for instance, when backing into a parking space or garage. In theory, at least, fewer accidents. Whether or not this goal is fully achievable, sonar technology has made the most critical element, the sensors, a reality.

Echo-ranging has numerous applications for marine vehicles, too. A typical scene in any major harbour is the huge ocean liner or tanker docking in tight quarters, with a swarm of tug boats frenetically tooting warning signals. A ranging system could furnish continuous, exact readings of the vessel's distance from close-range objects - in bright daylight, heavy fog or total darkness.

Other aspects of shipping can benefit too. Crane operators loading ship holds cannot see the unloading site and must depend on hand signals or radio contact. Precise distance readouts initiated by a transducer on the pallet rigging could provide the information required, in-

stantaneously, and with absolute precision.

Medical Aids

As helpful an application of sonar ranging as the sonar cane is the installation of Polaroid's ultrasonic system on a wheelchair. Existing technology makes it possible to automate a wheelchair to a high degree, enabling the user to operate the device easily. The echo-ranging system, with its continuous transmission and reception of sound signals, can signal obstacle-avoidance warnings, provide automated controls and even stop the wheelchair.

A system that automatically focuses liquid lenses in a pair of reading glasses may assist those whose own lenses have been removed in cataract operations. The transducer can automatically measure the distance to the page and adjust the lenses accordingly.

Precision positioning data can be a boon to technicians and doctors using radiation equipment, including X-ray systems and sophisticated devices like computer and tomography (CAT) scanners, when it is essential to maintain a precise distance between the patient and radiating elements - for safety as well as suitable imaging. Ultrasonic distance measurements can make exact, continuous calculations that adjust to body contours, even if the patient moves. The entire scanning process can be automated to provide perfect results every time, lessen the traditional retakes, unnecessary cost and possible patient harm.

Instrumentation and automation

Applications for ultrasonic measurement in scientific instrumentation, manufacturing and agriculture are literally limitless. For example, a fruit grower in Florida has already used the technique to automate three spraying operations. The distance readings, from the spray vehicle to the trees being treated, control the nozzle aperture, spray pattern and duration - even turn the sprayer on and off.

Cybernetics provide a challenging testing ground for sonar distance measurement technology. An American teenager won a science and engineering fair award recently for his self-controlled mobile robot. The distance measurements made possible by Polaroid's echo-ranging system protected the unit from damage and allowed it to operate by itself. Cybernetic equipment, including highly articulated robots, can provide incalculable benefits by performing in hostile environments where humans cannot function - to handle fires and chemical disasters, to perform at high efficiency in explosive atmospheres and in temperature extremes.

In fact, the ability to gauge accurately and to control remote operations in potentially unsafe environments is essential these days. The remote manual

manipulation of nuclear materials, for instance, could be safer and more efficient if operators knew the exact distances involved, or if procedures were fully automated.

For example, think of the remote transfer of radioactive materials, the need for exact positioning of fuel rods in a nuclear reactor, or the handling of any materials in dangerous surroundings, temperature extremes, radioactive environments, or areas with chemical fumes and combustibles.

Inventory control is always a major problem when thousands of items, many bulky or difficult to count manually are involved. Want to count a stack of paper sheets in a high volume printing operation? Since the number of sheets per unit of height is known, the sonar transducer can continuously measure the height of the stack and provide information to a calibrated readout device. Interested in continuously monitoring the volume of liquid in a huge storage tank - to accuracies within millimetres of the exact level? Once again, echo-ranging can provide the means with sensors located within the tank.

Whether employed to sense the movement of paper webs on automated high-speed printing presses, assure elevator stopping accuracy, count objects, measure and regulate fluid levels or even guide toys or mechanical robots, Polaroid's echo-ranging system is certain to play an important role in bringing the future measurably closer.

'Talking cars'

Cars of the future are likely to 'talk' to their drivers.

Microcomputers will make a major impact on vehicles of the future. However, they could produce so much information on the state of the car and outside conditions that there could be a problem for the driver in absorbing it all. This could be solved by the use of a speech synthesis micro-computer which would be able to 'talk' to the driver. The robot passenger could constantly scan the information presented by the car's sensors and verbally inform the driver of any dangerous situation. The driver could also ask the talking computer for information such as average speed and the estimated time of arrival. A three-chip computer system already exists to provide a vocabulary of 256 words with adequate diction quality.

selektor SELEKTOR

selektor

The potential of the biochip

Semiconductor technology has brought microelectronics to the stage where the size of individual transistors on a chip approaches that of large molecules in cellular material. It is reasonable to suppose that the scale will soon be small enough for us to design circuits capable of organizing themselves into simple forms of artificial intelligence. Coupled with newly-developed techniques for implanting probes in living material, they might simulate biological systems and even be capable, to some degree, of repairing them.

The idea of implanting electronic systems into living tissue is not new. Cardiac devices such as the familiar pacemaker have now progressed to the stage where they embody simple microprocessors to adapt them more closely to specific characteristics of individual hearts, and several laboratories are working on microelectronic hearing devices that by-pass a defective inner ear by directly exciting a small part of the nerve bundle forming the auditory nerve. These devices use tiny electrodes, several micrometres in diameter, which are made by photolithography.

Similarly, it is possible to stimulate a precise part of the optic nerve, or visual cortex, to produce bright spots in the field of vision. By adding a microprocessor to a multi-electrode system it might be possible to pre-process and use them to build up rudimentary images of the visible world. Other work being done includes the electrical stimulation or control of defective neural units in people who are paralysed in the lower parts of their bodies or down one side. Research into the working of the nervous system, including the brain, has substantially benefited from electronic techniques for exciting and probing. But all these developments have been severely restricted by the lack of large arrays of ultra-small electrodes and miniature processing systems capable of exciting and probing in a fine mesh over a large enough portion of the neural networks, and of doing so without causing damage. So far, sensors are either too coarse or too few in number to cope with the complexity of individual cells or neural systems.

These problems could, in theory, be overcome by borrowing from the microfabrication techniques used in making silicon chips. But there still remains the problem of transmitting the information from, say, a 100 000-electrode array to the experimenter. Extensive sorting and pre-processing is obviously necessary, which means incorporating a versatile, high-density microprocessor. Such an

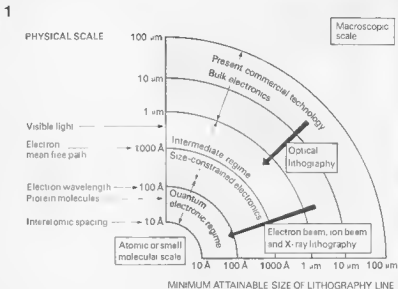

Figure 1. Orders of size for features in silicon-chip devices, showing sizes of lithography lines required.

'intelligent' implantable sensor for monitoring and controlling might be termed a *biochip*.

Tissue repair

If advanced medical instrumentation were to be developed along biochip lines it could significantly improve our knowledge of the electrical signals (and chemical ones, if chemically-sensitive ultra-small devices were used) that govern learning, memory and behaviour. From this knowledge, and by reversing the job of a sensing biochip to that of control, it would become a real, if still distant, possibility that neural tissue might be at least partly repaired.

Part of the research programme in advanced microelectronics is to study the feasibility of such biochip instrumentation. The University of Warwick, in collaboration with certain laboratories in the USA, are exploring problems to do with electronic processes in ultra-small devices, complex system design and bio-compatible materials important to future biochip technology. The silicon-chip revolution is now reaching a stage where further miniaturization and circuit cleverness will call for extensive changes in the way devices are made, in the design of computer architectures and even in the scientific basis for understanding and exploiting electronic processes.

Industry is now getting to the end of the era of large-scale integrated circuits (LSI), in which, typically, a microprocessor is manufactured as an array of some 64 000 transistors interconnected on a silicon chip about four square millimetres in area and sizes of the smallest features are about two to four micrometres. Biochip developments will mean very-large-scale integrated (VLSI) cir-

cuits comprising many millions of components packed on to a single chip. Individual circuit elements as small as 200 angstroms (20 nm, or 0.02 μm) will be used. This is about the size of large molecules in cellular matter. Many of the ideas and techniques of bulk solid-state physics which have held for the last three decades of electronics will no longer work on this ultra-small scale.

Solid-state microcircuits are built by a process which is basically photographic, known as photolithography. First, a wafer of silicon several centimetres in diameter is cut from a single crystal. Next, a thin, insulating layer of silicon dioxide is grown on its surface and coated with a photo-sensitive film, known as the photoresist. A pattern of the intended circuit is then projected onto the photoresist using a beam of ultra-violet light or, in advanced lithography, some other radiation. The exposed film is then developed by dissolving away the exposed areas, leaving a pattern of open, insulator regions. These are in turn removed by etching, usually by acids, to reveal the underlying silicon surface. Very small amounts of impurity atoms may then be diffused into the open silicon regions by placing the wafer in a controlled, hot furnace containing the impurity gas. In this way, the pattern of exposed silicon is given the electrical properties that are wanted. The result is an array of planar transistors or other circuit elements. A similar procedure is used to lay down metallic electrodes and to make interconnecting pathways to link the circuits.

Photolithography is very economical because a large number of identical circuits can be made on one wafer before it is cut into separate integrated-circuit

2

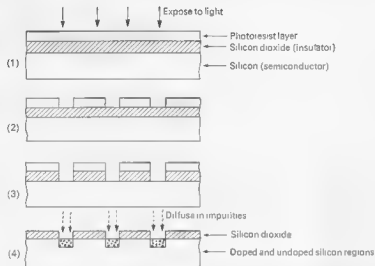

Figure 2. Photo-lithographic process for making integrated circuits: (1) An oxide layer is grown on the silicon wafer, followed by a photoresist layer; (2) The photoresist is exposed and the pattern etched; (3) The exposed oxide layer is etched away; (4) The photoresist is stripped away and impurity atoms are diffused into the silicon layer. The final structure is equivalent to an array of planar transistors.

chips. By making the circuit components smaller, more components can be built into each chip, making it more versatile. There are additional advantages in that smaller transistors use lower power and operate faster. Because the cost per component is related to the area it occupies on the chip, higher component density means greater economy. The number of components per chip has about doubled each year since 1960, so we might expect a million-component chip to be attained in the early 1980s.

In a move toward VLSI, recent advances in optical projection systems and the use of light in the far ultra-violet part of the spectrum show that circuit features as small as $0.5 \mu\text{m}$ can be inserted into the pattern by photolithography. The smallest limits are fixed in the end by diffraction effects, which can be overcome only by using shorter-wavelength radiation. Advanced lithography techniques now being developed for VLSI use soft X-rays and electron and ion beams to give a resolution of features down to the order of 100 angstroms ($0.01 \mu\text{m}$). New high-precision techniques are being worked on for the etching and diffusion stages to complement the fine pattern generation and transfer; in particular, plasma etching and ion implantation are promising.

Conventional computer systems will be difficult to incorporate on VLSI chips because of the very high proportion of interconnect paths, which take up a lot of space. This 'wiring' problem is brought about because so-called sequential processing architectures are in use, in which computations are carried out as a long chain of logic operations. Parallel or concurrent architectures, in which computers can perform a large number of operations simultaneously,

offer better space-filling pathways but are not as well developed. Choosing the computer architecture to use in VLSI chips will mean considerable re-thinking of basic computer science; constraints imposed by the economies of design and fabrication of the equivalent electrical circuits will not be the least of the problems to be solved.

A great deal of research effort is devoted to exploring and exploiting novel electronic processes which become available in sizes somewhere between solid-state LSI and the true atomic scale. In a conventional bulk semiconductor device, electrons or 'holes', which are vacancies in energy bands normally filled by electrons, are swept from one electrode to another

through the application of a control voltage. The time this takes is called the transit time. A steady average drift velocity is reached when the rate at which the electrons gain momentum and energy from the accelerating electric field is balanced by the rate of loss of energy and momentum through collisions with impurities and vibrating atoms in the host semiconductor. Ohm's law is obeyed if the fields are weak and there are many completed collisions within the transit time. But in very small devices the accelerating electric fields can be very large because the control voltages cannot be scaled down below the thermal noise level, that is, the small voltage arising from the temperature-dependent, random motion of electrons. Non-ohmic conduction happens easily and the very short transit times may make it impossible to achieve a steady drift velocity. This condition is called the transient regime.

At smaller scales, the transit time eventually becomes less than the mean free time between collisions. The conduction becomes ballistic: electrons no longer see the scattering mechanisms within the device volume, and free acceleration should take place. However, the electrons can still interact with the encroaching environment of the device, that is, with the imperfections and atomic vibrations in the contacts, interfaces and surrounding insulator regions. In this regime, conduction is constrained by size. In the extreme, when the device is small enough, Heisenberg's uncertainty relation indicates that it becomes more and more difficult to confine the electrons to the device. Quantum effects become strong, and the available energy states for the electrons become discrete rather than continuous. The wave-nature of the electron becomes a dominant factor when the size of the silicon approaches the 100-angstrom region, for the electron waves can then

3

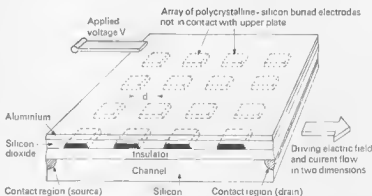

Figure 3. A two-dimensional superlattice. The atomic-like potential barriers and wells are electrically controllable by a voltage applied to the aluminium 'gate' electrodes. By means of the control voltage V and the superlattice spacing d , the implanted superlattice may be used to override the dynamical effect of the natural silicon lattice.

escape from the device and may overlap into adjacent devices; this is known as the tunnelling phenomenon. Conduction still goes on, but to understand what is happening requires the full theory of quantum mechanics.

Superlattices give us a good example of the sort of quantum effects which can be exploited in ultra-small systems. In a perfect crystal, the electronic properties of the material are fixed by a periodic array of atomic potentials, which diffract the electron waves as they propagate through the crystal lattice. An artificial one-dimensional lattice, known as a superlattice, can be superimposed on the crystal lattice by growing alternate layers of various materials on a semiconductor substrate, separated by a few hundred angstroms. By varying the composition and separation of the layers it is possible to control the electron dynamics in a direction perpendicular to the layers.

Superlattice effects have been demonstrated by a number of laboratories, particularly Dr Ray D'Angelo's group at Bell Telephone Laboratories in the USA. The two-dimensional example in figure 3 is of a superlattice proposed by Dr R.T. Bate, of Texas Instruments. This structure could be made by using one of the advanced lithography techniques.

Co-operative Networks

When the separation between devices approaches molecular size, it becomes more and more difficult to isolate any particular device from its neighbours. In a similar way to the superlattice example, the overall architecture of the VLSI system of devices may become more important than the host semiconductor in fixing the electrical properties of the array. Already, unexpected interactions have appeared between circuit elements. For example, the phenomenon of 'cross-talk' between memory cells in high-density LSI memory chips is accepted as a reliability problem. Exploiting such behaviour between devices could lead to more versatile electronic networks which would not need the high proportion of space-consuming wiring patterns that are now used in microprocessors. The behaviour of an orthodox electronic logic system is fixed once the pattern of devices and their interconnecting pathways has been established. A different behaviour might be imparted to it by rewiring, that is, re-ordering the devices, but this is normally impossible in integrated-circuit systems. We are studying an alternative approach. We have built theoretical models to simulate arrays of electronic devices which are only partially isolated from each other. The arrays are intended to undergo spontaneous self-organizing, or co-operative transitions between differently-ordered electrical structures. The idea is illustrated in figure 4, where groups of devices in the VLSI array are

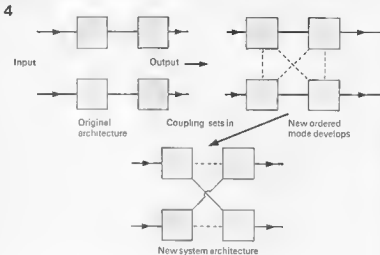

Figure 4. A synergetic electronic network. The blocks represent groups of devices in the VLSI array which communicate through built-in pathways and by interacting directly.

represented as blocks which communicate through built-in pathways and by the devices directly interacting.

Information is received at the input in the form of coded electrical signals which are processed and passed to the output as additionally-coded signals. At the lowest input-signal strengths the array behaves according to the built-in architecture. At some higher level of input signal, cross-interactions between the devices arise through, for example, tunnelling of electrons. Competition between these new channels of communication and the original built-in coupling then gives rise to a differently-ordered electrical architecture. The new architecture, and hence the new processing function, is sustained as long as the input signal stays strong enough. This type of system has to have a great deal of freedom in the coupling between devices, a small number of which control the others, so many parallel paths are necessary.

Preliminary studies are encouraging enough to foresee many applications for biochips embodying cooperative VLSI networks. For example, they might be used in self-healing logic arrays that would be capable of repairing a certain amount of radiation damage. They might form the basis of memory systems capable of sorting and relating data, and of 'artificial intelligence' units to assist in processes such as pattern recognition.

Implantable Electronics

Many problems, to do with the materials used, have to be solved before high-intelligence, implantable electronic systems can come about. First, the biochip must be effectively insulated against saline fluids so that it is not penetrated by unwanted dopant ions, such as

sodium, which destroy semiconductor devices. The insulating layer, from a few hundred angstroms to several micrometres thick, must be chemically bonded to the chip: a conventional wrapping is incapable of preventing saline penetration to at least a few micrometres. Second, the biochip must be compatible with the host biological material, so the outer layers must be made from materials which are chemically inert, such as plastics. This poses problems to do with the interface between the outer, inert layer and the relatively active electronic layers of the chip. The layers must stick together well enough to prevent the structure unpeeling. Third, the phenomenon of electrolysis, which might cause the metal micro-electrodes to dissolve in their electrolytic surroundings when electric currents flow, poses long-term corrosion problems and may make it difficult to obviate toxic by-products. Though a number of new materials show promise, solving the problem of passivating the biochip implants will not be practicable for some time.

Bionic science is in its infancy. But in spite of design and other technological problems it is believed to be a promising area for interdisciplinary research, with many potential benefits to medical science.

Dr. J.R. Barker,
Spectrum no. 17

(596 S)

selektor
ELEKTOR

Canned circuits...

Earlier in the year readers were invited, in the form of a competition, to send in their impression of what electronics could do in a can. No great limitation was imposed on what type of can was used although 10 gallon oil drums and the like were ruled out. This did not matter however since all entries included the use of the good old beer or soft drinks can.

The ideas poured in and they ranged from the very funny to the very serious, useful circuits.

This issue is mainly composed of 23 of the best entries, in fact, the prize winners. Judging, which was carried out by our international editorial staff, was difficult. Of the final selection, seven have been published complete with a printed circuit board. These were chosen as the best in terms of an original idea coupled with practicality. These seven readers will each receive a Casio LCD credit card calculator that can also be used to compose and play back your own tunes.

The remaining sixteen prize winning entries are again original ideas but were either not quite so practical or needed a little extra in the way of construction. The prize for these readers is the AM/FM radio Radio shown here.



There is one other prize specially awarded to the constructor of the locomotive. Strictly speaking, this idea did not include electronics, however, it is fun and we liked it.

What of the other entries? The fact that they did not win prizes obviously does not mean that they were no good. On the contrary, some were hilarious. How about a Budgie entertainer for example? So many of the entries fell by the wayside because the idea (almost always very good) could not be followed up with the practical application of the can itself. For instance, one reader sent in the complete circuit of an oscilloscope built in a number of cans. Think of the problems that they could cause on the workbench.

We hope you enjoy this issue, it was fun making it. Who knows, it may supply that last minute Christmas present. ■

W. Korell

bath thermometer

Many people don't like to leave anything to chance, and often with good reason. Jumping into a scalding bath can be a scathing experience, to say the least! The more tentative amongst us will therefore welcome this bath thermometer which can be used to test the temperature of the water before taking the plunge. It will satisfy even the most demanding of bathers from infant to grandmother.

The bath thermometer uses sixteen LEDs to give an indication of three temperature ranges: yellow ones indicate 'cold', green 'warm' and red 'hot'. The bath should therefore be at the correct temperature when one of the green LEDs is lit.

Circuit diagram

The circuit diagram for the bath thermometer is given in figure 1. All the functions required to control the row of LEDs (D1...D16) are contained in

IC1. The 'scale' of the thermometer is determined by the voltage levels on pin 12 and pin 13 of IC1. The upper threshold (pin 13) is fixed at a level of approximately 5.2 V while the lower threshold (pin 12) is adjustable by means of the preset potentiometer P1. If the input voltage at pin 11 is outside the preset limits, either the first or last LED in the row will be on continuously, depending on whether the input voltage was too low or too high respectively.

The input voltage is determined by the resistor network P2, R3 and the NTC (temperature dependant resistor, NTC = negative temperature coefficient). The input voltage will therefore vary as the resistance of the NTC varies with temperature. The exact temperature can be established with preset potentiometer P2. Two small 9 V batteries are all that are required to take care of the circuit's power supply. The voltage at pin 10 of IC1 is stabilised (12 V) by IC2. Resistor R1 determines the brightness of the LEDs.

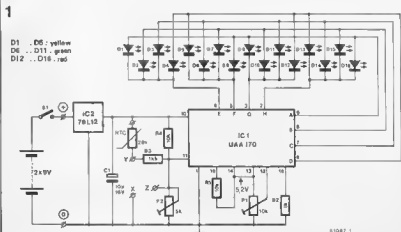

Figure 1. The circuit of the bath thermometer. The row of LEDs gives an accurate indication of the temperature. The temperature range to be displayed can be adjusted with P1 and the exact temperature detected by the thermistor can be adjusted with P2. The x, y and z points are included for another application of the printed circuit board.

2



Construction

How do we get it all into the can? First the components are mounted on the printed circuit board shown in figure 3 and the circuit tested. The Candis comments article gives some advice on how to open the can. The top should be removed in such a way that the folded edge remains undamaged, if possible, as this will be used as part of the watertight seal. One or two holes are then drilled in the base of the can (depending on the type of thermistor used) for the connecting wires of the NTC. The NTC can then be mounted using a suitable epoxy resin in such a way that the holes and the thermistor are covered (test for leaks with water). When the can is completely waterproof, a few ballast weights are stuck to the bottom from the inside (see figure 2). The printed circuit board, the perspex lid and the battery holder (if required) can be combined to form a slide-in unit. The batteries could even be attached to

the base with double-sided tape. In either case, however, the circuit board and the board (or perspex disc) on which the LEDs are mounted will have to be spaced from each other by a distance corresponding to the length of the LEDs. Apart from this, the perspex lid has four holes drilled into it for the screws of the clamp attachment and one in the centre for the screw which holds the complete assembly. For the clamp attachment it is best to use screws with retaining clips which hold the slide-in unit firmly in place beneath the lid edge. It is sealed with a rubber band or O ring in the groove. Finally, a miniature toggle switch is mounted in the perspex lid. This will also have to be made waterproof with the aid of a rubber band or O ring.

Once the thermistor, switch and batteries have been connected to the circuit board, the bath thermometer must be tested again and any adjustments required can be carried out with the aid of P1 and P2. Nominal bath temperature is within the range 24°C ... 38°C. Now everything can be put together and the thermometer taken for its first 'dip'. If the can is too buoyant, or floats at a peculiar angle, extra ballast weights will have to be added or the alignment of the slide-in unit and/or batteries re-adjusted.

As can be seen from figure 3, the printed circuit board for the bath thermometer is of a somewhat multipurpose design. The inner circle of the component overlay has the same diameter as the can. The outer circle, however, corresponds to the diameter of the majority of rev counters on the market. Of course, a rev counter could also be built into the can. A suitable control circuit was published in *Elektor* way back in 1976, but it is too large for this purpose. If a rev counter is required, it should be possible to construct the circuit on a small veroboard.

Parts list

Resistors:

R1, R4 = 10 k
R2 = 1 k
R3 = 1k5
P1 = 10 k preset potentiometer
P2 = 5 k preset potentiometer
NTC = 20 k thermistor

Capacitors:

C1 = 10 µ/16 V

Semiconductors:

D1 ... D5 = yellow LED
D6 ... D11 = green LED
D12 ... D16 = red LED
IC1 = UAA 170
IC2 = 78L12

Miscellaneous:

S1 = miniature spst toggle switch

Figure 2. The side view of the inside of the bath thermometer shows the principle components involved in the construction.

3

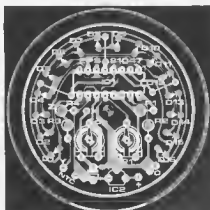
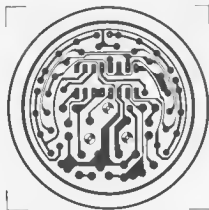

Figure 3. The printed circuit board for the bath thermometer can fulfil two tasks as described in the text.

xylophone

With Christmas practically on the doorstep, small, sound producing circuits become very popular. This novel circuit, although not entirely original, has been included mainly because of its simplicity and, by making use of the printed circuit board, can be constructed very quickly — just in time to replace that forgotten Christmas present!

This design again makes use of reed switches, only on this occasion they have a different function. By placing several of them next to each other, a form of keyboard is obtained which can be played by means of a magnet attached to a wooden stick.

The circuit diagram of the xylophone is shown in figure 1. Eight reed switches are used to make up a single octave. Closing any one of them will start up the oscillator. This consists of N1, C1 and the resistor in series with the closed reed switch. As the value of C1 is fixed, the actual frequency of the oscillator is determined by the combined value of the particular resistor and series potentiometer.

The frequency of the first note, C, is fixed by the values of C1 and R1 and will be about 350 Hz. Potentiometers P1...P7 are used to preset the frequency of the other notes to the accuracy required. The output signal from the oscillator is buffered by N2 and amplified by the darlington transistor T1 to provide sufficient drive for the loudspeaker. The volume of the output signal can be adjusted by means of preset potentiometer P8. The reed switches should be positioned approximately 1.5...2 cm from each other on the board.

To play the xylophone a small magnet is mounted on the end of a wooden or plastic rod. When this is brought sufficiently near to a reed switch the latter will close and start the oscillator.

There is of course one thing to bear in mind when playing the xylophone: don't hit the keys as hard as you would if you were playing a 'real' version of the instrument, as the reed switches are encapsulated in glass!

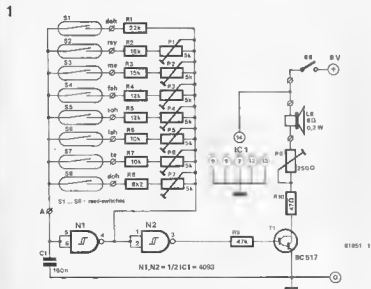

Figure 1. The circuit diagram of the xylophone, as you can see, is simplicity itself. The preset potentiometers P1...P7 are used to 'tune' the various notes.

Parts list

Resistors:

R1 = 22 k
R2 = 18 k
R3 = 15 k
R4, R5 = 12 k
R6, R7 = 10 k
R8 = 8k2
R9 = 47 k

R10 = 47 Ω
P1...P7 = 5 k (4k7) preset potentiometer
P8 = 250 Ω preset potentiometer

Capacitors:
C1 = 180 n

Semiconductors

T1 = BC 517
IC1 = 4093

Miscellaneous:

S1...S8 = reed switch
S9 = spat switch
LS = 8 Ω /0.2 W loudspeaker

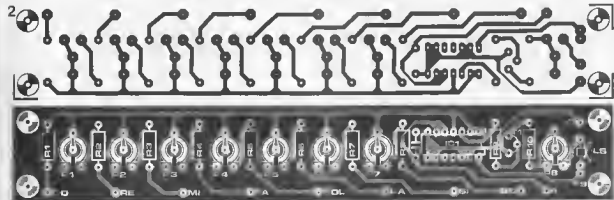

Figure 2. The printed circuit board and component overlay for the xylophone circuit. The reed switches are mounted in a row on the board.

A well known favourite stand at any fair used to be the coconut shy where a crowd invariably gathered to watch the occasional expert knock down too many coconuts to carry. Regrettably, this atmosphere is becoming a thing of the past with slot machine and pin table booths being a poor substitute. It's still possible, however, to try your hand at knocking down skittles or other objects with a set of five, well worn, wooden balls. The design in this article is based on just this subject. Can shy is a game consisting of a few cans, a few soft balls, some electronics and a little effort.

that the can is 'knocked down' and the player can concentrate on the remaining five.

More fun is added to the game if each can is made to look like someone you know, such as Dad, Mum, M.I.L., your local traffic warden or even the prime minister. You can then have a knock at them without offending their feelings, or better still, without them hitting back.

A word or two on construction

Dealing with the construction first and the circuit later may seem a little

can shy

E. Paul

Why the electronics in such a simple game you may ask. After all, the knock-about cans in the old-fashioned shies managed very well without. That is true but they had to be replaced by hand. Include a few components and the tiresome task of gathering up the fallen cans and returning them to the shelf is removed. In addition, electronics helps to make the game a good deal more interesting. Read on to find out how.

Each can is fitted with two eyes (two green LEDs) and a nose (two red LEDs). The eyes light up individually for a short period, one after the other in each can. The player can now only 'knock down' the can with illuminated eyes. If the target is hit, the eyes will go out and the cans 'nose' will turn red. This means

unusual, but in this instance it is more practical as the circuit is based on various mechanical aspects.

With the aid of rubber bands and a few 'screw eyes', the cans are suspended in a chipboard (or similar) frame in such a way that they are able to swing freely. The illustrations in figures 1 and 2 give a good indication of what it should look like. It is important to stabilise each can to prevent it from twisting on its own axis. Using three mounting points on the top and bottom of each can would accomplish this.

A set of six contact plates must be fitted on the rear wall of the frame and positioned to line up, as near as possible, with the centre of each can. Suitable material for the plate would be

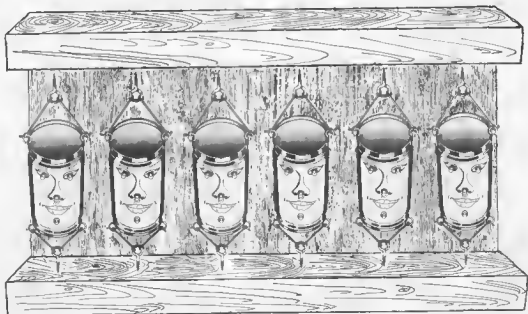

Figure 1. Front view of the can shy.

2

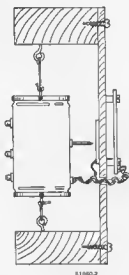

Figure 2. From the side various mechanical details can be seen. Each can is suspended with rubber bands so that it can be knocked back without being able to turn on its own axis. Also shown is how to mount the pin in relation to the contact plate.

copperclad board. This must be connected to positive on the power supply. On the rear of each can a protruding pin (a screw for example) is fitted in

such a way that a gap of not more than 3 cms exists between the end of the pin and the contact plate. It should be noted that the 'pin' must be insulated from the body of the can. When a player hits a can at the right time, the can will be knocked back to make a contact between the pin and the plate. Optical evidence of the bull's eye will be seen by the nose lighting up and the eyes going out. To prevent having to replace cans after every fourth or fifth throw, it will be advisable to use a very soft ball and throw gently.

The circuit diagram

As can be seen from figure 3 the circuit diagram is divided into two sections. To the left (section A) is the hit recognition circuit and to the right (section B) is the clock generator and can selection circuit.

First let us consider section A, the hit recognition circuit. Six of these must be constructed and one placed in each can. The circuit basically consists of two AND gates built up with the NANDs N1...N4. Provided pins 2 (N2) and 10 (N4) are high and that the can contact (S1) is open, the output of the first AND gate at pin 8 will be at zero. From this it follows that pin 9 will be low and the output of the second gate (pin 11) will be high. The transistor T1 therefore switching on the eye LEDs, D3 and D4. The circuit will then be ready to indicate a hit.

This will happen, if and when a can is hit thereby closing S1 temporarily. The logic conditions of both inputs of the first AND gate (pin 1 and 2) will then be high together with the corresponding

output at pin 6. A trigger current will then flow via resistor R1 to the thyristor gate which switches on and activates the nose LEDs. This causes the input of the second AND gate pin 9 to go low which is in turn transferred to the output pin 11 causing transistor T1 to put out the eye LEDs. The hit display is activated and will remain lit until switch S2 is depressed to interrupt the supply voltage. The circuit is now ready and waiting for the next hit.

If by now all the mechanical and electrical tasks have been carried out, the first ball can be thrown. The six cans can be 'knocked down' one after the other, switch S2 can be depressed and the entire game can start all over again. Section B is what makes the game all the more interesting, for it makes sure the eye LEDs only light for a certain time. The clock generator is built with the 555 timer IC operating as an astable multivibrator. The duty cycle can be varied with the aid of trim potentiometers R9 and R11. The pulse duration — the time during which the eye LEDs are lit — is set with the trimmer R9 and the pulse interval with R2. The output signal of the clock generator (pin 3 of the 555) feeds the 4017 decade counter. Of the ten outputs only six are required for the six recognition circuits. Each output is connected to one input of the two AND gates in the recognition circuit (pins 2 and 9). Now the target will move from can to can at the clock frequency. Which counter output is connected to which recognition circuit is left to the cans owner to decide. The order can be changed from time to time, which prevents experts from walking off with all the prizes.

3

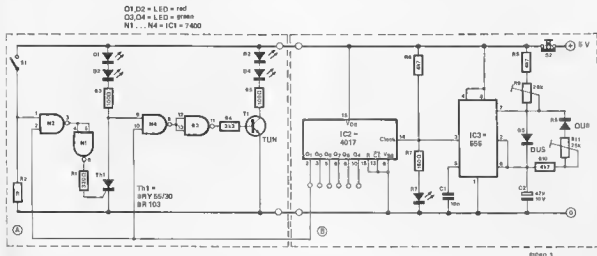

Figure 3. The circuit consists of two sections: the hit recognition circuit (section A) and the target selection circuit (section B).

D. Butler

midnight raid detector

This canned alarm is intended to repel inmates who insist on delving into the fridge late at night in order to quench their thirst or make off with a tasty snack. It can also be used as a deterrent for 'extra-curricular' snacks by persons on a diet.

trify it, but these strike us as being rather extreme forms of punishment. There are kinder and more humane ways in which to cure the compulsive raider and the circuit described here provides a useful example.

Picture the scene. It is the dead of night, pitch black and all around is as silent as the grave. Suddenly, a ghost in pyjamas creeps stealthily downstairs. Who is it? Maybe dad carefully groping his way to the kitchen. The fridge door creaks open, the light flashes on and a hand moves in the direction of the beer cans. The nearest can is grabbed and . . . bleep bleep bleep bleep . . . a horrendous din shatters the silence. There is no need to relate what happens next!

The circuit diagram of the contents of the can is shown in figure 1. A single IC and two transistors are the only active components required. The NAND gates N3 and N4, together with resistor R3

and capacitor C3, form a squarewave oscillator with a frequency of around 1 kHz. This oscillator is turned on and off by a second comprised of N1, N2, R2 and C2. The frequency of this second oscillator is much lower than the first, approximately 3 Hz. It can be started and stopped by means of the pushbutton switch S1. When S1 is closed, C1 will charge up almost to supply voltage. When S1 is open, C1 will slowly discharge through R1 ensuring that the circuit remains operative for a few seconds longer.

The output of the 1 kHz oscillator is fed to transistors T1 and T2 which are connected as a darlington pair and which provide sufficient signal amplification to drive the loudspeaker. Capacitor C4 serves to decouple the entire circuit. As CMOS gates are used, current consumption will be very low, even when S1 is closed, and a small 9 V battery is the only power source required.

The choice of can into which the circuit is to be incorporated will obviously depend on the particular brew that is normally consumed. A hole for the loudspeaker is made in the base of the can as shown in figure 2. The loudspeaker used must naturally be smaller in diameter than the can itself. Enough space must be left to mount the pushbutton which will protrude slightly further than the base of the can. The circuit board for the unit can be made

1

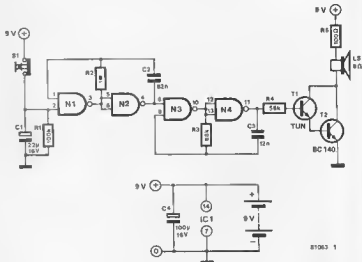

Figure 1. The circuit diagram of the midnight raid detector. An oscillator with a frequency of 1 kHz is turned on and off by another having a frequency of 3 Hz.

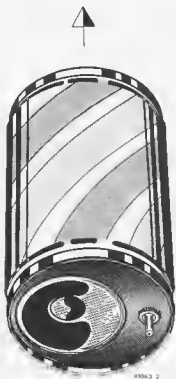

Figure 2. This drawing shows where to position the loudspeaker and the pushbutton on the base of the can.

small enough to pass through the loudspeaker hole. To prevent the contents of the can rattling the can can be padded with foam rubber.

The battery and pushbutton should be connected to the circuit board and then the whole assembly can be inserted into the can via the loudspeaker aperture. Once the pushbutton has been mounted in the hole provided, the loudspeaker can be installed by gluing it to the base of the can. Battery replacement will then become rather tedious, but it would be more difficult to construct a removable lid. In any case, one battery should last for a considerable length of time.

If all goes well the circuit should produce a noise as soon as the battery and pushbutton are connected. When the can is put down, with the loudspeaker on the bottom, the noise should stop after a few seconds. If it doesn't, the pushbutton may not protrude far enough and will have to be adjusted.

Final note: If no-one in your family happens to be a phantom raider, the circuit can still be employed at parties where a much larger audience will be present!

NiCad piggy bank

W. Holdinghausen

The relative shapes of a can and nickel cadmium cells could lead to the porcine conclusion that they were related. We are not sure how we got into this, but the friendly looking pig is not only an ideal container for the baby NiCads, but it feeds and maintains them in a healthy condition.

How did the subject of pigs get into this you might well ask. A fair question to which we are still looking for a reasonable answer. However, we did ask for canned circuits with particular emphasis on the unusual...

Mother pig is, in fact, a rather sophisticated NiCad charger. When first switched on, she checks to see how hungry her NiCads are. If necessary they are supplied with a charging current for a period of time. The current is then reduced but remains at a high enough level to ensure that the cells are maintained in good condition.

Operation

Mum contains quite a few vital organs. In the first place, the supply is stabilised by means of a voltage regulator IC5. Next, the circuit round IC1 monitors the voltage fed to the NiCads. Charging time is taken care of by IC1 and IC2. Of course, being a mum, she also has to have a memory. This consists of N1 and N2 and ensures that the NiCads can only be discharged once.

Keeping a close check on the supply is carried out as follows: when the supply voltage is switched on and the batteries are connected, IC1 monitors the voltage of the cells by way of R15. If this voltage is high enough (the cells are therefore not quite empty), pin 7 will become low. This causes the voltage across C5 to rise very quickly, whereas the voltage across C6 will rise at a much slower rate. As a result, transistor T3 will discharge the NiCads via R16.

As soon as the cells are empty enough, (depending on the setting of P1) pin 7 will become high and C5 will discharge within a matter of seconds via R7. This causes flipflop N1/N2 to change state and stops the discharge. Pin 3 of IC1 has the same waveform as pin 7 and so will

Details concerning the mother

- It is suitable for four cells.
- It discharges to a set voltage.
- It charges to a set voltage or for a set time period.
- Its maximum charge current is 100 mA.

When dealing with this particular electronic pig, it is as well to remember that when the green eye is lit she is relatively happy with her brood. But when her red eye lights — she will charge!

also be high now. This causes a small current to be fed to the NiCads via the constant current source, T1, which charges them. While they were being discharged the green LED was lit, now the red one will be lit.

When the supply voltage is switched on, the time delay circuit around IC2 and IC3 will have been reset to zero via C8. After about 14...17 hours (adjustable with P2) output Q7 will go 'high' and this will reach the input of IC1 via D9. This changes the state of outputs 3 and 7 to zero again. The red LED will go out and charging will stop. The green LED will light, but the flipflop N1/N2 will now be unable to change, because the voltage across C6 will no longer be zero. The batteries will therefore not be discharged either, and because they always discharge a little by themselves, anyway, they will be supplied with a small current by way of R1 to compensate for this.

Thus, to put it briefly, the green LED lights and the batteries are discharged. Then the green light goes out and discharge stops. The red LED will now light and the batteries are charged again. When they are fully charged, the green LED will light again.

3

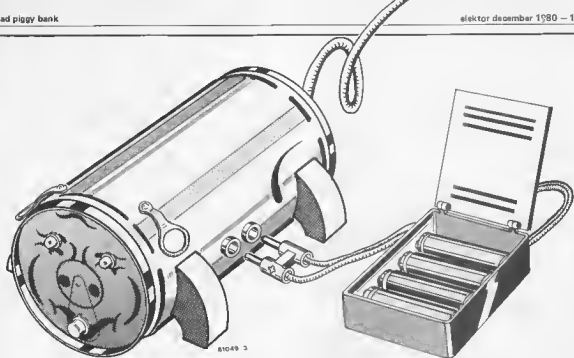

Figure 3. An example of how mother should look.

Parts list

Resistors:

- R1 = 27 k
- R2 = 220 Ω
- R3 = 470 Ω
- R4, R16 = 3k3
- R5, R13, R14, R15 = 10 k
- R6, R9 = 33 Ω
- R7 = 47 k
- R8, R19 = 1 M
- R10 = 27 Ω
- R11 = 660 Ω
- R12 = 47 Ω /1/2 W
- R17 = 220 k
- R18 = 680 k
- P1 = 10 k preset pot.
- P2 = 250 k preset pot.

Capacitors:

- C1 = 470 μ /35 V
- C2 = 47 μ /16 V tantalum
- C3, C7, C8 = 100 n
- C4, C6 = 10 μ /16 V
- C5 = 100 μ /16 V

Semiconductors:

- T1, T2 = BC 557B
 - T3 = BC 547B or BC 140
 - D1, D2 = 1N4001
 - D3 = LED, green
 - D4 = LED, red
 - D5, ... D9 = DUS (1N4148)
 - IC1 = 555
 - IC2 = 4060
 - IC3 = 4040
 - IC4 = 4011 B
 - IC5 = 78L12
- Miscellaneous:
transformer 2 x 15 V 100 mA
can

4

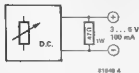

Figure 4. The small test circuit which replaces the NiCad cells when the charger is being set up.

Construction

Building the printed circuit should not present too many problems, leaving all the more time to 'decorate' the can. Figure 3 shows what is meant. It is not compulsory to copy this idea, of course, for it is much more fun to give free reign to your imagination. Just make sure, it's electrically safe - there is no need for the pig to be suicidal - insulate the mains transformer and ensure a good earth connection. The top of the can is left untouched, this is where the two LEDs and T3 are mounted. For the sake of appearance it is more amusing to use a BC 140 for T3 rather than a BC 547. Their connections are identical. Test the electronics before assembling everything in the can.

Setting up

Two different methods are possible. The simplest method makes sure that the batteries are not discharged too much, lower than one volt for instance. Potentiometer P1 is turned until the circuit stops discharging at 4 volts. Do this by turning P1 clockwise. This will mean

that charging will stop at a point several volts higher than the switch off voltage. However, this is so high (6 to 7 volts) that the NiCads will never make it. This is why charging is stopped after a set time.

The other method of adjustment does not set the discharge voltage, but the voltage at which charging is stopped. This should be at 5.7 volts (1.42 V per cell) and is set by P1 at room temperature. The discharge voltage will then be about 3 volts. If the set switch-off voltage is not reached within 14 hours, charging will be stopped after this period anyway by the timer.

Something should also be said about the maximum charge time. This time is counted from the moment at which mother is connected to the mains. If the NiCads are first discharged, the remaining charge time will be shorter than the set time. It may therefore be better to extend this time a little.

It is also possible to shorten the discharge time by selecting a lower value for R12. Then, however, the maximum charge current will be less than 100 mA. The circuit in figure 4 is used to replace the four NiCads during the setting up. It consists of a normal stabilised supply with an adjustable output. The resistor connected in parallel across the output ensures that the voltage does not rise while setting the charge rate. It is included because most stabilised supplies can only produce current and not consume any.

To assist with the setting up of the 14 hour period, it is useful to know that the input of IC3 (pin 10) should go high in just under 7 minutes. M

The only electronic components required for the construction of the 'rifle' are two nine volt batteries, an electrolytic capacitor, a low voltage light bulb and a lens with a focal length in the region of 30 . . . 50 mm.

The target consists of a simple optical schmitt trigger with an adjustable threshold so that it can be made to operate correctly despite variations in ambient lighting conditions.

The circuit of the 'light emitting pistol' is shown in figure 1. Two 9 V batteries connected in series charge a capacitor. When the microswitch (S) is closed the

In addition, the light is concentrated into a beam by a small bi-convex lens. It is therefore important to mount the bulb at the focal point of the lens.

An example of possible pistol construction is shown in figure 2. The microswitch is mounted so that it will be operated when the pistol trigger is pressed. A closer approximation of the true rifle range may be obtained by providing the pistol with an external power source instead of the 9 V battery. Each marksman can then 'purchase' a certain number of rounds (capacitor charges) from the range warden (which of course will provide you with extra funds to replenish the gallery should any cans become damaged — wishful drinking?).

Figure 3 shows the circuitry involved in the target unit. It consists of an optical schmitt trigger which is constructed from two transistors and an LDR (light dependent resistor). Initially, the circuit is adjusted so that normal daylight will have no effect on the schmitt trigger. That is to say, the LDR (R1) will have a relatively high resistance and transistor T1 will conduct. As a result, transistor T2 will be turned off and the two LEDs (D1 and D2) will be unlit. If a more intense beam of light (from the pistol) strikes the LDR, the positions will be reversed. The voltage drop at the base of T1, caused by the fall in resistance of the LDR, will turn off this transistor, T2 will turn on causing the two LEDs to light. This situation will remain until the resistance of the LDR increases once more.

The complete circuit of the target can be inserted into an empty beer can without too much difficulty (it's just a question of finding somewhere for the previous contents . . .). The only important issue is that the LEDs and the LDR must be mounted so that they face the marksman (see figure 4).

E. Müller

a 'flash in the can'

Most of us will never admit to being a poor marksman when confronted with the rifle range at the local fairground. Of course, we are all experts — or at least we would be if it was possible to practice at home (Thankfully, the legal eagles of this country take a very dim view of people popping off their relatives and neighbours!). The circuit described here, however, is perfectly harmless and allows you to construct your very own shooting gallery.

capacitor is discharged rapidly through the low internal resistance of the bulb. To enhance the intensity of the 'flash', three times the normal operating voltage of the bulb is applied for a split second.

1

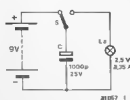

Figure 1. The circuit of the light emitting pistol could hardly be simpler. The fully charged capacitor is discharged rapidly through a low voltage bulb.

2

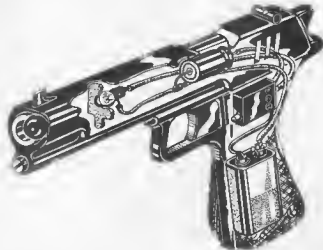

Figure 2. An idea of the construction of the light emitting pistol. An external power source could be used instead of the battery.

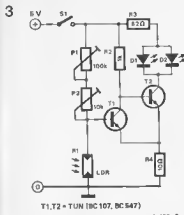

Figure 3. The circuit diagram of the target consists of an optical schmitt trigger. When an intense beam of light falls on the LDR the LEDs will light.



Figure 4. The LEDs and the LDR should be positioned so that they face the 'marksman'.

The preset potentiometers P1 and P2 are adjusted so that the ambient lighting just fails to operate the schmitt trigger. Potentiometer P1 serves as a 'coarse' control and P2 as the 'fine' adjustment. Of course, if the surroundings are too well lit then it may be impossible to adjust the unit so that the LEDs go out. The solution to this is to turn a few lights off (or if you are outside and the sun is *that* bright, what are you doing playing cowboys??).

As soon as all the manual adjustments have been completed, the game can start. The distance between the target and the shooter should not be more than about 10 m. When the pistol is aimed at the target the light beam should strike the LDR to register a 'hit', indicated by the LEDs lighting. To reactivate the target the LDR will have to be covered (shaded) for a short while. Just enough time to empty the next target container! **M**

candid comments ...

... on opening cans

How to open a can.

Yes, we know that you grab the ring in the top and heave, but a problem arises when you try and push a 2 x 3 inch printed circuit board and assorted components down through the hole it leaves. Not to mention transformers, sheets of perspex, hanging weights, motors, loudspeakers, relays and a whole host of LEDs. As you will find, in the pages of this issue, all these things and more have to, somehow, find their way into the average sized can. Read on to find out how simple it can be.

Fortunately, beer cans do not come in all shapes and sizes. The average size is almost the only size. All, without exception are round, most are about 5 or 6 inches high and seemingly, almost all eventually find themselves in the local park or picnic area.

Before delving into the real depths of can opening, it would be as well to first

make a pointed comment on what not to do. We at Elektor have this habit of trying to keep as many of our readers as possible. So if you are reading this with an Aerosol or other spray can in your hand with a view to cutting it up, please — please put it in the nearest rubbish bin. These cans are not for opening, even in the fourth category — impossible (more on this later). For the record, many of these cans, even when empty, still retain a fair amount of pressure. A warning is printed on them, please take note of it.

On now to less dramatic cans. First get your can and empty it. Beware, this is the part that you could get to like. Remember that cans are available in a great variety of colours and the wrong one could spoil the finished effect you have in mind for your project.

There are obviously a number of ways to open a can besides the one already mentioned. These methods fall into three categories. Difficult. Messy. Very difficult and messy. There is also one other but that is impossible. Joking aside, all the methods are admirably suited to cutting fingers so do be very careful.

It is equally difficult to judge which is the easiest or which is the most difficult method. It's all probably subjective anyway. We will start with the difficult method first.

The difficult method

This involves cutting the bottom or the top out of the can. To do this, a ring of holes must be drilled in whichever end you wish to remove. First, mark a circle slightly in from the edge of the top (or the bottom) of the can. Next, with a centre punch (not a screw driver) make a series of 'pop marks' around the circle, spaced apart by just over the diameter of the drill that you intend to use. The drill should not be too big, by the way, harm can come to a young lad like that. Then, very carefully, drill out the ring of holes. Don't worry too much about the appearance of the result, unless its covered with a red liquid, that could be blood! All that remains to be done now is to, very carefully and slowly, file the



ragged edge smooth. Patience here will give an excellent result.

The messy way

This method can be a lot of fun. How to open a full, unopened, can. Well for a start you need will power because the contents will get wasted. Soft drink cans will be fine for this method. Lesson one, do not SHAKE the can, never mind what we tell you later. Lesson two, if you own a sou'wester and wellies, put them on.

Obviously, you use this method when you want to keep the top of the can in its original state. In other words, your project simulates an unopened can, the Midnight Raider Detector for example. First, take yourself, the can, a small nail and a hammer outside. Now, place the can upside down on the ground, hold the nail with its pointed end touching the centre of the bottom of the can and — wait for it — hit the nail with the hammer. For added family entertainment, first shake the can vigorously for five minutes. Hilarious isn't it. Once the hole has been enlarged, the contents can easily be poured out. Carry on using the Difficult method remembering to epoxy the opening tab from the inside.

The very difficult and very messy method

Now we come to the hard part, cutting the can in half. Seasoned men have been known to go glassy eyed at the very

thought of it but, provided you have emptied enough cans to practise on, you should be all right. Count them, if you have over ten forget it and try again tomorrow. For those hardy souls still standing we will continue.

The trick in this one is to stop the can from buckling in the process. First, fill the can with fairly damp fine sand (or better, cement powder, but don't take all afternoon about it) and tamp it down by banging the can down smartly onto a solid surface. Try the ground, covered with a thick piece of card to save damaging the bottom of the can. Keep topping up the can until you can feel the sand is solid through the hole in the top. Don't forget to keep the sand nice and damp. Fun isn't it. When you are satisfied that no more sand will go in, mask the hole with masking tape or similar.

A layer or two of the same masking tape can now be wound round the can at approximately the height at which you intend to cut. This serves two purposes. It will (hopefully) protect the finish on the can should the saw slip and it will allow you to mark a guideline easier. The latter can be carried out by standing the can on a flat surface. Then take a pencil and hold it against a solid heavy object placed next to the can. Put the point of the pencil against the can (at the right height), and rotate the can. Simple? Try it.

Having masked, marked and packed the

can, it can now be cut using a very fine saw blade, a Junior hacksaw would be suitable. What do you mean — the sand all runs out? Back to the beginning again. Go and get another can from the fridge (and empty it) and this time dampen the sand more and get more in. One little variation on the above theme. We didn't want to tell you, but try using plaster of paris, instead of sand, and allow it to set before cutting. This will result in total success but it isn't half the fun! How do you stop the plaster from sticking to the can? Easy, swirl it round with a drop of oil first.

Finishing

There are probably a great many methods of covering the ragged edges of the cut can to give it a neat appearance. A simple and cheap way out is by using a length of PVC insulating sleeving, slit down one side, and glued over the edge. It's useful to remember that it is available in a variety of colours. Nice. Both the Kaleidoscope and the Genie require the use of two sections of a can fitted together. To make the joint well needs quite a lot of mechanical skill. The use of a 'sleeve' between the two halves is probably the easiest — if you can find a suitably sized can to make the sleeve from.

To make the can exactly the same as when you bought it, watertight that is, also needs some ingenuity. It really depends on what you can find in your junk box in the form of a sealing ring. If any readers do happen to know of a sealing ring that will fit the top (or bottom) of a can, please let us know, give us a ring so to speak.

An important point to remember. Many cans are sprayed internally with a type of plastic during manufacture. This film makes a good insulator but *should not* be relied upon where mains is concerned. Make absolutely certain that the mains earth point does actually reach the metal of the can and make any insulation in the proper manner.

Before fitting your project into the can it might be as well to remove all traces of the previous contents, be it beer, soft drink, damp cement powder or sand. Not one of these materials can in any way improve on the electronics and besides, traces of three month old beer emanating from your Bath Thermometer might cause questions to be asked.

We don't pretend to have covered all aspects of can opening but we have tried to give a few less obvious pointers. There are not too many reference works on the subject and up until this issue the editorial staff knew of only one method of opening a can. In fact, they practise it regularly.

A prize will not be awarded to the first reader to count how many times the words 'can' or 'cans' is mentioned in this article. Please mark your completed entry, 'cans' and send it to Terry Wogan, c/o BBC, London.

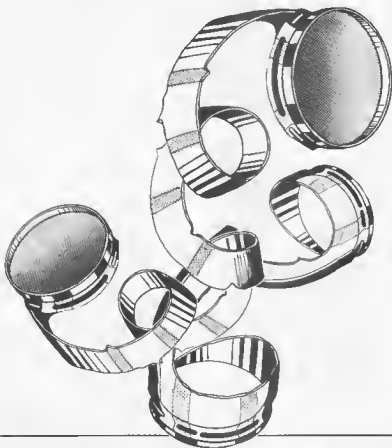

3

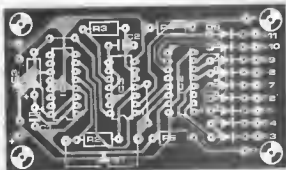
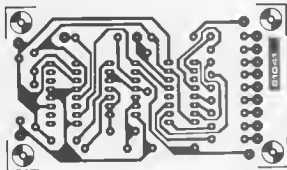

Figure 3. The layout for a printed circuit board.

Parts List

Resistors.

- R1, R4 = 100 k
R2 = 27 k
R3 = 47 k
R5 = 1 k

Capacitors.

- C1, C3 = 10 μ /16 V
C2 = 3n3

Semiconductors:

- D1, D9 = DUS
D10 ... D18 = LED
IC1 = 4528 or 4098
IC2 = 4017
IC3 = 4011

Miscellaneous:

- S1 = pushbutton
S2 = SPST switch
S3 ... S11 = SPDT switch

at that moment will be indicated by the LED which lights up at the counter output and so it will be clear who has to dip their hand into their pocket in order to pay for the next round.

If the counter happens to stop at 'zero', no LED will light and then the round will have to be paid for out of the 'kitty', unless of course the landlord happens to be in a generous mood! If the honour of buying a round should happen to fall on an absentee (whose switch will be in the B position) the monostable will be retrIGGERED so that the counter continues to count until one of the people present is selected.

Figure 3 shows a suitable printed circuit board for the project. In comparison with the low constructional costs involved, the performance of the drinks round indicator is extraordinarily high, provided, of course, the constructor is a member of the 'club' and made exempt of all payment. \blacksquare

Editorial note: No responsibility will be accepted for debts and/or medical expenses incurred by repeated use of the rounds indicator. Depending on the licensing laws in your area, a single battery should not run out before closing time, but it may be an idea to carry a spare ...

kaleido- scope

We never fail to be amazed at the things that some of our readers can produce from virtually nothing in terms of bought components. A good idea for the basic project is obviously a head start. The kaleidoscope in this article is an excellent example of something practical and original from next to nothing.

J.M. Hainque

In this particular article a certain amount of mechanical skill is required with electronics taking a back seat for a change. From the diagram in figure 1 it will be seen that, as far as the electronics is concerned, one 4093 and two 4026 IC's and five resistors are all that is required.

The gates N1 and N3 form two very simple oscillators. When the start button S is pressed, these generate the clock signals for the two counter-decoders, IC1 and IC2. The outputs of the decoders are fed directly to a total of 15 red, yellow and green LEDs which are combined to form a multi-coloured triangular display. The clock frequencies of the oscillator are low to give the impression of random trails of coloured trails within the triangle.

1

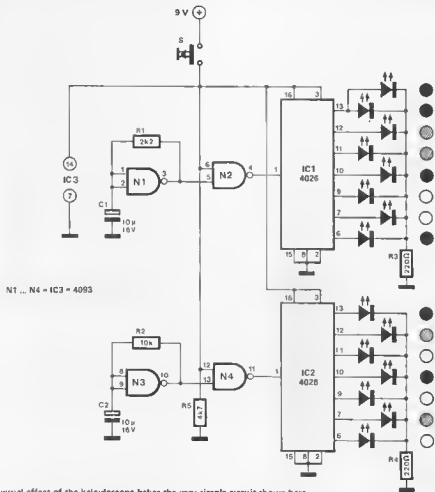
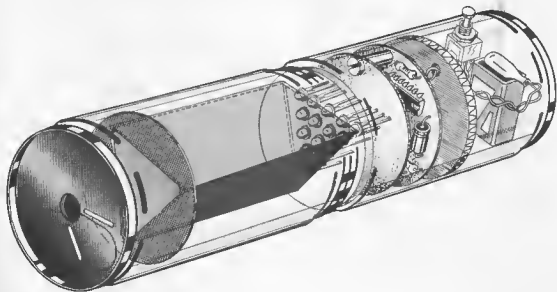

Figure 1. The visual effect of the kaleidoscope belies the very simple circuit shown here.

2



©1076 2

Figure 2. The construction of the kaleidoscope uses sections from two cans to allow for the length of the mirrors. The illustration is intended as a guide only as readers will have ideas of their own.

3

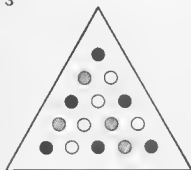

Figure 3. This suggested layout for the LEDs has proved to be very effective in practice. A further possibility is the use of a plug and socket arrangement between the LEDs and the circuit board. This would allow a change of pattern.

The display is even more attractive when three 'mirrors' are placed to form a triangular 'tube' as in the manner of a normal kaleidoscope. The reflecting sheet in the prototype was in fact three pieces of polished copper clad board. However, it would not be unreasonable to find handbag mirrors that would fit, the improved results would certainly be worth the effort.

The construction is illustrated in figure 2 and is relatively simple. Two cans are used to give sufficient depth to the completed container. The upper can needs to be long enough to contain the mirrors, the display board and the electronics boards. The lower section will then suffice as the battery holder and cap. Some experimenting with different ideas will be useful for joining the two can halves together, see the article on can opening.

The three 'mirrors' can be epoxied together to form a triangular tube which is then mounted on a disc of perspex used for the LED display. The electronics, discs of Veroboard, and a protective cover of perspex, can be fitted using threaded spacers. The lower can section, the 'cap', might then possibly be fitted using a central threaded spacer. This should leave ample room for one (or two in parallel) 9 volt batteries standing vertically.

It should be emphasised that the cut edges of the can need to be carefully protected since the finished kaleidoscope is likely to encourage a lot of interest, particularly among children. ■

an oscilloscope with mechanical X deflection

panoramascope

After reading the subheading, the serious minded electronics enthusiast may be excused for thinking that Elektor have taken a step backwards in circuit design. Why do we need to use anything mechanical in oscilloscope construction (apart from the knobs and switches) with all this amazing 'micro chip' technology we know about? Well, we asked for original and innovative ideas and we certainly got them. Actually, this device is not as peculiar as it may appear at first sight.

The inventor of this particular piece of electronic wizardry has made full use of the geometric properties of a tin can and has combined them with a drop of mechanics and a spot of electronics to produce an oscilloscope. The end result is a panoramascope which in principle dates back to the days when pictures first started to move.

H. Luhmer

The mechanics involved

Figure 1 illustrates the (not insurmountable) mechanical problems that face the enthusiast wishing to construct the panoramascope. A slot is cut into the side of the can behind which the row of LEDs are mounted. Holes are drilled in the centre of the top and bottom of the can where the 'bearings' are to be mounted. The author actually used jack plugs and sockets. In this way the supply voltage can be fed in through the top plug and socket combination while the (Y) input signal to the display board can be fed up through the lower pair. It is not certain for how long these bearings will stand up to the mechanical stresses and strains of everyday rotation, but no doubt the inventive enthusiast will devise a more elegant method of solving the problem. Possibly by feeding the supply voltage and signal into the unit by means of 'slip rings'.

In order to spread the forces acting on the can during rotation as evenly as possible, a threaded rod has been positioned diametrically opposite the central axis of the board and a counterweight has been attached to the wall

Obviously, it would be unwise to expect sensational technical data and precision from such an instrument. However, as illustrated in figure 1, the panoramascope is undoubtedly original and very easy to operate. When the device is switched on, the 'drum' containing the row of LEDs will rotate directly in front of the observer. If a DC or AC signal is then connected to the Y input, the row of LEDs will light in sympathy with the signal, and an oscilloscopic image will be built up. This proves that a mechanical X deflection can successfully be employed to display an alternating (or DC) signal on a 'screen'.

In actual fact, it is an optical illusion. When light spots are rotated at a high speed our relatively slow optical sensors are no longer able to distinguish between the sections of the picture.



a christmas competition

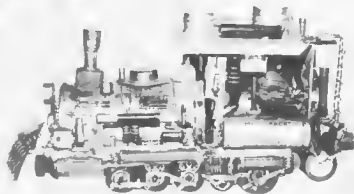

locomotive

It doesn't squeak, play tunes, light up or move about. But it does include a can, electronic components and it took quite a lot of imagination to work it all out, not to mention mechanical expertise to build it.

H. Thiele

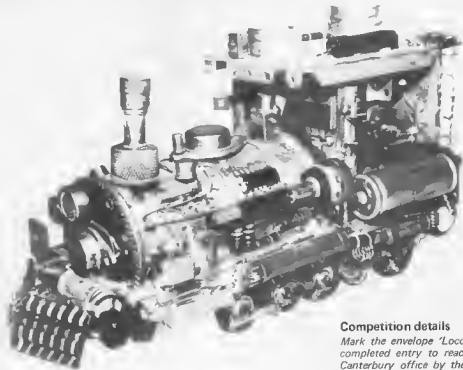

Yes it is a locomotive, no it will not run and no we do not know the prototype! However, it is original and well within the spirit of the canned circuits competition. We did not actually say that the circuits *must* work did we? This is, in fact, the only entry that has all the electronic components outside the can — so we invented a special class for it — and a prize!

According to its creator, only items from the junk box were used. Hardly any holes were drilled or screws used. The main item in the tool kit consisted of a 50 watt soldering iron and (sufficient) solder.

The prize

Just to be different, we have decided to make the locomotive the basis of a competition. A prize of a bedside radio (an unusual one at that) will be won by the first reader to send in the most complete and correct list of all of the components used in the construction of the locomotive. We do not expect a 100% correct entry so give it a try.

Most, if not all, of the components will be familiar to many but the identity of a few parts are reminiscent of the valve days and will possibly elude our younger readers, although we could be mistaken about that. It's fun and it could take quite a time identifying all of the parts — if you can. The can? Oh yes, that's the boiler. **■**

Competition details

Mark the envelope 'Loco' and post the completed entry to reach the Elektor Canterbury office by the first post on the 5th January 1981. The judges decision must be final and no correspondence can be entered into.

we wish all our readers



merry christmas



and a happy new year



1980 cumulative index

Audio

analogue delay technology	2:34
FET op-amps in the FORMANT	2:09
frequency doubler	1:22
IC tremolo	7:62
legato gate interface for FORMANT	7:15
loudspeaker fuse	7:23
loudspeaker fuse	7:78
moving coil preamp	7:98
PWM amplifier	5:22
stereo dynamic preamplifier	7:05
super tiny amplifier	7:65
talk funny on board	1:30
ulp amp	7:40
V-FET amplifier	7:10
voltage controlled harmonic generator	7:67

Car and bicycle

active car aerial	4:24
afterburner	4:45
aide-de-camp	4:31
automatic battery charger	4:44
automatic cycle lighting	7:07
battery protection	4:08
battery voltage indicator	4:30
car of the eighties	4:03
car stabiliser	7:16
dip-stick probe	4:16
fuel consumption meter	4:34
improved anti-theft device	7:38
intelligent wiper delay	4:18
power flasher	4:46
r.p.m. indicator as an economy guide	11:04
security rear light	7:38
simple fuel economy meter	11:16
simple wiper delay	4:43
solid state tachometer	8:00
stop thief!	4:28
thyristor ignition system	2:32
transistor ignition	4:10

Domestic and hobby

aide-de-camp	4:32
automatic curtain control	11:30
automatic pump control	11:25
bath thermometer	12:07
cheap light meter	7:14
coffee machine switch	11:42
current saving home trainer	7:24
digital thermometer	2:44
draught detector	11:08
dual slide fader (1)	3:24
dual slide fader (2)	10:36
electronic garden gnome	12:48
energy monitor	7:59
energy saving motor control	11:39
exposure meter and development timer	7:08

flexible intercom	5:44
fridge alarm	11:34
garden path lighting	7:14
infrared receiver	7:02
infrared transmitter	7:02
midnight raid detector	12:12
morse trainer	6:35
operational hours counter	11:44
post indicator	7:74
private telephone exchange	7:60
programmable slide fader	10:05
remote control	3:36
remote control dimmer	7:35
remote control slide projector	10:24
sensibell	7:04
smoke detector	6:32
temperature transmitter	7:34
Timbug II	6:18
touch doorbell	10:10
TV ... interference suppression	2:12
VOX printed circuit board	9:22
water detector	7:22
wet alert	7:25

Fun, games and model building

a flash in the can	12:16
armless bandit	7:64
can shy	12:10
dice shaker	12:29
din can	12:39
drinks round indicator	12:19
enigme	7:26
genie in a can	12:40
kalliedoscope	12:20
locomotive	12:24
midnight raid detector	12:12
missile attack	7:69
mobile can	12:38
multigame can	12:35
musical box	7:30
musical cube	6:20
sensibell	7:04
Tilt	12:33
Timbug II	6:20
water can	12:46

Generators

colour generator	1:06
crystal controlled sinewave generator	7:81
digital sinewave generator	7:16
noise at high frequencies	6:34
precision VCO	7:40
sound effects generator	7:58
variable pulse width generator	7:74
video pattern generator	10:28
voltage controlled harmonic generator	7:67

1980 cumulative index

HF			
active car aerial	4-24	elektor μ P's	5-04
aerial amplifiers	2-27	FSK PLL demodulator	7-87
aerial booster	2-04	hexadecimal display decoder	7-83
AFC via the tuning diode	7-12	hexadecimal keyboard	7-72
alternative amplifier for the Ω -aerial	7-12	high speed readout for elekterminal	9-28
degitching remote control	7-88	Junior Computer	5-08
digital tuning scale	1-08	Junior Computer memory card	10-22
frequency lock system	5-18	more on TV games	6-28
FSK PLL demodulator	7-87	more scope for the elekterminal	7-22
high frequency optocoupler	7-37	more TV games	10-17
LCO tuning scale	10-32	new busboard for microprocessors	1-31
low-pass filter	7-71	printer for microprocessors	3-28
narrowband IF strip	6-22	PROM programmer	7-90
noise at high frequencies	6-34	RAM tester	6-70
remote control	3-36	RS 232 interface	7-77
remote control dimmer	7-35	RS 232 line indicator	7-30
remote control slide projector	10-24	SC/MP as a mini organ	6-37
selective CW filter	7-69	small μ P switching supply	7-72
simple remote control	12-44	synchronous FSK	7-17
state variable filter	7-52	8 k RAM + 4, 8 or 16 k EPROM on a single card	9-04
super regenerative receiver 87-180 MHz	7-80		
test transmitter	7-19	Miscellaneous	
TV . . . interference suppression	2-12	canine defence	12-47
variable HF oscillator	7-39	cheap seconds	7-71
VSWR meter	1-18	cheap source of energy	7-99
Ω aerial	6-08	disco lights controller	6-06
4.4 MHz crystal filter	7-06	electronic fuse	7-34
		EXOR edge detector	7-29
		frequency conversion	7-02
		frequency lock system	5-18
		how does this strike you?	7-95
		hybrid cascode	7-16
		knock switch	7-68
		odd divider	7-57
		pest pester	6-04
		plus or minus unity gain	7-25
		PWM battery charger	7-18
		running lights	7-78
		sawtooth synchronous to mains	7-26
		shop window lighting	7-92
		skin resistance biofeedback	7-29
		trigger with presettable thresholds	7-42
		universal display	7-84
		universal warning alarm	7-28
		variable logic gate	6-30
		voltage controlled duty cycle	7-08
		voltage drop detector	7-77
		Music	
		better piano	7-85
		chorosynth	3-17
		clavitar	3-04
		FET opamps in the FORMANT	2-09
		legato gate interface for FORMANT	7-15
		marimba can	12-34
		musical box	9-30
		piano that sounds like a piano	3-13
Informative articles			
analogue delay technology	2-34		
candid comments	12-17		
car of the eighties	4-03		
eighties, the	1-04		
ejektor, measuring multipath	9-26		
electrolytology	9-33		
elektor μ P's	5-04		
energy saving know-how	11-13		
energy saving motor control	11-39		
how to recycle dry cell batteries	11-10		
IC guide	7-49		
Josephson computer	9-15		
know the ins and outs of your central heating	11-36		
LCDs	5-34		
long life technique in light bulbs	11-28		
modern methods of voltage regulation	1-32		
more on TV games	6-26		
more TV games	10-17		
PWM applications	1-36		
switched capacitors	10-12		
TV . . . interference suppression	2-12		
using the vocoder	9-38		
Microprocessors			
8ASIC cassette interface	5-24		
cassette interface adaptation	7-09		
elektterminal width extender	6-36		

1980

cumulative index

pipng can	12-42
sample and hold for synthesisers	7-42
talk funny on board	1-30
two more piano octaves	7-89
using the vocoder	9-38
vocoder (1)	1-24
vocoder (2)	2-14
xylophone	12-09

Power supplies	
side-de-camp	4-32
converter	7-06
intelligent NiCad charger	7-22
NiCad piggy bank	12-13
precision power unit	9-08
simple symmetrical supply	7-75
stabilised 10 350 volt power supply	7-79
variable power supply 0-50 V/0-2 A	7-86
2 amp voltage regulator	7-03
-12 V from +5 V	7-34

Test and measuring equipment

acoustic ohmmeter	7-63
audio frequency meter	7-88
automatic range switch	7-99
battery voltage indicator	4-30
canometer	12-30
continuity checker	7-95
display	2-32
digital heart beat monitor	7-96
digital tuning scale	1-08
dip-stick probe	4-16
electronic linear thermometer	9-12
exposure meter and development timer	7-08
extending the 1/4 GHz counter	2-14
fuel consumption meter	4-32
luxury transistor tester	6-14
mini speed control	1-16
NiCad charger	7-37
panorama scope	12-22
phase meter	7-27
RAM tester	7-70
RMS to DC converter	7-75
RS 732 Irne indicator	7-30
semiconductor barometer	7-33
simple analogue voltmeter	7-30
simple L/C meter	7-44
simple opamp tester	7-07
simple 555 tester	7-31
test transmitter	7-19
VSWR meter	1-18
wind-o-meter	7-13

link 80

an index to missing links

The purpose of the Link is to assist the home constructor by listing corrections and improvements to Elektor circuits in one easy to find place. At a glance it can be seen whether a project involved any problems. Don't forget to check previous Links if the project in question was published before January 1980.

E60

ICU — a mini microprocessor
March 79 (E47), p. 3-28

Burglar's battery saver
Jul./Aug 79 (E51/52), p. 7-05

Pcb for variable fuzz box
Oct. 79 (E54), p. 10-20

Charging NiCads

Dec. 79 (E56), p. 12-10

Voice operated control switch
Dec. 79 (E56), p. 12-10

Colour generator

Jan. 80 (E57), p. 1-06

Vocoder

Jan./Feb 80 (E57/58), p. 1-29, p. 2-16

ESS 005 Luna

E61

Car collision alarm
Jul./Aug 79 (E51/52), p. 7-89

Top Preamp

Dec. 79 (E56), p. 12-15

Choroynth

March 80 (E59), p. 3-17

E62

Top Preamp
Dec. 79 (E56), p. 12-13

Etakterminal

Active car aerial
April 80 (E60), p. 4-24

E66

8 k RAM card
Sep. 80 (E65), p. 9-04

E67

NiCad charger
Jul./Aug. 80 (E63/64), p. 7-37

VFET amplifier

Jul./Aug 80 (E63/64), p. 7-10

Car alarm

April 80 (E60), p. 4-28

E66

Programmable slide fader
Oct. 80 (E66), p. 10-05

dice shaker

R. Mohunol

Not an ice shaker, but a dice shaker, an ingeniously simple idea. No high technology electronics involved, but then that was hardly the object of the circuits in this issue.

What's it all about? Well, throwing dice, only this time using an electro-mechanical design based on the ordinary, old-fashioned dice.

The constructional drawing in figure 2 illustrates the principle. The dice are placed on the diaphragm of a small loudspeaker and are shaken by feeding the loudspeaker with a 50 Hz signal derived directly from the secondary

1

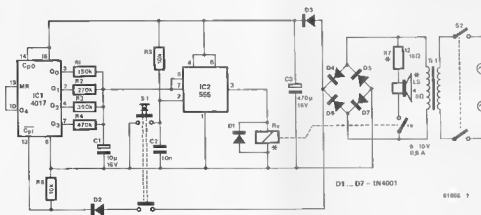

Figure 1. In the circuit of the dice shaker, the switch S1 is a double pole pushbutton. A 'biased' toggle switch would also be suitable.

2

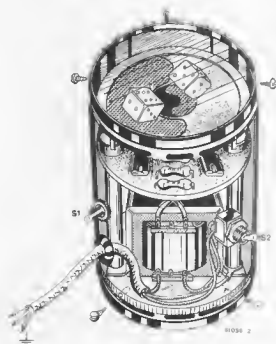

Figure 2. The dice shaker could be constructed as shown here. Care must be taken to ensure that both the transformer and the mains earth lead are fitted securely.

winding or a small transformer (9... 10 V/0.5 A).

The basic minimum of components required are a can, a loudspeaker, a transformer and a switch. To be on the safe side, however, it is advisable to include a timer controlled by a random pulse width generator, to make absolutely sure that the length of time for which the dice are shaken is unpredictable.

Figure 1 shows the circuit of the shaker. The loudspeaker is connected across the secondary winding of the transformer via the contacts of the relay controlled by the 555 timer IC2. Pressing the start button S1 will trigger IC2 (S1a), and a 100 Hz pulse train will be fed from the bridge rectifier, via S1b, to IC1. This 4 bit counter selects a random RC time constant for IC2 from the networks R1/C1, R2/C1 or R4/C1 and thereby determines the time during which the relay is switched, in other words, the 'shaking time' for the dice.

If an 8 Ω loudspeaker is used, a 12 Ω 3 watt resistor must be connected in series with it. The value of the resistor must be raised to 16 Ω /4 watt with a 4 Ω loudspeaker. It is preferable to use a relay with a high coil impedance, certainly not less than 300 Ω .

It must be emphasised that the mains earth lead must be a good secure connection to the can.



canometer

measuring can

S. Heilmann

The fact that a can has rotational properties was the inspiration behind this particular design in which the roll plays a very important role. The circumference of the can is used to measure distances with a fair degree of accuracy. The distance covered, or rather, rolled is indicated on a four digit display, the maximum readout being 99.99 metres.

Distances can be measured in three basic ways: by using a ruler, a tape measure, or by electronic means. The first two are often time consuming and prone to inaccuracy and the third is relatively expensive. A fourth possibility is now provided by none other than this canometer, its prime merit being simplicity.

It is, in fact, just an electronic meter incorporated into an empty can and which indicates the measured distance on a digital display.

The principle behind the circuit could hardly be more basic. When a cylinder is rolled along a flat surface, the distance that it covers during one revolution will be the same as its circumference. If the diameter of the cylinder, or can,

is known, along with the number of revolutions the can has made, the distance covered can be calculated very easily. Therefore, the electronics involved only has to record the number of revolutions, calculate the distance travelled and display the result. However, with a little bit of ingenuity, we can dispense with the mathematical section altogether, thereby making the electronics even simpler.

The diameter of the common 0.33 litre can is approximately 65.8 mm. This can be increased to 66.8 mm by adding a layer of sellotape around the can. This will then bring the circumference of the can up to 21 cm, a nice whole number.

To detect how far it has travelled, the can utilises a disc which has 21 segments. Each segment consists of a dark and a transparent section. The disc can revolve on a central axis and is weighted with either lead or solder so that the weighted portion will remain face downwards when the can is rolling. A photo detector construction from an LED and a photo transistor, on either side of the disc, is incorporated so that the transistor generates a pulse each time a segment rolls past. Since there are 21 segments and the can has a circumference of 21 cm, you don't need a degree in mathematics to work out that each pulse from the photo transistor corresponds to 1 cm of travel!

Effectively, the can rolls together with all its contents (circuit boards, battery etc.) but the disc stays still.

Circuit diagram

The circuit diagram of the canometer is shown in figure 1. The photo detector mentioned previously is made up from LED D2 and the photo transistor T2. Whenever the light from the LED passes through transparent section of the disc the transistor T2 will generate a pulse. This pulse is shaped by the schmitt trigger N1 and fed to the clock input of IC2

via gate N2. However, the pulse will only be allowed through N2 when the output of the flipflop, formed by N3 and N4, is high. In other words, after the start button, S2, has been depressed. If the stop button, S3, is pressed the clock pulse will be inhibited again and any reading obtained will remain on the display. The counter section of IC2 will therefore only operate after the start key has been depressed and the can is rolling. Switch S4 serves to reset the circuit.

All the functions required to process the pulse data (counter, decoder and the multiplex control circuitry for the displays) are contained in IC2. Common cathode displays are used and the decimal point of Dp2 is utilised to distinguish between metres and centimetres.

Although IC2 requires a regulated supply voltage of 5 V, it appears to work quite happily at lower voltages as well. A supply voltage slightly greater than 4 V was therefore selected so that three 1.5 V batteries (connected in series) can be used for the power source. A 9 V battery could also be used if the canometer is not going to be rolled very often. To keep dissipation down to a minimum a germanium transistor (T1) has been incorporated to stabilise the supply voltage. The circuit has only one adjustment point, potentiometer P1. This regulates the sensitivity of the photo transistor.

Construction

The complete circuit can be mounted on two printed circuit boards as shown in figures 2 and 3. The round display board is mounted at right angles to the rectangular board after which the corresponding connections are made with short wire links.

The axle for the segmented disc is mounted on the rectangular board in the position marked by a dotted line. The space with the triangular points next to it has to be removed first with the aid of a fretsaw. This is essential so that the disc will be positioned correctly between the LED and the photo transistor.

The segmented disc is illustrated in figure 5. In fact this can be carefully cut out and glued onto a circular piece of perspex with the same diameter. This is then weighted with lead or solder, bearing in mind that the completed disc must be able to pass through the slot in the board without touching the sides. Once it is mounted on the axle it must be able to turn freely.

Prior to final assembly in the can, preset potentiometer P1 should be adjusted so that the display increments by one each time a segment of the disc passes through the light beam (after S2 has been depressed of course!).

The only other requirements are that the can needs to be 'screened' so that no light can enter to cause a misreading and

1

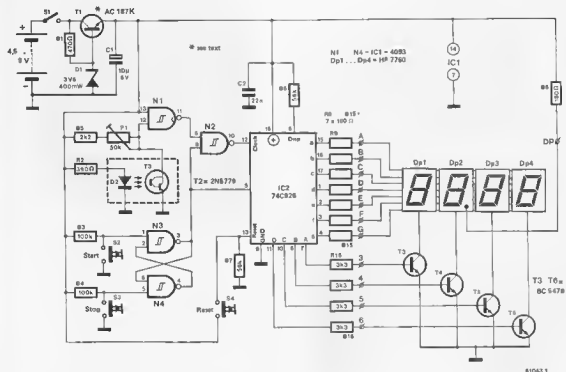

Figure 1. The complete circuit diagram of the rolling distance meter.

2

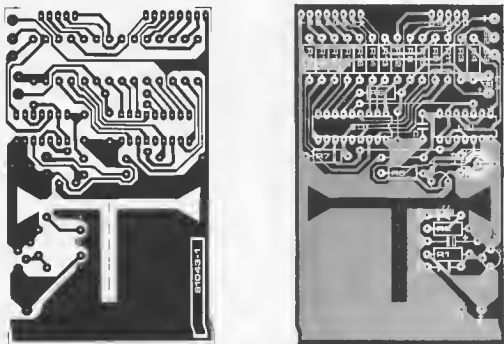

Figure 2. The printed circuit board end and component layout for the main part of the circuit. Provision has been made for mounting the segmented disc on this board.

3

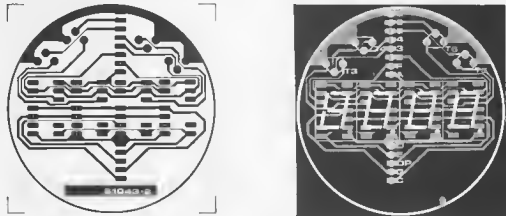

Figure 3. The printed circuit board and component layout for the display section.

4

parts list

Resistors:

R1 = 470 Ω
 R2 = 390 Ω
 R3,R4 = 100 k
 R5 = 2k2
 R6,R7 = 56 k
 R8 = 180 Ω
 R9 . . R15 = 100 Ω
 R16 . . R19 = 3k3
 P1 = 50 k preset potentiometer

Capacitors:

C1 = 10 μ /6 V
 C2 = 22 n

Semiconductors

T1 = AC 187K
 T2 = 2N5779 or equivalent
 T3 . . T6 = BC 5478, BC 107
 D1 = zener diode 3V9, 400 mW
 D2 = LED red
 IC1 = 4093
 IC2 = 74C926, 74C928
 Dp1 . . . Dp4 = HP 7760

Miscellaneous:

S1 = single pole switch
 S2,S3,S4 = push button

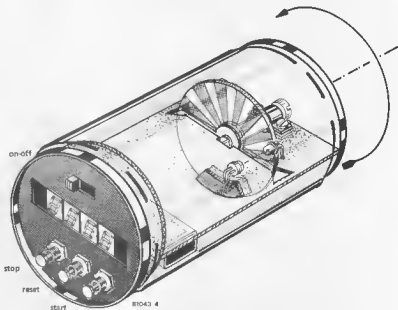

Figure 4. The construction of the canometer end and the suggested format of the disc. The letter can be cut out and pasted onto a perspex disc of the same diameter.

5



Figure 5. The segmented disc can be cut out and glued onto a circular piece of perspex.

the axle for the segmented disc must be positioned in line with the central axis of the can.

Operation

The directions for use as given by the author are so clear there is no need to add anything to them:

- Switch on the canometer
- Place the can at the starting point of the distance to be measured, press 'reset' followed by 'start'
- Roll the can as evenly as possible until the 'finish', then press 'stop', pick up the can and read off the dis-

tance measured from the display

- Note that the unit will only work correctly when the can is rolled in one direction, if the canometer is put into reverse half way through a measurement an incorrect reading will result.
- Interim measurements are also possible: 'stop' is pressed at the required point, the distance indicated on the display is noted and the can is replaced in the same position. Then press the 'start' button and continue.
- Do not forget to switch off the canometer after use.
- Roll on!

tilt

Remember the old 'ring the bell' game that consisted of a bent length of wire and a loop on a handle, where the object of the exercise was to see who had the steadiest hand? Elektor now present a very compact version of the game which simply involves the moving of a can from one place to another without it making a (somewhat terrifying) noise. The basic circuit could also be employed in many other applications such as an electronic plumb-bob or level indicator (audio spirit level?). In this particular instance the cylindrical shape of the can has been used to its fullest advantage. The most important component being a pendulum which

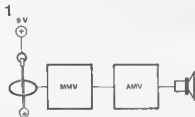

81061 1

2

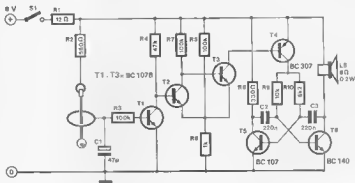

81061 2

P. Gröger

reacts to any movement of the can by swinging and thereby effectively closing a switch. As can be seen from the block diagram, the remainder of the circuit is very simple. The pendulum triggers a monostable multivibrator which in turn activates an astable multivibrator in the form of an audio tone generator.

As soon as the pendulum touches the contact loop (see circuit diagram), the electrolytic capacitor at the input of the circuit will charge up rapidly via R2. Transistor T1 will conduct and activate the Schmitt trigger formed by T2 and T3, which turns on the oscillator (T5 and T6) via transistor T4.

If the can is at rest and the pendulum no longer touches the contact loop, the electrolytic capacitor, C1, will discharge through the base-emitter junction of T1. Only when the capacitor is discharged to below about 0.7 V will T1 turn off thereby inhibiting the oscillator via the Schmitt trigger and T4. This means that the oscillator will continue to produce a noise for about 5 seconds after the can has 'settled down'. If a longer duration is required, the value of R2 can be decreased and the value of C1 increased.

The 'sensitivity' of the instrument depends on the diameter of the contact loop and its distance from the weight of the pendulum. The smaller the contact loop and the closer it is to the



81061 3

weight, the more sensitive to movement the device will be.

The circuit has high operational reliability, low quiescent current consumption and is economical to construct. Being camouflaged, the circuit has another application as a burglar alarm. Who would expect a beer can to start making a noise?

marimba can

The steel band plays a significant part in the characteristic sound of Caribbean music. The mainstay of this sound is the marimba, a steel drum with different sized indentations in the top. It is played in a manner that is a cross between the drums and the xylophone. The originals were, in fact, constructed out of old 50 gallon steel oil drums.

W. Fröse

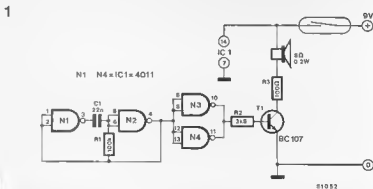

Figure 1. The circuit of the marimba can could hardly be more simple and a complete set will not cost very much at all.

2

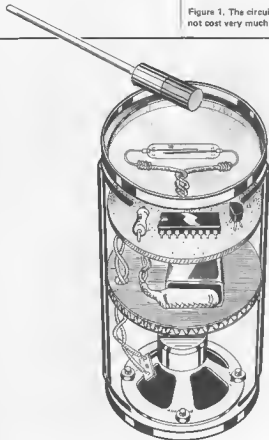

Figure 2. Construction of the marimba can is reasonably straight forward.

of tones available. Since it is possible to use any 'make' of can, a selection of different ones could be useful to make it easier to remember which can contains which tone.

As figure 1 shows, a number of cans need not be expensive even when taking into consideration the cost of the full cans in the first place. Anyway, think of the excuse we offer you, 'I am just going out to get some more cans for my marimba set'.

The CMOS 4011 IC contains four NAND gates, two of which (N1 and N2) provide an astable multivibrator to generate the tone. The other two gates (N3 and N4) are used to provide the base drive current for transistor T1 which, in turn, drives the loudspeaker. The can and the loudspeaker together act as a resonant cavity to produce the characteristic sound of the marimba. The RC time constant of the astable multivibrator determines the pitch and, using the values given (C = 22 n, R = 100 k) will be about 150 Hz. If the 100 k resistor is replaced by a preset potentiometer of the same value, it will be possible to tune the can comfortably within several octaves from the desired pitch.

Battery consumption will be very low since the reed switch only operates for a very brief period. In other words, battery life is dependant on how often you play. Once a night should be enough.

Nine assorted switches and a potentiometer provide so many variations that one and the same circuit can be used to play at least six different games: throwing dice, heads-or-tails, snakes and ladders (versus an opponent or against the on board 'computer' if desired) and two variations of the well known 'skeeet'.

As can be seen from the diagram in figure 1, the heart of the circuit is a ten channel running light: IC1 acts as a clock generator for the divide-by-ten counter IC2 which controls up to ten LEDs directly. The remainder of the circuit consists of a flipflop constructed around N1 and N2, an oscillator formed by N4 and a loudspeaker amplifier stage, T2.

To describe the complete operation of the circuit it is best to examine the operations involved in each game in turn.

multi-game can

This can is so versatile that a number of different games can be played with it and it can also be used as an egg timer. All it involves is a series of switches and some electronics to alter the characteristics of a simple running light display. The circuit also includes a modest sound effects unit to provide extra dimensions to the game being played. All the electronics involved can be squeezed onto a printed circuit board that will fit inside a 'standard' can.

R. de Boer

Throwing dice

For this game the rotary switch, S3, is placed in position 6, S2 is closed, S4 is placed in position (a) (reset), S5 is left open, S8 is placed in position (a) and the setting of potentiometer P1 is adjusted to give an output frequency of 20...30 Hz.

If switch S1 is then closed briefly the die will start to roll. After a preset roll time, adjustable by means of potentiometer P2, the result will be shown by one of the first six LEDs lighting (D10...D15).

Operation

Since the rotary switch, S3, is in position 6, the counter will always be reset when it reaches this number (via T3 and S4). Providing a clock signal is present therefore, IC2 will keep counting from 0...5.

When S1 is closed, capacitor C1 will charge up rapidly via R1. Transistor T1 will then start to conduct, activating the clock generator IC1. This if course starts the die (in fact a six channel running light) rolling at a speed determined by the setting of P1. When S1 is released, capacitor C1 will slowly discharge through P2 and R5. Therefore, transistor T1 will gradually turn off and the die will slow down before coming to a halt. The period of time that this takes is determined by the setting of P2.

The roll of the die is rendered audible by feeding the clock pulses generated by IC1 to the loudspeaker interface via diode D26.

Heads-or-tails

Now that we have discovered how to throw dice with this circuit, the following game will be as easy as falling off a log. The operation is virtually identical. The only difference being that S3 is

now moved to position 2. This means of course that the counter can only count to two and only two LEDs can light: D10 for 'heads' and D11 for 'tails' - or vice versa.

Snakes and ladders (1)

For this game the positions of the switches have to be altered slightly: S2 and S5 will be 'off', S3 in position 9, S4 in position (b) (stop) and S8 in position (a). Potentiometer P1 should be adjusted to give a frequency of around 1 Hz.

During this game, two players may alternately 'climb' one, two or three rungs of a 'ladder' (the ladder is the row of LEDs). This is done by keeping S1 closed until the LEDs indicate the number of rungs that the player has climbed (the number of rungs to be climbed must be stated before the player presses S1). The player to cause the last LED to light is the winner and this is proclaimed by a squeaking tone from the loudspeaker.

Operation

Again a running light display is used, only this time at a much lower frequency. Switch S1 starts the oscillator and causes the LEDs in the row to light one after the other. When output 9 of IC2 becomes high the last LED in the row will light and, via S3, T3 and S4, the clock enable input of the counter will also go high. This causes the counter to stop. At the same time, the oscillator formed by N4 is enabled via D28. The output of this oscillator is made audible via D27 and the loudspeaker amplifier T2. The on/off switch, S9, can be used to reset the circuit.

Snakes and ladders (2)

This is virtually the same game as before, but this time the on board 'computer' is the opponent. Whenever it is the 'computer's' turn, S8 is switched to position (b) for a short period to obtain its 'opinion'. One of three LEDs will light to indicate whether it wishes to climb one, two or three rungs of the ladder. When S8 is moved back into position (a), switch S1 is operated to carry out the 'computer's' request. After that it is the turn of the human once more.

Although the computer isn't up to much electronically speaking, you will soon find out that it can be a formidable opponent to beat! It is guaranteed to win in any game that it is allowed to start (every other game) provided there is no cheating!

Operation

Diodes D1...D9, together with S8, constitute the 'computer'. When S8 is switched to position (b) one of the LEDs D11, D12 or D13 will light to indicate that the computer wishes to ascend one, two or three rungs respectively. In this position, via S81, the

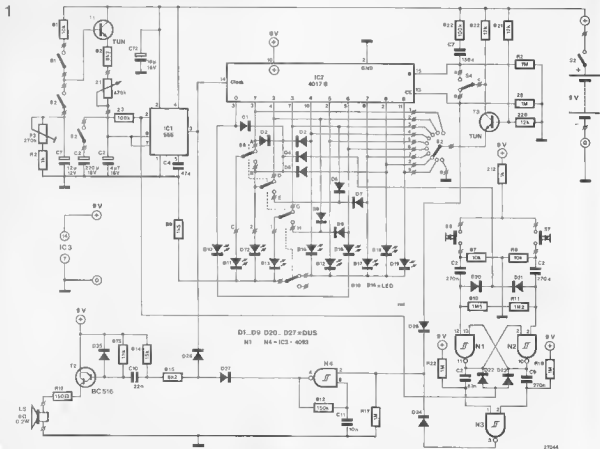

Figure 1. The electronic interior of the multi-game can. It all centres around the running light constructed around IC1 and IC2.

'ladder' LED is suppressed to avoid confusion.

Skeet (1)

This game requires yet another combination of the switches. This time place S1 to the 'on' position, S3 to zero, S5 to 'off' and S8 to position (a). The speed of the game can be adjusted by means of P1 as required (between about 3... 30 Hz).

The object of the game is to 'shoot' the light running from left to right on the row of LEDs. When the sixth LED in the row lights (D15), either S6 or S7 must be depressed very quickly. If one of these switches is depressed at exactly the right moment, a buzz will be heard and the target will remain stationary for a split second after which it will continue on its journey.

Operation

As a result of depressing either S6 or S7 a pulse is generated which will have absolutely no effect provided that output 5 (pin 1) of IC2 is low. If this output was high, however, the pulse will be allowed to pass. The output of N1 or N2 (depending on whether it was S6 or S7 that was depressed) will then go low for about 1½ to 2 seconds (determined by the networks C5/R10 and C6/R11). During this time the clock

generator is inhibited via D22 or D23 so that the target is stopped.

If the output of N1 goes low, the output of N3 will go high for about half a second (determined by C8/R4). If on the other hand, it was the output of N2 that went low, the duration of the pulse at the output of N3 will be set to about one second by C9 and R18. In either case, the oscillator (N4) will be enabled to accompany each 'hit' with a buzzing tone — a short one if S6 was pressed and a longer one if S7 was depressed.

Skeet (2)

Again, the target is shot as it moves from left to right across the display, but now two players are involved. This gives rise to a great deal more excitement.

Both players have a separate button, either S6 or S7. The object of the exercise is to see who is the fastest shot. This will be indisputably determined by the duration of the buzz — as explained above. (Note: the switches must be released immediately otherwise there will be no audible difference between the length of the tones produced by S6 and S7).

Operation

The flipflop, N1/N2, removes any doubts concerning which player has the

fastest reactions. As soon as one of the pushbuttons is depressed the output of either N1 or N2 will go low and inhibit the other gate. Thus, the other player's shot will have no effect whatsoever. If both players fire too early, or too late, the target will simply run on.

Egg timer

As mentioned earlier, the multi-game can can also be used as an egg timer. For this application switches S1 and S5 are placed in the 'on' position, S2 to 'off', S4 to (b) (stop), S8 to (e) and S3 and P1 are set as required.

This particular egg timer again utilises the running light display (did you expect anything else?), but this time of course it operates at a very, very low frequency. In fact, more of a crawling light! With S5 closed an extra large capacitor (C2) is included in the frequency determining network of the clock generator. According to the setting of P1 it can now take between 1½... 80 seconds for the 'snail pace' light to move from one position to the next. Absolutely ideal! For an egg timer, or any other kind of timer for that matter. If, for instance, P1 is set to give a pulse every 30 seconds and S3 is switched to position 6 an alarm tone will sound after 3 minutes (6 x 30

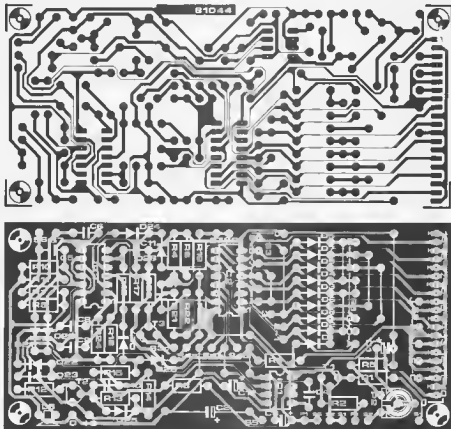

Figure 2. Due to the miniscule proportions of the printed circuit board and the number of switches required, it may be an idea to think about using an empty sardine can rather than a beer can.

Parts list

Resistors

R1,R7,R8 = 10 k
 R2,R15 = 8k2
 R3,R22 = 100 k
 R4,R6,R17,R18,R24 = 1 M
 R5,R19 = 1 k
 R9 = 1k5
 R10,R11 = 1M5
 R12 = 150 Ω
 R13,R14 = 15 k
 R16 = 150 k
 R20,R21,R23 = 12 k
 P1 = 470 k potentiometer
 P2 = 470 k preset potentiometer

Capacitors:

C1 = 22 μ /16 V
 C2 = 220 μ /16 V
 C3 = 4 μ 7/16 V tantalum
 C4 = 47 n
 C5,C6,C7 = 270 n

C7 = 150 n
 C8 = 92 n
 C10 = 22 n
 C11 = 10 n
 C12 = 10 μ /18 V tantalum

Semiconductors*

T1,T3 = TUN
 T2 = BC 510
 D1...D9, D20...D28 = DUS
 D10...D19 = LED red
 IC1 = 555
 IC2 = 4017 B
 IC3 = 4093

Miscellaneous

S1,S2,S5,S9 = SPST switch
 S3 = 10 position rotary switch
 S4 = SPDT switch
 S6,S7 = pushbutton
 S8 = 4 pole double throw
 LS = 0.2 W/8 Ω loudspeaker

seconds). All sorts of times can be preset in this manner — within reason of course!

Construction

There is no constructional drawing for this particular project, but it should not be too difficult to manage without. Unlike some of the other circuits published in this issue, very little mechanical knowledge is required to construct it. The loudspeaker is best mounted on the base of the can. The ten LEDs should be mounted in a neat row so that they are visible from the outside of the can — either on the side or on top underneath a perspex cover. All the switches as well as the potentiometer P1 should be accessible from the outside. The remainder should not cause any problems, because a printed circuit board has been designed for the complete circuit (see figure 2). This board is small enough to fit inside a normal can. The supply may be provided by a single 9 V battery. Being so small, it can easily be squeezed in somewhere. **M**

mobile can

R. Wenzalburger

the true 'tin robot'

Although no great claims are being made as to the practical

applications of this circuit, the final result is both interesting and amusing. The circuit also provides a peek (albeit a very small one!) at the amazing sciences of robotics and cybernetics. This (almost) cybernetic can is able to move forwards or backwards at the sound of a handclap. The only criterion is that the handclap must be loud enough for the can to 'hear' it. As the mechanics and 'brain' of the can are completely hidden from view, your friends will be completely mystified by the can's mobility.

How does the can receive this gift of mobility? The circuit diagram of the electronic contents of the can is shown in figure 1. The soundwaves from the handclap are detected by a crystal microphone and amplified up to 10,000 times by the chain of gates N6, N1...N3. The gain of the amplifier stage can be adjusted by means of P1. The amplifier section is made up from CMOS gates — a little known application — as one IC contains a number of gates and the use of CMOS technology keeps the current consumption down to a minimum.

After amplification, the signal is rectified by Q1 and shaped by N7. The resultant pulse performs four operations simultaneously: flipflop FF1 is reset and thereby transistor T5 is turned on via N10. The emitters of T3 and T4 will then be effectively grounded. A second handclap will have no effect on FF1 at this stage.

The output of flipflop FF2, on the other hand, will change state every time a handclap command is received. This second flipflop determines the direction in which the motor, M, will turn. This change in direction is achieved with the aid of the transistor bridge circuit consisting of T1...T4. When the Q output of FF2 is low, transistor T3 is turned on and transistor T2 is turned off (both via N9). Simi-

larly, as the Q output of this flipflop will be high at the same moment in time, T1 will be turned on and T4 will be turned off (this time via N8). This means that the motor current will flow through T1, T3 and T5. When the outputs of FF2 change state transistors T2 and T4 (and T5 of course) will conduct and the current through the meter will flow in the opposite direction.

The monostable multivibrator constructed around N4 and N5 is also triggered by the pulse from N7. This monostable will remove the reset from the counter, IC1, for about three seconds. If four pulses (handclaps) reach the clock input of IC1 during this time, the Q4 output of the counter will go high and, via FF1 and N10, transistor T5 will be turned off. In other words, after clapping four times in a row, the can will stop moving altogether. Finally, the network C9/R12 constitutes a 'power on reset' circuit which ensures that no current will flow through the motor when the power is first applied to the circuit. Similarly, C10 and R18 reset the counter (IC1) when the circuit is first switched on.

Mechanical structure

The circuit of the mobile can can be constructed on two round boards which have the same diameter as the can. First

1

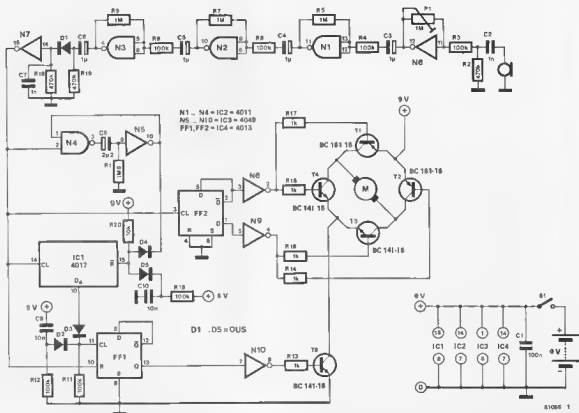

Figure 1. The circuit diagram of the mobile can contains two points of interest: the (analogous) amplifier chain that uses digital components and the transistor bridge circuit used to change the direction of rotation of the motor.

the can must be cut into two parts (see article on can opening). Figure 2 shows the mechanical construction of the mobile can.

The 9 V battery can be fixed to the lid of the can (with double sided tape, for instance). The microphone can then be mounted next to it behind the opening where the ring pull used to be. The two circuit boards can then be fixed to the walls of the can slightly lower down. A small DC motor (6...9 V) is anchored to the bottom section of the can. A weighted disc is then attached to the motor's spindle.

This weighted disc is the only special component used and, as it is most unlikely that such a piece of equipment is laying at the bottom of your junk box, a word of explanation about its construction would not be amiss.

The disc can be cut from veroboard, perspex or other similar material. The diameter of the disc should be 1 cm less than the diameter of the can. A hole is drilled in the centre to accept the motor spindle (this should be a fairly tight fit). Four holes are then drilled near the outside of the disc so that they are geometrically opposite each other (think of the points of a magnetic compass). These holes will then serve as the anchorage points for the four weights. The latter can be made from (rolled) lead and should be secured with nuts

and bolts. The whole assembly should weigh about 100...200 g and should be as finely balanced as possible. It may require a substantial amount of experimenting and adjusting until the disc rotates accurately enough. In any case, it may be necessary to attach small counterweights to the lid and/or base of the can to compensate for any inaccuracies in the final assembly of the complete unit.

Switch S1 is a miniature toggle switch mounted on the base of the can. Alternatively, a mercury switch can be incorporated so that power is applied to the circuit when the can is laid down. It is a good idea to give the mobile can a complete test before fitting the two sections back together and fastening them securely in a similar manner to that described in the can opening article (candid comments). If everything goes according to plan you can invite your neighbours around for a demonstration of the beer rolling home after you instead of the (more usual?) other way round. M

2

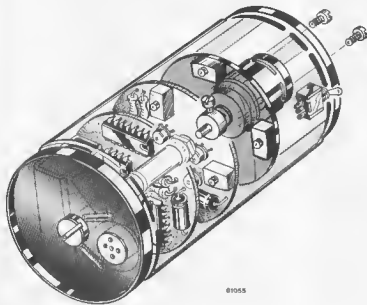

Figure 2. The mechanical construction of the mobile can is quite simple. The weighted disc (see text) must be well balanced.

din can

L. van Ginderen

The number of possible applications for noise emitting circuits is absolutely astounding — far too many to be listed in the available space. This is particularly true of the unit described here. Although not exactly original in concept, the can is capable of producing a din which will almost certainly leave your ears tingling for quite a while.

1

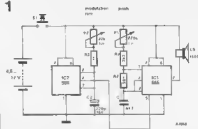

Figure 1. IC1 generates a tone which is modulated in frequency by IC2.

The circuit consists of very few components which together form a 'Kojak' type siren. The majority of the work is done by two (555) timer IC's. The first (IC1) generates an audible tone whose frequency can be adjusted by means of potentiometer P1. The output of this timer is fed directly to a loudspeaker. The loudspeaker however does not emit a constant tone, as IC1 is modulated by a low frequency sawtooth waveform generated by IC2. The frequency of the sawtooth can be regulated by means of potentiometer P2. As a result, the complete circuit generates a frequency modulated signal which sounds just like a siren. The pitch can be adjusted with P1 and the modulation rate with P2. The circuit is compact enough to be mounted in a can together with the batteries and loudspeaker and can be used quite successfully on children's cycles, skate boards etc. or as an 'anti-attack' alarm. M

for blood!! The ring pull can then be solidly glued from the inside. To make sure that the centre of gravity is as high as possible (so that the can falls over easily) the battery should be attached to the lid (with double-sided tape, for instance). This is illustrated in figure 2. The pendulum is very simple in construction. A steel rod is glued (or bolted) to the moving plate of a (cannibalised) 6 V heavy duty relay. A piece of lead is then attached to the top of the rod. The lead should be available from your local steeplejack, alternatively a fishing weight will suffice. The required weight of the weight will have to wait to be established by trial and error.

Obviously, the centre of gravity is also effected by the components on the board (see figure 3). Capacitor C7 in particular is rather large so it should not be mounted on the board but should be placed somewhere near the battery or the relay.

The sensor S2, must be well concealed. By far the easiest solution is to cut the can in two and form the sensor by using insulating tape to rejoin them (see figure 2) making sure that the two sensor halves are sufficiently separated. A solder tag on both sections is sufficient to provide the connections for the sensor.

Of course, the genie is its own worst enemy, since falling over can do it a great deal of damage. To avoid too many dents it is a good idea to provide the can with a few rubber rings (elastic bands) to soften the worst blows. The

2

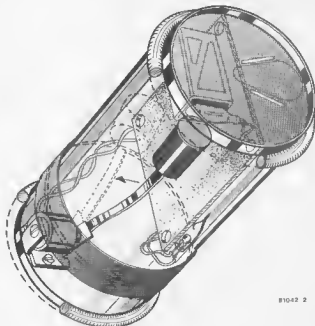

81042 2

Figure 2. The mechanical structure of this 'intelligent' can demands a fair amount of ingenuity. The pendulum should be vertical at rest.

can will then be much less likely to suffer 'brain damage'.

Remarkably, there is no requirement for an on/off switch. The quiescent current

of the circuit is extremely low. Since this depends on the leakage current of T1, this transistor should be a reliable BC 558. In other words, no TUN!

3

Parts list

Resistors:

R1 = 10 k
R2 = 6M8
R3 = 1 M
R4 = 100 k
R5 = 22 k
R6 = 470 k
R7 = 4k7
R8 = 390 Ω
R9 = 100 k
P1 = 1 M preset potentiometer

Capacitors:

C1 = 100 p
C2, C3 = 100 n
C4 = 3 μ 3/10 V tantalum
C5 = 10 μ /10 V tantalum
C6 = 220 n
C7 = 4700 μ /10 V

Semiconductors

T1 = BC 558B
D1 ... D3 = DUS
IC1, IC2 = 4011
Th = thyristor 60 V/2 A

Miscellaneous:

Re1 = 6 V relay

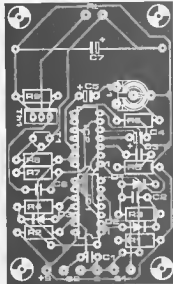
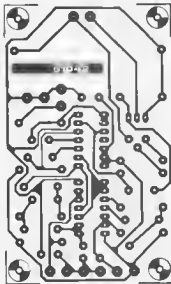

Figure 3. The printed circuit board and component overlay of the artificial 'brain'.

sound to subside after some time. The circuit's sensitivity can be affected by changing R22, if necessary.

2

The case

Figure 2 shows how the circuit is mounted in the can. The lid has been sawn off and holes have been drilled in the lower side for the loudspeaker. On one side of the can there are the touch contacts and on the other the thumb key. The sensors may be drawing pins.

The printed circuit board and the component overlay are illustrated in figure 3. This fits the can exactly. The on/off switch is mounted in the lid together with a socket for a standard jack plug. The NTC resistor is connected to the pins of the jack plug. A length of pipe is glued onto it and provided with an opening just in front of the NTC. Figure 2 is a drawing of the mouthpiece in greater detail.

Now, how to play the instrument! Switch the supply on, place your thumb on the earth sensor and one or more fingers on the others. Then blow as hard as you can until a sound is produced. After a while it's good to remember that the blow threshold can be preset with P2. Please, don't take it to Glasgow!

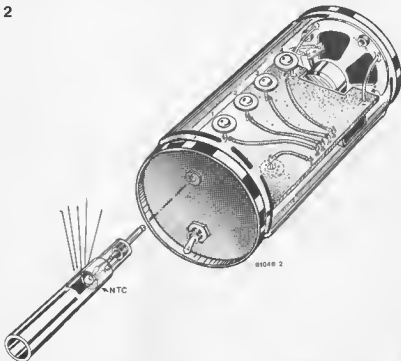

Figure 2. The drawing shows what the structure will look like, once the instrument is built and also how the mouthpiece is constructed.

3

Parts list

Resistors:

- R1,R3,R5,R7 = 10 M
- R2,R4,R6,R8,R15,R22 = 1 M
- R9 = 22 k
- R10 = 6k8
- R11,R12 = 18 k
- R13 = 8k2
- R14 = 2k2
- R16 = 15 k
- R17 = 1k5
- R18 = 47 k
- R19 = 1k5 NTC
- R20,R21 = 4k7
- R23 = 3k3
- R24 = 5k6
- R25 = 820 Ω
- P1,P2 = 5 k preset potentiometer

Capacitors:

- C1 = 100 n
- C2 = 1 μ/16 V
- C3 = 4μ7/16 V
- C4 = 100 μ/16 V

Semiconductors

- T1,T2,T3 = 8C 5478
- D1 .. D8 = 1N4148
- D9 = zener diode 5V6, 400 mW
- IC1 = 4049
- IC2 = 741

Miscellaneous

- S1 = single pole switch
- LS = 8 Ω/0,2 W Loudspeaker

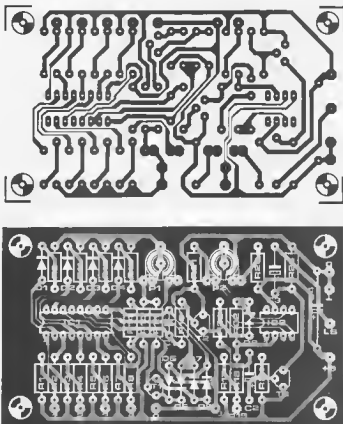

Figure 3. The printed circuit board and component overlay for the diagram given in figure 1.

simple remote control

Remote control systems have gained a foothold in all walks of life, whether it be for reasons of comfort or practicality. Probably the best known and most used system is the remote control of domestic television sets, but of course there are many other possibilities. Elektor has concerned itself with the subject on several occasions in the past and is pleased to present yet another variation on the theme — one which will benefit the ill and disabled in particular.

F. Kasparec

Conventional remote control transmission units are often adorned with a large array of buttons or switches, meaning that a certain percentage of operational errors cannot be avoided. The alternative introduced here requires only one pushbutton, thereby enhancing its security and ease of operation considerably. All that is required is a glance at the descriptions on the can

The transmitter

Figure 1 gives an impression of what the transmitter unit looks like. It is constructed from a standard sized beer or soft drinks can with the text 'Source I . . . Source IV' written on the outside to indicate the four possible functions. Naturally, the wording could be altered to: lights, television, radio,

corresponding to the four possible functions, and then press the button.

The message is transmitted ultrasonically for two reasons:

1. the G.P.O. and the Home Office are very particular about the use of radio waves.
2. if an infra-red system was used the energy consumption would be very high unless a lens was incorporated.

heater, for instance, if required. If the transmitter is only to be used to control four light sources, the familiar dimmer IC, S 566B, could also be incorporated into the lighting system. The single pushbutton can be labelled 'PRESS' if desired. So much for the exterior.

The inside of the remote control transmitter is very compact. In addition to the transmission electronics there is

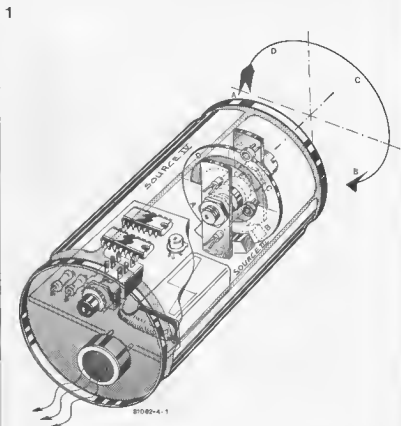

Figure 1. The transmitter for the remote control system can be incorporated (at a pinch!) in a 'standard' can. All the components should be firmly mounted, with the exception of course, of the revolving encoder disc.

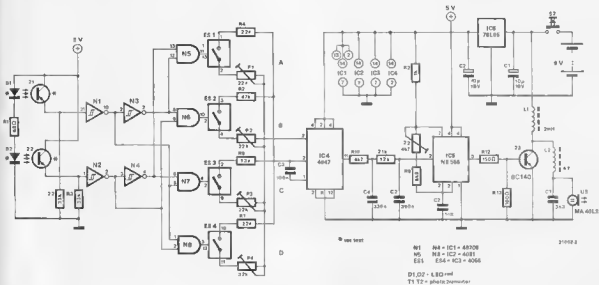

Figure 2. The circuit diagram of the simple remote control transmitter. Two photo detectors, together with an encoder disc, control which of the four channels is to be operated.

an optical encoder which selects one of the four functions to be transmitted.

The entire circuit is shown in figure 2. The encoder consists of two photo detectors (D1/T1 and D2/T2) as well as the encoder disc (see figure 3). Two LEDs are used as light sources and virtually any type of photo transistor can be used for the receptors. An interesting prospect would be to incorporate 'ready made' photo detectors, where the LED and photo transistor are already integrated into a compact assembly.

The encoder disc is positioned in the can in such a way that it can rotate freely between the two photo detectors. The position of the encoder disc will then determine whether both photo transistors are turned on, turned off, or whether just one of them is turned on. The two-bit information thus obtained can then be deciphered by the following demultiplexer. This is accomplished with the aid of inverters N1...N4 and the AND gates N5...N8.

The decoded 2-bit information is then passed to the MOS switches S1...S4 where S1 corresponds to position A of the encoder disc, S2 to position B and so on.

The frequency of the astable multivibrator constructed around IC4 is determined by the capacitor C3 and by the resistance value connected between pins 2 and 3. This resistance value will depend on which of the four switches, S1...S4, is closed. If, for instance, switch S1 is closed, the combined value of P1 and R4 will determine the frequency of oscillation. As the preset values of potentiometers P1...P4 will

each be different, there will be four different modulation frequencies available at the output of the AMV (pin 11). The output signal is fed to the modulation input of a 555 timer (IC5) via a low pass filter. The timer is also connected as an astable multivibrator. The frequency of the second oscillator is modulated by the signal from the first. The resultant (FM) output signal at pin 3 of IC5 is fed to the ultrasonic transducer via transistor T3 and the coil L2.

The on/off switch for the unit is a pushbutton (S5). It has two functions. It connects the power supply to the circuit and simultaneously causes the desired function to be transmitted. This guarantees that current is drawn from the power supply only when the remote control unit is actually operated.

With regard to the receiver, the circuit published in the 'remote control slide projector' article (Elektor October 1980, page 10-24, figure 3) could be a possibility. Depending on how it is to be used, it may have to be modified here and there.

A few other hints

The encoder disc can be made from a piece of relatively thin perspex with a diameter of not more than 5 cm. The necessary markings can be made up from black self-adhesive tape and stuck on to the disc (see figure 3). The encoder disc must be mounted between the two photo detectors in such a way that it can turn freely and produce the correct 2-bit information.

Although the disc is mobile, it should

3



Figure 3. For two-bit information the construction of the encoder disc will be relatively simple.

not be able to turn when the can is swivelled horizontally on its axis. To ensure that this does not happen, the hole drilled in the disc near to the edge should be used as a fixture for a counterweight. The weight will then keep the disc in a fixed position even if the can is swivelled rather abruptly. Suitable counterweights can be made up from washers held by a nut and bolt. When the can is rotated the counterweight should not touch the board at any position!

The printed circuit board and the battery should not be allowed to roam around loose inside the can. It is best to pad the inside with foam rubber or some other suitable material. The constructional drawing of figure 1 should answer any other queries regarding the contents of the remote control transmitter.

Finally, the markings on the outside of the can. It is obviously important that each one should correspond to the command executed. Once the transmitter is complete and the receiver has been installed, you're ready to go: just look at the function you require and press the button.

canine defence

Pets can be found in any shape or size as the recent pet rock craze in the USA testifies. Some people find warmth and companionship in a can (it takes all sorts . . .). This article is for those readers who wish to protect their pet. No longer shall you can be completely defenceless against the rough and tumble of everyday can life and its most feared enemy, the young human male.

T. Stokes

The canine defence is in two parts, first line defence and second line defence. The first is in fact operating permanently in the form of a flashing light. This will enable you to locate your pet can at night and has the added bonus of indicating to other humans that your can is alive and well. This part of the circuit uses the well known LM3909 to flash an LED mounted in the top of the can. The value of timing capacitor C1 can be varied to alter the flash rate if required.

The second part of the circuit is an alarm. When the can is tilted or in any

ponents can of course be altered to suit the individual reader, although the din produced by the values given should be enough to protect most cans.

A supply voltage of 4.5 volts is required and this can be supplied by means of three HP7 batteries connected in series. Since the quiescent current drain is very low an on-off switch is not necessary and the batteries can be carefully soldered into the circuit with short connecting leads.

Construction

To fit the circuit the bottom of the can must be opened. First, try to persuade your pet that it is in his/her own interest that this operation be carried out. The article on can 'surgery' should be followed carefully with particular attention paid to the anaesthetic. This can take the form of medicinal liquids, brandy for instance, with the added advantage that it does not necessarily have to be wasted. Two or three 'rinses' could suffice although some readers may prefer more.

The circuit may be assembled on Veroboard (or similar) and fixed to the inside of your pet with 'Blu-tack'. None of the components are in any way critical and are available from most suppliers.

An 80 ohm loudspeaker will give the maximum output but any speaker will do providing it will fit inside the can. The total resistance of the speaker and R6 should be about 100 ohms. Remember to drill a few holes in the top of the can before fitting the speaker.

For the owners 'who have everything', two (or even more) complete circuits could be fitted into your pet with one speaker at the top and the other at the bottom, if you'll pardon the expression. On a serious note, the completed can without the flashing light, would make a novel 'burglar alarm' if placed inside the bedroom door. But of course, it could have hundreds of uses . . .

other way disturbed the mercury switch MS will activate the monostable formed by N1 and N2. This will in turn start the oscillator (N3/N4) and a continuous tone will be produced for about ten seconds before switching off. This timing is determined by the values of R3 and C2 while the frequency of the oscillator depends on R4 and C3. The values of all these com-

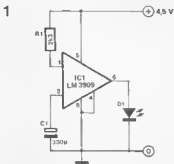

Figure 1. The first part of the circuit uses the LM3909 LEO flasher IC.

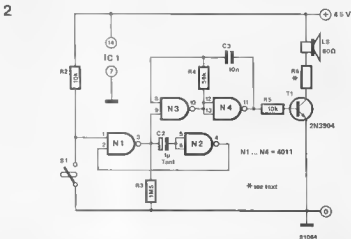

Figure 2. Any type of mercury switch can be used in the alarm circuit. Care should be taken to protect it from damage inside the can.

electronic garden gnome

For the keen gardener, a moisture indicator with a LED display could be a very useful aid. It is simple and cheap to build and can be used anywhere including the greenhouse. For the gnomelass garden it can even be equipped with a rod and line . . .

W. Holdinghausen

It would appear that garden gnomes are a disappearing commodity in the contemporary garden. A suggestion that the majority left in the early seventies with gnomenclature of where to was dismissed. However, the replacement presented here is far more progressive than its old counterpart and of course, it will not budge an inch (unless kicked).

Using cans for aesthetic purposes is by no means new. The idea was one among many that brought Andy Warhol to fame (and riches) in the sixties. For the purposes of this article, the can is ideal. It is water-proof, readily obtainable and can be purchased full of all kinds of beverages. All it requires is emptying to make the perfect garden gnome.

Our gnome contains an electronic circuit (of course) designed to measure the moisture content of the top layer of soil. Indication to the gardener is by means of LEDs allowing him to see at a glance if watering is required. If painted in frightening colours, the can will also serve to scare off birds provided enough of them are used. Even better would be to include an acoustic circuit, examples of which may be found elsewhere in this issue. Although, whoever heard of a frighteningly coloured gnome with lights on its face measuring moisture while scaring birds and fishing?

The circuit diagram

Enough about gnomes and on to the circuit which uses an analogue switch as the heart of the moisture detector. Between the two sensor probes, the soil will represent a resistance R_E with a value dependant on its moisture content. The potentiometer P1 together with R_E constitutes a voltage divider with its centre at the control input of the CMOS analogue switch ES1.

As the soil dries out, the value of R_E will rise causing an increase in the control voltage of ES1. When this reaches a level of about two thirds of the supply voltage, ES1 will close and be latched

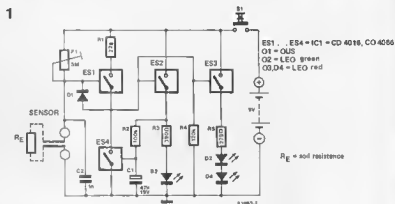

Figure 1. The electronic garden gnome is a soil moisture sensor using LEDs that flash when the garden needs watering.

2



Figure 2. The drawing shows an up-to-date garden gnome prototype. The facial features are provided by three light emitting diodes and a switch.

by D1. At the same time ES2 and ES3 will also close lighting LEDs D2 . . . D4. The capacitor C1 will then charge via ES2 and R2 to about 6 volts. When this level is reached, ES4 will switch the control inputs of ES2 and ES3 to zero until C1 is discharged again via R2, R3 and D2. All this causes the LEDs to flash on and off to a three second cycle. If the garden is now watered, the increase in moisture content of the soil will lower the resistance of R_E thereby switching off ES1.

The threshold at which dryness is indicated is adjustable by P1. The correct level depends on the type of soil, the distance between the probes and the amount of growth in the soil. Adjustment can best be determined by experiment. Switch S1 is the test button and pressing this will show if the water can be needed.

It's amazing that it takes science (and Elektor) to find out that an ohm or two in the garden can protect your plants from withering. ✻

market

Low cost 2716 EPROM programmer

A low cost programmer for use with INTEL 2617 EPROM memories has been introduced by Technova Developments Ltd. The unit is particularly useful for the development engineer wishing to modify an existing program.



Features of the programmer include automatic address increment after writing, address selection for data verification with address increment/decrement, and the ability to correct errors before entry into the EPROM. The length of the programming pulse is crystal controlled for reliable programming.

Technova Developments Ltd,
Francis House,
Blaisfield Heath,
Norwich, Norfolk, Nr 13 4SF.,
Tel. (0603) 712288

(1709 M)

10-bit, low cost, high speed, digital-to-analog converter

Precision Monolithics Inc. announces the addition of the DAC-101 to its line of precision, high-quality digital-to-analog converters. The DAC-101 is a 10-bit digital-to-analog converter that offers precision, high reliability, and high speed at low cost for applications having a limited temperature range.

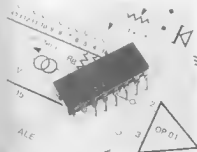

The DAC-101 offers an internal precision reference, a high stability thin-film R-2R ladder network, and a 0 to 2 mA current output for 0 to 10 V outputs. Fast settling time of 200 ns typical and low power consumption of 200 mW typical are combined in a 16 pin DIP package. Non-linearity grades are 0.1% maximum, 0.2% maximum, and 0.3% F.S. The DAC-101 operates over a supply range of ± 6 V to ± 18 V and can directly accept DTL and TTL logic inputs; CMOS logic are easily adapted.

The high reliability of the DAC-101 is enhanced by 100% burn-in, 100% stabilization bake, 100% centrifuge, 100% temperature cycling, and 100% fine and gross leak per MIL-STD-883B.

Precision Monolithics Incorporated,
1500 Spaca Park Drive,
Santa Park Drive,
Santa Clara,
California 95050,
Tel.: (408) 246-9222,
TWX 910-338-0528,
Cable Mono

(1720 M)

market

Jubilee cases

West Hyde Developments, the Aylesbury based specialists in electronic packaging, have recently introduced the 'Jubilee' range of cases. There are two new cases in the range highly suitable for visual display units, video terminals, TV games, keyboards and micro-processors.

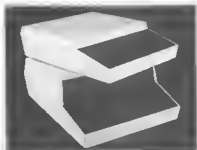

Made in tough, lightweight and flame retardant PPD structured foam (Noryl) by an injection moulding process, both cases are easily machined using ordinary tools. The standard finish is textured light grey, with a textured black keyboard plate.

VDU TVT1 Micro-Computer Enclosure

A case with a flat top behind the keyboard panel. Top height 35 mm, overfluff height 137 mm. The base moulding has ribs and bosses for component mounting, ventilation slots, and a 112 mm diameter fan opening (four fixing holes on a 148.5 mm diameter circle).

VDU TVT2 Micro-Computer Enclosure with screen

The dimensions for this case are as per the

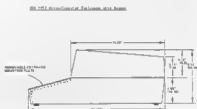
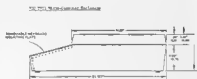

VDU TVT1, except for maximum case height 206 mm, the height at the rear being 181 mm.

West Hyde Developments Ltd.,
Unit 9,
Park Street Industrial Est.,
Aylesbury,
Buckinghamshire, HP20 1ET
Tel.: Aylesbury (0296) 20441,
Telex: 83570.

(1721 M)

41612 style socket connector

The latest addition to the range of 3M Scotchflex insulation displacement connectors is the 3553 64 socket connector which has been designed to meet the requirements of the DIN 41612 specification. It has two rows of contacts with $\cdot 100''$ by $\cdot 100''$ spacing.

The 3553 is available in versions with or without mounting flanges and is fully polarised on assembly. Strain relief clips and pull tabs are also available if required.

A new locator plate - the 3443-64S has been designed specifically for both versions of the 3553 connectors. It is supplied with a shim already fitted, so that the Scotchflex Assembly Press operator can change the locator plate without having to adjust the height of the press. The plate fits all Scotchflex assembly presses.



The 3553 socket connector is fully compatible with standard DIN 41612 style header-connectors available throughout the industry and complements the other Scotchflex DIN 41612 style, the 3332 with a 100" by 200" spacing which is already available.

3M United Kingdom Ltd.,
3M House,
PO Box 1,
Bracknell,
Berkshire RG12 1JU.
Telephone: Bracknell (0344) 58436.

(1713 M)

market

SRQ series BCD and BCHEX miniature programme switches

Ambit's data products division now offers a neat solution to 'on-card' programming via BCD and BCHEX with a range of switches for either vertical or horizontal mounting. For most data applications, this type of switch is far more satisfactory than DIL switching — as well as being cheaper.



The SRQ series are suitable for a variety of applications, including programming frequency synthesizers, cash registers, timing devices, coin operated machines, computer games etc.

Ambit International,
200 North Service Road,
Brentwood,
Essex CM14 4SG,
Tel.: (0277) 230909,
Telex: 995194 Ambit G.

(1719 M)

Mains plug/transformer unit

Light Soldering Developments Ltd. are introducing a very useful combined mains plug and transformer unit, allowing the use of low-voltage soldering irons directly from the 240 volt mains.

The DOHMPug has a tough moulded polypropylene case, with integral pins to fit



the standard 13 amp mains socket. It contains a vacuum-impregnated double-wound transformer, giving 40 watts output at 24 volts. Low-voltage soldering irons, heated wire strippers, etc. up to 40 watts loading may be wired into the special detachable output lead of the DOHMPug, which is then plugged directly into a 240 volt mains socket. There can be no danger as the DOHMPug provides only low-voltage output. The transformer windings are protected by a 250 mA cartridge fuse. A particularly useful application is the operation of the LITESOLD LE40 24 volt electronically temperature controlled soldering iron, where the use of the DOHMPug avoids the need for a much larger and more expensive power unit, and provides in effect a totally safe and portable 'mains' electronically controlled iron, as illustrated in the photograph.

Light Soldering Developments Limited,
Spencer Place,
97/99 Gloucester Road,
Croydon, CRO 2DN, England
Telephone: 01-689 0574,
Telegrams: Litesold Croydon,
Telex: 8811945

(1718 M)

market

New pocket-size, hand held-box

A pocket size, hand-held box, ideal for housing remote control handsets, instruments

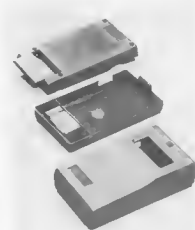

etc., is the latest addition to the Vero range of plastic enclosures.

It incorporates a 20 x 50 mm cut-out slot which may be used for fitting a VOU panel or switches and a 12 x 35 mm recessed panel for labelling. A circuit board 71 x 107 mm can be accommodated in the top section of the two part body by the use of four self-tapping screws, whilst the bottom section will house a board of 56 x 105 mm. The two sections snap together and are secured by four screws which enter through the base, when this is done there is an overlap which gives the box a rugged strength and at the same time soundly seals the inside circuitry. There is an integral battery compartment which will accept EP3 or a nickel cadmium stack of 25 x 45 mm, it has a slide-off cover which allows easy access for insertion and removal of batteries.

This attractively styled enclosure is moulded in high-impact polystyrene which has a textured, non-slip finish to aid handling and minimise scratching.

Vero Electronics Limited,
Industrial Estate,
Chandler's Ford,
Eastleigh,
Hampshire,
SO5 3ZR

Telephones: (0703) 66300

(1716 M)

High profile DILswitch

A new 3 pole way, high profile DILswitch has been added to the ERG DIL 16 range of dual in-line switches. The body measures 20.5 long by 8.5 mm deep including the actuator which protrudes above the main body by 2.6 mm.



Aimed at front panel switching applications where space is at a premium, this new component has gold plated contacts with ratings of 240 V a.c. 2 A (non switching), 30 V 0.25 A (switching). Typical initial contact resistance is 18 mΩ. The switch has an insulation resistance of 100 GΩ, while operational temperature range extends from -55 to +100°C. Operating force is 250 grams (typical) Manufactured to meet BS 2011 acceleration, bump, vibration and shock specifications, life expectancy within typical rated load is < 20,000 break/makes.

Erg Industrial Corporation Limited,
Luton Road,
Dunstable,
Bedfordshire, LU5 4LJ,
England.
Telephones: 0582-62241 (7 lines),
Telex: 82349

(1727 M)

market

Rectangular motor - thinner than a pencil!

What must be one of the smallest and most compact d.c. motors in the world - with surprisingly high power - has been introduced by Portescap. Known as the 712 L, it measures a mere 7 by 12 by 16 mm! Although small in size, with supply potential of 1.2 V the 712 develops a mechanical power of some 70 mW. The starting torque is 2.5×10^{-4} Nm and the no-load speed is 11,000 r.p.m.

Such high performance, low inrush and short time constant are achieved by combining new



materials with established techniques. A major factor in achieving the high performance is the use of samarium-cobalt magnetic material. When coupled with Portescap's 'wornless' rotor design, gold-alloy brushes and sintered-bronze bearings, one achieves not only high efficiency but also high reliability and maintenance-free operation.

Portescap (U.K.) Limited,
204 Elgar Road,
Reading, RG2 0DD,
Tel.: Reading (0734) 861485/6/7/8,
Telex: 847661

(1712 M)

Rotary speed converter

A new converter designed for tachometry applications in the automotive industry and for general industrial measurements of revolutions per minute is available from Gould Instruments Division. Designated Gould Model 13-4618 30, it is ideal for testing all types of internal combustion engines, electric motors, variable-speed drivers, and other rotating machinery.

The device is a frequency/voltage converter calibrated to read out directly in revolutions per minute. It accepts inputs from ignition-coil primaries, magnetic proximity pickups, and optical pickups.



In an automotive application, the ignition-coil input is buffered, rectified and filtered to provide reliable operation from automotive ignition pulses which usually contain high-frequency noise, overshoot and damped oscillations. The magnetic pickup input, on the other hand, has low impedance, which provides maximum energy transfer from the pickup and helps to reject high-frequency ambient noise. The optical pickup input provides up to 100 mA of light-emitting-diode excitation at 5 V and operates on a sink current of only 0.12 mA.

The converter is designed for plug-in operation with Gould 2000 Series recorders, and may be operated independently when installed in an optional portable or rack-mounted case. Its three measurement ranges of 2500, 5000 and 10000 rev/min each produce a full-scale output of 5 V d.c. on a rear output connector. In addition, a front-panel monitor jack provides a linear output of 1 mV per rev/min, which is independent of the range-switch setting. An internal crystal-controlled oscillator ensures calibration accuracy.

For convenience and reduced chance of error in automotive applications, a multiposition switch allows the operator to select the number of cylinders or number of fan blades on an engine being tested. Selecting 2, 4, 6 or 8 cylinders on this switch causes the output to read directly in revolutions per minute when ignition-coil inputs are used. Selecting 1, 2, 3, 4, 5, 6 or 7 fan blades gives the correct rev/min output when a magnetic or optical pickup senses that number of impulses per revolution from a rotating cooling fan or other device.

Gould Instruments Division,
Roebuck Road,
Hemel,
Essex

(1715 M)

market

'Simple to program' IC test system from MIT(E)

The Instruments Division of specialist suppliers MIT (Engineering) Ltd has extended its range of IC Test systems by introducing a

new 'simple to program' tester developed by Minato. The system enables testing of all TTL devices and will carry out DC parametric and functional testing of parts up to 24 pins. The Minato ICT 4100 is a simple to use, low cost, bench top unit incorporating its own VDU. The machine has been designed for ease of use with just 6 switches and a thumbwheel. Programs for the different devices are created via an external keyboard (VDU, Teletype, etc.) and stored on floppy disks, paper tapes or cassettes.

The creation of a program is simple. The user enters a test number, the type of test to be run, his own parameters for VIH, VIL, VoH, VoL, VCC, maximum input and output currents and any specific frequencies. He then enters a pin number and the specified level expected with respect to the status of any of the other pins. This enables the user to do a complete DC parametric and functional test on a device or simply test selected parts of a device, its parameters and functions. Test results are given by GO/NOGO as well as the display of 3 digits on the DC Test. Fault analysis can also be carried out by displaying the test pattern being run, this gives the particular test parameters and the pin numbers of the DUT and their status at time of failure.



Peripheral interfaces allow the ICT-4100 to be connected to Floppy Disk systems, Typewriters, Teletypes, Paper Tape Readers/Punches and VDUs, etc., so storage of programs can be in any media the user desires.

Micro-Image Technology,
(Engineering) Limited,
Greenhill Industrial Estate,
Ridding,
Derby DE55 4DA,
Telephone: Leabrooks 604411,
Telex: 377008

(1710 M)

New sony radio turns science fiction into science fact

Sony technologists have turned science fiction into 'science fact' for the average radio listener with the development of the ICF-2001, which the company describes as, 'the most advanced portable communications receiver in the world'.

This radio, no bigger than a hard-cover book, not only captures English-language short wave programmes from Australia to Finland, foreign language services from the four corners of the globe, ship-to-shore, amateur and citizen band transmissions, as well as standard medium wave, long wave and FM broadcasting, it has a built-in mini computer instead of a tuning dial. Instead of searching endlessly for your favourite or, indeed, a new station, with the

ICF-2001 you simply punch-in the frequency on a pocket-calculator-style keyboard on the front of the set, or instruct it to scan the wave bands and stop automatically each time it comes to an "on-air" transmission. If it's a station you want to keep for future listening, you simply enter it in the computer memory and recall it by pressing one of six "pre-set" buttons — a memory which remains even when you change batteries or switch-over to running the set from a mains power adaptor.

For the businessman who needs to keep in touch with news from his export markets, or news from home when he is travelling, the ICF-2001 is ideal. It is also the obvious family radio for immigrants to keep in touch with events in their home countries and their culture. The ICF-2001 is adding to the ranks of the world's DX'ers too — those enthusiasts whose hobby is searching the airwaves for distant transmissions, and a fascinating hobby which the ICF-2001 is enabling hundreds of blind and handicapped people to adopt with its pushbutton controls replacing tuning knobs which required a steady eye and an even steadier hand.



Selling for around £150, the ICF-2001 also brings powerful world communications within the financial range of many more people. Receivers with similar receiving specifications have previously cost five to ten times the price of the ICF-2001.

Sony (UK) Ltd,
Pyrena House,
Sunbury Cross,
Sunbury on Thames,
Middlesex, TW16 7AT,
Tel.: Sunbury on Thames 87644

(1725 M)

market WORLDWIDE

Miniature combined data decoder and LCD display modules

Four new compact modules types OM 180/181/182/183 from Ambit International's module products division provide ideal solutions to many MPU data output decoding and display requirements.

Two versions (DM 180/OM 181), based on the ICM 7211 (DF 411) provide simultaneous decoding and display from multiplexed 8CD inputs. Additional options provide for either HEX or Code B displays. The DM 180/OM 181 operate from 3.5 V to 6 V at typically only 20 μ A consumption in either 4 or 3.5 digit display formats.

The DM 182/3 provide decoding and display using serial data inputs compatible with most types of MPU. Consumption from 3 V to 15 V is typically 60 μ A — again in either 4 or 3.5 digit formats.



All modules measure 60 x 30 x 7 mm and 12.5 mm LCDs with integral incandescent backlighting, and may be supplied with panel mounting bezel if required.

Ambit International,
200 North Service Road,
Brentwood,
Essex CM14 4SG,
Telephone (0277) 230909,
Telex 995194 Ambit G

(1726 M)

market WORLDWIDE

Low cost printer mechanism will print at speeds up to 120 characters/second

The LRC M410 Printer from Impeptron Limited is a low cost bidirectional 40 column dot matrix machine for printing onto single or multi-ply roll paper. It is capable of speeds up to 120 characters per second, 3 lines per second.

The uncomplicated assembly consists of a solenoid printhead drive section, line feed mechanism, electronic control circuitry and ribbon cartridge. With an optional multi-line validation mechanism it can print up to 10 lines on a single ticket as well as on the normal roll paper.

A standard roll paper is used (as in telex, printing calculators, etc) up 3.87" wide, while each printed line is 3.33" long (40 characters).



The ribbon cartridge is easily loaded and removed and provides ribbon for about 5-million character strikes. The line feed mechanism is operated independently of the mains drive mechanism, and can perform line feeds at the rate of 1-line/second.

The printhead is driven at a constant velocity across the print area, allowing character width to be controlled by the time duration between print pulses. There are a number of different techniques for character generation and the printer can reproduce almost any character font, as long as the maximum print solenoid cycle is not exceeded.

Despite its low cost the LRC M410 is sturdy and built to last. Operational life is estimated at 100 x 10⁶ characters, and it may be operated in hostile environments with impunity. Operational temperature range is at 0° to 50° C and maximum vibration during use is 1g, 10 to 400 Hz. Overall dimensions are 6.75 x 6.65 x 3.75 inches.

Impeptron Limited,
Foundry Lane,
Horsham,
W. Sussex, RH13 5PX,
Tel.: 0403-50111.

(1717 M)

16 mm diameter potentiometers with 5:1 reduction built-in

The Ambit K16A20 series of potentiometers offers an exceptionally neat and low cost means of improving control potentiometer resolution. The pot is based on the standard ALPS 300 degree rotation 16 mm diameter series, and fitted with an integral epicyclic drive with 5:1 reduction ratio.

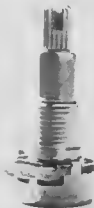

It is available in E12 series from 100 ohm to 1 Mohm — although Ambit are stocking a restricted range of values at the present time. Applications include wiper tuning, accurate control of instrument settings, high resolution null controls etc.

Ambit International,
200 North Service Road,
Brentwood,
Essex, CM14 4SG,
Tel.: (0277) 230909,
Telex: 995194 Ambit G.

(1723 M)

market WORLDWIDE

COMPUTERS AUDIO RADIO MUSIC LOGIC TESTGEAR CB GAMES KITS

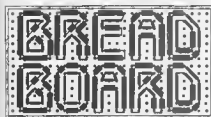

26th Nov - WEDNESDAY - 10am-6pm
 27th Nov - THURSDAY - 10am-8pm
 28th Nov - FRIDAY - 10am-6pm
 29th Nov - SATURDAY - 10am-6pm
 30th Nov - SUNDAY - 10am-4pm

COMPONENTS DEMONSTRATIONS SPECIAL OFFERS MAGAZINES BOOKS

Royal Horticultural Halls Elverton Street

Westminster London SW1

November 26-30 1980

It's all at Breadboard '80

This is **the** exhibition for the electronics enthusiast. From November 26-30 there is only one place in the universe for the electronics enthusiast to be - Breadboard '80, at the Royal Horticultural Hall in London. The majority of leading companies will be exhibiting, including all the top monthly magazines in the field. There will be demonstrations on most stands and many feature special offers that are **EXCLUSIVE** to Breadboard!

All aspects of this fascinating field are catered for, from CB to home computing, so whether you want to buy a soldering iron or a synthesiser - or just keep up to date with your hobby - don't miss Breadboard '80.

AVOID QUEUES - GET ADVANCE TICKETS

Send to: Advance Tickets, Modmags Ltd,
 145 Charing Cross Rd, London WC2H 0EE

Please send: tickets @ £1.50

..... tickets @ £1.00 (Student/Child/OAP)

TO:

.....

.....

.....

.....

.....

Enclose P.O./Cheque for £.....

junior computer 1



the practical introduction
 to a powerful system



For anyone who wishes to become familiar with (micro)computers, this book will mean the start of a fascinating hobby. Both beginners and experienced hobbyists now have the opportunity to build and program their own personal computer at a very reasonable cost.

PRICE: UK £4.25
 Overseas £4.45
 (Prices include P&P)

To order please use the Order Card in this issue.