

# elektor

65  
September 1980

ISSN 0308-308X

UK 250

up to date electronics for job and leisure

**8 K RAM + EPROM card**

using the  
**Elektron**  
vocoder

precision  
power supply

Germany  
Austria  
Belgium  
France  
Italy  
Japan  
Netherlands  
Sweden  
Switzerland  
U.S.A.

£ 2.00  
DM 7.50  
S 2.50  
Fr 20  
L 15

Germany  
Netherlands  
Italy  
Belgium  
Sweden  
Switzerland  
U.S.A.

DM 8.50  
Dfl. 7.50  
Fr 25  
K 28  
S 20  
Fr 2.20  
\$ 3.50

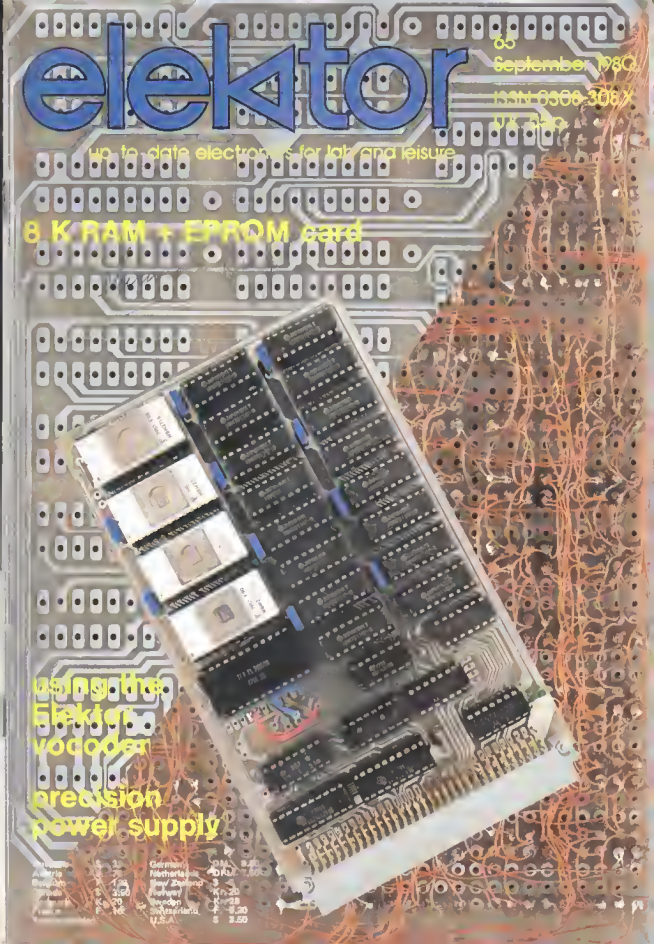

**selektor** ..... 9-01

**8K RAM + 4,8 or 16K EPROM on a single card** ..... 9-04  
 Many readers have requested that the 4K RAM card for the Elektor SC/MP system be updated. The new card presented in this article contains a total of 8K of RAM, up to 16K of EPROM and can be used with either of the Elektor SC/MP systems or the Junior Computer.

**precision power unit** ..... 9-08

**electronic linear thermometer** ..... 9-12  
 Conventional mercury thermometers are, of necessity, rather fragile and therefore break very easily, always at the most inopportune time. Electronic thermometers, on the other hand, are not as fragile and can enjoy a much longer life. The 'readout' can be a great deal more accurate with infinitely better legibility. The electronic thermometer featured here can be built by anyone to fit almost anywhere which is certainly not true of the conventional type.

**the Josephson computer** ..... 9-15  
 Large computers can consist of over a hundred thousand logic circuits and are able to execute more than a million instructions per second. Fast as this may seem, a computer 20 times faster than this is currently being developed by IBM. It stems from a brand new branch in technology, namely, the Josephson technique

**VOX printed circuit board** ..... 9-22

**elektor: measuring multipath** ..... 9-26

**high speed readout for elekterminal** ..... 9-28  
 With minor a modification to the Elekterminal it is possible to 'store' the entire contents of the display (TV screen) on a cassette tape.

**musical box** ..... 9-30

**electrolytology** ..... 9-33  
 There is nothing new about the fact that electrolytic capacitors possess inductance due to the method used in their construction. At high frequencies their impedance will be largely determined by this parasitic inductance. An electrolytic capacitor even acts as a band pass filter and thus also has a resonant frequency.  
 What fewer people will be aware of is that the capacitance is clearly frequency dependent. Elektor takes a closer look 'inside' electrolytic capacitors this month.

**curve tracer** ..... 9-36  
 This article describes an economic curve tracer for transistors and diodes. No really professional test instrument, of course, but an extremely useful aid to quickly carry out a general test either to compare transistors or select them.

**using the vocoder** ..... 9-38  
 Several months ago (Elektor no. 56, December 1979), Elektor published a 10 channel vocoder. When building a vocoder there are a few 'obstacles' which ought to be taken into account. Readers who have already built one and are familiar with it will find that this article provides useful information on how to improve on the vocoder's technical qualities.

**market** ..... 9-45

**advertising index** ..... UK 22

# contents

content  
 cont  
 con

*Sivinder Singh*

**EDITOR:**  
 W van der Horst

**UK EDITORIAL STAFF**  
 T. Day E. Rogans  
 P. Willems

**TECHNICAL EDITORIAL STAFF**  
 J. Barandrecht  
 G.H.K. Dam  
 P. Holmes  
 E. Kreppeisauer  
 G. Nachbar  
 A. Nachtmann  
 K.S.M. Weiraven



# selektor selektor

## Bright outlook for liquid crystals

Reliable, long-life liquid-crystal displays are now familiar features of mass-produced watches and pocket calculators. But the work of the university, government and industrial research teams that made them available so cheaply is by no means at an end, for the growing complexity of devices means more stringent specifications of materials. Liquid crystals of a newly-developed type promise to hold the key to further important innovations. Digital electro-optic displays using liquid crystals are now commonplace in watches, pocket calculators and clocks; and, thanks to advertising, the terms liquid crystal and liquid-crystal display are now familiar to all. The success of such devices is entirely dependent upon the quality of the thin, fluid film of liquid-crystal material that is used to present the figures and is shown in the photo.

Progress in making satisfactory liquid-crystal displays was held up for a long time simply because liquid-crystal materials with good, stable characteristics were not available, but things suddenly changed with the discovery of the cyano-biphenyl class of liquid crystal.

### Immediate demand

The potential of these liquid crystals seemed to be excellent, and it was borne out by an extensive test programme at RSRE. There was an immediate demand for the new materials. BDH Chemicals, at Poole, in the South of England, solved the problems of production and made them in large quantities, pure enough to guarantee reliable performance in display devices.

One interesting feature of this collaboration between a university, a government research laboratory and a chemical company is that the research, in bringing together two scientific disciplines, chemistry and physics, has led to more in the nature of mutual stimulus than to problems of communication and understanding.

### Liquid crystals

What are liquid crystals? They have been known for many years, having been discovered by the Austrian botanist Reinitzer in 1888. He observed that the organic chemical cholesteryl benzoate melted sharply at 145°C but did not form a clear liquid. Instead, it gave a cloudy fluid which became clear only when heated to 179°C. The intermediate phase was eventually recognized as a liquid crystal. Soon, other



Photomicrograph of a smectic liquid crystal (see article on page 2) with a magnification of about 200. The liquid-crystal phase was formed by cooling a thin film of isotropic liquid (black background) and is highly ordered in spite of being able to flow. In other words, though liquid crystals are fluid they have some of the optical properties of solid crystals. This makes it possible, using nematic liquid crystals which can be electrically controlled, to produce the familiar sort of display seen in the lower part of the picture.

# selektor selektor

1

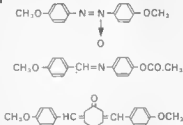

Figure 1. Soon after the discovery of the first liquid crystals, it was found that other organic compounds behaved in a similar way.

A common feature of the materials was that the molecules were long and narrow, and contained ring systems and double bonds lending rigidity to the molecules.

2

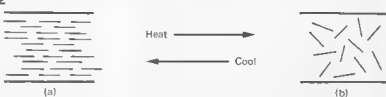

Figure 2. Reversible transition from a nematic liquid crystal (a) to the disordered isotropic liquid (b).

organic compounds were found to behave in a similar way, and a common feature of all the materials was that the molecules were long and narrow. Moreover, they all contained ring systems and double bonds which lent them rigidity (see figure 1).

It is not unreasonable that compounds made up in such a way should behave as they did. Their crystal lattices consist of a rigid, three-dimensional, ordered array of the rodlike molecules; when the crystals are heated, thermal vibrations eventually overcome the intermolecular interactions, the molecules become free to move in any direction and the rigid crystal ceases to exist. With less elongated or more nearly spherical molecules, the material is a true liquid, with total disorder of the molecular system. But with rod-shaped molecules there is a strong tendency for their long axes to stay parallel, over considerable molecular distances, even after the crystal has collapsed. This brings about a fluid but nevertheless quite highly organized phase.

Because of the molecular order which

persists, the material in this phase has many of the optical properties of a crystal, yet it can flow; that is why we use the term liquid crystal. Only when we heat the material to a higher temperature is the truly disordered, liquid state produced (see figure 2).

It is quite common for the molecules in liquid crystals to retain a parallel arrangement, in layers. When this happens the crystals are known as smectic liquid crystals and are rather viscous; they have not, so far, been of much commercial use. A great deal more important are the so-called nematic liquid crystals, which are much more fluid and possess a non-layered, parallel molecular arrangement.

#### Optical active

Another form of the nematic liquid crystal is found when the molecules of the compound are optically active, that is, when they can take up either a right-handed or left-handed structure, related one to the other as an object is to its mirror image. Through the asymmetry of the intermolecular force fields in a liquid-crystal phase made up entirely of right-handed or of left-handed molecules, the molecules are no longer arranged mainly in parallel in three dimensions, instead, the molecular arrangement may be thought of as in the diagram in figure 3. Here, the molecules lie parallel to one another in sheets, but there is no ordered arrangement of their ends. Crystals with this sort of structure are known as cholesteric liquid crystals.

Passing upwards through a stack of such sheets, we find that the long axes of the molecules lie progressively in a single-handed sense, forming a right-hand or left-hand helical arrangement with a well-defined pitch. Because of the relationship  $\lambda = Pn$ , where  $\lambda$  is the wavelength of the incident light,  $P$  is the pitch and  $n$  is the refractive index (usually about 1.5), such crystals have the property of selectively reflecting coloured light, when  $P$  is within the range of wavelengths of visible light. For this reason, suitably pitched cholesteric liquid crystals are used in digital thermometers and for various forms of surface thermography; the pitch and the colour of the reflected light change with temperature.

Obviously, the existence of materials giving fluid but ordered states of matter provides a considerable challenge to inventively minded people to find other applications for them. The need to heat a solid to form the nematic or cholesteric phase was a severe drawback, but in turn it challenged organic chemists to provide materials that formed those phases in the ambient temperature range. The aim was eventually achieved, but at first the materials had certain drawbacks.

#### Room temperature

The first room-temperature phases were



Figure 3. Portrayal of the molecular arrangement in a cholesteric liquid crystal. The arrow represents the direction of the molecule's long axis in each sheet.

# selektor

#### 4

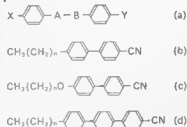

Figure 4. The first room-temperature liquid-crystal phases were formed by compounds, or mixtures of compounds which all had the general form shown in (a), where the linking group  $-A-B-$  was of the type  $-N-CH-$ ,  $-N=N(O)-$ ,  $-CO-O-$  and so on. Such linking groups made the compounds unstable or coloured, and this problem was eliminated by linking the two rings directly in a biphenyl structure. To avoid shortening the nematic temperature range, cyano and saturated alkyl or alkoxy groups were used at the ends of the molecules to give 4-alkyl- and 4-alkoxy-4'-cyano-biphenyls as in (b) and (c). The *p*-terphenyl derivatives such as (d) were then developed.

formed by compounds, or mixtures of compounds, which all had the general form shown in (a) in figure 4, where  $-A-B-$ , the linking group, was of the type  $-N-CH-$ ,  $-N=N(O)-$ ,  $-N=N-$ ,  $-CO-O-$  and so on. But these linking groups made the compounds chemically or photochemically unstable, or coloured them. The best group was the ester linkage  $-CO-O-$ . Nevertheless, the existence of these room-temperature nematics allowed physicists to explore the potential value of such materials and, from the early 1960s, it seemed certain that they would be exploited.

The disadvantage of the central group was recognized and it was eliminated by linking the two rings directly in a biphenyl structure. Shortening the molecules might seriously restrict the temperature range of phases, so, from previous experience, a cyano group was used as one of the end groups. The group for the other end was chosen to be a saturated alkyl group or an alkoxy group. In this way, the idea of the 4-alkyl- and 4-alkoxy-4'-cyano-biphenyls was born. Their structures are shown in (b) and (c) respectively (figure 4). One of the first materials synthesized was that shown as (b) in the diagram, with a chain of five carbons. It melted at  $21.5^\circ\text{C}$  and was nematic until  $35^\circ\text{C}$ ; the nematic phase was maintained indefinitely at room temperature and down to  $4^\circ\text{C}$  in a supercooled state. The nematic phase was colourless, the compound highly stable chemically and photochemically, and the material was non-toxic and apparently devoid of harmful properties. A wide range of these compounds was made. Several melted at low temperatures and the compounds of the form (c) in the diagram had the higher-temperature change of phase from nematic liquid crystal to isotropic liquid.

#### Derivatives

From this range of compounds, mixtures could be produced that behaved as a system melting at around  $0^\circ\text{C}$  or just below and remaining nematic until over  $50^\circ\text{C}$ . This temperature range was judged to be too narrow and led to the development of analogous *p*-terphenyl derivatives such as that shown as (d) in the diagram.

The nematic phases of these materials persist at temperatures up to well above  $200^\circ\text{C}$ , but by incorporating suitable amounts of compounds such as (d) with, say,  $n=4$ , in mixtures of the materials (b) and (c) new systems were obtained with wider nematic ranges from  $-10^\circ\text{C}$  to  $60.5^\circ\text{C}$ ,  $-12^\circ\text{C}$  to  $72^\circ\text{C}$  and so forth.

With their strongly dipolar cyano group at one end of the molecule, these compounds have a high positive dielectric anisotropy, which means that the electric permittivity along the long axis is greater than it is across the short axis; so, in the nematic phase, the molecules have a strong tendency to align parallel

# selektor 2010

to the direction of the field. This is just what was needed, for the availability of such wide-range nematic systems on a commercial scale from BDH Chemicals allowed electronics companies to make electro-optic displays capable of excellent performance and long life.

## Twisted nematic devices

The watch or calculator display is simply a thin sandwich of the nematic liquid crystal between two glass plates coated on their inner surfaces with a transparent, conductive film of an electrode material such as  $\text{In}_2\text{O}_3$  or  $\text{SnO}_2$ . By treating the electrode surfaces in a suitable way, the molecules of the liquid crystal are made to lie parallel to them but their directions are arranged at a right angle across the film. The intervening molecules in the film, which is 6 to  $12\ \mu\text{m}$  thick, take up a quarter helical arrangement, as shown in figure 5. If light entering the sandwich is polarized in a plane parallel to the long axes of the molecules at the film's surface, it is guided through a right angle as it passes through the film and it emerges through a second polarizer set at right angles to the one through which it enters. So, in its so-called off state the cell transmits brightly and can be used to produce bright reflections if a back-mirror is used. But when a small voltage, of about 2.5 V in a  $12\ \mu\text{m}$  cell is applied across the film, the molecules turn rapidly to align at a right angle to the electrodes. Light is no longer guided as it passes through the cell, which appears black. It is obvious that if only parts of the cell are activated electrically (for example, groups of seven bar electrodes in a figure-of-eight arrangement) we have a way of presenting black information on a bright background without having to generate light energy within the device. When we switch the field off, the molecules rapidly realign to form the twisted state. This is the basis of the display in which the cyano-biphenyl liquid crystals have been so successful. The only movement is molecular, so the response times are very fast, and, with a power consumption in the microwatt range, batteries have a long life.

## Cholesteric devices

Biphenyl liquid crystals provide us with a means of making stable cholesteric materials. We need only introduce a branched carbon chain for X instead of  $\text{CH}_3(\text{CH}_2)_n-$  or  $\text{CH}_3(\text{CH}_2)_n\text{O}-$ , and provided it makes the system active optically, for example, with a  $(+)-\text{CH}_2\text{CH}_2\text{CH}(\text{CH}_3)\text{CH}_2-$  group, the material will be cholesteric. Materials of this sort were made at Hull,

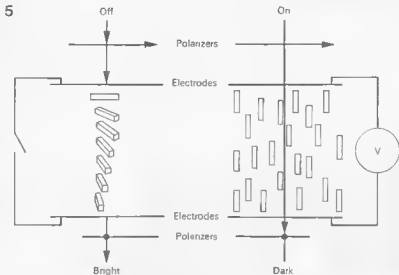

Figure 5. The change in molecular arrangement when a twisted nematic liquid-crystal is switched electrically from the bright off state (left) to the dark on condition (right). When the field is switched off, relaxation from the on to off state takes place rapidly through forces starting at the surfaces.

and they went into commercial production. Incorporating them in the nematic hosts shown in (b) and (c) of the diagram above produces cholesterics with a range of pitch values that depend upon concentration. Such compounds are added in very small amounts to nematic liquid crystals used in the twisted nematic device to ensure that when the device is switched off, the quarter helix always regenerates with the same sense, so avoiding patches through reversed-twist areas. In greater concentration, they are added to nematics to form quite high-pitch cholesteric phases for use in another form of device which does not need polarizers. In such devices, the twist of a cholesteric of positive dielectric anisotropy can be unwound electrically to yield a nematic phase, which then twists back to a cholesteric when the electro-motive force is switched off. There is an optical contrast between the switched-on and switched-off states, which can be made more pronounced by dissolving dichroic dyes in the liquid crystal, thereby making it possible to produce a negative colour contrast in these cholesteric-nematic phase change displays, with numbers in white on a coloured background.

## New material

The cyano-biphenyl and cyano-terphenyl materials have provided the essential means of producing the reliable liquid-crystal display devices which are now preferred to light-emitting diode displays, particularly for battery-operated instruments. But devices are becoming more and more sophisticated, which means more stringent requirements of performance and properties of the liquid-crystal material, so there is still

a great deal to do.

For example, in multi-function calculators and watches, matrix addressing of the display greatly reduces the number of individual electrical contacts needed for the electrode elements. Mixtures of the cyano-biphenyl liquid crystals with other nematic materials allow this to be achieved, but for ideal performance we need materials with operating-voltage thresholds that are largely independent of temperature. Mixtures of a new type of nematic material developed at Hull have now been found at RSRE to be less dependant on temperature than any earlier materials are, and they may well be the key to further success. Cholesteric materials of *negative* dielectric anisotropy are the basis of positive-contrast colour displays, with coloured numbers on a colourless background, making use of dye-cholesteric-nematic phase-change. Such devices are at their best if the materials are of the type with a low birefringence, that is, with refractive indexes that have much the same values in the directions of the long axes and the short molecular axes. Work going on at Hull, RSRE and BDH Chemicals aims to combine these desirable physical characteristics in liquid crystals that are stable at room temperature.

Prof. G.W. Gray, in *Spectrum* no. 167

(570 S)

# selektor 2010

The extremely popular 2114 RAM IC has four times the memory capacity of the type used for the original (4 k) RAM card. This means that a card with twice the memory capacity can be constructed with half as many ICs. It will be apparent that this leaves a certain amount of 'free space' on the actual board. Why not fill it up with EPROM? By doing this we can kill two birds with one stone — there is no Elektor EPROM card as such for any of the Elektor computer systems.

The decoder (IC5) divides the entire address range into 4 k 'pages'. Each memory section (including the RAM area) can be placed anywhere within the 64 k address range. When 2708s are used for the EPROMs, they can be positioned on any page by connecting a single link from IC5 to both inputs of N1. Two pages are required if 2716s are used and this involves installing two wire links between IC5 and N1. If, however, 2732s are used, one complete page can be allocated to each EPROM.

# 8K RAM + 4,8 or 16K EPROM on a single card

Many readers have requested that the 4 k RAM card for the Elektor SC/MP system be updated. The new card presented here contains a total of 8 k of RAM, up to 16 k of EPROM and can be used with either of the Elektor SC/MP systems or the Junior Computer.

The 27xx series of EPROM was chosen as the 2708, 2716 and 2732 are all pin compatible (1k, 2k and 4k EPROMs respectively). Obviously, to be 'universal' certain connections have to be made 'programmable' (see circuit diagram in figure 1). The address decoding and the logic level on the chip select inputs depend on the particular type of EPROM used. These connections can be altered by means of wire links on the printed circuit board (figure 2).

This will be explained in detail further on.

The next step in the address decoding is to enable the individual memory ICs. As far as the RAM is concerned this will be in sections of 1k (two ICs per section). The EPROMs, on the other hand, will be in sections of 1k, 2k or 4k (for 2708s, 2716s and 2732s respectively). The RAM section is taken care of by the 3 to 8 line decoder IC6. One half of a similar IC, IC7 (2 to 4 line decoder) is used to select the EPROMs. Wire links are included to pre-program the A and B inputs of IC7 for the particular type of EPROM to be used (see table 1). The order of addressing will be slightly different when 2716s are used, but this should not cause any problems in practice, provided the EPROMs are programmed (and installed) in the correct order. Table 2 gives an example of the relevant addresses and connections for when the RAM section is placed on pages 1 and 2 followed sequentially by the EPROM sections.

The memory card is completely buffered to keep the load on the bus system to a minimum. The address bus is buffered by IC1 and IC2. These are uni-directional buffers which have PNP inputs requiring a very low input current. The same is true of the data bus buffers (IC3 and IC4). These are bi-directional, the direction of data transfer being controlled by the logic level on the common select line. When this line is low the buffers enable the transfer of information into the RAM section, and when the select line is high the data contained in the RAM/EPROM sections can be read out.

While the memory card is not being addressed the data bus buffers are held

Table 1

EPROM type	input A	input B	address order	
2708	A10	A11	IC25-26-27-28	
2716	A12	A11	IC25-27-26-28	beginning at an even page
2716	A12	A11	IC26-28-25-27	beginning at an odd page
2732	IC7 deleted (see text).			

Table 1. This table shows the connections to the A and B inputs of IC7 for the different types of EPROM.

Table 2

RAM	EPROM		
	2707	2716	2732
1k0 = 1000 ... 13FF	IC25 = 3000 ... 33FF	3000 ... 37FF	3000 ... 3FFF
1k1 = 1400 ... 17FF	IC26 = 3400 ... 37FF	4000 ... 47FF	4000 ... 4FFF
1k2 = 1800 ... 1BFF	IC27 = 3800 ... 3BFF	3800 ... 3FFF	5000 ... 5FFF
1k3 = 1C00 ... 1FFF	IC28 = 3C00 ... 3FFF	4800 ... 4FFF	6000 ... 6FFF
1k4 = 2000 ... 23FF			
1k5 = 2400 ... 27FF			
1k6 = 2800 ... 2BFF			
1k7 = 2C00 ... 2FFF			
connect pins 9 and 5 of IC5 to inputs of N2	connect pin 14 of IC5 to inputs of N1	connect pins 14 and 3 of IC5 to inputs of N1	connect pins 14, 3, 11 and 7 of IC5 to pins 9 ... 12 of IC7 (IC7 is deleted!).

Table 2. An example of the possible address format when the RAM section is sequentially followed by the EPROMs.

1

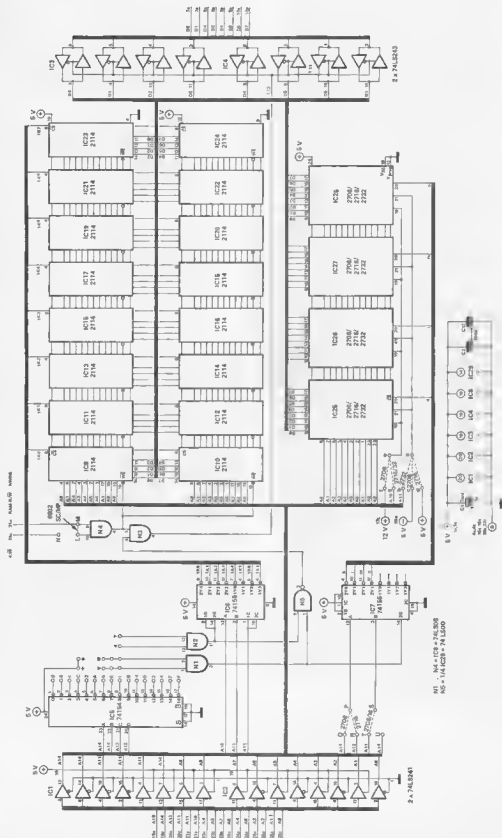

Figure 1. Complete circuit diagram of the RAM/EPROM card. The connections which need to be mounted for the various types of EPROM are clearly shown.

2

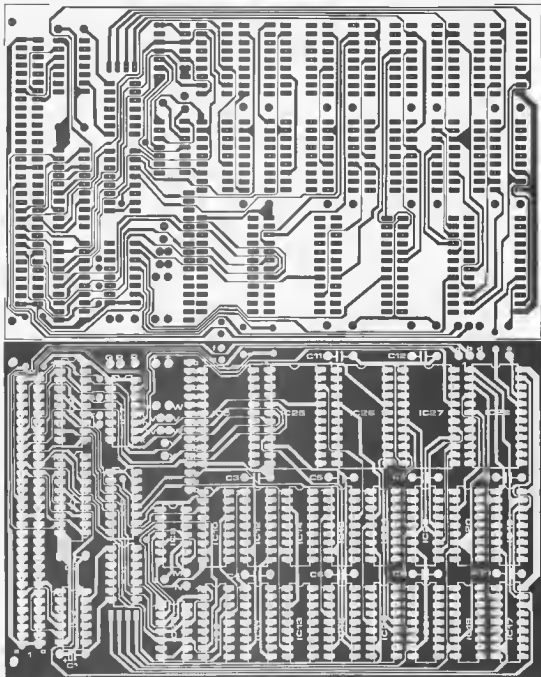

Figure 2. The printed circuit board and component layout for the RAM/EPROM card. There is room for 8k of RAM and up to 16k of EPROM on the (double sided) board.

#### Parts list

Semiconductors:  
 IC1, IC2 = 74LS241  
 IC3, IC4 = 74LS243  
 IC5 = 74154  
 IC6, IC7 = 74(LS)155  
 IC8 = 74LS08  
 IC9 . . . IC24 = 2114 (RAM)

IC25 . . . IC28 = 2708, 2716  
 or 2732 (EPROM see text)  
 IC29 = 74LS00

#### Capacitors.

C1 = 1  $\mu$ /10 V tantalum  
 C2 . . . C12 = 100 n

(All parts available from  
 Technomic)

in the write mode (via gates N3 and N5) to ensure that the card is unable to interfere with the data bus. When the card is being addressed, the buffers are switched to the read mode. Data can then only be entered into the RAM

section when a WRITE signal is present (via N4). The two wire links shown at the inputs to N4 enable the memory card to be used with the Elektor SC/MP system or the Junior Computer (both inputs connected to 31a), or with most

other microprocessor systems.

#### Arranging the memory blocks

The way in which the address decoding is done on this card makes for a large degree of flexibility — provided you



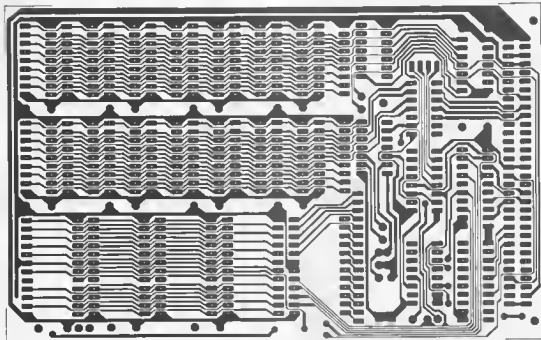

know what you're doing! The first thing to realize is that IC5 divides the address area into 4kByte blocks, and that N1 (with inputs V and W) selects one or more of these for the EPROMs, whereas N2 (inputs X and Y) selects two 4kByte blocks for the RAM. In general:

IC5 output	4kByte address block	2x 4kByte RAM area selected by:	
		X	Y
0	0000 ... 0FFF	0	
1	1000 ... 1FFF		1
2	2000 ... 2FFF	2	
3	3000 ... 3FFF		3
4	4000 ... 4FFF	4	
5	5000 ... 5FFF		5
6	6000 ... 6FFF	6	
7	7000 ... 7FFF		7
.	.	.	.
.	.	.	.
F	F000 ... FFFF	F	

For each type of memory block, some specific points must be noted:

#### RAM area

Two 4kByte blocks are required, one for IC9...IC16 and one for IC17...IC24. One of these blocks must be on an even-numbered page (0, 2, 4, etc.) and the other on an odd page. For example, X = 4 and Y = 5 would define a consecutive RAM area from 4000...5FFF.

#### EPROMs type 2708

For four of these 1kByte EPROMs, a 4kByte address field is required. This is selected by connecting one of the outputs from IC5 to N2 ('V'); the other input to N2 ('W') is either connected to

V or, via a wire link, to positive supply. The 4kByte field is further subdivided by IC7 (connected to address lines A10 and A11), to select the EPROMs as follows:

IC25 V000...V3FF  
IC26 V400...V7FF

4kByte EPROM area for 2708s	2x 4kByte EPROM area for 2716s	
	V	W
0	0	
1		1
2	2	
3		3
4	4	
5		5
6	6	
7		7
.	.	.
.	.	.
F	F	

IC27 V800...VBFF  
IC28 VC00...VFFF

#### EPROMs type 2716

An 8kByte address field is required in this case (4 x 2kByte). The same principles apply as discussed above for the RAM area: V must be connected to an even-numbered output from IC5, and W to an odd-numbered output. For example, if V = 2 and W = 7, the four EPROMs will correspond to the following address fields:

IC25 2000...27FF  
IC26 7000...77FF  
IC27 2800...2FFF  
IC28 7800...7FFF

Note that IC25 and IC27 form a 4kByte pair, as do IC26 and IC28.

#### EPROMs type 2732

Each of these ICs corresponds to a 4kByte address field - in other words, to one output from IC5! In this case, no further subdivision of this field is required, so that IC7 becomes redundant! N1 is not required either, but its two inputs (V and W) must be connected to +5 V by means of wire links.

The four 4kByte blocks required can be programmed by wire links direct from the corresponding outputs of IC5 to the holes intended for pins 9...12 of IC7 (k...n). Pin 9 (k) corresponds to IC25, pin 10 (l) to IC26, etc. This means that if, say, IC2B is to be located on the last page, a wire link must be taken from output F of IC5 to pin 12 (n) of the IC7 position.

#### Wire links and unused positions

An important point to note is that unused inputs should not be left floating. This was already mentioned above, as regards N1 and N4. The same obviously applies to N2, if the total RAM area is not to be used as yet: unused inputs must be connected either to +5 V or to an unused output from IC5.

Particular care should also be taken with the wire links at the inputs to IC7 and IC25...IC27. These depend on the type of EPROM used, as follows:

2708: P-Q, S-T, e-f, a-c.  
2716: P-R, S-T, e-g, a-d.  
2732: e-g, a-b.

Finally, it should be noted that the supply common (0 V) connection to the board must be applied via two sets of connector pins: 4 a/c + 16 a/c and 32 a/c. These two sets are *not* interconnected on the board! M

As we all know it is virtually impossible to construct a precision voltage source with standard components. Close tolerance devices (both active and passive) are very difficult to obtain. If resistors are connected in series and parallel to produce the required value, a tolerance of 0.1% is out of the question. The solution, therefore, is to find integrated components with 'everything included'. The majority of so called precision voltage regulators suffer from the disadvantage that they can only provide one output voltage. Elektor's

The voltage across  $R_{SET}$  is buffered by an opamp before being fed to the internal series pass transistor. The IC contains integrated 0.1% tolerance resistors between various pins which can be interconnected to provide a combination of values. Resistors with values of 5k, 10k, 2k and 6k are located between pins 9 and 7, 7 and 6, 6 and 5 and 8 and 4 (ground) respectively. The output current is determined by  $LLIM$  (100  $\mu A$ ) and the current flowing through  $R_{SENSE}$  and can be calculated from:

# precision power unit

When calibrating voltmeters an accurate reference voltage is, of course, essential. As far as digital voltmeters are concerned the reference voltage will have to be very accurate indeed for such meters to be of any significant value. If close tolerance precision resistors are incorporated in the DVM's input attenuator, the reference voltage should meet accuracy requirements outside the basic measuring range. Thus, a reference voltage is required with an accuracy that corresponds at least to the tolerance of the divider resistors. The precision power unit described here produces several reference voltages with an accuracy of 0.1%! To make full use of the degree of precision achieved, the unit has been incorporated into a high quality power supply.

design team, however, have discovered a little known IC from National Semiconductor which is able to produce several accurate voltages and has excellent characteristics and can also be incorporated into a power unit as a 'normal' regulator IC. This device has the part number LH 0075.

The block diagram of the precision power unit is shown in figure 1. As can be seen, it is very similar to conventional circuits of this kind. Pre-stabilisation has been included to limit the input voltage to the regulator IC. This protective measure is quite justified considering the cost of the IC. Both voltage and current can be adjusted separately. By including a pair of series pass transistors an output current of up to 2A can be produced. A description of the technical specifications for the unit is given in table 1.

The internal structure of the IC is shown in figure 2. A constant current source is fed to a zener diode via a field effect transistor. This produces a highly accurate, temperature stable reference voltage with a variation of 0.003%/°C! This reference voltage is then used to produce two further constant currents ( $I_{SET}$  and  $I_{LIM}$ ). The output voltage is determined by the (1mA) current flowing through resistor  $R_{SET}$  and can be calculated from the formula:

$$U_{OUT} = I_{SET} \cdot R_{SET}$$

$$I_{OUT(max)} = \frac{R_{LIM}}{R_{SENSE}} \cdot I_{LIM}$$

The IC can also be used as a programmable current source when pin 9 is connected to ground via a 25k resistor. The output current will then be determined by the values of  $R_{LIM}$  and  $R_{SENSE}$ . A potentiometer could be used for  $R_{LIM}$  so that the output current can be made adjustable.

## Circuit diagram

The complete circuit diagram of the precision power unit is shown in figure 3. The maximum secondary voltage of the mains transformer is limited to 30V so as not to exceed the input requirements of IC2. The transformer voltage is rectified by B1 and smoothed by C1 before being fed to the pre-stabiliser IC1. LED D1 indicates that the circuit is switched on.

By including a zener diode (D2) in series with the ground lead of IC1, its output voltage is 'raised' to 30.2V to provide an adequate (and safe) input level for IC2.

The output voltage of the circuit can be adjusted by means of potentiometer P2 which is connected as shown in figure 4. The output current limit is set by P1, R2 and R6. Resistor R6 is included in

Table 1

### Technical Data

Variable Output voltage:	0 V to +25 V
Fixed Output voltage:	+1.5 V, 2 V, 5 V, 6 V, 8 V, 10 V, 12 V, 15 V, 18 V
Accuracy:	0.1%
Voltage regulation:	type 0.008%/V
Ripple suppression:	80 dB
Pre-settable current limit:	0 to 2 A
Load regulation:	type 0.075%

Table 1. Technical specification of the precision power unit. As the figures show, the unit is indeed precise.

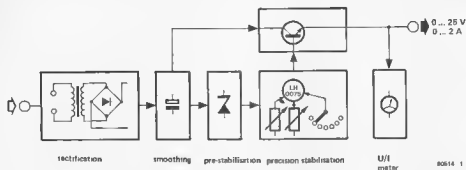

Figure 1. Block diagram of the Elektor precision power unit. The stabilisation section consists basically of one IC (LH0075), two potentiometers and a selector switch.

parallel with P1 to reduce the maximum output current to 2A, while R2 acts as a current sense resistor. The output voltage is selected by a multi-position switch (see figure 4) connected, as mentioned before, to the internal precision resistors of IC2. This switch connects the various resistors in series or parallel as required.

Transistors T1 and T2 increase the current output capability of the supply and the resistors in their emitter leads (R7 and R8) ensure that the current is divided equally between them.

Resistor R3 is included as a dummy load for the unit and diodes D4 and D5 protect the circuit from negative transients.

The output voltage and current can be monitored by including a moving coil meter and a double pole switch. If the unit is to be used to power HF circuits an extra 100 nF capacitor should be connected directly across the output.

2

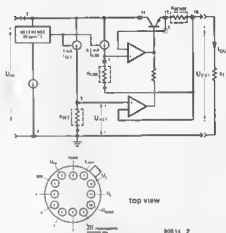

Figure 2. The internal diagram of the LH0075 and its pinout. The case is electrically insulated.

3

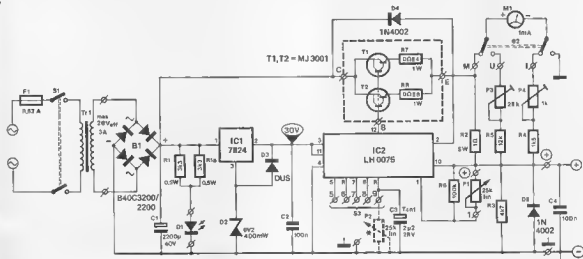

Figure 3. The complete circuit diagram of the unit. The output voltage can be preset to various values between 1.5 ... 18 V or can be continuously variable between 0.2 ... 25 V. The output current can be limited to anything between 0 ... 2 A.

4

## Parts list

## Resistors

R1, R1a = 1k $\Omega$ /0.5 W  
 R2 = 1  $\Omega$ /2 W  
 R3 = 4k7  
 R4 = 1k5  
 R5 = 12 k  
 R6 = 100 k  
 R7, R8 = 0 $\Omega$ 168/1 W  
 P1, P2 = 25 k lin  
 P3 = 25 k preset  
 P4 = 1 k preset

## Capacitors

C1 = 2200  $\mu$ /40 V  
 C2, C4 = 100 n MKM  
 C3 = 2 $\mu$ 2/25 V tantalum

## Semiconductors

D1 = LED  
 D2 = 6V2/400 mW zener diode  
 D3 = DUG 10A 150l  
 D4, D5 = 1N4002  
 T1, T2 = 2N3055  
 IC1 = 7824  
 IC2 = LH 0075 (National)  
 B1 = B40C3200/2200 or  
 100 V/4 A bridge rectifier

## Miscellaneous

Tr1 = 30 V/3 A transformer  
 F1 = 0.63 A slo-blo fuse  
 S1 = double pole mains switch  
 S2 = double pole toggle switch  
 S3 = 11 way, 3 pole wafers switch  
 M1 = 1 mA moving coil meter

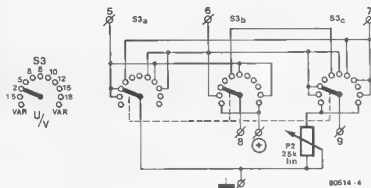

Figure 4. The wiring of the voltage selector switch S3. Three wafers are used and, therefore, the wiring must be thoroughly checked.

5

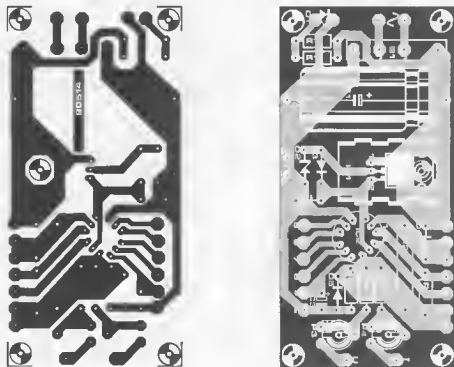

Figure 5. Printed circuit board and component layout for the precision voltage unit. The socket for IC2 can be made up from 'socket strip'.

6

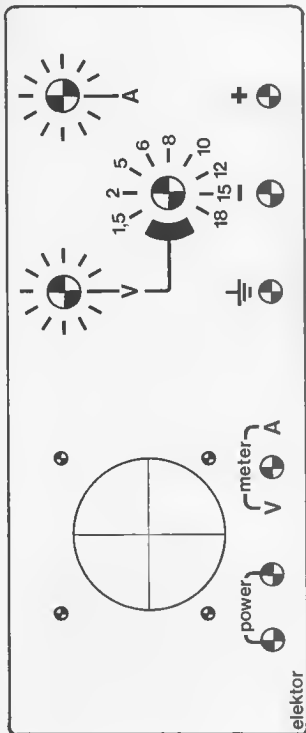

Figure 5. Proposed front panel layout for the unit.

7



Figure 7. The new scale for the 1 mA moving coil meter.

### Construction and setting up

The printed circuit board and component layout for the precision power unit is shown in figure 5. The socket for IC2 can be made from 'socket strip' by cutting off four strips of three contacts. A suggested front panel layout for the unit is shown in figure 6. Once this has been attached, and the meter scale substituted for the one shown in figure 7, the unit can be wired as shown in figures 3 and 4.

All wiring should be carried out with a great deal of care and attention to detail as one mistake could burn a hole in your pocket.

After the wiring has been checked thoroughly (several times!), the output voltage of IC1 should be measured *without* IC2 inserted. If this voltage is any higher than 32 V there is something wrong with the pre-stabilisation circuit which could result in damage to IC2.

If the voltage is correct the unit can be switched off and IC2 inserted. Again, check several times that the IC is positioned correctly. With S2 in the 'voltage' position, S3 switched to one of the preset ranges and a voltmeter connected across the output, the unit can be checked and P3 adjusted to give the correct reading on the scale of M1.

The current range can be adjusted with the aid of a known load resistor. Switch the unit off, turn P1 fully anti-clockwise and switch S3 to the 10 V position. With a load resistor of 10  $\Omega$ /10 W connected across the output (or a universal meter switched to the 1A-range - or higher) rotate P2 until the meter needle stops moving. According to Ohm's Law a current of 1A will then flow through the load resistor. The meter scale can be adjusted by means of P4.

Once the above checks have been carried out successfully the unit can be installed in a suitable case and is ready for use. ■

# electronic linear thermometer

## a semiconductor used as a temperature sensor

The conventional mercury thermometer has been with us for a long time, mainly because it serves its purpose very well. It does however suffer from a number of major disadvantages. They are, of necessity, rather fragile and therefore break very easily, always at the most inopportune time. A relatively long period is required for them to stabilise and they are not the easiest thing in the world to read. Electronic thermometers, on the other hand, are not as fragile and can enjoy a much longer life. The 'readout' can be a great deal more accurate with infinitely better legibility. Furthermore, they can be built by anyone to fit almost anywhere which is certainly not true of the conventional type. The actual sensor, in this case a semiconductor diode, is very small allowing it to be mounted in previously impossible situations. A further advantage is that, due to its linear characteristics, expensive equipment is not required to calibrate the unit.

Various types of sensors are available for the purpose of constructing a fully electronic thermometer. Temperature sensitive resistors are often used, with either a positive temperature coefficient (PTC) or a negative temperature (NTC). A temperature coefficient that is positive means that the resistance increases with the temperature while with a negative coefficient the resistance will decrease with temperature. The disadvantage of thermal sensitive resistors, however, is that they are not linear. The characteristic which represents the curve of the resistance as a function of the temperature is not a straight line, but slightly curved. Therefore, unless elaborate compensation networks are included, a resistor can only be used within a small temperature range, for then the small part of the curve used can be considered to be a straight line. For greater temperature ranges a different sensor will have to be used. With respect to fairly high

temperatures of up to 1000°C thermocouples are needed. These, however, demand a rather specialised technique [cold welding compensation, compensation of temperature influence as a result of current passing through, etc.] and are therefore not suitable for domestic use.

Temperature sensors using semiconductor diodes or transistors do not suffer from these drawbacks. They can be applied within a wide temperature range, are not complicated in structure and are as compact as the other sensors.

The temperature sensitivity of the semiconductor sensor is based on the principle that the forward voltage will change with temperature when the forward current is maintained at a constant level. An example of this is shown in figure 1, when the forward voltage is a function of the temperature in the BAX 13 diode. It will be seen that it can exhibit PTC or NTC characteristics depending on the value of the forward current. At a current of 1 mA the diode has a distinct negative temperature coefficient which reduces as the forward current is increased. At a figure approaching 75 mA the forward voltage is practically temperature independent which can of course be very useful. When the forward current is increased beyond this point the diode then behaves with a positive temperature coefficient. All very interesting but not of great importance to us in this instance.

What is significant, however, is that all the lines in figure 1 are straight. In fact this linearity continues at temperatures below freezing point. Thus, the BAX 13 would make an ideal temperature sensor. Furthermore, most of the common

1

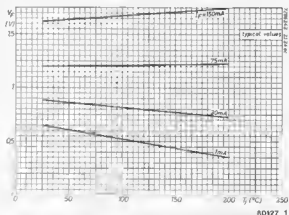

Figure 1. The forward voltage of the BAX 13 is shown plotted as a function of temperature at four different forward currents. It can be seen that at any value of forward current the plot is a straight line.

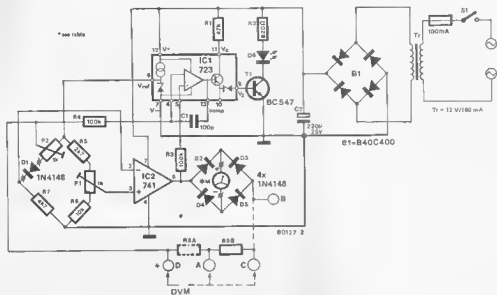

Figure 2. The circuit diagram of the linear thermometer. Using the 1N4148 as a sensor, the temperature can be displayed with the aid of a moving coil meter or a digital voltmeter with 'floating' inputs.

Table 1

scale	meter M	temperature range	R8	DVM
0-30	0-300 $\mu$ A	-30...+30°C	1 k	-0.3...+0.3 V
0-30	0-100 $\mu$ A	-30...+30°C	3 k	-0.3...+0.3 V
0-50	0-300 $\mu$ A	-50...+50°C	1,67 k*	-0.5...+0.5 V
0-50	0-500 $\mu$ A	-50...+50°C	1 k	-0.5...+0.5 V
0-100	0-1 mA	-100...+100°C	1 k	-1...+1 V

\* 2 x 3k3 in parallel.

Table 1. A number of alternative values for R8 together with the measurement ranges obtained for various moving coil meter scales.

types of diodes have similar characteristics providing the forward current is kept as constant as possible.

### The circuit diagram

The circuit diagram shown in figure 2 was first published in the 1979 Summer Circuits issue and many readers requested a printed circuit board for it which is now available. A suitable diode to use as a temperature sensor can be the common 1N4148. Its forward voltage drops by about 2 mV per rise in °C. If a diode is to be used as the basis for temperature sensing it is important that two main conditions are met in the circuit. Firstly, as previously mentioned, the forward current through the diode must remain as stable as possible. Secondly, the circuit measuring the forward voltage of the diode must have a high impedance.

The sensor diode, D1, is included in a bridge network which is supplied with the reference voltage from a 723 IC. At 0°C the bridge must be completely balanced, that is, there must be no voltage difference between the two inputs of IC2. The 741 will, in fact, ensure this itself since R7 is connected to the inverting input and constitutes a feedback path. The IC will maintain or make the voltage across R7 equal to the voltage at its non-inverting input.

When the temperature of the sensor diode is 0°C, the voltage across R7 will be equal to the voltage across R6 plus part of the preset P1. The output of IC2 is then adjusted to zero by P1, effectively balancing the bridge. The display of the thermometer is a meter in the output of IC2. The meter has been connected in a bridge rectifier circuit and it will therefore read in one direction only. This then makes the adjustment of P1 a

simple matter.

Any variation in temperature will result in a change in the forward voltage of the sensor diode D1. Since the voltage across R7, D1 and P2 is the reference voltage of the 723, and therefore constant, any change in the forward voltage of D1 will result in a voltage variation across R7. This will be immediately detected by IC2 which will react by passing a small current, via the meter, to P2 to compensate for the change. Any variation of the current through D1, due to changes in forward voltage, will therefore be avoided by the reaction of IC2. Thus the path through the meter bridge circuit and R8 is a servo control loop to maintain the current through D1 at a constant level. The current level through R8 (the current which counteracts the change in voltage across R7) reflects the temperature of the sensor diode. The meter will, of course, indicate this and can be provided with a scale graduated in degrees.

As mentioned, the meter is connected in a bridge rectifier circuit. This means that the meter will always read in the same direction, regardless of whether the temperature of D1 is above or below 0°C. In other words, the meter will give an identical reading for both +10°C and -10°C. Some indication is needed to show whether the temperature is above or below zero.

So far, only the reference voltage section of the 723 has been used. Since this IC also contains an opamp with a transistor output, this could be used for the indicator circuit, with the addition of a few other components. The opamp is

## 3

## Parts list:

## Resistors:

R1 = 47 k  
 R2 = 820  $\Omega$   
 R3, R4 = 100 k  
 R5 = 2k7  
 R6 = 10 k  
 R7 = 4k7  
 R8 = see text.

## Capacitors:

C1 = 100 p  
 C2 = 220  $\mu$ /25 V

## Semiconductors:

Tt = BC 547B  
 D1 ... D5 = 1N4148  
 D6 = LED  
 IC1 = 723  
 IC2 = 741

## Miscellaneous:

Moving coil meter (see text).  
 B1 = B40C400 12 V/100 mA  
 bridge rectifier  
 TR = 12 V/100 mA mains  
 transformer  
 Plastic box type 80C 430  
 West Hyde or Verobox type  
 2518-H Electrovelu.

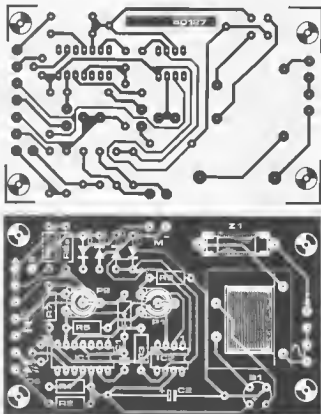

Figure 3. The printed circuit board end component layout for the linear thermometer. Provision has been made to mount a small transformer on the board.

used as a comparator with the output of IC2 and the reference voltage being connected to the non-inverting and inverting inputs respectively. Assuming that the circuit is calibrated for zero deflection of the meter at 0°C, a fall in temperature will result in an increase in the output level of IC2. This will take the non-inverting input of the opamp high and with it the output. Transistor T1 will turn on, lighting the LED. When the temperature rises above zero, the reverse process will occur and the LED will be extinguished.

If a digital voltmeter with a 'floating' input is available, the meter described above may be omitted. The DVM may be used to measure the voltage across R8 in the feedback loop. This will correspond to the current passing through it and therefore to the temperature of the sensor diode. If this option is used the output of IC2 can be directly connected to R8, since the meter, its bridge rectifier and the temperature polarity indication circuit (R1 ... R4, T1 and D6) need not be used. It will be obvious that neither of the terminals of the DVM must be earthed. The polarity of the temperature (above or below 0°C)

will be indicated by the positive or negative sign of the DVM display.

### Construction and calibration

The construction of the Linear Thermometer should not present any difficulties if the printed circuit board is used. The layout for this is shown in figure 3. Room on the board has been allowed for the small 12 V 100 mA mains transformer required. The completed printed circuit board may be fitted in a type BOC 430 plastic case from West Hyde or the 65-2518 H from Vero. The mounting holes on the board have been drilled to fit either of these boxes.

For the temperature sensor the 1N4148 diode is recommended. This may be mounted at a reasonable distance from the circuit board if desired. For air temperature measurements, the diode can be used without any form of cover, provided it is protected from accidental damage by some means. To measure the temperature of electrically conductive fluids, the diode will need to be electrically insulated. The insulation should be as thermal as possible for obvious

reasons.

Depending on which type of meter is chosen, it may be necessary to adjust the values of R8A and R8B as well as the limits of the measuring range. Table 1 gives some guidelines for this purpose. The connection points for a DVM are shown in figure 2.

Before calibration can begin, a quantity of ice must be produced from distilled or demineralised water (available at the chemist's). The ice is crushed and placed in a position where it can melt slowly. The sensor diode is then put in the melting ice and P1 is adjusted for a zero reading on the meter. This then is freezing point calibrated, now for the other end of the scale. With P2 in a central position, the sensor diode can be placed in boiling water (also distilled or demineralised). The voltage across R8 can now be set to exactly 1 V by P2. This should complete calibration but if a reliable reference thermometer is to hand, further checks can be made on a comparison basis.



Large computers can consist of over a hundred thousand logic circuits and are able to execute more than a million instructions per second. Fast as this may seem, a computer 20 times faster than this is currently being developed by IBM. It stems from a brand new branch in technology, namely, the Josephson technique. Its most striking aspect is that it can only function at extremely low temperatures, at which most life has come to a complete standstill, for it is then that electrons move with an increased velocity.

## superconductors supercede semiconductors

# the Josephson computer

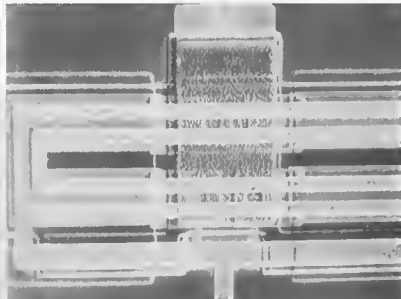

Figure 1. An electron microscopic photo of a Josephson chip. Similar to the method used in semiconductor technology, circuits may be photolithographically miniaturised. The Josephson technique, however, has nothing to do with semiconducting. This is an experimental OR gate which switches in 50 picoseconds ( $50 \cdot 10^{-12}$  seconds). Even faster switching times are possible (photo IBM).

There are two ways in which to expand a computer's capacity: either by including more logic circuits, or by enabling them to work at a higher speed. The Josephson computer, the 'super brain' of the near future, draws its strength from its rapidity.

The speed at which a computer carries out its instructions is measured in the cycle time or clock generator period. The large computers in operation today have a cycle time of around 30-50 ns (nanosecond = one millionth of a second). The world's fastest computer, which oddly enough is not an IBM design, but a CRAY (small scale specialist industry), has a cycle time of 12 ns. With the aid of the Josephson technique it is hoped to reduce this to 1 ns. In actual fact, the first prototypes will probably have a cycle time of 2 ns, but even this amounts to their being 20 times faster than the large present-day computers. Apart from their speed, the prototypes' performance will resemble that of the IBM 370/168, one of the biggest existing computers.

Achieving such a short cycle time is not only a matter of searching for high-speed logic circuits. It

also involves solving the problem pertaining to the transport of countless electrical signals. In one nanosecond an electrical signal can only travel about 15 cm, which means if that is to be the cycle time, the dimensions of the entire computer will have to be no more than 15 cm. For this reason, the Josephson computer as designed by IBM will be 13.5 x 13.7 x 14 cm.

The question is now: will the hundred thousand logic circuits required by an extensive computer be able to fit into such a tiny space? Yes, by means of large scale integration (LSI) which modern technology has fortunately already achieved. Several tens of thousands of chips can be integrated. However, if they belonged to the semiconductor type, the circuit would be doomed to disintegrate after a very brief lifespan, as they would dissipate several kilowatts.

Thus, what is needed is a technology including similar miniaturisation possibilities, but which at the same time produces higher speeds and much less dissipation. All this is achieved by the Josephson technology. Figure 1 shows the result: a Josephson chip.

## Superconductors and electron tunnels

In 1962 while still a university student, the British physicist *Brian D. Josephson* laid the theoretical foundation for the Josephson effect named after him. It is based upon two physical phenomena: superconductivity and electron tunnelling.

Superconductivity was discovered in

1911 by a university professor at Leiden, *Heike Kamerlingh Onnes*. He noted that certain metals (superconductors) lose all resistance to electric current flow when they are cooled to below a certain temperature (which is different for each superconductor). The resistance literally drops down to zero ohms. Kamerlingh Onnes found that superconductivity will only take place if the current is maintained at a certain level. If it rises above that value, the metal will start to act as an ordinary conductor, despite its being sufficiently cooled. It also appeared to be possible to disturb the superconductivity with a magnetic field.

It was only in 1957 that a satisfactory explanation for this phenomenon could be given. One of the people responsible was *John Bardeen*, one of the three inventors of the transistor. What it comes down to is that in the superconducting state an electric current must not be regarded as a stream of 'single' electrons, but of 'pairs' (Cooper pairs, named after another founder of the theory). The electrons belonging to such a pair now move in step with each other, so to speak, and no longer need to "cling" to the atom nuclei. With each other's help they shoot between the nuclei. Superconductivity stops when the electron pairs become separated for some reason. This may be due to an increase in temperature or current, or due to a magnetic field. Strictly speaking, superconductivity is only valid for direct currents; as for alternating currents, they cause a slight deviation from the 'ideal' superconductivity until far into the high frequency range.

Whereas superconductivity was explained long after its discovery, with *electron tunnelling* (the tunnel effect) it was quite the opposite. The theory has been in existence for some time before the phenomenon could be demonstrated during the sixties. It has nothing to do with superconductivity and in fact also occurs at everyday temperatures. It is the tunnel diode, often applied as a gigahertz amplifier or as a fast switch, which makes use of the effect.

Contrary to what might be expected, a thin insulator between two conductors will allow an electric current to pass. Thus, despite the fact that its ohmic resistance is infinite, current will flow. This involves quantum mechanics and so is rather complicated. Basically, it means that the electron should not only be regarded as a particle, but also as a wave phenomenon. It 'rebounds' as it were against the barrier formed by the insulator, but being a wave it penetrates it slightly, provided that the insulator is not too thick.

### Josephson: superconducting tunnelling

Josephson combined the two physical phenomena by applying the electron

tunnelling theory to electron pairs responsible for superconductivity. This is because an electron pair can also be considered as a wave. Remarkably, the thin insulator, which really should not allow any current to pass at all, was now found to act as a *superconductor*. This occurred when the metals around it were in a superconducting state.

This effect is called the Josephson effect. A year later it was also observed in the American Bell laboratory.

A thin insulator between two superconductors is called a *Josephson junction*. This is the principle behind the Josephson computer. Since superconductivity only takes place at very low temperatures, the entire computer is cooled by submerging it into liquid helium. Its boiling point is around 4.2 degrees Kelvin ( $-269^{\circ}\text{C}$ ). Thus, more than anything else, the Josephson computer has to 'keep its cool'. There are additional applications for the Josephson effect outside the computer field. It can, for instance, be used to measure tiny magnetic fields and voltages, and can also be applied in microwave technology.

### The Josephson junction used as a switch

As we have just seen, a superconducting material can be brought out of this state in three different manners: by an increase in temperature, an increase in current and by the creation of a magnetic field. This is not only true of superconducting metals, but also of the Josephson junction — even more so, in fact. That is why Josephson called it a 'weak super conductor'. When it is

brought out of its superconducting state, it does not start acting as a normal conductor, like metal, would, but as an ordinary tunnel junction. In practice, this means that the Josephson junction then demonstrates a resistance of a few hundred ohms, so that it is possible to switch its resistance from zero to a few hundred ohms. The Josephson computer uses this phenomenon.

Switching from a superconducting to a resistant state, and vice versa, happens at a speed that few physical processes can match. The switching time is around 6 picoseconds (a picosecond is one billionth of a second), less than 1% of the 1 ns cycle time IBM seeks to achieve in the Josephson computer. By way of comparison, the fastest semiconductor switches take ten times longer.

This incredible speed is not the only advantage the Josephson junction has to offer. Its dissipation (heat development) when in a superconducting state is nil, even when a current of 0.1 mA is flowing. For, after all, its resistance is also nil. In fact, dissipation will be very low, even in the resistant state, as the circuit's supply voltage will be approximately 10 mV.

A Josephson computer including a 16 Mbyte memory capacity is therefore expected to dissipate a mere 7 watts of electrical power. What a difference, compared to the amount of kilowatts produced by present-day computing monsters!

This does not mean that a Josephson computer will not lead to high electricity bills. On the contrary, cooling it to 4.2 Kelvin will require about 15 kilowatts. Cooling techniques have fortunately long since been developed,

## 2

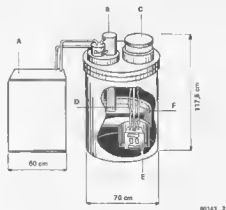

Figure 2. The Josephson computer will have an unusual appearance. Most of it will be taken up by the cooling system required to maintain 4.2 K ( $-269^{\circ}\text{C}$ ). This requires a lot of energy: 15 KW, whereas the computer itself needs only 7 W(!). A: compressor for the cooling; B: cooling system; C: interface and supply operate at room temperature; D: in- and output connections; E: the actual computer; F: liquid helium at 4.2 K.

3



Figure 3. The structure of a Josephson junction (3a) and its voltage/current ratio curve (3b). The Josephson junction consists of two superconductors (shaded areas) with a very thin insulator, the Josephson barrier, between them.

The operation of a cooling installation (cryostat) hardly differs from that of a domestic fridge. Its design is such, that it can be switched off for as long as a hundred hours at a time without any detrimental effect to the superconductivity. Figure 2 outlines the installation. It consists of a cryostat able to hold 460 litres. A compressor takes care of the cooling. The actual computer, the block of less than 4 litres, is submerged in the cryostat.

### The U-I curve

The relationship between the current passing through a component and the voltage across it can be expressed in the form of a graph: the U-I curve. The U-I curve of a Josephson junction is shown as a circuit diagram in figure 3a and as a graph in figure 3b. It is rather unusual, as it has two curves. It looks as though at certain I current values the voltage U can assume two different values!

What happens if the current through a Josephson junction is allowed to rise above zero? First we remain within the lefthand plot of the curve. The current

4

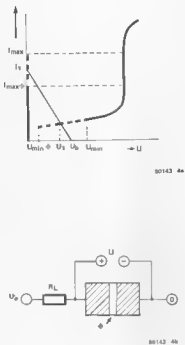

Figure 4. The influence of a magnetic field on the voltage/current ratio curve (4a). The diagonal is the load line caused by including load resistor  $R_L$  (4b).

increases, but the voltage is still 0 volts. Its resistance is nil and it is in the superconducting condition. This continues until the current rises above  $I_{max}$ , for as soon as this happens the junction will cease to be in a superconducting state. Thus, we jump (literally) to the right branch of the curve and there is a voltage across the junction. If the current is allowed to drop down below  $I_{max}$  we continue to remain in the right branch of the curve, for there is still a voltage across the junction. The superconducting condition will only occur again, therefore, if the current is reduced to below  $I_{min}$ , or if the voltage is brought down to below  $U_{min}$ , which comes down to the same thing.

Thus, the Josephson junction can be made to switch from a superconducting state to a resistant state by increasing the current passing through it very briefly. Switching back to a superconducting state is achieved by decreasing it very briefly. The Josephson junction has a memory function: the superconducting and resistant states both being stable, they can be fixed. This distinguishes it from a transistor,

for in the latter's case at least two transistors are required to store a single bit. In this manner, a memory component is prevented from dissipating power in either of its two conditions.

### Magnetism

By varying the current passing through a Josephson junction, we can switch it from its superconducting state to a resistant state and back again. But this isn't always convenient, as in electronics we prefer to switch a current with the aid of another independent current or voltage. Ideally, the Josephson junction should have a base- or gate-electrode, or something similar. Fortunately, this appears to be possible and not even all that complicated.

Use is made of magnetism. The values  $I_{max}$  and  $U_{min}$  (as also  $I_{min}$ ) are found to depend on the size of the magnetic field. This is shown in the curve in figure 4a. The maximum superconducting current  $I_{max}$  drops to  $I_{max} \emptyset$  when a magnetic field is applied. The minimum voltage in the resistive state  $U_{min}$  will then drop to  $U_{min} \emptyset$ . Thus, the Josephson current can be preset at a fixed current  $I_L$ . If a magnetic field is applied, it will switch from its superconducting state to normal conductance. Similarly, it will switch back to superconductivity when the magnetic field is removed. For this to happen, there must be a voltage  $U_L$  of between  $U_{min} \emptyset$  and  $U_{min}$  across the junction. This is done by switching it in series with a load resistor  $R_L$ , as drawn in figure 4b. The diagonal  $I_L - U_B$  in figure 4a is a load line, like the ones found in transistor graphs. It indicates the various current/voltage combinations which are possible after the load resistor has been added. Switching happens along this line.

Since the supply voltage  $U_B$  is very low (a few millivolts), very little power is dissipated in the resistor. In the resistant state about  $0.5 \mu W$  is consumed. Often self inductances are employed for the load in the Josephson technique.

How is a magnetic field generated? Simply by emitting an electric current along the Josephson junction, for each current has its own magnetic field around it. Since the junction is highly sensitive to the magnetic field, a small current is all that is necessary. Figure 5 gives an enlarged view of the way in which a Josephson switch can be introduced into a chip. Above the Josephson junction there is a control channel through which the control current  $I_C$  flows. The arrows indicate the magnetic field created by the current. Current I through the junction is affected by the much smaller control  $I_C$ . The Josephson switch is a *current controlled current switch*. In 1965 the IBM technician, Juri Matisoo, succeeded in making and testing such a switch.

**Standard component: the SQUID**

It would be an advantage if the junction's sensitivity to magnetic fields were at a maximum, for then the control current could be low. This is achieved by making the surface area of the junction as large as possible. However, this also has disadvantages: for not only does a large junction naturally occupy more chip space, but it will also switch more slowly. The Josephson junction has a capacitance, a slowing-down factor, which increases with junction surface area.

This dilemma has been solved by the development of the SQUID, a kind of Josephson 'standard component' with two or more small Josephson junctions. In the SQUID use is made of the cooperation of different Josephson currents. This cooperation is rather complex and may be compared with the interference of wave forms (light, for instance). It is connected with the fact that Josephson currents tend to be unevenly distributed over a Josephson junction in the presence of a magnetic field. Figure 6

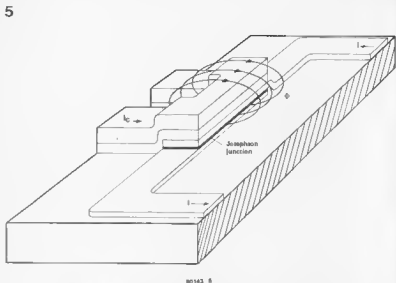

Figure 5. Highly enlarged outline of a Josephson switch. The current  $I$  is switched under the influence of a magnetic field  $\Phi$  (indicated with arrows) induced by the control current  $I_c$ .

6

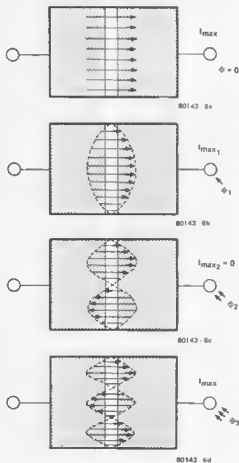

Figure 6. When a magnetic field  $\Phi$  is created the current through a Josephson junction is not evenly distributed. At certain levels of magnetic force, the total current through the junction may even become nil ( $\Phi_2$ ).

illustrates this. It shows what the current distribution in increasingly magnetic field looks like when the current through it is equal to the maximum superconducting current  $I_{max}$ . As the magnetic force augments,  $I_{max}$  will decrease and may even equal 0 at a magnetic flux of  $\Phi_2$ . At that level in magnetic force, the Josephson cannot attain a superconducting state, however small the current flow through it. If the magnetic field is further increased however,  $I_{max}$  will rise again. Not drawn is how  $I_{max}$  will again equal zero, if the magnetic field force is further increased. This is why the magnetic field to maximum superconducting current ratio forms such a peculiar, periodical curve (figure 7). Now the two Josephson junctions may be made so that at a certain magnetic field force, one junction can easily become superconducting and the other not at all, while at another level the situation will be exact reverse. The two junctions are both controlled by the same control current. Thus, the control current sends the controlled current into a certain direction: either via one Josephson junction, or via the other. This is what occurs in a SQUID, a 'Superconducting Quantum Interference Device'. It enables the sensitivity of a large Josephson junction to be combined with the speed of a small one. SQUIDS can be made in all sorts of versions and may include more than two Josephson junctions.

**Logic circuits**

SQUIDS form the pillars of the Josephson computer. They enable all the known logic circuits in semiconductor technology to be made: inverters, gates, flipflops. An AND gate, for

instance, may be made by controlling a SQUID with not one control current but two. Then the two control channels will be created above the junctions. The SQUID will switch only if both the control currents are large enough. Such a type is also called a 'current injection device', as shown in figure 8. Similar circuits make OR gates possible.

As for flipflops, these can be constructed in various ways. One of the most interesting makes use of induced superconducting loop currents, for such currents flow indefinitely!

### Alternating voltage

A remarkable characteristic inherent to the Josephson junction is its perfectly symmetrical non-polarised structure. This means it can be connected either way around. What is more, a Josephson circuit may be equally well fed with an alternating voltage, which is the case in the Josephson computer. The great advantage here is that the supply voltage will then function as a clock signal. In other words, its stomach is also its heart and so quite a few electrical connections may be omitted. This also helps to reset circuits.

The power supply of the first prototype computer will consist of a 500 MHz sine-wave oscillator producing 7 watts power. It is 'on dry land' and so is not cooled. On each of the more than ten thousand chips included in the Josephson computer, there will be a number of voltage controllers to limit the voltage to an upper threshold of 12 millivolts. The sine-wave will then have become a square wave. By voltage limiting in many places interference between signal paths is avoided.

The synchronisation of such a high speed computer poses a serious problem. During a two nanosecond clock period an electrical signal will only travel 30 cm. Highly specialized techniques are needed to ensure that processes occur simultaneously in the way they should.

### The material

Although it should not be taken lightly, a Josephson computer is not difficult to manufacture. This is because familiar techniques may be used on a large scale, such as the manufacture of semiconductor IC's. Although the materials used are different, the procedure is very similar: layers are evaporated, patterns are applied photolithographically and etched. Complicated semiconductor processes like diffusion and implantation are not even necessary for Josephson chips. On the other hand, more layers are applied (ten to fourteen, instead of three to six) and the tunnel barrier (the insulator between the superconductors) is very hard to make, because it has to be so thin.

The materials used in a Josephson computer have to comply with two obvious requirements; they must be

7

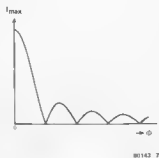

Figure 7. As a result of the uneven distribution drawn in figure 6, this remarkable relationship between current  $I$  through a junction and the magnetic field  $B$  is established. Such an effect is used in the 'Josephson standard component', the SQUID.

capable of sustaining freezing temperatures and great changes in temperature. After all, a Josephson computer is built and probably repaired at room temperature. Because of the fluctuations in temperature, the materials used must have similar expansion coefficients, among other things, which reduces the choice of possibilities considerably.

The latter aspect is quite a headache for IBM technicians. It is true that enormous progress has been made (the error factor after 400 temperature cycles has already been brought down from 99% to 0.1%),

but there are so many chips that the sensitivity to temperature changes is still far too great.

Josephson chips are based on silicon, like the semiconductor type. Silicon was chosen because its use in the semiconductor industry is well established. Some experts believe that more is known about silicon than about any other material on earth.

Contrary to semiconductor chips, the silicon here takes no part in the electrical process. Thus, its semiconducting characteristics are not at all involved, for the Josephson computer silicon is merely an insulator. The fact that it is also a good heat conductor is an extra advantage.

Different insulating and protective layers are made from another material used in semiconductor technology: silicon oxide. The superconducting layers consist of the metal niobium or of a lead alloy (with bismuth, or with indium and gold).

The Josephson barriers made from lead and indium oxides are subjected to very tough requirements. They are no thicker than 4 to 6 nanometres, about thirty atom diameters (the other layers are about 100 nm thick). Furthermore, the density of that layer is highly critical, as the maximum superconducting current depends on it exponentially. What it comes down to is that the layer must be made in such a way that the average density may only vary from the standard by less than an atomic diameter. This is like covering an acre with a layer of soil three centimetres thick without it varying anywhere by

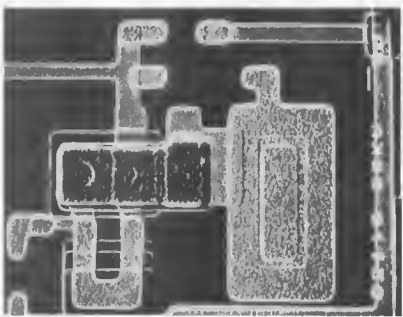

Figure 8. A current injection device, one of the methods to produce a logic AND gate by means of the Josephson technique. The gate works with two Josephson junctions, shown as vesicle circles in the dark horizontal rectangle. The left-hand junction has five times the surface area of its right-hand counterpart. The smallest dimensions are around 2.5  $\mu\text{m}$ , which is as tiny as an LSI semiconductor chip (IBM photo).

more than a millimetre. This feat required brand new evaporation techniques.

### Soldering with mercury

The chips couldn't be connected until another new technique was developed, for of course the Josephson chips couldn't just be mounted onto printed circuit boards. Apart from the undesirable cooling effects, the computer with its more than ten thousand chips would be far too big.

How it is put together is shown in figures 9 and 10. Figure 9 displays a module about 30 x 25 x 15 mm. The chips here are packaged very closely together. Not only do the substrates of the chips consist of silicon, but so does the rest of the module. Without any other form of case, the chips are mounted onto the small cards face down, according to the 'bonding' process (from the semiconductor technology).

9

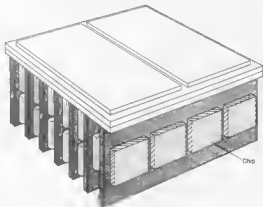

80143 - 9

Figure 9. It is very important that the Josephson chips be mounted closely together. This little block measures about 30 x 25 x 15 mm. Every card contains four or eight chips of 6,4 x 6,4 mm (shaded area) which are mounted face downward. Both the large card and the 'diagonal cards' consist of mono crystalline silicon, along which delicate copper wiring patterns have been affixed by photolithographical means.

10

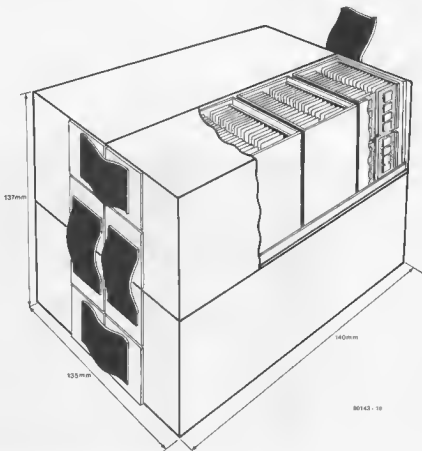

80143 - 10

Figure 10. This is how the entire computer is put together using the blocks shown in figure 9. It contains more than ten thousand chips and is, as illustrated in figure 2, submerged entirely in liquid helium. From the rear side flat cable runs to the interface and to the supply which operate at room temperature.

This makes the heat transfer to the liquid helium highly efficient.

The chip cards are connected to the larger card by means of minute connectors. These have 'micropins'. A micropin is 0.2 mm long and 0.075 mm in diameter. Larger pins would cause the magnetic field to be too large, which would slow down the signal transfer and cause cross-talk. The individual distance between the micropins is half a millimetre, (an ordinary DIL-IC's pins are 2 mm apart). The micropins are connected, not with solder, but with mercury, as this solidifies at low temperatures (below -40°C). At room temperature, the liquid mercury is stored in drops with a 0.4 mm diameter in specially made cavities.

Four modules (which sometimes vary in size) in figure 9 are combined to form a 'W module'. Twenty one such modules constitute the entire computer shown in figure 10. More than the thousand chips have been collected in a block of less than 14 x 14 x 14 cm. The CPU and the fast 32 K byte scratch memory are both included in one of the twenty one W modules. The other twenty are occupied by the large 16 M byte main memory. Once it is submerged in liquid helium, this block outshines all present-day computers

### Why a Josephson computer?

It is almost certain that a Josephson

computer can be built. Already, complete 16 K RAMs and CPU chips have been made according to the Josephson technique. Problems left to be solved involve developing a sufficient resistance to temperature changes, as mentioned above. Furthermore, suitable fast I/O systems still have to be created, for without its 'hands and feet' even the most cold blooded of brains will not be up to much. At this stage, however, these problems seem unsurmountable. Whether a Josephson computer will ever be a market product is hard to say. The microprocessor is threatening to put an end to the golden age of the large-size computer. Fewer calculations are dealt with 'centrally' in favour of the small, specialised microcomputer systems. It does not look as if the world is desperate for even larger and faster computers. Nonetheless, IBM must see some future in its Josephson computer, as otherwise it would not have put so much time and effort (and money!) into research. There are still a number of fields where the present-day computing monsters lack ability. Computer simulations of physical or economic processes, for instance, could be far more accurate and take place on a larger scale. Computer simulations are also important in weather forecasts and in some fields of purely scientific research (nuclear physics). And of course then it could have military applications.

Another field which would welcome a huge computing capacity is pattern

recognition, in which the computer interprets sound (speech) and video signals (written text, video and radar). A third possibility is provided by the great data banks which must be accessible for many users at once. In any case, IBM is already speculating upon fields which are still reserved for the ordinary semiconductor microcomputers and which one day, in the distant future, could well be taken over by Josephson technology . . .

### Sources:

- Spektrum der Wissenschaft, Juli 1980: 'Superleitende Computer', Juri Matisov;*
- IBM Research Highlights, June 1979: 'Experimental IBM circuits are the world's fastest';*
- IEEE Spectrum, May 1979: 'Computing at 4 degrees kelvin', W. Anacker (IBM).*

### Temperature

A word on temperature, which is a peculiar concept. It is quite different from heat. Heat can but *cause* a change in temperature, no more. In modern physics temperature no longer has much to do with cold or heat. Rather it is considered as a gauge of the trembling pertaining to atomic nuclei. Atomic nuclei do not stay in a fixed position, but move around a fixed point. Using a little imagination, a particle of matter may be seen as a swarm of mosquitoes. The swarm remains stationary, whereas the individual mosquitoes are highly mobile.

The more atomic nuclei in movement, the higher the temperature. To the physicist, therefore, temperature is inherent to matter-- it is one of its *characteristics*.

If the temperature of a piece of matter is lowered, the atomic nuclei start moving less wildly. This is true of all material. If the temperature is low enough, the atomic nuclei will become immobile. Since temperature is a measure for atomic mobility, it is not strange that the temperature at which the nuclei become immobile is the same for all kinds of matter.

Standing still is as immobile as you can get. This brings us to the conclusion that a lower temperature will therefore not be possible. For this reason, the temperature at which atomic nuclei stand absolutely still is called the absolute zero. It is somewhere around -273.4°C. It can also be expressed as 0 K (in the past: 0°K). K represents Kelvin, the absolute temperature unit.

### The tunnel effect

The tunnel effect is based on the fact that a thin insulator applied between two conductors will allow an electric current to pass. The phenomenon is explained in *quantum mechanics*. What this boils down to is that particles do not have a certain *fixed* mass, speed, energy, etc., as was believed in classical (newtonian) physics. A random distribution is involved. You could say that in classical physics a particle used to be considered as a hard little globule moving in perfect orbits at a well defined speed, whereas in quantum mechanics everything is much 'hazier'. Here a particle looks more like a cloud, not clearly circumscribed, but ending 'somewhere'. The averages of the various

chance distributions of mass, speed and energy will however still be the same as in classical physics.

Classical physics has no explanation for the tunnel effect. According to it, the particles--electrons-- would all have too little energy to be able to penetrate the thin insulator barrier. Quantum mechanics states, however, that although the average energy of the various particles would be deficient, nevertheless it is possible for one particle to have enough energy. Some particles must therefore be almost immobile, whereas others are highly mobile.

In other words, according to quantum mechanics, the particles are no longer all identical.

# VOX printed circuit board

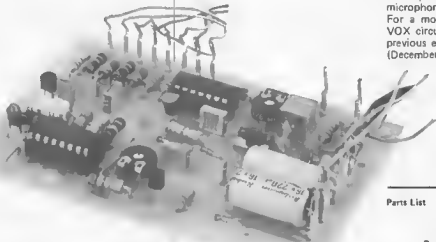

The VOX switch published in the December 1979 issue of Elektor attracted a lot more attention than expected and it is for this reason that a printed circuit board has now been produced.

A brief recap of the original article will be useful to those readers who are unfamiliar with the purpose of a VOX switch. Basically it is a voice operated electronic switch, normally used to operate a transmitter/receiver. It can have other uses of course, but its main purpose is to allow the hands to be free when using the microphone. As soon as a sound is picked up by the microphone the VOX will switch the transmitter/receiver to 'transmit'. At the end of the speech passage the VOX will switch back (after a short delay) to 'receive'. The delay is presettable and is included to cater for breaths and hesitations. This VOX is fine but there are drawbacks in practice. Sound picked up by the microphone can include squeaky chairs, doors closing or even beer cans popping open, should this occur in the vicinity. It is not of course desirable for the transmitter to switch on in these instances. The Elektor VOX switch avoids this problem by the addition of a filter designed to exclude all frequencies other than those in the speech band. The filter can be made 'active', to a certain degree, to the characteristics of a

particular voice pattern, since both the bandwidth and the centre frequency are adjustable (with P2 and P3 respectively). The two other potentiometers are to preset the input sensitivity (P1) and the length of the delay (P4). In practice, the range of P1 should be adequate since the gain of the microphone preamp A1 can go up to 100 X.

Delay time however can be a matter of personal preference. With the values of P4, R20 and C7 as given in figure 1 the delay time is adjustable between 0.5 and 2.5 seconds. The range can be altered by changing the values of any or all of these components.

The layout of the printed circuit board for the VOX is shown in figure 2. Everything in figure 1 is included on the board with the exception of the two stereo potentiometers, the relay and the microphone.

For a more precise description of the VOX circuit readers are referred to the previous article published in Elektor 56 (December 1979). **M**

## Parts List

### Resistors:

R1,R3,R4,R10,R13,R16 = 10 k  
R2,R17 = 47 k  
R5,R6,R7,R14,R19 = 22 k  
R8,R11 = 3k9  
R9,R12 = 1k2  
R15 = 100 k  
R18 = 4k7  
R20 = 220 k  
R21,R22 = 6k8

### Capacitors:

C1 = 1  $\mu$  (MKM)  
C2,C3 = 22 n  
C4,C5,C10 = 100 n  
C6 = 2 $\mu$ 2/16 V  
C7 = 4 $\mu$ 7/16 V  
C8,C9 = 220  $\mu$ /16 V  
C11 = 100 p  
C12 = 27 n

### Semiconductors:

T1,T2,T3 = TUN  
T4 = TUP  
D1,D2,D3 = DUS  
IC1 = TL 084  
IC2 = 4528

### Miscellaneous:

P1,P4 = t M preset  
P2 = t M lin.  
P3 = 10 k log.  
L1 = 5 turns 0.1... 0.25 CuL  
wre on ferrite bead



1

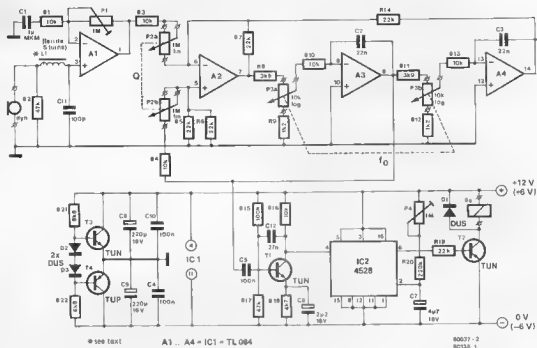

Figure 1. The circuit diagram of the voice operated control switch.

2

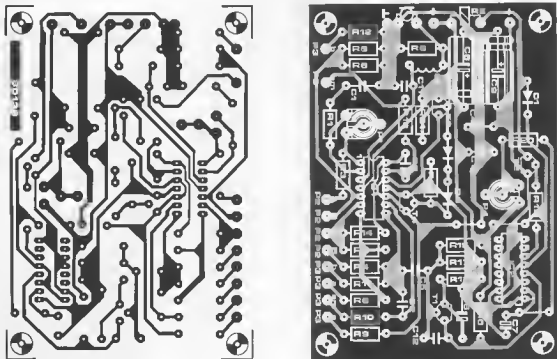

Figure 2. The VOX printed circuit board layout.

# Britain's first com puter kit.

## The Sinclair ZX80.

# £79.95

**Price breakdown**  
ZX80 and manual: £69.52  
VAT £10.43  
Post and packing FREE

Please note, many kit makers quote VAT-exclusive prices

You've seen the reviews... you've heard the excitement now make the kit!

This is the ZX80 'Personal Computer World' gave 5 stars for 'excellent value'. Benchmark tests say it's faster than all previous personal computers. And the response from kit enthusiasts has been tremendous.

To help you appreciate its value, the price is shown above with and without VAT. This is so you can compare the ZX80 with competitive kits that don't appear with inclusive prices.

### 'Excellent value' indeed!

For just £79.95 (including VAT and p&p) you get everything you need to build a personal computer on home PCB, with IC sockets for all ICs, cassette leads for direct connection to a cassette recorder and teletext (black and white or colour), everything!

Yet the ZX80 really is a complete, powerful full-featured computer, matching or surpassing other personal computers at several times the price.

The ZX80 is programmed in BASIC, and you can use it to do quite literally anything from playing chess to managing a business.

The ZX80 is pleasantly straightforward to assemble, using a fine-tipped soldering iron. It immediately gives you what a good job you've done: connect it to your TV link it to an appropriate power source and you're ready to go.

### Your ZX80 kit contains...

- Printed circuit board, with IC sockets for all ICs
- Complete components set, including all ICs - all manufactured by selected world leading suppliers
- New rugged Sinclair keyboard, touch-sensitive wipe-clean
- Ready-modified case
- Leads and plugs for connection to domestic TV and cassette recorder (Programs can be SAVED and LOADED on to a portable cassette recorder.)
- FREE course in BASIC programming and user manual
- **Optional extras**
  - Mains adaptor of 600 mA at 9 VDC nominal unregulated (available separately - see coupon)
  - Additional memory expansion boards allowing up to 16K bytes RAM (Extra RAM chips also available - see coupon)

\*Use a 600 mA at 9 VDC nominal unregulated mains adaptor. Available from Sinclair if desired (see coupon)

### The unique and valuable components of the Sinclair ZX80.

The Sinclair ZX80 is not just another personal computer. Quite apart from its exceptionally low price, the ZX80 has two uniquely advanced components: the Sinclair BASIC interpreter, and the Sinclair teach yourself BASIC manual.

The unique Sinclair BASIC interpreter offers remarkable programming advantages:
 

- **Unique 'one-touch' key word entry:** the ZX80 eliminates a great deal of tiresome typing. Key words (RUN, PRINT, LIST, etc.) have their own single-key entry.

- **Unique syntax check:** Only lines with correct syntax are accepted into programs. A cursor identifies errors immediately. The prevention of long and complicated programs with faults only discovered when you try to run them.

- **Excellent string-handling capability:** takes up to 26 string variables of any length. All strings can undergo all relational tests (e.g. comparison). The ZX80 also has string input to request a line of text when necessary. Strings do not need to be dimensioned.

- Up to 26 single dimension arrays
- FOR/NEXT loops nested up to 26
- Variable names of any length
- BASIC language also handles full Boolean arithmetic, conditional expressions etc
- Exceptionally powerful editing facilities allows modification of existing program lines
- Randomise function useful for games and secret codes, as well as more serious applications

- Times under program control
- PEEK and POKE enable entry of machine code instructions. USR causes jump to a user's machine language sub-routine
- High resolution graphics with 22 standard graphic symbols
- All characters printable in reverse under program control
- Lines of unlimited length

sinclair  
ZX80

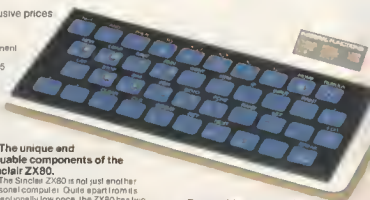

### Fewer chips, compact design, volume production - more power per pound!

The ZX80 owes its remarkable low price to its remarkable design: the whole system is packed on to fewer newer more powerful and advanced LSI chips. A single SUPER ROM for instance, contains the BASIC interpreter, the character set, operating system and monitor. And the ZX80's 1K byte RAM is roughly equivalent to 4K bytes in a conventional computer - typically storing 100 lines of BASIC (Key words occupy only a single byte).

The display shows 32 characters by 24 lines. And Benchmark tests show that the ZX80 is faster than all other personal computers. No other personal computer offers this unique combination of high capability and low price.

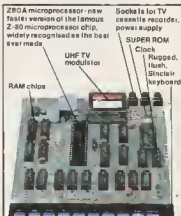

# Complete

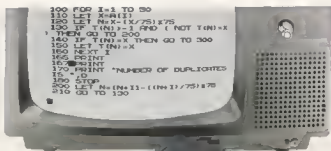

### The Sinclair teach-yourself BASIC manual.

If the specifications of the Sinclair ZX80 mean little to you - don't worry. They're all explained in the specially-written 128-page book free with every kit! The book makes learning easy, exciting and enjoyable, and represents a complete course in BASIC programming - from first principles to complex programs. (Available separately - purchase once refunded if you buy a ZX80 later.) A hardware manual is also included with every kit.

### The Sinclair ZX80. Kit: £79.95. Assembled: £99.95. Complete!

The ZX80 kit costs a mere £79.95. Can't wait to have a ZX80 up and running? No problem! It's also available, ready assembled and complete with mains adaptor, for only £99.95.

Demand for the ZX80 is very high, use the coupon to order today for the earliest possible delivery. All orders will be despatched in strict rotation. We'll acknowledge each order by return, and tell you exactly when your ZX80 will be delivered. If you choose not to wait, you can cancel your order immediately and your money will be refunded at once. Again, of course, you may return your ZX80 as received within 14 days for a full refund. We want you to be satisfied beyond all doubt - and we have no doubt that you will be.

**SINCLAIR**  
**ZX80**  
Science of Cambridge Ltd

6 Kings Parade, Cambridge, Cambs., CB2 1SN  
Tel: 0223 311466

ORDER FORM		To Science of Cambridge Ltd, 6 Kings Parade, Cambridge, Cambs., CB2 1SN	
		Remember: all prices shown include VAT, postage and packing. No hidden extras.	
		Please send me:	
Quantity	Item	Item price £	Total £
	Sinclair ZX80 Personal Computer kit (Price includes ZX80 BASIC manual - excludes mains adaptor)	£79.95	
	Ready assembled Sinclair ZX80 Personal Computer (Price includes ZX80 BASIC manual and mains adaptor)	£99.95	
	Mains Adaptor(s) (600 mA at 9 V DC nominal unregulated)	5.95	
	Memory Expansion Board(s) (each one takes up to 3K bytes)	12.00	
	RAM Memory chips - standard 1K bytes capacity	16.00	
	Sinclair ZX80 Manual(s) (manual free with every ZX80 kit or ready made computer)	5.00	
NB: Your Sinclair ZX80 may qualify as a business expense		TOTAL	£
I enclose a cheque/postal order payable to Science of Cambridge Ltd for £			
Please print:			
Name: Mr/Mrs/Miss			
Address: _____			
			£9/80

# ejektor

an invitation to investigate, improve and implement imperfect but interesting ideas

Multipath distortion occurs when the signal of a transmitter reaches the receiver along more than one 'path'. Figure 1 illustrates this. If the difference in distance between two of those signals is equal to an odd number of half wave lengths, then these are out of phase relative to each other. This is the case in figure 2 where the direct (a) and the reflected (b) signals of figure 1 have been drawn. If they are both equal in strength, then one cancels the other. This is an extreme case and it does not occur that often. There is usually a difference in amplitude between a direct and a reflected signal and, often, more than one reflected signal reaches the receiver. On the other hand, the signals add when the difference in distance corresponds to an even number of half wave lengths. Let us now consider the complete music or speech modulated transmission signal. It will be seen that things are quite different. After modulation there are a large number of signals of various frequencies and the chances are that one or more frequencies will occur in the total spec-

An AM synchronous demodulator does not produce distortion in the envelope detector. Normal or synchronous SSB (single side band) will of course not cause any problems. The multipath signal processed by a synchronous demodulator remains undistorted but is coloured by a phase-like effect. So far so good. It isn't until dealing with FM that really nasty effects start cropping up. The original signal, which has a constant amplitude when this modulation method is used, is changed by multipath conditions into a signal in which AM is also present. After limiting in the receiver, the unwanted AM signal becomes a PM (Phase Modulated) signal, which means that the deviation will increase with the modulation frequency.

The L-R signal is then the worst affected and during stereo reception the presence of multipath will be immediately audible. Amplitude minimum levels may also occur on the unmodulated carrier, which will cause mono signals to be badly distorted too after demodulation.

# measuring multipath

## Multipath Distortion

*Multipath distortion; an unpleasant phenomenon, especially with FM stereo. Often the only thing you can do to combat it is to empirically rotate the aerial. What's important is that the distortion produced by the receiver can even be recognized as a multipath problem. For quality FM receivers, therefore, a multipath meter is highly desirable. The standard recipe for such an indicator can be improved on as this article will show.*

1

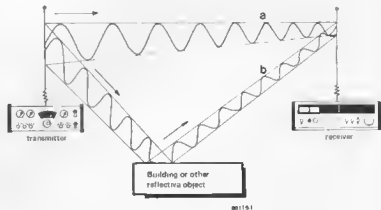

Figure 1. Multipath distortion is caused when the transmitted signal reaches the receiver via two (or more) paths of different lengths.

trum which will show signs of minimum amplitude or maximum interference as a result of multipath. The amount of interference incurred depends on the kind of modulation applied and on the way in which demodulation takes place in the receiver.

If during AM (Amplitude Modulation) a few side band components are amplified or weakened, this will merely cause the demodulated signal to be 'coloured'. If, however, the modulation depth at peak amplitude is greater than 100%, the envelope detector which is present in the majority of broadcasting receivers will start to produce a fair amount of distortion. The same is true when low amplitude levels occur in the carrier wave. Listeners to short wave radio will be familiar with this phenomenon. Where distant radio stations are concerned, short wave signals constantly reproduce themselves along various paths through the ionosphere.

Although an effective AM suppression in an FM receiver is certainly useful to have, it is impossible to counteract multipath distortion once it has arisen. For this reason top quality FM receivers, more often than not, are equipped with a multipath indicator during manufacture.

### Multipath indicator circuit

In figure 3 the block diagram of an FM receiver has been drawn in which the ordinary S meter is expanded with the additional facility of multipath indication. With the switch in position 1, it operates as a multipath indicator and, on position 2 as an S meter. The input signal of the indicator circuit is derived by detecting the outputs of all the IF amplifiers (here A1, A2 and A3) and adding them. Why not just the output signal of A3? Because A3 will already be limited to average

strength signal levels and will therefore not form a very reliable source of information for the S meter.

The added signal of the three IF amplifiers is just right for the amplitude of the signal received as far as the DC component is concerned. Therefore, for the S meter indication, this signal may be fed directly through an RC network to the meter.

Whenever multipath distortion occurs, the added signal (point A) will contain an AC component during modulated transmissions. The simplest way to construct a multipath meter is to amplify the AC (A4) and rectify it, as shown in figure 3. This method nevertheless has one big drawback. The indication is dependent on the transmitter modulation. During modulation intervals nothing is indicated and this proves to be quite a nuisance in practice. The logical solution, therefore, is to make use of the 19 kHz pilot tone (always available in the signal). This may be achieved by replacing the circuit inside the dotted area of figure 3 by figure 4a. The amplifier A4

2

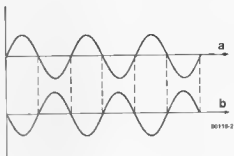

Figure 2. The direct (a) and reflected (b) signals may often be in exact antiphase when they reach the receiver aerial and cancel each other completely.

3

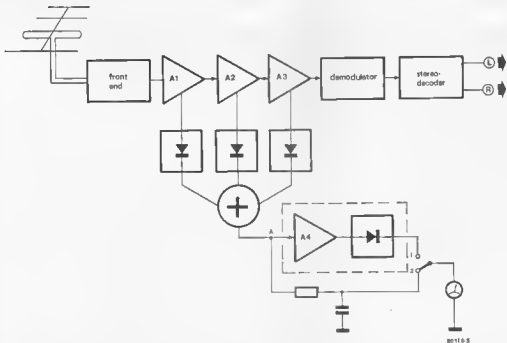

Figure 3. An FM receiver equipped with a multipath meter in the normal method. When switched to '1' the meter indicates multipath distortion. On '2' it acts as an S meter.

(with increased gain) is preceded by 19 kHz band filter. After detection this will result in a continuous multipath indication which is completely independent of the normal transmitter modulation.

An even better solution is given in figure 4b. The voltage drop across the diodes does not even come into it. Here too, the 19 kHz component is first filtered from the detected and added IF signals. This is now mixed with an artificially produced 19 kHz signal which may be derived from the PLL stereo decoder for instance. The two input signals of the mixer give a direct representation of multipath distortion. Thus, after the mixed product has been low pass filtered it can be fed to the meter without any further modifications.

4

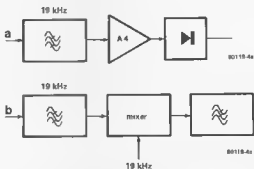

Figure 4. A fairly simple alternative (4a) to the dotted area in figure 3 and a slightly more complicated and effective version (4b).

The heart of the extension circuit consists of two multiplexers, IC1 and IC2. The information at one or the other set of inputs is passed to the outputs of the multiplexers depending on the (logic) state of the select input. The data lines of the keyboard and those of the memories are each connected to a separate 'group' of inputs. When the select input is taken low the keyboard data will be passed through to the outputs, and when the select input is high the data from the memories will pass through. To be able to store the memory contents on tape, therefore, the select input will have to be taken high. This is accomplished as follows:

address counter so that the data stored in the next memory location becomes available. When the WRITE pulse occurs (immediately afterwards) the UART will operate once more.

The entire cycle is repeated until the complete page has been 'dumped'. The 'end-of-page' pulse (RP) inhibits both the DAV pulse and the R/W pulse via FF2, N6 and N7.

By pressing the reset button (S2 of figure 1) FF1 and the RS flip-flop (N1/N2) are both reset and the Elekterminal can be operated normally once more. The information stored on cassette can be re-entered via the serial input.

# high speed readout for elekterminal

With a minor modification to the Elekterminal it is possible to 'store' the entire contents of the display (TV screen) on a cassette tape. The majority of the connections can be wired to the existing expansion sockets. For the remaining connections just three of the copper tracks between the UART and the CRTIC on the main board of the Elekterminal have to be broken.

When the start button, S1 of figure 1, is depressed, the  $\bar{Q}$  output of FF1 goes low. As the Q output of FF1 is high, the memory WRITE signal is inhibited by N4. When one of the keys on the ASCII keyboard is depressed, preferably the space key or a control key, a strobe pulse (KS) will be generated. The leading edge of the strobe pulse will cause the data from the keyboard to be entered into the UART in parallel. With switch S1 in figure 2 closed, this information will be passed out of the transmitter section of the UART and back into the receiver section in series. Once a complete character has been transferred in this manner the Data Available (DAV) output, pin 19, of the UART will go high for a short period of time. The trailing edge of this pulse will set the RS flip-flop formed by N1 and N2 which in turn will take the select inputs of the multiplexers high. The memory data, together with the R/W signal, will now be present at the multiplexer outputs. Shortly after the DAV pulse, an R/W pulse is generated which acts as a substitute for the strobe pulse. This means that the data held in memory will be shifted in and out of the UART repeatedly. This information passing out of the UART in series can now be stored on cassette. Since the recorder will have to be running before a key is depressed, the character which starts the cycle will also be recorded. This is why it is advisable to use the space key or a control key, as these will have very little effect on the actual display.

A DAV pulse is generated after each complete byte has been shifted out (and back in again). The leading edge of this pulse also increments the memory

## The modifications

1. Break the copper track between pin 6 of IC19 (N11) and pin 3 of IC1...IC8.
2. Break the copper track between pin 16 of IC10 (CRTIC) and pin 19 of IC8 (UART).
3. Break the copper track between pin 3 of IC18 (N12) and pin 23 of IC8 (UART).
4. Connect points A1, A2, B1, B2, C1 and C2 of figure 1 to the corresponding points in figure 2.
5. Connect pin 27 of IC10 (RP) in figure 2 to the point marked RP in figure 1.
6. Connect the following:
 

in figure 1:	in figure 2:
pin 3 of IC1	to point M0 (IC6)
pin 8 of IC1	to point M1 (IC5)
pin 10 of IC1	to point M2 (IC4)
pin 13 of IC1	to point M3 (IC3)
pin 3 of IC2	to point M4 (IC2)
pin 6 of IC2	to point M5 (IC1)
7. Disconnect points KB0...KB6 between the keyboard and IC8 in figure 2 and re-connect as follows:
 

KB0	from keyboard to pin 2 of IC1
KB1	from keyboard to pin 5 of IC1
KB2	from keyboard to pin 11 of IC1
KB3	from keyboard to pin 14 of IC1
KB4	from keyboard to pin 2 of IC2
KB5	from keyboard to pin 5 of IC2
KB6	from keyboard to pin 11 of IC2
8. Finally, connect the outputs of the two multiplexers in figure 1 to the UART (IC8) in figure 2 as follows:
 

pin 4 of IC1	to pin 26 of IC8
pin 7 of IC1	to pin 27 of IC8
pin 9 of IC1	to pin 28 of IC8
pin 12 of IC1	to pin 29 of IC8
pin 4 of IC2	to pin 30 of IC8
pin 7 of IC2	to pin 31 of IC8
pin 9 of IC2	to pin 32 of IC8

1

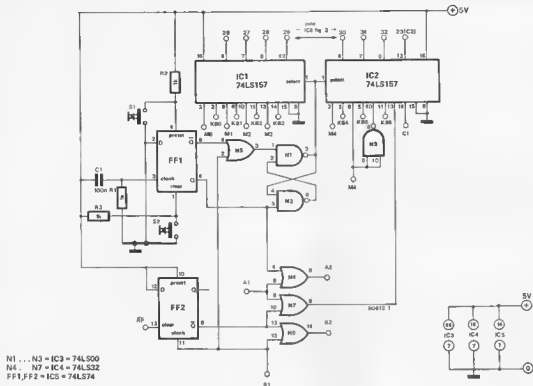

Figure 1. The complete extension circuit.

2

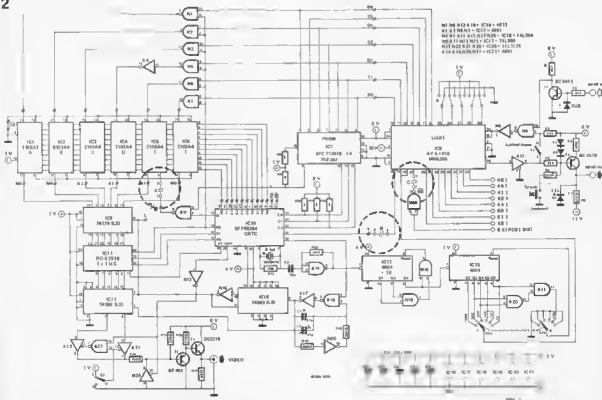

Figure 2. The original circuit, with the various connection points clearly marked. The points where copper tracks must be broken are shown inside the dotted circles.

Readers who collect musical boxes will probably think that an 'electronic musical box' sounds as crazy as a gas telephone or a steam radio. After all, what made the musical box so enjoyable was winding it up and listening to its familiar tune. The circuit presented here shows that electronics can be used to replace the wear-prone internal workings of a musical box. In fact, an advantage over its old-fashioned counterpart is that this circuit is able to play no less than 27 tunes. Applications can also include toys, video games and doorbells.

# musical box

As can be seen from figure 1, the actual melody generator is a single IC (IC4). It is the AY-3-1350 from General Instrument Microelectronics, a company with an excellent name for solid state musical devices. The circuitry around IC4 generates the clock signal, selects the melody required and amplifies the output level.

To select a particular tune, one of the connections marked A...E will have to be grounded and pin 15 of the melodic chip must be connected to one of the points marked 1...4. There are several ways in which the desired code

can be presented to the IC. One method is to use wire links, another is to incorporate switches and a combination of the two is also possible. The printed circuit board has been designed to accommodate either of the two methods shown in figure 2.

If the circuit is constructed exactly as shown in figure 1 and wire links are placed between points K...N and R...V (see figure 2a), the following procedure will take place.

When one of the pushbuttons, S<sub>A</sub>...S<sub>E</sub> is pressed, one of the points marked A...E will be connected to ground via

Table 1

figure 2a	figure 2b	melody
	S2	S3
— SA	0	A Toreador
— SB	0	B William Tell
— SC	0	C Hallelujah Chorus
— SD	0	D Star Spangled Banner
— SE	0	E Yankee Oodles
KR SA	1	A John Brown's Body
KS SB	1	B Clementina
KT SC	1	C God Save The Queen
KU SO	1	O Colonel Bogey
KV SE	1	E Marseillaise
LR SA	2	A America, America
LS SB	2	B Deutschland Lied
LT SC	2	C Wedding March
LU SO	2	D Beethoven's 5th
LV SE	2	E Augustine
MR SA	3	A A Sole Mio
MS SB	3	B Santa Lucia
MT SC	3	C The End
MU SD	3	D Blue Danube
MV SE	3	E Brahm's Lullaby
NR SA	4	A Hell's Bells (specially composed)
NS SB	4	B Jingle Bells
NT SC	4	C La Vie en Rose
NU SO	4	O Star Wars
NV SE	4	E Beethoven's 9th
SF		Descending Octave Chime
SG		Westminster Chime



1

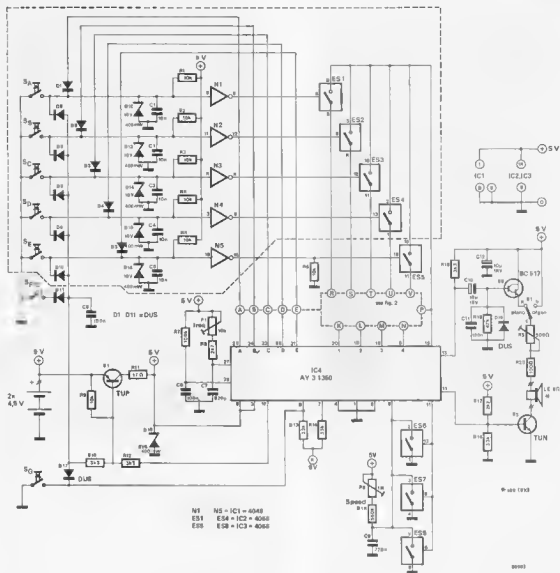
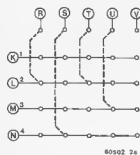

Figure 1. This completes circuit of the 'electronic musical box'.

2a



2b

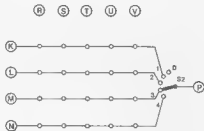
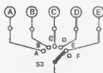
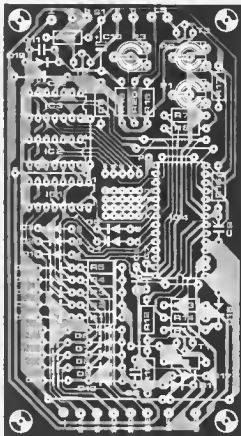
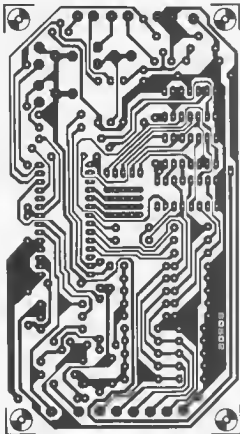

Figure 2. Using wire links, as shown in figure 2a, five melodies can be pre-selected. If this is considered too much of a restriction, two five-way switches can be used, as shown in figure 2b.

3



## Parts list

## Resistors:

R1...R6,R9 = 10 k  
R7 = 100 k  
R8,R17 = 2k7  
R10,R12,R16 = 3k3  
R11 = 27  $\Omega$   
R13,R14,R18 = 33 k  
R15 = 560 k  
R19 = 47 k  
R20 = 100  $\Omega$

P1 = 10 k preset  
P2 = 1 M preset  
P3 = 500  $\Omega$  preset

## Capacitors:

C1...C5 = 10 n  
C6,C8,C11 = 100 n  
C7 = 220 p  
C9 = 220 n  
C10,C12 = 10  $\mu$ /16 V

## Semiconductors:

D1...D11,D17,D19 = DUS  
D12...D16 = 10 V/400 mW  
zener  
D18 = 5V6/400 mW zener  
T1 = TUP  
T2 = 8C 517  
T3 = TUN  
IC1 = 4049  
IC2,IC3 = 4066  
IC4 = AY-3-1350

## Miscellaneous:

SA...Sg = pushbutton switch  
S1 = S.P.D.T.  
S2 = 5 position wafers switch  
S3 = 6 position wafers switch  
LS = 8  $\Omega$ /0.5 W loudspeaker  
(see text)

one of the diodes D1...D5. Each pushbutton has a total of five melodies at its disposal. The choice can be cut down to one by means of a wire link. Thus, one of five predetermined melodies can be selected per switch and, in addition, two well-known chimes may be 'played' by depressing Sp or Sg. Table one shows the melodies which are available and the combination of connections required to select each one. The code numbers and letters correspond to those given in the circuit and in the component layout shown in figure 3.

The second method is to use a pair of multi-way switches, in which case the area inside the dotted line in figure 1 may be omitted. This will enable any one of 25 melodies to be selected. As

can be seen from figure 2b, points A...E can be grounded by means of a six position wafers switch, S3. Switch S2 connects one of the points K...N to point P. The melody will be initiated upon depressing Sp. Resistor R6 and the electronic switch ES5 are not necessary for this latter option. They are shown outside the dotted line as ES5 is contained in a separate IC to ES1...ES4.

The oscillator is formed by C7, R8 and P1 together with part of IC4. The pitch of the melody being played can be adjusted by P1, the length of each note can be adjusted by P2, leaving P3 to regulate the volume.

Two 4.5 V batteries are all that is required to power the circuit as the quiescent current consumption is only a

few microamps. Transistor T1 and the zener diode D18 are included to drop the voltage down to 5 V for those parts of the circuit requiring a lower voltage. The nominal loudspeaker impedance is 8  $\Omega$ , but if one with a higher impedance is to be used, the value of R20 can be reduced accordingly. Switch S1 is still to be mentioned. Its function is to select between a 'piano' sound with slow decay (position a) and a constant volume 'organ' sound (position b). It should keep the children amused for hours!

M

Capacitors are a vital part of electronics, so it is important to realise exactly how they work. In its simplest form the capacitor consists of two flat metal plates which are separated by an electrically insulating substance called dielectric (see figure 1). When a voltage is applied to the plates (figure 2), the following happens. The electrons (negatively charged particles) which originate from the negative pole of the voltage source, will repel the electrons on plate (b) when they reach plate (a) (since similar charges repel each other). The electrons on plate (b) will be attracted to the positive pole of the voltage source. Electrons are therefore

AC is allowed to pass through.

There are various methods of increasing the value of capacitance. In the first place by having a larger plate surface area, secondly by using a thinner dielectric and thirdly by using an improved dielectric. In order to obtain the greatest possible capacitance from the smallest possible size, manufacturers have examined various techniques.

Capacitors are normally made from very thin sheets of metal foil separated by a thin dielectric. The thinner the dielectric, the greater the capacitance, but at the same time the maximum voltage that can be applied has to be reduced to avoid breakdown. To increase the

# electrolytology

## an inside look at capacitors

There is nothing new about the fact that electrolytic capacitors possess inductance due to the method used in their construction.

At high frequencies their impedance will be largely determined by this parasitic inductance. An electrolytic capacitor even acts as a band pass filter and thus also has a resonant frequency.

What fewer people will be aware of is that the capacitance is clearly frequency dependent. This has to do with moving ions in the electrolyte, which will be discussed later.

being moved — in other words there is an electric current flowing. Since plate (a) is being charged and electrons are disappearing from plate (b), a potential difference occurs across the plates. Whenever this voltage is equal to that at the source, the electron flow will stop. The capacitor will then be fully charged. It should be mentioned that there is no current flowing from plate (a) to plate (b), for both plates are separated by insulating material.

The current is of a temporary nature (until the capacitor is fully charged). By continuously reversing the polarity of the applied voltage the current can be maintained. That is why a capacitor will only pass alternating current.

The amount of current depends on the amount of charge which is displaced inside the capacitor, which in turn depends on the applied voltage and on the value of the capacitor. The relationship between voltage and charge is expressed in capacitance. The greater the capacitance, the more charge is displaced for a given voltage and more

capacitance even further, several layers of metal foil and dielectric can be piled on top of each other (see figure 3). This is called a layered capacitor.

The dielectric may consist of paper, plastic or a type of ceramic material. Thus, there are paper, polyester, polycarbonate and ceramic capacitors. Each type of dielectric gives rise to its own special characteristics and makes the capacitor suitable for certain purposes.

In addition to the layered construction, there is the more common wound method where the metal foil and the dielectric are rolled up (see figure 3b). A capacitor of this kind will have a higher parasitic inductance than the layered type.

Up to now these have all been foil capacitors, being made up from thin strips of metal and insulating material. In spite of the extremely thin metal foil and dielectric used, dimensions increase at an alarming rate at high capacitance values and working voltages. For this reason, the maximum value of foil capacitors

1

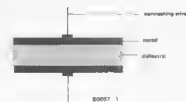

Figure 1. In its simplest form a capacitor consists of two flat metal plates which are separated by an electrically insulating material (sometimes air).

2

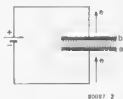
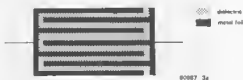

Figure 2. By connecting a voltage to the plates, a charge can be produced due to the electron movement.

3a



3b

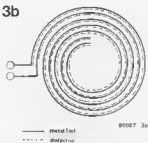

Figure 3. To obtain large capacitances in small dimensions, several layers of metal foil and dielectric can be placed on top of each other (3a). Another method is to roll up the metal foil and dielectric (3b).

capacitors is restricted to a few microfarads. For larger values electrolytic capacitors must be used.

4

### The electrolytic capacitor

The plates of the electrolytic capacitor also consist of very thin metal foil. The material will be either aluminium or tantalum. Taking the aluminium type as an example, it will be found that basically the electrolytic capacitor has the same structure as an ordinary capacitor: two plates and an insulator. Since the electrolytic capacitor is polarised, it has an anode plate (positive) and a cathode plate (negative). The cathode contains not only the metal foil, but also an electrolyte (electrically conductive fluid). In figure 4 the simplified structure of the electrolytic capacitor is shown. The cathode only serves to pass current to the electrolyte by way of its large surface area.

The dielectric consists of aluminium oxide, a good insulator with a high breakdown voltage (800 million volts per metre). This means the dielectric can be very thin enabling large capacitances (even up to 1 farad) to be reached in relatively small dimensions. The layer of aluminium oxide is obtained by anodising the aluminium foil. Anodising is an electrochemical process, whereby the aluminium is dipped into an electrolytic bath (figure 5). A voltage is applied (the activating voltage) between the bath and the aluminium which acts as the anode (positive). The oxygen ions (negatively charged), in the solution, combine with the aluminium and the density of the layer of aluminium oxide created depends on the value of the activating voltage. The density of the dielectric can therefore be controlled very accurately. The oxidised aluminium foil is then ready for use as the anode of the electrolytic capacitor.

Nowadays, all electrolytic capacitors are wound. The foils of the anode and the cathode are separated by a layer of paper for two reasons. Firstly, to prevent a short circuit between the two aluminium foil layers and secondly, to act as a holder for the electrolyte (sponge effect).



Figure 4. In the case of the electrolytic capacitor, the cathode plate is not only made up of metal foil, but also includes an electrolyte (electrically conductive fluid). The dielectric consists of aluminium oxide obtained through anodisation.

To increase the capacitance of electrolytic capacitors the anode plate is etched before oxidation to provide a greater surface area (see figure 6). As the cathode is made up from a fluid, it will adapt itself to the rough surface area of the anode. Modern production methods for electrolytic capacitors almost always follow this construction method. The electrolyte need not always be a fluid, often a form of 'paste' is used. Hence the terms 'wet' capacitors. As mentioned before, the electrolytic capacitor is polarity conscious, with the anode always being positive with respect to the cathode. The voltage across the capacitor must never exceed the oxidising voltage, as this would cause the anodisation process to continue and the electrolytic capacitor to explode due to the heat produced. If the electrolytic capacitor is connected incorrectly (with the anode negative in relation to the cathode) the aluminium foil of the cathode plate will be subject to anodisation and again the capacitor will come to a bad end. For AC purposes special bipolar electrolytic capacitors (which are not polarity conscious) have been developed.

### The electrolytic capacitor and its impedance

We have already seen that the winding method produces an unwanted side effect — that of induction. At higher frequencies especially, the parasitic induction contributes greatly to the im-

5

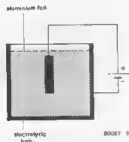

Figure 5. Anodisation is an electrochemical process, whereby the aluminium is dipped in an electrolytic bath and 'plated' with a layer of oxide by means of an electric current. Here the aluminium acts as the anode.

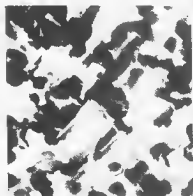

Figure 6. A 2500 times enlargement of etched aluminium, as used in electrolytic capacitors. Due to the etching the operational surface area is greatly increased. (Siemens Data Book 1980/81).

pedance (AC resistance) of the electrolytic capacitor. With the exception of bipolar types, capacitors are only suitable for DC anyway, so is there a problem? The answer is yes, for when an AC signal is superimposed on a DC level this will create considerable problems. Consider for instance, what happens in the smoothing circuit for mains supplies, when circuit voltages are disconnected or when two amplifier stages are AC coupled. In these cases it is impossible to merely rely on the given value of the capacitor.

7

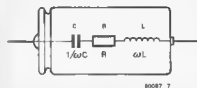

Figure 7. The equivalent circuit of the electrolytic capacitor.

In addition, the electrolytic capacitor has a resistance produced by the electrolyte. This resistance is highly dependent on temperature. The frequency dependence of the impedance is clearly shown in the equivalent circuit of the electrolytic capacitor (figure 7). Basically, the electrolytic consists of a capacitor, a resistor and an inductor connected in series. By way of illustration, the impedance curve of an electrolytic capacitor of 100  $\mu\text{F}/63\text{ V}$  has been plotted at different temperatures in figure 8. At frequencies of up to 60...80 kHz (at 20°C) the impedance is mainly determined by the R and C in the equivalent circuit, and at higher frequencies by the R and L. The curve also shows that the electrolytic capacitor has a resonant frequency, where its impedance will be at a minimum. In other words, it acts as a band pass filter for high frequencies (LCR series loop).

### AC and DC capacitance

As stated, the cathode of an electrolytic capacitor is made up of an electrolytic

fluid (or paste) Current conduction in a fluid takes place rather differently than in a solid. In solids only electrons move about, whereas in fluids ions also take part. Because of their small size and mass, electrons are very mobile and can keep up with the speed of voltage variation. This is not the case with the much larger and heavier ions. These are much slower, especially at low temperatures. If the temperature becomes low enough for the electrolyte to solidify, the ions will be frozen, as it were, and will not take part in the conduction. Only the electrons will then be able to displace the charge (a characteristic of solids). The result is a greatly reduced capacitance.

Since ions are less mobile, they will have difficulty in penetrating the deepest pores of the etched anode, as they do not have enough time. For this reason the deepest pores will not be effective in the operation of a capacitor under a superimposed AC, which means a smaller anode surface area to operate on. Thus, the effective value of an electrolytic capacitor under DC conditions will be greater than with AC. In other words, the capacitance is frequency dependent. Electrolytics therefore have a DC and an AC capacitance. The AC capacitance is measured according to DIN standards with a 50 Hz signal of  $\leq 0.5\text{ V}$  (low enough to prevent destruction) and at a temperature of 20°C. The IEC standard prescribes a measuring frequency of 100 or 120 Hz. The DC capacitance is determined by timing a single discharge from an electrolytic capacitor charged to a nominal voltage.

The DC capacitance is usually 1.1 to 1.5 times greater than the AC value. The greatest differences are found with electrolytic capacitors having a low maximum working voltage. The dielectric in these is very thin and so the dimples in the rough anode are relatively deeper after anodisation than in the case of capacitors with a high maximum working voltage.

After the 'digifarad' article was published (Elektor 54, October 1979), several readers drew our attention to the fact that the values of electrolytic capacitors measured with this instrument have to be interpreted with care. This is because the digifarad measures capacitance according to a method which is very similar to that used to determine the DC value. Since the AC value is indicated on most electrolytic capacitors, the digifarad will more often than not overestimate the value. This is not necessarily incorrect, but it will have to be taken into account when the capacitor is used.

By way of illustration, several values of electrolytic capacitors at different frequencies are given in the table.

8

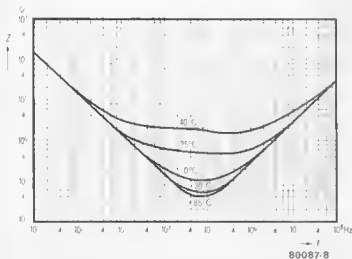

Figure 8. The impedance characteristics of an electrolytic capacitor at various frequencies (Siemens Data Book 1980/81).

table 1

Type	Measured capacitance in $\mu\text{F}$ at:			
	0 Hz	50 Hz	100 Hz	1000 Hz
47 $\mu\text{F}$ , 350 V	54.1	49.2	47.9	43.2
	112%	103%	100%	90%
6800 $\mu\text{F}$ , 25 V	8760	7370	7330	6670
	120%	100%	100%	90%
680 $\mu\text{F}$ , 25 V	829	759	749	689
	111%	101%	100%	93%
100 $\mu\text{F}$ , 25 V	133	122	121	110
	110%	101%	100%	90%
4.7 $\mu\text{F}$ , 25 V	4.27	4.04	3.92	3.47
	109%	103%	100%	88%

### Literature:

Siemens Data Book 1980/81.  
'Aluminium and Tantalum Electrolytic Capacitors'.

### The design

Figure 1 gives the layout of a design which escaped notice in last year's Summer Circuits '79 (no. 6). This is a cheaply constructed curve tracer for transistors and diodes. No really professional test instrument, of course, but an extremely useful aid to quickly carry out a general test either to compare transistors or select them. Naturally, hobbyists will have to have an oscilloscope (with separate x and y inputs), because the curves will be displayed on the oscilloscope screen.

Since it is impossible to tell which transistor characteristic is more important than another, there is no such thing as the 'most important curve'. Transistor handbooks speak of the most read curve.

to the Y input and the ground connection of the oscilloscope 'hangs' resistor R7. This is the TUT's collector resistor and the voltage across it is naturally proportional to the collector current of the transistor tested. In this way, an  $I_C$  will appear on the vertical axis of the oscilloscope. The TUT's emitter is connected to the X input so that the collector/emitter voltage ( $U_{CE}$ ) can be read horizontally on the screen.

What causes the curves to appear on the screen? Two signals are fed to the TUT. A 5 step position staircase waveform is fed to the base and during each step a sawtooth is fed to the collector. This means the collector voltage changes continually at a certain base drive current. This occurs at quite a speed so

# transistor curve tracer

## $I_C/U_{CE}$ characteristics directly onto the screen.

There are never enough simple circuits which provide useful and low-cost additions to the 'home lab'. This particular design possesses all the advantages to make it a glorious example of its kind. It offers oscilloscope owners a neat, additional measurement facility. It is easy to build, contains common parts and is inexpensive. Reason enough to design a printed circuit board for it.

This involves the  $I_C/U_{CE}$  characteristics where the collector current is plotted as a function of the collector/emitter voltage at different drive currents. Figure 2 gives an example of such a characteristic. At the same time it (roughly) indicates the drive currents the curve tracer uses. The current amplification may be directly derived from the  $I_C/U_{CE}$  characteristics and, after a few calculations, so may the transistor's output impedance. The latter is affected by the curve's slope. Generally speaking, the more horizontal and straight it is, the higher the collector/emitter impedance.

Back to the schematic. The transistor under test is indicated as 'TUT' as usual. Between the points which are connected

that the oscilloscope screen simultaneously shows 5 characteristics for 5 different base drive currents. The staircase signal and the sawtooth waveform are controlled by means of an astable multivibrator. The AMV consists of T1 and T2 and generates a square wave with a frequency of approximately 1 kHz.

The sawtooth is obtained very easily by integrating the square wave via R5 and C5. Creating the staircase voltage is a little more complicated. During the positive half-cycle of the square wave produced by the AMV, C3 is charged to a maximum which is equal to the supply voltage. During the negative half-cycle, C3 will turn on transistor T3 and thus the voltage at T4's emitter (connected

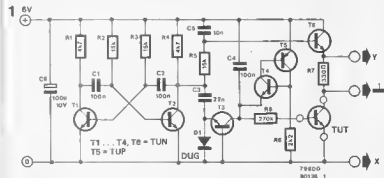

Figure 1. The circuit diagram of the curve tracer.

2

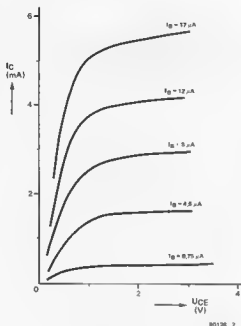

Figure 2.  $I_C/U_{CE}$  curves of a transistor. In our circuit five different base drives are measured.

4

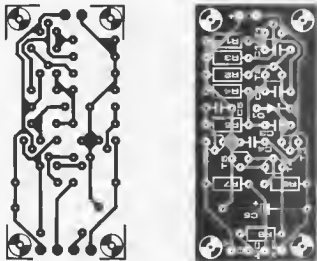

Figure 4. The printed circuit board of the curve tracer.

#### Parts list

**Resistors:**  
 R1, R4 = 4k7  
 R2, R3, R5 = 15 k  
 R6 = 2k2  
 R7 = 330  $\Omega$   
 R8 = 270 k

**Capacitors:**  
 C1, C2, C4 = 100 n  
 C3 = 22 n  
 C5 = 10 n  
 C6 = 100  $\mu$ /10 V

**Semiconductors:**  
 T1 ... T4, T6 = TUN  
 T5 = TUP  
 D1 = DUG

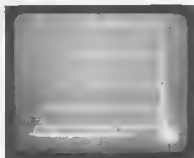

Figure 3. This is how the curves appear on the oscilloscope screen.

to the TUT's base via R8) will become a little lower. By loading C4 intermittently, each successive negative half-cycle will reduce the emitter voltage of T4 in steps until T4 starts to conduct turning on T5. C4 is soon discharged and a new cycle starts.

The number of stages which make up a single cycle is determined by the ratio of C3 to C4 and is 5 here. By adjusting the value of C4 the number of stages (and thus the number of curves indicated on the screen) can be changed as required.

#### In practice

The photo in figure 3 shows how the curves appear on the oscilloscope screen. The circuit's only flaw now comes to light—the characteristics are traced from right to left, instead of the other way around. Unfortunately, nothing can be done about this. In practice it does not present a problem. What is serious however, is that the tracer is only suitable for NPN transistors. NPN types cannot be tested with it. If this is considered to be a drawback, however, there is a cheap solution: two printed circuit boards may be built instead of one. The circuit requires few components, so why not? The second circuit will then be a PNP version. For T1...T4 and T6 use TUPs, T5 will be a TUN, C6, D1 and the supply leads will be switched around. Furthermore, such a PNP version will trace the curves from left to right, only now the Y axis will be negative so that they will appear upside down on the screen. A little strange perhaps, but you'll soon get used to it...

As mentioned above, diodes may also be tested. These are connected with the anode to R7 ( $\downarrow$ ) and the cathode to the supply zero (X). The I/U characteristics of the diode in question will now appear on the screen. Figure 4 shows the printed circuit board. It is highly compact and can be built in less than no time.

Last word. Since the circuit only requires a few mA, the supply will not have to be very 'heavily' tested. However, the supply voltage must be well regulated for it to work properly.

# using the Elektor Vocoder

Several months ago (Elektor no. 56, December 1979), Elektor published a 10 channel vocoder. When building a vocoder there are a few 'obstacles' which ought to be taken into account. Readers who have already built one and are familiar with it will find that this article provides useful information on how to improve on the vocoder's technical qualities. To start with it is a good idea to check the initial adjustment.

F. Visser

Each channel in the vocoder contains three presets. Two of these are intended to eliminate leakage of the Voice and Carrier signals to the vocoder's output; the third sets the dynamic range of the voltage control circuit (in the analyser section, where the audio signals are split up into small bands and are converted into DC control voltages). This is important if the vocoder is to respond to a wide range of input signal levels and reproduce the speech sounds as accurately as possible. In passing, it should be noted that this high 'responsiveness' may cause a disturbing side effect when the vocoder is used during live performances, where there is usually a high level of interference. In such cases the vocoder will analyse and synthesize the entire complex sound, producing an undesirable cacophony. Further on in this article, methods will be suggested to suppress these side-effects. For the moment, however, let us concentrate upon setting up the vocoder properly.

The best way to start is to adjust potentiometers P1, P5 and P9 in the band pass, high pass and low pass filters respectively. These presets compensate the output offsets of the filters that follow the rectifiers in the analyser section. To a large extent, this deter-

1

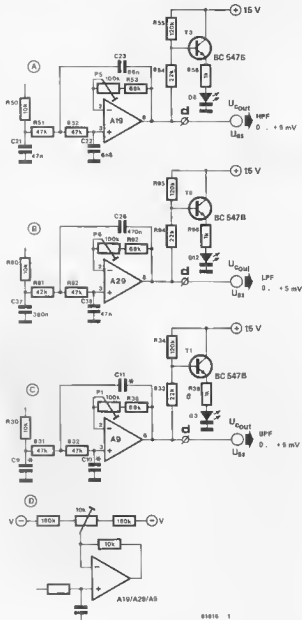

61010 1

mines the vocoder's dynamic range.

The offset should not be more than 5 mV. If this cannot be achieved it may be advisable to modify the offset compensation slightly, as shown in figure 1. In the original design HA 4741 type opamps were used, as these have a smaller offset than the TL series.

Unfortunately, they are also more difficult to obtain and more expensive. If all the U<sub>OUT</sub> buses are now connected to the U<sub>IN</sub> buses, there is no danger of undesirable offset voltages turning on the OTAs in the synthesizer section (or cutting them off ~ if the offset is negative).





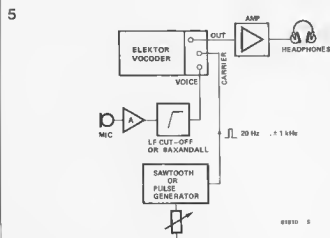
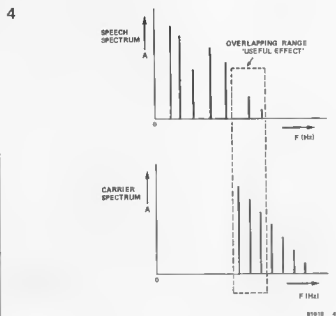
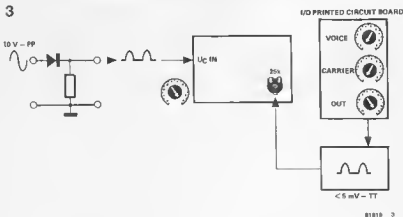

voice appears to be used as the modulation signal on this recording, with a formant range that is less suitable for the classical vocoder with a relatively small number of channels. Later on in 'Funky Town' the melody is played in a lower key and a male voice sings the lyrics. The improved intelligibility is very noticeable!

The Elektor vocoder has the advantage that it can offer a reasonable solution to the problem of non-overlapping frequency spectra. By connecting the voltage control outputs of the analyser to channels one or two places higher up in the spectrum instead of to the control input of the corresponding synthesizer channel, the significant spectral information is moved up, as it were, to a range that encompasses the higher carrier frequencies. This technique, known as 'formant shift', will be dealt with in depth later on in this article.

In addition to the vocoder's use as a voice processor there are many ways in which sounds can be superimposed on different kinds of carrier signals. The best way to get to know the vocoder is to systematically carry out experiments, using a microphone and a simple sawtooth or pulse generator.

### The microphone

As far as the microphone is concerned, a high quality type is best: if the modulation spectrum is free from coloration, the end product will also be good. Not everyone will be able to afford a high-priced microphone, of course, so a few suggestions on how to obtain good results with a reasonable quality microphone may prove useful.

In the first place, it may prove useful to give the microphone pre-emphasis — in other words, emphasize certain frequencies, where necessary, or attenuate them. This is done by means of tone controls or with separate filters. One of the most important corrections to be made is to attenuate the low frequency range. It is difficult to give precise figures for this, as it of course depends on the type of microphone used and also on the distance between the mouth and the microphone. The closer the microphone, the more low frequency components will reach the analyser, not to mention the sound of breathing and explosive consonants (p, k, etc.).

Sometimes, depending on the high frequency spectrum of the carrier signals, it may be advisable to boost or attenuate the treble range. As a rule, a standard Baxandall tone control with a turnover frequency around 1 kHz is fine.

### The carrier

Many sound sources may be used as carrier material, but a simple function

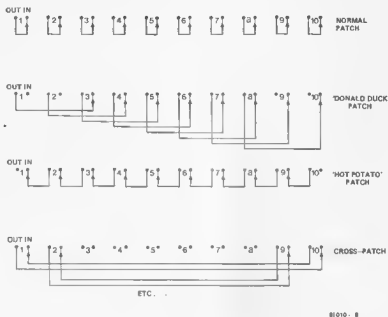

generator with a control range between about 20 Hz and 1 kHz would be ideal for the first experiments. The most suitable wave forms to experiment with are triangle, square wave, sawtooth and pulseforms. Should such a generator not be available, you can always build one based on one of the many Elektor circuit designs.

### Monitoring the results

The best way to judge the results is to use headphones. The system can also be used to drive a conventional audio system with loudspeakers, but headphones are preferable as they avoid acoustic feedback problems.

### A few simple examples

When the microphone, generator and headphones are connected (figure 5) and everything is switched on, the first experiments may be carried out. If you don't want to fall back on sentences like 'Testing . . . one . . . two . . . three . . .' it is perhaps useful to have a text in front of you. Experience has taught us that not everyone possesses the 'gift of the gab' at such moments!

The frequency of the generator is set at about 50-60 Hz, using a pulse waveform. The result will be a resonant, clear, synthesized voice. If the frequency remains unchanged, the result sounds like the 'Cylon effect'. Cylons are robot-like creatures from the American TV series and film: 'Battlestar Galactica'. A vocoder was in fact used

to produce their robot voices.

By raising the carrier frequency while continuing to speak, the synthesized voice can be made to change in pitch. It will become less intelligible once the frequency is above 500-600 Hz; this effect was mentioned earlier, when discussing the Funky Town recording.

It should be clear that the pitch of the synthesized vocoder product depends exclusively on the carrier's pitch. The next test to be described will demonstrate this.

The frequency is set to a low value, for instance 100 Hz, and now the pitch of the voice is changed by singing instead of speaking, or by producing other sound varying in pitch. You will notice that the resulting timbre will change, as if a band-pass filter were being used, but that the fundamental frequency will remain the same. This is because the generator is still set at a fixed frequency. Nevertheless, this is a source of regular misunderstandings. Witness the fact that the vocoder is often compared to a harmonizer or to a pitch shifter — equipment used to shift the fundamental frequency and the spectrum of speech or music.

If the same good intelligibility is required at higher frequencies, 'formant shift' can be used. The Elektor vocoder is one of the few vocoders on the professional market that offers this interesting facility. Formant shift literally means shifting the intelligibility information to a higher or lower frequency range. By coupling the output voltages of the analyser to the control inputs of synthesizer filters which do

not have the same  $F_0$ , the measured formants are transposed to another place in the spectrum. If, for example, the voice at the speech input is much lower than the fundamental frequency of the carrier signal, the result can be made more intelligible by shifting the formants to a higher carrier spectrum. The synthesized 'voice' will become clearer and at the same time assume an entirely different character. This phenomenon can be used with great success to produce 'funny' voices.

The higher the analyser spectrum is moved up, the more the voice will sound like Donald Duck. If the analyser spectrum is transposed down, the speaker will sound as if he suffers from the proverbial hot potato. Quite a different way to manipulate the formants is 'formant inversion'. To obtain this effect the analyser and synthesizer channels are cross-coupled. Not surprisingly, the result will be practically unintelligible. All transient sounds, such as K, P, T and hissing sounds will be superimposed on the low end of the carrier spectrum, whereas the low frequency information in the speech signal will control the high end of the carrier spectrum. Furthermore, of course, the formants will be thoroughly mixed. A good example of this is the 'O' sound which comes out as a 'U'. In spite of the fact that the result is virtually unintelligible, this effect can be useful when making (complex) musical sounds. This is illustrated in figure 6.

The results obtained so far through speech synthesis will all sound robot-like. In the first place, this is due to

the pulse signal used as a carrier: it contains a lot of higher harmonics, creating a slightly grating, 'mechanical' sound. If a sawtooth is used instead of a pulse shaped signal as a carrier, the result will be softer. This illustrates that the carrier's complexity affects the timbre. To attenuate the robot sound further there are all sorts of other tricks.

By modulating the carrier signal, for instance with a low frequency sine wave or triangular signal, a much more life-like 'human' sound is produced. Other modulation effects may involve a low frequency random signal or, even better, a control signal that is derived from the fundamental frequency of the original speech. This can be simulated by tuning the generator to the voice pitch and then adjusting it by hand to follow the inflections. When an accurate frequency/voltage converter ('pitch extractor') is used a very natural sounding voice can be synthesised, which shows that the intonation of the voice is a very essential part of human speech. A few suggestions to obtain carrier modulation are given in figure 7.

### Unvoiced consonants

Up to now, the unvoiced consonants (S, SH, SK, SY, K, T, P, F, etc.) have been neglected. These cannot be successfully reproduced by only using a sawtooth or pulse as a carrier. To synthesize unvoiced consonants, a detection system is required with the aid of which noise can be added to the carrier signal at the right moment. Since the Elektor vocoder does not (yet) possess that Voiced/Unvoiced detector, another trick will have to be used for the moment.

A very clever expedient was developed by Harald Bode, vocoder manufacturer, and he has now taken out a patent for it. Bode constructed a sort of 'bypass' circuit for high frequencies derived from the analyser section. In the case of the Elektor vocoder this has been provided by means of potentiometer P17 on the highpass filter. This contains the high frequency range of the speech spectrum where most unvoiced sounds are produced. By adding this signal directly to the output, a reasonably complete 'speech' signal may be obtained.

Nevertheless, it is worthwhile to listen to the unvoiced sounds as they are reproduced when pulse or sawtooth waves form the carrier signal. By producing hissing and 'plop' noises in the microphone while switching the generator from triangle to squarewave to sawtooth to pulse waveshapes, you can hear how important it is to have a wide carrier spectrum for unvoiced sounds. Using a triangular wave, which only has even harmonics, the result will be very poor, whereas the pulse which contains all the harmonics will produce something remotely like an S or an F.

Whistling into the microphone with a

7

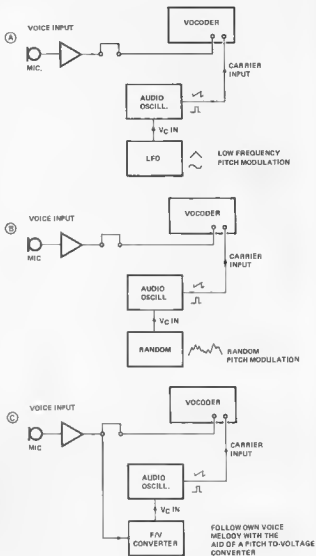

fixed pulse frequency as a carrier will also show how much high frequency energy it possesses.

### The vocoder for musicians

The experiments just carried out may seem a little too simple, but they emphasize the basic operation of the vocoder. Once the user really feels he understands exactly what is happening, the variety of applications will only be limited by his imagination. When used for musical applications, the vocoder will be restricted to keyboard and string instruments. After all, a saxophone player can hardly be expected to blow and talk and sing all at the same time!

Guitar and bass guitar players will discover that more often than not the dynamic range of their instrument will not be sufficiently wide to produce intelligible or clearly articulated sounds.

Depending on the effect that they wish to achieve, it may be advisable to connect an effects box between their instrument and the vocoder carrier input, with which additional high frequency components may be added to the original sound. Examples of such devices are phasers, flangers, boosters, distortors, fuzzers, frequency doublers, etc.

It may also be interesting to connect the guitar to the speech input of the vocoder, while using an organ, string quartet or synthesizer as the carrier signal. This of course requires strict coordination between the various players. Chords or a melody will be played on the keyboard instrument, whereas the guitar is used to play a melody or a rhythmic pattern — preferably monophonic, so no chords. The newly generated sounds will have the envelope shape and some of the spectral characteristics of the guitar. Many other

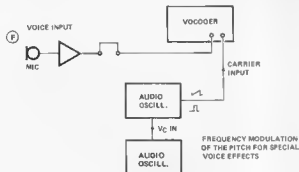
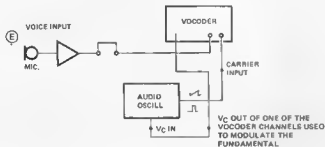
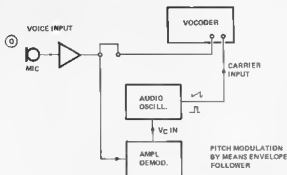

81010 7

### The vocoder at live performances

When performing with the vocoder on stage during a concert, a few aspects need to be treated with care.

There are basically two characteristics in the vocoder, which could turn the performance into an absolute catastrophe.

In the first place its sensitivity or 'responsiveness' which was mentioned earlier. Like so many devices, the Great Compromise will have to be sought. Providing the vocoder with a wide dynamic range may create chaos in noisy surroundings. This is because the vocoder makes no distinction between what it hears and what it is supposed to hear. ('Not in front of the vocoder!') Everything that enters the analyzer is processed in the usual fashion and appears synthesized at the output of the equipment and those of you who have experienced the result know what a terrible din that can be!

The only suitable methods to suppress such sensitivity to undesirable noises is to use a highly directional microphone which is spoken into from as short a distance as possible or to use two microphones in antiphase. The latter method is illustrated in figure 8.

When two (identical) microphones are used in this way it is important to speak or sing in front of one of them at as short a distance as possible. A pop cap and a bass roll-off filter are indispensable. Another advantage of this method is that acoustic feedback may be noticeably reduced. Feedback sensitivity happens to be another drawback of the vocoder, as a result of the phase shifts in ranges where the synthesizer filters overlap.

### The vocoder in the studio

The above-mentioned precaution to curb nasty side effects are of course less important in recording studios and may

musical instruments may of course be equally well combined.

For electronic pianos the same applies as for the guitar. Here too, the use of some kind of effects device is recommended.

Organists and synthesizer players have a much easier time. A nice effect which can be produced on most keyboard instruments is the bass effect, by making explosive noises with the mouth in the microphone and letting them decay. Wind instruments like the tuba, trombone, etc. can be imitated with a little practice. Electronic synthesizers, like the Elektor Formant, offer an extremely wide range of possibilities. Apart from generating carrier sounds, the synthesizer can also be used to produce signals to control the vocoder synthesizer inputs directly, and the analyzer outputs of the vocoder can be used to control numerous units in the modular synthesizer.

8

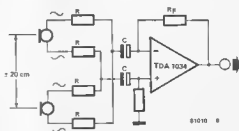

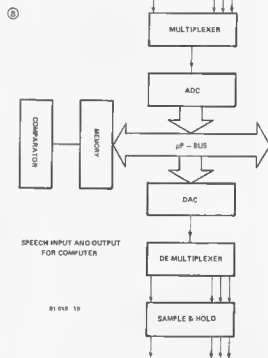
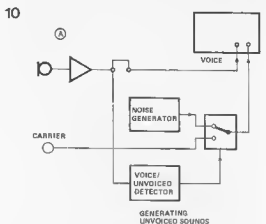
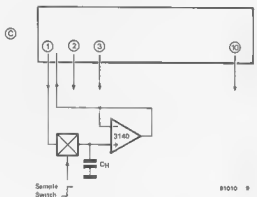
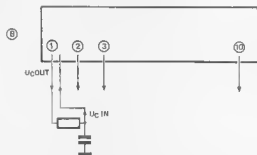
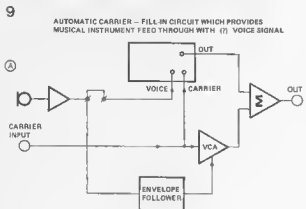

even be totally unnecessary. The vocoder is an instrument which is highly suitable for use in the studio, provided that a few details are taken into account - particularly when dealing with existing recordings. The vocoder is not a miracle machine with a 'talent button' or a 'success filter', but an instrument which one must learn to use, preferably in the initial stages of a musical production, where required. If 'vocoding' is postponed until all the material is recorded on the various tracks of a multi track recorder, there is a chance

that the material may not be spectrally wholly suitable and that the synchronisation between the Voice and Carrier signals may not be sufficient. The problem in the sound studio is often that 'time is money' and so a producer will sometimes get a little impatient if the vocoder does not obtain astounding results at first bat. Vocoding is then postponed until the final mix-down stage, where it is often much more difficult to obtain the desired effect. Fortunately, more and more sound

technicians seem to understand that the vocoder needs to be played, like any other instrument, and that learning to play may take some time. Finally, figure 9 provides a few examples in which the vocoder can play an interesting part, especially if more voltage control equipment is available. Figure 10 gives a few suggestions for peripheral devices to make the vocoder more versatile. The voiced/unvoiced detector, in particular, is scheduled for publication in the near future.

# market

## Large 7-segment characters

Characters up to 80 mm high may be electrically controlled using a new range of 7 segment display units from Impetron Limited. The displays can be clearly read up to 35 metres away. Units in the 'S' Series operate using simple low-voltage signals to create local magnetic fields behind the segments. Each segment is simply a rotating magnetic bar, finished in matt black on one side and bright reflective yellow on the other. After creating a desired character, no power is consumed until a change is next required.

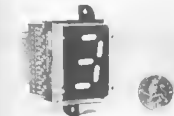

Because moving parts are kept to a minimum, and there are no filament lamps, operational life is extremely long. An additional feature is the use of semi-hard magnetic cores for the electromagnets, which allows high velocity character changes driven from rapid pulse trains.

Two sizes of unit are available initially, with character sizes of 40 x 32 mm (Type S0) and 80 x 40 mm (Type S1). Each unit includes a built-in driver circuit which controls the segments using 16 V dc signals. Maximum power consumption occurs during character change and units are rated at 0.07 Watts.

*Impetron Limited,  
Foundry Lane,  
Horsham,  
W. Sussex, RH13 5PX.  
Tel: 0403-50111*

(1023 M)

The Mod-1 type U series which are free-standing units, account for eighteen of these and are unique for their built-in handles. In addition to the usual handles either side of the front panel, each side panel is formed to an elegant shape incorporating the profile of a substantial handle, giving comparatively effortless lifting and carrying, however heavy the contents.

These distinctive cases are manufactured in three widths, two depths and heights of 3, 4 and 8U, have a smart blue and natural anodised finish and take a wide range of card guides, edge connectors, and other accessories.

*West Hyde Developments Ltd.,  
Unit 9 Park St. Ind. Est.,  
Aylesbury, Bucks HP20 1ET  
Telephone: Aylesbury (0296) 20441*

(1624 M)

## Tape-stereo-radio-clock display

Just introduced by Fairchild's Optoelectronics Product Group is the FLB 4010 4-digit LCD. This 42-pin tape-stereo-clock display features four digits 10 mm high plus decimal points. Other symbols available include a stereo mode indicator, a tape mode indicator, tape direction indicators, and AM-FM radio mode indicators. Transflector and reflector versions are available. With transmissive LCD operation the display has the ability to allow light to pass through the cell from the rear as well as



reflect light incident on the front. The glass-frit seal used is highly reliable and the biphenyl liquid crystal material very stable. A typical connection system would consist of a PC board, a pair of conductive elastomer connectors on which the display is placed. A bezel would then hold the assembly together. Operating voltage is typically 3 Vrms in the form of a square wave at 32 Hz. Contrast ratio is typically 20 : 1.

*Fairchild Camera & Instrument (UK) Limited,  
230 High Street,  
Potters Bar,  
Herts EN5 8BU,  
Telephone (0707) 51111*

(1625 M)

## A case with a difference

West Hyde Developments have recently enlarged their Mod-1 range. This now amounts to some 62 different enclosures and 37 chassis units.

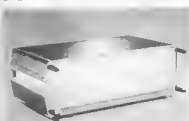

## Microwave frequency counter

Elax announce the Eldorado Model 990 18-GHz microwave frequency counter. The Eldorado 990, from Elax, has a standard operating range from 20 Hz to 18 GHz with -25 dBm sensitivity. Options extend this range to 26 GHz and provide sensitivity to -30 dBm. Input protection to 2 watts is incorporated and the instrument features a +25 dBm overload specification.

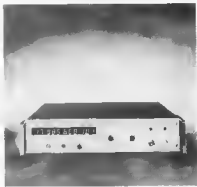

A large 11 digit planar display provides high readability while the basic 1 Hz resolution can be reduced to increase measurement time. This is a microprocessor based instrument with the MPU controlling the measurement and sequence as well as the display and control functions. Remote control of mode, resolution and reset are provided through an optional IEEE 488 interface from which results can also be output. The remote control interface can also be used for pre-setting any desired number from 0 to 9999999999 for receiver LO monitoring.

*Elax Systems Ltd.,  
Crossway House,  
Bracknell,  
Berkshire.  
Tel. (0344) 52929,*

(1626 M)

## Photodiode for optical sensing operation

The Symot 320/1 range of photovoltaic photodiodes now includes the SP-10N type measuring 10.1 x 10.1 mm and having an active area 91.16 mm<sup>2</sup>. The photo-voltage at 25°C is 0.43 V, and the photo-current is 590 nA (test conditions 1000 Lux). Dark current is typically 1.5 mA (reverse voltage 2 V) and the capacitance is 7,000 pf. Peak sensitivity is at 830 nm wavelength.

The package is equipped with flying leads, covered in vinyl tubing.

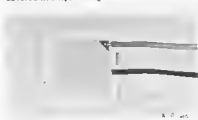

This photodiode is suitable for a wide range of optical sensing applications where the shape is advantageous, including stroboscopes, light reflection, smoke detection, motion detection, wire detection, toys and electronic games.

The prototype price is £ 2.45; typical price for 1,000 pieces is £ 1.20 each.

*Symot Limited,  
22a Reading Road,  
Henley on Thames,  
Oxon RG9 1AG,  
Tel: (04912) 2663.*

(1621 M)

# market

## Low-profile p.c. relay

A new sub-miniature relay designed specifically for printed circuit board applications is the lightest relay of its kind available. Weighing only 12.5 grammes, the Type SF low profile relay offers a choice of either double-pole double-throw or 4 pole double-throw contact configurations, and contact ratings of 2 A d.c. or 50 W, at a maximum of 60 V d.c. into a resistive load. The bifurcated cross-bar contacts are of gold over silver palladium alloy, and are designed for long operational life and high reliability.

In addition to the standard or basic relay, designated SFA, other more specialized versions are available including non-polarity self-latching (SFL) and polarity self-latching (SFB) types. Further, a variety of alternative contact forms may be incorporated to meet individual user requirements.

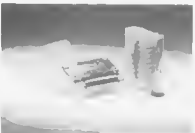

The relay's p.c. terminals are arranged in the industry standard dual in-line 0.1 in. grid format, and it has been designed for installation using a variety of techniques, including flow soldering. Electrical characteristics of the SF series of low-profile p.c.b. relays include coil operating voltages of 5, 6, 12, 24 or 28 V d.c., power consumption of approximately 0.56 W and an operational temperature range from  $-30^{\circ}\text{C}$  to  $+70^{\circ}\text{C}$ . It measures 28.4 mm x 21.4 mm x 7.5 mm high, when mounted on a p.c. board.

*Diamond H Controls Ltd.,  
Vulcan Road North,  
Norwich NR6 5AH,  
Telephone: (0603) 45291/3.*

(1635 M)

## Fast response temperature sensors

Two temperature sensors featuring fast response times have been announced by Texas Instruments Limited. The new devices, designated TSU 102 and TSF 102, feature a positive temperature coefficient and are members of a family of devices which includes the previously announced TSP 102 and TSM 102. The two older devices have been in production for over a year. All members of the family have a nominal room temperature ( $25^{\circ}\text{C}$ ) resistance of 1000 ohms and are available in  $\pm 1\%$ ,  $\pm 2\%$ ,  $\pm 3\%$ ,  $\pm 5\%$  and  $\pm 10\%$  tolerances. The devices are produced using a planar process. The resistance element uses the spreading-resistance principle which results

in close unit-to-unit tracking of the temperature/resistance slope.

The TSF 102 is equipped with a 'thermal antenna' or flag which provides close coupling of the device to the object to be monitored. Due to small thermal mass the TSF 102 and TSU 102 offer improved thermal response over the TSP 102 and TSM 102 for applications requiring it. These devices also offer a much smaller package for applications such as medical thermometers where physical size is a consideration. The slope of the temperature/resistance response-curve for all devices in the family is easily linearised by the addition of a series or a shunt fixed resistor.

*Texas Instruments Limited,  
Manton Lane,  
Bedford, MK41 7PA,  
England  
Tel: 0234-67466*

(1638 M)

## Energy measurement

Digital power integrators are now available in Northern Design's ND 26 series of custom instruments. Initially designed to monitor and control internal mixers in the rubber and plastic industry, they are equally suitable for energy management in any process industry. Specifically intended for industrial applications, these instruments give a direct reading — in watt or kilowatt hours — of the energy consumption of a process or machine operating off single or three phase power systems. They are supplied in a din style panel mounting case 172 x 144 mm and feature a



one inch high four digit display, and a 'Set Offset' control. This allows the operator to preset a power level (such as the no-load power consumption of a mixer) so that the integrators measure only the energy consumed in the process, deducting energy loss in the process plant. Optional features include analogue and digital outputs, plus a battery stand-by facility to store readings in the event of power loss.

*Northern Design,  
Cambridge Place,  
Wapping Road,  
Bradford BD3 0EE,  
West Yorkshire, England.  
Tel: (0274) 306710.*

(1631 M)

## The first push-pull RF power fet's

RF designers will be interested in the first RF Push-Pull VMOS power devices just introduced by Siliconix for broad-band applications from 2 to 200 MHz.

The new RF devices combine the well known advantages of push-pull operation, such as even order harmonic suppression, with the proven advantages of VMOS devices, such as high power at high efficiency, low noise figures, no thermal runaway, no current hogging when paralleled, the ability to withstand infinite VSWR and greatly simplified designs.

The OV 281200 (OV 1112) delivers 120 watts minimum and the DV 288DD (DV 1111) 80 watts. Also available is the DV 2840D (DV 1110) 40 watts driver. All these devices deliver rated output at 28 Volts and provide a minimum power gain of 10 dB at 175 MHz. They can each be operated in Class A, B or C and are well suited for a variety of broadband RF amplifier applications. The most obvious advantage to the push-pull package is the reduced amplifier size and the ability to directly connect impedance matching transformers to the devices.

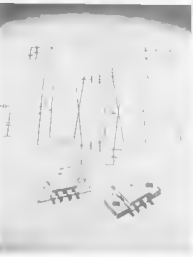

These new push-pull transistors are easily broadbanded within the VHF bands. The lower frequency limit is governed only by the transformer design. Because the transconductance is virtually constant over wide frequency excursions, the input loading requirement remains relatively constant within the hf region. Thus the input VSWR is quite stable over an unusually broad bandwidth.

Virtually no external feedback is required to ensure stability. Thus overall efficiency is unusually high and out-of-band stability is thereby significantly enhanced. Low external feedback also means that gain is flat across a very wide bandwidth. RF designers are finding VMOS particularly attractive because baseband noise is 10 to 15 dB lower than in comparable bipolar devices.

This new family of RF VMOS devices exhibits a reverse gain of  $-35\text{ dB}$  or more. So variations in output loading have little effect upon the input of the amplifier. Equally important, VMOS power amplifier circuits have exhibited the ability to withstand 20 : 1 VSWR at any phase angle.

*Siliconix Limited,  
Morrison,  
Swansea SA6 6NE,  
Tel: (0792) 74681.*

(1620 M)



# market bulletin

## Miniature multi-way connector with integral locking feature

H & T Components announce the availability of a series of low-cost, miniature multi-way connectors combining compactness with extreme reliability.

The RPC connector series has been introduced by H & T Components for applications in equipment such as communications, radar, instrumentation and data collection systems. It has been designed to meet requirements for high density interconnection with high power capability. The lightweight, plasticshrouded RPC plug and socket measures only 15 mm in diameter x 55 mm overall, excluding its flexible protective shroud for the cable entry. It is rated at 5 A, and proofed to 500 V a.c. Probably the most important feature of the RPC connector, however, is its integral 'one-touch' locking system. This consists of a locking arm which is part of the body moulding, which mates the two connector elements positively and securely to prevent accidental disconnection.



The RPC series offers almost 200 user options, enabling it to meet a wide range of individual application requirements. It is constructed in moulded gray or black plastic, and is available with from two to seven contacts in either gold or silver plated brass or phosphor bronze. It offers the choice of panel or p.c.b. mounting, and is supplied with a choice of 'solder bucket' or p.c.b. terminations.

H & T Components,  
Crowdy's Hill Estate,  
Kambrey Street,  
Swindon,  
Wiltshire SN2 6BN.  
Tel: Swindon (0793) 693681-7.

(1622 M)

## Low-cost hand-held digital multimeter

The new Alpha V, the latest and smallest in the comprehensive range of digital multimeters from Gould Instruments Division, is a low-cost, hand-held instrument combining versatility and ruggedness. The Alpha V has a 3½-digit liquid-crystal display, and the 25 measuring ranges cover the five basic functions of DC voltage, AC voltage, DC current, AC current, and resistance. Costing only £85.00 (plus V.A.T.), the Alpha V is being



offered with an introductory discount of 5% on quotations of from two to nine units and 10% for larger quantities.

The Alpha V has a maximum reading of 999 and a maximum resolution of 100 µV, DC accuracy on the 200 mV range is  $\pm 0.5\% + 0.5\%$  of full scale. DC and AC voltages are each covered in five ranges from 200 mV to 1 kV, and DC and AC current in five ranges from 2 mA to 10 A. The five resistance ranges go from 200 Ω to 20 MΩ. Range and function selection is by two rotary switches on the clearly coded front panel, which make the instrument very easy to use.

The multimeter is powered by a 9 V carbon-zinc or alkaline battery (PP3 or equivalent), the latter giving a typical life of 200 hours. Battery-low indication is provided by the multimeter's display, which shows 'BAT' when less than 10% of useful battery life remains. Automatic decimal-point, polarity and overrange indication is also provided.

The case is of high-impact ABS plastic, and the display is shock-mounted behind a tough polycarbonate plastic window. The battery and the protection fuse are easily accessible, and a single calibration control is provided. Estimated mean time between failures is in excess of 20 000 hours.

The Gould Alpha V measures only 178 mm (7 in) x 76 mm (3.07 in) x 38 mm (1.5 in) and weighs 282 g. Accessories supplied with the basic instrument include standard red and black test leads, battery and handbook. Other accessories available are a soft protective carrying case, high-voltage probe, r.f. detector, and a special set of test leads rated at 2 kV RMS and 20 A.

Gould Instruments Division,  
Roebuck Road,  
Hainault,  
Essex  
Telephone 01 500 1000

(1637 M)

## Low cost digital storage oscilloscope

Designated the Model MS-1650, this versatile instrument combines a 10 MHz real time oscilloscope with a digital storage system employing a 1024 x 8 bit memory. Digital storage offers several advantages over

the more common tube storage, notably the variable pre-trigger and post-trigger viewing — simultaneous display of real time waveforms and previously recorded waveforms for detailed and unambiguous comparison — permanent hard copy record by output to a peripheral device, such as a pen recorder.

Oscilloscopes employing digital storage techniques present the user with a number of practical advantages when observing one shot, transient or slow speed signals — display, quality and clarity do not deteriorate with time and the display is completely without flicker.

MS-1650 can protect its stored signal data by an internal optional nickel-cadmium battery, which retains the memory data when the a.c. mains power is switched off or inadvertently removed.



The MS-1650 digital storage oscilloscope incorporates a rectangular CRT, and is robustly constructed with a die-cast front panel and integral carrying handle, tilt stand. It weighs only 9 kg, measures 284 x 138 x 400 mm, and costs just £1,440 with a two year guarantee.

House of Instruments,  
34/36 High Street,  
Saffron Walden,  
Essex, CB10 1EP.  
Tel: (0799) 22612.

(1632 M)

## Miniature Dustproof Presets

The HO621A is a low cost miniature cermet trimmer, with an almost indestructible adjustment cap for applications throughout all types of electronic circuitry. The 6 mm diameter makes the trimmer small enough to fit virtually any application. Despite costing only 15 p in 1000 off quantities — a carbon track version (HO651A) is available at 9.5 p for less demanding situations.



Ambit International,  
200 North Service Road,  
Brentwood - Essex CM14 4SG,  
tel. (0277) 230909

(1629 M)

# market

## Weller rework station

The DS100 PEC is a complete soldering and desoldering station operating from a mains power supply and generating its own desoldering suction from a built-in vacuum pump. The unique feature of the unit is that the working temperature of the soldering and desoldering instruments can be continuously adjusted between 50° and 450°C with a tolerance of  $\pm 2^\circ\text{C}$ . The latest precautions for avoiding interference voltages have been incorporated to enable use on highly sensitive components without risk. The station consists of a basic power supply control unit and vacuum pump (factory compressed air may also be used), a two stage foot switch, two safety stands, a Tamtronic soldering iron, and a Temtronic desoldering pencil with transparent solder collector and replaceable filter.



Toolrange Ltd.,  
Lipton Road,  
Reading,  
RG3 2SA  
Telephone (0734) 29446

(1557 M)

## Tuneable inductors

Toko's range of tuneable inductors now includes the 12VX series of high inductance tuneable coils - available with primary/tap and secondary up to 68mH nominal, although tuning 30% of this centre value by slug core adjustment.

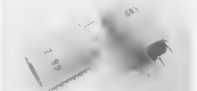

1cm grid

The 12VXA is designed for bias oscillators, tuneable traps, MODEM applications and is suitable for all types of LC filter designs, where the versatility of a tuning adjustment is an invaluable advantage, since it is easier to use standard value capacitors.

Ambit International,  
200 North Service Road,  
Brentwood - Essex, CM14 4SG  
tel. (0277) 230909,

(1559 M)

## Communications aerial switch unit

Telecommunications Accessories Limited have launched an aerial changeover designed for use in high security installations. The device allows the operator to change from one aerial to another in the event of malfunction or damage, thus maintaining radio contact at all times.

Switch operation is by a 12-volt relay and the unit has a loss of less than 1dB over the frequency range 0-500 MHz.



Telecommunications Accessories Limited,  
Thame Industrial Estate, Bandet Way,  
Thame, Oxon OX9 3SS,  
Great Britain.  
Tel: Thame 3621/2/3.

(1567 M)

## Math processor chips boost micro-computer performance

Intel has introduced two new math processor chips, the 8231 (fixed point) and 8232 (floating point), which increase the performance of a microcomputer system by a factor of up to 100 times when carrying out mathematical operations. Both chips act as dedicated peripherals interfacing directly to Intel's 8080, 8085 and 8088 microcomputers in addition to all other general-purpose processors with 8-bit data buses.

The 8232 will perform 64-bit double-precision or 32-bit single precision floating point addition, subtraction, multiplication and division. Double precision operation is most likely to be used in scientific instruments such as chromatographs and spectrographs since they require calculations to be carried out over a wide dynamic range with

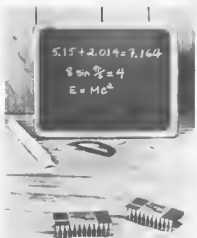

a high level of accuracy

Single-precision (32-bit) operation will be used on those occasions when speed is a more important consideration than absolute accuracy. The processing time depends on the data, however, a typical single-precision multiply takes approximately 100 microseconds. The 8232's floating point algorithm is a subset of the proposed IEEE floating point standard which is the same as used for Intel's floating point arithmetic library software and the I58C 310 arithmetic processor board. In fact, this standard is used in all Intel hardware and software to ensure that programs written in different languages and run on different systems will always yield the same result.

The 8231 is intended for use in process and industrial control applications requiring a real time mathematics capability over smaller dynamic range. It operates in a fixed point mode, performing 16 and 32-bit addition, subtraction multiplication and division. Other functions which can be performed by the 8231 include the calculation of sine, cosine, tangent, cosecant, secant, cotangent, square root, logarithm, natural logarithm, exponentials and powers.

Both the 8232 and 8231 math processor chips contain a 16-bit arithmetic logic unit, a programmed algorithm controller, an 8 by 16-bit operand stack, a 10-level working register stack, command and control registers and a read only memory containing all the control software. All transfers between the host processor (including operand, results, status and command information) take place over an 8-bit bidirectional data bus.

Both chips are manufactured using Intel's HMOS technology and are available in 24-pin dual-in-line packages. Each requires +12 V and +5 V power supplies.

INTEL Corporation (UK) Ltd.,  
4 Between Towns Road, Cowley,  
Oxford OX4 3NB,  
Tel: Oxford (0865) 771431

(1562 M)

# market

# market

## Lightweight polypropylene tool box

The new 151 Cantilever tool box from Racco is made from rugged polypropylene and has overall dimensions of 500 x 220 x 220 mm. Four tool trays each 480 x 75 x 35 mm fold out when the lid is opened. The top two trays are provided with movable dividers. A fold flat lid and two safety catches complete an extremely lightweight package. Finished in brown and fawn with white compartmented tool trays it is an ideal alternative to heavy metal tool boxes.



The Racco 151 Cantilever Tool Box costs £12.50 + VAT

*Toolrange LTD.,  
Upton Road,  
Reading RG3 4JA,  
Tel: Reading (0734) 29446 or 22245*

(1573 M)

## Illuminated push button switches offer RFI shielding

The capital RF 335 series of illuminated push button switches is now available from Symot Limited.

Single or dual lamp units are offered in change over combinations up to 4 poles. The normal rating is 2 amps, 250 VAC. Steel housings, finished with a black oxide bezel are standard and stainless steel clips ensure positive retention from front of panel. The panel cutout dimensions are 0.928 inches x 0.972 inches.

Momentary and alternate action switches with complementary indicator only units are available. Lens modules can be full-screen or horizontally or vertically split and a simple adapter provides full RFI shielding. Lenses are available in all standard colours. The lens mo-



dule design ensures that the T16 flange base lamps do not move during operation, thus reducing lamp failure.

Lamp replacement is easily achievable from front of panel

*Symot Limited,  
22a Reading Road,  
Henley-on-Thames,  
Oxon. RG9 1AG,  
Tel: (049 12) 2663.*

## Flatter flat pack relay

Miniature p.c.b. type LZN relays from IMO Omron are now flatter. These highly reliable ultra low profile (11.5 mm) flat pack type miniature relays, available in two or four pole, employ the international grid terminal arrangement. The LZN has triple gold flashed silver contacts rated 3A @ 24 VAC, these twin bifurcated contacts plus the unique card file oil system for the contact drive ensures reliable switching of low voltages. Operating voltages are 6-48 V DC. These competitively priced flat packs have extremely long life, in excess of 100 million operations minimum, low coil resistance plus reliable low voltage switching makes the LZN ideal for the alarm industry where these considerations are so important.

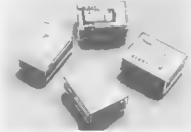

*IMO Precision Controls Ltd.,  
349 Edgware Road,  
London W2 1BS,  
Tel: 01 723-2231/4 and 01 402-7333/6.*

1575 M

## DIL switches sealed

Dual in line switches, type 338, are now offered by Symot Limited. The principal advantage claimed for these switches is the terminal sealing technique which is designed to prevent contamination from flux and solder.

These DIL switches embody a single point contact system, with self-cleaning wiping action which results in a low and stable contact resistance. The initial figure of less than 50 milliohms at 2 V DC, 10 mA, is guaranteed for over 10,000 switching operations.

Temperature coefficient is fully documented over the range -25°C to +60°C.

*Ambit International  
200 North Service,  
Brendwood - Essex CM14 4SG  
tel. (0277) 230909*

(1560 M)

## UHF cavity filters

Toko's 232MT series of helical resonators represents a substantial price breakthrough for communications quality UHF filters.

Originally developed for applications ranging from UHF RF filters to the first IF of SHF (satellite broadcasting) systems, the series are available in the range 380-480 MHz with either two or four chambers.

The insertion loss is only 1.8 dB max for four pole units, with a shape factor (6/60 dB) of better than 5:1, representing an RF bandwidth of 2.25 MHz at 60 dB, an ultimate stopband of some -70 dB



Gold flashed terminals and heat resistant plastics have been chosen to increase the reliability of these switches, which are rated at 50 V DC, 100 mA, non switching and 5 V DC, 100 mA in the switching mode. The terminal pitch is 2.54 mm x 7.62 mm.

*Symot Limited,  
22a Reading Road,  
Henley-on-Thames,  
Oxon. RG9 1AG  
Tel: (049 12) 2663*

(1572 M)

# 3½ DIGIT LCD MULTI-METER KIT

# NEW

Build the Practical Electronics handheld DMM. This superb product offers professional precision with extended battery life. Five function operation (AC and DC VOLTS, AC and DC CURRENT, RESISTANCE) with ability to check diodes. 0.5" LCD display with "Battery Low warning Auto-polarity, Auto-zero. Full protection against transients and overloads with ability to withstand mains on any range. 0.5% basic DC accuracy and 15 different ranges. It measures AC/DC voltages from 0.1mV to 500V. AC/DC current from 0.1µA to 2A. Resistance from 0.1Ω to 20MΩ. 200 hour battery life.

The Kit contains all parts needed to construct the multimeter plus assembly instructions, battery and test leads.

We also offer a calibration service (£5.00 + VAT) and a trouble-shooting and calibration service (£7.50 + VAT). Various other component parts are also available as listed.

The multimeter is also available fully assembled and calibrated at a cost of £39.70 + P&P + VAT.

Lascar Electronics Ltd., Unit 1, Thomas Road, Basildon, Essex. Telephone No: Basildon (0268) 727383.



**FEATURED  
AS A  
PROJECT IN  
PRACTICAL  
ELECTRONICS**

	£	P & P	VAT	TOTAL
PE-DMM KIT	32.95	1.00	5.09	39.04
ICL 7106	8.95	0.50	1.42	10.87
LCD DISPLAY	7.95	0.50	1.27	9.72
PCB	4.95	0.50	0.62	6.27
FULLY ASSEMBLED DMM (INC. LEADS)	39.70	1.25	6.14	47.09

To: Lascar Electronics, Unit 1, Thomas Road, Basildon, Essex.

Please send me Data  FULLY ASSEMBLED DMM (INC. LEADS) £47.09

PE-DMM KIT £39.04  ICL 7106 £10.87  LCD DISPLAY £9.72  PCB £6.27

Name \_\_\_\_\_

Address \_\_\_\_\_

Tel No \_\_\_\_\_

Enclose cheque/P.O. value

**SOMETHING TO SELL?  
SOMETHING TO BUY?  
SOMETHING TO EXCHANGE?**

You can reach over 75,000 readers with a Classified Ad. in Elektor.

Send copy, with payment, by the following dates:

31st July for October issue  
29th August for November issue  
26th September for December issue

Please see "Conditions of Acceptance" on Classified page in this issue.

## sc/mputer (1)

build your own  
microprocessor system



## sc/mputer (1)

This first book of a series describes how to build and operate a simple microprocessor system based on the National Semiconductor Microprocessor (INS 8060). The system may be extended to meet various requirements - these will all be discussed in the SC/MPUTER books.

PRICE/UK ..... £3.70 inc P&P  
OVERSEAS SURFACE MAIL . . £3.90 inc P&P