

# elektor

61  
may 1980

U.K. 55p.  
U.S.A | Can. \$1.75

up-to-date electronics for lab and leisure



Germany Dfl. 3.40  
Netherlands Dfl. 3.75  
New Zealand \$ 50

Norway Kr. 10  
Sweden Kr. 14  
Switzerland F. 4.60

selektor .....	5-01
elektor $\mu$ P's .....	5-04
An in depth look into the various microcomputer systems published in Elektor.	
<b>Junior Computer</b> .....	5-08
At last a small, inexpensive microcomputer, for anyone interested in learning more about computers.	
	
coming soon .....	5-17
<b>frequency lock system</b> .....	5-18
One up on PLL; this system ensures better and more stable tuning than ever before.	
<b>PWM amplifier</b> .....	5-22
In spite of some teething problems, Pulse Width Modulation (PWM) is considered by many to be the future of audio. This month a 3 watt power amplifier is featured.	
<b>BASIC cassette interface</b> .....	5-24
Here is a cassette interface with on-board software. This will enable SC/MP and BASIC computer users to store programs on cassette.	
<b>LCDs</b> .....	5-34
Liquid Crystal Displays (LCD's) are an economic alternative to the well known LED's, and LCD's consume much less power. Elektor takes a closer look at LCD's this month and gives ideas for experimentation.	
<b>flexible intercom</b> .....	5-44
There always seems to be a need for better communication, and the home is no exception. The intercom featured here offers flexibility in location and operation.	
missing link .....	5-47
market .....	5-48
advertising index .....	UK-26

# contents

content  
cont  
con

**EDITOR:**

W van der Horst

**UK EDITORIAL STAFF**

T Day  
P. Williams

**TECHNICAL EDITORIAL STAFF**

J Barendrecht  
G H K Dam  
P. Holmes  
E Krempelsauer  
G Nachbar  
A Nachtmann  
K S M Walraven

*Due to lack of space, the  
MPG article has been postponed  
until the June issue*



# selektor SELEKTOR

## Hot water from the freezer

The price of energy has risen considerably during the past few years and it certainly does not look as if this is ever likely to drop. It is time to take steps to conserve energy in a field which, until recently, attracted attention on an academic level only.

### Current consumption in the freezer

Nowadays, about 47% of homes in Britain own a freezer. Recently there has been a drop in annual sales. This is because freezers consume a great deal of current. How does this compare with other household appliances? Figure 1 shows the general energy requirements in the home. 84% is used up by primary energy sources such as natural gas or coal and by secondary energy sources such as electricity, coke or oil fuel, 10% is required to heat water. The country's 450 million electrical household appliances including TV, radio sets and lighting only consume 6% between them.

So although household appliances use up a relatively small percentage of the total energy consumption, industry is justified in its efforts to cut power requirements. In 1978 25% of the total went on domestic electricity. Figure 2 shows the three appliances which consume most electricity in the kitchen. 17% alone is used up by cooling and freezing equipment. Although their compressors require no more than 100 to 150 W, the huge amount of energy consumed is explained by the fact that they are almost continuously switched on. The total current consumption may be divided equally between the fridge and the freezer. The consumption of the freezer alone (6,5 GWh a year) corresponds to that of agricultural machinery or — to name another example — to about 70% of the railway and traffic requirements. It would, therefore, make a considerable difference if a freezer's energy could be 'frozen'. Even if only part of it could be transferred in the form of domestic heat, it would be a step in the right direction from an economic point of view.

Figure 3 shows the rising energy curve of fridges and freezers. The latter are usually more economical, because they are better insulated.

### Balance of energy and heat transfer

A freezer with a 300 litre capacity — about the size recommended for a family of four — uses up an average of 2.3 kWh a day. It is transformed into heat across the compressor and cooling circuit. The balance of energy is shown

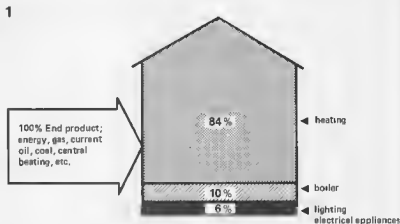

Figure 1. The use of energy in the household.

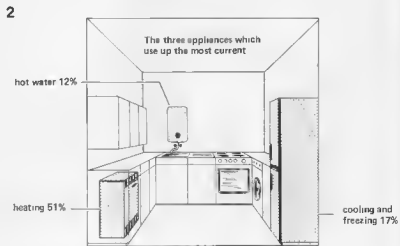

Figure 2. Current consumption in the home.

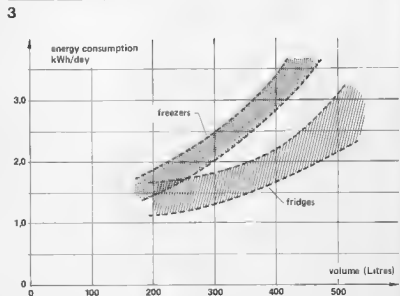

Figure 3. Energy consumed by freezers.

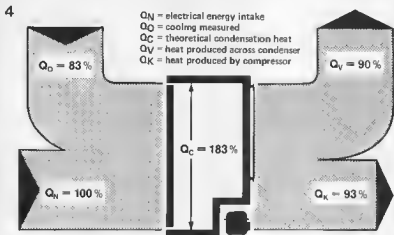

Figure 4. Heat transfer in a freezer.

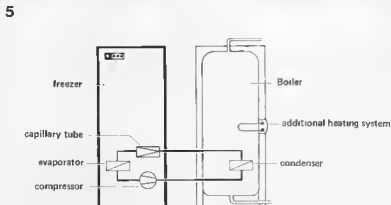

Figure 5. A freezer including a heat transfer system.

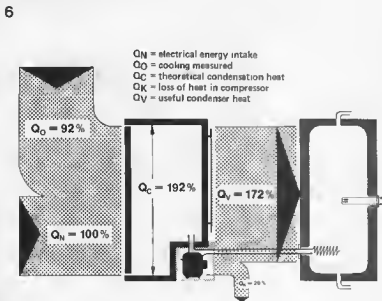

Figure 6. A freezer including a heat transfer system.

in figure 4. The electricity consumption  $Q_N$  is used as a 100% rating. By means of the evaporator  $Q_O$  is drawn from the inside. The amount normally corresponds to the heat which penetrates the inside of the freezer through the door seals etc. The theoretical condensation heat  $Q_C$  represents the entire heat quantity as 183%. 90% of it is heat emission  $Q_V$  in the condenser, 93% is heat emission  $Q_K$  produced by the compressor.

The balance of energy shows that it would be quite simple to transfer part of the heat emitted to boil water. For this purpose the condenser is replaced by a condenser spiral in a hot water tank, so that heat  $Q_V$  may be directly used to heat water. An additional heating system ensures that water is heated to the required temperature or to that needed during a short period or consumption peak.

The cross-section in figure 5 shows how such a system is built up. The freezer is connected to the boiler by means of tubes along which the refrigeration substance circulates. In this way, 90% of the electrical energy extracted from the freezer may be used to heat water until a temperature of about 60°C. With the aid of a simple technique it is possible to increase the level of heat by 100% or more. This because the system operates as a water pump.

In this process the compressor plays an important part. If it were insulated from the outside air, an oil cooler could be installed to reclaim 80% of the heat. The performance flow diagram of such a system is shown in figure 6. In the diagram measuring values are recorded which compressors normally achieve. The condensation temperature  $T_C = 50^\circ\text{C}$  and the evaporation temperature  $T_O = 30^\circ\text{C}$  correspond to the common freezer values. The operation time of the compressor is assumed to be 100%, or continuous duty.

$Q_N$  represents the electrical energy increase with a 100% rating. The cooling obtained  $Q_C$ , 92%, is slightly higher in comparison with the value shown in figure 4. This is because the thermic relationships have changed in the cooling circuit. Of the condensation heat  $Q_C$ , which theoretically should be 192%, about 20% is lost due to transmission and radiation in the compressor. For water heating purposes  $Q_V = 172\%$  is available. The heat produced is therefore 1.72 times greater than the electrical energy intake.

The excessive heat is drawn from the outside air into the room the freezer is in. As it extracts heat from its surroundings, it provides an ideal means to cool cellars. An added advantage is that no extra energy need be used. To avoid thermic feedback between the freezer and the boiler, these should not, of course, be placed in the same room.

#### Economic considerations

The condenser spiral, insulated compressor with oil cooler including various

control and safety installations will cost about £ 125. If we suppose that approximately £ 40 a year may be saved once the system is in operation, it will have paid for itself within 2½ years. Compared with other boiler systems, this is extremely short. Even when water is oil heated equivalent energy costs may be saved.

Figure 7 shows the entire system as it is available today. Twenty such systems have been tested and are still functioning well after more than eighteen months. Figure 8 gives an idea of the machinery involved inside a freezer. Clearly visible are the two insulated tubes along which the cooling medium transports the condenser and oil cooler heat. In the return tubes the fluid is at room temperature and does not therefore require insulating. The four tubes are the only connections between the freezer and the boiler. A boiler is shown with a 290 litre capacity, as installed in a modern home. (Recommended for a family of four.)

**Technical layout**

Whereas the freezer needs to be cooled continuously, how much hot water is consumed depends on the time of day and even on the day of the week (figure 9). In the upper half of the diagram the amount of hot water consumed is shown with relation to the time of day. Also recorded are the hourly averages of consumption in a family of four on an ordinary weekday. There is a considerable difference in quantity consumed at the weekend. In a simplified manner, the total water consumption is shown in the lower half of the drawing. This is with relation to the days of the week, where the consumption and boiler efficiency ratio is expressed in kilowatt hours, in other words, as energy required by the boiler. This graph also shows the energy which a 300 litre freezer can produce for water boiling purposes. With a power rating of 1.72, barely 4 kWh or about 46% of the total energy required may be used to boil water. The boiler capacity,

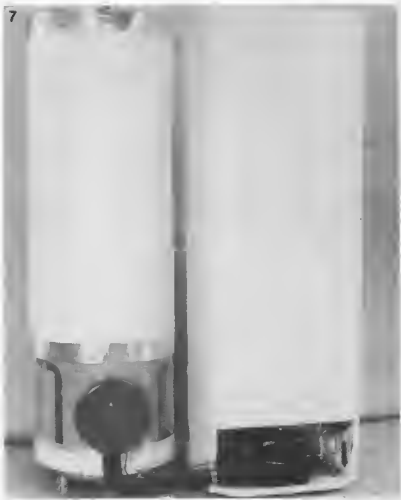

290 litres, is shown to be in proportion to the cooling of the 300 litre freezer. The additional heating apparatus is exclusively used to cover the energy consumption peaks.

Otto Koehn,  
at the 15th AEG-Telefunken  
technical press colloquium

(534 S)

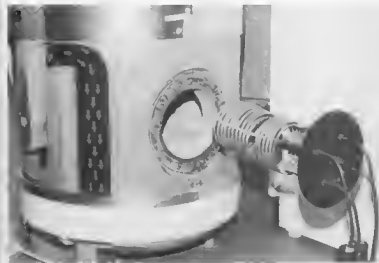

**9**

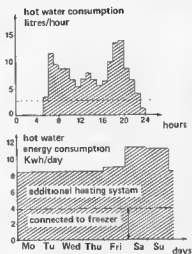

Figure 9. Specific hot water requirements for a family of four. Temperature obtained; 60° C.

# elektor microprocessors

No less than three microprocessor systems have been published to date by Elektor. To the beginner this may seem rather confusing. It is hoped that the following description will serve as a guide to anyone wishing to construct an Elektor system.

The systems were published in the following chronological order: the SC/MP, the games computer and the Junior Computer (JC). Although the purpose of this article is to provide a general survey rather than a detailed discussion of the manifold possibilities of microprocessors, practical examples will be given by way of illustration. (This does not imply, however, that no other uses may be found for the systems.)

First of all, let us deal with the SC/MP (pronounced 'scamp') system. Its principal feature is its modular construction. The microprocessor of the same name is manufactured by National (type number INS8060). This involves a number of printed circuit boards of the Euro-card format (approximately 10 x 16 cm) which are interconnected by means of a bus system. The bus is nothing more than a set of conductors connecting all the 1 points, the 2 points, etc. Its modular construction allows it to be a highly flexible unit. Its smallest version is made up of only two cards. The system may be extended by adding more cards to the bus printed circuit board. These will not only provide

more memory capacity (additional RAM and/or ROM), but a printer, for instance, may also be installed.

The Junior Computer is constructed on a single printed circuit board (excluding the supply). An attempt has been made to build the cheapest and smallest unit possible, without eliminating any of its 'real' microprocessor characteristics. By means of a connector on the board, the Junior Computer can be coupled to the SC/MP system. The result is a SC/MP system using an additional processor.

The odd man out of the threesome is the games computer. It was designed to generate colour TV pictures directly on the screen. The pictures are programmed to move and change in form and colour. Thus, it is in fact a luxury TV game device. Additional games may be introduced (such as space war, football and Master Mind). The hardware (the computer itself) has been specially adapted. It consists of two individual keyboards of 12 keys and of a 4 key section to be used by both players. In addition, there is an input for two joysticks ('steering levers') and a loudspeaker has been

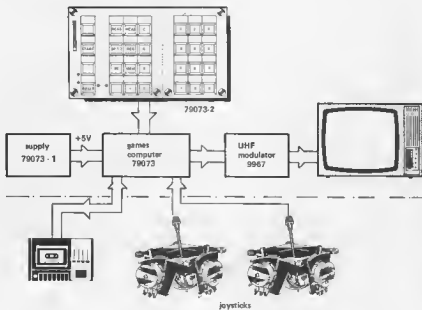

Figure 1. The system structure of the games computer.

built in for special sound effects. Programmes may be easily changed with the aid of a cassette recorder which tapes them, so that they may be played whenever required.

The games computer was not designed for expansion since its prime purpose was for programming. Any possible future additions will only affect its memory capacity.

Both the Junior Computer and the SC/MP were designed for more general use. Not only do they carry out specific tasks, but games may also be played (without a TV). Both machines are capable of developing programmes (already included in the standard monitor programme) and of operating in high-level computer languages. The SC/MP, for instance, can use tiny BASIC.

Every command to be carried out by the SC/MP is then issued by a terminal. This is a separate unit which has a keyboard and VDU and/or printer. The keyboard consists of figures 0...9 as well as the alphabet and specific control characters. In order to operate this system effectively, therefore, a terminal is essential because it enables the computer to communicate in a high level language. Since 'normal' words are used, the alphanumeric keyboard is necessary.

The Elektterminal was described in Elektor's November and December 1978 issues. Instead of the Elektterminal a hexadecimal keyboard and display may be used. This is a separate module described in the earlier series on the SC/MP. The system is then fully oper-

ational at a machine language level, and the Elektterminal can always be added at a later date. Without extensions, the JC is also programmed on machine language.

**The microprocessor**

The first aspect to consider is which microprocessor should be selected. The microprocessor is at the heart of any microcomputer system, and to a great extent it determines its capabilities and the speed at which tasks are carried out. At first sight the best choice would appear to be a microprocessor with great potential and high speed. On the other hand, it is very difficult to programme hundreds of instructions. Experience has shown, that, ideally speaking, the programmer should know them all by heart. As far as speed is concerned, it is of course an advantage for the processor to be fast, without needing a higher speed (and therefore higher priced) memory. In practice, however, programs tend to be held up only when high level languages are used or when complicated mathematical calculations are made.

Another aspect which merits attention is how many programmes are available. Generally speaking, a processor may take over other programmes, after minor modification, provided these were written for the same type of processor. In this respect, the 6502 is a good choice.

Each system hitherto discussed relies on a different microprocessor: the games computer on the 2650 from Signetics,

the SC/MP on the INS 8060 from National and the Junior Computer on the 6502 from Rockwell. Of these, the SC/MP (8060) operates in the simplest and slowest manner. The 6502, on the other hand is the most complex and fastest. Between the two extremes lies the 2650's performance. Since the SC/MP's relatively slow operation is sometimes considered a handicap, a processor card has been manufactured for it which is obtainable together with a faster Z-80 processor (not by Elektor). By way of conclusion, a brief description of the construction of each system will be given and especially with regard to their combination possibilities. For further technical details, reference should be made to articles on the subject published in Elektor.

**The TV Games Computer**

Number one on our list is the games computer. It consists of a central printed circuit board, including a keyboard (see figure 1), a power supply and, usually, a UHF modulator so that a normal colour TV with an aerial input may be used. In addition, it is advisable to make use of a cassette recorder to store the programmes. To facilitate programming, the monitor is equipped with extensive debugging capabilities including two breakpoints. Two joy sticks may also be added to control the games.

**The Junior Computer**

For simplicity, the Junior Computer

2

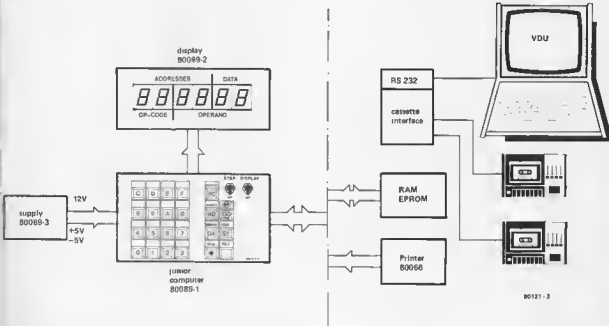

Figure 2. The section to the left of the dotted line contains the basic Junior Computer. The modules to the right may be added if required.

3

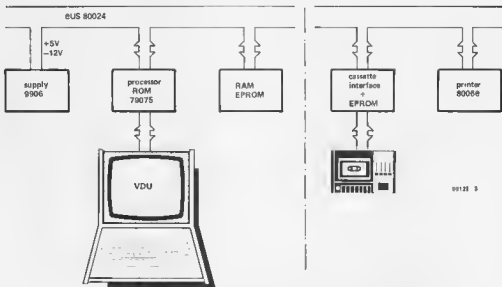

Figure 3. The SC/MP has been equipped with a terminal. By placing a pre-programmed ROM with Tiny BASIC on the processor circuit board, it may be operated in BASIC. Expansion possibilities are shown to the right of the dotted line.

is built on a single printed circuit board (see figure 2). Of course, it also needs a supply capable of producing +12, +5 and -5 V. The keyboard is constructed directly onto the board. The six seven-segment displays are mounted onto a small auxiliary board which is soldered in a slanting position onto the central board. Later on, a cassette interface and one or two cassette recorders may also be added. Furthermore, a connection may be made to the SC/MP bus by means of the connector which is on the board. This can come in handy, for instance, when more memory is required than is included in the circuit (1 K EProm with the monitor programme and 1 K RAM).

The Junior Computer system operates in a hexadecimal code: in other words, using 0...9 and then A, B, C, D, E, F. The monitor program features a hex assembler. When jump instructions are encountered, the hex assembler provides the correct byte for the corresponding location. The monitor then passes on the addresses to the computer.

Before more complicated tasks (using high level languages, assemblers, etc.) can be fulfilled, a terminal must be connected. This can be done with the aid of the cassette interface board. For the necessary memory power, however, more EPROM will have to be introduced. This involves using the 8 K EPROM + 8 K RAM card belonging to the SC/MP.

For typing programmes, the cassette interface board will have to be added. Additional EPROM and/or RAM will have to be included, whenever one wishes to operate the available editor

assembler, disassembler or when programming in high level languages (such as BASIC).

### The SC/MP system

Finally, it is time to consider the SC/MP system. Because of its modular construction, several configurations are possible. The minimum (BASIC version) system is based on two cards (see figure 3). The first is the processor card which includes an address and data bus buffer and the possibility to connect a terminal (RS 232 interface). For the second the 8 K EPROM + 8 K RAM may be chosen. If so, the monitor programme must be part of the EPROM and as much RAM as required (from 1 K to 8 K) may be added. When a keyboard is used with the 2 card system it is able to run BASIC programs. The processor card has an IC (ROM) socket specifically for this.

For programme storage purposes the cassette interface may be added. With the aid of the matrix printer card a printed listing of machine language programmes may be obtained. The supply voltages required depend on which EPROMs are used. The 8 K EPROM + 8 K RAM card employs 2716 EPROMs and requires 5 V. On the cassette interface card there is room for EPROMs of the 5204 type and these require +5 and -12 V. Instead of the 2716, the 2708 may also be used. As a result, two more supply voltages (+12 and -5 V) will have to be added to the 8 K circuit and the memory capacity will be halved (to 4 K). The existing supply already produces the +5 V and

-12 V. On the SC/MP bus lines, all voltages mentioned are available.

Apart from the modules mentioned above, there are still a few cards available which are based on a somewhat smaller system which communicates with the outside world by means of a keyboard, and eight seven-segment displays. This model resembles the Junior Computer in its elementary form. With the aid of these cards, a unit may be assembled as follows, (figure 4).

The SC/MP processor card plus the extension card constitute the actual computer. The data lines are not buffered, thereby restricting the size of the system. In order to build up a more complex system, a data bus buffer must be added (printed circuit board number 9972). The operator has 1½ K of EPROM available (the monitor programme) and 1 K of RAM. The RAM may be expanded with the aid of the 4 K RAM card. Data is written and read by means of 26 keys and eight seven-segment displays, installed in the hex-I/O printed circuit board. An auxiliary board will be needed for the connection of a cassette recorder (number 9905). A terminal, however, may be fitted with another circuit board (79101, interface for micro-processor). The layout is shown in figure 5.

### Which one is for you?

These then are the Elektor computers to date. Three complete systems designed for different purposes. The SC/MP for constructors with a desire for a



4

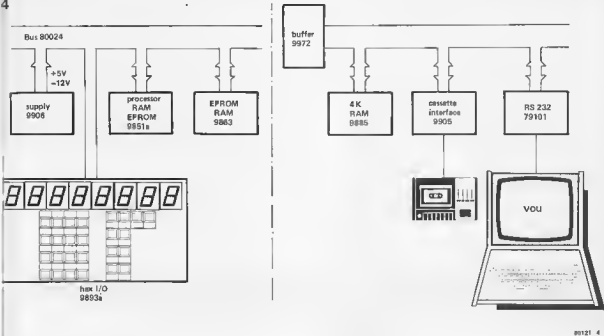

Figure 4. The smaller SC/MP system (using different cards)

large system which can be expanded and/or modified as and when required. The TV Games Computer for those who want to see the results of their programming instantly in a visual form. The Junior Computer for the beginner, easy to construct and economical with great potential.

- For the beginner ... the obvious choice will be the Junior Computer with its excellent teaching facilities.
- For the expert ... the SC/MP will probably be the most desirable with its many system variation possibilities. Why not add

the Junior Computer to it (have a two computer family)?

- For the programmer ... The TV Games is 100% FUN. Designed specifically for programming, it succeeds in its purpose very well.
- For the constructor ... If building is your wont the SC/MP will be fine. You can fill two kitchen tables with it.
- For the experimenter ... We are all one of these at heart really. And if you fit all of the above categories there can only be one answer ...

It is worth noting here that two new

computer books will be available from Elektor, one for the SC/MP and one for the Junior Computer.

**What does the future hold?**

There are two things you can be sure of with Elektor, we always have something up our electronic sleeves. How about a PASCAL compiler for the Junior Computer or a complete computer cassette system? There are even rumours of a new VDU system using an unconverted TV set. Maybe even a new computer ... who can tell? Just watch this space!

5

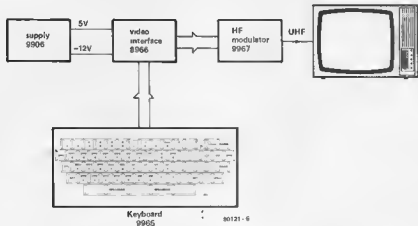

Figure 5. A terminal may also be built with the aid of Elektor printed circuit boards. 16 rows of 64 characters may be displayed onto an ordinary TV screen.

# junior computer

The cost and complexity of home computers is a serious deterrent to the newcomer to computer operating and programming. We know of many readers who would like to 'build their own' but who lack the necessary technical knowledge. The Junior Computer has been designed (for just this reason) as an attempt to 'open the door' to those readers who need a push in the right direction.

It should be emphasized that, although simple to construct, the Junior Computer is not a 'toy' but a fully workable computer system with the capability for future expansion. It has been designed for use by amateurs or experts, and software to be published will include a PASCAL compiler — the computer language of the future.

The purpose of this article is to give a general description of the operation and construction of the Junior Computer. It has been decided to publish a more detailed description in book form.

The arrival of 'The Junior Computer' Books 1 and 2 on the market will be announced shortly. This, however, is a preview intended to give the reader an idea of what the computer entails.

There are many readers who would like to know more about home computers but who may not be technically minded or who consider them too complicated to understand. These two reasons, coupled with cost, tend to prevent many people from 'taking the plunge'. To help overcome these problems we have designed the Junior Computer (JC). Do not be misled by the term 'Junior' — this computer provides the first step to understanding large and powerful systems. Although small in size, the Junior Computer can be used with high level languages (PASCAL for instance). This is possible because it uses a simplified method of operation and has the advantage of various expansion possibilities.

The heart of the JC occupies no more than a single printed circuit board which should dispel any fears produced by large and complicated systems. The intention of this article is to encourage readers to take the initial steps towards constructing and operating their own personal computer. Extensive and precise details will not be dealt with here but will be published in depth in book form — the Junior Computer Books 1 and 2. We can however whet the appetite and set the ball rolling. Specific data concerning the computer are given in Table 1, this is intended for readers who are already familiar with computers.

## Block diagram

The fundamental features of the Junior Computer are shown in the simplified block diagram of figure 1. The heart of any computer system is the CPU, or central processing unit. In this particular case it is a 6502 microprocessor, a 40 pin chip that you can hold in the palm of your hand — but shouldn't! Its purpose is to control communications between the various units inside the computer in accordance with the instructions of the program. A clock generator (oscillator) serves as a 'pace-maker' for the processor.

A certain amount of memory is required by the microprocessor to store programs and data. In the JC it consists of two sections. The first one for storing permanent data and the monitor program. The monitor Program contains a number of routines which perform such chores as program loading,

debugging and general housekeeping. The second section of memory is used for storing temporary data and program instructions.

The block marked I/O (input/output) maintains contact between the computer and the outside world including the keyboard and display. In the circuit the I/O appears as the PIA, or peripheral interface adapter. It takes care of the data transfer in two directions and can (temporarily) store data. The operator communicates with the computer via the keyboard and display.

Computers are not as 'intelligent' as some television programmes would have us believe. In fact, they merely carry out (programmed) instructions in a certain (programmable) order. There are three sets of parallel interconnections (called buses - not the Midland Red type!) which carry the various data and control signals. First of all there is the data bus to consider. It is made up of a number of lines along which data travels from block to block. The processor must also be able to indicate the memory location where data is to be stored or removed. This is performed by the second bus, the address bus. Last, but by no means least, is the control bus

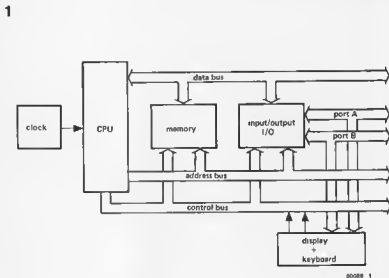

Figure 1. Block diagram of the Junior Computer.



Photo 1. The completed Junior Computer looks like this. The keyboard and display can be clearly seen, the microprocessor and other components being on the other side of the printed circuit board.

which ensures that the CPU is able to control the internal status, for instance the nature and direction of data transfer and the progress of successive program sections.

This then very briefly covers the various blocks, their functions and their interconnections. We can now move on to look at the circuit in greater detail.

### Circuit diagram

The circuit diagram of the entire Junior Computer (except for the power supply) is shown in figure 2. Now that the block diagram has been examined, each section should be easily recognisable. The 6502 microprocessor is IC1. Below it is the clock generator formed by N1, R1, D1, C1 and the 1 MHz crystal. The system uses a two-phase clock, shown in the circuit diagram as signals 01 and 02. The memory is constituted by IC2, IC4, IC5 and part of IC3. The monitor program is stored in IC2, a 1024 byte EPROM (Erasable Programmable Read-Only-Memory). This is the basic program in the computer (not to be confused with BASIC - a high level computer language). The RAMs (Random Access Memory) IC4 and IC5 serve as user memory and together have a capacity of 1024 bytes.

In the PIA, IC3, there are another 128 bytes of RAM. The PIA constitutes a data buffer which controls all the data transfer passing in either direction between the computer and ports A and B. The port lines are fed out to a 31 pole connector. IC3 also contains a programmable interval timer. The displays (Dp1... Dp6) and keys

2

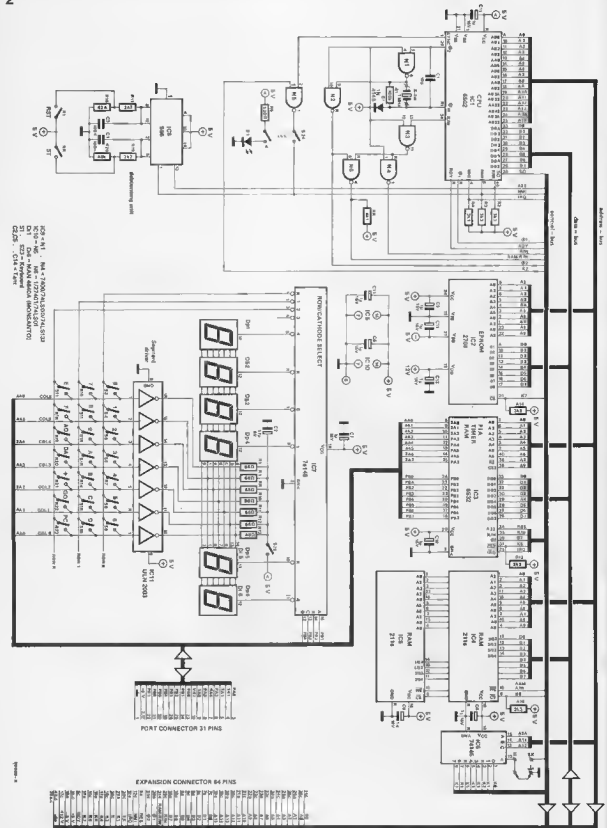

Figure 2. The circuit diagram of the Junior Computer.

(S1...S23) are at the bottom of the circuit diagram. Of these keys, sixteen are for the purpose of entering data and addresses in hexadecimal form and the remaining seven have various control functions. Data to the displays and from the keyboard is transferred across seven lines from port A. The information on the displays is controlled by the software in the monitor program, which also ensures that key function signals are recognized. IC7 multiplexes the displays and periodically checks the state of the rows of keys to see which one, if any, is being depressed. With the aid of switch S24 the display may be switched off. The display may be used in two different ways. Usually, the four left hand displays will indicate an address and the two right hand ones will indicate the data in the address location concerned. As a second possibility, the two left hand displays can show the (hexadecimal) code of an instruction while the others display the address of the data corresponding to this instruction. This makes program entry much easier.

The address decoder, IC6, provides chip select signals for each of the various memory blocks. These appear as K7, K6 and K0 for the EPROM, PIA and the RAMs respectively. The other five selection signals are available externally for memory expansion. The RAMs also require a R/W (read/write) signal. This is made available via gate N6 and is generated by a combination of the R/W signal in the 6502 and the  $\phi 2$  clock pulse ( $\phi 2 = \text{data bus enable}$ ). Another control signal is the reset signal RES, which places the microprocessor and the PIA in the correct initial condition for the monitor program. A reset is generated when key RST (S1) is pressed and half of a 556 timer (IC8) is used to suppress any contact bounce this key might produce.

There are two ways in which a program being run can be interrupted by means of the NMI (non-maskable interrupt). The first one is provided by the STOP key S2 (which uses the other half of IC8 for contact bounce suppression) and the second is provided by the STEP switch S24 when this is in the 'ON' position. When the output of N5 then changes from high to low, the IRO (interrupt request) connection causes the program being run to be interrupted, for instance by programming the interval timer in IC3. Also present on the control bus are the two clock signals  $\phi 1$  and  $\phi 2$  which control the PIA and the RAM R/W signals. These determine the direction of data transfer. Finally, lines RDY, SO and EX provide possibilities for future expansion.

All the address, data and control signals are fed to a 64 pole expansion connector which, as its name suggests, is meant for the purpose of expanding the system further at a later stage. Figure 3 shows the power supply for the Junior Computer. This produces three voltages: +5 V for all the ICs and the displays,

3

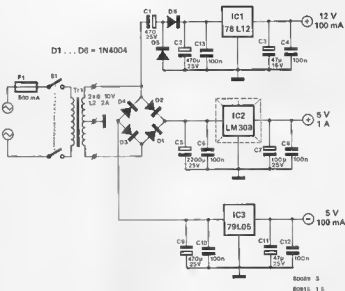

Figure 3. The power supply which produces the three voltage levels required by the Junior Computer.

and +12 V and -5 V for the EPROM (IC2). Capacitors C5...C14 insure the necessary decoupling.

### A few remarks

Before work is begun on the construction of the Junior Computer, two more aspects have yet to be considered. The entire system is built up on three printed circuit boards of which one is double sided with plated through holes. It is advisable to check all the through connections with an ohmmeter to make sure that both sides of the circuit are well connected. This will avoid problems later, for after soldering it is very difficult to trace any breaks. Normally, of course, the 2709 EPROM will not have been programmed when it is bought. The monitor program (or 'hex dump') is given, so that the reader who has a PROM programmer at his disposal may program the IC himself. Alternatively, pre-programmed 2708s can be purchased from the retailers listed at the end of this article.

### How to build the Junior Computer

Construction of the Junior Computer is not difficult by any standards. If it is assembled carefully (paying particular attention to solder connections) and the instructions are followed to the letter, very little can go wrong. The three sections of the JC are each constructed on a separate printed circuit board: the main board (including keyboard) the

display board and the power supply.

The smallest of the printed circuit boards is the display board (figure 6). This is connected to the main board by means of thirteen wire links. The seven-segment displays can be soldered directly onto the printed circuit board. The main board is double sided and is shown in figures 4 and 5. With the aid of the component overlay it is possible to see on which side to mount the various components. First resistors R1...R20 and diodes D1 are mounted, then capacitors C1...C13, followed by all the IC sockets. It is advisable to use IC sockets especially for IC1...IC3. Be sure to use a top quality type with gold contacts.

The other side of the board can now be assembled. Switches S1...S23 (Digitast) and LED D2 (remember the LEDs polarity) can now be mounted. Two holes remain free next to the keyboard for switches S24 and S25. These switches are connected to the main printed circuit board using short lengths of insulated wire. A single wire link is placed on the main board to connect the 'D' input of IC6 to the zero volt rail. The other connection indicated between D and EX is meant for future expansion. The 31 pole connector is mounted on the keyboard side, followed by the 64 pole connector which is positioned on the other side of the board.

The display printed circuit board can now be connected to the main board. The distance between the two boards

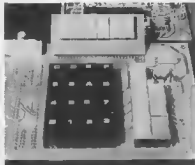

4a

should be about 5 mm. All that remains to complete the computer board is to solder the 1 MHz crystal in place, and finally, fit IC1 ... IC3 (the expensive ones) into their sockets. The main board is now complete.

The power supply has been left until last. The simple construction should not give anyone any headaches. All components are mounted according to figure 7, not forgetting the mica insulating plate (with a smear of heat-sink compound) under IC2. Connections between the power supply and the computer can be made using a four wire cable to the 64 pole connector as follows:

- +12 V to pin 17c
- +5 V to pins 1a, 1c
- 5 V to pin 18a
- 0 V to pins 4a, 4c

It would be wise to make absolutely sure that these connections are correct. An error here can be very costly. This completes the construction of the Junior Computer and now we approach the moment of truth.

### Switch on

Just before you do that, one more check-over would not be a waste of time. Are all the chips the right way round? Are there any cut offs of wire lying on the boards? A final thorough inspection could save you money. Now switch on ... and of course nothing happens, the display remains unlit. There is no reason for alarm yet, everything is exactly as it should be. Now press the RST key and random hexadecimal characters appear on the display. This is quite in order and as good a proof as any at this time that your JC is functioning correctly. It can now be fitted into the case of your choice.

### Something wrong, after all?

Unfortunately, (due to Murphy's Law no doubt) there is a possibility that pressing the RST key will depress the operator rather than cause anything to appear on the displays. This will of course occur with an unprogrammed 2708 (IC2). A survey of the most common errors and how to deal with them are given below. First verify that the supply voltages at the 64 pole connector are as follows:

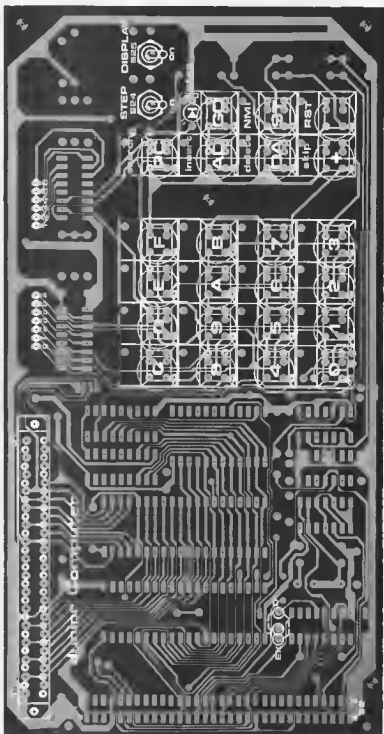
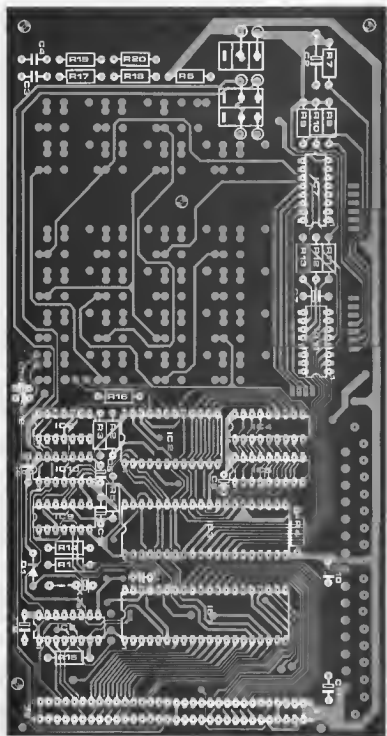

Figure 4. Component overlay of keyboard (a) and components (b) of the main printed circuit board (EPS 80089-1).

4b

**Parts list junior-computer****Resistors:**

R1 = 100 k  
 R2,R3,R4,R14,R15,R16 = 3k3  
 R5 = 4k7  
 R6 = 330  $\Omega$   
 R7 ... R13 = 68  $\Omega$   
 R17,R19 = 2k2  
 R18,R20 = 68 k

**Capacitors:**

C1 = 10 p ceramic  
 C2 = 47  $\mu$ /6 V tantalum  
 C3,C4 = 100 n MKH  
 C5 ... C14 = 1  $\mu$ /35 V tantalum

**Semiconductors:**

IC1 = 6502 (Rockwell)  
 IC2 = 2708  
 IC3 = 6532 (Rockwell)  
 IC4,IC5 = 2114  
 IC6,IC7 = 74145  
 IC8 = 556  
 IC9 = 74LS00, 7400, 74LS132  
 IC10 = 74LS01, 7401  
 IC11 = ULN2003 (Sprague)  
 D1 = 1N4148

**Miscellaneous:**

S1 ... S21,S23 = digitast  
 (Shadow)  
 S22 = digitast + LED  
 S24 = double pole switch  
 S25 = single pole switch  
 Dp1 ... Dp6 = MAN 4640A  
 common cathode (Monsanto)  
 connector 64-pole male  
 perpendicular solder to  
 DIN 41612  
 connector 31-pole female  
 perpendicular solder to  
 DIN 41617  
 1 MHz-crystal  
 1 24-pin IC sockets  
 2 40-pin IC sockets

**Parts list supply****Capacitors:**

C1,C2,C10 = 470  $\mu$ /25 V  
 C3,C11 = 47  $\mu$ /25 V  
 C4,C5,C8,C9,C12,  
 C13 = 100 n MKH  
 C6 = 2200  $\mu$ /25 V  
 C7 = 100  $\mu$ /25 V

**Semiconductors:**

IC1 = 78L12ACP (5%)  
 IC2 = LM309K  
 IC3 = 79L05ACP (5%)  
 D1 ... D6 = 1N4004

**Miscellaneous:**

Tr1 = transformer prim, 220 V  
 sec, 2 x 9 ... 10 V/1,2 ... 2 A  
 S1 = double pole switch  
 F1 = fuse 500 mA, with fuse  
 holder

Table 1

## General information on the Junior Computer

- single board computer
- programmable in machine language (hexadecimal)
- microprocessor type 6502
- 1 MHz crystal
- 1024 bytes of monitor in EPROM
- 1024 bytes of RAM
- PIA type 6532 with two I/O ports,
- 128 bytes of RAM and a programmable interval timer
- six digit seven segment display
- hexadecimal keyboard with 23 keys: 16 'alpha' keys and 7 double function control keys

## Control keys (normal mode)

- + : increment address on display by one
- DA : enter data
- AD : enter address
- PC : call up contents of current program counter position
- GO : start program from address on display
- ST : interrupt program by way of NMI
- RST : call up monitor
- STEP : step by step run through program

## Control keys (editor mode via ST)

- insert : insert program step before address shown on display
- input : insert program step after address shown on display
- skip : jump to next op-code
- search : search for a certain label
- delete : delete row of characters on display

## Possibilities

- debugging : all internal registers may be shown on display
- hex editor : label identification with hexadecimal figures JMP, JSR, branch instructions operate with label
- hex assembler : conversion of label numbers into displacement values for real address
- branch : calculate address offset for jump instructions

## Applications

- compatible with SC/MP bus
- can be used as a basis for many expansions
- can be used as a 6502 CPU card
- educational computer for beginners
- can be expanded with:
  - elekterminal
  - cassette interface
  - video interface
  - BASIC and PASCAL
  - matrix printer
  - assembler
  - disassembler
  - editor

5a

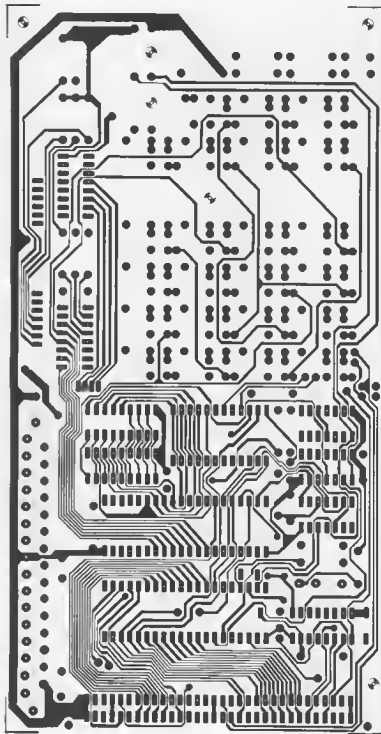
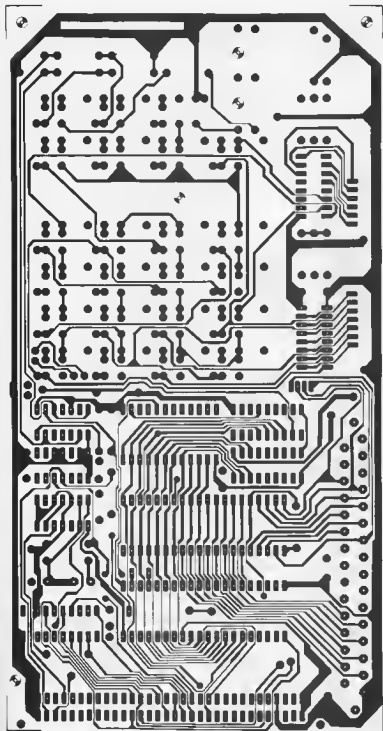

Figure 5. The track pattern for both sides (a and b) of the main board.



5b



6



Figure 6. The display printed circuit board (EPS 80089-2).

- between pins 1a and 4a:  $+5\text{ V} \pm 5\%$
- between pins 17c and 4a:  $+12\text{ V} \pm 5\%$
- between pins 18a and 4a:  $-5\text{ V} \pm 5\%$

If one of the voltages measured is not within the above tolerance, connections between the supply and computer should be removed and the supply checked separately.

If the supply voltages are in order, but the computer refuses to react to the RST key, further measurements will have to be carried out. The voltage between pin 13 and pin 17 of ICB should be less than 0.5 V when RST is

7

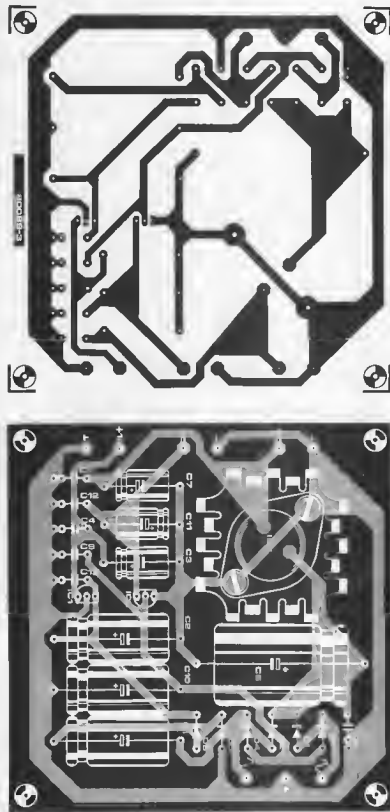

Figure 7. The printed circuit board and layout of the power supply (EPS 80089-3).

pressed. If this is not the case, the error will be in:

- the timer IC8
- the pull-up resistor R2
- the RST key S1.

With the supply switched off, the resistance between pin 12 of IC6 and 0 V (connector pin 4a) can be measured. If there is no 'short' between these two points the wire link will have been placed in the wrong position on the main board.

The last check to carry out involves the clock generator and for this an oscilloscope will be required. The CPU produces two clock signals which are fed to the expansion connector: Ø1 on pin 30a and Ø2 on pin 27a. With the aid of the 'scope it can be seen whether a 1 MHz square wave is present at both points (minimum RMS value 3 V). In the event of the oscillator not operating or showing a defect, this will probably be due to capacitor C1, diode D1 or IC9. Of course, other faults are possible, but the above checks should clear most problems.

For readers who have facilities for programming their own EPROM (IC2) the monitor dump is given here (figure 8). There are 64 rows of 16 bytes each, a total of 1024 bytes. The first column gives the hexadecimal address for the byte in col Ø.

Your Junior Computer is now rearing to go and it is possible to begin your programming lessons. Each section of the Junior Computer Book is clearly illustrated with examples that can be put into practice on your very own computer. As mentioned earlier, there are plans afoot for the publication of a number of programs and a PASCAL compiler for the JC. Look out for further details. ■

	0	1	2	3	4	5	6	7	8	9	A	B	C	D	E	F	
1C00:	85	F3	68	85	F1	68	85	EF	85	FA	68	85	F0	85	FB	84	
1C10:	F4	86	F5	BA	86	F2	A2	01	86	FF	4C	33	1C	A9	1E	8D	
1C20:	83	1A	A9	04	85	F1	A9	03	85	FF	85	F6	A2	FF	9A	86	
1C30:	F2	D8	78	20	88	1D	D0	F8	20	88	1D	F0	FB	20	88	1D	
1C40:	F0	F6	20	F9	1D	C9	13	D0	13	A6	F2	9A	A5	FB	48	A5	
1C50:	FA	48	A5	F1	48	A6	F5	A4	F4	A5	F3	40	C9	10	D0	06	
1C60:	A9	03	85	FF	D0	14	C9	11	D0	06	A9	00	85	FF	F0	0A	
1C70:	C9	12	D0	09	E6	FA	D0	02	E6	FB	4C	33	1C	C9	14	D0	
1C80:	0B	A5	EF	05	FA	A5	F0	85	FB	4C	7A	1C	C9	15	10	EA	
1C90:	85	E1	A4	FF	D0	0D	B1	FA	0A	0A	0A	0A	05	E1	91	FA	
1CA0:	4C	7A	1C	A2	04	06	FA	26	FB	CA	D0	F9	A5	FA	05	E1	
1CB0:	85	FA	4C	7A	1C	20	D3	1E	A4	E3	A6	E2	E8	D0	01	C8	
1CC0:	86	E8	84	E9	A9	77	A0	00	91	E6	20	4D	1D	C9	14	D0	
1CD0:	2A	20	6F	1D	10	F7	85	FB	20	6F	1D	10	F0	85	FA	20	
1CE0:	D3	1E	A0	00	B1	E6	C5	FB	D0	07	C8	B1	E6	C5	FA	F0	
1CF0:	D9	20	5C	1E	20	F8	1E	30	E9	10	3E	C9	10	D0	0A	20	
1D00:	20	1E	10	C9	20	47	1E	F0	C1	C9	13	D0	14	20	20	1E	
1D10:	10	BB	20	5C	1E	20	F8	1E	A5	FD	85	F6	20	47	1E	F0	
1D20:	A9	C9	12	D0	07	20	F8	1E	30	A0	10	D0	C9	11	D0	09	
1D30:	20	83	1E	20	EA	1E	4C	CA	1C	A9	EE	85	FB	85	FA	85	
1D40:	F9	A9	03	85	F6	20	8E	1D	D0	FB	4C	CA	1C	A2	02	A0	
1D50:	00	B1	E6	95	F9	C8	CA	10	F8	20	5C	1E	20	8E	1D	D0	
1D60:	FB	20	8E	1D	F0	FB	20	8E	1D	F0	F6	20	F9	1D	60	20	
1D70:	5C	1D	C9	10	10	11	0A	0A	0A	0A	85	FE	20	5C	1D	C9	
1D80:	10	10	04	05	FE	A2	FF	60	A0	00	B1	FA	85	F9	A9	7F	
1D90:	8D	81	1A	A2	08	A4	F6	A5	FB	20	CC	1D	B8	F0	0D	A5	
1DA0:	FA	20	CC	1D	88	F0	05	A5	F9	20	CC	1D	A9	00	8D	81	
1DB0:	1A	A0	03	A2	00	A9	FF	8E	82	1A	E8	E8	2D	80	1A	88	
1DC0:	D0	F5	A0	06	8C	82	1A	09	80	49	FF	60	48	84	FC	4A	
1DD0:	4A	4A	4A	20	DF	1D	68	29	0F	20	DF	1D	A4	FC	60	A8	
1DE0:	B9	0F	1F	8D	80	1A	8E	82	1A	A0	7F	88	10	FD	8C	80	
1DF0:	1A	A0	06	8C	82	1A	E8	E8	60	A2	21	A0	01	20	85	1D	
1E00:	D0	07	E0	27	D0	F5	A9	15	60	A0	FF	0A	B0	03	C8	10	
1E10:	FA	8A	29	F7	4A	AA	98	10	03	18	69	07	CA	D0	FA	60	
1E20:	20	6F	1D	10	21	85	FB	20	60	1E	84	F7	84	FD	C6	F7	
1E30:	F0	12	20	6F	1D	10	0F	85	FA	C6	F7	F0	07	28	6F	1D	
1E40:	10	04	85	F9	A2	FF	60	20	A6	1E	20	DC	1E	A2	02	A0	
1E50:	00	05	F9	91	E6	CA	C8	4	F6	D0	F6	60	A0	00	B1	E6	
1E60:	A0	01	C9	00	F0	1A	C9	40	F0	16	C9	60	F0	10	A0	03	
1E70:	C9	20	F0	0C	29	1F	C9	19	F0	06	29	0F	AA	BC	1F	1F	
1E80:	84	F6	60	A5	E6	85	EA	A5	E7	85	EB	A4	F6	B1	EA	A0	
1E90:	00	91	EA	E6	EA	D0	02	E6	EB	A5	EA	C5	E8	D0	EC	A5	
1EA0:	EB	C5	E9	D0	E6	60	A5	E8	85	EA	A5	E9	85	EB	A0	00	
1EB0:	B1	EA	A4	F6	91	EA	A5	EA	C5	E6	D0	06	A5	EB	C5	E7	
1EC0:	F0	10	38	A5	EA	E9	01	85	EA	A5	EB	E9	00	85	EB	4C	
1ED0:	AE	1E	60	A5	E2	85	E6	A5	E3	85	E7	68	18	A5	E8	65	
1EE0:	F6	85	E8	A5	E9	69	00	85	E9	60	38	A5	E8	E5	F6	85	
1EF0:	E8	A5	E9	E9	00	85	E9	60	18	A5	E6	65	F6	85	E6	A5	
1F00:	E7	69	00	85	E7	38	A5	E6	E5	E8	A5	E7	E5	E9	60	40	
1F10:	79	24	30	19	12	02	78	00	10	08	03	46	21	06	0E	02	
1F20:	02	02	01	02	02	02	01	01	02	01	01	01	03	03	03	03	6C
1F30:	7A	1A	6C	7E	1A	B1	E6	A0	FF	C4	EE	F0	D0	D1	EC	D0	
1F40:	0A	88	B1	EC	AA	88	B1	EC	A0	01	60	88	88	88	D0	E9	
1F50:	60	38	A5	E4	E9	FF	85	EC	A5	E5	E9	00	85	ED	A9	FF	
1F60:	85	EE	20	D3	1E	20	5C	1E	A0	00	B1	E6	C9	FF	D0	1D	
1F70:	C8	B1	E6	A4	EE	91	EC	88	A5	E7	91	EC	88	A5	E6	91	
1F80:	EC	88	84	EE	20	83	1E	20	EA	1E	4C	65	1F	20	F8	1E	
1F90:	30	D3	20	D3	1E	20	5C	1E	A0	00	B1	E6	C9	4C	F0	16	
1FA0:	C9	20	F0	12	29	1F	C9	10	F0	1A	20	F8	1E	30	E6	A9	
1FB0:	03	85	F6	4C	33	1C	C8	20	35	1F	F0	EE	91	E6	8A	C8	
1FC0:	91	E6	D0	E6	C8	20	35	1F	F0	E0	38	E5	E6	38	E9	02	
1FD0:	91	E6	4C	AA	1F	D8	A9	80	85	FB	85	FA	85	F9	20	6F	
1FE0:	1D	10	F2	85	FB	20	6F	1D	10	EB	85	FA	18	A5	FA	E5	
1FF0:	FB	85	F9	C6	F9	4C	DE	1F	FF	FF	2F	1F	1D	1C	32	1F	

Figure 8. The JC's hexadecimal monitor dump.

# coming soon

## Pest Pester

Perpetually plagued by mosquitos? This summer, protect your person with the 'Pest Pester'.



## Disco Lights

Brighten up your parties to the beat of the disco greats. Not Travolta, but the next best thing - Disco Lights.



## 8K RAM + 8K EPROM

SC/MP and Junior Computer owners who are short on memory may extend their systems with an 8K RAM + 8K EPROM board.



## Summer Circuits 80

As usual the July/August issue will have more than 100 circuits to keep you busy over the summer.



Even though the superhetrodyne receiver is an invention dating from the earliest days of radio, the principle behind it nevertheless remains valid. Almost every radio operates on an oscillator which is mixed with the aerial signal to produce an IF signal. Early tuners had terrible drifting problems. In modern units however, the oscillator gets a little electronic help. This is necessary because it is by no means easy to continue oscillating for long periods without the penalty of some drift.

This help may come in the form of a circuit which subjects the differential output of the mixer to an electronic check. It must continually ask itself: is the IF frequency right? If a deviation

frequency dividers are engaged in the operation.

One important drawback of the frequency synthesiser is the oscillator's inability to generate any given frequency (within its range); it can only produce those which are equal to a fixed frequency, multiplied by a whole number. Thus, a frequency synthesiser cannot be tuned continuously — its output jumps step by step. That is the price that has to be paid for stability! A price we can well afford, as long as we make sure the steps are small. Furthermore, the signals to be received are not just anywhere on the frequency band: for broadcast transmitters, the band is also divided into fixed steps.

The constant comparison made between

one up on PLL

# frequency lock system

One of the basic requirements of any radio receiver is a stable front-end (or tuning heart), with the ability to tune a station in, and hold it without drifting. Automatic Frequency Control (AFC) was one of the first methods found to solve this problem, but it ran into trouble when trying to tune in a weak station, adjacent to a strong one. Then PLL came along. The PLL (Phase Locked Loop), while solving the AFC pitfall, was tricky to design and complicated. There is now a system that promises to be the future standard of tuners.

seems imminent, the oscillator is instructed (by means of a control voltage) to alter its frequency so that a correct IF is regained. This is basically how AFC works. With the aid of AFC, a highly stable oscillator frequency may be achieved; that is to say, provided that the receiver has an input signal.

However, it is equally possible to regulate the phase rather than the frequency of the oscillator signal. This is what a PLL system does. The oscillator is tuned for a certain transmission frequency. A control loop ensures that the oscillator signal remains in a strict phase ratio to the HF signal. The control signal for the oscillator, which is obtained from the phase ratio of the oscillator and HF signal, therefore varies according to the modulation. In other words, the control signal also produces the desired LF signal.

Just like other types of feedback (that's what it is!) a phase locked loop often suffers from instability. Feedback amplifiers may oscillate under unfavourable circumstances; similarly, a PLL control loop may suffer from PLL 'jitter'. This occurs when the oscillator frequency fluctuates so rapidly that, although its average remains the exact value of the HF signal, the result produced is unfit for use. This is the reason why a PLL system may turn out to be quite disappointing in practice. Things are different, fortunately, when a frequency synthesiser is used.

## A crystal (clear) comparison

A frequency synthesiser is quite a complex circuit which continually compares the oscillator signal with that of a highly stable crystal oscillator. The synthesiser checks whether the oscillator frequency remains as constant as the crystal frequency. For this purpose, all sorts of

the oscillator frequency and a stable crystal frequency also takes place in the frequency lock system described in this article. The block diagram in figure 1 demonstrates the basic principle.

The input signal of the frequency lock is generated by the oscillator in the receiver's tuning section (HF):  $f_{osc}$ .

The frequency lock system provides the oscillator with an output signal in the form of a control voltage  $U_c$ . The circuit controls  $U_c$  in such a way that  $f_{osc}$  is exactly equal to one of a series of 'scanning frequencies': frequencies which are separated by a fixed distance.

## How it works

The heart of the frequency lock circuit is the D flipflop FF. This operates as a harmonic mixer with two inputs: the D input and the clock input of the flipflop. The input signals are symmetrical square waves, at frequencies  $f_{osc}$  and  $f_{cl}$  respectively. A symmetrical square wave also appears at the Q output of the flipflop with a frequency  $f_q$ . The latter frequency is, of course, dependent on the two input frequencies, according to the following formulae:

$$f_q = |f_{osc} - c \cdot f_{cl}| \text{ and } f_q \leq \frac{1}{2} f_{cl}$$

The two vertical lines refer to the absolute value. In other words, the number not preceded by a plus or a minus sign (otherwise  $f_q$  would turn into a negative frequency, which would be ludicrous).

The figure  $c$  in the formula is a positive whole number. Let us suppose  $f_{osc}$  equals 2005 kHz and  $f_{cl}$  equals 20 kHz. From the condition  $f_q \leq \frac{1}{2} f_{cl}$  it then follows that  $c$  must be equal to 100 and  $f_q$  will be 5 kHz. If  $f_{osc}$  is equal to 2010 kHz,  $c$  has two possible values, namely  $c = 100$  and  $c = 101$  ( $f_q$  will then be 10 kHz). Therefore, a raster of  $\frac{1}{2} f_{cl}$  (the clock frequency) is created.

Variable  $c$  is also called the harmonic number.

If the input signals of the harmonic mixer,  $f_{osc}$  and  $f_{cl}$ , are kept constant, the formula gives the value of the output frequency  $f_q$ . However, there is another way of getting the same result: by keeping the output frequency together with one of the input frequencies at a constant level. Let us suppose that  $f_q$  is equal to 250 Hz and  $f_{cl}$  is equal to 1000 Hz. Which values may  $f_{osc}$  assume without invalidating the formula? Let us start by substituting a 1 for  $c$ . Then:

$$250 = |f_{osc} - 1 \cdot 1000|$$

That is correct where  $f_{osc} = 1250$  Hz and (remember we're talking about an absolute value) where  $f_{osc} = 750$  Hz. Now let us replace  $c$  with a 2. The formula then reads:

$$250 = |f_{osc} - 2 \cdot 1000|$$

and that is correct where  $f_{osc} = 2250$  Hz and  $f_{osc} = 1750$  Hz. Any whole number ('integer') may replace  $c$ , with the result that  $f_{osc}$  may assume the following values: 750 Hz, 1250 Hz, 1750 Hz, 2250 Hz, 2750 Hz, 3250 Hz . . . etc. Exactly the series of raster frequencies required!

The question is now: how can we maintain a constant single input ( $f_{cl}$ ) and output frequency ( $f_q$ )? The input frequency should not give any problems, for it may be derived from a stable crystal oscillator. In the block diagram  $f_{cl}$  is shown to originate by dividing the

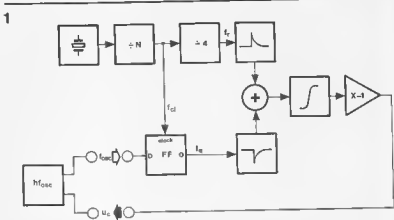

80038 1

Figure 1. A block diagram of the frequency regulator. An important part is played by the D flipflop FF, which operates here as a harmonic mixer. The frequency regulator continually compares the oscillator frequency with a highly stable crystal frequency.

frequency of a crystal oscillator by  $n$ . Keeping the output frequency  $f_q$  level is no easy task, for it is impossible to influence it directly. The only other frequency which can be directly affected is  $f_{osc}$ . That is why an automatic control system is used.  $f_{osc}$  is controlled in such a way that  $f_q$  remains constant. For this purpose  $f_q$  is continuously compared to a stable reference frequency  $f_r$ . Both signals are fed to simple pulse generators, one of which produces a positive pulse at every period, the other a negative pulse. The output signals of the two pulse generators are

added together and summed by an op-amp IC. The output signal of the mixer/buffer produces the control voltage  $U_c$  which regulates the frequency  $f_{osc}$ . If  $f_q$  is equal to  $f_r$ , the average output voltage of the counter (IC2) will be nil and so will the control voltage  $U_c$ . At the input of the mixer there will be as many positive as negative pulses. If  $f_q$  is too high for one reason or another, more negative than positive pulses will reach the input of the mixer. After some time the output of the mixer will also become negative. This will cause  $U_c$

2

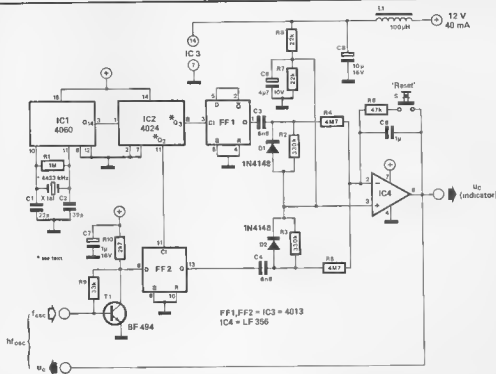

80038 2

Figure 2. In the elaborated layout the structure of the block diagram is still noticeable.

3

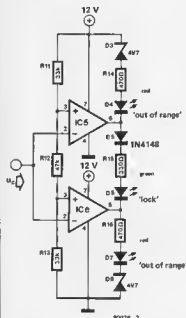

IC5, IC6 = 741

Figure 3. This window comparator makes the control voltage visible. When the green 'lock' LED lights, the control circuit is activated.

to rise and, therefore,  $f_{osc}$  to drop until  $f_0$  is again equal to  $f_r$ . Quite a complicated business, but the result is worth it; with crystalline precision  $f_{osc}$  can be made to equal one of the frequencies in the raster frequency series.

### In practice

Now that the block diagram has been dealt with in detail, few words need be said on the practical layout given in figure 2. In any case, the block diagram can easily be recognized in it. One highly advantageous aspect comes to light immediately: in spite of the circuit's complicated operation, it is very reasonable in price. Such a remarkable piece of electronic ingenuity requires only a few IC's and one or two components. It is much simpler than the PLL system.

IC1 contains a crystal oscillator and a fourteen bit binary counter. For the crystal, a 4.43 MHz type has been chosen, like the one used in colour TVs. It is inexpensive and easily obtainable. It can be replaced by a crystal of a different frequency without any difficulty, provided that it is between 1 and 6 MHz. Only the difference in individual distance between raster frequencies will show that a crystal of another frequency is being used.

The signal at pin 3 of IC1 has a frequency of approximately 270 Hz. This is the input signal of a second counter, IC2. There the frequency is

4

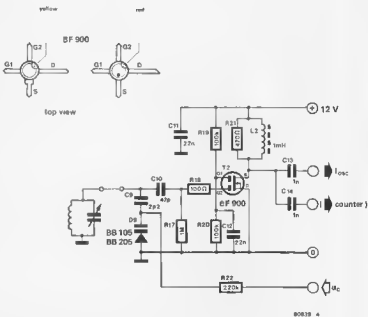

Figure 4. This circuit may be added to existing HF oscillators. Diode D9 is in series with C9, which is in parallel with the tuning capacitor.

divided once more by four [output Q2 on pin 11], so that a signal of some 70 Hz is generated. This is indicated as signal  $f_{c1}$  in the block diagram. Thus, the raster frequencies come to be separated by approximately 70 Hz. A signal is also derived from the Q3 output of IC2. Its frequency is divided by two by means of FF1 so that a frequency regulation of approximately 17 Hz is achieved.

FF2 is the harmonic mixer. The two pulse generators are each simply constructed from a diode and a resistor (D1/R2 and D2/R3 respectively). To avoid having to use a split supply they both operate at one half of the supply voltage. Op-amp IC4 is wired as a mixer and operates as the one given in the diagram together with the inverting buffer amplifier. Its output voltage is the control voltage  $U_c$ . The 'reset' push button S has been provided to interrupt the entire control process. This is important when tuning to another frequency.

It is absolutely essential for IC4 to be the type indicated, because it has a high impedance FET input.

### Indicator

The control voltage  $U_c$  is not only used to regulate the frequency of the oscillator in the HF section, it is also desirable to make its value apparent in one way or another. The ring circuit of the frequency regulator is only operative when  $U_c$  does not deviate too much

from its zero level and only then is the receiver optimally tuned. For this reason  $U_c$  is made visible with the aid of the indicator circuit of figure 3. This is called a window comparator. When  $U_c$  is 'in range', the green 'lock' LED (D6) lights. The receiver is then tuned, if one of the two red 'out of range' LEDs lights, it is advisable to alter the receiver's tuning to prevent the frequency regulator from becoming inactive (when D4 lights it moves to a lower frequency, when D7 lights, it moves to a higher one).

### Connecting it to the HF oscillator

There are many different receivers and as many different high frequency oscillators. There are, therefore, various ways to connect the frequency regulator.

The classic model operates with the aid of a resonance circuit consisting of a coil and a variable capacitor in parallel. The oscillator signal is across the resonance circuit. The oscillator frequency may be regulated by the control voltage if a varicap diode is wired parallel to the tuning capacitor (see figure 4).

The oscillator signal across the resonance circuit is derived by means of an amplifier stage with a dual gate MOSFET. Due to the high input impedance of the MOSFET, the resonance circuit is lightly loaded. The amplifier stage has two outputs: one for the  $f_{osc}$  signal sent to the frequency regulator and one with the same signal to feed the input of

a frequency counter, which may be included. The latter output is of no importance to the frequency regulator, but is included, as an option.

D9 is the varicap diode. It is connected to the tuning capacitor in series with C9. Otherwise, the slightest variation in  $U_C$  would lead to an enormous change in the oscillator frequency and result in instability.

If the tuning loops of the receiver are already provided with varicaps, another one will, of course, not be necessary. The control voltage  $U_C$  may then be added to the tuning voltage at the varicap of the oscillator circuit. D9, C9 and R22 (figure 4) can then be omitted. If, as more often than not is the case, the receiver is provided with a 'counter' output (at which the oscillator frequency is available), figure 4 may be left out altogether. The input of the frequency regulator is then connected to the 'counter' output.

Figure 4's circuit must be attached as closely as possible to the oscillator. It is, as it were, part of the oscillator. The input of the amplifier stage is highly sensitive and prone to interference.

### Experimenting

A circuit like the frequency lock is ideal for hobbyists who enjoy experimenting. The layout offering the best results differs from case to case. It depends on the drift features of the receiver oscillator and in some cases it may be worthwhile to change the original layout a little.

For instance, the clock frequencies of FF1 and FF2 may be chosen at a higher or lower level by deriving them from IC2 outputs other than Q2 and Q3 now used. A prerequisite is, however, that the two IC2 outputs used be next to each other (the clock frequency of FF1, therefore, is half that of FF2). Choosing a higher or lower level clock frequency will affect the distance between the raster frequencies (they will be either closer to or further away from each other) and also the speed at which the frequency regulator operates.

If the clock frequencies of the flipflops change, capacitors C3, C4 and C5 will also have to change. At twice the frequencies they will be half their value. In stead of enlarging C5 (for which an electrolytic capacitor may not be used), R4 and R5 may have a higher value.

The frequency regulator may also use an external reference frequency. This could, for instance, be derived from the time base of a counter. Such a frequency (for instance 1 MHz) may be fed by means of a capacitor of 39 pF to pin 11 of IC1. In that case, R1, C1, C2 and the crystal are no longer required. If a low frequency reference AC is available (of say, 100 or 250 Hz), IC1 may even be omitted entirely. The reference frequency can then be directly connected to pin 1 of IC2. Any external reference frequency must, of course, be (crystal) stabilised.

# greater simple sound effects

H. Thienel

In the simple sound effects generator published in Elektor May 1979, only eight of the twelve outputs of IC2 are used. This modification, using the last four outputs, adds a further dimension. Only five resistors and one transistor are required as the circuit diagram shows.

Transistor T2 has a similar function to

T1 in the original circuit. The base drive for T2 is provided by outputs Q9...Q12 of IC2 via resistors R10...R13. This addition to the circuit causes the fundamental frequency to fluctuate continuously. The result is an even better(?) noise. Try it and see.

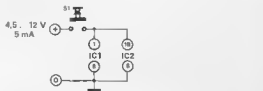
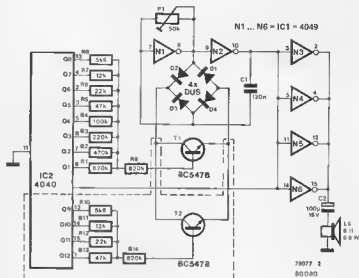

The subject of digital audio has been dealt with in Elektor before and certainly will be again. The benefits are impressive, so much so that virtually all major manufacturers of audio equipment are investigating its possibilities. Recording companies too are aware of the potential of a digital system (digitally recorded records are already available commercially).

Until quite recently, the performance of PWM amplifiers was disappointing due to the poor quality semiconductors used. With the introduction of modern high speed switching transistors, PWM is now coming of age.

fed to an op-amp IC1. This is used as a comparator and is followed by a number of schmitt triggers in parallel. This has two purposes. Firstly the waveform needs to be 'square' and secondly sufficient base drive current is needed for the output stage which uses two ordinary but fairly fast transistors (BD 137/138).

The entire amplifier oscillates and produces a square wave. This is because one of the inputs of the comparator (IC1) is connected to the output by means of an RC network. Both inputs of IC1 are biased to one half of the supply voltage using voltage divider R3/R4. Whenever

# PWM amplifier

In spite of some initial teething troubles, Pulse Width Modulation (PWM) is considered by many to be the next step in audio circuit design. The PWM amplifier described in the Elektor September 1979 issue has been used as a model for the following article. Although it has only a modest 3 watt output, it is a practical and efficient amplifier.

E. Postma

## The PWM amplifier

In Elektor's December 1978 and September 1979 issues, a fair amount was said about PWM amplifiers. However, it might be a good idea to recap the principles briefly. A PWM amplifier contains a symmetrical square wave generator. The duty cycle of this square wave is then modulated by the audio signal. The output transistors do not operate linearly but function as switches, that is, they are either full on or off. Under quiescent conditions the duty cycle of the output waveform is 50% which means that each of the output transistors is fully saturated (conducting) for an equal amount of time. The average output voltage is therefore zero. It therefore follows that if one of the output switches is closed for a longer period than the other, the average output voltage will then be either negative or positive depending on the polarity of the input signal.

It can be seen then that it is the average output voltage that is proportional to the input signal. Since the output transistors function exclusively as switches, very little power loss occurs in the output stage.

The September 1979 issue discussed a variation of the above principle. This was a self oscillating PWM amplifier in which the square wave generator, the pulse width modulator and the output stage formed a single unit. This produced an efficient amplifier with only a very small number of components. A modified version of that circuit with a printed circuit board is described here.

## The circuit diagram

The circuit of the complete amplifier is shown in figure 1. It can be seen that a PWM amplifier need not be very complicated at all. The input signal is

the output of IC1 is low and the emitters of T1/T2 are high, capacitor C3 is charged by way of R7 and the voltage rises at the non-inverting input. If it rises above the level of the inverting input, IC1's output changes low to high and the emitters of T1/T2 change from high to low. As a result, C3 is now discharged through R7, the voltage at the plus input drops below that of the minus input and the output of IC1 switches back to a low state. The result is a squarewave output; the frequency of which is determined by R7 and C3. The values given result in an oscillation at 700 kHz.

Provided Murphy doesn't get in the way, we should have an oscillator. Now we have to pulse width modulate it. The level at the inverting input of IC1, which is used as a reference, does not remain constant but is determined by the audio signal. The point at which the output of the comparator changes, is also determined by the amplitude. As a result the width of the square waves is constantly changed (modulated) by the audio signal.

At the output of the amplifier, filtering is required: it is not supposed to act as a 700 kHz transmitter! An LC/RC network is used, consisting of L1/C6 and C7/R6.

With a load of 8 ohms and a supply voltage of 12 volts, the amplifier produced 1.6 watts. At 4 ohms, 3 watts were measured. Cooling the output transistors was not necessary. The harmonic distortion proved to be surprisingly low for such a simple design. Less than 0.32% total harmonic distortion from 20 Hz-20 kHz was measured.

Figure 2 shows the printed circuit board and parts layout for the amplifier. Its construction requires little time and money, so it offers an excellent opportunity for anyone wanting to become better acquainted with PWM.





1

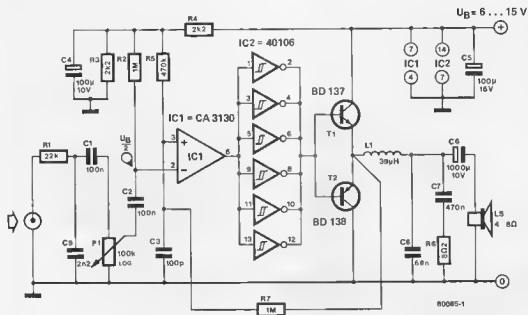

Figure 1. The self-oscillating PWM amplifier. With a 12 V supply, it will deliver 3 watts into 4 ohms.

2

## Parts List

## Resistors:

- R1 = 22 k
- R2, R7 = 1 M
- R3, R4 = 2k2
- R5 = 470 k
- R6 = 8Ω2
- P1 = 100 log. potentiometer

## Capacitors:

- C1, C2 = 100 n
- C3 = 100 p
- C4 = 100 µ/10 V
- C5 = 100 µ/16 V
- C6 = 68 n
- C7 = 470 n
- C8 = 1000 µ/10 V
- C9 = 2n2

## Semiconductors

- IC1 = CA3130
- IC2 = 40106
- T1 = BD137
- T2 = BD138

## Miscellaneous:

- L1 = 39 µH

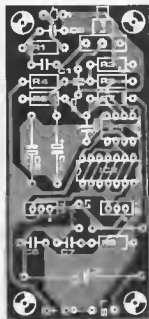
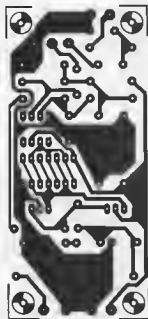
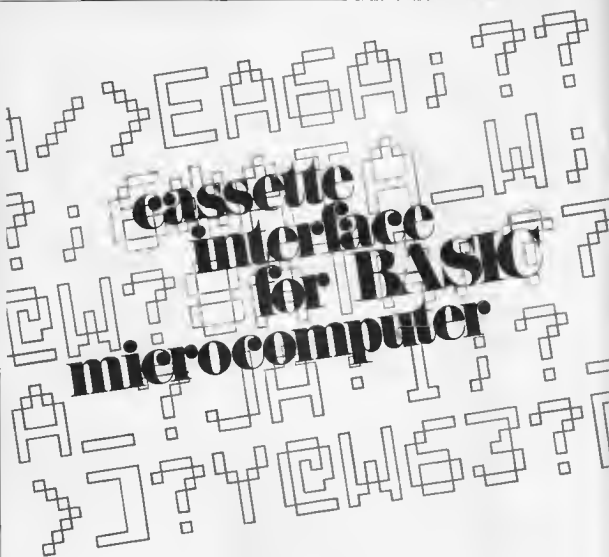

Figure 2. The printed circuit and parts layout of the PWM amplifier.



# cassette interface for BASIC microcomputer

## interface and software on one Eurocard

No cassette interface is included in the BASIC microcomputer described in Elektor, May 1979; furthermore, NIBL doesn't include suitable cassette routines. The obvious solution is to combine these two missing links on a single p.c. board: a handful of ICs for the interface hardware, and ½ K worth of software in EPROM.

With these extensions, programs for the BASIC microcomputer can be stored on and retrieved from tape.

The combination of cassette interface plus the necessary software on a single p.c. board offers several interesting possibilities.

- Users of a (normal) SC/MP system can use this p.c. board to keep certain special programs close at hand.
- Users of the BASIC microcomputer can use this board (without the components for the interface) for permanent storing of BASIC programs — control routines, say.
- Even without the NIBL ROM, the BASIC computer board makes a good CPU card, with complete in- and output buffering. The EPROM section can therefore be used to store a 2 K-byte monitor routine (we are working on this!), located on page 8. The BASIC card already contains a TTY interface, so that a TTY or VDU (the Elektor-

minimal, for instance) can be used for developing programs in machine language.

- With this card added to the existing SC/MP system, it becomes relatively easy to use other CPU cards instead of the original SC/MP card. In this way, the system can be converted to any other microprocessor — the Z80, for instance.

- The main purpose for developing this new p.c. board was to add a cassette interface to the BASIC microcomputer. However, there is also room for a hexadecimal monitor program. This means that programs in both BASIC and machine language can be developed on the same computer. After all, NIBL allows for running machine-language routines as part of a program in BASIC (by means of the LINK command).

## The interface

The hardware for the interface consists of an FSK modulator (FSK = Frequency Shift Keying) and an FSK demodulator, as shown in figure 1. When a logic '1' is applied to the input of the FSK modulator, a 2400 Hz sinewave appears at the output. A logic 0 at the input is coded as a 1200 Hz signal. These 2400 Hz and 1200 Hz tones are recorded on tape.

When the tape is played back, the demodulator must obviously convert the 2400 Hz and 1200 Hz signals back to logic 1s and 0s. This digital signal is applied to the serial input ( $S_{in}$ ) of the BASIC microcomputer, the software takes care of the conversion from serial to parallel mode and stores the data in the correct memory locations.

1

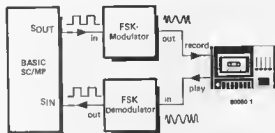

Figure 1. The basic principle of the cassette interface described.

2a

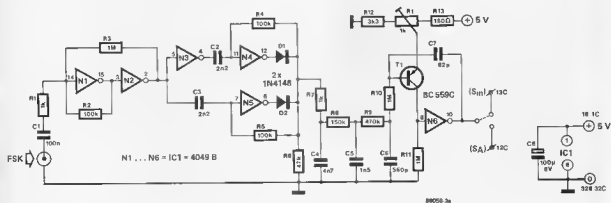

Figure 2a. Complete circuit of the FSK (frequency shift keying) demodulator.

2b

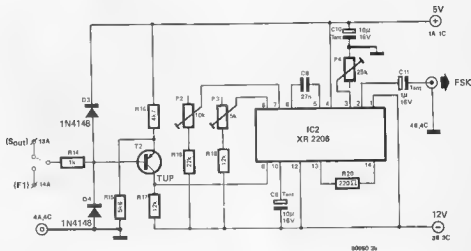

Figure 2b. The FSK modulator.

Table 1

```

> 'LIST
10 PR"WHAT IS THE FIRST ADDRESS";
20 INPUT A: REM INPUT.
30 PR"WHAT IS THE LAST ADDRESS";
40 INPUT B: REM INPUT.
50 DO
60 PR A,"=";
70 INPUT C: REM INPUT: # XX
80 @=A-C
90 A=A+1
100 UNTIL A=B+1
110 PR"LAST ADDRESS REACHED"
>

```

Table 1. This BASIC program can be used for loading the machine-language programs by means of a TTY or VDU — such as the Elektornal.

```

4 MHz - SC/MP
1200 Hz : AA#5A, BB#07
2400 Hz : AA#52, BB#4F
2 MHz - SC/MP
1200 Hz : AA#52, BB#4F
2400 Hz : AA#10, BB#1B

S 0
BC#F C481 L21 01
BF#02 07 CAS
BC#D3 00 KOP
BC#84 C48A L21 AA
BC#85 8F98 DELX 00
BC#00 C488 L21 00
BC#8A 07 CAS
BC#00 C48B L21 00
BC#D0 8F98 DELX 00
BC#0F 98F2 ZHP S 0

```

Table 2. This program can be used for adjusting the modulator.

```

4 MHz - SC/MP

S 0
BC#00 C482 L21 02
BC#02 C833 ST 23 #BC36
S 1
BC#04 C481 L21 01
BC#86 07 CAS
BC#87 00 KOP
BC#00 C48A L21 0A
BC#8A 8F98 DELX 00
BC#8C C488 L21 00
BC#8E 07 CAS
BC#8F C48C L21 00
BC#11 8F98 DELX 00
BC#13 0622 DELX 23 #BC36
BC#15 9804 JZ S 2
BC#17 F800 ADD 00 #BC18
BC#18 9850 ZHP S 1

S 2
BC#10 C484 L21 04
BC#1D C859 ST 18 #BC37
S 3
BC#1P C481 L21 01
BC#21 07 CAS
BC#22 00 KOP
BC#23 C452 L21 52
BC#25 8F98 DELX 00
BC#27 C488 L21 00
BC#29 07 CAS
BC#2B C436 L21 36
BC#2C 8F98 DELX 00
BC#2E 0400 DELX 00 #BC37
BC#30 980C JZ S 0
BC#32 F800 ADD 00 #BC33
BC#34 9850 ZHP S 3
BC#36 55 077E
BC#37 55 077E

2 MHz - SC/MP
BC#1-04

```

Table 3. A program that will prove useful when calibrating the demodulator.

### FSK modulator

The FSK modulator is virtually a textbook recipe: 'Take one IC...'. In this case, a function generator — the XR2206 (see figure 2b). Two supply voltages are required (+5 V and -12 V), both of which are available on the existing supply board. Since the input signal is at TTL logic level, transistor T2 is included as a level converter.

The output level is set by means of P4, it should be adjusted to suit the input sensitivity of the recorder used. P2 and P3 set the two output frequencies (1200 Hz and 2400 Hz, respectively). The easy way to do this is to use a frequency counter. However, it is also possible to use the computer itself as a calibration aid, as described in the next section.

### Calibrating the modulator

Since all timing in the existing SC/MP system is derived from a crystal oscillator, it is possible to obtain extremely accurate reference frequencies by means of a fairly simple program. Table 1 lists a program in BASIC that can be used in order to load the program given in Table 2 by means of a TTY or a VDU. This second program is used to generate the actual reference frequencies. Once this program has been loaded, it can be started by means of a LINK command. At Flag 0 (pin 14c on the connector) a squarewave will now appear, with a frequency of either 1200 Hz or 2400 Hz. The actual frequency depends on the numbers stored at locations 'AA' and 'BB' (see Table 2). Above this table, the numbers for both locations are given, both for the BASIC microcomputer (4 MHz clock frequency) and for the Elektor SC/MP system (2 MHz clock).

The complete procedure is as follows. When using the BASIC microcomputer, the first step is to load Table 1. As soon

as it is started ('RUN'), the computer will ask for the first address; this must be entered in hexadecimal: #0C00, for instance. Then the last address is entered in the same way. The computer will now proceed to request data for the addresses — note, however, that it will specify each address as a decimal number: 0C00 = 3072. The display will therefore initially read '3072 = ?'; the opcode for the first address can now be entered (#C4). Once the complete program has been entered in this way, it can be started: 'LINK #0C00'. The desired reference frequency will now appear at Flag 0.

The reference signal and that from the FSK modulator are both applied to the simple test circuit given in figure 3. The output can be connected to a high-impedance headphone, or to a tape recorder with some kind of level indicator. The correct numbers are loaded into the program for a 1200 Hz reference tone, and a logic 0 is applied to the input of the modulator. P4 in the modulator is set to maximum. If headphones are used, three frequencies will now be heard: the 1200 Hz reference, the output from the modulator, and the difference (beat) frequency. P2 is now adjusted until the beat frequency becomes zero. When using the level indicator on a tape recorder, P2 and the potentiometer in figure 3 are both manipulated in turn, in such a way that the signal level becomes as low as possible — the reference frequency and the modulator output will then be almost identical.

The program can now be modified to produce the 2400 Hz reference frequency, and a logic '1' is applied to the input of the modulator. Using the same procedure as that described above, P4 can now be adjusted until the two output frequencies are (virtually) identical.

### FSK demodulator

The circuit of the FSK demodulator is given in figure 2a. The input signal is first passed to a trigger circuit (inverters N1 and N2). This converts the sinewave output from the tape into a symmetrical squarewave. Two differentiating networks (N4 and N5) produce short spikes at both the positive- and negative-going edges of the squarewave, since N3 is included as an inverter in the feed to N4. These spikes are passed to a low-pass filter R7...R9 and C4...C6; the voltage across C6 is therefore proportional to the frequency of the input signal. A comparator circuit, consisting of T1 and N6, converts this 'smoothed' voltage to the corresponding TTL logic levels: 0 or 1 for 1200 Hz or 2400 Hz, respectively.

The only adjustment point in the demodulator is P1 in the comparator circuit. For this calibration, a tone generator could be used. Alternatively, a simple program will allow the computer itself to do the work.



## CASSETTE ROUTINES OPERATING PROCEDURE

OPTIONAL SPEED SELECT:  
START ADDRESS: 1000  
SPEED ADDRESS: 41FF5

AUTOSTART 500 BAUD:  
START ADDRESS: 40000

## LOAD ROUTINE:

||LN000000

SELECT: L=LOAD/D=UNP L (D=INPUT)  
|>|0|E PROMPTS AFTER LOADING PROGRAM|

||LN000000

SELECT: L=LOAD/D=UNP L ERROR (D=INPUT)  
|>|0|E PROMPTS AFTER ERROR DETECTED|

## ADDRESSING SPEED:

>001FF5+450 (FOR 10000)

||LN000005

SELECT: L=LOAD/D=UNP L

## DUMP ROUTINE:

EXAMPLE:

>001FFC+140 (0000 IN ADDRESS HIGH)

>011FFD+400 (0000 IN ADDRESS LOW)

>011FFA+40F (1 END ADDRESS HIGH)

>011FF9+41F (1 END ADDRESS LOW)

||LN000000

SELECT: L=LOAD/D=UNP D (D=INPUT)  
|>|0|E PROMPTS AFTER DUMPING PROGRAM|

FOR DIFFERENT SPEEDS SEE LOAD ROUTINE

Table 4. 'Instructions for use' for the cassette routines.

0	0000 00 NOP	0070 C40C ST PC 121	5 12   0000P	0120 C4F1 ST PC 111	010C 3F 20PC 1	0109 3C	0108 3C
0001 C412 L03 3C	0071 C40D ST PC 121	0072 C40E L03 3C	0073 C40F L03 3C	0121 C4F2 ST PC 111	0110 26 00C0	010A 00 CSA	0109 00 CSA
0002 01 XAE	5 7	0074 C410 L03 3C	0075 C411 L03 3C	0111 C4F3 ST PC 112	010F C40E L03 00	010B 00 CSA	010A 00 CSA
0003 0001 30P 5 1	0076 C412 L03 3C	0077 C400 L01 00	0078 C401 L01 00	0112 C400 L01 00	010E 31 00A5	0107 00 30P 1	0106 00 30P 1
0004 C400 L01 00	0079 C402 L01 00	0080 C403 L01 00	0081 C404 L01 00	0113 C401 ST PC 112	010D 30 00A0	0104 00 CSA	0103 00 30P 1
0005 01 XAE	0082 C405 L01 00	0083 C406 L01 00	0084 C407 L01 00	0114 C402 ST PC 112	010C 31 00A5	0102 00 30P 1	0101 00 30P 1
5 1	0085 30 30P0 5	0086 C408 L01 00	0087 C409 L01 00	0115 C403 ST PC 112	010B 3F 00PC 1	0100 00 30P 1	00FF 00 30P 1
0006 C408 L01 00	0088 C40A L01 00	0089 C40B L01 00	0090 C40C L01 00	0116 C404 ST PC 112	010A 3F 00PC 1	00FF 00 30P 1	00FE 00 30P 1
0007 01 X0A0 1	0091 C40D L01 00	0092 C40E L01 00	0093 C40F L01 00	0117 C405 ST PC 112	0109 3F 00PC 1	00FD 00 30P 1	00FC 00 30P 1
0008 01 X0A0 1	0094 C410 L01 00	0095 C411 L01 00	0096 C412 L01 00	0118 C406 ST PC 112	0108 3F 00PC 1	00FB 00 30P 1	00FA 00 30P 1
0009 01 X0A0 1	0097 C413 L01 00	0098 C414 L01 00	0099 C415 L01 00	0119 C407 ST PC 112	0107 3F 00PC 1	00F9 00 30P 1	00F8 00 30P 1
0010 01 X0A0 1	009A 3F 00PC 1	009B C417 L01 00	009C C418 L01 00	0120 C408 ST PC 112	0106 3F 00PC 1	00F7 00 30P 1	00F6 00 30P 1
5 2	009D C400 ST PC 121	009E F2F7 AC00 P3 121	009F 00 30P 1	0121 C409 ST PC 112	0105 3F 00PC 1	00F5 00 30P 1	00F4 00 30P 1
0011 C400 L01 00	00A0 C401 ST PC 121	00A1 3F 00PC 1	00A2 3F 00PC 1	0122 C40A ST PC 112	0104 3F 00PC 1	00F3 00 30P 1	00F2 00 30P 1
0012 3F 00PC 1	00A3 3F 00PC 1	00A4 3F 00PC 1	00A5 3F 00PC 1	0123 C40B ST PC 112	0103 3F 00PC 1	00F1 00 30P 1	00F0 00 30P 1
0013 C401 L01 00	00A6 3F 00PC 1	00A7 3F 00PC 1	00A8 3F 00PC 1	0124 C40C ST PC 112	0102 3F 00PC 1	00EF 00 30P 1	00EE 00 30P 1
0014 3F 00PC 1	00A9 3F 00PC 1	00AA 3F 00PC 1	00AB 3F 00PC 1	0125 C40D ST PC 112	0101 3F 00PC 1	00ED 00 30P 1	00EC 00 30P 1
0015 C402 L01 00	00AC 3F 00PC 1	00AD 3F 00PC 1	00AE 3F 00PC 1	0126 C40E ST PC 112	0100 3F 00PC 1	00EB 00 30P 1	00EA 00 30P 1
0016 3F 00PC 1	00AF 3F 00PC 1	00B0 3F 00PC 1	00B1 3F 00PC 1	0127 C40F ST PC 112	00FF 3F 00PC 1	00E9 00 30P 1	00E8 00 30P 1
0017 C403 ST PC 0FF 111	00B2 3F 00PC 1	00B3 3F 00PC 1	00B4 3F 00PC 1	0128 C410 ST PC 112	00FE 3F 00PC 1	00E7 00 30P 1	00E6 00 30P 1
0018 C403 L01 00	00B5 3F 00PC 1	00B6 3F 00PC 1	00B7 3F 00PC 1	0129 C411 ST PC 112	00FD 3F 00PC 1	00E5 00 30P 1	00E4 00 30P 1
0019 01 XAE	00B8 3F 00PC 1	00B9 3F 00PC 1	00BA 3F 00PC 1	0130 C412 ST PC 112	00FC 3F 00PC 1	00E3 00 30P 1	00E2 00 30P 1
0020 01 X0A0 1	00BB 3F 00PC 1	00BC 3F 00PC 1	00BD 3F 00PC 1	0131 C413 ST PC 112	00FB 3F 00PC 1	00E1 00 30P 1	00E0 00 30P 1
0021 C404 ST PC 0FF 111	00BE 3F 00PC 1	00BF 3F 00PC 1	00C0 3F 00PC 1	0132 C414 ST PC 112	00FA 3F 00PC 1	00DF 00 30P 1	00DE 00 30P 1
0022 C404 L01 00	00C1 3F 00PC 1	00C2 3F 00PC 1	00C3 3F 00PC 1	0133 C415 ST PC 112	00F9 3F 00PC 1	00DD 00 30P 1	00DC 00 30P 1
0023 01 XAE	00C4 3F 00PC 1	00C5 3F 00PC 1	00C6 3F 00PC 1	0134 C416 ST PC 112	00F8 3F 00PC 1	00DB 00 30P 1	00DA 00 30P 1
0024 3F 00PC 1	00C7 3F 00PC 1	00C8 3F 00PC 1	00C9 3F 00PC 1	0135 C417 ST PC 112	00F7 3F 00PC 1	00D9 00 30P 1	00D8 00 30P 1
0025 C405 ST PC 0FF 111	00CA 3F 00PC 1	00CB 3F 00PC 1	00CC 3F 00PC 1	0136 C418 ST PC 112	00F6 3F 00PC 1	00D7 00 30P 1	00D6 00 30P 1
0026 C405 L01 00	00CD 3F 00PC 1	00CE 3F 00PC 1	00CF 3F 00PC 1	0137 C419 ST PC 112	00F5 3F 00PC 1	00D5 00 30P 1	00D4 00 30P 1
0027 01 XAE	00D0 3F 00PC 1	00D1 3F 00PC 1	00D2 3F 00PC 1	0138 C420 ST PC 112	00F4 3F 00PC 1	00D3 00 30P 1	00D2 00 30P 1
0028 01 XAE	00D3 3F 00PC 1	00D4 3F 00PC 1	00D5 3F 00PC 1	0139 C421 ST PC 112	00F3 3F 00PC 1	00D1 00 30P 1	00D0 00 30P 1
0029 01 XAE	00D6 3F 00PC 1	00D7 3F 00PC 1	00D8 3F 00PC 1	0140 C422 ST PC 112	00F2 3F 00PC 1	00CF 00 30P 1	00CE 00 30P 1
0030 01 XAE	00D9 3F 00PC 1	00DA 3F 00PC 1	00DB 3F 00PC 1	0141 C423 ST PC 112	00F1 3F 00PC 1	00CD 00 30P 1	00CC 00 30P 1
0031 01 XAE	00DC 3F 00PC 1	00DD 3F 00PC 1	00DE 3F 00PC 1	0142 C424 ST PC 112	00F0 3F 00PC 1	00CB 00 30P 1	00CA 00 30P 1
0032 C406 L01 00	00E0 3F 00PC 1	00E1 3F 00PC 1	00E2 3F 00PC 1	0143 C425 ST PC 112	00EF 3F 00PC 1	00C9 00 30P 1	00C8 00 30P 1
0033 01 XAE	00E3 3F 00PC 1	00E4 3F 00PC 1	00E5 3F 00PC 1	0144 C426 ST PC 112	00EE 3F 00PC 1	00C7 00 30P 1	00C6 00 30P 1
0034 C406 L01 00	00E6 3F 00PC 1	00E7 3F 00PC 1	00E8 3F 00PC 1	0145 C427 ST PC 112	00ED 3F 00PC 1	00C5 00 30P 1	00C4 00 30P 1
0035 01 XAE	00E9 3F 00PC 1	00EA 3F 00PC 1	00EB 3F 00PC 1	0146 C428 ST PC 112	00EC 3F 00PC 1	00C3 00 30P 1	00C2 00 30P 1
0036 01 XAE	00EB 3F 00PC 1	00EC 3F 00PC 1	00ED 3F 00PC 1	0147 C429 ST PC 112	00EB 3F 00PC 1	00C1 00 30P 1	00C0 00 30P 1
0037 01 XAE	00EE 3F 00PC 1	00EF 3F 00PC 1	00F0 3F 00PC 1	0148 C430 ST PC 112	00EA 3F 00PC 1	00BF 00 30P 1	00BE 00 30P 1
0038 01 XAE	00F1 3F 00PC 1	00F2 3F 00PC 1	00F3 3F 00PC 1	0149 C431 ST PC 112	00E9 3F 00PC 1	00BD 00 30P 1	00BC 00 30P 1
0039 01 XAE	00F4 3F 00PC 1	00F5 3F 00PC 1	00F6 3F 00PC 1	0150 C432 ST PC 112	00E8 3F 00PC 1	00BB 00 30P 1	00BA 00 30P 1
0040 01 XAE	00F7 3F 00PC 1	00F8 3F 00PC 1	00F9 3F 00PC 1	0151 C433 ST PC 112	00E7 3F 00PC 1	00B9 00 30P 1	00B8 00 30P 1
0041 01 XAE	00FA 3F 00PC 1	00FB 3F 00PC 1	00FC 3F 00PC 1	0152 C434 ST PC 112	00E6 3F 00PC 1	00B7 00 30P 1	00B6 00 30P 1
0042 01 XAE	00FD 3F 00PC 1	00FE 3F 00PC 1	00FF 3F 00PC 1	0153 C435 ST PC 112	00E5 3F 00PC 1	00B5 00 30P 1	00B4 00 30P 1
0043 01 XAE	0100 3F 00PC 1	0101 3F 00PC 1	0102 3F 00PC 1	0154 C436 ST PC 112	00E4 3F 00PC 1	00B3 00 30P 1	00B2 00 30P 1
0044 01 XAE	0103 3F 00PC 1	0104 3F 00PC 1	0105 3F 00PC 1	0155 C437 ST PC 112	00E3 3F 00PC 1	00B1 00 30P 1	00B0 00 30P 1
0045 01 XAE	0106 3F 00PC 1	0107 3F 00PC 1	0108 3F 00PC 1	0156 C438 ST PC 112	00E2 3F 00PC 1	00AF 00 30P 1	00AE 00 30P 1
0046 01 XAE	0109 3F 00PC 1	010A 3F 00PC 1	010B 3F 00PC 1	0157 C439 ST PC 112	00E1 3F 00PC 1	00AD 00 30P 1	00AC 00 30P 1
0047 01 XAE	010C 3F 00PC 1	010D 3F 00PC 1	010E 3F 00PC 1	0158 C440 ST PC 112	00E0 3F 00PC 1	00AB 00 30P 1	00AA 00 30P 1
0048 01 XAE	010F 3F 00PC 1	0110 3F 00PC 1	0111 3F 00PC 1	0159 C441 ST PC 112	00DF 3F 00PC 1	00A9 00 30P 1	00A8 00 30P 1
0049 01 XAE	0112 3F 00PC 1	0113 3F 00PC 1	0114 3F 00PC 1	0160 C442 ST PC 112	00DE 3F 00PC 1	00A7 00 30P 1	00A6 00 30P 1
0050 01 XAE	0115 3F 00PC 1	0116 3F 00PC 1	0117 3F 00PC 1	0161 C443 ST PC 112	00DD 3F 00PC 1	00A5 00 30P 1	00A4 00 30P 1
0051 01 XAE	0118 3F 00PC 1	0119 3F 00PC 1	011A 3F 00PC 1	0162 C444 ST PC 112	00DC 3F 00PC 1	00A3 00 30P 1	00A2 00 30P 1
0052 01 XAE	011B 3F 00PC 1	011C 3F 00PC 1	011D 3F 00PC 1	0163 C445 ST PC 112	00DB 3F 00PC 1	00A1 00 30P 1	00A0 00 30P 1
0053 01 XAE	011E 3F 00PC 1	011F 3F 00PC 1	0120 3F 00PC 1	0164 C446 ST PC 112	00DA 3F 00PC 1	009F 00 30P 1	009E 00 30P 1
0054 01 XAE	0121 3F 00PC 1	0122 3F 00PC 1	0123 3F 00PC 1	0165 C447 ST PC 112	00D9 3F 00PC 1	009D 00 30P 1	009C 00 30P 1
0055 01 XAE	0124 3F 00PC 1	0125 3F 00PC 1	0126 3F 00PC 1	0166 C448 ST PC 112	00D8 3F 00PC 1	009B 00 30P 1	009A 00 30P 1
0056 01 XAE	0127 3F 00PC 1	0128 3F 00PC 1	0129 3F 00PC 1	0167 C449 ST PC 112	00D7 3F 00PC 1	0099 00 30P 1	0098 00 30P 1
0057 01 XAE	012A 3F 00PC 1	012B 3F 00PC 1	012C 3F 00PC 1	0168 C450 ST PC 112	00D6 3F 00PC 1	0097 00 30P 1	0096 00 30P 1
0058 01 XAE	012D 3F 00PC 1	012E 3F 00PC 1	012F 3F 00PC 1	0169 C451 ST PC 112	00D5 3F 00PC 1	0095 00 30P 1	0094 00 30P 1
0059 01 XAE	0130 3F 00PC 1	0131 3F 00PC 1	0132 3F 00PC 1	0170 C452 ST PC 112	00D4 3F 00PC 1	0093 00 30P 1	0092 00 30P 1
0060 01 XAE	0133 3F 00PC 1	0134 3F 00PC 1	0135 3F 00PC 1	0171 C453 ST PC 112	00D3 3F 00PC 1	0091 00 30P 1	0090 00 30P 1
0061 01 XAE	0136 3F 00PC 1	0137 3F 00PC 1	0138 3F 00PC 1	0172 C454 ST PC 112	00D2 3F 00PC 1	008F 00 30P 1	008E 00 30P 1
0062 01 XAE	0139 3F 00PC 1	013A 3F 00PC 1	013B 3F 00PC 1	0173 C455 ST PC 112	00D1 3F 00PC 1	008D 00 30P 1	008C 00 30P 1
0063 01 XAE	013C 3F 00PC 1	013D 3F 00PC 1	013E 3F 00PC 1	0174 C456 ST PC 112	00D0 3F 00PC 1	008B 00 30P 1	008A 00 30P 1
0064 01 XAE	013F 3F 00PC 1	0140 3F 00PC 1	0141 3F 00PC 1	0175 C457 ST PC 112	00C9 3F 00PC 1	0089 00 30P 1	0088 00 30P 1
0065 01 XAE	0142 3F 00PC 1	0143 3F 00PC 1	0144 3F 00PC 1	0176 C458 ST PC 112	00C8 3F 00PC 1	0087 00 30P 1	0086 00 30P 1
0066 01 XAE	0145 3F 00PC 1	0146 3F 00PC 1	0147 3F 00PC 1	0177 C459 ST PC 112	00C7 3F 00PC 1	0085 00 30P 1	0084 00 30P 1
0067 01 XAE	0148 3F 00PC 1	0149 3F 00PC 1	014A 3F 00PC 1	0178 C460 ST PC 112	00C6 3F 00PC 1	0083 00 30P 1	0082 00 30P 1
0068 01 XAE	014B 3F 00PC 1	014C 3F 00PC 1	014D 3F 00PC 1	0179 C461 ST PC 112	00C5 3F 00PC 1	0081 00 30P 1	0080 00 30P 1
0069 01 XAE	014E 3F 00PC 1	014F 3F 00PC 1	0150 3F 00PC 1	0180 C462 ST PC 112	00C4 3		

5

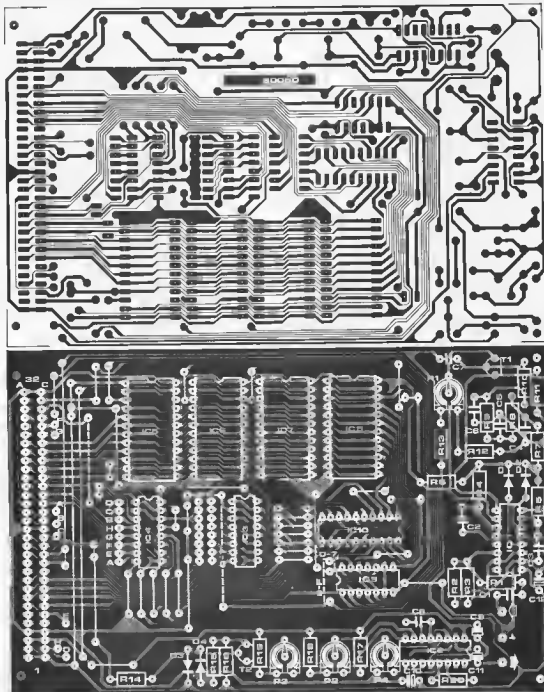

Figure 5. Printed circuit board and component layout for the cassette interface and EPROM section — the circuits given in figures 2a, 2b and 4.

#### Parts list for figure 5.

##### Resistors:

R1,R7,R14 = 1 k  
 R2,R4,R5 = 100 k  
 R3,R10,R11 = 1 M  
 R6 = 47 k  
 R8 = 150 k  
 R9 = 470 k  
 R12 = 3k3  
 R13 = 150 Ω  
 R15 = 5k6  
 R16 = 4k7

R17,R19 = 12 k  
 R18 = 22 k  
 R20 = 220 Ω  
 P1 = 1 k  
 P2 = 10 k  
 P3 = 5 k  
 P4 = 25 k

##### Capacitors:

C1 = 100 n  
 C2,C3 = 2n2  
 C4 = 4n7  
 C5 = 1n5  
 C6 = 560 p  
 C7 = 82 p  
 C8 = 27 n  
 C9,C10 = 10 μ/16 V Tantalum.  
 C11 = 1 μ/16 V Tantalum  
 C12 = 100 μ/6 V

##### Semiconductors

D1... D4 = 1N4148  
 T1 = 8C1798, 8C5598 or equ.  
 T2 = 8C177, 8C557, TUP  
 IC1 = N1... N6 = 4049 B  
 IC2 = XR-2206  
 IC3,IC4 = 74(LS)155  
 IC5,IC6,IC7,IC8 = MM5204Q  
 IC9 = 74(LS)20  
 IC10 = 81 (LS)95





Table 6.

Address	Function	Displacement
1FF0	CHECKSUM	F2
1FF1	BLOCK COUNTER	F3
1FF2	BYTOUT-BYTE	F4
1FF3	BIT COUNTER	F5
1FF4	DUMMY VARIABLE	F6
1FF5	SPEED BYTE	F7
1FF6	TEMPORARY SPEED BYTE	FB
1FF7	NOT USED	
1FF8	NOT USED	
1FF9	NOT USED	
1FA	END ADDRESS HIGH	FC
1FB	END ADDRESS LOW	FD
1FC	BEGIN ADDRESS HIGH	FE
1FD	BEGIN ADDRESS LOW	FF
1FE	SAVED P3 (L)	@FF/@01
1FF	SAVED P3 (H)	@FF/@01

## SUBROUTINE ADDRESSES

PUT C:	B1CE	Send one character to TTY via F0.
GECO:	B1BF	Retrieve one character from TTY via Sg and send 'echo' via F4
BYTOUT:	B12B	Transmit one byte via Sout.
LDBYTE:	B155	Retrieve one byte via S <sub>IN</sub> .

Table 6. Specifications of the 'scratchpad' on Page 1. The subroutines addresses are also given.

is given, followed by the start address 8006, this address was listed in Table 4. Finally, Table 4 gives an example of a Dump procedure. First, the begin and end addresses of the program to be 'dumped' are specified. Then the program is started, by means of a LINK command, either at address 8000 (for autostart) or at 8006 (after specifying the desired transmission rate in address 1FF5). The tape is started, and a D is keyed in — the Dump routine will run and the program is stored on tape.

When using NIBL, the end address of the program to be dumped is found by giving the command 'PR TOP'. The computer will respond by printing a decimal number; this must be converted to the equivalent hexadecimal value before it can be specified for the Dump routine. The begin (and end) address depends on the Page used: #111E for Page 1, #2000 for Page 2, #3000 for Page 3, and so on. Page 1 is the only one with a 'peculiar' begin address; the reason is that NIBL uses the first 11D memory locations for storing data.

## Scratchpad

To avoid the need for an additional RAM card, locations 1FF0 to 1FFF on Page 1 are used as scratchpad for the cassette routines. The data stored at the various addresses are listed in Table 6.

Note that, since this section of memory is used as scratchpad, the end addresses on Page 1 should never be higher than 1FEF (4080 in decimal).

Table 6 also lists the various subroutine addresses, with a brief indication of what they do.

## More on the EPROMs

At present, ½ K EPROMs are not as 'readily available' as could be wished. If the MM5204Q proves difficult to obtain, a 2 K EPROM can be used instead. The details of this modification are given further on — note that the same idea may prove useful in many other applications as well! However, assuming that the MM5204Q is to be used, there is still one minor problem. These EPROMs are not quite fast enough for use in a 4 MHz system such as the BASIC microprocessor! For

this application, a minor modification of the CPU card will also be required. Before going into detail, it seems advisable to summarize the various possibilities for the EPROM section:

- four ½ K EPROMs, type MM5204Q.
- When used in combination with the Elektor SC/MP system (2 MHz clock), these can be mounted without any further modifications. For use with the BASIC microcomputer, however, the 'slow memory access' described below must be added to the CPU card.
- one 2 K EPROM, type 2716. This alternative is discussed further on; it is equally suitable, without further modifications, for both 2 MHz and 4 MHz systems.
- one 4 K RAM card, used as ROM.

This is the way the software was originally tested, and it works on all systems.

## Slow memory access

As explained above, this modification to the CPU card is only required if the MM5204 is used as EPROM in conjunction with a 4 MHz system such as the BASIC microprocessor, in all other cases, it is unnecessary!

The problem is that these EPROMs are not quite fast enough. For this reason, the microprocessor's 'read' cycle must be lengthened slightly. This can be achieved by using the NHOLD input: when this control pin is connected to supply common, the SC/MP is 'frozen' so that it maintains the current status. A read cycle (or a write cycle, for that matter) can be extended for as long as required in this way. For the present application, the read cycle must be extended by 250...500 ns. Since Page 0 is fully used for NIBL, there is no need to extend the read cycle there. The write cycle can remain unaltered for all pages of memory.

9

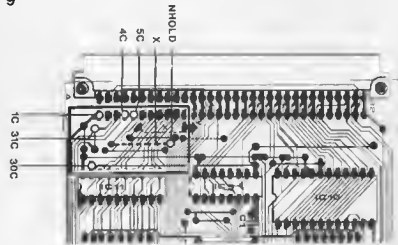

Figure 9. The actual connections between the 'slow memory access' board and the existing BASIC microcomputer CPU board are clearly shown. Note that the wire link marked 'X' must be removed.

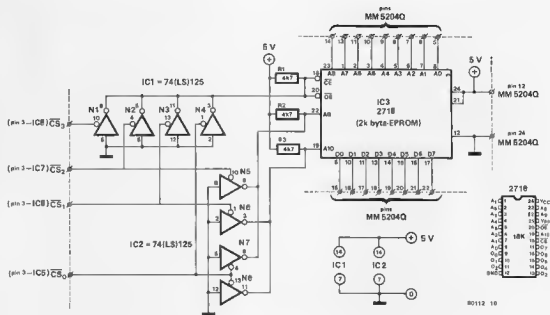

Figure 10. Should the MM5204Q prove difficult to obtain, there is an alternative: use one 2716 to replace four 5204s!

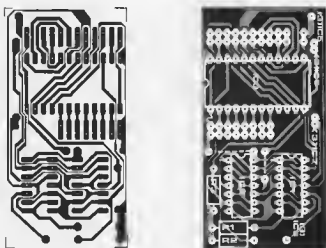

Figure 11. Printed circuit board and component layout for the extension circuit given in figure 10.

#### Parts list for figure 11.

Semiconductors  
 IC1, IC2 = 74(LS)125  
 IC3 = 2716, 2 K byte EPROM  
 suitable for +5 V supply. Intel,  
 National Semiconductor or  
 Motorola versions are ideal.

Resistors.  
 R1 ... R3 = 4k7

This read cycle extension can be achieved as shown in figure 6. The NRDS signal from the bus is passed through N1 to N2, where it is gated by the signal on connector pin 30c. This is one of the address lines: it ensures that the NRDS signal is only passed when one of the pages 1...15 is selected — not for page 0, in other words. The output from N2 triggers a monostable multivibrator (N3/N4) that delivers an output pulse of approximately 0.5  $\mu$ s. The result is that the NRDS pulse is lengthened by this amount. The effect on the software timing is so small that the in- and output routines will still function as intended. No modifications are required in the software.

The four components needed can be mounted on a very small printed circuit board. The board and component layout are given in figure 7. As can be seen in the photo (figure 8), this board is mounted near the connector on the CPU board by means of short wire links. The actual connections are shown in figure 9: they are all either wire links on the existing board or pins on the connector. Note that the wire link marked 'X' must be removed.

#### An alternative for the MM5204

4 x 5204 = 2716. This may seem peculiar arithmetic, but it is actually a good alternative solution if the MM5204 should prove difficult to obtain. The idea is that four 1/2 K EPROMs can be replaced by one 2 K version. The

12

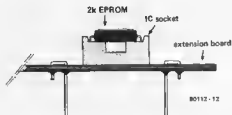

Figure 12. The stiff wire links, used for the connections between the p.c. board given in figure 11 and the main board are each looped through two holes adjacent to IC3 as shown here.

cassette routines given in Table 5 can be located in the first  $\frac{1}{2}$  K, and the remaining  $\frac{1}{2}$  K can be used for other software — a monitor program, for instance (currently under development!).

As shown in figure 10, the chip select connections to the  $\frac{1}{2}$  K EPROMs are decoded by means of eight logic gates. Four of these (N5...N8) re-encode the four chip select signals into the two-bit data required to address IC3. Gates N1...N4 ensure that the EPROM is put out of action when no chip select signals are present.

Admittedly, these gates are not strictly necessary: all the control signals required are already present 'somewhere' on the cassette interface p.c. board. However, that little word 'somewhere' is the reason for investing in the two additional ICs. It is now possible to

mount the complete circuit on a small p.c. board that simply plugs into the IC sockets on the existing board. No messing about!

In principle, you would assume that any 2 K EPROM labelled .2716 could be used, but unfortunately this is not quite true. The limitation is that the IC must work off a single +5 V supply. The Texas Instruments version, for example, needs three supply voltages, for this reason, it cannot be used in this circuit.

The printed circuit board for the 'EPROM alternative' is given in figure 11. After mounting the ICs and resistors, short and stiff connecting wires must be soldered into place to form the connections to the existing IC sockets on the cassette interface p.c. board. This is where the two rows of holes on each side of IC3 come in. The idea is that

each piece of wire is looped through two holes, so that a fairly rigid mechanical construction is achieved (see figure 12). The two rows of wire 'pins' are then inserted into two IC sockets, as shown in the photo (figure 13). The 2 K EPROM is located above the IC socket for IC6; the connecting wires are inserted into one row each of the sockets for IC5 and IC7. The four remaining connections to the extension board are connected to four wire links that carry the chip select signals; this is clearly shown in the photo.

### In conclusion

As anyone who is actively interested in the 'hardware' side of microprocessors will know, what is written today may well be out of date tomorrow. This is certainly true when you attempt to design 'general purpose' additions, such as the cassette interface described here. Against all odds, we have tried to make this module suitable for all SC/MP systems... Furthermore, we have attempted to solve the availability problem of EPROMs by offering several alternatives.

If you can build and install any of the variations described here, we will have succeeded in our aim. Even if you only succeed after working out some other alternative according to the principles laid out, we feel that this article is not wasted. After all, the idea is to provide you with a cassette interface! And, provided you can obtain any of the EPROMs listed, this should certainly be the case if you are the proud owner of either of the SC/MP systems described in Elektor. **M**

13

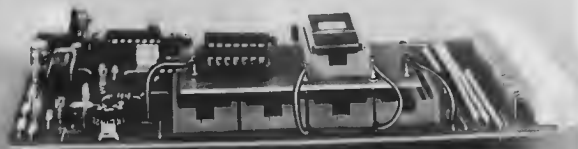

Figure 13. This photograph clearly shows the relative position of the two boards (figures 5 and 11). The two rows of wire links plug into the sockets for IC5 and IC7; the remaining four connections are wired to four wire links that carry the 'chip select' signals, as shown here.

Liquid crystal displays are an economic alternative to the well known LED. They combine high readability with versatility. As far as amateurs are concerned, however, judgement is still being suspended. This is because, until recently, LCD's have always been difficult to obtain, expensive, and involved complex operation. Now, at last, they are in a new phase of development and the prices have come down dramatically.

# LCDsplays

A little current leads to a lot of contrast.  
The world's most well known optical illusion.



During the past two years LCDsplays have been catching up with their LED counterparts. In fact, it almost looks as if LED's will soon be considered old-fashioned. This is hardly surprising, when both types of display are compared. LCD's consume approximately 1000 times less current than LED's. Contrast under bright light improves rather than deteriorates. Furthermore, LCD's are extraordinarily versatile. They can be transparent and allow for great flexibility in size and form.

Before the above advantages could be capitalized on, a few initial problems had to be overcome. This was done successfully with the result that high quality LCD's are being mass produced. They now have a satisfactory lifespan and temperature range.

One beneficial affect of the rising quality of the product is that it is becoming more and more in demand in industry and therefore more readily available on the retail market.

## Inside LCD's

A detailed knowledge of the technological background of LCD's is not strictly necessary in order to be able to use them. Readers who take an interest in this particular aspect are referred to the bibliography which is given at the end of this article.

An LCD Display basically consists of two very thin glass plates between which there is a liquid crystal layer some 10  $\mu\text{m}$  thick. This layer consists of a crystalline molecular structure. What is essential is that the molecular structure changes under the influence of an electrical field. Depending on the direction in which the molecules are organized, the liquid crystal layer becomes either transparent or reflective. The inside surface of the two glass plates is coated with a transparent, conductive layer and this forms the electrodes. A voltage applied to them creates an electrical field which causes the molecules in the liquid crystal layer to change direction. The plane affected (or segment of a digital display) then alters in transparency.

Figure 1 shows the basic construction of an LCD. The  $\text{SiO}_2$  layers given in the figura should be mentioned. These insulate the electrodes from the effects of the liquid crystal and the two polarizers (polarisation filter discs). The alignment of the crystalline structure is such that transparency will not change until a voltage is applied. The organisation of the crystal molecules in the electrical field is shown in figura 1. When an (alternating) current is applied between the two electrodes, the crystal molecules will be arranged horizontally. As can be seen, the lower half has no drive current and so the liquid crystals are in a vertical configuration.

In an unenergized state in a reflective LCD, a vertical and a horizontal polar-

izer are laminated onto the liquid crystal cell at right angles (or  $90^\circ$  rotated) to each other (see figure 2a). Vertically polarized light entering the front of the cell (A) follows the rotation of the crystal alignment as it passes through the cell again rotating  $90^\circ$  degrees, the polarized light passes through the horizontal polarizer to the reflector (E). The light is then returned through the cell again rotating  $90^\circ$  degrees, and passes out of the LCD through the vertical polarizer.

In an energized state, however, (see figure 2b) across one or more of the character segments the crystal molecules in the segment align themselves with the electrical field. Rotation does not therefore occur in the energized segment. The vertically polarized light from the energized segments cannot pass through the horizontal polarizer, but is rather absorbed by it. The segments therefore appear as dark images against a light background. The opposite happens with parallel polarisation filters, the powered segments are transparent and appear as bright images on a dark background.

Things are different when a semi-transparent mirror is used as a reflector (figure 3b). It results in 'transflective' displays which can be illuminated from in front as well as from behind.

When current consumption is of minor concern, in mains power equipment for example, the light source behind the display can be constantly on. If the surrounding brightness is greater than the light intensity effected by the built-in lighting, the display operates in a reflective manner. If the external brightness is less, 'transillumination' or transmission occurs.

There are also displays which operate exclusively on a built-in light source, that is to say, producing transmission without a reflector (see figure 3c). These are called transmissive displays. Recent developments seem to favour reflective and transflective displays, whereas the transmissive type tends to be pushed into the background. The former types nearly always display dark characters on a bright background, whereas the transmissive type features transparent characters on an opaque (dark) background.

### Characteristics

The prime feature of the LED is brightness, while that of the LCD is contrast: the main criterion for readability. Contrast involves a certain light/dark ratio of segment brightness during the 'on' and 'off' state when the external light is constant and it is seen from the same angle. The ratio is between 1:10 and 1:20. A good example of this effect is the text of this magazine where black and white contrast is sharp. The operational ratios also have an influence on the contrast, especially on the viewing angle and on the triggering

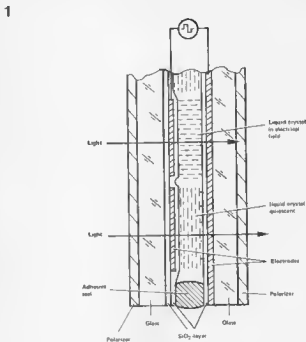

80090 1

Figure 1. Basic construction of an LCD. The layer of liquid crystal is hermetically enclosed between two glass plates. The glass plates contain transparent, conductive electrodes. As shown in the layout, the direction of the molecules changes under the influence of an electrical field. In combination with the externally adhesive polarisation filters, 'capazing' the molecules between the triggered electrodes causes a change in the transparency of the corresponding segment.

2

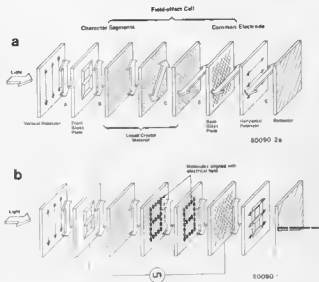

80090 2a

80090 2b

Figure 2. According to the position of the polarisation filters the following takes place: Figure 2a. In an unenergized reflective LCD, the segments are transparent when the filters are parallel to each other. Polarized light is rotated  $90^\circ$  by the liquid crystal material. Figure 2b. The triggered segments become opaque (dark) when the filters are at right angles to each other. Rotation does not occur in an energized reflective LCD.

3

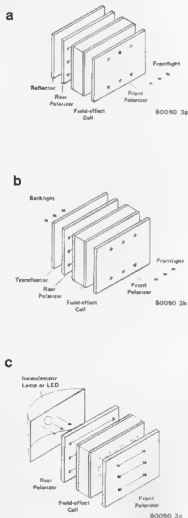

Figure 3. Depending on the construction of the display, there are the following types of LCD: Figure 3a. Reflective operated. At the rear a reflector has been incorporated. Figure 3b. Transflective display. A semi-transparent reflector enables it to be illuminated from behind as well. Figure 3c. Transmissive display.

4

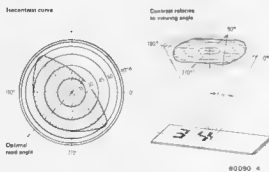

Figure 4. The contrast produced by an LCD depends on the viewing angle. This is illustrated by the isocontrast curve.



(static or multiplex). The viewing angle is shown in figure 4. LCDs achieve a viewing angle of up to  $160^\circ$ , where the light/dark ratio is 1 : 3.

The contrast is also dependent on the operating voltage. For maximum contrast a certain field intensity between the segment electrodes and the back plate electrode is required, which relies on a certain voltage. Figure 5 shows the typical voltage curve. When the voltage rises the liquid crystal molecules are realigned gradually. The contrast at a certain voltage depends on the percentage of molecules in the field which have already changed direction. When contrast is at a maximum, this will be around 100%. If the voltage is further increased, the contrast will remain constant rather than increase. This may be a disadvantage if multiplex applications are sought. Contrary to multiplexing LCD's, the shorter 'on' period (analogous to the increase of segment current with an LED) is not compensated.

The level of operating voltage required may be freely chosen. On the one hand it is determined by the basic material used and on the other by the density of the liquid crystal layer. The thinner the layer, the higher the field intensity (at the same voltage level) and the lower the operating voltage required. Nowadays, LCD's are being designed with operating voltages in the region of 1.5 V to 20 V. The contrast curve shown in figure 5 is temperature dependent. At higher temperatures, contrast is achieved at a lower voltage. The curve then becomes more pronounced. If the temperature is low, the opposite happens: the curve then flattens out. Again, this may cause problems if a multiplex operated system is used.

The switch-over times of an LCD rely on the voltage and temperature. Figure 6a shows the time lapse of contrast when the LCD is switched 'on' and 'off' respectively. It features a relatively long switch-on delay ( $t_d$  in the figure) of 100 ms, before any change in con-

5

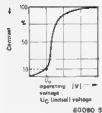
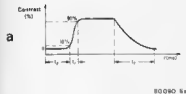

Figure 5. Contrast intensity with relation to segment voltage. After the initial voltage  $U_0$  has been exceeded, the contrast increases very rapidly to a maximum beyond which very little improvement can be achieved.

6



b

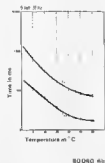

Figure 6a. Typical contrast curve of an LCD when switched 'on' and 'off'. It features long delay when switched 'on', relatively fast ascent and slow descent. By increasing the drive voltage, the switching on time (delay + ascent) is markedly reduced. The switching off time, however, lengthens slightly. Figure 6b. When the temperature drops, LCD's always switch more slowly.

7

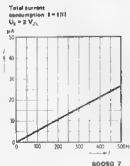

Figure 7. The current increase of LCD's is in linear proportion to the frequency. The segments represent a capacitive load.

trast takes place. If the contrast is to reach 90% of the maximum value, another 70 ms ( $t_r$ ) will be required. When it is switched off, the contrast starts to fade immediately but takes about 230 ms ( $t_f$ ) for it to be complete. Depending on the type of material used, the turn 'on' time with a rising operating voltage, becomes markedly shorter, whereas the turn 'off' time lengthens only slightly.

Temperature is also an important factor. Generally speaking, when the LCD's are in a warm environment, they switch more rapidly (see figure 6b).

### Lifespan and temperature range

Both aspects are closely connected. A great deal is known about the lifespan of LCD's, nevertheless, it merits a few words here.

What is a lifespan? It all depends on the type of display used (reflective, transmissive or transfective). A 50% drop in contrast leads to various results. The lifespan is also dependent on the number of operating hours until a failure rate of 50% occurs.

No matter how the lifespan is defined, it is certain that during the past few years great progress has been achieved. A life expectancy of more than 50,000 hours (almost six years of operation!) is now quite normal.

In the early stages of development, problems affected the LCD's resistance to ultra violet light, humidity and foreign debris. As glass plates used to be stuck together with adhesive material, the liquid crystal was not hermetically sealed and therefore had a lifespan of only one to two years. This was solved by the introduction of special laminating material for glass. By coating the plates with a thin layer of quartz, the liquid crystal remains unimpaired and at the same time the electrodes are

insulated against it.

More stable substances are now being sought to extend the temperature range and improve the switching times. The chemical stability of a few of the most recent liquid crystals is of such a high quality that it has once again become feasible to use the old adhesive technique. This is an important step on the road towards large surface displays with a view to the alphanumeric LCD's of the future.

Polarizers have not, however, undergone a similar development. Light polarization takes place in a polyvinyl alcohol foil, which is stretched to a maximum and then soaked in an iodated compound. The foil is very thin (25  $\mu$ m) and must be pasted to a carrier foil. Polarizers tend to bleach in high temperature and humid surroundings, which may result in a loss of contrast. A solution would be an LCD with 'sun glass' (darker polarizer)! By using impermeable protective foil and improved adhesive and solidifying processes, polarizers would then be well protected against humidity.

### Operational and storage temperatures

As mentioned above, the performance of LCD's slows down when the temperature drops. At temperatures of about  $-10^\circ\text{C}$  they even freeze up altogether with the result that the liquid crystal becomes a solid. At the other temperature extreme the liquid becomes thinner until it loses its crystal structure. A distinction should be made between the operating and the storage temperature ranges. If the working temperature exceeds its range, the display will become inoperative. It is only when the storage temperature range is exceeded, however, that permanent damage is done.





Photo 1. LCDsplays allow great variety in form and shape.

2

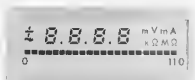

Photo 2. A combination of analogue and digital values measured using LCDsplays.

Liquid crystal material currently in use has a working temperature range with a lower limit between  $-5^{\circ}$  and  $-15^{\circ}\text{C}$  and an upper limit between  $40^{\circ}$  and  $80^{\circ}\text{C}$ . The storage temperature range has a lower limit of  $-20^{\circ}$  to  $-40^{\circ}\text{C}$  and an upper limit of  $60^{\circ}$  to  $85^{\circ}\text{C}$  (depending on the liquid crystal used).

### Voltage control

LCD segments are triggered into operation by applying an alternating current. It must be a frequency of over 30 Hz (to prevent the display from flickering.) This is essential and it makes no difference whether the electrodes have been insulated against the effects of the liquid crystal or not. If they have not been insulated, the application of a direct voltage will result in electrolysis thereby destroying the electrodes. If the electrodes are in fact insulated, the ions in the liquid crystal are shifted. This breaks down the electrical field and the display fades at once.

If the supply is DC (as in battery powered equipment), an AC waveform will have to be generated by means of an oscillator. To prevent the display from visibly flickering, the frequency range is limited at its lower end. The

8

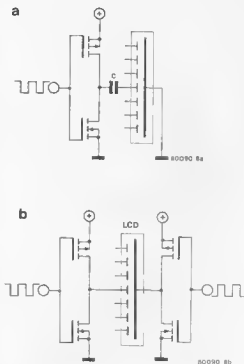
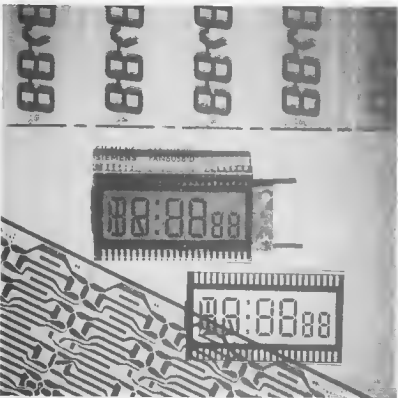

Figure 8. Direct drive circuits.

Figure 8a. A push-pull transistor stage. The capacitor ensures a direct voltage division, so that an AC is applied to the segment.

Figure 8b. Triggering is possible without a capacitor with the aid of two transistor stages (bridge circuit).





upper end is limited by the resistance of the electrodes and the capacitance (the RC time constant) of the segments in the display. In an equivalent circuit an LCD segment represents the parallel connection of capacitor C and of a high-valued resistor R. The capacitance is primarily determined by the size of the segment surface. For instance, its capacitance per digit depends on the height of the digit and on the LC material and will be between 150 pF (8 mm digit size, high quality LC) and 4 nF (maximum value for 25 mm digit, standard LC).

The resistance is dependent, among other things, on the segment's surface and on the quality of the electrodes' insulation. In the above examples the corresponding values for the direct voltage resistance would be 1400 M $\Omega$  (8 mm) and 8 M $\Omega$  (25 mm high).

If only alternating current is applied, the resistance in the segment may be disregarded. The current consumption will then rely on capacitance and frequency (figure 7). In the case of a display with a very small surface area, it is possible to reach a working frequency of up to 1 kHz; with larger displays, however, there is little point in having an operating frequency of over 100 Hz. Usually, manufacturers indicate an operating frequency of 32 Hz at 50 mV.

### How does it work?

The next distinction which must be made is the difference between static operation (direct segment control) and multiplex operation (switched segment control). As its name suggests, static operation provides each segment with its own drive, and one common electrode may be used by all the segments (and usually is). Thus, in this respect it is like the seven segment LED displays (common cathode or common anode). As opposed to multiplex operation, static operation is uncritical with regard to contrast, tolerance and temperature. Figure 8a shows a simple control circuit for a segment with a push-pull transistor stage. The transistors are part of a CMOS inverter IC, a CD4007 or CD4009, for instance. The inverter receives a square wave of 30-50 Hz at its input and switches at its output between +U<sub>b</sub> and 0 V. The peak value of the alternating current applied to the segment is equal to half the operating voltage.

Capacitors are expensive and take up a lot of space when compared with IC gates, so it would be an advantage if the circuit could be built without any discrete components as shown in figure 8b. After inversion, the square wave at the rear electrode is 180° out of phase with the one at the segment electrode. Between the two electrodes lies an alternating current with a peak value equal to the supply voltage U<sub>b</sub>. This principle can be put into practice

9

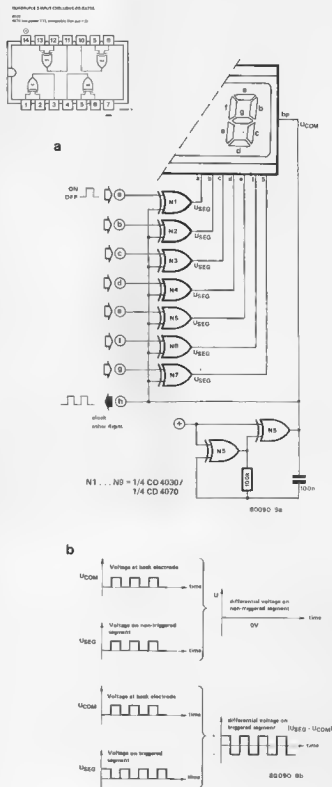

Figure 9a. A complete direct drive circuit with EXOR gates as segment drives. Figure 9b. The pulse diagram shows that an AC is present at the triggered segments.

In an elegant manner with the aid of EXOR gates of the CMOS type (for instance, CD 4030 or CD 4070). Figure 9a shows the circuit. A gate is required for every segment. To one of the inputs of each gate and the display common, a constant low frequency alternating current is applied. The other gate input then controls the segments. If there is a logic 1 at the control input the square wave at the segment electrode will be out of phase (with reference to the display common) and in phase if it is a logic 0. This is clearly shown in the diagrams in figure 9b. Because the signals are in phase when the segment is powered, no difference in voltage occurs. When they are out of phase, the AC rises with a difference in potential of twice the amplitude of the square wave (between the triggered segment electrode and the common electrode).

This must of course be taken into account when the supply voltage of the LCDs is fixed. On the data sheet this is usually given as the effective value of the AC waveform. The effective value of the waveform is equal to its peak value and this is equal to the operating voltage  $U_D$  of the CMOS gates. For an LCD specifying an operating voltage of 4 to 6 V the CMOS drive circuit will be fed with 5 V.

### Multiplexed operation

The threshold values of the LCD contrast curve may also be multiplexed, although this will be limited to a few steps. The reasons for this are:

- The contrast is not pronounced.
- The contrast curve is temperature dependent.
- As opposed to LED's the contrast may not be increased by means of short interval overdrive.
- If the system is direct voltage (as opposed to multiplexed) controlled, these problems are avoided, although

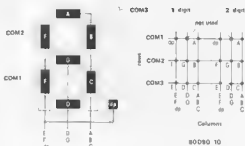
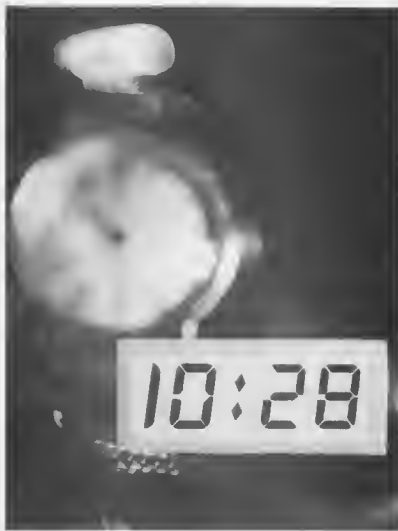

Figure 10. Layout of segment and back electrodes in a three step multiplex LCD. The segments at the matrix points are between rows (back electrodes) and the segment group connections (columns). In this example a matrix position (row 1, column 2) has not been used.

the high number of connections to the display and drive circuit is often a drawback.

Commonly used LCD's include the 'three step multiplex'. In this type up to three segments are attached to a single connection. Figure 10 shows a seven segment display for a three step multiplex operation with a matrix organisation for two digits. This example does not include two matrix points which could be added. If all the matrix points are to be optimally exploited, only  $\frac{n}{3} + 3$  connections will be required for 18 segments. The system becomes operative in three chronological stages.

First, all the segments at the back electrode COM 1 are triggered, then those at COM 2 and those at COM 3, after which the cycle starts again. In order to trigger the back electrodes (COM = 'rows' in the matrix) and the segments groups (columns in the matrix) square waves are used which supply an AC to the triggered segment. Furthermore, the control signals have to be such, that the AC is in phase for the 'on' segments and out of phase for the switched 'off' segments. The row and column signals have to differ in amplitude. Usually, the higher voltage is applied to the back electrodes and the lower to the segments. Figure 11 gives a practical example of digit 4 which is lit in the seven segment display shown in figure 10. The triggered segments are given in the matrix as shaded circles.

The corresponding pulse schedule shows from top to bottom: clock, COM signals, column signals and the differential signals  $U_{COM} - U_{COL}$  which become operative in segments dp, nc, G and C.

One multiplex step corresponds to one clock period. The column signals are obtained when a square wave is connected through to a clock signal, and to an equal voltage for the rest of the time (the two subsequent clock periods) to the COM row concerned. The pulse at the COM transmission activates the rows concerned. Whether the segments on the row (matrix points) are 'on' or 'off', depends on the phase layer of the column signal at that moment. For an inoperative point, the column signal is in phase and for a triggered one it is out of phase to the column signal. In the pulse diagram, for example, column signal COL 1 is out of phase to the common signal COM 1 during the first multiplex step (pulse on COM 1). The decimal point (dp) is switched 'on' during the first step. This can also be seen in the differential signal (COM 1 - COL 1). The voltage operated at both segment electrodes is added to the COM and COL signal. This is not true of the untriggered segment nc on the first row. Here the column signal COL 2 is in phase to the COM 1 signal. The

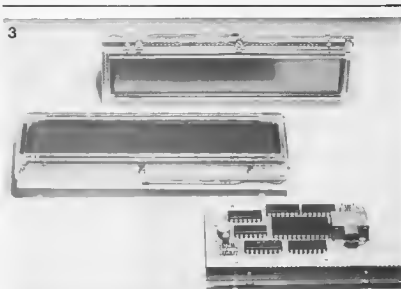

Photo 3. Alphanumeric 48 digit LCD unit. This ready-to-incorporate module by GEET has a display surface of 142 x 22 mm, two rows of 24 digits, where every digit is made up of a 5 x 7 matrix (a total of 1680 display dots). The module already contains a multiplex drive circuit and consumes 2 mA. The printed circuit at the rear of the display module is optional and has a character generator, ASCII input bus and display interface.

result at segment nc is an AC which is definitely smaller than at the triggered dp segment, because the COM and COL signals are now subtracted. The value of the AC remains below that of the minimum operating current of the LCD. The untriggered segment will of course not be activated. The column signal is generated by means of a shift register, at each output

of which an EXOR gate has been connected. The second input of all the EXOR gates is at the clock for direct triggering. This is how the information ('1' or '0') at the shift register's output can determine the state of the square wave at the output of the EXOR gate (inverted or non-inverted). After the gates, CMOS analogue switches follow, which switch the voltage values when



Photo 4. Liquid crystal screen in a pocket TV prototype manufactured by National Panasonic (Matsushita). With a total of 57,000 display dots it operates on a supply of 4.6 V.

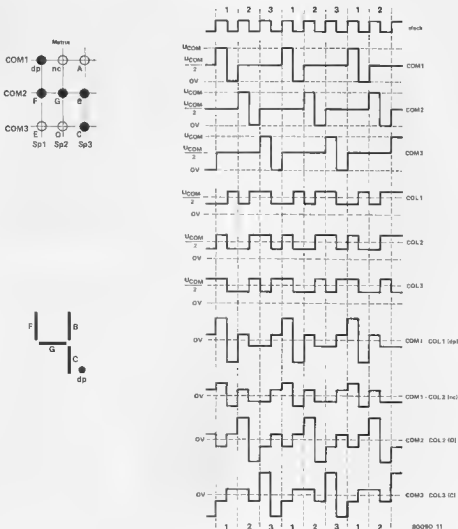

Figure 11. Segment control for digit '4' + dp on a seven segment LCD in a three step multiplex. The pulse diagram shows from top to bottom: a clock, COM signals, column signals and the differential signals which become operative at the segments dp, nc, G and C.

the column signal is generated. The optimum ratio of row voltage to column voltage is  $V_{opt} = \sqrt{n}$  where  $n$  is the number of multiplex steps. For a three step multiplex the ratio is  $\sqrt{3} = 1.73$ . Figure 12b shows the required voltage values for three step multiplexes to be generated and the corresponding voltage phase for the COM and COL signals. The voltage  $U_0$  is the starting voltage (for a 10% contrast) of the display and this is indicated on the data sheet. Usually 1.05 V is enough.

### Conclusion and outlook

More information can now be displayed with multiple segment displays. They are available with 1120 light

spots (32 alphanumeric characters in a 7 x 5 format). The portable, battery driven data terminal with an LC screen is no longer an illusion. The complex control systems behind such displays can be simplified by means of integrated drive circuits. As the number of multiplex steps in LCD's is, technologically speaking, limited, the LCD has to become 'active' for average to large quantities of information. That means that at every intersection of the control wires there is an active semiconductor element, such as an FET.

The rear of the display consists of a large area chip, on which the corresponding transistor matrix has been etched.

A display of this type was recently

introduced by National Panasonic (Matsushita). It was demonstrated in a prototype pocket TV set with a flat LCD screen (see photo). The reflective LCD contains 57,000 (240 x 240) displays dots on a chip measuring 44 x 56 mm.

Figure 13 shows the basic construction of the screen. Every matrix point on the silicon substrate consists of a capacitor and of an FET. 110,000 transistors and capacitors on a single chip!

The sample TV consumes barely 1.5 W with a battery voltage of 4.6 V (2 lithium cells). It is not likely to be mass produced until a further reduction in dimensions and current consumption has been achieved. At any rate, the example shows that a flat LCD screen

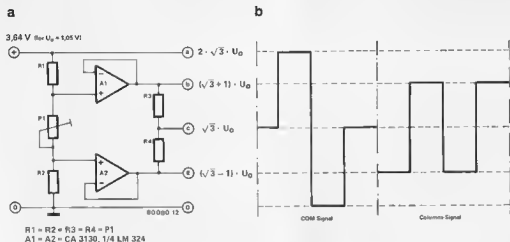

Figure 12. The required voltages for a three step multiplex and corresponding voltage levels of row and column signals.

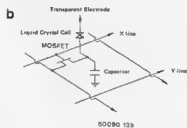
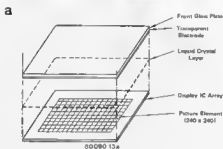
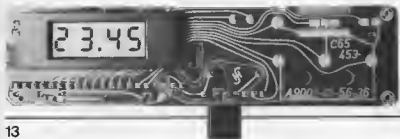

Figure 13a. The construction of the 'flat' LCD TV screen.  
 Figure 13b. The 'electronic components' in each matrix point of the TV screen.

can already be produced at this stage in development. As far as multi coloured LCD's are concerned, however, the production of these cannot be expected in the near future.

#### Sources:

VALVO: 'Liquid crystal display elements', VALVO technical information for Industry, March 1978, nr. 780329.

FAIRCHILD: 'LCD 78', LCD brochure of the Fairchild Camera and Instrument Corporation.

Martin Bechteler: 'Liquid Crystal Displays highly reliable components' SIEMENS components report 17(1979), Volume 3.

Paul Smith: 'Multiplexing Liquid-Crystal Displays' Electronics, May 25, 1978, p. 113.

D. Davies, W. Fischer, G. Force, K. Harrison and S. Lu: 'Practical liquid crystal display forms forty characters', Electronics, January 3, 1980.

Figure sources:  
 Figures 1, 4, 6b, 7, 9b, 11, 12b, photo 2 and photo 3: Siemens.  
 Figures 2a, 2b Fairchild Camera and Instrument Corp.  
 Figure 6a: VALVO.  
 Figure 10: Data Modul.  
 Figure 13, photo 4: National Panasonic/Matsushita  
 Photo 1: HAMLIN

# flexible intercom system

P. Deckers

## a mobile communication system

Certain requirements must be met if an intercom system is to be fully flexible and efficient. It is essential that any station can call any other without the need for a master station. The number of interconnecting wires should be as few as possible, conversations between any two stations should remain private and the standby current drain needs to be low. It would be useful if the system could also operate as a babyphone without blocking the line.

The intercom described here complies with all of these requirements while being flexible with regard to station location.

Number 98 in the Elektor Summer Circuits (1979) issue reached a respectable twelfth position in our recent competition, reason enough for us to look at the circuit in greater detail. It achieves everything that is required of an intercom system and consequently remains unchanged. (A minor error did occur in the original circuit diagram, however, resistor R20 should have a value of  $1\Omega$  and not  $1k\Omega$ ).

The intercom system is designed to have a maximum of five stations with complete security between any two. Furthermore, any station can be wired as a babyphone. The system operates on a four-wire ring cable laid in any convenient manner, that is, two or more stations can be connected in the same length of cable 'in series', or individually by a 'spur', or in any combination that happens to fit the 'bricks and mortar'. For further flexibility suitable sockets

can be placed in any desired position and if all stations are equipped with plugs they then become completely mobile. The only criterion in the cable network is that the power supply should be connected to it - at any convenient point.

### Block diagram

Figure 1 shows the block diagram of one of the stations (number two) together with the power supply. The four wires of the ring circuit carry the positive and negative of the 15 volt supply, the audio signal, and the control signal (S). Depending on the station's number, one of four reference voltages can be switched to the control line while a fifth reference voltage is connected directly to one input of a window comparator. In this way the

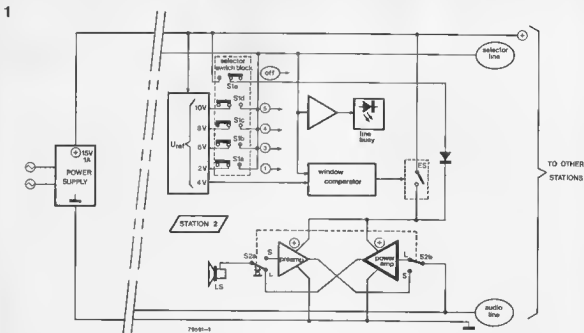

Figure 1. The block diagram of a single intercom station. The power supply only appears once throughout the system and can be connected to the ring cable at any convenient position. Station 2 is shown here.

comparator will receive the second lowest reference voltage from station 2 and the highest, for instance, from station 5.

As the comparator's other input is connected to the control line, when the voltage on the S line is the same as the reference voltage for a particular station, the electronic switch (ES) will close thereby supplying power to the preamp and power amplifier stages. When inoperative, the 'push-to-talk' switch (S2) will be in the 'listen' position, so that the audio signal on the LF line reaches the loudspeaker by way of S2 and the power amplifier. To reply, push-

button S2 is pressed. The loudspeaker will then be connected to the input of the preamp and will function as a microphone. The output signal of the preamp is fed to the LF line via S2b.

When there is a reference voltage on the S line, a 'line busy' indicator will light at every station.

To call a particular station, the corresponding key (S1a...S1d) is pressed causing the relevant reference voltage to appear on the S line. As all five switches are mounted in an interlocking group, pressing one of the keys S1a...S1d will cause the S1e key to drop out and to feed the amplifiers with supply volt-

age. Again, S2 can be used to switch between transmission and reception. As the S line voltage no longer corresponds to the reference voltage of the station itself, the ES switch will remain open.

### Circuit diagram

Figure 2 shows the complete circuit diagram of one station. The five reference voltages are derived from the supply via five zener diodes (D1...D5) which are connected in series. Resistor R1 ensures that a current of approximately 12 mA passes through the zener

2

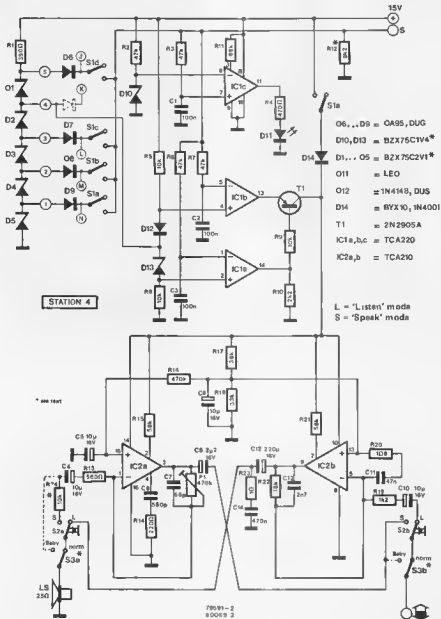

Figure 2. Circuit diagram of intercom station 4. Diodes D6...D9 and switches S1a...S1d are connected differently for each station. The reference voltage at the junction of D12/D13 determines the station's number.

3

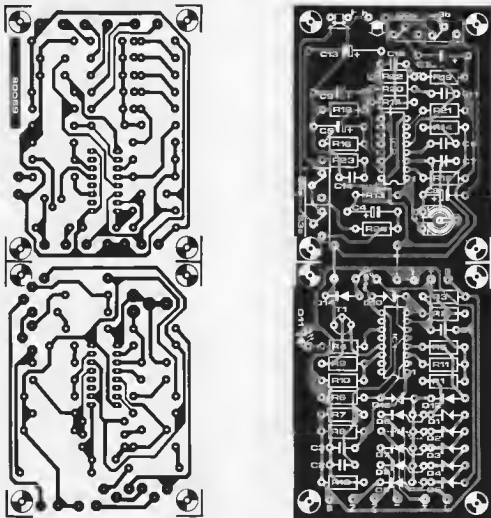

Figure 3. The printed circuit board and component layout for one station.

## Parts list

Resistors:	R18 = 33 k
R1 = 390 $\Omega$	R19 = 1k2
R2, R3, R7, R8 = 47 k	R20 = 10 $\Omega$
R4 = 470 $\Omega$	R22 = 18 k
R5, R6, R9, R24 = 10 k	R23 = 1 $\Omega$
R10 = 2k2	P1 = 470 k (500 k) preset
R11 = 68 k	
R12 = 8k2	Capacitors:
R13 = 580 $\Omega$	C1, C2, C3 = 100 n
R14 = 220 $\Omega$	C4, C5, C9, C10 = 10 $\mu$ /16 V
R15, R21 = 56 k	C6 = 560 p
R16 = 470 k	C7 = 56 p
R17 = 39 k	C8 = 2 $\mu$ /16 V
	C11 = 47 n
	C12 = 2n7
	C13 = 220 $\mu$ /16 V
	C14 = 470 n

## Semiconductors:

D1 ... D5 = 8ZX75C2V1 (or green LED, or 3 x 1N4148 in series)  
 D6 ... D9 = OA95, DUG  
 D10, D13 = 8ZX75C1V4 (or red LED, or 2 x 1N4148 in series)  
 D11 = LED  
 D12 = 1N4148, DUS  
 T1 = 2N2905A  
 IC1a,b,c = TCA220  
 IC2a,b,c = TCA210

## Miscellaneous:

S1a ... S1e = 5 key interlocking switch  
 S2a,b = double pole pushbutton switch  
 S3a,b = double pole on/off switch



diodes. The call up voltages for the other four stations are selected by means of switches S1a...S1d via diodes D6...D9. The remaining reference voltage is connected to the junction of diodes D12 and D13 which form one input of the window comparator (IC1a and IC1b). As it is station four which is shown in the diagram, the reference voltage will be 8.4 V (4 x 2.1 V). Therefore the voltage levels on the non-inverting inputs of IC1a and IC1b are 7 V and 9 V respectively. When the voltage on the S line is somewhere between these two levels, the output of IC1a will be low and the output of IC1b will be high. Transistor T1 (the electronic switch of figure 1) will start to conduct thereby providing the preamp and power amplifier (IC2a and IC2b respectively) with power. A call up voltage greater than 1.4 V on the S line is detected by IC1c which will light D11 to indicate that the audio line is busy. S1a...S1d together with S1e form a row of interlocking keys. When one of these is pressed, any key which was depressed earlier will spring back. Switches S1a...S1d are wired so that contact is made when they are depressed. Switch S1e on the other hand, is wired so that contact is made when it is not depressed ('the other way round'). S1e should be depressed whenever one has no intention of conveying a message. This will put the unit in the receiving or 'listen' mode. Switch S3 enables the intercom to be used as a babyphone. In the baby's room the intercom station is switched over to 'babyphone'. This makes the unit's preamp slightly more sensitive since it bypasses resistor R24. The output of the preamp is fed continuously to the LF line via S3b. Every other station can 'listen in' to this room simply by pressing the corresponding button (and at the same time conver-

sation can be held between the other stations as normal).

### Construction and setting up

The printed circuit board and component layout for the flexible intercom are shown in figure 3. There are four mounting holes in the centre of the board, apart from the ones at each of the four corners. This enables the board to be mounted as a single unit. An alternative is to saw it in half and mount the two halves one on top of the other. Both halves are connected by a pair of wires.

During construction the correct positioning of diodes D6...D9 and the connection of the key switches must not be omitted. This is because there are five reference voltages and only four connections to the S line. The fifth is connected directly to the junction of D12/D13. This means that there is one wire link on each of the five printed circuit boards and in each case it is in a different place.

The power supply can be virtually any 15 V/1 A type. A suitable circuit is shown in figure 4. The power supply can be connected to the ring cable at any convenient point.

It should be mentioned that the 2.1 V and 1.4 V zener diodes may prove difficult to obtain, in which case they may be substituted for green LEDs and red LEDs respectively. For this purpose the LEDs should be forward biased. Resistor R12, the pull down resistor on the control line, is only required in one of the stations.

The intercom system needs very little adjustment. The sensitivity control P1, should be adjusted while the circuit is switched to the babyphone mode, whereas the sensitivity of the intercom during normal operation is determined by the value of R24.

# missing link

Modifications to Additions to Improvements on Corrections in Elektor Circuits published in Elektor

### Car Collision Alarm

Elektor no 51/52, July/August 1979 issue p 7-89. In order to ensure that transistor T4 is saturated, so that the alarm goes off correctly, T3's emitter will have to be connected to the 5 V supply instead of the 12 V supply, R9 should have a rating of 2W and D1 will have to be replaced by a wire bridge.

### Top Preamp

Elektor no 57, December 1979 issue p. 12-15. On the p.c. board parts layout IC5 should be rotated 180°.

### Chorusynth

Elektor no 59, March 1980 issue p. 17-23. The parts list for our Chorusynth proto-type was inadvertently substituted for the revised, updated one. We apologise for the error, and include a complete and corrected parts list below.

One last note, the regulator IC17 should be rotated 180° on the parts layout in figure 5

#### Resistors:

R1 = 10 M  
R2, R3, R6, R10,  
R21 = R43, R64, R68,  
R74, R75, R82, R84 = 10 k  
R4, R73 = 100 k  
R5 = 1 k  
R72 = 5k6  
R7, R77, R78 = 1 M  
R8, R9, R19, R20,  
R66, R70, R80 = 47 k  
R11, R53, R62 = 22 k  
R12 = R15 = 18 k  
R16 = 15 k  
R17 = 4k7  
R18 = 82 k  
R44 = R52 = 1k8  
R63, R67 = 39k  
R65, R69 = 6k8  
R71, R978 = 330 Ω  
R76 = 100 Ω  
R79 = 470 k  
R81 = 2k2  
R83 = 1 k  
R85 = 220 Ω  
R86A, R1128 = 5.6 Ω  
R86B, R1028 = 0.56 Ω  
R87A = 6.8 Ω  
R87B, R90B = 150 Ω  
R88A, R89A, R92A = 10 Ω  
R88B, R108, R112A = 22 Ω  
R89B, R110A,  
R111A, R113A = 27 Ω  
R90A, R91, R94A, R1098 = 8.2 Ω  
R92B, R98B = 88 Ω  
R93A, R96A, R97A,  
R99A, R100A = 12 Ω  
R93B = 39 Ω  
R94B, R106B = 1.6 Ω  
R95A, R98A, R101A, R102A,  
R105A, R109A = 15 Ω

4

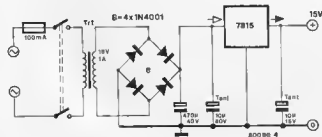

Figure 4. A simple power supply circuit for the intercom system. Virtually any 15 V/1 A type supply will suffice.

(parts list continued overleaf)

## Part list Chorosynth (continued)

R95B, R114A = 33  $\Omega$   
 R96B = 120  $\Omega$   
 R99B = 1  $\Omega$   
 R100B = 1.8  $\Omega$   
 R101B = 560  $\Omega$   
 R103A, R104A,  
 R106A, R107A = 18  $\Omega$   
 R103B = 180  $\Omega$   
 R104B, R114B = 470  $\Omega$   
 R105B = 3.3  $\Omega$   
 R107B = 2.7  $\Omega$   
 R110B = 270  $\Omega$   
 R111B = 680  $\Omega$   
 R113B = 2.2  $\Omega$   
 R115B = 120 k  
 R116 = 100  $\Omega$   
 R115A = 1k24 1%

## Potentiometers:

P1 = 1 M preset  
 P2 = 1 M lin  
 P3 = 22 k lin  
 P4, P5 = 10 k lin  
 P6, P7, P8, P9 = 25 k preset  
 P10, P11 = 500 k log  
 P12, P13 = 10 k preset  
 P14 = 250  $\Omega$  preset

## Capacitors

C1 = 470 n  
 C2, C3, C4 = 3n3  
 C5 = 2n2  
 C6, C7, C8, C9, C18 C26,  
 C41 = 10  $\mu$ F/35 V tantalum  
 C10 . . C14, C17, C3B, C39,  
 C40, C42 . . C45,  
 C50, C51 = 100 n  
 C53 = 47 n  
 C15, C36 = 4 $\mu$ 7/35 V tantalum  
 C16 = 2 $\mu$ 2/35 V tantalum  
 C27, C28, C31, C52 = 10 n  
 C29, C30, C35, C37 = 47 n  
 C32 = 12 n  
 C33 = 22 n  
 C34 = 27 n  
 C46 = 1000  $\mu$ /35 V  
 C47 = 330  $\mu$ /35 V  
 C48, C49 = 330 n

## Semiconductors

D1 . . D4 = DUS  
 D5, D6 = 1N4001  
 T1 . . T5, T8, T10, T13 = BC 557  
 T6, T7, T12 = BC 547  
 T9, T11 = BF 256B for BF 245B1  
 IC1 = LF 356  
 IC2, IC4 IC7 = 555  
 IC3 = 741  
 IC8, IC9 = 4520  
 IC10, IC11, IC12, IC18 = 4011  
 IC13, IC14 = TL 084  
 IC15 = 78L15  
 IC16 = 78L12  
 IC17 = 79L15

## Miscellaneous:

T1 = 16 V/150 mA transformer  
 S1, S5 . . S15 = SPDT  
 S2, S3, S4 = DPDT  
 L1 . . L4 = 5 turns of 0.2 mm dia. enamelled copper wire on a ferrite bead

# market

## Anti-slipping material

When you're trying to repair a tiny mechanism on the workbench, but it keeps slipping away; or you want to solder a connection on a circuit board, which won't stay put, or you must adjust a delicate instrument, holding it in place while doing so without leaving vicemarks on it — how do you solve these problems?

The answer in these and similar situations may well be an antislip material, produced by Spring (Switzerland) and now available in the UK from Cobonic Ltd., London. Called 'Stop Slip' elastomer, these high-friction flexible mats come in two thicknesses — 1 mm and 2 mm — and any desired dimension up to 1 meter (3 2 ft) square. The 1 mm material, which can also be ordered in roll lengths, is produced only in a deep blue; the 2-mm mats are available in three additional colours: green, red and yellow.



What makes a StopSlip elastomeric pad so useful is its incredibly high coefficient of friction. A piece of StopSlip material can be brought very close to vertical, and flat objects simply placed on it — not stuck on — will stay in place.

Tackiness of the StopSlip mats is inherent in the material: it does not gradually decrease, nor is it affected by repeated wetmopping.

Cobonic Ltd., Knapton Mews, Seely Road, London SW17 9RL.  
 Telephone: (011) 767-6780

(1522 M)

## A new generation of cases

The Bocon range of instrument cases from West Hyde Developments have been widely acclaimed for their impeccable tooling, and the latest two types will certainly be no exception.

The Bocon 'Desk' series is made in black ABS in four sizes. These beautiful mouldings have an ingenious stepped tongue and groove construction, with highly polished surfaces and flat, textured areas on the top. The one-piece front panel is natural anodised aluminium, angled to provide three separate surfaces. Inside there is provision for p.c. boards or chassis.

The Bocon 'Commander', BDC 690, is a keyboard and display enclosure made in black foam plastic. The housing is designed to accept most proprietary keyboards, and has a similar finish to the rest of the Bocon range.

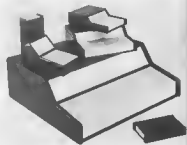

The front and rear panels are natural anodised aluminium, completely flat, and the rear aperture will accept a 19" rack frame 3U high. There is a second smaller 'Commander' Model BDC 680, for keypads and smaller displays, constructed as two clip-together halves in black ABS. The two top anodised panels are also flat and the base incorporates four brass inserts to support a standard Euro card.

West Hyde Developments Ltd.,  
 Unit 9, Park St, Ind Est.,  
 Aylesbury, Bucks HP20 1ET  
 Telephone: (0296) 20441

(1523 M)

## The world's lowest noise audio preamp IC?

Claims based on the above superlative tend to be taken with a pinch of salt, and particularly in the electronics business, where such a stab of affairs may be very short lived. However, the HA12017 now in stock at AMBIT is a sufficiently superior device to warrant such billing.

The SIL housed IC uses Hitachi's new silicon surface process, to provide an exceptionally low noise characteristic, that is reliably repeatable in mass production. Under standard pickup conditions, a S/N ratio of 82.6 dB is achieved, with an equivalent input noise of just 0.185  $\mu$ V.



However, as well as this phenomenal feature the IC has less than 0.002% THD over the audio band of 20 Hz to 20 kHz, at an output level of 10V (RMS) — again with the measurement carried out under IIAA conditions. The SIL package means that isolation between stages is kept to a maximum.

Ambit International,  
 200 North Service Road,  
 Brentwood,  
 Essex, CM14 4SG.  
 Telephone: (0277) 230909.

(1512 M)

# market

# market

## Improved capacity range tuning diodes

Toko has now introduced the new KV1235 and KV1236 range of high capacity ratio tuning diodes.

Both types employ the unique 'snap-apart' principle of packaging, that enables close tolerance matching of multiple diode arrays to be achieved whilst maintaining full layout flexibility, with individual tuning diode packages.

The new diodes have a guaranteed 16.8:1 tuning capacity range with only 1... 9 V DC tuning bias required, and are supplied in only two banks of basic min/max capacity values. The actual swing is typically from 25 pF to 500 pF (20:1), allowing for a great deal of stray capacity and general circuit tolerance in radio designs.



The diodes are available in matched triplets (KV1235), or pairs as illustrated (KV1236). Ambit is stocking these devices, together with applications data covering a revolutionary new technique in radio design that virtually eliminates tracking error and stray electrostatic pickup on antenna connection wiring.

*Ambit International,  
200 North Service Road,  
Brentwood,  
Essex, CM14 4SG.  
Telephones: (0277) 230909*

(1513 M)

## New Trio oscilloscope offers high technology at low cost

The Trio Model CS-1830 oscilloscope has been introduced to meet an extremely broad spectrum of signal measurement requirements, and offers a comprehensive range of user facilities for the display of audio, video, pulse and digital signals within a band width from DC to 30 MHz. These include sweep and trigger display functions, which assist in the detailed analysis and measurement of complex waveforms, and a vertical sensitivity of only 2 mV per division.

The CS-1830 uses a domed mesh PDA rectangular c.r.t. of 120 x 96 mm, which incorporates an internal graticule. This type of c.r.t. also provides extreme brightness and clarity



of display and introduces minimal parallax distortion.

Other features include an automatic synchronisation system, which eliminates the need for problematical sync. determination procedures; a 'single-sweep' facility, for the measurement of single pulse waveforms, a 'hold-off' function, which ensures stable synchronisation for highly complex video or logic waveforms; and 'auto free-run', which assists in voltage measurement and the detection of input signals.

Additionally, delayed and normal sweeps are selectable for both display channels, and Lissajous patterns may be used for the measurement of phase differences in the signals input to the two channels. Its input impedance is 1 M $\Omega$ , and it will accept signal inputs at up to 600 V peak-to-peak or 300 V DC. Accessories include 2 complete probes, power cable and operators' manual. It is priced at £ 455.

*House of Instruments,  
34/36 High Street,  
Saffron Walden,  
Essex, CB10 1EP.  
Telephone: (0799) 22612*

(1517 M)

## Lightweight vice

Ideal for both professional and amateur workshops, as well as laboratories and field service engineers, OK's new VV-1 light duty vice has been designed for precision handling of small components and assemblies. Normally it would be fixed to work surfaces by a lever-operated suction mechanism but where permanent installation is required it can be screwed down.

The 1½in (38 mm) wide jaws have 1½in (32 mm) travel controlled by a large knob for



precise positioning. The body is moulded from tough ABS, with built in fixing lugs, and the unit is light enough to be carried in a tool kit. Priced at £ 3.29 including VAT and postage.

*OK Machine & Tool (UK) Ltd,  
Dutton Lane,  
Eastleigh,  
Hants SO5 4AA,  
Telephone: (0703) 610944*

(1515 M)

## Semi-automatic half panel turntable units

Symot Limited announce that two models of a semi-automatic half-panel turntable unit are now in production: the model FX 201 DR incorporating a coralsite type direct drive motor, and the model FX 201 XR, a belt drive model incorporating a frequency generator servo motor. Both models have a mechanically similar appearance and incorporate a high quality 12" aluminium die cast platter, rubber mat and 50/60 Hz strobe markings on the periphery.

The tone arm is of high-quality, low-mass, tubular S-shaped construction, incorporating a removable head shell. The arm has an oil damped cue control and an adjustable anti-skating device. The tracking force is controlled by a removable and adjustable counter weight. Both models incorporate an automatic return and stop function initiated at the end of record play by the relative position of the tone arm.

Wow and flutter is typically 0.06 wrms (DIN) for the direct drive model and 0.075 wrms (DIN) for the belt drive model. Fumble for



both models is typically better than 65 dB DIN B.

Both motors require low voltage DC supplies, the direct drive variant nominally 16 V and the belt drive variant nominally 12 V.

Load current for the direct drive variant is 100 milliamps or less for 33 ⅓ rpm and the belt drive variant requires 60 milliamps or less, again at 33 ⅓ rpm. Starting current for both models is about 750 milliamps maximum.

*Symot Limited,  
22a Reading Road,  
Henley on Thames,  
Oxon RG9 1AG  
Telephones: (049 12) 2663*

(1519 M)

# market

# market

## DC switched and tuned AM radio unit

The new 91072 from Ambit International is available in three stages of complexity, culminating in a four band unit that can be (uniquely) both switched and tuned by DC connections only.

Switching uses a 'ground-to-make' system, enabling easy control from MPU bus lines if required.

The standard bands are: Longwave 150-400 kHz, Mediumwave 510-1620 kHz, SW1 5-10 MHz and SW2 1.6-4 MHz. Any frequency span of approximately up to 3:1 ratio can be accommodated in the region 100 kHz to 30 MHz to special order.

The unit is intended for broadcast radio reception, and is fitted with a 68 kHz bandwidth multi-element ceramic filter. A

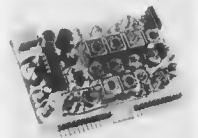

buffered local oscillator output, together with DC switchoff through a high impedance drive is also available.

Tuning a complete 3:1 frequency span is achieved with only 1...9 V bias, thus the unit may readily be interfaced with any Ambit tuning synthesiser system.

The board is normally supplied in a screening can, with edge connector terminations, or may be supplied as a bare PCB for incorporation into larger enclosures (as illustrated). The antenna for LW/MW is a ferrite rod, but the other two bands are intended for long wire termination. If required, the two SW bands may be substituted with wire fed MW/LW.

*Ambit International,  
200 North Service Road,  
Brentwood, Essex, CM14 5JG.  
Telephone: (0277) 230909*

(1514 M)

## 4½-digit multimeter

Gould Instruments Division has introduced a new 4½-digit multimeter, the DMM12, which features a liquid crystal display, a measurement accuracy of 0.05% and a built-in electronic technique for making true root-mean-square (r.m.s.) measurements on AC signals. Using the latest solid-state circuitry and components specifically selected for high stability and low noise performance, the DMM12 has 27



measurement ranges for AC and DC voltage, current and resistance, and is also available with optional probes for radio-frequency and high-voltage measurements.

The Gould DMM12 digital multimeter has an ergonomically designed front panel using the latest international symbols. Maximum reading is 19999, and maximum resolutions on current, voltage and resistance measurements are 10 µV, 10 nA and 100 mΩ, respectively. The liquid crystal display incorporates separate positive or negative polarity indication plus a decimal point. Overrange and 'battery low' are also indicated using the display.

The true r.m.s. sensing AC/DC converter used in the DMM12 can accept waveforms with a crest factor (peak/r.m.s. ratio) of up to 4:1 at full scale, and a combined AC/DC facility is available to measure AC waveforms with a DC content. The true r.m.s. value measures the energy content of an AC waveform, and hence makes the DMM12 ideally suited to power-system measurements.

The DMM12 is housed in a rugged case and meets IEC348 and VDE specifications. Standard models are mains/line powered but option BP12 gives true portability with rechargeable cells.

*Gould Instruments Division,  
Roebuck Road,  
Hainault,  
Essex, IG6 3UE  
Telephone: (01) 500 1000*

(1518 M)

## Portable capacitance meter

The new Model B20 portable capacitance meter from Havant Instruments Limited is an economical multi-range instrument combining digital accuracy with complete portability. Its ten ranges cover capacitances from 0.1 pF to 1 Farad. Accuracy is 0.5% or 1% of full scale, and resolution down to 0.1 pF, according to range.

In use the capacitor leads are simply inserted into a pair of slots and the capacitance is indicated on the clear 4-digit LED display. A flashing display provides overrange indication. Provision is also made for using jack plugs



(1521 M)

when measuring in-circuit capacitances. The Model B20 is ideal for production line or laboratory use. It has a robust and attractive moulded case but weighs only 875 g (1.51 lb). It will operate with rechargeable or disposable cells and there is provision for a charger. A tilt stand, spare fuses and 26-page operating manual are supplied.

*Havant Instruments Ltd,  
Unit 3,  
Westfield,  
Portsmouth Road,  
Horndean,  
Hants.  
Telephone: (0705) 596020*

(1520 M)

## A new magnetic tape head

Being introduced by Monolith Electronics is a new magnetic tape head for compact cassette machines.

The C44RP2ES01 is a four channel cassette head for record and playback, which also has combined two independent half track erase sections, thereby providing for full stereo autoreverse record/playback and erase all in one unit.

This head is produced to the standard "EIAJ" mounting format, making it suitable for most tape transports, having 17 mm spaced mounting holes, and measuring 12 mm from hole centre to front face. Wiring is facilitated by the use of a printed circuit board mounted to the rear.

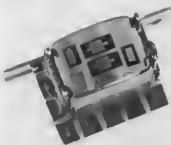

Each record/playback channel has an impedance of 650 ohms at 1 KHz, with a head gap in the order of 1.5 microns giving a playback frequency response of +10 dB over the range 8 KHz/333 Hz.

The erase sections have an efficacy of better than 55 dB on a 1 KHz signal. The C44RP2ES01 was designed for autoreversing stereo recorders, but may also be suitable for certain data recording purposes.

*The Monolith Electronics Co. Ltd,  
5/7 Church Street, Crewkerne,  
Somerset TA18 7HR,  
Telephone: (0460) 74321*

# market

# market

## Miniature chokes

The new BR8S series of fixed inductors adds a fourth member to TOKO's range of signal chokes.

The BR8S spans from 100  $\mu$ H to 15 mH in a diminutive package, based on 5 mm pin spacing, with O's as high as 80.

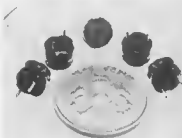

The major applications are in transient suppression in sensitive logic circuitry, and as a general decoupling device to keep equipment RF interference levels within the recently introduced international standards.

*Ambit International,  
200 North Service Road,  
Brentwood,  
Essex, CM 14 4SG.  
Telephone: (0277) 230909*

(1508 M)

## Miniature encoder switch produces BCD signals

A miniature rotary encoder switch, having 10 positions and a four line binary coded decimal output, has been introduced by Impetron Limited.

Measuring only 23 x 23 x 19 mm overall (excluding mounting pins and spindle) the BCM 23 switch will enable designers to fit a low cost encoder into tight corners. The device will prove particularly useful where manual controls or mechanical assemblies have to be interfaced to electronic logic.

The unit has five signal pins and two fixing tags for PCB mounting, and may also be front panel mounted using a threaded spindle bush and nut. One signal pin is for voltage supply,

while the others represent 1, 2, 4 and 8. On position '0' no contact is made, but as the spindle is clicked around its remaining 9 positions the four output pins represent the number of the position selected in 8CD form. The spindle may be continuously rotated, and in this mode may be used as a shaft encoder with 36° resolution.

The BCM 23 is manufactured to high standards, although it is a relatively low cost device. Rated operational life is greater than 10<sup>7</sup> rotations, (2 million steps) and operating torque is as low as 500 gcm.

The electrical rating of the switch is such that it may be directly connected to substantial current drains. Power rating is 3 W maximum, with maximum voltage and current ratings of 200 V and 500 mA DC

*Impetron Ltd.,  
Foundry Lane,  
Horsham,  
W. Sussex RH13 5PX,  
Telephone: 0403-50111*

(1510 M)

## Economy wire stripper and cutter

A new simple-to-operate wire stripper and cutter has been introduced by AB Engineering Company. Known as the AB MK 001, it features a knurled knob adjustment to control the stripping depth, a retaining clip to ensure it remains in the closed position in the tool box or pocket and a curved cutting edge which provides a scissor-like action for clean wire cutting.

Based on the well proven AB MK 100, the new MK 001 has an improved locking device and is priced at £1.85.



*AB Engineering Company,  
Timber Lane,  
Woburn, Beds. MK 17 9 PL.  
Telephone: (052525) 322/3/4/5.*

(1511 M)

## Weston 6000 autoranging multimeter

This compact, rugged, lightweight instrument combines the accuracy and convenience of digital readout and measurement hold with the broad range coverage of conventional VOM's. 3½ digit ½" high reflective liquid crystal display gives excellent readability over a wide range of ambient light levels. The autoranging facility means that 26 ranges of measurement are available with only two switches to select functions. Two disposable 9 V transistor batteries offer more than 200 hours of continuous operation. A carrying handle serves as a tilt stand and a display window protector. The unit is supplied with

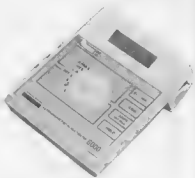

leads in a strong carrying pouch — ideal for tool kit use. DC and AC volts 200 mV, 2 V, 20 V, 200 V and 1000 V ranges. DC and AC current 2 mA, 20 mA, 200 mA, 2 A, 10 A ranges. Resistance ranges 2000 to 20 M $\Omega$ . Typical accuracy 0.5%. Overall dimensions 7" x 5½" x 2½". The Weston 6000 Multimeter with pouch costs £ 145.00 + VAT.

*Toolrange Ltd.,  
Upton Road,  
Reading RG3 4JA.  
Telephone: (0734) 29446 or 22245*

(1526 M)

## Wire wrapping kit

Ideal for small scale production, field service or hobby use, OK Machine & Tool (UK) Ltd's 'Just Wrap' Kit complements the new 'Just Wrap' wire wrapping tool. The tool wraps 30 AWG (0.25 mm) wire onto standard 0.025 square posts without stripping or slitting the insulation and can 'daisy chain' continuously through several points or be used for point-to-point wiring. It contains a built-in wire cut-off device for terminating the final connection of each chain. The JWK-6 Kit

### JUST WRAP KIT



contains the tool plus the JUW-1 unwrapping tool and four 50ft wire refill cartridges one each in red, white, blue and yellow, all packed in a sturdy, re-usable clear plastic box

*OK Machine & Tool (UK) Ltd,  
Dutton Lane,  
Eastleigh,  
Hants SO5 4AA  
Telephone: 0703 610944*

(1516 M)

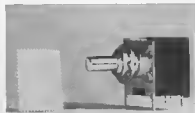

# market

# ELEKTOR BOOK SERVICE

## 300 CIRCUITS

"FOR THE HOME CONSTRUCTOR"

This book of more than 250 pages contains clear descriptions of 300 projects ranging from the basic to the sophisticated

PRICE £1.95 + 50p postage & packing (UK only)  
OVERSEAS SURFACE MAIL £3.70

300  
circuits

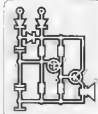

## BOOK 75

PRICE £3.00 + 50p postage & packing (UK only)  
OVERSEAS SURFACE MAIL £3.70

A selection of some of the most interesting and popular construction projects that were originally published in Elektor issues 1 to 8. 30 projects are contained in this book, plus a 'DATA' section which includes a chart of pin connections and performance for common-anode LED displays, valuable information on MOS and TTL ICs, opamps, transistors and our tap-tun-dug-dus code system for transistors and diodes. With over 100 pages, the wide variety of projects in this book stimulates the professional designer to up-date his knowledge and even the beginning amateur should be able to build most of the projects.

## FORMANT

COMPLETE CONSTRUCTIONAL DETAILS OF  
THE ELEKTOR FORMANT SYNTHESISER

If you are even mildly interested in synthesisers then this is the book for you. It's all here - setting up procedures, hints and tips and more. We have taken the trouble to include a FREE cassette of sounds that the FORMANT is capable of together with suggestions on how to achieve them.

PRICE £4.00 + 50p postage & packing (UK only) OVERSEAS SURFACE MAIL £5.70



## DIGIBOOK

Provides a simple step-by-step introduction to the basic theory and application of digital electronics. Written in Elektor's typical style, there is no need to memorise dry, abstract formulae - instead you will find clear explanations of the fundamentals of digital circuitry, backed up by experiments designed to reinforce this newly acquired knowledge. For this reason DIGIBOOK is accompanied by an experimenter's PCB which will facilitate practical circuit construction.

PRICE £4.50 + 50p postage & packing (UK) OVERSEAS SURFACE MAIL £5.20

*When ordering please use the  
ELEKTOR READERS ORDER CARD  
in this issue*