

# elektor

up-to-date electronics for lab and leisure

58  
February 1980

U.K. 55p.  
U.S.A | Can. \$1.75

vocoder (2)

constructional details

aerial amplifiers  
yes or no? and, if so, how?

digisplay  
logic levels on a scope.

Australia	\$ 1 50*
Austria	S 38
Belgium	F 63
Denmark	Kr 10
France	F 8
Germany	DM 4 40
Netherlands	DFL 3 75
New Zealand	\$ 1 50
Norway	Kr 10
Sweden	Kr 14
Switzerland	F 4 60
* recommended	

# elektor

# 58

# contents

february 1980  
volume 6  
number 2

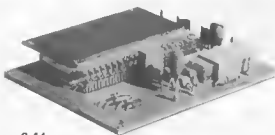
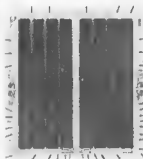
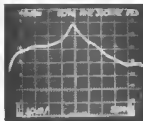

page 2-44

The integrated circuit used in the digital thermometer was originally intended for use in freezers. Only a few other components are required for this unit, and mounting the IC underneath the LCD display makes for a very compact construction.



page 2-04

The aerial booster can be provided with a frequency selective input filter, giving this result. Alternatively, omitting this filter enables selective amplification over the entire 80 ... 800 MHz range.

page 2-34

Analogue delay technology is becoming ever more complex and ever more 'powerful'. This chip, for instance, contains four split-electrode CTDs. Together, they perform a mathematical operation that can prove of fundamental importance in speech recognition and synthesis.

selektor ..... 2-01

aerial booster ..... 2-04

The design targets for this novel aerial amplifier were: low noise, ample gain, wide dynamic range, wide frequency range and last, but by no means least, the possibility of using the same printed circuit board for both wide and narrow pass-band versions.

FET opamps in the Formant ..... 2-09

At several points in the Formant music synthesiser circuit, FET source followers are used as high-impedance output buffers. This type of stage is not always the best solution and an alternative is well worth considering, an operational amplifier with an FET input stage.

TV interference suppression ..... 2-12

Annoying interference on a TV receiver can be caused, among other things, by local transmitters. Usually, however, this can be dealt with in a fairly simple and effective way.

coming soon ..... 2-13

elektor vocoder (2) ..... 2-14

Last month, we explained the basic principles of the Elektor vocoder. From the block diagrams and circuits given, it should be clear how the unit works - once you've built it. And that is what this article is about: the printed circuit boards, full constructional details and calibration procedures.

aerial amplifiers ..... 2-27

Aerial amplifiers are frequently used to try to improve the sensitivity of an existing receiver.

Contrary to the opinion of those who claim that aerial signal amplification is of no use whatsoever, many advocates insist that amplification will often lead to improved performance. For a well-founded appraisal of the various 'for and against' arguments it is interesting to investigate the problems involved.

display (A. Kreut) ..... 2-32

One of the winning circuits of the Eurotronics competition was circuit no. 68 in the 1979 Summer Circuits issue: the display. We promised p.c. boards for winning circuits ...

analogue delay technology ..... 2-34

Bucket brigade delay lines are not unknown to Elektor readers. We've used them in an analogue reverb unit and for a TV scope. At that, we've really only scratched the surface of what promises to be a new area in electronics: analogue delay line technology. New types of delay line are appearing at regular intervals, and new applications are even more commonplace. Not only reverb, phasing and similar 'musical' applications, filtering, scrambling and real-time spectrum analysis are also possible.

extending the 1/2 GHz counter ..... 2-41

A few readers have suggested extension circuits for the 1/2 GHz counter (Elektor, June 1978). The two extensions described here - leading-zero blanking and period measurement - are independent circuits. This means that either or both can be added, as required.

digital thermometer ..... 2-44

The AY-3-1270 (General Instrument) is intended for use in freezers. It can also be used in a very compact digital thermometer circuit, as described here. Either liquid crystal (LCD) or LED displays can be used.

market ..... 2-48

advertisers index ..... UK 26

# DORAM 'ARE BACK IN BUSINESS'

DORAM Electronics Ltd., a name well known in the home electronics market, are back in business under new management. We aim to combine our many years of experience supplying kits and components worldwide with personal service to our new customers.

## ELEKTOR PROJECT PACKS

Touch Tuning (79519)	£17.80	Colour Generator 80027	£19.70
Gate Dipper (79514)	£15.95	Sound Generator (80009)	£18.45
Digifard (79088)	£25.10	Simple Sound Effects (79077)	£ 5.90
Variable Fuzz box (9984)	£ 6.55	Digital Tuning Disp 80021	£36.30
Topamp DM931 (80023)	£16.85	Oscillographics (9970)	£11.50
Topamp DM961 (80023)	£31.75	Sinewave Generator (79019)	£ 8.90
Topamp Power Supply (OM931) 8 ohm	£22.45	Cackling Egg Timer (9985)	£ 7.20
Topamp Power Supply (OM961) 8 ohm	£20.80	Electronic Nuisance 80016	£ 3.85
Timp Modulator 80054	£10.00	Guitar Preamp (77020)	£ 6.22
Guitar Frequency doubler 80065	£ 5.45	Metal Detector (9750)	£11.45
Consonant (9945)	£34.65	Elekdoorbell (79095)	£22.00
Preconsonant (9954)	£5.75	Video bofeedback (9825 1-2)	£19.75
Luminant (9949)	£20.70	Simple Function Generator (9453)	£27.70
Elektonado + H/S (9874)	£19.50	Equaliser + Slider pots (9832)	£17.70
Moving Coil preamp (9911)	£19.50	Steam Train 80019	£ 6.50
Touch Dimmer (78065)	£6.80	Mini Counter (9927)	£25.65
Ioniser (9823)	£9.55	Nicad Charger (79024)	£14.25
Pools Predictor (79053)	£8.15	Lab Power Supply 2.5 Amp (79034)	£33.45
Kirlian Camera (4523/9831)	£18.40	Lab Power Supply 5 Amp (79034)	£41.65
Magnetiser (9827)	£4.90	Piano + Keyboard	£259.00

## SC/MP MICROPROCESSOR KITS

RAM I/O (9846-1)	£27.60
CPU Board (9851)	£57.45
Memory Ext. (9863)	£49.45
BUS Board + Sockets (9857)	£11.65
HEX I/O (9893)	£52.85
4K RAM (9885)	£104.45
Power Supply (9906)	£20.95
Cassette Interface (9905)	£14.45
ASCII Keyboard (9965)	£46.30
Elekterminal (9966)	£69.55
ELBUG Eproms	£37.00
Basic Micro (79075)	£57.75
Micro Interface (79101)	£6.75
TV Modulator (9967)	£6.25

Buying one of our PROJECT PACKS will save you the frustration of tracking down those evasive components that hold up the completion of your project. We can usually supply for all new projects as soon as

Topamp preamplifier	£34.30
Shortwave Converter 49 or 11M	£9.95
Auto light Dimmer (80029)	£10.35
Parametric Equaliser Filter (9897-1)	£6.45
Parametric Equaliser Tone Control (9897-2)	£5.20
Universal Digital Meter (79005)	£14.65
SEWAR 80008	£18.45
Audio Analyser (9932)	£14.80
Matrix Printer 80068	£57.90
Matrix Printer Unit EP702A	£68.65
Timer Controller 79093	£29.50

+SEND FOR OUR FREE PRICE LIST+

they are published. Our packs include EPS circuit boards and all the components listed in the article together with sockets and solder. Cases can be supplied as extra items if required.

## TV GAMES COMPUTER



This TV Games Computer is designed around the Z80 microprocessor and enables you to design and play games of your own invention rather

than rely on pre-programmed modules. Once a game is designed it is stored on cassette tape for future use. Features of the system include

- + Joystick and Keyboard control
- + 8 Colours
- + Sound Effects
- + Object size control
- + Score display

Full kit includes all electronic components and boards

£215.00

Part list available on request.



ACCESS ordering service now available. Place your order by telephone or ring our 24 hour Answering Service.

### HOW TO ORDER

Send a cheque or postal order to Oorem Electronics Ltd, Fitzroy House, Market Place Swaffham, Norfolk, PE37 7OH. All our prices include VAT, please add 40p for postage and packing. Office hours Mon-Fri 9 am to 5 pm. Telephone Swaffham (0760) 21627. Telex 817912 Ooram G

**a de boer company**

# selektor

## RCA Satcom III

Satellites can provide a better quality, more reliable and more economical alternative to land-based facilities for long haul and multipoint voice, data, facsimile, radio and television communications. These communications can be transmitted not only to remote areas but to a virtually unlimited number of locations at the same time — all at service rates lower than existed before the development of domestic satellite technology.

The RCA domestic communications satellite system is the first of its type to provide such a broad range of commercial satellite services in the United States.

On December 12, 1975, RCA launched the first of its satellites — Satcom I —

beginning a new generation of communications spacecraft. Satcom II followed on March 26, 1976, and Satcom III on December 6, 1979. Each RCA satellite is capable of serving the 50 states with a wide range of communications services for government, business and the media. Satcom III, however, is fully utilized by the cable TV industry.

The spacecraft are controlled from tracking, telemetry and control earth stations at Vernon Valley, N.J. and South Mountain, California. The RCA Satcoms are basically repeater stations, receiving signals from various earth locations and beaming the signals back down to about 1,400 receiver antennas. Without the spacecraft, thousands of miles of ground cables and microwave links would be required to perform the same task. If not used for TV, each of the satellite's 24 channels can carry 1,000 voice circuits or 64 million bits per second of computer data.

### General description

The RCA Domestic Communications Satellite (RCA Satcom III) is a 24-channel spacecraft to provide commercial

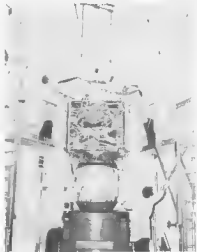

# selektor

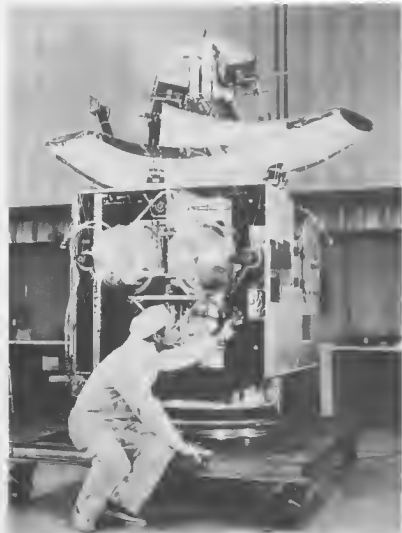

communications to Alaska, Hawaii and the contiguous 48 states. Each channel carries 1,000 voice grade circuits, one FM/color TV transmission, or 64 million bits per second of computer data.

The spacecraft was placed into a 22,300 mile geosynchronous orbit by a Delta 3914 launch vehicle. With solar panels deployed, the satellite spans 37 feet. The spacecraft main body measures 5'4" x 4'2" x 4'3".

The three-axis stabilized spacecraft is equipped with the power, attitude control, thermal control, propulsion, structure and command, ranging and telemetry necessary to support mission operations from booster separation through eight years in geosynchronous orbit.

Spacecraft life, with continuous full power, is designed to be eight years.

### Communications payload

The RCA Satcom III communications capability is provided by 24 powered TWTAs (Traveling Wave Tube Amplifier) channels and four redundant TWTAs channels. RCA Satcom I and II provided only the 24 powered TWTAs channels. RCA Satcom III's four redundant TWTAs channels can be switched to replace any of the 24 powered TWTAs channels which may become unusable over the life of the spacecraft.

The 24-channel communications satellite payload consists of a fixed, four-reflector antenna assembly with six offset feedhorns, lightweight transponders, high efficiency TWTAs, and low density microwave filters. Rigid mounting of the antennas maintains alignment and eliminates risks associated with deployment. The RCA-developed,

# selektor

graphite-fiber, epoxy-composite material for microwave filters, waveguide sections, and antenna sections achieves ultra-light weight while retaining standard electrical designs for critical elements

Frequency and polarization interleaving of the separate channels is employed with the transponder and four antennas to achieve 24 channels, each having a 34-MHz usable bandwidth within the 500-MHz allocation. The dielectric antenna reflectors employ orthogonal conducting grids such that the embedded wires provide cross-polarization isolation which doubles the channel capacity by permitting frequency spectrum reuse within the permissible bandwidth.

The four-reflector antenna assembly provides general coverage of the lower 48 states and Alaska, with a spot-beam coverage of Hawaii. The narrowband command and telemetry channels use the edges of the allocated 500-MHz band on both the 6-GHz uplink and 4-GHz downlink

#### Structure

The spacecraft mainbody, measuring 64" x 50" x 51", mounts all electronic boxes, batteries, propulsion and attitude control equipment on three, honey-combed, structural pallets. All transponder components are mounted on a south pallet (that side of the spacecraft



# selektor

oriented parallel to the orbit plane pointing south in the operational mode), and all the housekeeping equipment on the opposite north pallet

A third earth-facing pallet provides a mounting surface for four communication antenna-reflectors with their separate composite feed assembly, two command/telemetry antennas, and the earth sensors for attitude sensing.

The two sides between the equipment pallets and earth-facing pallet provide shear stiffness for the mainbody structure. Integrated with these assemblies are four spherical propellant tanks. The 915-pound kick motor is housed in the center column of the spacecraft through the sixth side of the mainbody. A conical adapter attaches the motor to the cylindrical column and also provides transition support from the launch vehicle interface to the baseplate structure.

#### Attitude control

The attitude control subsystem employs a sealed, high-speed (4,000 rpm) wheel with a separate earth sensor and closed-loop magnetic roll control. The RCA-designed Stabilite attitude control system provides three-axis control by virtue of the gyroscopic rigidity of the wheel and its servo-controlled exchange of angular momentum with the spacecraft mainbody.

The inertial stability permits attitude determination by a single, roll/pitch, earth-horizon sensor without the complexity of a yaw gyro or star sensor. Continuous control of the pitch axis alignment to the orbit normal is achieved by magnetic torquing with no expendables or moving parts.

The system maintains orientation during normal orbital operation, orbit adjust, and the acquisition and injection maneuvers. The pointing capability during normal operation is  $\pm 0.21$  degree about roll,  $\pm 0.30$  degree about yaw, and  $\pm 0.19$  degree about pitch.

The spacecraft has 12 hydrazine thrusters in a closed-loop system for North/South, East/West station-keeping. During a period of approximately 7 minutes every 3 weeks, this loop with its rate gyro will be energized to modulate the North/South stationkeeping thrusters and compensate for residual thrusters misalignment or mismatch to maintain attitude control.

#### Thermal control subsystem

A Thermal Control Subsystem provides control of heat absorption and rejection to maintain all components of the spacecraft within safe operation temperatures, which range from 10 to 30 degrees Centigrade.

Space-type mirrors and thermal blanketing insulation are employed to provide passive heat control.

Layers of aluminized insulating material offer high resistance to radiant heat

# selektor

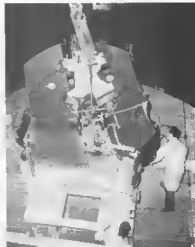

flow. The highly reflective mirrors maximize heat rejection and minimize heat absorption.

Under changing conditions of season and array life degradation in orbit, the battery temperature is maintained between 0 and +10 degrees Centigrade for maximum battery life.

#### Power subsystem

The Power Subsystem consists of two bi-folded solar array panels and three nickel-cadmium batteries. The subsystem delivers a maximum output of 740 watts of regulated 35 volts at beginning of life and 550 watts after eight years. During the two eclipse periods that are experienced each year, power will be supplied by the batteries. Sun-oriented solar arrays and a direct array-to-load connection maximize the efficiency and minimize the weight of the electrical power generation, storage and regulations subsystem.

With the spacecraft mainbody always aligned vertically, a single-axis clock-controlled drive shaft maintains the array toward the sun. Solar cells, which convert the sun's energy into electrical power, cover an area of 71.5 square feet.

Input converters in each subsystem convert the 24.5 to 35.3 voltage range to their specific requirements at constant power and efficiency. These converters, including one in each of 24 Traveling Wave Tube Amplifiers, are designed to preclude a major single-point failure mode.

#### Propulsion subsystem

An on-board propulsion subsystem is designed to maintain the spacecraft on



### RCA Satcom domestic communications satellite (RCA Satcom III)

#### mission objective:

Provide commercial communications to Alaska, Hawaii and the contiguous 48 states

#### launch information:

##### launch site:

Air Force Eastern Test Range  
Cape Canaveral, Florida

##### launch vehicle:

Three-stage Delta 3914, with nine castor, solid-propellant, strap-on motors

#### orbital elements:

##### circular:

Geosynchronous, 22,300 miles above the equator

##### period:

24 hours

##### inclination:

Equatorial, zero

#### spacecraft information:

##### height:

37 feet with solar panels extended

##### main body measurements:

5'4" x 4'2" x 4'3"

##### weight:

2,050 pounds

#### stabilization subsystem:

Three-axis stabilized, earth oriented

#### spacecraft design life:

Eight years

station throughout its eight-year life.

The RCA Satcom III carries 216 pounds of hydrazine monopropellant in four tanks for in-orbit use. Upon command from the ground, selected thrusters can be fired to provide spin-axis control in the transfer orbit, as well as velocity control in synchronous orbit. The hydrazine reacts with a catalyst to provide the energy thrust from the twelve reaction engine assemblies.

The passive surface-tension propellant feed ensures operation with no risk of bladder deterioration. Two independent, cross-connected half-systems are designed to maintain control, even in the event of failure of any thruster, valve or tank.

Maintenance of the station longitude and equatorial orbit inclination to 0.1 degree requires about 21 minutes of thrusting once every 3 weeks.

An apogee kick-motor uses a solid-propellant fuel to provide the 2,000 pound transfer orbit thrust capability. A dual-squib igniter is designed to ensure reliable in-orbit firing.

#### Command, ranging and telemetry subsystem

The functions of command, reception,

decoding and distribution, along with automatic and manual telemetry and transponding range tones are handled by the command, ranging and telemetry subsystem.

Command signals are modulated on a 6.425-GHz carrier and received by one of the spacecraft's two omni antennas. Each of the two command receivers produces three isolated outputs containing the Frequency Shift Key (FSK) command tones. Two outputs from each receiver are sent to the dual command logic demodulator for further processing and conversion to a digital bit stream.

Logic level commands are distributed to the spacecraft from the demodulator. Other commands, such as thruster driver, relay closure and pyrotechnic firing, are generated in the central logic processor. The processor has the capability to implement 160 redundant commands.

During attitude maneuvers, the processor provides an interface between the thruster firing commands and the actual operation of the thrusters.

The ranging function involves the use of the two command receivers and two

beacon transmitters.

The telemetry function is performed by the dual telemetry mode. This unit samples each of 128 analog telemetry points at 64 frames per second. The sampling is controlled by counters within the module. The telemetry points are available for storing house-keeping data, sync and spacecraft identification.

The two beacon transmitters with carrier frequencies of 3701 and 4199-MHz can operate at two selectable output power levels. The high-power output level is used continuously during launch and transfer orbit operations and prior to earth orientation in synchronous orbit. The low-output power level is used during geosynchronous mission operations.

(521 S)

**selektor**  
SELEKTOR

An aerial booster that scores on all of the above points is rarely found, as some of the performance requirements are conflicting. For most contemporary transistors it is necessary to make a compromise between low noise content and good power handling; all too often, the large currents involved also produce high noise levels.

However, while the Elektor design team were searching for a solution to this problem, semiconductor R & D engineers have come up with high frequency transistors that remain sufficiently 'noiseless' when subjected to large currents. The devices around which the circuit of this article is built, namely the Siemens BFT 66 and BFT 67, are particularly efficient in first amplifier stages such as aerial boosters — say no more! The favourable characteristics of these transistors will be further exploited by giving the booster a dual function; for wideband operation the booster is made to work with a high current to prevent overload at high input levels, whereas a lower current is employed for narrowband operation.

a high performance amplifier, their outlay does not weigh so heavily on the constructor's budget

To be able to profit fully from the improved characteristics of the BFT 66 and BFT 67, the makers publish data sheets including application examples which can be used as a starting point for the amateur and which considerably simplify construction.

The circuit for a single stage amplifier is shown in figure 1, while figure 2 shows a two-stage circuit of extended bandwidth. Respective performance details are given in the graphs of figures 3 and 4. The latter circuit gives more uniform figures for noise and gain over the full frequency band from 25 MHz to 1 GHz. For the single stage amplifier, gain decreases and noise increases with rising frequency. Around the 100 MHz mark, however, its noise content is clearly lower and the gain higher than for the amplifier of figure 2. Measurements taken for the circuit of figure 1 at a frequency of 800 MHz proved to be 15 dB for gain and less than 2 dB for noise, verifying that the single stage

# aerial booster

effective frequency range 80 . . . 800 MHz

The design targets for this novel aerial amplifier were; low noise, ample gain, wide dynamic range, wide frequency range and last, but by no means least, the possibility of using the same printed circuit board for both wide and narrow passband versions.

Aerial booster performance largely depends on the characteristics of its active elements

It is self-evident that high quality transistors are absolutely essential in the design for a high quality booster, to skip on this specification is false economy. Although passive elements are equally important in the construction of

an amplifier will behave satisfactorily in most applications. The BC 177 transistor in figure 1 serves merely to stabilise the collector supply of the BFT 66 to a working level of approximately 6.5 V to give a collector current of 3.7 mA.

The graphs of figures 5 and 6, taken from the aforementioned data sheets, show the noise and intermodulation behaviour respectively. Figure 5

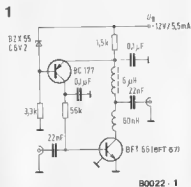

Figure 1. BFT 66 transistor in a typical single-stage aerial signal booster circuit (Siemens publication).

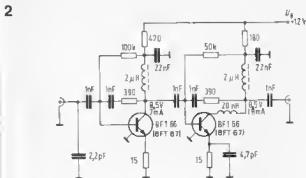

Figure 2. BFT 66 transistors in a typical two-stage wide band aerial signal booster circuit (Siemens publication).

3

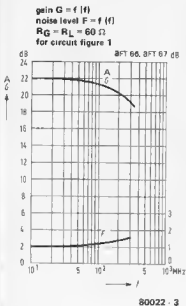

Figure 3. Gain and noise as a function of frequency in the circuit of figure 1.

4

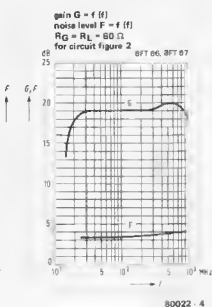

Figure 4. Gain and noise as a function of frequency in the circuit of figure 2.

5

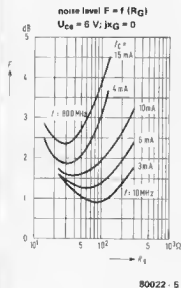

Figure 5. BFT 66 noise level as a function of source resistance, with collector current as a parameter, at 10 and 800 MHz. Rather flat minima appear in the 50 to 75  $\Omega$  vicinity. Noise increase with increasing current is slow compared to more common types of transistor, which is of advantage in serial signal booster or wide band amplifier applications.

6

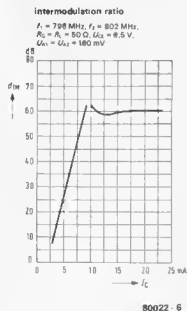

Figure 6. Intermodulation ratio at 180 mV output level as a function of collector current. Graph shows the large signal handling capacity of the BFT 66. A 60 dB ratio is obtained with collector current as low as 8 mA.

represents noise level at frequencies of 10 and 800 MHz as a function of source resistance, with collector current as a parameter. With a resistance of between 50 and 75  $\Omega$  and a collector current of 10 mA, the noise level is below 3 dB - even at 800 MHz. The graph of figure 6 shows the intermodulation ratio as a function of the collector current. For this measurement, two input signals capable of giving an output of 180 mV are applied. Intermodulation ratio is then defined as the difference in level, expressed in dB, between the input signals and the amount of intermodulated signal product at the output. In the range 2.5...10 mA this ratio continuously increases with current and finally maximises to about 60 dB at 10 mA. Further increase in current will not improve on this figure, which is an indication of the large signal handling capacity of the circuit.

An output level of 180 mV can hardly be expected anywhere but in close proximity to a transmitter and is, at any rate, considerably more than most receivers can handle. In narrow bandpass or single channel amplifiers using a BFT 66 the collector current can, therefore, be set to below 10 mA. For wide band amplifiers, however, it is recommended that a collector current of 10 mA be used to obtain the full 180 mV (105 dB  $\mu\text{V}$ ) output level.

### Circuit description

The circuit consists of a single stage amplifier (a BFT 66 transistor) and will operate anywhere in the 80 to 800 MHz band. Its gain and noise characteristics approach those indicated by the graph of figure 3. Since it was initially intended to function over a restricted bandwidth, the standard version of the circuit as shown in figure 7 features a frequency selective input network (C6, C7, L1 and C8). The actual values of the filter components for five different bands are listed in table 1. Without this network the circuit will function as an aperiodic amplifier over the entire 80 to 800 MHz range.

This standard circuit can be powered from a 16...21 volt DC source via the co-axial cable centre conductor. The HF signals are blocked by inductor L3. The supply voltage is stabilised by IC1 to between 11.5 and 12.5 V thereby fixing the transistor working point. Quiescent collector current is determined by resistor R3 while L2 constitutes the HF collector load. Capacitor C3 provides HF decoupling. Transistor current is set by the base bias resistors R1 and R2, and stabilised by negative DC feedback via R2 from the junction of R3/L2.

### Wiring and inductor construction

Due care and cleanliness are essential for mounting the components to the printed circuit board (figure 8). As is the rule for all HF circuitry, live HF conductors like those joining C6, C1,



transistor T1 and C2 must be kept as short as possible.

The construction of the inductors should not be too difficult. L2 and L3 are identical and are wound on a ferrite bead of ferroxcube material, as used for HF suppressors, 5 mm long and 3.5 mm in diameter, with a 1.5 mm bore. Five turns of 0.2 mm diameter enamelled copper wire are led through the hole and wound toroidally around the bead as illustrated in photograph 1.

Inductor L1 is of the air core type; an 8 mm diameter mandrel is temporarily used to wind the number of turns listed in table 1. Coils for the two lower frequency ranges can be made from enamelled copper wire of the same section instead of silvered copper wire. Turn spacing should equal wire diameter. The highest frequency inductor requires just half a turn around a 4 mm mandrel. Photograph 2 shows how to connect the input and output cables to the board. If co-axial connectors are used, wires between them and the circuit board must also be extremely short.

### Setting up

Trimming capacitors C7 and C8 are used to tune the input filter to the passband required. Initially, C7 is set for minimum capacitance and C8 approximately midway. The receiver is then tuned to a weak transmission, preferably halfway across the band. C8 is then adjusted for best reception; this can be achieved by obtaining a maximum reading on a signal strength meter, a minimum of noise in the audio output, or a good quality TV picture. Reception is then tuned to perfection by means of C7.

Precise tuning is carried out gradually by fine adjustment of C8 for possible improvement. If C8 requires a new setting, C7 will also require some correction. These alternate steps should be continued until no further improvement is noticeable.

Final criterion for correct tuning is signal-to-noise maximisation in audio reception or optimisation of picture

1



Photograph 1. Looking at finished L2 to L5 inductors: five turns of 0.2 mm enamelled copper wire toroidally wound on a choke type ferrite bead.

2

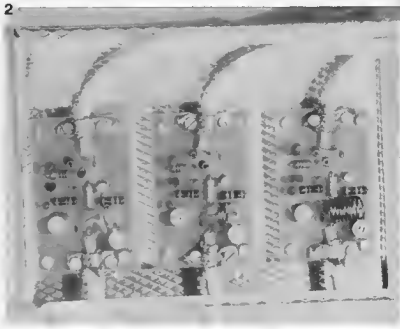

Photograph 2. Typical combination of three boosters showing how the co-ax cables connect correctly to the circuit boards.

Table 1

Frequency selective input filter parameters

Frequency band	Inductor L1 number of turns silvered copper wire on 8 mm dia mandrel	Trimming capacitors C8, C9
FM (100 MHz)	8 turns wire dia 1 mm	green marker 2 . . 22 pF
2 m (144 MHz)	8 turns wire dia 1 mm	yellow marker 2 . . 10 pF
VHF (200 MHz)	3 turns wire dia 1 mm	grey marker 1.2 . . 6 pF
70 cm (432 MHz)	1 turn wire dia 2 mm	grey marker 1.2 . . 6 pF
UHF (600 MHz)	0.5 turn wire dia 2 mm (4 mm dia mandrel)	grey marker 1.2 . . 6 pF

quality for TV reception. A signal strength meter, if available, can be used for the initial settings, but final tuning can best be accomplished by adjusting for a minimum of noise.

### Modifications and further applications

So far we have dealt only with narrow band operation. For wide band

operation, components C6, C7, L1 and C8 become redundant. The function of input capacitor is now assumed by C1. Input connection can now be made where L1 joined C1. With these modifications the amplifier can be used over the entire 80 to 800 MHz range. It can be made to operate as low as 10 MHz, however, by substituting all 1 nF capacitors with 10 nF ones.

As previously mentioned, the booster can be powered via the aerial cable. A

7

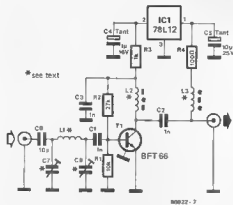

Figure 7. BFT 66 in universal booster circuit, featuring DC negative feedback to stabilise transistor working voltage, frequency selective input filter and IC stabiliser for power supply via leaddown cable. The frequency selective filter can be omitted and so enable amplification over the entire 80 to 800 MHz frequency range.

8



Figure 8. Printed circuit board and component lay-out for the amplifier of figure 7.

9a

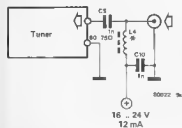

Figure 9a. Adapter at lower end of co-ax cable for remote DC power supply.

9b

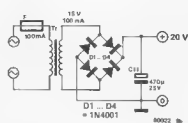
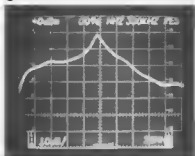

Figure 9b. Separate power supply unit which will feed up to 6 boosters.

3



Photograph 3. Booster gain as a function of frequency with selective input filter set to 87.5 .. 104 MHz band.

horizontal scale: 10 MHz/division  
vertical scale: 10 dB/division  
intermediate frequency: 96 MHz  
input level: -38 dBm  
output level:  
maximum peak in trace: -12 dBm  
Graph reveals a maximum gain of 26 dB (not a poor figure, by the way).

#### Parts List

##### Resistors:

R1 = 10 k  
R2 = 27 k  
R3 = 1 k  
R4 = 100 Ω

##### Capacitors:

C1, C2, C3, C9, C10 = ceramic disc, 1 nF  
C4 = 1 µF/16 V (tantalum)  
C5 = 10 µF/25 V (tantalum)  
C6 = ceramic disc, 10 pF  
C7, C8 = synthetic foil trimmers, see Table I

##### Semiconductors\*

T1 = BFT 66 or BFT 67  
IC1 = 78L12 or IM 340L-12

##### Miscellaneous

L1 = air cored inductor, see Table I  
L2, L3, L4, L5, L6 = 5 turns 0.2 mm dia copper enamelled on ferrite bead length 5 mm, dia 3.5 mm (ferroxcube, e.g.)

10a

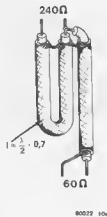

Figure 10a. Co-axial loop to convert 240 Ω balanced into 60 Ω unbalanced impedance, matching balanced aerial to booster input. Loop length as a function of signal wavelength is listed in Table II for the more common frequency bands.

10b

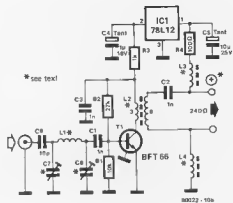

Figure 10b. Matching the booster output to a 240 Ω flat twin cable.

10c

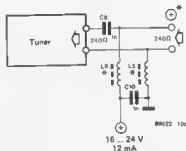

Figure 10c. Circuitry to power the booster via a 240 Ω balanced flat twin cable

suitable circuit to adapt the power supply at the lower end of the cable is shown in figure 9a. High impedance inductor L4 prevents HF signals from being grounded, capacitor C10 serves as a HF decoupler, while C9 separates the power supply line from the tuner input circuitry. Inductor L4 is identical to L2 and L3: 5 turns of 0.2 mm enamelled copper wire through a ferrite bead.

Figure 9b shows the circuit for a separate DC supply if the receiver power unit can not be used. This supply will feed up to six boosters. If it is decided to mount the power supply near the booster(s), inductor L3 becomes redundant, and the supply is connected directly to R4.

The booster is intended to match inputs and outputs rated at an impedance of 60 Ω (not less than 50 Ω, not more than 75 Ω). Cables with impedances of 240 Ω, such as flat twin, will require

Table II

## Balun parameters

Band	Frequency range	Wavelength in metres	Loop length
FM	87.5 to 104 MHz	3.43 to 2.83	1.10 metres
2 m band	144 to 146 MHz	2.00	0.70 metres
III (VHF)	174 to 223 MHz	1.72 to 1.35	0.53 metres
70 cm band	432 to 440 MHz	0.7	0.25 metres
IV/V (UHF)	470 to 854 MHz	0.64 to 0.35	0.17 metres

some method of impedance matching. Commercial balanced-to-unbalanced adapters can be used, of course, but home made constructions will perform just as well and are less expensive.

The construction of such a 'balun' is illustrated in figure 10a. A 240 Ω balanced aerial can be matched to the booster input with the aid of a co-axial cable loop whose actual length is half the wavelength of the required signal, multiplied by a reduction factor of about 0.7. The loop lengths for various frequency bands are given in table II.

A booster-to-downlead unbalanced-to-balanced transformer construction is shown in figure 10b. Inductor L2 is now made to function as a 1 to 4 impedance transformer. Two 0.2 mm diameter enamelled copper coils are wound through a single ferrite bead, 3 turns for the primary and 6 for the secondary. Inductor L4 makes the DC ground

connection for the twin lead. When connecting the downlead to the booster, correct DC polarity must be observed.

Figure 10c shows the circuitry required to power the booster via a 240 Ω flat twin cable. With a power supply incorporated, these components, together with C2, L3 and L4, are unnecessary. ■

When the Formant circuit was developed, FET Opamps and especially the 'high-speed' versions were practically non-existent. The only economical alternative was to use standard Field-effect transistors in the well-known source follower circuit (figure 1a).

As those who have heard the Formant will know, this solution works. However, there are certain disadvantages.

1. The amplification achieved is not precisely 1, but slightly less (approximately 0.9).
2. Because of tolerances in the FETs, the source resistor has to be selected carefully.
3. The gate-source bias voltage ( $U_{GS}$ ) causes a certain 'offset' in the output

# FET opamps in the Formant

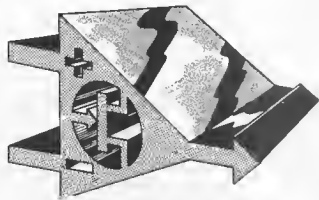

At several points in the Formant music synthesiser circuits (described in Elektor, May 1977 . . . April 1978), FET source followers are used as high-impedance output buffers. This type of stage is not always the best solution and an alternative is well worth considering: an operational amplifier with an FET input stage. This article will examine the use of these more up-to-date components and will give a description of ways to adapt the VCO's.

voltage, with respect to the input voltage. This must be compensated in one of the following stages.

4. The dynamic range is relatively small.
5. The gate-source bias voltage is temperature-dependent and therefore the output voltage tends to drift.

These disadvantages are not so serious — they don't limit the Formant's potential as a musical instrument. Nevertheless, it is better to avoid them altogether by replacing the FET source follower circuit (figure 1a) by a voltage follower circuit, using an FET opamp (figure 1b). All source followers in the Formant (in the Interface, VCO and VCF circuits) can be eliminated in this way.

## When is it worth it?

One of the FET source follower's greatest drawbacks is its temperature

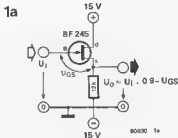

Figure 1a. A source follower with an N-channel field effect transistor. This stage serves as a high-impedance buffer in the Formant Interface, VCO and VCF circuits.

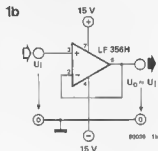

Figure 1b. Voltage follower using an FET operational amplifier. This circuit can replace the FET source followers in the Formant and provides better temperature stability.

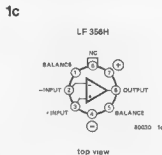

Figure 1c. Pinning of the LF356H.

drift. The other disadvantages affect the construction (making it more complicated and time-consuming) rather than the quality.

In a VCO, in particular, the temperature drift should be reduced to a minimum, because when several VCO's are used together any mistuning is immediately audible. As far as the Interface is concerned, temperature drift may cause the entire circuit to be out of tune, which can be heard when it is played together with other instruments. In practice, this is rarely a problem and so there doesn't seem to be much point in converting this module to FET opamps. Only if you're dealing with a keyboard compass of more than 5 octaves (and

therefore a greater dynamic range), it may be advisable to use FET opamps instead of source followers. The low slew-rate requirements in the interface mean that economical FET opamps (TL084 and TL074) can replace source followers T1, T3 and T4. The fourth opamp can take over the function of one of the 741s (IC5 or IC6, for instance). All these changes will involve a lot of 'flying wires'! Once the circuit has been modified, the offset adjustment (P4) must be repeated. In the VCF, the FET's have no real effect on the temperature stability, so that little would be gained by modifying it.

### FET opamps in the VCO

VCO's which are already in use can easily be converted. However, their oscillator and curve shaper will have to be realigned. For this reason, the modification is only advisable if the frequency stability is still not good enough — even though it is high compared with many other synthesizers.

Figure 2a shows the original circuit, which has two source followers. Of these, only T2 affects the oscillator's frequency stability; the simplest conversion, therefore, will entail replacing this FET by a voltage follower using an LF 356H. The rest of the circuit can remain unchanged, as shown in figure 2b. However, the oscillator and the curve shaper must be re-adjusted, since this modification will alter both the amplitude and the DC level of the sawtooth.

Figure 3a gives the modified component layout for the circuit shown in figure 2b. Connections 1 and 5 of the metal-case version of the LF 356 (IC12) are not used and these wires can be cut short. Connection 6 is soldered to 2. R17 and T2 are unsoldered from the VCO board and IC12 is mounted, as shown in figure 3a.

If a new VCO module is to be built from scratch, more extensive changes may be considered. Figure 2c shows the new circuit: FETs T2 and T3, source resistors R17 and R20, gate resistor R16, and trimmer P10 have all been removed. The voltage follower opamp (IC12) replaces both source followers. Resistor R18 is changed to 470  $\Omega$ . A metal film resistor is not strictly necessary. If the 'ultimate' in temperature stability is required, though, a 470  $\Omega$ /2% metal film resistor should be used.

Figure 3c shows the modified component layout for new VCO's. IC12 substitutes T2/R17; a wire link to the left of it replaces T3/R16.

The FET opamp in the new oscillator circuit, as shown in figure 2c, not only improves the frequency stability, but also reduces the component count in comparison with the original circuit. Furthermore, the removal of preset P10 makes the adjustment that much easier.

2a

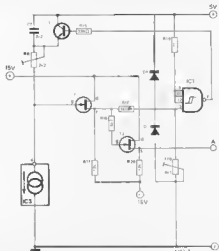

Figure 2a. The oscillator circuit in the VCO contains two FETs used as source followers; only T2 affects the frequency stability.

2b

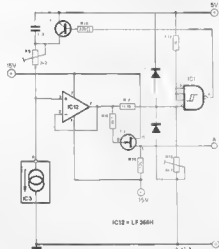

Figure 2b. The easiest modification, in order to improve the temperature stability of an existing VCO, is to replace T2 by an FET opamp (IC12).

2c

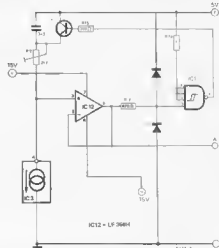

Figure 2c. When building a new VCO module, it is worth considering this simplified oscillator circuit. The FET opamp now replaces both source followers, and preset potentiometer P10 can be omitted.

3a

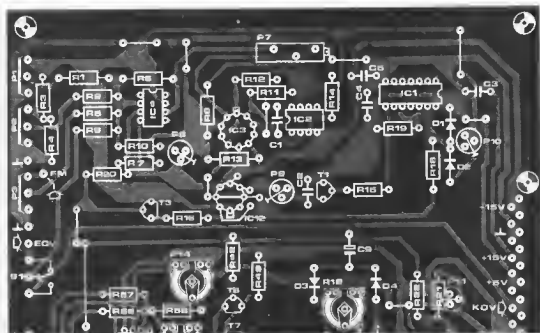

Figure 3a. This modified component layout corresponds to the circuit given in figure 2b.

3b

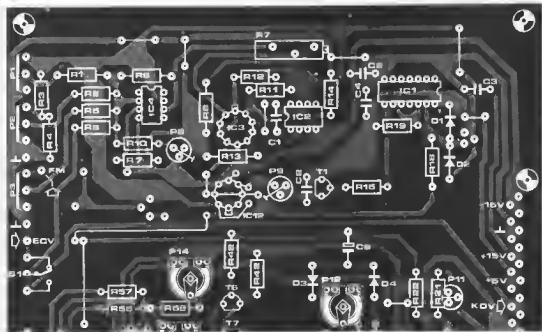

Figure 3b. Component layout for the simplified version of the oscillator circuit given in figure 2c.

In actual fact, it is not always the fault of (amateur) transmitters that they cause interference on TV sets. As a rule, it is the 'broad-band aerial amplifier' included in the TV set's aerial system which is at the root of the problem. Broad-band amplifiers have the disadvantage of being rather indiscriminate. They pick up and amplify everything, including signals which are not meant for them at all. When powerful broadcast, amateur or mobile transmitters are around, the voltage in the aerial amplifier rises to such an extent that the amplifier becomes completely 'jammed' and this makes a clear reception of TV signals very difficult.

the broad-band amplifier, is stripped at a certain point and connected to one end of a piece of coax. This coax, believe it or not, is the filter. It should be exactly  $\frac{1}{4}$  wave length of the signal that is to be eliminated. The other end of this piece of coax, which is known as  $\frac{1}{4} \lambda$  (quarter-lambda) stub, remains open. This is how it works:

Radio waves reaching the open end of the  $\frac{1}{4} \lambda$  stub are reflected. For the unwanted signal, the stub is exactly  $\frac{1}{4} \lambda$  long, so that the reflected waves have travelled a distance of  $2 \times \frac{1}{4} \lambda = \frac{1}{2} \lambda$  by the time they get back to the beginning of the stub. Consequently, the reflected wave is in exact phase-opposition with

# TV interference suppression

Nearly everybody will agree that interference on TV can be extremely annoying. Interference can be caused, among other things, by local transmitters. Usually, however, this can be dealt with in a fairly simple and effective way.

So what do you do? Well, after reading the above, it would seem an obvious conclusion that it is probably better to do without an aerial amplifier altogether. For that matter, very often one is included in the aerial system 'just to be on the safe side', without it being strictly necessary.

It is a much better (and cheaper!) idea to simply use a good TV aerial which is a powerful 'amplifier' anyway (and will have a more accurate directional effect and an improved front-back ratio — both important factors). If, on the other hand, you cannot manage without an amplifier, it is advisable to use tuned aerial amplifiers (also known as channel amplifiers). These, being narrow-band, do not pick up unnecessary signals and so interference is no longer a problem.

However, if you already have an aerial system which is fitted with a broad-band amplifier, it is rather frustrating to talk about the kind of aerial you should really have.

Quite a few interference problems can be dealt with in an inexpensive way by simply inserting a band-stop filter in the broad-band amplifier's input. This eliminates the interfering signal (produced by an amateur transmitter, for example) before it reaches the broad-band amplifier. The so-called  $\frac{1}{4} \lambda$ -filter is a good choice: it is easy to make — all you need is a piece of coax cable!

## The $\frac{1}{4} \lambda$ -filter

Figure 1 shows what the filter looks like. In passing, it should be noted that this filter can be used for all kinds of purposes — not only eliminating interference in broad-band amplifiers! As the drawing demonstrates, the (coax) aerial cable, leading from the aerial to

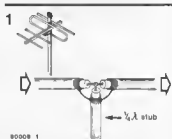

Figure 1. The filter is a piece of coax, connected in the lead from the aerial to the broad-band aerial amplifier. In practice, it is often best to connect the  $\frac{1}{4} \lambda$  stub at the input of the amplifier.

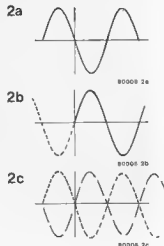

Figure 2. The filter works as follows: The voltage reflected in the stub (2b) is in exact anti-phase to the input voltage (2a), so that the resulting voltage (2c) is nil.

the input signal, so that the resulting voltage is nil. This is illustrated in figure 2. Figure 2a shows the input voltage, figure 2b shows the reflected voltage and figure 2c gives the result.

Everything always sounds marvellous in theory, but often turns out differently in practice. Here too, unfortunately this is the case. What happens is that the  $\frac{1}{4}\lambda$  stub attenuates the reflected wave,

so that the resulting voltage is not completely nil, as shown so optimistically in figure 2c. It doesn't have to be! A reduction by about 30 dB (32 times) is usually achieved with the aid of the filter and nine times out of ten that is enough. Furthermore, the filter not only blocks interference on the wave length which is four times as long as the  $\frac{1}{4}\lambda$  stub, but it also works for wave lengths corresponding to  $\frac{3}{4}\lambda$ ,  $\frac{5}{4}\lambda$ ,  $\frac{7}{4}\lambda$  etc. The input signal and the reflected wave are in anti-phase at these frequencies as well!

### In practice

As far as the exact length of the filter is concerned, simple theory is one thing, practice another. The speed at which radio waves travel along coax is not the same as that in air. For this reason, the wave length inside the cable is shorter than that outside: a radio wave may have a wave length of 3 ft. outside and as little as 2 ft. inside the coax cable. The reduction factor, in that case, is:  $\frac{2}{3} = 0.67$ .

Let us consider a rejection filter for a 2-metre amateur transmitter. Amateur transmitters on the two-metre and 70-centimetre bands seem to be prime targets for complaints about interference. On the two-metre band  $\frac{1}{4}\lambda$  corresponds to  $\frac{1}{4} \times 2 = 0.5$  metres. In order to find out what the exact length of the  $\frac{1}{4}\lambda$  stub should be, this figure must be multiplied by the reduction factor of the coax. Every manufacturer (and reliable retailer) will be able to supply this information. It is advisable to make the cable slightly longer than the calculated length, so that once the stub has been connected, it can be trimmed for maximum suppression of the interfering signal. This can be done by cutting off small bits at a time. When you have found the correct length, the  $\frac{1}{4}\lambda$  stub can be rolled up. It looks neater, that way.

One of the characteristics of this type of filter, as mentioned earlier, is that it will eliminate several frequencies. This can be an advantage: a filter for the 2-metre band can be used for signals on the 70-centimetre band as well. The spectrum-analyser photo's (figures 3 and 4) illustrate this. Figure 3 shows how the filter attenuates interference at the frequency for which it was originally intended: 144 MHz (the 2-metre band). Figure 4 illustrates the effect at 432 MHz (70-centimetre band).

Since the damping of the coax cable is greater at higher frequencies, the attenuation achieved is less than that at 144 MHz. As the photo's illustrate, the difference is approximately 6 dB. The spectrum-analyser photograph in figure 5 gives an idea of the attenuation over the whole frequency range (horizontally 100 MHz per division).

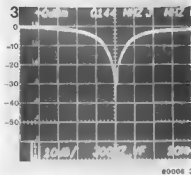

Figure 3. A spectrum-analyser photo of a coax  $\frac{1}{4}\lambda$  filter for the 2-metre band. The attenuation is approximately 36 dB.

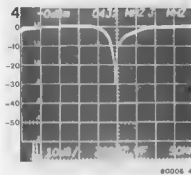

Figure 4. The rejection filter intended for the 2-metre band can also be used for the 70-centimetre band, with marginally poorer results.

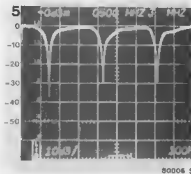
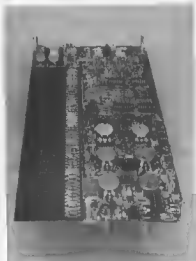

Figure 5. A spectrum-analyser picture over a much wider frequency range (100 MHz per division) shows that there are many more frequencies at which the input signal and the signal reflected by the filter are in anti-phase.

# coming soon

## March

- Chorosynth: a low-cost string synthesiser
- Printer for microprocessors



## April: car special!

- electronics in cars
- fuel consumption meter
- intelligent wiper delay
- electronic ignition
- and many others!



## May

- cassette interface for BASIC  $\mu$ P
- a practical intercom







# elektor vocoder (2)

## construction and alignment

Last month, we explained the basic principles of the Elektor vocoder. From the block diagrams and circuits given, it should be clear how the unit works — once you've built it. And that is what this article is about: the printed circuit boards, full constructional details and calibration procedures. Every effort has been made, at the design stage, to make this a straightforward project for the home constructor; the extensive explanation of the construction given here is intended as the necessary 'software backup!'

First, let's put one thing right. Last month, we stated that there were to be twelve printed circuit boards Wrong: there are fourteen now. The wiring between the twelve original boards was getting so extensive that it was decided to plug them all into a so-called 'bus board' that runs along the back of the case. This board turned out to be so long that it had to be cut in two, for postal reasons. All other boards, with the exception of the power supply, are plugged into connectors on the bus board. This is a great help, both for construction and 'service' — so we hope no-one will complain about the two additional boards. . .

### Power supply

Before getting to the p.c. board layouts, we must first provide the power supply circuit, as promised. As shown in figure 1, this circuit is so simple that it is hardly worth talking about.

The symmetrical  $\pm 15\text{V}$  supply is obtained in the easiest possible way, using two integrated voltage regulators (IC19, IC20). The total current consumption is only 200 mA, so the 400 mA mains transformer will be more than adequate. Obviously, a larger transformer could be used, provided it fits in the case: future extensions, if and when they come, can then be powered from the same supply.

For biasing the OTAs, a further symmetrical  $\pm 5\text{V}$  supply is also required. As shown in figure 1b, these voltages are derived from the (stabilised)  $\pm 15\text{V}$  supply, by means of another pair of integrated voltage regulators (IC21, IC22). The two tantalum electrolytics, C86 and C87, and the 100 n

capacitors C84 and C85 are essential for this type of regulator: they suppress its annoying tendency to break into spontaneous oscillation.

A printed circuit board for the supply is given in figure 2. To be more precise, it only accommodates the circuit shown in figure 1a; the  $\pm 5\text{V}$  supply (figure 1b) is mounted on the bus board.

### A new feature

We owe an explanation, although it is doubtful that many readers will have noticed it!

Just before going to press last month, our esteemed 'boffins' came up with a small but very useful extension. It was included in the circuits for the high-pass filter and the input/output module (part 1, figures 5 and 6) at the last minute, but we didn't quite get around to explaining it in the text — mainly owing to the fact that we were chasing around, trying to find out whether we were *allowed* to include it! The trouble was that our beautiful 'find' turned out to be patented — by Bode. We were still trying to find out how this effected us (fortunately, it doesn't) when the issue went to press, with the result that there were a few details in the circuits that remained completely unexplained in the text. This is common practice in industry, of course, but we feel that it is rather below-standard for a self-respecting technical magazine. Our apologies!

What extension? In figure 3, part of the high-pass filter is repeated. There's a potentiometer, P17, with a series resistor (R117). When we point out that the lower end of the series resistor is connected to the second input, 'K', of

1

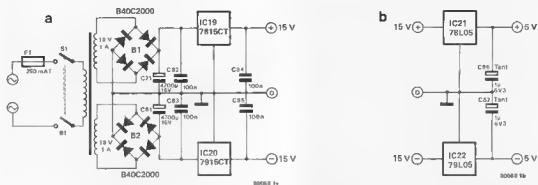

Figure 1. The very simple power supply circuit for the vocoder. Although it is more than adequate for the moment, there is no harm in using a larger mains transformer so that it can also cater for possible future extensions.

#### Parts list for figure 2 (power supply)

##### Capacitors:

C71, C81 = 4700  $\mu$ /40 V  
C82 C85 = 100 n

##### Semiconductors.

B1, B2 = bridge rectifier  
B40C2000  
IC19 = 7815 CT  
IC20 = 7915 CT

##### Sundries.

mains transformer, 2 x 15 V or  
2 x 20 V/400 mA  
S1 = double pole mains switch  
fuse, 250 mA (sloblo)

2

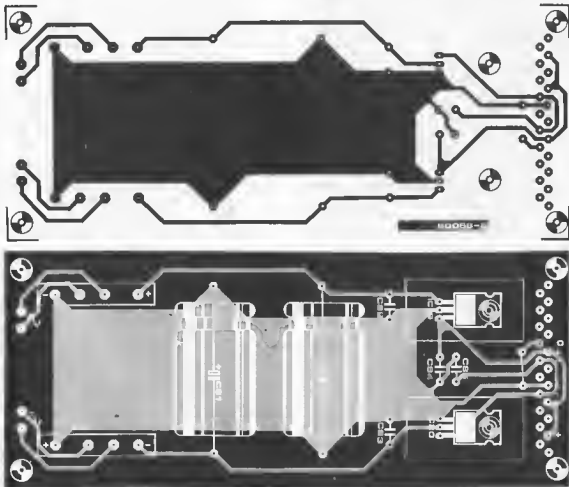

Figure 2. The printed circuit board for the power supply. As explained in the text, only the +/- 15V supply circuit (figure 1a) is mounted on this board; the +/- 5V supply is mounted on the bus board.

3

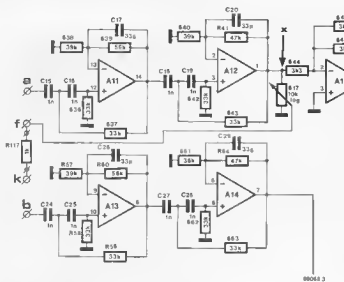

Figure 3. Part of the high-pass filter circuit. P17 and R117 are added so that a small amount of the original speech signal can be added to the final output. This 'high-frequency blend' can be particularly useful when the carrier signal is lacking in high frequencies.

the summing amplifier (part 1, figure 6), the basic idea may suddenly dawn. Some of the signal at the output of the high-pass filter (A11/A12) is taken off by P17 and added, without 'vocoding', to the final output.

In this way, the lack of a voiced/unvoiced detector and associated noise generator can be camouflaged to some extent. More than 'some extent', in fact: the results can be surprisingly good! When the carrier signal is lacking in high-frequency content, there is not enough 'replacement signal' for the unvoiced 'hissing' sounds in speech (the 's', for instance). In this case, the high frequency components of the original speech signal can be added to the output signal; the correct 'blend' is set with P17. In many cases, this vastly improves the intelligibility of the vocoded signal.

Provision is made for mounting the potentiometer, P17, on the p.c. board for the filter modules. The ground connection and that for the wiper ('f') are both at the edge of the board; the 'hot end' of the potentiometer is connected to a copper pad marked 'x' on the copper side of the board. Resistor R117 is mounted on the bus board. The connection from the lower end of this resistor to the input of the summing amplifier (points 'k') is included as a copper track on the bus board.

### Input/output and filter boards

We can now do one of two things. Either repeat all the circuits already published last month, in part 1, or else ask you to dig out that January issue and refer to it as required. The latter option seems to be the most sensible.

All right, so now we've got part 1 in front of us. A general block diagram of the filter units is given in figure 2, and complete circuits for the band-pass, low-pass and high-pass filter units in figures 3, 4 and 5, respectively. In the accompanying text, it was explained that a modular construction was to be used: one printed circuit board for each complete filter unit. No wild guess, this; in fact, our printed circuit board designer had already come up with a single, universal design for the filter board, suitable for all types of filter: low-pass, band-pass and high-pass. The layout of this universal filter board is given here, in figure 4. Figure 5 shows the component layouts, with accompanying parts lists, for mounting a band-pass filter unit (figure 5a), low-pass filter (5b) and high-pass filter module (5c). The values for capacitors C1...C11 in the eight band-pass filter units are listed in Table 1. This table was also included in part 1, but it is repeated here with the rest of the parts lists. Observant readers may notice that the supply-

decoupling capacitors (C73...C76, 8 x C77 and 8 x C78, shown in figures 3, 4 and 5 in part 1) are missing in the layouts given in figure 5. Not to worry: they are included on the bus board. Then there's the board for the in- and output module (the circuit shown in part 1, figure 6). The copper and component layouts are given in figure 6. This p.c. board is exactly the same size as the filter unit board (70 x 168 mm). For that matter, the supply board (figure 2) is also the same size, even though it is not the intention at this time to mount it as a plug-in module. As before, the decoupling capacitors for the input/output module (C79 and C80) are mounted on the bus board.

Now for a closer look at the boards. Mounting the components shouldn't be a problem — provided you don't get the various component layouts for the filter board mixed up. And don't forget the wire links; although they're not mentioned in the parts list, they do play an essential role. All connections to the boards are along the two ends. At one end, the connections associated with front-panel components; at the other end, the connector plug.

On the filter boards, this means that the 'front' of the board contains the control voltage connections,  $U_{c,out}$  and  $U_{c,in}$  (points d and e in the circuits), the LED output and the connections for the  $U_{c,in}$  level control (8 x P3, P7, P11). The 'rear' of the board contains all 'internal' connections: the speech and carrier inputs (points a and b), the vocoded output (point c), the supply connections and, for special applications (to be described later), a second set of control voltage connections ( $U_{c,out}$  and  $U_{c,in}$ ).

Similarly, on the input/output board, the front panel connections are at one end: input and output jacks with associated level controls (P13, P14, P15). The 'connector' end is for the supply voltages and the internal in- and outputs a, b, c and k.

This system means that each board can easily be built as a separate, plug-in module. A 21-pin connector is mounted on the 'inner' end of each of the filter-unit boards and the input/output board (one suitable type is made by Siemens). The front panel is mounted at the other

Table 1

band-pass filter number	centre frequency	frequency range	C1...C8	C9	C10	C11
BPF 1	265 Hz	210 - 320	82 n	220 n	33 n	330 n
BPF 2	390 Hz	320 - 460	56 n	150 n	22 n	220 n
BPF 3	550 Hz	460 - 640	39 n	100 n	15 n	150 n
BPF 4	800 Hz	640 - 960	27 n	68 n	10 n	100 n
BPF 5	1200 Hz	960 - 1440	18 n	47 n	6n8	68 n
BPF 6	1770 Hz	1440 - 2100	12 n	47 n	6n8	68 n
BPF 7	2650 Hz	2100 - 3200	8n2	47 n	6n8	68 n
BPF 8	3900 Hz	3200 - 4600	5n5	47 n	6n8	68 n

Table 1. The values of capacitors C1...C11 for the eight band-pass filter units must be selected from this table.

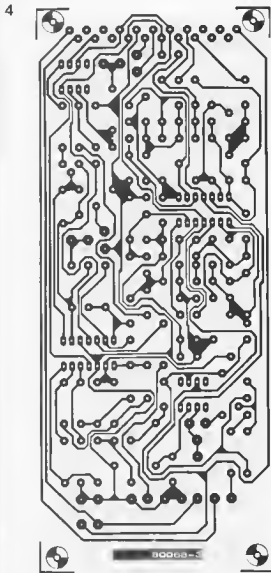

Figure 4. Copper layout for the universal filter board.

end; it contains the control(s), jacks and LED. This construction is illustrated in figure 7. a sketch of a complete filter-unit module. The small (3 mm) earphone jacks shown are a good choice for the input connections.

If the 'high-frequency blend' feature shown in figure 3 is to be added in the high-pass filter unit, this will obviously call for a second potentiometer on its front panel. The input/output module also has a more densely populated front panel: it contains three potentiometers and three large-sized headphone jacks for the speech and carrier inputs and the vocoded output.

#### Final assembly

Now we come to the job of combining all the separate boards (or modules) into

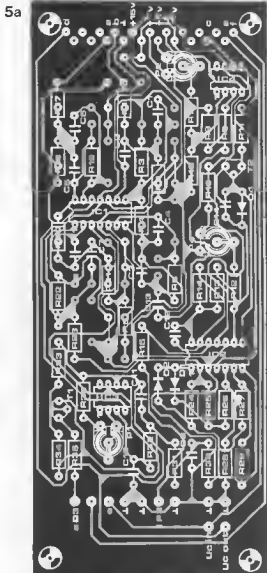

Figure 5. Three different component layouts for the filter-unit board: for bend-pass filters (5a), the low-pass filter (5b) and the high-pass filter (5c) respectively. (For figures 5b and 5c: see following page.)

#### Parts list for figure 5a (BPF)

##### Resistors

- R1, R17, R30 = 10 k
- R2, R18 = 680  $\Omega$
- R3, R7, R19 = 100 k
- R4, R20 = 8k2
- R5, R21 = 560  $\Omega$
- R6, R22 = 82 k
- R8, R26 . . . R29, R31, R32 = 47 k
- R9, R10 = 150  $\Omega$
- R11 = 4k7
- R12 = 1 M
- R13, R33 = 22 k
- R14, R15 = 33 k
- R16 = 15 k
- R23, R24, R25 = 3k3
- R34 = 120 k
- R35 = 1 k
- R36 = 68 k

##### Capacitors

- C1 . . . C11 see Table 1
- C12 = 33 p
- C13 = 180 n
- C14 = 22 n

##### Semiconductors\*

- T1 = BC 547B
- T2 = BC 557B
- D1, D2, D4 = 1N4148
- D3 = LED
- IC1, IC2 = TL 084
- IC3 = 741
- IC4 = CA 3080

##### Sundries

- P1 = 100 k preset
- P2 = 25 k preset
- P3 = 10 k lin.
- P4 = 10 k preset
- 21-pin connector - see combined parts list

5b

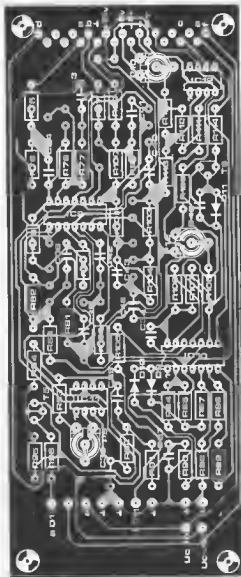

5c

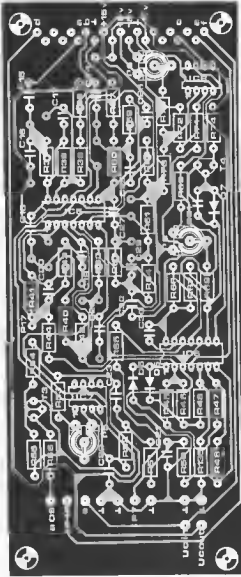
**Parts list for figure 5b (LPF)****Resistors:**

R75, R76, R79, R80, R97, R98,  
R101, R102 = 27 k  
R77, R82, R99, R104 = 150 k  
R78, R100 = 180 k  
R81, R95, R103 = 120 k  
R83, R84, R85 = 3k3  
R86 = R89, R91, R92,  
R111 = 47 k  
R90 = 10 k  
R93 = 68 k  
R94, R107 = 22 k  
R96 = 1 k  
R105, R106 = 33 k  
R108 = 1 M  
R109 = 15 k  
R110 = 100 k  
R112, R113 = 150 Ω  
R114 = 4k7

**Capacitors**

C33, C36, C40 C43 = 33 n

C37 = 390 n

C38 = 47 n

C39 = 470 n

C44 = 33 p

C45 = 22 n

C46 = 180 n

**Semiconductors**

T5 = BC 5478  
T6 = BC 557B  
D9, D10, D11 = 1N4148  
D12 = LED  
IC9, IC10 = TL 084  
IC11 = 741  
IC12 = CA 3080

**Sundries:**

P9 = 100 k preset  
P10 = 25 k preset  
P11 = 10 k lin.  
P12 = 10 k preset  
21-pin connector — see combined parts list

**Parts list for figure 5c (HPF)****Resistors:**

R36, R37, R42, R43, R58, R59,  
R62, R63, R65, R66 = 33 k  
R38, R40, R57, R61 = 39 k  
R39, R60 = 56 k  
R41, R47, R48, R49, R51, R52,  
R64, R71, R135 = 47 k  
R44, R45, R46 = 3k3  
R50 = 10 k  
R53 = 68 k  
R54, R67 = 22 k  
R55 = 120 k  
R56, R117 = 1 k  
R68 = 1 M  
R69 = 15 k  
R70 = 100 k  
R72, R75 = 150 Ω  
R74 = 4k7

**Capacitors:**

C15, C16, C18, C19, C24, C25,  
C27, C28 = 1 n

C17, C20, C26, C29, C30 = 33 p

C21 = 47 n

C22 = 6n8

C23 = 68 n

C31 = 22 n

C32 = 180 n

**Semiconductors:**

T3 = BC 547B  
T4 = BC 557B  
D5, D6, D7 = 1N4148  
D8 = LED  
IC5, IC6 = TL 084  
IC7 = 741  
IC8 = CA 3080

**Sundries:**

P5 = 100 k preset  
P6 = 25 k preset  
P7 = 10 k lin.  
P8 = 10 k preset  
P9 = 10 k log (see text)  
21-pin connector — see combined parts list

6

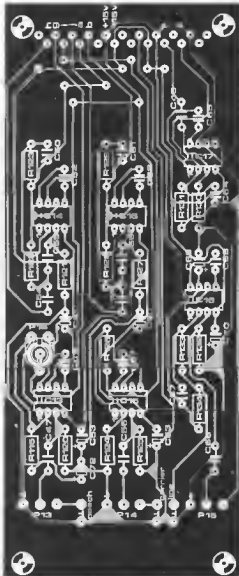
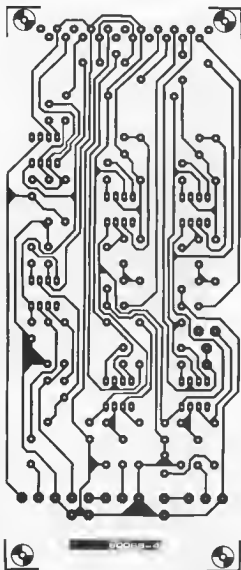

Figure 6. Printed circuit board layout for the input/output module.

#### Parts list for figure 6 (input/output unit)

##### Resistors:

R115, R130 = 1 k  
 R120, R125 = 220 k  
 R121, R124, R127, R128,  
 R129, R132, R13 = 100 k  
 R126 = 1 M  
 R131 = 47 k  
 R134 = 150  $\Omega$

##### Capacitors:

C47, C56, C66 = 220 n  
 C48 = 100 n  
 C49, C50, C52, C57, C61, C62,  
 C64, C65, C67, C68 = 33 p  
 C51, C53, C60, C63, C69,  
 C70 = 10  $\mu$ /16 V tantalum  
 C54, C55, C58, C59 = 39 n  
 C72 = 22  $\mu$ /16 V tantalum

##### Semiconductors.

IC13 = TDA 1034N, N

IC14, IC15, IC16,  
 IC18 = TDA 1034B  
 IC17 = LM 301

##### Sundries:

P13, P15 = 10 k fog.  
 P14 = 100 k log.  
 P16 = 1 M preset  
 21-pin connector — see combined  
 parts list

one complete 10-channel vocoder. The constructional block diagram (figure 8) illustrates the principle. It shows all the plug-in modules and the power supply, as can be seen, the bus board is a great help. Without it, the wiring would become rather messy.

The letters a, b, c, d, e and k, shown in figure 8, are also included on the various p.c. boards; they correspond to the indications in the circuits given in part 1. For simplicity, the supply is shown in figure 8 as a single board. In practice, as explained earlier, the  $\pm 5$  V supply is actually mounted on the bus board. P17 and R117 are also included in the block diagram; they are only required if the high-frequency blend option is to be added.

Also shown in figure 8, enclosed in dotted lines, are the supply connections and two mysterious connection links.

7

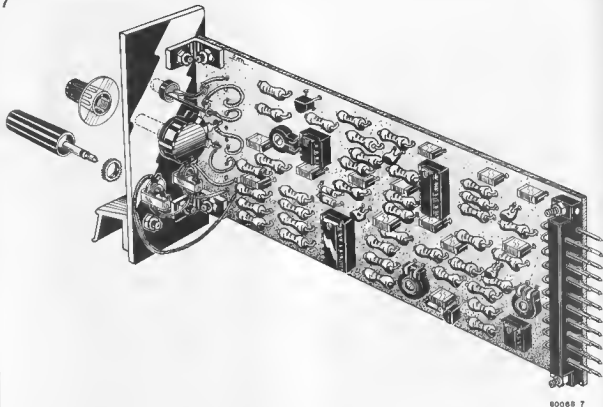

80068 7

Figure 7. This is what a complete filter-unit module will look like. No further wiring is required: all 'internal' connections are routed through the 21-pin connector.

These refer to nine connections on the bus board, into which connector pins can be inserted. At a later date, they will provide an easy way to add a voiced/unvoiced detector with its associated noise generator. All supply voltages are available in this group, so that the unit can be powered from the main vocoder supply. The connection links between two pairs of contacts are actually those shown in the circuit of the input/output module (part 1, figure 6), at the outputs of A31 and A33. The links are already included as copper tracks on the board; when a voiced/unvoiced detector is to be added, these tracks are scratched away so that the speech and carrier signals run through this module.

Having said so much about the bus board, it's time to take a look at it — or them, actually: as mentioned earlier, it is supplied in two sections that must be joined by means of wire links. Figure 9 shows the two p.c. boards and their component layouts. As can be seen, there was plenty of room between the eleven 21-pin 'female' connectors to mount the 5V supply, decoupling capacitors and one or two other odds and ends.

One point has not been mentioned yet (nor shown in figure 8, to avoid confusion): beside each connector,

there are two connections for the  $U_{C,in}$  and  $U_{C,out}$  control voltages for each filter module. These are included with an eye to possible future extensions. For instance, in a complete system it may prove useful to route the control voltage interconnections through a plug-in matrix board, instead of using loose cables on the front panel.

The various modules and the bus board are designed to fit neatly into a module case, as shown in figure 10. A standard 19 inch case can be used, with guide strips to hold the boards. This type of case is available from various manufacturers. The 19 inch width is just right for mounting the eleven modules at the spacing dictated by the bus board — no coincidence, this! The mains transformer and supply board can be mounted on the back plate, as shown in figure 10. A neat way to make the connections between the supply board and the bus board is by using so-called flat cable.

For the various signal and control voltage in- and outputs, jack plugs are a good choice; the smaller (3 mm) type for all  $U_{C,in}$  and  $U_{C,out}$  connections and a larger version (6 mm) for the signal in- and outputs. Flexible cables with a small plug on each end can then be used to make all desired control

voltage connections on the front panel. The mains switch, and an LED for power on/off indication, can be mounted on the front panel of the input/output unit. An alternative can be seen in figure 10: a potentiometer with built-in mains switch can be used for the output level potentiometer, P15. One word of warning, however: sometimes, the electrical screening between the switch and the potentiometer may prove inadequate — giving rise to an annoying hum.

### Alignment procedure

We assume that everybody still has the original circuits, given in part 1, to hand; in any event, we will be referring to them regularly... There are three preset potentiometers on each filter-unit module that must be correctly adjusted. This means that three separate adjustments must be performed for each board, as follows:

1. First the preset that sets a DC bias voltage for the inverting input of the OTA in each unit. In the eight band-pass filters, this is P2; on the low-pass filter board it is P10 and for the high-pass filter it is P6. The purpose of this adjustment is to ensure that the varying DC bias voltage, derived from the

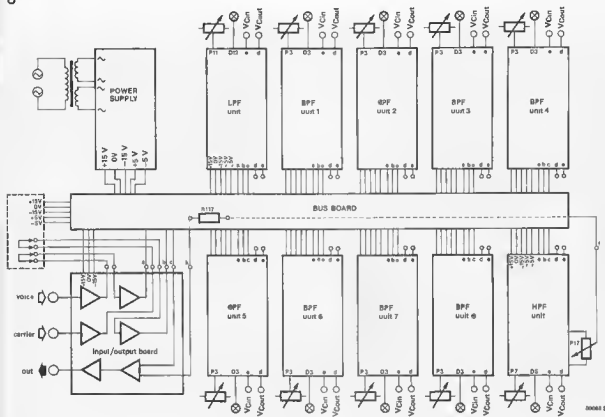

Figure 8. Block diagram of the complete vocoder. The indications a, b, c, d, e and k correspond to those given in the circuit diagrams (part 1). They are also included on the p.c. boards.

control voltage output of the analyser section when a speech input is present, cannot "break through" to the "vocoded" signal output. In simple terms: a signal present at point 'e' should not appear at output 'c'. This adjustment is carried out as follows:

- The  $U_{c,out}$  and  $U_{c,in}$  sockets on the front panel are interconnected by means of patch cords.
- All control voltage level potentiometers on the front panels (8 x P3, P7 and P11) are set to minimum, with the exception of the one on the module that is to be set up; that control is set to maximum.
- A steady noise signal is applied to the "speech" input. One simple way to do this is to blow gently into the microphone.
- The bias potentiometer on that module (P2 for a band-pass filter, say) is adjusted for minimum output signal from the vocoder.

If measuring equipment is available, a more precise alignment procedure can be considered. Instead of blowing into a microphone, a test signal can be applied direct to the  $U_{c,in}$  input of the module; a suitable test signal is a low-frequency sine wave (500 Hz or less), superimposed on a fixed DC voltage. The output signal from the vocoder can be observed on an

oscilloscope, and the preset is adjusted for minimum LF output. In some of the modules, it may prove impossible to reduce the break-through to an acceptably low level. In this case, the OTA is almost certainly the culprit: in any batch there will always be a few that have too high a leakage from the control input to the output. The only solution is to replace them.

2. The next step is the preset in the voltage-to-current converter for the OTA: P4 in the band-pass filter units, P12 in the low-pass filter and P8 in the high-pass filter module. This adjustment is intended to set the initial point of the control characteristic to the same level for all modules. The procedure is as follows:

- A suitable test signal is applied to the "carrier" input — white noise is a good choice.
- A very low DC voltage (approximately 200 mV) is applied to the  $U_{c,in}$  input of the module that is to be adjusted. This calibration voltage can be derived from the +5 V supply by means of a 25:1 attenuator (a 22 k resistor in series with 1 k, for instance).
- The control voltage level control on the front panel of the module (P3, P7 or P11) is set to maximum.

- The preset potentiometer (P4, P8 or P12) is now adjusted so that an output signal just appears at the main output.

- If the test voltage proves to be outside the adjustment range of one or more of the modules, the whole procedure can be repeated with a slightly higher or lower test voltage.

3. Finally, the easiest adjustment. P1, P5 and P9 in the band-pass, high-pass and low-pass modules, respectively. These presets determine the DC offset of the active low-pass filter that is the last stage in the analyser section of each module.

With no (speech) input signal, each preset is adjusted for minimum  $U_{c,out}$  voltage of the corresponding module

### In conclusion

We've got an interesting photo for you, saved to the last. With a spectrum analyser and a lot of patience, we succeeded in plotting each of the filter characteristics separately and combining them in a single photo. The result of our efforts is shown in figure 11. At the left in the display, the characteristic of one of the two (identical) low-pass filters; this is followed by a neat procession of band-pass filter characteristics and,



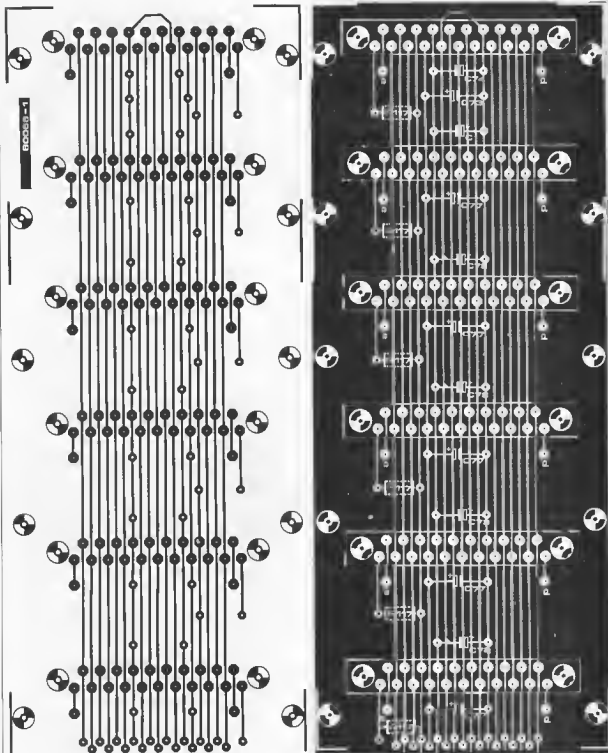
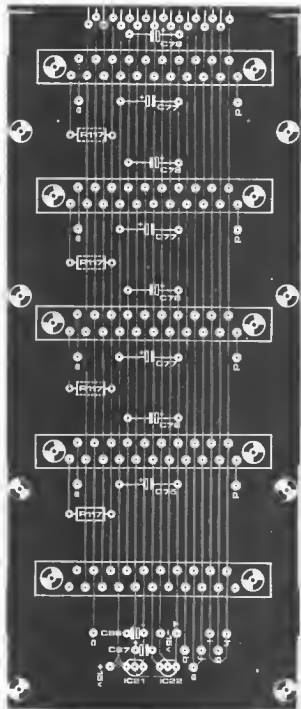
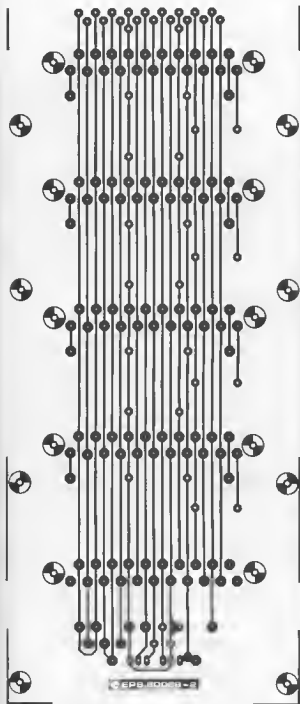

Figure 9. The bus board comes in two sections, that are interconnected by means of wire links. This board not only contains the 11 'female' connectors; there was also room for the  $\pm 5$  V supply, decoupling capacitors, and several connection points for possible extensions at a later date.



#### Parts list for figure 9 (bus board)

##### Resistors:

R117 = 1 k (see text)

##### Capacitors

C73 ... C76 = 10  $\mu$ /16 V

8 x C77 and 8 x C78 = 10  $\mu$ /16 V  
C86, C87 = 1  $\mu$ /6V3 tantalum

##### Semiconductors:

IC21 = 78L05  
IC22 = 79L05

##### Sundries

11 of 21-pin 'female'  
connectors - see combined  
parts list

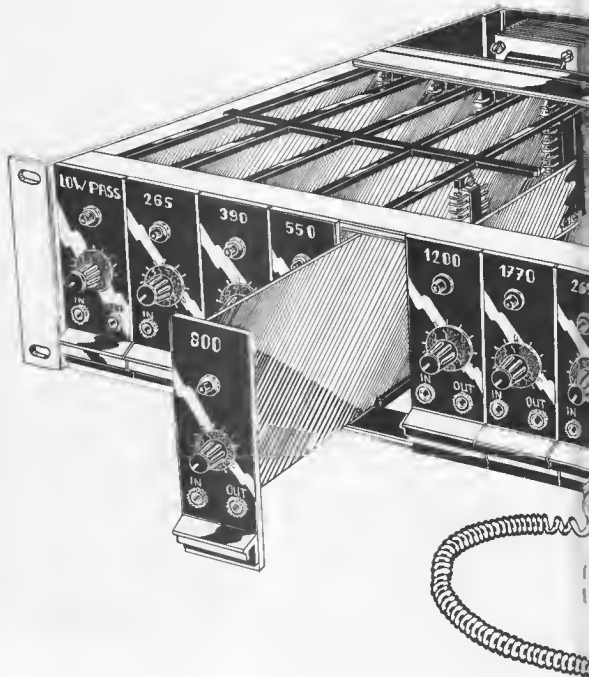
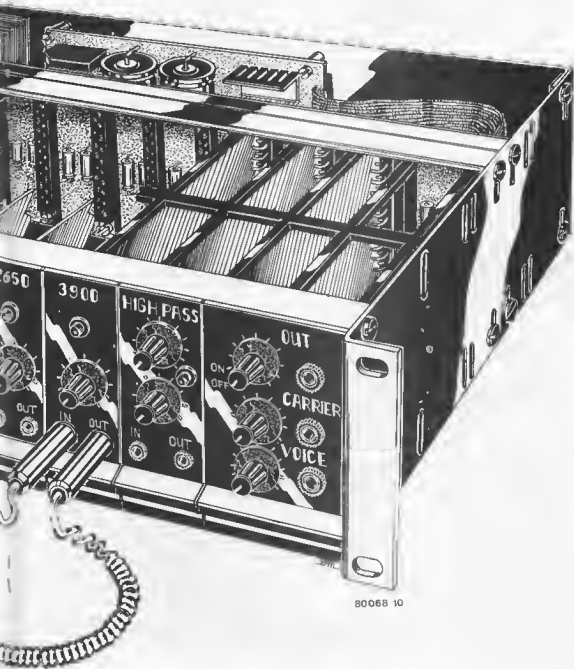

Figure 10. All modules are designed for mounting in a 19 inch case. The plug-in modules exactly fill the front panel area; main transformer and supply board fit on the back panel.



**Combined parts list for complete vocoder**
**Resistors:**

150 $\Omega$	→ 21 off
560 $\Omega$	→ 16 off
680 $\Omega$	→ 16 off
1 k	→ 13 off
3k3	→ 30 off
4k7	→ 10 off
8k2	→ 16 off
10 k	→ 26 off
15 k	→ 10 off
22 k	→ 21 off
27 k	→ 7 off
33 k	→ 27 off
39 k	→ 4 off
47 k	→ 73 off
56 k	→ 2 off
68 k	→ 10 off
82 n	→ 8 off
100 n	→ 7 off
120 k	→ 12 off
150 k	→ 4 off
180 k	→ 2 off
220 k	→ 2 off
1 M	→ 11 off

**Capacitors**

33 p	→ 24 off
1 n	→ 8 off
5n6	→ 8 off
6n8	→ 5 off
8n2	→ 2 off
10 n	→ 1 off
12 n	→ 8 off
15 n	→ 1 off
18 n	→ 8 off

22 n	→ 11 off
27 n	→ 8 off
33 n	→ 9 off
39 n	→ 10 off
47 n	→ 8 off
56 n	→ 8 off
68 n	→ 6 off
82 n	→ 8 off
100 n	→ 7 off
150 n	→ 2 off
180 n	→ 10 off
220 n	→ 5 off
330 n	→ 1 off
390 n	→ 1 off
470 n	→ 1 off

1 $\mu$ /6V3 tant.	→ 2 off
10 $\mu$ /16 V	→ 20 off
22 $\mu$ /16 V tant	→ 1 off
4700 $\mu$ /40 V	→ 2 off
10 $\mu$ /18 V	→ 6 off

**Potentiometers.**
**Presets.**

100 k	→ 10 off
25 k	→ 10 off
10 k	→ 10 off
1 M	→ 1 off

**Linear:**

10 k	→ 10 off
------	----------

**log**

10 k	→ 3 off
100 k	→ 1 off

**Semiconductors**

8C547B	→ 10 off
8C557B	→ 10 off

1N4148	→ 30 off
LED	→ 10 off
B40C2000	→ 2 off
TL 084	→ 20 off
741	→ 10 off
CA 3080	→ 10 off
TDA 1034 NB,N	→ 1 off
TDA 1034 B	→ 4 off
LM 301	→ 1 off
7815	→ 1 off
78L05	→ 1 off
7915	→ 1 off
79L05	→ 1 off

**Sundries:**

mains transformer 2 x 15 V 400 mA	→ 1 off
double-pole mains switch	→ 1 off
3 mm — jacks + sockets	→ 20 off
6.3 mm — jacks + sockets	→ 3 off
21-pin connectors	} → 11 off
Siemens type C42334-A54-A63 or type C42334 A54 A64	
21-pin connectors	} → 11 off
Siemens type C42334-A53-A608 or type C42334 A53 A8	
or type C42334-A53-A407	
or type C42334-A53-A408	

**VERD19" case**

card frame no. 33 2200 B	→ 1 off
slab guide 114 mm 33.0438 A	→ 4 off
slab guide 101 mm 33.0437 F	→ 4 off

**Printed circuit boards:**

EPS 80068-1 + 2, (bus board)
EPS 80068-3, (filter board, 10 off)
EPS 80068-4, (input/output board)
EPS 80068-5, (supply board)

finally, the high-pass filter.

The minor differences in peak amplitude are caused by unavoidable component tolerances. Not that they have any real effect, in practice, since they can be compensated for by means of the control voltage level controls on the front panel.

As can be seen, the filters provide a nicely regular division of the audio spectrum. Their Q is virtually identical, as is apparent from their equal band-pass 'widths' on this logarithmic frequency scale.

This is by no means our last word on the subject of vocoders. Exactly what is to come, and when, has not yet been finally decided — so we won't make any promises. Anyway, for the time being all enthusiastic constructors should have plenty to do . . .

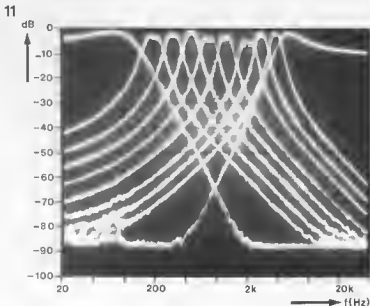

80068 11



are they worth it?

# aerial amplifiers

Aerial amplifiers are frequently used to try to improve the sensitivity of an existing receiver. All too often it is found that any increase in sensitivity is accompanied by an increase in the noise content of the resultant signal. For this reason it becomes apparent that such an amplifier needs very careful design. If the amplifier is only required to compensate for the losses in an aerial distribution network, or the like, then the problems become less severe.

Contrary to the opinion of those who claim that aerial signal amplification is of no use whatsoever, many advocates insist that amplification will often lead to improved performance. For a well-founded appraisal of the various 'for and against' arguments it is, therefore, interesting and even important to investigate more deeply into different aspects of the problems involved.

This article deals with reception on VHF/FM and UHF/TV wavebands. With equipment that performs satisfactorily on these frequencies there should be no need for further aerial signal amplification. With a system that consists of a high quality receiver, an effective aerial and a short low-loss cable between them, even the best of aerial boosters will not improve the performance.

Not everyone, however, has such an optimum combination. In many instances the aerial lead can spoil results by attenuating the signal to an extent depending on the cable quality and length. A coaxial cable of average quality and a length of, say, 20 metres may attenuate the signal by as much as 6 dB. This means that a mere 25% of the signal picked up by the aerial actually arrives at the receiver with consequent deterioration of reception, especially in fringe areas.

The above example illustrates the principal justification for the use of aerial boosters: to make up for signal losses between aerial and receiver, such as cable damping and mismatching.

Aerial signal amplifiers are sometimes used, or rather abused, to compensate for low sensitivity in existing receivers. In this case they will function as untuned receiver input stages. This application does, however, have its hazards, the most objectionable one manifesting

itself as cross-modulation — offsetting any increase in signal strength.

## Ways and means

The logical application for aerial signal amplifiers is to overcome transition losses between aerial and receiver. A few requirements must, however, be fulfilled to achieve the best results. For one thing, the amplifier must be masthead positioned. It can be powered either by an incorporated supply unit or, via the coax cable itself, from a power unit at the lower end of the cable.

Obviously, the best results are obtained by tuning the masthead amplifier. In practice, however, this method is usually ruled out because of the complicated layout and the necessity for a separate tuning control. Second best is a bandpass amplifier which operates over a limited band of channels. Incoming signals outside its specific frequency band will be rejected, thereby eliminating hazards such as intermodulation and preventing powerful radiations from outside the band from squelching or otherwise impeding reception of the desired transmission.

These arguments may explain why wide band amplifiers are not the first choice for single band aereals, such as VHF/FM types. Wide band amplifiers may be put to good use in multiple band systems where a number of aereals, each with its own bandpass amplifier, are followed by frequency selective 'splicing' networks. In this instance, a wide band amplifier could be inserted in the common downward to compensate for any cable losses (see figure 1).

## Gain versus noise

It is not enough that the aerial booster has a certain gain; its self-generated noise must be appreciably lower than that of the receiver. In order to evaluate this comparison, the magnitude of self-generated noise in an amplifier or receiver is defined by the symbol  $F$ . This is the relation between the signal-to-noise power ratio at the input and the S/N power ratio at the output of the amplifier in question. The relation can be algebraically expressed as:

$$F = \frac{P_{si}}{P_{ni}} \cdot \frac{P_{so}}{P_{no}}$$

$P_{si}$  = input signal power level  
 $P_{ni}$  = input noise power level  
 $P_{so}$  = output signal power level  
 $P_{no}$  = output noise power level.

In the ideal case, a 'noiseless' amplifier, the  $F$  number is unity. In all other cases it is higher. It is expressed as a number without dimension or in  $kT_0$  units, the numeral in both expressions being the same, for example  $F = 4 = 4 kT_0$ . It is often convenient to express the relation logarithmically in decibels, in view of

1

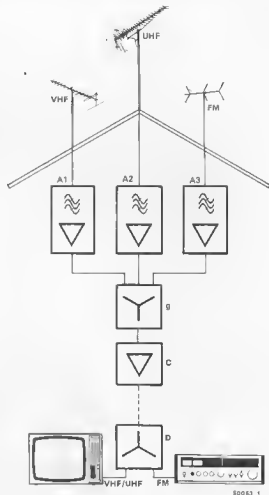

Figure 1. Aerial signal amplification and splicing network. Each aerial has its own amplifier [A1 . . . A3] active over the selected aerial band. Cross-over network B splices the three aerial signals and applies the sum to a further amplifier C. This last amplifier is a wide band type and makes up for losses in the coax cable and the signal splitting network D. Other losses such as mismatching and plug-to-socket connectrons are also overcome. Depending on reception conditions, aerial gain and cable efficiency, some or all of the amplifiers may be redundant. Some makes of amplifier have built in splicing networks.

the common practice to define power ratios in dB, thus:

$$F(\text{dB}) = 10 \log F(kT_0)$$

$F$  numbers for good receivers are often less than a factor of 5 (7 dB) and for high quality tuners they can vary between 3 and  $4 kT_0$  (4.8 and 6 dB). To justify their use, the  $F$  number of aerial amplifiers must be much better to be of any advantage. For a cascade of amplifiers (see figure 2) this works out as follows:

$$F_{\text{Tot}} = F_1 + \frac{F_2 - 1}{G_1} + \frac{F_3 - 1}{G_1 \cdot G_2} + \frac{F_4 - 1}{G_1 \cdot G_2 \cdot G_3}$$

in which  $G$  stands for power gain. This formula shows that the  $F$  number of the first amplifier represents the main contribution to the overall noise; the effect

of the second stage amounts merely to its  $F_2$  number divided by the gain of the first stage.

Since high gain in the first amplifier stage practically nullifies the influence of noise in the second and third stages, sensitivity and noise of the entire receiving equipment are largely dependant on the quality of this first stage. This means that the performance of a receiver with insufficient sensitivity and noise characteristics can be considerably 'tuned up' by a good aerial amplifier. On the other hand, no improvement can be expected from an amplifier whose  $F$  number is the same as or worse than that of the receiver, or whose gain is not high enough to overcome the effect of noise in the receiver.

These considerations can be illustrated in the following example. Let us assume that a given receiver has an  $F$  number of 5 and that it is preceded by an ampli-

fier with an F number of 3. The overall F number will then depend greatly on the amplifier's gain. For an amplifier with a gain of 2 (3 dB) the overall noise still works out to be  $F = 5$  — no improvement at all. For a gain factor of 10 (10 dB), the improvement amounts to  $F_{tot} = 3.4$ . An amplifier gain of 100 (20 dB) brings the overall noise down to 3.04, a figure which practically equals that of the amplifier itself.

## Gain and losses — noise and sensitivity

Improvement in noise characteristics does improve receiver sensitivity. The question still remains: is it really worth all the trouble and expense?

The usual way to define sensitivity is to state the signal input voltage for a certain demodulated (or for stereo, dodecoded) output at a given audio signal-to-noise ratio. The signal at the aerial input terminals of the receiver depends not only on the receiver noise figure but also on demodulation method, modulation depth, audio frequency bandwidth and receiver input impedance. Only if all these remain the same, will any improvement in sensitivity and noise characteristics bear any effect. The improvement can be calculated from the formula

$$G = \frac{F_r}{F_{tot}} \quad \text{or} \quad g = \sqrt{\frac{F_r}{F_{tot}}} \quad \text{where};$$

$F_r$  = receiver noise number (kT<sub>0</sub>)

$F_{tot}$  = overall noise number (kT<sub>0</sub>)

G = improvement in power ratio

g = improvement in voltage ratio.

Transformation of these equations gives us; Improvement in dB = 10 log G or 20 log g.

Having got this far, what is the effect of this improvement on the final audio signal? The equations show improvement in the high frequency S/N ratio with respect to the demodulator input. However, the audio output signal from the demodulator also has a S/N ratio. For amplitude modulated signals this S/N figure corresponds closely to the HF S/N ratio. This is not so in the case of FM signals, especially when the input signal is on the high or low side.

Technical data sheets of high quality stereo receivers often include a graph to indicate the S/N ratio as a function of

2

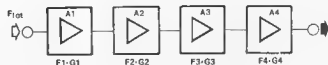

$$F_{tot} = F_1 + \frac{F_2-1}{G_1} + \frac{F_3-1}{G_1 G_2} + \frac{F_4-1}{G_1 G_2 G_3}$$

80053 2

Figure 2. The noise figure F of an amplifier is the crucial factor in determining the amplifier's noise content and sensitivity. With a number of amplifier stages in cascade the noise and gain of the first stage determines the overall noise and performance of the entire set-up.

the input level for both mono and stereo. Figure 3 shows such a graph, in which it can be seen that the S/N ratio at low input levels (around 1 μV) suddenly decreases with an increase in input level. Firstly in a linear proportion and afterwards, from a certain level on, it remains constant. In the given example the upper limit appears to be some 200 μV for mono and 300 to 400 μV for stereo. How can these figures be translated into actual receiver performance?

When reception of an FM signal is weak, any small improvement in signal level from aerial or amplifier can result in an appreciable improvement in the audio signal-to-noise ratio. This improvement will not be quite so spectacular with high FM signal levels. This means that the S/N increase in high quality equipment is hardly worth the additional amplification; in mediocre equipment the S/N increase is more effective. It is, however, very likely that the latter type of receiver falls short in other respects too, such as selectivity and fidelity. Under these circumstances it seems a better proposition to invest effort and money into better equipment.

If an existing receiver or tuner performs

and the addition of an amplifier would appear to be a more convenient and affective solution.

## Compensation for cable losses

Losses in coaxial cables determines their quality and may differ between various makes. As a rule-of-thumb the larger its diameter, the better its characteristics. As can be seen from figure 4, coax cable attenuation increases with frequency, the attenuation at 200 MHz may be anything between 4.5 to 45 dB/100 m, a figure of 25 dB/100 m being typical for inexpensive run-of-the-mill general purpose coax. Special quality cables marketed as 'low-loss' types may show attenuations of some 12 or 15 dB/100 m. To these coax cable attenuations a figure must be added for inevitable (small) mismatches.

Obviously, the sum of these losses adversely effects the sensitivity and noise characteristics of the whole receiving system, which can not be made good by increasing the receiver gain only. This effect can be put down in figures by considering a number of amplifiers, represented by the well known 'black boxes', connected in cascade. The black box which represents the cable has a noise figure of nearly unity and a 'gain' figure 'D' that is negative and stands for the attenuation. From this, it follows that the equation for cable plus receiver can be represented by

$$F_{tot} = 1 + \frac{F_r - 1}{D}$$

The overall noise for the cascaded masthead positioned amplifier, cable and receiver is given by the equation

$$F_{tot} = F_a + \frac{F_r - 1}{G_a - D}$$

where  $F_a$  is the noise figure of the amplifier and  $G_a$  its gain. This equation demonstrates that in the masthead configuration the overall noise is determined by the noise and power gain of the amplifier, just as in the case without

satisfactorily, especially as regards S/N behaviour, but its IF gain is not quite up to scratch, then optimum sensitivity can be achieved by employing a good amplifier. In spite of slightly reducing the overall S/N ratio, this will supply the higher incoming signal level required to 'fill up' the demodulator. Although, in this particular case, it may be possible to increase the IF gain, this procedure may be a relatively clumsy undertaking

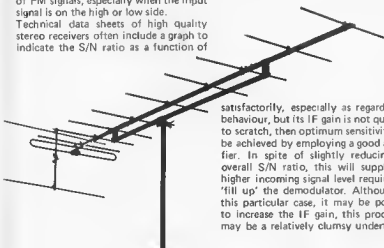



3

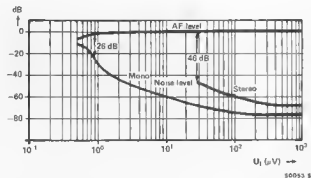

Figure 3. This graph shows the mono and stereo noise levels, together with the audio output level, as a function of the HF signal input for a typical high quality stereo receiver with a noise figure of 3.5 kTo. The graph clearly shows that the signal-to-noise ratio is not linearly proportional to the input level.

cable losses. The overall performance differs merely in that the effective amplifier gain has suffered because of cable attenuation; it now amounts to  $G_a \cdot D$ . If amplifier noise is less than receiver noise, and the overall gain is sufficient, cable losses can be completely eliminated, the overall noise figure dropping below that of the receiver.

With the amplifier positioned at the lower end of the aerial cable, its beneficial effect will be considerably inferior. The noise equation then becomes

$$F_{tot} = 1 + \frac{F_a - 1}{D} + \frac{F_r - 1}{G_a \cdot D}$$

which shows that the detrimental effect of cable losses is maintained to the full.

### Numerical examples

Figure 5 compares different configurations of the same components, namely:

- an FM stereo receiver with a noise factor of 3.5 and a sensitivity in accordance with figure 3, measured with a sweep of  $\pm 40$  kHz and a bandwidth of 180 Hz to 16 kHz;
- an aerial amplifier with a noise number of 1.5 and 20 dB (100 times) power gain;
- a cable with 6 dB (factor 0.25) attenuation.

The following configurations are shown;

- 1: receiver without cable or amplifier,
- 2: receiver without cable but with amplifier,
- 3: receiver with masthead amplifier and cable,
- 4: receiver with cable and amplifier at lower end,
- 5: receiver with cable but without amplifier.

Table 1 lists the figures for overall noise, gain in dB, aerial signal level for 60 dB stereo S/N, and S/N ratio for 100  $\mu$ V aerial signal for each configuration. The

4

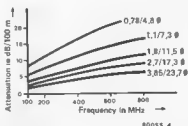
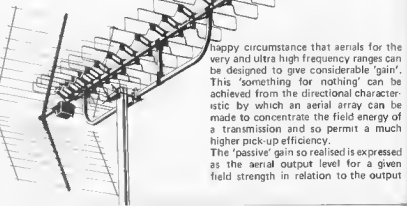

Figure 4. Coaxial cable attenuation increases with frequency. Cable quality depends to a large extent upon inner conductor section and screen diameter. The graph shows cable attenuation as a function of frequency for five different cable constructions, with conductor section and screen diameter as parameters.



conclusion is that in the absence of an aerial cable the amplifier is good for a 5 dB improvement in S/N; with a 6 dB cable loss the improvement can be as high as 10 dB. Even though these figures cannot be completely realised in practical applications, due to unavoidable mismatching etc., layout 3 shows a clear superiority over layout 4 and is decidedly close to the ideal of layout 2.

### Overload problems

Overloading of the amplifier or receiver is a possible adverse result of aerial amplification. Most modern types of amplifier are reasonably free from this effect, so the first one to suffer would be the receiver itself. Severe overloading may even result in complete squelching, especially if the amplifier is of the untuned type and not fitted with automatic gain control.

Overload conditions manifest themselves by the production of harmonics, unwanted demodulation and intermodulation. These spurious signals can result in multipoint tuning to the same transmission, swamping weaker transmissions, images and beat frequencies. Strong and weak signals on neighbouring wavelengths could be demodulated together, especially in receivers with deficient AM suppression. Other harmful phenomena are chirping 'birdies' in FM stereo demodulation as well as chatter and whistles in AM reception.

When one or more of these troubles manifest themselves, the best advice would be to substitute tuned amplification or else discard it altogether and install an aerial with directional characteristics and high gain. Another solution might be to insert a tuned pre-amplifying stage with automatic gain control or invest in a superior receiving system.

### The best HF stage is a good aerial

This adage is given new life by the

happy circumstance that aerials for the very and ultra high frequency ranges can be designed to give considerable 'gain'. This 'something for nothing' can be achieved from the directional characteristic by which an aerial array can be made to concentrate the field energy of a transmission and so permit a much higher pick-up efficiency.

The 'passive' gain so realised is expressed as the aerial output level for a given field strength in relation to the output

5

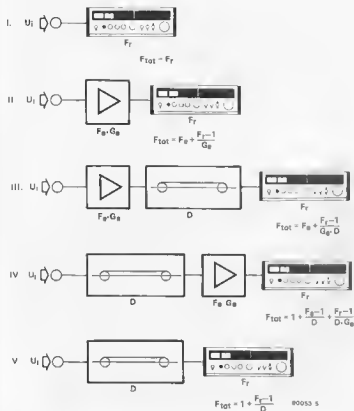

Figure 5. Performance comparison between different configurations with the following components:

- I. receiver only
- II. receiver preceded by serial signal amplifier;
- III. receiver with masthead amplifier and lossy cable;
- IV. receiver with cable end amplifier at lower end;
- V. receiver with cable but without amplifier.

Equations characterising equipment performance for each configuration are listed in table 1.

Table 1 (see figure 5)

Data assumed

$F_r = 3.5$ ;  $F_a = 1.5$ ;  $G_a = 100$  (20 dB);  $D = 0.25$  (-6 dB)

For receiver sensitivity see figure 3.

configuration (figure 5)	$F_{tot}$ ( $kT_G$ )	improvement (dB)	sensitivity <sup>1)</sup> ( $\mu V$ )	signal-to-noise <sup>2)</sup> (dB)
I	3.5	0	100	60
II	1.53	3.6	66	64
III	1.6	3.4	68	63
IV	3.1	0.5	94	61
V	11	-5	177	56

<sup>1)</sup> for 60 dB stereo S/N

<sup>2)</sup> for 100  $\mu V$  input (stereo)

6

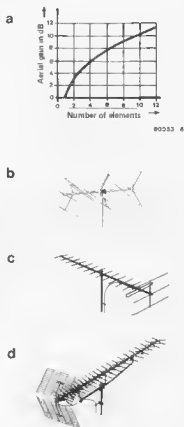

Figure 6. An efficient aerial is the best HF stage. Multi-element arrays can supply much higher signals than a simple dipole without inherent self-generated noise. This is illustrated in the graph of figure 6a which shows aerial gain as a function of the number of elements. Figures 6b to 6d illustrate the following arrays:

- 6b, a 14-element UHF array with around 12 dB gain;
- 6c, a 13-element VHF array with around 11 dB gain;
- 6d, an UHF array with as many as 91 (!) elements for a typical gain of around 16 dB.

of a simple dipole. It is usually expressed in dB; an aerial of 8 dB gain picks up 6.3 times the energy of a dipole. This gain in turn results in a clean 8 dB improvement in the signal-to-noise ratio, which verifies the truth of the statement heading this chapter. An aerial, no matter how high its gain, cannot be overcontrolled - and it needs no power supply.

In spite of these arguments there may be instances where it is absolutely necessary to use an aerial signal amplifier, due to circumstances beyond the listener's or viewer's control. In these cases the design for an efficient one may prove welcome and so, true to form, Elektor have come up with the goods. Such a design is described elsewhere in this issue.

It was probably the simplicity of the circuit's design which helped it to score such high points. It extends the uses of an oscilloscope considerably and at a relatively low cost. Usually one can only observe several TTL levels at once by taking notes at the same time. If the levels are static there is no problem, but when levels vary it becomes more difficult. The digisplay can be used to observe static levels as well as slowly changing ones (for signals which change rapidly, other methods will have to be sought), so that an overall picture of everything happening in the circuit is obtained at a glance.

result is an oscillator which starts up without any trouble at all — unlike the older version.

The complete circuit works as follows. The logic levels which are to be displayed on the oscilloscope screen as 'noughts' and 'ones', are fed to the IC1 inputs and are passed in sequence to the output (pin 10) in inverted form. Which input signal reaches the output depends on the information at the inputs A, B, C and D. This is provided by a hexadecimal counter (IC2), driven by the oscillator (N1 and N2). As the oscillator always runs (as long as voltage is applied), the binary information will keep changing from 0 to 15 and then start all over again. The input signals to IC1 are therefore scanned, appearing in sequence at pin 10.

The circuit around T1 is a sinewave generator. The sinewave produced passes through R7 to the Y output. C4, C5, R5 and R6 constitute a phase-shifting network. If the W output of IC1 is low, this network is blocked. If, on the other hand, pin 10 is high, the phase-shifted sinewave reaches the X output through R9. The binary information given by IC2 is also used to determine the position of the 'ones' and 'noughts' on

p.c. board for the

# digisplay

## The lay-out

The original circuit (as published in the Summer Circuits issue) has been modified slightly, as shown in figure 1. The oscillator around N1 and N2, in particular, needed some attention. The

One of the winning circuits of the Eurotronics competition was circuit no. 68 in the 1979 Summer Circuits issue; the digisplay. We promised p.c. boards for winning circuits . . .

A. Kraut

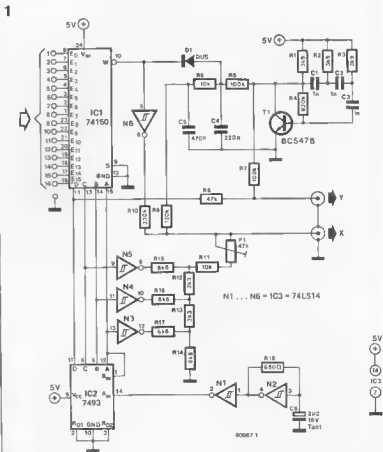

Figure 1. The digisplay, originally published in the 1979 Summer Circuits issue. A few minor changes were made when designing the p.c. board.

2

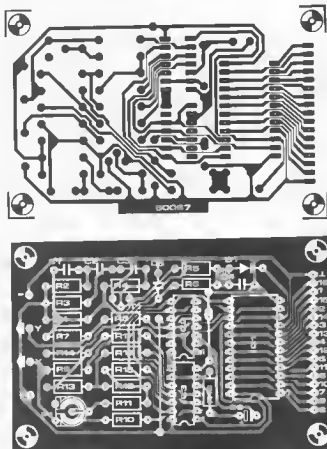

Figure 2. This is what it's all about: a p.c. board for the digisplay.

#### Parts list

##### Resistors:

R1, R2, R3 = 3k9  
 R4 = 820 k  
 R5, R7 = 100 k  
 R6, R11 = 10 k  
 R8 = 47 k  
 R9 = 120 k  
 R10 = 330 k  
 R12, R13 = 3k3  
 R14, R15, R16, R17 = 6k8  
 R18 = 680  $\Omega$   
 P1 = 47 k preset potentiometer

##### Capacitors

C1, C2, C3 = 1 n  
 C4 = 220 p  
 C5 = 470 p  
 C6 = 2 $\mu$ 2/16 V (Tantalum)

##### Semi-conductors:

T1 = BC 547B  
 D1 = DUS  
 IC1 = 74150  
 IC2 = 7493  
 IC3 = N1 . . . N6 = 74LS14

##### Miscellaneous:

1 x 16-pin TTL-testclip

the oscilloscope screen. N3 . . . N5 superimpose various DC voltages on the X output. In this way, each input signal is given its own position on the screen — at least, as far as the first eight input signals are concerned. There are, however, sixteen signals altogether, so that in order to get a clear overall reading two different DC voltages must be applied to the Y output. This has been done by using the D output of IC2. Two rows of eight signals are displayed on the screen, corresponding to the sixteen pins of a DIL IC.

If the output of IC1 is low, a sinewave appears at the Y output and a DC voltage at the X output. The spot on the oscilloscope's screen is therefore horizontally fixed, whereas vertically it moves up and down with the sinewave. The result is a short, vertical line on the screen.

When the output of IC1 is high, the phase-shifting network is no longer blocked, so that a sinewave is fed to the X output as well as the Y output. Since these sinewaves are shifted in phase with respect to each other, a lissajous figure in the shape of an ellipse appears on the screen. The ellipse's position is also determined by the DC voltage at the Y and X outputs.

P1 is one component which was not part of the original circuit. It has been added as an adjustment point for the horizontal position of the ones. If the IC1 output is low, the output of N6 will be high. This is the case when the input of IC1 being scanned at that moment is also high. This voltage is applied to a voltage divider consisting of R10, P1, R11 and one or more of the other resistors, depending on which of the gates between N3 and N5 is (are) low at that particular moment. Using P1, the DC level at the X output can be slightly altered.

When the output of N6 is low (caused by a '0' at the 'active' input of IC1), R10 merely constitutes a minor load for the DC bias at the X output; P1 now has very little effect on this voltage.

#### The construction

A suitable p.c. board is shown in figure 2.

With its low current consumption (approximately 20 mA), the digisplay can often be fed from the circuit being measured. If a separate supply is required, however, this circuit can be used as shown in figure 3. There is no room for it on the p.c. board, but it shouldn't be too difficult to construct on a piece of Veroboard or similar.

Finally, it should be mentioned that only TTL levels can be displayed on the screen with the aid of the digisplay and that an oscilloscope which has a connection for an external time base (X input) must be used. Unconnected inputs cause 'ones' to appear on the screen. The best way to make the necessary connections between the signals to be measured and the digisplay is with the aid of a TTL test clip.

3

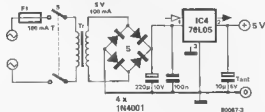

Figure 3. The digisplay can often be fed from the circuit which is being measured. If a separate supply is required, however, this circuit can be used.

Bucket brigade delay lines are not unknown to Elektor readers. We've used them in an analogue reverb unit and for a TV scope. At that, we've really only scratched the surface of what promises to be a new area in electronics: analogue delay line technology. New types of delay line are appearing at regular intervals, and new applications are even more commonplace. Not only reverb, phasing and similar 'musical' applications: filtering, scrambling and real-time spectrum analysis are also possible.

There are two main types of electronic components that can be used to delay an analogue signal. Although their operating principles are completely different, they can be used in very similar applications.

The first group are the so-called *charge transfer devices*; CTD for short. Bucket brigade delay lines belong in this category, as do charge coupled devices (CCDs). Both of these types of CTD can be used in virtually identical applications.

Charge transfer, using a CTD, is not the only way to delay an analogue signal. Another way is to convert the electrical signal into mechanical vibrations. These vibrations can cause mechanical 'waves'

# analogue delay technology

## CTDs and SAWs

in a solid, for instance; at some distant point you pick up these waves again and convert them back into an electrical signal. With a little care — making sure that the mechanical wave can only travel along one path, for instance, so that the path length is constant — it is possible to make the electrical output signal identical to the original input. Delayed, of course, but that is the whole object of the exercise.

This principle is used in *surface acoustic wave devices*, or SAWs. A 'SAW filter', for instance, is fairly well-known,

## Little capacitors, all in a row

If you want to delay an analogue signal, you have to store it somewhere for a while. One solution is to 'sample' the signal at regular intervals and store the samples. This is what happens in a CTD.

One of the simplest CTD arrangements is shown in figure 1. Basically, it is nothing more than a chain of little capacitors. One 'plate' of the capacitor is a gate electrode; the other is the corresponding part of the semi-conducting P-silicon layer. The dielectric for the capacitor is silicon oxide.

Each group of three capacitors ( $g_1 \dots g_3$ , for instance) form one step in the delay line. The analogue samples of the signal are moved down the chain as charge packets: one packet for each sample. Starting with the situation where the first charge packet is 'underneath' the first  $g_1$ , the procedure is as follows. The voltage on  $g_2$  is made more positive, and that on  $g_1$  more negative. This 'pushes' the (negative) charge from  $g_1$  to  $g_2$ . Then  $g_3$  is made more positive and  $g_2$  more negative (but not as negative as  $g_1$ ), squeezing the charge packet on to  $g_3$ . Finally, it is moved in the same way to  $g_1$  in the next set of three; simultaneously, the next charge packet

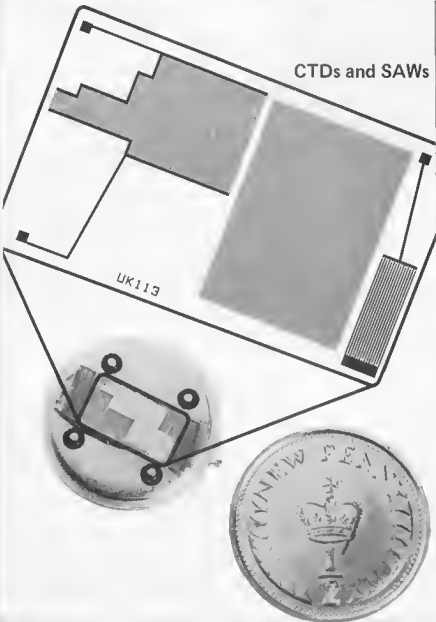

— corresponding to the next sample — moves underneath the first  $g_1$ . In all, three 'transfer pulses' are needed to move the charge packet up one step in the delay line. The rate at which the charge packets are moved along the chain depends on the frequency of these transfer pulses; this, in turn, determines the total delay time.

The first step in the CTD is a normal PN junction. The analogue input signal is applied (with a positive bias voltage) to the N-silicon embedded in the substrate. This pulls a negative charge (electrons) to the P-side of the junction; the higher the input voltage, the greater the charge. A short pulse on the 'sampling electrode',  $g_s$ , pulls this charge 'underneath'  $g_s$  — ready to start down the line. Note that another way of looking at this is to consider the whole input circuit (input electrode, sampling electrode, and first 'gate',  $g_1$ ) as a MOS transistor. The three electrodes can be considered as source, gate and drain of this device, respectively.

The last step in the CTD is simplicity itself. The output signal is taken off from the last electrode. Since this is a capacitive source — and a very small capacitance, at that — a very high impedance buffer amplifier must be used.

It should be noted that three capacitors per step is not essential. It can be done with two (if you're very skillfull!) or with more than three. In practice, three capacitors are often used, however, since this is the minimum required to keep the charge packets from 'running into each other' when using straight-forward technology.

There are other ways of making a CTD, as mentioned earlier. However, the basic principle — moving charge packets along some chain — is always the same

1

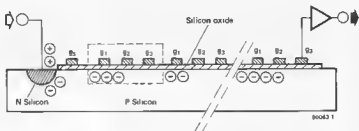

Figure 1. This simplified cross-section through a CTD (Charge Transfer Device) illustrates the basic construction: a row of little capacitors, passing on a succession of charge packets. In this example, each step consists of three capacitors.

2

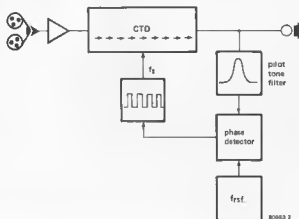
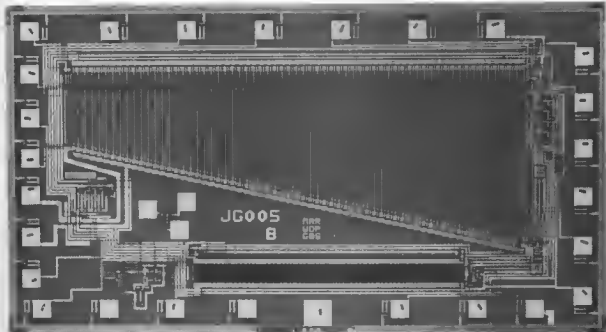

Figure 2. This system can be used to eliminate flutter in tape recorders (both audio and video). The control loop ensures that the pilot tone frequency at the output is constant, and with it, 'cleans up' the actual audio or video signal.



## Two advantages

Charge transfer devices have two significant advantages: the total delay can be varied by altering the frequency of the transfer pulses — offering easy external control. Furthermore, a CTD is fairly simple to make — for an IC manufacturer, that is! The manufacturing process is the same as that used for normal integrated circuits.

For this reason, it is also an attractive idea to combine a CTD with some other semiconductor device, on the same chip. The buffer amplifier in figure 1, for instance, and the 'clock' generator that provides the transfer pulses. It is also possible to incorporate a charge transfer device in a circuit for one particular application, and integrate the whole lot on the same chip. A hundred-step CTD (using 300 capacitors) can be squeezed onto an area of only 2.5 x 0.25 mm. This is only 2.5% of the total area on a 5 x 5 mm LSI chip!

## So what do you do with them?

The sampling rate determines the highest frequency that can be delayed by a CTD. Devices are commercially available that can be used at sampling rates of up to 20 MHz, which means that signals up to 10 MHz can be handled. In the lab stage, devices exist that work at a sampling rate of 130 MHz (signals up to a good 60 MHz). Speed is one thing, length is another: CTDs with more than 1000 steps in the chain are quite common already!

'Normal' CTDs, as described so far (special types will be dealt with later), have been used in Elektor more than once. For sound effects, in particular: phasing, flanging, vibrato, chorus, reverb and even echo; all of these effects, and more, can be obtained with CTDs. There is little to be gained by going into all this again; the list at the end of this article refers to all previous articles.

Another application is for measuring instruments. For instance, CTDs can be used for timebase expansion or compression. This possibility is utilised in the extended version of the Videoscope

3

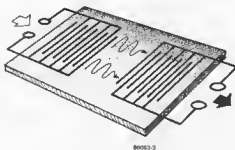

Figure 3. Basically, a Surface Acoustic Wave (SAW) device looks something like this. The conducting electrode 'fingers' are deposited on a piezo-electric substrate; this transmits the signal as a mechanical 'wave' from input to output transducer.

4



Figure 4. This type of SAW device, with ever-decreasing spacing of the 'fingers' in the output transducer, can be used for spectrum analysis of short signal 'bursts'.

A signal is first 'stored' in a CTD using one sampling frequency, and then 'played back' using a different frequency. The result is that the output signal is either a 'stretched' or a 'compressed' version of the input signal. Another 'measuring' application of CTDs is so-called 'transient recording'. Transients are defined, quite succinctly, in the Oxford dictionary, as 'not permanent' and 'of short duration'. Very true. This type of signal — interference pulses, say — is not easy to examine on an oscilloscope: it's gone before you realise that it was there. To view a transient on a 'scope, you have to store it. In a CTD,

for instance, that way, it can be 'played back' once for each sweep and at a different speed, if necessary. One important application for this is medical electronics: irregular heart-beats, brain-waves, and so on.

### Stop fluttering

The application shown in figure 2 is intended for video recorders — and audio recorders too, for that matter. The idea is to eliminate the effect of rapid variations in the tape speed (flutter). For video recorders, especially, even the least trace of flutter is notice-

## ZnO Si-MOSFET SURFACE WAVE TRANSVERSAL FILTER

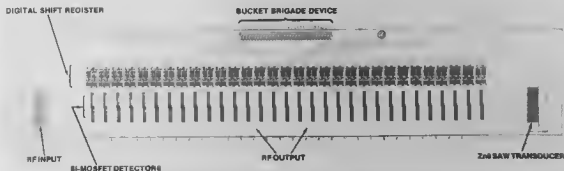



able in the reproduced signal. During recording, a reference or 'pilot' tone is also recorded on the tape. At the playback side, this pilot tone is filtered out and compared with a stable reference, using a phase detector. The output from the phase detector is used to vary the output frequency of a clock generator that provides the 'transfer pulses' for a CTD; the whole signal, pilot tone and all, passes through this CTD. Provided the delay time is long enough, the loop can be designed to maintain a constant pilot tone frequency at the output of the CTD. This, in turn, means that any 'flutter' in the main signal is eliminated.

### Surface acoustic waves

A surface acoustic wave device works on an entirely different principle than a CTD. The reason for discussing both in the same article is that they are both suitable for a very similar (and very extensive!) range of novel applications. The basic construction of a SAW device

is even simpler than that of a CTD - see figure 3. Its operation is based on the piezo-electric effect. Piezo-electric materials alter their shape when a voltage is applied across them, and vice versa: when they are 'mechanically deformed' a voltage appears across the material. A sudden, sharp blow on a piece of piezo-electric material can produce a brief pulse of several thousand volts. More than adequate for a very nice spark, as can be seen in one type of 'electronic' lighter. A somewhat less obvious application of the same effect is in 'crystal' microphones and some 'tweeters'.

A SAW device consists of a slice of piezo-electric material, with conducting electrodes on its surface. At one end, the electrodes are used for an 'input transducer' that converts an electrical input signal into mechanical vibrations; at the other end, a similar set of electrodes converts the mechanical vibrations back into an electrical signal. The mechanical vibrations travel as a kind of shock wave, mainly along the surface of the material; the amplitude of this

'surface acoustic wave' is very small, in the order of a few nanometres ( $10^{-9}$  m).

### The SAW filter

If the piezo-electric material is sufficiently pure and regular of structure, the speed with which the mechanical wave travels across the surface is virtually constant over a wide (input) frequency range. It is in the order of 3000 metres per second, or one hundred-thousandth of the speed of an electromagnetic wave in vacuum. The means that the wavelength is also shorter, in the same proportion. For example, the wavelength of a 30 MHz signal in air is 10 metres; in a SAW device, the corresponding wavelength is only 0.1 mm.

This fact can be used to construct a SAW filter: a selective device. If the electrodes, for both the input and the output transducer, are spaced at 0.1 mm intervals, signals with this wavelength will be boosted - whereas signals at a different wavelength will tend to cancel. As more and more electrodes are used in parallel (so-called 'fingers'), for both input and output transducers, the filter becomes more and more selective. In practice, SAW filters are manufactured that are almost incredibly 'sharp'.

At present, these devices are used for signal frequencies from 5 MHz up to a few GHz. They are already in use as selective filters in the IF strip of some television receivers. The advantage is that the assembly is simplified, since no 'alignment' is needed; the disadvantages (unimportant in TV sets) are high damping and the fact that the 'resonance frequency' is completely fixed in the manufacturing process - there is no way to alter it afterwards.

### Other possibilities

Using surface acoustic wave devices as highly selective bandpass filters is one possibility. But there are others.

In the SAW device shown in figure 4, for instance, a different electrode layout is used. The input transducer (at the left) consists of only two 'fingers', so that it is relatively broad-band - not at all selective. The output transducer consists of several 'fingers' at decreasing distances. Initially, the fingers are widely spaced, making that section of the transducer especially sensitive to relatively low-frequency signal components; as the spacing decreases, the transducer becomes more sensitive to higher frequencies.

Now, let us assume that a short signal

### 5a

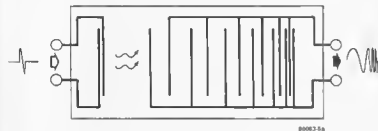

### 5b

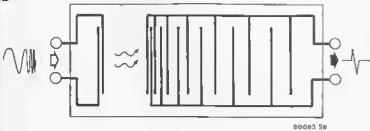

Figure 5. A pair of 'chirp' filters, as used in radar systems - and medical electronics, for that matter. The 'transmitter' shown in figure 5a converts a short spike into a characteristic signal; the 'receiver' (figure 5b) will convert this signal - and no other - into a spike.



'burst' is applied to the input. The input transducer converts it into a 'wave' that travels across the device. After a very short delay, signal components start to appear at the output: first the low-frequency components and then, as the wave passes under more closely spaced fingers, the signal components at higher frequencies. The total input signal is split up, in other words, with its various frequency components appearing consecutively at the output.

As sketched in figure 4, the output signal from this device can be rectified and displayed on an oscilloscope. This forms the basis for a high-frequency spectrum analyser! If the scope is triggered at the same moment that the signal burst is applied to the SAW device, the amplitude of the lower frequency components will be displayed first — followed by the amplitude of ever higher frequency components, as these appear at the output of the SAW.

Obviously, this system can only 'analyse' the signal one burst at a time. Even so, it can be the basis of a one-chip spectrum analyser. This would require quite a bit of additional electronic circuitry on the same chip as the SAW device, of course; in this connection, it is interesting to note that monolithic devices have already been manufactured that include both a SAW device and 'normal' semiconductors on the same chip. This is not as impossible as it may seem at first sight. On part of a silicon substrate, an integrated circuit can be manufactured in the normal way; on another part of the same substrate, a layer of piezo-electric material (zinc oxide, for instance) is deposited, as the basis for the SAW device. The electrode 'fingers' can be added at the same time as the conducting strips for the rest of the integrated circuit.

### Chirp!

The same SAW device used in figure 4 is drawn again, twice, in figure 5. This is not just an easy way to fill magazine pages (!): we are interested in another useful application.

A brief, 'spiky' pulse is applied to the input of the SAW device in figure 5a. This type of pulse contains a whole range of frequency components, as the corresponding wave travels down the SAW device, a so called 'chirp' signal appears at the output: a sinusewave at rapidly increasing frequency. If this signal is applied to the input of the second SAW device, as shown in figure 5b, the inverse characteristic of this device (high frequencies first, low frequencies last) pulls the various components together again — re-creating the original 'spike'.

Chirp signals of this type are used for radar. There, the whole idea is to transmit a short pulse and listen for the echo — in other words, listen for your pulse coming back after bouncing off some object. The problem is to know

6a

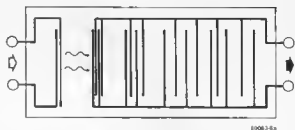

6b

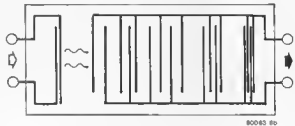

Figure 6. A less regular 'chirp' filter pair. As before, one filter can be used to 'recognise' the signal transmitted by the other.

7

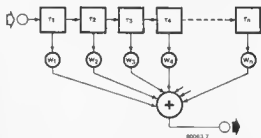

Figure 7. The basic principle of a 'transversal' filter. Virtually any filter characteristic can be selected, by choosing the correct combination of delay time ( $t$ ) and weighting factors ( $w$ ).

whether it really is *your* pulse that you're hearing — there are plenty of others around! However, if the pulse is converted into a 'chirp' before transmission and the received signal is converted back, your very own chirp is the only signal that will produce a nice sharp pulse at the output. An additional bonus is that the transmitter doesn't have to put all its power into one short pulse. To put it another way: with a given peak output power rating, a radar transmitter can put a lot more energy into a chirp signal than it could into a spike.

### Matched filters

The chirp filters described above are one example of so-called matched filters. One filter converts a spike input into a particular output signal; the other will

only produce a spike output when that particular signal is applied to its input. In other words, the second filter is 'selective' for that particular signal [note that has nothing to do with 'normal' filter selectivity, for one particular frequency!].

An almost unlimited number of variations are possible, on the same theme. The transmission filter can be designed to create almost any output 'tune', and the corresponding second filter will reconvert this into a spike. A further example is given in figure 6. It should also be noted that the two filters in a matched pair can be interchanged: instead of transmitting, the filter shown in figure 6a can be used to 'decode' a signal transmitted by that shown in figure 6b. The only difference is that the 'tune' will now be played 'backwards'.

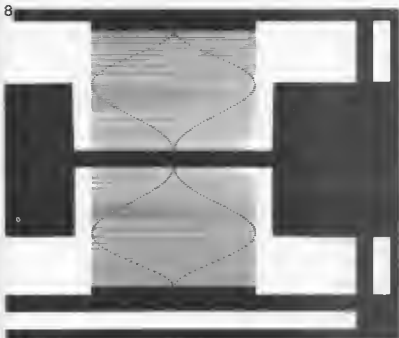

Figure 8. This SAW transversal filter is symmetric: both In- and output transducer have been given a special shape. [Photo courtesy of AEG-Telefunken.]

9

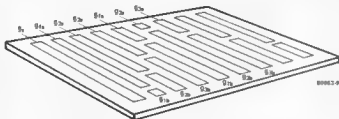

Figure 9. A 'split-electrode CTD' can also be used for special functions. In this case, the gate electrodes are divided into two sections, only one of which plays a role in the actual charge transfer operation.

### Transversal filters

Basically, this type of filter is constructed as shown in the block diagram (figure 7). The output is obtained as the 'weighted sum' of several delayed copies of the original input signal: the various delayed signals are each attenuated by some 'weighting' factor,  $w$ , and then added.

It is outside the scope of this article to explain exactly how this filter works. Suffice it to say that almost any frequency characteristic can be obtained by selecting the correct delay times and weighting factors. Calculating these is quite a job, but it's worth it if the desired frequency characteristic is almost impossible to obtain with standard capacitors, inductors and resistors.

The correct delay times are easily programmed into a SAW device, of course: they are determined by the

distance between the 'fingers'. The greater the distance, the longer the delay. The weighting factors, on the other hand, are slightly less obvious — until you realise that, instead of attenuating a given signal level, you can arrange to pick up less of the signal in the first place. This is achieved by varying the length of the fingers, as can be seen in figure 8. As is fairly common practice, the delay times are constant in this version — the distance between the fingers of the output transducer is constant.

### Back to the CTD

We started with charge transfer devices (CTDs), and now the transversal filter brings us back to them. These devices are eminently suitable for constructing

this type of filter.

The most common construction is sketched in figure 9, so-called 'split electrode' technology. The gate electrodes of the CTD are each split into two sections, only one of which is actually involved in the charge transfer operation.

Once again, the details of *how* this type of device works are outside the scope of this article, the only interesting thing is what it can do: perform very complicated functions in a very simple way. For example, the four split-electrode CTDs shown in figure 10 are programmed to perform a series of highly complicated mathematical operations, known as the 'Discrete Fourier Transform, using the chirp Z transform algorithm'. Not that we intend to explain what *that* is, either! Suffice it to say that, basically, it can be used for spectrum analysis (in the same way as the SAW device shown in figure 4), but for continuous signals — not only short bursts. It is to be expected that this type of device will play an important role in speech recognition and speech synthesis.

In the not-too-distant future, we may expect some fairly revolutionary applications of these devices. To give some idea: it has been calculated that, in their own type of application, these devices can perform such complicated calculations that it would take one thousand of the largest IBM computers to match their speed!

### Programmable

If more flexible performance is required, some way must be found to program the device as required. The SAW transversal filters and split-electrode CTDs described above are pre-programmed for one particular application.

This is not too difficult. As shown in figure 11, using CTDs as an example, a chain of delay stages can be manufactured with a whole series of outputs. In practice, this simply means bringing out each gate electrode to its own pin (instead of the last one only). The level of each output signal can be adjusted, by means of the corresponding potentiometer, to set up any desired filter characteristic.

Admittedly, this system is expensive, and rather clumsy. However, it doesn't take much imagination to imagine future developments. Integrated circuit 'potentiometers' are already known, and what's to stop you including them on the same chip as the delay line? You can even go one step further: add a micro-computer, on the same chip, that calculates and sets up the correct level on these integrated potentiometers to obtain any desired characteristic. As integrated circuit technology progresses, we should see some very interesting devices appearing!

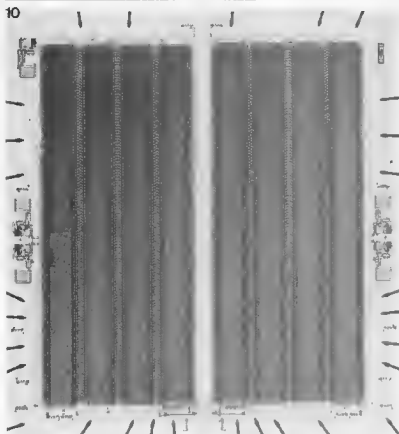

Figure 10. This chip contains four split-electrode CTDs. Together, these four filters perform a mathematical operation that can prove of fundamental importance in speech recognition and speech synthesis systems. [Photo courtesy of Reticon.]

11

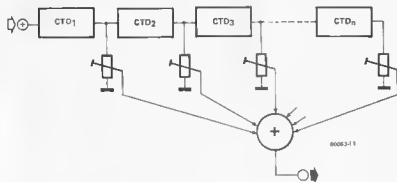

Figure 11. This basic principle of a programmable transversal filter lends itself for all kinds of large-scale integration. In principle, the most sophisticated filters can be set up on a device of this kind.

An alternative possibility is a modification of the split-electrode technique described above — for that matter, it can also be used to vary the length of the 'fingers' in the SAW device. The idea is to mount MOS switches at one or more places along each (split) electrode or finger. By opening or closing these

switches, the effective length of the electrode or finger can be varied. Once again, the MOS switches could be controlled by an on-chip microcomputer. Or, if only a limited number of different characteristics are required, the various 'switch settings' can be stored in an on-chip ROM.

### What of the future?

Plenty! As will be obvious, analogue delay lines are useful in many more applications than 'just' audio reverb and sound effects systems. Both CTDs and SAW devices may be expected to play an ever more important role in everyday electronics. For this reason, it is not surprising that a large number of well-equipped research laboratories are spending a lot of time on further developments. And with so many 'bright lads' working on them, new applications are certain to be found! Enough is enough — a good motto, when writing an article. Our intention was to put the whole idea of 'analogue delay lines' in a new perspective. We could go on, in the same vein; the whole field of light-sensitive CTDs, for instance, remains to be discussed. Flat television cameras? Some other time, maybe.

M

### Lit.:

- Robert W. Broderson & Richard M. White: *New technologies for Signal Processing*, Science 195-4283, March 18th, 1977. (No article for light reading, this!);  
TV scope. *Elektor*, December 1978, p. 12-34;  
*Analogue reverberation unit*, *Elektor* October 1978, p. 10-44;  
*Delay lines*, Part 1: *Elektor*, February 1979, p. 2-11;  
Part 2: *Elektor*, May 1979, p. 5-18;  
*Phasing-vibrato with analogue shift registers*, *Elektor*, December 1976, p. 12-36.

# extending the $\frac{1}{4}$ GHz counter

A few readers have suggested extension circuits for the  $\frac{1}{4}$  GHz counter (Elektor, June 1978). The two extensions described here — leading-zero blanking and period measurement — are independent circuits. This means that either or both can be added, as required.



## leading-zero blanking (H.J. Busch)

This little extension circuit suppresses unnecessary (leading) zeroes in the display. It has one minor disadvantage: the decimal point is not recognised as such. This means that a display of, say, 00.0123 will be converted to 123. This is no real problem, in practice, since it will not happen if the correct range is selected.

The circuit (figure 1) operates as follows. In the original circuit the digits are scanned in succession, from left to right. When the last digit is displayed, the corresponding 'digit strobe' pulse clears flip-flop FFA. Transistor T<sub>A</sub> is turned off, so that the first five displays are blanked. During the following scan, leading zeroes are detected by gates N<sub>A</sub> and N<sub>B</sub>: a zero corresponds to segment off and segment f on, so that the output of N<sub>B</sub> will be '0'.

The displays remain blanked until some other digit appears. At that point, both inputs to N<sub>C</sub> become 'high', so that its output goes 'low' and sets the flip-flop. The anodes of all displays are now connected to +12 V, via T<sub>A</sub>, so that this digit (and all following digits in this

scan) will be displayed. The flip-flop is reset at the end of the scan, in preparation for the next cycle.

The RC network, R<sub>B</sub> and C<sub>A</sub>, is included to eliminate any brief spikes at the output of N<sub>C</sub>. These can occur, due to the delays in the previous gates, and would set the flip-flop prematurely.

To include this circuit, the emitters of T<sub>2</sub>...T<sub>6</sub> and one end of resistors R<sub>22</sub>, R<sub>24</sub>, R<sub>26</sub>, R<sub>28</sub> and R<sub>30</sub> on the display board must be disconnected from the +12 V supply rail; they are connected to the collector of T<sub>A</sub>. The easiest (and neatest!) way to do this is by cutting the copper track between R<sub>33</sub> and T<sub>2</sub> and 'just past' R<sub>22</sub>. The track between these two points is connected to T<sub>A</sub>; the two 'loose ends' of the original track are reconnected by means of a piece of wire.

The various inputs to the extension circuit are connected to the indicated points on the display board.

## Period measurement (H. Schödel)

A frequency counter can be modified to measure (period) time. The most

1

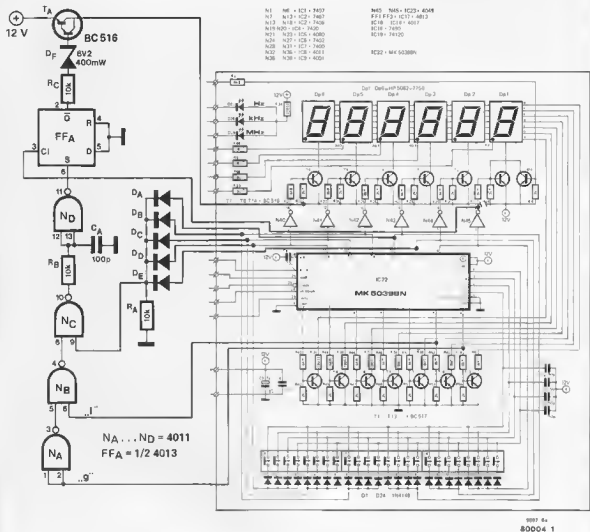

Figure 1. Only a few components are needed to add leading-zero blanking to the 1/4 GHz counter.

common system is to use the input signal to open and close a 'count gate'; during the time that this gate is open, a signal of known frequency is passed to the counter. The number of pulses counted is a measure of the period time of the input signal.

A suitable extension circuit is given in figure 2. For period measurement, S2 in the 1/4 GHz counter is switched to position 'preset' and switch S<sub>A</sub> in the extension circuit is closed. The output from the low frequency input amplifier (pin 8 of IC27) is used to clock flip-flop FF<sub>2</sub>. (Forget N<sub>H</sub> and MMV<sub>A</sub> for the moment — they will be discussed later.) For one period of the input signal, the Q output of this flip-flop will be high, enabling NAND gate N<sub>E</sub>; one of the internal reference frequencies (as selected by S<sub>B</sub>) is passed via this count gate and a buffer stage (T<sub>B</sub>) to the clock input of the counter (IC22).

At the end of this period, the Q output of FF<sub>2</sub> goes low, blocking the count gate; the Q output goes high so that N<sub>F</sub> can now pass the control signal from IC13 to the clock input of FF<sub>2</sub> (pin 11). To include this extension circuit in the counter, the wire link between pin 4 of IC13 and pin 11 of IC17 on the time-base and control board (EPS 9887-1) must be removed. This is the shorter of the two links between IC8 and IC17. The output of IC13 (pin 4) is connected to input 5 of N<sub>F</sub>; the output of N<sub>G</sub> is connected to the clock input of IC17 (pin 11). When switch S<sub>A</sub> is open the Q output of FF<sub>2</sub> is permanently high, so that the original link between IC13 and IC17 is effectively restored: the counter works in the normal way. The other connections to the extension circuit are straightforward, and do not affect normal operation of the counter. For certain specific applications, some

circuit variations may be needed. For instance, if the period time of signals at frequencies above 1 kHz is to be measured, the input to FF<sub>2</sub> must be blocked during the control pulse time. This can be achieved by including an additional NAND gate and a monostable multivibrator ('one-shot'), as sketched in figure 3; in figure 2, these components (N<sub>H</sub> and MMV<sub>A</sub>) are included in dotted lines.

### Rapid frequency count

While on the subject of modifications: in some cases (measuring high frequencies, or quickly setting up the output frequency of a tone generator) a shorter gate time can prove useful — 0.1 second, say.

As can be derived from the main circuit (figure 6a in the original article), the

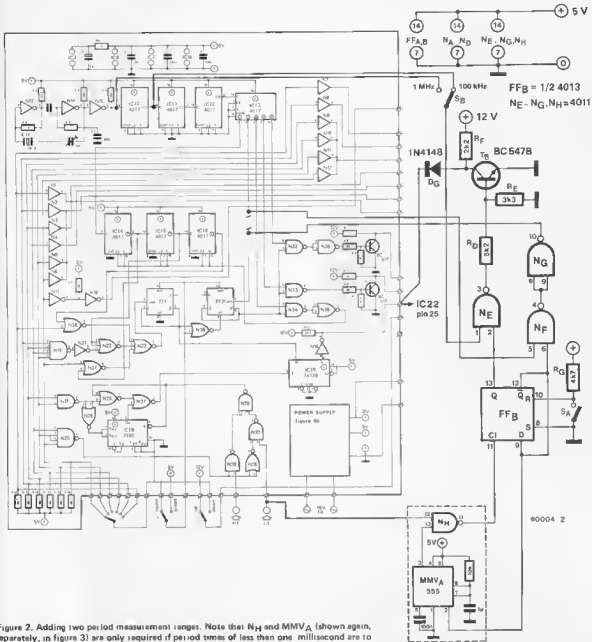

Figure 2. Adding two period measurement ranges. Note that  $N_H$  and  $MMVA$  (shown again, separately, in figure 3) are only required if period times of less than one millisecond are to be measured. Otherwise, the LF input is connected direct to pin 11 of FF<sub>B</sub>.

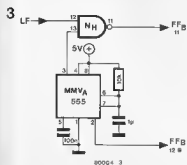

Figure 3. This 'input gate' may be added to the period-count circuit.

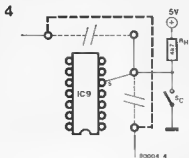

Figure 4. These modifications add a 'rapid count' facility.

logic level at pin 5 of  $N_{H7}$  can be used to determine the gate time. This is achieved by removing two wire links, adjacent to  $IC_9$  (shown as thin dotted lines in figure 4), and restoring the through connection (the dashed line in figure 4). Pin 5 of  $IC_9$  is now floating, so that an additional switch can be used to select the gate time.

From figure 3 in the original article, it can be seen that selecting the 0.1 s gate time makes the two lowest ranges identical; it has no effect on the 'FM tuning' range. For the other four ranges, it should be noted that the reading obtained must be multiplied by 10.

In principle, the AY-3-1270 is a digital voltmeter, with display drive capability for the range from  $-399$  to  $+399$ . Obviously, any other physical quantity can be measured and displayed — provided a suitable sensor is available. For temperature measurement, an NTC resistor can be used; a useful measurement range is from  $-39.9^{\circ}\text{C}$  to  $+39.9^{\circ}\text{C}$  (approximately  $-40^{\circ}\text{F}$  to  $+104^{\circ}\text{F}$ ). For low temperature measurements only — in a (deep) freezer, for instance — the range can be set from  $-39.9^{\circ}\text{F}$  to  $+39.9^{\circ}\text{F}$ .

The IC also has two switching outputs: one switches when the temperature rises above a preset temperature; the other when the temperature drops below it.

# digital thermometer

with either LCD or LED display

As more and more electronics is squeezed onto integrated circuit 'chips', it becomes increasingly attractive for manufacturers to add relatively inexpensive 'features' to all kinds of domestic equipment. Programmable timers in ovens and digital thermometers in freezers are only two examples. The ICs developed for this kind of work are often suitable for a variety of other circuits.

The AY-3-1270 (General Instrument) is intended for use in freezers. It can also be used in a very compact digital thermometer circuit, as described here. Either liquid crystal (LCD) or LED displays can be used.

The hysteresis at the two switching points can be set by means of a few diodes.

If the mains fails (for more than ten seconds), the display will start to flash when the power comes back on. It will give an indication of the temperature at that moment, until the reset button is operated; only then will it start to give a normal, continuous display of the actual temperature. The rest of the circuit works normally as soon as the power is applied, so that the switching outputs still operate. If the measuring range is exceeded, this will also result in a flashing display.

Figure 1a gives the circuit, for use with a liquid crystal display. The temperature sensor is R3, an NTC resistor. It is part of a bridge circuit, consisting of R1...R4 and P1. The voltage difference between the R1/R2 and R4/P1 junctions is measured by the IC and converted into a temperature display.

A ceramic resonator, F1, and two capacitors (C1 and C2) are the frequency-determining elements for an on-chip oscillator. This provides the clock pulses for the measuring system. The frequency itself is not so important (any value between 300 kHz and 800 kHz can be used) but the frequency stability is essential — which is the reason for the resonator.

The measurement is done as follows. Capacitor C4 is charged via P2 and R5, so that the voltage across this capacitor increases exponentially. This voltage is compared with the reference voltage at the R1/R2 junction, and with the 'measurement' voltage at the junction of R4 and P1. The time that it takes for the exponentially-increasing voltage to rise from the first of these voltages to the second determines the value displayed. C4 is then discharged, and the next measurement cycle begins. The 'zero degrees' point is set by means

1

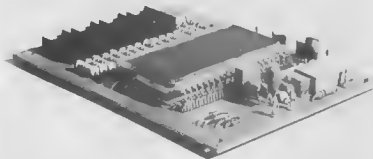

Photo 1. The prototype, with an LCD display mounted. The IC is underneath the display, making for a very compact construction.

Note that the resistors and IC sockets for the LED displays are not actually required for an LCD version.

of P1; P2 is used to calibrate the scale, by adjusting it for a correct reading at some other temperature. This will be explained in greater detail later.

Unfortunately, NTC resistors are not ideal temperature sensors. In particular, the resistance variation is nowhere near linear, as a function of temperature: it is approximately logarithmic. The exponential increase of the voltage across C4 compensates for this, to within reasonable accuracy.

### Hysteresis

As mentioned earlier, the hysteresis at the switching point can be programmed by adding a few diodes. The various possibilities can be derived from the table.

An example will illustrate this. Let us assume that the basic switching temperature is to be 22.4°C, and that a hysteresis of  $\pm 2^\circ\text{C}$  is required. According to the table, the temperature is set by inserting three diodes: from pin 7 to pin 3 ('20'), from pin 7 to pin 4 ('2'), and from pin 8 to pin 5 ('0.4') - making

22.4. The hysteresis setting requires two diodes: from pin 6 to pin 2 and from pin 8 to pin 2. The 'maximum temperature' output (relay 2, output 2 on the p.c. board) will now switch on at 22.4°C and off at 24.4°C; the 'minimum temperature' output (relay 1, output 1) switches on at 22.4°C and off at 20.4°C.

The LED display version of the circuit (figure 1b) is virtually identical. The main difference is that current-limiting resistors must be included in series with the display segments. Furthermore, a more robust supply is required to drive the LEDs. To program the IC for LED display drive, a diode must be included between pin 9 and pin 2. Note that this diode should *not* be included if an LCD display is used!

### Construction

A printed circuit board design and component layout are given in figure 2. This is suitable for both versions of the circuit - using either LEDs or LCDs, in other words. As mentioned above, diode

D3 must be included between pins 2 and 9 of the IC for the LED display version only.

The other diodes, for programming the desired temperature and hysteresis, are mounted in the holes adjacent to the numbers 2... 9 on the board. Note that all these diodes must 'point in the same direction' as the large diode symbol on the component layout.

For an LCD display version, diode D3 and resistors R8... R27 are omitted. In this case, the p.c. board can be shortened, as indicated by the dotted line beside R8 and R24. The LCD display is mounted above the IC; this is achieved by using a 'low-slung' IC socket for IC1 and inserting the display in two 'single-line' IC connector strips.

The two alternative constructions are shown in photos 1 and 2. The LCD version is illustrated in photo 1. Note that the resistors and sockets for the LCD display don't belong - they are included on the prototype board for test purposes. Photo 2 is the LED version; the connector pins for the

1a

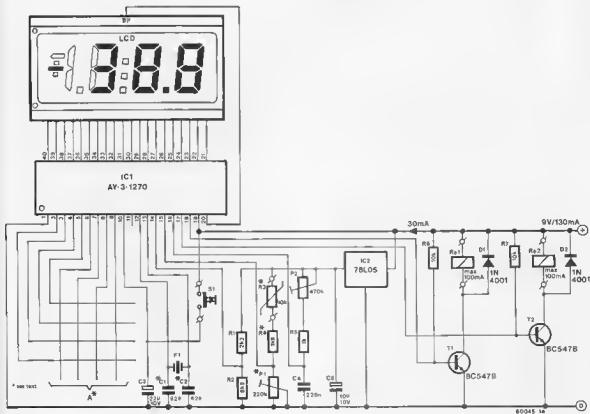
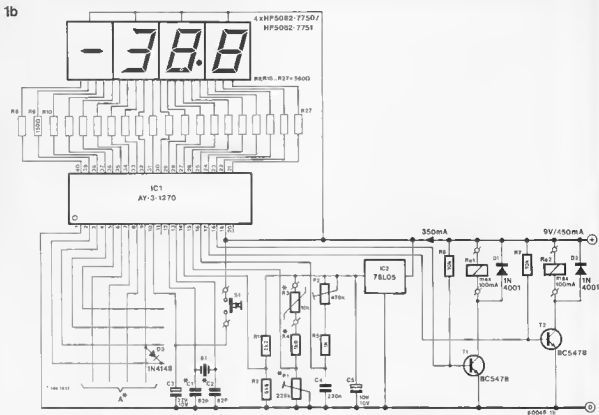

Figure 1. The digital thermometer can be used with either an LCD display (figure 1a) or seven-segment LEDs (figure 1b). The temperature sensor is an NTC ('thermistor'), R3, that is included in a bridge circuit.





2

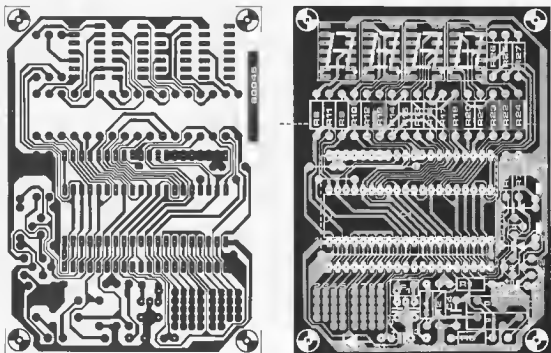

Figure 2. The p.c. board and component layout. This design is suitable for both LCD and LED versions; when using an LCD display, part of the board is redundant and can be cut off — as shown by the dotted line.

Table

2 <sup>0</sup> [pin 6]	2 <sup>1</sup> [pin 7]	2 <sup>2</sup> [pin 8]	2 <sup>3</sup> [pin 9]	
0.1	0.2	0.4	0.8	renths [pin 5]
1	2	4	8	units [pin 4]
10	20	negative	not used	tens [pin 3]
				LED display [pin 2]
				hysteresis 0
*				± 0.2
	*			± 0.4
*	*			± 0.8
*		*		± 2
*	*	*		± 4
*	*	*		± 8

\* include diode at this position

2

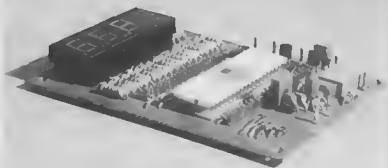

Photo 2. An LED display version. Note that a diode must be included between pins 2 and 9, in the position provided!

## Parts list

## Resistors

R1 = 2k2  
R2 = 6k8  
R3 = NTC [10 k at 25°C]  
R4 = 1k8  
R5 = 1 k  
R6, R7 = 10 k  
R8, R10 ... R27 = 560 Ω/½ W  
[for LED display only]  
R9 = 150 Ω/½ W  
[for LED display only]  
P1 = 220 k multistep preset  
P2 = 500 k multistep preset

## Capacitors:

C1, C2 = 82 p [see text]  
C3 = 22 μ/16 V tantalum  
C4 = 220 n MKM  
C5 = 10 μ/10 V tantalum

## Semiconductors:

T1, T2 = 8C5478  
D1, D2 = 1N4001  
D3 = 1N4148 [for LED display  
only]  
D4 etc. = 1N4148 [see text]  
IC1 = AY-3-1270  
IC2 = 78L05

## Sundries:

S1 = pushbutton  
display, two options:  
Type 43D5R03 (LCD),  
or equivalent;  
or 4 LED displays type  
HP 5082-7750, or equivalent  
[common anode]  
F1 = ceramic resonator, 400 kHz,  
CSB 400A [Stretner], see text  
Re1, Re2 = relay, 9 V/100 mA

3

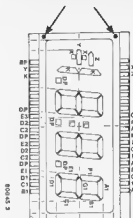

Figure 3. The pinning of the LCD display. This can be a useful guide when looking for equivalents. Note that the display must be mounted 'the right way round': two dots identify the left-hand end.

LCD display are also visible on this (prototype) board.

The ceramic resonator is 'tuned' by means of two 82 p capacitors. A special dual capacitor exists for this purpose, but two normal capacitors are just as good. The p.c. board is designed to fit either alternative. Should the resonator type CSB400A prove difficult to obtain, the CSB455A (455 kHz) can be used instead.

## Calibration

The calibration procedure depends on the type of scale that is required: Fahrenheit or Centigrade (Celsius), low temperature or room temperature, etc. The basic principle is the same in all cases, however.

First, the zero point must be set, by means of P1. P2 is turned fully anti-clockwise and the sensor is cooled to zero degrees. For a Centigrade scale, this is easy: the NTC is immersed in a mixture of water and ice cubes (without shorting the leads!). P1 is adjusted until the display reads 00.0.

The sensor is now warmed or cooled to a second calibration temperature, within the intended operating range of the unit. For room temperature (Centigrade scale only) 20°C is a good choice. If the unit is to be used in a refrigerator or freezer, -20°C is more suitable; for a Fahrenheit scale, the initial calibration at 0°F will usually be cold enough, and so freezing point (32°C) can be used for the second calibration temperature.

With the sensor at the second temperature, P2 is now adjusted until the correct reading is obtained. The accuracy over the whole range depends on the characteristics of the NTC. Over a large range (0° ... 40°C, say) an accuracy of approximately ± 1°C can be expected; over a smaller range and using suitable calibration points (0° ... 40°F, calibrating at 0° and 32°) an accuracy of within ± 1°F can be obtained.

# market

## Super sensitive miniature reed relays.

Erg Components have designed the PM11 and PM12 reed relays to operate on very low power. For example, a single normally open contact in the PM11 assembly requires only 37 mW to maintain operation in ambient temperatures from  $-40^{\circ}\text{C}$  to  $+40^{\circ}\text{C}$ . The relays will accommodate the full miniature range of reed inserts available providing a switching power of up to 20 W inductive loads



Both measure 38.5 mm long with widths of 10 mm (PM11) and 15 mm (PM12). They are of fully vacuum encapsulated epoxy resin construction in printed circuit mounting styles suitable for flow soldering and solvent cleaning.

Erg Components, Luton Road, Dunstable, Beds. LU5 4LJ.  
Telephone (0582) 62241.

(1425 M)

## High level probe.

Those who are unfortunate enough to have to work with voltages in the region of 5 kV will be the first to agree that insulation remains a very important part of the proceedings. With this in mind, Hellermann Electric have introduced a miniature probe lead



rated at 7 amps continuous, 14 amps instantaneous, at 5000 VDC. The model 4602 is available in red or black in lengths of 48". The probe has a 2 mm solid pin tip and a built in finger guard

Hellermann Electronic Components,  
Imberhorne Way, East Grinstead,  
West Sussex, RH19 1RW.  
Telephone. (0342) 21231

(1426 M)

## Portable load meter

A portable meter that can operate with any strain-gauged load cells, pressure transducer or similar device has been announced by Strainstall Ltd. Known as the Type 1900 Load Meter it weighs just 1.3 kg and is 18 cm long, 7 cm high and 18 cm deep. It has a carrying handle which also serves as a stand.

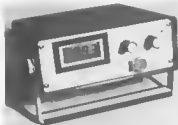

The load meter can be supplied with ordinary dry-cell batteries or with rechargeable cells and a built-in charger. The display is liquid-crystal for ease of reading and long battery life. The instrument can be supplied ready calibrated in tons, kilograms, kilo-Newtons or any other required units.

Strainstall Ltd., Harelico House,  
Denmark Road, Cowes, Isle of Wight, 77B.  
Telephone: 098 3295111.

(1431 M)

## Portable in-circuit microprocessor analyzer

A portable high-performance microprocessor system analyzer, suitable for all Z80A, 8080A or 8085A — based systems, has been announced by BFI Electronics Ltd. The AQ8080Z is a powerful diagnostic instrument that uses advanced in-circuit interactive testing techniques to aid product development, production testing, field service or personnel training.

Unlike logic analyzers, the AQ8080Z provides interactive access to the microprocessor's internal registers, and to all system memory and I/O ports. It may be used to examine or modify the contents of the program counter, the stack pointer, or any single register or register pair, including the Z80A background and index registers.

Unlike emulators, the analyzer does not require removal of the microprocessor chip — which can even be soldered in. The user may test his complete system intact while eliminating the possibility of damage to either chip or socket.

The AQ8080Z is connected to the system under test through a buffered clip-on probe, and separate probes are used to meet the different interface requirements of Z80A, 8085A and 8080A. Probes can be changed in

a few seconds, permitting convenient use of one instrument on all three microprocessor types.

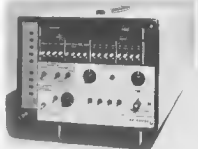

The probe assembly includes a 40-pin spring contact clip. Active buffer circuitry located near the clip minimizes loading, permits operation at full standard clock rates, and provides isolation between the system under test and the analyzer. Protective circuitry also prevents possible damage to the microprocessor or to the analyzer due to reversed or offset clip connections.

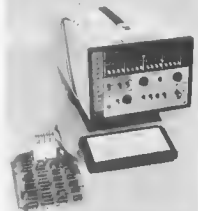

During operation the analyzer displays provide a complete picture of the system under test. They include:

Address, in hexadecimal  
Data, in binary and hexadecimal  
System status

Microprocessor cycle status  
Analyzer control indicators

Switch register, in hexadecimal  
Although the AQ8080Z is an extremely sophisticated item of equipment, it weighs only 6.8 kg (15 lbs) and measures 48 cm deep by 26 cm wide by 20 cm high (19 x 10.4 x 7.8 inches).

BFI Electronics Limited,  
516 Welton Road, West Molesey,  
Surrey KT8 0QF,  
Tel: 01 941 4066.

(1438 M)

# market

# market

## Touch sensitive continuity tester

The new Touch Sensitive Circuit Tracer from Vero Systems is a low-cost cable continuity tester with high and low impedance inputs offering significant advantages over previously available instruments. It improves upon traditional 'buzz-box' methods of continuity testing by introducing the ability to use the human body as a conductor thereby leaving both hands free of probes. 9V battery operated, the unit has a unique dual capability with high (15 M $\Omega$ ) and low (2.5 K $\Omega$ ) impedance inputs and its low current consumption gives a typical battery life of 6 months.



This product has been designed for audio hi-fi purposes but is suitable for some data recording read/write applications.

**THE MONOLITH ELECTRONICS CO LTD.,**  
5/7 Church Street, Crewkerne,  
Somerset TA18 7HR, England.  
Telephone: (0460) 74321

(1439 M)

## Miniature DVM

A neat and tidy version of the standard 3 $\frac{1}{2}$  digit LCD DVM is now available from Ambit International - the DVM176. The overall dimensions of this new unit are only 60 x 38 x 12.8 mm - enabling easy mounting in a wide variety of applications.



The unit is supplied with an integral bezel and is constructed using a high quality gold plated through hole printed circuit board and a 0.5" liquid crystal display. Based on the functions of the Intersil ICM7106, the DVM176 provides 200 mV full scale reading, true differential input and reference, a single 9V/1 mA supply, auto zero with true polarity and 1 pA input current.

**Ambit International, 2 Gresham Road,**  
Brentwood, Essex.  
Telephone: (0277) 227050.

(1427 M)

## New professional radio ICs

Two new circuits which will considerably increase the level of integration possible in professional radio equipment have been introduced by Plessey Semiconductors. Both products, the SL6270 and SL6310, are additions to the recently introduced SL6000 series of radio linear circuits.

The SL6270 is a microphone amplifier with integral gain control. The circuit provides a constant output level whether the speech into the microphone is very loud or soft and

therefore applications are anticipated in the tape recording and public address systems fields.

One of the limitations of battery life in hand-portable receivers is the high quiescent power consumption of the audio amplifier. The SL6310 is designed to avoid this excessive consumption by means of a novel feature which allows the circuit to be switched off in weak or noisy signal conditions by application of a 'mute' signal. Even when operating normally, the standby current is only 5 mA, half that of comparable products, but the SL6310 is still capable of 500 mW output power.

Both the SL6270 and SL6310 are available in 8 lead TD5 or 8 lead DIL plastic packages.

**Plessey Semiconductors Limited,**  
Chesney Manor,  
Swindon, Wiltshire.  
Telephone: (0793) 36251.

(1436 M)

## Eavesdropping on airlines

A portable MW FM/AIR radio is the latest addition to Ingersoll Electronics' range of products. Not only will the XK 725 receive all the regular stations, but it will also pick up airline frequency transmissions.



The radio is battery operated (3 x H975), has a carry-strap, and is small enough (150 mm x 70 mm x 35 mm) to fit in a bag or satchel. It has sensitive fingertip tuning with an LED tuning readout, a telescopic aerial and an earphone socket.

**Ingersoll Electronics Ltd,**  
202 New North Road, London, N1 7BL.  
Telephone: 01-226 1200

(1433 M)

The unit's fast response electronic buzzer gives an audible confirmation of continuity. For noisy environments, or where more than one unit is in use, it has both adjustable volume control and an optional earphone. A readily accessible compartment facilitates the rapid changing of the PP3 battery. Readily interchangeable crocodile lead, wrist strap and probe are all available for use with the unit.

**Vero Systems (Electronic) Limited**  
362 Spring Road,  
Sholing  
Southampton  
Hampshire  
SO9 50J  
Telephone: (0703) 440611

(1435 M)

## Magnetic tape head

The C42RPS18 is a twin quarter track stereo cassette tape head providing separate, independent, record and playback sections. This system provides a monitoring facility of the recording being made.

A further advantage is that the winding impedances and head gaps can be optimised for both the record and playback functions, the consequence of this being high flux density transfer to the tape, with improved playback frequency response.

The C42RPS18 is constructed using a Fe-Al-Si alloy for extended head life. All critical dimensions are to international standards, making them suitable for direct interchanges with existing record/playback heads on most single capstan mechanisms.

The record section impedance is 60  $\Omega$  and playback 900  $\Omega$ , at 1 kHz. The record/playback frequency response in the range 333 Hz/14 kHz is -18 dBV.

# market

# market

## Carry handle/tilt foot

A carrying handle for use with their popular 'G' range and 'D' cases has been recently developed by the Enclosures Division of Vero Electronics Ltd. The assembly is equally suited to custom designed enclosures as it combines the functions of an attractive, comfortable carrying handle with a convenient adjustable tilt foot which can be locked at any angle to suit the user.

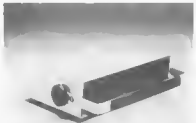

The carry handle/tilt foot is manufactured from satin anodised aluminium with black PVC trim in four sizes, although special sizes can be provided for production quantities. It is supplied as a kit comprising a handle with grip, pivot lock assembly and the necessary fastenings.

Vero Electronics Ltd., Industrial Estate,  
Chandlers Ford, Eastleigh, Hampshire,  
SO5 3ZR

Telephones: (042 15) 69911.

(1430 M)

## Business and domestic intercom

A new solid-state intercom that doubles as a

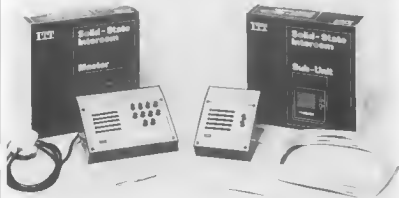

security and alarm system for business and domestic premises is being offered by ITT Terryphone.

Consisting of a master unit and up to nine sub-units, the system is easily installed in many configurations. Both units are finished in brushed aluminium and black. Self adhesion pads on the base allow the units to be permanently fixed to the desk, table or wall. Simple press-button-to-talk operation is on the master and sub-units. Each sub-unit can be called independently from the master or all the sub-units in the system can be called simultaneously. Depressing the self-latching security button means that unusual noises from children, equipment, intruders, etc. will be picked up and transmitted to another part of the premises. In smaller concerns — such as public houses, hotels, shops and offices — the intercom doubles as a security system after business hours. In the home, it can also be used as a baby alarm.

ITT Terryphone, Station Approach,  
London Road, Bicester, Oxon OX6 7BZ.  
Telephone Bicester (08692) 44661.

(1434 M)

## Pushbutton switches

The VAQ Series of snap action pushbutton switches from IMO Precision Controls Ltd have been re-designed to provide an answer to the many applications where low cost and small size are the prime consideration.



They consist of a snap action microswitch, with solder or AMP terminals, mounted on a moulded bracket with a 12 mm diameter panel fitting.

Two diameter series of push button are available in a variety of different colours and each size can be supplied with an aluminium safety shroud for protection.

The snap acting switch is rated at 15 A, 240 VAC and provides an operating life of up to ten million operations. The switches hold approvals from CSA, SEV and UL, and have an operating force of only 400 grams.

IMO PRECISION CONTROLS LTD,

349 Edgware Road,

London W2 1BS

Tel: 01 723 2231/4 and 01 402 7333/6.

(1428 M)

## Bar-graph liquid-crystal display

A dual 20-element bar-graph liquid-crystal display is now available from Hamlin Electronics. Each bar has a separate backplane so that the two bars can be driven independently. Numerical annunciators and over-range/under-range indicators are also included.

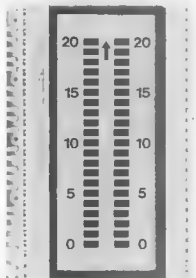

The display is available with pins for dual-in-line mounting or with snap-on terminal strips. An application note with a drive circuit for the display is also available.

Hamlin Electronics Europe Ltd.,  
Diss, Norfolk, IP22 3AY.  
Telephone: (0379) 4411/2/3.

(1432 M)

# market

# market

## Modular keyboard enclosure

Newly available from Vero Electronics Limited is a modular keyboard enclosure, available in attractive two-tone brown 17" wide to house most universal layout 'QWERTY' keyboards.

The front panel has no visible fixing screws — access to the inside of the case is gained by removing four base screws and the end moulding. This allows the front panel to be slid out for service or programming to the board.



The keyboard enclosure can be supplied in non-standard lengths to allow the addition of auxiliary keypads, individual keycaps, etc.

Vero Electronics Limited,  
Industrial Estate,  
Chandler's Ford,  
Eastleigh,  
Hampshire,  
SO5 3ZR,  
Telephone: (042 15) 69911

(1437 M)

Manufactured in ABS with optional clear lid in SAN, all sides of the base section incorporate 5.08 mm (0.2") spaced slots capable of supporting 1.5 mm (0.062") printed circuit boards.

Both versions of the lid are secured by four screws and incorporate a small flange which sits recessed into the base giving the box excellent water repellent properties.

Ideal for use in a variety of applications, the transparent version of the lid is suitable where viewing of, but not necessarily access to, internal components is required.

Boss Industrial Mouldings Limited,  
2 Herne Hill Road,  
London, SE24 0AU  
Telephone: 01-737 2383.

(1429 M)

## Application manual on solid-state relays

A 24 page manual covering solid-state relay applications, with extensive information on device specification and selection and a guide to troubleshooting relay-based circuits, is now available from Hermin Electronics. The manual covers everything from relay definitions and comparisons between electro-mechanical, solid-state and hybrid relays to protection circuits, load considerations and failure modes, and gives typical circuits to illustrate different application areas. All relevant electrical parameters are discussed in detail, and the manual also includes a comprehensive glossary of relevant terms aimed at the nonspecialist.

Hermin Electronics Europe Ltd., Diss,  
Norfolk IP22 3AY  
Telephone: Diss (0379) 4411/2/3

(1384 M)

## Deep profile clear lid Bimbox

A new, 2 part, deep profile version of their BIM 2000 range of Bimboxes has been introduced by Boss Industrial Mouldings Limited. It is available with base and lid colours in black, grey, orange, or blue with the added attraction of an optional clear lid.



# market

## New British sensor detects solids and liquids

The first of a comprehensive range of non-contacting proximity switches to be developed and manufactured in Britain has been introduced by Setpoint Ltd of London, SW8 — a Huntleigh Group Company.

The Proxistor solid state capacitive switch can be used to detect virtually any solid or liquid material and give a positive response — without the need for maintenance or regular adjustment. Reliability is exceptional — Setpoint backs all Proxistor switches with a two year guarantee against faulty operation in normal service.

Proximity switches of this kind have featured heavily in automatic machinery supplied by manufacturers in West Germany and America, but many British companies are still using conventional mechanical limit switches and

putting up with frequent maintenance and replacements.

The Setpoint capacitive Proxistor switches operate over a range of between 2 mm and 20 mm from the material to be detected. When material enters the range the capacitance of the target area changes and the switch is activated. This will occur with nearly all materials, although some will have a more marked effect on the capacitance than others. The Capacitive Proxistor range can therefore be used to distinguish one material from another, and switch when the chosen material is present.

Proxistor switches are faster than conventional mechanical switches, do not suffer from contact erosion or bounce and, once set up, the performance in any particular environment will not vary. Designed for exposed mounting they are dust and water-proof and withstand most acids, alkalis, oils and other chemicals.

The housing is made from flame retardant, self-extinguishing glass reinforced plastic, rated to UL 94V-0. It is also impact and vibration resistant. The switches are protected against reverse connection, transient overload and noise.



Proxistor switches will operate directly with electronic and electro-mechanical devices such as counters, relays, solenoids, logic modules and a wide range of industrial instruments.

The Capacitive range are available in a variety of AC and DC models. Each is totally self-contained and incorporates an LED to indicate output state. This illuminates when the switch is closed.

Operating temperatures for the Capacitive range is from  $-25^{\circ}\text{C}$  to  $+85^{\circ}\text{C}$ . The Setpoint Capacitive range of Proxistor switches conforms to the latest European CENELEC standards, making them ideal for original equipment manufacturers exporting to the Continent.

Setpoint Limited,  
Ingate Place,  
London SW8 3NS  
Tel: 01-720 3961.

(1440 M)

# market

# The Perfect Lead... Acorn Microcomputer System 1

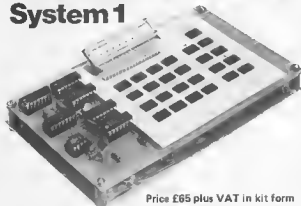

Price £65 plus VAT in kit form

This compact stand-alone microcomputer is based on standard Eurocard modules, and employs the highly popular 6502 MPU (as used in APPLE, PET, KIM, etc). Throughout, the design philosophy has been to provide full expandability, versatility and economy.

## Specification

The Acorn consists of two single Eurocards.

1. MPU card  
6502 microprocessor  
512 x 8 ACORN monitor  
1 K x 8 RAM  
16-way I/O with 128 bytes of RAM  
1 MHz crystal  
5 V regulator, sockets for 2K EPROM and second RAM I/O chip.
2. Keyboard card  
25 click-keys (16 hex, 9 control)  
8 digit, 7 segment display  
CUTS standard crystal controlled tape interface circuitry.

**Keyboard instructions:**  
Memory Inspect/Change (remembers last address used)  
Stepping up through memory  
Stepping down through memory

Set or clear break point  
Restore from break  
Load from tape  
Store on tape  
Go (recalls last address used)  
Reset

**Monitor features**  
System program  
Set of sub-routines for use in programming  
Powerful de-bugging facility displays all internal registers  
Tape load and store routines

## Applications

As a self teaching tool for beginners to computing.  
As a low cost 6502 development system for Industry.  
As a basis for a powerful microcomputer in its expanded form.  
As a control system for electronics engineers.  
As a data acquisition system for laboratories.

## START WITH SYSTEM 1 AND CONTINUE AS AND WHEN YOU LIKE



Acorn Controller  
£35 plus VAT (min config.)



Acorn Memory 8 k  
£95 plus VAT (kit form)



Acorn VDU  
£88 plus VAT (kit form)

## Acorn Software in ROM

the CPU card of System 1, it allows for up to 4K EPROM, 1K RAM and 32 I/O lines. It has on board 5 V regulator and optional crystal control. Custom programs may be developed on System 1 and the card makes an ideal dedicated hardware module.

A fully buffered memory card allowing up to 8 k RAM plus 8 k EPROM on one eurocard, in an Acorn system both BASIC and DOS may be contained in this module. Static RAM (2114) is used and the card may be wired into other systems.

A memory mapped seven colour VDU interface with adjustable screen format. Full upper and lower ascii and teletext graphics are features of this module which along with programmable cursor, light pen, hardware scroll etc., make this the most advanced interface in its class.

- Acorn BASIC — a very fast integer BASIC in 4 k  
Acorn COS — a sophisticated cassette operating system with load and save and keyboard and VDU routines in 2 k  
Acorn DOS — a comprehensive disc operating system in 4 k

Acorn Computers Ltd.  
4A Market Hill, Cambridge, Cambs.  
Cambridge (0223) 312772.

## Order Form

Please send me the following:

- (qty) Acorn Microcomputer kit @ £65 plus £9.75 VAT.  
 (qty) Acorn Memory kit @ £95 plus £14.25 VAT.  
 (qty) Acorn VDU kit @ £88 plus £13.20 VAT.  
 (qty) Acorn Power Supply (for System 1 only) @ £5.95 plus £0.89 VAT.  
 (qty) Acorn Microcomputer assembled and tested @ £79 plus £11.85 VAT.  
 (qty) Acorn VDU assembled and tested @ £98 plus £14.70 VAT.

Post and packing free on all orders.

I enclose a cheque for £ . . . . .  
(indicate total amount) made out to Acorn Computers Ltd.  
Please send me further details of this and other Acorn options

Name \_\_\_\_\_

Address \_\_\_\_\_