

elektor

57
January 1980

U.K. 55p.

U.S.A. | Can. \$1.75

up-to-date electronics for lab and leisure

colour generator
for a lovely light show

digital tuning scale
add this to your receiver

mini drill control
constant speed under load

elektor
special
offer
inside

*Winnas Bred
1980*

Austria	S 12
Denmark	DKr 20
France	F 8
Germany	DM 4.40
Netherlands	DF 3.75
Norway	Nkr 10
Sweden	Kr 14
Switzerland	Sfr 4.80
USA/Canada	\$ 1.75

elektor

57

contents

january 1980
volume 6
number 1

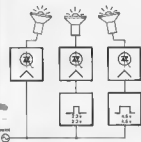

page 1-06
The colour generator produces a fairly constant amount of light, shifting slowly through the spectrum. When used for indirect lighting, it produces a beautiful effect.



page 1-08
The electronics inside radio receivers have changed radically over the years, but tuning scales remain basically the same. The 'bent wire on a string' principle is still the most popular. In this article, a **digital tuning scale** is described.



page 1-24
Here it is at last! A 10-channel **vocoder**. The design offers good performance at a very reasonable cost. **Ideal** for musicians with a lot of enthusiasm but insufficient funds to back it up!

selektor	1-01
the eighties	1-04
colour generator (W.H.M. van Oersumel)	1-06
digital tuning scale	1-08
mini drill speed control	1-16
<p>Miniature electric drills have been available for some time. Most of them are battery powered. For precision work, it is useful to have a speed control, if constant speed can be maintained, independent of the load, so much the better. Both of these objectives can be achieved fairly simply, using an integrated voltage regulator.</p>	
VSWR meter	1-18
<p>To get the maximum power output from a transmitting aerial, it must be properly matched to the transmitter. Amateur radio operators often make use of a so-called voltage standing wave ratio meter.</p>	
frequency doubler	1-22
<p>This frequency doubler circuit for guitars produces an output that is one octave higher than the original input signal.</p>	
elektor vocoder (1)	1-24
talk funny on board	1-30
new bus board for microprocessors	1-31
modern methods of voltage regulation	1-32
<p>In this article we take a look at the advantages and disadvantages of switching regulators from a practical point of view.</p>	
elektor: PWM applications	1-36
market	1-39
advertisers index	UK-30

Amirita

Now, the complete MK 14 micro-computer system from Science of Cambridge

VDU MODULE. £33.75 (£26.85 without character generator) inc. p & p.

Display up to 1/2K memory (32 lines x 16 chars, with character generator); or 4096 spot positions in graphics mode) on UHF domestic TV. Eurocard-sized module includes UHF modulator, runs on single 5V supply. Complete ascii up per-case character set can be mixed with graphics

POWER SUPPLY. £6.10 inc. p & p.

Delivers 8V at 600 mA from 220/240 V mains - sufficient to drive all modules shown here simultaneously. Sealed plastic case, BS-approved

CASSETTE INTERFACE MODULE. £7.25, inc. p & p.

Store and retrieve programs on any cassette recorder. Use for serial transmission down single line at up to 110 baud (teletype speed), e.g. over telephone line, and to communicate between two or more MK 14s.

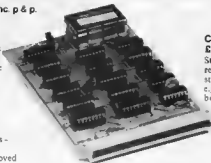

MK 14 MICROCOMPUTER KIT £46.55 inc. p & p.

Widely-reviewed microcomputer kit with hexa decimal keyboard, display, 8 x 512-byte PROM, 256-byte RAM, and optional 16-line I/O plus further 128 bytes of RAM.

Supplied with free manual to cover operations of all types - from games to basic maths to electronics design. Manual contains programs plus instructions for creating valuable personal programs. Also a superb education and training aid - an ideal introduction to computer technology.

Designed for fast, easy assembly; supplied with step-by-step instructions.

PROM PROGRAMMER. £11.85 inc. p & p.

Use to transfer your own program developed and debugged on the MK 14 RAM to PROM (745571) to replace SCI05 monitor for special applications, e.g. model railway control. Software allows editing and verifying

To order, complete coupon and post to Science of Cambridge
Return as received within 14 days for full money refund if not completely satisfied.

To: Science of Cambridge Ltd, 8 Kings Parade, Cambridge, Cambs., CB2 1SN.

Please send me:

- MK 14 standard kit @ £46.55.
 Extra RAM @ £4.14 per pair.
 RAM I/O device @ £8.97.
 VDU module including character generator @ £33.75.
 VDU module without character generator @ £26.85.
 Cassette interface module @ £7.25.
 PROM programmer @ £11.85.
 Power supply @ £6.10.
 Full technical details of the MK 14 System, with order form

All prices include p+p and VAT

I enclose cheque/MO/PO for £ _____ (total)

Name _____

Address (please print) _____

Science of Cambridge Ltd

8 Kings Parade, Cambridge, CAMBS., CB2 1SN.
Tel: 0223 311488

The Perfect Lead... Acorn Microcomputer System 1

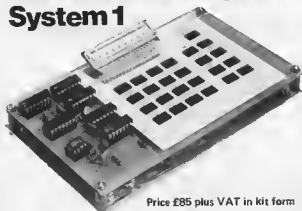

Price £85 plus VAT in kit form

This compact stand-alone microcomputer is based on standard Eurocard modules, and employs the highly popular 6502 MPU (as used in APPLE, PET, KIM, etc). Throughout, the design philosophy has been to provide full expandability, versatility and economy.

Specification

The Acorn consists of two single Eurocards.

1. MPU card
6502 microprocessor
512 x 8 ACORN monitor
1 K x 8 RAM
16-way I/O with 128 bytes of RAM
1 MHz crystal
5 V regulator, sockets for 2K EPROM and second RAM I/O chip.
 2. Keyboard card
25 click-keys (16 hex, 9 control)
8 digit, 7 segment display
CUTS standard crystal controlled tape interface circuitry.
- Keyboard instructions:
Memory Inspect/Change (remembers last address used)
Stepping up through memory
Stepping down through memory

Set or clear break point
Restores from break
Load from tape
Store on tape
Go (recalls last address used)
Reset
Monitor features
System program
Set of sub-routines for use in programming
Powerful de-bugging facility displays all internal registers
Tape load and store routines

Applications

As a self teaching tool for beginners to computing.
As a low cost 6502 development system for industry.
As a basis for a powerful microcomputer in its expanded form.
As a control system for electronics engineers.
As a data acquisition system for laboratories.

START WITH SYSTEM 1 AND CONTINUE AS AND WHEN YOU LIKE

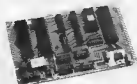

Acorn Controller
£35 plus VAT (min config.)



Acorn Memory B k
£95 plus VAT (kit form)



Acorn VDU
£88 plus VAT (kit form)

Acorn Software
in ROM

the CPU card of System 1, it allows for up to 4½ k EPROM, 1½ k RAM and 32 I/O lines. It has on board 5 V regulator and optional crystal control. Custom programs may be developed on System 1 and the card makes an ideal dedicated hardware module.

A fully buffered memory card allowing up to 8 k RAM plus 8 k EPROM on one eurocard, in an Acorn system both BASIC and DOS may be contained in this module. Static RAM (2114) is used and the card may be wired into other systems.

A memory mapped seven colour VDU interface with adjustable screen format. Full upper and lower ascii and teletext graphics are features of this module which along with programmable cursor, light pen, hardware scroll etc., make this the most advanced interface in its class.

- Acorn BASIC — a very fast integer BASIC in 4 k
Acorn COS — a sophisticated cassette operating system with load and save and keyboard and VDU routines in 2 k
Acorn DOS — a comprehensive disc operating system in 4 k

Acorn Computers Ltd.
4A Market Hill, Cambridge, Cambs.
Cambridge (0223) 312772.

Order Form

Please send me the following:

- (qty) Acorn Microcomputer kit @ £65 plus £9.75 VAT.
 (qty) Acorn Memory kit @ £95 plus £14.25 VAT.
 (qty) Acorn VDU kit @ £88 plus £13.20 VAT.
 (qty) Acorn Power Supply (for System 1 only) @ £5.95 plus £0.89 VAT.
 (qty) Acorn Microcomputer assembled and tested @ £79 plus £11.85 VAT.
 (qty) Acorn VDU assembled and tested @ £98 plus £14.70 VAT.

Post and packing free on all orders.

I enclose a cheque for £
(indicate total amount) made out to Acorn Computers Ltd.
Please send me further details of this and other Acorn options

Name _____

Address _____

ACORN
COMPUTER

selektor selektor

Cries of stress

Interpreting the tiny noises that materials and structures emit when they are loaded is the fastest-growing technique in non-destructive testing. It is already being applied to find developing cracks in mechanical structures, leaks in nuclear reactor systems end, at the other end of the scale, to detect loose bits of solder or other debris that might short-circuit electronic equipment.

It is common knowledge that when we bend a piece of wood to its breaking point, it makes a noise before it fractures. It has even been said that early miners were soon sorted out into the 'quick and the dead' by how well they could assess the creakings in the rock above their heads. Audible warnings of movements in the ground used to come, too, from wooden pit props, especially if they were cut from larch. And many eye-witness accounts of disasters to do with mechanical structures such as bridges, boilers and pressure vessels refer to a loud creak or crack being heard some time before the breakdown eventually occurred.

So it is hardly to our credit that engineers have only recently come to exploit the phenomenon of what we now call acoustic emission, to give us valuable information about materials under load. This is particularly true when we reflect that Robert Hooke, the great English experimental physicist, drew attention as long ago as 1681 to 'the possibility of discovering the internal motions and actions of bodies... whether animal, vegetable or mineral, by the sound that they make'. Two centuries later, the medical profession had adopted the stethoscope to help discover the health of patients, and by the turn of this century the first experiments were under way at Cambridge to detect the electrical signals from organs within the human body. Seismology has been well established for many years, making it all the more remarkable that it was only in 1924 that Ehrenfest and Joffe, in Russia, first reported hearing 'ticking' noises from a crystal of rock sheared at 450° C. This was followed by a report in 1927 from Claussen-Nekudov in Germany of a correlation between tiny jumps in the lengths of stretched specimens of brass and aluminium, held at temperatures above 400° C, and weak 'crackling' noises the specimens gave off. But it was not until further work had been done by Kaiser, in Munich in 1950, that anyone began seriously to consider that we could learn something useful by listening to the sounds coming from metal or wood under stress.

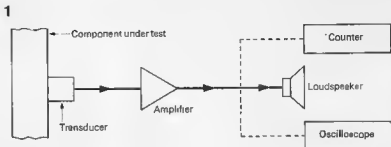

Figure 1. Simple system for detecting acoustic emissions. A counter or an oscilloscope can be added, as shown.

Today we know that most materials, including wood, metal, plastics and rock, give out such noises, and that by listening to them we can find out three things. First, we can detect that something, an 'event', has happened in the material. Second, by measuring the difference between the sound arriving at two or more sensors, and knowing the speed of propagation of the sound in the material, we can calculate where the event took place. Third, by studying the signal we can sometimes infer the nature of what has happened. We may, of course, need to amplify the sounds and listen beyond the audible frequency range to hear them. But even more, we have discovered recently that not only mechanical and thermal loading produces noise, but electrical stressing too: insulators and dielectric materials give early, audible warning of electrical breakdown.

Need for Research

Few engineering structures fail during use; but the risk is always there, so we must guard against it. The more serious the consequences of failure, the more searching the precautionary measures must be and the more often they have to be taken.

When a structure such as a pressure vessel fails, it does so either with a hiss or a bang, and in the latter instance people may be killed and extensive damage may be done to property, so the most important aim in design, manufac-

selektor selektor

2

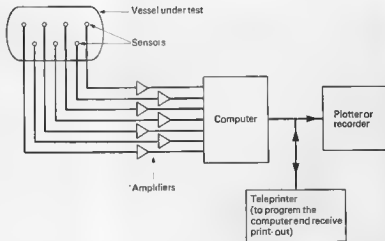

Figure 2. Multi-channel system for finding the source of acoustic emissions. Sensors mounted on the structure detect the stress waves from relaxations such as growing cracks, and the computer finds the site of their origin by assessing differences between the times at which signals arrive from points at various distances from the source.

selektor ZEITUNG

3

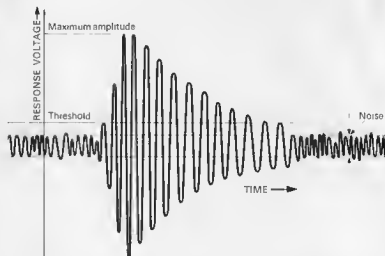

Figure 3. Theoretical response of a piezoelectric transducer to a single stress wave.

automatically print information about the place and extent of an event, within a second or two of its happening, on a diagram of the structure under test.

An idealized picture of the signal from a PZT transducer excited by a single stress wave is shown in figure 3. To analyse such signals it is usual to count the number of times the signal crosses the threshold level, which is set above the noise level, to give what is known as the ring-down count. It is also common to measure the amplitude of the signal or the repetition rate at which such signals are received, or to analyse the frequencies contained in the complex wave. Various combinations of measurements may be made, depending on the structure under study.

So far, the widest application of acoustic-emission techniques, now known as AE, is in non-destructive testing. NDT is carried out on all bridges,

boilers, boats, aircraft and nuclear reactors, to name only a few structures, to find out whether they are safe to use. AE has one enormous advantage over all other NDT techniques in that it is able to monitor an entire structure when, perhaps, only a few points may be accessible. This makes it particularly attractive for monitoring large process or pressure vessels in dangerous environments, allowing a watch to be kept from a safe place.

Theoretically, any abrupt relaxation anywhere within a material gives out a pulse of stress waves which can be detected and used to find and study the source. In practice, not all such events can be detected. A simple way of looking at this is to think in terms of a partition process in which any event, which may be the growth of a crack, a change of state (phase transformation), local yielding, electrical breakdown and

4

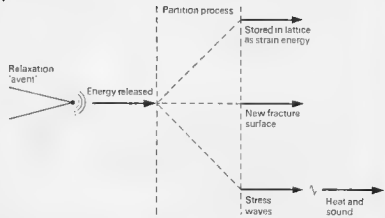

Figure 4. Any 'event', or relaxation in a material releases energy which we may regard as taking one of three forms, through a partition process.

ture and inspection to ensure that the risk of either sort of failure, and especially of an explosion, is as small as possible. The various compulsory measures, codes of practice, design procedures and inspection routines are now very good, as is shown by the extremely low incidence of failure; but demands on integrity are becoming more stringent, through the use of higher pressures and the need to store more dangerous materials than hitherto. As the vessel ages, the risk becomes greater that there is some insidious deterioration going on somewhere in the structure.

It is, of course, reasonable to suppose that experience guides us to the part of the vessel where deterioration is most likely to occur, and that appropriate non-destructive inspection can be concentrated there at regular intervals in the hope of detecting cracks before they grow too big. But sometimes the available inspection techniques do not have the resolution or reliability needed to find the sort of flaws that have to be detected if they are not to become dangerous.

One of the most serious limitations of established non-destructive test procedures, which include ultrasonics, radiography, and magnetic and eddy-current techniques, is that it is not always easy to apply them precisely at the place to be examined. This is where the so-called acoustic-emission technique has much to offer, because it enables us to listen to the whole of the volume of the material in the structure from only one or two places, which are likely to be easily accessible. Nevertheless, confidence in an ability to hear defects growing, without missing any, depends upon first proving that the kinds of defect we are looking for always emit detectable noises under specified conditions. Research is now going on in many countries to define what can and, rather more important, what cannot be heard with this new technique.

Detecting and Processing

A sensor mounted on the surface of a component can easily detect the stress waves beneath it. The most common sensors are pieces of piezoelectric (PZT) ceramic which, when vibrated, produce small voltages. Detecting, amplifying and processing systems vary from something as simple as that shown in figure 1 (no more complicated than a gramophone pick-up, amplifier and loudspeaker) to multi-channel, computer-on-line defect-tracing systems such as that outlined in figure 2, which

selektor 2010

so on, releases energy which in the end takes one of three forms. This is shown diagrammatically in figure 4, where it is seen to end up as energy stored in the atomic lattice of the material, as a new crack surface or as heat and sound. A transitional form of the last of these is stress waves and, provided they are detected, they may enable us to infer something about the other two, but one of the fallacies in the early hopes for AE was always to assume that detected energy meant some sort of crack growth. Though that is often true, there are many instances of noise being made without a crack occurring (for example, the well-known 'cry of tin' is plainly audible when we bend a stick of tin; it is caused by bending of the crystals in the metal). It follows that it would be wrong to assume a unique relationship between the number or amplitude of the stress waves counted and the area of crack produced, without knowing a great deal more about the circumstances under which the crack is growing and unless calibration experiments have been done; such experiments are by no means easy.

An even more important point is to note the difference between AE and all other forms of NDT. In any other NDT technique it is possible to go back again and again to check the indications of a flaw in the material, but noise is generated only by movement of the flaw, that is, while the event is taking place. This means that the material or

structure has to be suitably stressed mechanically, thermally or electrically to stimulate the sort of event we are trying to detect, and the AE monitoring equipment must be switched on and thoroughly reliable at the time the sound is emitted.

Potential

Metals, composite materials, ceramics, ferro-electric materials and dielectrics all make a noise when stressed. Studies have shown how we can use the noises to gain information about the quality of the material, the growth of cracks and other defects within structures, and whether the cracking is caused by tensile loading, fatigue, stress corrosion or some other factor; the technique also enables the sounds associated with certain kinds of phase transformation within the solid material to be detected. So AE can be used as a tool for materials research. It has already proved able to detect changes as diverse as deterioration in the condition of concrete, a growing crack in an aircraft wing, the formation of ice crystals in ice-cream and unreliability of thermistors in electronic systems. Use of AE for process control in welding and to keep a lookout for loose parts in equipment being assembled is already established and it is being used in mines to monitor micro-seismic activity around places where the rock formation is hazardous.

SPECTRUM No. 165

(512 S)

selektor 2010

(513 S)

Computing at the speed of light

A 'superfast' computer working at the speed of light to make calculations 1000 times faster than even the speediest of today's electronic brains could be the result of a radical break-through in thinking machine technology made by a team of scientists at Heriot-Watt University in Scotland's capital city, Edinburgh.

Harnessing space-age laser technology, the Heriot-Watt team have produced a unique and revolutionary device called a 'transphaser', which they claim, is the key to a totally new generation of optical computers whose switches are operated not by electronic components but by high intensity light beams.

Research has shown that an optical computer using laser controlled switches instead of conventional altronic devices is literally just around the corner. This would represent a breakthrough of the same magnitude as the transistor, the component on which the post-war electronics revolution was based.

The technique developed by the Heriot-Watt team involves the direction of a laser beam onto a flat crystal of a semiconductor made of the elements antimony and indium. An adjustment of the laser's power causes the crystal to start resonating, in turn suddenly boosting the brightness of the laser beam being transmitted through it. That sudden jump in output is the basis for an incredibly fast optical switch.

It is a remarkable development that it is now possible to switch, control and even delay the progress of something as rapid as a beam of light within a timescale that can only be measured in picoseconds - that is an incredible one millionth of a millionth of a second.

first prize winner

As our regular readers will know, the articles published in the July/August summer circuits edition this year were the entries for the Elektor competition in which you, our readers, voted the winners. Against stiff opposition (with competitors from 14 countries) the first prize went to Mr. John Mitchell of Balham, London. Mr. Mitchell, pictured here with his prize, was a clear winner with a total of 58,158 points for circuit number 106, the Chorosynth. His choice of goodies was a Roland MP 700 electric piano, Roland RS 202 string synthesiser and a Roland JC 120 amplifier. Readers will be pleased to know that a printed circuit board for the Chorosynth is nearing completion and will be published together with a full length article in two or three months time.

A final word on the competition: out of the 20 prizes, the U.K. won six - with three of them inside the first four places!



the eighties

Goodbye, seventies!

January 1980: the beginning of a new decennium. It's always interesting to try to guess what will happen in the next few years. Now, especially — so many predictions have already been made for this period, ranging from rosy optimism to the most gloomy pessimism. Everybody has heard of George Orwell's book '1984' — even if they haven't actually read it. We don't expect to have a 'Big Brother' within the next ten years, but what about all the other pessimistic prophecies? Are we to be killed by radiation when the ozone layer in the upper atmosphere disappears, or are we to freeze to death when our energy supplies run out just in time for the next Ice Age, or will we be roasted alive due to the 'greenhouse effect' of all that CO₂ we're putting out?

It may seem strange, but we just don't feel like being pessimistic. Technology is developing. The direction it takes is for us to decide; if we're even half as intelligent as we think, we should be able to solve our problems in time.

Let's make a few guesses about what will become technically feasible within the next ten years. First off: easy access to all kinds of information, for everyone who wants it. Teletext and Viewdata are still in their infancy, but we can expect that these services will expand rapidly. At the same time, a lot of the 'learning by rote' is disappearing from education — this type of 'ballast' can just as well be stored in computer memories. If we are to really utilise this type of 'data bank', however, it is important that we learn to interpret facts and judge results correctly. This need will be reflected in education: there will be more emphasis on teaching how to find the information you need, and how to use it once you've found it. At the same time, it is to be hoped that higher education will become more truly 'universal' (why else call those institutes 'Universities?') and less specialist-oriented. One of our main problems at present is that specialists from different fields often cannot communicate on anything above the lowest level.

We seem to be getting off our subject: what will become technically feasible within the next few years. Even if we restrict ourselves to technical prophecies, however, we've got a problem. It is to be expected that a completely new technology will appear within the next few years — with far-reaching consequences. However, without knowing what that technology is, it's difficult to guess at the results!

This is no wild assumption. Think back over the last century. It started with 'passive' electronics — well, just 'electricity', really — but the telephone, telegraph and electric light were in use. Then, in 1907, the first 'valve': an active component! With it, radio, radar and television became possible, to give a few examples. Even the first computer, in the mid-forties. But things were becoming big and bulky... until the transistor appeared, in 1947: the first of the semiconductors. Using this new technology, we are now making things that would be virtually impossible with valves: portable radios, pocket calculators, digital wrist watches, heart pacemakers, powerful computers... From thermionic valve to semiconductor took forty years. The semiconductor has been with us for over thirty years now, and everyone maintains that progress is becoming ever more rapid. Isn't it time for another radically new technology? With the same impact as valves and semiconductors, in their day? It would seem likely. But what is it to be? Molecular electronics? Optical electronics — or 'optronics', to coin a phrase? Whatever it is, it will almost certainly be used to make life easier. Further developments of semiconductor technology are also moving in that direction. This means that it is possible to make some educated guesses about the future — new technology or no. Here we go:

Goodbye record! Goodbye tape!

For sound recording, gramophone records and tapes are nearing the end of their useful life. Even the brand new, almost revolutionary Philips 'Compact Disc' is not likely to last. Admittedly, sound recording will go digital. As far as that goes, the Compact Disc is a step in the right direction. But all that fiddling with moving, mechanical parts! No, vinyl disc and tape will follow the wax cylinder — into the museum. In a digital audio system (say 16 bits and a sampling rate of about 50 kHz), one hour in stereo corresponds to some 6000 Mbits. Six thousand million bits! Where can you store them? At present, the answer is: on a Compact Disc. But integrated circuit memories also exist. There's even a 'bubble memory' with a storage capacity of 1 Mbyte, but it's still rather expensive... Currently available ROMs haven't enough storage capacity for digital audio, but things are improving rapidly: see figure 1. The coming ten years

should see ROMs with enough capacity to replace the vinyl disc and pre-recorded cassettes. Even the 'home recording' days of tape and cassette are numbered. EAROMs (Electrically Alterable ROMs) can be programmed by the user, and it won't be long before they, too, have enough storage capacity. Audio will soon be 'all solid state'!

Goodbye, organs!

Not the musical instrument variety. The human body contains a large number of vitally important organs. Those who have the misfortune to be forced to do without one of these, find themselves in a very awkward situation. Some artificial organs do exist — artificial kidneys, for instance — but they are terribly clumsy things.

As electronic circuits become ever smaller and our understanding of how the human body works becomes ever greater, the chances of building artificial replacements are increasing. As a first step, we might have artificial limbs that are controlled by the existing nervous system, and have a sense of 'touch'. Later on, vital organs. Suitable transducers could translate all relevant biochemical and mechanical data into electrical signals. These would go to a Central Processing Unit (a 'bioprocessor?') that is programmed to take the correct action — again via suitable transducers. The whole unit would work on the following lines: if the concentration of substance X in the bloodstream is higher than value Y, convert it into substance Z. A pipe dream? No, it'll come. Not in the next ten years, perhaps, but we should certainly see the first steps in that direction.

Goodbye, home constructor?

Will electronics last, as a hobby? We don't mean do-it-yourself repairs of factory-made equipment: that's not a hobby, that's bitter necessity... More and more interesting circuits are becoming available ready-made, often using custom-designed integrated circuits or 'hybrid' technology. And cheap, too: they often cost less than the components needed for a home-construction job. So what's the future in our hobby? In the first place, building your own equipment has the advantage that you can include all the most recent developments — before they reach the shops, even! Also, you can build it exactly the way you want it, make it do exactly what you want — not what some designer thinks you want.

Then there's the challenge to your ingenuity. Designing something that nobody has ever made before. Or using components for some job that they were never intended to do. As an example, think of the speech distorter ('Talk funny') we described last month. EXAR introduced the 2206 as a function generator IC - but it makes a very good ring modulator for sound effects.

Furthermore, as with any hobby: it's something to do! Collecting bottle-tops has no economic value, but a lot of people enjoy doing it. Electronics, as a hobby, has the added advantage that it always has something new to offer. Admittedly, that's also the frustrating part...

New components are being introduced almost every day. The manufacturers are delighted when one of their new products is discussed at length in a magazine like *Elektor*. But when it comes to actually supplying it to retailers, their enthusiasm often seems to evaporate. Then, by the time it finally does become available, some other manufacturer announces something even newer and better. Once again, of course, the home constructors come right at the bottom of the waiting list.

Not that we have much ground for optimism, but the least we can do is ask: Please, all you manufacturers out there, please start reserving a reasonable proportion of the first batch for the retail trade! We would be most grateful.

Goodbye, bulk!

Electrical equipment is bulky. TV sets, loudspeaker cabinets, even lighting fixtures - they're all ugly obstacles, when you come to think of it. Oh yes, we know that 'industrial designers' are doing their best to fit all those bits and pieces into boxes that don't look too bad - but, if you ask us, they're fighting a losing battle.

In the coming years, things should improve. Components are becoming smaller and flatter, so that it is becoming

easier to design enclosures that look neater. For television sets, the 'flat screen' is just around the corner. In fact, National has already introduced a 'pocket-sized' version. Philips had the technology within its grasp fifteen years ago, if only they'd realised! Now, suddenly, people are taking a new look at electro-luminescent panels.

Flat loudspeakers have been tried. Remember the 'isoplanar'? It looked like a picture, hanging on the wall, but music came out of it. It was a pity that the quality of both sound and picture left a lot to be desired. Electrostatic loudspeakers are famous, but you're not supposed to place them flat against the wall. For that matter, they're not particularly pratty ornaments in a living room. However, a lot of very clever people are still working on the problem. Within the next ten years, a truly 'flat' loudspeaker for high fidelity music reproduction may well become available. Flat 'lamps' should become available in the near future. Already, so-called panel lighting is well-known: the lamps are mounted behind flush-fitting translucent panels in ceiling or even floor, giving evenly distributed light. The next step is a flat panel that gives enough light - without mounting a conventional lamp behind it.

We could go on, giving more examples, but the general message is clear: the 'functional units' in our homes will become smaller, less obtrusive. This means that there will be more room for things that are just 'nice to look at' - whether they serve any 'functional' purpose or not. Plants or art objects, maybe, or even just room to move around in without feeling cramped!

Goodbye, drudgery!

Automation at work: some people are afraid it will cost them their jobs. Automation at home: very welcome. The affect of automation in the next ten years will depend on our own wishes, to a very large extent. One thing is clear: work will be valued differently, and it will have to be distributed more evenly.

Working hours will be shorter, as more and more of the work is done by machines. This is nothing more than a continuation of a process that has been going on for a century or more: the 'working week' has halved, from eighty hours to forty, and are we any the worse for it?

The main result is: more 'free time'. Which brings us to the main question: what are we going to do with it? A lot of people spend most of their 'spare time' doing things that they'd really prefer *not* to do. Mowing the lawn, for instance, takes a lot of time; but there are very few people who consider mowing lawns an ideal hobby. We are not the first to predict the introduction of an 'intelligent lawn mower': a gadget that does the job without you having to run behind it.

Automated kitchen? Yes, definitely, by overwhelming majority vote. We've already got 'programmable' ovens, that can almost cook a meal on their own. This trend is bound to continue.

A 'house-keeping computer'? Why not? In both meanings of the word. If we're going to have a programmable lawn mower, we may as well have a programmable vacuum cleaner. Controlled by a central 'domestic computer', that can also take care of central heating and turning on the lights and closing the doors, in a few spare milliseconds. At the same time, it can be used as an invaluable aid for balancing the household budget.

While we're at it, let's go a step further. If we link our home computer to a bigger, urban computer, it can keep us posted on the price of meat, do our banking, replace our twenty-volume encyclopedia, replace our letter-box, even? And still have time to spare.

All in all, a lot of the chores that eat up our spare time at present will be taken off our hands in the next few years. Which leaves us with truly 'free' time. So what do we do with it? Something creative?

What about modelling in clay. You can't? How do you know, have you ever tried? Maybe an electronic tutor would help. Using a laser, a three-dimensional image can be created 'in thin air'. This can be used as a 'mould': you shape the clay until it fits the image. After gaining some experience this way, the step to 'free modelling' should be relatively easy.

Computers can also be used to design patterns for dress-making or needlework. They can make an ideal 'scratch-pad', showing the finished article from various angles; when you're satisfied, they can draw the necessary patterns.

For that matter, computers are a hobby in themselves. A lot of people enjoy building their own computer, and then working out programs for it. Which brings us back to the present, and *Elektor*. We will do our utmost, in the next ten years, to provide you with an interesting magazine!

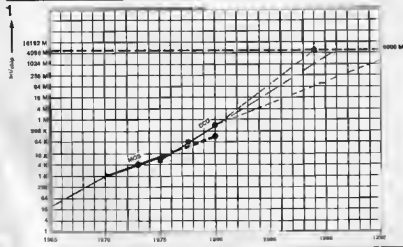

colour generator

using coloured light for an effective display

Circuits for producing light effects are well-known — but this one is different. It generates a fairly constant amount of light, shifting slowly through the spectrum. When used for indirect lighting, it produces a beautiful effect that can be useful in all kinds of applications: parties (both indoors and outside), shop windows, or even as a permanent 'light play' in the garden.

W.H.M. van Dreumel

The circuit consists of three almost identical sections. The heart of each section is a Siemens IC, type S 566B*, that was originally intended for a touch-activated light dimmer (see *Elektor*, Summer Circuits 1978, p. 7-90). When the control input of this IC is operated continuously, it will provide a drive signal to the triac that causes the lamp to fade up and down periodically. The complete cycle time is seven seconds. By using three of these ICs and offsetting their cycles by $2\frac{1}{3}$ seconds,

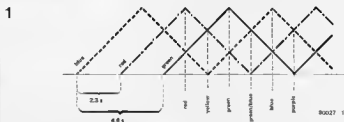

Figure 1. The three primary colours are faded up and down as shown here; the result is light at fairly constant level that runs through the complete spectrum every 7 seconds.

three overlapping cycles are obtained as illustrated in figure 1. Each IC is used to control a lamp that gives one of the primary colours: red, green and blue. If all three lamps are aimed at the same white background, the total colour will sweep through the colour spectrum in 7 seconds.

A block diagram of the circuit is given in figure 2.

The circuit

The complete circuit is given in figure 3. The basic circuit configuration is similar to that for the touch dimmer mentioned earlier. The circuits around T4 and T5 provide the correct initial time delays when the circuit is first switched on. P1 and P2 are used to set these initial delays to $2\frac{1}{3}$ and $4\frac{2}{3}$ seconds, respectively. The design of the ICs themselves assures that this offset will be maintained indefinitely, once they have been started at the correct moments.

As in the original circuit, R1 and C1 are used to derive the 15 V supply from the mains. A zener diode, D1, does the actual stabilising.

The printed circuit board and component layout are given in figures 4 and 5. Note that the complete circuit is connected to the mains. This means that the circuit must be built into an insulating case; particular care must be taken when adjusting the initial time delays.

*Note that the NE566 cannot be used in this circuit! That IC is a function generator — it has nothing in common with the S 566B.

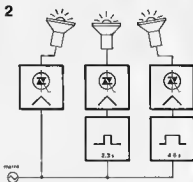

Figure 2. Block diagram.

Parts list

Resistors:

- R1 = 330 Ω /1 W
- R2, R5, R10 = 1M5
- R6, R7, R11 = 4M7
- R3, R4, R8, R9, R12, R13 = 470 k
- R14, R16, R18 = 10 k
- R15, R17, R19 = 120 Ω
- R20, R21 = 100 k
- P1, P2 = 470 k preset

Capacitors

- C1 = 220 n/400 V
- C2 = 47 μ /25 V
- C3, C6, C9 = 470 n/400 V
- C4, C5, C7, C8, C10, C11 = 47 n
- C12, C13, C14 = 150 n/400 V
- C15, C16 = 100 n

Semiconductors:

- IC1, IC2, IC3 = S 566B (Siemens) see note
- T1, T2, T3 = 8C 107B, 8C 547B or equ.
- T4, T5 = 8C 177B, 8C 557B or equ.
- Tri1, Tri2, Tri3 = 2 A/400 V triac (e.g. TIC 226D, Texas Instruments)
- D1 = 15 V/1 W zener diode
- O2 = 1N4001
- O3, O4 = 5.6 V/250 mW zener diode

Sundries:

- L1, L2, L3 = 50 μ H/2 A (ring core)
- F1, F2, F3 = 2 A slobber (p.c.b. mounting)
- Le1 = blue lamp, max. 400 W
- Le2 = green lamp, max. 400 W
- La3 = red lamp, max. 400 W

3

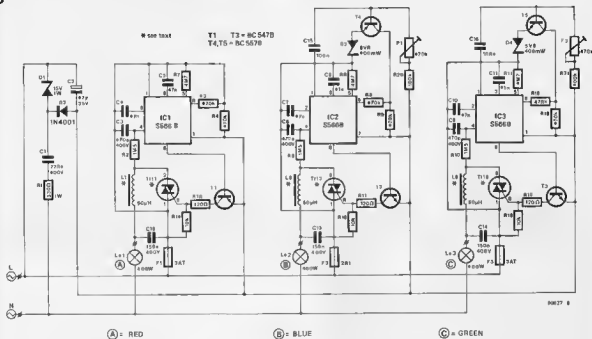

Figure 3. Complete circuit of the colour generator.

4

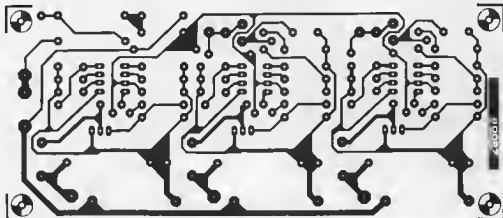

Figure 4. The printed circuit board.

5

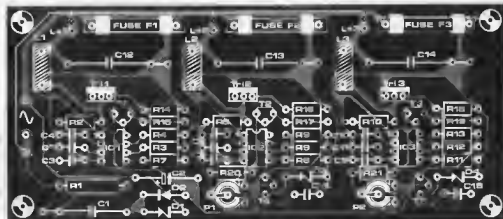

Figure 5. Component layout.

no strings attached

digital tuning scale

The electronics inside radio receivers have changed radically over the years, but tuning scales remain basically the same. The 'bent wire on a string' principle is still the most popular. A more 'sophisticated' system in the most expensive of modern receivers is digital frequency indication. In this article, an 'add-on' digital tuning scale is described.

It's not so easy to add digital frequency indication to an existing receiver. The design must be small enough to fit in the available space; it must work on all wavebands, it must be easy to install; the total cost price must be kept within reasonable limits. All in all, quite a tall order!

The trouble with most designs of this kind is that they use an expensive frequency divider (a 95H90, for instance), to bring the high oscillator frequency down to a value that can be handled by normal frequency counters. What you really want is one IC, specifically designed for this kind of work. Recently, Valvo introduced two ICs:

LED display direct — i.e. without any additional transistor buffers.

The counter is crystal-controlled. It can be programmed to correct for different IF frequencies, so that the same unit can be used for all AM and FM receivers. Furthermore, channel number indication can be selected on the VHF-FM band instead of frequency indication.

The system

The basic principle is quite straightforward. The oscillator frequency of the receiver is measured, and the IF fre-

quency is subtracted from this to obtain the actual transmitter frequency. As such, the IF frequency is not available in the receiver, of course. The SAA1070 derives this frequency from a 4 MHz crystal oscillator, by means of a frequency divider. A whole range of IF frequencies can be obtained by selecting the correct division ratio.

In practice, it is not the oscillator signal that is fed to the 1070. The first step in the chain is the SAA1058; the internal block diagram of this IC is given in figure 1. The outputs from the AM and FM oscillators are fed to the two pre-amplifier inputs. This is followed by a six-stage divider, that can be 'blocked' by an external gate signal (derived from the SAA 1070). An output buffer stage boosts the signal to a comfortable level for the 1070.

The SAA1070 is a rather more complicated IC, as the internal block diagram (figure 2) shows. It is a complete frequency counter with LED drive capability — and some more besides. To limit the power dissipation (and the

the SAA1058 and the SAA1070. The 1058 is a programmable high-frequency divider, with an input pre-amplifier stage, the 1070 is a frequency counter that can drive a seven-segment

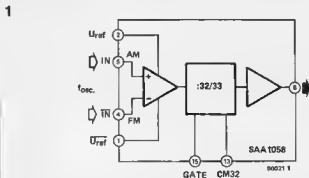

Figure 1. Simplified internal block diagram of the SAA 1058.

2

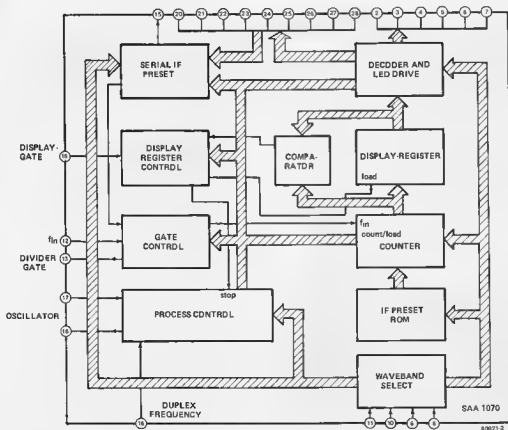

Figure 2. The SAA1070 consists of a complete frequency counter, 'duplex' LED display drive, an IF frequency preset memory, and various logic and control circuitry — including a crystal oscillator.

3

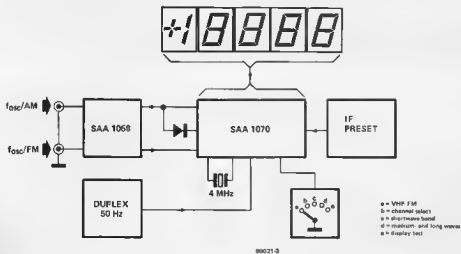

Figure 3. Block diagram of the complete digital tuning scale.

4

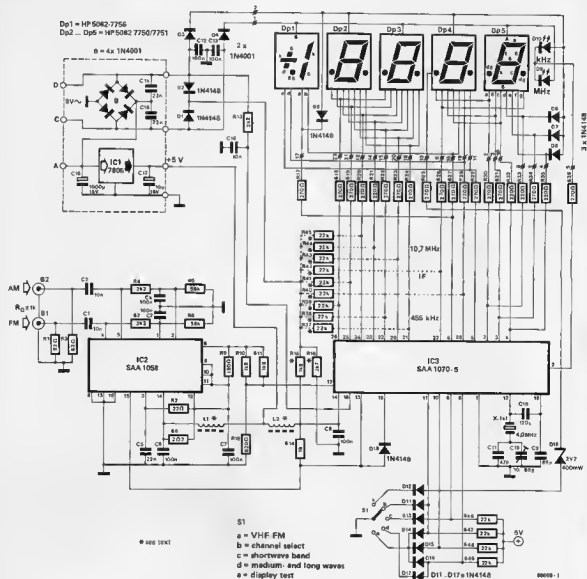

Figure 4. The complete circuit.

Parts list

Resistors:

R1, R2 = 82 Ω
 R3, R4 = 3k3
 R5, R6 = 56 k
 R7 = 27 Ω
 R8 = 2 Ω
 R9 = 180 Ω
 R10, R11, R15 = 1k8
 R12 = 820 Ω
 R13 = 2k2
 R14 = 1 k
 R18 = 2k7
 R17 ... R36 = 270 Ω / $\frac{1}{2}$ W
 R37 ... R45 = 22 k (see text)
 R46 ... R49 = 22 k

Capacitors:

C1, C2, C18 = 10 n
 C3, C4, C6, C7, C8, C12, C13 = 100 n
 C5, C14, C15 = 22 n
 C9 = 68 p
 C10 = 120 p
 C11 = 47 p
 C16 = 1000 μ /16 V
 C17 = 10 μ /6 V tantalum
 C19 = 10 ... 60-p-miniature
 trimmer

Semiconductors:

D1, D2, D5 ... D8,
 D11 ... D18 = 1N4148
 D3, D4 = 1N4001
 D9, D10 = LED

D19 = 2V7/400 mW zener diode

IC1 = 7805

IC2 = SAA 1058 } VALVO

IC3 = SAA 1070 }

Dp1 = HP 5082 - 7756

Dp2 ... Dp5 = HP 5082 - 7750 / 7751

Miscellaneous:

4 MHz crystal
 L1, L2 = 5 mm ferrite bead,
 with three turns of 0.3 mm
 enamelled wire
 S1 = single-pole five-way switch
 8 V/600 mA mains transformer

5

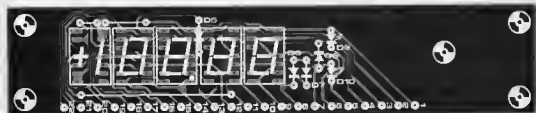
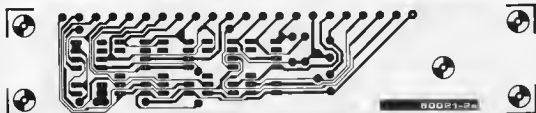
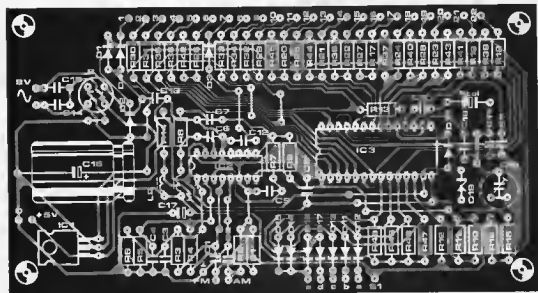
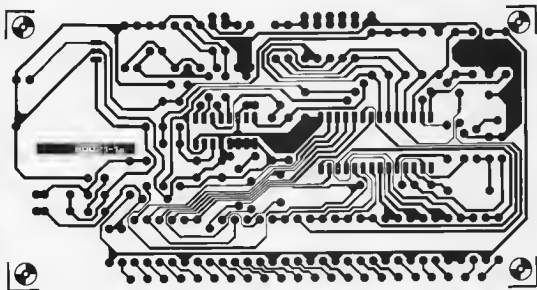

Figure 5. Two printed circuit boards are required: a display board and a main board.

number of pins needed on the IC!) the display is subdivided into two sections, and these are driven alternately. This is called 'duplexing'. The necessary control signal is derived from the mains by two simple half-wave rectifiers.

The data to be displayed are stored in the display register. These data can only be modified once every three counts; even then, they are only updated if a new value must be stored. This system reduces 'display flicker' to a minimum. During each count cycle, the dividers in the 1058 are enabled via the 'gate control' section in the 1070, and the internal counter receives the output signal from those dividers. When the count is complete, the 'IF preset' (stored in ROM) is subtracted and the result is compared to the existing display data. If necessary, the new data are now stored in the display register. The 'IF preset ROM' contains the data for a whole series of different Intermediate Frequencies. The correct data are selected by applying corresponding logic levels to the 'waveband select' inputs.

A block diagram of the complete circuit is given in figure 3. The oscillator signals (from the AM and FM oscillators in the receiver) are fed to the SAA1058, for initial frequency division and gating. The output from this IC goes to the SAA1070. A 4 MHz crystal and the '50 Hz duplex' provide the necessary reference frequencies. The five-way selector switch determines the waveband, and 'IF frequency preset' resistors determine the corresponding IF frequency that must be subtracted. The seven-segment displays are driven by the SAA1070.

The circuit

The complete circuit of the digital tuning scale is given in figure 4. The two oscillator signals are fed through coupling capacitors C1 and C2 to the corresponding inputs of the SAA1058. The DC bias for the preamp is derived from the internal reference voltages, via R3 and R4; the positive supply is decoupled by means of R7 and C5. The CM32 control input to the dividers is grounded, setting the division ratio to 1:32. The IC has an open collector output (pin 8), so R9 is included as collector resistor.

The output signal from IC2 goes to a voltage divider (R10, R11 and R12), and from there to the signal input of IC3 (pin 12). The positive supply to the SAA1070 is decoupled by L2 and C8. Resistor R14, from positive supply to the gate control circuit, is included to ensure a reliable start of the internal 'process control' when the circuit is switched on.

The bulk of the crystal oscillator circuit is included in the IC; the only external components are capacitors C9, C10 and C11, trimmer C19 and the 4 MHz crystal. The oscillator frequency

6

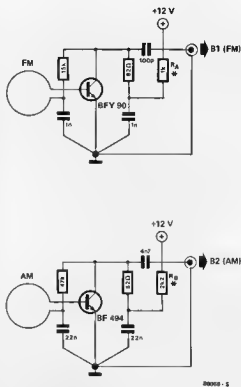

* see text

Figure 5. In some cases, input preamplifiers may be required. The two versions given here are for VHF-FM and AM use, respectively. Resistors R_A and R_B can be given other values if a different supply voltage is available in the receiver.

must be set to exactly 4 MHz. This can be measured at pin 18; note, however, that capacitive load at this point detunes the oscillator by -4 Hz per pF. In other words, if a 10 pF probe is used, the frequency should be set to 3.999960 MHz (i.e. 4 MHz -40 Hz); when the probe is removed, the oscillator frequency will be 'spot on'. Alternatively, of course, the receiver can be tuned to a known frequency, after which the oscillator is adjusted until the correct display is obtained. In this case the trimming screwdriver will detune the oscillator slightly, so that some patience is required. . .

Switch S1 is the wave-band selector. If you're lucky, the existing selector switch (or pushbutton block) in the receiver may have a set of spare contacts; if not a separate switch will have to be added. Switch positions 1 and 2 both apply to the VHF-FM band: in position 1 the frequency is displayed, whereas position 2 gives a display of the channel number. Position 3 is for the short-wave band and position 4 for long and medium waves. Finally, position 5 is for testing the displays: all segments should light in this position. The correct IF frequencies are selected

Table 1

resistor					VHF-FM IF frequency MHz
R43	R44	R45	R42		
0	0	0	0	10.70	
1	0	0	0	10.80	
0	1	0	0	10.6125	
1	t	0	0	10.625	
0	0	t	0	10.6375	
1	0	1	0	10.65	
0	t	t	0	10.6625	
1	t	t	0	10.676	
0	0	0	t	10.6875	
1	0	0	t	10.70	
0	t	0	t	10.7125	
1	t	0	1	10.725	
0	0	1	1	10.7375	
1	0	t	1	10.75	
0	1	1	t	10.7625	
t	t	1	1	10.775	

Table 1. To program the circuit for a specific IF frequency, certain resistors must be either added or omitted. For VHF-FM, resistors R42 . . . R45 are selected as shown here: a '0' indicates that the resistor is omitted, whereas a '1' means that it must be included. 22 k resistors are used.

Table 2

resistor						AM IF frequency (kHz)	MW/LW
R37	R38	R41	R39	R40	SW		
0	0	0	0	0		460.00	460
0	0	0	1	0		448.75	449
1	0	0	1	0		450.00	450
0	1	0	1	0		451.25	451
1	1	0	1	0		452.50	452
0	0	1	1	0		453.75	453
1	0	1	1	0		455.00	454
0	1	1	1	0		456.25	455
1	1	1	1	0		457.50	456
0	0	0	0	1		458.75	457
1	0	0	0	1		457.50	458
0	1	0	0	1		458.75	459
1	1	0	0	1		460.00	460
0	0	1	0	1		461.25	461
1	0	1	0	1		462.50	462
0	1	1	0	1		463.75	463
1	1	1	0	1		465.00	464
0	0	0	1	1		463.75	465
1	0	0	1	1		465.00	466
0	1	0	1	1		466.25	467
1	1	0	1	1		467.50	468
0	0	1	1	1		468.75	469
1	0	1	1	1		470.00	470
0	1	1	1	1		471.25	471
1	1	1	1	1		472.50	472

Table 2. As table 1, but in this case for selecting the IF frequency for short, medium and long waves. Resistors R37... R41 are added or omitted according to this table.

by means of resistors R37... R45, as will be discussed later (see 'calibration').

Construction

Two printed circuit boards are used, as shown in figure 5: a 'main board' and a 'display board'. The two boards are mounted at right angles and interconnected by means of short wire links, as shown in the photo.

The position of the decimal point in the display is fixed; two LEDs are used to distinguish between kHz and MHz. The two coils (L1 and L2), for supply decoupling of the ICs, each consist of three turns of 0.3 mm enamelled copper wire on a 5 mm ferrite bead.

Care should be taken when mounting the voltage stabiliser IC (IC1): its metal 'back' should be towards R6. In other words, if it is bent over as shown in the component layout the plastic 'front' will face the board. A small heatsink is sufficient (1.5°C/W).

The total current consumption is quite small: an 8 V/600 mA transformer will be adequate.

Connections to the receiver

In some cases, the oscillator signals can be taken direct from the receiver without any special precautions. For this to be possible, two conditions must be met: a point must be found in the existing oscillator circuit where the impedance is (considerably) less than 1k, and the oscillator must be able to drive this additional load without noticeable detuning.

An alternative solution is to use a pick-up coil, so that no direct (soldered) connection is required. Even then, care must be taken to avoid undue loading of the oscillator. In most receivers, the complete tuner is contained in a screening box - both to reduce the sensitivity to stray fields and to 'protect' the rest of the receiver from the strong field produced by the oscillator. Holes are provided in this case, for trimming purposes; one of these holes will correspond to the oscillator coil, and it can be used for inserting the pick-up coil. A suitable coil diameter is chosen: small enough to fit through the hole, and certainly not larger than approximately 6 mm (1/4") diameter. The coil consists of three turns of enamelled copper wire; any wire diameter between 0.3 mm and 0.6 mm can be used.

The oscillator coil in the receiver can be located by inserting a screwdriver in the various holes (without turning anything!). The hole where maximum detuning is found will correspond to the oscillator. In some tuners (a few of the TOKO types, for instance) the oscillator coil can be recognised as the only one with an aluminium core (instead of ferrite).

The connection between the pick-up coil and the digital tuning circuit should be made with 50...75 Ω coax cable. The pick-up coil is lowered through the hole in the tuner until a stable frequency display is obtained, without serious detuning of the oscillator. Should this prove impossible, an additional preamp will be needed. The circuit given in figure 6 boosts the input sensitivity to better than 3 mV. More

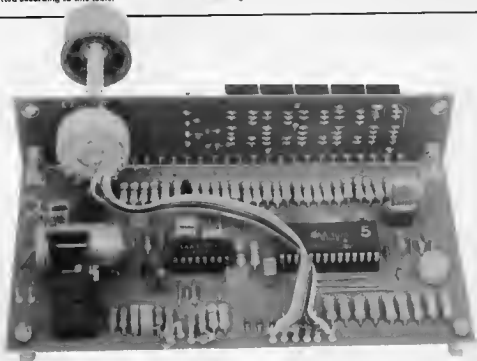

on this later; first, let's take a look at the AM oscillator.

Most receivers have at least long- and medium-wave bands, some also have one or even several short-wave bands. Sometimes, different oscillators are used for each band; in virtually all cases, different oscillator coils will be selected for each band. Obviously, a single pick-up coil is not enough; one will be needed for each of the oscillator coils. All pick-up coils (10 turns each) are connected in series across the AM input to the digital tuning scale. As with the FM coil, the AM coils must be placed so that a stable frequency display is obtained without severe detuning; also as before, a preamplifier may be needed: see figure 6.

As figure 7 shows, the preamplifiers don't take up much space. They don't take much current, either: about 5 mA for the AM preamp and 10 mA for the FM version. For other supply voltages, the values of R_A and R_B can be modified, as follows:

$$R_A = \frac{U_b - 1}{12} \quad (\text{for FM})$$

$$R_B = \frac{U_b - 1}{6} \quad (\text{for AM})$$

Alternatively, the supply for the preamps can be derived from the digital tuning circuit: a 5 V supply connection is provided. Correct values for R_A and R_B in this case are 330 Ω and 660 Ω , respectively, the screening braid of the coax cable can be used as supply common return lead.

Once the correct position for a pick-up coil has been found (with or without preamp), it can be fixed with a little glue or a strip of insulating tape.

Calibration

The first step is to program the digital tuning circuit for the AM and FM IF frequencies in the receiver. This is done by inserting some of the resistors R37...R45, as shown in tables 1 and 2. A '1' in the table means that a 22 k resistor must be mounted at that position; a '0' signifies that the resistor should be omitted.

The 4 MHz crystal oscillator can now be adjusted, using C19. As mentioned earlier, the frequency can be measured at pin 18 (bearing in mind the frequency offset introduced by the probe: -4 Hz per pF). Alternatively, the receiver is tuned to a transmitter of which the frequency is known, and C19 is adjusted to obtain the correct frequency display. This requires a little patience: the oscillator will shift slightly off tune when the screwdriver is removed from the trimmer!

If the correct setting proves to be outside the range of the trimmer, the IF frequency is probably incorrectly programmed. Once C19 is correctly set

7

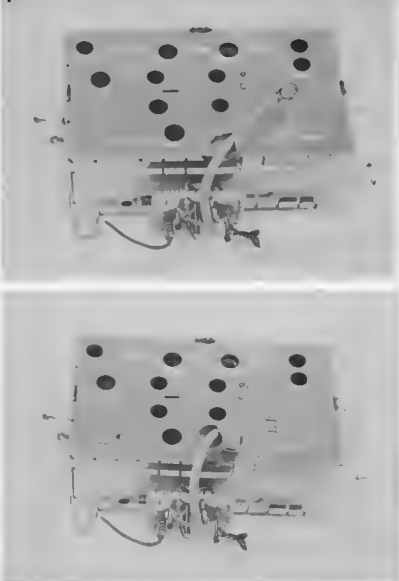

Figure 7. These photos show the pick-up coil and preamplifier, before and after inserting the coil into a tuner.

for one frequency, the adjustment should be correct throughout all wavebands — once again, provided the correct IF frequencies have been selected! In other words, if the correct display is obtained for one VHF-FM transmitter, the long-, medium- and short-wave bands should also be accurate.

Not all receivers!

In most receivers, the oscillator frequency is above the transmitter frequency; it is for this type of receiver that the digital tuning scale is intended. There are, however, exceptions — where the oscillator frequency is lower than the signal frequency — and this circuit is not suitable for them. One notable exception, unfortunately,

is the popular Variometer tuner described in *Elektor* (March and April 1977). In this particular case, it is possible to modify the oscillator circuit so that it can be used with the digital tuning scale: the new circuit is given in figure 8. However, as explained in the original article, this modification leads to reduced image frequency rejection — still good enough, in most cases, but not as good as the original version.

In the car

A digital tuning scale may also prove useful for car radios. At first sight, this would seem no different than the applications described so far. However, there is a difference: we have yet to

8

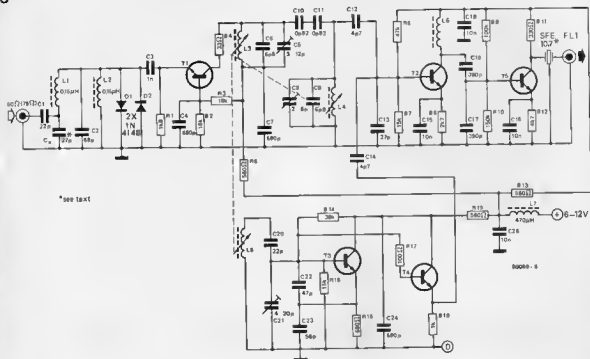

Figure 8. The digital tuning scale is unsuitable for use with receivers where the oscillator frequency is lower than the transmitter frequency. Fortunately, this type of receiver is rare; one example is the Variometer tuner described in Elektor in 1977. Its circuit can easily be modified, as shown here.

9

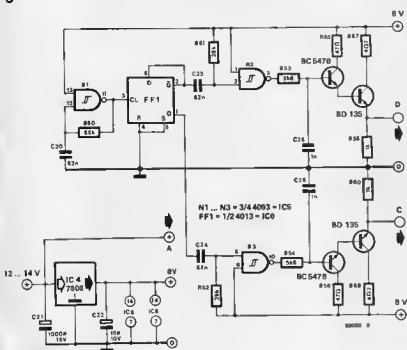

Figure 9. For use in cars, this special supply circuit is required to obtain the necessary AC input.

find the car electrical system that runs on 50 Hz AC! The LED display 'duplexing' is based on AC drive, so this must be simulated if the circuit is to be used in a car.

A suitable supply circuit is given in figure 9. No p.c. board has been designed for it, but it shouldn't be too much of a problem to mount it on Veroboard or something similar. The letters A, C and D at the various outputs correspond to the three supply inputs to figure 4.

The last word . . .

The 'oscillator' inputs of the digital tuning circuit are quite sensitive, so they must be adequately screened.

Furthermore, the circuit itself produces quite a bit of interference, so it must be mounted in a screened box. In the prototype, this was made up from sections of copper laminate board. **M**



mini drill speed control

Miniature electric drills have been available for some time. Most of them are battery powered. For precision work, it is useful to have a speed control; if constant speed can be maintained, independent of the load, so much the better. Both of these objectives can be achieved fairly simply, using an integrated voltage regulator.

Before going into the actual circuit, it is a good idea to take a brief look at how these little DC motors work. Why does the speed drop when the motor is loaded?

Normally, a fairly constant voltage is applied to the motor. Off load, the speed increases until the power consumption is exactly sufficient to cover the electrical and mechanical losses in the motor. When the motor is loaded, the speed drops. This reduces the back EMF, so the current through the motor increases; a new equilibrium is reached when the increased power consumption equals the reduced electrical and mechanical losses plus the power delivered to the load. In other words, the motor supplies the power required by the load — but at reduced speed. Obviously, there is a limit: if the motor is loaded too heavily, it will stop.

If the speed is to remain constant, the voltage across the motor will have to be increased when the motor is loaded. In this way, the current (and the power output) can increase without affecting the speed.

more power is supplied to the motor — countering the tendency for the speed to drop.

Basically, this is a feedback system — and positive feedback, at that. For correct operation, the amount of feedback must obviously be set accurately. One solution would be to use a preset potentiometer for R2. This is not very practical, however: where do you find a 4.7 Ω pot that will happily tolerate a current of up to 1 A? Adding P2 is an infinitely better solution. With its slider turned right up, the circuit becomes identical to that given in figure 1, as far as the regulator is concerned; the voltage across the motor is held constant. As the slider of P2 is turned down, more and more positive feedback is added. With P2 set correctly, the motor speed will remain almost constant, independent of load.

Construction

A suitable printed circuit board is given in figure 3. The only components not mounted on this board are the trans-

former, fuse, and potentiometer P1. Having built the circuit, and before connecting the motor, an initial check is advisable. The slider of P2 is turned fully clockwise. Power is then applied, and P1 is set to maximum resistance — corresponding to the maximum output voltage. This voltage (between the '+' and '-' output terminals) is measured. It should be safely below the maximum permissible motor voltage — say about 20% down. If it is too far off this value, the value of R1 will have to be modified: increasing R1 reduces the voltage, and reducing R1 brings the voltage up.

P1 is now turned back about halfway, and the drill is connected. Preset P2 is carefully adjusted so that the motor speed is on the verge of increasing. The idea is that too much feedback will cause the drill speed to run right up, out of control; too little feedback, on the other hand, will make the circuit less effective. It is possible that, with a given motor, even the lowest setting of P2 is not low enough: the speed still drops when the motor is loaded. In that case,

former, fuse, and potentiometer P1. Having built the circuit, and before connecting the motor, an initial check is advisable. The slider of P2 is turned fully clockwise. Power is then applied, and P1 is set to maximum resistance — corresponding to the maximum output voltage. This voltage (between the '+' and '-' output terminals) is measured. It should be safely below the maximum permissible motor voltage — say about 20% down. If it is too far off this value, the value of R1 will have to be modified: increasing R1 reduces the voltage, and reducing R1 brings the voltage up.

P1 is now turned back about halfway, and the drill is connected. Preset P2 is carefully adjusted so that the motor speed is on the verge of increasing. The idea is that too much feedback will cause the drill speed to run right up, out of control; too little feedback, on the other hand, will make the circuit less effective. It is possible that, with a given motor, even the lowest setting of P2 is not low enough: the speed still drops when the motor is loaded. In that case,

$$U_{\text{out}} = \frac{R1 + R2}{R2} \times U_{\text{control}}$$

For the 79G, U_{control} is -2.23 V.

As can be seen, the output voltage of this regulator is determined by the voltage on the control input — i.e. that at the R1/R2 junction in figure 1. To be more precise, it is the voltage between the control input and the 'common' connection that sets the output voltage. Knowing this, the actual circuit (figure 2) is not so difficult to understand.

When the motor is loaded, its speed will tend to drop. The current through the motor increases, producing a larger voltage drop across R2. The IC will now try to restore the original voltage difference between the 'control' end 'common' connections, by increasing its output voltage. This, in turn, means that

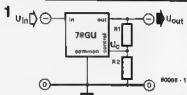
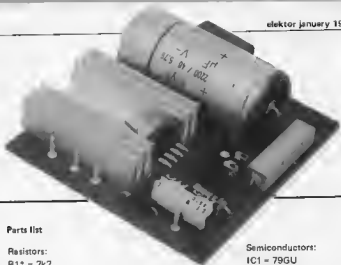

Figure 1. In the basic regulator circuit, the IC adjusts the output voltage to maintain a constant -2.23 V between its control input and the 'common' connection. This means that the output voltage is determined by R1 and R2.

the value of R2 will have to be increased and the calibration procedure repeated. Obviously, this circuit is no miracle worker. If the motor is loaded further when it is already running flat out, at maximum voltage, the speed will drop. Which is just as well — a higher voltage than the maximum permissible will burn out the motor. This is why it is so important to select the correct value for R1 — it determines the maximum voltage that can be applied to the motor. For that matter, it is a good idea to check this again once P2 has been adjusted: set P1 to maximum, and measure the motor voltage as it is loaded more and more. It should not run up to more than 20% above the nominal motor voltage; if it does, the value of R1 will have to be increased further. Alternatively, a resistor can be included in parallel with P1 — reducing the maximum resistance value that can be set by this potentiometer. There is no need to worry about damaging the IC — it is internally protected against output short-circuits and thermal overload. ■



Parts list

Resistors:
R1* = 2k2
R2* = 4.7 Ω/5 W
P1 = 10 k lin.
P2 = 100 Ω preset potentiometer

Capacitors:
C1 = 2200 μ/35 V
C2 = 2μ2/35 V tantalum
C3 = 100 μ/16 V
C4, C5 = 1 μ/25 V tantalum

Semiconductors:

IC1 = 79GU
D1 = 1N4001
B1 = B40C1500

Sundries:

Tr = 18 V/1 A transformer
F = 100 mA fuse, slobber
Heatsink for IC1

* see text

2

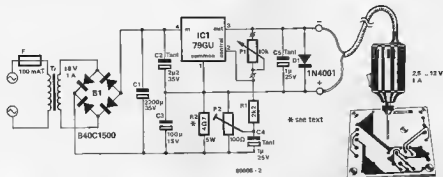

Figure 2. The complete circuit. P1 sets the motor speed; preset P2 is adjusted so that the speed remains constant under load. On some drills, a lower value for C2 and/or C3 may give better results. In fact, one of the drills we tried ran best when these capacitors were omitted!

3

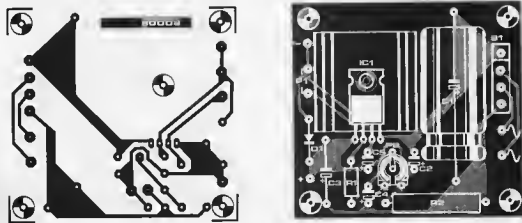

Figure 3. Printed circuit board end component layout. Note that only two connections are provided to P1: the connection between the wiper and one end is made at the potentiometer.

VSWR meter



To get the maximum power output from a transmitting aerial, it must be properly matched to the transmitter. For that matter, a really serious mismatch can spell disaster for the (expensive) output stage of the transmitter. For these reasons, amateur radio operators often make use of a so-called voltage standing wave ratio meter — an 'SWR' meter. In this article, we will not only describe the theory — what it is, what it does, how it works; a practical circuit for an SWR meter with a very wide frequency range is also given. With a p.c. board, of course.

Nearly everybody who has any experience of electronics has heard of impedance matching. But how many people really know what it's all about? Not that it is so important, in most cases — in fact, one of its prime purposes would seem to be that it provides audio fanatics something to discuss when they've exhausted every other possible topic . . .

There is, however, a group of electronics enthusiasts that rightly considers impedance matching to be of prime importance. Amateur radio operators! For them, an impedance mismatch can have disastrous results. At best, their range will be drastically reduced; at worst, they may blow up the output stage of their transmitter.

Fortunately, it is not too difficult to avoid mismatching. Provided you know what you're doing, that is! If you buy a transmitter ready-built, the output impedance is usually specified. The same is true for transmitting aërials: the manufacturer will normally specify the impedance. The idea is that you use an aerial with an impedance that matches the output impedance of the transmitter, and that you use connecting cable with the same characteristic impedance. For instance, if the transmitter output is specified as 75 Ω the obvious thing to do is to use 75 Ω coax cable and a 75 Ω aerial.

However, life is not always so simple. Many amateurs not only build their own transmitter; the transmitting aerial, too, is often the result of personal experiment. In this case both impedances are unknown, so that optimum energy transfer from transmitter to aerial can only be obtained by experimenting.

Why?

The simplest possible equivalent circuit for a transmitter with its load is given in figure 1. An ideal AC voltage source, U , supplies power to the load, Z_0 , via the internal impedance, Z_i . The power supplied to Z_0 can be calculated as follows:

$$P_0 = \frac{U^2 \cdot Z_0}{(Z_i + Z_0)^2}$$

In this formula, U is the (open-circuit) voltage supplied by the voltage source; P_0 is the power supplied to the load Z_0 . For a given value of Z_i , the maximum power is supplied to the load when Z_0 equals Z_i . In other words, if the output impedance of the transmitter is 75 Ω, a cable with a 75 Ω characteristic impedance should be used. Similarly, the power transfer from the cable to the aerial is highest when the aerial impedance is equal to that of the cable. In that case, all the power supplied by the transmitter is pumped into the aerial (the losses in the cable will normally be negligible). What happens when the aerial impedance does not match the characteristic impedance of the cable?

1

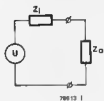

Figure 1. The simplest equivalent circuit for a transmitter working into a load. For best power transfer, the load impedance Z_0 should be equal to Z_1 .

3

2

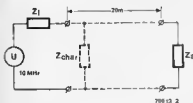

Figure 2. In practice, the aerial will normally be connected to the transmitter by means of a cable. At 10 MHz, a 60-foot cable (20 metres) is equivalent to one full period of the high-frequency signal.

The energy transfer from cable to aerial is not ideal in this case, and a standing wave appears along the cable. This can be clarified as follows.

Normally, the aerial is not mounted on top of the transmitter. It will be on the roof, or at the top of a high mast, or in some other suitably high position. In most cases, it will be some distance away from the transmitter — the latter being at a more comfortable location inside the house. The transmitter and aerial are then linked by a cable. In other words, the power output from the transmitter runs down the cable to the aerial. All very straightforward, you would think, but let's take a closer look at what happens in the cable.

The electrical signal moves down the cable at high speed: 200,000 to 300,000 km/s (i.e. well over 100,000 miles per second!). This seems very fast, but let's see how long it takes the signal to pass down a 60-foot cable (20 metres). A simple calculation (using the metric figures it's simple, anyway!) shows that it will take about 100 ns. For a radio amateur, 10 MHz is not such a high frequency — but the period time at this frequency is also 100 ns. This means that the AC voltage source in figure 2 will have produced one complete period before any signal appears at the other end of the cable, 20 metres further on! This means that the voltage source can't 'see' whether or not the cable is terminated with the correct impedance. The transmitter only 'sees' a small part of

the cable, and recognises its 'characteristic impedance'. The current pumped into the cable is therefore determined by this cable impedance. When this current arrives at the aerial, the results depend on the aerial input impedance. If the whole system is properly matched, the complete power output from the transmitter goes into the aerial: the same voltage across the same impedance corresponds to the same current — i.e. the current coming down the cable. If the aerial impedance is too high, however, it will 'reflect' some of the power. Put it this way: the same voltage across a larger resistance corresponds to a smaller current. Some of the current coming down the cable is 'left over', and it bounces back down the cable towards the transmitter. The same sort of effect occurs if the aerial impedance is too low. The power that is reflected back to the transmitter interferes with that coming the other way. The result is a standing wave. This can actually be detected by passing a field-strength meter along the cable; at some points a maximum is found, and at others the field strength is at a minimum. The maxima and minima occur at regular intervals. If the aerial is incorrectly matched, the field strength at that point will be low — corresponding to low output from the aerial.

If the aerial impedance is unknown, the degree of mismatch can be determined by measuring how much energy is reflected. By using directional couplers that only pass power in one direction,

the reflected power can be separated from the power fed to the aerial. The ratio between these two is a measure for the accuracy of the impedance match. To be more precise, the ratio between sum and difference of the forward-going voltage (U_f , towards the aerial) and the reflected voltage (U_r) is taken, as follows:

$$\text{VSWR} = \frac{U_f + U_r}{U_f - U_r}$$

VSWR is the Voltage Standing Wave Ratio.

It will be obvious that the VSWR equals 1 if the reflected voltage is zero; it becomes infinite if the complete signal is reflected. This would occur if the aerial impedance is zero or infinite. Note that the aerial impedance referred to is that at the transmitted frequency. If the aerial is correctly designed for this frequency, it will be in resonance and its impedance will be real.

The VSWR meter

By now we have some idea of what we want to measure. The next question is: how?

The VSWR meter circuit given in figure 3 can be used for transmitting frequencies between 2 MHz and 30 MHz. The unit is connected in series with the cable, close to the transmitter. The current flowing from transmitter to

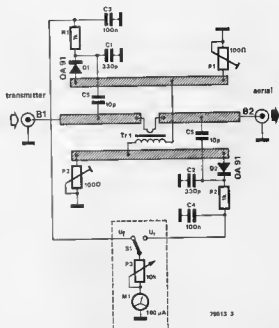

Figure 3. The VSWR meter circuit can be used for transmitting frequencies up to 30 MHz. Germanium diodes must be used, preferably type OA91. The transformer is wound on an Amidon ring core.

4

aerial and vice versa passes through the primary of a transformer. Both of these currents produce a current in the secondary; the direction of the current flow in the secondary is obviously determined by the direction in the primary. By combining the total voltage ($U_f + U_s$) with the correctly chosen and half-wave rectified secondary voltage, U_f and U_s can be obtained separately. These voltages (across C2 and C1, respectively) can be measured with a simple meter circuit, consisting of low-pass filters (R1/C3 and R2/C4) and a meter with preset series resistor.

At frequencies above 30 MHz, no transformer is needed. The same job can be done by adding two secondary 'strips' that run parallel to the main through feed. This is shown in figure 4. The directional characteristics of this circuit are best when the following conditions are met:

$$\frac{P1}{Z_{2L}} = \frac{Z_{1L}}{Z_a} \text{ and } \frac{P2}{Z_{2L}} = \frac{Z_{1L}}{Z_a}$$

where Z_a is the impedance for which the unit is intended.

Obviously, electrical waves can run in both directions along all the strips; however, if the above conditions are met, waves in one direction will decay quite rapidly. With the diodes only conducting in one direction (as all good diodes should do...), the forward-going wave will build up a voltage across

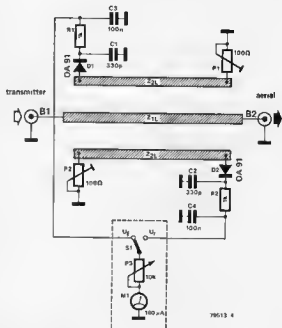

Figure 4. An even simpler circuit for a VSWR meter can be used if higher frequencies (100 MHz ... 300 MHz) are used.

5

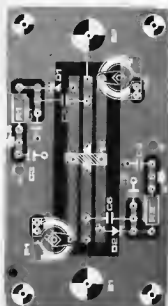
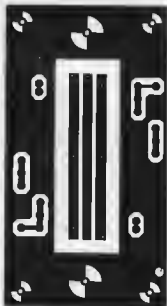

Figure 5. The same p.c. board can be used for both circuits; S1, P3 and the meter are mounted off the board. Note that the central strip must be interrupted for the circuit given in figure 3, as described in the text.

C2 and the reflected wave can be measured across C1. As before, the two voltages can be measured with a simple meter circuit. The frequency range of this VSWR meter is approximately 100 MHz ... 300 MHz.

The p.c. board

There is no need for two separate p.c. board designs for the two circuits. There are so few differences between the two that the same design can be used for both, as shown in figure 5.

If the circuit given in figure 3 is to be mounted (for measurements at up to 30 MHz), the centre stripline must be divided into two halves. This is done by scratching away some of the copper between the two central holes. The transformer is wound on an Amidon ring core. The secondary winding consists of 30 turns; the primary is only half a turn, which is equivalent to passing a wire link through the ring. This link is soldered into the two holes in the central strip, effectively fastening down the transformer at the same time. This construction is clearly illustrated in the photo.

Mounting the high-frequency version (figure 4) is even easier. The central strip is left intact, of course. The only important point to watch is that C5, C6 and the transformer are omitted.

Parts list

Resistors:

R1, R2 = 1 k
P1, P2 = 100 Ω preset
P3 = 10 k preset

Capacitors:

C1, C2 = 330 p (ceramic)
C3, C4 = 100 n
C5*, C6* = 10 p (ceramic)

Semiconductors:

D1, D2 = OA91 or equivalent

Sundries:

M1 = meter, 100 μ A f.s.d.
Tr1* = Amidon ring core, type T50-B;
primary: 0.5 turns, 1 mm CuAg;
secondary: 30 turns, 0.5 mm CuI
S1 = single-pole change-over switch
2 off connectors (BNC, SO239)

* These components are only required for the low-frequency version (up to 30 MHz).

6

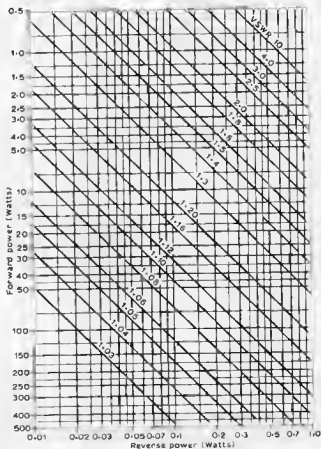

Figure 6. This graph illustrates the significance of the VSWR value. In practice, values of less than 2 are considered to be quite good!

Calibration

For both circuits, calibration is quite easy. The unit is included in the cable, close to the transmitter. First, the switch is set to the 'U_r' position, and P3 is adjusted so that a fairly high reading is obtained on the meter. Note that these three components are not mounted on the p.c. board. Now, with the switch set to the 'U_r' position, P2 is adjusted for minimum deflection.

After this adjustment, the circuit is connected 'backwards': the 'aerial output' is connected to the transmitter, and the 'transmitter input' goes to the aerial. The same calibration procedure is repeated, but this time P2 is left untouched and P1 is adjusted for minimum deflection in the 'U_r' position. After restoring the original connections, the adjustment of P2 can be checked; then P1 again, and so on until no

further improvement can be obtained. Having found the optimum settings for P1 and P2, the switch is set to position 'U_r' and P3 is adjusted for full scale deflection. In the 'U_r' position, the meter will now indicate the strength of the reflected wave. If all impedances are correctly matched, the meter deflection will be zero. This corresponds to VSWR = 1, as explained above; in other words, the VSWR scale on the meter runs from 1 to ∞ .

If a different aerial is tried, the meter will now indicate how accurately it is matched - or how badly... If the meter originally has a linear scale, it is easy to fill in the correct VSWR values: full scale is ' ∞ ', three-quarters of full scale is '7', the mid position is '3', one-quarter is '1.6', one-tenth is '1.2', one-twentieth is '1.1' and zero is '1'. In practice, a VSWR of less than 2 is quite good.



frequency doubler

raise your guitar one octave

This frequency doubler circuit for guitars produces an output that is one octave higher than the original input signal. An uncommon, but particularly useful, feature is that the original signal and the frequency-doubled version can be mixed in any desired proportion.

As can be seen in the block diagram given in figure 1, the signal from the guitar is amplified and then fed along two separate paths. The lower path carries the basic signal; in the upper path, full-wave rectification is used to obtain frequency doubling. After a 'balance' control, the two signals are summed; the output is at the correct level to drive a suitable 'guitar' amplifier. The complete circuit is given in figure 2. In practice, it is rather more compact than it looks: the four opamps are all contained in a single IC. The first stage, A1, is an input preamplifier/buffer. The gain can be varied between $\times 50$ and $\times 1$, by means of P1. The values given for R1 and C1 in the circuit may have to be modified to suit a particular guitar. The correct input impedance is determined almost exclusively by the value of R1; C1 will have to be modified accordingly (if R1 is decreased, C1 must be increased and vice versa) unless a different low-frequency cut-off point is desired.

The DC output voltage from A1 is 0 V — in other words, it is biased mid-way between the positive and negative supply rails. This output is connected direct to the non-inverting inputs of A2 and A3, so that these two opamps are also biased to the mid-point. This ensures that the maximum (symmetrical) AC voltage swing is available throughout the circuit.

Opamps A2 and A3 are used in a full wave rectifier circuit. For the type

of signals that we are dealing with, full-wave rectification is equivalent to frequency doubling — which is what the whole exercise is about! The output from A3 is fed to one half of a stereo potentiometer (P2a); the 'basic' signal, from the output of A1, goes to the other half of this potentiometer. By wiring one of the (linear) potentiometers 'upside down' (when the slider of P2a is connected to the C4 end, the slider of P2b is at supply common) the desired 'balance control' is obtained. The output signals for three possible settings are given in figures 4, 5 and 6. Figure 4 is the frequency-doubled signal (P2a turned right up, so P2b is down); figure 5 corresponds to the half-way situation — original and doubled signal in equal amounts; figure 6 is the original signal only.

The final opamp, A4, is the summing stage. It is actually a virtual-earth mixer, with unity gain for both signals.

Construction

A printed circuit board design for the

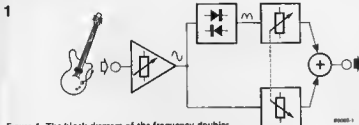

Figure 1. The block diagram of the frequency doubler.

frequency doubler is given in figure 3. It is designed to fit in a compact case. For the same reason, two 9 V batteries are used for the supply. The current consumption is only 8 mA, so they should last for quite a while. ■

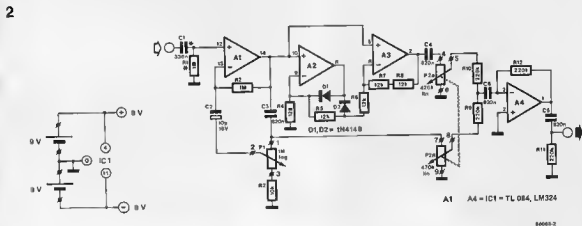

Figure 2. The complete circuit.

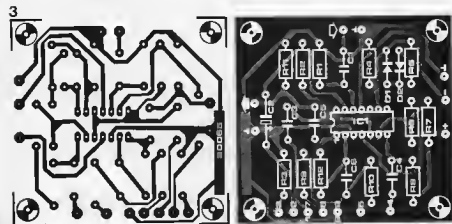

Figure 3. The printed circuit board is quite small. That's the advantage of using quad opamps!

Parts list

Resistors:

R1*, R2 = 1 M
 R3 = 10 k
 R4, R5, R6, R7, R8 = 12 k
 R9, R10, R11, R12 = 220 k
 P1 = 1 M log
 P2a/P2b = 470 k lin stereo
 (see text!)

Capacitors.

C1* = 330 n
 C2 = 10 μ /16 V
 C3, C4, C5, C6 = 820 n

Semiconductors:

A1, A2, A3, A4 = IC1 = TL 084;
 LM 324 can also be used.
 D1, D2 = 1N4148

Sundries

Two 9 V batteries, with clamp.

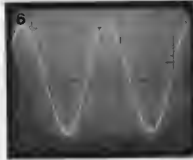
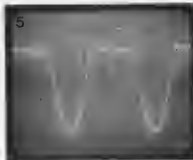

Figures 4, 5 and 6. Three possible output signals, from a sine-wave input: frequency-doubled only; doubled end original in equal amounts; end original signal only.



an absolute first!

After all the articles describing the theory of vocoders, there must be a lot of enthusiastic readers just itching to build one. This is just the sort of challenge that Elektor designers love: a lot of people want it, but nobody has come up with a suitable design until now. Now, here it is at last! A 10-channel vocoder, designed in collaboration with Synton Electronics — an acknowledged specialist in the field. The design offers good performance at a very reasonable cost. Ideal for musicians with a lot of enthusiasm but insufficient funds to back it up!

Certainly for those who would rather wield a soldering iron than a formula, the theory of vocoders has by now been discussed in more than adequate detail. Two years ago we discussed the 'hows and whys' and described the basic principles of a few commercially available vocoders. Last month's article 'Vocoders' was intended as a brief recap of the history and technology of vocoders, and at the same time as a 'warming-up exercise' for the construction project described this month. The difficulties associated with designing a vocoder were discussed at length. Obviously, these difficulties are even more apparent when the design is intended for home construction, as opposed to commercial production: the circuits must be absolutely reliable, and the effect of component tolerances must be reduced to a minimum. Fortunately, the problems are not insurmountable, as we will see.

One more time . . .

We've explained what a vocoder is, often enough . . . 'We didn't really oughta repeat ourselves'. However, for those who are still unsure, in spite of all explanations given in earlier publications here is a brief definition:

A vocoder is a 'box' with two inputs: one for a speech signal and one for a

elektor vocoder (1)

specifications

number of channels:	10
speech input sensitivity:	adjustable 10 mV . . . 7.7 V
impedance:	10 k Ω
carrier input sensitivity:	770 mV
impedance:	100 k Ω
line output output level:	770 mV
frequency range	30 . . . 16,000 Hz

'carrier' or 'repleceman' signal (in practice, this is usually some kind of 'music' signal). Inside the 'box', the speech characteristics are superimposed on the carrier signal. A single output signal results. It contains all the characteristics (and intelligibility) of the speech input, but the basic sound produced by the speaker (vibrations of vocal chords, resonances in the oral and nasal cavities) are replaced by those of the music signal. The result is something that sounds like the music, but talks as well.

How? This has been explained, in many previous articles. However, in the

interest of providing a smooth transition to the block diagram and circuits that are to come, let us take a quick look at what is 'inside the box'.

Most vocoders are so-called 'channel vocoders'. Other systems do exist (heterodyne-based, for instance) but these are so complex that they are rarely used in practice. The Elektor design is also a channel vocoder, so we will forget the other possibilities. Last month's article gave block diagrams that illustrate the basic principle. A quick look at the block diagram of the Elektor vocoder (figure 1) shows that it is almost identical.

A channel vocoder consists of two main sections: the analyser and the synthesiser. These are very similar, both consisting mainly of an identical set of filters (two groups of ten in the Elektor vocoder).

In the analyser section, the filters are used to split the incoming speech signal into corresponding frequency bands. The output from each filter is rectified and passed through a low-pass filter; the total result is a set of varying DC voltages, each corresponding to the 'envelope' of the speech signal within that particular frequency band.

The synthesiser section splits the 'carrier' signal into the same set of frequency bands. The output level in each band is varied by a voltage controlled amplifier (VCA) that is driven by one of the varying DC control voltages produced by the analyser section. The result is that the amplitude 'envelope' of each frequency band in the speech signal is superimposed on the corresponding

frequency band of the carrier signal. The outputs of all VCAs are then summed, to produce the total output signal: basically, the tonal characteristics of the carrier signal with the articulation of the speech. Talking music, in other words.

The Elektor vocoder

After we had already done quite a bit of experimenting with vocoder circuits, we happened to come into contact with Synton Electronics - the manufacturer of the well-known Syntovox vocoders. Some very profitable discussions with these specialists led to the circuit described here: a vocoder, designed specifically for home construction.

The number of channels (frequency bands in the analyser and synthesiser sections) is limited to ten, for several good reasons. That number is adequate for good music reproduction and good 'speech' intelligibility; furthermore, it is a reasonable compromise between performance and price. Admittedly, a twenty-channel version sounds better, more 'detailed'; but, in practice, the improvement is not often worth the vastly greater cost and complexity required. Not only do you need twice as many filters: they must also be much 'steeper' (approximately 50 dB/octave) and this requires careful design and expensive components. Usually, strict selection of components is necessary for this type of filter - not a very feasible proposition for the average amateur. For a ten-channel vocoder, on the

other hand, 24 dB/octave filters can be used. These are not nearly as complex and - even more important - quite reliable results can be obtained without having to resort to exotic components or test equipment.

For that matter, reliability was an important factor in the design of the whole circuit - not only the filters. Wherever possible, the circuit is set up so that component tolerances and wiring will not affect the operation; furthermore, a larger number of adjustment points are included than is normal in professional equipment. By this means, good results can be obtained without the component selection normally required.

Two features are deliberately omitted from the basic version: spectrum analysis and a voiced/unvoiced detector. The reason is obvious: although admittedly useful, these features are also expensive! However, the design does provide the option of adding them at a later date, and it is quite likely that we will be publishing suitable designs in the near future. For the present, however, we will do without. One little gimmick is included: ten LEDs, one for each channel, give an indication of the varying spectrum of the speech signal. Not that it has much practical use - but it doesn't cost anything, either.

What does it all cost? An important consideration, for most people! From a quick look at figures 3...6 it is apparent that there are quite a few components in a vocoder. In plain language: it's crawling with opamps. To make matters worse, a lot of p.c. boards

1

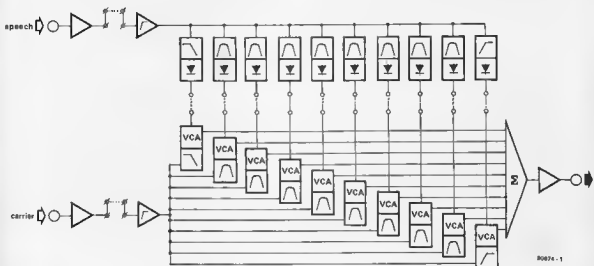

80674 - 1

Figure 1. Block diagram of the Elektor vocoder.

2

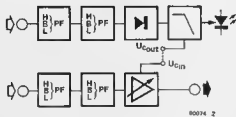

Figure 2. Block diagram of one filter unit.

Table 1

band-pass filter number	centre frequency	frequency range	C1 ... C8	C9	C10	C11
BPF 1	265 Hz	210 - 320	82 n	220 n	33 n	330 n
BPF 2	390 Hz	320 - 460	56 n	150 n	22 n	220 n
BPF 3	550 Hz	460 - 640	39 n	100 n	15 n	150 n
BPF 4	800 Hz	640 - 960	27 n	68 n	10 n	100 n
BPF 5	1200 Hz	960 - 1440	18 n	47 n	6n8	68 n
BPF 6	1770 Hz	1440 - 2100	12 n	47 n	6n8	68 n
BPF 7	2650 Hz	2100 - 3200	8n2	47 n	6n8	68 n
BPF 8	3900 Hz	3200 - 4600	5n6	47 n	6n8	68 n

Table 1. In figure 3, the values of capacitors C1 ... C11 must be selected from this table.

3

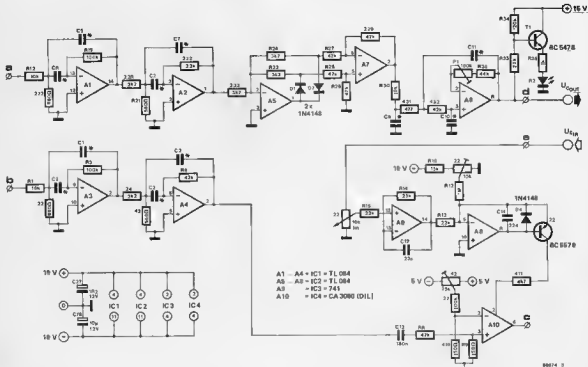

Figure 3. The complete circuit of one band-pass filter unit.

go into a unit of this kind - and they are not nearly as cheap as we would like. All in all, our estimate of the total cost works out at somewhere in the region of £ 100. A lot of money for a home construction project - but very cheap for a good vocoder, like this one.

What's in the box?

A block diagram of the vocoder is given in figure 1. The upper half is the analyser section, and the lower half is the synthesiser.

Let's take a look at the analyser first. The microphone signal is passed to a suitable preamplifier. Although not shown in the block diagram, the sensitivity of this input is adjustable over a wide range, so that it can also be used as a line input from an external microphone preamp. The preamplifier is followed by a buffer stage that includes bass cut, with a roll-off below approximately 30 Hz.

The output from the buffer stage is fed to the filters that split it into frequency bands. Ten filters, corresponding to ten bands, not all equal, however. Taken together, the filters cover the whole audio band, from about 30 Hz to 16 kHz, but the first filter (low-pass) and the tenth (high-pass) take care of a disproportionately large part of the spectrum. The low-pass filter covers the range from 30 Hz to 200 Hz; the

high-pass is for everything above 4600 Hz. The central range, from 200 Hz to 4600 Hz, is most important for speech; it is divided into eight bands by the remaining filters.

Each filter is followed by a precision rectifier and a low-pass filter. The latter is not shown, as such, in the block-diagram — it is taken as an essential part of the rectifier stage. Obviously: for a vocoder, we are not interested in rapid fluctuations of the speech signal or remaining half- or full-wave rectified frequency components; what we want is the general level trend for each frequency band.

The first step in the synthesiser section is also a preamplifier, for the carrier signal this time. Once again, it is followed by a buffer stage — similar to the one in the analyser. From here, the signal is passed to the filters; these are identical to the first group. The output of each filter goes to a voltage-controlled amplifier (VCA). Each VCA receives its control voltage from the corresponding filter and rectifier in the analyser section. The output signals from all ten VCAs are summed, the total signal is passed to the output buffer stage. Finally, about all those dotted lines. In both the analyser and the equaliser section, the link between the input preamplifier and the following buffer stage is brought out, to create the

possibility of adding a voiced/unvoiced detector at a later date. What happens is that both outputs and both inputs are brought out to a connector; from there, they run along a bus board to a further connector (intended for the detector); along the way, the copper tracks are deliberately bridged so that each amplifier output is connected to the corresponding buffer input. When a voiced/unvoiced detector is to be added, the bridge between the tracks must be broken.

Furthermore, the connection between each rectifier output and the corresponding VCA control input is shown as a dotted line. These points are brought out to sockets on the front panel. This has the advantage that it is now possible to deliberately connect some or all of the outputs to the 'wrong' VCAs, for special effects. This will be discussed later, in greater detail, when we come to 'using the vocoder'.

For the moment, we are more interested in the electronic details of the various sections shown in the block diagram. Time for the circuits.

The circuits

A modular construction was chosen for the vocoder, as we will see later on. The various circuit sections are mounted on separate printed circuit boards. Twelve in all: one for the supply, one

for the input amplifiers and buffers plus the summing amplifier and output buffer, and one so-called filter unit board. This contains one complete section, as shown enclosed in dotted lines in figure 1: two complete high-, low- or bandpass filters with the associated rectifier and VCA. A more detailed block diagram of one filter unit is given in figure 2.

Since the circuit of the complete vocoder is rather too extensive to swallow in one gulp — for that matter, it would be virtually impossible to print on a single magazine page — it is easier to deal with each circuit section separately. First the central building block of the vocoder: the filter unit. In particular, the band-pass filter version, as it appears eight times with only minor component value changes.

The band-pass filter

The circuit is given in figure 3. Those who may have felt that we were exaggerating when we said that the complete circuit was so extensive, should be having second thoughts by now. All of these components represent just one filter unit — and there are ten of them in our vocoder.

The band-pass version shown here is required eight times. Each one takes care of its own band in the total range (200 Hz ... 4600 Hz), and this is ob-

4

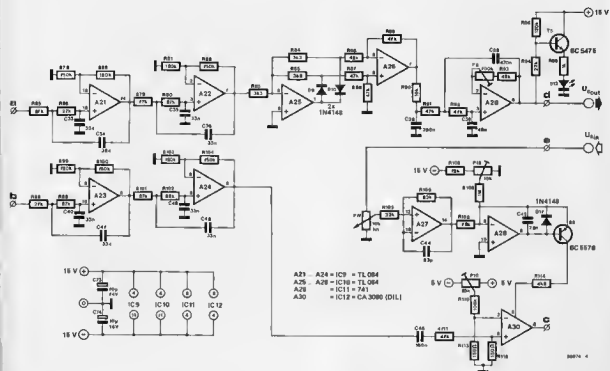

Figure 4. The low-pass filter unit.

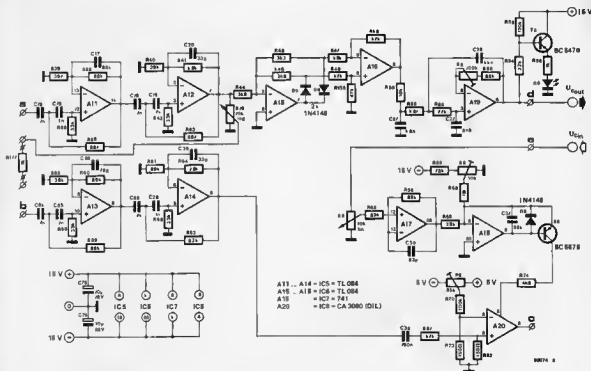

Figure 5. The high-pass filter unit.

viously reflected in the component values. In particular, the values of capacitors C1...C11. Table 1 gives the correct values for the bandpass filters BPF1...BPF8, with the resultant centre frequency of each filter.

On talking a closer look at the circuit given in figure 3, it is not too difficult to recognise the various sections that make up the block diagram shown in figure 2. First, let's pin down the in- and outputs. Points 'a' and 'b' are the filter inputs for the analyser filter (speech) and synthesiser filter (carrier), respectively; 'c' is the signal output — the output of the VCA, in other words. Point 'd' is the control voltage output from the rectifier (more properly, from the final low-pass filter) in the analyser; Vc,out; 'e' is the control voltage input, Vc,in, for the VCA in the synthesiser. A1 and A2, with associated components, make up the band-pass filter in the analyser section. An identical configuration, using A5 and A7, does the same job in the synthesiser. The precision rectifier is constructed around A3 and A4, it is followed by the low-pass filter, using A9. Finally, A10 is the VCA. Admittedly, there are a few more opamps — but these will be discussed later.

One thing is very obvious: there are a lot of opamps in this circuit. Not only in this one, for that matter — the whole vocoder is opamp-based. The main reason for this is to keep the circuit as simple as possible — using transistors,

it would really become messy... Fortunately, the high-quality opamps that are readily available nowadays are quite suitable for audio work.

Most of the opamps used in this filter unit are JFET-input types. There are four of them in a TL084. Another possibility is to use a 4741 — with the added advantage that its current consumption is lower. Both of these types have been used in previous *Elektor* designs, with good results, and availability should not be a problem. They cost about one pound each. A common-or-garden 741 is also used in the circuit and for the VCA — an OTA, type CA3080. Quite familiar to *Elektor* readers!

The band-pass filters are of a fairly well-known type: in both sections, two so-called Rauch filters are connected in cascade. The slightly different component values for the first and second filter in each pair ensure that a slightly 'flattened' top is obtained for the total filter characteristic, instead of the sharp peak that a single filter would give. Each filter gives a slope of 12 dB/octave, so that two in cascade provide the desired 24 dB/oct. In passing, it is perhaps interesting to note that the slope of any properly-designed filter can be estimated by counting the 'active' capacitors and multiplying by 6. A single filter in this circuit contains two capacitors, making for 12 dB/octave.

Back to the circuit. In the analyser section, the band-pass filter is followed

by two opamps in a full-wave rectifier circuit (A3, A4, D1, D2) and an RC network (R30 and C9) to take care of the worst of the ripple. An active low-pass filter (A9) does the bulk of the smoothing. It is a good idea to tailor the low-pass filter to suit the frequency range selected by the preceding band-pass filter. For this reason, C9, C10 and C11 are given different values for each section, as listed in Table 1.

The no-signal DC component in the Vc,out control voltage should be zero, in the ideal case. For this reason, an offset adjustment (preset P1) is included for A9. The LED indication of the 'speech spectrum' that was mentioned earlier is obtained by using the same control voltage to drive a LED (D3) via a transistor (T1).

In the synthesiser section, the first two opamps (A5 and A7) are used in the same filter configuration as that in the analyser. Then the VCA, for which an OTA (A10) is used. Since an OTA (Operational Transconductance Amplifier) is basically a current-controlled amplifier — not voltage-controlled — a minor circuit extension is needed. The control voltage from the analyser section (Vc,in) is buffered (A6) and then fed to a voltage-to-current converter: A8 and T2. Basically, this is a voltage-controlled current source, variations of the control voltage, Vc, are converted into variations in the bias current for the OTA (at pin 5 of A10). P4 is used to set a threshold value for this current —

6a

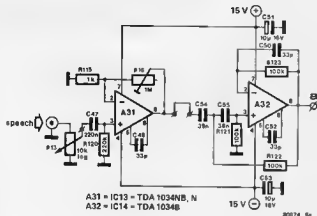

Figure 6a. Microphone/line 'speech' input amplifier.

6b

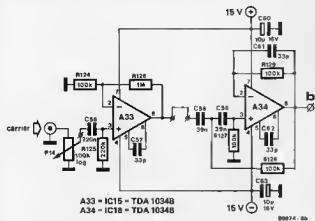

Figure 6b. Line 'carrier' input amplifier.

6c

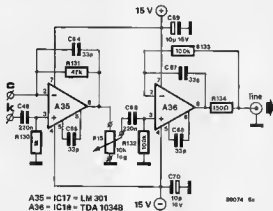

Figure 6c. Output amplifier.

the calibration procedure will be described later. The same applies to the calibration of P2, this adjustment is included to balance the input differential amplifier in the OTA—a necessary precaution to prevent the bias current variations breaking through to the output, in the absence of a 'carrier' signal.

Low- and high-pass filters

Figures 4 and 5 both bear a strong resemblance to the circuit given in figure 3. This is hardly surprising: the only real difference between the band-pass filter units (figure 3), the low-pass filter unit (figure 4) and the high-pass filter unit (figure 5) is the actual filter circuit. And even there, the difference is marginal. Both the low- and high-pass filters are standard variants on the well-known Sallen & Key filter. As before, two sections are connected in cascade to obtain a total filter slope of 24 dB/octave (four capacitors, remember?). The cut-off point for the low-pass filter is set at 200 Hz; for the high-pass filter, this is 4600 Hz.

In- and output module

The remainder of the vocoder proper is shown in figure 6: the in- and output circuits. These are all mounted on one p.c. board.

For these sections, good signal-to-noise ratio and drive capability are extremely important. The 'ideal' opamp for this job is the illustrious TDA1034 (or NE5534). If availability is a problem, an LF 357 can be used as a (temporary) replacement—although the signal-to-noise ratio will suffer.

The speech input circuit is given in figure 6a. Opamp A31 is used as a very low-noise microphone preamp. The voltage gain can be set between $\times 1$ and $\times 1000$, for any input sensitivity between 10 mV and 7.7 V. The input impedance is roughly equal to 10 k Ω , and in practice microphones with almost any impedance can be used. A line input is also provided, suitable for signals from an external microphone preamplifier; in this case, the gain is set to about $\times 12$. The output from A31 is brought out, via the bus board, to a spare connector; from there, it comes back to the sensitivity control P13. As mentioned earlier, this is done to offer the possibility of adding a voice/unvoiced detector at a later date. The sensitivity control is followed by a buffer/amplifier stage, A32. By adding C54 and C55, this stage also serves as an active rumble filter. Output 'a' from A32 is connected to all ten inputs 'a' on the filter units. Figure 6b is the 'carrier' input circuit. The sensitivity control, P14, is followed by an input preamplifier with a gain of approximately $\times 10$ (A33). As before, the signal then loops around the spare connector; finally, A34 is used as a combined buffer/amplifier/active bass-cut filter—identical to the one in figure

6a. Output 'b' is again connected to all ten inputs 'b' on the filter unit boards. The outputs of all filter boards (point 'c' in figures 3, 4 and 5) are all connected to input 'c' in figure 6c: the input of the summing amplifier. The first stage (A35, an LM301) is followed by an output level control (P15) and an output buffer stage (A36). A TDA1034 is used for this final stage, for the same reasons given earlier (low noise and high output drive capability). The nominal (line) output level of the vocoder is approximately 700 mV; the output impedance is very low (a few ohms) due to the negative feedback; the effect of R134 is cancelled (this resistor is included for stability and short-circuit protection).

What's to come?

The power supply circuit, printed circuit boards and parts lists are still outstanding. Then, of course, constructional details and calibration procedure. Quite a lot, all told, but we hope to squeeze it all in next month.

What else? An article on 'using a vocoder' is scheduled, and there are plans for extending the LED indication — little more than a gimmick in the present design — so that the vocoder can be used as a simple spectrum analyser. A very useful extension. The further plans are rather more vague, but we certainly hope to do something about the voiced/unvoiced detector and associated noise generator in the not-too-distant future. One thing is for sure, we haven't heard the last of vocoders yet — not by a long chalk! **M**

Lit.:

- Elektor*, April and May 1978: Vocoders.
Elektor, December 1979: Vocoders today.
Elektor, December 1979: Toppreamp.

talk funny on board

The electronic speech distorter, described last month as "Talk funny?", is quite a nice little circuit. On second thoughts, it seemed a pity that the p.c. board was not available via the EPS service — but that is easily remedied.

While 'cleaning up' the layout given as a suggestion last month, all wiring between switches, potentiometers etc. was included on the board. This means that these components can be wired direct to the board; the drawing given as figure 5 in the original article can be ignored.

One final point: it is advisable to increase the value of P4 to 47 k (50 k), as shown in the parts list below. **M**

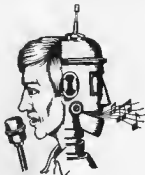

Parts list

Resistors:

- R1 = 3k9
 R2 = 47 k
 R3, R6 = 1 k
 R4 = 56 k
 R5 = 100 k
 R6 = 2k2
 R7 = 220 Ω
 R9 = 100 k
 P1 = 100 k log
 P2 = 470 Ω (500 Ω) preset
 P3 = 4k7 (5 k) preset
 P4 = 47 k (50 k) preset
 P5 = 10 k lin

Capacitors:

- C1, C7 = 100 n
 C2, C3 = 2μ2/10 V
 C4 = 1 μ (not elco!)
 C5 = 15 n
 C6 = 1 μ/10 V

Semiconductors:

- IC1 = XR2206CP
 T1 = BC 109C, BC 549C,
 or equ.
 D1 = DUS

Switches:

- S1, S2, S3, S5 = single-pole
 changeover
 S4 = single-pole, make

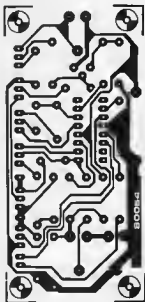

new bus board for microprocessors

In most microprocessor systems, the various subsections are interconnected via a bus board. The Elektor SC/MP system is no exception; its bus board (p.c. board no. EPS 9857) is designed to take up to three plug-in cards.

The trouble with microprocessor systems is that they grow . . . If several memory cards are to be used in the SC/MP system, when including NIBL-E for example, even two bus boards may not provide enough space. For this reason, a new bus board has been designed. As can be seen, it is the same size as the old one - but it will fit five cards instead of three. The two additional connectors are mid-way between the three original connector positions. This makes for easier up-dating of an existing SC/MP system, certainly from the mechanical point of view.

At the same time, the wiring between adjacent bus boards has been simplified. At the left-hand end of the board, contact rows a and c have been transposed (note that this means that no connector should be mounted at this point!) so that the interconnection between two bus boards can now be done with wire links, with very little danger of short circuits between the a and c connections. The same applies when connecting the bus board to the supply: here, too, the criss-crossing of the wire links is avoided.

The new bus board is supplied under no. EPS 80024. **M**

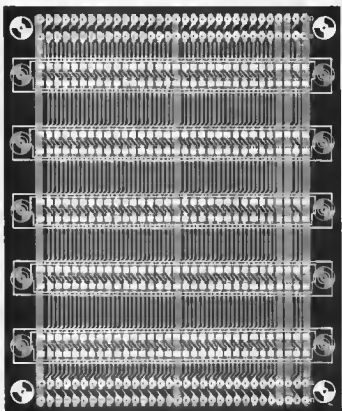
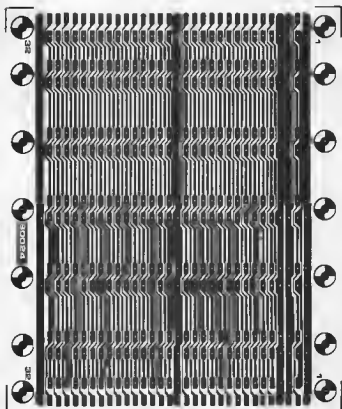

modern methods of voltage regulation

how to use switching voltage regulators

For optimum performance, it is desirable that good voltage regulators are used in modern electronic systems. Usually, these regulators are of the conventional type based on the series pass transistor. These present few problems either in design or manufacture; however, they are not noted for their efficiency. This has led to an increasing trend to the use of switch-mode power supplies which are far more efficient. In this article we take a look at the advantages and disadvantages of switching regulators from a practical point of view.

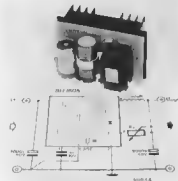

Photograph 1. A slightly unorthodox presentation of a circuit! Still, it should be clear enough. The circuit will supply 5 A at 5 V.

In conventional power supply circuits the series pass transistor is operated in a linear mode at a point somewhere between the two extremes, cutoff and saturation. The transistor acts as a variable resistor and will dissipate relatively large amounts of power due to the voltage dropped across it. Power dissipation will increase proportionally with increase in load current or input/output voltage differential. This is the major disadvantage of conventional voltage regulators.

In contrast, the transistor in a switching power supply circuit is operated only at cutoff or saturation, it is either full on or fully off. These are the optimum working conditions for a transistor. As we all know, efficiency is the ratio between output and input power. In general, a voltage regulator based on the series pass transistor will seldom reach an efficiency of 50%, whereas switching regulators can reach a figure of 75% (and sometimes even higher). This may not seem revolutionary, but a closer look will reveal its true value.

Take a power supply unit designed for a 10 Watt (5 V, 2 A) output. With an efficiency of 50% the input power requirement is 20 Watts — twice that of the output. The difference between the two, 10 W, is dissipated by the circuit. For the same power unit, but using a

switching regulator with an efficiency of 75%, the dissipation works out to be 3.3 W, an improvement of 300%! This enables the use of a much smaller heatsink and a transformer of about two thirds the size of that in a conventional system.

The other side of the coin

Compared with conventional regulators, it must be admitted that the beauties of the switching system are marred by a few blemishes. The output ripple is considerably higher (maybe some tens of millivolts) and their response to load surges is more sluggish. The circuitry can produce hissing or whistling sounds and, moreover, are prone to the radiation of RF interference due to the fast switching process. This, of course, may have adverse effects on other parts of the system. The efficiency of switch-mode power supplies relies to a large extent on the switching speed and, therefore, "fast" transistors (and diodes for that matter) are necessary. The selection of these devices has to be made very carefully with due regard to parameters. Suitable types are manufactured for this specific purpose but they are expensive. One other cause of concern, especially to amateurs, is the need for an inductor — and a special one

1

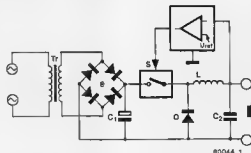

Figure 1. Block schematic diagram for a switching regulator. S represents an electronic switch. Inductor L stores energy as long as S is closed, to release it when S opens.

at that. Some notes are included on this later in the text.

2

How do switching regulators work?

There are two basic types of switching power supply currently in use. A block schematic diagram of the simpler version is shown in figure 1. The regulator control circuit differs from normal in that the solid state switch, S, either switches output power on or off without consuming energy. The circuit also features a 'swinging' inductor and a diode whose function will become clear further on.

The principle illustrated in figure 2 would approach the ideal. Here, the mains voltage is directly rectified and applied to a switching circuit fitted with a regulator system so as to produce an alternating current of controlled voltage at a frequency much higher than the mains. This regulated voltage is reduced to the required output level and then rectified and smoothed. The transformer in this case is a ferroxcube power transformer designed to operate at high chopping frequencies, about 25 kHz for example, and is much smaller than a conventional mains transformer with a similar power rating.

It should be noted at this point that in practice switching regulators do not use a symmetrical squarewave, but rather a controlled waveform normally set at a 6:1 duty cycle - this being found most efficient.

Free extras

Switching systems are capable of providing more than just stepped down positive voltages. They can also produce negative outputs, but a real gain over conventional systems is their ability to provide higher output voltages than the input! This offers the possibility of deriving a number of positive and negative outputs from a single source by using different regulator circuits. Figures 3, 4 and 5 illustrate the principle and show that the components used are identical, only the configuration differs.

Circuit description

Figures 3a and 3b show the operation of a step-down voltage regulator. The unregulated voltage is applied across the input terminals U_{in} and the stabilised output is produced across the load R_L . With switch S open, no input current can flow and the full input voltage appears across the switch contacts. With S closed however (figure 3a), the full input is applied across diode D (non-conductive) and also appears at the 'high' end of inductor L. Although initially the full voltage appears across the inductor, the current through it will

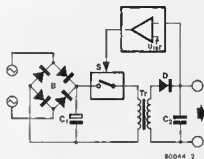

Figure 2. An elegant configuration which eliminates a bulky mains transformer by substituting a small type with a special core operating at a much higher frequency. This design is not to be recommended for the amateur, for safety reasons.

3

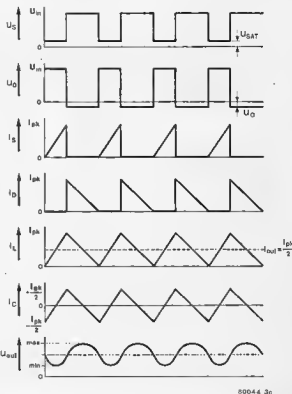
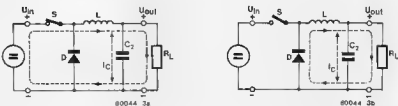

Figure 3. The performance of a switching regulator is determined by the properties of inductor L. Currents through inductors are persistent, like voltages across capacitors.

only increase exponentially to charge capacitor C2 and raise the output voltage. As soon as the output voltage across R_L and C2 rises to a predetermined level, S is made to re-open and block the input current (figure 3b). The current through L will not instantly drop to zero, since the stored magnetic energy objects to being left in the inductor; as shown by the arrows in figure 3b, the current now flows through D (conductive in this direction) continuing to charge C2 and feed R_L .

When the current supplied by L drops below the current taken by the load, C2 makes up the difference and, by losing its charge, lowers the output voltage. As soon as the output drops below its predetermined limit, the switch will be repeated.

To assist those readers who want more precise information, the graphs of figure 3c sketch the various current and voltage waveforms in the circuit.

A number of manufacturers are now producing integrated circuits designed specifically for switch-mode power supplies.

A typical example is represented in photograph 1. This 5 volt 5 amp regulator features a Fairchild SH 1605 integrated circuit and only five other components. A few performance details are worth noting:

- Input: between 12 and 18 V;
- Maximum output: 5 V, 5 A;
- Minimum output current: 2 mA;
- Ripple: 100 mV;
- Efficiency: 70%

Polarity reversal

By a slight change of the configuration (including reversing the diode), the regulator circuit can be made to reverse the polarity of the input voltage. Figure 4 shows how this is done using a Texas TL 497 IC.

The operating principle should now be familiar: magnetic energy is gathered in inductor L during the period that S is closed. Once S opens, L generates a current that charges C2 to a negative voltage via the diode D. When C2 is charged to the required amount S closes and off we go again.

Voltage step-up

The circuits described so far step the input voltage down or reverse its polarity. However, as mentioned earlier, switching regulators are also capable of stepping the voltage up. Figure 5 illustrates the principle of operation. With switch S closed, current can only flow through the inductor L. When S opens however, a large voltage is induced in L which charges up capacitor C2 via the diode D. Once the voltage across C2 is sufficiently high, the switch is made to close again.

A practical circuit using the Fairchild μ A 78S40 is also shown in figure 5. This

4

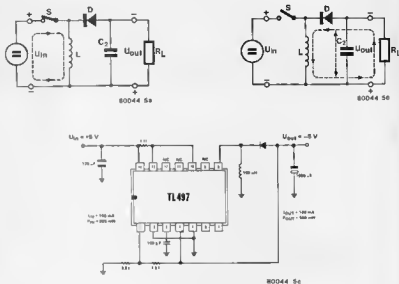

Figure 4. Reverse-polarity outputs at voltages higher or lower than the input are obtainable with this configuration.

5

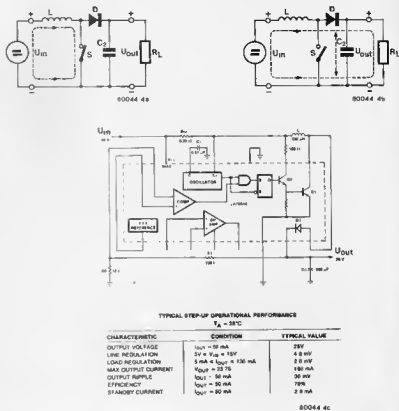

Figure 5. This configuration supplies regulator outputs at voltages higher than the rectified transformer output.

TYPICAL STEP-UP OPERATIONAL PERFORMANCE		
$T_A = 35^\circ C$		
CHARACTERISTIC	CONDITION	TYPICAL VALUE
OUTPUT VOLTAGE	$I_{out} = 50 mA$	20V
LINE REGULATION	$3V = V_{in} = 15V$	4.8 mV
LOAD REGULATION	$3 mA < I_{out} < 100 mA$	2.0 mV
MAX OUTPUT CURRENT	$V_{in} = 23.75V$	100 mA
OUTPUT RIFPLE	$I_{out} = 50 mA$	50 mV
EFFICIENCY	$I_{out} = 50 mA$	78%
STANDBY CURRENT	$I_{out} = 50 mA$	2.0 mA

80044 4c

component, like the previously mentioned Texas IC, can be used in all three basic configurations, namely, step-down, reversal and step-up.

From a 10 V input, this circuit can supply 160 mA at 25 V with an efficiency of 79%. The μA 78S40 permits currents as high as 1.5 A to be handled. The corresponding output current is half this amount i.e. 750 mA. It must be noted however, that the internal diode (D1) cannot carry more than 300 mA. The performance can be extended, of course, by fitting an external diode and switching transistor.

More technical data

Only a few applications of the integrated circuits have been discussed. The list of literature at the end of this article refers to manufacturers' data sheets, for readers who wish to design their own equipment.

A few hints

The construction of a switching regulator is similar, to a certain degree, to the construction of high frequency circuits. The steep switching edges and the consequent high frequency contents demand considerable care. It is imperative that those conductors which carry switched currents are as short as possible. The circuitry must be grounded at one single point only.

The output capacitor principally determines the output ripple and tantalum types are recommended as being preferable for the high frequencies involved. As an alternative to a single large capacitor, the total capacitance required can be made up from ordinary electrolytic types connected in parallel. Some further improvement can be gained by using capacitors intended for working voltages of twice the output voltage.

Unfortunately the majority of common rectifier diodes are unsuitable. This same rule applies to the switching transistor: if not fast enough, the semiconductors will dissipate excessive heat, reducing regulator efficiency.

Inductor construction

Most amateur constructors prefer to steer clear of the problems associated with coil design and construction. Although ready-made inductors are now available, it is sometimes unavoidable that the hobbyist himself has to calculate and construct the inductors required. Fortunately, this is not too difficult; even so, some suggestions may be useful.

The inductors in question are usually wound on ferrite cores, such as Siemens N27 or Philips 3C8, which suit the purpose owing to their low losses at the high frequencies involved, some 20 to 50 kHz.

6

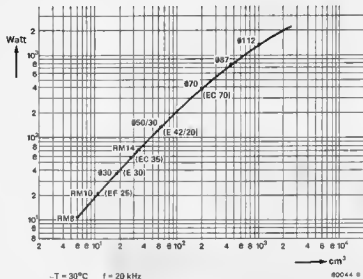

Figure 6. This graph specifies the safe amount of transferable power as a function of the (ferroxcube) core size of an inductor.

To simplify calculation, only two design parameters will be treated, namely, the permitted core field strength and the inductance required. The graph of figure 6 specifies the safe amount of transferable power as a function of the inductor core size. For field strengths beyond a safe value the inductance decreases with consequent excessive current through the inductor. This 'unsafe' current will not only rapidly destroy the switching transistor and the rectifier diode, but also cause the output voltage to rise dangerously. For these reasons, it is important to use cores of generous section. The graph indicates that a pot core of 30 mm diameter can handle as much as 30 W.

Having decided upon the core section, the desired inductance can now be obtained. To this end, the A_L inductance parameter must be found. This is a function of the type of magnetic material, the core section and the magnetic gap, and is given by the manufacturer. In most cases it is possible to settle on parameters that permit a convenient number of turns, such as 50 or 100, to be wound. A small number may seem to be more convenient, but should be discouraged since it leads to higher inductor losses. Optimum efficiency is obtained by using the thickest wire consistent with completely filling the core.

The resultant inductance is equal to the A_L parameter figure expressed in nanohenries multiplied by the square of the number of turns. For a core with an A_L of 400 nH and a desired inductance of 300 μH this works out at

$$\sqrt{\frac{300 \cdot 10^{-6}}{400 \cdot 10^{-9}}} = 27 \text{ turns.}$$

References

- Philips: *Data Handbook 'soft ferrites'*.
- Siemens: *Datenbuch 'Ferrite'*.
- Fairchild: *Data Sheet SH 1605*.
- Data Sheet μA 78S40*.
- Application note SH 1605*.
- Application note μA 78S40*.
- Texas Instruments: *Application Report 'designing switching voltage regulators with TL 497'*.

ejektor

an invitation to investigate, improve and implement imperfect but interesting ideas

PWM applications

There are several possible applications for the self-oscillating PWM system described in *Elektor 53*, September 1979. Two interesting examples are discussed in this article: an interference suppressor and a multi-channel volume control. The interference suppressor (a sort of 'spike trap', really) is extremely effective; the volume control has the advantage of good tracking between almost any number of channels.

The type of interference we are interested in is the typically 'spiky' stuff: sharp spikes at relatively long intervals, often at much higher level than the desired signal. This type of interference is usually caused by electric sparks — in electric motors, ignition systems, or even lightning. It is usually difficult to suppress properly, because the high levels at high frequencies tend to overload receivers, causing a kind of intermodulation distortion. Normal selective filtering isn't much help with this type of interference, since the spectrum extends from almost DC up to 200 MHz or so. Even when the components above the audio range are removed, an interference pulse remains within the audio band — even if its amplitude, width and slew rate have changed.

Effective suppression is possible, however, if the spikes are shorter than half the period time of the highest wanted frequency (see figure 1). During the 'spike time', T_s , the signal path can be interrupted, the interference

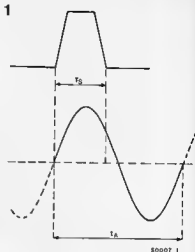
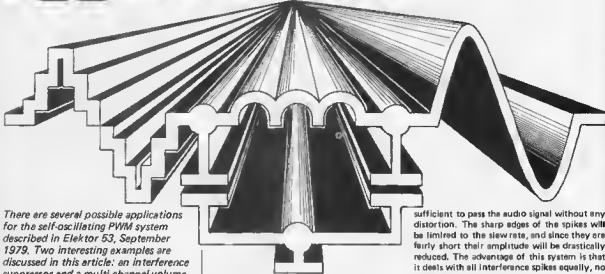

Figure 1. In this case, the interference pulse is assumed to be shorter than half the period time of the desired signal. This means that it can be removed, provided it can be detected.



pulse is blocked. So is the signal, of course (figure 2a); but low-pass filtering at the output will clean it up again (figure 2b) — basically, this is the same principle as sampling.

A better way of filling the 'hole' where the spike was is to keep the signal level constant for the duration of the spike. This could be done by using a sample-and-hold circuit in the signal path, and arrange for the sampling pulses to be interrupted briefly when an interference spike is detected.

This idea is illustrated in figure 2c. Better still would be to draw a straight line between the signal values before and after the spike, as shown in figure 2d; but this would be rather expensive, since some kind of delay line is required.

In all cases, some way must be found to detect the presence of the interference pulse. This is usually done by level detection: the amplitude of really nasty spikes is greater than that of the signal. Spikes at the same or even lower level than the maximum signal amplitude remain undetected.

There is another way to get rid of spikes: use a circuit with a relatively low slew rate — just

sufficient to pass the audio signal without any distortion. The sharp edges of the spikes will be limited to the slew rate, and since they are fairly short their amplitude will be drastically reduced. The advantage of this system is that it deals with all interference spikes equally, no matter what their level with respect to the audio signal. The disadvantage is that the spikes are not suppressed completely — but then, of course, the other systems also leave some kind of bump or dip where the spike was. A further disadvantage of many slew-rate systems is that they are asymmetrical; they react in a different way to positive and negative-going spikes.

The self-oscillating PWM system described in the recent September issue can be used as the basis for a slew-rate interference suppressor, as shown in figure 3. As long as the PWM amplifier, A1, is not overloaded (by an input signal with high amplitude and/or frequency), the output signal v_o will follow the input signal v_i . With one difference: the output signal consists of a series of steps, approximating the input signal shape. The output can only vary by one step for each period of the internal clock signal.

This type of system will work best for short interference spikes, as illustrated in the plots in figure 3. The longer the spike with respect to the internal clock period, the more pronounced its effect will be in the final output signal.

The circuit

The circuit shown in figure 4 is a practical illustration of the principle described above. It is intended specifically for reducing the interference from car ignition systems when listening to a VHF-FM car radio.

The input signal is first amplified (A1) to the level required for the pulse-width system proper (A2, A3). This system is most effective for input signal levels between 3 V and 6 V peak-to-peak. The frequency of the internal clock signal is set by P2; for use in a VHF-FM stereo radio, the 'clock' frequency should be at least 106 kHz to avoid 'aliasing'. This is the same principle, once again, as sampling: the clock frequency ('sampling rate') must be at least twice the highest signal frequency (53 kHz in an FM-stereo system).

However, the circuit becomes less effective as the clock frequency is increased, as described earlier. For this reason, it has proved better in practice to set the internal clock frequency to 38 kHz. If a stereo signal is present, the clock

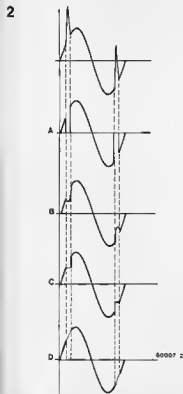

Figure 2. Starting from a signal with two short interference spikes, and assuming that these spikes can be detected, the possibilities for suppressing them are as follows:

- a) Interrupt the signal path for the duration of the spikes. This leaves a gap.
- b) as a), but with the addition of some kind of integration (a low-pass filter, for instance) to fill the gap.
- c) in this case, the signal level remains constant for the duration of the spikes, giving a flat portion. This signal will look much better after integration than the previous examples.
- d) very good, but very expensive: the signal levels before and after the spikes are compared, and a straight-line interpolation between them is inserted. This requires some kind of analog delay lines, since the circuit cannot provide an output signal until after the spikes.

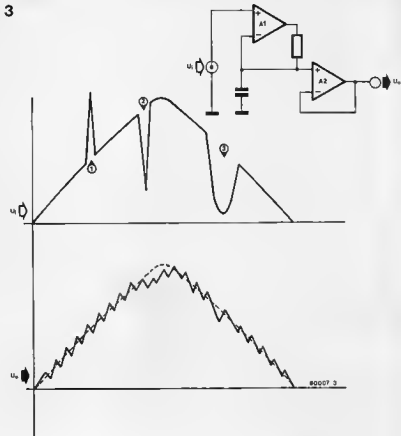

Figure 3. Block diagram of the PWM interference suppressor. The signal level across the capacitor can only vary in steps. A brief spike can never increase the level by more than one step. As the width of the spike increases, it can 'run over' several steps so that it becomes more and more noticeable.

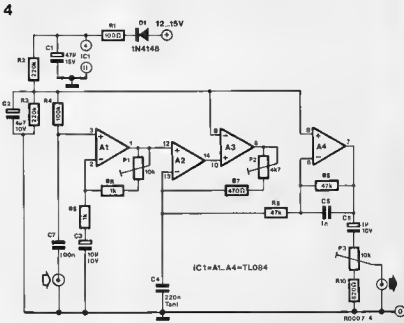

Figure 4. Complete circuit of an interference suppressor for VHF-FM (and short-wave) receivers.

will synchronise to the sub-carrier (to the 19 kHz pilot tone, to be precise); aliasing now results in partial demodulation of the stereo-difference component, instead of producing nasty distortion.

The output signal level is set by P3 to correspond to the original input level.

The optimum setting of P1, P2 and P3 is a compromise between interference suppression and signal quality. If high quality music reproduction is required, slightly less effective interference suppression will have to be tolerated, if only 'traffic news quality' is needed, virtually complete suppression is possible.

Note that the audio signal should be taken from a point in the receiver before the de-emphasis network. If this is not possible, the existing de-emphasis network should be removed; in the circuit given here, R9 and C6 provide the correct roll-off.

The same circuit can also be used in short-wave receivers, provided the IF bandwidth is greater than the highest modulation frequency. In practice, this means that the circuit will be suitable for normal broadcast band short-wave listening.

Construction of the circuit is not critical. When installing it, however, it must be realised that the internal clock signal is very rich in harmonics. For this reason, the circuit must be adequately screened.

Other applications and improvements

There is no reason why use of this type of interference suppressor should be limited to audio systems. When you consider that an acceptable TV picture can be obtained with only 1...2 MHz bandwidth, it seems obvious to design a 'snow plough' for TV receivers. However, this requires adequate knowledge and understanding of the TV set in question, to find the correct point in the circuit and maintain correct level and impedance matching.

Going back to the audio application, the circuit can be improved by arranging for the clock frequency to be modified as required by the input signal. This is illustrated in figure 5.

The clock frequency is controlled by the bias current I_{bc} of an OTA (Operational Transconductance Amplifier). This bias

5

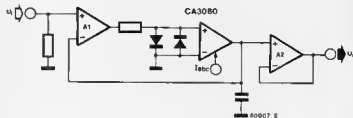

Figure 5. If the internal clock frequency in the PWM system is varied as a function of the input signal (using an OTA, for instance), a dynamic interference and noise suppressor can be obtained.

6

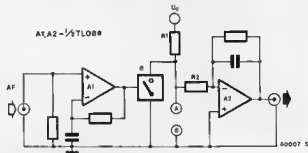

Figure 6. Block diagram for a multi-channel volume control. The control voltage, U_c , is common to several of these units; it varies all output levels, with extremely good tracking.

current could be derived from the input signal. With a little care, the result would be a dynamic noise and interference suppressor.

Multi-channel volume control

The basic circuit is given in figure 6. The audio signal is converted into a pulse-width modulated signal, and this is used to drive an electronic switch. When the switch, S, is closed, the voltage between points A and B is zero. When the switch opens, on the other

hand, the voltage is equal to $(1 - R1/R2) \times U_c$. The output voltage is therefore proportional to the control voltage U_c ; if the same control voltage is used for several channels they will all track exactly. Very useful!

The control range depends on the characteristics of the electronic switch. Both breakthrough (from control input to output) and non-zero 'closed' impedance (the saturation voltage of a switching transistor, for instance) will limit the maximum suppression obtainable.

A practical circuit will illustrate the principle. In figure 7, A1 and A2 provide the PWM signal, T1 is the electronic switch, and A3 smooths the output signal from the switch; note that the amplitude at any given moment is determined by two signals: the PWM signal derived from the input signal and the control voltage U_c .

To increase the range of possible applications, an additional feature is added. The control voltage (U_c) is also applied to the non-inverting input of A3. Rapid fluctuations of the control voltage will now lead to amplitude modulation of the output signal.

The control range of this circuit is equal to:

$$20 \log \frac{U_o (U_c = 12 \text{ V})}{U_o (U_c = 0 \text{ V})} = 60 \text{ dB.}$$

The distortion depends on the frequency of the input signal and on the value of U_c — the latter, in particular, due to the poor switching characteristics of T1. For instance, at an input signal level of 1.8 V and an input frequency of 6 kHz, a low control voltage of 0.12 V will lead to approximately 1% distortion. Obviously this circuit can either be improved or simplified, depending on the intended application.

7

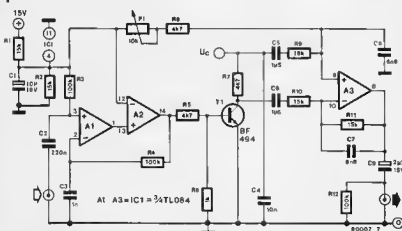

Figure 7. A practical circuit for the multi-channel volume control. In this case, an additional feature is added: an AC component superimposed on the DC control voltage (U_c) will lead to amplitude modulation of the output signal.

market

Portable portfolio system

The model 200 Portfolio is a unique folding production bin system which offers up to 30 separate compartments over a width of 800 mm, but which when closed occupies only a 200 mm cube. Each system is supplied complete with compartment dividers and labels. Each individual tray measures 195 x 95 x 40 mm.



The unit is light and robust and can be folded, stacked and locked with all compartments held securely in place. The Portfolio 200 is available ex-stock from Toolrange and is one example of the large range of electronic production and assembly aids featured in the new Toolrange catalogue.

Toolrange Ltd.,
Upton Road,
Reading RG3 4JA
Tel.: (0734) 29446 or 22245

(1349 M)

Dual variable operational amplifiers

A new family of dual variable operation amplifiers, the CA3280G Series from RCA Solid State, combines two operational transconductance amplifiers in a single package and offers significant performance advantages in parameters such as output current, amplifier matching, input offset voltage, bandwidth, slew rate, noise and reliability. The two amplifiers are independent, differential-input types, and the output is a current proportional to the differential input voltage and the transconductance, which is programmable via a separate input terminal.

The amplifiers used in the CA3280G Series are designed so that the initial input offset voltage is low (500 μ V maximum) and shows little variation (less than 500 μ V) with changes in programming current. Interdigitation, or cross-coupling, of critical portions of the circuit reduces the amplifier dependence on thermal and processing variables, and the offset-voltage drift with temperature is only 5 μ V/degC maximum.

All characteristics of the two operational transconductance amplifiers used in the devices are matched to within 5%, and internal current-driven linearising diodes reduce the external input current to an offset component. An additional advantage in the circuit design is that the differential amplifier

emitters are brought out for use in emitter-coupled dual differential amplifier applications.

Peak output current can be as high as 650 μ A at a bias current of 500 μ A, and operating bandwidth is 9 MHz at a bias current of 1 mA. Noise voltage is typically only 8 nV/Hz at 1 kHz, and total harmonic distortion is typically only 0.4%.

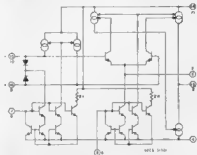

Applications for the CA3280G Series include voltage-controlled amplifiers, voltage-controlled filters, voltage-controlled oscillators, multipliers, demodulators, sample-and-hold circuits, instrumentation amplifiers, function generators, triangle/sine-wave converters, comparators, and audio pre-amplifiers.

The devices are supplied in 16-lead dual-in-line plastic packages and are available with operating temperature ranges of -55°C to +125°C (CA3280AG) and 0°C to +70°C (CA3280).

RCA Limited / Solid State - Europe,
Sunbury-on-Thames,
Middlesex, England.
Tel.: Sunbury-on-Thames 85511

(1352 M)

market

Speed measurement system

Orbit Controls is marketing a complete speed measuring system. It comprises 11 types of tachometer and over 30 different kinds of digital signal transducer.

The tachometers include both 4- and 6-digit types that can be used for the accurate measurement of frequency, speed, flow or rates for the ratio of two frequencies, speeds or rates etc.). The retrometric mode is selected simply by an internal switch. Rewired and



(1347 M)

variable timebase models are available and the system also includes a phase-locked loop tachometer with an input frequency range from 2 Hz to 200 Hz. Other units cover inputs from DC to 100 kHz with a 100 mV RMS sensitivity. Internal, precision 1 MHz crystal oscillators assure a stable reference signal and accurate timing. Typical accuracy is $\pm 0.01\% \pm 1$ count ($\pm 0.005\% \pm 1$ count for the phase-locked loop unit).

The range of complementary digital velocity transducer includes opto and magnetic pick-off types and infra-red units. Many are available in bolt-type mounting with a choice of metric or imperial threads.

Orbit Controls Limited,
Lansdown Industrial Estate,
Gloucester Road,
Cheltenham, Glouce GL51 8PL.
Tel.: 0242-26608

(1356 M)

Two bubble memory development kits

To enable engineers to learn how to use magnetic bubble memories, GEC Semiconductors have just announced two Intel kits. The first is Bubble Memory Prototype Kit type BPK-71 and the second is type IMB-100 1 Megabit Bubble Memory Development Board.

BPK-71 is the simplest kit. It basically comprises the Intel type 7110 1 Megabit bubble memory with the standard drive semiconductor, a current pulse generator and a format/sense amplifier. All that is needed to make this a complete basic memory system is an mpu-based controller and a power supply.

The kit is supplied with complete documentation which includes application information on system interconnections and a complete description of the necessary mpu-based controller. The controller described uses an Intel 8085 and it enables the magnetic bubble memory system to interface directly to a Multibus and 8080/8085 μ Ps.

The second 'kit' is a full development board (IMB-100), containing not only the basic memory and its drive and formatting/sense circuits, but also a complete controller to provide the necessary I/O facilities and interface to a Multibus. However, instead of being a single-chip LSI controller it is made up with separate standard components.

The IMB-100 is complete (except for its power supply) on a printed circuit board with an 86-pin double-sided edge connector. It measures approximately 30 cm (12 in.) long by 17 cm (7 in.) wide and it has a depth of 1.45 cm (0.57 in.).

A set of programs for exercising the IMB-100 is supplied on a double density diskette for use on an Intellec microcomputer development system with ISIS-11.

GEC Semiconductors Ltd.,
East Lane, Wembley,
Middlesex, HA9 7PP.
Tel.: 01-904 9306

market

market

DIL switch covers

An optically clear nylon dust cover is now available for Erg DIL switches. These tough, dust-proof covers form a firm snap-on fit to DIL switches: types SDS8, SOO4 and SDC4. The status of individual switches may be seen at a glance, and the covers also act as a simple but effective security measure in preventing accidental movement of any switch member.



The Erg DIL switch covers are obtainable in packs of 10. Other colours are available to order, and covers with legends or other printing can also be supplied.

*Erg Components Ltd.,
Luton Road,
Dunstable, Beds LU5 4LJ.
Tel.: 0582-62241*

(1357 M)

100 MHz oscilloscope

A new high-performance oscilloscope from Gould Instruments Division, the Gould Advance DS3600, is the company's first oscilloscope to break the 100 MHz bandwidth barrier. Featuring a new compact case design, we are told that it can withstand the most exacting working environments, particularly in fieldservice applications. The new instrument is also available with an optional digital measuring unit, the DM3010, which makes it a complete measuring system for a wide range of analogue and digital applications. The OS3600 is a dual-channel instrument with a maximum sensitivity of 2 mV/cm. The full 100 MHz bandwidth is available from 5 mV/cm, and the 2 mV/cm sensitivity is maintained up to 85 MHz. A high-writing-speed cathode-ray tube with 16 kV overall accelerating potential gives bright, clear traces at sweep speeds down to 5 ns/cm, and signals of low repetition rate and short transition times can be viewed with relative ease. —

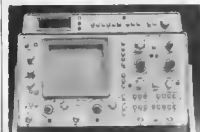

Main and delayed timebase controls are completely independent for ease of use and non-ambiguity. A X10 expansion facility gives a maximum sweep speed of 5 ns/cm for high-resolution timing measurements. An alternate timebase display facility is available, which allows detailed measurements to be made using the delayed timebase while still maintaining a relationship with the main sweep, even when sweep speeds are changed. A comprehensive selection of triggering modes means that the OS3600 can trigger on the most complex waveforms. A variable trigger hold-off control allows the trigger to be disabled by up to one trace length to facilitate triggering of a complex waveform that has no separate sync. or trigger pulse. In addition to the normal range of vertical display modes, a pushbutton-actuated trigger facility is incorporated. This allows continuous display of the trigger signal simultaneously with one or both of the input channels, and with an external trigger signal it effectively provides a third channel with a sensitivity of either 50 mV/cm or 0.5 V/cm. Other standard features on the oscilloscope include a calibrated delay vernier control, 'uncal' warning lights on all variable gain/sweep controls, a trace location facility, an internal illuminated graticule, versatile X-Y display facilities, and the ability to carry out differential amplitude measurements. The optionet DM3010 digital measuring unit consists of a 3½-digit multimeter which can be used completely independently of the oscilloscope for measuring d.c. voltage, current and resistance. It can also be used in conjunction with the OS3600 for accurate measurements of signal amplitude, time interval and frequency. Timing relationships can be measured to within ±1% in most cases.

The Gould Advance OS3600 carries the Gould 2 year guarantee
*Gould Instruments Division,
Roebuck Road, Hainault, Essex.
Telephone: 01-500 1000*

(1386 M)

market

Vacuum fluorescent display digital frequency meter

A new LCO frequency meter offering the advantages of the wide environmental capability of a VF (vacuum fluorescent) display is now available from Ambit. As well as all the usual received frequency options, with IF offsets for all AM/FM standards, the direct count capability of this unit make it an ideal workshop instrument. Coverage extends from 10 kHz to 3.9999 MHz, or to 39.999 MHz for AM and short-wave applications, plus to 399.99 MHz in VHF.

The bright green display is clearly visible over approximately 20 feet, taking advantage of the generally improved visibility of green, with the tendency of most people to see red digits as slightly blurred — due to minor vision defects such as myopia.

The unit is available with a suitable transformer for mains operation, or with a



DC/DC & AC converter for single rail 9 to 14 volt operation.

The second board visible in the photograph shows the input shaping and prescaler board, required for SW and VHF functions

*Ambit International, 2 Gresham Road,
Brentwood, Essex.
Telephone: (0277) 227050.*

(1397 M)

Push-button thermocouple selector unit

The Modal '3508' is a new push-button operated thermocouple selector unit from Comerh housed in a miniature DIN-size panel mounting case. Its use increases the flexibility of the company's digital thermometers by enabling one thermometer to be switched, quickly and reliably, between up to seven thermocouple sensors.

Two-wire inputs are connected to terminal strips on the rear of the unit. These terminals have been carefully positioned to minimise errors which can be caused by draughts on the back panel. The 3508 selector unit has been designed to be compatible with Type K (Ni-Cr/Ni-Al) thermocouples. It is supplied with 0.5 m of lead and a compatible plug for connection to the measuring instrument.



A simple clip-on case is available. If required, to convert the unit for bench top use. Also available is a small, 'double-decked' bench case to take the selector unit and a thermometer.

*Comerh Electronics Limited,
Rustington,
Littlehampton, West Sussex BN16 3QZ.
Telephones: 09062-71911*

(1389 M)

market

market

Multi-purpose magnifier

A new inexpensive but highly efficient magnifier is announced by Combined Optical Industries Ltd. Called the Handstand, it can be used as a hand-held magnifier or it may be inserted into a simple stand, leaving both hands free.



The lens, the wide rim protecting it and the flat handle are made as a single integral moulding from a high-grade acrylic material, which is shatter-resistant and has a better light transmittance than any glass lens. It has a diameter of 96 mm (approximately 4 inches), permitting both eyes to be used to view the work. Magnification is about 2 times.



The supporting stand is a metal pressing with a non-toxic nyloncoated grey finish. The base lies flat on the table so that it does not get in the way. The upright has two slots. Inserting the magnifier handle into the lower slot supports it at the correct focal distance above work lying flat on the table, while inserting it into the upper slot holds it at the correct angle to view work held in the hands. The COIL Handstand was specially designed for intricate repairs, delicate assembly, close inspection and similar work which would otherwise give rise to eye strain.

Combined Optical Industries Ltd.,
200 Beth Road, Slough, SL1 4DW.

(1383 M)

Miniature general purpose LEDs

A range of miniature general purpose LEDs has been introduced by B & R Relays Ltd. The new L series are low cost general purpose devices available as both panel mounting and p.c.b. mounting types. They are available in red, green or amber, and operate from 2 V nominal supplies with a current drain of only 10 mA (red) and a typical lifetime in excess of 50,000 hours.



As supplied in its basic p.c.b. mounting form, these LEDs feature a very wide angle of view of 120° to increase the range of visibility. Attractive chrome finish panel mounting types are fully shrouded and come complete with protective bezel plate, threaded screw and fixing nut. For easy polarity identification and ease of insertion into p.c.d. holes, one lead is supplied slightly longer than the other.

B & R Relays Ltd,
Templefields Harlow CM20 2BG Essex,
Telephone: Harlow (0279) 34551

(1388 M)

VHF tunerhead

The range of VHF tunerheads stocked by Ambit has been extended to include the EF 5804. This has been designed with synthesised control in mind, and can tune the entire range of band 2 FM (88-108 MHz) with only 2 to 8 V bias.

Using a wider range of tuning voltages, coverage is possible from 88-136 MHz. Custom made versions covering other portions of VHF in the range 30-200 MHz are available to special order.

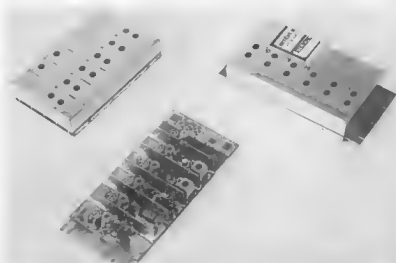

The unit employs the very latest dual gate MOSFETs, and provides an overall gain of 40 dB with a 2.3 dB noise figure. A pin diode AGC attenuator is used in an internal AGC clamp circuit, and provision for external IF derived AGC is available via the control gates of the FETs.

A fully buffered local oscillator output is provided, together with an IF preamp using an FET. 6 varactor tuned stages provide the exceptional RF selectivity necessary to make best use of the high gain.

Ambit International, 2 Gresham Road,
Brentwood, Essex.
Telephone: (0277) 227050.

(1396 M)

Fast A/D converters

A new 16 and 14 bit A/D converter series from DMC provides an exceptional combination of resolution, accuracy, speed and stability. First designed for the toughest analytical instrumentation requirements, these converters now make 18 and 14 bit performance practical for a wide variety of applications.

Model 2816 converts 16 bits in 100 microseconds, and Model 2814 converts 14 bits in 50 microseconds. Maximum linearity error is $\pm 0.0015\%$ of full scale for the 2816, and $\pm 0.003\%$ of full scale for the 2814. Both models have excellent temperature stability, with maximum linearity TC of $\pm 0.5 \text{ ppm}/^\circ\text{C}$. Maximum power consumption is only 1.4 watt, and PSRR is 0.002%.

This series offers considerable flexibility and convenience. There are four full-scale standard signal range selections, and built-in trimmers are provided for gain and offset. They can be easily recalibrated in the field, or set to cancel system errors.

AMPLICON electronics Ltd.,
Lion mews, Hove BN3 5RE,
Telephone: Brighton (0273) 720716.

(1390 M)

market

market

Miniature enclosures

The new Pac Tec HP miniature enclosures from OK Machine & Tool (UK) Ltd are ideal for hand-held devices such as calculators, key pads, thermometers, paging systems, intercoms as well as making useful terminal boxes in common with the larger Pac Tec units, these new mini enclosures are moulded from tough ABS. The two sections are held together by screws and any necessary cut-outs can easily be made in the top or bottom panels. Where special faces are required in quantity the enclosures can be modified to specification by OK.

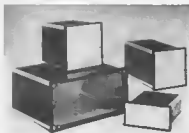

Access to the inside of the box is easily gained through the removable top and bottom panels. Two screws only need to be removed to slide out either panel. Removal of the rear panel reveals PCB mounting slots integral with the corner extrusions.

Manufactured from black PVC clad steel with anodised aluminium front and rear panels, the boxes are supplied in kit form for easy assembly and will house boards from 80 x 90 mm up to 176 x 150 mm.

Vero Electronics Limited,
Industrial Estate, Chandler's Ford,
Eastleigh, Hampshire, SO5 3ZR,
Telephone: (042 15) 69911.

(1392 M)

Powerful DMM

Microprocessor techniques have allowed Fluke to incorporate some very useful features in their latest low cost 4½ digit 8050A DMM. Apart from being a very compact and highly accurate bench/portable model with 39 measurement ranges and nine functions, the 8050A also provides dB computing and offset modes in addition to a high performance true RMS capability.

In the dB mode, the 8050A DMM is a real time saver allowing the user to call up any of 16 reference impedance levels from 8 to 1200 ohms and to display the readings directly in dB's without any tedious computation or dedicated dB meters.

Additionally, a reference/offset mode allows any input signals to be stored either as a reference value for relative dB readings or as an offset against any reading. In offset mode, the user can zero-out any lead resistances for really high resolution impedance measurements or set up a reference offset and display only the variance from that reading.

These absolute and relative dB modes with offset greatly simplify measurements in audio, amplifiers and telecommunications circuits as well as in production testing where only the variance from the stored value may be required. The offset facility is available on all functions such as AC/DC Volts or Amps, Resistance or Conductance.

The high resolution 4½ digit LCD display is matched by a basic DC accuracy of 0.03%

specified over a full year. AC or DC measurements can be made down to 10µV, 10 nA or 10 milliohms. In addition to its comprehensive volts, ohms and amps ranges, the 8050A also has two conductance ranges for high impedance measurements to 100,000 Megohms, as well as low power ranges for in-circuit measuring of diodes and resistors. An additional safety feature is an HV display whenever a dangerous voltage over 40 V is present on the probes. This is especially useful in the dB or relative modes where the displayed reading does not show the actual input value. Further safeguards protect against overloads or misuse and the instrument is conservatively rated to withstand transients to 6 kV.

A wide range of accessories such as high voltage probes, current transformers, shunts, temperature and RF probes, remote hold probe, battery pack, and safety leads make the 8050A a complete measurement system for the bench or field.

Fluke International Corporation,
Colonial Way, Watford, Herts.
WD2 4TT,
Telephone: Watford (0923) 40511.

(1395 M)

Hi-Style instrument case

The Enclosures Division of Vero Electronics have launched a new range of moulded instrument cases. The 'Hi-Style' case is an attractive two-tone brown case moulded in ABS.

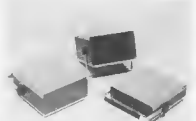

Available in three heights the range is supplied complete with a carrying handle, which doubles as a tilt foot. The angle of tilt is adjustable and locks in the carrying position. The base section has moulded-in PCB mounting pillars and apart from these the inside of the case is clear for maximum space utilisation. Flat front and rear panels, removable for easy machining are held in position by the assembled case — no fixing screws. The front panel is supplied painted black, to match the handle trim, and the rear is supplied silver. Interchangeability of these panels allows the user choice of colour scheme.

Vero Electronics Limited, Industrial Estate,
Chandler's Ford, Eastleigh, Hampshire,
SO5 3ZR
Telephone: (042 15) 69911

(1394 M)

Standard colours are grey, tan, black or blue but special finishes are available. Other options include EMI/RFI shielding end belt, wrist or shoulder straps. External dimensions are 28.4 mm high X 91.4 mm wide X 146.1 mm deep.

OK Machine & Tool (UK) Ltd,
43a The Avenue, Southampton,
Hants SO1 2SY,
Telephone: 0703 38966/7.

(1391 M)

DIN Panel Mounting Boxes

A range of Panel Mounting Boxes to DIN43700 have recently been introduced by Vero Electronics Limited. The four sizes are primarily intended for use as detachable modules in a console or instrument panel. A specially designed latching system allows the easy removal of the box from its mounting by a simple half-turn of two screws on the front panel. Access to the rear of the panel to remove the box as with previously available types, is therefore unnecessary. The boxes will fit to any panel thickness between 2 and 6 mm since continued rotation of the latch screws draws the fixing latch along until it clamps the panel securely. A single rectangular cut-out is all that's needed for mounting



market

market

Keyless digital lock in chip form

The LS7220 is a 14-pin DIP CMOS IC that offers 5,040 4-digit combinations, and detects the proper sequential closing of 4 switches and sets a Lock Control output HIGH, improper sequencing of the input keys or activation of a 'dummy' input key resets the chip. A save control memory, settable only in UNLOCK condition, preserves the lock outputs' status when desired. A built-in capacitor delays changes of the lock outputs when the chip is disabled.

Power may be 5 V to 18 VDC with quiescent currents between 20 and 70 μ A (all inputs and outputs open). The outputs for lock-control, save, and lock-indicator can each supply up to 30 mA for direct drive of indicator LEDs and lock relays. Operating temperature range is -20°C to $+70^{\circ}\text{C}$, suiting the chip for automotive and marine anti-theft and other security applications.

LSI Computer Systems, Inc.
(Manufacturer of Custom & Standard LSI circuits),
1235 Walt Whitman Road,
Melville, NY 11747, U.S.A.
Telephone: 516/271-0400.

(1387 M)

Rectangular LEDs

Litronix has introduced a range of three light emitting diodes to meet the specific requirements of applications where the close spacing of such products is an essential function.

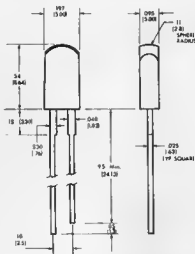

Designated RL-10 (red diffused lens), GL-11 (green diffused lens) and YL-12 (yellow diffused lens), the lamps are rectangular in shape to afford close spacing and emit a rectangular wedge of light when viewed from the end

Suitable for a variety of panel indicator applications, the rectangular 'prevestons' lamps may be end-stacked for a linear bar effect

At a forward current of 20 mA, all three devices have a typical luminous intensity of 2 mcd. The RL-10 has a minimum luminous intensity of 0.8 mcd and the GL-11 and YL-12 are both rated at 1.0 mcd

Litronix Inc., 33 Churchgate,
Hitchin, Herts, SG5 1DN,
Telephone: Hitchin 56322.

(1385 M)

JeDEC standard 'chip' test sockets

A versatile series of 'chip carrier' test sockets, designed to accept all JEDEC Standard microcircuit carriers, has been introduced by BFI Electronics Limited.

The sockets will accept carriers from 16 to 84 leads inclusive, with body sizes up to and including 1 1/4 ins square on 0.05 in. centres. In addition, only minor tooling changes allow the sockets to accept JEDEC Standard 0.04 in. centre packages or virtually any other non-standard chip carrier.

A positive locking and unlocking system enables loading and unloading using only one's fingers. In addition, a specially designed lid allows the same socket to accept packages ranging from 0.050 to 0.100 in. thick

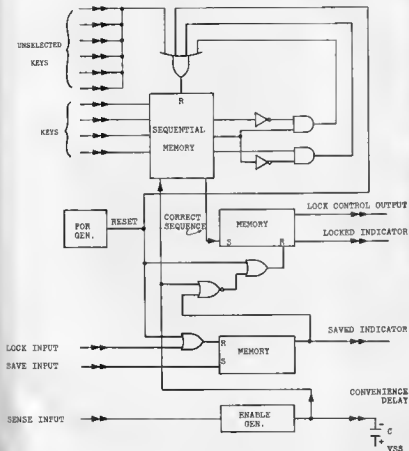

Other significant features of this 'chip carrier' range include a lid design that eliminates shorting against contacts or P.C. Board and which will not separate from the socket body under normal usage. Integral socket mounting holes and minimum lid overhang at the back of the socket, permit maximum socket mounting density

All sockets in the range are ideally suited for both test and burn-in applications and are available in a wide variety of materials to meet specific requirements.

BFI Electronics Limited,
516 Walton Road, West Molesey,
Surrey KT8 0QF.
Telephone: 01-941 4066. Telex: 261395.

(1393 M)

Introducing another new book from Elektor

300 circuits

£1.95

special offer £1.-

P.S. Please include 30 p. for post & packing.

Elektor Publishers Ltd.

Offer valid until 31st January 1980.

COMPLETE CONSTRUCTIONAL DETAILS OF THE ELEKTOR FORMANT SYNTHESISER

If you are even mildly interested in synthesisers then this book is for you. What is a VCF? ... a dual VCA? ... a VCO? (we have one of the best). It's all here with setting up procedures, hints and tips and more ... You can now read about the famous ELEKTOR FORMANT ... and HEAR it ... We have taken the trouble to include a FREE cassette of sounds that the FORMANT is capable of together with suggestions on how to achieve them.

**ORDER NOW
PRICE
£ 4.30**
including
postage
and
packing



The book the synthesiser world has been waiting for!

ELEKTOR now release the FORMANT BOOK with a FREE CASSETTE.

ORDER DIRECT FROM ELEKTOR, 10 LONGPORT CANTERBURY, KENT CT1 1PE.