

elektor

56
December 1979

U.K. 55p.

U.S.A. | Can. \$1.75

up-to-date electronics for lab and leisure

build your own VOCODER

Sumner King

integrated preamp

electronic nuisance

vox switch

steam train with
whistle



Australia	\$ 1.50*
Austria	S 38
Belgium	F 63
Denmark	Kr 10
France	F 8
Germany	DM 4.40
Netherlands	DFL 3.75
New Zealand	\$ 1.50
Norway	Kr 10
Sweden	Kr 14
Switzerland	F 4.60
* recommended	

elektor

56

contents

december 1979
voluma 5
number 12

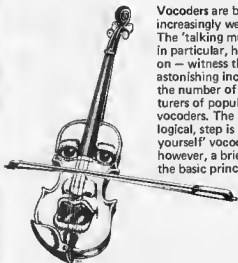

page 12-02
Vocoders are becoming increasingly well-known. The 'talking music' effect, in particular, has caught on — witness the astonishing increase in the number of manufacturers of popular music vocoders. The next, logical, step is a 'build-it-yourself' vocoder. First, however, a brief recap of the basic principles.



page 12-08
The electronic nuisance is like a cricket at night: infuriating. A few minutes after you switch off the light, it starts to make a noise; when you turn on the light to look for it, it stops.

page 12-20

The steam train sound effects generator fits inside the model. It provides the steam sound, varying with the speed of the engine; a steam whistle is also included.

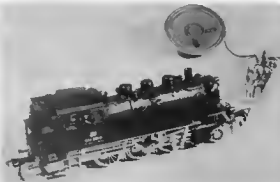

elektor	12-01
vocoders today (F. Vissler)	12-02
electronic nuisance (W. Verbiert)	12-08
charging nicads — fast	12-10
Nicad cells have the advantage that they can be recharged, so that they don't have to be replaced as often as normal dry batteries. The only disadvantage is that charging takes time, and this can be a nuisance when you want to re-use them almost immediately. Rapid charging is the solution, but it must be done properly	
toppreamp	12-13
No run-of-the-mill preamp, this. Only truly useful controls are included, making for a small and easy-to-operate 'dash-board'. The size of a Mini and the performance of a Jaguar. And for a reasonable outlay, at that. A perfect front-end for the topamp power amplifier published last month.	
steam train	12-20
cumulative index 1979	12-23
link 78/79	12-26
talk funny?	12-27
Deliberate electronic distortion of speech and music signals can give fascinating results. Professional musicians use extremely expensive equipment to obtain their very own weird and wonderful 'sound'. For electronics enthusiasts, it is much more fun to get the same sort of results from very simple circuits. Which is what this article is about: getting effective effects using a single IC, the 2206.	
sawar	12-30
This project has been designed as a 'front end' to the Analogue Reverb Unit with the purpose of allowing greater flexibility with reverb effects. It produces a variable rate clock signal together with five different modulation waveforms that can be used for phasing, vibrato and other effects. A random signal generator is also included for chorus effects. The composite output signal is intended to be connected to the external clock input of the analogue reverb unit.	
tailoring potentiometers (G. Reinhold)	12-36
Most potentiometers are supposed to have a fairly straightforward linear or logarithmic characteristic. This is all right in most applications, but sometimes the particular characteristic required is not readily available. Fortunately, it is not too difficult to obtain various modified characteristics by adding one or two fixed resistors. Which is what this article is about.	
voice operated control switch	12-40
Amateur radio operators normally use a Push To Talk (PTT) button to switch from 'receive' to 'transmit'. This changeover can also be done automatically, using a circuit that detects the speech signal from the microphones. This kind of automated PTT button is usually referred to as a VOX.	
market	12-42
missing link	UK 16
advertisers index	UK 30

Search Dept
6 Dec, 1979

selektor SELEKTOR

Do-it-yourself with bit and board

Microcomputers as a hobby

For more than half a century there have been radio hobbyists and amateur radio enthusiasts. Originally they used crystals, valves and discrete component semiconductor technology. The advent of microelectronics greatly expanded the

opportunities open to hobbyists and consequently, for example, led to a boom in radiocontrolled models. Today the number of electronics hobbyists is estimated to be millions in Europe alone. A significant percentage of this number — estimated to be as high as 15 per cent — dedicate most of their spare-time to the new technology of microprocessors. Some hobbyists are more concerned with basic hardware, while others are searching for innovative applications. Both activities are often pursued collectively in clubs. One of the largest groups in Germany has been formed at Siemens in Munich. The 250 members of this group have been meeting on a regular basis for two

selektor SELEKTOR

years; mainly to attend lectures and participate in training courses. Programmes and systems are being prepared as joint efforts in order to 'harmonize' the activities of the group, for example collective orders for components and related equipment reduce costs: Uniform p.c. boards provide a simple basis for all kinds of circuits. Altogether 700 Siemens employees cooperate with each other. There are also some 'freelancers' in the group. All members are kept in touch by a newsletter, which reports about the most recent microcomputer programmes, device developments and technical literature.

The main interest is, of course, centred on the application of microcomputers, ranging from intrusion detection; word processing for personal invitation cards; electronically composed, recorded or reproduced music to novel circuits for cameras. Again and again rolling stock, points and signals of model railways are ingeniously controlled to simulate the real thing. While another member is endeavouring to make telegraph characters appear noiselessly on a screen; and several other members are tracking Earth satellites. One enthusiast in particular is developing a VOR radio navigation aid in which the frequencies of all European ground stations are stored. The pilot can now do without the standard reference lists. It is especially this last application which is on the brink of going beyond a spare-time activity. The innovation has already aroused the interest of some manufacturers.

*Siemens Limited,
Siemens House,
Windmill Road,
SUNBURY-on-THAMES,
Middlesex TW16 7HS.
Tel.: Sunbury-on-Thames
(09327) 85691.*

(505 S)



Do-it-yourself work with bit and board has led to a professional result: incorporated in the instrument panel of this ultralight aircraft is a VDR radio navigation set equipped with a microcomputer. The work was carried out by Walter Frater of the Munich gliding club.

The compass course to the next ground station is continuously 'pre-calculated' and indicated by the digital liquid-crystal display below the navigation panel. At present, the microcomputer is being programmed for all European navigation frequencies. The pilot can now leave frequency reference lists on the ground.

selektor SELEKTOR

vocoders today

talking music
is here to stay

F. Visser



When we first discussed vocoders in *Elektor*, a few years ago, they were still relatively unknown. Since then, interest in this type of sound-effect system has grown at an astonishing rate. Especially where the popular music vocoder is concerned, the number of different manufacturers and types seems to be increasing exponentially and this trend is nowhere near its end.

There is every reason, therefore, to take another look at the vocoder phenomenon — especially since we have now reached the point where we can describe a vocoder circuit specifically designed for the home constructor! More on that next month; first, we will recap the background and basic principles of vocoders briefly, so that everyone knows what we're talking about.

It's not surprising that vocoders have become so popular in such a short time. Certainly in the popular music field, where interest in all kinds of artificial effects has increased rapidly over the last few years. Add to this the undeniable fascination of anything associated with artificial speech production (nothing new: this has been going on for centuries!) and you have two solid foundations for this vocoder.

History

Although artificial speech production is not really a job for a vocoder, the first experiments in that direction can still be seen as the earliest stage of vocoder history.

A Mr. von Kempelen was the first to experiment successfully in this field. Around 1790, he produced a complicated machine consisting of an amazing array of bellows, membranes, resonators and pipes. Believe it or not, it produced 'human speech' sounds!

At the beginning of this century, Stewart succeeded in constructing the first electrical synthesiser of simple speech sounds. This speech synthesiser inspired Homer Dudley, at the Bell Labs in the United States; his invention was patented in 1936. He called his speech analyser/synthesiser a 'Vocoder' — from VOICE enCODER-decoder. This vocoder was intended for transmitting speech over a transmission link with the smallest possible bandwidth. Purely for telecommunications, in other words.

Inevitably, the military showed great interest in the vocoder. Not only did it have the advantage of requiring only

a narrow transmission bandwidth; it also offered the possibility of speech coding — 'scrambling'.

Around 1950 one of the first musical applications of the vocoder, the 'talking piano', appeared on a gramophone record ('Sparky'). The effect was exceptionally effective, certainly when one considers the state of the art at that time, but it was accepted without a stir. It was merely another byproduct of the 'mysterious art of electronics'. The same casual, if mystified, acceptance was widespread when Radio Luxemburg first introduced their well-known jingle, and again when the Beatles used an EMI vocoder to produce some extremely sophisticated effects.

It wasn't until 1975 that the mystery surrounding the vocoder started to dissolve. Until then, it had been used only in a few large laboratories (Bell, Siemens, EMI, Philips, Sennheiser). With good reason: those vocoders were so big that some of them filled a whole room.

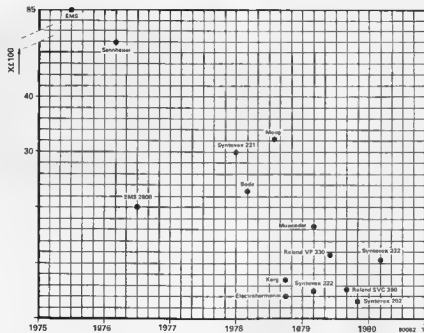

Figure 1. The almost explosive increase over the last few years of types on the market and the falling prices are both nicely illustrated in this graph.

It is interesting to compare the development of the vocoder with that of the computer. The latter was initially seen as a rather frightening and very powerful machine. Only 25 years ago, it was thought that two computers would suffice for the whole of the United States: one on the East coast and one on the West coast. In fact, we are now rapidly approaching the point where there will be a computer in every home! It is unlikely that the popularity of vocoders will go quite that far. However, like earlier 'revolutionary' inventions (railways, cars, computers, electronic music synthesizers), it is likely that it will become far more commonplace than was originally expected. Speech analysis, speech synthesis, speech recognition, speech input and output for computer systems, and — last but not least — applications in (electronic) music: vocoders are used in all these fields, and the end is nowhere near in sight.

What's on the market?

1975 can be considered a turning-point in the history of the vocoder. In that year, a British manufacturer of music synthesizers and similar specialised equipment introduced a vocoder designed by Tim Orr. EMS was already known as a company with 'vision'; it was one of the leaders in the field of electronic music. In this case, they were again the first to launch a completely new instrument: the vocoder.

It is outside the scope of this article to analyse the marketing philosophy of all present-day manufacturers of

Table 1

	Approximate price (excl. VAT)
Bode Vocoder	£ 2300
Electroharmonic	£ 400
EMS Vocoder	£ 8500
EMS 2000 Vocoder	£ 2000
EMS 1000 Vocoder	£ 945
Korg Vocoder	£ 726
Moog Vocoder	£ 3081
Muscoder	£ 1630
Roland VP 330	£ 1143
Roland SVC 350	£ 507
Sennheiser VSM 201	£ 5000
Syntovox 221	£ 2950
Syntovox 222	£ 495
Syntovox 232	£ 1050
Syntovox 202	£ 275

Table 1. A list of vocoders that are presently available, with an approximate price.

vocoders, but a single example may serve to illustrate the confusion and hesitation — both on the part of the manufacturers and on the part of musicians — which has become apparent since the EMS Vocoder first appeared. Dr. Robert A. Moog, the 'father' of the music synthesiser, first built a channel vocoder in 1970. It consisted of a multitude of filters, envelope followers and voltage controlled amplifiers, and it was used for an adaptation of a Beethoven chorale by Walter Carlos for the film 'Clockwork Orange'. At the time, Moog apparently failed to see any commercial future for a more practical version of this device. It wasn't until the fearfully expensive EMS vocoder appeared that a few other manufacturers suddenly showed interest (Sennheiser, Synton, Bode). This forced Moog to face facts: his extensive range of products was incomplete without a vocoder.

However, the presently available Moog vocoder is not his own design: it is manufactured under licence. The rights belong to Harald Bode, who has had his own (patented) vocoder on the market for some time. This patent will be discussed later.

The growing competition and falling prices since 1975 are clearly illustrated in figure 1. The last two years, in particular: a new manufacturer — or a new type, at least — every few months! For those who are more interested in price than in date of introduction, the available types with approximate prices are listed in table 1.

Applications

The first large vocoder systems on the market (EMS Vocoder, Sennheiser VSM 201, Syntovox 221) were aimed at the 'high end' of the market. They were expensive — well above the means of musicians or even small sound studios — and so complicated to operate that it was difficult to attain high levels of artistic achievement... Their use was limited to large studios, radio stations, film studios and a very few well-known pop groups or composers with their own studio. Furthermore, a system that offered good intelligibility and speech precision was useful for speech research.

A large potential market remained unexploited: the musicians and groups who are always on the look-out for new effects, a new 'sound'. It was to be expected that Japan would be the first to introduce a vocoder at a price that the average musician could afford. It was to

be expected... but it didn't happen! In November 1978, at an Audio Engineering Society exhibition in New York, the American manufacturer Electroharmonix introduced a vocoder system priced at about 800 dollars. Admittedly, a Japanese manufacturer (Korg) also had a vocoder on show — but it was much more expensive. Both of these vocoders were quite obviously rush jobs, and the commercial departments were unexpectedly faced with the task of explaining this highly complex unit to a very broad group of potential customers. To make matters worse, the few people who did know anything about it by and large failed to realise its full potential: they were interested mainly in the 'talking music' effect. There is, however, a completely different field of applications for the vocoder: speech training for the handicapped. Speech sounds, or even complete words, can be produced by a vocoder. These can serve as an example for the learner, and his own attempts can be compared with the original.

A further, possibly highly important, application of vocoders is in 'expression training'. Modifying sounds by making other (vocal) sounds often proves to have a most beneficial effect for those who join in this kind of (group) therapy. The most interesting — and funny! — effects are obtained when one succeeds in overcoming initial inhibitions, when faced with a group.

Musical applications

A vocoder offers the possibility of superimposing speech characteristics



onto the sound of a musical instrument (Electric Light Orchestra, Herbie Hancock) or any other basic sound. But there is more. It is also an ideal aid for modifying the timbre of a sound, for instance by superimposing vocal 'colouration'.

There are a few restrictions that must be considered. Two points in particular limit the choice of sound sources. In the first place it is essential that the two sounds occur simultaneously — vocoding is a 'live' process — and furthermore the spectra of the two sound sources must overlap as much as possible. Some examples are given in figure 2 and 3. Colouration of the sound from a musical instrument is not the only possibility. The loudness of the final output is also determined by the loudness of the speech signal. This can be extremely useful in itself. The attack and decay of the musical sound can be varied by

singing louder or softer; instrumentals that would normally have a relatively slow 'attack' can be made more percussive by vocalising the desired 'explosive' effect; chords played on an organ, polytonic synthesiser or by a string ensemble can be coloured and rhythmically articulated by singing short tones at the desired pitch.

Obviously, all this calls for some practice. The musical effects that can be obtained by means of a vocoder depend entirely on the vocal capabilities (and the long wind!) of the vocoder player.

One of the most important characteristics of the vocoder in musical applications is that it is a kind of interface between the musician and the musical instrument. A vocoder is an ideal aid to musicians who wish to achieve a personal 'sound', a unique 'signature', in their performance. The musician has

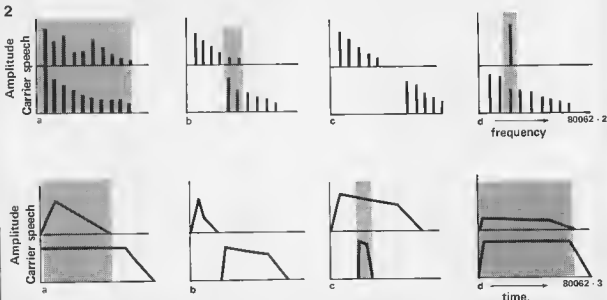

Figures 2 and 3. The two input signals to a vocoder, 'speech' and 'carrier', must have overlapping frequency spectra (figure 2). Furthermore, they must occur more or less simultaneously (figure 3). The more they overlap, the better the effect. Figures 2a and 3a show good frequency and time overlap, and figures 2d and 3d are also acceptable. Taken together, however, figures 2b and 3b will not work because of the 'time' discrepancy; similarly, figures 2c and 3c illustrate a case where no frequency overlap occurs.

a 'real time' tool that he can use to modify the complete tonal structure immediately, while he is playing. He can make the sound harsher, fuller, softer, more percussive. The results are immediately obvious, so that a kind of feedback mechanism occurs: the musician can hear exactly what he is doing and modify his vocal control accordingly. The result, as far as 'playing' the instrument is concerned, is similar to playing a conventional instrument; for example, the light touch on a keyboard instrument or the precise lip control and embouchure for wind instruments. In these cases, the final result is also determined by a similar 'feedback' mechanism. It is worth noting that this effect is almost absent when playing other electronic instruments, since the programming, presets and so on can only be modified by means of a separate hand or foot control. This control does not lend itself to such immediate and precise control of the total sound, with the result that it is extremely difficult for the musician to produce exactly the desired effect.

Designing a vocoder

It is no easy matter to design a vocoder that is suitable for (mass) production. Before going into the problems, however, it is essential to take a closer look at the basic principles involved. For a more extensive discussion, readers are referred to the two articles on vocoders in the April and May 1978 issues of Elektor. In this article, we will keep the explanations as brief as possible.

Basically, then, a vocoder consists of two groups of identical filters; one of these is used to divide the speech spectrum into narrow bands, from each of which a voltage is derived that can be used to control the other group of filters, which reconstruct the speech spectrum. This would seem rather pointless — using speech to make speech — but the difference is that the second group of filters receive a completely different input signal as a basis for the reconstructed speech. The first group of filters is the 'analyser' section, the second is the 'synthesiser'. The input signal to the synthesiser section is called the 'carrier', 'excitation' or 'replacement' signal.

As the block diagram in figure 4 shows, the analyser section is basically similar to a graphic equaliser, with one major difference: the outputs of the various filters are not summed. Each is followed by its own rectifier and low-pass filter; together, these form an envelope follower. In this way, an audio signal can be converted into a set of control voltages (V_c) for driving the synthesiser section.

The second group of filters, the synthesiser section, could also consist of a graphic equaliser (figure 5). In this case, each of the filters is followed by a voltage controlled amplifier; the outputs

4

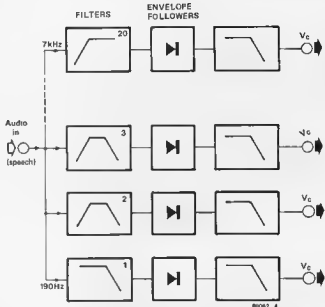

Figure 4. The analyser section of a basic vocoder consists of a set of filters and rectifiers with low-pass networks (envelope followers). This section derives a set of control voltages from the input (speech) signal: one V_c for each frequency band.

of these VCAs are summed to produce the final output. This system, in its simplest form, would seem to fulfil the requirements for a vocoder. In all probability, the results obtained would indeed be faintly reminiscent of the real thing... However, intelligibility and dynamics would leave a lot to be desired.

Numerous tests and intensive investigation have led to a list of requirements, relating to the various sections of the block diagrams discussed above. The exact requirements depend to some extent on the application for which the vocoder is intended.

In general, if vocal sounds are to be

superimposed on some other sound, filters covering the range from 300 Hz to 3 kHz will usually suffice. Obviously, using more filters and covering a larger total bandwidth will lead to better 'definition'. The large EMS, Sennheiser and Synton vocoders use about twenty filters, covering a range from approximately 200 Hz to 8 kHz. Within this range, bandpass filters are used for both analysis and synthesis. Frequencies below 200 Hz and above 8 kHz are covered by a low-pass and a high-pass filter, respectively, so that the complete audio band from 30 Hz to 16 kHz is processed by the vocoder.

When a large number of filters are used,

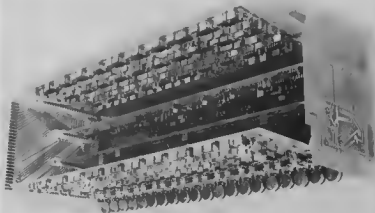

5

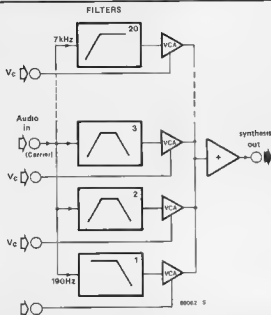

Figure 5. The other section in a basic vocoder is the synthesiser. A group of filters is used to split up the 'carrier' signal (music, for instance) into small frequency bands. The output level in each band is determined by the control signals applied to the voltage controlled amplifiers (VCA); these control signals (V_c) are normally derived from the analyser section.

deciding how to subdivide the audio band is no real problem. However, in this case design of the filters is critical: a fairly narrow and well-defined pass-band is required, and the centre frequencies must be accurate. In large vocoders, like those mentioned above, it is customary to use third-octave filters (or an approximate equivalent). Vocoders that use less filters must obviously use a wider spacing of the centre frequencies — the same total range must be subdivided into fewer pass-bands. Furthermore, the filters may cover different bandwidths, giving more precise analysis and synthesis in the frequency range that is important for speech intelligibility.

The number of filters used (and the spacing) determines the required bandwidth and the filter steepness outside the band. If filters are set close together but with an insufficiently steep cut-off, there will be a large frequency overlap. The result is that the speech becomes indistinct and 'woolly'. This will almost invariably happen if two graphic equalisers are used, as suggested in the basic example given earlier. Equaliser filters are just not good enough for this application.

The easiest and cheapest way to obtain a filter with a sharp cut-off is to use a gyrator, but this has other drawbacks. This type of circuit tends to 'ring' noticeably and unwanted frequencies do leak through; both of these effects severely affect the intelligibility. We could go on like this, crossing off the various types of filter, but there is little to be gained by beating around the bush: in practice, there is really only one filter type that is suitable.

As you would expect, it is by no means the cheapest.

For optimum intelligibility, the initial slope of the filter should be in the order of 50...54 dB/oct. This type of filter is used in the Synton Syntovox 221. Regrettably, the large number of close-tolerance components required precludes its use in low-cost vocoders. The Sennheiser VSM 201, for instance, uses 36 dB/octave filters; in the large EMS vocoder, about 30 dB/oct. is used. The high price of professional vocoder systems is a direct result of the high component and assembly costs involved in the large number of high-precision filters.

But good filters aren't the only problem. In the analyser section each filter must be followed by an envelope follower, consisting of a precision rectifier and a low-pass filter. Output offset voltages are the headache here: they can ruin the dynamics of the whole system. There are only two alternatives: either use very carefully selected components or else include a calibration facility. Another point to watch is the cut-off frequency of the low-pass filter. It's not a good idea to use identical filters: the cut-off frequency should be related to the centre frequency of the corresponding analyser filter.

Hold on: we're not out of the woods yet. Things get worse before they get better; the synthesiser section poses even more problems.

Each filter in the synthesiser section must be followed by a voltage (or current) controlled amplifier. If you draw up a list of all the ways to make a voltage controlled amplifier (VCA), the OTA (operational transconductance amplifier) turns out to be the best bet. This is not to say that it is ideal — it most definitely is not. The transconductance (gm) tolerance is bad enough, but there are two more problems. In the first place, OTAs are noisy. They hiss. This is not quite fair, perhaps — there are other noisy opamps — but the problem is that only very low signal levels can be used if the distortion is to be kept within reasonable limits, so the signal-to-noise ratio suffers. Furthermore, the signal leakage from control input to signal output is often considerable. Not that you can blame the manufacturer of the OTA (CA 3080): this leakage is not included in the specifications, and in most applications it is relatively unimportant. For a vocoder, however, it is essential that this leakage is minimal; otherwise the control signals from the analyser can break through to the output, even in the



Photographs. The photos show several commercial vocoders, from various manufacturers. The photo of the 'innards' of a vocoder gives some idea of the complexity involved in the more expensive types. That particular model is the 20-channel vocoder, type 221, manufactured by Syntovox.

absence of a 'carrier' signal. This is a nuisance, to put it mildly...

As before, the solution is to either select the components carefully or else provide a calibration point. For really good results, you really have to do both. In the constructional project that will be described next month, a large number of adjustments are included for this reason; even so, a test procedure to reject really 'bad' OTAs will improve the final performance.

So far, we have only considered the most essential parts of a vocoder system: the analyser and the synthesiser. Using these two, speech sounds can be superimposed on other signals. Some speech sounds, that is: the so-called 'voiced' sounds (vowels, for example). Complete speech synthesis, including 'unvoiced' sounds (s, f, p, and so on) is not possible with this basic system. For this, a noise generator and a voiced/unvoiced detector are required; the latter, in particular, is quite a complex circuit. It is the intention to describe it in greater detail at a later date. However, if the vocoder is to be used for musical applications, the basic system discussed so far is perfectly adequate. For that matter, most low-cost vocoders presently available also lack a voiced/unvoiced detector, mainly for reasons of price.

If the vocoder is used in conjunction with musical instruments that produce a broad spectrum, with plenty of higher harmonics, a reasonable approximation of the unvoiced sounds will be obtained without a voiced/unvoiced detector and associated noise generator.

Patents

A search through the files in the patent office shows that there are hundreds of patents directly related to the vocoder, and even more that have some bearing on it: patents in areas like speech recognition, detecting the fundamental speech frequency, etc.

The most recent patent relating to vocoders is in the name of Harold Boda, the manufacturer of the Bode vocoder (that is also manufactured under licence by Moog). The main point in this patent is a clever little trick that Bode uses in his vocoders to increase the intelligibility of speech — the filters used in the vocoder have a slope of only 24 dB/octave.

As explained earlier, the intelligibility of synthesised speech depends on the type of filter used: its general performance, and the slope outside the passband. If a vocoder is not intended for speech synthesis in the full sense — where external control voltages can be used to create intelligible speech — then the intelligibility for musical applications can be improved by adding the high frequency portion of the speech signal (above 3 kHz) to the output signal from the vocoder. This high frequency signal only contains the noise signal and



transients, for consonants like k, p and t.

The main disadvantage of this system is that a real voice must be used to drive the vocoder: if artificial control signals are used, the high frequency content will be missed in the output. Furthermore, this 'high frequency bypass' system produces a similar effect to 'signal breakthrough' in the vocoder. Despite these disadvantages, the effect is interesting enough; it is worth experimenting with when you are building your own vocoder.

The future

It is difficult to estimate future developments in vocoders. At present, it seems unlikely that a digital version will be produced. The conventional analog vocoder has the unique feature that it works 'real time'. The incoming signal is analysed immediately, and the output from the analyser can be used for simultaneous synthesis. In spite of the problems involved in using sharp analog filters (phase shift), it seems unlikely that a digital alternative with a reasonable price will be found in the near future. Synthesising speech artificially is another matter, of course. There are several digital approaches to this. The problem facing the would-be digital vocoder constructor is to analyse complex signals, like speech, sufficiently rapidly and accurately to make a workable vocoder.

The popular music vocoder has a bright future. The number of manufacturers and types will increase rapidly, and this is bound to lead to falling prices. However, it is unlikely that the near future will see vocoders in the same price range as 'effect boxes'. A vocoder is too complex for that, using large numbers of close-tolerance components if optimum performance is required. That, and the number of man-hours

required to build one unit, precludes the appearance of a mass-produced low-cost vocoder for some time to come.

It is to be expected that vocoders will be incorporated in electronic organs in the not-too-distant future. In a few years time, most organs should have a 'vocoder' button — offering one of the most intriguing and creatively-inspiring effects of our time at the touch of a finger!

What of the near future? Next month? That, at least, can be foreseen with great certainty: for the first time, as far as we know, a vocoder designed specifically with the constructor in mind. Build your own vocoder! ■

Lit.:

- Elektron, April and May 1978: Vocoders.*
- Elektron, January 1978: Elektor Equaliser.*

electronic nuisance

an infuriating little circuit

W. Verbiest

Have you ever been kept awake by a cricket? You switch off the light and snuggle down, and just as you're drifting off to sleep the insect starts to make an irritating noise. As soon as you switch on the light to look for it, it stops again. Tracking down this type of noisy nocturnal nuisance can be infuriatingly time-consuming. The same result can be obtained electronically. What's the point? Well, just for the fun of it.

Practical jokers will want to hide the circuit in such a way that it will take some time to find it. For this reason, it must be small; furthermore, it will have to be battery-powered — a mains cable would be a dead give-away. The circuit described here fulfils both requirements: it fits on a small p.c. board and is powered by a small 9 V battery.

The light sensor is an LDR. In the dark, its resistance is quite high; preset potentiometer P1 is adjusted so that the inputs of the CMOS gate N1 are just at logic zero under these conditions. The calibration procedure will be described later.

The two CMOS gates, N1 and N2, are connected as a 'trigger' circuit. When the voltage at the inputs of N1 falls below the trigger threshold, the output of N2 switches to logic zero. Transistor T1 is turned off, and C1 can now charge up through R5.

The voltage across C1 rises so slowly that it takes a few minutes for it to reach the upper trigger threshold of the second trigger circuit, N3 and N4. At that point, the output of N4 swings up to logic one — i.e. practically the full supply voltage. This takes the reset input of the 555 timer (IC2) high, enabling this IC. The 555 is used in an oscillator circuit, driving a loudspeaker, so that an irritating tone is produced.

When the victim turns on the light to hunt for the source of the noise, the resistance of the LDR decreases sharply. The trigger circuit (N1/N2) changes state, turning on T1. C1 discharges rapidly through R4, the output of the second trigger circuit goes 'low' and the oscillator is turned off.

When the light is switched off again, the circuit again waits a few minutes before making a noise. Very infuriating . . .

Calibration

Preset potentiometer P1 must be adjusted so that the inputs of N1 are at logic zero when the circuit is in the dark. The easiest way to do this is to connect a voltmeter to the output of N2. First, P1 is adjusted so that this output swings up to nearly full supply

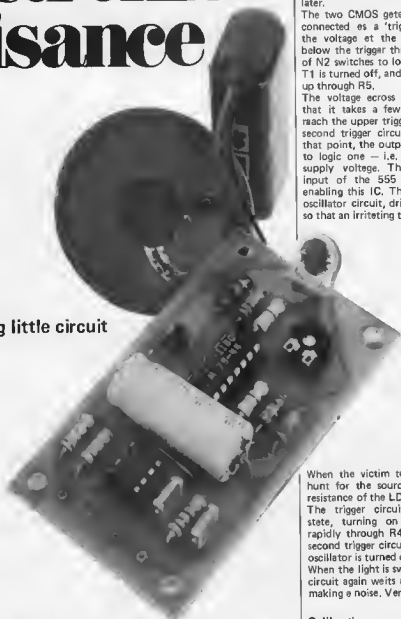

1

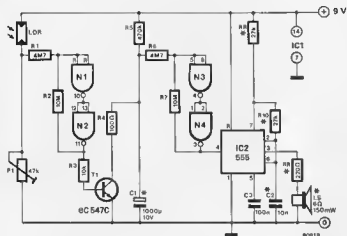

N1 ... N4 = IC1 = 4011

* see text

voltage; then P1 is turned back until the output switches to the 'low' level (practically 0 V) – with the LDR in the dark, of course. This completes the calibration.

The time delay, from the moment the light is turned off to the first squeak from the oscillator, can be modified according to personal taste by altering the value of C1. In the same way, a different frequency can be obtained by selecting a different value for C2. The ratio of resistor R9 to R10 determines the type of sound obtained.

Finally, the sound level depends on R8. Note, however, that this resistor should not be less than 100 Ω. Any loudspeaker impedance from 4 Ω up can be used; the higher the impedance, the louder the output.

Figure 1. Not much is needed for an electronic nuisance. The LDR turns the circuit on in the dark.

2

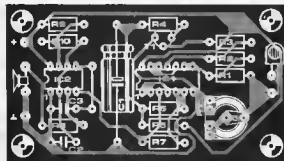
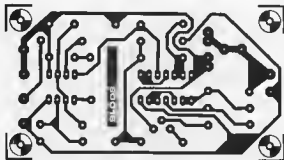

Parts list

Resistors:

R1, R6 = 4M7
 R2, R7 = 10 M
 R3 = 10 k
 R4 = 100 Ω
 R5 = 470 k
 R8* = 220 Ω
 R9*, R10* = 27 k
 P1 = 47 k preset potentiometer
 LDR

Capacitors:

C1* = 1000 µF/10 V
 C2* = 10 n
 C3 = 100 n

Semiconductors:

T1 = BC 107B, BC 547C or equ.
 IC1 = 4011
 IC2 = 555

* see text

Figure 2. All the components for the nocturnal nuisance fit on this p.c. board.

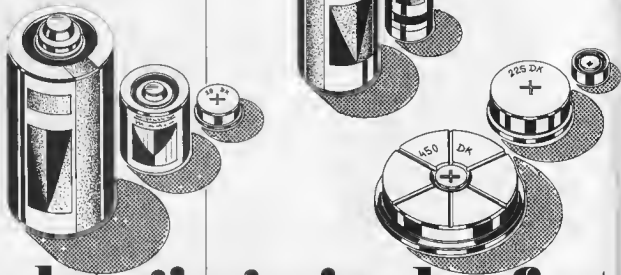

charging nicads - fast

more haste? more speed!

Nicad cells have the advantage that they can be recharged, so that they don't have to be replaced as often as normal dry batteries. The only disadvantage is that charging takes time, and this can be a nuisance when you want to recharge them almost immediately. Rapid charging is the solution, but it must be done properly.

Rapid charging (within one hour) of nicads is a popular theme. You regularly see circuits for charging these cells with a constant voltage. This is a very poor solution, since the total charge is completely unknown in this case (although this system can be used to charge open cells).

All problems associated with charging nicads are aggravated when you start rapid charging. On the one hand, you want to be sure that the cells are fully charged when the charging cycle is terminated; on the other hand you know that the cell will only tolerate a limited amount of over-charging. If they are charged beyond the safe limit, gas pressure builds up very rapidly inside the cell. A safety valve may open, if there is one; otherwise the cell is likely to explode. Even when a safety valve is provided, this cannot do more than limit the damage: the capacity of the nicad cell (in mAh) is reduced — permanently.

Until recently, the only safe way to charge nicad cells rapidly was to first

discharge them completely, and then charge them with a known current for the correct length of time. In this way, there is no danger of overcharging a semi-charged cell, with all the associated risks.

Figure 1 gives the basic relationship between cell voltage, temperature and pressure, as the cell is charged from zero to 100% — and above. Initially, voltage, temperature and pressure all increase slowly. As the cell nears the full-charge limit, the voltage starts to rise more rapidly. At the same time, more and more of the energy being pumped into the cell goes into the production of gas (oxygen) instead of being stored as chemical energy in the electrodes. This causes the pressure to increase; as a result, some of the oxygen is reconverted at the negative electrode — producing heat. As the temperature increases, the cell voltage drops: nicads have a negative temperature coefficient, approximately $-4 \text{ mV}/^\circ\text{C}$. It is this effect that causes the hump in the voltage plot: initially the voltage rises, but when the cell is

fully charged it begins to fall again. This principle is valid for all nicad cells. The actual values given in figure 1 are only intended as a general indication, of course; they depend on the construction of the cell, and so different values will be obtained for different types. Manufacturers always specify whether their cells are suitable for rapid charging, what maximum current may be used and how much over-charging is permissible.

To avoid explosions, or opening of the safety valve, the safe limits specified by the manufacturer must not be exceeded. The charging cycle must therefore be stopped in time. One or more of the three parameters given in figure 1 may be used to determine the end of this cycle. Measuring the pressure build-up inside the cell is not very practical, so we may as well forget it. Measuring the temperature is possible, but rather clumsy. Which leaves us with the cell voltage.

Back to square one? No, not quite. Because of the effect of the temperature, it is *not* possible to use a certain, fixed voltage level to determine the cut-off point. However, the shape of the plot is generally valid — and it has the makings of a reliable indication.

The circuit given in figure 2 reacts to the rate at which the cell voltage rises. From figure 1, it is apparent that the voltage starts to rise rapidly as the fully-charged limit is reached. When the slope becomes sufficiently steep an LED lights. Alternatively, a relay can be used to disconnect the cell at this point.

The circuit itself is quite cunning. An oscillator (A4) gives one short pulse every 10 seconds or so, closing the (electronic) switches S1 and S2. When these switches are closed, A1 operates as a voltage follower (and C2 is discharged), so that C1 is charged to the input voltage at pin 3 of A1. The input offset voltages of A1 and A2 are automatically compensated for by the circuit, so that the output voltages of A1 and A2 will be identical at this stage. At the end of the pulse from A4, the two switches open, A1 now becomes an integrator, and C1 is disconnected from its input. At this point, the output voltages of A1 and A2 are still identical. If the input voltage (derived from the voltage across the nicad cell) rises, however, this voltage increase will be integrated by A1. The faster the voltage rises, the higher the output voltage of A1 will be. If the voltage difference between the outputs of A1 and A2 becomes greater than the trigger threshold of A3, its output will swing high and LED D3 will light.

The trigger threshold of A3 depends on the value of R14 and on the initial output voltage of A1 and A2. A higher initial voltage (corresponding to a larger number of nicad cells in series) will lead to a higher threshold. This means that it is the *relative* rate at which the voltage increases that determines the cut-off

1

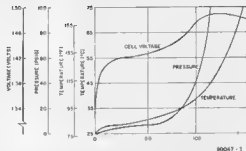
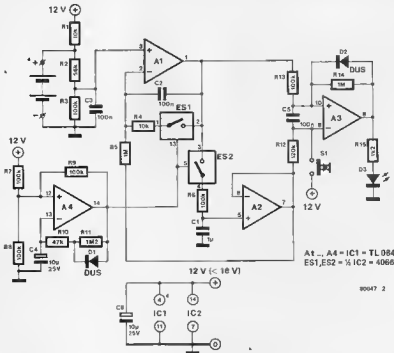

Figure 1. Voltage, pressure and temperature variations in a nicad cell, during a rapid-charging cycle.

2



At ... A4 = IC1 = TL084
ES1, ES2 = 1/2 IC2 = 4066

80047 2

Figure 2. This rapid-charge cut-out circuit reacts to the more rapid increase in cell voltage as the 100% charged point is reached.

point — the shape of the plot in figure 1, in other words. The circuit can therefore be used, without any readjustment or switching, for anything between 4 and 12 cells — provided a suitable supply voltage is chosen (between 12 V and 18 V; the voltage divider R2/R3 is included so that the supply voltage can be equal to the voltage across the nicads, provided it remains within the range mentioned).

This circuit has been tested extensively, and it works perfectly as long as all the nicad cells being charged at the same time are initially discharged by about the same amount. This will normally be the case if they are all used together to





3

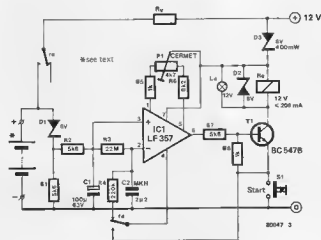
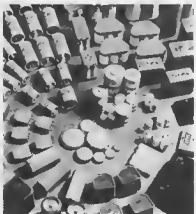

Figure 3. An industrial rapid-charge circuit that reacts to the falling cell voltage when the cell is fully charged (see figure 1).



power one model, for instance. However, we have not done comparative life tests to determine the effect of this type of rapid charging on the nicad cells.

It seems fairly safe, however, because the industry is quite prepared to go a step further! A well-known German manufacturer supplies the unit given in figure 3, for about £20. In this case a reliable, low-drift opamp is used to sense the rate of change of the input voltage. As long as this voltage is rising, the voltage at the inverting input will lag behind — remaining slightly lower — because C2 has to charge through a high resistance (R3). The output voltage of IC1 will be high, and the relay is pulled in.

Once past the highest point on the cell voltage curve (see figure 1), the input voltage starts to drop again. The voltage at the inverting input will still lag behind, but now the result is that it will be higher than that at the non-inverting input. The output of the opamp swings negative and the relay drops out.

It is apparent from figure 1 that this circuit will cut out a good deal later in the charging cycle than the circuit given in figure 2. The advantage is that the cut-off point is more reliable; furthermore, the cells will be more fully charged. On average, a cell must be charged to 120% if it is to reach 100% capacity; charging to 100% gives only 80% capacity. Strange, but true.

Going back to figure 3: preset P1 is adjusted so that the opamp output swings low when the voltage at the inverting input is 4 or 5 mV higher than that at pin 3. When the relay drops out, one of its contacts opens the connection from the emitter of the transistor (so that the relay cannot pull in again) and discharges C2, ready for charging a new set of cells. The other contact disconnects the cells from the supply. For both circuits, the same restrictions apply:

- All cells should have approximately the same capacity (this will always be the case if they are supplied as one complete unit).
- The cells must be suitable for rapid charging — see the manufacturers recommendations.
- The temperature of the cells must be approximately equal to ambient temperature before starting to charge them. 'Hot' cells would cool down initially, the cell voltage would change and the cut-off point might be incorrect.
- The cells should all be discharged by approximately the same amount. If they have been lying unused for some time, they will all have 'self-discharged' to some extent. The discharge level may vary quite considerably from one cell to another under these conditions. When charging, they will not all reach their full-charge level at the same time. The cells that were originally 'fuller' may be damaged by rapid charging in this case. A similar situation may occur after repeated rapid-charging. Since the capacity of the cells can never be identical, some of them will gradually become less fully-charged than others after several charge-discharge cycles. For this reason, it is advisable to charge in the normal way first (7 hours at a current equal to 20...30% of the capacity of the cells). The next time the cells must be charged, rapid charging will be permissible; after about five 'rapid charges', it is time for another 'normal charge' cycle.
- For rapid charging, the current should be equal to twice the cell capacity. At lower currents, the shape of the voltage curve will not be sufficiently pronounced.

toppreamp

integrated preamp for the topamp

No run-of-the-mill-preamp, this. Only truly useful controls are included, making for a small and easy-to-operate 'dashboard'. The size of a Mini and the performance of a Jaguar. And for a reasonable outlay, at that. A perfect front-end for the topamp power amplifier published last month.

'Small is beautiful' is the modern slogan, especially where electronic equipment is concerned. One advert shows a baby sitting on a complete 'hi-fi rack', in a familiar position. Although the symbolism is probably unintentional, it illustrates the size of the equipment. Then there are midjet TV sets, with a screen about the same size as the same baby's hand. Apparently, somebody has decided that all that empty space inside a cabinet serves no useful purpose. Not only 'small' is beautiful: simplicity is another key word. In audio equipment, for instance, the number of controls (and in- and outputs, for that matter) is being reduced to the essential minimum. There are even amplifiers without tone controls on the market. For the same price, believe it or not.

Pruning

Reducing the number of knobs, switches, inputs and outputs makes a preamp less expensive; at the same time, a smaller p.c. board and cabinet will suffice — making for a further price reduction. Some of this profit can be re-invested, as in the design described here, by using better components to obtain better performance — special low-noise opamps, for instance.

The first question, obviously, is: what can we do without, what is essential, and what is maybe-yes-maybe-no? What do you really need in a preamp?

- output to power amplifier? Yes, obviously.
- output to tape recorder? Yes, if you've got one; no, if not. Conclusion: the option must be available.
- input from tape recorder? Again, yes or no. Optional; with a 'monitor' switch, if it is included.
- inputs from other signal sources? Yes, obviously. But which ones? Dynamic pickup? Yes. Tuner? Yes, that too. Microphone? 'Auxiliary'? Nine times out of ten they remain unused, so let's be democratic and leave them

Table

Specifications

- input sensitivity (for 500 mV output into a 10 k load):

dynamic pickup:	2.6 mV (50 k Ω , 1 kHz)
tuner:	130 mV (\geq 50 k Ω)
tape:	130 mV (\geq 50 k Ω)
- output impedance: < 1k Ω
- tone control: \pm 10 dB at 50 Hz (bass)
 \pm 10 dB at 10 kHz (treble)
- balance control: +3.3 dB, \rightarrow dB (10 k load)
+2.3 dB, \rightarrow dB (no load)
- signal-to-noise ratio (referred to 500 mV RMS):

dynamic pickup:	65 dB (1 k Ω in series with 100 mH across the input)
tuner:	75 dB
- maximum input voltage, dynamic pickup input, at 1 kHz: approximately 200 mV RMS
- frequency response (tone controls 'flat'): 15 Hz . . . 100 kHz \pm 0 dB
- crosstalk (20 Hz . . . 20 kHz): < -60 dB
- gain (balance control in mid position, output load 10 k):

from dynamic input to tape output:	34 dB (x50)
from dynamic input to preamp output:	45.5 dB (x188)



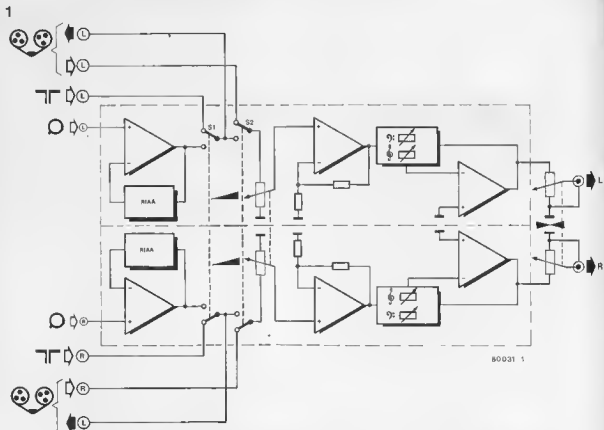

Figure 1. The pruning operation described in the text is evident in the block diagram. However, reducing controls and 'features' to a minimum doesn't mean that the performance must suffer. Quite to the contrary, in fact.

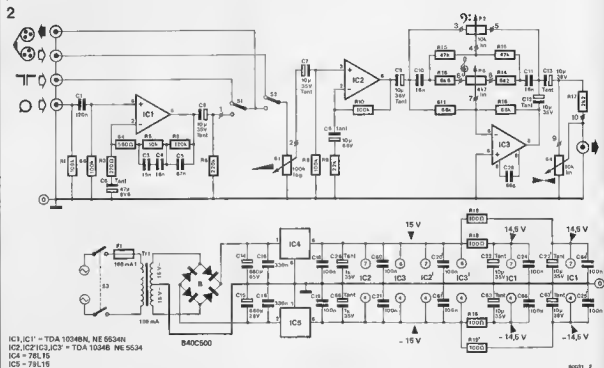

Figure 2. Complete circuit for one channel of the toppreamp, with the complete power supply.

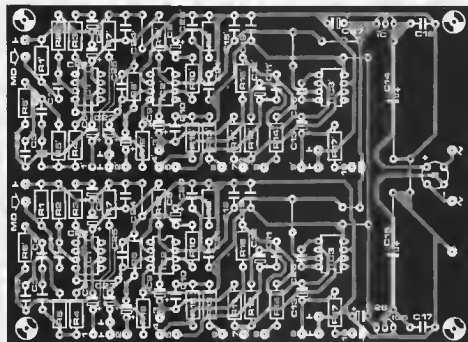
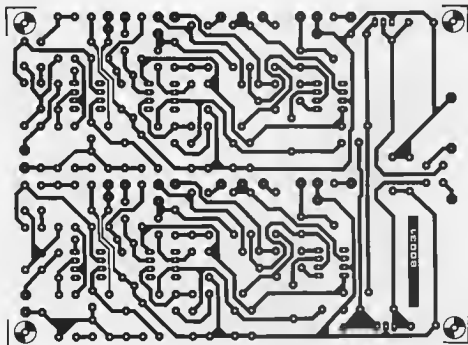

Figure 3. Two channels and the stabilised power supply are mounted on this p.c. board.

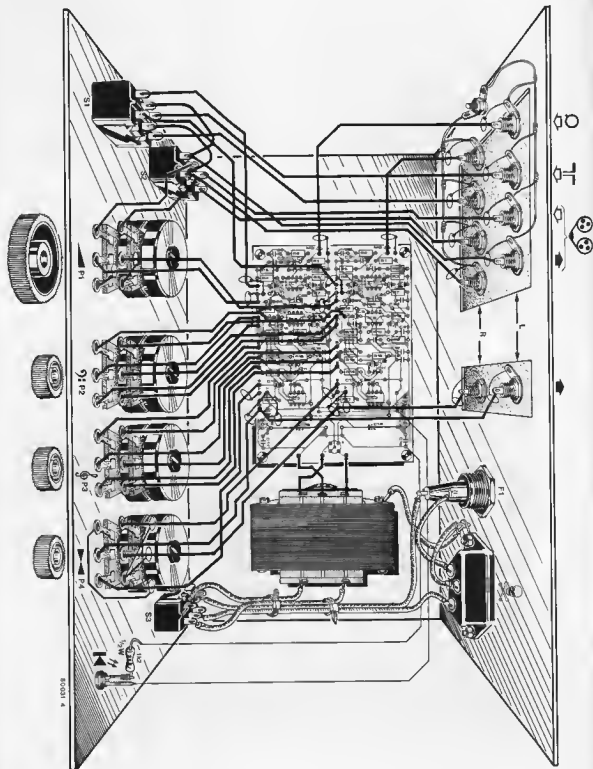

Figure 4. Wiring diagram.

Parts list

Resistors:

R1, R1', R2, R2', R8, R8', R10, R10' = 100 k
 R3, R3' = 270 Ω
 R4, R4' = 560 Ω
 R5, R5' = 10 k
 R6, R6' = 120 k
 R7, R7' = 220 k
 R9, R9' = 22 k
 R11, R11', R12, R12' = 82 k
 R13, R13', R14, R14', R17, R17' = 2k2
 R15, R15', R16, R16' = 47 k
 R18, R18', R19, R19' = 100 Ω
 P1 + P1' = 100 k log. stereo
 P2 + P2', P4 + P4' = 10 k lin. stereo
 P3 + P3' = 4k7 (5 k lin. stereo)

Capacitors:

C1, C1' = 120 n
 C2, C2' = 47 μ /5V3 tantalum
 C3, C3', C4, C4', C10, C10', C11, C11' = 15 n
 C5, C5' = 27 n
 C6, C6', C7, C7', C8, C8', C9, C9', C12, C12', C13, C13', C22, C22', C23, C23' = 10 μ /35 V tantalum
 C14, C15 = 220 μ /25 V
 C16, C17 = 330 n
 C18, C19, C20, C20', C21, C21', C24, C24', C25, C25' = 100 n
 C26, C26' = 22 p
 C27, C28 = 1 μ /35 V tantalum

Semiconductors:

IC1, IC1' = TDA1034BN, NE5534N (Philips/Signetics)
 IC2, IC2', IC3, IC3' = TDA1034B, NE5534 (Philips/Signetics)
 IC4 = MC78L15CP (10%) or MC78L15ACP (5%) (Motorola) or equ.
 IC5 = MC79L15CP (10%) or MC79L15ACP (5%) (Motorola) or equ.
 B1 = B40C500

Miscellaneous:

S1 + S1', S2 + S2' = two-pole two-way switch
 S3 = two-pole mains switch
 Tr1 = 2 x 15 V 100 mA transformer
 F1 = fuse, 100 mA slo-blo

5a,b

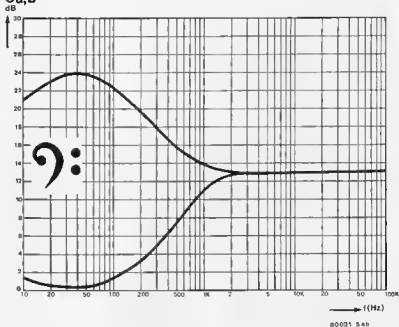

5c,d

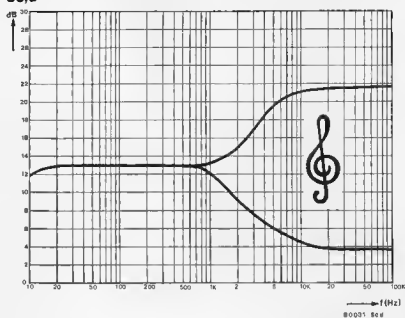

out. Moving coil input? Better not. It raises the price for the majority who don't want it, and the minority who do can add a separate preamp. Democracy again.

- volume control? Yes, carried by majority vote.
- physiological volume control? Oh no, please! An awkward potentiometer with tap, a handful of R's and C's, a sidelong glance at the Fletcher-Munson curves (if you know where to find them) and the result is... a mess. Those curves relate to actual sound pressure, and that in turn depends on the '0 dB level', the loudspeakers and

the living room. No, the only way to do the job properly is to provide suitable bass and treble controls. Which answers the next question:

- tone controls? Yes, we'd better have them. Bass and treble both. Not the vicious kind of course, but say ± 10 dB with well-chosen turn-over frequencies. And with a nice and smooth control characteristic, not the kind that does nothing for a while and then suddenly gives maximum cut or boost like a switch. A 'cancel' switch might be useful, but a 'flat' centre position is just as good.
- rumble and scratch filters? If so,

with a switch? Yes, not really and no, in that order. A fixed rumble filter is essential, but at a fixed, low frequency and as sharp as possible. The idea is to protect the loudspeakers (and the amplifier, for that matter) from high-level subsonic signals. Scratch filters are another matter. They're useless unless they operate within the audio band, so leaving them permanently in circuit is out of the question. On the other hand, signal sources are improving so rapidly that a scratch filter is likely to be left permanently out of circuit if a switch is provided. This being the case, it is simpler and cheaper to leave them out

5e

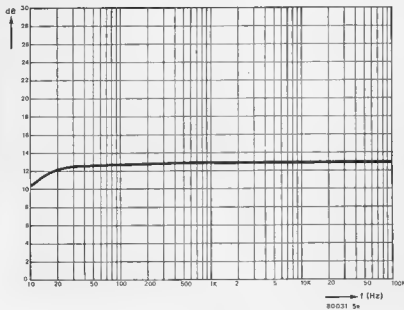

Figure 5. Tone control characteristics.

6

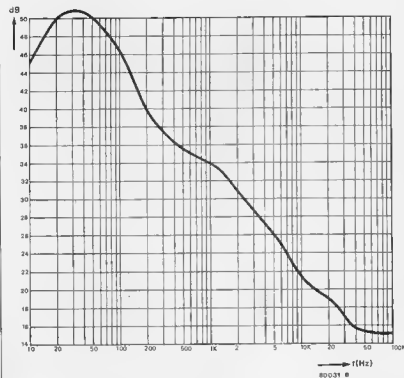

Figure 6. The frequency response of the dynamic pickup preamplifier (RIAA/IEC equalisation).

of the circuit entirely.

- balance control? Yes, unfortunately.

More often than not, the mid-position of the balance control is not the best setting — even though it should be, in the ideal case. An effective balance control is desirable; it is useful if it can suppress one channel completely. If nothing else, this can be useful for test purposes.

- mono/stereo switch? The only real use for this is to reduce the hiss when listening to a weak VHF-FM stereo transmission. For this reason it belongs in the tuner (and often is built in). No need for two of them, so: omit.

- other gimmicks? No, we're only looking for essential controls.

Clean lines and attractive performance

After this pruning operation, we are left with only those features that are necessary and sufficient. A preamp designed according to this principle will do exactly what it is meant to do: help to give listening enjoyment without leading to knob-blindness.

The block diagram of the toppreamp is given in figure 1. The input selector switch, S1, has only two positions: tuner or MD preamp. The selected signal is passed to the tape output and to the monitor switch, S2. This is followed by the volume control, and an amplifier stage that boosts the signal level to that required to drive most power amplifiers (500 ... 1000 mV). The following tone control stage has a 'flat' gain of 0 dB — times one, in other words.

The last link in the chain is the balance control.

From block diagram to design

The circuit diagram is given in figure 2. One channel is shown, with the complete supply circuit. Since the circuit is simplicity itself, only a fairly brief discussion should suffice.

The preamp for dynamic pickups consists of one opamp (IC1) and a handful of passive components. The only peculiarity in this circuit is R4: this flattens out the frequency response above approximately 35 kHz (instead of carrying on down ad infinitum, as specified by the RIAA equalisation curve). Frequency compensation for IC1 is now unnecessary, so that better dynamic performance of the opamp (slew rate) can be achieved.

The main amplifier stage (IC2) is a standard circuit. With the values given for R9 and R10, the gain is set at x5. The tone control stage (IC3 with its surroundings) is rather less conventional. Two capacitors, C10 and C11, determine the turn-over frequency for both bass and treble controls. A more common circuit would use four capacitors. The electrolytics C9 and C12 keep DC voltages well away from the potentiometers P2 and P3. By now this pre-

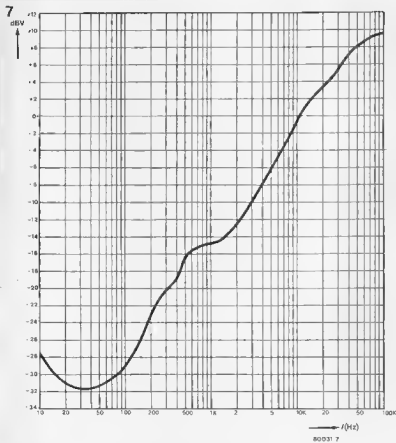

Figure 7. The maximum input voltage for the dynamic pickup preamp, in mV RMS, as a function of frequency.

The opamps: worth a closer look

The NE1034 (TDA1034) is a bipolar opamp — in other words it contains NPN and PNP transistors, just like its predecessors (741, TBA221, LM301, LM307 and so on). Another feature in common with many of its brethren is the pinning: identical to the 741. But that is where the similarity ends.

The inner life of the IC is shown in the accompanying diagram. There is no point in going into all the details, but three points in this studio-audio-opamp deserve some attention. The output stage is capable of handling up to 10 V RMS, with a power bandwidth of 70 kHz and without crossover nastiness, into a 600 Ω load. Furthermore, the input stage is designed for very low noise: the equivalent input noise is 7 nV/Hz at 30 Hz and 4 nV/Hz at 1 kHz. There is even an extremely low-noise N version, specified at 5.5 and 3.5 nV/Hz, respectively, its noise figure is only 0.9 dB (at 20 kHz bandwidth and a 5 k Ω source resistance).

The unity gain bandwidth is approximately 20 MHz; with frequency compensation (22 pF between pins 5 and 6) it is still a quite respectable 10 MHz. A cunning arrangement of four capacitors (C1...C4) provides high bandwidth and high slew rate (13 V/ μ s, uncompensated, 6 V/ μ s with compensation).

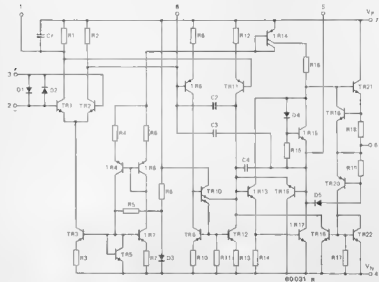

Frequency compensation is needed for closed-loop gains of less than three. Finally, some other important specs: open-loop gain: $\times 100,000$
open-loop bandwidth: approximately 1200 Hz (uncompensated)

caution, fortunately, is fairly common: without it, the controls invariably become very noisy.

Finally, the balance control. A linear potentiometer is used. The mid-position must give equal gain for both channels, but it's a pity to throw away 6 dB of gain in both channels. The solution is to add R17: with an open output, only 2.3 dB is lost in the mid-position; loaded by a 10 k input impedance (that of the topamp, say) the loss is still only 3.3 dB. As an additional bonus, adding R17 provides a more 'comfortable' control characteristic — see 'Tailoring potentiometers', elsewhere in this issue.

The supply must be stabilised and adequately smoothed. IC4, IC5, and lots of capacitors take care of these requirements.

Construction

Two hundred and ninety-three holes in 137% square centimeters of copper-laminate board provide space for all the components requirement for a stereo version. The result is given in figure 3; components marked with an accent are for the right-hand channel. The potentiometers and switches are not mounted on the board. This keeps the size (and price) down and gives more flexibility in the construction. A complete wiring diagram is given in figure 4. Although "cinch" plugs are shown for in- and outputs, other types can obviously be used as required.

approximately 600 Hz (compensated)
By way of comparison: for a 741, this is less than 10 Hz!
supply voltage range: $\pm 3 V \dots \pm 20 V$
common-mode rejection: 100 dB
current consumption: typical: 4.2 mA
maximum: 7 mA

steam train

letting off steam - electronically, of course!

Electronics can be used to simulate the most amazing range of different things. Cybernetic models, sound effect generators, electronic noses — you name it, it's been tried! Some things, obviously, are more difficult than others; the sound of a steam engine is certainly easier to imitate than the taste of certain types of coffee. However, it can be a problem to fit a realistic sound effects generator inside a model engine. It's possible, though, using miniature components and a little p.c. board.

This design is intended for use in HO models. These are big enough to provide adequate room for the electronics — either in the boiler or in the tender. In smaller models, the same design may fit... but not on the p.c. board given here! The circuit can be used on both AC and DC systems.

What, exactly, does this steam train simulator do? First off, it imitates the bursts of escaping steam from the cylinders. To be even half-way realistic, this must obviously be related to the speed: the faster the engine goes, the faster the steam bursts must come. The different sound going up or down a gradient would be a neat extra, but the electronics required took up too much room... Then, of course, there's the steam whistle. That is included.

The circuit is powered by a battery or nicad cell, so that the engine will still make suitable noises at low speeds or even when stationary.

The block diagram

As you would expect, the steam sound is derived from a noise generator (see figure 1). No problem for an electronic system. (It's usually more of a problem to get rid of it!) The desired rhythm is obtained by means of a modulator driven by a VCO (Voltage Controlled Oscillator). This VCO produces a low frequency signal that varies with the engine speed; its control voltage is derived from the supply to the motor.

The steam whistle sound is also derived from the noise signal. In this case the noise is fed to a low-frequency oscillator (LFO), producing the characteristically 'hoarse' steam whistle sound. A power amplifier (A) boosts the outputs from the modulator and the LFO, to drive the loudspeaker.

The steam whistle is turned on by a switch. This can be done by hand, of course, but that's not so realistic. A better system is to mount a micro-switch under the engine, and add 'humps' between the rails to operate it at suitable points.

The circuit

At first sight, the circuit given in figure 2 may be a bit frightening. It may seem

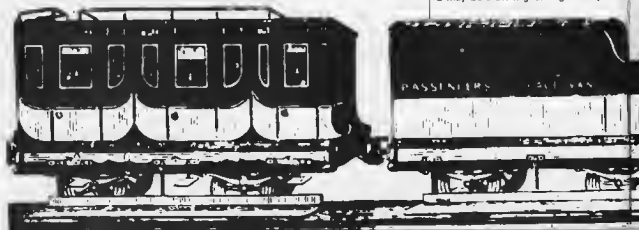

incredible, but it all fits on the p.c. board shown in figure 3! However, let's forget the construction for the moment, and take a closer look at the circuit.

The original noise source is a zener diode, D1. Its output is amplified by T1 and opamp A1. The next step is to modulate the noise signal, producing the 'bursts of steam'. This is done by A2; the control signal for this modulator is derived from a low-frequency VCO (A3). Potentiometer P1 sets the modulation depth. P2 determines the DC bias for A2; this varies the noise level and 'sound'. With the train station, P2 is adjusted for the desired 'parking hiss'.

1

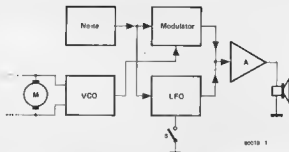

00010 1

Figure 1. Block diagram of the steam train sound generator. A noise generator provides the steam sound and adds the characteristically 'hoarse' sound to the steam whistle.

2

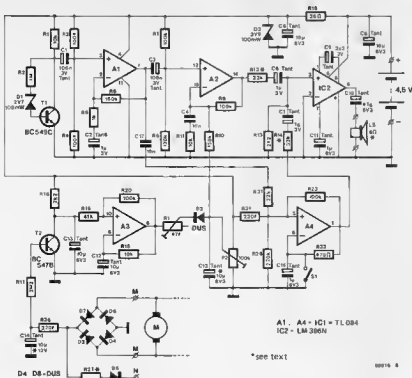

00010 2

Figure 2. It may seem incredible, but this complete circuit fits on the p.c. board given in figure 3.

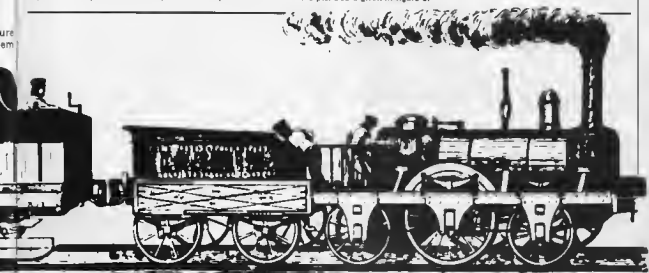

When the engine starts to move, there must obviously be a drive voltage (AC or DC) across the motor, M. This voltage is rectified by D4...D7, turning on T2. The VCO (A3) starts to oscillate, modulating the noise signal. Including diode D3 has several interesting effects: the voltage across C15 is pulled down more rapidly than it can rise, so that a sound more like sudden bursts of steam is obtained; as the speed increases, the average DC voltages across C15 will tend to increase, so the noise level goes up; finally, when the engine stops the voltage across C15 rises slowly to the final 'parking' level.

As the engine speeds up, the voltage across the motor rises. This increases the frequency of the VCO, so that bursts of steam occur more rapidly. There is, of course, a slight delay: if the voltage across the motor increases suddenly, it takes a while for the engine to pick up speed. A similar delay is therefore incorporated in the control circuit: C14. If necessary, the value of this capacitor can be modified until the rate of the bursts of steam corresponds sufficiently accurately to the actual speed of the engine even when it speeds up or slows down. A fixed 'calibration' of this type is only an approximation, obviously; coupling more or less coaches to the engine will upset the synchronisation slightly. In practice, however, this effect was hardly noticeable.

The steam whistle sound is produced by A4. Basically, this is a low-frequency oscillator. Some noise signal is added, via C17, to produce the characteristic sound. The whistle is turned on and off by switch S1. As mentioned earlier, it's a good idea to use a micro-switch underneath the engine, operated by raised humps between the tracks.

The 'steam' and 'whistle' signals are both fed to IC2: the output amplifier (you can hardly call it a 'power' amplifier...). The levels of the two signals can be modified by altering the values of R12 and/or R14.

Construction

The p.c. board end component layout

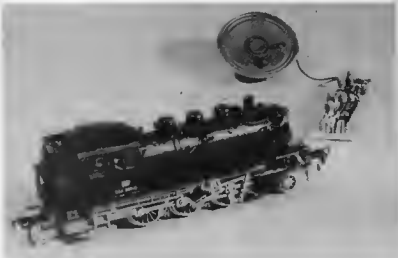

are given in figure 3. To keep the size down, the (1/8 watt) resistors and the diodes are mounted vertically. For the same reason, tantalum electrolytics are used — they're much smaller than the normal type.

On the component layout, there was only room for the resistor and capacitor numbers (without the R or C). Be warned: don't mix them up!

It may be a problem to obtain a suitable loudspeaker, small enough to fit inside the engine or tender. If it's any help, any impedance between 4 Ω and 16 Ω is permissible.

Finally, the supply. Three 1.5 V batteries in series will do the job, but nicad accumulators are a more practical proposition. They can be charged from the main motor supply, when the engine is running. A suitable connection is provided ('N' on the p.c. board, and in figure 2, for that matter); this is connected to the '+' of the nicad cells. Don't forget the positive supply connection ('+' to the rest of the circuit, in this case! 'N' is not connected to '+' on the board. The value of resistor R27 depends on the maximum motor voltage and the capacity of the nicad cells: the maximum charging current, in mA, must be limited to one-tenth of the

capacity of one cell in mAh. In other words, the maximum charging current for a 500 mAh cell is 50 mA; this limit is set by the value of R27 and the voltage difference between the maximum motor voltage and the total cell voltage (4.5 V).

If normal dry batteries are used, R27 and D8 can be omitted.

Note that connection N and the connection to switch S1 are both on the copper side of the p.c. board. **M**

Parts list

Resistors:

R1, R11, R16 = 10 k
R2 = 1 M
R3, R4, R6, R7, R8, R9, R20, R23 = 100 k
R8 = 120 k
R5 = 1 k
R10 = 150 k
R12, R14 = 33 k
R13, R18 = 2k2
R15 = 39 Ω
R17 = 2M2
R19 = 47 k
R21 = 22 k
R22 = 470 Ω
R24, R25, R26 = 220 k
R27 = see text
P1 = 47 k preset
P2 = 100 k preset

Capacitors:

C1, C3 = 0.1 μ /3 V tantalum
C2, C6, C7, C8 = 1 μ /3 V tantalum
C4, C17 = 10 n
C5, C12, C13, C15 = 10 μ /6.3 V tantalum
C9 = 2 μ /3 V tantalum
C10 = 47 μ /6.3 V tantalum
C11, C16 = 1 μ /6.3 V tantalum
C14 = 10 μ /12 V tantalum

Semiconductors:

T1 = BC 549C, BC 109C or equ.
T2 = BC 547B, BC 107B or equ.
IC1 = TL084
IC2 = LM386N
D1 = 2V7/100 mW zener diode
D2 = 3V9/100 mW zener diode
D3...D8 = DUS

3

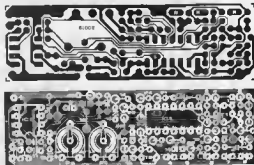

Figure 3. Printed circuit board and component layout for the generator. The resistors and diodes are mounted vertically, and connection points 'N' and 'S1' are both on the copper side of the board, for reasons of space. Note that only resistor and capacitor numbers are given, without 'R' or 'C'.

1979 cumulative index

Audio

assistantor	4-20
audio analyser	9-38
audio sectioner	8-03
chorosynth	8-07
class tells	1-22
crosstalk canceller	3-04
current dumping amplifier	7-37
digitally-controlled phaser	7-67
d.j. killer	7-51
improved DNL	7-08
monitor output	9-17
noise level meter	7-71
octave shifter for electronic guitars	7-10
opto-receiver for speech	7-40
opto-transmitter for speech	7-40
parametric equaliser	9-26
programmable sequencer	10-38
sequencer	7-80
sound effects with analog reverb	12-30
sound processor	7-42
stentor	4-14
talk funny	12-27
topamp	11-10
toppreamp	12-13
ultrasonic receiver for headphones	7-57
ultrasonic transmitter for headphones	7-54
using an equaliser	9-04
vocoders today	12-02
256-note sequencer	7-96

Car and bicycle

automatic battery charger	7-50
automatic battery charger	7-72
automatic windscreen clearer	7-70
battery monitor	7-48
bicycle speedometer	7-69
car anti-theft protection	7-23
car collision alarm	7-89
car light reminder	4-13
digital milometer	7-91
digital rev counter	10-15
dwell meter	7-30
fuel economiser	11-22
heated rear windscreen	7-22
motorcycle emergency lighting	7-31
varispeed windscreen wiper delay	7-78

Design ideas

capacitance and inductance meter	7-68
emergency break	7-74
FM stereo noise reduction	7-14
metal detector	7-77
news detector	7-15
non-stop Newton's cradle	7-77
sawtooths up or down an octave	7-62
TV programme multiplexer	7-34

Domestic and hobby

aquarium thermostat	6-28
barometer	7-34
clap switch	2-27
digital contrast meter	7-43
doorbell drone	7-39
electronic weathercock	7-35
elekdoorbell	6-12
fermentation rate indicator	7-95
flash sequencer	11-14
flexible intercom system	7-94
IR lock	7-79
liquid level sensor	7-10
moisture sensor	7-20
monoselector	6-32
musical doorbell	5-47
photo-flash delay	7-38
pools predictor	2-06
programmable timer/controller	5-08
random tune doorbell	5-17
slave flash	7-38
sun lamp timer	7-11
tape-slide synchroniser	7-92
thermometer	7-62
UFO detector	7-36

Fun, games and model building

bio-control	7-33
building the TV games computer	4-26
digital wooing aid	7-17
electronic horse	8-03
electronic nuisance	12-08
electronic poker dice	7-66
emergency flight controller	7-44
flashing badge	7-47
I see your point	11-39

miniature traffic lights	7-04
model railway block controller	7-04
pachisi	7-06
quiz master	4-24
remote control motor switch	11-18
robot with reflexes	7-88
servo controlled motor	11-40
simple sound effects	5-32
speed controller for model railways	7-84
steam train	12-20

Generators

AC millivoltmeter and signal squirt	1-16
aircraft sound effects generator	7-90
electronic horse	8-03
FM stereo generator	1-26
frequency synthesiser	7-28
IHF toneburst generator	1-06
programmable function generator	7-75
programmable melody generator	8-04
simple sound effects	5-32
sinewave generator	3-21
sinewave oscillator	7-22
spot sinewave generator	2-20
sweep generator	5-28
variable pulse generator	3-18
video pattern generator	8-00

HF

FM IF strip	6-22
FM PLL using CA 3089	7-45
FM stereo generator	1-26
shortwave converter	11-34
stereo decoder	6-16
touch tuning	10-06
voice operated control switch	12-40

Informative articles

applikator, heavy stuff: audio at 200 Watts	9-34
applikator, programmable sound generator	1-32
applikator, universal counter, type ICM 7216	3-24
class tells	1-22
computers end chess	1-34
crosstalk canceller	3-04
delay lines	2-11
delay lines (2)	5-18
ejektor, electronically variable resistance	1-25
ejektor, self oscillating PWM amplifier	9-46
ejektor, squelch for FM radio receivers	2-30
electronics the easiest way	11-18
goodbye E300/E310, hello J300/J310	6-27
how I beat the monster	1-40
ionosphere	11-34
I played TV games	10-28
I played TV games (2)	11-24
measuring by the book	1-02
missing link in audio systems	2-39
niceds	8-04
one-bit for audio	9-22
optical memory disc	2-03
switching mains powered equipment	5-13
tailoring potentiometers	12-36
using an equaliser	9-04
using Elbug	2-32
VHF stereo test transmissions	6-20

Microprocessors

BASIC microcomputer	5-34
building the TV games computer	4-26
capitals from the ASCII keyboard	5-24
D/A for μ Ps	2-10
FSK modem	7-30
interface for μ Ps	5-25
I played TV games	10-28
I played TV games (2)	11-24
new programs for the SC/MP	10-12
N18L-E	5-34
page extension for the Elektorterminal	9-18
pseudo PROM	7-76
shift-lock for ASCII keyboard	7-27
speed controller for model railways	7-84
the ICU, a 'mini' microprocessor	3-28
using Elbug	2-32
μ P TV games	4-06

Miscellaneous

automatic emergency lighting unit	1-48
battery saver	10-09
burglar's battery saver	7-05
calculator as a chess clock	7-41
charging nicads — fast	12-10
chess challenger 10 plays like a human	1-39
DC polarity protection	1-19
Formant — an invitation to our readers	2-39
home trainer	11-20
inclusive always/exclusive never gate	7-61
LED lamps	7-15
low voltage dimmer	11-39
metronome	7-06
oscillographs on board	1-13
quick starter for fluorescent lamps	7-46
reliable nicad charger	1-08
right-up and left-down	6-40
short interval light switch	10-20
solar tracker	7-07
TAP switch	4-19
TAP thieves on the head	9-45
ten channel TAP	7-19
variable logic gate	6-21
vicious chess buzzer	7-25
zero pF screen	4-23
2 switches — 2 lamps — one wire	7-27
5-minute chess clock	7-73
7-segment displays on a 'scope	7-85

Music

audio sectioner	8-01
cartridge life-expectancy counter	7-26
chorosynth	8-07
digitally controlled phaser	7-67
disco lights	7-02
octave shifter for electric guitars	7-10
p.c.b. for variable fuzz box	10-20
programmable melody generator	8-04
ring modulator	3-14
sequencer	7-80
sound effects with analog reverb	12-30
sound processor	7-42
talk funny	12-27
vocoders today	12-02
256-note sequencer	7-96

Power supplies	
PSUs on PCBs	3-36
robust lab power supply	3-08
Test and measuring equipment	
AC millivoltmeter and signal squirt	1-16
analogue frequency meter	7-49
autoranger	7-24
autoranging peak meter	7-59
curve tracer	7-05
'de luxe' transistor tester	7-13
digiferad	10-16
display	7-65
digital heart beat monitor	7-20
floating input for DVM	7-16
FM stereo generator	1-26
four quadrant multiplier	7-80
frequency counter for synthesisers	7-58
frequency multiplier	7-28
frequency ratio meter	7-12
frequency synthesiser	7-28
f-to-v converter for multimeter	7-99
gate-dipper	10-22
harmonic distortion meter	7-53
IHF toneburst generator	1-06
impedance bridge	10-10
improved LED VU/PPM	1-12
linear thermometer	7-18
logic analyser	7-46
oscilloscope light pen	7-48
passive oscilloscope probe	1-30
pH meter circuit for DVM	7-87
resistance bridge	7-09
ribbon cable tester	7-83
simple synthesising of PPMs	7-81
sinewave generator	3-21
sixteen logic levels on a 'scope	1-20
spot sinewave generator	2-20
strain gauge	10-26
swamp generator	5-28
transistor tester	7-12
transistor tester	7-16
universal digital meter	1-43
variable pulse generator	3-18
voltage comparison on a 'scope	7-18
voltage prescaler	7-32
voltage transducer	7-74
3-state CMOS logic indicator	7-03

Please note:

Our offices will be closed
from 22-12-1979 through 1-1-1980.

the Elektor staff
wish all our readers

**merry
christmas**
**and
a happy
new year!**



link 78/79

an index to missing links

The intent of the Link is to assist the home constructor by listing corrections and improvements to Elektor circuits in one easy to find place. A simple check of the Link will show whether any problems were associated with a project. Don't forget to check previous Links if the project in question was published before January 1978.

E29

Formant — part 3
March 78 (E35), p. 3-07

E30

Formant — part 4
Jan 78 (E33), p. 1-31

E31

Formant — part 5
Jan 78 (E33), p. 1-31

SC/MP

Feb. 78 (E34), p. 2-38
RAM I/O board
Jul/Aug 78 (E39/40), p. 7-55

E32

Formant — part 6
Feb. 78 (E34), p. 2-16

E33

Noise generator
March 78 (E35), p. 3-07

E34

SC/MP — part 4
March 78 (E35), p. 3-07

E36

Elbug
Jul/Aug 78 (E39/40), p. 7-55

E36

Elektornado
May 78 (E37), p. 5-26
Moving coil preamp
May 78 (E37), p. 5-26

E37

Digital reverberation unit
Dec 78 (E44), p. 12-54

E38

½ Ggahertz counter
March 79 (E47), p. UK-16

E39/40

CMOS FSK modulator
Dec. 78 (E44), p. 12-54
Consonant
Feb. 79 (E46), p. 2-31
FET audio amplifier
Dec 78 (E44), p. 12-54

E41

Master tone generator
Oct. 78 (E42), p. 10-08
Piano
Oct. 78 (E42), p. 10-08
Temperature controlled soldering iron
Feb. 79 (E46), p. 2-31

E42

Central alarm system
March 79 (E47), p. UK-16
Oats bus buffer
Dec. 78 (E44), p. 12-54

E43

ASCII keyboard
Dec. 78 (E44), p. 12-54
Ceckling egg timer
Feb. 79 (E46), p. 2-31
Ring the bell and win a prize
Dec. 78 (E44), p. 12-54
Tag
Dec. 78 (E44), p. 12-54

E44

Elekterminal
June 79 (E50), p. UK-13

E48

TV games computer
June 79 (E50), p. UK-13

E49

BASIC microcomputer
Oct. 79 (E54), p. 10-51
NIBL-E
June 79 (E50), p. UK-13

E50

Aquarium thermostat
Oct. 79 (E54), p. 10-51
Elekdoorbell
Oct. 79 (E54), p. 10-51

E51/52

Automatic heated rear windscreen
Oct 79 (E54), p. 10-51
Chorosynth
Oct. 79 (E54), p. 10-51
Linear thermometer
Oct. 79 (E54), p. 10-51
Moisture sensor
Oct. 79 (E54), p. 10-51
Programmable digital function generator
Oct. 79 (E54), p. 10-51
Servo amplifier
Oct 79 (E54), p. 10-51
Video pattern generator
Oct. 79 (E54), p. 10-51
µP-programmable speed controller for model trains
Oct. 79 (E54), p. 10-51
256-note sequencer
Oct. 79 (E54), p. 10-51
metronome
Dec. 79 (E56), p. UK 16

E54

Digital rev counter
Dec. 79 (E56), p. UK 18

LINK 77

June 78 (E38)

LINK 76

June 77 (E26)

LINK 75

June 78 (E14)

talk funny?

ring modulator,
chopper and frequency modulator

Deliberate electronic distortion of speech and music signals can give fascinating results. Professional musicians use extremely expensive equipment to obtain their very own weird and wonderful 'sound'. For electronics enthusiasts, it is much more fun to get the same sort of results from very simple circuits. Which is what this article is about: getting effective effects using a single IC, the 2206.

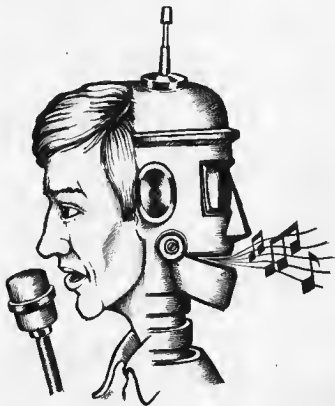

One of the best known and most impressive distorters for audio signals is the ring modulator. Normally speaking, a ring modulator circuit has two inputs: one for the audio signal (speech, for instance) and one for a 'carrier'. The weirdest effects are obtained when the carrier frequency is within or just above the audio range, using different carrier shapes (sinewave, squarewave or triangular waveform) can produce different effects.

The circuit can be drastically simplified by using a 2206. This IC contains a suitable generator for the 'carrier', and a multiplier circuit that is ideally suited for use as a ring modulator. The internal block diagram is shown in figure 1.

The oscillator (VCO) is already connected internally to the multiplier. This means that, basically, applying an audio signal to the other multiplier input (pin 1) will produce a 'ring-modulated' output at pin 2. Simplicity itself!

Obviously, a few other components are needed in a practical circuit. Not many, though, as shown in figure 2. A single capacitor, C4 (C_{ext} in figure 1), determines the frequency range of the VCO. With the value given, the 1M potentiometer (P1; R_{ext} in figure 1) can be used to set any frequency between approximately 10 Hz and 10 kHz. The wave-shape is selected by means of S1: switch closed for sinewave, switch opened for triangle.

The audio input signal is fed to the modulation input via C1. A voltage divider circuit (R1, P2, R2) sets two DC bias levels: the voltage across C2 provides the basic internal DC reference, and P2 is used to adjust the operating point of the multiplier. This adjustment is important: it determines the 'carrier level' (the output from the oscillator)

Table

Technical data for the complete circuit (figure 3).

Functions.

Ring modulator

Chopper

Frequency modulator

Frequency range of VCO:

Low range: 1 Hz... 300 Hz

High range: 100 Hz... 20 kHz

Frequency modulation:

± 30% frequency swing for IV top-top modulation signal.

Impedances:

Input 30 k

Output 2 k

Signal levels:

Input, nominal 1 V_{tt} (350 mV RMS)
maximum 8 V_{tt} (2.8 V RMS)

Output, maximum 10 V_{tt} (3.5 V RMS)

Supply:

12 V, stabilised; 30 mA max

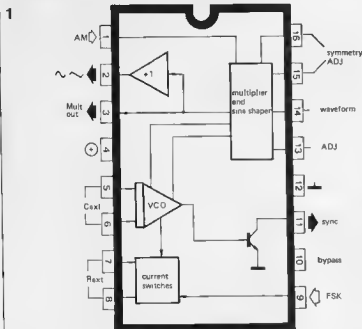

Figure 1. Internal block diagram of the 2206. This IC is a complete function generator, containing a VCO and a multiplier. The letter is ideally suited for use as a ring modulator.

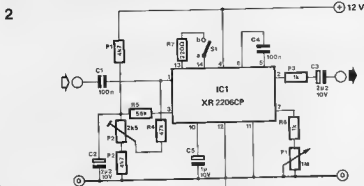

Figure 2. A simple circuit, using the 2206 as a ring modulator.

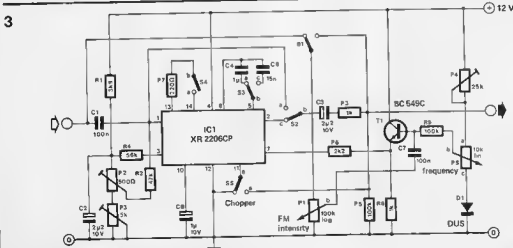

Figure 3. The simple circuit given in figure 2 can be extended as shown here. The 2206 is now used to the full: the input signal can be ring modulated and/or frequency modulated and/or chopped.

present in the final audio output. The easiest way is to short the audio input end then adjust P2 for zero audio output. Only then is the circuit operating as a true ring modulator. If P2 is incorrectly set, the oscillator frequency will appear at the output, amplitude modulated by the input (speech) signal. This can give interesting effects, but it isn't really the intention!

A stabilised supply must be used, otherwise the OC settings may drift. This would mean regular re-adjustment of P2 — which is rather a nuisance.

Chopping and frequency modulation

The circuit can be extended, as shown in figure 3. Only a few additional components are needed to really use the IC to the full. Apart from adding the 'chopper' and 'frequency modulator' features, a useful linear frequency scale for the oscillator control is obtained as an additional bonus.

The basic ring modulator circuit is virtually identical to the circuit given in figure 2. The main difference is that the multiplier bias adjustment is improved: P3 is used for initial coarse adjustment, with P2 in the mid position; then P2 is used to tune out the last traces of the carrier.

The chopper circuit makes use of a squarewave output available at pin 11. To be more precise, this is the collector of an internal switching transistor (see figure 1). With S5 in position 'chopper', this point is connected to the signal output. When the transistor is turned on, the output is shorted; since the transistor is turned on and off periodically by the internal oscillator, the chopper frequency is determined by the setting of P5 (the VCO frequency control). Switch S2 can be used to select the audio signal before or after the ring modulator; note, however, that in the latter case the 'carrier' frequency for the ring modulator and the chopper

4

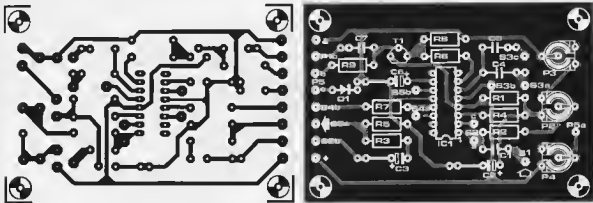
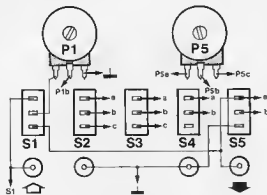

Figure 4. A possible printed circuit board layout for the complete circuit given in figure 3.

5



80054 5

Figure 5. Wiring diagram for the front panel controls. The small arrows indicate connections to the corresponding points on the board.

6

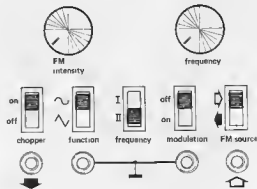

80054 6

Figure 6. A suggested front panel layout.

frequency are identical — they are both derived from the same VCO.

The main reason for modifying the frequency control circuit for the VCO is to obtain a linear voltage control point. The frequency of the VCO varies linearly with the voltage at the base of T1; this voltage is determined by the setting of P5, but a frequency modulation signal can be superimposed via C7. P1 sets the modulation level; S1 is used to select either the audio input signal or the output signal.

The frequency control range is set by P4. The procedure is as follows. Turn P5 right up (lowest frequency) and set P4 to maximum resistance. C5 is switched into circuit via S3 and P2 is offset so that the oscillator signal appears at the output. P4 is now slowly turned down until the oscillator stops, and then turned back until it starts again reliably. This is the optimum setting. Once again, it depends on the supply voltage — so the latter must be stabilised.

7

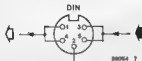

Figure 7. A combined in- and output can be wired as shown here.

A simple supply using a 78L12, say, is adequate. A suitable circuit and p.c. board were given in *Elektor*, July/August 1978, p. 7-75.

A basic printed circuit board layout for the circuit itself is given in figure 4, and the two sides of the front panel with the controls are shown in figures 5 and 6. Finally, a suggestion for a combined in- and output connection is shown in figure 7. All of these drawings are included as suggestions only; the final design may be modified according to personal taste.

How funny does it sound?

Sound effects are always difficult to describe — you've got to hear them. The

ring modulator 'sound' is perhaps the best known: all kinds of additional frequencies are added to the original signal, without any harmonic relationship. If really sharp dissonances are what you want, the 2206 ring modulator is just the trick!

The effect can be 'improved' by switching from sinewave to triangle: if you're not careful, you end up with a completely scrambled signal. On the other hand, using a low-frequency sinewave produces a more 'pleasant' sound — the ring modulator adds an interesting rhythmic effect to the original.

The chopper facility can be useful on its own, producing a kind of 'robot' or 'computer' sound. When used in combination with the ring modulator, the most weird results can be obtained. In the same way, combining frequency modulation with the ring modulator can be interesting: low modulation levels produce a kind of vibrato effect, and high modulation levels — well. Try it!

SEWAR[®]

sound effects with
the analogue reverb

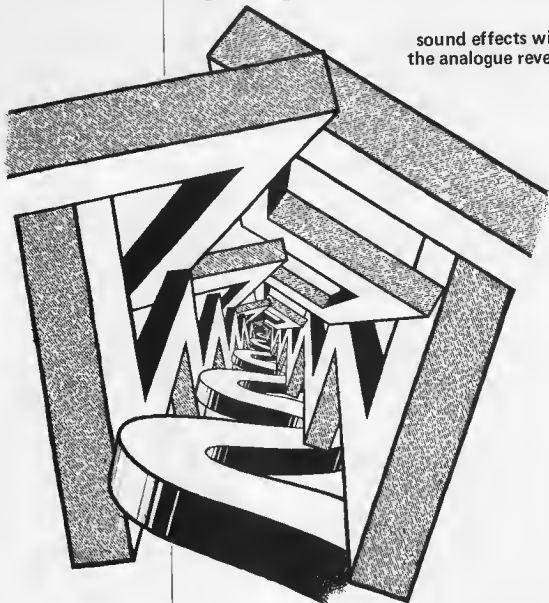

We have recently published a number of articles featuring delay lines and the most popular was the Analogue Reverb Unit in Elektor 42 (October 1978). It would appear that this article was greeted with such enthusiasm by our readers that many have been encouraged to experiment further.

The following project has been designed as a 'front end' to the reverb unit with the purpose of allowing greater flexibility with reverb effects. It produces a variable rate clock signal together with five different modulation waveforms that can be used for phasing, vibrato and other effects. A random signal generator is also included for chorus effects. The composite output signal is intended to be connected to the external clock input of the analogue reverb unit.

It will be seen, when referring to Elektor 42, that the Analogue Reverb Unit (ARU) uses the well known SAD 1024 shift register. As most of our readers will know, this device operates on the 'bucket brigade' principle. Briefly, this is analogous to a chain of buckets from input to output. The sampled signal at the input corresponds to the level of water in the first bucket. At the 'word of command' (clock pulse) this bucket is poured into the second bucket (which was of course empty). At the next word of command the second bucket is emptied into the third and so on for 512 times, the number of stages in one half of a SAD 1024. We should explain to newcomers to electronics that we don't really use water (at least, not yet) and the water level in our mythical bucket is in reality a charge packet on an almost mythical capacitor (they are physically very small). Back in the real world, it will be apparent that the delay time is dependent mainly on two factors: the number of stages in the shift register (or registers), and the clock frequency. The first is a hardware design parameter and not

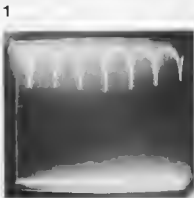

Figure 1. The oscillograph shows the comb-like structure of the phasing effect produced by adding a delayed to an undelayed signal.

easily altered, but the clock frequency is something that can be varied — and that is where we get to the point of this project.

Table 1

Technical data	
Clock pulse generator frequency range:	20 kHz to 250 kHz
waveform:	square
amplitude:	15 V p-p
Random modulation generator average fluctuation rate:	adjustable
average amplitude:	1.4 V p-p
Periodic modulation generator frequency range:	0.1 Hz to 10 Hz
waveforms:	sine, triangle, square, rising ramp sawtooth, falling ramp sawtooth
Power consumption:	± 15 V/50 mA

2

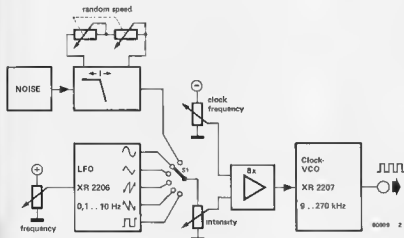

Figure 2. Block diagram of the clock pulse generator. Five different waveforms plus a random modulation signal can be selected.

A variable clock frequency has rather more going for it than might at first appear. If the output of the delay line is mixed with a 'clean copy' of its input signal the resulting periodic phase cancellation and addition will produce the so-called comb frequency response shown in figure 1. Now, if the clock frequency is raised and lowered the comb will 'open and close'. This in audible terms produces the phasing (or flanging) effect. A chorus effect is obtained by an entirely random variation of the clock frequency. The range of possibilities will now be apparent. Before getting too deeply involved in this circuit some readers may prefer to become better acquainted with 'bucket brigade' shift registers, and for this the previously mentioned article in Elektor 42 should prove useful.

The external clock

The design target was to develop the maximum in sound effect possibilities. The final concept is shown in the block diagram of figure 2.

The low frequency oscillator (LFO) is variable between 0.1 and 10 Hz and produces five different waveforms: sinusoidal, triangular, rising sawtooth, falling sawtooth and square. As a sixth possibility a noise source generates a random signal which is low pass filtered to limit the passband. The filter roll-off frequency is adjustable for variation of the average speed of the random signal. Switch S1 selects the required modulation waveform and the modulation depth is varied by the intensity control. After amplification the resultant signal controls the frequency sweep of the voltage controlled clock pulse generator (VCCPG?). Figure 3 shows the VCO output frequency as a linear function of the modulation control signal. The frequency modulated output of the VCO is connected to the input of the analogue reverb unit thereby producing the various sound effects discussed in previous paragraphs.

Sewar Circuit

As can be seen from the circuit diagram of figure 4, the unit is built around three integrated circuits, a function generator (XR 2206), a VCO (XR 2207) and four FET input op-amps housed in one package (TL084 or TL074). The circuitry around the function generator (IC1) may be familiar to regular Elektor readers. The oscillation frequency is determined by components C2 + C3, R3, R4 together with potentiometer P4. Since availability of bipolar electrolytic capacitors may be limited, the required capacitance is made up from two 220 µF types connected back-to-back. The resultant 110 µF suffices to bring the frequency down to 0.1 Hz, the upper limit being 10 Hz.

3

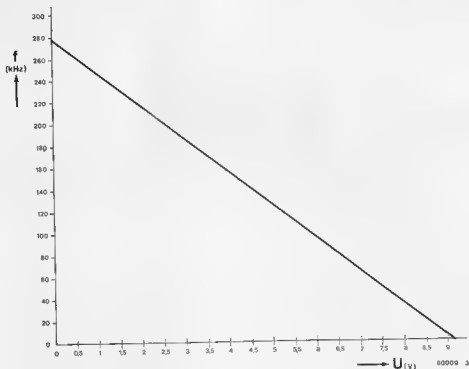

Figure 3. The graph shows the VCO output frequency as a quasi-linear function of the control voltage, in a ratio of approximately 30 kHz per volt.

The output waveforms and amplitudes are defined by the networks connected to various pins of the waveform generator. Switch S1a...S1d functions as follows.

Switch position 1 connects the filtered noise generator output to the VCO. The waveform generator is switched off and S1c contacts c1 shorts pin 11 to ground to suppress any stray radiation.

Switch position 2 corresponds to a sinusoidal waveform which is available from pin 2 of the waveform generator. The sine wave is produced by connecting resistor R2 across pins 13 and 14 via contact b2 while contact a2 shorts pin 1 to ground. The amplitude of the sine wave can be adjusted by means of preset potentiometer P3.

Switch position 3 corresponds to a triangular output at pin 2, by disconnecting R2 from pin 13. The amplitude of the triangular waveform can be adjusted by means of P1 which is connected to pin 1 via contact a3.

Switch position 4 corresponds to a positive going sawtooth waveform by removing the short from pin 11 and connecting this pin to the FSK input (pin 9) via contact c4. The positive going ramp of the sawtooth lasts for half of the triangle period, the negative going slope is determined by the resistance of R1 and is much steeper. The sawtooth frequency is therefore, practically twice that of the sinusoidal and triangular waveforms. The amplitude is

again adjusted by means of P1.

Switch position 5 corresponds to a negative going sawtooth waveform by moving the bias at pin 1 from P1 to P2 via contact a5, thereby inverting the sawtooth polarity. The output amplitude is now controlled by P2.

Switch position 6 corresponds to a squarewave output. The generator output is now taken from pin 11 via R6 and S1d contact d6. It is clipped to 1.4 V p-p and made symmetrical with respect to ground by the network composed of R5, R6, R7 and the reverse-parallel connected diodes D1/D2. This symmetry obviates the need for a coupling capacitor which would otherwise distort the square pulse shape, especially at low frequencies.

Any DC component at pin 2 of the function generator IC is blocked by the coupling capacitor C1. This DC component is apt to surge when S1 is operated, and these surges cannot be sufficiently biased via the high resistance of P5 alone. However, the reverse-parallel connected diodes D3/D4 become conductive only on these surges and together with R8 speed up the discharge rate of the capacitor.

The random signal is generated as follows. Transistor T1 is used as a noise source. Its base-emitter breakdown comes into effect at around 8 V and makes the transistor behave like a very noisy zener diode. The resultant noise signal is greatly amplified by A1 and A2

in cascade which function as active low-pass filters due to capacitors C6 and C7 in their feedback loops. This combination gives a roll-off frequency of about 10 Hz. The random signal zero frequency component is offset by the bias control P8 at the non-inverting input of A2. The filtered output of A1 + A2 is passed through a further active low-pass filter, A3, with a 12 dB roll-off at an adjustable frequency controlled by P6. This sets the average fluctuation speed of the random signal. The final output is available at selector switch contact d1.

The sweep control signal from the modulation mode selector switch, S1, is attenuated by P5 to the modulation depth desired. This is applied to the non-inverting input of the 16 dB amplifier, A4, whose output determines the oscillator frequency of the VCO, IC2, as shown in the graph of figure 3. The VCO control signal is composed of the periodic or non-periodic waveform from the mode selector switch, plus a zero frequency component introduced at the inverting input of A4. The centre frequency of the VCO is then adjustable by P7 to between 20 kHz and 250 kHz. The stabilised voltage required for this is supplied by the network R20, D5 and D6. Capacitor C9 is the reactive component of the oscillator circuit and this capacitor determines the free-running frequency of the VCO. The power supply for the VCO is stabilised Intern-

4

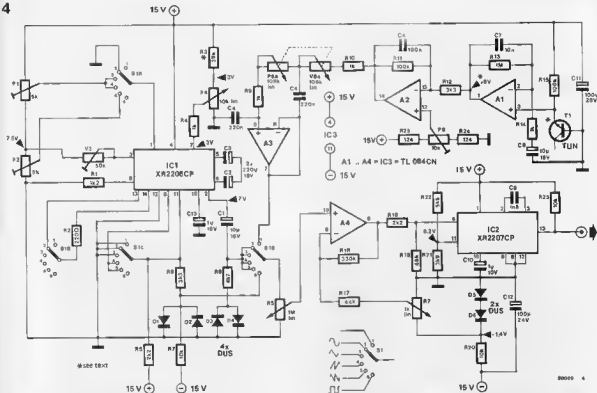

Figure 4. The complete circuit is made up from only three active integrated circuits plus a number of discrete passive components for efficient operation.

ally with the help of capacitor C10. The final squarewave output signal to be fed to the reverberation unit is taken from pin 13 of the VCO. The power supply for the clock generator (± 15 V 50 mA) can be derived from the supply for the reverberation unit.

Construction and setting up

The printed circuit and component layout for the ARU 'front end' is shown in figure 5. Assembly of the printed circuit board should not present any problems if suitable sockets are used for the integrated circuits. Electrolytic capacitors, particularly C1, C2, C3 and C8, should be low leakage types.

Special attention should be paid to the selection of transistor T1. With the circuit parameters given, its standing emitter voltage must lie between 6 V and 8.5 V, this voltage is the same as that of the DC component at the output of the unity gain amplifier A1. If the reading obtained lies outside this range a different device must be tried. A multi-meter can be used for setting up the circuit parameters although an oscilloscope may be preferable. Test DC levels are indicated at a number of points on the circuit diagram to simplify setting up.

Prior to further measurements, the working range of P7 should be tested. This is done with P5 set to zero output. The voltage on the wiper of P7 should vary from 0V to around 8.5 V, after

which P7 is set to give an output of 5 or 6 volts. The actual figure will serve as a reference around which the modulation signals will swing symmetrically.

The first output test is on the squarewave, for which S1 is moved to the sixth position and P5 set to maximum output. With P4 set for the lowest oscillator frequency (its wiper fully towards R3) the meter reading will fluctuate between a low and a high reading, in a 3 to 5 second period, symmetrically about the reference level established previously. The peak-to-peak amplitude of the squarewave should be some 7 or 8.5 volts. The actual voltages obtained should be noted, since they will have to serve as a standard for the other waveform measurements.

Should the squarewave oscillation stop or the frequency rise too high when P4 is turned to the fully clockwise position, then the value of R3 should be altered. This can be done with the aid of a 47 or 50 k Ω trimmer end, once the correct value has been found, a fixed resistor can be substituted.

The next test is on the sinewave, for which S1 is set to its second position and P3 adjusted to give a sinewave output equal in amplitude to that of the squarewave.

To test the triangular waveform, with S1 in position three, P1 is adjusted for correct output amplitude. A similar procedure is followed for the two sawtooth amplitudes with correspond-

ing switch positions and control adjustments.

The final adjustment to complete the setting up procedure is the random signal setting — with S1 in the first position and P5 at maximum. To reduce the noise amplitude to a comfortable level, a 1 μ F capacitor is used to bridge the emitter of T1 to ground (capacitor positive terminal to emitter). Potentiometer P8 is used to adjust the DC output component to match the reference level established in the preliminary operation. If the meter reading appears to be somewhat erratic, due to the extremely high gain in the noise amplification circuit, the output should be adjusted so that its average reading approaches that of the reference level. The 1 μ F bridging capacitor is now removed, end the circuit is ready.

ARU + Sewer

So far, the circuit is just a front end that supplies a sequence of clock pulses at a controlled variable rate. Its effect will only be audible when connected to an electronic reverberation system and associated equipment, such as that described in the October '78 issue of Elektor. Consequently, some adaptations are necessary to the reverber circuit board.

The reverberation unit must use the SAD 1024 integrated circuit. To prepare the unit for a high clock rate, a wide LF band is required, which is made possible

5

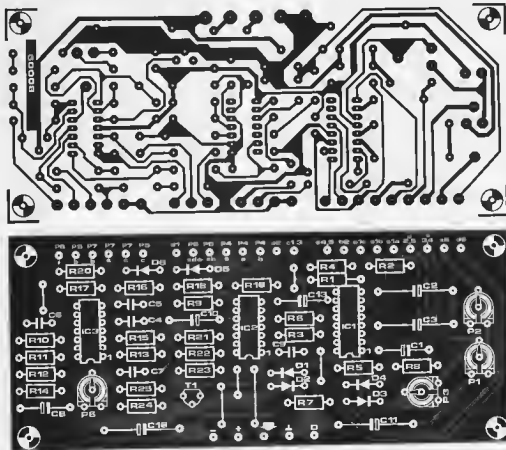

Figure 5. Printed circuit board end component layout for the clock pulse generator.

Table 2

Sound effects	effect	phasing	vibrato	chorus	random phasing	random vibrato
	modulation waveforms	sine or triangle	sine or triangle	random	random	random
	undelayed signal amplitude	maximum	zero	zero	maximum	zero
	delayed signal amplitude	maximum	maximum	maximum	maximum	maximum

Parts list

Resistors:	R17, R19 = 68 k
	R21 = 3k9
	R22 = 5k6
	R24, R25 = 12 k
	P1, P2 = 4k7 (5 k) preset
	P3 = 47 k (50 k) preset
	P4 = 10 k lin
	P5 = 1 M lin
	P6a, P6b = 100 k lin stereo
	P7 = 1 k lin
	P8 = 10 k preset
	Capacitors:
	C1, C8 = 10 μ /16 V
	C2, C3 = 220 μ /16 V
	C4, C5 = 220 n
	C6 = 100 n
	C7 = 10 n
	C9 = 1n5
	C10, C13 = 1 μ /10 V
	C11, C12 = 100 μ /25 V
	Semiconductors:
	IC1 = XR 2206
	IC2 = XR 2207
	A1, A2, A3, A4 = IC3 = TL 074, TL 084
	T1 = BC 548B, BC 108B, BC 547B (TUN)
	D1, D2, D3, D4, D5, D6 = 1N4148, 1N914 (DUS)
	Sundries:
	S1a+S1b+S1c+S1d = 6-way 4-gang rotary switch

C7 = 10 n
C9 = 1n5
C10, C13 = 1 μ /10 V
C11, C12 = 100 μ /25 V

Semiconductors:
IC1 = XR 2206
IC2 = XR 2207
A1, A2, A3, A4 = IC3 = TL 074, TL 084
T1 = BC 548B, BC 108B,
BC 547B (TUN)

D1, D2, D3, D4,
D5, D6 = 1N4148, 1N914 (DUS)

Sundries:
S1a+S1b+S1c+S1d = 6-way 4-gang rotary switch

6

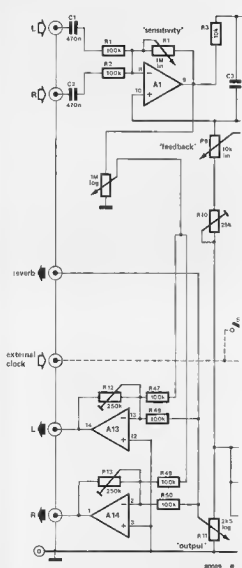

Figure 6. For the phasing effect an additional control is required to blend the delayed to the undelayed signal. A single control is needed for mono operation.

by adapting the low-pass filters to a 15 kHz roll-off. The method of doing this has been explained, together with other modifications, in the October '78 article. The cable connecting the clock unit to the reverberation unit must, of course, be screened.

In order to obtain the desired phasing effect, an additional control is required for blending the delayed to the undelayed signal. This modification is suggested in figure 6, for mono, and figure 7 for stereo operation, the latter featuring a mono/stereo switch and a 500 (470) k Ω tandem volume control. The phasing effect is most pronounced when the delayed and undelayed components are of approximately the same intensity.

Selecting and setting the clock rate and

its frequency sweep is a fairly simple matter. The first action is to set control P5 to minimum, cutting out all frequency modulation, and to adjust P7 to set the clock rate to the delay required. The required modulation mode is then selected and the modulation depth can then be adjusted by increasing P5. If the sweep gets too wide with respect to the centre frequency, which shows up as an audible whistle, the setting of P7 will have to be altered - normally around halfway. For some effects the equipment may be used without any modulation at all i.e. with P5 set at minimum.

The effects obtainable are described in more detail in the May '79 issue of *Elektor*, pages 5-18...5-24. They are recapped in Table 2. Quite unusual

reverb/phasing and reverb/vibrato effects can be found by using the variable feedback possibility of the reverberation system. Apart from these, the triangle and sawtooth modulation waveforms permit a wide variety of experimental sound effects, which must be heard to be believed.

References:

- Forment (4)
Elektor E30 October 1977, 10-40 etc.
- Analogous reverberation unit
Elektor E42 October 1978, 10-44 etc.
- Delay lines (2)
Elektor E49 May 1979, 5-18 etc.
- Simple function generator
Elektor E33 January 1978, 1-40 etc.

7

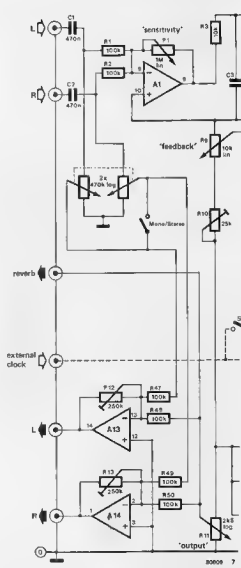
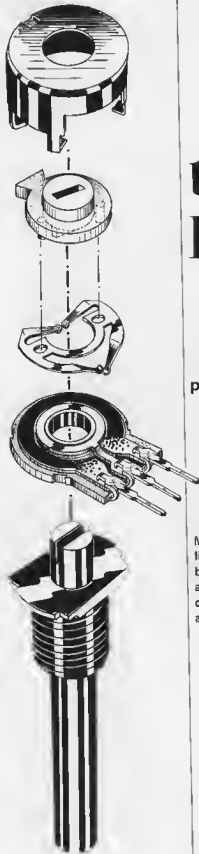

Figure 7. Stereo operation necessitates the addition of a tandem control plus a mono/stereo switch.



tailoring potentiometers

potentiometer + resistor(s) = modified potentiometer

Most potentiometers are supposed to have a fairly straightforward linear or logarithmic characteristic. This is all right in most applications, but sometimes the particular characteristic required is not readily available. Fortunately, it is not too difficult to obtain various modified characteristics by adding one or two fixed resistors. Which is what this article is about.

The indications 'lin' or 'log' on a potentiometer (or potmeter, as they are often called) refer to the intended effect of moving the wiper along the track. The resistance measured between the wiper and one end of the potmeter is supposed to increase in linear or logarithmic fashion as the wiper is moved along the track. This type of characteristic is usually drawn in a graph, where the resistance between the wiper and the end of the track is expressed as a percentage of the total resistance, and plotted as a function of the wiper position.

There are applications where the characteristic is unimportant. Not many, though. In most cases, the type of adjustment required dictates the 'ideal' potentiometer characteristic for that application. The next step is to find out whether it exists...

The three most common characteristics are shown in figure 1. The wiper position (for either a rotary or 'slider' potentiometer) is plotted along the horizontal axis as a percentage of the total track length: $x = 0$ corresponds to the 'low' end (fully anti-clockwise for a rotary potentiometer) and $x = 100$ stands for the other extreme position. The vertical axis gives the percentage resistance between the wiper and the 'low' end of the track.

The 'linear' characteristic is the easiest one to draw: it goes in a straight line from zero resistance at the low end to maximum resistance at the other. (Note that this is the theoretical characteristic: we have yet to find the potmeter that will give zero resistance at one end...). Potentiometers marked 'log' are supposed to have a so-called positive logarithmic characteristic; this is the one marked 'pos-log' in figure 1. In this case, the attenuation in dBs varies linearly as a function of the wiper position — just the job for volume controls, for instance. Finally, a less well-known characteristic is the 'antilog' potmeter ('neg-log') in figure 1. As can be seen, it is a mirror image of the normal logarithmic plot; this can be useful in certain tone-control circuits, for example.

So much for the theoretical characteristics. What about real-life potentiometer? Well... Figures 2 and 3 give the results for a whole series of logarithmic and linear potentiometers, respectively. The linear plots are bad enough, but the log versions are hopeless!

Add a resistor or two...

Fixed resistors can be added between either or both ends of the potentiometer and the wiper, as shown in figure 4. The result is still, basically, a potentiometer — but its characteristic can be weird or wonderful, depending on the ratio between the total potentiometer resistance and that of the fixed resistor(s).

The possibilities are plotted in a fascinating array of graphs. Figure 5, for example, shows what can be achieved by adding one fixed resistor to a linear

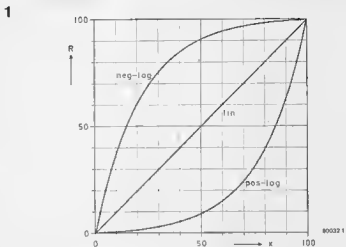

Figure 1. Three types of potentiometer are normally available: those with linear, logarithmic ('pos-log') and anti-logarithmic ('neg-log') characteristics.

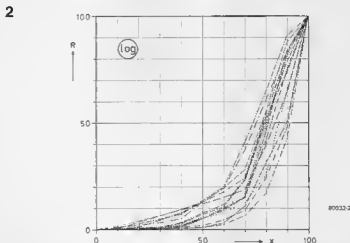

Figure 2. In practice, so-called logarithmic potentiometers may have a wide variety of characteristics. In practice, the desired characteristic is approximated more or less (more less than more, usually) by a series of straight lines.

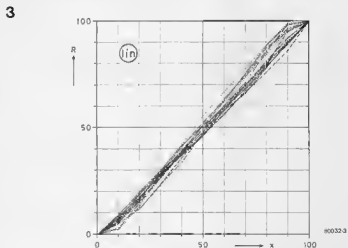

Figure 3. Linear potentiometers are usually better. The main problems occur at the two extreme ends.



Figure 4. One or two fixed resistors can be added, between the wiper and one or both of the ends. The results can be surprising!

potentiometer. The potentiometer resistance is taken as 100 'units'; the fixed resistor value can then be given as a percentage. 'R = 25', say, means that the value of the fixed resistor is 25% of that of the potentiometer — a 470 k potmeter and a 120 k fixed resistor is a close approximation. In figure 5, the full lines in the upper left-hand half correspond to the situation where the fixed resistor is mounted between the top of the potmeter and the wiper; the dotted lines show what can happen if the resistor is mounted in the position shown for R3. Note that the two plots for R = 10 (i.e. one-tenth of the total potentiometer resistance) are fairly close approximations of the anti-log and log characteristics. This means that a 4k7 lin potmeter can be modified to 4k7 log by adding a 470 Ω resistor between the wiper and the 'low' end! For what it's worth, the theoretical results of 'padding' a log potentiometer with one resistor are given in figure 6. The upper plot for R2 = 10 is a reasonable approximation of a linear characteristic. Anybody who feels like trying it is referred to figure 2. . .

What about adding two resistors? Why not. The results (see figures 7 and 8 for lin and log potentiometers, respectively) are intriguing, to say the least. In these plots, one resistor is taken as 25% of the full potmeter value and plots are given for various values of the other; the circuits given in the top left and bottom right-hand corners correspond to the full and dotted line plots, respectively. Finally, figures 9 and 10 give some idea of what can be achieved if the two resistors have the same value, varying from 10% to 100% of the total potmeter value. Obviously, all these plots must run through the point where the wiper is set to half of the total resistance value. Anybody who wants fine control in the centre of the potentiometer range and coars control toward the ends should take a look at the plot for R2 = R3 = 10 in figura 9.

'Add a resistor or two', we said. And look what happened! Two more things can happen, not so obvious from the plots. The total resistance of the modified potentiometer is no longer constant, or it is reduced. The circuit driving it may not like this. . . Also, the plots given for fixed resistors between the wiper and the 'low' end of the potmeter may be taken as dire warning. . . The same sort of thing will happen if a relatively high-value potentiometer is followed by a relatively low-impedance circuit!

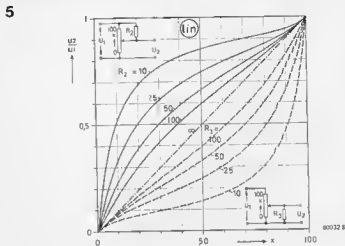

Figure 5. These characteristics can be obtained by adding one resistor to a linear potentiometer.

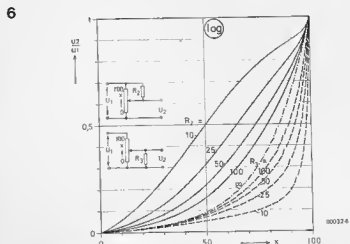

Figure 6. Provided one has access to a logarithmic potentiometer with a theoretically ideal characteristic, these modified characteristics can be obtained by adding one fixed resistor.

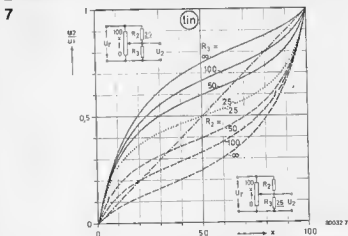

Figure 7. Using two resistors and a linear potentiometer. The full lines correspond to the situation where R2 is fixed, and equal to % of the total potentiometer value; the dotted lines are obtained when R3 is fixed and R2 is varied.

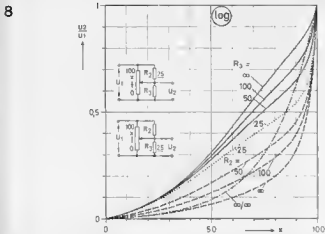

Figure 8. A logarithmic potentiometer and two resistors can produce this intriguing set of plots. As before, the full lines are valid when R_2 is fixed and R_3 is varied, and the dotted lines are obtained when R_3 is fixed at $\frac{1}{2}$ of the total potentiometer value. The basic logarithmic plot is also indicated, as a reference.

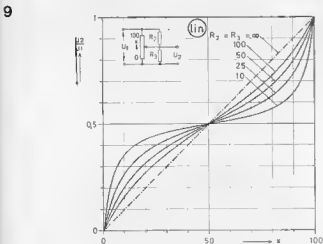

Figure 9. Using a linear potentiometer and two equal potentiometers, this set of plots can be obtained.

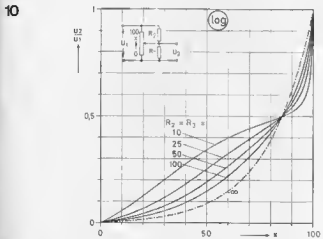

Figure 10. Similarly, two equal resistors can be used in combination with a logarithmic potentiometer.



Most commercially available VOX units have the disadvantage that they react to any sound above a certain level. Background noises can easily cause a VOX to switch over to 'transmit', with the result that any message coming in is 'cut to pieces' and may become completely unintelligible.

Even so, a VOX is a useful little gadget. It's nice to have both hands free when transmitting — for making notes, adjusting knobs, or pouring a cup of tea. If only the VOX was better behaved! It would make life so much easier.

The VOX described in this article may be the answer to a prayer. It's intelligent enough to do what it's told — ignoring chairs scraping on the floor and things like that.

next section is the band-pass filter, with adjustable centre frequency and Q. The output signal (if any) from this filter goes to an amplifier stage with a gain of 200. Even fairly small signals will drive this stage into clipping, so that the output becomes more like a squarewave than anything else. This signal is used to trigger a monostable multivibrator, which provides an output pulse of (you guessed it!) adjustable length — from 0.5 to 2.5 seconds, to be precise. The monoflop is retriggerable; in other words, as long as trigger pulses keep coming within the selected period time, the output will remain 'high' continuously.

Finally, a buffer stage is used to drive the relay.

voice operated control switch

transmit from
the word 'Go'.

Amateur radio operators normally use the Push To Talk (PTT) button to switch from 'receive' to 'transmit'. This changeover can also be done automatically, using a circuit that detects the speech signal from the microphone. This kind of automated PTT button is usually referred to as a VOX.

1

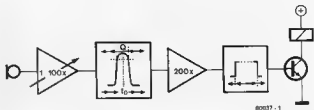

Figure 1. Block diagram of the 'intelligent' VOX. The centre frequency and Q of the filter are independently variable, so that a frequency band can be selected that is characteristic for the speaker.

Block diagram

The VOX is connected behind the microphone. This means that any sounds picked up by the mike are passed to the input of the VOX. To avoid the disadvantages outlined above, the VOX must be able to discriminate between 'His master's voice' and other loud noises. A good solution in practice is to pass the signal from the microphone through a fairly narrow band-pass filter. This filter is tuned to a frequency band that proves typical for that particular speaker; all sounds outside the band are ignored. The output from this filter can be used to control the PTT switch.

Figure 1 is the block diagram of the intelligent VOX. The signal from the microphone is fed to an input amplifier stage; the gain of this stage can be set anywhere between $\times 1$ and $\times 100$. The

The circuit

As can be seen from figure 2, the input impedance of the circuit is determined almost exclusively by R2: 47 k. This means that the circuit provides a negligible load, and so it can be connected in parallel with the microphone amplifier in the transmitter.

The gain of the input stage (IC1a) is equal to $P1/R1 + 1$. With P1 at minimum, the circuit gives unity gain; the other extreme setting corresponds to $\times 101$. It is advisable to keep the gain down as far as possible, while still maintaining reliable operation: too high a setting will not make the circuit react any faster, but it will increase the danger of unwanted background noises getting through! L1 and C1 are included to block high frequency input signals — the circuit is intended for use with a trans-

mitter! The gain of the input stage can be varied over such a wide range that the type of microphone used is not really important.

The following three opamps, IC1b... IC1d, are connected as a 'state variable' filter. The tandem potentiometer P2a/b sets the Q of the filter — the relative width of the pass-band, in other words. The Q can be varied between 1 and 50. The other pair of potentiometers, P3a/b, adjusts the centre frequency. By manipulating P2 and P3, the filter can be tailored until it corresponds to the desired voice band.

The output from the filter (pin 8 of IC1c) is taken to a single-transistor amplifier stage (T1), and from there to the trigger input of the monostable (type 4528). The latter, in turn, drives the transmit/receive relay via T2. The period time of the monostable is determined by P4, R20 and C7. With the values given, any period between 0.5 and 2.5 seconds can be set. If desired, a different range can be obtained by modifying the values of any or all of these components.

A stabilised 12 V power supply must be used. The current consumption will depend on the relay more than anything

else; a 500 mA supply will normally be more than adequate. The opamps require a symmetrical supply, and this is obtained by including an 'artificial centre-tap', consisting of T3 and T4. Obviously, if a symmetrical ± 6 V supply is available, this part of the circuit (T3, T4, D2, D3, R21 and R22) can be omitted. The capacitors C4, C8, C9 and C10 should be included, no matter what type of supply is used.

Construction

No p.c. board was designed for this circuit — amateur radio operators are usually sufficiently experienced to do without! Screened cable should be used for the connection to the microphone, and the shorter the cable the better.

It's always a good idea to use sockets for the ICs. There are no other constructional points that require special attention. As far as the choice of components is concerned, only two points are worthy of note. The two tandem potentiometers should preferably be selected for good tracking between each pair — this makes the filter easier to adjust. Furthermore, the

type of transistor used for T2 will depend on the relay. It may be necessary to use a BC141 — possibly even with a cooling fin. Note that the base current to this transistor is limited to about 0.5 mA, so if a really 'heavy' relay is used, the transistor must have sufficient current gain or else a Darlington pair must be used.

2

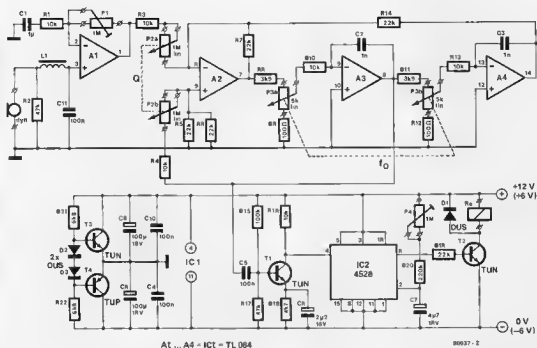
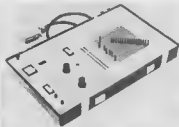

Figure 2. The complete circuit. The four opamps are all contained in a single IC (a TL 084), so the unit can be quite compact.

market

Data transmission test set

A Data Transmission Tester Model 281 (PO Data) Tester No. 12e) has been introduced by Melden Electronics. It is a battery operated, portable instrument for monitoring and controlling CCITT V24/V28 interchange circuits between data terminal equipment and the data circuit terminating equipment. Data terminal equipment is connected to the tester via flying leads. Each interchange circuit is permanently monitored by two LED indicators. One indicator illuminates when the circuit is in the ON condition and the other indicator illuminates when the circuit is in the OFF condition. An open circuit condition will extinguish both indicators.



A matrix switching board is provided for controlling purposes. When using the matrix, each circuit can be individually interrupted and control conditions applied simultaneously to the input and output circuits. Test leads are provided so that any circuit can be monitored externally. All the interchange circuits may be controlled simultaneously if required.

The tester also contains a timer-counter to measure Ready for Sending delay, Backward Channel Ready delay (up to 9999 milliseconds) or the frequency of Transmitter and Receiver Signal Element Timing signals (up to 9999 Hz).

Power is derived from two 9 volt dry-cell batteries housed within the case underneath flip-top covers. The case itself is of fibre-glass construction fitted with a carrying handle and detachable lid.

*Melden Electronics Limited,
Melden House,
579 Kingston Road, Raynes Park,
London, SW20 8SD.
Tel.: 01-543 0077*

(1337 M)

Plastic control knobs

A new range of high quality plastic control knobs has been introduced by Argo Electronic Components Ltd. These control knobs, which have an attractive modern design, are produced in 13 mm, 16 mm, and 19 mm diameters and all incorporate a pointer. The body of the knob is moulded in black phenolic resin with a brass insert, and has fine knurling to ensure positive grip and control. They are available for use with shafts having diameters of 1/8 inch, 4 mm, 6 mm and 3/8 inch. Coloured ABS plastic caps can be fitted to the knobs



and are available in red, green, blue, yellow and white. Alternatively a self coloured spun aluminium cap can be fitted.

*Argo-Electronic Components Ltd.,
Electric Avenue,
Westcliff-on-Sea, Essex, SS0 9NW,
Telephone: Southend-on-Sea (0702) 43355,*

(1306 M)

market

Microcomputer learning aid with free training

Now available from Cambridge Micro Computers Ltd. with full technical support and a free one-day training course, the SGS-ATES Nanocomputer is a microcomputer learning aid that can also be expanded to a full-scale industrial microprocessor system. The single-board Nanocomputer is based on the Z-80 microprocessor, and is supplied complete with a comprehensive training manual that starts from first principles, providing a full 'do-it-yourself' course in microprocessing.

The Nanocomputer uses a calculator-style hand-held hexadecimal data input and display station. Using the Nanocomputer, a student is able to design and study complete micro-computer systems, and a conversion kit and additional interface boards allow the system to be expanded to a full-scale CLZ80 micro-computer.

For tutorial use, the Nanocomputer can be interfaced with a low-cost audio cassette

recorder to store students' programs or pre-recorded teaching and experimental exercises. For further development, a range of boards is available to cover visual-display-unit, additional memory, PROM programmer, input/output and floppy-disk storage expansion. At the highest level, the upgraded micro-computer is supported by both Assembler and BASIC high-level languages.

The basic Nanocomputer system uses a Z-80 8-bit central processing unit with eight 4k x 8-bit dynamic random-access memory chips for program storage and 2 k bytes of EPROM storage for the operating system software. The main system signals on the Nanocomputer circuit board are all connected to multipin Euro-connectors to form an expansion bus structure, and these signals are used by the student to understand the micro-processor operation and perform computer-based experiments.

Two Z-80 PIO devices provide input/output interfaces. One PIO circuit is used to interface the hand-held keyboard/display unit and an audio cassette recorder or serial terminal and the other is available for connection by the user to experimental circuits or external equipment. All inputs and outputs are TTL compatible, with eight outputs capable of driving Darlington transistors directly.

The NC-Z operating system used by the Nanocomputer contains routines to display, on the 8-digit 7-segment display, the contents of any central-processor register, memory location or input/output port in hexadecimal form or to store any value entered on the keyboard. All input/output communication is software-generated, and programs can be loaded and dumped in a simple error-free format.

User programs loaded in the Nanocomputer's random-access memory can be executed by a software-based single-step command key. This executes the program instruction by instruction, and the central-processor registers, ports or memory can be displayed after each step, providing an invaluable debugging tool. Programs can also be executed at the full 2.5 MHz Nanocomputer speed, and return to the operating system can be made at any time, with the machine status saved for display. Built-in test programs are also incorporated.

To upgrade the Nanocomputer to a full CLZ80 microcomputer, a kit of components is available which includes a new software monitor program and provides sufficient hardware and software expansion to cover areas such as text processing and communications, data acquisition and retrieval, word processing and typesetting, machine control, automation and instrumentation.

Cambridge Micro Computers Ltd. is offering one-day 'hands-on' introductory courses based on the Nanocomputer at a cost of £40 (plus V.A.T.); the course is offered free of charge to every purchaser of a Nanocomputer.

*Cambridge Micro Computers Limited,
Cambridge Science Park,
Milton Road,
Cambridge, CB4 4BN
Tel.: (0223) 314666*

(1346 M)

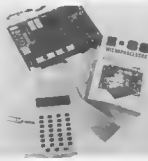

market

market WUSt.KGf

Frequency counter

A portable 100 MHz frequency counter, the MAX-100, equally suited to the needs of hobbyists or professional electronics users is available from Continental Specialties Corporation. The instrument's range can be extended to 500 MHz by the use of the PS-500 pre-scaler and a range of accessories and power supply options make the MAX-100 extremely versatile for laboratory, workshop or field use.

The unit gives continuous readings from 20 Hz to a guaranteed 100 MHz, and has a 0.6 inch high 8-digit LED readout. The input is sampled for one second with 1/4 second updates, and the crystal-controlled timebase has an accuracy of 3 parts in 10⁶. A high-sensitivity preamplifier gives readings from signals as low as 30 mV, and the input is diode protected to a peak of 200 V. The extreme left-hand digit flashes automatically when the input signal exceeds 100 MHz.

The MAX-100 can be used with a clip-lead input cable or an optional low-loss in-line

cable tap (for use with UHF connectors), and an optional 'mini-whip' antenna is available for use where direct coupling is not feasible. A choice of four power sources is available: internal battery; AC mains (110 or 220 V); a mobile 12 V DC supply; or an external DC supply. Battery-charger/eliminators are available for AC or 12 V supplies.

Applications for the MAX 100 frequency counter and the PS-500 pre-scaler cover all areas of electronics and communications and a detailed applications brochure is provided.

*Continental Specialties Corporation,
Shire Hill Industrial Estate,
Saffron Walden,
Essex, CB11 3AO.
Tel.: (0799) 21682*

(1342 M)

Texas bubbles

A family of physically and electrically interchangeable magnetic bubble memories with the largest capacity device having one-million bits of storage has been announced by Texas Instruments. Bubble domains for these new memories are two-micron diameter.

The first two devices — to be available as board-level systems — are the T1B1000, a binary megabit device organised as 512K x 2; and the T1B0500, a half-Megabit device with 512K x 1 organisation. In the second quarter

of 1980 a binary quarter-Megabit device compatible with the two larger devices will be available. The family approach will allow designers to vary system storage capacity by interchanging the bubble devices.

The T1B1000 has a maximum non-volatile storage capacity of 1,229,400 bits. A portion of this storage is used for redundancy handling and error-correction. The available data-storage capacity with error-correction capability is a full 128K bytes. It uses a block replicate architecture and is organised as two identical sections of 512K bits each. There are 300 minor loops per section with 2049 bits per loop. A page of data consists of bubbles from 256 of the loops. Of the remaining loops 18 are used for error-correction information, and as many as 26 are allowed to be defective. At 100-kilohertz bubble field frequency, the T1B1000 has an access time of 11.2 milliseconds. Data rate is 180K bits per second. All members of the new bubble memory family are packaged in a 24-pin 3.3 x 3.56 cm package with pins on 100-mil centres.

*Texas Instruments Limited,
Merton Lane,
Bedford, MK41 7PA.
Tel.: 0234 67466*

(1339 M)

Large area clock/panel meter LCDs

A series of large area liquid crystal displays has recently been announced by the Optoelectronics Product Group of Fairchild Camera and Instrument (UK) Ltd. They can be supplied in 3½ and 4 digit versions and are suitable for clock and digital panel meter display purposes. Digit height is 0.5 inches.



A colon is included for use when the displays are employed in a timekeeping mode and decimal point and polarity signs are provided for panel meter usage. Major features include a high reliability glass frit seal and use of a highly stable liquid crystal material. The 3½ and 4 digit versions are designated type FLB 3513 and FLB 4013 respectively. Operating voltage is 5 volts typical with a maximum drive current requirement, at 3 V with all segments on, of 5 µA.

*Fairchild Camera and Instrument (UK) Ltd,
230 High Street,
Potters Bar,
Herts, EN6 5BU.
Tel.: (0707) 51111*

(1340 M)



market WUSt.KGf

market

Remote temperature controller

The 6101 electronic temperature controller from CAL offers precise settings in the total span -200°C to $+1600^{\circ}\text{C}$. Nine standard ranges cover the most popular sectors, while others are available to order.

Despite measuring only $48 \times 48 \times 99$ mm deep, this miniature controller houses an output relay capable of directly switching a 3 kW resistive load (14 A, 220 V, 50 Hz). The controller comprises two separate units, the plug-in control section, and a remote bezel and dial giving great flexibility in mounting arrangements. The dial potentiometer is connected to the controller by a single, flexible lead.

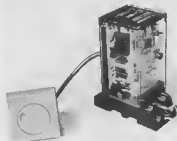

The use of proportional control techniques gives reliable accuracy (typically $\pm 1\%$) and the unit will accept thermocouple or PT100 inputs, two or three wire. A simple on/off control function is available to order. The standard DIN size 48×48 mm bezel is manufactured from self-extinguishing ABS coated in Nextel to give a tough finish coupled with dial clarity.

Controls & Automaton Limited,
Regal House, 55 Bancroft,
Hitchin, Herts SG5 1LL.

(1344 M)

3 more cases from Vero

The large range of moulded plastic enclosures available from Vero Electronics has been extended with the introduction of three new cases in black and gray high-impact polystyrene.

A desk top case measuring 228×216 mm, ideal for control equipment and keyboards, is available in two versions, one with a raised top unit for digital readouts, encoders and other switches. Both have a base section moulded with an integral rear panel to accommodate connectors and plugs. Also provided in the base are six mounting bosses with holes to take self-tapping screws. Top and base sections screw together and the kits come complete with aluminium front panels and fixing screws.

Measuring $150 \times 85 \times 45$ mm high, the other case has a spacious front panel for identification and controls, which are protected by a

raised edge all round. Assembly of components and connections to the front panel is simple as, with the case cover removed, components are accessible from all sides. The front panel is connected to the base by moulded posts and retained by the front cover. Mounting pillars are moulded into the base, and a raised edge surface is provided for cable grommets or components.

Vero Electronics Limited,
Industrial Estate, Chandler's Ford,
Eastleigh, Hampshire, SO5 3XR.
Tel.: (042 15) 69911

(1345 M)

market

Sub miniature microswitch

The series SSL is the latest, low cost, addition to the IMO/OMRON range of high quality small size microswitches. The SSL offers very small size with high contact rating of 5 A @ 240 VAC and exceptionally long life of 10 million operations. These miniature

switches ($10 \times 6.5 \times 19.7$ mm) are available in three operating styles. Plunger (SSL1), Hinge Lever (SSL1L) and Hinge Roller (SSL1L2). Construction is tough polycarbonate with stainless steel actuators for strength and improved life characteristics. Connection is via 0.5 mm thick terminal for PCB or solder connection.

IMO Precision Controls Ltd.,
349 Edgware Road,
London W2 1BS.
Tel.: 01-723 2231/4

(1354 M)

50 Metre Burglar Beam

A new Burglar Beam unit is now available from Photain Controls Limited, which is capable of detecting an intruder over any distance up to 50 metres. The unit can be mounted indoors or outdoors and will operate under all weather conditions other than those which produce an obscuration effect similar to that produced by an intruder. For example normal rain, snow or mist are completely ignored but a cloudburst, blizzard or dense smog would have the effect of reducing the effective operating distance.

Each unit comprises a transmitter and a receiver. The transmitter emits a pulse modulated gallium arsenide infra-red beam which is collimated to approximately 5° solid angular width. The receiver detector element comprises a special semiconductor device which operates in the passive mode and is therefore unaffected by any form of ambient light including direct sunlight. The device emits pulses relative to the pulses received from the transmitter and these are fed through a de-modulator circuit to the output relay. The relay is de-energised in the alarm condition to provide fail-safe operation.

Each unit operates from a 12 V DC supply with a current consumption of only 100 mA and all components are under-run to provide long life without maintenance. The units have a wide application as an intruder detector in all types of premises and also in storage yards, along security fences and across driveways or other entrances.

Photain Controls Limited,
Unit 18, Hangar No. 3,
The Aerodrome, Ford,
Arundel, West Sussex. BN18 0BE.
Tel.: Littlehampton (09064) 21531

(1350 M)



2 1/2 cms

Fruity box?

A new moulded thermoplastic box with card guides is now available from Hellermann Electronic Components. Named after the Roman goddess of fruits (?) the Pomona Model 4384 is moulded from glass filled nylon thermoplastic that is almost unbreakable. Three slots are provided to permit lengthwise mounting of 1/16" thick circuit boards. Boards can also be mounted horizontally. The box is available in black or blue and comes complete with cover and screws.

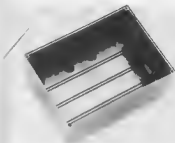

Maximum operating temperature is +102°C (+216°F).

Hellermann Electronic Components,
Imbarhorne Way,
East Grinstead,
West Sussex, RH19 1RW.
Tel.: (0342) 2123

(1355 M)

Small (!) resistance measurement

If your battery and bulb continuity checker is becoming the worse for wear it may be time to upgrade it. How about the Gould Advance A1100 automatic continuity tester which includes an additional facility for resistance measurement. This new equipment is designed for tests on cable harnesses used in the telecommunications and aerospace industries, where small spurious resistances can often have a critical affect on equipment operation.



To use the resistance facility, the operator first goes through all the test points with the normal automatic scanning function, which would indicate small resistances as open circuits, and then steps through the 'open' circuits manually. Resistance values up to 2kΩ are indicated on a front panel liquid-crystal display. Very useful for the home constructor but definitely not bench mounted.

Gould Instruments Division,
Roebuck Road,
Hainault,
Essex, IG6 3UE.
Tel.: 01.500.1000

(1338 M)

market

Sealed keyboards resist contamination

Sealed keyboards in 3 x 4 and 4 x 4 button configurations are now available from Grayhill INC., La Grange, Illinois. The keyboard surface and the contact system is sealed by a graphic overlay which resists the vast majority of common contaminants. These keyboards can be used out-of-doors as well as in applications that require a washable front surface. Called the GRAYHILL Series 88, these keyboards are flange mounted. A gasket seal that allows the keyboard to be sub-panel or topside mounted is available to provide complete sealing to the front panel.

Grayhill offers the 3 x 4 keyboards in the standard telephone legend plus colorful adaptations of the numeric telephone legend. The 4 x 4 keyboards are offered in colorful hexadecimal legends. An outstanding feature of the Series 88 keyboards is the availability of inexpensive custom legends. The coloration, legending, button shape, button outline, button grouping and keyboard outline can be easily customized to meet requirements of a front panel design.

The Grayhill Series 88 is offered with matrix, 2 out of 7, 2 out of 8, or single pole/common bus circuitry. The contact system is rated for 3 million cycles per button. A snap dome contact system is utilised to provide positive audible and tactile feedback to the operator. The Series 88 electrical character-

istics have been designed to be compatible with logic circuitry.

GRAYHILL, INC.,
561 Hillgrove Avenue,
La Grange, Illinois 60525.

(1351 M)

LCD thermometer

A pocket-sized LCD Platinum-RTD thermometer system has been introduced by Wahl International Ltd. The Heat-Prober Model 350XC has a range of -100° to 550°C with a 0.1° resolution and an accuracy of ± 0.5%. Features include 200 hours continuous operation from a replaceable 9 V battery, top of meter access to calibration potentiometers for quick and precise field adjustment, and a line of more than 20 interchangeable calibrated plug-in Platinum-RTD probes. The surface probe No. 145X (illustrated) has an articulated, spring loaded sensor tip for good surface contact and fast response.



The Heat-Prober thermometer system is ideal for quality control, plant maintenance, energy conservation, processing and laboratory applications for surfaces, liquids, powders and gases.

Wahl International Ltd.,
c/o BEAM Communications Ltd.,
117 Piccadilly,
London, W1V 9FJ.
Tel.: 01-491 3502

(1341 M)



market

Plastic case for portable electronic equipment

A grey plastic case designed to house portable, battery-operated electronic equipment is now available from Continental Specialties Corporation. The new CBP-1 case, which features a flip-down tilt stand and a separate moulded-in battery compartment, is ideally suited to housing transistor radios, transceivers, and instruments for field or benchtop use, as well as in audio equipment, business systems and computer peripherals.



The CBP-1 case, which measures 1.75 x 5.63 x 7.75 inches (44 x 143 x 197 mm), comes complete with a battery compartment cover, a red transparent plastic front panel, four rubber feet, all necessary screws, a power jack socket and two fitted switchplates.

Continental Specialties Corporation,
Shire Hill Industrial Estate,
Saffron Walden,
Essex CB11 3AQ.
Tel.: (0799) 21682

(1348 M)

UHF modulator

Astec have announced the availability of a new UHF high performance modulator, type UM128B. The modulator is intended for use in computer graphics or VCR applications. The vision carrier is pre-tuned to channel E36 (581.25 MHz). The integral sound sub carrier oscillator may be pre-tuned to 5.5 MHz or 8.00 MHz. Separate balanced modulator circuitry is used to provide excellent linearity and very low content of low unwanted mixing products. The colour sub-carrier/sound sub-carrier beat product is -55 dB with respect to carrier thus resulting in interference free pictures.

10 20 30 40 50 60 70



The UM128B is designed to operate from a 5.0 V \pm 10% supply and consumes only 9.0 mA. It is housed in a robust screened box measuring 71 mm x 37 mm x 20 mm that can be PCB mounted. RF output is via a co-ax socket.

Astec Europe Ltd.,
4a, Sheet Street,
Windsor, Berkshire.
Tel.: (07535) 55245

(1353 M)

market

Melodic chip

A new single-chip tunes synthesizer, which can be programmed to generate up to 28 different tunes, has been introduced by General Instrument Microelectronics Limited. Designated the AY-31350, the 28-lead N-MOS device operates from a single 5 V power supply, and is suitable for use in toys, musical boxes, doorchimes and other 'novelty' products. The chip is based on a standard GIM microcomputer circuit and will normally be mask-programmed during manufacture. Its repertoire consists of popular or classical tunes selected for their international acceptance. The standard circuit is pre-programmed with 25 short tunes plus 3 simple chimes, but this may be altered to suit the application. It is possible for instance, to program just a single tune of up to 251 notes. The chip can

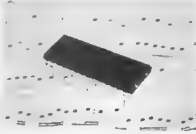

also generate tunes from data held in external PROMS, enabling different tune sets to be 'plugged-in'.

The AY-31350 may operate in a number of different modes, making it suitable for a wide variety of different applications. In a doorchime for instance, it can be connected to play any one of 25 pre-selected tunes from the front door bell push, with one of 5 tunes from the back door. In addition a third bell push can be wired to play a simple chime. All the tunes would be selected by switches or a matrix board inside the chime cabinet. The device also has applications in low cost paging systems, where key personnel are each allocated one tune. A brief tune played over loudspeakers in a noisy factory would be much easier to recognise than a spoken name. To conserve power, the circuitry may be connected so that when a bell push is activated it 'powers-up', plays a tune and then automatically powers down. Releasing the button and repressing would cause either the same tune to be played again, or the next tune to be selected, depending on the precise operational mode of the device. Alternatively, the circuit may be wired to replay tunes over again until the button is released. The pitch, tone and speed of tunes may be independently set by simple external components. These may be either preset or brought out as potentiometers as a user control. What now Avon?

General Instrument Microelectronics Ltd.,
Regency House,
1-4 Warwick Street,
London, W1R 5WB.
Tel.: 01-439 1891

(1343 M)

missing link

Modifications to
Improvements on
Corrections in
Circuits published in Elektor

Digital rev counter

Elektor 54, October '79, page 10-15. The binary outputs of IC3a and IC3b have been reversed on the circuit diagram. The outputs from IC3a should be taken from pins 3, 4, 5 and 6 (A, B, C, D.) while the outputs from IC3b should be taken from pins 11, 12, 13 and 14 (A, B, C, D.).

Metronome

Elektor 51/52, July/August 1979, page 7-06. One end of the potentiometer and the slider should be connected to +9 V, instead of supply common.

This kit
FREE
for new subscribers

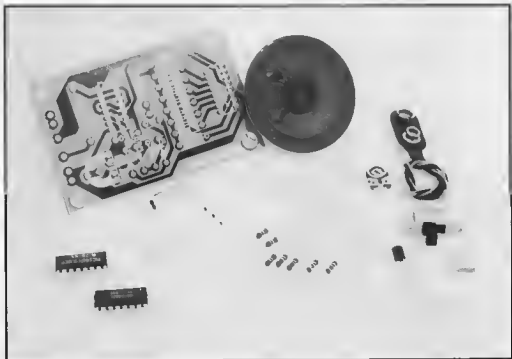

(offer valid until December 31st 1979)

A complete kit (including loudspeaker) for the simple sound effects generator will be sent free to all new subscribers. This offer is valid for all applications postmarked up to and including December 31st 1979.

As the name suggests, the simple sound effects generator will produce a range of sounds from that of an American police siren to one closely resembling the 'twittering' of birds.

You can become a subscriber by filling out the order card included in this issue and including the text 'subscription and free kit'. The kits will be sent out at the end of January.

elektor

up-to-date electronics for lab and leisure

Elektor House,
10 Longport,

Canterbury, Kent.
Tel. (0227) 54430.

The NEW Marshall's 79/80 catalogue is just full of components

and that's not all . . .

... our new catalogue is bigger and better than ever. Within its 60 pages are details and prices of the complete range of components and accessories available from Marshall's.

These include Audio Amps, Connectors, Boxes, Cases, Bridge Rectifiers, Cables, Capacitors, Crystals, Diacs, Diodes, Displays, Heatsinks, ICs, Knobs, LEDs, Multimeters, Plugs, Sockets, Pots, Publications, Relays, Resistors, Soldering Equipment, Thyristors, Transistors, Transformers, Voltage Regulators, etc., etc.

Plus details of the NEW Marshall's budget Credit Card. We are the first UK component retailer to offer our customers our own credit card facility.

Plus — Twin postage paid order forms to facilitate speedy ordering.

Plus — Many new products and data.

Plus 100s of prices cut on our popular lines including ICs, Transistors, Resistors and many more.

If you need components you need the new Marshall's Catalogue.

Available by post 65p post paid from **Marshall's, Kingsgate House, Kingsgate Place, London NW6 4TA**. Also available from any branch to callers 50p.



Resale Sales, London: 40 Crocklewood Roadway, NW2 3ET. Tel: 01-452 0161/2. Also 325 Edgware Road, W2. Tel: 01-723 4242. Glasgow 35 West Regent Street, G2 2DD. Tel: 041-332 4133. And Bristol: 108A Stokes Croft, Bristol. Tel: 0272 426801/2.

PORTABLE PRECISION

A range of 3½ digit LCD multimeters offering high precision and extended battery life. All feature 0.5" LCD read-out with 'battery low' warning, inputs protected against overloads and transients, Auto-polarity, Auto-zero, rugged ABS cases and a full 1-year warranty.

The LMM-200 is a compact handheld multimeter with 0.5% basic accuracy and 15 different ranges. It measures voltage from 0.1mV to 500V, current from 0.1µA to 2 Amps, and resistance from 0.1Ω to 2MΩ.

The LMM-2001 is an identical multimeter but with 0.1% basic accuracy.

The LMM-100 has an adjustable handle, a 2,000 hour battery life and is ideally suited to field or bench use. It measures voltage from 0.1mV to 1KV, current from 0.1µA to 2 Amps, and resistance from 0.1Ω to 20MΩ. 0.1% basic accuracy.

Lascar Electronics Ltd, Unit 1, Thomasin Road, Basildon, Essex. Telephone No. Basildon (0266) 727363.

	£	P & P	VAT	TOTAL
LMM-200	34.95	1.00	5.39	41.34
LMM-2001	44.95	1.00	6.89	52.84
LMM-100	69.95	1.50	10.72	82.17
TEST LEADS	1.95	0.25	0.33	2.53

To: Lascar Electronics, Unit 1, Thomasin Road, Basildon, Essex.

Please send me Data

LMM-100 £82.17 LMM-200 £41.34 LMM-2001 £52.84 TEST LEADS £2.53

Name _____

Address _____

Tel No _____

include cheque P.O. order