

elektor

53
September 1979

U.K. 55p.

U.S.A | Can. \$1.75

high fidelity at home

flatten your living room with an equaliser



Wunder Stoff

Austria S 150* Austria S 36 Denmark Kr 10 Germany DM 4 20 New Zealand \$ 1 50 Sweden Kr 14
* recommended Belgium F 59 France F 8 Netherlands DFL 3 50 Norway Kr 10 Switzerland F 4 40

MAGPLIN



A 63-key ASCII keyboard with 625-line TV interface, 4-page memory and microprocessor interface. Details in our catalogue.



Our catalogue even includes some popular car accessories at marvellous prices.



A 10-channel stereo graphic equaliser with a quality specification at an unbeatable price when you build it yourself! Full specification in our catalogue.



These are just some of the metal cases we stock. There are dozens of plastic ones to choose from as well. See pages 52 to 57 of our catalogue.



A massive new catalogue from Magplins that's even bigger and better than before. If you ever buy electronic components this is the one catalogue you must not be without. Over 290 pages, sumo-size full colour - it's a comprehensive guide to electronic components with hundreds of photographs and illustrations and huge other usage of available data.

Magplins 1979-80 catalogue available prices call after and all the latest news from Magplins.



Mobile amateur radio, TV and FM aerials plus lots of accessories are described in our catalogue.



A digitally controlled stereo synthesiser the 5600S with more facilities than almost anything up to £3,000. Build it yourself for less than £700. Full specification in our catalogue.

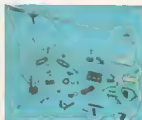

A superb range of microphones and accessories at really low prices. Take a look in our catalogue - send the coupon now!



An attractive mains alarm clock with radio switching function and battery back up! Complete lot with case only £15.92 (incl. VAT & p & p) MA1023 module only £8.42 (incl. VAT).

Post this coupon now for your copy of our 1979-80 catalogue price 70p.

Please send me a copy of your 280 page catalogue. Enclose 70p (plus 17p p&h) if I am not completely satisfied I may return the catalogue to you and have my money refunded if you live outside the U.K. send £1.35 or ten International Reply Coupons.

Enclose £0.70

NAME _____

ADDRESS _____

_____ E979



A superb technical bookshop in your home! All you need is our catalogue. Post the coupon now!



A hi-fi stereo tuner with medium and long wave, FM stereo and UHF TV sound! Full construction details in our catalogue.



Add-on bass pedal unit for organs. Has excellent bass guitar stop for guitarists' accompaniment. Specification in our catalogue.

MAGPLIN

ELECTRONIC SUPPLIES LTD

All mail to:-
 P.O. Box 3, Rayleigh, Essex SS6 8LR.
 Telephone: Southend (0702) 554155.
 Shop: 284 London Road, Westcliff-on-Sea, Essex
 (Closed on Monday)
 Telephone: Southend (0702) 554000

elektor

53

contents

september 1979
 volume 5
 number 9

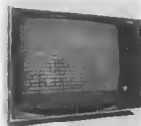

page 9-18

A display of 16 lines of 64 random characters may look impressive, but in practice the corresponding memory capacity is somewhat restricting. Even a simple BASIC program will require more space. For this reason, the page extension for Elektorterminal should prove a useful addition.



page 9-26

Use of a parametric equaliser allows the frequency response of a domestic hi-fi setup to be tailored to a degree previously only attainable in recording studios. One section in particular should prove of interest to a great many readers: the parametric tone controls, with adjustable turnover frequencies.



'Flatten your living room with an equaliser'. Great, but how? The bulk of this issue is dedicated to descriptions of the necessary hardware, and how to use it in practice.

elektor 9-01

using an equaliser 9-04

Although there are many different types of equaliser, they all perform the same basic task, namely the correction of deficiencies in the frequency response of one's speaker system and/or listening environment. As such they represent an extremely useful tool in the quest for 'perfect' hi-fi. Unfortunately, however, equalisers are all too often misused, and in extreme cases actually do more harm than good. This article takes a look at the various types of application for which equalisers are most suited, and also explains how to get the best out of this versatile instrument.

monitor output 9-17

page extension for Elektorterminal 9-18

With the aid of the extension board described, the memory capacity of the Elektorterminal can be expanded to 4 pages each of 16 lines x 64 characters.

one-til for audio 9-22

The advent of digital audio has produced quite a few surprises: digital designers discovered that only by pushing to the very limit of their capabilities could they meet the performance standards commonly set by conventional analog equipment; analog designers, on the other hand, were surprised to discover that digital equipment could sound so good. In this article, both of these 'surprises' are examined. How can digital audio work so well, and why is it so difficult to get it to work in practice?

parametric equaliser 9-28

A combination of state-variable filters and a highly specialised Baxandall tone control network is used in the 'parametric' equaliser described in this article, which offers considerable advantages over the more common 'graphic' equaliser.

applikator 9-34

Heavy stuff: audio at 200 watts

audio analyser 9-38

Without an accurate picture of the frequency response of the sound reproduction system, the use of an equaliser can do more harm than good. For this reason an audio spectrum analyser, which can pinpoint the deficiencies in a particular audio chain and/or listening environment, is a virtually indispensable piece of equipment for the equaliser-user.

TAP thieves on the head (E. Schöfer) 9-45

ejektor 9-46

Self-oscillating PWM amplifier.

market 9-49

advertisers index UK-30

Into the bio-electronic age

The fight for dominance in information technology is little appreciated by politicians or understood by the man in the street. But Europe should have no illusions about what is at stake, says Douglas Stevenson, vice president ITT and group executive, components and semiconductors. The age of biocomponents, where man can operate machine by thought alone, is very near. . . . Fifty years ago was not a good time for forecasters. In early 1929 most of them were still optimistic about the New York stock market. By October the crash had come. The world was not to emerge from the Depression until World War II. Had I been making a forecast in 1929

selektor
SELEKTOR

about the development of electronic components, I too would have been wrong. Most of the basic circuit elements like resistors, capacitors, inductors, the electron tube, the cathode ray tube were known. In no way, though, would I have forecast the development of semiconductor technology. Yet the transistor was less than 20 years away! Since then the pace of development has speeded up. Things change so rapidly that the period we can forecast with any degree of certainty gets shorter. Nevertheless, certain trends can be projected and others predicted. For example, the number of people employed in the electronic components industry will continue to shrink. At the same time, the fewer people will be developing and producing a greater variety and a greater volume of components. It is important to distinguish between volume and value. In real terms the total industry will grow in value over the next decade by no more than five per cent per annum. In physical terms though the number of functions that will be performed will increase in the order of 20 to 30 per cent a year. Electronics will play a much greater part in our lives.

Towards a leisured society

Look at domestic applications. Most labour-saving devices in the home are based on a 19th century development, the electric motor. It has been the major technical factor in removing the domestic servant from our society in such great numbers. Today, households that would never contemplate the employment of a servant have several labour-saving devices, which are no more than concealed fractional horsepower motors: vacuum cleaners, washing machines, driers, polishers, mixers, fans, pumps, lawn mowers, power tools. Essentially these all lighten physical effort. The impact of electronics in the

home has so far largely been in making life more pleasurable. It has been an entertainment medium — appearing in the form of radio, television, hi-fi sets, recorders and, more recently, video games.

A recent development, the pocket calculator, is a pointer of things to come. The enormous growth area is in computing: all the processes involved in the storage, handling, transmission and display of information. The number and power of these processes will increase in the home, and more so, in industry and commerce.

Electronics will make our lives easier by taking over the job of remembering many simple but necessary things, doing what has to be done at the right time. An example not far away is the pre programming of family television viewing. It is possible to produce an edition of the *Radio Times* with bar-encoded programme references. A week beforehand, say, the viewer can select the programmes he wants to see and, with a light pen, scan the encoded references. These will be stored by the TV set, which will switch on and off automatically when the time comes.

That is one simple application that within the next decade we shall come to accept as the normal way of organising part of our relaxation. Our present methods will seem quaint. Another application already growing is in security systems. These range from individual programmed locks to complete surveillance, checking and alarm systems.

selektor
SELEKTOR

The future though is not so much in individual applications as in integrated systems. There will be home automation systems compact enough to go under the stairs or take up little room in a cupboard. They will do everything from controlling lighting, central heating and other appliances like cookers and washing machines, to providing meter readings for electricity, gas and water. We can already see in Prestel the home linked to the outside world by a combination of the telephone and the TV set. Without stepping outside the house one

selektor
SELEKTOR

can consult a computer-based data bank for up-to-the minute facts and figures on all sorts of services. Linking a home automation system with the telephone and the TV set, we shall have the essential elements of recording, control, transmission and display of information. Many of our activities that now involve going out in all weathers, finding a place to park, battling with the crowds, even staying away from home, will in future be accomplished from our own armchairs.

These systems will be based upon the very low-cost computing power that the microprocessor offers. This will give tremendous impetus to the development of automatic systems. The technology is available now to take us through the next 10 to 15 years. The question is one of application.

An energy-dependent world

Developments like this are not simply a move towards a more leisured or



lazier society, depending upon your point of view. They are an economic necessity. Every day it becomes clearer that the turning point of the 1970s was the sharp increase in oil prices at the end of 1973. That brought home to us the value of energy, the fact that the world's resources were finite and had to be conserved. People had to adjust to the fact that the high growth rates of the 1960s were no longer possible. Electronics has two contributions to make. Apart from saving power, electronics also make possible a completely new approach to a problem. There is a world of difference between physical communications and telecommunications. It is much easier and cheaper to communicate information than to transport people, be they suburban commuters or supersonic day-trippers to New York. As the cost of labour rises and, in real terms, telecommunications charges fall, so it will be cheaper to have home meter readings impulsed over a line rather than taken by a human reader. The postman could disappear in favour of a home facsimile.

selektor

The energy factor cannot be underestimated. At the end of the century there will be an energy gap, which could lead to international and social instability, and a resulting cataclysmic nuclear war would not be impossible. In time, the gap has to be filled by safe fusion energy. There might be a period between the two, 10 years or so, when the future of the world hangs in the balance.

The new industrial revolution

What then are the relative futures for discrete components and integrated circuits? So much has been said recently about integrated circuits, microprocessors in particular, that discrete components would seem to have a distinctly limited future.

In real terms they will continue to grow up until about 1985. Decline — but not in power elements — should then take place. It will be a slow process. By the turn of the century I foresee demand for discrete components in physical terms being about 75 per cent of what it is today but, although volume will be down, value will be up. The components industry will continue to develop along lines of greater integration in a broad sense of the term. We have seen components become circuits, become a system, become a system that is programmable. We have to think more and more in terms of sub-systems.

The major component manufacturers have already entered the sub-system fields and even gone into complete systems. Examples are the complete

Position of Japan's Electronic Industry in the International Market

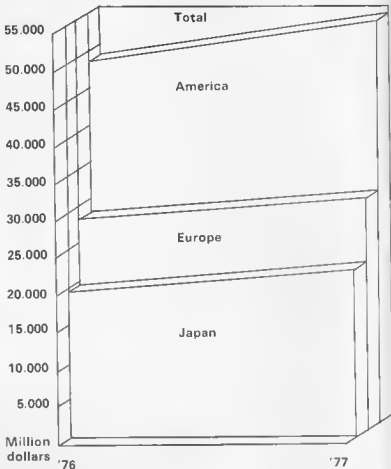

driver units for ground-to-air missiles, which are complex quasi-systems in their own right. This trend will continue wherever the basic technology is interdependent with the function of the total system. You cannot separate the two.

Any component that provides an interface with a human being, or acts as a power unit, has an indefinite future. Into these categories come items like push button switches, displays, power units, motors — be they linear or rotating. Human beings are not going to diminish in proportion to microelectronics. They have to receive and communicate information. Similarly, to interact with the real world, miniature devices will still have to have their powers amplified and directed.

On the other hand discrete passive components will decline. Included in these are the discrete resistor, inductors and the low capacity capacitor. Many of the functions performed by these passive devices can now be simulated cheaply by active elements in a semiconductor.

To survive in circumstances of rapidly developing technology, changing product

mixes and shifting price structures, manufacturers are going to have to get their forecasts right, if not the first time then very quickly the second. The major process of survival of the fittest — and in the fight no manufacturer can assume

selektor

he is a natural survivor — should have taken place by the early 1990s.

The Japanese will make every attempt to get the same control of the industrial and professional sectors of electronics that they have achieved in consumer electronics worldwide. That will be the major political factor in the industry over the next 10 to 15 years. It is different in kind from a commercial battle over the manufacture of items like motorcycles and cars or the construction of supertankers. It is nothing less than a fight for dominance in the whole area of information technology, which is the key to everything else. The

Japanese understand very well the interdependent triangle of the future, survival and technology/political power - and will act accordingly. The Western World has to have no illusions about what is at stake.

This, I believe, is understood at industrial senior management level but not fully appreciated at top political level and hardly at all by the man in the street. Manufacturing capability in ISI and the ability to apply low-cost computing power means nothing less than a new industrial revolution. It is the absolute cutting edge of technology in the world today, whether it's going to end up with the control of chemical plants or sophisticated toys.

On a practical working level, the industry will concentrate into massive units developing and manufacturing components. In 50 years' time, some 30 per cent of these units will be produced in Japan, some 40 per cent in the US, and selected areas of Western Europe will account for another 30 per cent. The secondary technologies will increasingly go off-shore.

selektor 201979

The totally integrated specialist

In the fight for survival, the vulnerable companies will be medium-sized, those that have neither the resources and the mass markets of the large nor the skill and flexibility of the specialist manufacturer. There will be no place for, say the specialist manufacturer of a high-quality microwave or optical device turning over in current values up to \$20 million a year. To survive he will have to have an edge with his technology and do superbly well at it. If I were looking for a secure long-term pension, I would not invest in a manufacturer turning over less than \$200 million in a product spread.

The future profile of the distribution of company sizes will be double-humped, with some level and very uneven ground in the \$20 - \$200 million area. There, it will be very difficult to support the R + D, the capital investment, the marketing. As a simple example, a set of tools just to make a colour TV tube, which can be regarded as a medium-technology product, currently costs \$6 million. Twenty years ago it was possible to survive by making 50,000 tubes a year. Today a break-even figure is about two million. For any hope of industrial survival, we shall have to maintain technology in depth. That means deciding which technologies we have to be in. These must be the primary technologies. We have to maintain at least parity with our

competitors in these. In other technologies, those of secondary importance, it will be necessary to maintain a capability to bring into being, if need be, a reserve of industrial muscle. The EEC might declare to the Japanese that it is not going into the production of certain devices, but that it will maintain the capability so that Europe is not held to ransom.

A possible limitation on our ability to do so will be the scarcity of truly creative physicists and engineers. We may well lack manpower of the right calibre and in the right numbers. Just as there will be totally integrated systems, so there will be totally integrated engineers and physicists. By the turn of the century, individuals will need to possess integrated disciplines to be able to design systems. The equipment will demand a human being who correlates 100 per cent with it.

In the production of electronic components we shall see the elimination of the man on the shop floor - except for maintenance purposes. Within 20 years, no unskilled people will be used in the electronics industry. With totally controlled environments there will not even be a need for people to sweep the floor.

On the other hand, there will be a heavy capital investment in machinery, which will be making products with a short life cycle. Fault diagnosis will be done by computers. Again, systems will be integrated and of such a complexity that only a few large organisations will be able to afford them.

A profound change in work

Output will be in such volumes that it will have to have assured markets. Producers will lock into their customers. One will adopt the other. Small companies will have to interface with their customers on a continuous basis. Once again the word is integration. Technological developments of this kind and magnitude are going to mean profound changes in society. The pattern of work will change. A great reduction of working hours is unlikely.

selektor 201979

We shall not see the 30 hour week in the next five decades.

A component we do not yet have but would dearly love to develop is one that can convert sunlight, not into power as a solar cell does, but into chemical energy as do organic living species. This involves producing artificial membranes in the laboratory containing compounds which perform specific or even analogue functions. In ITT work is already being done on membranes that can separate negative

selektor 201979

and positive charges. Thus, by distinguishing ions, these membranes could have very practical applications as storage elements or in pollution control. They could carry out simple tasks like sensing and filtering anything from a toxic atmosphere to a very low concentration of impurities. They could do this with an efficiency and accuracy that is beyond the scope of current physical methods. Super-clean environments are possible.

Developments of this kind are only the start of translating biological functions into other useful energies or actions. This enormous area will be the next great stage in the evolution of components. The sort of thing I have in mind is photosynthesis on a large scale, the equivalent of a plant taking in sunlight and moisture - and growing. Another example of the efficient storage and transmission of energy. Electronics will move into bio-engineering, bio-physics and bio-chemistry. We accept as an everyday fact that we can synthesise the human voice. So why not food for a hungry world?

Going even further, why not connect a human being directly to a computing system? I do not believe it is beyond the bounds of possibility that the output of a human brain can be directly fed into a computer. What an amplification of mental power! And without going through any software. A considerable amount of mathematical analysis has already been done on the brain. The missing link is the bio-component or subsystem.

This would take electronics into neurology. Such an advance could speed up developments in an undreamed of way. At present we are obliged to use software, a stage that may occupy many man-years in translating a sequence of precise, detailed instructions acceptable to an unthinking machine. There is a shortage of software people. Hence the implementation of projects gets delayed.

It is an enormous problem. If we could have a direct human connection to the computer how much simpler life would be. We already have artificial limbs and fingers actuated by brain signals. With an organic interface a person can place his fingers on a sensor and pass 'thought' signals to instruct equipment.

By the end of this century, we shall see the first bio-electronic components and subsystems performing, at the very least, basic functions like separation and storage. Direct connection of man and machine belongs to the 21st century.

(ITT Profile)

The great advantage of an equaliser is that, unlike conventional bass and treble tone controls, which can provide only a fairly limited amount of boost or cut at the extremes of the audio spectrum, it is possible to iron out (equalise) peaks or dips in a response over the entire range of audio frequencies. Not only that, but with a *parametric* equaliser, the centre frequency, Q and gain of the equaliser filters can all be tailored to exactly compensate for non-linearities in the response of any given system.

Although the use of equalisers was originally limited to professional sound recording studios, their undoubted benefits have led to an increasing number of amateur applications: dedicated hi-fi enthusiasts, having lavished considerable attention and expense on cartridges, pick-up arms, turntables, amplifiers and loudspeakers, are now resorting to equalisers to 'upgrade' the last link in the audio



using an equaliser



chain, namely the listening room.

Unfortunately, however, many amateurs fail to make the most of the facilities offered by a sophisticated parametric equaliser, and simply end up using it as a sort of 'super-duper' tone control, twiddling the knobs to get a bit more bass here, less treble there and so on. This article is therefore intended to provide a few insights on how to achieve effective room equalisation, whether it be for domestic or PA-system applications.

Equalising your living room

In recent years the subject of room equalisation has become something of a fad. Various audio design consultants and well-known manufacturers of audio equipment have conducted extensive research into the response of domestic listening environments. Bruel and Kjaer, for example, offer a comprehensive measurement and equalisation system for listening rooms, whilst Philips loudspeakers are specially designed to compensate for the deficiencies of the 'average living room'. The subject of room equalisation, with particular reference to the effect of the placement of loudspeakers, has been discussed in a spate of recent articles, and numerous hobbyist magazines have produced designs for (graphic) equalisers. There is no doubt that people are now generally aware of the effect of the shape and contents of the listening room on the reproduction of the audio signal.

That the room has considerable effect is hardly surprising, especially when one considers how much care and attention is paid to the internal construction of loudspeakers (bracing ribs, damping

Although there are many different types of equaliser, they all perform the same basic task, namely the correction of deficiencies in the frequency response of one's speaker system and/or listening environment. As such they represent an extremely useful tool in the quest for 'perfect' hi-fi. Unfortunately, however, equalisers are all too often misused, and in extreme cases actually do more harm than good. The following article takes a look at the various types of application for which equalisers are most suited, and also explains how to get the best out of this versatile instrument.

1

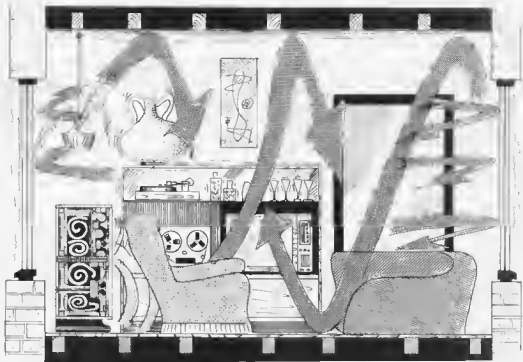

Figure 1. Considerably more attention is spent on the internal design of loudspeakers than on the interior of one's living room, despite the fact that the latter has a profound effect upon the sound of the music signal being reproduced.

materials, air-tight seals etc.): in a sense, the listening room is simply a giant loudspeaker cabinet, in which the listener sits. However, as a rule little or nothing is done to improve the response of the room. Of course it is possible to take such steps as to change the curtains, fit wall-to-wall carpeting, experiment

with different loudspeaker placements, swap the furniture around etc. Although whether the living room will remain liveable-in is another question!

A simpler solution to the problem of 'upgrading' your living room is to employ an equaliser, which will compensate for the inherent deficiencies

in the room's frequency response.

Assuming, for example, that the room in question has the response shown in figure 2a. Using an equaliser the response of the audio system can be tailored to look like that shown in figure 2b, i.e. the inverse of the room's response, with peaks at 1600 Hz and 4 kHz, dips at 50

2

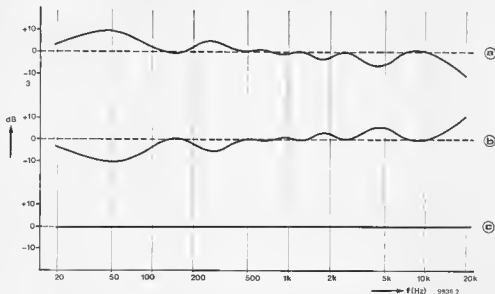
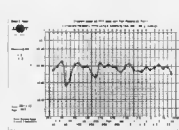
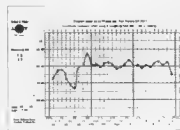
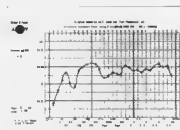
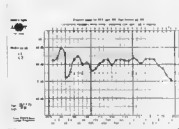
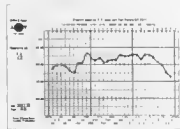
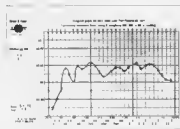
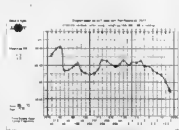
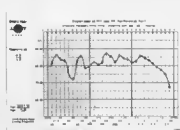
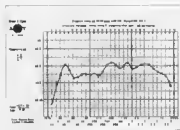
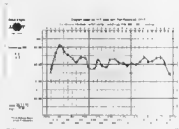
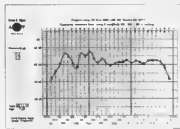
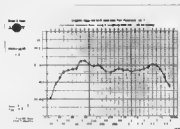
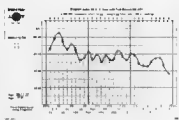
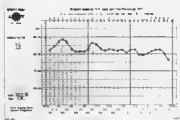
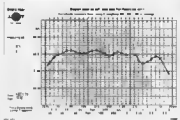

Figure 2. An example of how, in principle, it is possible to obtain a uniform frequency response with the aid of an equaliser. The irregular response of figure (a) is smoothed out by setting up the inverse response (shown in figure (b)) on the equaliser filters. The result (figure (c)), in theory at least, is the desired perfect reproduction.



A page from Bruel and Kjaer application note 13-101, which throws an interesting light on the topic of room acoustics. The frequency responses shown here were measured using 5 different loudspeakers, set up in 3 different living rooms.

3

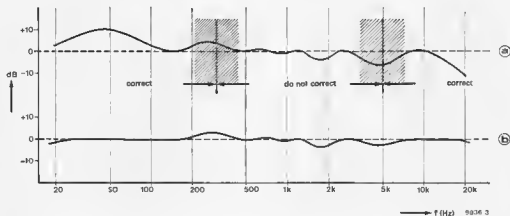

Figure 3. In hi-fi applications it is neither necessary nor indeed advisable to attempt to iron out every single peak and dip in the response. In particular, the band of mid-range frequencies between approximately 300 Hz and 5 kHz is best left untouched, so that the resultant corrected response will look something like that shown in figure 3b.

and 250 Hz and treble boost above 10 kHz. Thus, in theory, the resulting combined frequency response (i.e. that which, so to speak, reaches the ears of the listener) should be the perfectly flat line shown in figure 2c.

Unfortunately, however, as one might expect, things are not quite so simple in practice. The situation is complicated by the fact that the signal which reaches the listener is a mixture of direct and indirect sound. The direct sound is that which travels straight from the loudspeakers to the listener's ears, whilst the indirect sound is that which has first been reflected off the walls, ceiling, floor and furniture. It is the indirect sound, therefore, that is 'coloured' by the acoustics of the rooms. This fact has two consequences:

The relative proportions of direct and reflected sound will vary at different points in the room. Due to path length differences between the direct and indirect signals, either phase cancel-

lation or phase reinforcement may occur, creating nodes and anti-nodes at different locations in the room. For this reason it is only possible to equalise the frequency response of a particular listening position. If that position is altered the frequency response will have altered also.

Secondly, the human ear responds differently to direct and reflected sound, particularly at frequencies within the vocal spectrum between roughly 300 Hz and 5 kHz. The direct sound is recognised as the primary factor determining the 'quality' of the sound source, whilst the reflected sound provides information relating to the listening environment. Excessive equalisation can therefore lead to highly undesirable results, namely strong colouration of the direct sound in an attempt to compensate for a reflected signal heavily influenced by the room acoustics. As already mentioned, careless or over-enthusiastic use of an equaliser can do more harm than good. However the prospective user should not be put off by this fact, since an equaliser can offer tangible benefits to the hi-fi enthusiast who, for practical reasons, is constrained to listen to his system in a small and acoustically-poor room, with his speakers positioned in non-ideal locations.

The advantages of an equaliser can be illustrated by taking a closer look at the frequency response of a typical living room, as shown in figure 2a. The same curve is shown again in figure 3, with several 'critical' areas emphasised. For the band of frequencies from roughly 300 Hz to 5 kHz, the golden rule is 'leave well alone' (assuming that it is the acoustics of the room and not deficiencies in the response of the loudspeakers which are responsible for irregularities in the response). However peaks and dips in the response which

occur at frequencies outside this band can be flattened out with the aid of an equaliser; at frequencies which are at the junction of these regions (i.e. around 300 Hz and 5 kHz), limited equalisation may be useful in certain cases. What this means for the response curve of figure 3e is this:

- the prominent resonance at around 50 Hz can be completely eliminated (that this also results in an improvement of approximately 10 dB in the signal-to-noise ratio is an added bonus).
- The smaller peak at around 250 Hz lies in a transitional area, thus partial equalisation is possible, if desired. The most sensible procedure is to audibly compare the results obtained with and without equalisation.
- The barely perceptible 'bump' at 150 Hz is really too small to be worth considering; furthermore it lies right in the middle of the critical mid-range of frequencies and should therefore be left untouched.
- The dip at around 1600 Hz is likewise inside the critical vocal spectrum which should be avoided.
- The somewhat larger dip at approximately 5 kHz straddles the second crossover area, thus once again a partial or limited equalisation may prove worthwhile.
- Finally, the roll-off in the response above 10 kHz can legitimately be corrected with the equaliser; care should be taken not to apply excessive amounts of boost, however, since there is the danger of damaging one's tweeters (!)

After the above corrections have been carried out (and assuming that the dip at around 1600 Hz is the result of the room acoustics and not one's loudspeakers), the overall response which is obtained, should look something like

4

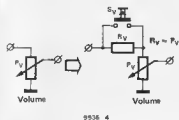

Figure 4. In most cases it is a relatively simple affair to incorporate a switch selectable 6 dB attenuator into a P.A. system. A resistance R_V of approximately the same value as the volume control (P_V) is connected in series with the latter, and a pushbutton switch S_V is then connected in parallel with the resistance.

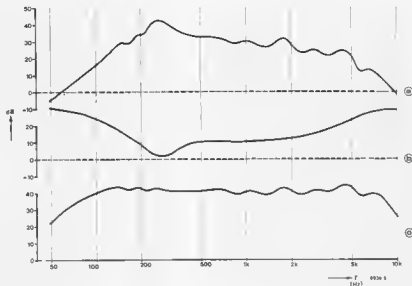

Figure 5. The frequency response of P.A. systems is frequently fairly poor. That shown in figure 5a is a typical example. With relatively simple equalisation, however, (figure 5b) one can obtain a response like that shown in figure 5c, which in practice improves the quality of reproduction to a quite amazing degree.

that shown in figure 3b — and hopefully there should be a correspondingly discernible improvement in the resulting sound!

As the above example illustrates, it is not necessary to make a large number of corrections in order to obtain an 'acoustically' flat response. All that is required in this example is a circuit to provide treble boost, and three variable resonance filters — in fact those facilities offered by the type of parametric equaliser described elsewhere in this issue.

The following paragraphs describe how to go about actually setting up an equaliser for optimum results in a variety of practical situations.

P.A. systems

P.A. systems used in conference halls and auditoria are usually installed by professionals. However there are many situations such as local community meetings, school prizegivings etc. where smaller halls have to be set up acoustically by comparative 'amateurs'.

The most common problems encountered in this type of case are 'lack of intelligibility', 'not loud enough', and persistent acoustic feedback. Before explaining the main causes of these problems a few preliminary remarks on the nature of P.A. systems would not go amiss. The primary aim of a P.A. system is not to achieve 'high-fidelity' reproduction, but rather optimum intelligibility. Unfortunately, in practice this is often confused with maximum volume. Of course, in some cases intelligibility can be improved by bumping up the

volume, but it is often true, particularly in badly designed or wrongly set-up systems, that increasing the output from your speakers simply produces the dreaded acoustic feedback or 'howlround'. One must therefore attempt to (a) make the system less susceptible to feedback, and (b) search for other ways of improving intelligibility than simply winding up the volume control.

To take the problem of acoustic feedback first: most people know that this irritating phenomenon is caused by sounds from the loudspeakers being picked up — either directly or via reflections off the walls, ceiling, etc. — by the microphone(s). These are then amplified, fed back to the loudspeakers, only to be picked up once more by the microphones, and so on until a nasty high-pitched howl is produced (hence the name 'howlround'). In order to increase the volume without provoking this unpleasant effect, the only answer is to ensure that less of the loudspeaker signal is picked up by the microphone(s). This can be done in several ways:

- by using directional (cardioid) microphones, which are less sensitive to sound from the rear.
- by using loudspeakers which also have a directionally dependent response. It is probably not so well known that cardioid loudspeakers exist. By positioning these with their backs to the microphones, acoustic feedback can be considerably reduced.
- by not positioning the loudspeakers right next to the microphones. This

may appear rather an obvious point, but it is surprising how many people fail to observe this elementary precaution.

- by setting the output level of those speakers which are nearest the microphones lower than that of speakers situated further down the hall. Many loudspeakers already have a facility for reducing the output level; in those that do not it is a simple matter to incorporate a small value series resistor to provide the desired level of attenuation. This step may at first appear a little self-contradictory, however it allows the amplifier volume to be turned up without significantly increasing the feedback signal to the microphones.
- at any given time, do not have more microphones switched on than is necessary. If there is only one person speaking, then one microphone is all that is required. Switching additional mikes on will simply increase the chance of feedback.
- ensure the volume control is adjusted correctly! This may also appear to be rather an obvious point, but in practice it is often more difficult to observe than it may seem. The following couple of tips should help:
 - acoustic feedback is more liable to occur in an empty hall than in a full one. For this reason it is often sufficient to adjust the volume control so that the system is just on the point of 'howlround', with an empty hall. Once the hall has filled up the volume setting should prove spot-on.

The difference between a correct volume setting and one which is just on the verge of howlround is about 3 to 6 dB. It is often possible to tell when a system is on the verge of howlround by the fact that it sounds decidedly 'echoey' — the effect is slightly similar to that obtained with artificial reverberation units. One can capitalise on the above fact by incorporating a switched 3 to 6 dB attenuator in series with the volume control (see figure 4). With the attenuator switched out of circuit, one first adjusts the volume control unit the P.A. system just starts to howl-round (bear in mind that acoustic feedback builds up gradually), then one simply switches in the attenuator, and the system should be ready for use.

Once acoustic feedback has been reduced to a minimum, the next step is to attempt to increase the intelligibility of the P.A. system without recourse to the volume control. There are basically two main ways of doing this: reduce the amount of reverberation generated in the hall, and improve the quality of the sound itself. The former point basically boils down to improving the acoustics of the hall by installing heavy curtains, thick carpeting, etc., and unfortunately is normally fairly expensive. The second measure, i.e. improving the reproduction of the speech signal is where electronics, in the shape of an equaliser, come in. It is not generally appreciated that the quality of the reproduced sound signal plays an important part in determining its intelligibility. It has been proven time and again in practice that a flat frequency response over a reasonably wide spectrum — roughly 100 Hz to 10 kHz — will lead to a considerable improvement in the intelligibility of the average P.A. system. Unfortunately, however, there are a number of prevalent misconceptions regarding the ideal frequency response and how to obtain it. These have led to the appearance of such monstrosities as bass cut 'speech switches' which roll off the response below 200, 300 or even 400 Hz, special 'speech' (loudspeaker) cabinets, which often have a truly horrific response, and speech microphones (whose response is sometimes little better than that of the loudspeakers). All that is needed is for the bass tone control on the amplifier to be set to minimum and the 'presence filter', which, more likely than not, has also found its way into the P.A. system, to be switched in, and one has all the ingredients for a full-scale acoustic disaster!

Figure 5a shows the measured response obtained from such a set-up, with the tone controls set to their mid-positions(1).

Using a simple parametric equaliser, the attempt was then made to iron out the grosser irregularities by employing the filter response shown in figure 5b. The

resultant overall response is shown in figure 5c. What cannot be shown however is the amazing improvement in the intelligibility of the sound signal as a consequence of this measure. Whereas previously the speaker could barely be understood in an extremely quiet environment, after the equaliser had been used every word was clearly intelligible even with the noisiest of audiences.

Practice has proven that an equaliser is an extremely useful and effective tool for obtaining clear and readily comprehensible reproduction when working in halls with difficult acoustics. However, the way in which an equaliser is used in P.A. applications differs from that when employed with domestic hi-fi systems. It has already been stated that, when equalising the response of an audio chain and/or listening environment, the band of frequencies between roughly 300 Hz and 5 kHz should be left well alone. In the case of a P.A. installation, however, almost exactly the opposite is true: precisely this range of frequencies between 300 Hz and 5 kHz — or to be more accurate, the slightly broader band of frequencies between 100 Hz and 10 kHz — should be corrected with the equaliser. The extremes of the audio spectrum are of little significance for the intelligibility of the resultant speech signal.

Furthermore, whether the response of the reproduced signal is completely flat or not is also of secondary importance. For example dips in the response of up

to 4 or 5 dB will often have little audible effect. The crucial factor as far as P.A. systems are concerned, is the presence of large resonant peaks in the response, since the highest peak effectively determines the maximum setting of the volume control which can be used without causing howlround. Consequently, the equaliser should be employed to ensure that all the peaks in the system's response are on the same level. This process is illustrated in figure 6. Although, at first sight, the response curve of figure 6a may appear to be slightly better, in practice superior results will be obtained with the curve in figure 6b. Of course, as it stands the latter response is far from perfect, and with judicious filtering it is possible to achieve the optimum response shown in figure 6c.

For those readers who are still less than convinced as to the advantages of an equaliser in this type of application, it may be worth pointing out that the cost of a (home-built) equaliser is nothing compared to the price of new microphones or speakers.

Electronic music

A less common but nonetheless important area of application for equalisers is in electronic music, where their flexibility and tone-shaping capabilities make them a useful addition to electronic synthesisers and organs. In direct contrast to the procedure

6

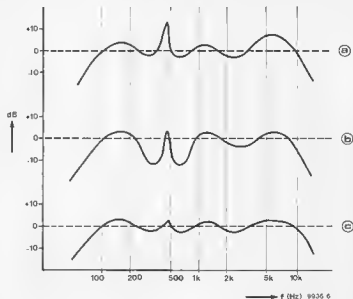

Figure 6. In the case of P.A. systems the equaliser should be set up such that all the peaks in the response have approximately the same amplitude. Although the curve in figure 6a may at first sight appear the better of the two, the fact is that the response of figure 6b will give superior results in practice. That is of course not to say that the latter represents an ideal case; using the same filters it is also possible to obtain the response shown in figure 6c.

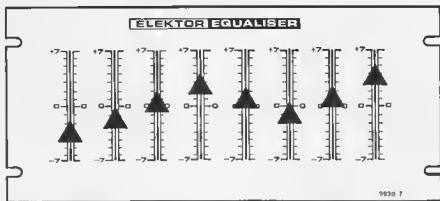

Figure 7. The 'graphic' equaliser owes its name to the fact that by arranging the (slide) potentiometers for the filter controls in a row across the front panel they provide an immediate graphic representation of the frequency response of the equaliser.

adopted in domestic hi-fi and P.A. applications, the filter parameters are not preset and thereafter left untouched; rather the filter settings are varied constantly as demanded by the (live) performance of the passage of music being played. For this reason the filter controls on the equaliser must be well-calibrated and ergonomically designed — a precondition which has led to the popularity of graphic equalisers, where the pattern of the slider potentiometers on the front panel provides immediate visual feedback regarding the overall filter response (see figure 7). However that is not to say that parametric equalisers are unsuited for this type of application — quite the reverse. Their greater scope (control of all the filter parameters) renders them much more flexible and affords the skilled user the possibility of achieving a wide range of different effects.

Setting up an equaliser

Before discussing the specific problems encountered when attempting to equalise the frequency response of domestic hi-fi and P.A. systems, there are several general points which can be made.

Firstly, and most importantly, it is essential that the frequency response which is to be corrected is already known. At the risk of sounding repetitive, fiddling around with the equaliser controls and 'playing it by ear' will almost certainly produce little in the way of tangible benefit and more likely than not will do more harm than good. However, measuring the frequency response in question is not such a fearsome undertaking as one might imagine and worried readers should banish any ideas about expensive Bruel and Kjaer measuring equipment that might be needed. In fact all that one requires is the audio spectrum

analyser described elsewhere in this issue, a little patience, and a certain understanding of what one is trying to achieve. The point here is that exceptionally precise filter settings (within ± 0.5 dB) are not necessary, nor does one have to have an *absolutely* accurate picture of the frequency response. It does not matter whether a particular peak or trough happens to occur at *exactly* 225 Hz — what is more important is that irregularities in the frequency response can be detected (without necessarily knowing their precise location) and then corrected. Frequency response curves such as those shown in figures 2, 3, 5 and 6 may well be interesting for the audio consultant or engineer, but as far as the hi-fi owner is concerned the only thing that counts is the sound reaching his ears!

The measurement and correction procedure for a domestic listening room can be carried out in a number of ways, although in each case the general

principles involved are the same. The choice is basically one of ancillary equipment, whether one uses a measurement microphone, headphones, test records etc.

Setting up an equaliser for a P.A. system is somewhat simpler in that it only makes sense to utilise the existing microphone(s) to obtain the results of the spectral analysis. Since this step in fact forms the basis of the various procedures which can be adopted with domestic hi-fi systems we shall examine it first, before going on to discuss how to obtain the best results from an equaliser in domestic audio applications.

P.A. systems

It goes without saying that, as far as possible, the performance of the P.A. system should be optimised before the equaliser is introduced. That is to say the positioning of the microphone(s) and loudspeakers should be carefully chosen; ideally, cardioid microphones should be used, and, if necessary, the output level of the frontally situated speakers lowered. Only when no further improvements of this nature can be achieved should the equaliser be brought in. The setting-up procedure discussed here assumes that one possesses a parametric equaliser and the audio spectrum analyser described elsewhere in this issue. The procedure followed with an octave or third-octave graphic equaliser is broadly similar; any differences will be mentioned as they arise.

1. The first step is to adjust the equaliser controls to obtain a linear frequency response. This is done by connecting the noise generator direct to the equaliser input and the analyser filter and display to the output of the equaliser (figure 8). The analyser filter should be adjusted for

8

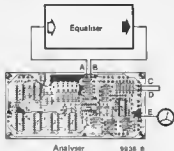

Figure 8. Before the equaliser is incorporated into the P.A. system it must first be adjusted for a flat response. This can be done with the set-up shown here.

maximum Q (1/12 octave bandwidth). With this arrangement it is a simple matter to trace and correct any peaks or dips in the response which are caused by the equaliser itself (the filter sections of a graphic equaliser should be adjusted one at a time).

2. One next has to find a suitable point in the amplifier at which to connect the equaliser. If the amplifier has a monitor input, then in most cases one need look no further (see figure 9a). Figures 9b and 9c however, illustrate how it is possible to incorporate a monitor switch oneself. This topic is discussed in greater detail in the article 'Making a monitor switch' contained elsewhere in this issue.

3. The output of the equaliser should then be connected to point B in figure 9, the noise generator connected to the equaliser input, and the analyser filter end display to point A in figure 9. This arrangement is depicted in figure 10.

4. The frequency response of the system can now be measured; first of all however, it is important that the potentiometer control which sweeps the centre frequency of the analyser filter up and down the audio spectrum has been provided with a (calibrated) scale (from, say, 1 to 10). If several microphones are used in the P.A. system under test, only the main mike, i.e. the one used most often, should be switched on. The results obtained can be plotted to form a graph such as that shown in figure 11a. The points most worth plotting are the highest values of a peak and the lowest of a dip. If an octave or third-octave equaliser is used then the analyser filter should be varied stepwise in octave or third-octave increments. The readings obtained for each frequency band are then plotted as shown in figure 12a.

5. Using a ruler one then draws a line approximately mid-way between the highest peak and lowest dip (see figures 11b and 12b); this represents the theoretically ideal response to which one is approximating.

6. The Q of all the bandpass filters in the parametric equaliser are set to maximum (if a graphic equaliser is being used points 6 to 13 are omitted) and using the analyser filter the first peak or dip in the measured response is located; in figure 11b for example, this is the peak between measurement points 2 and 3. Since it is a peak, the first equaliser filter is set for maximum cut and the centre frequency of the filter slowly adjusted until there is a (fairly sudden) drop in the analyser reading. The centre frequency of the equaliser filter is then fine-tuned until the reading on the analyser display is at a minimum. Finally, the attenuation of the filter is reduced to the point where the meter reading coincides with the theoretically uniform response.

7. The analyser filter is then tuned up the audio spectrum until the next irregularity in the response is encoun-

9

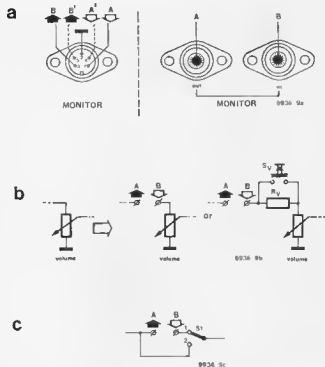

Figure 9. It is necessary to find a suitable point in the amplifier at which one can connect the equaliser. In general this will be in the region of the volume control. If the amplifier already possesses a monitor input then this can be used.

tered. If, as in figure 11b, this is a dip, the second equaliser filter is set for maximum boost, tuned in to the appropriate frequency, and the gain of

the filter varied until the desired reading on the analyser meter is obtained. If further deficiencies in the frequency response exist, this procedure is then repeated with the remaining equaliser filters.

8. The next step is to tune the analyser filter to the frequency at which the bass response of the system begins to roll off sharply. This point is indicated with an arrow in figure 11b. The Baxandall bass control on the equaliser should then be set for maximum cut, and its 3 dB point adjusted until the meter reading falls to 0.7 of its original value.

9. The turnover frequency of the treble filter in the tone control network is adjusted in exactly the same way. Were one to measure the resultant overall response (not that this is necessary), it would look roughly like that shown in figure 11c.

10. The centre frequency of the analyser filter is now tuned down to the point just below that at which the turnover frequency of the bass control was adjusted. The gain of this filter should then be increased until it coincides with the theoretical 'flat' value. The same procedure is performed for the treble control.

11. The analyser filter is tuned to a frequency on the 'flank' of the first

10

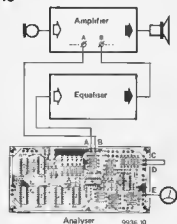

Figure 10. Once the equaliser has been adjusted for a flat response and a suitable connection point in the amplifier has been found, the analyser and equaliser are connected as shown.

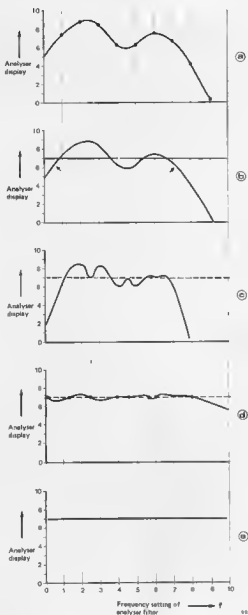

Figure 11. The various stages in the measurement/correction of a P.A. system's frequency response. Figure (a) shows the original measured response, whilst in figure (b) the flat horizontal line represents the 'ideal' frequency response to which one is attempting to approximate. After the first adjustments which the equaliser the response should look something like that shown in figure (c), whilst figure (d) shows the result obtained once the complete adjustment procedure has been carried out. The remaining 'blemishes' can be further treated by 'fine tuning' with the equaliser until, hopefully, the desired perfectly linear response of figure (e) is obtained.

peak or dip in the response and the Q of the first equaliser filter is reduced until the reading of the meter at this point reaches the nominal 'ideal' value. This procedure is repeated for the rest of the equaliser filters.

12. Theoretically, the equaliser should

now be set up correctly and the response curve of the system should resemble that shown in figure 11e, i.e. flat over the range of the spectrum analyser. Unfortunately, however, this will rarely be the case in practice, and it will be necessary to repeat the above procedure

from point 4 onwards in a slightly modified form. The reason for this can be explained if one looks at the curve shown in figure 11d, which represents the probable frequency response obtained so far. The curve exhibits the following faults:

- The turnover frequency of the bass tone control is too low, with the result that the response slopes too sharply at this point. The remedy - increase the turnover frequency and reduce the gain slightly.

- The centre frequency of the first (equaliser) bandpass filter is too high, the consequence being that the filter introduces too much attenuation and has too large a bandwidth. Each of these filter parameters should therefore be adjusted.

- The second bandpass filter is correctly adjusted, however the centre frequency of the third is slightly low, causing over-attenuation and resulting in too small a bandwidth.

- The turnover frequency of the treble control is too low, causing the response to roll off at high frequencies; once again this should be corrected.

13. With an octave or third-octave (graphic) equaliser the adjustment procedure is considerably simpler; this is in fact one of the main advantages of this type of equaliser. A filter with switchable centre frequency (in steps of an octave or 1/3 octave) is employed as analyser filter. The adjustment procedure consists simply of setting up each frequency band in turn and varying the gain of the corresponding equaliser filter until the analyser reading coincides with the nominally flat value. As expected, the resultant response curve (see figure 12c) has a certain waveness, which is unavoidable when using a graphic equaliser. However this is of only minor importance in this type of application.

14. Irrespective of the type of equaliser which is employed, the adjustment procedure, once completed, should be checked with the aid of the following test: The system should be set up as for normal use, i.e. the equaliser is connected to point A in figure 9 and the pink noise generator removed. The analyser filter and display, however, are left connected to point A (see figure 13) for the time being. The volume control of the amplifier is then turned up to the point where acoustic feedback just starts to occur. Using the analyser filter it is a simple matter to detect the frequency at which the signal is oscillating, whereupon the gain of the corresponding equaliser filter should be reduced a fraction.

If the equaliser has been optimally set up, the system should no longer oscillate at the same frequency. If, however, it should continue to do so, then it means that the equaliser has not been correctly set up and the adjustment procedure should be repeated point for point.

16. If more than one microphone is used in the P.A. system, the above procedure is only carried out with the

main mike. The response obtained with each of the other microphones is measured separately as described in point 4. Should these all prove to be reasonably flat, the system is ready for use as it stands. If this is not the case, however, then one of the following steps may prove necessary. If one mike has an irregular response and it is of a different type to the main mike, then one should consider replacing it. If the discrepancies are only minor, then basic equalisation (one equaliser filter per mike) for each microphone may be adequate. Bear in mind that a dip in the response of the other microphones is less important than the presence of a peak. Finally, a compromise solution is also possible: i.e. one switches on all the mikes and adjusts the equaliser for the optimal response.

In conclusion it is worth pointing out that all the above measurements were carried out using a pink noise test signal. This type of signal source was in fact chosen for a very good reason. Were the response of the system measured using e.g. a sine wave generator, the response shown in figure 5a would look something like that in figure 14. The response is characterised by countless dips and peaks separated by little more than a couple of Hertz and varying in amplitude by between 20 to 30 dB. These very sharp dips and peaks are intrinsic to the response and cannot be corrected. If attempting to equalise a response measured using a sine wave generator the important thing is to align the tops of the peaks; the average and minimum amplitude levels are of minor importance, since, as already mentioned, it is the signal peaks which determine at what point the system succumbs to acoustic feedback.

Although the measurements obtained with a sine wave generator are more accurate, they are also considerably more time-consuming. In addition, when plotting the response of a system,

12

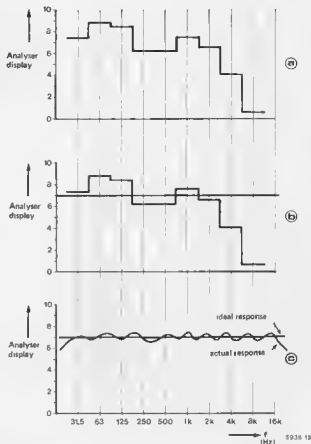

Figure 12. With octave and third-octave graphic equalisers the response can only be varied in octave or third-octave steps, hence there is little point in measuring the response of the system more accurately than this. Figure (a) shows the measured response with an octave/third-octave analyser filter; in figure (b) the nominal 'flat' value is drawn in, whilst figure (c) shows the response obtained with the equaliser optimally adjusted. The 'waviness' of the response is an inherent result of employing a graphic equaliser and cannot be rectified. However in practice it has little effect upon the final sound quality.

13

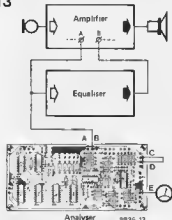

Figure 13. With the set-up shown here it is possible to check the performance of the P.A. system after equalisation.

there is the added difficulty of ensuring that one is recording only the peak signal levels.

The living room

As in the case of P.A. systems, the most suitable point in the reproduction chain to incorporate the equaliser is the monitor input of the amplifier. If such an input does not already exist, then, as already mentioned, it is a relatively simple matter to incorporate such a facility oneself.

For stereo hi-fi systems a 'stereo' equaliser in the shape of two independently variable mono equalisers is required. Quad fans need not worry, since generally speaking there is little to be gained from using an equaliser for the rear channels.

Once installed there are several methods which can be adopted to set up the

equaliser. The simplest is to use the complete audio analyser described elsewhere in this issue in conjunction with a measurement microphone. However other approaches in which only part of the audio analyser is used together with a pair of high impedance headphones are also possible (it is even possible to dispense with the audio analyser entirely!). Each of these methods will be described in detail.

a. Analyser and measurement microphone

The adjustment procedure with analyser and measurement microphone is essentially the same as that adopted with P.A. systems. By 'measurement' microphone is meant a mike whose frequency response is sufficiently flat to ensure that it does not introduce a significant degree of error into the

Automatic Frequency Response Recorder
Type 230
Measuring Circuit

Brüel & Kjær

Frequency *50 dB*
Form Speed B 1 0.1 0.01
Serial No. *A C E G*

Recording No. _____
Date _____

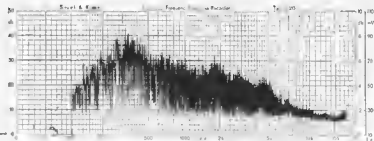

Figure 14. Until now the frequency responses shown have all been 'idealised'. However if the response is measured extremely slowly (15 to 20 minutes for one complete response curve) using a swept sinewave generator then the resultant graph looks rather different from that shown in figure 5a! One can clearly see that there are a large number of quite sharp peaks and dips which are only a few Hertz apart. These rapid variations in amplitude cannot be corrected however, and consequently there is a little point in measuring them. When using a noise generator as a test signal source, one obtains an 'averaged' response curve, which is much more useful when it comes to practical adjustments with the equaliser.

measurements. A good quality microphone of the type intended for use with reel-to-reel tape recorders should fit the bill.

The connections for the analyser and microphone are illustrated in figure 15. The microphone should be situated in the 'ideal' listening position within the room and care should be taken to exclude extraneous noise sources (wives, children etc.) One then works through the same procedure as described for P.A. systems, but with one notable exception. As already mentioned, any dips or peaks in the response occurring between roughly 300 Hz and 5 kHz should generally be left alone. Until now, however, there has been no need for the frequency scale on the analyser filter control to be calibrated, which

means that there is no way of telling where these frequencies occur! Fortunately, however, there are alternative methods of determining this frequency band with sufficient accuracy: e.g. the use of test records which have a number of specified frequencies recorded on them; alternatively one can utilise the knowledge that on a piano (or the 8' register of an electronic organ) 300 Hz coincides roughly with d^1 — the d above middle c , and 5 kHz with e^5 (i.e. four octaves above middle e).

In figure 3a the frequency response exhibited a dip at around 1600 Hz, and it was stated that if this was a result of the room acoustics, it should not be equalised; if however it was caused by the response of the loudspeaker, then it was legitimate to remove the dip using

the equaliser. The simplest method of ascertaining which of these two situations is in fact the case is to measure the loudspeaker response in two different rooms. The most suitable room for this purpose (assuming it is large enough!) is the bathroom! However one must of course be extremely careful when using electrical equipment in the vicinity of water taps etc. At any rate, if the same dip in the response occurs when the loudspeaker has been set up in a different room, then one can safely assume that it is the fault of the loudspeaker itself.

Since a stereo equaliser actually consists of two separate mono equalisers, in theory the adjustment procedure should be carried out twice, once for each channel, and in each case with the other channel completely disconnected. In practice, however, it is sufficient to feed the noise signal to the desired channel and simply to turn the balance control on the amplifier to the appropriate end stop. Any crosstalk between channels should be too small to affect the resultant measurement.

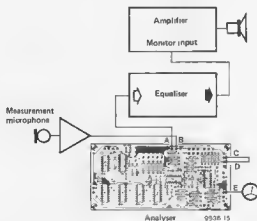

Figure 15. If a reliable measurement microphone is available the arrangement shown here can be used to measure the response of a hi-fi system and living room.

Test records

Certain hi-fi stores stock various test records which often include pink noise test signals. In principle, these can be used in place of the pink noise generator of the audio analyser. The adjustment procedure then becomes slightly more inconvenient, since one must constantly search for the right spot on the record for each measurement; however this in no way interferes with the accuracy of the adjustment procedure.

Sinewave test signal

It is also theoretically possible to use a pure sinewave (whether from a sinewave generator or a test record) as a test signal, however this approach is not recommended. As has already been

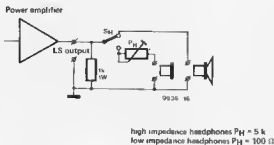

Figure 16. When using headphones to measure the room's response a volume control is necessary to be able to adjust the signal from the 'phones' until it sounds the same as that from the loudspeaker. In addition one must be able to switch between the two, so as to make a direct comparison.

explained, the actual frequency response of the system consists of a large number of very rapid variations in signal level. Were a sine wave generator employed as a test signal source, these peaks and dips would be reflected in the measurement. One would then have to determine the 'average' frequency response of the system before one could set about equalising it. A small drift in the oscillator frequency, a fractionally incorrect setting of the controls, could lead to differences in signal level of from 5 to 10 dB. Such is the risk or error using a sine wave test signal that it is best to avoid this approach altogether.

Headphones

There may be those who do not wish to purchase a measurement microphone (and suitable pre-amp) solely for the purpose of setting up an equaliser. If that is the case an alternative solution is to use a pair of high-quality headphones. The adjustment procedure is simplest if one has a pair of 'open' headphones, i.e. which do not acoustically isolate the ears from external sounds. Figure 16 shows how the headphones are connected to the amplifier. This set-up allows one to switch from loudspeaker to headphones and to vary the volume of the headphone signal until it sounds the same as that from the loudspeaker (It is important that the headphones do not muffle or distort the loudspeaker signal in any way).

Since the switch and volume potentiometer must be operated from the desired listening position, a sufficient length of suitable cable is required.

The connections between the amplifier, equaliser and analyser are shown in figure 17.

Once again, it is possible to use a test record as a pink noise source in place of the noise generator on the analyser, although it is less convenient. The

display or meter section of the analyser is not used with this set-up (no measurement mike), instead one trusts to one's ears to distinguish between signal levels. This does require a certain amount of concentrated listening, however in practice this has proven to work quite well. The adjustment procedure is as follows:

1. The analyser filter control is set to roughly its mid-position, and with the S_H switch (see figure 17) in the 'loudspeaker' position, the noise signal is adjusted to a reasonable room level. If the volume of the noise signal is too high it is not only extremely disagreeable, but there is also a risk of damage to the speaker¹

2. Potentiometer P_H is set for

maximum resistance, switch S_H is moved to the 'headphones' position, and P_H is then adjusted until the signal from the headphones sounds to be at the same level as that from the speaker was.

3. The frequency of the analyser filter is gradually moved up and down the entire spectrum and the differences between the signal levels of the loudspeaker and of the headphones are noted — loudspeaker slightly louder, much louder, the same, etc. At the same time one should observe at what points the highest peaks (i.e. greatest signal levels) and lowest dips (smallest signal levels) occur. A useful method of recording one's observations is illustrated in figure 18a; figure 18b shows the corresponding frequency response. With this information one can now proceed to set up the equaliser in the manner described above, using the signal level established in point 1 as the nominal 'flat' value. As already mentioned, the band of mid-range frequencies should normally be left unaltered.

Summarised briefly, the remainder of the adjustment procedure is as follows:

4. All the equaliser (bandpass) filters are set for maximum Q. With the aid of the analyser filter the first peak (in figure 18 this lies between test points 1 and 2) is detected, the first equaliser filter is set for maximum cut and its centre frequency adjusted until it coincides with the top of the peak. The amount of attenuation introduced by the filter is then adjusted until the signal level of the loudspeaker and headphones is the same. This procedure is repeated with the remaining equaliser filters for any other irregularities which require correction (in figure 18 the other prominent peaks and dips fall within the

17

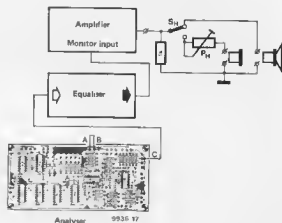

Figure 17. Connections between amplifier, equaliser and analyser when using headphones to measure the room's response.

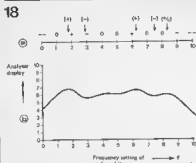

Figure 18. An example of how one can audibly chart the response of the room when using headphones. ++ signifies: loudspeaker much louder than headphones, 0 means both are equally loud, etc. The tops of peaks and bottoms of dips are marked with an arrow. The actual curve which corresponds to this notation might look something like that shown in figure (b).

critical mid-range of frequencies to be left alone).

5. Using the analyser filter, find the frequency at the lower end of the spectrum at which the loudspeaker begins to sound perceptibly quieter than the headphones (just below point 1 in figure 18); set the bass control filter of the equaliser to its lowest frequency and

adjust it for maximum cut. Then gradually increase the turnover frequency until the loudspeaker sounds even quieter still. Repeat the above procedure for the equaliser treble control (in figure 18 the reference frequency will probably lie just above test point 9).

6. Set the analyser filter frequency to minimum and increase the gain of the bass control until the 'flat' level is obtained; adjust the treble control in the same way.

7. On the sides of the original first peak in the response there should now be two new peaks. Adjust the analyser filter until it coincides with one of these new peaks and reduce the Q of the first equaliser filter until it has disappeared. If necessary repeat this procedure with the remaining equaliser filters.

8. Finally, sweep the analyser filter up and down the entire audio spectrum and check to ensure that all the adjustments that have been made are correct. It will generally prove necessary in practice to make a few additional corrections or alterations. Once done, the system is now ready for use and can be subject to the crucial test of introducing a suitable music signal and listening to hear (hopefully) the improvement in the resultant sound.

Bibliography:

J. Moir: *Interactions of loudspeakers and rooms*. *Wireless world*, June 1977.
 Bruel and Kjaer: *Relevant Hi-Fi tests at home*. Paper at the 47th Audio Engineering Society Convention. Also available as a Bruel and Kjaer application note.

Bruel and Kjaer: *Hi-Fi tests with 1/3 octave weighted, random noise*. Bruel and Kjaer application note no. 13-101.

Philips: *Sound equalisation using Philips K and Q-filters*. ELA application note 17.8100.35.331011.

2

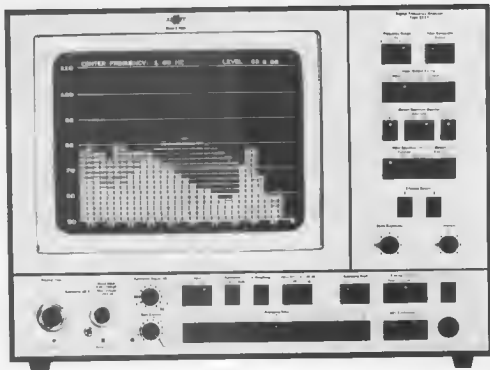

An example of an extremely sophisticated (and expensive) spectrum analyser used for professional applications. The model shown here is the 2131 Digital Frequency Analyser from Bruel and Kjaer, which splits the audio spectrum up into octave or third-octave frequency bands and displays the corresponding signal levels on a CRT.

1a



2a

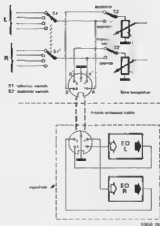

1b



1c



monitor output

2b

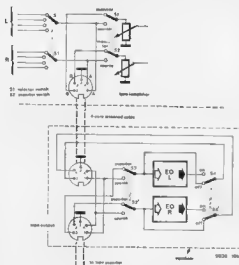

2c

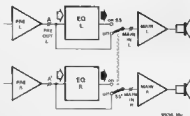

A monitor output is useful for connecting an equaliser, as suggested elsewhere in this issue. Fortunately, it is a fairly simple matter to add this facility to an existing amplifier.

In most cases, only minor surgery is required: the signal path must be cut at a suitable point in the (pre-)amplifier. The top of the volume control is usually as good a place as any (figure 1a). The two loose ends, A and B, can be connected to a DIN socket as shown in figure 1b: pins 1 and 4 are used for recording (preamplifier output), pins 3 and 5 for playback (via the volume control) and pin 2 is connected to supply common. For a mono connection, pins 1, 2 and 3 are normally used; pin 5 is left floating, and pin 4 may or may not be connect to pin 1.

The point at which the signal path is interrupted should have a reasonable nominal signal level (100 mV...1 V); furthermore, no DC should be present at this point. It is usually a good idea to add a 'monitor' switch, as shown in

figure 1c, so that the original connections can be restored if no equaliser or tape recorder is connected.

Connections to the equaliser

The equaliser can be connected as shown in figure 2a, 2b or 2c. In figure 2a, the monitor connection is used. In some cases, a series resistor or voltage divider may be present in the 'A' connection (preamplifier output); if so, this should be removed. With switch S2 in the 'monitor' position, the equaliser is in circuit; in the other position ('source') the equaliser is bypassed.

The disadvantage of this circuit is that the monitor connection on the amplifier is always in use: it is no longer available for connecting a tape recorder. The solution is shown in figure 2b: add a further monitor connection at the input of the equaliser. The original monitor switch, S2, is always set to the 'monitor' position and S3 is used as the monitor switch for the tape recorder. The equaliser is switched in or out of circuit by means of S4.

Finally, some commercial amplifiers (particularly those intended for PA work) have a connection at the back marked 'PRE OUT/MAIN IN'. The equaliser can be included at this point, as shown in figure 2c.



page extension for elekterminal

With the aid of the extension board described here, the memory capacity of the Elekterminal can be expanded to 4 pages (each of 16 lines x 64 characters). Interconnecting the two boards is not a problem, since they can be mated quite simply by means of connectors.



A memory capacity of 16 page lines is in practice somewhat restricting. Even a simple BASIC program will generally require additional lines. For this reason expansion of the video memory is highly desirable.

To increase the number of pages in the VDU's memory it is first necessary to provide a control circuit which will select the correct page, bearing in mind that the 16 lines displayed on the screen may be composed of sections of two successive pages. To this end a page counter is required, which selects the desired page by enabling the appropriate memory IC. The basic principle is illustrated in the block diagram of figure 1. Pages 1, 2 and 3 are accommodated on the extension board, whilst page 0 is housed on the Elekterminal board. The page counter is in turn controlled by the CRTIC of the Elekterminal and by the up and down keys of the ASCII keyboard.

To be able to manipulate several memory pages satisfactorily the following functions are necessary:

- the page counter must be capable of counting up and down.
- the memory must 'wrap round', i.e. upon reaching the end of the last page, the start of the first page must reappear on the screen.
- conversely, when 'counting down', the last page must follow the first.
- it should be possible to reproduce sections of two successive pages on the screen.

The above facilities can be summarised by representing the memory as a drum, on which the four pages are spread out. The drum can be revolved in either direction, and any 16 successive lines can be displayed on the screen.

Page counter

The operation of the page counter can best be explained with reference to the CRTIC in the Elekterminal circuit. The latter contains a page-end comparator which provides two output signals, RP and RS. The RS output is used to indicate the transition somewhere in mid-screen from one page to another. If a complete page is on the screen, the RS output is high. If however sections of two pages are on the screen, then the page at the bottom of the screen is taken as the 'actual page'. During this portion of the page the RS output is high, whilst during the portion of the previous page it is low. For example, if lines 7...16 of page 2 and lines 1...6 of page 3 are on the screen, then the RS output is low for the first 10 lines and high for the last 6 lines.

The RP output provides a '0' pulse when a page boundary is exceeded at the bottom of the screen. This pulse is only generated if pressing the LF (line feed) or ESC (escape) key will result in the transition to the next page. Together, the RS and RP signals are used to control the page counter.

Circuit

As can be seen from figure 2, the circuit of the page counter is quite straightforward, and consists of an up-down counter (IC1), a 4-bit full adder (IC2), and a 2-to-4 line decoder (IC3). The three additional pages of memory are formed by 18 RAM's, type 2102A4 (figure 3). It is also possible to use low power memories for this application (type 2102AL4), which would result in a saving of roughly 30% in current consumption. The extension board also includes an anti-bounce circuit (found N3...N6) for the page-up and page-down keys on the ASCII keyboard, which could not be used until now. Their purpose is to enable the user to 'turn over' a complete page of memory at one go, i.e. scroll a full 16 lines up or down, regardless of whether it is one complete page or formed by sections of two successive pages.

When the RP output of the CRTC goes low, or the page-up key is pressed, the up-down counter is incremented by 1; pressing the page-down key causes the counter to decrement by 1. The full adder then determines the binary sum of the counter contents and the RS signal. Depending upon the result, the decoder takes the corresponding output low, thereby enabling the appropriate memory IC.

When a complete page is on screen the RS output is high, with the result that the page numbers are all increased by 1. The page numbering recognised by the page counter is shown in the block diagram of figure 1. As already mentioned, page 0 is situated on the Elakterminal board. If sections of two successive pages are on-screen, the RS output will be low for the first page, and high for the second, so that the counter will automatically 'turn the page' at the correct point. For a description of the operation of the page memories the reader is referred to the article on the Elakterminal (Elektor 44, December 1978).

Printed circuit board

The printed circuit board for the extension to page memory (see figure 4) is provided with two connectors thereby facilitating interconnection with the terminal board. The 26-way connector should be soldered to the underside of the extension board, so that it mates with the connector socket on the terminal board. A number of connections however are not made via this connector. These are B0...B4, B6 and the connections to the page-up and page-down keys. Provision is made for an 8-way connector, the pins of which are connected to the corresponding pins of the second connector on the terminal board. Of course the connector is not essential, it is equally possible to make these connections simply using ribbon cable.

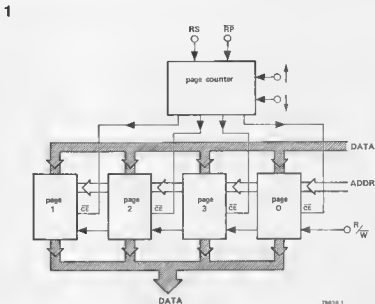

Figure 1. Block diagram of the extension to page memory. Page 0 is accommodated on the Elakterminal board.

2

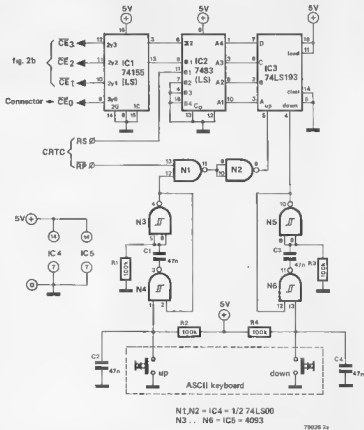

Figure 2. Circuit diagram of the page counter and anti-bounce logic. The numbering of the input and output connections corresponds to that used on the Elakterminal board.

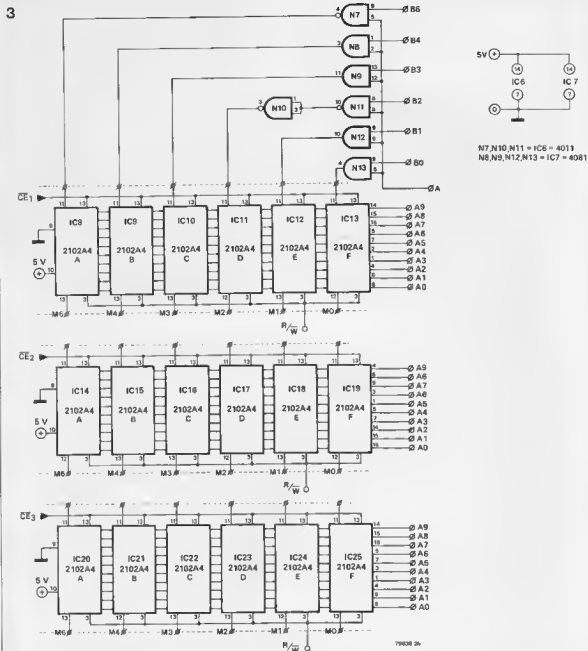

Figure 3. The memory extension circuit.

For the connections to the page-up and page-down keys there are two possibilities: either the key contacts can be connected directly to the extension board, or they can be routed via the extension board. If connectors are being used, then the latter option is the simplest. A small modification to the terminal board is also required before the memory extension is complete, namely the wire link between \overline{CE} of IC3 and ground (see figure 5) should be removed.

Scrolling

Once the memory is provided with extra pages, scrolling the text up a line at a

time will normally be done with the aid of the ESC key. If the LF key is used, the text will scroll up, but the following line will be blanked, i.e. the line will appear vacant whilst the contents of the line are also erased from page memory. As mentioned, with the aid of the page-up and page-down keys the text can be scrolled in either direction a page at a time. Upon reaching the end of page memory (64 lines), the page counter wraps round to the start of the first page.

Power supply

If normal memories are used, the current consumption of the extension circuit is

roughly 800 mA. By employing low power memories this figure can be reduced to approximately 400 mA. It may prove necessary in some cases to uprate the Elektorterminal power supply. Readers are referred to the article on the SC/MP power supply contained in Elektor 36, March 1978.

4

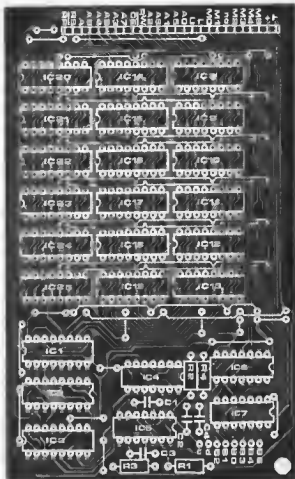
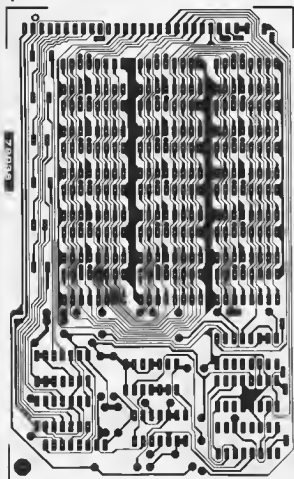

Figure 4. Track pattern end component layout of the printed circuit board for the extension of page memory.

Parts list:

Resistors:

R1 . . . R4 = 100 k

Capacitors:

C1 . . . C4 = 47 n

Semiconductors:

IC1 = 74LS155*

IC2 = 74LS83*

IC3 = 74LS193

IC4 = 74LS00

IC5 = 4093

IC6 = 4011

IC7 = 4091

IC8 . . . IC25 = 2102-1, 2102A4,
2102AL4

Miscellaneous: **

male connector mounted on
underside of p.c.b. ITT-Cannon
G09A45C4DBAA

1 x 26 way (if using ribbon cable,
type G09A45C4DCAA)

*Low power Schottky is
preferable, however conven-
tional TTL ICs can also be used.

**Note that the use of connectors
is not essential

5

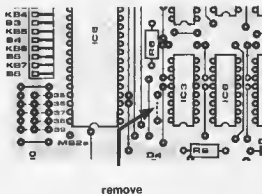

79038 3

Figure 5. This figure clearly shows the wire link on the Elekterminal board which must be removed.

one-nil for audio

digital audio:
the whats,
the whys
and the hows

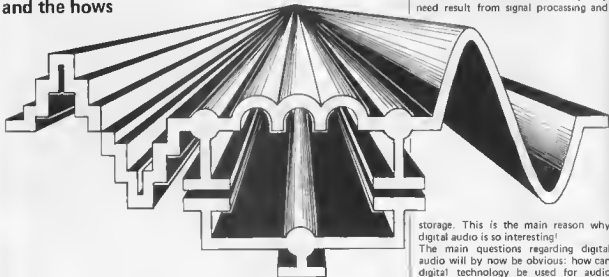

Digital systems have one major advantage over their analog counterparts: they can tolerate extremely high interference levels without loss of information. Rapid advances in digital technology in recent years is forcing designers in such traditionally analog areas as tape recording, long-line transmission and reverberation to take a long, hard look at their digital competitors. The advent of digital audio has produced quite a few surprises on both sides of the fence: digital designers discovered that only by pushing to the very limit of their capabilities could they meet the performance standards commonly set by conventional analog equipment; analog designers, on the other hand, were surprised to discover that digital equipment could sound so good. In this article, both of these 'surprises' are examined. How can digital audio work so well, and why is it so difficult to get it to work in practice?

There are fundamental differences between digital and analog systems. A very basic analog circuit (such as a single-transistor emitter follower) can easily handle a signal (voltage) that varies continuously, taking on any value between some maximum and some minimum. It will introduce very little distortion (less than 0.1%) and a small amount of noise will be added. However, it is virtually impossible to eliminate the added noise and, as more and more of these stages are connected in series, the signal quality will progressively worsen. A digital system, on the other hand, would require something like a 12- or even 16-bit databus to pass the same information. However, the quality of the signal can then remain the same no matter how many stages are to be connected in series. A digital system must be quite sophisticated if it is to achieve the same quality as an analog system, but it then has the advantage that no further reduction in quality need result from signal processing and

storage. This is the main reason why digital audio is so interesting! The main questions regarding digital audio will by now be obvious: how can digital technology be used for audio applications; how good can the quality be, in theory and practice, and what is it going to cost? The answers depend to a large extent on one essential unit: the analog-to-digital converter.

Analog-to-digital conversion

A digital audio system contains five distinct sections: an analog input circuit, an analog-to-digital converter, digital processing and/or storage units, a digital-to-analog converter and an analog output circuit (see figure 1). No matter what techniques are employed in the two conversion sections, their basic function is the same: 'translating' an analog (e.g. audio) signal into an equivalent digital signal and vice versa. The 'equivalent digital signal' consists of a rapid succession of binary numbers (or 'words' as they are commonly called — for no apparent reason); each 'word' represents one particular voltage level at one particular moment in time. 'One voltage level', 'one moment in time' ... virtually all the major differences between analog and digital audio

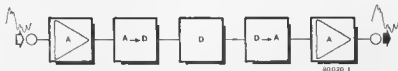

In a digital audio system, the analog input stage (A) is followed by an analog-to-digital converter (A \rightarrow D). The signal can now be digitally (D) processed, transmitted or stored. A digital-to-analog (D \rightarrow A) converter and analog output stage complete the chain.

stem from these two. Let us first consider voltage levels. An analog signal varies between some maximum and some minimum level, and can take any value between these two extremes. In theory, therefore, an infinite number of different voltage levels are possible: 0.12345 V is slightly less than 0.12346 V, and 0.123455 V is midway between these two levels... In practice, however, there is a limit to the accuracy with which an analog voltage can usefully be defined. This limit is a result of an unavoidable analog phenomenon: noise. Assume, for instance, that the analog noise level is in the order of 0.0001 V (i.e. 0.1 mV). The difference between the three voltages given above is then 'masked' by the noise: a 'true' signal level of 0.1234000... V could be shifted to any level between, say, 0.1233 V and 0.1235 V - depending on the level of the noise signal at the particular moment in time that we are interested in. For the same reason, an output signal of exactly 0.1234 V can be obtained for any input level in the range from 0.1233 V to 0.1235 V. One output level 'represents' a range of possible input levels.

A similar effect exists in digital systems - but for an entirely different reason. As stated earlier, each 'word' in a digital system represents one particular voltage level. In a given system, the number of possible 'words' is limited: using 12 bits, say, the binary numbers range from 000 000 000 000 to 111 111 111 111. In this case, 2^{12} or 4096 different numbers are possible. Therefore, only 4096 different voltage levels can be represented - out of the infinite number of possible levels in any analog system! The only solution is to divide the analog signal range into the same number of smaller regions as there are digital 'words'. For instance, if analog voltages between -2 and +2 V are to be processed in a 12-bit digital audio system, the range could be divided into steps of

approximately 1 mV. Any input voltage between, say, 1.022 V and 1.023 V would then be represented by the binary number 001 111 111 110. This process is called *quantization*, and the inaccuracy that it involves (a given analog signal level can only be represented to within, say, ± 0.5 mV) is known as 'quantization error'. It is also referred to as 'quantization noise', since the effect is similar in many ways to analog noise. However, in some cases it may sound much worse...

The second phrase to be discussed is 'one particular moment in time'. An analog signal varies continuously; if it is 1.000... V at one particular moment, it may be found to have dropped or increased significantly a fraction of a second later. Fortunately, however, it can be shown that if the signal is 'sampled' at a sufficiently high rate, then no information will be lost. In other words, if the signal level is measured at sufficiently short intervals it is possible to reconstruct the original signal exactly from these measured levels.

Theoretically, the 'sampling frequency' must be at least twice the highest frequency present in the signal that is to be sampled. For instance, if a system is intended to pass audio signals over the full range from 20 Hz to 20 kHz, the sampling frequency must be at least 40 kHz. In practice a higher sampling frequency is normally required, to avoid all sorts of nasty effects - as will be discussed further on.

A block diagram

The basic principles of a digital audio system, as described above, can now be summarized in a block diagram (figure 2).

The incoming (analog) audio signal must first be passed through a low-pass filter,

to remove any signal components at frequencies higher than half the sampling frequency. The next step is to sample the analog signal: the signal level is measured (and 'stored') at, say 25 microsecond intervals (corresponding to a sampling frequency of 40 kHz). Each sampled voltage level is then converted into a corresponding digital 'word'. The result, so far, is that the analog input signal has been converted into a rapid succession of binary numbers. Ignoring practical problems, which will be discussed later, the only theoretical sources of poorer signal quality have now been passed: the low-pass filtering at the input (limiting the band-width of the signal) and the conversion process with its associated quantization error.

A digital signal is now available. It has the major advantage that it is extremely tolerant of abuse: it really takes some doing to maltreat this signal to the point that the individual binary numbers are no longer recognisable. The 'rapid succession of binary numbers' can be delayed, transmitted over long lines, stored on tape, etc... and in most cases the output will still contain sufficient information to recreate a 'clean' digital signal that is identical to the original input. Passing this signal through a digital-to-analog converter and an output low-pass filter produces the analog output signal.

It will be obvious from the above that the analog output signal can never be identical to the original input signal. Quite apart from practical problems, the quantization process will always get in the way - dividing the analog signal range into a limited number of smaller ranges, and collapsing each of these into a representative 'centre voltage'.

Quantization noise

If the analog input is a high-level speech or music signal, the audible effect of

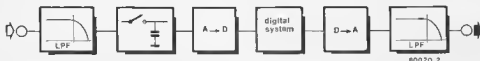

Block diagram of a complete digital audio system. To make use of the 'perfect' signal handling capabilities of the 'digital system' proper (for signal delay, transmission, storage or other manipulation), the other five blocks must be added. Regrettably, since they do introduce distortion, noise, and other ' nastiness'.

3

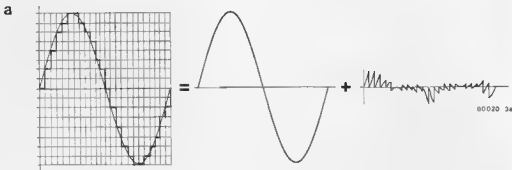

A 'quantized' signal is equivalent to the intended (sine-wave) signal plus an 'error' signal.

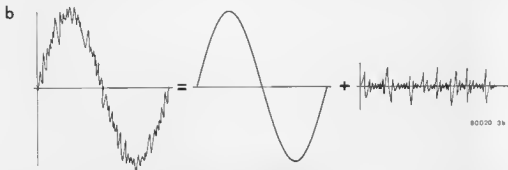

Similarly, a normal analog signal is equivalent to the intended sine-wave plus 'noise'.

quantization will be very similar to white noise. The apparent signal-to-noise ratio is determined by the number of 'quantization intervals' into which the analog signal range is divided — and, therefore, by the number of bits used in the system. This is illustrated in figure 3. In figure 3a, the output from a 4-bit system (16 levels) is shown. This signal is equivalent to a mixture of the intended (sine-wave) output and an error signal, as can be seen; by way of comparison, figure 3b gives the result of mixing the same sine-wave with a noise signal.

For each additional bit used in the system the number of available quantization intervals doubles, so the amplitude of the error signal is halved — effectively, the 'signal-to-error ratio' is improved by 6 dB. It is therefore reasonable to assume* that the signal-to-noise ratio in a digital system will be equal to 6 dB multiplied by the number of bits — e.g. 72 dB for a 12-bit system.

Considering the fact that 72 dB is quite good, as signal-to-noise ratios go, one might assume that a 12-bit system is good enough for most applications. If better performance is required, one could always add a few more bits — say, a total of 16 bits would give 96 dB signal-to-noise. Regrettably, life is rarely so simple... In the first place, extra bits are expensive.

This will be obvious if we take a closer look at the 12-bit system, as an example. 12-bits correspond to some 4,000 levels, whereby the first (or 'Most Significant') bit defines whether the required level is in the range 0... 2047 of 2048... 4096. The last (or 'Least Significant') bit, on the other hand, corresponds to one level step — from 1234 to 1235, for instance. This means that the level step corresponding to the first bit is some 2,000 times larger than that for the last bit. If the latter is to have any significance, the step for the first bit must be accurate to within 1/2000, or one-twentieth of one percent. Using 1% component tolerances? Forget it! To make matters worse, this type of highly accurate level detection must be carried out at high speed: the complete analog-to-digital or digital-to-analog conversion must be completed within the sampling period — i.e. within 20 microseconds or so.

For a 16-bit system, conversion accuracy to within approximately 15 parts-per-million is required... and 50,000 times per second, at that! It will be obvious that, at this rate, we are rapidly approaching the limit of present-day technology.

To make matters worse, more bits are required in practice for a given signal-to-noise ratio than the 6dB-per-bit rule would imply. Speaking very broadly, one additional bit is required in a playback-only system (using pre-recorded tapes or records) and two

additional bits are preferable in a full record-and-playback system. These bits are needed to counteract all sorts of nasty effects associated with the quantization process.

Quantization nastiness

When a normal audio signal at a suitable level is fed through a digital audio system, the quantization noise will usually be equivalent to white noise, and the signal-to-noise ratio will be 6 dB per bit. However, there are some very important exceptions to this rule, and in practice digital audio systems can sound much worse.

Quantization distortion. As an example, assume that a low-level sinusoid is applied to a digital audio system; the peak level is slightly less than one quantization interval (figure 4). Since the signal only crosses one quantization level, the output will be one of two possible digital 'words'. This is equivalent to a squarewave output: the system is operating as a hard limiter. In this case, the quantization error is equivalent to distortion — there is no noise in the analog sense! The audible result can be similar to crossover distortion in a power amplifier.

Granulation noise and birdies. In the example given above, the quantization process introduced distortion. Similarly, if the input signal exceeds the maximum level for which the digital system was designed, 'hard clipping' will occur: all

* Not only reasonable to assume, actually it can be proved mathematically.

levels above the maximum are coded and reproduced as equal to maximum level. Once again, the result is severe distortion: in other words, higher harmonics are added to the signal. As long as these harmonics remain within the permissible frequency range of the system (i.e. less than half the sampling frequency), the result will simply be a distorted output. However, when harmonics are generated above this frequency, things will really go wrong. The problem is that, effectively, these high frequencies are also sampled, producing sum and difference frequencies that can 'fold down' to within the audible range.

As an example, assume that a 9.5 kHz sine wave is applied to a digital audio system that uses a 50 kHz sampling frequency. If distortion occurs as a result of the quantization process, harmonics can be produced at 19 kHz, 28.5 kHz... 47.5 kHz, 57 kHz... etc. As a result, 2.5 kHz and/or 7 kHz components may be produced. These will remain present in the analog output signal after the second low-pass filter.

This type of error signal is neither noise nor distortion in the normal analog sense, since the new signal components are discrete frequencies but they are not harmonically related to the original signal. For this reason, they are far more irritating than either noise or distortion.

This effect is sometimes referred to as 'granulation noise'; it sounds something like two pieces of sand-paper being rubbed together. In some cases, the beat notes may drift rapidly through the frequency range, producing an effect like birds singing.

Modulation noise The effects described so far are inherent to digital audio systems - even in theory. In practical systems, imperfections in the actual electronics are a further source of error. It is outside the scope of this article to discuss these in detail - interested readers are referred to an extremely good discussion by Mr. Blesser in the *Journal of the Audio Engineering Society* (see *Literature*). Suffice it to say that, in general, the effect of these errors is that the noise output will vary with the analog signal, producing modulation noise. Severe errors could, of course, produce all kinds of other

effects, but these are unlikely to occur in practice.

Dither noise

The noise and distortion products discussed so far have one thing in common: they are all more irritating and sound more unpleasant than white noise. Subjective tests show that this additional 'irritation' is equivalent to 6... 12 dB less signal-to-noise ratio. In other words, a 12-bit digital system with a measured SN-ratio of 72 dB will 'sound' approximately as good as a straightforward analog system with a signal-to-noise ratio of only 60... 66 dB. One way to cure this problem would be to add a few more bits - reducing the noise signal to the point where it is inaudible. However, additional bits are expensive.

An alternative solution is to add a small amount of white noise to the analog input signal. The peak-to-peak value of this so-called 'dither' signal is approximately equal to one quantization interval. Without going into (mathematical) detail, it can be stated that this will effectively eliminate the 'quantization nastiness', and result in a deterioration of the signal-to-noise ratio of only 2... 4 dB. The same 12-bit system mentioned above would then have an effective SN-ratio of 68... 70 dB.

A good rule-of-thumb in practice is to assume that one bit is required to counteract the irritating effects of quantization noise. For a 16-bit system, for example, the SN-ratio will be at least $15 \times 6 = 90$ dB, and it may be one or two dB better.

Peak overload prevention

If an audio system - any audio system - is overloaded, the output will be distorted. In a digital audio system, however, the results can be disastrous. As mentioned earlier, if the input signal exceeds the maximum level for which the system was designed, 'hard clipping' will occur as a result of the quantization process. The resultant harmonics are effectively sampled, producing new frequencies within the audio band.

To avoid this, the signal *must* be limited before the input low-pass filter. In a playback-only system (such as the new

Philips 'compact disc'), the peak program level can be monitored before the recording is made, so that limiting becomes merely a question of correct level-setting. If the system is to be suitable for recording 'raw' program material, however, the only safe solution is to add a hard limiter before the low-pass filter. The clipping level for this limiter will have to be set at approximately 3 dB below the nominal 100% level of the digital system, to ensure that the peak signal level will remain within the permissible limit even after low-pass filtering. Another way of looking at this is to say that the digital system must have at least 3 dB leeway above the nominal full-drive level; this costs one additional bit (since half-bits don't exist).

The rule-of-thumb given earlier can now be extended as follows. If the 'dynamic range' of a digital audio system is defined as the number of dBs between the peak input level and the effective noise level, this dynamic range will be approximately equal to the number-of-bits-minus-one times 6 dB for a playback-only system and the number-of-bits-minus-two times 6 dB for a system that must also be suitable for recording. In the former case, the performance can be improved by 1 or 2 dB by careful design; in the latter case, up to 4 or 5 dB improvement is possible.

This means that if a digital audio recorder is advertised as 'using a 16-bit system' and having a 'dynamic range of 86 dB', these claims are quite probable. On the other hand, if 96 dB is claimed for a 16-bit recorder, the designers must be extremely clever - or else the advertising copy-writer has slipped up.

What of the future?

Digital audio is here to stay. The twin advantages of guaranteed high performance and reliability are too good to miss. Solving the practical problems discussed above is a question of time, and as digital technology advances and prices come down it is to be expected that digital equipment will filter down the audio market until even the cheapest audio equipment goes digital. It is not difficult to envisage a point in the not-too-distant future when even the trusty LP disc is replaced by a PLOM (Play Only Memory) on a single (silicon?) chip. Meanwhile, those of our readers who are interested in an extremely full and detailed discussion of the theoretical and practical aspects of digital audio are referred to:

Literature.

'Digitization of Audio: A Comprehensive Examination of Theory, Implementation, and Current Practice', Barry A. Blesser, *Journal of the Audio Engineering Society*, October 1978, Volume 26, Number 10, Pages 739... 771.

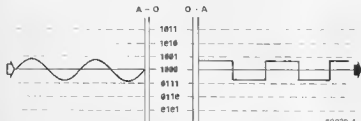

A low-level input signal will be 'squared-up', causing distortion, unless suitable measures are taken (adding dither noise, for instance).

The article on using an equaliser, also contained in this issue, gives a detailed discussion of the problems posed by deficiencies in the frequency response of loudspeakers and of the listening environment. It explains that the solution of these problems is to use an equaliser to adjust the overall frequency response of the hi-fi chain/listening environment. Use of an equaliser will therefore not be discussed in detail in this article.

Before proceeding with a discussion of the parametric equaliser it is perhaps a good idea to discuss why it is superior to the more common 'graphic' equaliser. A 'graphic' equaliser such as the Elektor Equaliser consists of a number of band selective filters with fixed centre frequencies spaced at equal intervals on a logarithmic frequency scale, usually at octave intervals, though more expensive units may boast third-octave filters. Each of these filters is equipped with a gain control so that it can apply boost or cut to the band of frequencies over which it is active. The term 'graphic' arose from the common

Figure 2 shows how the characteristics of a parametric filter section may be varied. Figure 2a shows variation of the gain, figure 2b shows adjustment of the bandwidth, while figure 2c shows adjustment of the centre frequency. Figure 3 illustrates the adjustments possible with the parametric tone controls. Figure 3a shows how variable boost and cut may be applied to the extremes of the audio spectrum, as with normal tone controls, while figure 3b illustrates the unique feature of the parametric tone controls, namely the adjustable turnover frequencies of the bass and treble controls. Having briefly discussed the differences between parametric and graphic equalisers, the advantages of a parametric equaliser can now be illustrated. In a nutshell, the purpose of an equaliser is to make the frequency response of an audio reproduction chain flat by providing gain where there are dips in the response and attenuation where there are peaks. Figure 4a shows the response of a typical reproduction chain, as might be measured using an audio analyser. This has a number of obvious deficiencies. The 'grass' on the trace is due to a large number of sharp (high Q) resonances, which can be as

parametric equaliser

A combination of state variable filters and a highly specialised Baxandall tone control network is used in the 'parametric' equaliser described in this article, which offers considerable advantages over the more common 'graphic' equaliser. Use of a parametric equaliser allows the frequency response of a domestic hi-fi setup to be tailored to a degree previously only attainable in recording studios. Such is the versatility of a parametric equaliser that even sceptics who turn up their noses at audio equalisers may be forced to revise their opinions.

use of slider potentiometers in such equalisers, whose slider position is erroneously supposed by some to represent the frequency response of the system. However, the term 'graphic' will be used to distinguish between this type of equaliser and the parametric equaliser.

The only variables in a graphic equaliser are the gains of the individual filter sections, since the centre frequency and Q (which determines the bandwidth) of each filter are fixed. A parametric equaliser has fewer filter sections than a graphic equaliser, but all the parameters of the filter are adjustable, e.g. gain, bandwidth and centre frequency. A block diagram of the Elektor parametric equaliser is shown in figure 1. This consists basically of just three parametric filter sections — band selective filters whose gain, centre frequency and Q are all adjustable. Deficiencies at the ends of the audio spectrum are catered for by a parametric Baxandall-type tone control to provide bass and treble adjustment. These controls operate in a similar manner to the parametric filter sections, but employ lowpass and highpass filters rather than band selective filters.

much as 20 dB deep. Fortunately these peaks and troughs are inaudible due to their very sharpness, since they each occupy a bandwidth of only a few Hz. This is perhaps just as well since it would be impossible to cancel out each of these resonances.

If this 'grass' is ignored then the response becomes something like that shown in figure 4b, in which the major deviations from a flat response are more readily apparent. It is evident that the response falls off sharply below 50 Hz and above 10 kHz, that a large peak exists at about 750 Hz and a trough at about 6 kHz.

In addition there is a slight 'ripple' in the response due to a number of peaks and troughs a few dB deep. If one accepts the fact that deviations of a few dB can be ignored (and that in any case they will be very difficult to eliminate) then the response curve can be simplified to that of figure 4c, which shows only the principal deviations from a flat response. These are the deficiencies that must be removed by an equaliser.

Parametric or graphic?

It is fairly obvious that to remove a peak or trough from the frequency response the correction applied must be the exact inverse of the deficiency, i.e. the boost or cut applied must be the same as the depth of the trough

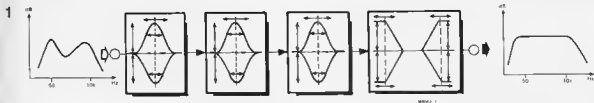

Figure 1. Block diagram of a parametric equaliser, which comprises three filter sections with variable gain, bandwidth and centre frequency, and tone controls with variable gain and turnover frequency.

2

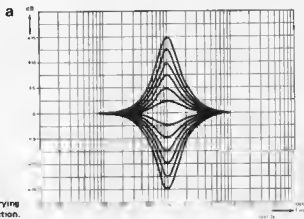
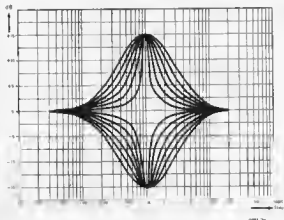
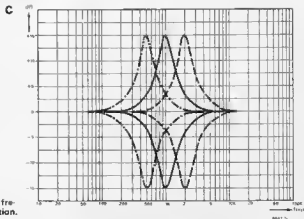

Figure 2(a). Illustrating the effect of varying the gain of a filter section.



(b). Showing the effect of varying the Q of a filter section.



(c). The effect of varying the centre frequency of a filter section.

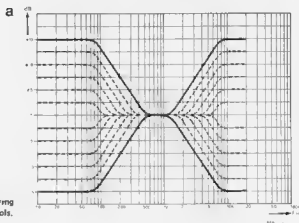
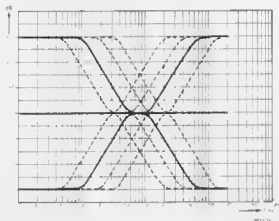

Figure 3. (a). Showing the effect of varying the gain of the parametric tone controls.



b

(b). Illustrating the effect of altering the turnover frequency of the bass and treble controls.

or height of the peak, it must be applied at exactly the right frequency, and the Q of the correction network must be the same as that of the peak or trough. It is apparent that these criteria can hardly ever be fulfilled by a graphic equaliser. Firstly, it is unlikely that the centre frequency of a peak or trough would coincide with the centre frequency of one of the equaliser filters. Secondly, since a graphic equaliser has filters with a fixed Q the shape of the filter response cannot be tailored to fit the curve of the peak or trough. In fact the only parameter that can be varied in a graphic equaliser is the degree of boost or cut. With a parametric equaliser on the other hand, the gain, centre frequency and Q of a filter section may be varied so that it is almost an exact fit for the peak or trough which it is to eliminate. At the extremes of the spectrum Baxandall tone controls with variable gain and turnover frequency can be used to compensate for the 'droop' which occurs.

Like the graphic equaliser, a parametric equaliser may have any number of

filter sections. The filter sections are necessarily rather more complex than those of a graphic equaliser; however, since each filter section is considerably more versatile it is possible to achieve satisfactory results with fewer filter sections, so that the cost is comparable with that of a graphic equaliser. For normal domestic use an equaliser consisting of three parametric filter sections plus Baxandall tone controls should be quite adequate.

Parametric filter section

The block diagram of a parametric filter section is given in figure 5. The heart of the filter is a selective network, which will be described in detail later, whose centre frequency and bandwidth (Q) can be independently varied. The gain of the filter can be varied by a ganged potentiometer, $P1$.

The selective network is a state-variable filter or two-integrator loop, which readers of the 'Formant' synthesiser articles will recognise as being essentially similar to the Formant VCF. However,

in this circuit the centre frequency of the filter is manually controlled by a two-gang potentiometer R_{int} , whose two sections vary the time constants of the integrator stages. The Q of the filter, and hence the bandwidth, is varied by altering the values of R_Q .

Complete filter circuit

Figure 7 shows the complete circuit of a parametric filter section. The state-variable filter around $A1$ to $A4$ is immediately recognisable, as is the variable gain amplifier, $IC1$. The Q determining resistors and potentiometers R_Q become $R6$, $R7$ and $P2$, whilst the centre frequency is set by $P3$. This arrangement differs somewhat from that shown in figure 6.

However, if R_{int} were a potentiometer connected as shown in figure 6 then it would have to have an inconveniently large value if the desired tuning range were to be covered. The arrangement of figure 7 is electrically equivalent and allows the effective value of R_{int} to be

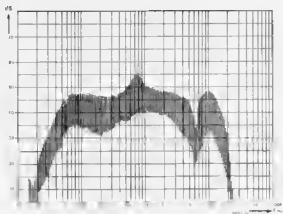

a

Figure 4. The frequency response of a typical reproduction chain, as it might be measured using an audio analyser. The 'grass' on the trace can be ignored,

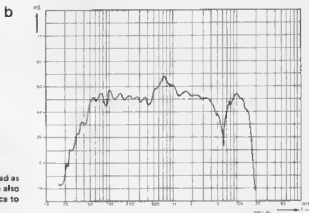

b

so that the response can be simplified as shown here. The few dB of ripple can also be ignored, reducing the trace to

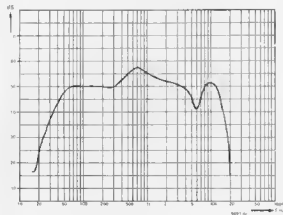

c

its simplest form. The remaining peaks and troughs in this simplified frequency response graph can be removed by using an equaliser,

5

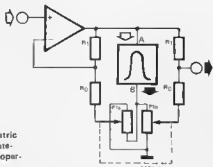

Figure 5. Block diagram of a parametric filter section, which consists of a state-variable band selective filter and an operational amplifier.

6

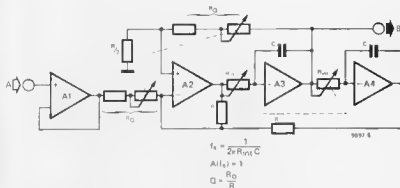

Figure 6. Circuit of the state variable filter.

7

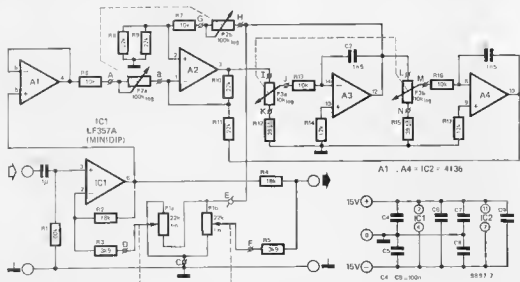

Figure 7. Complete circuit of a parametric filter section.

varied from 10 k with P3 at maximum to about 2.65 M with P3 at minimum. This allows the centre frequency of the filter to be varied between about 40 Hz and 10 kHz. The Q of the filter may be varied between about 0.45 and 5 using P2, while the gain can be adjusted by P1 between ± 15 dB, which should be more than adequate for room equalisation purposes.

If desired the tuning range of the filter may be varied by changing the value of R_{int} , using the equation of figure 6 to calculate the required maximum and minimum values. Different components may then be substituted for P3, R12, R13, R15 and R16. The minimum value of R_{int} (P3 at maximum) is equal to R13 (R16), whilst the maximum value of R_{int} (P3 at minimum) is equal to

$$\frac{P3a + R12}{R12} \times R13,$$

similarly for P3b, R15 and R16.

The Q adjustment range may also be varied by altering the values of R8, R9, R10, R11 (=R) and R6/P2a, R7/P2b (=RQ), using the second equation given in figure 6. However this information is included only for the benefit of experimenters, and the average constructor is advised to stick to the component values given.

Tone controls

The circuit of the parametric Baxandall bass and treble controls is shown in figure 8. This employs the same principles used in the parametric filter section. However, instead of using a band selective filter network the bass control uses a lowpass network connected between two buffers A1 and A2, whilst the treble control uses a highpass

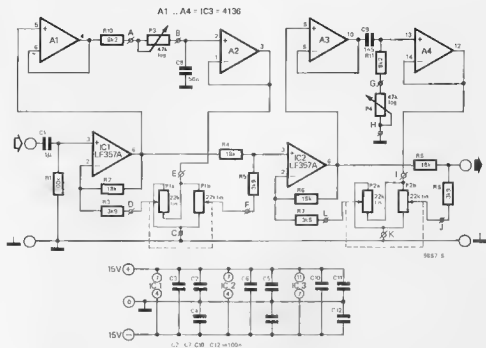
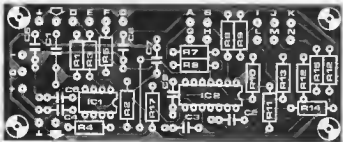
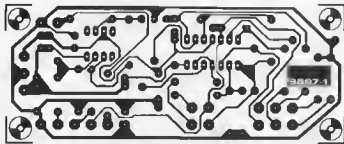

Figure 8. Circuit of the parametric tone controls. These are essentially similar to the parametric filters but use highpass and lowpass sections instead of selective filters.



Parts list to figures 7 and 9

Resistors.

- R1¹ = 100 k
- R2, R4 = 18 k
- R3, R5 = 3k Ω
- R6, R7, R13, R16 = 10 k
- R8, R9, R10, R11 = 22 k
- R12, R15 = 39 Ω
- R14, R17 = 12 k
- P1 = 22 k lin stereo
- P2 = 100 k log stereo
- P3 = 10 k log stereo

Capacitors

- C1¹ = 1 μ MKM, MKH (poly-carbonate, polyester)
- C2, C3 = 1n5 MKM, MKH
- C4, C5, C6, C7, C8, C9 = 100 n MKM, MKH

Semiconductors:

- IC1 = LF 357A
MINI DIP (National)
- IC2 = 4136 (Exer, Raytheon)

¹ omitted on certain boards; see text

² replaced by a wire link on certain boards; see text.

Figure 9. Printed circuit board end component layout for a parametric filter section.

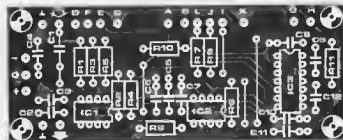
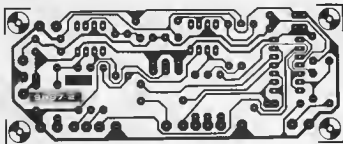

Figure 10. Printed circuit board end component layout for the parametric tone controls.

Parts list to figures 8 and 10

Resistors.

R1¹ = 100 k
 R2, R4, R6, R8 = 18 k
 R3, R5, R7, R9 = 3k9
 R10, R11 = 8k2
 P1, P2 = 22 k (in stereo)
 P3, P4 = 47 k log

Capacitors

C1² = 1 μ
 C2, C3, C4, C5, C6, C7, C10, C11,
 C12 = 100 n
 C8 = 56 n
 C9 = 1n5

Semiconductors:

IC1, IC2 = LF 356A or LF 357A
 MINI DIP (National)
 IC3 = 4136 (Exar, Raytheon)

¹ omitted in certain cases; see text

² in some cases may be replaced by a wire link; see text

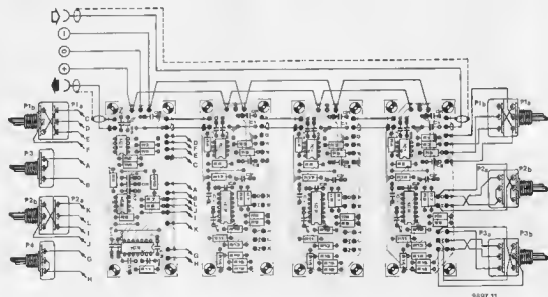

Figure 11. Interconnection of three filter sections and tone controls to form a complete parametric equaliser.

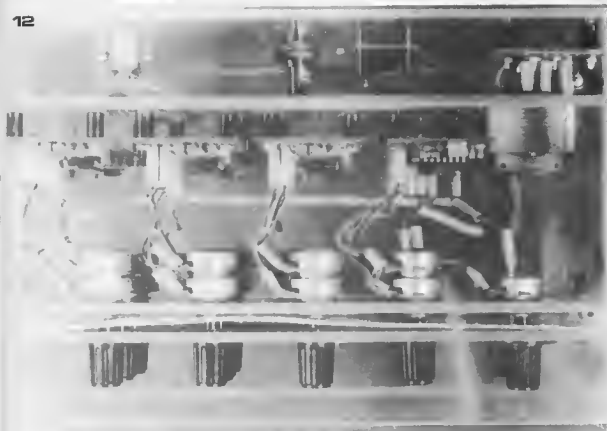

Figure 12. The completed prototype of the equaliser.

network connected between A3 and A4. The breakpoints of these filters can be varied, between 50 Hz and 350 Hz for the bass control using P3, and between 2 kHz and 13 kHz for the treble control using P4. The maximum gain of both controls can be varied between ± 15 dB using P1 and P2.

Construction

To make the equaliser more versatile it was decided to use a modular form of construction so that as many filter sections as required could be included. This also means that the sophisticated tone control section can be used as a unit in its own right by those readers who do not want an equaliser but would like a versatile tone control system.

Each filter section is therefore built on an individual printed circuit board, the track pattern and component layout of which is given in figure 9, whilst a separate board is used for the tone controls, the layout of which is given in figure 10. The boards are so designed that, when they are stacked side by side, the output of one board aligns with the input of the next. The connection points for the potentiometers are all labelled with letters, which correspond to those printed in the circuit diagrams of figures 7 and 8.

The interconnection of three filter sections and a tone control section to form one channel of a complete equaliser is shown in figure 11. If a stereo version is required then this arrangement must, of course, be duplicated. To avoid cluttering the diagram the potentiometer connections are shown to only one filter section and the tone control section. However, connections to the other three filter sections are identical. Since the inputs and outputs of each section have the same DC potential (zero volts) the input coupling capacitor C1 and resistor R1 are required only on the board connected to the input. On every other board R1 can be omitted and C1 be replaced by a wire link. Since the zero volt rails of each board are interconnected via signal earth the '0' connection of every board except the tone control should be left unconnected, otherwise earth loops may occur. Only the '0' connection on the tone control board should be connected to the 0 V terminal of the power supply.

For the power supply the use of a pair of the commonly available IC voltage regulators is suggested. Alternatively, if the equaliser is to be incorporated into an existing system with a ± 15 V supply then it may be possible to derive the supply to the equaliser from this.

The choice of a suitable housing for

the equaliser is left to the taste of the individual reader. One point, however, is worth noting. Adjustment of the equaliser is fairly time-consuming, but once the controls are set they should not require readjustment unless there are any changes in the reproduction chain or listening environment. It is thus a good idea to make the controls tamper-proof, for example by fitting a lockable cover plate in front of them, or by fitting spindle locks to the individual potentiometers. Alternatively the knobs could be dispensed with altogether, the ends of the spindles slotted to accept a screwdriver and the potentiometers recessed behind holes in the front panel.

Bibliography:

1. *The Elektor Equaliser*, Elektor No. 33 January 1978.
2. Kleis, D. *Reduction of acoustic feedback in sound systems applications*; paper at the 44th AES convention, Rotterdam, 1973.

appikator

Under the heading Aplikator, recently introduced components and novel applications are described. The data and circuits given are based on information received from the manufacturer and/or distributors concerned. Normally, they will not have been checked, built or tested by Elektor.

Heavy stuff: audio at 200 watts

One of RCA's specialties is high-power transistors. Three recent additions to the range are the BD 550, BD 550A and BD 550B. These three heavyweights are intended for use in quasi-complementary audio output stages, and a few of RCA's designs are described here.

The most remarkable characteristic of the three transistors is their high collector-emitter breakdown voltage — especially the BD 550B, with its V_{CE0} of 250 V! The main specifications for the three versions are listed in table 1.

To start the ball rolling, figure 1a gives the circuit of a 120 W audio power amplifier. Its main characteristics are given in table 2. The design is not particularly revolutionary, but it serves to illustrate the principle. The main problem when designing high-power amplifiers is to find an output device that will withstand the high voltages and currents required; it must also have a sufficiently high slew rate to handle the highest audio frequencies at full drive. The BD 550A is a good start, but even it would fall short in an amplifier of this type. For this reason, two transistors are used in parallel in each half of the output stage — making four in all for one (mono) power amplifier. One driver is provided for each pair of output devices. The circuit is arranged so that T8...T10 operate as one very-heavy duty NPN transistor; similarly, T11...T13 simulate an almost complementary PNP transistor.

The quasi-complementary output stage is preceded by two long-tail pairs: T1/T2 and T4/T5; internally, the whole amplifier is DC-coupled. T3 and T7 are both used as current sources. Negative feedback (about 30 dB) is applied to the base of T2 via R6. The quiescent current is set by T6; it is adjusted by

Table 1.

maximum ratings

	BD 550	BD 550A	BD 550B	
V_{CE0}	130	200	275	V
V_{CEO}	110	175	250	V
V_{CER} ($R_{BE} = 100 \Omega$)	130	200	275	V
V_{EBO}	5			V
I_C	7			A
I_B	2			A
P_T ($T_j = 25^\circ C$)		150		W
T_j		-65...200		$^\circ C$

electrical characteristics

characteristic	test conditions	BD 550		BD 550A		BD 550B	
		min	max	min	max	min	max
I_{CER}	$V_{CE} = 110 V$	—	1	—	—	—	—
	$V_{CE} = 175 V$	—	—	—	1	—	—
	$V_{CE} = 250 V$	—	—	—	—	—	1
f_{CEO}	$V_{CE} = 95 V$	—	5	—	—	—	—
	$V_{CE} = 150 V$	—	—	—	5	—	—
	$V_{CE} = 200 V$	—	—	—	—	—	5
I_{EBO}	$V_{EB} = 5 V$	—	1	—	1	—	1
V_{CEO}	$I_C = 0.2 A$	110	—	175	—	250	—
V_{CER}	$I_C = 0.2 A; R_{BE} = 100 \Omega$	130	—	200	—	275	—
f_T	$I_C = 0.2 A; V_{CE} = 10 V$	5 typ.	—	5 typ.	—	5 typ.	—
	$I_C = 4 A; V_{CE} = 4 V$	15	75	—	—	—	—
hFE	$I_C = 2 A; V_{CE} = 4 V$	—	—	15	75	10	50
	$I_C = 4 A; I_B = 0.5 A$	—	—	2	—	—	—
$V_{CE(sat)}$	$I_C = 2 A; I_B = 0.25 A$	—	—	2	—	2	—
	$I_C = 4 A; V_{CE} = 4 V$	0.75	1.75	—	—	—	—
V_{BE}	$I_C = 2 A; V_{CE} = 4 V$	—	—	1	2	1	2

1a

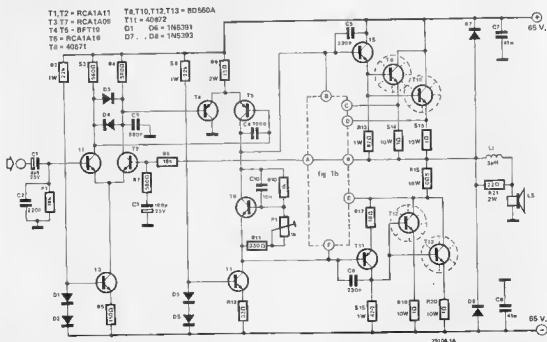

applikator

Under the heading Applikator, recently introduced components and novel applications are described. The data and circuits given are based on information received from the manufacturer end/or distributors concerned. Normally, they will not have been checked, built or tested by Elektor.

1b

Table 2.

Typical performance data of the amplifiers

	70 W (fig 4)	120 W (fig 1)	200 W (fig. 3)	unit
output power rated, 8 Ω load	70	120	200	W
typical, 4 Ω load**	40	120	200	W
typical, 16 Ω load	70	70	120	W
harmonic distortion	0,5	0,5	0,5	%
IM distortion (at 10 dB below maximum output power)	< 0,2	0,2	0,2	%
IHF power bandwidth 3 dB below rated power at 1 watt	5 . . 50 k 5 . . 100 k	5 . 50 k "	5 . . 35 k "	Hz Hz
sensitivity (full power)	600	900	900	mV
hum and noise (below continuous power output)				
input shorted	100	104	96	dB
input open	95	88	84	dB
with 2 k resistance on 20-ft cable on input	97	104	94	dB
input resistance	18	18	18	k Ω

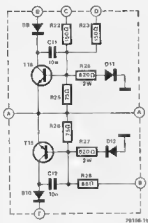

D9,D10 = 1N5391
D11,D12 = 1N914B
T14 = RCA1A10
T15 = RCA1A10

* not specified.

** at lower supply voltage, see text

2

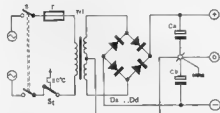

70100-2

means of P1. No 'optimum' value is specified by RCA; however, 100 mA through the output devices seems a safe bet.

As amplifiers get bigger and 'heavier', the chances of something going wrong increase. Disaster also becomes rather expensive, so protection devices are a good investment. D3 and D4 limit the drive to the second long-tail pair (T4/T5) in the event that the negative feedback gets out of sync with the input. Two further diodes, D7 and D8, protect the amplifier from excessive voltages at the output that could be induced by an inductive

3a

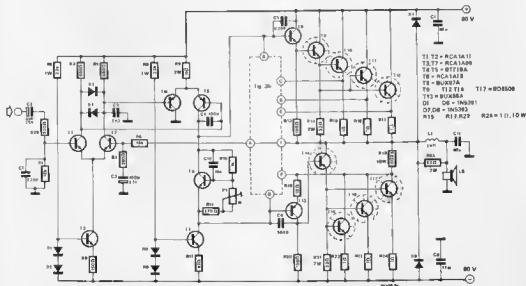

T1 T2 = RCA1A11
T3 T7 = RCA1A20
T4 T5 = 6BT18A
T6 = RCA1A12
T8 = 6XK07A
T9 T12 T14
T13 = 6XK08A
D1 D2 = 1N5391
D3 D8 = 1N5393
R15 R17 R23 R26 = 1 Ω , 10 W

aplikator

Under the heading Aplikator, recently introduced components and novel applications are described. The data and circuits given are based on information received from the manufacturer and/or distributors concerned. Normally, they will not have been checked, built or tested by Elektor.

3b

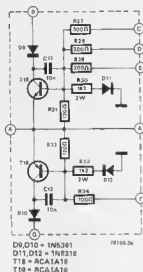

D9, D10 = 1N5381
D11, D12 = 1N5318
T8 = RCA1A18
T9 = RCA1A18
T10 = RCA1A18

load.

A further protection circuit is included in the dotted rectangle it is shown separately in figure 1b. The current through the output devices is monitored, by sensing the voltages across R14...R16. If the current rises above a maximum value, the corresponding half of the output stage is shut down by T14 or T15. A suitable power supply is shown in figure 2, the values for the various components are listed in table 3. Two protection devices are incorporated: a fuse and a thermal cutoff. The letter is mounted on the heatsink near the output devices — it turns off the amplifier if the temperature at that point rises above 80° C (180° F). Note that the transformer

Table 3.

component values for figure 2

	U_b (V)	trefo (stereo)	F (A)	D_a · D_d	C_e, C_b
70 W/8 Ω	45	2 x 32 V/4,5 A	2	1N1344B (6 A)	10 mF*/75 V
120 W/4 Ω	45	2 x 32 V/6,5 A	3	1N1202A (12 A)	10 mF/75 V
120 W/8 Ω	65	2 x 46 V/6,5 A	3	1N1202A (12 A)	10 mF/75 V
200 W/4 Ω	55	2 x 40 V/8,5 A	4	1N1202A (12 A)	10 mF/75 V
200 W/8 Ω	80	2 x 55 V/8,5 A	4	1N1202A (12 A)	10 mF/100 V

* 10 mF = 10,000 μF

will have to be capable of delivering 6 or 7 amps for a stereo amplifier.

Transistors T4, T5 and T7 need a small heatsink or cooling fan; T8 and T11 require a reasonably large heatsink; T9, T10, T12, and T13 must be mounted on a hefty heatsink (using mica insulating washers) with a thermal resistance of not more than 1° C/W for each transistor. T6 should also be mounted on this heatsink, to keep the quiescent current reasonably constant when the output transistors start running warm.

The components used in this circuit are not particularly common types, the transistors, in particular, are all RCA types and may not prove readily available. However, the circuit is not really intended as a straightforward construction project — rather, it may serve as a useful starting point for experiment. In this connection it may be noted that the amplifier as it stands will deliver 120 W into both 4 Ω and 8 Ω. If only a 4 Ω load is to be used, the supply voltage can be decreased to -45 V (2 x 32 V transformer) and BD 550s can be used instead of the BD 550A.

4b

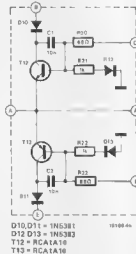

D10, D11 = 1N5381
D12, D13 = 1N5382
T12 = RCA1A18
T13 = RCA1A18

4a

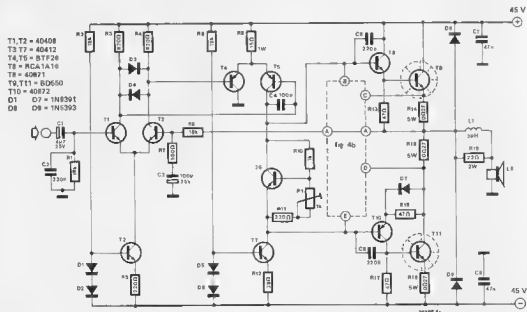

T1, T2 = 40408
T3, T7 = 40412
T4, T5 = B7F26
T8 = RCA1A18
T9 = 40871
T10, T11 = BD650
T12 = 40872
D1 = D7 = 1N5391
D8 = D9 = 1N5393

291084a

applikator

Under the heading Applikator, recently introduced components and novel applications are described. The data and circuits given are based on information received from the manufacturer end/or distributors concerned. Normally, they will not have been checked, built or tested by Elektor.

More . . .

In the 120 W amplifier, two power transistors were connected in parallel in each half of the output stage. This tactic can be extended: three transistors in parallel, instead of two, can be used to deliver even more power. The result is shown in figure 3a: a 200 W amplifier. Each half of the output stage now consists of five transistors: a pre-driver (T8, T13), a driver (T9, T14) and three output transistors (T10 . . . T12, T15 . . . T17). The protection circuit is again shown separately (figure 3b). The main specifications are included in table 2; the component values for the power

supply (figure 2) are listed in table 3.

As before, if only a 4 Ω load is to be used the supply voltage can be decreased (± 55 V; 2 x 40 V transformer) and the eight BD 550B transistors can be replaced by BD 550A's. Although 200 W is an awful lot of power, there is apparently a demand for even more . . . The same RCA application note gives a circuit for a 300 W amplifier, using the same principle of adding output devices in parallel. A total of eighteen BD 550B's are used, with a ± 86 V/5 A supply (for each channel), Quiescent dissipation: 90 W

. . . or less

After these horrifying figures, it is a good idea to conclude with a more 'reasonable' design. A circuit for a 70 W amplifier is shown in figures 4a (main circuit) and 4b (protection circuit); the specifications are given in table 2 and the power supply details in table 3. The same constructional notes (regarding cooling etc.) apply as given for the 120 W amplifier.

Lit
BD 550, BD 550A and BD 550B power transistors. RCA data sheet number 1109.

Why such heavy-duty output stages?

At first sight, the output stages may seem rather over-rated. Take figure 4, for example. The maximum collector-emitter voltage possible is less than 160 V, yet 250 V transistors are specified. Furthermore, if adequate cooling is provided the six output devices together can dissipate 900 W, delivering 21 amps into the load — although the peak current is less than half of this, even when delivering the full rated 200 W into 4 Ω ! Is RCA trying to sell more transistors than are really required?

No. Quite to the contrary, the RCA designers have the best interests of their customers at heart . . . A BD550B cannot meet all its maximum ratings simultaneously — no transistor can. This is obvious: the product of maximum voltage (250 V) and maximum current (7 A) is 1750 W — far more than the maximum rating of 150 W. The various limits can be plotted in a graph, as shown in figure A. The shaded area gives the permissible combinations of collector voltage and collector current: the so-called *safe operating area*.

The upper limit (A-B) is obvious: it corresponds to the maximum collector current rating. Similarly, the short vertical line (D-E) corresponds to the maximum collector-emitter voltage. The maximum power rating (150 W) is entered as a diagonal line (B-C): this is a straight line, since the scale divisions for U_{CE} and I_C are logarithmic. If linear scales are used, as in figure B, the effect of the maximum power rating becomes more apparent. The maximum current and voltage ratings (A-B and D-E) have little effect: the maximum power rating bites a huge chunk out of the safe operating area.

Obviously, if we really want to destroy a transistor we can exceed either its maximum voltage rating, or its maximum current rating, or its maximum power rating. There is, however, a more sophisticated way: *secondary breakdown*. This phenomenon is common to all transistors; it has to do with the fact that even moderate currents can cause sudden death to the transistor at collector-emitter voltages near the maximum rating. To steer clear of this effect, a further limitation of the safe operating area must be respected. This is entered as line C-D in the two graphs.

Now, let's take a fresh look at the 200 W amplifier. Full drive into a 4 Ω load corresponds to a peak voltage of 40 V and a peak current of 10 A. Even at this peak voltage, a

further 40 V remains across the transistors that are providing the peak current. From the dissipation curve (figure A) it is apparent that the BD550B can only pass 3 BA at this voltage, instead of the 'full' 7 A. Three of these transistors in parallel can pass 11.4 A, leaving a safe — but not excessive — margin.

It may seem strange that 40 V remain across the output transistors even at peak output voltage. After all, this means that the dissipation in the output devices is equal to the power delivered to the load. The main reason for this is that the supply voltage is chosen so that full power can also be delivered into an 8 Ω load — this requires a higher peak voltage

and a lower peak current. Furthermore, some voltage leeway improves the performance of the amplifier (lower distortion, better over-load characteristic) and a (nominal) supply voltage margin is required to cope with lower actual supply voltages caused by prolonged full-drive and mains fluctuations.

Lit
Solid-State Power Circuits, RCA Designers Handbook, Technical Series SP 52, Somerville USA 1971.

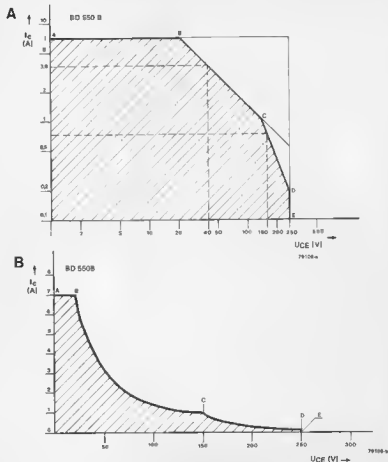

audio-analyser

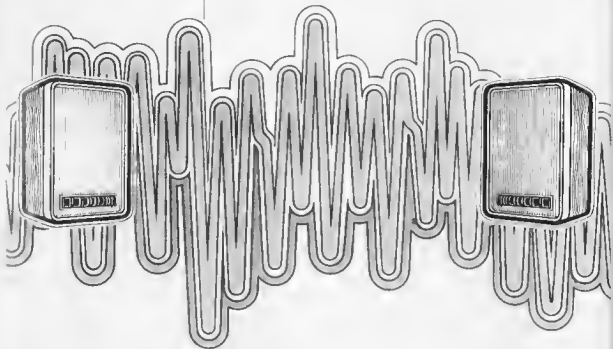

Without an accurate picture of the frequency response of the sound reproduction system, the use of an equaliser can do more harm than good. For this reason an audio spectrum analyser, which can pinpoint the deficiencies in a particular audio chain and/or listening environment, is a virtually indispensable piece of equipment for the equaliser-user.

Attempting to set up a room acoustically by twiddling the controls on an equaliser and 'playing it by ear' is an almost certain recipe for heated tempers and high blood pressure, such is the difficulty of the task. To obtain any real benefit from an equaliser it is essential that the user knows exactly what changes he wants to implement in the frequency response of the audio system in question. It therefore follows that a reliable audio spectrum analyser is required to provide the acoustic information which is a necessary preliminary to effective equalisation.

An audio analyser system basically consists of three sections: a test-signal source (pink noise generator), a microphone to monitor the output of the audio system under test, and a suitable means of analysing and displaying the energy level of the incoming signal. Broadly speaking, audio analysers fall

into one of two types, depending upon whether the analysis is real-time or not.

Real-time analyser

A *real-time analyser* is the most sophisticated, but also the most expensive way of obtaining a detailed picture of the spectrum of an audio signal. The operation of real-time analysers can be explained with reference to the block diagram of figure 1. A broadband test signal is fed to the audio system under test. Normally the test signal consists of pink noise, which has a uniform energy level over the entire spectrum. The output of the audio system is picked up by a measurement microphone and fed to a bank of octave or third-octave filters, which split the input signal into a corresponding number of adjacent frequency bands. The output voltage of each filter is then rectified

and displayed. Various types of display are possible — a moving-coil meter, an oscilloscope, or, as in the commercially available spectrum analyser shown in figure 2, a matrix of LEDs. The advantage of a real-time analyser is that it enables the average energy level of the entire spectrum to be determined at a glance. However, in view of the large number of displays and filter sections which are required, real-time analysers are not cheap. The above-mentioned pocket analyser of figure 2, together with a suitable noise generator, costs in the region of £600 — and that is only a fraction of what some of its 'larger brothers' can cost!

Since however, the primary application of the analyser is to monitor the response of an audio system to a constant test signal (the output of the pink noise generator, which has a uniform spectral intensity) real-time analysis is something of a superfluous luxury. A much cheaper, but none the less satisfactory arrangement is to have a single tuneable filter, which can be swept up and down the frequency spectrum as desired. This is in fact the solution adopted in the Elektor audio analyser.

The Elektor audio analyser

The block diagram of the Elektor, non real-time analyser is shown in figure 3. As can be seen, the basic principle of spectrum analysis remains the same, the only difference being that a single filter and display are employed, resulting in a considerable saving in cost. As far as the placing of the filter is concerned, three possible configurations come into consideration. In figure 3a the variable

1

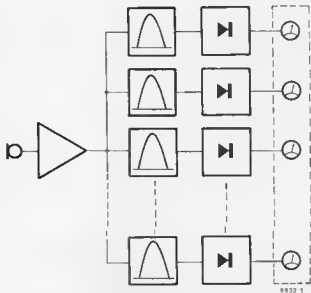

Figure 1. Block diagram of a real-time spectrum analyser.

filter is situated between the pink noise generator and the input to the audio system, whilst in 3b it is fed from the output of the microphone. In figure 3c two filters are employed in an effort to obtain the best of both worlds. Although in theory there should be no difference between these three arrangements, things are not so simple in practice. With the configuration shown in figure 3a, all manner of interference and stray noise can reach the microphone and adversely affect the measurement. With the arrangement of figure 3b, this problem is effectively obviated, since only interference which lies within the passband of the filter can reach the microphone. A disadvantage of this set-up, however, is that only a very small portion of the pink noise spectrum is used, whilst the audio system in question is of course required to reproduce signals over the entire range of audio frequencies. The arrangement of figure 3c thus represents the ideal solution, however in view of the increased cost and complexity of two tracking variable filters, it was decided that, for this type of application, one of the simpler circuits (figures 3a and b) would prove sufficient.

The basic requirements for an analyser of the above type are therefore:

- a pink-noise generator
- a bandpass filter with stepwise or continuously variable centre frequency
- a suitable microphone with preamplifier
- a rectifier circuit
- a display circuit

As far as the choice of microphone is concerned, it is clear that, unless it itself has a fairly flat response, one cannot hope to obtain an accurate picture of the response of the audio system/listening room under test. For this reason it is important to invest in a reasonably good quality microphone capsule and preamp.

As a display circuit, a multimeter is as good as any, and has the advantage of being cheap and commonly available.

The remaining circuits, which form the heart of the analyser — and the substance of the rest of this article — are shown in figures 4a, 4b and 4c.

Noise generator

As can be seen from the circuit diagram of the noise generator shown in figure 4a, it in fact consists of a pseudo-random binary sequence generator, which has a longer than normal cycle time. This ensures that the noise has a high spectral density and that it is not characterised by the annoying 'breathing' effect obtained with short cycle times. The length of the shift register (IC1...IC4) is 31 bits, and since the frequency of the clock generator (N5...N7, C1, C2, R3, R4) is roughly 500 kHz, the full cycle time is approximately an hour and a quarter!

EXOR-feedback is provided by N1...N4. The circuit however has no anti-latch up gating. Instead there are two pushbutton switches; the START button ensures a logic 1 at the data input Q_0 of the shift register (pin 7 of IC1), thereby starting the clock cycle.

2



Figure 2. Photograph of a commercially available hand-held real-time analyser, incorporating a LED-matrix display.

3

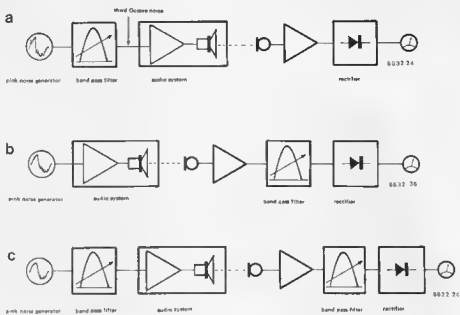

Figure 3. Three possible designs for a non real-time analyser.

4a

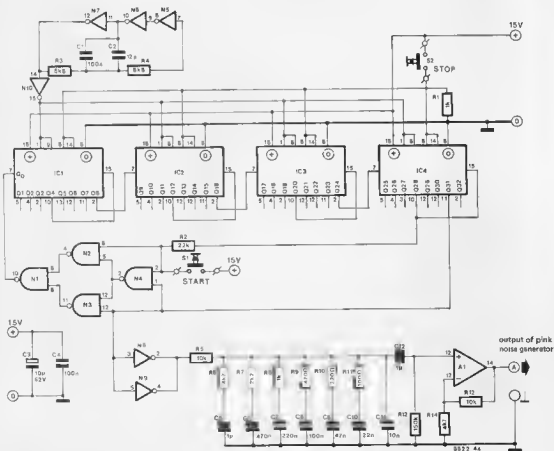

Figure 4a. The pink noise generator.

4b

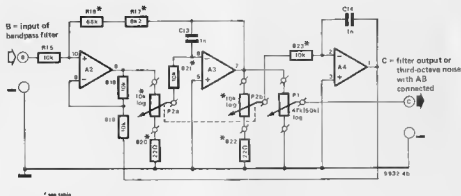

Figure 4b. The bandpass filter.

The cycle is inhibited by pressing the STOP button, S2. In this way it is possible to (temporarily) disconnect the noise source without switching off the supply voltage — a useful if not downright indispensable feature. The (pseudo-) white noise output of the shift register is fed to the pink-noise filter formed by R5 . . . R11, C5 . . . C11, before being amplified in the circuit round A1.

Bandpass filter

This section of the circuit (shown in figure 4b) is virtually identical to the

third octave filter described in the article on the CMOS noise generator in Elektor 33 (January 1978). The output level of the filter can be varied by means of potentiometer P1, whilst the centre frequency can be varied between approximately 40 Hz and 16 kHz by means of the stereo potentiometer P2a/P2b. If stepwise control of the centre frequency of the filter is desired, P2a/P2b can be replaced by a pair of attenuator networks and a twin-ganged switch. The necessary modifications are detailed in figure 5. Resistors R20 and R22 are replaced by a wire link, the values of R21 and R23 are altered, and

R40 and R41 are added. Table 1 lists the various resistance values required to give the ISO standard centre frequencies. When calibrating a parametric equaliser, a filter bandwidth of less than 1/3 of an octave is required. By altering the value of a wire link a bandwidth of approximately 1/2 of an octave can be obtained.

Rectifier circuit

It is of utmost importance that the amplitude of the test signal be measured accurately. If a pink noise test signal is used in conjunction with filters which

4c

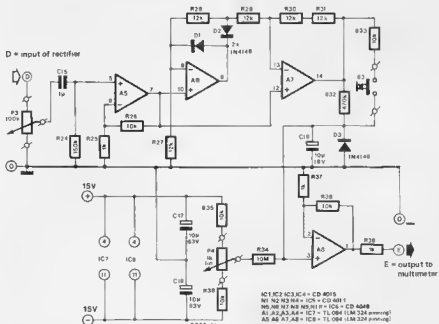

Figure 4c. The rectifier circuit.

IC1, IC2, IC3, IC4 = CD 4015
 IC5, IC6, IC7, IC8 = CD 4011
 IC9, IC10, IC11, IC12 = CD 4048
 A1, A2, A3, A4 = IC7 = TL 084 (LM 324 mirror)
 A5, A6, A7, A8 = IC9 = TL 084 (LM 324 mirror)

have a constant octave or 1/3 octave bandwidth (i.e. filters with a constant Q) one should really measure the RMS value of the noise — not an easy matter. Fortunately, however, a reasonably simple alternative exists — namely to measure the average of the modulus value, i.e. the average of the full-wave rectified noise signal. This is obtained by feeding the output of the peak rectifier to a lowpass filter.

The rectifier circuit is built round IC8. The input level control is followed by an amplifier, A5. The actual (full-wave) rectification is performed by A6, A7, R27...31, D1 and D2. The output of A7, which always presents a low impedance, is connected via R32 to C16. Because this capacitor has the same charge and discharge time, the voltage on the capacitor will equal the average value of the full-wave rectified noise voltage. The time that this voltage remains stored on the capacitor is determined by the RC time constant, R32.C16, or, if S3 is depressed, R32/R33.C16. Depressing S3 causes C16 to charge and discharge much more rapidly, so that the capacitor voltage will follow rapid variations in the noise voltage. Thus S3 is intended to provide a rapid overall view of the variations in noise level for different centre frequencies of the filter. For accurate measurements, the longer time constant of R32.C16 should be used. After being amplified in A8, the voltage on C16 is displayed on the multimeter. An offset control is provided (P4, R34...R36) to enable the meter to be calibrated accurately (zero deflection under quiescent conditions).

Construction

A printed circuit board, which is shown in figure 6, has been designed to accommodate the circuit of figures 4a, b and c.

Table

	1	2	3	4	5
31.5	1/1	21Ω + 20Ω	18 k	w	
31.5	1/3	20Ω + 20Ω	68 k	8k2	
40	1/3	50Ω	68 k	8k2	
50	1/3	40Ω + 20Ω	68 k	8k2	
63	1/1	40Ω + 30Ω	18 k	w	
83	1/3	40Ω + 30Ω	68 k	8k2	
80	1/3	10 Ω + 10Ω	68 k	8k2	
100	1/3	10 Ω + 30Ω	68 k	8k2	
125	1/1	12 Ω + 50Ω	18 k	w	
125	1/3	12 Ω + 50Ω	68 k	8k2	
160	1/3	22 Ω	68 k	8k2	
200	1/3	27 Ω + 10Ω	68 k	8k2	
250	1/1	33 Ω + 20Ω	18 k	w	
250	1/3	33 Ω + 20Ω	68 k	8k2	
315	1/3	22 Ω + 22 Ω	68 k	8k2	
400	1/3	56 Ω	68 k	8k2	
500	1/1	68 Ω + 30Ω	18 k	w	
500	1/3	68 Ω + 30Ω	68 k	8k2	
630	1/3	82 Ω + 80Ω	68 k	8k2	
800	1/3	100 Ω + 18 Ω	68 k	8k2	
1000	1/1	100 Ω + 47 Ω	18 k	w	
1000	1/3	100 Ω + 47 Ω	68 k	8k2	
1250	1/3	120 Ω + 68 Ω	68 k	8k2	
1600	1/3	220 Ω + 27 Ω	68 k	8k2	
2000	1/1	270 Ω + 47 Ω	18 k	w	
2000	1/3	270 Ω + 47 Ω	68 k	8k2	
2500	1/3	390 Ω + 18 Ω	68 k	8k2	
3150	1/3	470 Ω + 68 Ω	68 k	8k2	
4000	1/1	680 Ω + 47 Ω	18 k	w	
4000	1/3	680 Ω + 47 Ω	68 k	8k2	
5000	1/3	820 Ω + 150 Ω	68 k	8k2	
6300	1/3	1 k + 390 Ω	68 k	8k2	
8000	1/1	1k8 + 330 Ω	18 k	w	
8000	1/3	1k8 + 330 Ω	68 k	8k2	
10 000	1/3	3k3 + 390 Ω	68 k	8k2	
12 500	1/3	5k6 + 1 k	68 k	8k2	
16 000	1/1	39 k + 1k2	18 k	w	
16 000	1/3	39 k + 1k2	68 k	8k2	

Remarks

column 1: centre frequency in Hz

column 2: bandwidth in octaves

column 3: value of resistor to be connected between the junction of resistors R40 and R21 and ground and between the junction of R41 and R23 and ground, rounded up to values from the E12 series

column 4: value of R16

column 5: value of R17 (w = wire link)

5

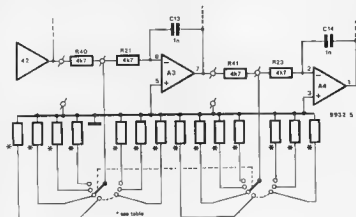

Figure 5. Modifications to the bandpass filter to obtain switched centre frequencies.

The design of the board is such that either of the configurations shown in figures 3a and 3b can be adopted. The construction of the standard version circuit should present no special problems. The wiring for the potentiometers and switches should be kept as short as possible. The connections for these components are arranged at one end of the board. Problems of a practical nature do arise, however, if one desires a number of switched filter frequencies, since one then requires a switch with a corresponding number of ways. Since switches with a large number of ways are both expensive and difficult to obtain, an alternative solution is simply to use the desired number of double-pole single-throw switches. This of course involves operating two switches each time one wants to alter the centre frequency of the filter. In addition to the switch(es), the choice of fixed filter frequencies involves the following alterations on the board (see

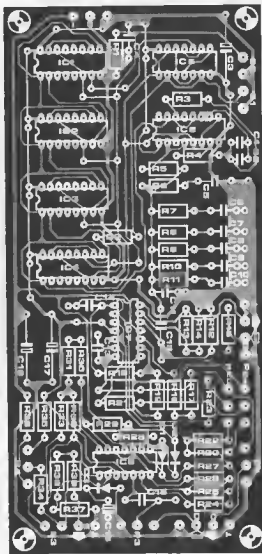
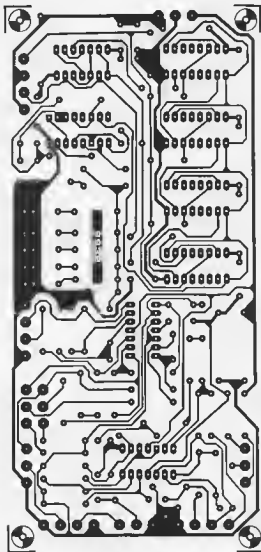

Figure 6. Printed circuit board for the circuit of figure 4.

parts list

Resistors:

R1, R8, R25, R37, R39 = 1 k
 R2 = 22 k
 R3, R4 = 6k8
 R5, R13, R15, R18, R19, R21, R23,
 R26, R33, R35, R36, R38 = 10 k
 R6, R14 = 4k7
 R7 = 2k2
 R9 = 470 Ω
 R10 = 220 Ω
 R11 = 100 Ω
 R12, R24 = 150 k
 R16 = 68 k
 R17 = 8k2
 R20, R22 = 22 Ω
 R27 . . . R31 = 12 k
 R32 = 470 k
 R34 = 10 M
 P1 = 47 k (50 k) log poten-
 tiometer
 P2a/P2b = 10 k log stereo poten-
 tiometer
 P3 = 100 k log potentiometer
 P4 = 1 k linear potentiometer

capacitors:

C1 = 100 p
 C2 = 12 p
 C3, C17, C18 = 10 μ /63 V
 C4, C8 = 100 n
 C5, C12, C15 = 1 μ MKM
 C6 = 470 n
 C7 = 220 n
 C9 = 47 n
 C10 = 22 n
 C11 = 10 n
 C13, C14 = 1 n
 C16 = 1 μ /35 V tantalum

Semiconductors

IC1, IC2, IC3, IC4 = CD 4015
 IC5 = CD 4011
 IC6 = CD 4049
 IC7, IC8 = TL 084 (Texas
 Instruments) DIL
 D1, D2, D3 = 1N4148

Miscellaneous:

S1, S2, S3 = pushbutton switch,
 single-pole push-to-make

7

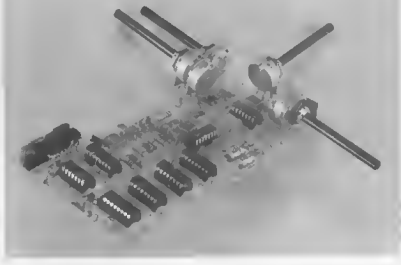

Figure 7. A prototype of the audio analyser.

figure 5): R21 and R23 become 4k7. R20 and R22 are replaced by a wire link. A 4k7 resistor (R40) is soldered between the 'top' two tags of P2a. A 4k7 resistor (R41) is soldered between the 'bottom' two tags of P2b. The resistor pairs forming the switched attenuator network are mounted externally on the switch(es). Suitable values are given in the table.

With a continuously variable filter frequency it is useful to equip P2a/b with a pointer and scale. The scale can of course be calibrated in frequencies, but it is not strictly necessary. What matters is that one has a series of reference points — peak or dip at such and such a filter setting, etc. If, however, an absolute frequency scale is desired, this can be obtained by using a tone generator and noting the frequency when the output voltage at point C is at a maximum, when feeding a pure sine-wave into point B.

Using the analyser

The multimeter (10 to 12 V full-scale deflection) which is used to display the amplitude of the noise signal is connected to the output (point E) of the rectifier circuit. In the absence of an AC drive voltage (i.e. point D disconnected or else P3 turned right down) the DC voltage at this point should be set by means of P4 to exactly 0 (m)V. The correct setting for P4 is obtained by repeatedly switching down the voltage range of the multimeter and checking the reading by reversing the polarity of the probes. It should be borne in mind

that, because of the long time constant of R34 and C16, it will take some time for adjustments to P4 to have any effect. The long discharge time of the storage capacitor in the rectifier circuit together with the natural inertia of the meter ballistics ensure that the needle responds only very slowly to changes in the level of the filter output. Thus when sweeping the filter up and down the audio spectrum, care should be taken to vary the filter frequency *gradually*, lest peaks or dips in the response are camouflaged by the slow response of the circuit.

If the analyser is used to measure a system with a completely flat response, the *mean* meter deflection (i.e. the mean between the maximum positive and negative deflections) should be independent of variations in the filter frequency. An audio system with a completely flat response would be pretty hard to find, however, something which does have a more or less flat response is a wire link! — by joining points A and B and C and D in this way (i.e. connecting the output of the noise generator to the bandpass filter and the output of the filter to the rectifier circuit) it is possible to test the operation of the audio analyser, and in particular, of the pink noise and bandpass filters. Variations of up to ± 2 dB (0.8...1.25) in the mean meter reading are acceptable. To prevent the rectifier circuit from being overloaded, the mean meter reading can be adjusted to occur at around 3...4 V.

Finally a word of warning: care should be taken to ensure that the noise signal does not overload one's audio equip-

ment. The risk of this happening is somewhat greater than in the case of a sine or squarewave input signal, since the distortion caused by overloading will be that much less noticeable (but none the less disastrous!). Tweeters in particular are susceptible to damage by being overloaded with high level noise signals.

Constructing the audio analyser is one thing, using it is another. The reader is therefore referred to the article on 'Using an equaliser', which deals with the subject of using the equaliser/analyser combination to measure and then correct a room's response.

Literature:

1. 'Digital noise generator', *Elektron* 21, January 1977
2. 'CMOS Noise generator', *Elektron* 33, January 1978

Over the years there have been numerous circuits designed to protect one's car from the attentions of thieves. Many of the designs have aimed at foiling the person who succeeds in bridging the ignition contacts or who has a false key. In such cases the usual idea is to employ a second switch in the lead to the ignition coil, which is hidden or camouflaged from the thief. In principle this approach is quite attractive, however it does have a couple of drawbacks. Firstly, the switch must of course be well hidden, and yet within reasonably easy reach of the driver - two seemingly conflicting requirements. Secondly,

considerable vibration. Many small relays used in cars are provided with flat contact 'tongues', which are ideal for this type of application. By employing a slight trick, it is possible to ensure that when the car goes into the garage for repairs or servicing, there is a simple way of keeping its 'secret' well hidden. If point 1 of the circuit is connected to one of the 'forks' of the contact tongue, then before taking the car into the garage, one simply connects point 2 of the circuit to the other 'fork', so that the car then starts normally. It will be apparent that, with only minor modifications to the relay connections, the

TAP thieves on the head

Touch activated anti-theft device for cars

E. Schorer

once the ignition is switched off and the ignition key removed, the second, concealed switch must also be in the off position, otherwise the anti-theft circuit is pointless. However it is all too easy to forget to operate the concealed switch when leaving one's car in a hurry. The circuit shown in the accompanying diagram represents an attempt to get round both these problems. To start the engine the ignition switch, S1, is first closed. This however fails to energise the ignition coil, since the contacts of the relay, re/a, which is inserted in the ignition lead, remain open. If however the touch contacts are bridged with the finger, a small base current will flow through T1, turning on this transistor and the Darlington pair, T2 and T3. As a result, the relay, re, pulls in, and once the contact re/b is closed, the relay will remain in that state. The engine can now be started normally. When the ignition switch is opened, the relay will automatically drop out, thus 're-arming' the anti-theft facility.

The circuit itself is quite straightforward. The RC network, R3, C2, which is included in the supply line of T1, and the stability capacitor C1, shield the circuit from the effects of any voltage transients generated by for example the wiper or heater motor, which may already be in operation before the relay is pulled in. This prevents the relay being actuated spuriously.

As far as the design of the touch switch is concerned, it is left up to the individual to choose the optimal form of camouflage. A suitably reliable and robust type of relay should be used, since it will obviously be subject to

circuit can be used as a touch switch with many applications in the car (e.g. windscreen washers, wipers etc.).

The circuit can easily be mounted on a small board, roughly 1,5 x 4 cm. It is recommended that both sides of the circuit be covered with a layer of protective lacquer.

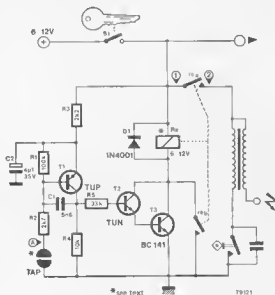

ejektor

an invitation to investigate, improve on and implement imperfect but interesting ideas

Self-oscillating PWM amplifier

With a contribution by P. Geelen

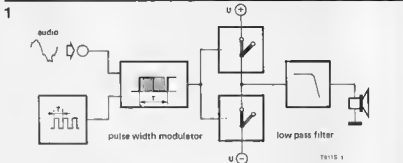

2a

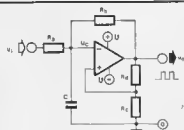

2b

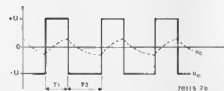

3

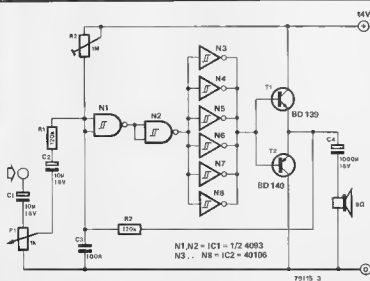

The increasing attention being paid to digital methods of audio signal processing has led to a search for ways of using output transistors as switches. A recent example is the Class D or PWM (pulse width modulation) amplifier, in which the analogue input signal is converted into a digital pulse train, the duty-cycle of which varies in sympathy with the amplitude of the input signal.

The basic principle of almost all PWM amplifiers is illustrated in the block diagram of figure 1. The output transistors are not operated linearly, i.e. the greater the input signal the harder they are turned on, and vice versa) but rather function as switches, i.e. are either turned hard on or hard off. This means that the transistors are either passing current but have very little voltage dropped across them, or else have the full supply voltage across them but are passing little or no current. As a consequence, very little power is dissipated in the transistors themselves, and the amplifier is in principle considerably more efficient than those with a conventional (linear) output stage.

The audio information is transmitted by modulating the duty-cycle of a squarewave

switching signal. Under quiescent conditions the duty-cycle of the switching waveform is 50%; each of the output transistors is therefore closed for an equal length of time, and the average output voltage is obviously zero. If however one of the switches (transistors) is closed for longer than the other, the average output voltage will either be positive or negative (depending upon the polarity of the input signal). The audio input signal is thus used to control the duty-cycle of the switching waveform such that the average output voltage is proportional to the input signal.

Apart from the advantage of increased efficiency, PWM amplifiers are in principle free of the problems caused by inherent non-linearities in the transfer characteristic of the output transistors (crossover distortion for example). On the other hand, there is the drawback of having to employ a low-loss lowpass filter to recover the analogue audio signal (otherwise the amplifier will tend to operate as an r.f. transmitter!).

In practice the above described principle can be implemented in a variety of ways, and although there are PWM amplifiers now on

the market (see article 'PWM audio amplifiers' in Elektor 44, December 1978), most of the approaches are still in the experimental stage. One method, which forms the basis of this article, is the self-oscillating PWM amplifier, in which the squarewave generator, pulse width modulator and the output stage are combined together. The circuit consists, as it were, of one large pulse width modulated squarewave generator. Such an approach should in principle result in a considerably simplified design.

Basic concept

The basic circuit of a pulse width modulated squarewave oscillator which could be used for this application is shown in figure 2a. At the output is an asymmetrical squarewave voltage u_0 , which fluctuates between a value of $+U$ and $-U$. This output waveform is shown in greater detail in figure 2b, where the voltage across capacitor C is also indicated. The duty-cycle, δ , of the squarewave is defined as the time that u_0 is 'high' over the time that u_0 is 'low', i.e. T_1/T_2 . It can be shown that the duty-cycle is dependent upon the analogue input voltage, u_{in} . Thus

$$\delta = \frac{\ln \frac{a \cdot u_{in} + b}{a' \cdot u_{in} + c}}{\ln \frac{a \cdot u_{in} + b}{a' \cdot u_{in} + c} + \ln \frac{a' \cdot u_{in} - b}{a' \cdot u_{in} - c}}$$

where $a = \frac{R_b}{R_a + R_b} \cdot \frac{1}{U}$;

$b = \frac{R_b}{R_a + R_b} + \frac{R_c}{R_c + R_d}$

$c = \frac{R_b}{R_a + R_b} - \frac{R_c}{R_c + R_d}$

In x is the natural log of x . Unfortunately, we would like the duty-cycle to vary linearly with the input voltage, u_{in} , which is patently not the case with all these logs floating about the equation. However

4

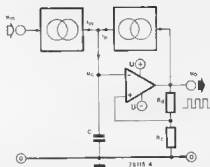

there is a 'trick' possible, which will yield the described result. Namely, if R_d is made much larger than R_c , then $\frac{R_c}{2 \cdot R_a + R_d}$ becomes so small that b and c are to all intents and purposes the same, and the numbers whose natural logs we must take then equal 1. That being the case, the logs can be approximated with a high degree of accuracy to a non-logarithmic form. Omitting the intermediate calculations, we arrive at the following result:

$$\delta = - \frac{R_b}{2 \cdot R_a + R_d} u_{in} + \frac{1}{2} (R_d \gg R_c)$$

This is precisely what we desire: the duty-cycle is linearly proportional to the input voltage. Furthermore it is apparent that the duty-cycle equals $\frac{1}{2}$ (50%) when the input signal is 0.

Practical circuit

In the Elektor lab an attempt was made to put the above - on paper highly attractive - idea into practice. The first result of our efforts is shown in figure 3. The amplifier/comparator stage of the block diagram is formed by the CMOS inverters N3...N8 and the two transistors. The inverters are connected

in parallel in order to ensure sufficient base current for the transistors. C3 is the equivalent of capacitor C in the figure 2. The negative feedback is applied via R2; R1 corresponds to R_b . The positive feedback, which in figure 2 was realised via R_c and R_d , may at first sight not be apparent in the circuit of figure 3, however it is present. Ous to the delay introduced by the CMOS gates, the circuit in fact oscillates in the same way as a conventional CMOS oscillator. The duty-cycle of the output waveform is adjusted to 50% by means of P2 (with the Inputs shorted). A breadboard version of the above circuit worked satisfactorily without a loudspeaker. A distortion of 2% was measured with an audio output signal of 6 V_{pp}. However, once the circuit was connected to a loudspeaker, the distortion rose to a completely unacceptable 40%.

Current sources

An improvement in the performance of the circuit can be expected if R_a and R_b in figure 2 are replaced by controlled current sources (see figure 4). Capacitor C is then charged and discharged by currents which can be regarded as remaining constant for the duration of each switching cycle. In the long term, the current I_{in} is directly proportional to the input voltage u_{in} . The output current, I_0 , is proportional to the asymmetrical squarewave output voltage, u_0 . When u_0 is high, I_0 is equal to I_+ , and when u_0 is low, I_0 equals $-I_-$. It can be shown that the duty-cycle, δ , of the output signal is proportional to the input voltage, u_{in} . This is true in an absolute sense, and not merely approximately. Thus:

$$\delta = - \frac{1}{2 \cdot I_-} \cdot I_{in} + \frac{1}{2}$$

A suitable (voltage) controlled current source is the operational transconductance amplifier (OTA), which will be familiar to Elektor readers. This is a special type of op-amp which produces an output current that is proportional to the input voltage. The output impedance of the op-amp is thus as high as possible, in contrast to the normal situation where it is as low as possible. As is apparent from figure 5, the use of voltage-controlled current sources considerably complicates the design of the circuit. For the satisfactory operation of the OTA's a number of ancillary resistors are required. The circuit is adjusted as follows: Initially IC1 is disconnected from the remainder of the circuit and the switching frequency (roughly 100 kHz) is set by means of P4. The duty-cycle of the switching waveform is then set to exactly 50% by means of P5. P5 is adjusted such that IC2 is not overloaded. IC1 is then connected in circuit and P3 adjusted to set the output current of the OTA. Distortion appears to be minimised when adjusting P3 for the smallest current at

5

- IC1 = CA 3090
- IC2 = CA 3090
- N1, N2 = IC3 = 1/2 4093
- N3...N8 = IC4 = 40106

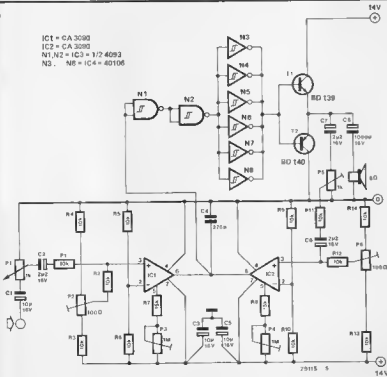

which the circuit continues to operate satisfactorily. Finally, the duty-cycle of the switching waveform is readjusted to 50%. Unfortunately, all the above measures seemed to be scarcely worth the bother, for the on-load distortion of the circuit was at least 30% (although only around 0.5% off-load).

of the amplifier circuits examined so far is overshoot of the squarewave caused by the inductance of the loudspeaker. IC2 cannot cope properly with the resulting voltage 'peaks', which on the negative-going edges of the waveform exceed zero volts. For this reason a circuit was tested in which IC2 was replaced by a 'double current source', built round discrete components, and which in the event of the squarewave falling below zero

volts discharged the capacitor.

As can be seen from figure 6, a fairly complicated circuit resulted. The function of capacitor C in the diagram in figure 2 is here assumed by C6. The additional current source to discharge this capacitor is formed by T1...T4. The adjustment procedure is largely similar to that of the previous circuit. IC1 is first disconnected and the switching frequency and duty-cycle set by means of P4 and P5. The frequency is varied by adjusting the position of both P4 and P5 at the same time, whilst the duty-cycle is varied by adjusting P4 with respect to P5. P2 and P3 are adjusted as described for the previous circuit.

The circuit proved to have a distortion of approximately 5% on-load, so that it at least represents a considerable improvement on earlier attempts. Of course it is a typical 'lab circuit', in that the performance still falls short of justifying the - as yet - fairly complex design. However it is nonetheless clear that the principle offers interesting possibilities.

Using V-FET's

Finally, figure 7 shows the results of further development, with conventional bipolar output transistors being replaced by V-FET's, which are of course capable of much higher switching speeds. Capacitor C in the original basic circuit here becomes C10. A symmetrical supply configuration has been adopted (+ and -7 V), whilst the idea of controlled current sources has been abandoned altogether. An amplifier stage formed using discrete components is however included between the input and C10. The distortion caused by omitting the controlled current sources is largely eliminated by overall negative feedback (via R15) of the audio signal. The low-pass filter at the circuit output is formed by coil L1 and capacitor C14. An RC network removes any high frequency components from the input signal.

The results of this (still highly experimental) circuit are quite encouraging: a distortion figure of approximately 0.4% was obtained for an output power of roughly 1W. It is of course obvious that as yet the performance of the circuit is out of all proportion to the complexity of the design, however the prospects appear sufficiently good to justify further research on an amplifier based on these principles.

Overshoot

A suspected cause of the enormous distortion

6

IC1 = CA 3080
N1, N2 = IC2 = 1/2 4093
N3 - N8 = IC3 = 40106

T1 T2, T5, T6 = BF 451
T3, T4, T7, T8 = BF 494
D1, D3, D4, D6 = 1N4148

D2 = 5V2/400 mW
D5 = 4V7/400 mW

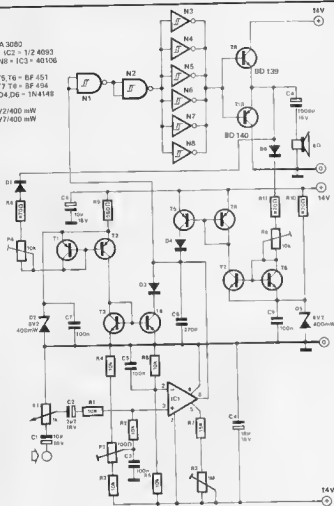

7

T1 T4 T5 = 6F 454
T6 = 6F 451
IC1 = LF 356
N1 N3 = IC2 = 1/2 40906

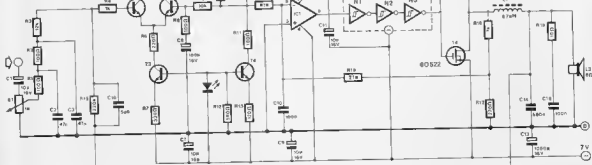

market

Bubble etcher for P.C.B. production.

Mega Electronics have introduced a new bubble etcher aimed at both hobby and professional user markets.

Designated the type PLBE-1210 bubble etcher this new p.c.

market

Solid-state relays and drivers

A new range of optically isolated AC solid-state relays and thyristor drivers are now available from Hamlin Electronics. The 7580 series use the latest hybrid thick-film technology to give an extremely compact single-inline package occupying less than half a square inch (1300mm²) of printed-circuit board mounting area. The optical isolation provides an input/output isolation voltage of 1500 V RMS, and the devices feature polarity-protected inputs, zero-voltage switching, and compatibility with integrated-circuit logic.

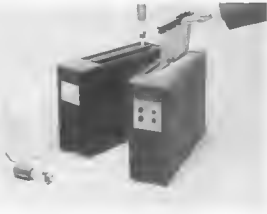

The relays have a load-current rating of 2 A RMS at a control voltage of 3 V DC and 1.75 A RMS at 32 V DC. Nonrepetitive single-cycle surge current is 70 A peak, and one-second overload current is 35 A peak.

The solid-state drivers are designed to interface between logic-level control circuits and power thyristors operating on the AC line. Output current to the thyristor is 50 mA RMS maximum or 150 mA pulse current.

The relays and drivers are mounted in a single-inline package measuring only 40 x 22 x 9 mm, and the package is phenolic coated to resist hostile environments.

Hamlin Electronics Europe Ltd.,
Diss, Norfolk, IP22 3AY,
Tel.: (0379) 4411/2/3, 2287/8/9

(1227 M)

Production encillery has a fluid capacity of 5 litres, and accepts printed circuits of up to 12x10 in. Extra capacity in the tank has been achieved by positioning the heating element so that it does not protrude into the tank itself. An important feature of the Type PLBE-1210 is that it reaches its operational temperature of 45°C within 30 minutes, from an ambient temperature of 20°C. The average etching time for both single-sided and double-sided boards is 4½ min. Other features include full thermostatic control of the fluid temperature, self-contained and independently switched pneumatics, and protection against evaporation and splashing.

Designed for both the hobbyist electronic engineer and the professional user, the Type PLBE-1210 bubble etcher measures 17½ in. wide x 13 in. high x 5½ in., and is priced at £55 including V.A.T.

Mega Electronics,
9 Radwinter Road,
Saffron Walden,
Essex, CB11 3HU.
Telephones: (0799) 21918

(1230)

cover all the currently available ranges of Signetics and National Semiconductor PROMs and EPROMs (electronically programmable read-only memories) — probably the broadest selection of industry standard types currently available.

SWIFT-SASCO aims to provide a 24-hour turn-round service for Prototype PROM quantities, and will offer production schedules for larger quantities. All the customer has to do is to supply a program in one of three forms: truth table, punched tape or master PROM. SWIFT-SASCO can also supply its full range of PROMs and EPROMs to customers for their own programming.

SWIFT-SASCO, P.O. Box 2000,
Crawley, Sussex, RH10 2RU
Telephone: (0293) 28700

(1224 M)

SWIFT-SASCO launches PROM programming service

SWIFT-SASCO has launched a programming service for programmable read-only memories (PROMs) based on a STAG Model PFX universal PROM programmer. The generic end adaptor modules

market



market

market

JUST KGT

Sweepable function generator

Continental Specialties Corporation introduce their new Model 2001 waveform function generator, electronically sweepable over a 10:1 to 100:1 range.

The 2001 offers sine, triangle, square and TTL square waves from 1 Hz to 100 KHz in five pushbutton selectable overlapping ranges, tuned with a 10:1 vernier dial featuring 50 increments, and an accuracy of $\pm 5\%$ of the dial setting.

The TTL output will drive 10 TTL loads with rise and fall times of less than 25 Nanoseconds.

Sine, square and triangle waveform outputs are variable over a greater than 40 dB range. The High Level output is rated 0.1-10 Vp-p into an open circuit, .05-5 Vp-p into a 600 Ohm load. A separate Low Level output, 40 dB down from the High Level output, is rated 1-100 mV into an open circuit, .5-50 mV into a 600 Ohm load. The variable amplitude control, once set, holds the output signal to within less than ± 0.5 dB over the entire frequency range.

The sinusoidal waveform offers less than 2% distortion and the triangular waveform is within less than 1% of linearity error. The standard (not TTL, which is a separate output) Square Wave features rise and fall times of less than 100 nanoseconds, and a time symmetry error of less than $\pm 2\%$. The Voltage Controlled Sweeping Oscillator (Sweep VCO) may be zero referenced from any frequency setting.

The 2001 is calibrated at 25°C $\pm 5^\circ\text{C}$, but operates over a 0-50°C

range. The 10"W x 3"H x 7"D package (25.4 x 7.6 x 17.8 cm) weighs in at 2.2 pounds (1.0 kg). Power requirements are 5 Watts at 220-240 VAC, 50/60 Hz.

Continental Specialties Corporation (UK) Limited, Shire Hill Industrial Estate, Units 1 & 2, Saffron Walden, Essex. CB11 3AQ, England. Tel: Saffron Walden (0799) 21682.

(1215 M)

Miniature rocker switch with five position capability.

Impectron Limited has launched in the UK a miniature rocker switch which can have up to five operating positions. Made by Petrick in West Germany, the Series 326 can have either a simple two pole make/break configuration, or a complex single pole type having 4 operating and one isolated position.

The new switch measures only 23.5 x 10 x 9.2 mm (excluding mounting pins) and is designed primarily for PCB mounting. In its most complex form the switch has five pins, the centre one of which is the pole contact. In its central (rest) position, the single pole is isolated, but as the rocker is depressed lightly at one end a distinct operating position is felt as the centre pole makes contact with the first pin. Further operating force brings the rocker to a second position, in which the pole makes contact with the second pin also. The action is the same at the other end of the rocker, making a single pole, 5 position configuration.

The housing is moulded from black ABS and contacts are heavily plated to ensure low deterioration with use. Life is greater than 10⁵ operation, while maximum contact ratings are



50 V, 25 mA D.C. Contact resistance is well below 200 m Ω , and operating temperature range extends from -25 to $+75^\circ\text{C}$.

Impectron Limited, Impectron House, 23-31 King Street, London W3 9LH, Tel: 01-992 5388.

(1217 M)

market

JUST KGT

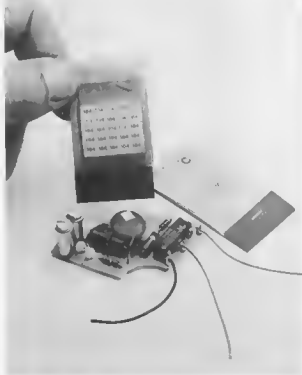

Miniature temperature indicator tabs.

These indicators are tiny self-adhesive tabs, 1/8" square, which change colour instantly from silver to black within 1% of the rated temperature. Ratings range from 40°C to 260°C in 41 increments. Ideal for electronics applications, 'Temp-checker' tabs can be used

on any clean dry surface. Available in a convenient book match pack; quantities of six packs and over are supplied in an outer wallet.

Carol Components Ltd., 40-44, The Broadway, Wimbledon, London, SW19. Telephone 01-540 7186

(1228 M)



market

Multirange capacitance meter

This attractive and simple-to-use instrument is the latest component test equipment available from Alcon Instruments. Known as the Varicaptester, it is a pocket-sized

On two selected ranges, capacitance can be indicated as $1 \mu\text{F}$ per second or $100 \mu\text{F}$ per second, thus extending the range to several thousand μF . Maximum sensitivity is $1 \text{ pF} \times \text{div}$. error, accuracy is 2.5%.

Power for all normal uses, including the application of 1.5 V or 22.5 V to the Varactor or Varicap diodes, is supplied using internal batteries. The user may, should he wish, apply a selected external voltage via provided terminals for this latter purpose. The Varicaptester comes complete with instructions, leads, case and



will accept signals from capacitive, inductive (Hall Effect) or simple switch closure keyboard systems having up to 128 keys.

The 40-lead NMOS circuit uses a sophisticated dual-pulse detection technique - unlike existing encoder circuits which normally rely on a contact closure for each key. The internal 'key validation' facility effectively protects the system against key bounce or spurious noise.

Of its 128-key handling capacity, the AY-3-4592 provides up to 112 keys with up to four 10-bit programmable codes, depending on the current status of the shift and control key inputs. The remaining 16 key inputs are reserved for discrete function non-encoded keys.

The keys are connected to the encoder circuit in a 16×8 matrix, with 16 drive lines and 8 sense lines. The drive lines are pulsed low sequentially by the encoder, the pulse is coupled from the drive line to the appropriate sense line, and a sense amplifier on the chip recognises that the key is down. The circuit may be programmed to encode and key for any special purpose.

An internal oscillator controls the matrix scanning rate. Minimum complex scanning period is 1.7 mSec at 1.2 MHz clock frequency, which effectively allows burst typing speeds equivalent to over 250 words per minute.

The AY-3-4592 is completely self contained and requires just a single +5 V power line (the usual requirement for normal encoder circuits includes an additional

-12 V power line). A 4592-Bit ROM, 128-Bit shift register, system clock and zener diode protection on all I/O pins are provided on-chip, and all inputs and outputs are TTL and CMOS compatible.

General Instrument
Microelectronics Ltd.,
Regency House,
1-4 Warwick Street,
London W1R 5WB, England
Telephone 01-439 1891 (1226 M)

market

The Vero 'G' Case.

Vero Electronics Limited have increased their large range of instrument cases with the introduction of the 'G' series. This unique design has a satin anodized aluminium top cover and front and rear panels and base in matt black PVC-clad steel and is available in three standard sizes.

The base and front and rear panels form an integrated chassis, with no visible fixings when assembled. Removing the screws which attach the fast allows the cover to be removed for servicing. A sloping visor front protects against glare for light displays.

Vero Electronics Limited,
Industrial Estate, Chandler's Ford,
Eastleigh, Hampshire, SO5 3ZR (1223 M)



batteries. Optional extras include component test-rigs for production testing.

Price is £82.50, and delivery is at this time 'off the shelf'.

Alcon Instruments Limited,
19 Mulberry Walk,
London, SW3 6DZ (1210 M)

market

Versatile encoder circuit for all types of keyboard

A new keyboard encoder micro-circuit from General Instrument Microelectronics, the AY-3-4592,



multirange capacitance meter with abilities extending from pF to thousands of μF .

Constructed in tough ABS plastic with simple range selection and a full-view cover, the Varicaptester can cope with all types of capacitors, including plain and polarised devices and Varicap and Varactor diodes.

A high quality movement complete with bright red pointer, antiparallax scale mirror and clear markings, help to guarantee the ease of reading, accuracy and repeatability. Component values up to $3 \mu\text{F}$ are read in conjunction with a green illuminated indicator (overflow) which clearly shows when the value of the component under test is too high and it requires a higher range.

For values above $3 \mu\text{F}$ a system of timing the interval between flashes of an LED provide direct indication of capacitance value.

market

Powerhouse microcomputer.

Powerhouse Microprocessors Ltd. of Hemel Hempstead has been formed as a new company to manufacture a West German designed microcomputer, called the Powerhouse 2.

The Z80 based Powerhouse 2 packs 48 k byte of memory, a 5 inch VDU and a 53 key keyboard into a good looking and compact (11 x 17 x 7 in., 14 lb; 280 x 431 x 178 mm, 6.4 kg) housing. Facilities include BOS, DOS, serial interfaces, flexible screen

logic (6-96 characters, 1-27 lines) and compatibility with all standard computers and terminals. The Powerhouse 2 is capable of controlling three Powerhouse mini floppy discs with a total capacity of 1 M bytes.

Options include: 14 k of BASIC in EPROM, IEEE 488 interface, true XY graphics and integral mini cassettes drive (40 k byte).

Applications include: real time process control, desk top computer for scientific and engineering calculations, commercial systems, automation of programmable laboratory instruments including cal-

Miniature 550 MHz frequency counter

The MAX 550 from Continental Specialities Corporation is a high performance 550 MHz frequency counter featuring fully automatic operation with a six digit display and crystal-controlled timebase. About the size of a pocket calculator, it has a guaranteed measurement range from 1000 Hz to 550 MHz using LSI techniques. Signal levels down to 250 mV can be measured with a 3 ppm accuracy. Fully portable with a battery life of up to 8 hours, typical applications include audio, RF, digital, video, and ultrasonic tests and checking. Size is 2 x 6 x 1.5 inches and a full range of accessories are available.

Continental Specialities Corporation,
Shire Hill Industrial Estate,
Essex, CB11 3AQ,
Telephone: (0799) 21682

(1219 M)

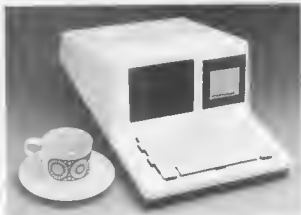

culations performed on data received and stored.

H.G. King,
Powerhouse Microprocessors Ltd.,
5-7 Alexandra Road,
Hemel Hempstead,
Herts, HP2 5BS,
Tel: (0442) 48422

market

100 W (RMS) MOSFET Power amplifier module

Ambit's PA100 uses complementary MOSFET output stages to achieve a uniquely fast and accurate DC amplifier that is suited to servo and audio amplification applications at power levels up to 100 watts RMS.

The use of power MOSFETs enables far simpler drive circuitry than with conventional bipolar stages, whilst at the same time offering power bandwidths up to 300 kHz plus, and harmonic distortion of less than 0.01% in the audio range.

Power Mosfets also mean far greater reliability through their inherent freedom from thermal runaway and secondary breakdown, as well as being suitable to drive types of load that bipolar amplifiers regards as potentially hazardous (i.e. reactive etc.).

The power devices are mounted at the board end on a right angle aluminium bracket, to enable easy mounting onto a suitable heatsink (not illustrated).

Ambit International,
2 Gresham Road,
Brentwood, Essex,
Telephone: (0227) 227050.

(1220 M)



(1232 M)

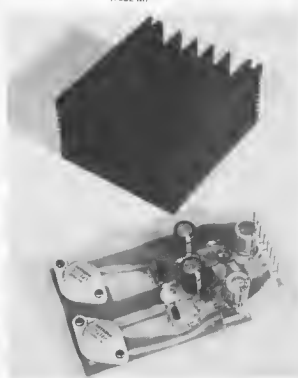

market



Pocket-sized digital thermometer

The new Wahl Digital RTD-Platinum Heat Prober thermometer is a pocket-sized high accuracy thermometer for instant digital readings to 0.1°C for surfaces, liquids, powders and gases. The Digital Heat-Prober system



features a selection of 15 interchangeable RTD-platinum probes for every type of plant, processing or laboratory application over temperature ranges of -50°C to 500°C.

Large, easy to read LED display reads to 0.1°C. Accuracy of ± 0.5% ± 1 digit. Repeatability of ± 0.2%. Built-in rechargeable bat-



tery or can be fine operated, Temperature changes are updated three times per second. The low

mass platinum resistance probes are constructed for fast, accurate measurements and are system calibrated.

Wahl International Ltd.,
BEAM Communications Ltd.,
117 Piccadilly, London W1V 9FJ,
Telephone: 01-4913502 (1225 M)

Mechanical IF filters

TOKO introduce the world's smallest mechanical IF filters for frequencies in the range 450 to 480 kHz.

The basic mechanical element is available either individually, the CFM2 series, or with integral input, and input/out matching IF transformers—known as CFMA and CFMO types respectively. The main advantages of these filters over conventional ceramic and crystal filters is the low cost and size required to achieve equivalent shape factor responses.

The CFMA and CFMO series also maintain an excellent skirt response by taking advantage of the IFT matching to keep the stopband below -70 dB. Priced at less than £1 for all types, TOKO CFM filters are available with a wide range of matching transformers, in bandwidths ranging from 4 kHz to 10 kHz, with stock centre frequencies of 455 kHz.

Ambit International,
2 Gresham Road,
Brentwood, Essex,
Telephone: (0277) 227050

(11229 M)

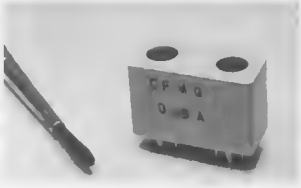

MOVING?

• Add your magazine label
• end name and new address
• below. Mail to -
• ELEKTOR PUBLISHERS LTD.,
• ELEKTOR HOUSE,
• 10 LONGPORT,
• CANTERBURY. CT1 2BR.

• (Block Letters Please)

Surname Initials

Street/Ave./Bldg.

Town

County/province/state

Post code/Zip/area code Country

Please attach magazine label here, list new address below, and mail six to eight weeks before you move. If you are receiving duplicate copies of ELEKTOR, please send both labels. Or if you have a question about your subscription attach label here and clip this form to your letter.



Elektor book service

The following books are available direct from the publishers, Elektor Publishers Ltd

BOOK 75

A selection of some of the most interesting and popular construction projects that were originally published in Elektor magazine issues 1 to 8. 30 projects are contained in this book, plus a "DATA" section which includes a chart of pin connections and performance for common-anode LED displays, valuable information on MOS and TTL-ICs, opamps, transistors and our turn-tup-dup-code system for transistors and diodes. With over 100 pages, the wide variety of projects in this stimulates the professional designer to up-date his knowledge and even the beginning amateur should be able to build most of the projects.

price £3.00 (post & pack 30p extra) USA & Canada \$6.50 (sent by Airmail)



DIGIBOOK

This brand new book from Elektor, provides a simple step-by-step introduction to the basic theory and application of digital electronics. Written in Elektor's typical style, there is no need to memorise dry, abstract formulae, instead you will find clear explanations of the fundamentals of digital circuitry, backed up by experiments designed to reinforce this newly acquired knowledge. For this reason **DIGIBOOK** is accompanied by an experimenter's printed circuit board which will facilitate practical circuit construction.

price £4.50 (DIGIBOOK PLUS PCB) post & pack 25p extra USA & Canada \$9.50

When ordering any of these books please use the Elektor readers service order form in this issue.

When ordering any of these books please use the Elektor readers service order form in this issue.

Elektor Publishers Ltd., Elektor House, 10 Longport, Canterbury, Kent CT1 1PE

Fotolak POSITIVE LIGHT SENSITIVE AEROSOL LACQUER

Enables YOU to produce perfect printed circuits in minutes Method Spray cleaned board with lacquer. When dry, place positive master of required circuit on now sensitized. Expose to daylight, develop and etch. Any number of exact copies can of course be made from one master. Widely used in industry for prototype work.

FOTOLAK	£7.00	Pre-coated	1 1/6	Fibre glass	Not 1
Developer	30	204mm x 114mm			£1.50
1 mm Chloride	50	204mm x 228mm			£3.00
		408mm x 228mm			£5.00
		36 mm x 305mm			£3.00

Plain Copper clad 1 mm thickness	Single size 1	Double size 1
Acrylic 2.00mm thick 54 fl.	£2.50	£7.25
Acrylic 1.00mm thick 54 fl.	£1.50	£1.75
Clear Acrylic Sheet for making master		1.20

Postage & Packing £5.00 per order. VAT 15% on total

G.F. MILWARD ELECTRONIC COMPONENTS LTD
369 Alum Rock Road, Birmingham B8 3DR.
Telephone: 021-327-2339

ADVERTISERS INDEX

AJD Supplies	UK11
Ambit International	UK16
Audio Electronics	UK12
Catronics	UK28
Classified	UK29
Chromasonics	UK26
Codespeed	UK26
Contour Electronics (Comtech)	UK9
Cossor Electronics	UK14
David George Sales	UK14
De Boer Elektronika	UK7
Elacom	UK16
Elektor	UK14, 15, 17, 18, 22 23, 24, 25, 26, 28, 30
Ferranti	UK25
Fraser-Manning	UK13
G.F. Milward	UK30
G.M.T. Electronics	UK19, 20, 21
Greenbank Electronics	UK16
Greenweld Electronics	UK12
Keytronics	UK25
Maplin	UK2
Marshall's	UK10
Monolith Electronics	UK27
Phononics	UK27
Ramar Electronics	UK27
T. Powell	UK32
Technomatic	UK31
Vero Electronics	UK18
Watford Electronics	UK8, 9